

# **AMBO UNIVERSITY INSTITUTE OF TECHNOLOGY**

## **DEPARTMENT OF URBAN LAND USE PLANNING**

**Course name : surveying and Photogrammetry-II**

**By Achalu Kedida**

# COURSE OUTLINE

**Chapter1:** Surveying control points

**Chapter2:** Topographic mapping and contour

**Chapter3:** Data collection by using total station

**Chapter4:** Analyzing ground surveying by using GIS

**Chapter5:** Photogrammetric data and analysis

# CHAPTER ONE

## SURVEYING CONTROL POINTS

# OUTLINE

- General overview of surveying and photogrammetry
- Surveying control points
- Methods of establishing control points
- Triangulation
- Objectives of Triangulation
- Triangulation layout

# WHAT IS SURVEYING ?

- surveying is the science, technology and an art of determining the **Relative position of various points** above, on or below the surface of the earth.
- Interchangeably surveying called Geomatics which means The **mathematics of earth**; the science of collection, analysis, and interpretation of data, especially instrumental data, relating to the earth surface.
- Surveying involves the measurements of distances, angles and direction.
- In addition surveying includes the process of converting the measurements in to positional information such as **maps** and **coordinates**.

# CLASSIFICATION OF SURVEYING

## ❑ Based on its application

- Route surveying
- Property survey
- Control Survey
- Topographic Survey
- Construction survey

## ❑ Based on instruments used

- Chain surveying
- Compass surveying
- Leveling surveys
- Theodolite surveys
- Tachometric Surveys
- EDM Surveys
- **Photogrammetric Surveying**

# WHAT IS PHOTOGRAMMETRY ?

- The art, science, and technology of obtaining reliable information about physical objects and the environment through the processes of recording, measuring, and interpreting photographic images and patterns of electromagnetic radiant energy and other phenomena.
- The art, science and technology of extracting meaningful information about objects and phenomenon from imagery, either in analog or digital form, and other spatial measurement systems like laser and radar data.

# USES OF PHOTOGRAMMETRY

## ■ Land surveying

Aerial photo used as base maps for relocating existing property boundaries. through stereoscopic viewing, the area can be studied in three dimensions.

## ■ Highway planning and designing

High altitude photos or satellite images are used to assist in area and corridor studies and to select the best routes.

## ■ preparation of different maps

tax maps, soil maps, forest maps, geologic maps and **maps for city and regional planning and zoning.**

## ■ In traffic management and traffic accident investigations



# ADVANTAGES OF PHOTOGRAMMETRY

- ❑ It is **ideal technology** when measuring objects such as
  - ✓ Vast region to be mapped
  - ✓ Irregular shapes
  - ✓ When objects are located in area
    - Too hot or cold
    - Too soft
    - Too toxic
    - Too radioactive to touch
    - Too inaccessible to conduct ground survey

# CONT...

- High speed of map generation
- Very precise
- Time effective
- Cost effective
- Based on well established and tested and algorithm
- Less manual effort
- Extraction of geometrical and qualitative information
- Cheaper than terrestrial methods

# CONTROL POINT

- Geographic positions are specified relative to a fixed reference.
- Positions on the globe, for instance, may be specified in terms of angles relative to the center of the Earth, the equator, and the prime meridian.
- Positions in plane coordinate grids are specified as distances from the origin of the coordinate system.
- Elevations are expressed as distances above or below a vertical datum such as mean sea level, or an ellipsoid such as GRS 80, WGS 84, clarck1880.
- Land surveyors measure horizontal positions in geographic or plane coordinate systems relative to previously surveyed positions called control points.

# CONT...

- A **control point** is a point on the ground or any permanent structure whose horizontal and vertical location/position is known.
- **Control points** are used as a starting point of all types of surveys.
- The **3D coordinates** (X, Y, Z) of each point to be surveyed can only be determined with respect to **well established reference points**.
- It provides the basis for **positioning structures** in each of the stages of **planning, design and construction**.
- To **set out structures** in all 3D in a correct relative position a number of **control stations** are established in project area.

# TYPES OF CONTROL POINTS

## □ Horizontal control

- Is provided by **two or more** points on the ground and precisely fixed in position by distance and direction.
- is usually established by a traverse.
- The **HD** to salient **points of the structure** can be measured from **horizontal controls**.
- Increasing the number of control station will increase the accuracy of the measurement.

# CONT...

## □ Vertical control

- provided by establishing the **reference bench marks** of known elevation relative to some specific datum.
- The **levels of various points** on the structure are determined from these BM.
- BM may be **master bench mark (M.B.M)** and **temporary bench mark (T.B.M)**
- **M.B.M** is established in project area by **running leveling** from nearby bench mark.

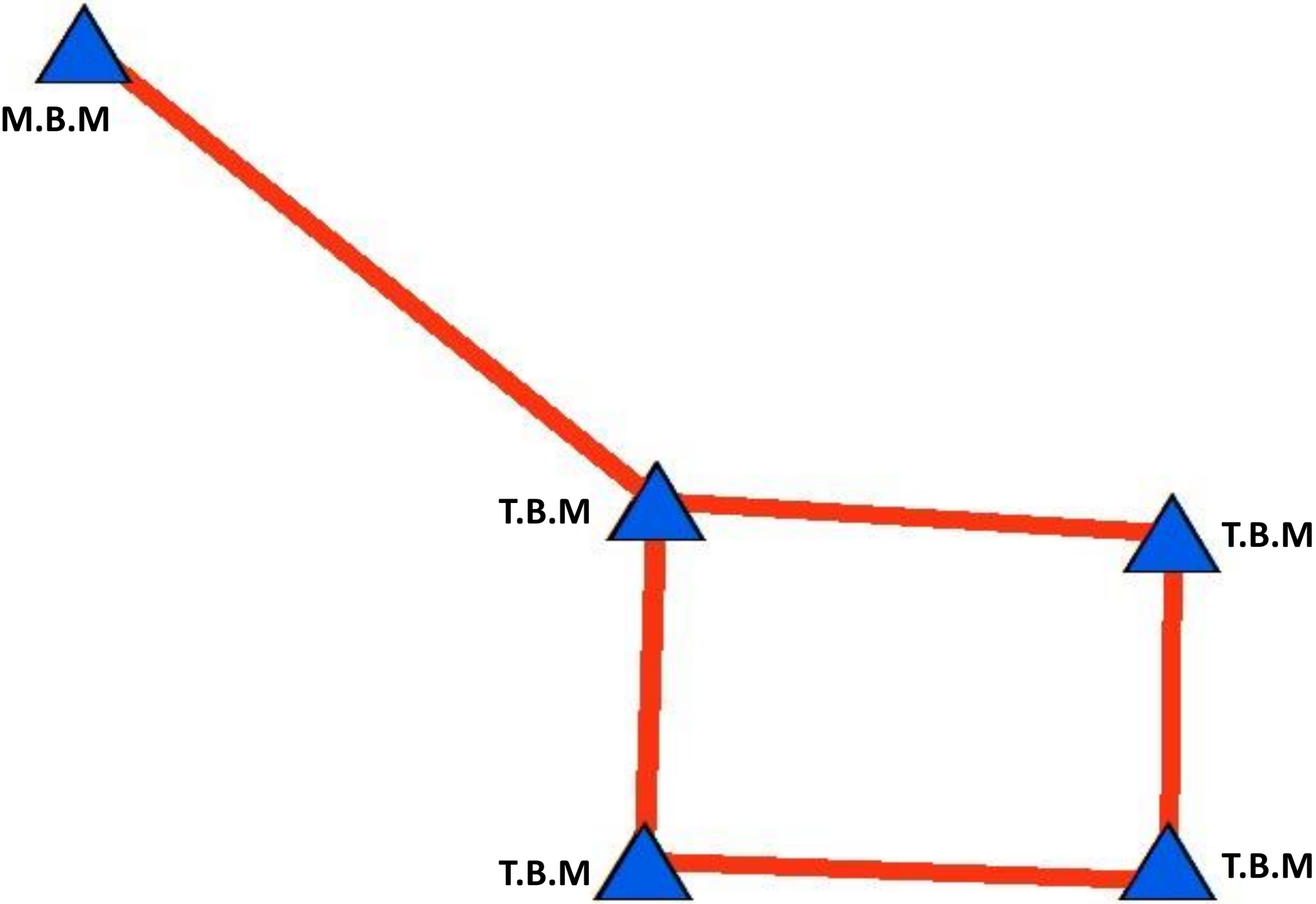

# THE CONTROL POINTS MUST BE

- 1) Convenient for use, that is, located sufficiently close to the item being built so that work is minimized and accuracy enhanced in transferring alignment and grade.
- 2) Far enough from the actual construction to ensure working room for the contractor and to avoid possible destruction of stakes.
- 3) Clearly marked and understood by the contractor in the absence of a surveyor.



# CONT...

- 4) Supplemented by guard stakes to deter removal and referenced to facilitate restoring them. Contracts usually require the owner to pay the cost of setting initial control points and the contractor to replace damaged or removed ones.
- 5) Suitable for securing the accuracy agreed on for construction layout.

# CONT...

- The control station are to be so constructed and protected they are not disturbed during course of construction.
- Control station required for long duration should be established in concrete or masonry pillars of 600 \* 600mm size and metal plates set in on its top and the station position is punched on these metal plates. fig (a)

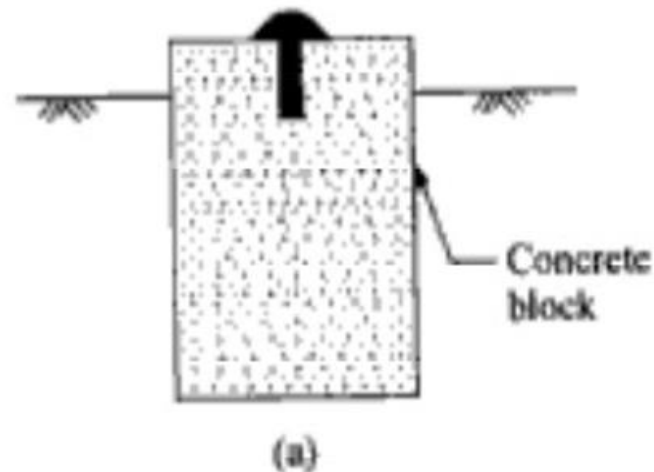

# CONT...

- Control station required for short period may be in form of wooden pegs 50\*50\*300mm driven directly in to ground fig (b)

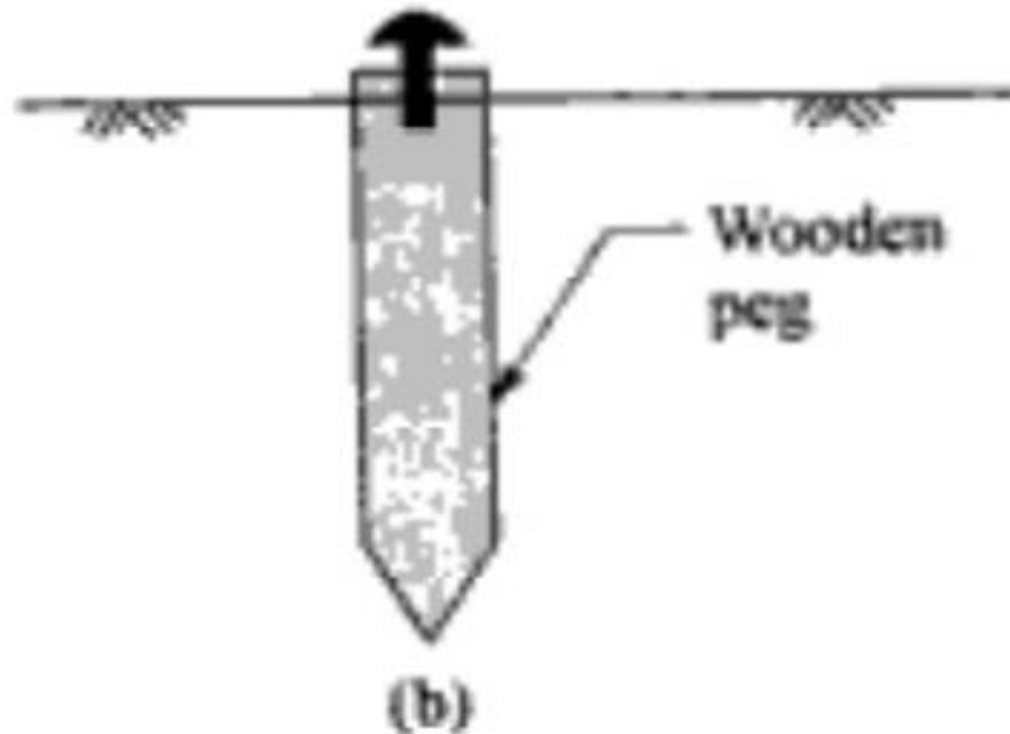

# METHODS OF ESTABLISHING CONTROL POINT

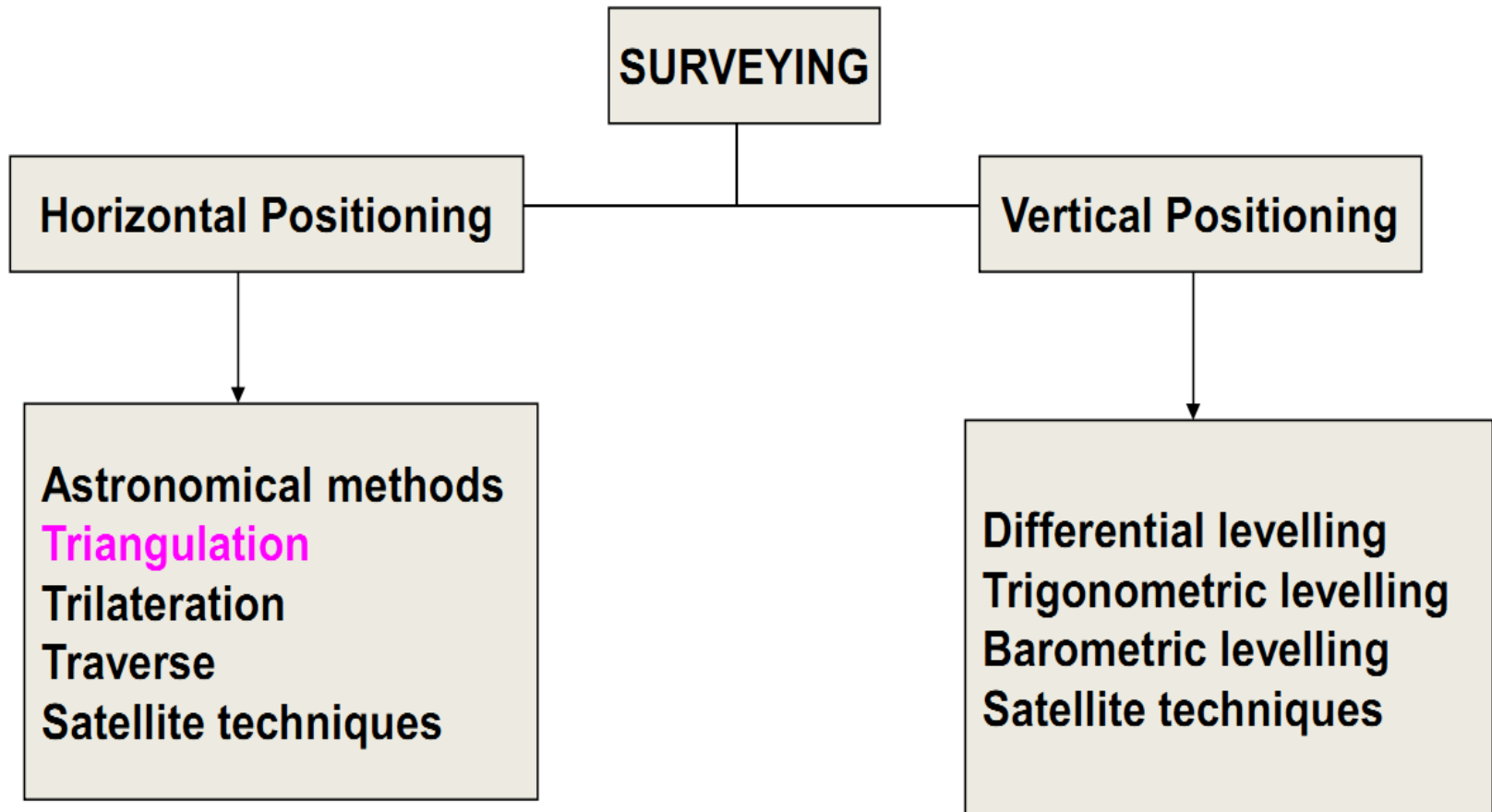

# TRIANGULATION

- Utilizes geometric figures composed of triangles
- Method of determining distance based on the principles of geometry.
- Horizontal angles and Length of base lines are measured by using surveying instrument.
- By using angles and base line lengths, triangles are solved trigonometrically and the positions of stations (vertices) are calculated.

# CONT...

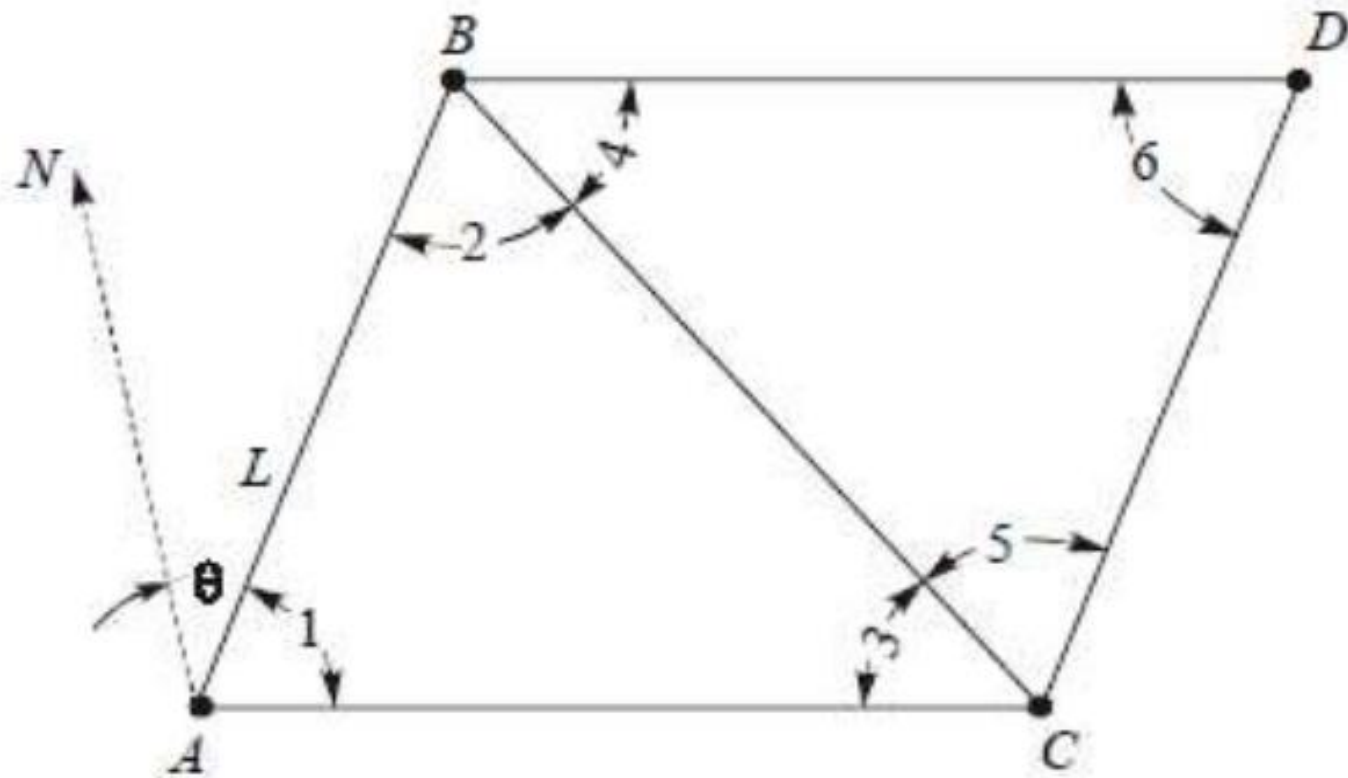

# CONT...

## Important Formulas in Trigonometry

Sine Law:

$$\frac{a}{\sin \alpha} = \frac{b}{\sin \beta} = \frac{c}{\sin \theta}$$

Cosine

$$c^2 = a^2 + b^2 - 2ab \cos \theta$$

$$b^2 = a^2 + c^2 - 2ac \cos \beta$$

$$a^2 = c^2 + b^2 - 2bc \cos \alpha$$

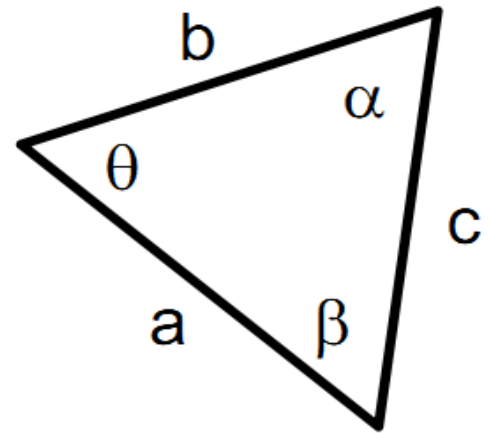

# OBJECTIVE OF TRIANGULATION

- To establish accurate control for plane and geodetic surveys of large areas
- To establish accurate control points for photogrammetric surveys of large areas.
- To determine accurate locations of points in engineering works
- To assist in the determination of the size and shape of the earth by making observations for latitude, longitude and gravity



# EXAMPLE

Given the polygon shown in Figure 1 which is a part of a triangulation system. The straight lines  $BE$  and  $AD$  are equal in length and point  $O$  is located at their midpoint. The azimuth of line  $BC$  is 255 degrees. If the angle  $\theta = 70$  degrees and length  $AB$  is equal to 500 meters, determine the length of  $CD$ . Note that  $\alpha = 90$  degrees.

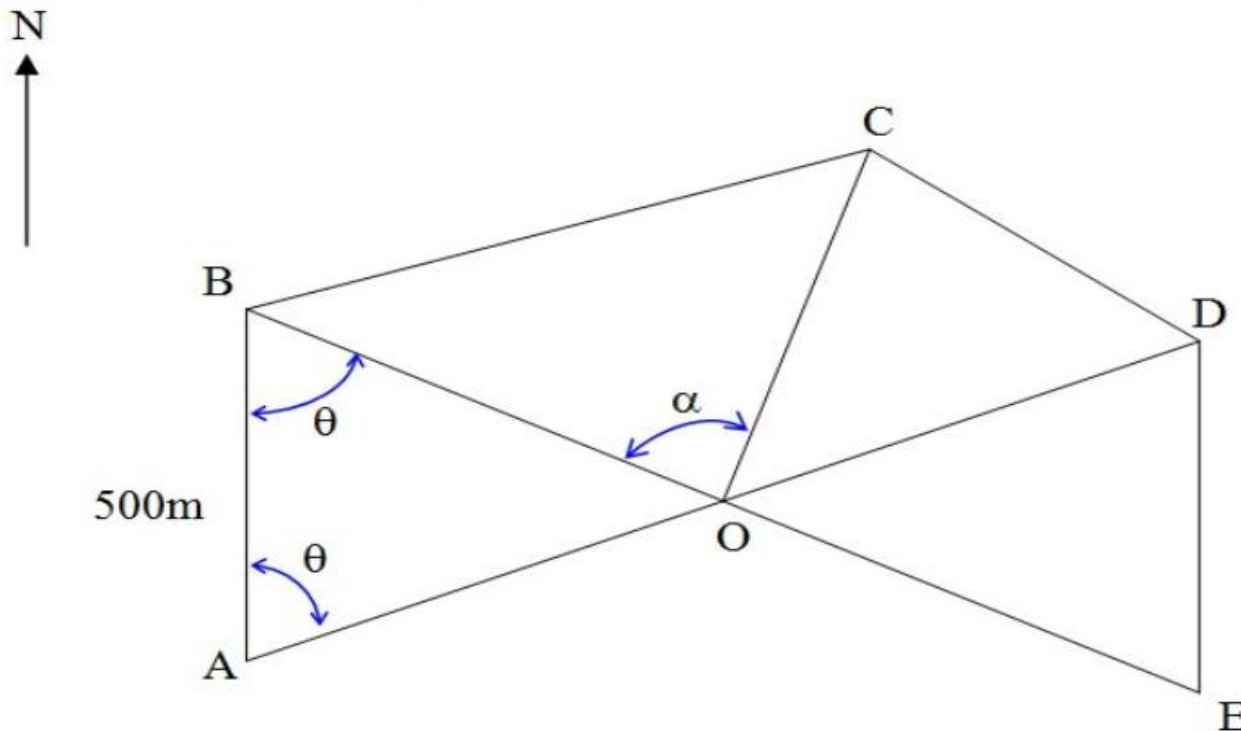

# SOLUTION

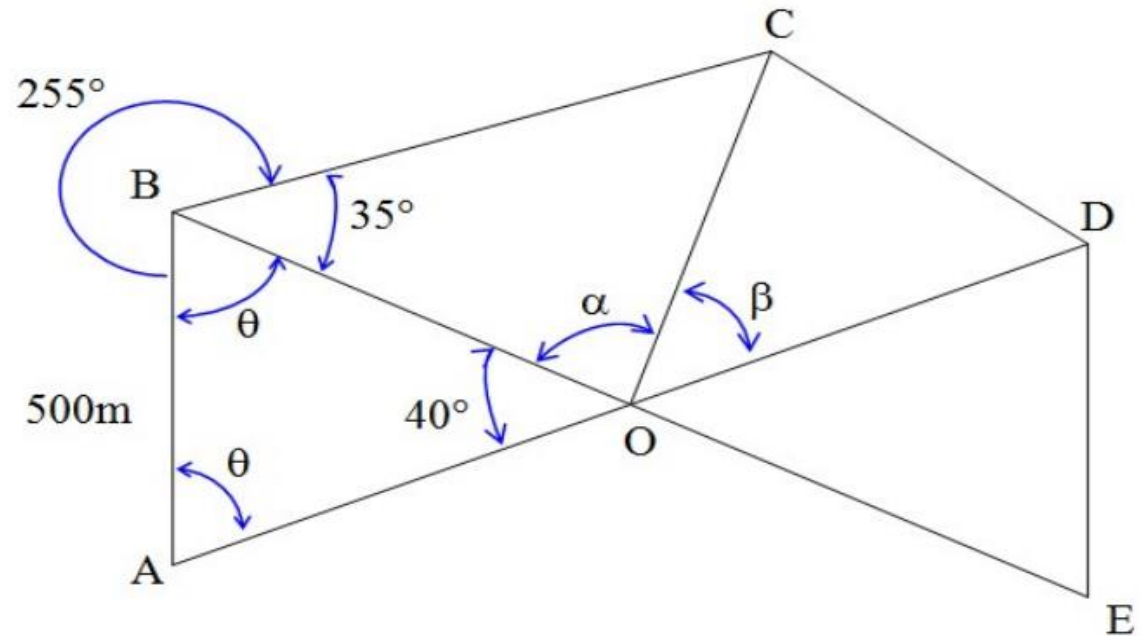

Consider  $\Delta ABO$ ,

$$\frac{500}{\sin 40^\circ} = \frac{BO}{\sin 70^\circ}; \text{ Therefore } BO = 730.951 \text{ m}$$

Since BE and AD are equal in length and point O are located in their midpoints,  
 $BE = AD = 2 BO = 2(730.951) = 1,461.902 \text{ m}$

# SOLUTION

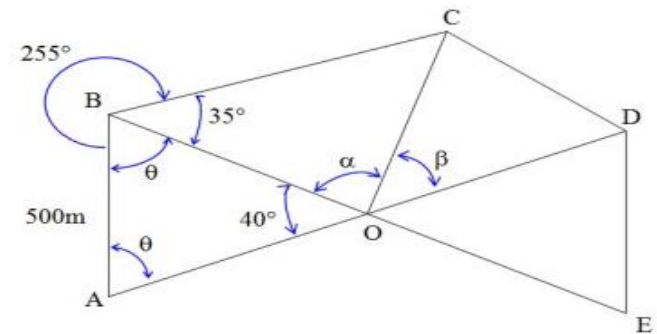

$$BO = OD = AO = EO = 730.951 \text{ m}$$

Consider  $\Delta BOC$ ,

$$OC = 730.951 \tan 35^\circ = 511.817 \text{ m}$$

Consider  $\Delta ODC$ , and by inspection,  $\beta = 50^\circ$

And by cosine law,

$$DC^2 = 511.817^2 + 730.951^2 - 2(511.817)(730.951) \cos 50^\circ$$

$$DC = 561.512 \text{ m}$$

# CALCULATION OF AZIMUTHS AND COORDINATES

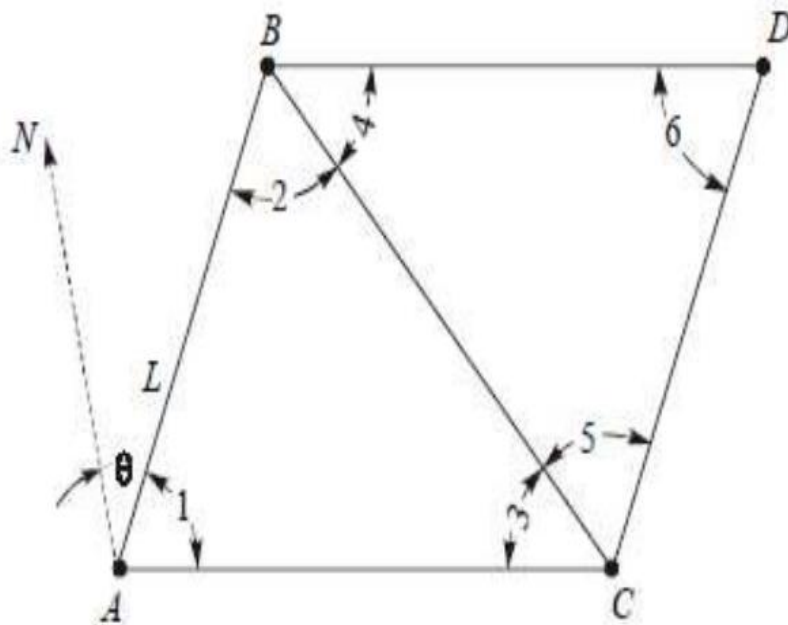

Azimuth of  $AB = \theta = \theta_{AB}$

Azimuth of  $AC = \theta + \angle 1 = \theta_{AC}$

Azimuth of  $BC = \theta + 180^\circ - \angle 2 = \theta_{BC}$

Azimuth of  $BD = \theta + 180^\circ - (\angle 2 + \angle 4) = \theta_{BD}$

Azimuth of  $CD = \theta - \angle 2 + \angle 5 = \theta_{CD}$

Departure of  $AB = l_{AB} \sin \theta_{AB} = D_{AB}$

Latitude of  $AC = l_{AC} \cos \theta_{AC} = L_{AC}$

Departure of  $AC = l_{AC} \sin \theta_{AC} = D_{AC}$

Latitude of  $BD = l_{BD} \cos \theta_{BD} = L_{BD}$

Departure of  $BD = l_{BD} \sin \theta_{BD} = L_{BD}$

# TRIANGULATION LAYOUTS

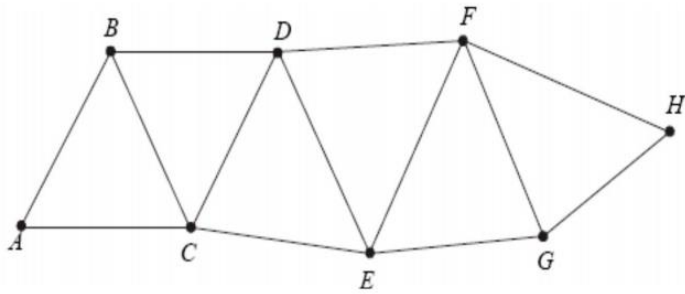

Single chain of triangles

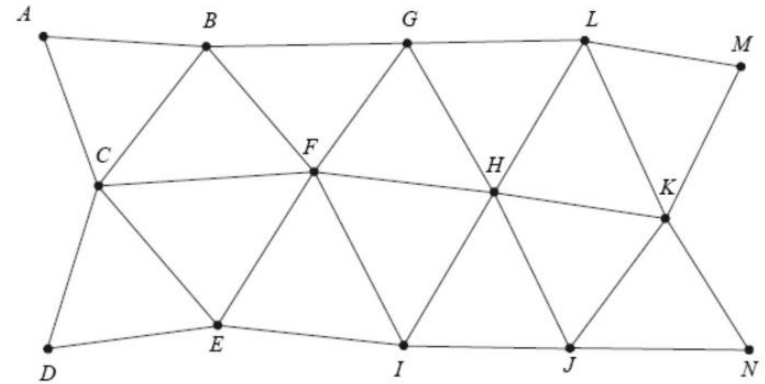

Double chain of triangles

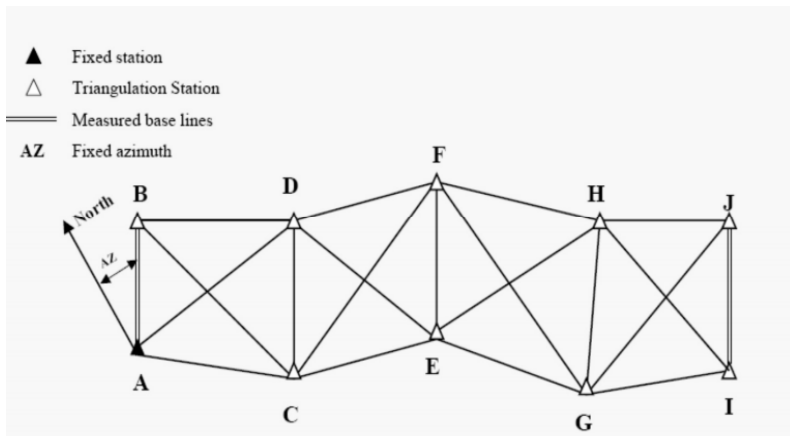

Braced quadrilaterals

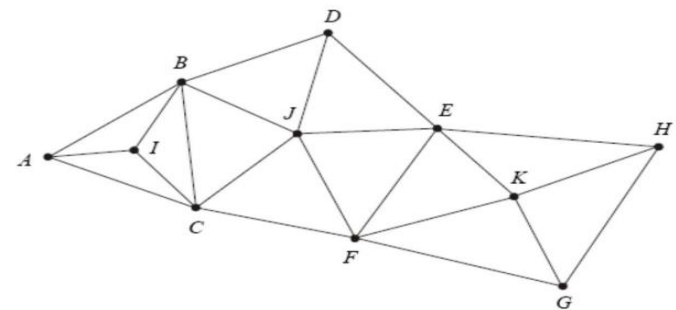

Centered triangles and polygons

# TRIANGULATION LAYOUTS FOR LARGE COUNTRIES

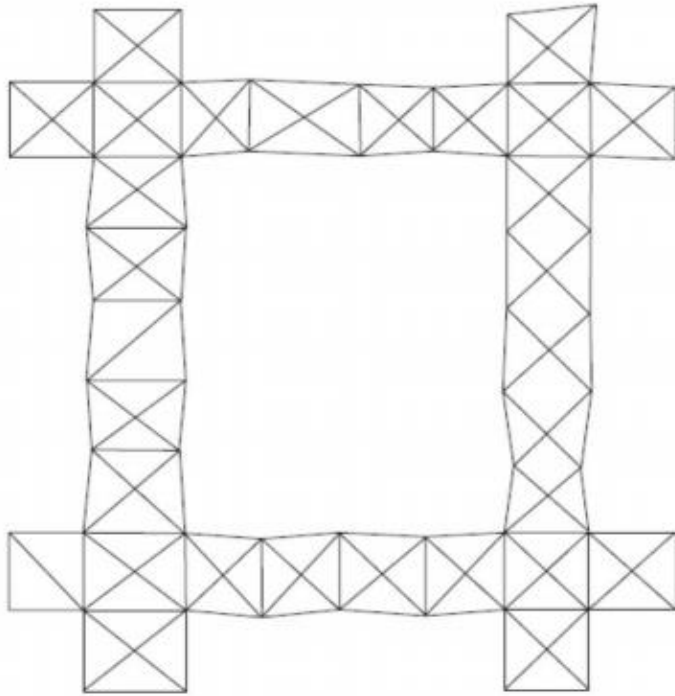

GRID IRON SYSTEM

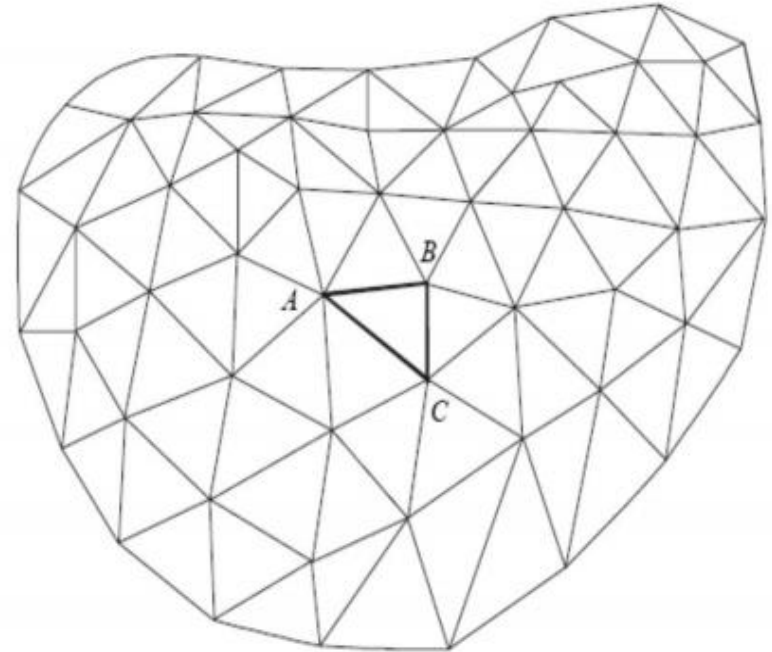

CENTRAL SYSTEM

# CONT...

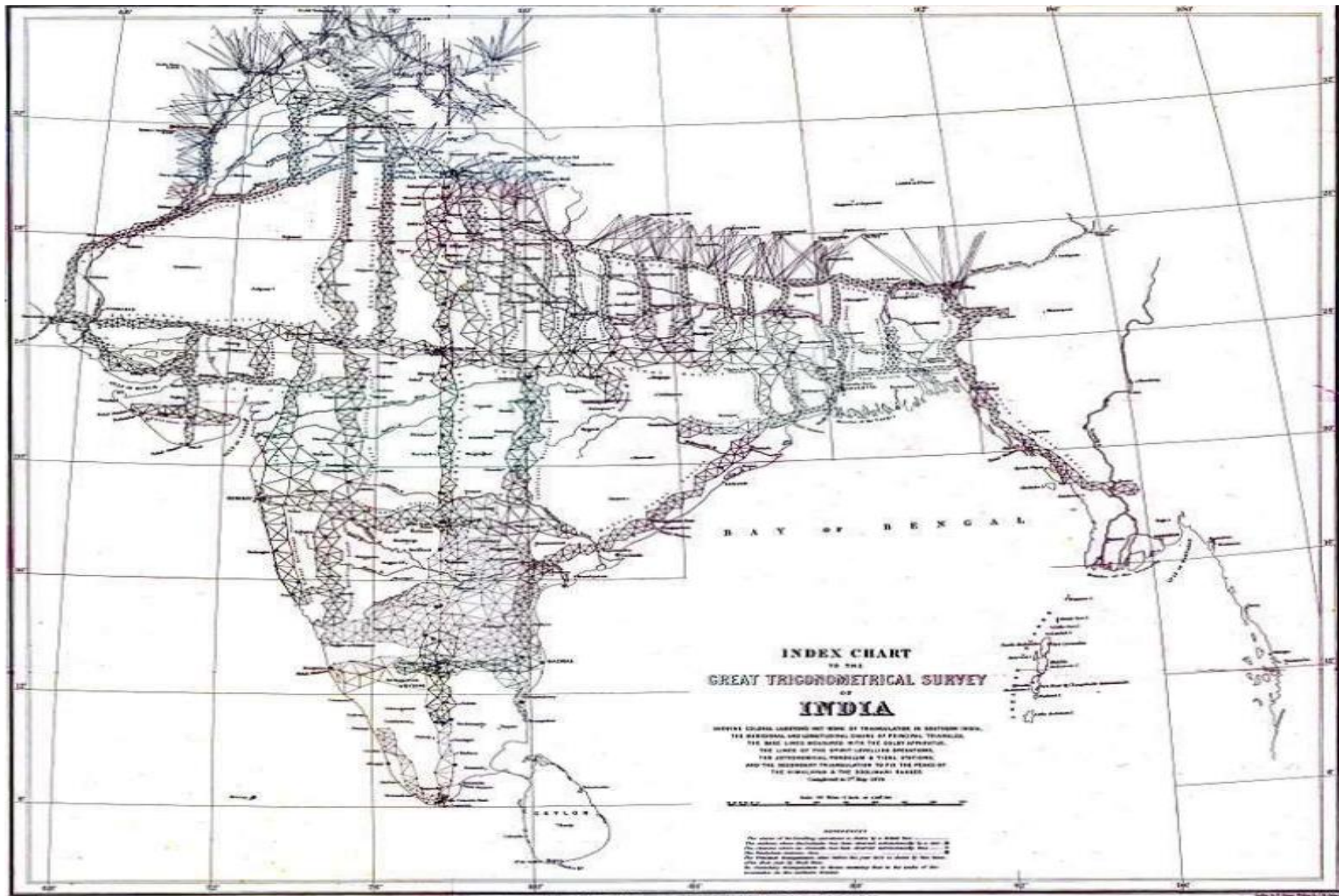

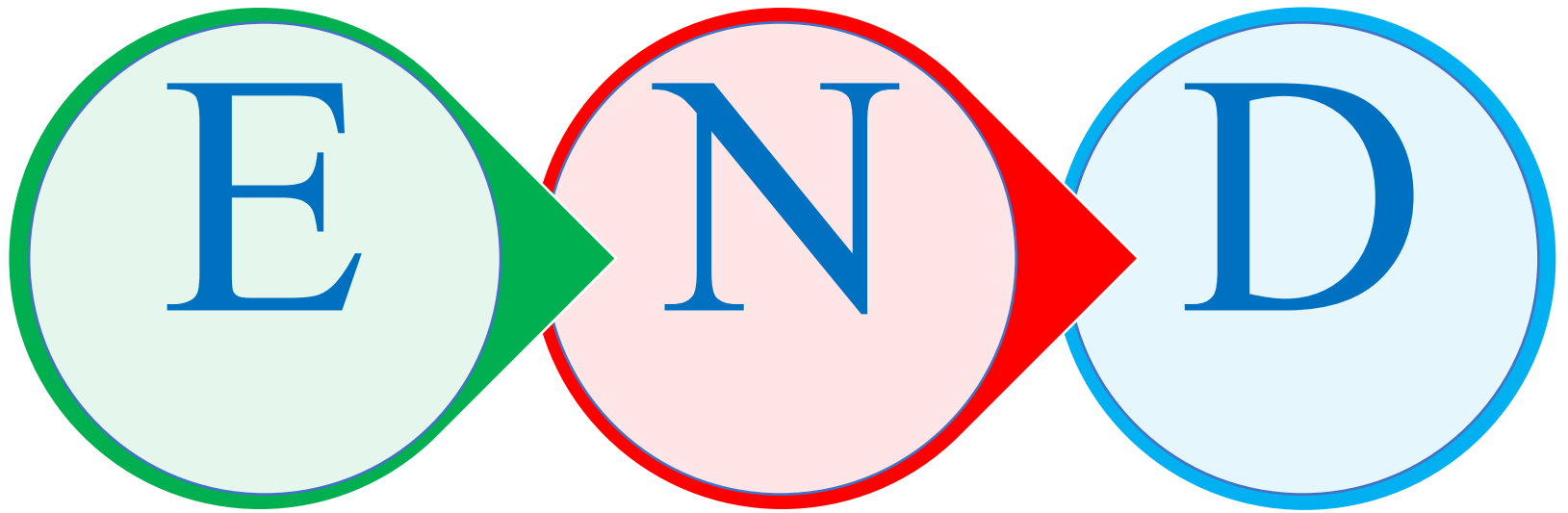



# CHAPTER TWO

## Topographic Mapping and Contour

# What is a Topography?

**Topography:** The relief features or configuration of an area.



# Topographic map

- ❖ A topographic map is a detailed and accurate illustration of man-made and natural features on the ground such as roads, railways, power transmission lines, contours, elevations, rivers, lakes and geographical names.
- ❖ The topographic map is a two-dimensional representation of the Earth's three-dimensional landscape.

# What information is on a topographic map?

- ❖ Topographic maps identify numerous ground features, which can be grouped into the following categories:
  - ✓ **Relief:** mountains, valleys, slopes, depressions as defined by contours
  - ✓ **Hydrography:** lakes, rivers, streams, swamps, rapids, falls
  - ✓ **Vegetation:** wooded areas
  - ✓ **Transportation:** roads, trails, railways, bridges, airports/airfield, seaplane anchorages

# CONT...

- ✓ **Culture:** buildings, urban development, power transmission line, pipelines, towers
- ✓ **Boundaries:** international, provincial/territorial, administrative, recreational, geographical
- ✓ **Toponymy:** place names, water feature names, landform names, boundary names

# Is a topographic map similar to a road map?

- ❖ Both types of maps show roads, water features, cities and parks, but that's where the similarity ends.
- ❖ Topographic maps show contours, elevation, forest cover, marsh, pipelines, power transmission lines, buildings and various types of boundary lines such as international, provincial and administrative, and many others.

# CONT...

- ❖ Topographic maps show a universal transverse mercator (UTM) grid, allowing the user to determine precise positions. In basic terms, topographic maps allow the user to see a three-dimensional landscape on a two-dimensional surface.

# Contour Lines

- ❖ Contour lines, or isohypses, connect points of equal elevation.
- ❖ Contour lines connect a series of points of equal elevation and are used to illustrate relief on a map.

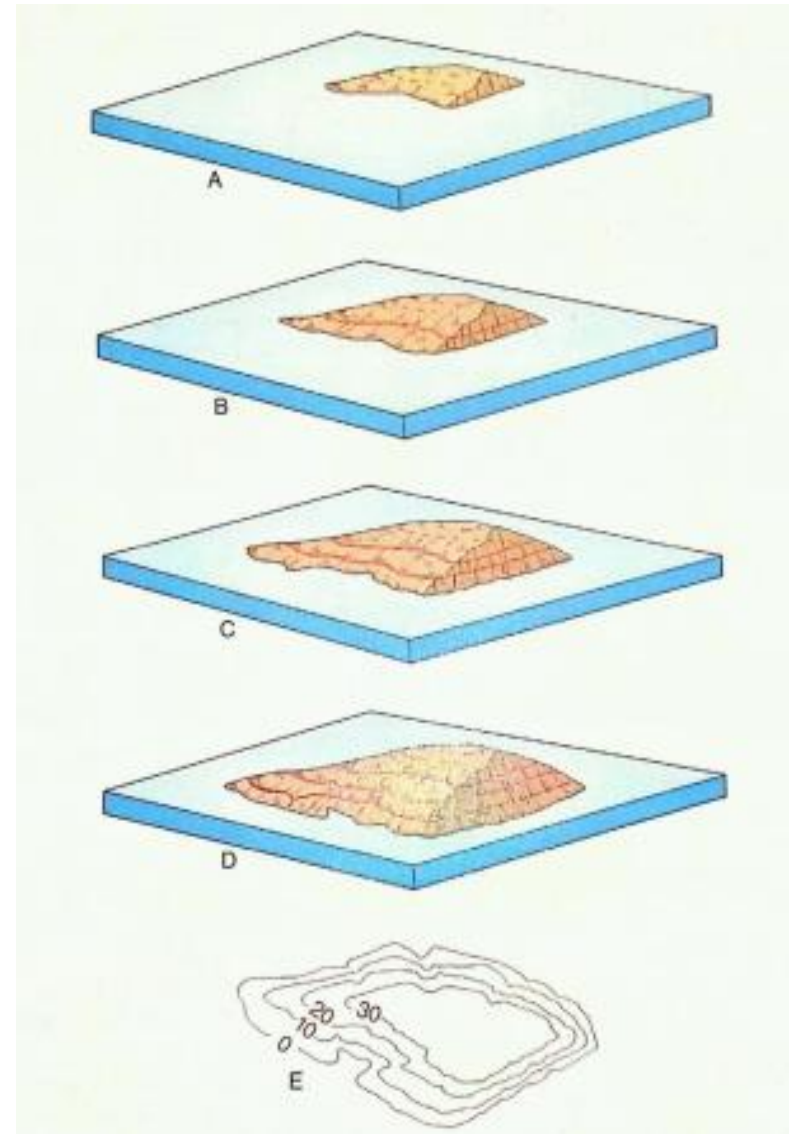



# CONT...

- ❖ They show the height of ground above mean sea level (MSL) either in metres or feet, and can be drawn at any desired interval.
- ❖ For example, numerous contour lines that are close to one another indicate **hilly** or **mountainous terrain**; when further apart they indicate a **gentler slope**; and when far apart they indicate **flat terrain**.

# Contour Map Characteristics

- **Index Contours** are bold or thicker lines that appear at every fifth contour line.
- Bolded to facilitate reading of the map
- Often occur in intervals of five contour lines.

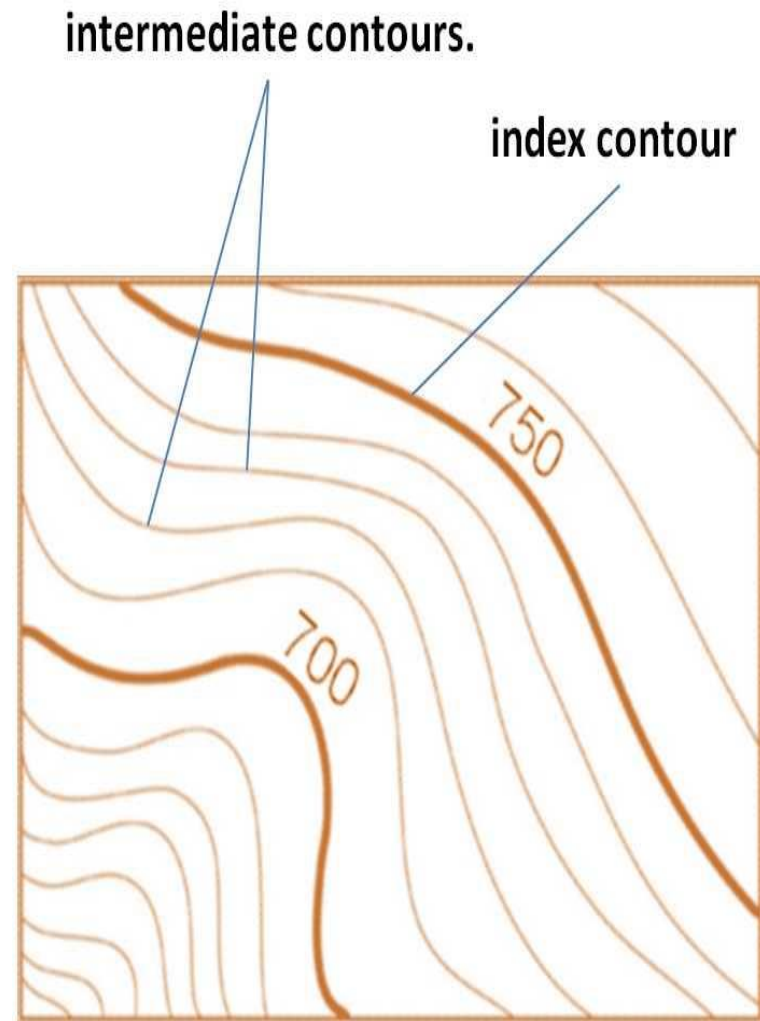

# CONT...

- **Contour Interval:** is the vertical distance or difference in elevation between **contour lines**
- **Concurrency:** Contour lines never cross or divide.

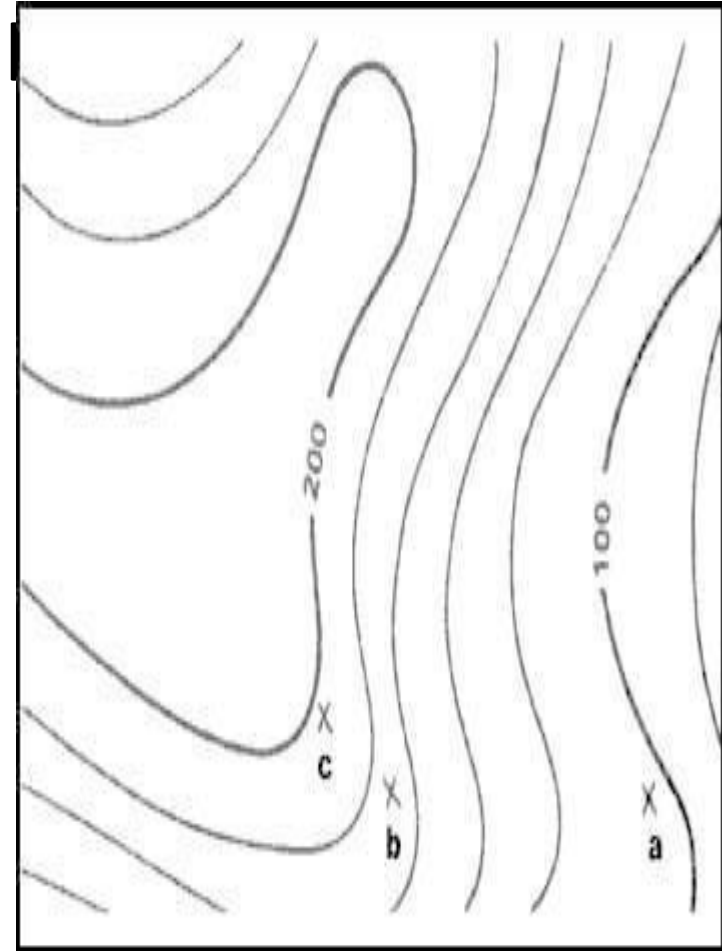

# Type of contours

- **Steep slope:** Contours are spaced so closer together
- **Gradual slope/ Gentle Slope:** Contours that are not steep, not plain

Gradual Slope

Steep Slope



# CONT...

- **Valleys:** Lines form a “V” pattern along valleys
- **“Vs” point upstream;** indicating the direction of the stream flow.
- Streams always flow downhill Contours can and do cross streams

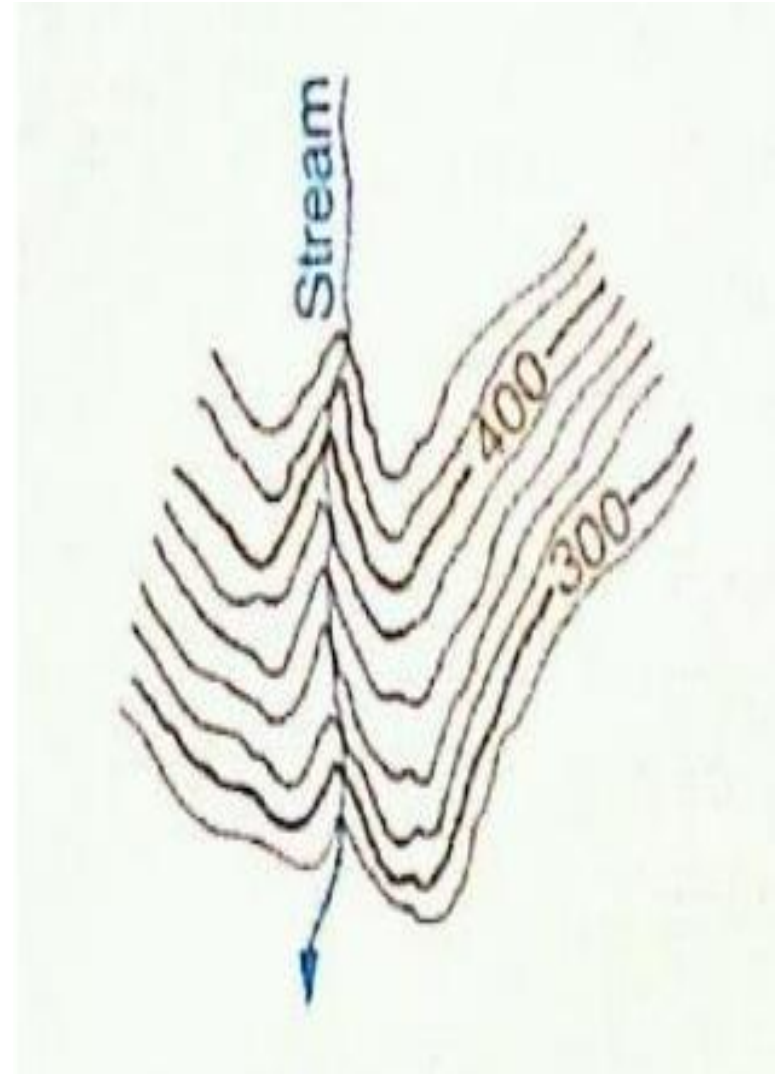

# CONT...

- **Cliffs:** May appear to merge on vertical cliffs, but are stacked.
- **Over Hanging Slope:** Contours seem crossing each other

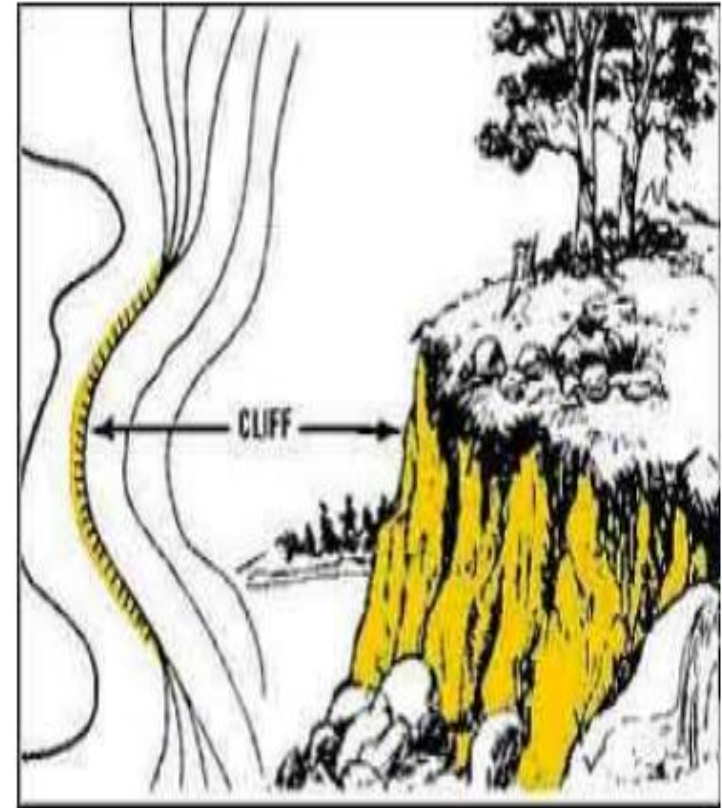

# CONT...

- **Convex Slope:** Contours are closer together towards the lower point

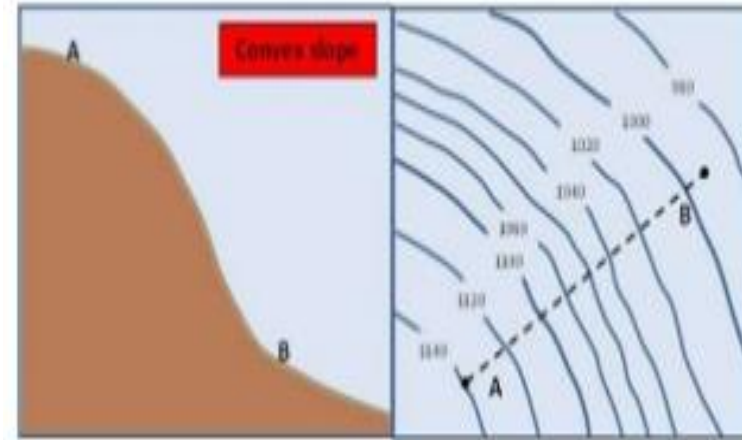

- **Concave Slope:** Contours are closer together towards the higher point

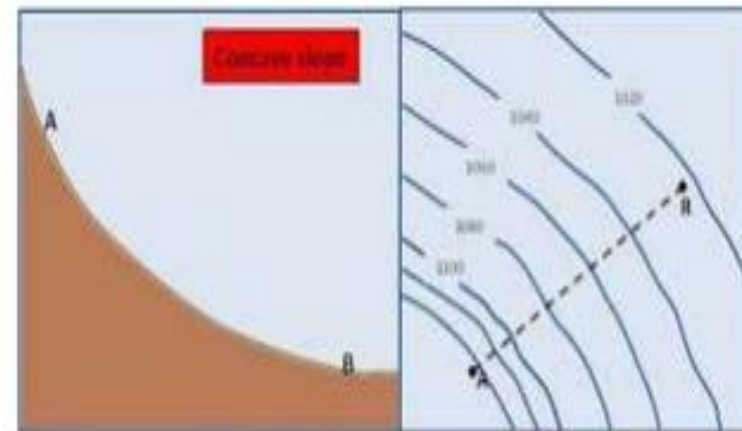

# CONT...

- **Terraced Slope:** Contours become closer together and further apart
- **Even Slope:** Contours are spaced almost at equal distance



shutterstock.com • 1460530343



# CONT...

- **Saddle Slope:** Contours that spaced between two hills or depression between two summits

Ridge with a Saddle

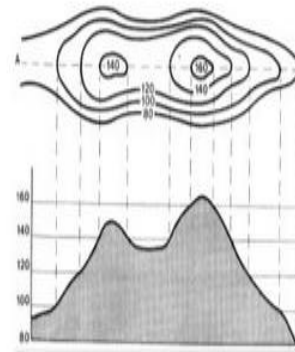

Valleys

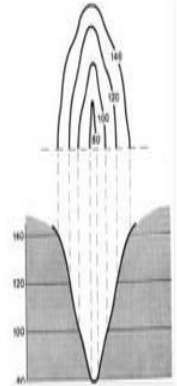

- **Spur Slope:** Contours form an arrow shape towards the lower ground

Spurs with Re-entrant

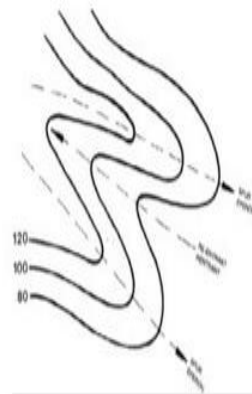

Separate Hills

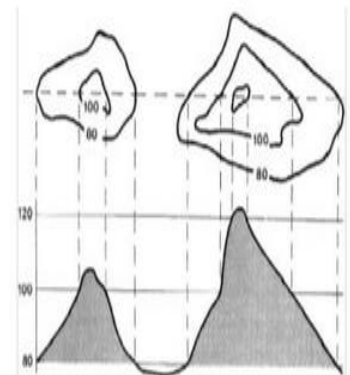

# CONT...

❖ Other geologic features commonly expressed by contour maps include:

- Drumlins
- Sink Holes
- Sand Dunes
- Volcanos
- Dissected Plateaus
- Rolling Hills
- Folds

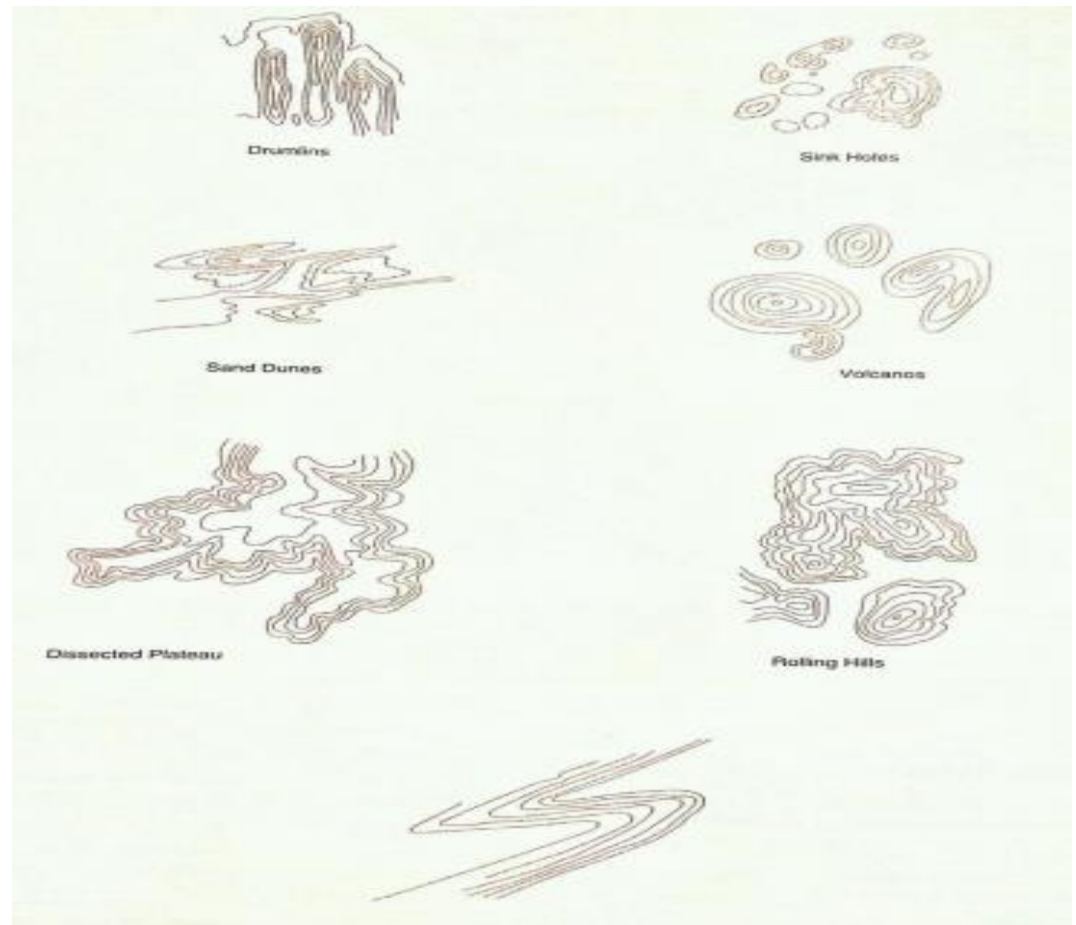

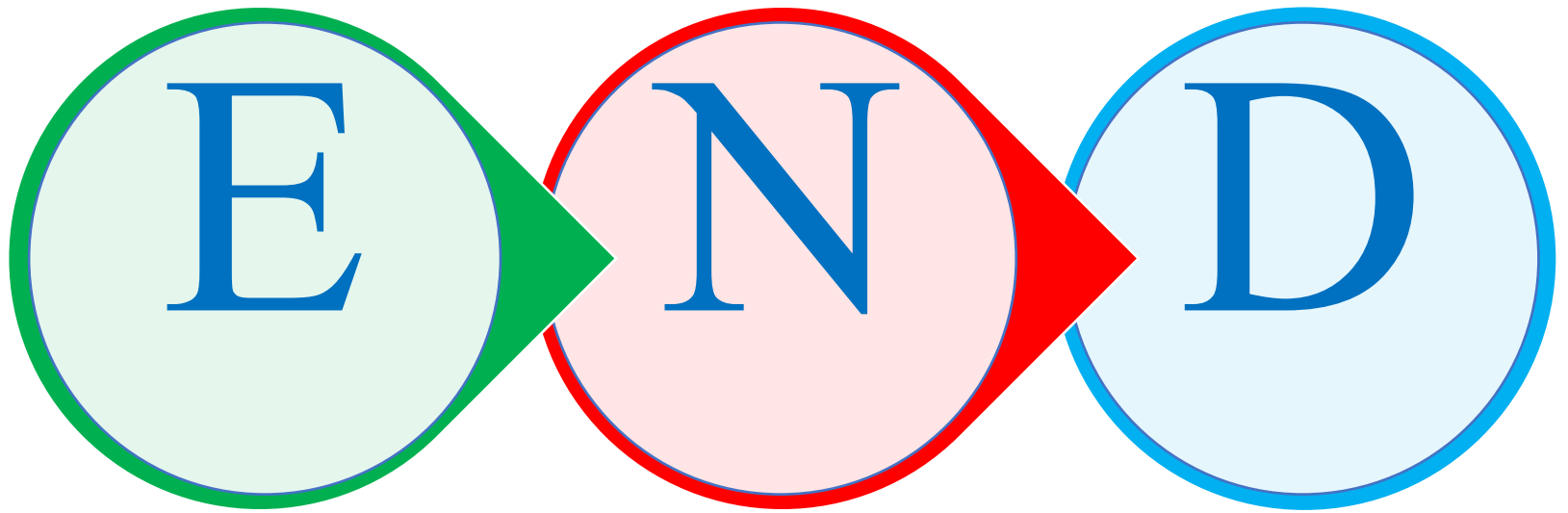

# **CHAPTER THREE**

## **DATA COLLECTION BY USING TOTAL STATION**

# INTRODUCTION

## □ What is data?

- **Data** are characteristics or information, usually numerical, that are collected through observation.
- In a more technical sense, data is a set of values of qualitative or quantitative variables about one or more persons or objects.
- Although the terms "data" and "information" are often used interchangeably, these terms have distinct meanings.
- In some popular publications, data is sometimes said to be transformed into information when it is viewed in context or in post-analysis.

# CONT...

- In academic treatments of the subject, however, data are simply units of information.
- Data is measured, collected and reported, and analyzed, whereupon it can be visualized using graphs, images or other analysis tools.
- Data as a general concept refers to the fact that some existing information or knowledge is represented or coded in some form suitable for better usage or processing.
- Raw data ("unprocessed data") is a collection of numbers or characters before it has been "cleaned" and corrected by researchers or surveyor.

# CONT...

- ❑ **Data collection** is the process of gathering and measuring information on targeted variables in an established system, which then enables one to answer relevant questions and evaluate outcomes.
- ❑ Data collection is a component of research in all fields of study including **physical and social sciences, humanities, and business.**
- ❑ While methods vary by discipline, the emphasis on ensuring accurate and honest collection remains the same.

# CONT...

- ❑ The goal for all data collection is to capture quality evidence that allows analysis to lead to the formulation of convincing and credible answers to the questions that have been posed.
- ❑ Regardless of the field of study or preference for defining data ([quantitative](#) or [qualitative](#)), accurate data collection is essential to maintaining the integrity of research.
- ❑ The selection of appropriate data collection instruments (existing, modified, or newly developed) and clearly delineated instructions for their correct use reduce the likelihood of [errors](#).



# CONT...

- Gathering data can be accomplished through a primary source or a secondary source.
- **primary source:** the researcher is the first person to obtain the data.
- **secondary source:** the researcher obtains the data that has already been collected by other sources, such as data disseminated in a scientific journal.

# Data Collection Methods

- In surveying there are many methods used for data collection, but we select the best method based on the need, type, location and accuracy of data.
- For example, we can use one of the following
  - ✓ Theodolite survey
  - ✓ Photogrammetric survey
  - ✓ Total station survey
- In this chapter we will see data collection by total station.

# Total station

## □ What is a Total Station?

- **Total station** is a surveying equipment combination of Electromagnetic Distance Measuring Instrument and electronic theodolite.
- It is also integrated with microprocessor, electronic data collector and storage system.
- It is an electronic transit theodolite integrated with electronic distance measurement (EDM) to measure **both vertical and horizontal angles** and the **slope distance** from the instrument to a particular point, and an on-board computer to collect data and perform triangulation calculations.

CONT...



# CONT...

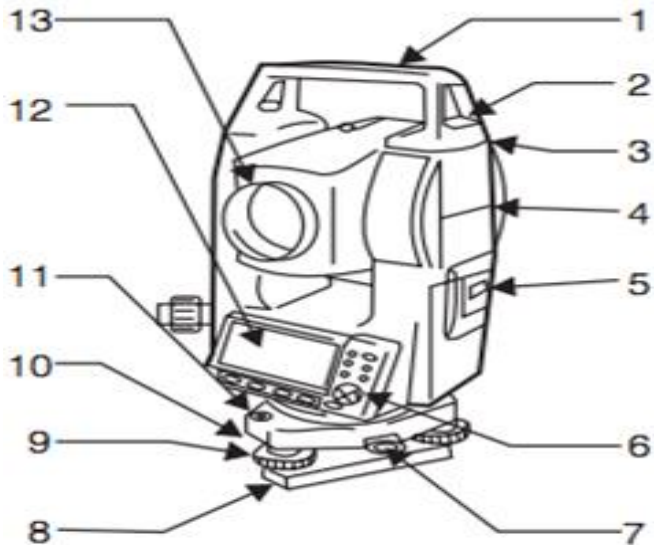

1. Handle
2. Handle securing screw
3. Data input/output terminal (Remove handle to view)
4. Instrument height mark
5. Battery cover
6. Operation panel
7. Tribrach clamp (SET300S/500S/600S: Shifting clamp)
8. Base plate
9. Levelling foot screw
10. Circular level adjusting screws
11. Circular level
12. Display
13. Objective lens

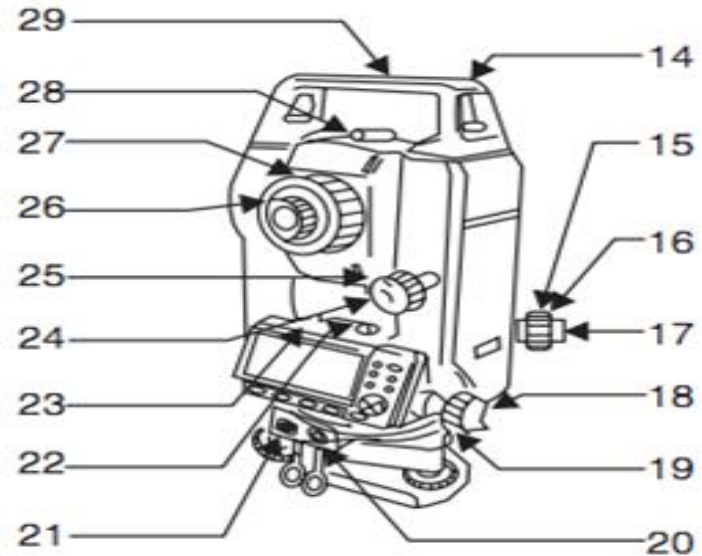

14. Tubular compass slot
15. Optical plummet focussing ring
16. Optical plummet reticle cover
17. Optical plummet eyepiece
18. Horizontal clamp
19. Horizontal fine motion screw
20. Data input/output connector (Besides the operation panel on SET600/600S)
21. External power source connector (Not included on SET600/600S)
22. Plate level
23. Plate level adjusting screw
24. Vertical clamp
25. Vertical fine motion screw
26. Telescope eyepiece
27. Telescope focussing ring
28. Peep sight
29. Instrument center mark

# Function of total station

- **Angle measurement:** Most total station instruments measure angles by means of electro-optical scanning of extremely precise digital bar-codes etched on rotating glass cylinders or discs within the instrument.
- **Distance measurement:** this is accomplished with a modulated infrared carrier signal, generated by a small solid-state emitter within the instrument's optical path, and reflected by a prism reflector or the object under survey.

# CONT...

- **Coordinate measurement:** the coordinates of an unknown point relative to a known coordinate can be determined using the total station as long as a direct line of sight can be established between the two points. Angles and distances are measured from the total station to points under survey, and the coordinates (X, Y, and Z) of surveyed points relative to the total station position are calculated using **trigonometry and triangulation.**

# CONT...

- **Data processing:** Some models include internal electronic data storage to record distance, horizontal angle, and vertical angle measured, while other models are equipped to write these measurements to an external data collector, such as a hand-held computer. When data is downloaded from a total station onto a computer, application software can be used to compute results and generate a map of the surveyed area.



# CONT...

- **Display:** Electronic display unit is capable of displaying various values when respective keys are pressed. The system is capable of displaying horizontal distance, vertical distance, horizontal and vertical angles, difference in elevations of two observed points and all the three coordinates of the observed points.
- **Electronic Book:** Each point data can be stored in an electronic note book (like compact disc). The capacity of electronic note book varies from 2000 points to 4000 points data. Surveyor can unload the data stored in note book to computer and reuse the note book.

# Capability of a Total Station

- Microprocessor unit in total station processes the data collected to compute:
  - Average of multiple angles measured.
  - Average of multiple distance measured.
  - Horizontal distance.
  - Distance between any two points.
  - Elevation of objects and
  - All the three coordinates of the observed points.

# ACCESSORIES FOR TOTAL STATION

- With approximately more than 40 different models are available to choose, they are currently the dominant instrument in surveying.



Tripods



Batteries & Chargers

Data & Power  
Cables



Prism Poles

Prisms



Tribraches



# Tripod

- A surveyor's tripod is a **device used to support** any one of a number of surveying instruments, such as **theodolites, total stations, levels or transits**



# Prism

- In surveying, a prism is a corner cube or retroreflector, normally attached on a surveying pole, used as a target for distance measurement using, a total station.



# CONT...

- The EDM instrument component installed in a Total Station is relatively small but still has distance ranges adequate for most work.
- Lengths up to about 2 km can be measured with a single prism, and up to about 6 to 7 km with triple prism.
- The angle resolution of available Total Stations varies from as low as a half-second for precise instruments suitable for control surveys, up to 20" for instruments made specifically for construction stakeout.

# TRIBRACHES

- A **tribrach** is an attachment plate used to attach a [surveying](#) instrument, for example a [theodolite](#), [total station](#), [GNSS](#) antenna or [target](#) to a [tripod](#).
- A tribrach allows the [survey](#) instrument to be repeatedly placed in the same position over a surveying marker point with [sub-millimeter precision](#), by loosening and re-tightening a lock to adjust the instrument base in a horizontal plane.



# OPERATION OF TOTAL STATION

- Because the Total Station contains delicate electronic components they are not as rugged as ordinary Theodolite.
- They must be packed and transported carefully, handled gently and carefully removed from their cases.
- The setting of Total Station over the station mark is similar to an ordinary Theodolite. This includes
  - ✓ Centering
  - ✓ Levelling
  - ✓ Removal of parallax



# CONT...

- Total Stations are controlled with entries made either through their built-in keyboards or through the keyboards of hand-held data collectors.
- Details for operating each individual total station vary somewhat and therefore are not described here.
- The **accuracy achieved** with total station is mainly depends on operator procedure of
  - ✓ Careful centering and levelling of the instrument
  - ✓ Accurate pointing at targets.
  - ✓ Taking averages of multiple angle measurements made in both direct and reverse positions

# Data Collection by total station

- In general the Total Station step-by-step procedure for measuring coordinate data goes as follows:
  1. Level the instrument
  2. Power up and initialize the instrument
  3. Select and make active the proper job name (i.e. "G1" for Group 1, etc.)
  4. Enter any XYZ data given to you (benchmarks, etc.) as "known data".
  5. In the "[MEAS]" menu select "[COORD]" to define the station position, select a back sight, and test the calibration of the instrument. After this step you will be ready to collect data.
  6. To successfully complete this step you MUST have the instrument leveled on a known coordinate point, and the target must be setup on another known point.
  7. Continue to use [COORD] to collect data at target points in the mapping area

# Data Collection Option in total station

- Measurements can be stored “on board” with all the total stations.

## □ The two options that are available are

- Data can be stored directly in the memory of the microcomputer, and later downloaded to an external storage device via connections or cables.
- The second option is the removable memory card. When one card is full, it can be removed and another card can be quickly installed.

# Advantages of Using Total Stations

- The following are some of the **major advantages of using total station** over the conventional surveying instruments:
  - Field work is carried out very fast.
  - Accuracy of measurement is high.
  - Manual errors involved in reading and recording are eliminated.
  - Calculation of coordinates is very fast and accurate. Even corrections for temperature and pressure are automatically made.
  - Computers can be employed for map making and plotting contour and cross-sections.
- However, surveyor should check the working condition of the instruments before using. For this standard points may be located near survey office and before taking out instrument for field work, its working is checked by observing those standard points from the specified instrument station.

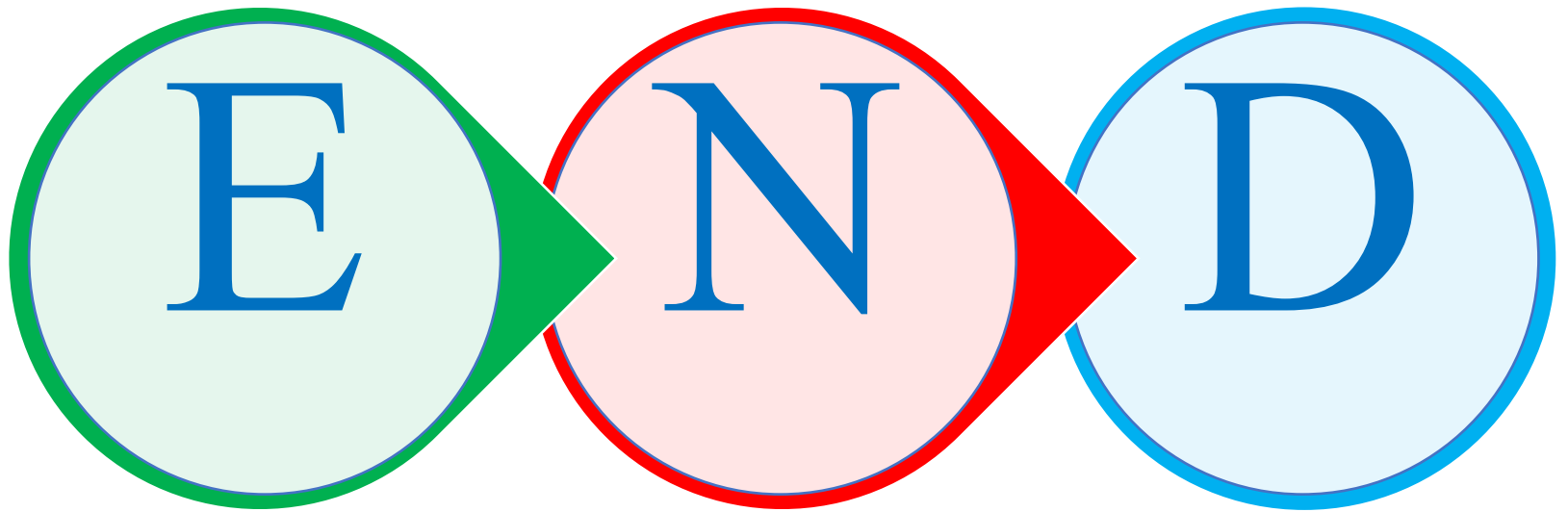

# CHAPTER FOUR

ANALYZING GROUND SURVEYING BY USING GIS

# CHAPTER FIVE

PHOTOGRAMMETRIC DATA AND ANALYSIS

- As you understand from the topic, those chapters focus on practical of analyzing ground data by using GIS and analyzing photogrammetric data. Thus, we will see it in lab when you come back to regular class.

# Prevent covid-19

- Stay @ home
- Keep your distance
- Use hand sanitizer and face mask
- Wash your hands with clean water and soap

IF YOU HAVE ANY QUESTION YOU CAN CONTACT ME VIA MY EMAIL

▪ [achalu5730@gmail.com](mailto:achalu5730@gmail.com)

**THANK YOU FOR FOLLOWING**



