

# Chapter One

## Transportation Systems

### 1.1 Introduction

**Transport** or **transportation** is the movement of people and goods from one location to another. Transport is performed by various modes, such as air, rail, road, water, cable, pipeline and space. The field can be divided into infrastructure, vehicles, and operations.

Infrastructure consists of the fixed installations necessary for transport, and may be roads, railways, airways, waterways, canals and pipelines, and terminals such as airports, railway stations, bus stations, warehouses, trucking terminals, refueling depots (including fueling docks and fuel stations) and seaports. Terminals may both be used for interchange of passengers and cargo, and for maintenance.

Vehicles traveling on these networks include vehicles of appropriate types such as automobiles, bicycles, buses, trains, trucks people, helicopters and aircraft. Operations deal with the way the vehicles are operated, and the procedures set for this purpose including financing, legalities and policies. In the transport industry, operations and ownership of infrastructure can be either public or private, depending on the country and mode.

Passenger transport may be public, where operators provide scheduled services, or private. Freight transport has become focused on containerization, although bulk transport is used for large volumes of durable items. Transport plays an important part in economic growth and globalization, but has a deteriorating impact on the environment. While it is heavily subsidized by governments, good planning of transport is essential to make traffic flow, and restrain urban sprawl.

### Need for Transport Facilities

- Transportation occurs even without the provision of transportation infrastructure
- As transport routes became used more frequently, their users began to collectively demand (and in some cases pay for) improvements (shorter journeys, smoother ride, greater certainty that facilities would be passable) thus raising the demand for PORTS, Hardened ROAD SURFACES, Bridges over rivers, cuttings through mountains, ...

### Transportation in Ethiopia

- Historic chronicles of 17<sup>th</sup> and 18<sup>th</sup> centuries show that there were small roads (rails and foot paths) in use in Ethiopia
- Routes served expansion of trade and religion

- Road transport accounts for 97% of the total domestic passenger and cargo traffic delivered by motorized transport
- The total travel and transport by all forms of motorized movement & non-motorized movement.
- Average Vehicle Ownership = 1 veh/620 persons (as low as 1 veh/4000 persons in rural areas)
- Walking, Head loading, back loading, and use of packed animals is prevalent in Ethiopia.

## 1.2 Different Modes of transport

A mode of transport is a technological solution that used a fundamentally different vehicle, infrastructure and operations. The transport of a person or cargo may be by one or more modes, the latter called intermodal transport. Each mode has its advantages and disadvantages, and will be chosen for a trip depended on the nature of the purpose, cargo and destination. While there transport in air and on water has their own mode, land transport has several modes.

### ❖ *Rail transport*

Rail transport is where train runs along a two parallel steelrails, known as a railway or railroad. They rails are anchored perpendicular to ties (or sleepers) of timber, concrete or steel, to maintain a consistent distance apart, or gauge. The rails and perpendicular beams are placed on a foundation made of concrete or compressed earth and gravel in a bed of ballast. Alternative methods include monorail and maglev.

A train consists of one or more connected vehicle that run on the rails. Propulsion is commonly provided by a locomotive, that hauls a series of unpowered cars, that can carry passengers or freight. The locomotive can be powered by steam, diesel or by electricity supplied by a trackside systems. Alternatively, some or all the cars can be powered, known as a multiple unit. Also, a train can be powered by horses, cables, gravity, pneumatics and gas turbines. Railed vehicles move with much less friction than rubber tires on paved roads, making trains more energy efficient, though not as efficient as ships.

Intercity trains are long-haul services connecting cities; modern high-speed rail is capable of speeds up to 350 km/h (220 mph), but this requires specially-built track. Regional and commuter trains feed cities from suburbs and surrounding areas, while intra-urban transport is performed by high-capacity tramways and rapid transits, often making up the backbone of a city's public transport. Freight trains traditionally used box cars, requiring manual loading and unloading of the cargo. Since the 1960s, container trains have become the dominant solution for general freight, while large quantities of bulk are transported by dedicated trains.



❖ **Road transport**

A road is an identifiable route, way or path between two or more places. Roads are typically smoothed, paved, or otherwise prepared to allow easy travel; though they need not be, and historically many roads were simply recognizable routes without any formal construction or maintenance. In urban areas, roads may pass through a city or village and be named as streets, serving a dual function as urban space easement and route. The most common road vehicle is the automobile; a wheeled passenger vehicle that carries its own motor. Other users of roads include buses, trucks, motorcycles, bicycles and pedestrians. As of 2002, there were 590 million automobiles worldwide.

Automobiles offer high flexibility and with low capacity, but are deemed with high energy and area use, and the main source of noise and air pollution in cities; buses allow for more efficient travel at the cost of reduced flexibility. Road transport by truck is often the initial and final stage of freight transport.



❖ Water transport

**Ship transport** Water transport is the process of transport a watercraft, such as a barge, boat, ship or sailboat, over a body of water, such as a sea, ocean, lake, canal or river. The need for buoyancy unites watercraft, and makes the hull a dominant aspect of its construction, maintenance and appearance.

In the 1800s the first steam ships were developed, using a steam engine to drive a paddle wheel or propeller to move the ship. The steam was produced using wood or coal. Now most ships have an engine using a slightly refined type of petroleum called bunker fuel. Some specialized ships, such as submarines, use nuclear power to produce the steam. Recreational or educational craft still use wind power, while some smaller craft use internal combustion engines to drive one or more propellers, or in the case of jet boats, an inboard water jet. In shallow draft areas, hovercraft are propelled by large pusher-prop fans.

Although slow, modern sea transport is a highly effective method of transporting large quantities of non-perishable goods. Transport by water is significantly less costly than air transport for trans-continental shipping; short sea shipping and ferries remain viable in coastal areas.



**Airway Transport:-**A fixed-wing aircraft, commonly called airplane, is a heavier-than-air craft where movement of the air in relation to the wings is used to generate lift. The term is used to distinguish from rotary-wing aircraft, where the movement of the lift surfaces relative to the air generates lift. A gyroplane is both fixed-wing and rotary-wing. Fixed-wing aircraft range from small trainers and recreational aircraft to large airliners and military cargo aircraft.

Two necessities for aircraft are air flow over the wings for lift, and an area for landing. The majority of aircraft also need an airport with the infrastructure to receive maintenance, restocking, refueling and for the loading and unloading of crew, cargo and

passengers. While the vast majority of aircraft land and take off on land, some are capable of take off and landing on ice, snow and calm water.

The aircraft is the second fastest method of transport, after the rocket. Commercial jets can reach up to 875 kilometres per hour (544 mph), single-engine aircraft 175 kilometres per hour (109 mph). Aviation is able to quickly transport people and limited amounts of cargo over longer distances, but incur high costs and energy use; for short distances or in inaccessible places helicopters can be used.



#### ❖ *Pipeline transport*

Pipeline transport sends goods through a pipe, most commonly liquid and gases are sent, but pneumatic tubes can send solid capsules using compressed air. Any chemically stable liquid or gas can be sent through a pipeline. Short-distance systems exist for sewage, slurry, water and beer, while long-distance networks are used for petroleum and natural gas.

Cable transport is a broad mode where vehicles are pulled by cables instead of an internal power source. It is most commonly used at steep gradient. Typical solutions include aerial tramway, elevators, escalator and ski lifts; some of these are also categorized as conveyor transport.

Spaceflight is transport out of Earth's atmosphere into outer space by means of a spacecraft. While large amounts of research have gone into technology, it is rarely used except to put satellites into orbit, and conduct scientific experiments. However, man has landed on the moon, and probes have been sent to all the planets of the Solar System.



### ❖ *History of transportation*



Bullock team hauling wool in Australia

Human's first means of transport was walking and swimming. The domestication of animals introduces a new way to lay the burden of transport on more powerful creatures, allowing heavier loads to be hauled, or humans to ride the animals for higher speed and duration. Inventions such as the wheel and sled helped make animal transport more efficient through the introduction of vehicles. Also water transport, including rowed and sailed vessels, dates back to time immemorial, and was the only efficient way to transport large quantities or over large distances prior to the Industrial Revolution.

The first forms of road transport were horses, oxen or even humans carrying goods over dirt tracks that often followed game trails. Paved roads were first built by the Roman Empire, to allow armies to travel quickly; they built deep roadbeds of crushed stone as an underlying layer to ensure that they kept dry, as the water would flow out from the crushed stone, instead of becoming mud in clay soils. The first water craft were canoes cut out from tree trunks. Early water transport was accomplished with ships that were either rowed or used the wind for propulsion, or a combination of the two. The importance of water has led to most cities that grew up as sites for trading, being located on rivers or at sea, offer at the intersection of two bodies of water. Until the Industrial Revolution, transport remained slow and costly, and production and consumption were located as close to each other as feasible.



The Wright Brothers' first flight in 1903

The Industrial Revolution in the 19th century saw a number of inventions fundamentally change transport. With telegraphy, communication became instant and independent of transport. The invention of the steam engine, closely followed by its application in rail transport, made land transport independent of human or animal muscles. Both speed and capacity increased rapidly, allowing specialization through manufacturing being located independent of natural resources. The 19th century also saw the development of the steam ship, that sped up global transport.

The development of the combustion engine and the automobile at the turn into the 20th century, road transport became more viable, allowing the introduction of mechanical private transport. The first highways were constructed during the 19th century with macadam. Later, tarmac and concrete became the dominant paving material. In 1903, the first controllable airplane was invented, and after World War I, it became a fast way to transport people and express goods over long distances.

After World War II, the automobile and airlines took higher shares of transport, reducing rail and water to freight and short-haul passenger. Spaceflight was launched in the 1950s, with rapid growth until the 1970s, when interest dwindled. In the 1950s, the introduction of containerization gave massive efficiency gains in freight transport, permitting globalization. International air travel became much more accessible in the 1960s, with the commercialization of the jet engine. Along with the growth in automobiles and motorways, this introduced a decline for rail and water transport. After the introduction of the Shinkansen in 1964, high-speed rail in Asia and Europe started taking passengers on long-haul routes from airlines.

❖ *Economic impact of transportation*



Transport is a key component of growth and globalization, such as in Seattle, United States

Transport is a key necessity for specialization—allowing production and consumption of product to occur at different locations. Transport has throughout history been the gate to expansion; better transport allows more trade and spread of people. Economic growth has always been dependent on increased capacity and more rational transport. But the infrastructure and operation of transport incurs large impact on the land and is the largest drainer of energy, making transport sustainability a major issue.

Modern society dictates a physical distinction between home and work, forcing people to transport themselves to place of work or study, supplemented by the need to temporarily relocate for other daily activities. Passenger transport is also the essence tourism, a mayor part of recreational transport. Commerce needs transport of people to conduct business, either to allow face-to-face communication for important decisions, or to transport specialists from their regular place of work to sites where they are needed.

### **Some Key Points:-**

1. People & Organizations alter their behaviour based on service expectations
2. Transport is part of a broad system -- economic, social, and political
3. Competition (or its absence) is a critical determinant of quality of service
4. Queuing for service, customers, and storage by vehicles/freight/travellers, is also a fundamental part of the system
5. Inter-modal and Intra-modal interchanges are key determinants of service quality
6. Capacity is affected by infrastructure, vehicles, technology, operating policy, etc.
7. Level of Service is a function of volume; near capacity LOS deteriorates dramatically
8. Information drives system operations and customer choices.



### **Key Roles of Transport:-**

1. Nation integration
2. Defence and strategic needs of a country
3. Governance of vast area under a control of a nation
4. Facilitates international and national trade and commerce
5. Promotes tourism
6. Facilitates social development activities: health, education, family planning, etc..
7. Gives time and place utility
8. Helps to fight natural disaster

### **Economic and Environmental Impacts of Transport**

#### **Economic impact:**

- a) Key component of growth and globalization
- b) Infrastructure building and operation of transport
- c) consumes huge amount of capital
- d) Traffic safety

#### **Environmental impact:**

- a) Infrastructure building consumes huge amount of land
- b) Transport is largest drainer of energy
- c) Air pollution
- d) Traffic noise

#### **Environmental impact**



Transport is a major use of energy, and burns most of the world's petroleum. This creates air pollution, including nitrous oxides and particulates, and is a significant contributor to global

warming through emission of carbon dioxide,[24] for which transport is the fastest-growing emission sector by subsector, road transport is the largest contributor to global warming. Environmental regulations in developed countries have reduced the individual vehicles emission; however, this has been offset by an increase in the number of vehicles, and more use of each vehicle.[24] Some pathways to reduced the carbon emissions of road vehicles considerably have been studied.[27]Energy use and emissions vary largely between modes, causing environmentalists to call for a transition from air and road to rail and human-powered transport, and increase transport electrification and energy efficiency.

Other environmental impacts of transport systems include traffic congestion and automobile-oriented urban sprawl, which can consume natural habitat and agricultural lands. By reducing transportation emissions globally, it is predicted that there will be significant positive effects on Earth's air quality, acid rain, smog and climate change.





## CHAPTER FIVE

### VERTICAL ALIGNMENT

The design of the vertical alignment of a roadway also has a direct effect on the safety and comfort of the driver. Steep grades can slow down large, heavy vehicles in the traffic stream in the uphill direction and can adversely affect stopping ability in the downhill direction. Grades that are flat or nearly flat over extended distances will slow down the rate at which the pavement surface drains. Vertical curves provide a smooth change between two tangent grades, but must be designed to provide adequate stopping sight distance. A vertical alignment of a highway consists of straight sections known as grades connected by vertical curves. The design of the vertical alignment therefore sections and appropriate length of vertical curves. The topography of the through which the road

A traverse has a significant impact on the design of the vertical alignment.

#### 5.1 GRADES

Grades may be defined as the rate of rise or fall along the length of highway. Flatter grades should be used where possible. On a long ascending grade it is preferable to place the steepest grade at the bottom and flatter the grade near the top. Maximum and minimum Gradients. The cost of operation of vehicles, the speed of vehicles and the capacity of a highway are highly affected by the grades provided. The grades should be selected so as to encourage uniform operation as far as possible for a given terrain and the vertical profile should be as smooth as economically possible. The minimum gradient for the usual case 0.5% should be used on all pavements to facilitate surface

Topography	Maximum Gradient (%), for Design Standard									
	DS1 to DS3		DS4 & DS5		DS6 to DS8		DS9		DS10	
	D	A	D	A	D	A	D	A	D	A
Flat	3	5	4	6	6	8	6	8	6	8
Rolling	4	6	5	7	7	9	7	9	7	9
Mountainous	6	8	7	9	10	12	13	15	14	16
Escarpment	6	8	7	9	10	12	13	15	14	16
Urban	6	8	7	9	7	9	7	9	7	9

*Note: First value shown is desirable value (D), second is absolute value (A).*

Table:- Maximum gradient

#### Critical length of grades

From the standpoint of vehicle operating characteristics and the effect on highway capacity, the steepness of the grade is not the only factor to be considered. The length of the grade can become a critical factor and must also be considered. The term “critical length of grade” is used to indicate the maximum length of a designated upgrade on which a loaded truck can operate without an unreasonable reduction in speed. For a given grade, lengths

less than critical ones result in acceptable operation in the desired range of speeds. If the desired freedom of operation is to be maintained on grades longer than critical ones, design adjustments such as change in location to reduce grades or addition of extra lanes should be made. It is recommended that a 20 Km/h speed reduction be used as the general guide (according ERA) for determining critical lengths of grades. Where it is necessary to exceed the critical length of gradient on heavily trafficked roads, it is desirable to provide either with safe passing distances on the rise, or a climbing lane for heavy vehicles. A climbing lane is an auxiliary lane added outside the continuous lanes and has the effect of reducing congestion in the through lanes by removing slower moving vehicles from the traffic stream.

### VERTICAL CURVES

Vertical curves are used to provide gradual change from one tangent grade to another so that vehicles may run smoothly as they traverse the highway. There are two types vertical curves

PVC = Point of vertical curvature

PVI = Point of vertical intersection

PVT = Point of vertical tangent

G1 = grade of initial tangent

G2 = grade of final tangent

L = Length of Vertical curve

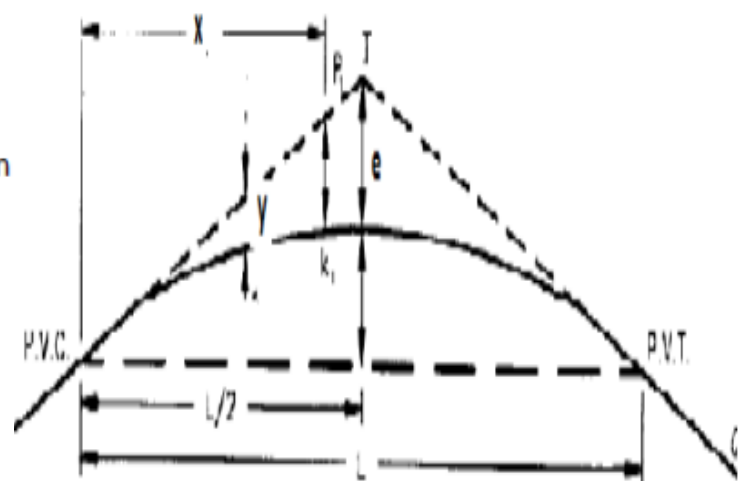

$$\Delta G = G_2 - G_1$$

$$r = \frac{G_2 - G_1}{L}$$

$$L$$

$$Y = \frac{rx^2}{2}$$

$$E_x = \frac{rx^2}{2} + G_1 x + E_{PC}$$

$$2$$

$$e = \frac{rL^2}{8} = \frac{(G_2 - G_1)L}{8}$$

### Length of Crest Vertical Curves

Minimum length of crest vertical curves based on sight distance criteria, generally are satisfactory from the standpoint of safety, comfort and appearance.

The minimum length of the vertical curve for the required sight distance is obtained as

#### Case I When $S < L$

$$L = \frac{\Delta G S^2}{100(\sqrt{2h_1} + \sqrt{2h_2})^2}$$

#### Case II When $S > L$

$$L = 2S - \frac{200(\sqrt{h_1} - \sqrt{h_2})^2}{\Delta G}$$

Where

$\Delta G$  = algebraic difference in grades (%)

$h_1$  = height of eye above roadway (m)

$h_2$  = height of object above surface (m)

$S$  = sight distance (m)

### Length of Sag Vertical Curves

The selection of minimum length of a sag vertical curve is controlled by the following criteria:

1. Headlight SSD
2. Passenger Comfort
3. Drainage Control
4. General appearance

The primary control used in design is headlight sight distance.

**Minimum length based on SSD (for Headlight SSD)**

1. When  $S < L$

$$L = \frac{\Delta G S^2}{200(H + S \tan \beta)} \dots \dots \dots$$

2. When  $S > L$

$$L = 2S - \frac{200(H + S \tan \beta)}{\Delta G}.$$

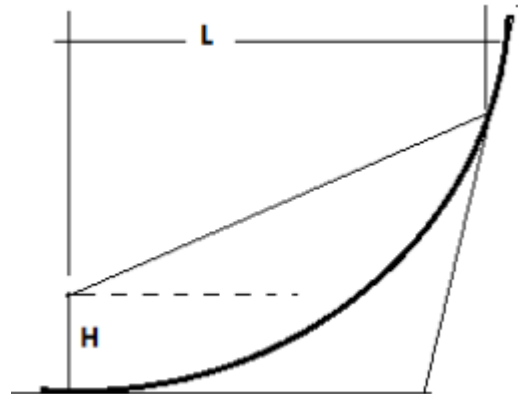

Where H – height of the head light above the ground (usually taken as 0.6 m)

B - Inclination of the light beams (usually taken as  $1^\circ$  )

**Driver Comfort:**

$$L = (V^2 A) / 395$$

**Length of Crest and Sag Vertical Curves Based on K factors**

The rate of change of grade at successive points on the curve is a constant amount for equal increments of horizontal distance and is equal to the algebraic difference between intersecting tangent grades divided by the length of curve in meters or  $A/L$  in percent per meters. The reciprocal  $L/A$  is the horizontal distance in meters needed to make 1% change in gradient and is termed “K”. Since K is a function of design speed, it can be used as a convenient “shortcut” to compute the minimum length for a crest vertical curve.

The value of K for both crest and sag curves

$$L_{\min} = \Delta G K$$

Design speed km/h	Rate of vertical curvature K, for SSD	K for PSD
20	2	10
30	3	50
40	5	90
50	10	130
60	18	180
70	31	250
85	60	350
100	105	480
120	210	680

Table: - Minimum Values for crest Vertical Curves

Design speed km/h	Rate of vertical curvature K, for SSD	K for PSD
20	2	10
30	4	50
40	8	90
50	12	130
60	18	180
70	25	250
85	36	350
100	51	480
120	74	680

Table: - Minimum Values for Sag Vertical Curves

### Vertical Alignment Considerations.

The following items should be considered when establishing new vertical alignment:

- The profile should be smooth with gradual changes consistent with the type of facility and the character of the surrounding terrain.
- A “roller-coaster” or “hidden dip” profile should be avoided.
- Undulating grade lines involving substantial lengths of steeper grades should be appraised for their effect on traffic operation, since they may encourage excessive truck speeds.
- Broken-back grade lines (two vertical curves—a pair of either crest curves or sag curves— separated by a short tangent grade) should generally be avoided.

### PHASING OF HORIZONTAL AND VERTICAL ALIGNMENTS

Phasing of the vertical and horizontal curves of a road implies their coordination so that the line of the road appears to a driver to flow smoothly, avoiding the creation of hazards and visual defects. It is particularly important in the design of high-speed roads on which a driver must be able to anticipate changes in both horizontal and vertical alignment well within the safe stopping distance. When designing new roadway projects, the following items should be considered to coordinate the horizontal and vertical alignments:

- Curvature and tangent sections should be properly balanced. Normally, horizontal curves will be longer than vertical curves.
- It is generally more pleasing to the driver when vertical curvature can be superimposed on horizontal curvature. In other words, the PIs (points of intersection) of both the vertical and horizontal curves should be near the same station or location.
- Sharp horizontal curves should not be introduced at or near the top of a pronounced crest



vertical curve or at or near the low point of a pronounced sag vertical curve.

- On two-lane roadways, long tangent sections (horizontal and vertical) are desirable to provide adequate passing sections.
- Horizontal and vertical curves should be as flat as possible at intersections where sight distances along both roads and streets is important and vehicles may have to slow or stop.

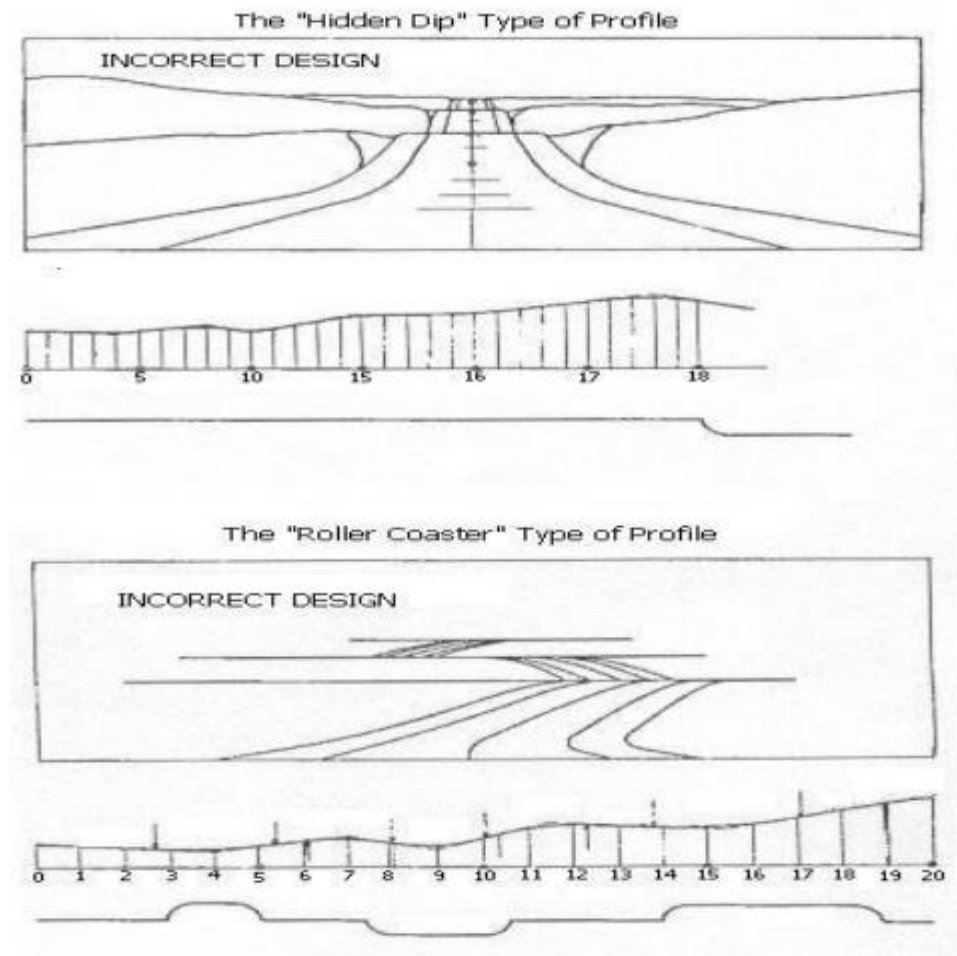

Figure: - Hidden dip and Roller Coaster Profiles

**Example: - Given**

- Design speed: 85km pr hr
- Topography: Mountainous
- Maximum gradient desirable: 6% From ERA manual
- Maximum gradient absolute: 8% From ERA manual
- Departed gradient:  $G_1 = -9.625\%$  and  $G_2 = -3.46\%$
- Minimum gradient: 0.5%

•Min. stopping sight: 175m From ERA manual

•Min .passing sight distance: 320m From ERA manual

**Calculate vertical elements from the given information.**

Since the gradient changes from - 9.625 % to - 3.46%, the vertical curve is a sag curve.

Algebraic difference in grade (A) = -9.625- - 3.46 = -6.165%,

Station of PVI is 0+431.798

Elevation of PVI= 2143.969m,

Minimum allowable "K" value = 36, ERA geometric manual table 9.2 for V=85km/hr

**1. Curve length required for minimum curvature, k**

$L=AK$  , where K is rate of vertical curvature.

K=36 for sag curve

$L= 6.165*36 =221.94m$

**2. Length required for safe stopping sight distance**

When  $SSD > L$

$L=2SSD - 200(h+ SSD\tan\alpha)/A$

Where for sag curve, the height from the ground to the eye of the driver,  $h =0.6$  and the angle b/n the ray from the observer's eye to the object,  $\alpha= 10$  Soothe required curve length is:

$$\begin{aligned}L &= 2SSD - 200(h+ SSD\tan\alpha)/A \\ &= 2*175 - 200(0.6+ 175*\tan 10)/6.165\% \\ &= - 61.78m\end{aligned}$$

**3. Length required for safe passing site distance**

$$\begin{aligned}L_c &= 2* PSD- 200(h+PSD \tan\alpha)/A \\ &= 2*320 - 200(0.6+ 320\tan 1^\circ) / 6.165\% \\ &= -96.85m\end{aligned}$$

Here the negative sign indicates that the curve length is visible and no need for sight distance consideration.

**4. Length required for passengers comfort**

$$\begin{aligned}L_c &= Vd^2*A /395 \\ &= 85^2*6.165/395 \\ &= 112.76m\end{aligned}$$

**5. Length required for aesthetic (appearance)**

$$\begin{aligned}L_c &= 30 *A \\ &= 30*6.165\end{aligned}$$

$$= 184.95\text{m}$$

**Determination of the curve elements**

Station of PVI is 0+431.798

Elevation of PVI=2143.969m,

Station of PVC = PVI- L/2

$$= 0+431.798 - 222/2$$

$$=0+320.789\text{m}$$

Elevation of PVC = Elevation of PVI - G1\* (L/2)

$$=2143.969\text{m} - (-9.625/100)*(222/2)$$

$$=2154.652\text{m}$$

Station of PVT = PVI + L/2

$$=0+431.798+ 222/2$$

$$=0+542.798$$

Elevation of PVT = Elevation of PVI+(G2)(L/2)

$$= 2143.969\text{m} + (-3.46/100)*(222/2)$$

$$= 2140.128\text{m}$$



## CHAPTER TWO

### Highway Route Selection

- **Highway Alignment:** The position or the layout of the centre line of the highway on the ground is called the alignment.
  - Horizontal alignment consists of straight paths and curves
  - Vertical alignment consists of grades and curves
- Improper alignment of a road facility implies capital loss initially in construction as well as loss in costs of maintenance and vehicle operation
- Once the road is aligned and constructed, it is not easy to change the alignment due to increase in cost of adjoining land and construction of costly structures by the road side.
- Hence careful considerations while finalising the alignment of a new road need not be over-emphasised.

#### Factors Controlling Highway Alignment

- **Obligatory Points**
  - Points through which the alignment is to pass
    - Chosen Bridge Site, Intermediate town to be accessed between the termini, a mountain pass, etc.
  - Points which should be avoided

Areas requiring costly structures, highly developed expensive areas, marshes and low lying lands subject to flooding, hilly terrain where there is a possibility of land slides, etc.

- **Traffic**
  - The alignment should suit the traffic requirements
  - Present and future travel patterns should be observed & forecasted
  - Traffic “Desire line” should be drawn showing path of traffic flow
- **Geometric Constraints**
  - Design factors such as max. gradient, minimum radius of curve, minimum available sight distance, maximum allowable super-elevation, etc. should be within the limits of allowable design values which are governed by the expected traffic speed
- **Economy**
  - Total transportation cost including initial construction cost, maintenance cost, and operation cost
    - Example :
      - Deep cuttings, high embankments, no of bridges that need to be constructed, etc. increases the initial cost of construction.
- **Other considerations**
  - Drainage considerations
  - Hydrological factors
  - Political considerations

- Monotony

## Location of Road Corridors

### General

- Road Design, Construction and Maintenance require an approach depending on the terrain. The shortest road alignment is not necessarily the easiest, quickest or most economical option for construction and maintenance. Frequently, topography, slope stability, flood hazard and erosion potential are likely to be the most significant controls in the choice of the most suitable alignment and design of cross-section.

Variations in geology and slope greatly influence road design and hence the cost of construction and these variations can occur over very short lengths of alignment. Geology, geomorphology and hydrology, therefore, are key factors in the design, construction and maintenance of roads in Ethiopia. An appreciation of these factors alone is not enough to construct roads in an environmentally sound way. Road geometry, earth works, retaining structures and drainage measures must be designed in such a manner as to cause the least impact on the stability of the surrounding slopes and natural drainage systems.

Excessive blasting, cutting, side tipping of spoils and concentrated or uncontrolled surface water runoff can lead to instability and erosion. Although many of these effects are often unavoidable, the design and the construction method adopted should aim to minimize them.

- This chapter describes the methodology for analyzing possible corridors and selecting the optimum route from technical, economic, social and environmental considerations. This may generally include two steps: the *desk study* and *route survey*.

### Desk study

- In this step, possible route corridors are selected based on various maps and other available information at office.
- Before commencing with selection of the route corridors, the controlling requirements of the route need to be defined. These may include the following:
  - ✓ What are the constraints in regard to the beginning and ending points of the road? Must these be at existing junctions in villages or towns? Are such junctions inadequate from a standpoint of skew or right-of-way? Do economic considerations such as amount of earthworks limit the alternatives?
  - ✓ Through which villages must the route pass? Must the route pass directly through these villages, or can linking roads connect the villages? If so, what are the implications to the villages in terms of lost trade?

- ✓ If major rivers are to be crossed, what are the possible crossing locations, given constraints of topography and geology? What are the economics of the alternative bridge sights with the corresponding road geometries?
- ✓ What is the desired design speed and design standard? How does this standard fit the terrain in terms of geometric parameters such as gradients, and horizontal and vertical curves?
- The desk study comprises a review of published and unpublished information concerning the physical, economic and environmental characteristics of a study area. Some of the data that may be required for the desk studies are the following sources:
  - ✓ Published literature covering a range of topics including road construction and maintenance case histories and geological, economic and environmental reviews.
  - ✓ Topographical maps
  - ✓ Geological maps, agricultural soil maps and other natural resource maps; and
  - ✓ Aerial photography
- For studying and selecting suitable alignment corridors, a detailed analysis based on the following references, maps, and aerial photography may be required:

REFERENCE:	SOURCE
- Index Map of Coverage Scales	Ethiopian Mapping Authority
- Atlas of Ethiopia	Ethiopian Mapping Authority
- Topographic Maps scale 1:250,000	Ethiopian Mapping Authority
- Topographic Maps scale 1:50,000	Ethiopian Mapping Authority
- Aerial photographs, approximate scale 1:50,000	Ethiopian Mapping Authority
- Geological Map of Ethiopia, scale 1:2,000,000	Geological Survey of Ethiopia, Ministry of Mines
- Hydrological Map of Ethiopia, scale 1:2,000,000	Ministry of Agriculture
- Land Use and Land Cover Map, scale 1:1,000,000	Ministry of Agriculture
- Hydro geological Map, Scale 1:1,000, 000	Ethiopian Institute of Geological Survey

#### ❖ Preliminary Identification of Potential Corridors

- Using the 1:50,000 scale maps and with knowledge of the constraints as listed in Section 3.2, it is possible to trace out some possible alternative alignments. This is readily accomplished by referring especially to the vertical geometric design criteria for

maximum grade and plotting possibilities through correlation with the contour lines shown on the map.

For instance, assume that the road classification and terrain are such that a 10% maximum grade is permissible. Assume also that the contour interval on the 1:50,000 map is 20 meters. A preliminary alignment needs to be selected such that a distance of no less than 200 meters is used to achieve the 20-meter interval, giving a 10% grade.

- The detail steps in this process are summarized in the following sections.

### **A. Routes Identification**

- The purpose of this reconnaissance stage of the survey process is to identify possible alternative routes in terms of the “corridors” within which they lie. Possible routes shall be examined on maps, satellite images and air photos, where available, and a broad terrain classification shall be made for collation of the regional information, possibly on a data storage system. Visits shall be made to site to check interpretations, and findings shall be summarized to assist in planning and next stage. Aerial photos at a scale of approximately 1:100 000 and Land sat images at 1:500 000 or 1:250 000 shall be used to interpret boundaries between terrain types, where changes in topography, geology, drainage pattern or vegetation (land use) occur. A change in any of these will give rise to different engineering conditions, which could affect the design of the road. Such items as the following shall be considered:
  - ✓ Changing course of major rivers
  - ✓ Drainage areas of major river systems
  - ✓ Extent of flooding of low-lying areas
  - ✓ Possible sources of water for construction
  - ✓ Possible sources of construction materials
  - ✓ Pattern of regional instability
  - ✓ Extent of erosion
  - ✓ Spread of deforestation
  - ✓ Assessment of land acquisition/site clearance problems
  - ✓ Location of all possible bridge sites

### **B. Feasibility of Selected Alternatives**

- At this stage, the corridors are appraised to select the best route. This shall be carried out mainly using aerial photos for all detailed interpretations, ideally at a scale of 1:20 000 – 1:60 000, as available. These can be supplemented by color information from Land sat images.



Detailed interpretations shall be made of conditions on all routes and, if necessary, a more detailed terrain classification of the area shall be made. The following items shall be investigated:

- ✓ Foundation conditions
- ✓ Drainage area and the location of culverts
- ✓ Locations of spoil and borrow areas
- ✓ Possible sources of construction materials
- ✓ Identification of most favorable bridge sites
- ✓ Possible major hazard areas such as poorly drained soils, springs, unstable areas, and erosion in river courses

### **C. Identify Feasible Corridors and Propose Alignment Alternatives**

- The identified corridors in part A after checked for their feasibility in part B, suitable alignments will be proposed for each corridors in this section, and they are studied and compared. This should be accomplished at 1:50,000 scale using the topographic maps.

The possible alternatives are evaluated by the following criteria:

- ✓ What are the relative lengths of the alternatives? Normally the shortest distance is preferable.
- ✓ What are the average and mean gradients of the alternatives? Normally the least severe grade alternative is preferred. However, the relation of minimum grade may be the inverse to the shortest length route.
- ✓ Which alternative more closely follows an existing road or track? This makes survey and construction easier and may indicate the route of least earthworks.
- ✓ Which alternative follows the least severe terrain type? An alignment through, for instance, rolling terrain should be less costly to construct, have lower vehicle operating costs and maintenance costs, and less severe horizontal curves than a route through mountainous terrain.
- ✓ Which route remains for a longer period on the crest of the terrain? Such an alignment minimizes the need for drainage structures.
- ✓ Which alignment minimizes the need for land acquisition? Which alignment minimizes the need to demolish buildings and houses?
- ✓ What is the total number of bridges required for each alternative? What is the total aggregate length of these bridges?
- ✓ Which route results in the least environmental disturbance to the surrounding area?
- ✓ Which route has the least overall project cost, including both design and construction?

### **Site Visit and Survey**

- After the preliminary office work, a site visit must be made to the road. Where terrain constraints made such a visit problematic, a flight can be made over the terrain and all potential routes can be directly examined from the air.

- When potential route corridors have been identified from the desk study analysis, then a reconnaissance survey is usually employed to verify interpretations, to help determine the preferred corridor, and to identify factors that will influence the feasibility design concept and cost comparisons.
- A team consisting of the following personnel should make a site inspection visit:
  - ✓ Highway Engineer
  - ✓ Soils & Materials Engineer
  - ✓ Hydrologist
  - ✓ Chief Surveyor
  - ✓ Bridge/Structures Engineer
  - ✓ Environmentalist/Sociologist, and
  - ✓ Local Administrative Personnel.
- In most cases, the reconnaissance survey will significantly modify the desk study interpretations. Reconnaissance survey data can either be recorded onto topographical maps or aerial photographs.
- During the route survey, the following information should be determined:
  - ✓ Terrain classification;
  - ✓ The location of topographical constrains, such as cliffs, gorges, ravines, rock out crops, and any other features not identified by the desk study;
  - ✓ Slope steepness and limiting slope angles identified from natural and artificial slopes (cutting for paths, agricultural terraces and existing roads in the region);
  - ✓ Slope stability and the location of pre-existing land slides;
  - ✓ Rock types, geological structures, dip orientations, rock strength and rip ability;
  - ✓ Percentage of rock in excavations;
  - ✓ Materials sources, presence and distribution;
  - ✓ Water sources;
  - ✓ Soil types and depth (a simple classification between residual soil and colluvium is useful at this stage);
  - ✓ Soil erosion and soil erodibility;
  - ✓ Slope drainage and groundwater conditions;
  - ✓ Drainage stability and the location of shifting channels and bank erosion;
  - ✓ Land use and its likely effect on drainage, especially through irrigation;
  - ✓ Likely foundation conditions for major structures;
  - ✓ Approximate bridge spans and the sizing and frequency of culverts;
  - ✓ Flood levels and river training/protection requirements;
  - ✓ Environmental considerations, including forest resources, land use impacts and socio-economic considerations;
  - ✓ Verify the accuracy of the information collected during the desk study;
  - ✓ The possibility of using any existing road alignments including local re-alignment
  - ✓ Improvements; and

- ✓ Information on the physical accessibility to bridge sites and the proposed corridors, including the geomorphology of drainage basins, soil characteristics, slopes, vegetation, erosion and scouring.
- During the site inspection the team should examine all alternatives. This information can be combined with the results of the desk study to determine the most appropriate alignment alternative.
- Site investigations shall be carried out for alternative routes, guided by the terrain evaluation. These shall note key physical and geotechnical features. Selected laboratory and field-testing shall also be carried out, again guided by the terrain evaluation.
- Finally, cost comparisons shall be made of alternative alignments to assist in the recommendation of the best route.

## **Road Functional Classification and Numbering**

The functional classification in Ethiopia includes five functional classes. The following are the functional classes with their description.

### **I. Trunk Roads (Class I)**

Centers of international importance and roads terminating at international boundaries are linked with Addis Ababa by trunk roads (see Table A-1). They are numbered with an "A" prefix: an example is the Addis-Gondar Road (A3). Trunk roads have a present AADT  $\square \square 1000$ , although they can have volumes as low as 100 AADT (see Table 2-1).

### **II. Link Roads (Class II)**

Centers of national or international importance, such as principal towns and urban centers, must be linked between each other by link roads (see Table A-2). A typical link road has over 400 - 1000 first year AADT, although values can range between 50-10,000 AADT. They are numbered with a "B" prefix. An example of a typical link road is the Woldiya-Debre Tabor- Woreta Road (B22), which links, for instance, Woldiya on Road A2 with Bahir Dar of Road A3.

### **III. Main Access Roads (Class III)**

Centers of provincial importance must be linked between each other by main access roads (see Table A-3). First year AADTs are between 30-1,000. They are numbered with a "C" prefix.

### **IV. Collector Roads (Class IV)**

Roads linking locally important centers to each other, to a more important center, or to higher class roads must be linked by a collector road. First year AADTs are between 25-400. They are numbered with a "D" prefix (see Table A-4).

### **V. Feeder Roads (Class V)**

Any road link to a minor center such as market and local locations is served by a feeder road. First year AADTs are between 0-100. They are numbered with an "E" prefix and are presented in Appendix A.

Roads of the highest classes, trunk and link roads have, as their major function to provide mobility, while the primary function of lower class roads is to provide access. The roads of intermediate classes have, for all practical purposes, to provide both mobility and access.

The classification and description of all existing trunk, link and main access roads within the country, including road name, distance, type of road and road numbering, are given in Appendix A.

**Objectives in setting a hierarchy:**

- To obtain best use of an existing network
- To ensure that each type of traffic is using the most appropriate route
- To minimize the risk to users and to the natural built environment
- To ensure better management, maintenance regimes and design policies
- To ensure funding for routes is targeted appropriately
- To offer network users a choice for how to travel

**Characteristics:**

**Primary Distributor** Fast moving long distance through traffic, no frontage



Development and no pedestrian.

**District Distributor**



**Local Distributor**



**Access Distributor** Slow moving vehicles, delivery vehicles, and frontage development, walking, no through vehicle movement

## CHAPTER THREE

### DESIGN CONTROL AND CRITERIA

#### INTRODUCTION

Highway geometric design is the process whereby the layout of the road through the terrain is designed to meet the needs of the road users. The principal geometric features are the road cross-section and horizontal and vertical alignment. It is dictated with in economic limitation to satisfy the requirements of traffic highway elements such as

- i. Cross-section
- ii. Horizontal alignment
- iii. Vertical alignment
- iv. Sight distance
- v. Vertical and lateral clearance
- vi. Intersections

#### 3.1. DESIGN CONTROL AND CRITERIA

The choice of design controls and criteria is influenced by the following factors: the functional classification of the road; the nature of the terrain; the design vehicle; the traffic volumes expected on the road; the design speed; the density and character of the adjoining land use; and economic and environmental considerations.

##### I. Functional Classification of Roads

To facilitate orderly highway development and efficient fiscal planning and to ensure logical assignment of jurisdictional responsibility, highways are classified according to function. Functional classification involves grouping streets and highways into classes or systems according to the character of service they are intended to provide. Highways generally serve a dual role in a highway system, providing both mobility and access to property. Thus highways may be viewed as a hierarchical system consisting of highway classes with differing purpose and

levels of importance. Functional classes of highways commonly used include principal arterial, minor arterial, collector, and local highways.

- Principal roads are intended primarily to enable traffic to move efficiently over relatively long distances. Ideally there is or no access to principal roads, because access may interfere with the fast and efficient flow of traffic.
- Distributor (minor) roads are intended to allow traffic to move between principal roads and the localities where trips start and finish. There is only limited access. Vehicle speeds are often lower than on principal roads.
- Collector roads allow traffic to move within a neighborhood and provide some access to individual properties.
- Local roads are exclusively intended to provide access to individual properties. Design speeds are lower here to allow for large proportions turning traffic and the frequent proximity to pedestrians.

The hierarchy of travel distances can be related logically to functional specialization in meeting the property access and travel mobility needs. Local rural facilities emphasize the land access function. Arterials for main movement or distribution emphasize the high level of mobility for through movement. Collectors offer approximately balanced service for both functions. This scheme is illustrated conceptually in Figure 3-1.

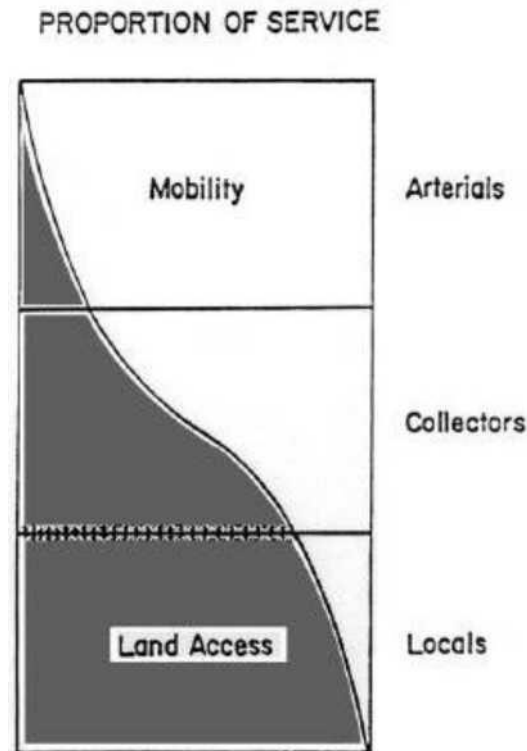

Figure 3.1:-Relationship of Functionally Classified Systems in Serving

The functional classification in Ethiopia includes five functional classes. The following are the functional classes with their description.

### I. Trunk Roads (Class I)

Centers of international importance and roads terminating at international boundaries are linked with Addis Ababa by trunk roads. They are numbered with an "A" prefix: an example is the Addis-Gondar Road (A3). Trunk roads have a present AADT >1000, although they can have volumes as low as 100 AADT.

### II. Link Roads (Class II)

Centers of national or international importance, such as principal towns and urban centers must be linked between each other by link roads. A typical link road has over 400 - 1000 first year AADT, although values can range between 50-10,000 AADT. They are numbered with a "B" prefix. An example of a typical link road is the Woldiya- Debre Tabor Woreta Road (B22), which links, for instance, Woldiya on Road A2 with Bahir Dar of Road A3.

### **III. Main Access Roads (Class III)**

Centers of provincial importance must be linked between each other by main access roads. First year AADTs are between 30-1,000. They are numbered with a "C" prefix.

### **IV. Collector Roads (Class IV)**

Roads linking locally important centers to each other, to a more important center, or to higher class roads must be linked by a collector road. First year AADTs are between 25-400.

### **V. Feeder Roads (Class V)**

Any road link to a minor center such as market and local locations is served by a feeder road. First year AADTs are between 0-100.

Roads of the highest classes, trunk and link roads have, as their major function to provide mobility, while the primary function of lower class roads is to provide access. The roads of intermediate classes have, for all practical purposes, to provide both mobility and access.

## **II. Topography and Land Use**

The location of a highway and its geometric design elements are affected to a large extent by the topography, physical features and land use of the area. The design elements such as grades, sight distance, cross-sections, speeds etc. are affected by hills, valleys, rivers, ponds lakes etc.

Ethiopian Road Authority classifies terrain as flat, rolling, mountainous and escarpment.

- Flat: Flat or gently rolling country, which offers few obstacles to the construction of a road, having continuously unrestricted horizontal and vertical alignment (transverse terrain slope up to 5 percent).
- Rolling: Rolling, hilly or foothill country where the slopes generally rise and fall moderately and where occasional steep slopes are encountered, resulting in some restrictions in alignment (transverse terrain slope from 5 percent to 25 percent)



- Mountainous: Rugged, hilly and mountainous country and river gorges. This class of terrain imposes definite restrictions on the standard of alignment obtainable and often involves long steep grades and limited sight distance (transverse terrain slope from 25 percent to 50 percent)
- Escarpment: Other terrains not classified under the above terrain types. (Transversal slope above 50%)

### **III. Design Vehicle**

Key controls in geometric highway design are the physical characteristics and the proportions of vehicles of various sizes using the highway. Therefore, it is appropriate to examine all vehicle types, establish general class groupings, and select vehicles of representative size within each class for design use. These selected vehicles, with representative weight, dimensions, and operating characteristics, used to establish highway design controls for accommodating vehicles of designated classes, are known as design vehicles. For purposes of geometric design, each design vehicle has larger physical dimensions and a larger minimum turning radius than most vehicles in its class. The largest design vehicles are usually accommodated in freeway design.

According AASHTO four general classes of design vehicles have been established, including:

(1) Passenger cars,

(2) Buses,

(3) Trucks, and

(4) Recreational vehicles.

The passenger-car class includes passenger cars of all sizes, sport/utility vehicles, minivans, vans, and pick-up trucks. Buses include inter-city (motor coaches), city transit, school, and articulated buses. The truck class includes single-unit trucks, truck tractor-semitrailer combinations, and truck tractors with semitrailers in combination with full trailers. Recreational vehicles include motor homes, cars with camper trailers, cars with boat trailers, motor homes with boat trailers, and motor homes pulling cars. In addition, the bicycle should also be considered a design vehicle where bicycle use is allowed on a highway. Both the physical characteristics and turning capabilities of vehicles are controls in geometric design. Vehicle characteristics and dimensions affecting design include power to weight ratio, minimum turning radius and travel path during a turn, and vehicle height and width. The road elements affected include the selection of maximum gradient, lane width, horizontal curve widening, and junction design.

The present vehicle fleet in Ethiopia includes a high number of four-wheel drive utility vehicles and overloaded trucks. There are four design vehicles are used in Ethiopia. These are:

- |                              |     |
|------------------------------|-----|
| 1. Utility vehicle-          | DV1 |
| 2. Single unit truck-        | DV2 |
| 3. Single unit bus -         | DV3 |
| 4. Semi-trailer combination- | DV4 |

## V. Driver Characteristics

Geometric design of a highway should consider users, especially drivers' performance limits. There are limits to a driver's vision, perception, reaction, concentration, comfort that could impact the highway safety and operating efficiency.

When driving, most drivers receive information visually from views of the road roadway

alignment, markings and signs. They do receive other information through vehicle feedback from the suspension system and steering control, roadway noise.

The information received by a drivers needs time processed before a response action takes place. A well- known study on the brake-reaction time has been made by Johansson and Rumar (1971). They reported that when an event is expected, the driver's reaction time has an average value of 0.6sec. for an unexpected event, the average reaction time is 0.8 sec. the average brake-reaction time of a driver (including decision time), is 2.5 sec. this is dependent on the driver's alertness. Brake-reaction time is important in determining sight distance in highway geometric design.

Driver expectancies are built up over time, with consistent road design. Unusual or unexpected geometric design or event always leads to longer reaction and response time. The geometric design or event always leads to longer reaction and response time. The geometric design of highway should be in accordance with the driver's expectation.

In recent years, there has been increased concern for older drivers. The percentage of older drivers among the population has increased over the years. Older drivers tend to have longer reaction time, and this should be reflected in the design.

## **V. Design Volume**

A further factor influencing the development of road design standards, and in particular the design speed, is the volume and composition of traffic. The design of a road should be based in part on factual traffic volumes. Traffic indicates the need for improvement and directly affects features of design such as number of lanes, widths, alignments, and gradients.

Traffic volume is number of vehicles that pass a point along a roadway during a specified time period. Traffic data for a road or section of road are generally available or can be obtained from field studies. The data collected by State or local agencies include traffic volumes for days of the year and time of the day, as well as the distribution of vehicles by type and weight. Here is definition of some terms.

- **Annual Average Daily Traffic (AADT):** is the number of vehicles that pass a particular point on road way during a period of 24 consecutive hours averaged over a period of 365 days.
- **Average Daily Traffic (ADT):** is the average of 24-hr counts collected over a

number of days greater than one but less than a year.

Vehicles of different sizes and weights have different operating characteristics that should be considered in highway design. Besides being heavier, trucks are generally slower and occupy more roadway space. Consequently, trucks have a greater effect on highway traffic operation than do passenger vehicles. The overall effect on traffic operation of one truck is often equivalent to several passenger cars.

## **VI. Design Speed**

Design speed is a selected speed used to determine the various geometric design features of the roadway. The assumed design speed should be a logical one with respect to the topography, anticipated operating speed, the adjacent land use, and the functional classification of highway. Except for local streets where speed controls are frequently included intentionally, every effort should be made to use as high a design speed as practical to attain a desired degree of safety, mobility, and efficiency within the constraints of environmental quality, economics, aesthetics, and social or political impacts. Once the design speed is selected, all of the pertinent highway features should be related to it to obtain a balanced design. Above minimum design values should be used, where practical. Some design features, such as curvature, super elevation, and sight distance, are directly related to, and vary appreciably with, design speed. Other features, such as widths of lanes and shoulders and clearances to walls and rails, are not directly related to design speed, but they do affect vehicle speeds. Therefore, wider lanes, shoulders, and clearances should be considered for higher design speeds. Thus, when a change is made in design speed, many elements of the highway design will change accordingly.

The selected design speed should be consistent with the speeds that drivers are likely to expect on a given highway facility. Where a reason for limiting speed is obvious, drivers are more apt to accept lower speed operation than where there is no apparent reason. A highway of higher functional classification may justify a higher design speed than a lesser classified facility in similar topography, particularly where the savings in vehicle operation and other operating costs are sufficient to offset the increased costs of right-of-way and construction. A low design speed, however, should not be selected where the topography is such that drivers are likely to travel at high speeds. Drivers do not adjust

---

their speeds to the importance of the highway, but to their perception of the physical limitations of the highway and its traffic.

### 3.2. HIGHWAY CROSS-SECTION ELEMENTS

The highway cross-section elements include all those features all those features of the highway which from its effective width and which affect vehicle movement. A cross-section will normally consist of the carriageway, shoulders or curbs, drainage features, and earthwork profiles. **Carriageway** is the part of the road constructed for use by moving traffic, including traffic lanes, auxiliary lanes such as acceleration and deceleration lanes, climbing lanes, and passing lanes, and bus bays and lay-byes. **Roadway** consists of the carriageway and the shoulders, parking lanes and viewing areas whereas an **Earthwork Profile** includes side slopes and back slopes.

For urban cross-sections, cross-section elements may also include facilities for pedestrians, cyclists, or other specialist user groups. These include curbs, footpaths, and islands. It may also provide for parking lanes. For dual carriageways, the cross-section will also include medians.

Specifically, aspects of the cross-section directly relate to the number of travel lanes to be provided and the width and location of shoulders or curbs, medians, slopes, embankments and ditches. Each of these elements will be discussed in the following paragraphs.

#### I. Highway Travel Lanes

The width of the surfaced road and number of lanes should be adequate to accommodate the type and volume of traffic anticipated and the assumed design speed of vehicles. The number of lanes is based primarily upon a capacity analysis for selected design year. The width of travel lanes will vary according to functional class of highway, design speed, traffic volume and level of development of the area.

The lane width of a roadway greatly influences the safety and comfort of driving. Lane widths of 2.7 to 3.6 m are generally used, with a 3.6-m lane predominant on most high-type highways. The extra cost of providing a 3.6-m lane width, over the cost of providing a 3.0-m lane width is offset to some extent by a reduction in cost of shoulder maintenance and a reduction in surface maintenance due to lessened wheel concentrations at the pavement edges. The wider 3.6-m lane provides desirable clearances between large

commercial vehicles traveling in opposite directions on two-lane, two-way rural highways when high traffic volumes and particularly high percentages of commercial vehicles are expected.

There are some circumstances where lanes less than 3.6 m wide should be used. In urban areas where pedestrian crossings, right-of-way, or existing development become stringent controls, the use of 3.3-m lanes is acceptable. Lanes 3.0 m wide are acceptable on low-speed facilities, and lanes 2.7 m wide are appropriate on low-volume roads in rural and residential areas.

Where unequal-width lanes are used, locating the wider lane on the outside (right) provides more space for large vehicles that usually occupy that lane. This also provides more space for bicycles, and allows drivers to keep their vehicles at a greater distance from the edge. Where a curb is used adjacent to only one edge, the wider lane should be placed adjacent to that curb.

## **II. Shoulders**

A shoulder is the portion of the roadway contiguous to the carriageway for the accommodation of stopped vehicles; traditional and intermediate non-motorized traffic, animals, and pedestrians; emergency use; the recovery of errant vehicles; and lateral support of the pavement courses. A shoulder also provides additional space for bicycle use, to increase sight distance on horizontal curves and to provide clearance for placement of road signs and guardrails. They vary from no shoulder on minor rural roads where there is no surfacing, to a 1.5-3.0m or even greater sealed shoulder on major roads depending on the terrain and design classification.

Shoulders may be surfaced either full or partial width to provide a better all-weather load support than that afforded by native soils. Materials used to surface shoulders include gravel, shell, crushed rock, mineral or chemical additives, bituminous surface treatments, and various forms of asphaltic or concrete pavements. This has several advantages. It would prevent edge raveling and maintenance problems associated with parking on a gravel shoulder. It would provide paved space for vehicular parking outside of the traffic flow. It would provide a better surface for vehicles experiencing emergency repairs. It would also provide for the very heavy pedestrian traffic observed in the villages.

The slope of the shoulder should be greater than that of the pavement. A shoulder of with high type surfacing should have a slope from 2 to 6 percent. Gravel shoulders should have cross-slopes from 4 to 6 percent, and turf shoulders should have 6 to 8 percent slopes to assure efficient drainage of water away from the pavement. All shoulders should be sloped sufficiently to rapidly drain surface water, but not to the extent that vehicular use would be restricted.

It is desirable that the color and texture of shoulders be different from those of the traveled way. This contrast serves to clearly define the traveled way at all times, particularly at night and during inclement weather, while discouraging the use of shoulders as additional through lanes. Bituminous, crushed stone, gravel, and turf shoulders all offer excellent contrast with concrete pavements. Satisfactory contrast with bituminous pavements is more difficult to achieve. Various types of stone aggregates and turf offer good contrast.

### **III. Medians**

In order to provide protection against a conflict with opposing traffic, highways are divided by a median strip. Medians are highly desirable on arterials carrying four or more lanes. The principal functions of a median are to separate opposing traffic, provide a recovery area for out of- control vehicles, provide a stopping area in case of emergencies, allow space for speed changes and storage of left-turning and U- turning vehicles, minimize headlight glare, and provide width for future lanes. Additional benefits of a median in an urban area are that it may offer an open green space, may provide a refuge area for pedestrians crossing the street, and may control the location of intersection traffic conflicts. For maximum efficiency, a median should be highly visible both night and day and should contrast with the traveled way.

The general range of median widths is from 1.2 to 24 m or more. Economic of the highway, signalization at intersection and right-of-way restriction limit the determination of median width. Cost of construction and maintenance increases as median width increases. The median width, particularly at rural unsignalized intersections, should be specifically designed to accommodate turning and crossing maneuvers of specific design vehicles. In urban and suburban areas, however, narrower medians appear to operate better at unsignalized intersections; therefore, wider medians should only be used in urban and suburban areas where needed to accommodate turning

and crossing maneuvers by larger vehicles. If right-of-way is restricted, a wide median may not be justified if provided at the expense of narrowed border areas.

Medians may be depressed, raised, or flush with the traveled way surface. A depressed median is generally preferred on freeways for more efficient drainage and snow removal. Median side slopes should preferably be 1V:6H, but slopes of 1V:4H may be adequate. Drainage inlets in the median should be designed either with the top of the inlet flush with the ground or with culvert ends provided with traversable safety grates.

Raised medians have application on arterial streets where it is desirable to regulate left-turn movements. They are also frequently used where the median is to be planted, particularly where the width is relatively narrow. Careful consideration should be given to the location and type of plantings.

Flush medians are commonly used on urban arterials. Where used on freeways, a median barrier may be needed. The crowned type is frequently used because it eliminates the need for collecting drainage water in the median.

#### **IV. Pavement Crowns**

Another element of the highway cross section is the pavement crown, which is the raising of the centerline of the roadway above the elevation of the pavement edges should be sufficient to provide adequate surface drainage whilst not being so great as to make steering difficult. The ability of a surface to shed water varies with its smoothness and integrity. On unpaved roads, the minimum acceptable value of cross fall should be related to the need to carry surface water away from the pavement structure effectively, with a maximum value above which erosion of material starts to become a problem.

The normal cross fall should be 2.5 percent on paved roads and 4 percent on unpaved roads. Shoulders having the same surface as the roadway should have the same normal cross fall. Unpaved shoulders on a paved road should be 1.5 percent steeper than the cross fall of the roadway. The precise choice of normal cross fall on unpaved roads will vary with construction type and material rather than any geometric design requirement. In most circumstances, cross falls of 4 percent should be used, although the value will change throughout the maintenance cycle.

When four or more traffic lanes are used, it is advisable to provide a higher rate of crown on the outer lanes in order to expedite the flow of water from the pavement into



the gutter or onto adjacent unpaved shoulders.

#### **V. Curbs**

A curb is a steep raised element of a roadway that provides following functions: drainage control, roadway edge delineation, right-of-way reduction, aesthetics, delineation of pedestrian walkways, reduction of maintenance operations, and assistance in orderly roadside development. A curb, by definition, incorporates some raised or vertical element.

Curbs are used extensively on all types of low-speed urban highways. In the interest of safety, caution should be exercised in the use of curbs on high-speed rural highways. Where curbs are needed along high speed rural highways due to drainage considerations, the need for access control, restricted right-of-way, or other reasons, they should always be located at the outside edge of the shoulder.

The design of curbs varies from a low, flat, angle-type (sloping) to a nearly barrier-type curb. Vertical curbs may be either vertical or nearly vertical and are intended to discourage vehicles from leaving the roadway. Vertical curbs may range from 150 to 200 mm in height. When the slope of the curb face is steeper than 1V:1H, vehicles can mount the curb more readily when the height of the curb is limited to at most 100 mm and preferably less. However, when the face slope is between 1V:1H and 1V:2H, the height should be limited to about 150 mm.

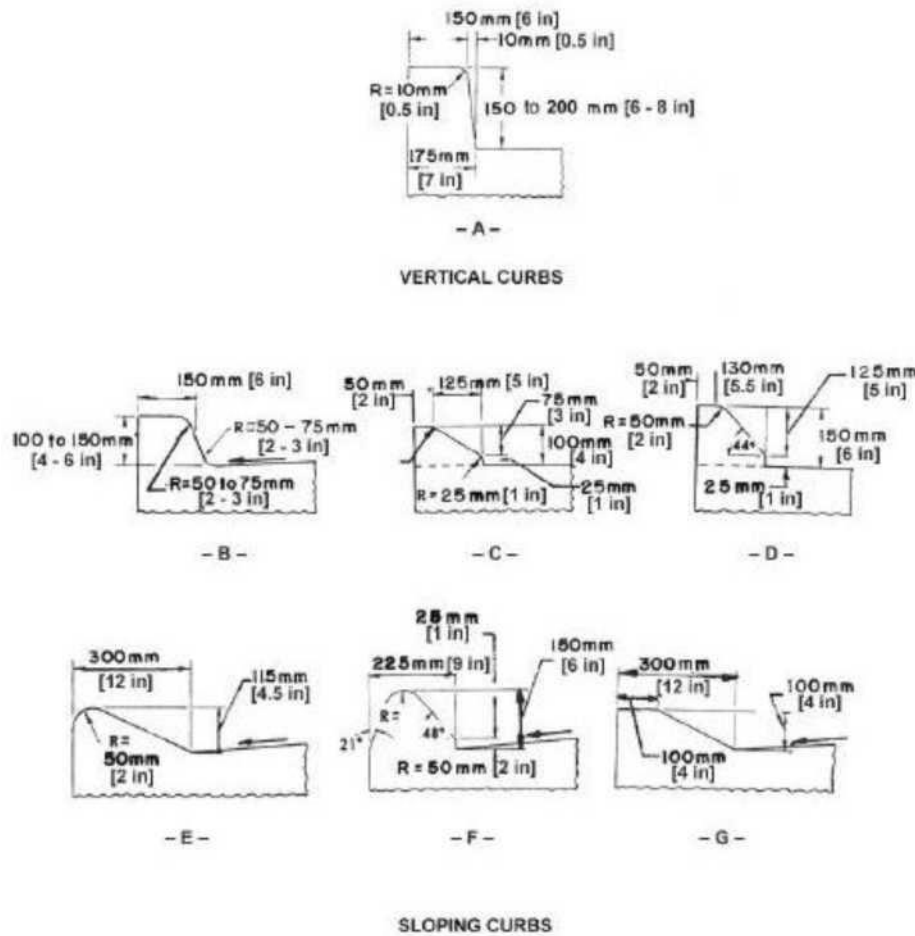

Figure 3- 2 Typical highway curb sections

## VI. Drainage Ditches

Drainage channels perform the vital function of collecting and conveying surface water from the highway right-of-way. Drainage channels, therefore, should have adequate capacity for the design runoff, provide for unusual storm water with minimum damage to the highway, and be located and shaped to provide a safe transition from the roadway to the back slope. Where the construction of a highway would have an adverse effect on drainage conditions downstream, drainage channels can be an effective means of flood storage within the highway right-of-way. Drainage channels include (1) roadside channels in cut sections to remove water from the highway cross section, (2) toe-of-slope channels to convey the water from any cut section and from adjacent slopes to the natural watercourse, (3) intercepting channels placed back of the top of cut slopes to intercept surface water, and (4) flumes to carry collected water down steep cut or fill slopes.

The primary purpose for construction of roadside channels is to control surface drainage. The most economical method of constructing a roadside channel usually entails the formation of open-channel ditches by cutting into the natural roadside terrain to produce a drainage channel. The minimum desirable grade for channels should be based upon the drainage velocities needed to avoid sedimentation. The

Maximum desirable grade for unpaved channels should be based upon a tolerable velocity for vegetation and shear on soil types. Generally, a broad, flat, rounded ditch section has been found to be safer than a V- type ditch, which also may be subject to undesirable erosive hydraulic action.

## **VII. Side slopes**

The graded area immediately adjacent to the graded roadway shoulder is the side slope. Side slopes should be designed to ensure roadway stability and to provide a reasonable opportunity for recovery for an out- of-control vehicle. Side slopes should be designed to ensure roadway stability and to provide a reasonable opportunity for recovery for an out-of-control vehicle.

In cross section with drainage ditch, the slope on the far side of the ditch where the roadside region slopes back to natural topography is back slope. The side slope down to the ditch is often referred to as the fore slope. Fore slopes of 1V:4H are used in a great deal in both cut and fill sections up to about 3m in depth or height, where the height of the cut or fill does not exceed 1.8 m, a maximum side slope of 1V:6H is recommended. The back slopes in cut areas may vary from 1V:6H to vertical in rock sections and to 1V:5H in normal soil conditions. In general, the selection of a side slope and back slope is dependent on safety considerations, height of cut or fill, and economic considerations.

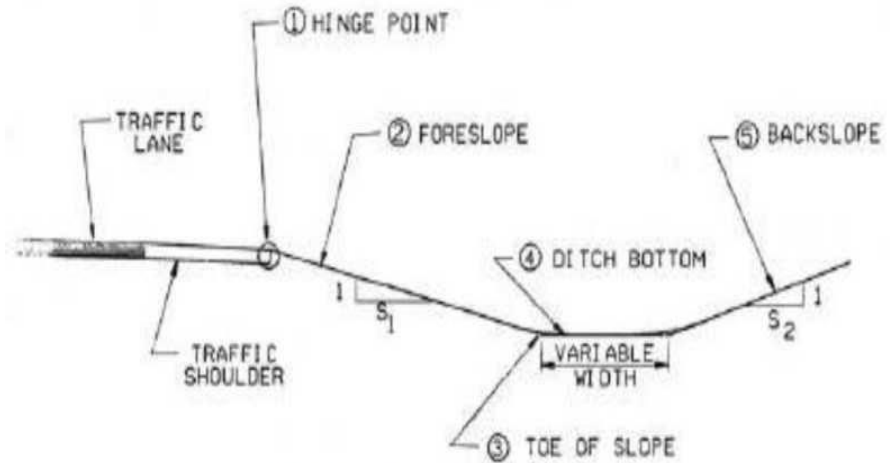

Figure 3-3 Designation of Roadside Regions

**Terms and Definitions for Road Cross Section Elements**

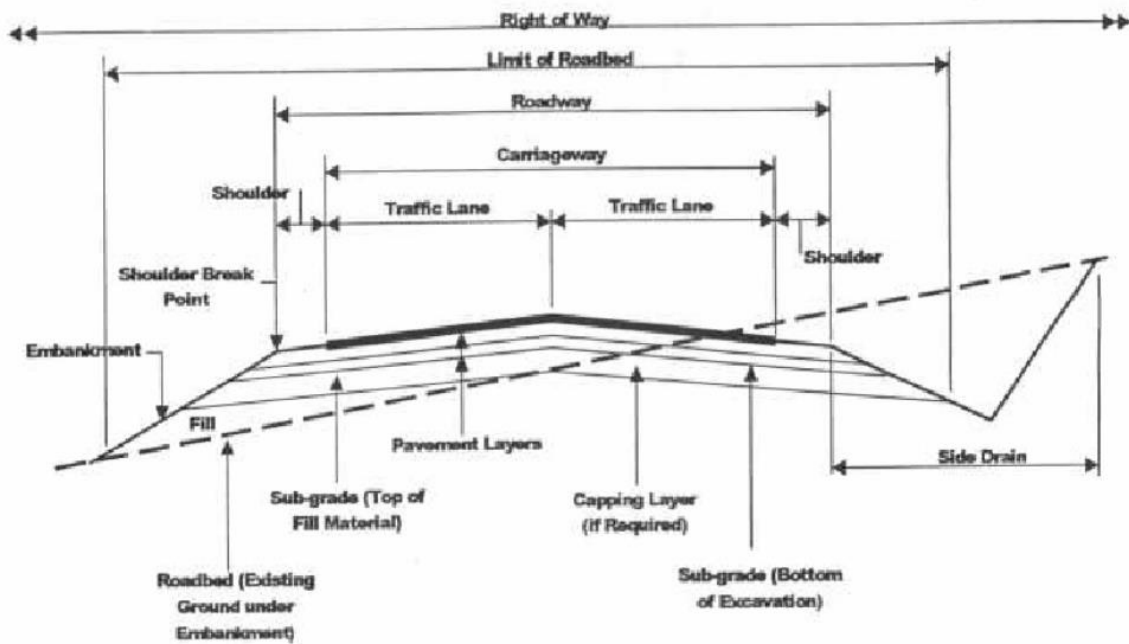

Figure 3.3: - typical highway cross section elements

## CHAPTER FOUR

### ELEMENTS OF GEOMETRIC DESIGN

#### 4.1. SIGHT DISTANCE

The driver's ability to see ahead contributes to safe and efficient operation of the road. Ideally, geometric design should ensure that all times any object on the pavement surface is visible to driver within eye-sight distance. However, this is not feasible because of topographical and other constraints, so it is necessary to design roads on the basis of lower, but safe, sight distances.

Sight distance is the length of highway visible to the driver of a vehicle. There are three different sight distances which are of interest in geometric design:

- Stopping sight distance:
- Passing sight distance
- Decision sight distance

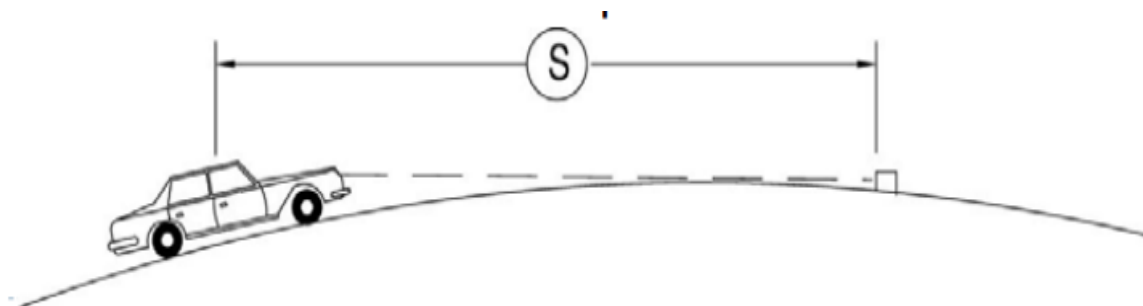

Figure 3.4: - sight distance

### 3.3.1. Stopping Sight Distance

Stopping sight distance is the minimum distance required to stop a vehicle traveling near a design speed before it reaches a stationary object in the vehicle's path. Sight distance at every point should be as long as possible but never less than the minimum stopping sight distance. The minimum stopping is based on the sum of two distances: (1) the distance traversed by the vehicle from the instant the driver sights an object necessitating a stop to the instant the brakes are applied; and (2) the distance needed to stop the vehicle from the instant brake application begins. These are referred to as brake reaction distance and braking distance, respectively. The first of these two distances is dependent on the speed of vehicles and the perception time and brake-reaction time of the driver. The second distance depends on the speed of the vehicle, the deceleration rate of the vehicle, and the alignment and grade of the highway.

**Brake reaction distance:  $0.278Vt$**

Where V : in Km/hr

t: in seconds

**Braking distance**

- Braking distance on a level road =  $V^2/ 254f$   
f = coefficient of friction
- Braking distance on slopes =  $V^2/(f \pm G/100)$

Where G is the grade of the highway

**Total stopping sight distance**

$$S = SSD = 0.278 Vt + V^2/254(f + G/100)$$

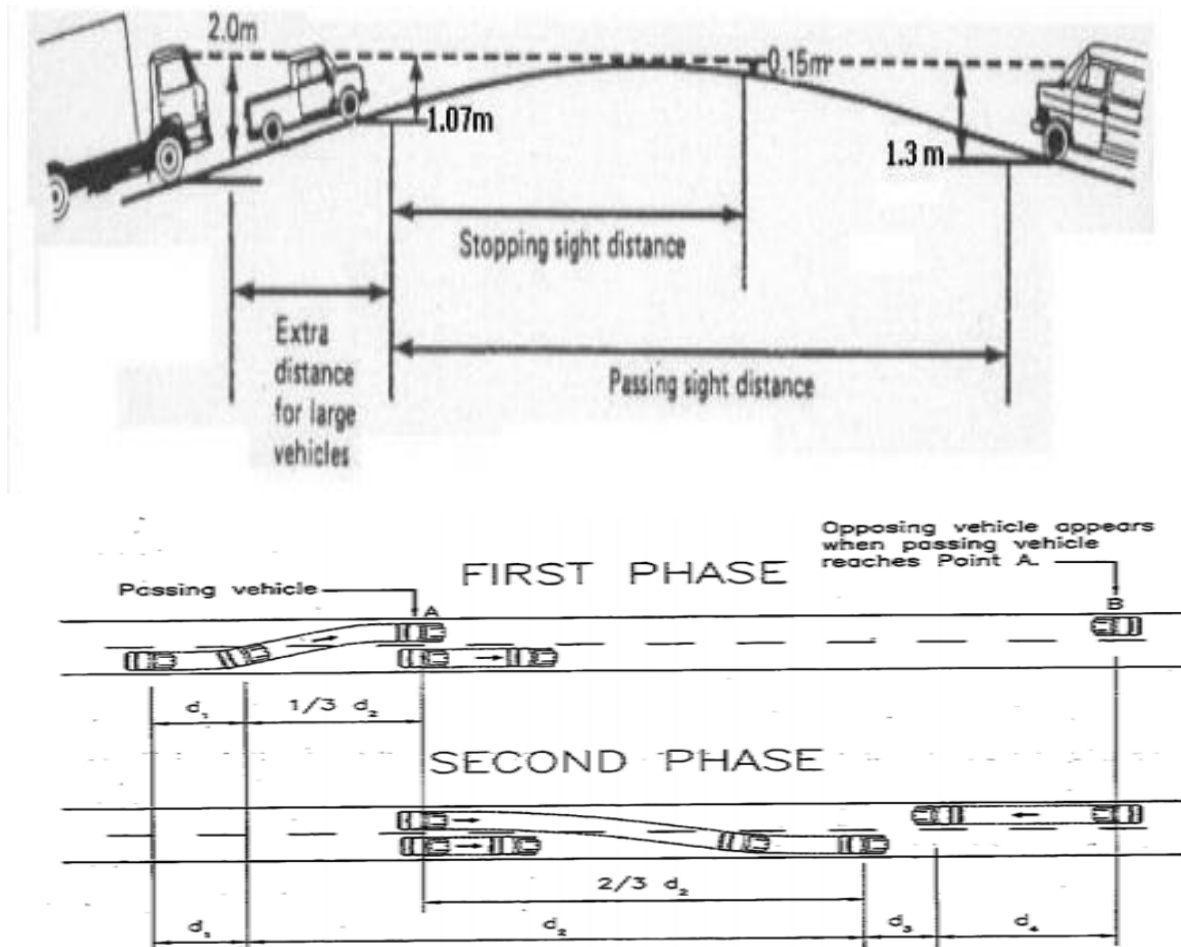

Figure 3.5:- Stopping sight distance

In single lane roads, when two-way movement of traffic is permitted then stopping sight distance should be equal to twice of the stopping distance plus 30 m safety distance.

**Criteria for Measuring Sight Distance**

Sight distance is the distance along a roadway throughout which an object of specified height is continuously visible to the driver. This distance is dependent on the height of the driver's eye above the road surface, the specified object height above the road surface, and the height and lateral position of sight obstructions within the driver's line of sight.

- S Driver's eye height: 1.07 meters
- S Object height for stopping sight distance: 0.15 meters
- S Object height for passing sight distance: 1.30 meters

### 3.3.2. **Passing Sight Distance**

Passing Sight Distance is the minimum sight distance on two-way single roadway roads that must be available to enable the driver of one vehicle to pass another vehicle safely without interfering with the speed of an oncoming vehicle traveling at the design speed. Passing sight distance for use in design should be determined on the basis of the length needed to complete normal passing maneuvers in which the passing driver can determine that there are no potentially conflicting vehicles ahead before beginning the maneuver. Minimum passing sight distances for design of two-lane highways incorporate certain assumptions about driver behavior.

1. The overtaken vehicle travels at uniform speed.
2. The passing vehicle has reduced speed and trails the overtaken vehicle as it enters a passing section.
3. When the passing section is reached, the passing driver needs a short period of time to perceive the clear passing section and to react to start his or her maneuver.
4. Passing is accomplished under what may be termed a delayed start and a hurried return in the face of opposing traffic. The passing vehicle accelerates during the maneuver, and its average speed during the occupancy of the left lane is 15 km/h [10 mph] higher than that of the overtaken vehicle.
5. When the passing vehicle returns to its lane, there is a suitable clearance length between it and an oncoming vehicle in the other lane.

The minimum passing sight distance for two-lane highways is determined as the sum of the following four distances,

- $d_1$ —Distance traversed during perception and reaction time and during the initial acceleration to the point of encroachment on the left lane.
- $d_2$ —Distance traveled while the passing vehicle occupies the left lane.
- $d_3$ —Distance between the passing vehicle at the end of its maneuver and the opposing vehicle.

$d_4$ —Distance traversed by an opposing vehicle for two-thirds of the time the passing vehicle occupies the left lane, or  $2/3$  of  $d_2$  above.



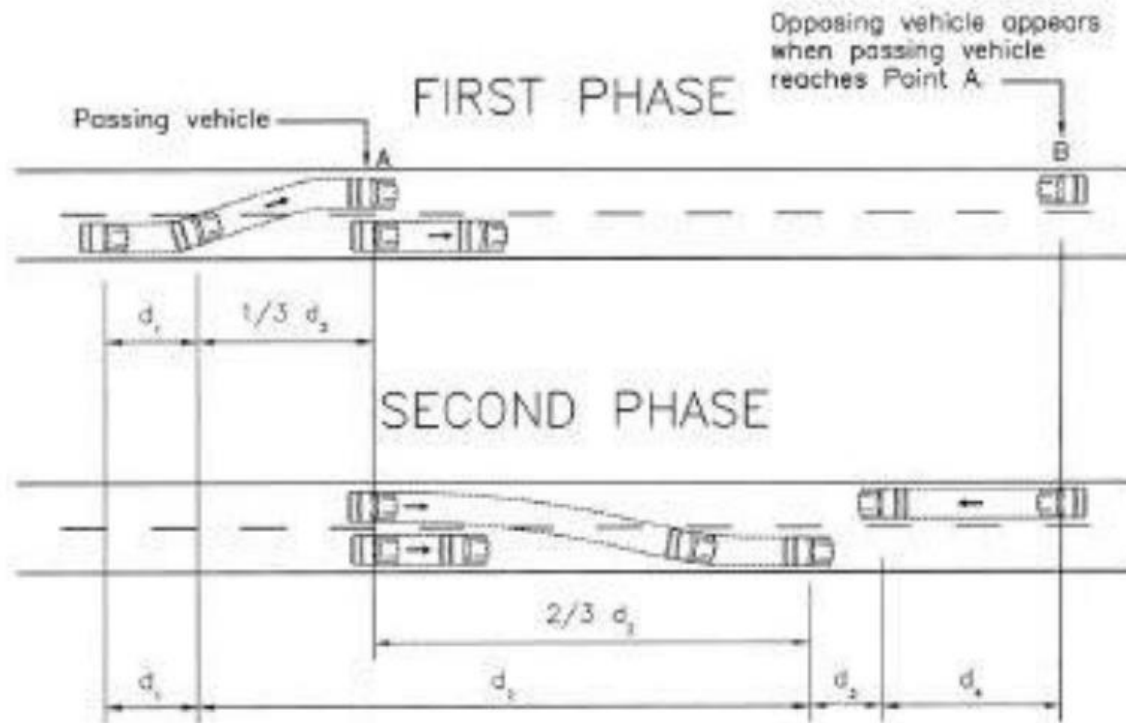

Figure:- elements of passing sight distance for two lane highways

- The formulae for these components are as indicated below:
  - $d_1 = 0.278 t_1 (v - m + (at_1/2))$
- Where
  - $t_1$  = time of initial maneuver, s
  - $a$  = average acceleration, km/h/s
  - $v$  = average speed of passing vehicle, km/h
  - $m$  = difference in speed of passed vehicle and passing vehicle, km/h
  - $d_2 = 0.278 vt_2$

- Where
  - $t_2$  = time passing vehicle occupies left lane, s
  - $v$  = average speed of passing vehicle, km/h
  - $d_3$  = safe clearance distance between vehicles at the end of the maneuver, is dependent on ambient speeds

Speed Group Km/h	50 - 65	66 - 80	81 - 100	101 - 120
$d_3$ (m)	30	55	80	100

Table 3.1:- Clearance Distance ( $d_3$ ) vs. Ambient Speeds (ERA2002)

$d_4$  = distance traversed by the opposing vehicle, which is approximately equal to  $d_2$  less the portion of  $d_2$  whereby the passing vehicle is entering the left lane, estimated at:  $d_4 = 2d_2/3$

The minimum Passing Sight Distance (PSD) for design is therefore:

**PSD =  $d_1 + d_2 + d_3 + d_4$ .....**

### 3.3.3. Intersection sight distance (ISD)

ISD refers to the corner sight distance available in intersection quadrants that allows a driver approaching an intersection to observe the actions of vehicles on the crossing leg(s). ISD evaluations involve establishing the needed sight triangle in each quadrant by determining the legs of the triangle on the two crossing roadways. Within this clear sight triangle, the objective is to remove or lower any object that obstructs the driver's view, if practical. Sight obstruction may include: buildings, parked or turning vehicles, trees, hedges, fences, retaining walls, and The actual ground line. Where a crossroad intersects the major road near a bridge on a crest vertical curve, items such as bridge parapets, piers, abutments, guardrail, or the crest vertical curve itself may restrict the clear sight triangle.

If it is impractical to remove an obstruction blocking the sight distance, consider providing traffic control devices or design applications (e.g., warning signs, turn lanes), which may not otherwise be considered

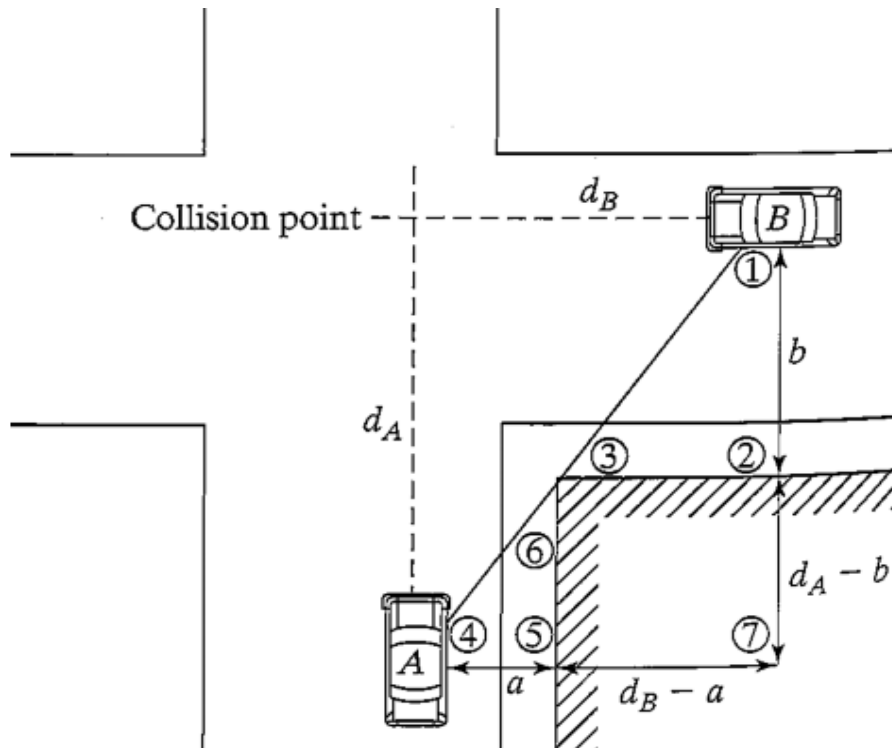

**From similarity of triangles  $\Delta 123$ ,  $\Delta 147$ ,  $\Delta 645$ , we get,**

$$\frac{b}{d_B - a} = \frac{d_A - b}{a} d_B = \frac{a d_A}{d_A - b}$$

#### 4.2. HORIZONTAL ALIGNMENT

Horizontal alignment includes the straight (tangent) sections of the roadway and circular curves that connect their change in direction. The design of the alignment depends primarily on the design speed selected for the highway. In addition to this, there other factors which affect the design of horizontal alignment such as type of curve, friction, super elevation and highway widening of pavements on curves.

Horizontal alignment should be as straight as possible but should be consistent with the topography through which it passes. Although a straight is the shortest distance, it is rarely physically or environmentally physical. Terrain conditions, physical features, and right of way limitations all contribute to the need for occasional directional changes. The resulting configuration of tangent and curve sections affects safe vehicle operating speeds, sight distances, and opportunities for phasing and highway capacity.

### 3.4.1 GENERAL CRITERIA

Horizontal alignment should meet these general considerations:

- 1) Alignment should be as straight as possible within physical and economic constraints. A flowing line that conforming generally to the contours is always preferable from construction, maintenance and aesthetic point of view to the one with long tangents that slashes through the terrain.
- 2) Alignment should be consistent. Try to avoid sharp curves at the ends of long tangents and sudden changes from gently to sharply curving alignment.
- 3) Curves with small deflection angle ( $5^\circ$  degrees or less) should be at least 150m (500ft) long and increased 30m (100ft) for every one-degree in deflection angle, to avoid the appearance of kink.
- 4) Avoid horizontal curvature on bridges when possible, however, when curvature is unavoidable, place the entire bridge on a single curve as flat as physical conditions permit. Ending or beginning curve on or near a bridge can present design and construction problems with super elevation transition.
- 5) Avoid "Brocken-back" - short tangent section between two curves in the same direction.

## DESIGN ELEMENTS IN HORIZONTAL ALIGNMENT

### I. Straight Line

Designers should generally attempt to create alignments that will provide the shortest distance between two established control points. Although long straights are economical, short and avoid centrifugal forces, they include monotony and headlight dazzling effect to the driver causing accidents. Therefore, the swung alignment in the landscape is preferred.

The following guidelines may apply concerning the length of straights:-

1. Maximum length should not be greater than  $20 \times \text{Velocity}$  (in meter).
2. Minimum length should not greater than  $2 \times \text{Velocity}$  for sight distance.
3. In curves of the same direction intermediate straight lines should be avoided or amounted to  $6 \times \text{Velocity}$ .

## II. Horizontal Curves

Generally, there four types of horizontal curves that are in the alignment of highways.

A. Simple B. Compound C. Reverse D. Spiral Curve

**Simple Curve:** - A simple curve has a constant radius to achieve the desired deflection without the use of an entering or existing transition. Because of their simplicity and ease of design, survey and construction, simple curves are most frequently used type of curve.

### NOTE:

M-middle ordinate

T-Tangent length

C-Cord length

L-Length of curve

R-Radius of curve

$\Delta$ -Central angle

PC-point of curvature

PT-Point of tangency

PI- Point of intersection

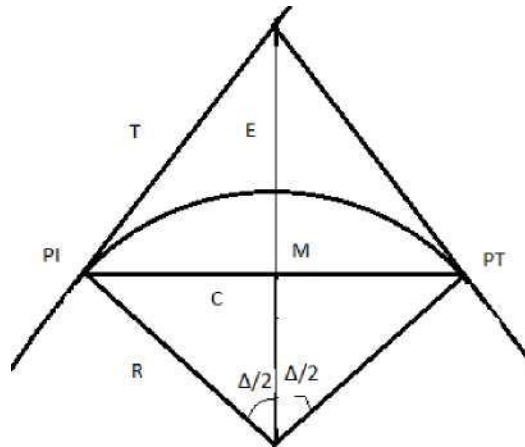

A simple curve is described either by its radius, for or by the degree of the curve. These are two ways to define degree of the curve, which is based on the 100 ft of arc length (Arc definition) on 100 ft of chord length (chord definition).

**From Arc definition:** -  $R = \frac{1746.5}{D}$  Where: - R: Radius of curve (m)  
D: Degree of the curve

- Tangent (T)  $T = R \tan \Delta/2$
- Middle Ordinate (M)  $M = R(1 - \cos \Delta/2)$
- Cord ( C)  $C = 2R \sin \Delta/2$
- Length of the Curve (L)  $L_C = \frac{R\Delta\pi}{180}$
- External Distance  $E = R (\sec \Delta/2 - 1)$  Or  $E = T \tan \Delta/2$
- $PC = PI - T$
- $PT = PI + L$

**III. Compound Curves** This is a curve which is consisting of a series of two or more simple curves of different radii turning in the same direction. The following guidelines should be followed when using compound curves:- 1. Compound curves are appropriate for intersection curb radii, ramps and transitions into sharper curves. 2. As the curvature becomes successively sharper, the radii of the flatter curve should not be more than 50% greater than that of sharper curve.

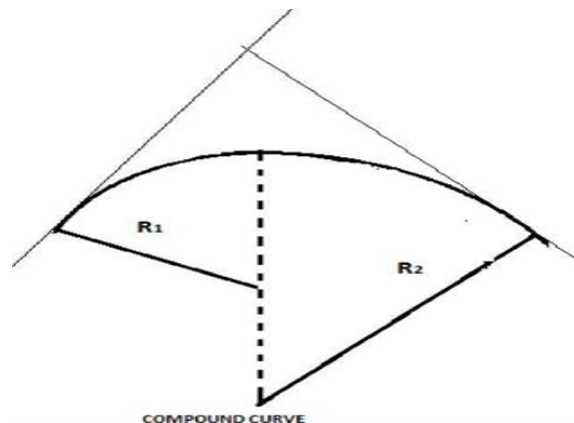

Figure: -compound curve

#### IV. Reverse Curves

Reverse curves usually consists of two simple curves with equal or different radii turning in opposite directions.

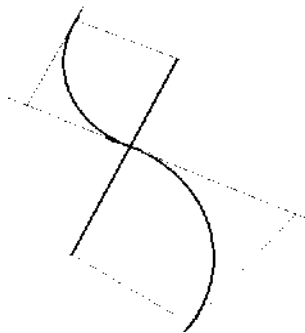
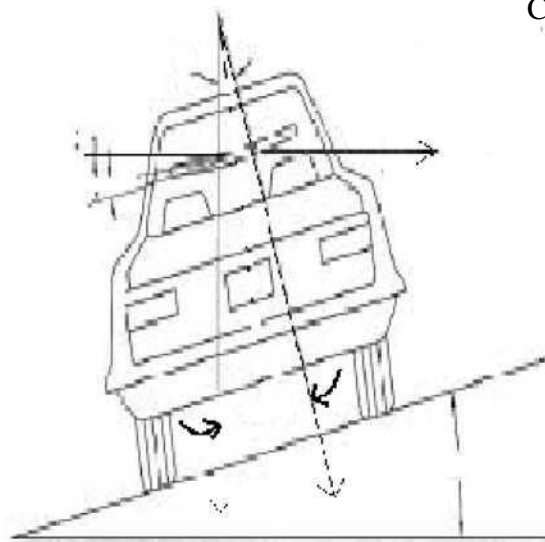

Figure:- Reverse curve

### 3.4.2 SUPER ELEVATION

Super elevation, a roadway cross-slope rate designated "e" is an integral part of the design of horizontal curvature that allows to safely and comfortably navigating through curves at higher speeds. Super elevation counterbalances the centrifugal force, or outward pull, of a vehicle traversing a horizontal curve. This is counterbalanced by providing roadway super elevation, by the side friction between the vehicle tires and the surfacing or some combination of the two.

Analysis of super elevation



Centrifugal force (out ward force)

$$F_c = \frac{WV^2}{gR}$$

#### Equilibrium condition

$$\frac{WV^2 \cos \alpha}{gR} = W \sin \alpha + W f_s \cos \alpha \dots\dots\dots *$$

$$\frac{[V^2 \cos \alpha = (\sin \alpha + f_s \cos \alpha) R] \frac{1}{G}}{\cos \alpha} \dots\dots\dots **$$

$$\frac{V^2}{g} = (\tan \alpha + f_s) R \dots\dots\dots ***$$

$$R : \frac{V^2}{g(\tan \alpha + f_s)}$$

- The tangent of angle of inclination of the roadway, i.e.  $\tan \alpha = e$

$$R = \frac{V^2}{g(e + fs)}$$

If  $g = 9.81 \text{ m/s}^2$  and  $V$  is in Km/h

$$R = \frac{V^2}{127} (e + fs)$$

Where  $V$ : Design speed

$e$ : maximum super elevation rate

$f$ : side friction

Limiting values have been established for both  $e$  and  $f$  in the formula. Since friction coefficients are dependent on vehicle speed, type condition and texture of roadway surface, weather conditions and type and condition of tires. The maximum rate of super elevation used highways is controlled by four factors: -

Climate conditions, terrain conditions, type of area and frequency of heavy-moving vehicles, whose operation might be affected by high super elevation rates.

In summary

- A rate of super elevation should not exceed 12%
- A rate of 4 % or 6 % is applicable for urban design in areas with little or no constraints.
- As per ERA manual 4 % for urban and 8 % for rural.

### SUPER ELEVATION TRANSITION

To meet the requirements of comfort and safety, super elevation should be introduced and removed uniformly over the length adequate for likely travel speeds. Super elevation transition section consists of the **Super elevation runoff** and **tangent run out** sections.

**Super elevation runoff:** - is the general term denoting the length of highway needed to accomplish the change in cross-slope in the outside-lane (flat) to of fully super elevation.

**Tangent run out:** - consists of the length of the roadway needed to accomplish a change in outside-lane cross slope from the normal cross slope rate to zero (flat).



When a transition curve is not used, the roadway tangent directly adjoins the main circular curve. This type of transition design is referred to as **tangent-to-curve** transition.

#### Minimum Length of Super elevation runoff

For appearance and comfort, the length of Super elevation runoff should be based on maximum acceptable difference between the longitudinal grades of the axis of rotation and edge of pavements. The maximum relative gradient is varied with design to provide longer runoff lengths at higher speeds and shorter at lower speeds.

Therefore the minimum length of Super elevation runoff is calculated using the following equation. Therefore the minimum length of Super elevation runoff is calculated using the following equation.

$$L_r = \frac{(wn)e}{D} (b_w)$$

**D**

Where  $L_r$ = minimum length of Super elevation runoff

D= maximum relative gradient (varies with V)

e= design Super elevation rate (%)

n = number of lanes rotated

w = width of one traffic

$b_w$ = adjustment factor for number of lanes rotated

Design speed (Km/h)	20	30	40	50	60	70	80	90	100	110	120	130
Maximum relative gradient	0.80	0.75	0.70	0.65	0.60	0.55	0.50	0.47	0.44	0.41	0.38	0.35

Table :- Maximum Relative Gradients

The above equation can be used directly for undivided streets or a highway where the cross section is rotated about the highway centerline and n is equal to one-half the number of lanes in the cross section. As the number of lanes increases the length also increases. Even though lengths of this order may be considered desirable; it is often not practical to provide such lengths in design. On a purely empirical basis, it is recommended that minimum super elevation runoff lengths be adjusted downward to avoid excessive lengths for multilane roadways.

Number of lanes rotated	Adjustment Factor
1	1
1.5	0.83
2	0.75
2.5	0.7
3	0.67
3.5	0.64

Table: - Adjustment factor for Number of Lanes

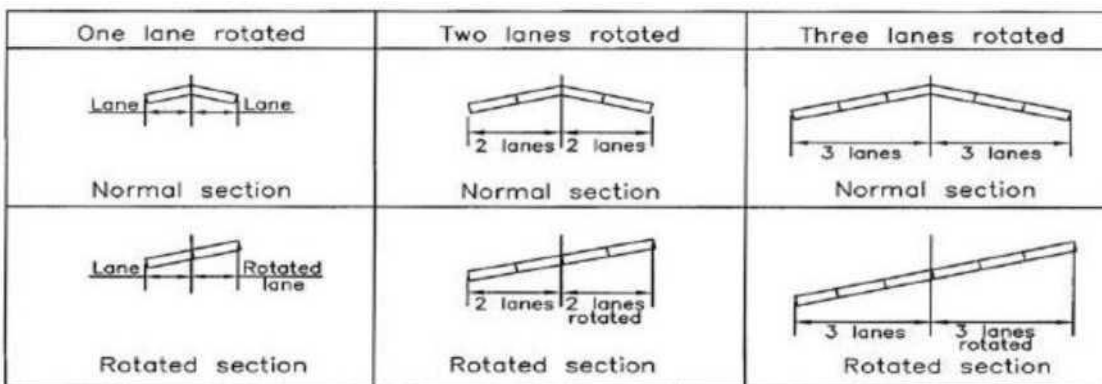

Figure:- super elevation

**Minimum Length of Tangent Runout:** The length of tangent runout is determined by the amount of adverse slope to be removed and the rate at which it is removed. To effect a smooth edge of pavement profile, the rate of removal should equal the gradient used to define the super elevation runoff length.

$$L_t = \frac{e_{NC}}{E} L_r$$

**E**

$L_t$ = minimum length of tangent runout

$e_{NC}$ = normal cross slope rate (%)

$e_d$ = design super elevation

$L_r$ = minimum length of super elevation runoff

**Runoff Location** On simple curves, 67 % of the super elevation runoff normally be developed on tangent and 33 % on circular curve. AASHTO suggests a range of 60 % to 90 % of the runoff placed on the tangent is acceptable.

Design speed Km/h	Portion of runoff located prior to the curve			
	1	1.5	2 - 2.5	3 - 3.5
20 – 70	0.80	0.85	0.90	0.90
80 – 130	0.70	0.75	0.80	0.85

Table: - Run off locations

On spiral curves, the super elevation runoff transition is normally within the entire length of the spiral (TS to SC and CS to ST)

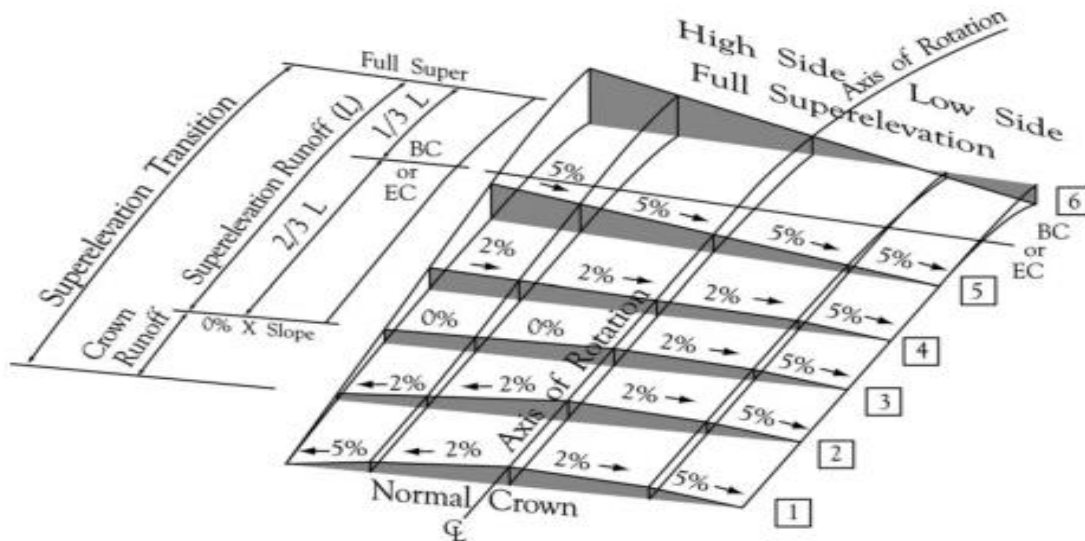

Figure:- super elevation transition

### Methods of Attaining Super elevation

Four methods are used to transition the pavement to a super elevated cross-section. These methods include

1. Revolving a travelled way with normal cross-slopes about the centerline profile.
2. Revolving a traveled way with normal cross-slopes about the inside-edge profile
3. Revolving a travel way with normal cross-slope about the outside-edge profile.
4. Revolving a straight cross-slope traveled way about the outside-edge profile.

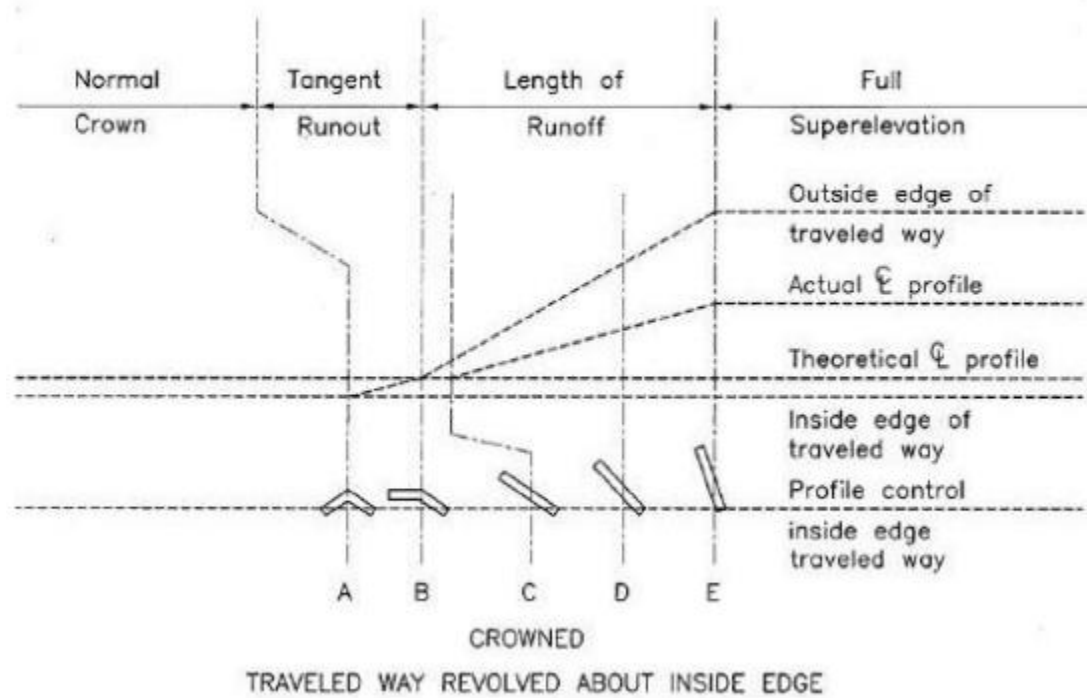
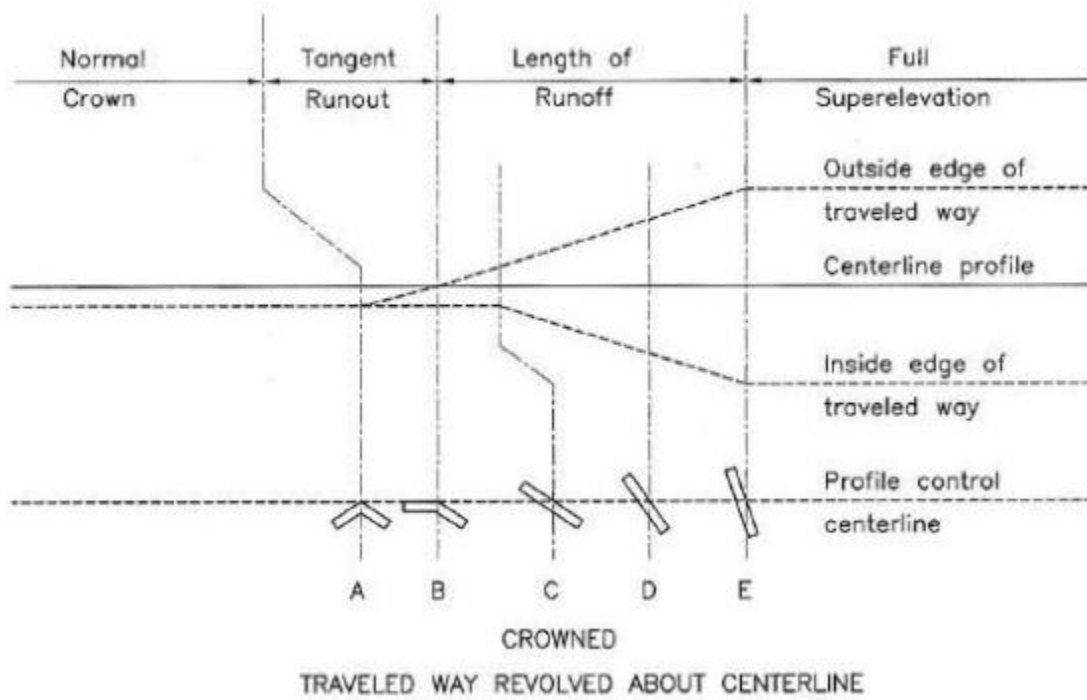

Figure Diagrammatic Profiles Showing Methods of Attaining Super elevation

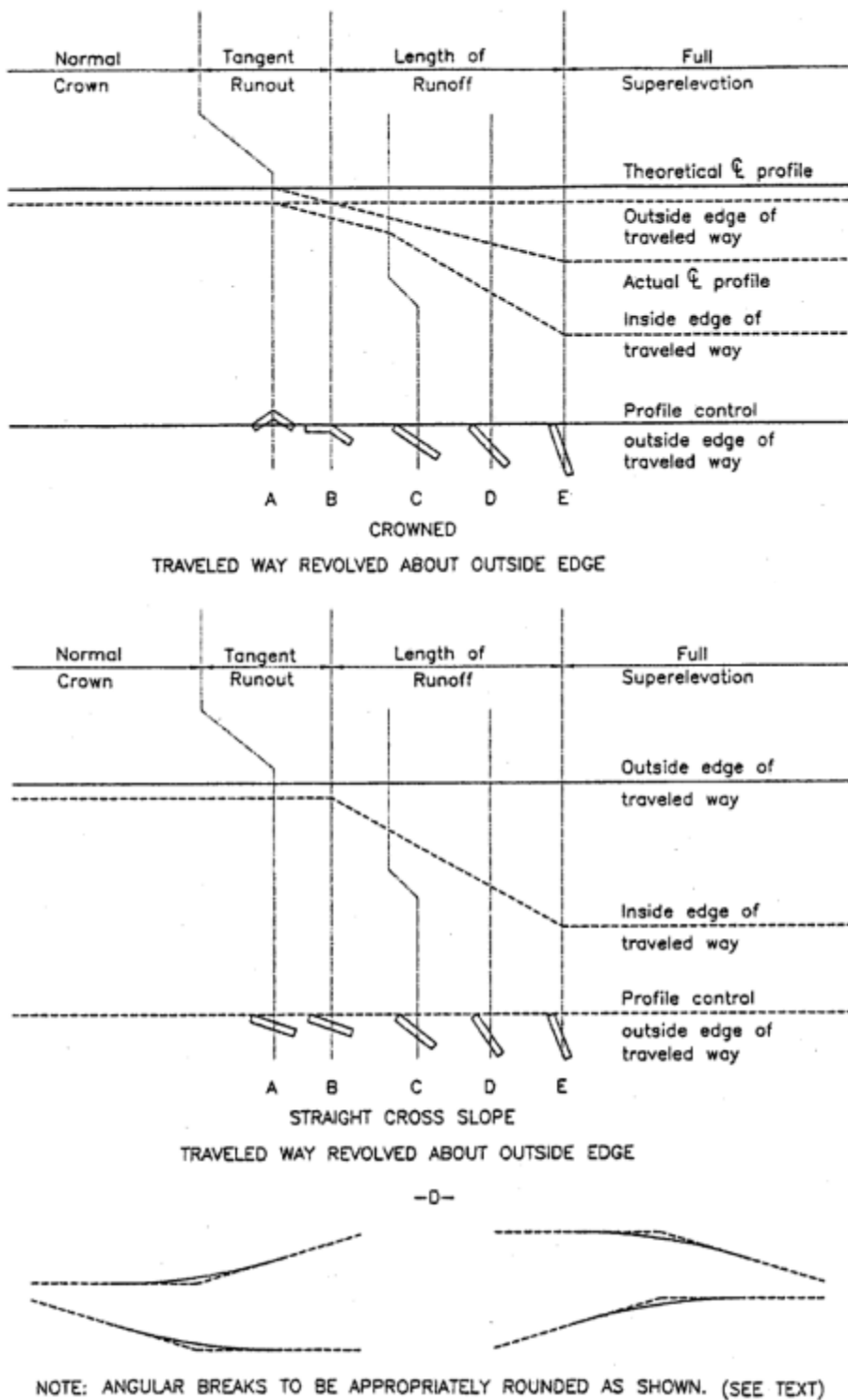

Figure:- Diagrammatic Profiles Showing Methods of Attaining Super elevation

**Axis of rotation with a Median** In the design of divided highways, the inclusion of the median in the cross-section influences the super elevation transition design. This influences arises from the several possible locations for the axis of rotation. The most appropriate location for this axis depends on the width of the median and its cross section. Common combinations of these factors and the appropriate corresponding axis location are described in the following 3 cases.

**Case I:** - the whole of the traveled way, including the median is super elevated as a plane section. The rotation in most cases is done about the centerline of the median. This method is used only for highways with narrow medians and moderate super elevation (specifically to width of 4 m or less)

**Case II:** - The median is held horizontal plane and two traveled ways are rotated separately around the median edges. This method is used mainly for pavements with median widths of 4 m and 18 m, although it can be used for any median.

**Case III:** - the two travelled ways are treated separately for runoff with a resulting variable difference in elevation at median edges. This design can be used with wide medians of 18 m or more.

**IV. Spiral Curves (Transition Curves)** Spiral curves have got a radius of curvature gradually changing from infinity to the designed radius. Transition curves are placed between tangents and circular curves or between two adjacent circular curves having substantially different radii. The advantages of transition curves in horizontal alignment are the following:-

1. A properly designed transition curve provides a natural, easy-to-follow path for drivers, such that the lateral force increases and decreases gradually as a vehicle enters and leaves a circular curve. Transition curves minimize encroachment on adjoining traffic lanes and tend to promote uniformity in speed.
2. The transition curve length provides a suitable location for the super elevation runoff.
3. A spiral curve also facilitates the transition in width where the traveled way is widened on a circular curve.
4. The appearance of the highway or street is enhanced by the application of spiral transition curves.

**Length of spiral** generally, the Euler spiral, which is also known as the clothoid is used in the design of spiral transition, curves. The radius varies from infinity at the tangent end of the spiral to the radius of the circular arc at the end that adjoins that circular arc. By definition, the radius of curvature at any point on an Euler spiral varies inversely with the

distance measured along the spiral.

**Widening of Curves** :-Extra width of pavement may be necessary on curves. As vehicle turns, the design vehicle occupies a greater width because the rear wheels generally track inside front wheels (offtracking) in negotiating curves, or drivers experience difficulty in steering their vehicles in the center of the lane. The other reason for widening is drivers have psychological shyness to drive close to the edge of the pavement on curves. The added width occupied by the vehicle as it traverses the curve is computed by adding the mechanical widening and psychological widening.

Let L= Length of wheel base of vehicle in m

b= Width of road in m

V- Design speed

R1= Radius of outer rear wheel in m

R2=radius of outer front wheel m

n= Number of lanes

Rc= Radius of curve in meter

$$L^2 = R_2^2 - R_1^2$$

$$L^2 = (R_2 - R_1)(R_2 + R_1)$$

$$\text{But } R_2 - R_1 = W$$

$$L^2 = W (R_2 + R_1)$$

$$W = L^2 / (R_2 + R_1)$$

Substitute  $R_2 = R_1 = R$

$$W = L^2 / 2R \dots \dots \dots \text{Mechanical widening}$$

The extra widening for **psychological** is assumed proportional to the speed and is taken as

$$\frac{V}{9.5\sqrt{R_C}} \text{ empirically} \dots \dots \dots \text{psychological}$$

Therefore, the total widening for n lanes is

$$W = \frac{nL^2}{2R_C} + \frac{0.1V}{\sqrt{R_C}}$$

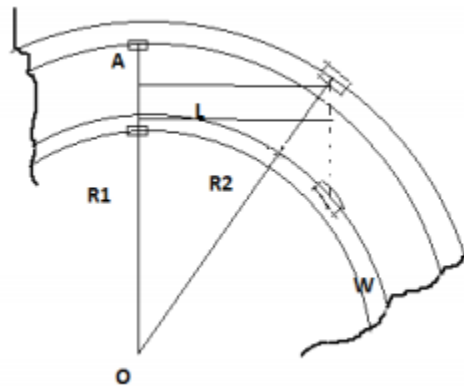

### 3.4.2 STOPPING SIGHT DISTANCE ON HORIZONTAL CURVES

Where there are sight obstructions (such as walls, cut slopes, buildings, and longitudinal barriers) on the inside of curves or the inside of the median lane on divided highways, a design may need adjustment in the normal highway cross section or change in the alignment if removal of the obstruction is impractical to provide adequate sight distance. Because of the many variables in alignment, in cross section, and in the number, type, and location of potential obstructions, specific study is usually needed for each individual curve. With sight distance for the design speed as a control, the designer should check the actual conditions on each curve and make the appropriate adjustments to provide adequate sight distance. For general use in design of a horizontal curve, the sight line is a chord of the curve, and the stopping sight distance is measured along the centerline of the inside lane around the curve.

Where sufficient stopping sight distance is not available

- (1) Increase the offset to the obstruction,
- (2) Increase the radius,
- (3) Reduce the design speed.

**When  $S < L$  (for two lane)**

$$M = R (1 - \cos \frac{28.65}{S} * S)$$

Where  $m$  = distance to obstruction from centerline of the inside lane

$w$  = width of inner pavement line

$\Delta$  = angle subtended at the center by an arc of length (in degree)

$R$  = radius of curve from the centerline of the inside lane



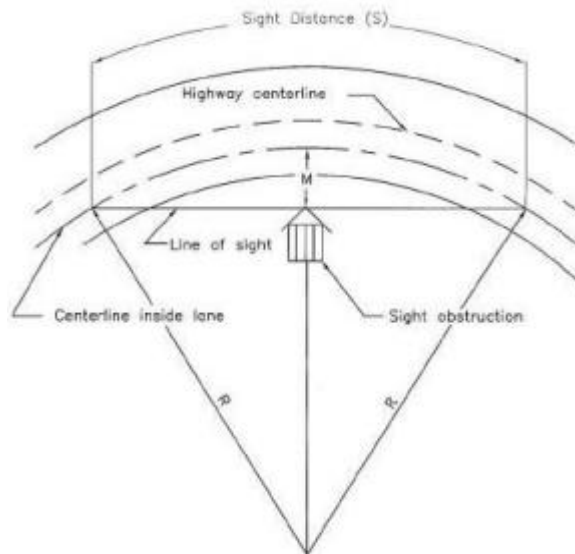

Figure: - Diagram Illustrating Components for Determining Horizontal

Where sufficient stopping sight distance is not available because a railing or a longitudinal barrier constitutes a sight obstruction, alternative designs should be considered for both safety and economic reasons. The alternatives are: (1) increase the offset to the obstruction, (2) increase the radius, or (3) reduce the design speed.

#### When $S > L$ (for two lane)

The above method presented is only exact when both the vehicle and the sight obstruction are located within the limits of the simple horizontal curve. When either the vehicle or the sight obstruction is situated beyond the limits of the simple curve, the values obtained are only approximate. If R is the radius of the curve from the centerline of the road.

$$m = R - (R - W/2) \cos \Delta/2 + \frac{S - L}{2} \sin \frac{\Delta}{2}$$

Where m= distance to obstruction from centerline of the inside lane

w= width of inner pavement line

Δ= angle subtended at the center by an arc of length (in degree)

R=radius of curve from the centerline of the inside lane

L=Length of the curve



## **2. RIGID PAVEMENTS**

### **2.1 General Characteristics**

Rigid pavements (also called concrete pavements), as the name implies, are rigid and very strong in compression. The strength of the pavement is contributed mainly by a concrete slab, unlike flexible pavements where successive layers of the pavement contribute cumulatively. The rugose surface required for an adequate resistance to skidding in wet conditions can be provided by dragging stiff brooms transversely across the newly-laid concrete or by cutting shallow randomly spaced grooves in the surface of the hardened concrete slab.

This constitution implies the following advantages :

- It is feasible to design rigid pavements for longer design lives, up to 60 years.
- Little maintenance is generally required
- Rigid pavement do not deform under traffic
- A relatively thin pavement slab distributes the load over a wide area due to its high rigidity. Localized low strength subgrade materials can be overcome due to this wider distribution area.
- Concrete is very resistant to abrasion making the anti-skidding surface texture last longer.
- In the absence of deleterious materials (either in the aggregate or entering the concrete in solution from an external source), unlike with flexible pavements, concrete does not suffer deterioration from weathering. Neither its strength nor its stiffness are materially affected by temperature changes.

The main disadvantages compared to flexible pavements are as follows :

- The initial investment is often more costly.
- If badly designed or not properly constructed, they tend to be more troublesome and reconstruction or repair is more difficult.

Until now, concrete pavements have not been extensively used in most tropical countries and in Ethiopia in particular, mainly due to a lack of tradition and experience in their design and construction. One characteristic of concrete pavements is that either they prove to be extremely durable, lasting for many years with little attention and maintenance, or they give troubles from the start, sometimes because of faults in design, but more often because of mistakes in construction.

### **2.2 Types of Rigid Pavements**

Depending on the level of reinforcement, the rigid pavements are categorized into three basic types:

- Jointed Unreinforced Concrete Pavements (JUCP)
- Jointed Reinforced Concrete Pavements (JRCP)
- Continuously Reinforced Concrete Pavements (CRCP)

### *2.2.1 JOINTED UNREINFORCED CONCRETE PAVEMENT*

In Jointed Unreinforced Concrete Pavements (JUCP), the pavement consists in an unreinforced concrete slab cast in place continuously and divided into bays of predetermined dimensions by the construction of joints. The bays dimensions are made sufficiently short so as to ensure that they do not crack. The bays are linked together by tie bars, the main function of which is to prevent horizontal movement (i.e. the opening of warping joints) and thus ensure load transfer through aggregate interlock.

### *2.2.2 JOINTED REINFORCED CONCRETE PAVEMENT*

In Jointed Reinforced Concrete Pavements (JRCP) the pavement consists generally in a cast in place concrete slab divided in reinforced concrete bays separated by joints. The reinforcement is made to prevent developing cracks from opening. This allows to design much larger bays than with JUCP. The bays are linked together by tie bars to prevent horizontal movement and thus ensure load transfer through aggregate interlock. The longitudinal reinforcement is the main reinforcement. A transverse reinforcement though not absolutely necessary in most cases is usually added to facilitate the placing of longitudinal bars.

### *2.2.3 CONTINUOUSLY REINFORCED CONCRETE PAVEMENT*

Continuously Reinforced Concrete Pavements (CRCP) are made of a cast in place reinforced concrete slab without joint. The expansion and contraction movements are prevented by a high level of sub-base restraint. The frequent transverse cracks are held tightly closed by a large amount of continuous high tensile steel longitudinal reinforcement.

### 3. PAVEMENT STRUCTURE

Rigid pavements generally consist of, as shown in Figure 1 below, a subbase, and a concrete slab constructed above the subgrade. (With a capping layer if required)

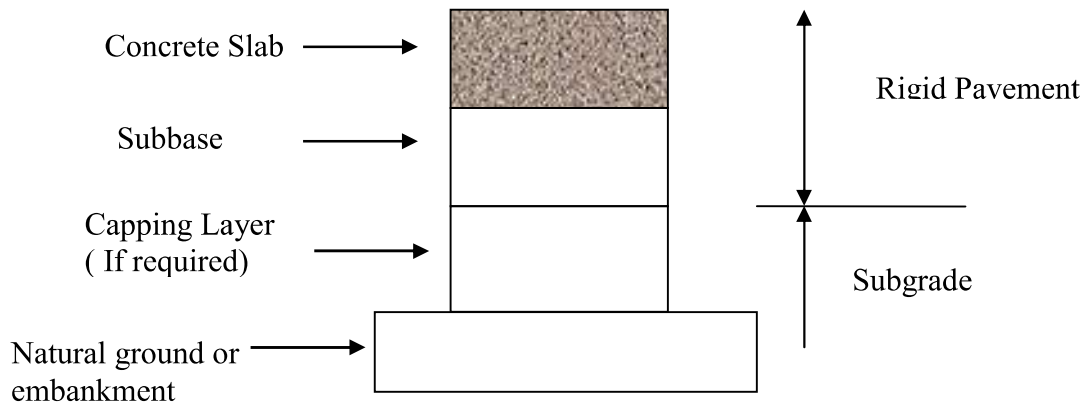

**Figure 1 Rigid Pavement structure**

The capping layer consists of selected fill and is provided in cases of low strength subgrade. It allows to increase the bearing capacity of the subgrade and thus enables a lesser pavement thickness to be adopted.

The subbase of a rigid pavement structure consists of one or more compacted layers of material placed between the subgrade and the concrete slab. In some cases the material can be cement stabilized to increase its quality. If the subgrade materials quality is acceptable and if the design traffic is low (less than one million equivalent standard axles (ESAs)), a subbase layer may not be necessary between the prepared subgrade and the concrete slab.

A subbase is provided under a concrete pavement for the following reasons:

- to provide a stable “working platform” for the construction equipment;
- to prevent “pumping” at joints and slab edges.

The concrete slab consists of Portland cement concrete, reinforcing steel (When required), load transfer devices and joint sealing materials.

Transverse reinforcement is provided to ensure that the longitudinal bars remain in the correct position during the construction of the slab. It also helps to control any longitudinal cracking that may develop.

The details regarding the design of the pavement slab thickness and the amount of reinforcement required are discussed in Chapter 7.

---

# Introduction to pavement design

## Overview

A highway pavement is a structure consisting of superimposed layers of processed materials above the natural soil sub-grade, whose primary function is to distribute the applied vehicle loads to the sub-grade. The pavement structure should be able to provide a surface of acceptable riding quality, adequate skid resistance, favorable light reflecting characteristics, and low noise pollution. The ultimate aim is to ensure that the transmitted stresses due to wheel load are sufficiently reduced, so that they will not exceed bearing capacity of the sub-grade. Two types of pavements are generally recognized as serving this purpose, namely flexible pavements and rigid pavements. This chapter gives an overview of pavement types, layers, and their functions, and pavement failures. Improper design of pavements leads to early failure of pavements affecting the riding quality.

## Requirements of a pavement

An ideal pavement should meet the following requirements:

- Sufficient thickness to distribute the wheel load stresses to a safe value on the sub-grade soil, structurally strong to withstand all types of stresses imposed upon it,
- Adequate co-efficient of friction to prevent skidding of vehicles,
- Smooth surface to provide comfort to road users even at high speed,
- Produce least noise from moving vehicles,
- Dust proof surface so that traffic safety is not impaired by reducing visibility,
- Impervious surface, so that sub-grade soil is well protected, and
- Long design life with low maintenance cost.

## Types of pavements

The pavements can be classified based on the structural performance into two, flexible pavements and rigid pavements. In flexible pavements, wheel loads are transferred by grain-to-grain contact of the aggregate through the granular structure. The flexible pavement, having less flexural strength, acts like a flexible sheet (e.g.

---

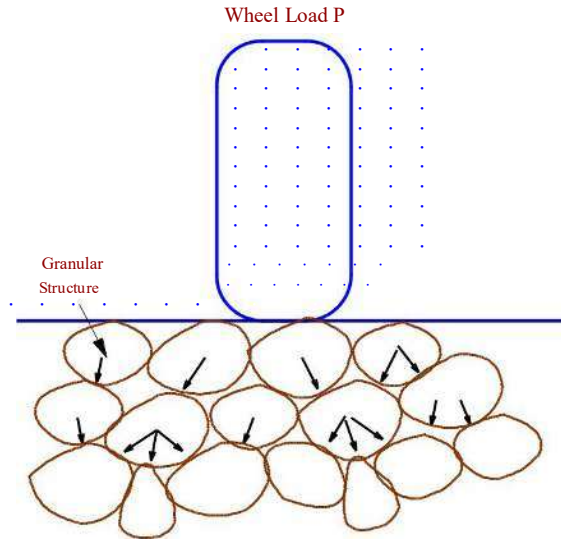

Figure 19:1: Load transfer in granular structure

bituminous road). On the contrary, in rigid pavements, wheel loads are transferred to sub-grade soil by flexural strength of the pavement and the pavement acts like a rigid plate (e.g. cement concrete roads). In addition to these, composite pavements are also available. A thin layer of flexible pavement over rigid pavement is an ideal pavement with most desirable characteristics. However, such pavements are rarely used in new construction because of high cost and complex analysis required.

## Flexible pavements

Flexible pavements will transmit wheel load stresses to the lower layers by grain-to-grain transfer through the points of contact in the granular structure (see Figure 19:1). The wheel load acting on the pavement will be distributed to a wider area, and the stress decreases with the depth. Taking advantage of these stress distribution characteristic, flexible pavements normally has many layers. Hence, the design of flexible pavement uses the concept of layered system. Based on this, flexible pavement may be constructed in a number of layers and the top layer has to be of best quality to sustain maximum compressive stress, in addition to wear and tear. The lower layers will experience lesser magnitude of stress and low quality material can be used. Flexible pavements are constructed using bituminous materials. These can be either in the form of surface treatments (such as bituminous surface treatments generally found on low volume roads) or, asphalt concrete surface courses (generally used on high volume roads such as national highways). Flexible pavement layers respect the deformation of the lower layers on to the surface layer (e.g., if there is any undulation in sub-grade then it will be transferred to the surface layer). In the case of flexible pavement, the design is based on overall performance of flexible pavement, and the stresses produced should be kept well below the allowable stresses of each pavement layer.

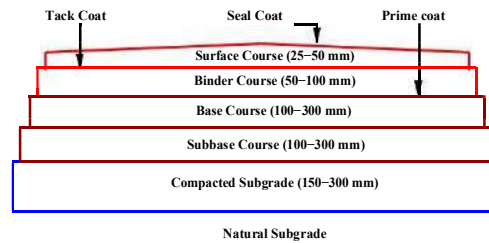

Figure 19:2: Typical cross section of a flexible pavement

## Types of Flexible Pavements

The following types of construction have been used in flexible pavement:

- Conventional layered flexible pavement,
- Full - depth asphalt pavement, and
- Contained rock asphalt mat (CRAM).

Conventional flexible pavements are layered systems with high quality expensive materials are placed in the top where stresses are high, and low quality cheap materials are placed in lower layers.

Full - depth asphalt pavements are constructed by placing bituminous layers directly on the soil sub-grade. This is more suitable when there is high traffic and local materials are not available.

Contained rock asphalt mats are constructed by placing dense/open graded aggregate layers in between two asphalt layers. Modified dense graded asphalt concrete is placed above the sub-grade will significantly reduce the vertical compressive strain on soil sub-grade and protect from surface water.

### Typical layers of a flexible pavement

Typical layers of a conventional flexible pavement includes seal coat, surface course, tack coat, binder course, prime coat, base course, sub-base course, compacted sub-grade, and natural sub-grade (Figure 19:2).

**Seal Coat:** Seal coat is a thin surface treatment used to water-proof the surface and to provide skid resistance.

**Tack Coat:** Tack coat is a very light application of asphalt, usually asphalt emulsion diluted with water. It provides proper bonding between two layer of binder course and must be thin, uniformly cover the entire surface, and set very fast.

**Prime Coat:** Prime coat is an application of low viscous cutback bitumen to an absorbent surface like granular bases on which binder layer is placed. It provides bonding between two layers. Unlike tack coat, prime coat penetrates into the layer below, plugs the voids, and forms a water tight surface.

### Surface course

Surface course is the layer directly in contact with traffic loads and generally contains superior quality materials. They are usually constructed with dense graded asphalt concrete (AC). The functions and requirements of this layer are:



---

It provides characteristics such as friction, smoothness, drainage, etc. Also it will prevent the entrance of excessive quantities of surface water into the underlying base, sub-base and sub-grade,

It must be tough to resist the distortion under traffic and provide a smooth and skid-resistant riding surface,

It must be water proof to protect the entire base and sub-grade from the weakening effect of water.

#### Binder course

This layer provides the bulk of the asphalt concrete structure. Its chief purpose is to distribute load to the base course. The binder course generally consists of aggregates having less asphalt and doesn't require quality as high as the surface course, so replacing a part of the surface course by the binder course results in more economical design.

#### Base course

The base course is the layer of material immediately beneath the surface of binder course and it provides additional load distribution and contributes to the sub-surface drainage. It may be composed of crushed stone, crushed slag, and other untreated or stabilized materials.

#### Sub-Base course

The sub-base course is the layer of material beneath the base course and the primary functions are to provide structural support, improve drainage, and reduce the intrusion of fines from the sub-grade in the pavement structure. If the base course is open graded, then the sub-base course with more fines can serve as a filler between sub-grade and the base course. A sub-base course is not always needed or used. For example, a pavement constructed over a high quality, stiff sub-grade may not need the additional features offered by a sub-base course. In such situations, sub-base course may not be provided.

#### Sub-grade

The top soil or sub-grade is a layer of natural soil prepared to receive the stresses from the layers above. It is essential that at no time soil sub-grade is overstressed. It should be compacted to the desirable density, near the optimum moisture content.

### Failure of flexible pavements

The major flexible pavement failures are fatigue cracking, rutting, and thermal cracking. The fatigue cracking of flexible pavement is due to horizontal tensile strain at the bottom of the asphaltic concrete. The failure criterion relates allowable number of load repetitions to tensile strain and this relation can be determined in the laboratory fatigue test on asphaltic concrete specimens. Rutting occurs only on flexible pavements as indicated by permanent deformation or rut depth along wheel load path. Two design methods have been used to control rutting: one to limit the vertical compressive strain on the top of Sub grade and other to limit rutting to a tolerable amount (12 mm normally). Thermal cracking includes both low-temperature cracking and thermal fatigue cracking.

---

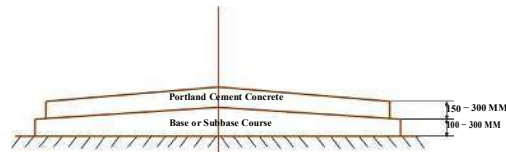

Typical Cross section of Rigid pavement

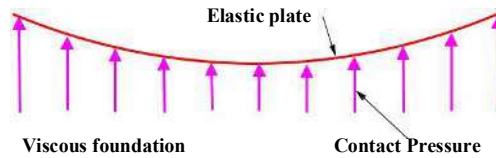

Elastic plate resting on Viscous foundation

## Rigid pavements

Rigid pavements have sufficient flexural strength to transmit the wheel load stresses to a wider area below. A typical cross section of the rigid pavement is shown in Figure 19:3. Compared to flexible pavement, rigid pavements are placed either directly on the prepared sub-grade or on a single layer of granular or stabilized material. Since there is only one layer of material between the concrete and the sub-grade, this layer can be called as base or sub-base course.

In rigid pavement, load is distributed by the slab action, and the pavement behaves like an elastic plate resting on a viscous medium (Figure). Rigid pavements are constructed by Portland cement concrete (PCC) and should be analyzed by plate theory instead of layer theory, assuming an elastic plate resting on viscous foundation. Plate theory is a simplified version of layer theory that assumes the concrete slab as a medium thick plate which is plane before loading and to remain plane after loading. Bending of the slab due to wheel load and temperature variation and the resulting tensile and flexural stress.

---

## Failure criteria of rigid pavements

Traditionally fatigue cracking has been considered as the major or only criterion for rigid pavement design. The allowable number of load repetitions to cause fatigue cracking depends on the stress ratio between flexural tensile stress and concrete modulus of rupture. Of late, pumping is identified as an important failure criterion. Pumping is the ejection of soil slurry through the joints and cracks of cement concrete pavement, caused during the downward movement of slab under the heavy wheel loads. Other major types of distress in rigid pavements include faulting, spalling, and deterioration.