



Ethiopian TVET-System



INDUSTRIAL ELECTRICAL MACHINE DRIVE TECHNOLOGY

Level-II

Based on May 2011 Occupational Standards

October, 2019



Module Title: Diagnosing and rectifying fault in motor drive system

TTLM Code: EELEMD2TTLM1019

This module includes the following Learning Guides

LG33: Prepare to diagnose and rectify faults

LG Code: EEEL EMD2 M05 Lo1LG-33

LG34: Diagnose and rectify faults.

LG Code: EELEMD2 M05 Lo2LG36

LG35: Complete and report fault diagnosis and rectification activities.

LG Code: EEEL EMD M05 LO3 LG 37

EEL EMD22	Version:01	Page No.2
	Copyright: Ethiopia Federal TVET Agency	

**Instruction Sheet****LG33: Prepare to diagnose and rectify faults**

This learning guide is developed to provide you the necessary information regarding to the following learning outcome and content coverage

- Applying electrical safe work practice
- Identifying and establishing OHS principles and procedures
- Documenting safety hazards.
- Determining the extent of faults.
- Selecting tools, equipment and testing devices

This guide will also assist you to attain the learning outcome and contents stated in the cover page. Specifically, upon completion of this Learning Guide, you will be able to:-

- Apply electrical safe work practice
- Identify and establish OHS principles and procedures
- Document safety hazards that have not previously been identified.
- Determine the extent of faults.
- Select tools, equipment and testing devices

Learning Instructions:

1. Read the specific objectives of this Learning Guide.
2. Follow the instructions described below 3 to 6
3. Read the information written in the “Information Sheet 1, Information Sheet 2, Information Sheet 3, Information Sheet 4 and Information Sheet 5”.
4. Accomplish the “Self-check 1, Self-check 2 Self-check 3, Self-check 4 and Self-check 1 Self-check 5”..
5. If you earn a satisfactory evaluation proceed to “Operation Sheet 1”.
6. Do the “LAP test”

EEL EMD22	Version:01	Page No.3
	Copyright: Ethiopia Federal TVET Agency	



1.1 Introduction to electrical safe work practice

The first step in developing a safe work environment is to have procedures in place which provide guidelines for employees to perform various tasks safely. The procedure should help eliminate injuries by providing rules and guidelines for people working on or near energized electrical circuit conductors.

It should address qualifications, tools, protective equipment, approval levels and attendance required for various tasks, as well as other additional cautionary information. Also this procedure should address safe approach distances for qualified and **unqualified** personnel.

When conductors are or may become energized, an alternative way of ensuring safety from the electrical hazards is to observe a safe approach distance (or clearance) from exposed conductors. It is important to know how close persons, or conductive objects which they might be carrying, can approach without endangering themselves. These clearances are greater for an **unqualified** person than for a qualified person.

Safety is very important not only to ensure our health but also to ensure our properties or equipment's.

Safety in the workshops is subject to a number of various risk assessments and safe codes of working practices which have to be observed and adhered to by all workshop users and enforced by the person in charge of these areas. Due to high risk activities taking place in the workshops access to these areas is restricted to authorized personnel only. No other person may enter the workshops without permission.

1.1.1 Workshop equipment and tools

- No machine may be used or work undertaken unless the technician-in-charge is satisfied that the person is capable of doing so safely if equipment is fitted with guards these must be used.
- Equipment must never be used if the safety guards have been removed.

EEL EMD22	Version:01	Page No.4
	Copyright: Ethiopia Federal TVET Agency	



- Any person working in the mechanical and electronic workshop must have read and signed the appropriate risk assessment if the work or equipment they are using has been risk assessed.
- No person shall mount any abrasive wheel unless he/ she has been trained in accordance with the use of Work Equipment.
- Grinding machines shall only be operated by technical staff and eye protection must be worn.
- Service records of all machine tools, plant and equipment must be kept. i.e There must be list of the date of any service/repair and name of the person responsible for carrying out that service/repair.
- Faults which cannot be repaired immediately should be reported to the technician-in-charge and a note should be attached to the machine where it is clearly visible indicating that the equipment is out of order.
- All Portable Electrical Equipment must be regularly inspected and tested for electrical safety.
- Ladders/stepladders should be individually identified and formal inspections carried out.
- No welding may be undertaken unless the technician-in-charge is satisfied that the person is capable of doing so safely.
- During any welding operation, the fume extraction system must be used.
- When using woodworking machines the dust extractor and face masks must be used.
- Equipment must be cleaned after use. Any materials, tools or equipment used must be tidied away.
- Precision measuring equipment, drills, etc. must be replaced in their appropriate cabinets after each working day.
- Tools and equipment must not be removed from the workshop without permission from the technician-in-charge.

1.1.2 Workshop practices and personal protective equipment

- Eating and drinking in the mechanical workshop areas are strictly prohibited.

EEL EMD22	Version:01	Page No.5
	Copyright: Ethiopia Federal TVET Agency	



- When working with machine tools or other equipment with rotating spindles, jewellery, loose clothing etc. are prohibited and long hair must be completely covered.
- Personal Protective Equipment (PPE) is supplied and must be used where necessary. Barrier cream, lab coats/overalls, eye and hearing protection, dust masks and safety shoes must be used as the work/risk assessment dictates.
- Lab coats/overalls and safety boots must be worn by technicians operating the machines.
- Any oil spillage, grease etc. must be cleaned up immediately.
- Do not carry loads such that the weight may be dangerous or vision obscured.

Self-Check -1	Written Test
----------------------	---------------------

Directions: Answer all the questions listed below . Use the Answer sheet on the next page:

INSTRUCTION-Say true if the statement is true and False if the thestetment false

___1.Safety is very important not only to ensure our health but also to ensure our properties or equipment.

___2.Safety procedures eliminate injuries by providing rules and guidelines for people working on or near energized electrical circuit conductors.

___3.**Equipment must be used if the safety guards have been removed.**

___4. **All Portable Electrical Equipment must not be regularly inspected and tested for electrical safety.**

___5.**Personal Protective Equipment (PPE) is supplied and must be used where necessary.**

Note: Satisfactory rating - 3 and 5 points Unsatisfactory - below 3 and 5 points

You can ask you teacher for the copy of the correct answers.

Answer Sheet

Score = _____
Rating: _____

EEL EMD22	Version:01	Page No.6
	Copyright: Ethiopia Federal TVET Agency	



Name: _____

Date: _____

Short Answer Questions

Information Sheet- 2	Identifying and establishing OHS principles and procedures
---------------------------------	---

2.1. Introduction to OHS principles and procedures

What is OHS ?

OHS stands for Health and safety – The purpose of OHS principles and procedures to guide and direct all employees to work and guide health and prevent them selves from electrical hazards. The OHS principles and procedures are very important and enable to be familiar with the electrical hazards associated with your workplace.

A safe work environment is not always enough to control all potential electrical hazards .You must be very cautious and work safely .

Safety rules help you control your and others risk of injury or death from workplace hazards

If you are working on electrical circuits or with electrical tools and equipment ,
you need to use following golden safety rules or procedures :

Rule no. 1

Avoid contact with energized electrical circuits . Please don ' t make fun of this rule if you already know this (and you probably already know if you are reading these lines) and remember that if something bad occurs – you probably won ' t have second chance that ' s not funny .

Rule no. 2

Treat all electrical devices as if they are live or energized.

You never know .

Rule no. 3

Disconnect the power source before servicing or repairing electrical equipment .

The only way to be sure .

EEL EMD22	Version:01	Page No.7
	Copyright: Ethiopia Federal TVET Agency	



Rule no. 4

Use only tools and equipment with non - conducting handles when working on electrical devices .Easy to check.

Rule no. 5

Never use metallic pencils or rulers, or wear rings or metal watchbands when working with electrical equipment . This rule is very easy to forget , especially when you are showing some electrical part pointing with metallic pencil .

Always be aware.

Rule no. 6

When it is necessary to handle equipment that is plugged in , be sure hands are dry and when possible , wear nonconductive gloves , protective clothes and shoes with insulated soles .

Remember Safety clothes , gloves and shoes

Rule no. 7

If it is safe to do so , work with only one hand , keeping the other hand at your side or in your pocket, away from all conductive material. This precaution reduces the likelihood of accidents that result in current passing through the chest cavity. If you ever read about current passing through human body you will know , so remember – work with one hand only.

If you don ' t clue about electric current path through human body ,

Rule no. 8

Minimize the use of electrical equipment in cold rooms or other areas where condensation is likely . If equipment must be used in such areas , mount the equipment on a wall or vertical panel .

Rule no. 9

If water or a chemical is spilled onto equipment , shut off power at the main switch or circuit breaker and unplug the equipment .

Very logical. NEVER try to remove water or similar from equipment while energized. After all , it ' s stupid to do so .

Rule no. 10

If an individual comes in contact with a live electrical conductor , do not touch the equipment , cord or person. Disconnect the power source from the circuit breaker or pull out the plug using a leather belt .

EEL EMD22	Version:01	Page No.8
	Copyright: Ethiopia Federal TVET Agency	



Tricky situation , and you must be very calm in order not to make the situation even worse.
Always disconnect the power FIRST

Rule no. 11

Equipment producing a “ tingle ” should be disconnected and reported promptly for repair .

Rule no. 12

Do not rely on grounding to mask a defective circuit nor attempt to correct a fault by insertion of another fuse or breaker , particularly one of larger capacity.

Rule no. 13

Drain capacitors before working near them and keep the short circuit on the terminals during the work to prevent electrical shock .

Rule no. 14

Never touch another person’ s equipment or electrical control devices unless instructed to do so .

Rule no. 15

Enclose all electric contacts and conductors so that no one can accidentally come into contact with them. If applicable do it always , if not be very carefull .

Rule no. 16

Never handle electrical equipment when hands, feet, or body are wet or perspiring, or when standing on a wet floor. Remember: Gloves and shoes

Rule no. 17

When it is necessary to touch electrical equipment (for example , when checking for overheated motors), use the back of the hand . Thus, if accidental shock were to cause muscular contraction , you would not “ freeze ” to the conductor .

Rule no. 18

Do not store highly flammable liquids near electrical equipment .

Rule no. 19

Be aware that interlocks on equipment disconnect the high voltage source when a cabinet door is open but power for control circuits may remain on.

Read the single line diagram and wiring schemes – know your switchboard .

Rule no. 20

De- energize open experimental circuits and equipment to be left unattended .

EEL EMD22	Version:01	Page No.9
	Copyright: Ethiopia Federal TVET Agency	



Rule no. 21

Do not wear loose clothing or ties near electrical equipment . Act like an electrical engineer , you are not on the beach .

What are correct work procedures established?

How do you establish correct work procedures?

Correct work procedures are the safest way of doing a job, job instruction, monitoring performance, and accident investigation.

Job safety analysis (JSA), also known as "job hazard analysis", is the first step in developing the correct procedure. In this analysis, each task of a specific job is examined to identify hazards and to determine the safest way to do the job.

Job safety analysis involves the following steps:

1. Select the job.
2. Break down the job into a sequence of steps.
3. Identify the hazards.
4. perform preventive and corrective measures

EEL EMD22	Version:01	Page No.10
	Copyright: Ethiopia Federal TVET Agency	



Self-Check -2

Written Test

Directions: Answer all the questions listed below. Use the Answer sheet on the next page:

INSTRUCTION-Say true if the statement is true and False if the thestetment false

- ____ 1.The purpose of OHS principles and procedures to guide and direct all employees to work and guide health and prevent themselves from electrical hazards.
- ____ 2.A safe work environment is not always enough to control all potential electrical hazards
- ____ 3.**Connecting the power source before servicing or repairing electrical equipment is recommended .**
- ____ 4.Use only tools and equipment with non - conducting handles when working on electrical devices.
- ____ 5.Storing highly flammable liquids near electrical equipment is necessary.

Note: Satisfactory rating - 3 and 5 points Unsatisfactory - below 3 and 5 points

You can ask you teacher for the copy of the correct answers.

Answer Sheet

Score = _____

Rating: _____

Name: _____

Date: _____

Short Answer Questions

Information Sheet- 3

Documenting safety hazards

EEL EMD22

Version:01

Page No.11

Copyright: Ethiopia Federal TVET Agency



3.1.Introduction to Definitions of safety hazards and terms

Safety hazards are unsafe working conditions that can cause injury, illness, and death.Safety hazards are the most common work place hazards.

Hazard: Anything (e.g. condition, situation, practice, behaviour) that has the potential to cause harm, including injury, disease, death, environmental, property and equipment damage. A hazard can be a thing or a situation.

Hazard Identification: This is the process of examining each work area and work task for the purpose of identifying all the hazards which are “inherent in the job”. Work areas include but are not limited to machine workshops, laboratories, office areas, stores and transport, maintenance, grounds, and teaching spaces. This process is about finding what could cause harm in work task or area.

Risk: The likelihood, or possibility, that harm (injury, illness, death, damage etc) may occur from exposure to a hazard.

Risk Assessment: Is defined as the process of assessing the risks associated with each of the hazards identified so the nature of the risk can be understood. This includes the nature of the harm that may result from the hazard, the severity of that harm and the likelihood of this occurring.

Risk Control: Taking actions to eliminate health and safety risks so far as is reasonably practicable. Where risks cannot be eliminated, then implementation of control measures is required, to minimize risks so far as is reasonably practicable. A hierarchy of controls has been developed and is described below to assist in selection of the most appropriate risk control measure/s.

Monitoring and Review: This involves ongoing monitoring of the hazards identified, risks assessed and risk control processes and reviewing them to make sure they are working effectively.

3.1.1 Hazard Identification, Risk Assessment and Control Procedure

Purpose

EEL EMD22	Version:01	Page No.12
	Copyright: Ethiopia Federal TVET Agency	



To ensure that there is a formal process for hazard identification, risk assessment and control to effectively manage workplace and safety hazards within the work shops.

Workplace hazard identification, assessment and control is an on-going process. It should be undertaken at various times, including:

- If it has not been done before.
- When a hazard has been identified
- When a change to the workplace may introduce or change a hazard. Such as when changes occur to the workequipment, practices, procedures or environment. As part of responding to a workplace incident, even where an injury has not occurred.
- At regularly scheduled times appropriate to the workplace.

It is often more effective and easy to eliminate hazards if risk management approaches used at the planning and design stages for products, processes and places for work.

There are three steps used to manage health and safety at work.

1. Spot the Hazard (Hazard Identification)
2. Assess the Risk (Risk Assessment)
3. Make the Changes (Risk Control)

At work you can use these three ThinkSafe steps to help prevent accidents.Using the ThinkSafe steps

1. Spot the hazard

Key point: A hazard is anything that could hurt you or someone else.

Examples of workplace hazards include:

- frayed electrical cords (could result in electrical shock)
- boxes stacked precariously (they could fall on someone)
- noisy machinery (could result in damage to your hearing)

During work experience, you must remain alert to anything that may be dangerous.

If you see, hear or smell anything odd, take note.

If you think it could be a hazard, tell someone.

2. Assess the risk

EEL EMD22	Version:01	Page No.13
	Copyright: Ethiopia Federal TVET Agency	



Whenever you spot a hazard, assess the risk by asking yourself two questions:

- how likely is it that the hazard could harm me or someone else?
- how badly could I or someone else be harmed?

Always tell someone (your employer, your supervisor about hazards.

For example:

- ask your supervisor for instructions and training before using equipment
- ask for help moving or lifting heavy objects
- tell your supervisor if you think a work practice could be dangerous

If you are not sure of the safest way to do something on

work experience, always ask your work experience supervisor.

3. Make the changes

Key point: It is your employer's responsibility to fix hazards.

Sometimes you may be able to fix simple hazards yourself, as long as you don't put yourself or others at risk. For example, you can pick up things from the floor and put them away to eliminate a trip hazard.

The best way to fix a hazard is to get rid of it altogether. This is not always possible, but your employer should try to make hazards less dangerous by looking at the following options (in order from most effective to least effective):

Elimination - Sometimes hazards - equipment, substances or work practices - can be avoided entirely. (e.g. Clean high windows from the ground with an extendable pole cleaner, rather than by climbing a ladder and risking a fall.)

Substitution - Sometimes a less hazardous thing, substance or work practice can be used. (e.g. Use a non-toxic glue instead of a toxic glue.)

Isolation - Separate the hazard from people, by marking the hazardous area, fitting screens or putting up safety barriers. (e.g. Welding screens can be used to isolate welding operations from other workers. Barriers and/or boundary lines can be used to separate areas where forklifts operate near pedestrians in the workplace.)

Safeguards - Safeguards can be added by modifying tools or equipment, or fitting guards to machinery. These must never be removed or disabled by workers using the equipment.

EEL EMD22	Version:01	Page No.14
	Copyright: Ethiopia Federal TVET Agency	



- Instructing workers in the safest way to do something - This means developing and enforcing safe work procedures. Students on work experience must be given information and instruction and must follow agreed procedures to ensure their safety.
- Using personal protective equipment and clothing (PPE) - If risks remain after the options have been tried, it may be necessary to use equipment such as safety glasses, gloves, helmets and ear muffs. PPE can protect you from hazards associated with jobs such as handling chemicals or working in a noisy environment.

Self-Check -3

Multiple choice Questions

Directions: Answer all the questions listed below. Use the Answer sheet provided in the next page:

CHOOSE THE BEST ANSWER FOR THE FOLLOWING QUESTIONS

1. ____ are unsafe working conditions that can cause injury, illness, and death.

A. Injury B. Safety hazards C. risk control D. Hazard Identification:

2. Examples of workplace hazards include

A. frayed electrical cords (could result in electrical shock)

B. boxes stacked precariously (they could fall on someone)

EEL EMD22	Version:01	Page No.15
	Copyright: Ethiopia Federal TVET Agency	



C. noisy machinery (could result in damage to your hearing)

D. All

3. ____ is taking actions to eliminate health and safety risks .

A. risk control B. Risk Assessment C. hazard D. Monitoring and Reviewing

4. Which of the following steps is used to manage health and safety at work.

A. Hazard Identification C. Risk Control

B. Risk Assessment D. All

5. ____ is the process of examining each work area and work task identifying all the hazards which are “inherent in the job”.

A. Safety hazards B. hazard identification C. risk D. Risk Control:

Note: Satisfactory rating - 3 and 5 points Unsatisfactory - below 3 and 5 points

You can ask you teacher for the copy of the correct answers.

Answer Sheet

Score = _____

Rating: _____

Name: _____

Date: _____

Short Answer Questions

LAP Test	Practical Demonstration
----------	-------------------------

Instructions: Given necessary templates, tools and materials you are required to perform the following tasks within 2-4 hours.

A. CTIVITIES

Students can complete the following Hazard, RiskAssessment and Control activities:

Work in the classroom in pairs or small groups, under the supervision of your teacher.

Task: 1. Choose an industry or type of workplace e.g. manufacturing, hairdressing salon

EEL EMD22	Version:01	Page No.16
	Copyright: Ethiopia Federal TVET Agency	



Task: 2. Make a list of hazards that may be present in that workplace

e.g. slippery floors from spilt water, oil etc; uneven floors

Task: 3. Choose 3 or 4 hazards and list them on your Worksheet.

Task: 4. Write down ways to control the hazards on the Worksheet.

Information Sheet- 4	Determining the extent of faults.
-----------------------------	-----------------------------------

4.1 Introduction to faults in motor drive systems

Faults in motor drive systems are failures occurring in drives systems either of electrical or Mechanical faults. Drives systems are classified into:

Electrical faults: stator winding short circuit, broken rotor bar, broken end-ring, inverter failure

Mechanical faults: rotor eccentricity, bearing faults, shaft misalignment, load faults (unbalance, gearbox fault or general failure in the load part of the driven. Electric motors may look like any other electrical component, but they have a massive impact on the company's profitability and productivity. As such, it is critical to perform regular preventive maintenance checks on electric motors to ensure they always perform at their peak.

EEL EMD22	Version:01	Page No.17
	Copyright: Ethiopia Federal TVET Agency	



For starters, prepare a checklist that focuses on examining and monitoring the motor and electrical wiring.

This allows you to detect and identify potential problems that the motor may face and lets you address these problems ahead of time. This will drastically bring down unexpected repair expenses.

Here are seven tips for better electric motor maintenance. be sure to add them to your checklist.

- Prepare a checklist that focuses on examining and monitoring the motor and electrical wiring

1. Perform Visual Inspections

A quick visual inspection can reveal some important details about the electric motor. Take a look at its physical condition and record your observations. If the electric motor operates in a rugged environment, you will see signs of corrosion and dirt buildup on individual components.

Observe the motor's windings to detect any hint of overheating, such as a burnt odor. Ensure relays and contacts are dust-free and aren't rusted. All these factors may cause an internal problem as the debris may pose a threat to the efficient performance of the equipment.

2. Perform a Brush and Commutator Inspection

Regular maintenance checks help ensure that electric motors won't experience inconsistencies or stop working abruptly. Look for signs of wear and tear; any hint of excessive wear leads to commutation problems with the motor. This means you need to change the brush in order to regain the integrity of the equipment's function. Also keep a check on the commutator to ensure it doesn't have any dents, grooves, or scratches. These rough spots indicate brush sparking. Additionally, inspect the motor mount, rotor, stator and belts thoroughly. Replace all worn out parts.

3. Conduct a Motor Winding Test

Once you have inspected the various machine components, you need to test the motor's windings. This test helps you identify any anomalies or failures in the windings. If you see any burn marks or cracks or smell a burning odor, conduct a mandatory motor winding test.

The test involves disassembling the motor to determine the abnormalities of the motor. If the windings are overheated, the chance of serious damage is higher.

EEL EMD22	Version:01	Page No.18
	Copyright: Ethiopia Federal TVET Agency	



Rewinding the motor and testing the wind insulation, which reveals information on the resistance level, are also critical parts of the test.

4. Check the Bearings

Check the bearings for noise and vibration as they indicate potential problems, like poor lubrication, dirt buildup, and wear and tear. If the bearing's housing is too hot to touch, it may mean the motor is getting overheated or there is an insufficient amount of grease. The maintenance requirements for bearings may vary, depending on where the equipment is situated. You need to be aware of the different kinds of bearings being used in the plant and what their repair requirements are.

5. Perform Vibration Tests

Sometimes, excessive vibrations are difficult to detect manually. But, if not detected on time, vibration can reduce the life span of an electric motor, which then eventually leads to motor bearing failure or failure of windings. In most cases, the cause of vibration is mechanical in nature, such as a faulty sleeve or ball bearings, too much belt tension, or improper balance. The electric motor can be tested by removing the belts or by disconnecting the load and then operating the motor.

Sometimes, even electrical problems can give rise to vibrations. A few tests, such as field vibration analysis that is conducted by mobile instruments that measure exact frequency and amplitude of vibrations, can help in detecting the exact cause of vibrations.

6. Use Infrared Thermography in Predictive Maintenance

Recently, this method of inspection has become popular with predictive maintenance due to its desired outcome.

With infrared thermography, an infrared camera is used to capture thermal images without interfering with the motor's operation. These images provide a temperature profile of the electric motor by giving heat patterns at several points throughout the motor simultaneously. All mechanical systems produce a particular amount of thermal energy; therefore, they have normal thermal patterns along with a maximal temperature at which the motor can work. In case any problem exists, such as insufficient air flow, insulation failure, or degradation in the stator, the infrared camera will immediately detect the unstable voltage in the form of a thermal image, helping you find its cause and solution.

7. Document Everything

Documentation is extremely important. Keep detailed records of all preventive maintenance schedules, tests performed and their results. Maintain records of all repairs and replacements, as well. Doing so allows you to have a better understanding of the equipment, identify which issues need to be addressed, or determine which parts have to be replaced or repaired. Your records also will be helpful for future audits and inspections.

EEL EMD22	Version:01	Page No.19
	Copyright: Ethiopia Federal TVET Agency	



Documentation is Extremely Important

Precautions to Take While Performing Maintenance Checks

- ✓ Only assign electric motor maintenance tasks to those individuals who are well-trained in handling electrical components. Those who perform this task need to be aware of hazardous situations.
- ✓ Qualified personnel who perform maintenance checks should be equipped with protective gear, along with dielectric tested gloves and approved electrical test devices.
- ✓ Employees must make sure that pulleys and belts are in proper alignment and ensure operating parts are moving easily and without excess friction.
- ✓ Contactors and relays can be checked by hand for binding and sticking parts.
- ✓ Employees must be encouraged to regularly perform a maintenance task that keeps their surrounding environment dust-free and clean to avoid creating an unwanted path for electric current to flow.

To ensure better maintenance of electric motors, all maintenance procedures and tests should be conducted systematically in order to pinpoint potential problems and correct them before they result in undesired downtime.

This approach not only improves the motor's operation, but also increases its life span.

Different electrical materials have different maintenance requirements, so regular inspections must be scheduled per their needs. With electric motors, it's a matter of understanding what they need and implementing those measures to enhance their productivity and the company's profitability.

Self-Check -4	Written Test
---------------	--------------

Directions: Answer all the questions listed below. Use the Answer sheet provided in the next page:

___1. stator winding short circuit, broken rotor bar, broken end-ring, inverter failure can be taken as Electrical faults.

___2. Bearing, shaft misalignment and gearbox fault are mechanical faults.

___3. poor lubrication, dirt buildup, and wear and tear results in problems on bearings.

___4. visual inspection is the last procedure while observing the physical condition of the motor.

___5. Qualified personnel who perform maintenance checks should be equipped with PPE.

Note: Satisfactory rating - 3 and 5 points Unsatisfactory - below 3 and 5 points

You can ask your teacher for the copy of the correct answers.

Answer Sheet

Score = _____

Rating: _____

EEL EMD22	Version:01	Page No.20
	Copyright: Ethiopia Federal TVET Agency	



Name: _____

Date: _____

Short Answer Questions

Lap Test	Perform maintenance activities on defective motor
-----------------	---



Procedures to be followed while Performing maintenance activities on defective motor

- Step1. Prepare tools
- Step2. perform visual inspections
- Step3. disassemble the motor properly with proper tools
- Step4. check winding tests
- Step5. Check the bearings if poor lubrication, and dirt buildup are available
- Step6. determine which parts have to be replaced or repaired.

EEL EMD22	Version:01	Page No.21
	Copyright: Ethiopia Federal TVET Agency	



Information Sheet- 5	Selecting tools, equipment and testing devices
-----------------------------	---

5.1 Selecting tools, equipment and testing devices

✓ To Be A “Troubleshooter” One Must Have : Knowledge On

Tools Needed

- Multimeters
- Wiring Tools
- Screwdrivers
- Miscellaneous Tools
- Do-It-Yourself Tools

Multimeters

- Required Features (minimum)

EEL EMD22	Version:01	Page No.22
	Copyright: Ethiopia Federal TVET Agency	



- ✓ Can measure up to 50 VDC
- ✓ Can measure up to 250 VAC
- ✓ Measures Resistance or Continuity
- Desirable Features
 - ✓ Can measure entry level current to approximately 250 milli-ampere
 - ✓ Can measure DC and AC current up to 10 Amperes

Types of Multimeter

1. Analog Multimeter



Advantage: Low Cost

Disadvantages: Difficult to read measured value. Need to start at highest range and work way down to suitable range.

EEL EMD22	Version:01	Page No.23
	Copyright: Ethiopia Federal TVET Agency	

2. Digital Multimeter



Advantages: Easy to read measured value More accurate readings

Disadvantages: High Cost Need to start at highest range and work way down to suitable range.

3. Auto-Ranging Multimeter

Advantage: Need only to select the function.

Disadvantage: - High cost

Wiring Tools

Wire cutter – Diagonal/Side Cutter

•5 or 6 inches overall size

•Plastic or Rubber cushion grip



Wire Stripper And Cutter Use To Strip-Off Or Remove Insulation Of Wires

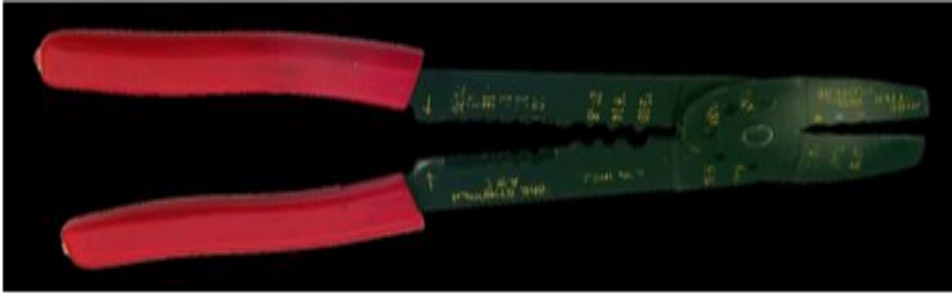

ELECTRICAL MASTER SET



WIRING TOOLS

Soldering Iron or Soldering Gun

- 30-40 Watts: used in fixing electronic components in circuit boards and splicing wires with small diameters.
- 60-100 Watts: used in fixing large components such as heat sink and transformers in circuit boards, and on for bigger diameter wire splicing.





Miscellaneous Tools

1. **Pliers** - use to hold objects such as wires and electronic/electrical components

TYPES

•Long/Needle Nose

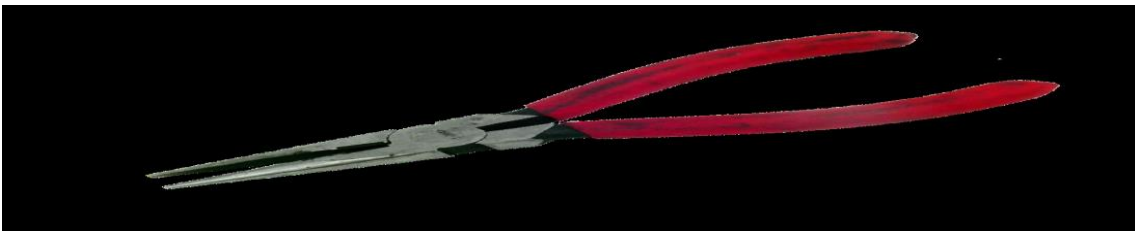

•Side Cutting Pliers

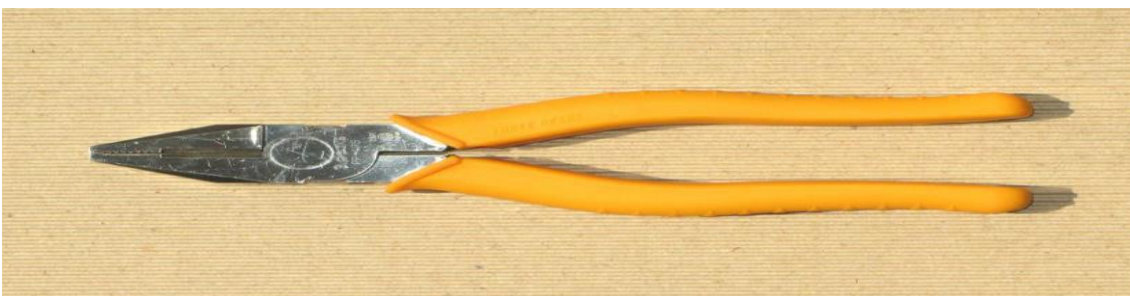

•Slip-Joint Pliers



2.WRENCH – for electrical and mechanical works

•Open Wrench

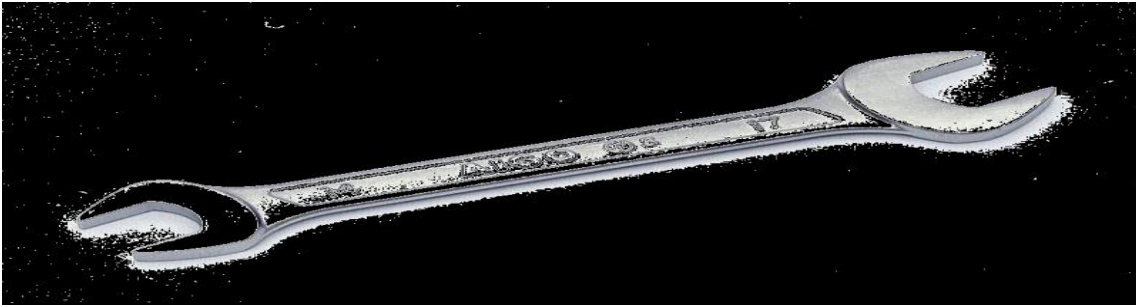

•Close Wrench



•Adjustable Wrench



Key Points on the Proper Use of Personal Protective Equipment

1) Proper selection

You must first understand the nature and degree of the potential hazards, and then select appropriate PPE that meets the relevant standards. Furthermore, some PPE (such as breathing apparatus) must properly fit the physique of the user before they can be

EEL EMD22	Version:01	Page No.27
	Copyright: Ethiopia Federal TVET Agency	



effective. PPE must meet the demands of the work environment and should be as comfortable and easy to use as possible.

2) **Correct use**

You must fully understand and abide by the correct usage methods of the PPE. Examples of incorrect use include different brands of filter being fitted to a respirator or the filters being cleaned with water.

3) **Correct maintenance**

PPE should be cleaned and dried after use, properly stored and regularly inspected. If you discover any damage to the PPE, you should immediately report this to your supervisor so that it can be replaced.

Trouble Shooting & Repair Procedures

Safety Concerns:

- Contact professionals and qualified servicemen for equipment that poses risk.
- Proper tools are a must.
- Instruments must be well-maintained and correctly calibrated.
- Most low-voltage electrocutions are the result of the failure to lock out, disconnect or isolate power.
- Use insulated gloves and tools.
- Use GFCIs. (Ground Fault Circuit Interrupter)

Main Concern

The effective & efficient working condition of a certain laboratory equipment depends on the following four features:

- Maintenance
- Servicing
- Troubleshooting
- Repair

Maintenance

EEL EMD22	Version:01	Page No.28
	Copyright: Ethiopia Federal TVET Agency	



- Maintenance is a continuous process.
- Must include both the Hardware and the Software.

Hardware:

- Cleaning/Dusting
- Maintaining prescribe levels of parameters such as electrical, environmental, and others.

Software:

- Reinstallation/Uninstallation
- Upgrade

Servicing

- Mainly associated with the hardware parts of the equipment.

It Includes:

- Check-ups,
- Repairs, and
- Updating of all physical components

Servicing

Steps:

1. Uninstall all physical components starting from power connections.
2. Clean dust from the components.
3. Perform a visual check or electronic check as required.
4. Reinstall all components carefully and properly.

Servicing (Cont.)

1. Check for loose wiring or crack cables.
2. Check if any jumper is missing, if required replace it with a new one.
3. Check for physical damages of peripherals and replace them if needed.
4. Tighten all internal and external connections.
5. Switch on the power supply and observe.

Troubleshooting

- Detection and rectification of faults in the equipment.
- Repairing means to rectify the problem in the hardware or software.

EEL EMD22	Version:01	Page No.29
	Copyright: Ethiopia Federal TVET Agency	



It is an essential part of troubleshooting.

Repairing may also include replacement of a component.

Six-Step Procedure

- A standardized approach toward electronic troubleshooting and maintenance:

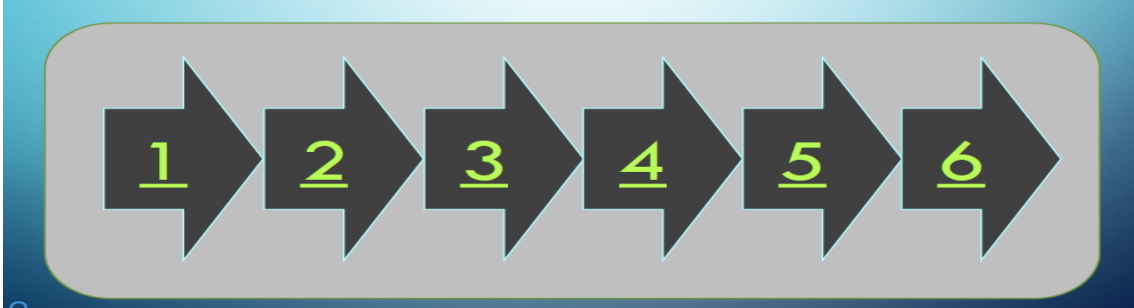

Symptom Recognition

- Determine if the equipment is functioning as design.
- A trouble symptom is an indicator of malfunction.
- Use your senses of SIGHT and HEARING.

Symptom Elaboration

- What fault is probably causing the specific symptoms?
- Symptom elaboration requires an evaluation of all observed displays.
- Indications must be evaluated in relation to each other as well as the overall operation.
- Record information observed! For example: How did each control affect an associated meter or other indicator?
- “Think” about the information before jumping to a conclusion

Listing Probable Faulty Functions

- Dividing the equipment into functional areas can save numerous trouble shooting steps.
- Use functional block diagram (FBD)

FBD shows the functional areas of an equipment, as well the detailed functions, levels of input and output parameters (voltage and current).

Localizing The Faulty Function

- Isolating the functional area that has an indication of malfunction. :
- Knowledge, skill, and proper test equipment should now be used to isolate the faulty functional area.

EEL EMD22	Version:01	Page No.30
	Copyright: Ethiopia Federal TVET Agency	



Localizing The Trouble To The Circuit

- Isolating the circuits within the faulty unit.
- More extensive troubleshooting is now required within the identified faulty unit.
- Look for improper voltages, improper waveforms, obvious component overheating.
- Isolate the defective circuit group.

Failure Analysis

Steps 1 and 2 were used to recognize, verify, and obtain descriptive information

Step 3 allowed you to make a logical selection of the logical faulty unit

Step 4 provided for simple input-output tests and localized the faulty functions

Step 5 localized the fault to the circuit within the faulty unit

Step 6 will involve the actual replacement or repair of faulty circuit components

EEL EMD22	Version:01	Page No.31
	Copyright: Ethiopia Federal TVET Agency	



Self check 5	Written Test
---------------------	---------------------

Directions: Answer all the questions listed below.

PART I TRUE/FALSE

If the statement is correct write TRUE if the statement is in correct write FALSE

- _____ 1.Solderined gun can be used for termination.
- _____ 2.Gloves are used for eye protection.
- _____ 3. Combination plier can be used to cut wires.
- _____ 4.Wire Stripper And Cutter is used to Strip-off or remove insulation of wires.
- _____ 5.A screw driver is used to hammering screws.

Note: Satisfactory rating - 3 and 5 points Unsatisfactory - below 3 and 5 points

You can ask you teacher for the copy of the correct answers.

Answer Sheet

Score = _____
Rating: _____

Name: _____

Date: _____

Short Answer Questions

Operation Sheet 1	Soldering of wires
-------------------	--------------------

EEL EMD22	Version:01	Page No.32
	Copyright: Ethiopia Federal TVET Agency	



PURPOSE: - after performing this operation the trainee's should be able to identify termination and can perform termination of wires.

Conditions: -

EQUIPMENT AND TOOLS: - combination plier, fixer, stripers, brush, soldering gun,

MATERIALS: - wires, lead, paper, connectors.

PROCEDURE:

✓ A sectional view is obtained by imagining the object, as if cut by a cutting plane and the Portion between the observer and the section plane being removed.

✓ DetailsGeneral Wire-Stripping Instructions

When stripping wire with any of the tools mentioned,

Observe the following precautions:

1. Do not attempt to use a hot-blade stripper on wiring with glass braid or asbestos insulation. These insulators are highly heat resistant.
2. When using the hot-blade stripper, make sure the blades are clean. Clean the blades with a brass wire brush as necessary.
3. Make sure all stripping blades are sharp and free from nicks, dents, and so forth.
4. When using any type of wire stripper, hold the wire perpendicular to the cutting blades.
5. Make sure the insulation is clean-cut with no frayed or ragged edges; trim if necessary.
6. Make sure all insulation is removed from the stripped area. Some types of wire are supplied with a transparent layer between the conductor and the primary insulation. If this is present, remove it.
7. When the hand strippers are used to remove lengths of insulation longer than 3/4 inch, the stripping procedure must be done in two or more operations. The strippers will only strip about 3/4 inch at one time.
8. Retwist strands by hand, if necessary, to restore the natural lay and tightness of the strands.
9. Strip aluminum wires with a knife as described earlier. Aluminum wire should be stripped very carefully. Care should be taken not to nick the aluminum wire as the strands break very easily when nicked.

PRECAUTIONS: - Apply all the necessary safetyequipment's.

QUALITY CRITERIA: - the trainee's should be able to perform full sectioning of solid objects by any direction of cut.

EEL EMD22	Version:01	Page No.33
	Copyright: Ethiopia Federal TVET Agency	



Instruction Sheet 1

LG34: Diagnose and rectify faults.

This learning guide is developed to provide you the necessary information regarding the following learning outcome and content coverage

- Applying appropriate use of PPE
- Managing risks in electro technology activities
- Interpreting work procedures and instructions

EEL EMD22	Version:01	Page No.34
	Copyright: Ethiopia Federal TVET Agency	



- Applying logical diagnostic methods for a.c. motor control system
- Testing suspected fault scenarios
- Rectifying faults in control components of the system
- Controlling variable speed drives for motors

-This guide will also assist you to attain the learning outcome and contents stated in the cover page. Specifically, upon completion of this Learning Guide, you will be able to:-

- Apply appropriate use of PPE
- Manage risks in electro technology activities
- Interpret work procedures and instructions
- Applying logical diagnostic methods for a.c. motor control system
- Test suspected fault scenarios
- Rectify faults in control components of the system
- Control variable speed drives for motors
- Control variable speed drives for motors

Learning Instructions:

6. 1. Read the specific objectives of this Learning Guide.
7. Follow the instructions described below 3 to 6
8. Read the information written in the “Information Sheet 1, Sheet 2, Sheet 3, Sheet 4, Sheet 5, Sheet 6, Sheet 7 and Information Sheet 8”.
9. Accomplish the “Self-check 1, Self-check 2 Self-check 3, Self-check 4 and Self-check 1 Self-check 5Self-check 6, Self-check 7, and Self-check 8”..
10. If you earn a satisfactory evaluation proceed to “Operation Sheet 1”.
6. Do the “LAP test”

Information Sheet-1	Applying appropriate use of PPE
----------------------------	--

1.1 Introduction to appropriate use of PPE

What is Personal Protective Equipment (PPE)?

PPE is defined in the Personal Protective Equipment at Work Regulations as: ‘All equipment (including clothing affording protection against the weather) which is intended to be worn or held by a person at work which protects them against one or more risks to their health and safety’.

EEL EMD22	Version:01	Page No.35
	Copyright: Ethiopia Federal TVET Agency	



PPE includes equipment such as safety footwear, hard hats, high visibility waistcoats, goggles, life jackets, respirators and safety harnesses.

Waterproof, weatherproof, or insulated clothing is subject to the Regulations only if its use is necessary to protect employees against adverse climatic conditions that could otherwise affect their health and safety.

The use of PPE generally implies working in a potentially hazardous work environment and its use is a major means of injury prevention.

1.1.1 Personal protective equipment types

PPE can be considered in the following categories, based on the type of protection afforded by the equipment:

- Respiratory protection - for example, disposable, cartridge, air line, half or full face
- Eye protection – for example, spectacles/goggles, shields, visors
- Hearing protection – for example, ear muffs and plugs
- Hand protection – for example, gloves and barrier creams
- Foot protection – for example, shoes/boots
- Head protection – for example, helmets, caps, hoods, hats
- Working from heights - for example, harness and fall arrest devices
- Skin protection – for example, hats, sunburn cream, long sleeved clothes
- Other personal protective equipment: This may include PPE for specific tasks such as disposable clothing for working with chemicals, radiation hazards, welding, painting.
- Examples include: lead aprons for x-ray protection; sleeve protectors, aprons, coveralls when using chemicals; leather jackets, trousers and spats for welding; thermal and cold protective clothing for work near furnaces and cool rooms.

[Refer to //www.safety.uwa./topics/physical/protective-equipment/head](http://www.safety.uwa./topics/physical/protective-equipment/head)

EEL EMD22	Version:01	Page No.36
	Copyright: Ethiopia Federal TVET Agency	



Self-Check -2

Matching

Directions: Answer all the questions listed below.

Instruction-Match column 'A' with column 'B'

"A" **"B"**

___1. Eye protection A. helmets, caps, hoods, hats

___2. Hearing protection B. shoes/boots

___3. Hand protection C. gloves and barrier creams

___4. Foot protection D. ear muffs and plugs

___5. Head protection E. spectacles/goggles, shields

EEL EMD22	Version:01	Page No.37
	Copyright: Ethiopia Federal TVET Agency	



Note: Satisfactory rating - 3 and 5 points Unsatisfactory - below 3 and 5 points

You can ask you teacher for the copy of the correct answers.

Answer Sheet

Score = _____
Rating: _____

Name: _____

Date: _____

Short Answer Questions

Information Sheet-2	Managing risks in electro technology activities
---------------------	---

2.1.Managing Electrical risks in the work place.

What is Risk Management?

What are electrical risks?

Electrical risks are risks of death, electric shock or other injury caused directly or indirectly by electricity. The most common electrical risks and causes of injury are:

- Electric shock causing injury or death. The electric shock may be received by direct or indirect contact, tracking through or across a medium, or by arcing. For example, electric shock may result from indirect contact where a conductive part that is not normally energised becomes energised due to a fault (e.g. metal toaster body, fence)
- arcing, explosion or fire causing burns. The injuries are often suffered because arcing or explosion or both occur when high fault currents are present.
- electric shock from 'step-and-touch' potentials
- toxic gases causing illness or death. Burning and arcing associated with electrical equipment may release various gases and contaminants
- fire resulting from an electrical fault.

Even the briefest contact with electricity at 50 volts for alternating current (V a.c.) or 120 volts for direct current (V d.c.) can have serious consequences to a person's health and safety.

EEL EMD22	Version:01	Page No.38
	Copyright: Ethiopia Federal TVET Agency	



High voltage shocks involving more than 1000 V a.c. or 1500 V d.c. can cause contact burns and damage to internal organs.

Electric shocks from faulty electrical equipment may also lead to related injuries, including falls from ladders, scaffolds or other elevated work platforms. Other injuries or illnesses may include muscle spasms, palpitations, nausea, vomiting, collapse and unconsciousness. Workers using electricity may not be the only ones at risk—faulty electrical equipment and poor electrical installations can lead to fires that may also cause death or injury to others.

What is required to manage electrical risks?

A person conducting a business or undertaking must manage risks to health and safety associated with electrical risks at the workplace.

In order to manage risk under the WHS Regulations, a duty holder must:

- identify reasonably foreseeable hazards that could give rise to the risk
- eliminate the risk, so far as is reasonably practicable
- if it is not reasonably practicable to eliminate the risk, minimise the risk so far as is reasonably practicable by implementing control measures
- maintain the implemented control measure so that it remains effective
- review, and if necessary revise, all risk control measures so as to maintain, so far as is reasonably practicable, a work environment that is without risks to health and safety.

Manage electrical risks in the workplace by following a systematic process that involves:

,,, identifying hazards

,,, if necessary, assessing the risks associated with these hazards

,,, implementing and maintaining risk control measures (e.g. inspecting and testing electrical equipment, using RCDs), and ,,,, reviewing risk control measures.

General Electrical Safety At The Workplace

The Risk Management Process

1. Identify the hazards

Identifying hazards involves finding all of the tasks, situations and sequences of events that could potentially cause harm.

Hazards arising from electrical equipment or installations may arise from:

- the design, construction, installation, maintenance and testing of electrical equipment or electrical installations

EEL EMD22	Version:01	Page No.39
	Copyright: Ethiopia Federal TVET Agency	



- design change or modification.
- inadequate or inactive electrical protection.
- where and how electrical equipment is used. Electrical equipment may be subject to operating conditions that are likely to result in damage to the equipment or a reduction in its expected life span. For example, equipment may be at greater risk of damage if used outdoors or in a factory or workshop environment.
- electrical equipment being used in an area in which the atmosphere presents a risk to health and safety from fire or explosion, for example confined spaces
- type of electrical equipment. For example, 'plug in' electrical equipment that may be moved around from site to site, including extension leads, are particularly liable to damage
- the age of electrical equipment and electrical installations.
- work carried out on or near electrical equipment or electrical installations, including electric overhead lines or underground electric services, for example work carried out in a confined space connected to plant or services.

Exposure to high electromagnetic fields may also present a potential hazard for workers with some medical conditions, for example pace makers. You must inform workers and other persons at the workplace of any potential electromagnetic hazards at the workplace that may affect a medical condition. You must also manage risks to health and safety arising out of electromagnetic hazards, including eliminating the risk so far as is reasonably practicable. If that is not reasonably practicable you must minimise the risk so far as is reasonably practicable.

Potential electrical hazards may be identified in a number of different ways including:

- talking to workers and observing where and how electrical equipment is used
- regularly inspecting and testing electrical equipment and electrical installations as appropriate
- reading product labels and manufacturers' instruction manuals
- talking to manufacturers, suppliers, industry associations, and health and safety specialists,,,,
- reviewing incident reports.

2. Assess the risks

Risk assessment involves considering what could happen if someone is exposed to a hazard (consequence) and the likelihood of it happening for work on energized electrical equipment.

A risk assessment can help determine:

- ,, the severity of an electrical risk
- ,, whether existing control measures are effective
- ,, what action you should take to control an electrical risk
- ,, how urgently the action needs to be taken.

EEL EMD22	Version:01	Page No.40
	Copyright: Ethiopia Federal TVET Agency	



To assess the risk associated with electrical hazards consider:

- What is the potential impact of the hazard?
- How severe could the electrical hazard be? For example, direct contact causing electrocution, fire or explosion causing serious burns or death.
- How many people are exposed to the hazard?
- How likely is the hazard to cause harm?
- „ Could it happen at any time or would it be a rare event?
- „ How frequently are workers exposed to the hazard?

Other factors that may affect consequence and likelihood include:

- the conditions under which the electrical equipment is used, for example wet conditions outdoors or confined spaces.
- work practices and procedures, for example isolation, to carry out maintenance
- the capability, skill and experience of relevant workers.

3. Control the risks

Once hazards have been identified and the risks assessed, appropriate control measures must be put in place.

The ways of controlling risks are ranked from the highest level of protection and reliability to the lowest. This ranking is known as the hierarchy of risk control. You must work through this hierarchy to choose the control that most effectively eliminates or minimizes the risk in the circumstances, so far as is reasonably practicable. This may involve a single control measure or a combination of two or more different controls.

Elimination

The most effective control measure is to remove the hazard or hazardous work practice. By designing-in or designing-out certain features, hazards may be eliminated.

Substitution

Replacing a hazardous process or material with one that is less hazardous will reduce the hazard, and hence the risk. For example, it may be reasonably practicable to use extra low voltage electrical equipment such as a battery-operated tool rather than a tool that is plugged into mains electricity.

Isolation

Preventing workers from coming into contact with the source of an electrical hazard will reduce the relevant risks.

4. Review the control measures

EEL EMD22	Version:01	Page No.41
	Copyright: Ethiopia Federal TVET Agency	



The controls that are put in place to protect health and safety must be reviewed regularly to make sure they work effectively. A person conducting a business or undertaking must review and as necessary revise a control measure in the following circumstances:

when the control measure does not control the risk it was implemented to control so far as is reasonably practicable before a change at the workplace that is likely to give rise to a new or different risk to health or safety that the measure may not effectively control

- if a new relevant hazard or risk is identified
- if the results of consultation indicate that a review is necessary
- if a health and safety representative requests a review.

The following questions will help you evaluate how well you are currently managing electrical risks in your workplace:

- Do you talk to your workers about electrical safety? Do any relevant new work methods or equipment have the potential to make work safer in your workplace?
- Are procedures for identifying electrical hazards in the workplace effective?
- Are electrical safety procedures followed? Do you encourage your workers to report electrical hazards?
- Do you regularly inspect and maintain your electrical equipment to identify safety problems?
- Do you fix or rectify identified electrical hazards in a timely manner?

EEL EMD22	Version:01	Page No.42
	Copyright: Ethiopia Federal TVET Agency	



Self-Check -2	Written Test
----------------------	---------------------

Directions: Answer all the questions listed below. Use the Answer sheet provided in the next page:

Instruction-Give short answer for the following questions

___1. The first Steps to implement risk management is _____

- A. Risk control
- B. Quantify and Prioritize
- C. Risk Identification
- D. Monitoring

___2. The last process in risk management is _____

- A. Identify Potential Exposures To Loss
- B. Decide Which Alternatives To Use
- C. Examine Alternatives
- D. Implement The Chosen Techniques
- E. Monitor Results

___3. The most common electrical risks and causes of injury are

- A. electric shock causing injury or death
- B. arcing, explosion or fire causing burns
- C. electric shock from 'step-and-touch' potentials
- D. fire resulting from an electrical fault
- E. All

___4. A risk assessment can help determine:

- A. whether existing control measures are effective
- B. the severity of an electrical risk
- C. what action you should take to control an electrical risk
- D. All

___5. Preventing workers from coming into contact with the source of an electrical hazard is___

EEL EMD22	Version:01	Page No.43
	Copyright: Ethiopia Federal TVET Agency	



A. Risk identification B. Control measure C. Risk assessment D. All

Note: Satisfactory rating , 3_5 points Unsatisfactory below 3 points

You can ask you teacher for the copy of the correct answers.

Score = _____
Rating: _____

Name: _____

Date: _____

Information Sheet-3	Interpreting work procedures and instructions
----------------------------	--

3.1 Introduction to work procedures and instructions

A work instruction is a tool provided to help someone to do a job correctly. This simple statement implies that the purpose of the work instruction is quality and that the target user is the worker. Factories have encumbered work instructions with content that has been added to satisfy auditors, lawyers, engineers, accountants and yes, even quality managers. We’ve piled on so much extraneous material that we’ve lost sight of the intended purpose of work instructions.

What is a Work Instruction?

A Work Instruction is a detailed sequence of steps that an employee needs to follow each time s/he performs a task. The purpose of a Work Instruction is to organize steps in a logical format so that an employee can easily follow it independently. Procedures for a process can be very long with multiple steps. Work Instructions enable us to remove some of the detail so that an employee can better understand the overall process.

- Work instructions should be very detailed on “how” to accomplish a specific job, task or assignment.
- For example, a work procedure could be developed for assembling the final housing of a product with step-by-step instructions including such detail as the torque requirements of the fastening screws.

Procedures and Work Instructions

Procedures describe a process, while a work instruction describes how to perform the conversion itself. Process descriptions include details about the inputs, what conversion

EEL EMD22	Version:01	Page No.44
	Copyright: Ethiopia Federal TVET Agency	



takes place (of inputs into outputs), the outputs, and the feedback necessary to ensure consistent results. The PDCA process approach (Plan, Do, Check, Act) is used to capture the relevant information. Questions that need to be answered in a procedure include:

- Where do the inputs come from (suppliers)?
- Where do the outputs go (customers)?
- Who performs what action when (responsibilities)?
- How do you know when you have done it right (effectiveness criteria)?
- What feedback should be captured (metrics)?
- How do we communicate results (charts, graphs and reports)?
- What laws (regulations) or standards apply (e.g., ISO 9001, 8th EU Directive, IFRS, Sarbanes-Oxley)?

EEL EMD22	Version:01	Page No.45
	Copyright: Ethiopia Federal TVET Agency	



Self-Check -3	Written Test
----------------------	---------------------

Directions: Answer all the questions listed below. Use the Answer sheet provided in the next page:

Instruction-Say true if the statement is true and false if false

- ___ 1 . A work instruction is a tool provided to help someone to do a job correctly
- ___ 2. Procedures describe how to perform the conversion itself.
- ___ 3. Instruction describe a process of inputs into outputs.
- ___ 4. The purpose of a Work Instruction is to organize steps in a logical format so that an employee can easily follow it independently.
- ___ 5. Procedures enable us to know where do the inputs come from in detail.

Note: Satisfactory rating – 3 & above points Unsatisfactory – below 3 points

You can ask you teacher for the copy of the correct answers.

Answer Sheet

Score = _____
Rating: _____

Name: _____

Date: _____

Short Answer Questions



Information Sheet-4	Applying logical diagnostic methods for a.c. motor control system
----------------------------	---

4.1 Introduction to logical diagnostic methods for a.c. motor control system

Diagnosis is the identification of the nature and cause of a certain phenomenon. Diagnosis is used in many different disciplines with variations in the use of logics, analytics, and experience to determine "cause and effect". In systems engineering and computer science, it is typically used to determine the causes of symptoms, mitigations, and solutions requirement caused by the high density of circuits in a semiconductor chip. A logic simulator may also reflect the progress of hardware technology. An mv-cost simulator generator has been developed which uses a general purpose programming language as the simulator media, in which the package logic is described as functional procedures. Several methods of fault location have also been described for path tests and combinational tests.

Motor trouble shooting chart

Troubleshooting Chart		
Failure	Probable Cause	Corrective Measures
Motor fails to start	1. No voltage supply	- Check feed connections to control system and from control to motor.
	2. Low voltage supply	- Check voltage supply and ascertain that voltage remains within 10% of the rated voltage shown on the motor nameplate.
	3. Wrong control connections	- Compare connections with the wiring diagram on the motor nameplate.
	4. Loose connection at some terminal lug	- Tighten all connections.
	5. Overload	- Try to start motor under no-load conditions. If it starts there may be an overload condition or a blocking of the starting mechanism. Reduce load to rated load level and increase torque.

EEL EMD22	Version:01	Page No.47
	Copyright: Ethiopia Federal TVET Agency	



	6. Brushes	- Brushes may be worn, dirty or incorrectly fitted.
High Noise Level	1. Unbalance	- Vibrations can be eliminated by balancing rotor. If load is coupled directly to motor shaft, the load can be unbalanced.
	2. Distorted shaft	- Shaft can be bent; check rotor balance and eccentricity.
	3. Incorrect alignment	- Check motor alignment with machine running.
	4. Uneven air gap	- Check shaft for warping or bearing wear.
	5. Dirt in the air gap	- Dismantle motor and remove dirt or dust with jet of dry air.
	6. Extraneous matter stuck between fan and motor casing.	- Dismantle motor and clean. Remove trash or debris from motor vicinity.
	7. Loose motor foundation	- Tighten all foundation studs. If necessary, realign motor.
	8. Worn bearings	- Check lubrication. Replace bearing if noise is excessive and continuous.
Overheating of bearings	1. Excessive grease	- Remove grease bleeder plug and run motor until excess grease is expelled.
	2. Excessive axial or radial strain on belt	- Reduce belt tension.
	3. Deformed shaft	- Have shaft straightened and check rotor balance.
	4. Rough bearing surface	- Replace bearings before they damage shaft.
	5. Loose or poorly fitted motor end shields	- Check end shields for close fit around circumference and tightness.
	6. Lack of grease	- Add grease to bearing.
	7. Hardened grease cause	- Replace bearings.



	locking of balls	
	8. Foreign material in grease	- Flush out housings and relubricate.
Intense Bearing Vibration	1. Unbalanced rotor	- Balance rotor statically and dynamically.
	2. Dirty or worn bearing	- If bearing rings are in perfect condition, clean relubricate the bearing, otherwise replace bearing.
	3. Bearing rings too tight on shaft and/or bearing housing	- Before altering shaft or housing dimensions, it is advisable to ascertain that bearing dimensions correspond to manufacturer's specifications.
	4. Extraneous solid particles in bearing	- Take bearing apart and clean. Reassemble only if rotating and support surfaces are unharmed.
Overheating of Motor	1. Obstructed cooling system	- Clean and dry motor; inspect air vents and windings periodically.
	2. Overload	- Check application, measuring voltage and current under normal running conditions.
	3. Incorrect voltages and frequencies	- Compare values on motor nameplate with those of mains supply. Also check voltage at motor terminals under full load.
	4. Frequent inversions	- Exchange motor for another that meets needs.
	5. Rotor dragging on stator	- Check bearing wear and shaft curvature.
	6. Unbalanced electrical load (burnt fuse, incorrect control)	- Check for unbalanced voltages or operation under single-phase condition.
	1. Control circuit conductors too light	- Install heavier conductors on control circuit.
	2. Control too far from motor	- Bring control closer to motor.



Slip Ring Motor Operating at Low Speed with External Resistance Disconnected	3. Open circuit on rotor circuits (including connections with control apparatus)	- Test circuit with a magneto, or other means, and undertake necessary repairs.	
	4. Dirt between brush and slip ring	- Clean slip rings and insulation assembly.	
	5. Brushes gripe on brush holders	- Select brushes of correct size.	
	6. Incorrect pressure on brushes	- Check pressure on each brush and adjust it accordingly.	
	7. Rough surfaces on slip rings	- File, sand and polish.	
	8. Eccentric rings	- Machine on lathe or with portable tool without removing from machine.	
	9. High current density on brushes	- Reduce load or replace brushes.	
	10. Poorly set brushes	- Reset brushes correctly.	
	Brush Sparking	1. Poorly set brushes with insufficient pressure	- Check brush setting; adjust for correct pressure.
		2. Overload	- Reduce load or install motor with higher capacity.
3. Slip rings in poor condition		- Clean rings and reset brushes.	
4. Oval slip rings. Rough surfaces and scored rings.		- Polish the slip rings with an emery and machine the same on lathe.	
5. Excess of Vibration		- Balance the rotor, check the brushes for free movement within holders	

Applying Logical diagnostic methods to diagnose motor control system faults

Fault detection, isolation, and recovery (FDIR) is a subfield of control engineering which concerns itself with monitoring a system, identifying when a fault has occurred, and pinpointing the type of fault and its location. Two approaches can be distinguished: A

EEL EMD22	Version:01	Page No.50
	Copyright: Ethiopia Federal TVET Agency	



direct pattern recognition of sensor readings that indicate a fault and an analysis of the discrepancy between the sensor readings and expected values, derived from some model. In the latter case, it is typical that a fault is said to be detected if the discrepancy or residual goes above a certain threshold. It is then the task of fault isolation to categorize the type of fault and its location in the machinery. Fault detection and isolation (FDI) techniques can be broadly classified into two categories. These include model-based FDI and signal processing based FDI.

Machine fault diagnosis

Machine fault diagnosis is a field of mechanical engineering concerned with finding faults arising in machines. A particularly well developed part of it applies specifically to rotating machinery, one of the most common types encountered.

To identify the most probable faults leading to failure, many methods are used for data collection, including vibration monitoring, thermal imaging, oil particle analysis, etc. Then these data are processed utilizing methods like spectral analysis, wavelet analysis, wavelet transform, short term Fourier transform, Gabor Expansion, Wigner-Ville distribution (WVD), cepstrum, bispectrum, correlation method, high resolution spectral analysis, waveform analysis (in the time domain, because spectral analysis usually concerns only frequency distribution and not phase information) and others. The results of this analysis are used in a root cause failure analysis in order to determine the original cause of the fault. For example, if a bearing fault is diagnosed, then it is likely that the bearing was not itself damaged at installation, but rather as the consequence of another installation error (e.g., misalignment) which then led to bearing damage. Diagnosing the bearing's damaged state is not enough for precision maintenance purposes. The root cause needs to be identified and remedied. If this is not done, the replacement bearing will soon wear out for the same reason and the machine will suffer more damage, remaining dangerous. Of course, the cause may also be visible as a result of the spectral analysis undertaken at the data-collection stage, but this may not always be the case.

The most common technique for detecting faults is the time-frequency analysis technique. For a rotating machine, the rotational speed of the machine (often known as the RPM), is not a constant, especially not during the start-up and shutdown stages of the machine. Even if the machine is running in the steady state, the rotational speed will vary around a

EEL EMD22	Version:01	Page No.51
	Copyright: Ethiopia Federal TVET Agency	



steady-state mean value, and this variation depends on load and other factors. Since sound and vibration signals obtained from a rotating machine which are strongly related to its rotational speed, it can be said that they are time-variant signals in nature. These time-variant features carry the machine fault signatures. Consequently, how these features are extracted and interpreted is important to research and industrial applications.

The most common method used in signal analysis is the FFT, or Fourier transform. The Fourier transform and its inverse counterpart offer two perspectives to study a signal: via the time domain or via the frequency domain. The FFT-based spectrum of a time signal shows us the existence of its frequency contents. By studying these and their magnitude or phase relations, we can obtain various types of information, such as harmonics, sidebands, beat frequency, bearing fault frequency and so on. However, the FFT is only suitable for signals whose frequency contents do not change over time; however, as mentioned above, the frequency contents of the sound and vibration signals obtained from a rotating machine are very much time-dependent. For this reason, FFT-based spectra are unable to detect how the frequency contents develop over time. To be more specific, if the RPM of a machine is increasing or decreasing during its startup or shutdown period, its bandwidth in the FFT spectrum will become much wider than it would be simply for the steady state. Hence, in such a case, the harmonics are not so distinguishable in the spectrum.

The time frequency approach for machine fault diagnosis can be divided into two broad categories: linear methods and the quadratic methods. The difference is that linear transforms can be inverted to construct the time signal, thus, they are more suitable for signal processing, such as noise reduction and time-varying filtering. Although the quadratic method describes the energy distribution of a signal in the joint time frequency domain, which is useful for analysis, classification, and detection of signal features, phase information is lost in the quadratic time-frequency representation; also, the time histories cannot be reconstructed with this method.

The short-term Fourier transform (STFT) and the Gabor transform are two algorithms commonly used as linear time-frequency methods. If we consider linear time-frequency analysis to be the evolution of the conventional FFT, then quadratic time frequency analysis would be the power spectrum counterpart. Quadratic algorithms include the Gabor spectrogram, Cohen's class and the adaptive spectrogram. The main advantage of

EEL EMD22	Version:01	Page No.52
	Copyright: Ethiopia Federal TVET Agency	



time frequency analysis is discovering the patterns of frequency changes, which usually represent the nature of the signal. As long as this pattern is identified the machine fault associated with this pattern can be identified. Another important use of time frequency analysis is the ability to filter out a particular frequency component using a time-varying filter.

Let's take a look at these in more detail.

Preparation

Before you begin to troubleshoot any piece of equipment, you must be familiar with your organization's safety rules and procedures for working on electrical equipment. These rules and procedures govern the methods you can use to troubleshoot electrical equipment (including your lockout/tagout procedures, testing procedures etc.) and must be followed while troubleshooting.

Next, you need to gather information regarding the equipment and the problem. Be sure you understand how the equipment is designed to operate. It is much easier to analyze faulty operation when you know how it should operate. Operation or equipment manuals and drawings are great sources of information and are helpful to have available. If there are equipment history records, you should review them to see if there are any recurring problems. You should also have on-hand any documentation describing the problem.

(i.e. a work order, trouble report, or even your notes taken from a discussion with a customer.)

Step 1 – Observe

Most faults provide obvious clues as to their cause. Through careful observation and a little bit of reasoning, most faults can be identified as to the actual component with very little testing. When observing malfunctioning equipment, look for visual signs of mechanical damage such as indications of impact, chafed wires, loose components or parts laying in the bottom of the cabinet. Look for signs of overheating, especially on wiring, relay coils, and printed circuit boards.

Don't forget to use your other senses when inspecting equipment. The smell of burnt insulation is something you won't miss. Listening to the sound of the equipment operating may give you a clue to where the problem is located. Checking the temperature of components can also help find problems but be careful while doing this, some components may be alive or hot enough to burn you.

EEL EMD22	Version:01	Page No.53
	Copyright: Ethiopia Federal TVET Agency	



Pay particular attention to areas that were identified either by past history or by the person that reported the problem. A note of caution here! Do not let these mislead you, past problems are just that – past problems, they are not necessarily the problem you are looking for now. Also, do not take reported problems as fact, always check for yourself if possible. The person reporting the problem may not have described it properly or may have made their own incorrect assumptions.

When faced with equipment which is not functioning properly you should:

Be sure you understand how the equipment is designed to operate. It makes it much easier to analyze faulty operation when you know how it should operate;

Note the condition of the equipment as found. You should look at the state of the relays (energized or not), which lamps are lit, which auxiliary equipment is energized or running etc. This is the best time to give the equipment a thorough inspection (using all your senses). Look for signs of mechanical damage, overheating, unusual sounds, smells etc.;

Test the operation of the equipment including all of its features. Make note of any feature that is not operating properly. Make sure you observe these operations very carefully. This can give you a lot of valuable information regarding all parts of the equipment.

Step 2 – Define Problem Area

It is at this stage that you apply logic and reasoning to your observations to determine the problem area of the malfunctioning equipment. Often times when equipment malfunctions, certain parts of the equipment will work properly while others not.

The key is to use your observations (from step 1) to rule out parts of the equipment or circuitry that are operating properly and not contributing to the cause of the malfunction. You should continue to do this until you are left with only the part(s) that if faulty, could cause the symptoms that the equipment is experiencing.

To help you define the problem area you should have a schematic diagram of the circuit in addition to your noted observations.

Starting with the whole circuit as the problem area, take each noted observation and ask yourself "what does this tell me about the circuit operation?" If an observation indicates that a section of the circuit appears to be operating properly, you can then eliminate it from the problem area. As you eliminate each part of the circuit from the problem area, make

EEL EMD22	Version:01	Page No.54
	Copyright: Ethiopia Federal TVET Agency	



sure to identify them on your schematic. This will help you keep track of all your information.

Step 3 – Identify Possible Causes

Once the problem area(s) have been defined, it is necessary to identify all the possible causes of the malfunction. This typically involves every component in the problem area(s). It is necessary to list (actually write down) every fault which could cause the problem no matter how remote the possibility of it occurring. Use your initial observations to help you do this. During the next step you will eliminate those which are not likely to happen.

Step 4 – Determine Most Probable Cause

Once the list of possible causes has been made, it is then necessary to prioritize each item as to the probability of it being the cause of the malfunction. The following are some rules of thumb when prioritizing possible causes. Although it could be possible for two components to fail at the same time, it is not very likely. Start by looking for one faulty component as the culprit. The following list shows the order in which you should check components based on the probability of them being defective:

First look for components which burn out or have a tendency to wear out, i.e. mechanical switches, fuses, relay contacts, or light bulbs. (Remember, that in the case of fuses, they burn out for a reason. You should find out why before replacing them.)

The next most likely cause of failure are coils, motors, transformers and other devices with windings. These usually generate heat and, with time, can malfunction.

Connections should be your third choice, especially screw type or bolted type. Over time these can loosen and cause a high resistance. In some cases this resistance will cause overheating and eventually will burn open. Connections on equipment that is subject to vibration are especially prone to coming loose.

Finally, you should look for defective wiring. Pay particular attention to areas where the wire insulation could be damaged causing short circuits. Don't rule out incorrect wiring, especially on a new piece of equipment.

Step 5 – Test and Repair

EEL EMD22	Version:01	Page No.55
	Copyright: Ethiopia Federal TVET Agency	



Testing electrical equipment can be hazardous. The electrical energy contained in many circuits can be enough to injure or kill. Make sure you follow all your companies safety precautions, rules and procedures while troubleshooting.

Once you have determined the most probable cause, you must either prove it to be the problem or rule it out. This can sometimes be done by careful inspection however, in many cases the fault will be such that you cannot identify the problem component by observation and analysis alone. In these circumstances, test instruments can be used to help narrow the problem area and identify the problem component.

There are many types of test instruments used for troubleshooting. Some are specialized instruments designed to measure various behaviors of specific equipment, while others like the multimeters are more general in nature and can be used on most electrical equipment. A typical multimeter can measure AC and DC Voltages, Resistance, and Current.

A very important rule when taking meter readings is to predict what the meter will read before taking the reading. Use the circuit schematic to determine what the meter will read if the circuit is operating normally. If the reading is anything other than your predicted value, you know that this part of the circuit is being affected by the fault.

Depending on the circuit and type of fault, the problem area as defined by your observations, can include a large area of the circuit creating a very large list of possible and probable causes. Under such circumstances, you could use a “divide and eliminate” testing approach to eliminate parts of the circuit from the problem area. The results of each test provides information to help you reduce the size of the problem area until the defective component is identified.

Once you have determined the cause of the faulty operation of the circuit you can proceed to replace the defective component. Be sure the circuit is locked out and you follow all safety procedures before disconnecting the component or any wires.

After replacing the component, you must test operate all features of the circuit to be sure you have replaced the proper component and that there are no other faults in the circuit. It can be very embarrassing to tell the customer that you have repaired the problem only to have him find another problem with the equipment just after you leave.

Please note, Testing is a large topic and this article has only touched on the highlights.

EEL EMD22	Version:01	Page No.56
	Copyright: Ethiopia Federal TVET Agency	



Follow up

Although this is not an official step of the troubleshooting process it nevertheless should be done once the equipment has been repaired and put back in service. You should try to determine the reason for the malfunction.

Self-Check -4	Written test
----------------------	---------------------

Directions: Answer all the questions listed below.

Instruction-Say true if the statement is true and false if false

- ___ 1. **Diagnosis** is the identification of the nature and cause of a certain phenomenon.
- ___ 2. Fault diagnosis is used in a root cause failure analysis to determine the original cause of the fault.
- ___ 3. No voltage supply may be the cause for failure to motor high noise level.
- ___ 4. Unbalanced electrical load is likely to be one of the probable cause for over heating of motor.

EEL EMD22	Version:01	Page No.57
	Copyright: Ethiopia Federal TVET Agency	



___5. Loose connection at some terminal lugs may be taken as one of the probable cause for motor fail to start.

Note: Satisfactory rating - 3 and 5 points Unsatisfactory - below 3 and 5 points

You can ask you teacher for the copy of the correct answers.

Answer Sheet

Score = _____

Rating: _____

Name: _____

Date: _____

Short Answer Questions

Operation Sheet- 1	Trouble shooting procedures working on electrical equipment
---------------------------	---

Preparation

Before you begin to troubleshoot any piece of equipment, you must be familiar with your organization's safety rules and procedures for working on electrical equipment. These rules and procedures govern the methods you can use to troubleshoot electrical equipment (including your lockout/tagout procedures, testing procedures etc.) and must be followed while troubleshooting.

Step 1 – Observe(visual inspection)

Step 2 – Define Problem Area

EEL EMD22	Version:01	Page No.58
	Copyright: Ethiopia Federal TVET Agency	



Step 3 – Identify Possible Causes

Step 4 – Determine Most Probable Cause

Step 5 – Test and Repair

Information Sheet-5	Testing suspected fault scenarios
---------------------	-----------------------------------

5.1 Introduction to Testing suspected fault scenarios

What is a Test Scenario?

A Test Scenario is defined as any functionality that can be tested. It is also called Test Condition or Test Possibility . As a tester, you may put yourself in the end user's shoes and figure out the real-world scenarios and use cases of the Application Under Test.

What is Scenario Testing?

Scenario Testing is a variant of Software Testing where Scenarios are Used for Testing. Scenarios help in an Easier Way of Testing of the more complicated Systems.

Why create Test Scenarios?

- Test Scenarios are created for the following reasons,
- Creating Test Scenarios ensures complete Test Coverage
- Test Scenarios can be approved by various stakeholders like Business Analyst, Developers, Customers to ensure the Application Under Test is thoroughly tested.
- It ensures that the software is working for the most common use cases.

EEL EMD22	Version:01	Page No.59
	Copyright: Ethiopia Federal TVET Agency	



- They serve as a quick tool to determine the testing work effort and accordingly create a proposal for the client or organize the workforce.
- They help determine the most important end-to-end transactions or the real use of the software applications.
- For studying the end-to-end functioning of the program, Test Scenario is critical.

Self-Check -5	Written test
----------------------	---------------------

Directions: Answer all the questions listed below.

Instruction- Give short answer

1. What is a Test Scenario? (2) points

2. Mention at least three reasons why test Scenarios are created. (3) points

Note: Satisfactory rating - 3 and 5 points Unsatisfactory - below 3 and 5 points

You can ask your teacher for the copy of the correct answers.

EEL EMD22	Version:01	Page No.60
	Copyright: Ethiopia Federal TVET Agency	



Answer Sheet

Score = _____

Rating: _____

Name: _____

Date: _____

Short Answer Questions

Information Sheet-6

Identifying causes of the faults

6.1 Identifying causes of the faults

General Troubleshooting Procedure

Symptom The machine does not start when the start button is pressed . At this point the problem could be mechanical or electrical . We will focus on just the electrical circuit faults for now.

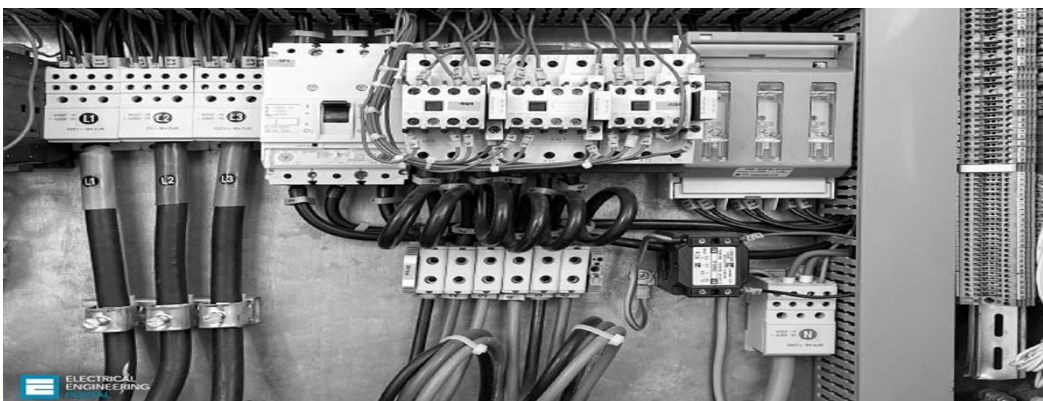

Figure 6.1.Troubleshooting An Open Circuit Faults in the Control Circuit .

This fault could be located in either the power circuit or the control circuit. The fault could also be many different types , such as, open circuit fault, short circuit fault or a ground fault.

EEL EMD22	Version:01	Page No.61
	Copyright: Ethiopia Federal TVET Agency	



This general troubleshooting procedure is designed to start in the middle of the problem area and give us the best idea which direction to go. The control transformer is a good place to start since it is in the middle of the circuit and is part of the power and control circuits.

The first three steps of this procedure will be the same for all faults and the rest will be completed throughout this chapter in more than one procedure. There is no one procedure that can guide you through any given problem.

For simplicity's sake we will now take one area and one type of fault at a time. The first fault we will investigate is the open circuit fault.

We will now investigate open circuit faults in the control circuit.

6.1.1 Open Circuit Faults in the Control Circuit

Open circuit faults – An open circuit fault is any fault that stops the operation of a machine due to an open wire or component .

Let ' s develop our procedure for troubleshooting an open circuit in the control circuit.

Remember that the first three steps will be the same for all faults .

Step 1

You must analyze the schematic diagram for a general circuit overview.

Step 2

You must carefully open the control panel with power energized since voltage checks will need to be made. (The operation of the voltmeter should have been verified before continuing)

Step 3

You should check the voltage at the X 1 and X 2 terminals at the secondary of the control transformer.

- If correct voltage is not present , then the problem is in the power circuit .
- If correct voltage is present and the contactor is energized, then the problem is in the power circuit.
- If correct voltage is present , the contactor is not energized and the OL is not tripped , then the problem is in the control circuit.

EEL EMD22	Version:01	Page No.62
	Copyright: Ethiopia Federal TVET Agency	

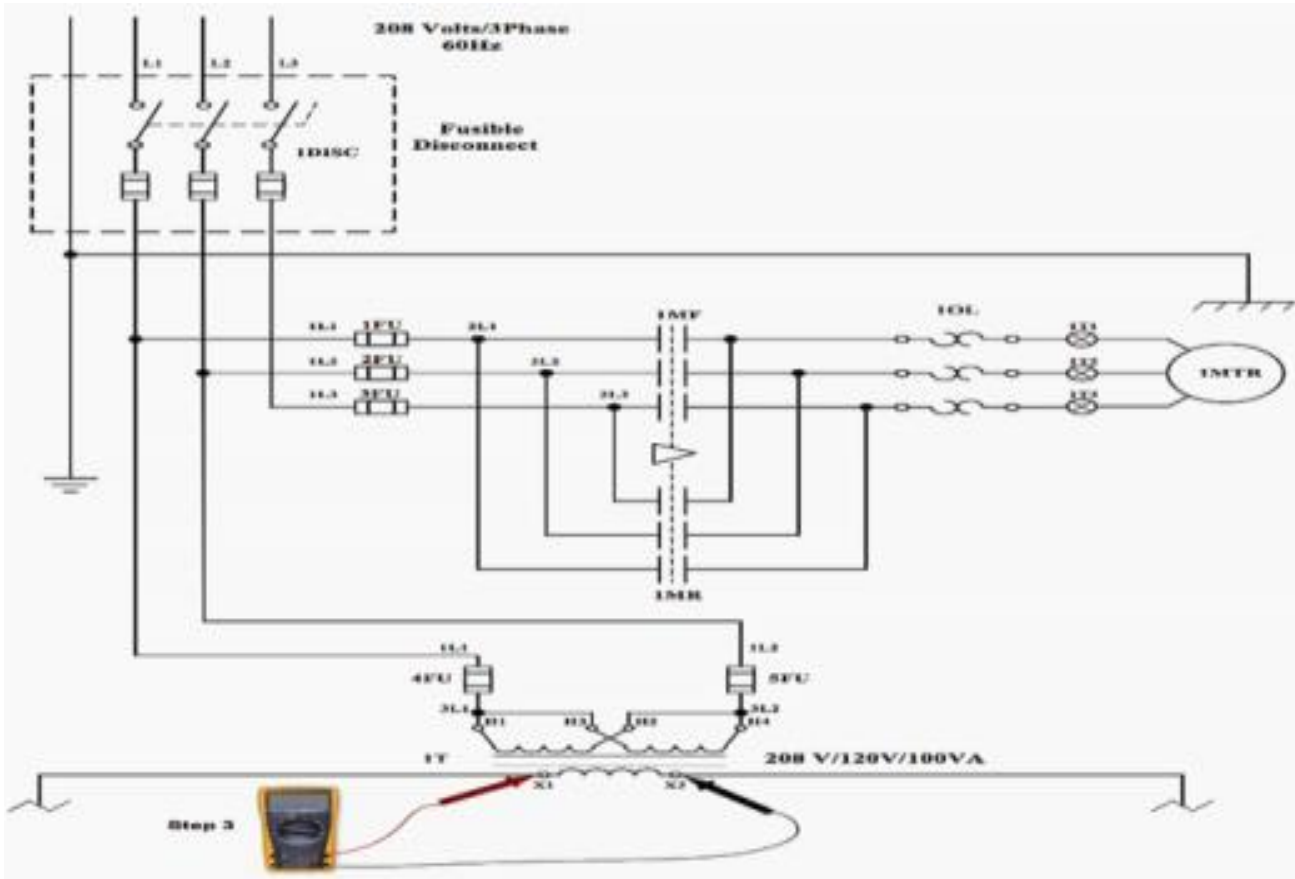

6.1.1 Schematic diagram - control circuit

Scenario // What 's happening ?

Scenario is the motor does not start when the start button is pressed. The correct voltage is present at X 1 and X 2 , the contactor is not energized and the OL is not tripped, then the problem is in the control circuit. For this scenario , the fault is an open circuit fault and inside the panel . From the schematic on the previous page you should have read 120 volts at terminals X 1 and X 2 .

Since the correct voltage is present we must troubleshoot the system in a logical order until we lose the correct voltage.

If the voltage changes from a good reading on one device to a different reading on the next device in logical order, then the device or wire in between those readings is open .

Step 4

You should check the voltage on X 1 at the top of the control circuit fuse and X 2 terminal at the secondary of the control transformer.

•If the correct voltage is present , continue to Step 5 .

•If the correct voltage is not present , then X 1 wire is open from the top of the fuse to the terminal on the secondary of the transformer.

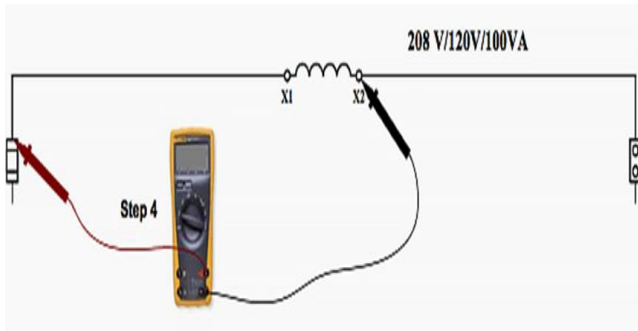

You should check the voltage on X 1 at the top of the control circuit fuse and X 2 terminal at the secondary of the control transformer.

Step 5

You should check the voltage on X 1 at the top of the control circuit fuse and X 2 at the top of the neutral link.

- If the correct voltage is present , continue to Step 6 .
- If the correct voltage is not present , then X 2 wire is open from the top of the neutral link to the terminal on the secondary of the transformer.

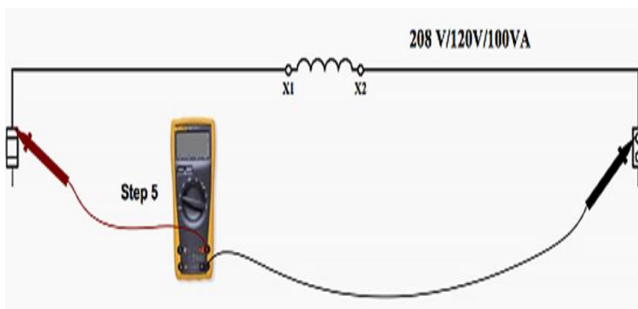

You should check the voltage on X 1 at the top of the control circuit fuse and X 2 at the top of the neutral link .

Step 6

You should check the voltage on wire # 1 at the bottom of the control fuse and X 2 at the top of the neutral link .

- If the correct voltage is present , continue to Step 7 .
- If the correct voltage is not present , then the control fuse is open .

If the fuse is open, then there is either a short circuit or ground fault. If the fuse is not open ,then there is an open circuit fault . This is our first indication that the fault is an open circuit fault .

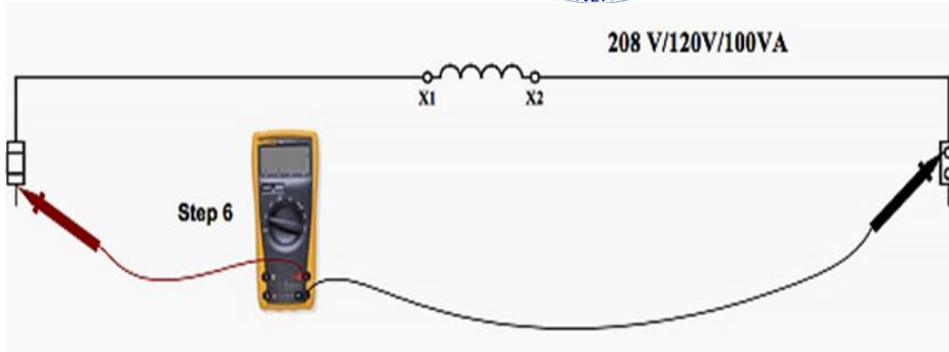

You should check the voltage on wire # 1 at the bottom of the control fuse and X 2 at the top of the neutral link .

Step 7

You should check the voltage on wire # 1 at the bottom of the control fuse and wire # 2 on the bottom of the neutral link .

- If the correct voltage is present , continue to Step 8 .
- If the correct voltage is not present , then the neutral link is open .

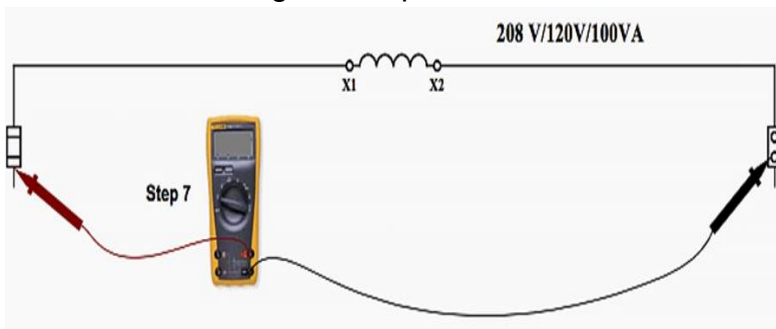

You should check the voltage on wire # 1 at the bottom of the control fuse and wire # 2 on the bottom of the neutral link.

Use the schematic diagram below as an illustration for Scenario A, assuming that we don 't know the location of the fault:

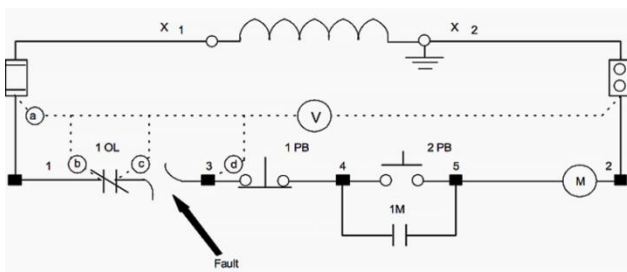

6.1.2 Schematic diagram as an illustration for Scenario A

Step 8



Since the voltage at point a (bottom of the fuse) is the correct voltage , we will use wire # 2 as your reference . We will make our measurements from left to right and then top to bottom until we find the voltage not present . If the correct voltage is present , continue to Step 9 .

Step 9

Check the voltage at point b (left side of 1 OL) with wire # 2 as a reference . If the correct voltage is present , continue to Step 10 .

- If the correct voltage is not present , then wire # 1 is open from the bottom of the fuse to the left of the normally closed contacts for 1 OL .

Step 10

Check the voltage at point c (right side of 1 OL) with wire # 2 as a reference .

- If the correct voltage is present , continue to Step 11 .
- If the correct voltage is not present , then 1 OL normally closed contacts are open .

Step 11

Check the voltage at point d (top of terminal # 3) with wire # 2 as a reference .

- If the correct voltage is present , continue to Step 12 .
- If the correct voltage is not present , then wire # 3 is open between the right side of 1 OL and the top of # 3 terminal.

Solution Of The Problem – The fault is between the point where the voltage is present and the point at which it is not present anymore .

EEL EMD22	Version:01	Page No.66
	Copyright: Ethiopia Federal TVET Agency	



Self-Check -6	Written test
----------------------	---------------------

Directions: Answer all the questions listed below.

Instruction-Give short answer for the following questions

1. Mention three types of faults you will come across in electrical systems. (3) points
2. What is an open circuit fault? (3) points

Note: Satisfactory rating - 3 and 5 points Unsatisfactory - below 3 and 5 points

You can ask your teacher for the copy of the correct answers.

Answer Sheet

Score = _____
Rating: _____

Name: _____

Date: _____

Short Answer Questions

EEL EMD22	Version:01	Page No.67
	Copyright: Ethiopia Federal TVET Agency	

Information Sheet-7	Rectifying faults in control components of the system
----------------------------	--

7.1 Rectifying faults in control components of the system

- To Be A “Troubleshooter” One Must Have : Knowledge On
 - ✓ Tools Needed
 - ✓ Basic Electrical And Electronic Components
 - ✓ Circuit Analysis
 - ✓ Repair And Maintenance Procedures

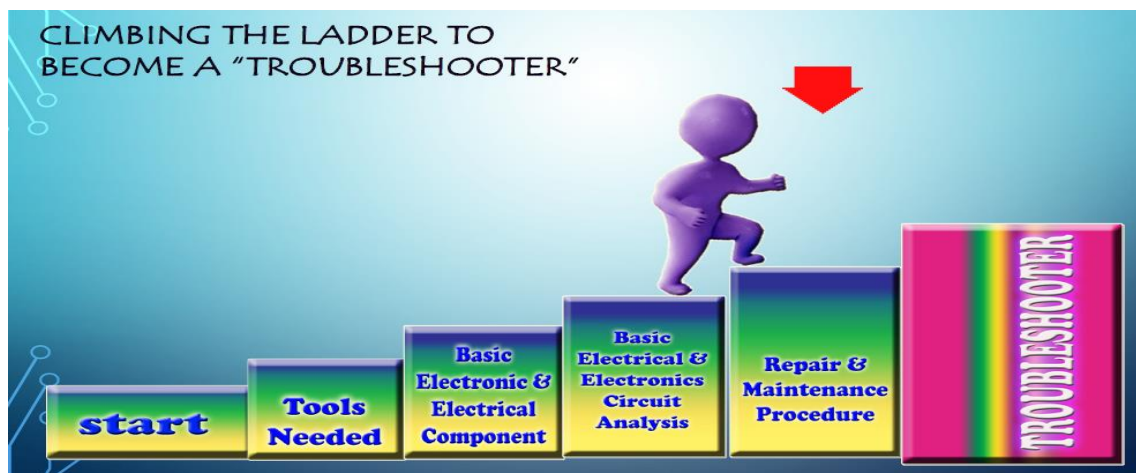

7.1.1 Tools Needed for Repair And Maintenance / troubleshooting

- Multimeters
- Wiring Tools
- Screwdrivers
- Miscellaneous Tools
- Do-It-Yourself Tools

7.1.2 Basic Electrical And Electronic Components

EEL EMD22	Version:01	Page No.68
	Copyright: Ethiopia Federal TVET Agency	



- **Passive Devices** – devices or components which do not require external source to their operation.

1. **Resistors** – a two-terminal passive component that opposes the flow of current (reduces the electric current) and at the same time lowers the voltage levels in a circuit.



2. **Capacitors** – a two-terminal passive component that is used to store energy. It can be used in a circuit as smoothing, coupling and bypass component.









3. **Inductors** – a two-terminal passive component that store energy in the form of magnetic field. It is used in circuit as “choke” and “reactor” in RF receiver and transmitter circuits..

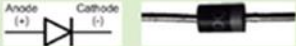

- **ACTIVE DEVICES** – devices or components which requires external source to their operation.

1. **Diodes** – a two terminal PN junction device that allows the flow of current only in one direction.

EEL EMD22	Version:01	Page No.69
	Copyright: Ethiopia Federal TVET Agency	

TYPE (BASIC)	SYMBOL/PICTURE	FUNCTION
RECTIFIER DIODES		Rectifier Circuits of Power Supply Units
ZENER DIODES		Voltage Regulator in Power Supply Units
LED – Light Emitting Diode		Calculator Displays, TV, Mobile Phone Displays
FUSE		Limit the amount of current that can be drawn by an electric circuit by opening (blowing or melting) when the current exceeds a preset limit.
BULB		Serve as the Load. It turns the electrical energy into light.
POWER CORD/PLUG		Temporarily connects an appliance or an equipment to the mains electricity supply via wall socket or an extension cord
SWITCHES		Necessary to turn the electrical circuit "on" or "off"

7.1.3 Basic Components Testing

Physical Appearance Of Good And Blown Fuse

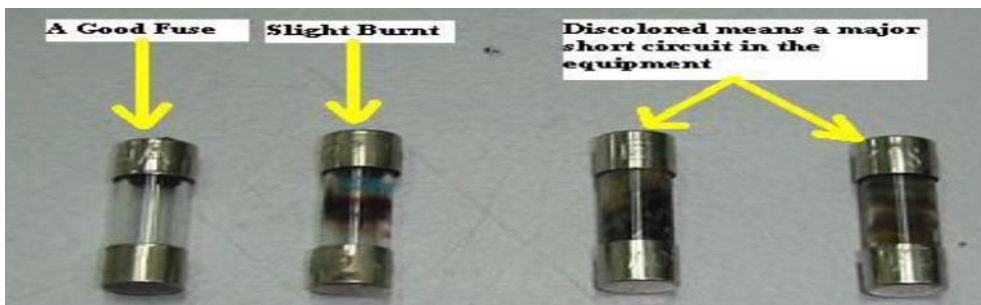

Using the continuity test function of the multimeter

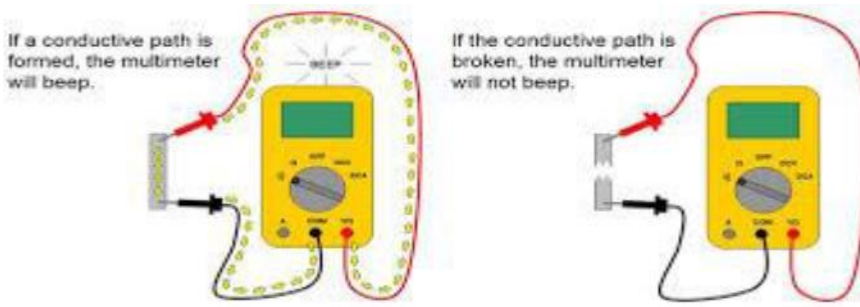

SWITCHES



- “ON” – multimeter reading must indicate continuity.
- “OFF” – multimeter reading must indicate no continuity.

TRANSFORMER

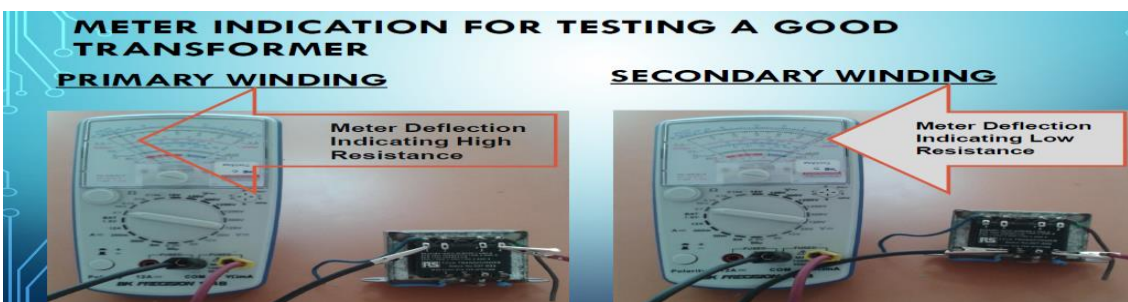

METER INDICATION FOR TESTING A BAD/DEFECTIVE TRANSFORMER

Shorted



Open



RESISTOR

Good Resistor

- **Measured Value** is within the range of the **Rated Value**.
- **Measured Value** – using an **Ohmmeter** or a **Multimeter**
- **Rated Value** – determining the Resistance of the Resistor thru **RESISTOR COLOR CODING**

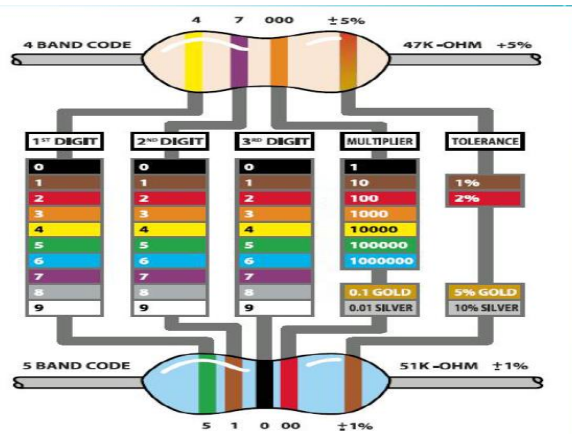

Bad/Defective Resistor

- **Open** – meter deflection indicates **INFINITE** resistance reading.
- **Shorted** – meter deflection indicates **ZERO** resistance reading.
- **Change Value** – rare defect of resistor; measured value is not within the range of the rated value.

Physical appearance of bad/defective resistor



FUSE, BULB AND SWITCH TESTING



POWER CORD/PLUG PROPER WIRING



7.1.4 BasicElectrica /Electronics circuit analysis

CIRCUIT COMPONENTS

1. Source
2. Switch
3. Connecting Wires
4. Load

1. SERIES CONNECTION

- BULB OR LAMPS (KNOWN AS THE LOAD) ARE ARRANGED IN CHAIN.
- CIRCUIT CURRENT HAS ONLY ONE PATH TO TAKE. CURRENT FLOWING THROUGH EACH RESISTOR IS THE SAME.
- TOTAL CIRCUIT RESISTANCE IS FOUND BY SIMPLY ADDING UP THE RESISTANCE VALUES OF THE INDIVIDUAL LOADS.
- TOTAL VOLTAGE AND POWER IS DIVIDED ACCORDINGLY THROUGH THE LOADS.

2. PARALLEL CONNECTION

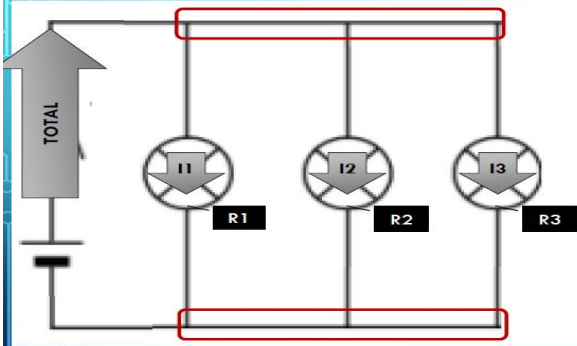

- LOADS ARE ARRANGED SUCH THAT TWO ELECTRICALLY COMMON ENDPOINTS ARE CREATED.
- TOTAL CIRCUIT CURRENT IS DIVIDED ACCORDINGLY THROUGH EACH PARALLEL BRANCH.
- TOTAL RESISTANCE IS FOUND BY ADDING UP THE RECIPROCAL OF THE RESISTANCE VALUES, AND THEN TAKING THE RECIPROCAL OF THE TOTAL.
- VOLTAGE IN EACH PARALLEL BRANCH IS THE SAME AS THE SOURCE VOLTAGE.

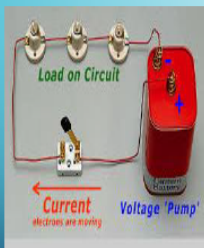

SERIES CIRCUIT	Electrical Parameter	PARALLEL CIRCUIT
$R_1 + R_2 + R_3 > R_T$	Total Resistance (R_T)	$\frac{1}{\frac{1}{R_1} + \frac{1}{R_2} + \frac{1}{R_3}} < \text{Smallest Resistance}$
Constant	Total Current (I_T)	Sum of the currents in each branch
Sum of all Voltage Drop	Total Voltage (V_T)	Constant
$V_T I_T$	Total Power (P_T)	$V_T I_T$

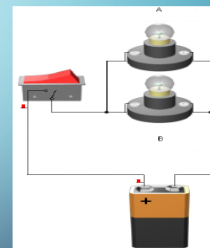

SERIES CONNECTION

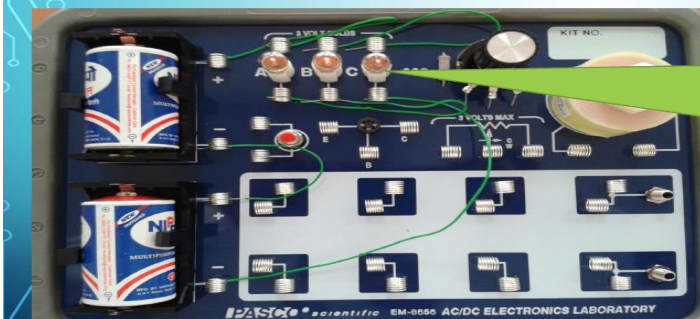

WHAT WILL HAPPEN IF ONE BULB BURNS OUT???

WHAT WILL HAPPEN IF ONE BULB BURNS OUT?



NONE OF THE BULBS WOULD LIGHT UP...

PARALLEL CONNECTION



WHAT WILL HAPPEN IF ONE BULB BURNS OUT???

WHAT WILL HAPPEN IF ONE BULB BURNS OUT?



REMAINING BULBS WOULD LIGHT UP...

Self-Check -7

Written test



Directions: Answer all the questions listed below.

Instruction- Say true if the statement is true and false if false

- _____ 1. Work site is made safe in accordance with established safety procedures.
_____ 2. Rectification of faults is documented in accordance with established procedures.
_____ 3. A volt meter is used to measure resistance.
_____ 4. An ohmmeter is used to measure voltage.
_____ 5. To be a trouble shooter one must have knowledge on basic electrical and electronic Components.

Note: Satisfactory rating - 3 and 5 points Unsatisfactory - below 3 and 5 points

You can ask your teacher for the copy of the correct answers.

Answer Sheet

Score = _____

Rating: _____

Name: _____

Date: _____

Short Answer Questions

Information Sheet-8	Controlling variable speed drives for motors
----------------------------	---

EEL EMD22	Version:01	Page No.76
	Copyright: Ethiopia Federal TVET Agency	



8.1 Introduction to motor drives systems

Nowadays, modern power electronics and drives are used in electrical as well as mechanical industry. The power converter or power modulator circuits are used with electrical motor drives, providing either DC or AC outputs, and working from either a DC (battery) supply or from the conventional AC supply.

8.1.1 Definitions of Electrical Drives

- An electrical drive can be defined as an electromechanical device for converting electrical energy into mechanical energy to impart motion to different machines and mechanisms for various kinds of process control.
- An electrical drive is an industrial system which performs the conversion of electrical energy into mechanical energy or vice versa for running and controlling various processes.
- An electrical drive is defined as a form of machine equipment designed to convert electrical energy into mechanical energy and provide electrical control of the processes. The system employed for motion control is called an electrical drive.

A drive can refer to the specific power electronic circuitry needed to drive the motor. Electric motors that drive industrial machines need some way to control motor speed. And at its most basic level, a motor drive controls the speed of the motor.

Some manufacturers refer to a controller and motor together as a drive system. However, from the electrical side of things, the drive is often specifically the electrical components that make up the variable frequency inverter itself. So drives are the interface between the control signals and the motor and include power electronic devices such as SCRs (silicon controlled rectifiers), transistors, and thyristors.

Matching the correct drive to the type of motor in an application is critical for getting the best fit for torque, speed, and efficiency. There are a wide range of drives available depending on the needs of the specific application and motor type. In general thought, drive types typically fall into two categories; dc and ac drives.

DC drives control dc motors. A basic dc drive is similar in operation to an ac drive in that the drive controls the speed of the motor. For dc motor control, a common method is a thyristor-based control circuit. These circuits consist of a thyristor bridge circuit that rectifies ac into dc for the motor armature. And varying the voltage to the armature controls the motor's speed.

AC drives control ac motors, such as induction motors. These drives are sometimes known as variable frequency drives or inverters. AC drives convert ac to dc and then using a range of different switching techniques generate variable voltage and frequency outputs to drive the motor.

An adjustable speed drive is a general term used sometimes interchangeably with variable speed drive or variable frequency drive. Again, from an electrical perspective, all of these ultimately refer to the frequency converter circuitry.

EEL EMD22	Version:01	Page No.77
	Copyright: Ethiopia Federal TVET Agency	



An ac motor's speed is determined by the number of poles and the frequency. Thus, as frequency is adjusted the motor's speed can be controlled as well. A common way to control frequency is by the use of pulse width modulation (or PWM).

A PWM drive sends pulsed inputs to a motor and by modulating the pulse width, making it either narrower or wider, increases or decreases the average dc voltage seen by the motor. Another powerful kind of drive function is known as regenerative braking or regen braking. This is a way of stopping a motor's rotation by using the same solid-state components that control the motor's voltage. The energy generated from braking can be channeled back into the ac mains or into filter capacitors. Advantages of regen drives include the ability to run a motor in either forward or reverse direction without having to physically switch the polarity of the motor leads and without the need for reversing contactors or switches.

8.1.2 Electrical Drives And Their Block Diagram

An electrical drive system has the following components .

1. Electrical machines and loads
2. Motor
3. Power modulator
4. Sources
5. Control unit
6. Sensing unit

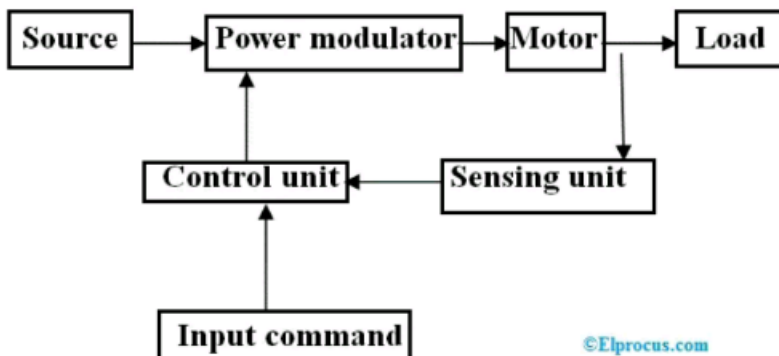

Fig.8.1.2 Electrical Drives And Their Block Diagram

EEL EMD22	Version:01	Page No.78
	Copyright: Ethiopia Federal TVET Agency	



1. Electrical machines and loads: usually a machinery to accomplish a given task. Eg-fans, pumps, washing machine etc.
2. Motor: actual energy converting machine (electrical to mechanical)
3. Power modulators regulate the power flow from source to the motor to enable the motor to develop the torque speed characteristics required by the load.

8.1.3 Types of Power Modulators

In the electric drive system, the power modulators can be any one of the following:

1. Controlled rectifiers (AC to DC converters)
2. Inverters (DC to AC converters)
3. AC voltage controllers (AC to AC converters)
4. DC choppers (DC to DC converters)
5. Cycloconverters (frequency conversion)

4. Electrical Sources- energy requirement for the operation of the system.

Very low power drives are generally fed from single-phase sources. Rest of the drives are powered from a three-phase source. Low and medium power motors are fed from a 400 V supply. For higher ratings, motors may be rated at 3.3 kV, 6.6 kV, and 11 kV. Some drives are powered from the battery.

5. Control Unit- adjust motor and load characteristics for the optimal mode.

Control unit for a power modulator is provided in the control unit. It matches the motor and power converter to meet the load requirements.

Types of control

- Manual control
- semiautomatic control &
- Automatic

Manual control: The electric drives with manual control can be as simple as a room fan, incorporating on switch and a resistance for setting the required speed.

Semiautomatic control: This control consists of a manual device for giving a certain command (Starting, braking, reversing, change of speed etc.,) and an automatic device that in response to command operates the drive in accordance with a preset sequence or order.

Automatic control: The electric drives with automatic control have a control gear, Without manual devices.

6. Sensing Unit

1. **Speed sensing:** Speed can be sensed by using a tachometer. Wind speed can be

EEL EMD22	Version:01	Page No.79
	Copyright: Ethiopia Federal TVET Agency	



sensed by anemometer similarly both speed and velocity can be measured by the speedometer.

2. **Torque sensing:** Magnetoelastic torque sensor is used in-vehicles applications on race cars, automobile, and aircraft.
3. **Position sensing:** Motion can be sensed through GPS, vibrometer, and rotary encoder.
4. **Current sensing and Voltage sensing** from lines or from motor terminals.
5. **Temperature sensing:** Thermistor is a device which is used for temperature Measurement.

8.1.4 Classification Of Electrical Drives

There are two types of electrical drives .

1. DC Drive: It is further classified into two types:
2. Non-regenerative DC drives: Non-regenerative DC drives are the mostconventional type. In their most basic form, they are able to control motor speedand torque in one direction.
3. Regenerative DC drives: Regenerative adjustable speed drives, also known as four-quadrant drives, are capable of controlling not only the speed and directionof motor rotation but also the direction of motor torque.

8.1.5 Characteristics Of Electric Drives

An electric drive provides electrical retarding and reduces service brake wear. It alsohas many operational advantages. It includes the control of wheel slip and slide thus reducing the tire wears. The system delivers a smoother ride for the operator. The electric drive system enhancements include improved retarding grids, slip control algorithms, the latest in diagnostic and troubleshooting software and silencers.

Microprocessor Based Electrical Drives

Microprocessor and microcontroller based electrical drives are DC motor drives, induction motor drives and traction motor drives.

Microprocessor Based DC Motor Drives

A microprocessor based control system can also be built where a phase controlled rectifier supplies a DC motor.

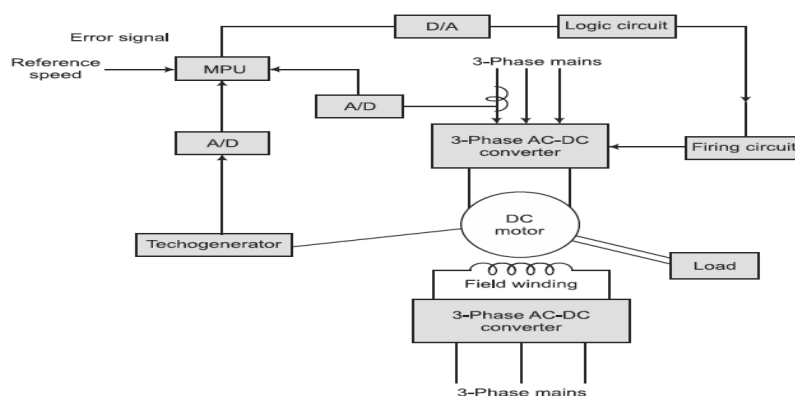

EEL EMD22	Version:01	Page No.80
	Copyright: Ethiopia Federal TVET Agency	



Fig. 8.1.6 Microprocessor based DC drives.

In **Fig. 8.1.6**, the armature and field winding of DC motor are supplied from three-phase AC supply to AC-DC converter then it is fed to the armature and field winding. A tachogenerator acts as a speed sensor, and it produces actual speed. Analog to Digital (A/D).

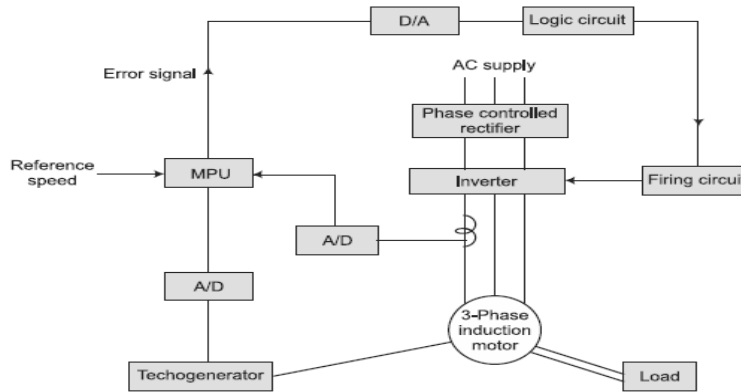

Fig.8.1.7 Microprocessor based AC drives.

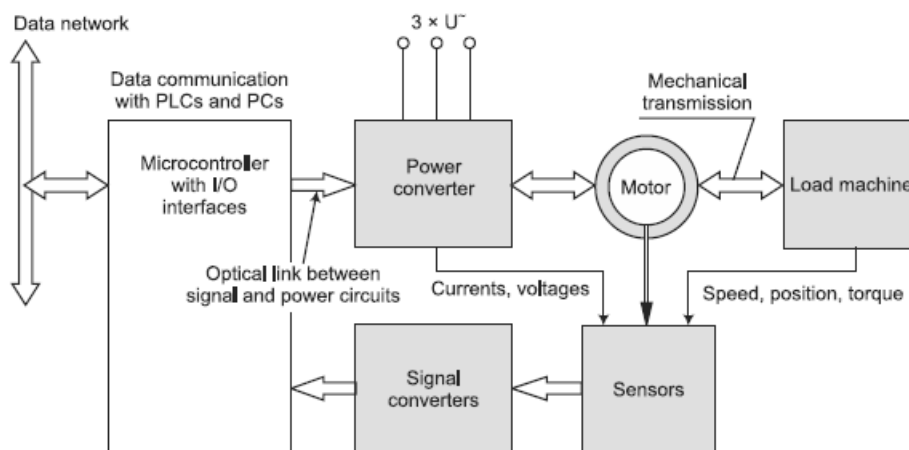

Fig.8.1.8 Microprocessor based traction drives.

In general, the main task of the electrical drive is the motion control of mechanisms.

An electrical drive is an automatic control system with a number of feedbacks where different automatic control principles, such as error driven feedback control, model-based **Fig.3** Microprocessor based AC drives.

Electrical Drives control, logical binary control, or fuzzy logic control methods, are used. Depending on a particular technical solution and selected control principle, different sensors for measuring of currents, voltages, velocity, acceleration, torque, etc., in an electrical drive are used.



Another information, like pressure signal for controlling pumps and compressors, air humidity and/or temperature signal for controlling of fans, etc., is also necessary.

8.1.9 APPLICATIONS OF ELECTRICAL DRIVES

Electric drives are used in boats,

1. traction systems,
2. lifts, cranes, electric car, etc.
3. They have flexible control characteristics.

The steady state and dynamic characteristics of electric drives can be shaped to satisfy the load requirements.

4. They are available in wide range of torque, speed, and power.
5. They can be started instantly and can immediately be fully loaded.
6. They can operate in all the four quadrants of the speed-torque plane.
7. They are adaptable to almost any operating conditions such as explosive and radioactive environments.

8.1.10 Advantages of Electric Drives

- Cost is too low as compared to another system of the drive.
- The system is more simple and clean.
- The control is very easy and smooth.
- Flexible in the layout.
- Facility for remote control.
- Transmission of power from one place to other can be done with the help of cables instead of long shafts, etc.
- Its maintenance cost is quite low.
- It can be started at any time without delay.

EEL EMD22	Version:01	Page No.82
	Copyright: Ethiopia Federal TVET Agency	



Self-Check -8	Written Test
----------------------	---------------------

Directions: Answer all the questions listed below.

Multiple-Choice Questions

___1. In electrical drives the component which is used to modulate power from source to motor.

- A. Control unit B. Power modulator C. Sensing unit D. Control command

___2.The power modulator which is used to convert fixed DC voltage to variable DC voltage.

- A. Controlled rectifier B. Un-controlled rectifier C. Chopper D.AC voltage controller

___3. Selection of an electric motor for any application depends on which of the following factors ?

- A. Electrical characteristics B. Mechanical characteristics

- C. Size and rating of motors D. Cost E. All of the above

___4. Which of the following is an examples of Electric Drives?

- A. Driving fans B. ventilators C. compressor D. Elivalator E. All

___5. What are the typical elements of an Electric Drive?

- A. Motor B. Power modulator C. Sources D. Control unit E.All

Note: Satisfactory rating - 3 and 5 points Unsatisfactory - below 3 and 5 points

Version:01	Page No.83
Copyright: Ethiopia Federal TVET Agency	

You can ask your teacher for the copy of the correct answers.



Score = _____
Rating: _____

Name: _____

Date: _____

Operation Sheet 1	Detection and rectification of faults in the equipment.
--------------------------	---

PURPOSE: - after performing this operation the trainees will be able to identify, test and analysis and rectify the faults in the equipment or circuits.

Conditions: -

EQUIPMENT AND TOOLS: - Digital multimeters, Bridge boards, combination plier, fixer, stripers, brush, soldering gun,.

MATERIALS: -, soldering lead, paper, connectors, Active and passive components, wires.

PROCEDURE:

Troubleshooting & repairing steps for detection and rectification of faults in the equipment.

Step1 Isolate the circuits within the faulty unit or the defective circuit group.

Steps 2 recognize, verify, and obtain descriptive information

Step 3 make logical selection of the logical faulty unit

Step 4 make input-output tests

Step 5 localize the fault to the circuit within the faulty unit

Step 6 replace or repair of faulty circuit components

PRECAUTIONS: - Apply all the necessary safety equipments.

EEL EMD22	Version:01	Page No.84
	Copyright: Ethiopia Federal TVET Agency	



QUALITY CRITERIA: - The trainees should be able to identify, test and analysis and rectify the faults in the equipment or circuits.

EEL EMD22	Version:01	Page No.85
	Copyright: Ethiopia Federal TVET Agency	

**Instruction Sheet****LG35: Complete and report fault diagnosis and rectification activities**

This learning guide is developed to provide you the necessary information regarding the following learning outcome and content coverage

- Following OH& S work completion risk control measures and procedures
- Making work site safe in accordance with established safety procedures.
- Documenting rectification of faults in accordance with established procedures.
- Performing operational/functional test

This guide will also assist you to attain the learning outcome and contents stated in the cover page.

Specifically, upon completion of this Learning Guide, you will be able to:-

- Follow OH& S work completion risk control measures and procedures
- Make work site safe in accordance with established safety procedures.
- Document rectification of faults in accordance with established procedures.
- Perform operational/functional test

Learning Instructions:

1. Read the specific objectives of this Learning Guide.
2. Read the information written in the “Information Sheet 1”.
3. Accomplish the “Self-check 1”.
4. If you earned a satisfactory evaluation proceed to “Operation Sheet 1”.

However, if your rating is unsatisfactory, see your teacher for further instructions or go back to learning Activity #1.

5. Submit your accomplished Self-check 1. This will form part of your training portfolio.
6. Do the “LAP test” (if you are ready) and show your output to your trainer.

➤ Your trainer will evaluate your output either satisfactory or unsatisfactory. If unsatisfactory, your trainer shall advise you on additional work. But if satisfactory you can proceed to learning Guide 3

Information sheet - 1	Following OH& S work completion risk control measures and procedures
----------------------------------	--

1.1 Introduction to electrical hazard awareness

EEL EMD22	Version:01	Page No.86
	Copyright: Ethiopia Federal TVET Agency	



This Information sheet will provide you with Introduction to electrical hazard awareness and you will understand the importance of following OH&S work completion risk control measures and procedures.

Hazard means: any potential or actual threat to the wellbeing of people, machinery or environment.

Electrical hazard safety means: taking precautions to identify and control electrical hazards. The reason why we follow OH&S work completion risk control measures and procedures is that electrical hazards exist in almost every workplace and one should know safety priorities.

Failing to take the necessary precautions can lead to:

- injury or death
- fire or property damage

Common causes of electrocution are

- making contact with overhead wires
- undertaking maintenance on live equipment
- working with damaged electrical equipment, such as extension leads, plugs and sockets
- using equipment affected by rain or water ingress

How do you respond to electrical incidents?

If you come across a person receiving an electric shock:

- if possible, disconnect the electrical supply (switch?)
- assess the situation – never put yourself at risk
- take precautions to protect yourself and anyone else in the vicinity
- apply the first aid principles (e.g. DRSABCD)
- assess the injuries and move the casualty to a safe area if required
- administer first aid if trained
- seek urgent medical attention

Do you want to be a victim?

You could be the victim if you:

- don't follow proper procedures around electricity
- use electrical equipment improperly
- use faulty electrical equipment

Can you protect yourself from electricity?

- Don't wear metal objects
- Turn power off

EEL EMD22	Version:01	Page No.87
	Copyright: Ethiopia Federal TVET Agency	



- Wear appropriate clothing
- Don't touch live parts
- Don't install or repair electrical equipment
- Clean and dry leads and plugs before use
- Use PPE

What are other safety measures?

- Heed warning signs
- Use the right equipment
- Study the operation manual
- Take care of extension leads
- Use the proper fuses and circuit breakers

Regular safety inspections are a part of YOUR job...

- Electrical equipment should be checked each time before use for defects
- If not tagged or the tag is out of date then report it and place it out of service

The key messages are....

- The risk of electric shock from correctly installed and maintained power sources is negligible, provided that sensible precautions are taken by the operator and correct work procedures are followed.
- Ensure that the right person is carrying out electrical work – licensed versus competent.
- Electricity is essential but, improperly used, it can be DEADLY!

Self-Check -1	Written Test
----------------------	---------------------

Name: _____

Date: _____

Directions: Answer all the questions listed below. Use the Answer sheet provided in the next page:

EEL EMD22	Version:01	Page No.88
	Copyright: Ethiopia Federal TVET Agency	



Multiple choice

___1. Which of the following is causes of electrocution ?

- A. making contact with overhead wires B. Undertaking maintenance on live equipment
C. Working with damaged electrical equipment D.All

___2. One can be victims of electrocution if he _____

- A. does' not follow proper procedures around electricity
B. use faulty electrical equipment C. use electrical equipment improperly
D.All

___3. One can protect himself from electricity by _____

- A. wearing metal objects B. Turning power off C. touching live parts D.All

___4. Which of the following are safety measures for hazard control ?

- A. Use the right equipment C. Study the operation manual
B. Use the proper fuses and circuit breakers D. All

___5. What will do if you come across a person receiving an electric shock?

- A. if possible, disconnect the electrical supply
B. take precautions to protect yourself and anyone else in the vicinity
C. apply the first aid principles
D. All

Note: Satisfactory rating above 3 points Unsatisfactory - below 3 points

You can ask you teacher for the copy of the correct answers.

Answer Sheet

Score = _____

Rating: _____

Information Sheet- 2	Making work site safe in accordance with established safety procedures
---------------------------------	--

2.1 Introduction to Workshop safety

EEL EMD22	Version:01	Page No.89
	Copyright: Ethiopia Federal TVET Agency	



Safety in the workshops is subject to a number of various risk assessments and safe codes of working practices which have to be observed and adhered to by all workshop users and enforced by the person in charge of these areas. Workshop safety is everyone's responsibility; the following rules have been put in place to ensure the safety of all students and staff.

2.1.1 Health and safety guidance on Workshop

Due to high risk activities taking place in the workshops access to these areas is restricted to authorized personnel only. No other person may enter the workshops without permission. Please read the safety rules carefully before entering the workshop.

Workshop rules

- Student affected by drugs or alcohol are not permitted in the workshop
- Students with any health problems that may affect workplace safety. (medication, epileptic fits) must report these conditions to the workshop staff.
- No food or drink in the workshop
- Wear the correct protective equipment for the tools you are using – ask if in doubt
- Ask how to use the tools safely
- Make sure your work piece is fixed securely before work commences
- Keep leads up off the floor Keep clear of any person operating tools and machinery (bumping an operator or get tangled in the lead could cause serious injury to you or the operator)
- Do not talk to anyone operating electrical equipment and machinery
- Keep your work area tidy Clean up any spills immediately

Ensure your safety in the workshop

When exiting the workshop Check that any tools you have been using have been put away in the appropriate spots, cleaned up your work area and notify the workshop staff.

Clothing & footwear

- Safety glasses and hearing protection - every person entering the workshop must collect these items from just inside the door. They must be worn at all times.
- Students that wear glasses should be aware these are not safety glasses, they are only impact resistant and may shatter, safety glasses must be worn.
- All loose clothing (eg shirts hanging out) must be tucked in.
- Safety boots or enclosed shoes must be worn in the workshop. Do not enter under any circumstances without this footwear, there are no exceptions to this rule.
- Long hair has to be tied up including fringes.
- Remove rings and loose jewellery before operating machinery they can be a hazard.

• Behavior

fooling around and practical jokes in the workshop will not be tolerated. These students will be told to leave.

EEL EMD22	Version:01	Page No.90
	Copyright: Ethiopia Federal TVET Agency	



• First Aid

All accidents, cuts and abrasions must be reported before leaving the workshop. If an accident does happen, no matter how small, it must be reported to the workshop staff and an Accident Report Form filled out. Filling out this form is imperative for any future complications resulting from an accident.

• Fires or other emergencies

Think before reacting to any emergency in the workshop, ensure you are reacting safely before you assist in an emergency. Do not attempt to fight any fire unless you have been trained to do so.

• Machinery usage

When students are operating machinery all other students are to stay clear and not to talk to the operator. If you feel uneasy or unsafe operating any tools or machinery in the workshop, inform the workshop supervisor and help will be provided.

• Machinery usage

When students are operating machinery all other students are to stay clear and not to talk to the operator. If you feel uneasy or unsafe operating any tools or machinery in the workshop, inform the workshop supervisor and help will be provided.

Machinery that students are not allowed to operate includes:

- Drop Saws
- Sac Panel Bench Saw
- Thicknesser
- Bench Rip Saw
- Lathes
- Pressure Testing Machine
- Milling Machine
- Plastic Moulder
- C.N. Router
- Circular Saws
- Laser

Self-Check -2	Written Test
----------------------	---------------------

Name: _____

Date: _____

EEL EMD22	Version:01	Page No.91
	Copyright: Ethiopia Federal TVET Agency	



Directions: Answer all the questions listed below. Use the Answer sheet provided in the next page:

Choose the best answer.

___ 1. Which of the following is correct about Workshop safety ?

A. everyone's responsibility C. only shop assistant's responsibility

B. only trainee's responsibility D. only trainer's responsibility

___ 2. The following is (are) used as safety device(s) in machines

A. Fail safe B. Safety interlocks C. Limit switch D. All of the above

___ 3. Industrial safety management is that branch of management which is concerned with _hazards from the industries.

A. Reducing B. Controlling C. Eliminating D. All of the above

___ 4- Which of the following is(are) physical hazard agent(s)

A. Falls B. Electricity C. Inhalation D. All of the above

___ 5- Check list for Job Safety Analysis (JSA) consists of

A. Work area, material, machine, tools C. Men, machine, material, tools

B. Men, machine, work area, tools D. Men, work area. Material, tools

Note: Satisfactory rating 3- 5 points

Unsatisfactory - below 3 points

You can ask your teacher for the copy of the correct answers.

Answer Sheet

Score = _____

Rating: _____

Information Sheet- 3	Documenting rectification of faults in accordance with established procedures
---------------------------------	--

3.1 Introduction to Fault reporting and documenting

EEL EMD22	Version:01	Page No.92
	Copyright: Ethiopia Federal TVET Agency	



Fault reporting

Fault Reporting is a maintenance concept that increases operational availability and that reduces operating cost through three mechanisms.

- Reduce labor-intensive diagnostic evaluation
- Eliminate diagnostic testing down-time
- Provide notification to management for degraded operation

Principle

Maintenance requires three actions.

- Fault discovery
- Fault isolation
- Fault recovery

Fault discovery requires diagnostic maintenance, which requires system down time and labor costs. Down time and cost requirements associated with diagnostics are eliminated for every item that satisfies the following criteria.

- Automated diagnostic
- Instrumented for remote viewing
- Displayed in the vicinity of supervisory personnel

Implementation

Fault reporting is an optional feature that can be forwarded to remote displays using simple configuration setting in all modern computing equipment. The system level of reporting that is appropriate for Condition Based Maintenance are critical, alert, and emergency, which indicate software termination due to failure. Specific failure reporting, like interface failure, can be integrated into applications linked with these reporting systems. There is no development cost if these are incorporated into designs. Other kinds of fault reporting involves painting green, yellow, and red zones onto temperature gages, pressure gages, flow gages, vibration sensors, strain gages, and similar sensors. Remote viewing can be implemented using a video camera.

Why keep a fault report after a fault has been diagnosed and repaired ?

There may be a pattern, or a recurring fault. Such a fault can be cured more quickly if there is a record of a previous diagnosis and corrective action. Therefore one can simply understand the status or condition of the system from the progress chart.

3.1.1 Definition of Progress check

What is a progress check?

Progress check is a written document that explains how much progress is being made on something you have previously planned.

What are the three fault codes used in a Periodic Test Condition Report?

C1 – danger present – this should be rectified immediately.

EEL EMD22	Version:01	Page No.93
	Copyright: Ethiopia Federal TVET Agency	



C2 – potentially dangerous – this should be rectified urgently.

C3 – improvement recommended – the problem needs to be rectified but it is not urgent.

The progress chart will give implications of the recorded information regarding a fault.

Danger – the reported fault raises the possibility that there is danger to those using the installation if the fault is not diagnosed and repaired.

Isolation – the faulty equipment, component or circuit will need to be isolated if repair cannot be carried out immediately.

Actions required – a decision needs to be made on what action to take: can the fault diagnosis take place immediately, can repair be effected, is the equipment or system under warranty?

Recommendation – sometimes it is not immediate action that is needed, but a recommendation for a solution to the problem. This can then be considered by the customer.

Self-Check -3	Written Test
----------------------	---------------------

Name: _____

Date: _____

Directions: Answer all the questions listed below. Use the Answer sheet provided in the next page:

Say True or false

EEL EMD22	Version:01	Page No.94
	Copyright: Ethiopia Federal TVET Agency	



- ___1. 'Fault Reporting is a maintenance concept that increases operational availability and reduces operating cost.
- ___2. Keeping or documenting a fault report after a fault has been diagnosed is unimportant.
- ___3. A progress check is a written document that explains how much progress is being made on something planned.
- ___4. From a periodic test condition report "danger present" recommends this should be rectified immediately.
- ___5. A recommendation from progress chart implies a solution to the problem.

Note: Satisfactory rating –15 points

Unsatisfactory - below 15 points

You can ask your teacher for the copy of the correct answers.

Answer Sheet

Score = _____
Rating: _____

Information Sheet- 4	Performing operational/functional test
---------------------------------	---

4.1 Performing operational/functional test

What is Operational Testing?

Operational acceptance testing (OAT), a testing technique performed to verify the operational readiness (pre-release) of a product or application under test as part of Software test life

EEL EMD22	Version:01	Page No.95
	Copyright: Ethiopia Federal TVET Agency	



cycle. This testing technique mainly focuses on operational readiness of the system, which is supposed to mimic the production environment.

Types of Operational Acceptance Testing: Operational Documentation Review

- ✓ Code Analysis
- ✓ Installation Testing
- ✓ End-to-End Test Environment Operational Testing
- ✓ Service Level Agreement Monitoring Test
- ✓ Load & Performance Test Operation
- ✓ Security Testing
- ✓ Backup and Restore Testing
- ✓ Fail over Testing
- ✓ Recovery Testing

Operational acceptance testing (OAT) is used to conduct operational readiness (pre-release) of a product, service, or system as part of a quality management system. OAT is a common type of non-functional software testing, used mainly in software development and software maintenance projects. This type of testing focuses on the operational readiness of the system to be supported, and/or to become part of the production environment. Hence, it is also known as operational readiness testing (ORT) or operations readiness and assurance testing (OR&A). Functional testing within OAT is limited to those tests which are required to verify the non-functional aspects of the system.

According to the International Software Testing Qualifications Board (ISTQB), OAT may include checking the backup/restore facilities, IT disaster recovery procedures, maintenance tasks and periodic check of security vulnerabilities.,[1] and whitepapers on ISO 29119 and Operational Acceptance by Anthony Woods,[2] and ISO 25000 and Operational Acceptance Testing by Dirk Dach et al., OAT generally includes:[3]

- Component Testing
 - ✓ Failover (Within the same data center)
 - ✓ Component fail-over
 - ✓ Network fail-over
 - ✓ Functional Stability
 - ✓ Accessibility
 - ✓ Conversion
 - ✓ Stability
 - ✓ Usability
- IT Service Management (Supportability)
 - ✓ Monitoring and Alerts (to ensure proper alerts are configured in the system if something goes wrong)

EEL EMD22	Version:01	Page No.96
	Copyright: Ethiopia Federal TVET Agency	



- ✓ Portability
- ✓ Compatibility
- ✓ Interoperability
- ✓ Installation and Blackout
- ✓ Localization
- ✓ Recovery (across data center)
- ✓ Application/system recovery
- ✓ Data recovery
- ✓ Reliability
- ✓ Backup and Restoration (Recovery)
- ✓ Disaster Recovery
- ✓ Performance, Stress and Volume,
- ✓ Maintainability

Procedures (Operability) and Supporting Documentation (Supportability)

Security and Penetration During OAT changes may be made to environmental parameters which the application uses to run smoothly. For example, with Microsoft Windows applications with a mixed or hybrid architecture, this may include: Windows services, configuration files, web services, XML files, COM+ components, web services, IIS, stored procedures in databases, etc. Typically OAT should occur after each main phase of the development life cycle: design, build, and functional testing. In sequential projects it is often viewed as a final verification before a system is released; where in agile and iterative projects, a more frequent execution of OAT occurs providing stakeholders with assurance of continued stability of the system and its operating environment.

An approach used in OAT may follow these steps:

- Design the system,
- Assess the design,
- Build the system,
- Confirm if built to design,
- Evaluate the system addresses business functional requirements,
- Assess the system for compliance with non-functional requirements,
- Deploy the system,
- Assess operability and supportability of the system.

For running the OAT test cases, the tester normally has exclusive access to the system or environment. This means that a single tester would be executing the test cases at a single

EEL EMD22	Version:01	Page No.97
	Copyright: Ethiopia Federal TVET Agency	



point of time. For OAT the exact Operational Readiness quality gates are defined: both entry and exit gates. The primary emphasis of OAT should be on the operational stability, portability and reliability of the system.

What is Operational Acceptance Testing?

Commonly referred to as OAT, Operational Acceptance Testing is testing that takes place just before implementation to production. The OAT test environment is often known as the 'pilot' environment. Everything required to support the application in production should be in place. The type of testing carried out here involves verification of procedures such as system start up and shut down and testing of housekeeping processes and verification of batch processing.

Typically OAT occurs after user acceptance testing (UAT) and is a final verification before a system is released. This testing typically employs real users accessing and using the system in a live state. Operation acceptance testing typically forms part of a phased roll-out prior to a system's formal Go Live state.

Following are definitions of three categories of test that shall apply:

1 Operational Test

That procedure required to ascertain only that a system or unit is operable. These tests should require no special equipment or facilities other than that installed on the aircraft and should be comparable to the tests performed by the flight crews.

It is not intended that the operational test of the unit shall meet the specifications and tolerances ordinarily established for overhaul, or major maintenance periods.

2. Functional Tests

That procedure required to ascertain that a system or unit is functioning in all aspects in accordance with minimum acceptable system or unit design specifications. These tests may require supplemental ground support equipment and should be more specific and detailed than an operational test. It should contain all necessary information to perform proficiency tests to maintain system or unit reliability at an acceptable level, without reference to additional documents.

3. System Test

That procedure containing all adjustment specifications and tolerances required to maintain system and/or unit performance at maximum efficiency and design specifications. It shall be self-contained and may duplicate other tests. It is normally used at major maintenance periods.

Elements and Performance Criteria

EEL EMD22	Version:01	Page No.98
	Copyright: Ethiopia Federal TVET Agency	



Prepare for work

- Work instructions are used to determine job requirements, including quality, material, equipment quantities and service manuals
- Job specifications are read and interpreted
- WHS requirements, including personal protection needs, are observed throughout the work
- Electronic system protection devices, processes and precautions are identified appropriate to the application
- Equipment and tooling are identified and checked for safety and correct operation
- Procedures are identified to minimize task time.

2. Service and adjust electronically controlled steering systems

- Service information is accessed and interpreted prior to commencing servicing procedures
- Current status and previous fault history of electronic steering/suspension system is determined in conjunction with the customer
- Current status of the electronic system is confirmed through a road test program
- Electronic system is serviced in accordance with manufacturer/component supplier specifications and enterprise procedure
- Fluids and lubricants are used in accordance with WHS and manufacturer/component supplier specifications
- Used fluids and lubricants are disposed of according to enterprise and WHS requirements

3. Rectify identified electronically controlled steering system faults

- Road test results are interpreted to verify system fault diagnosis
- Customer is notified of identified fault(s) and agreement is given before work is carried out
- Faulty components are removed and refitted with approved replacement parts in accordance with workplace procedures and customer requirements
- Faulty components are disposed of in accordance with workplace procedures and warranty requirements
- System adjustments are completed for components replaced

4. Test and confirm system faults have been rectified

- Test procedures are carried out to confirm rectification of system fault
- Documentation is completed in accordance with workplace/customer requirements
- Outcomes of rectification work is explained to the satisfaction of the customer to enable invoicing documentation to be completed

5. Clean up work area and maintain equipment

EEL EMD22	Version:01	Page No.99
	Copyright: Ethiopia Federal TVET Agency	



- Material that can be reused is collected and stored
- Waste and scrap is removed following workplace procedures
- Equipment and work area are cleaned and inspected for serviceable conditions in accordance with workplace procedures
- Serviceable equipment is tagged and faults identified in accordance with workplace procedures
- Maintenance is completed in accordance with manufacturer/component supplier specifications and site procedures
- Tooling is maintained in accordance with workplace procedures

Self-Check -4	Written Test
----------------------	---------------------

Name: _____

Date: _____

Directions: Answer all the questions listed below. Use the Answer sheet provided in the next page:

Say True or false

- ___1. Operational acceptance testing a testing technique performed to verify the operational readiness of a product or application.
- ___2. Operational test is that procedure required to ascertain only that a system or unit is operable.
- ___3. Continuity test of a thestaotor winding of the motor is tested by ohmmeter.
- ___4. Short circuit of amotor is tested across two terminals of stator winding(b/n W1 & w2).
- ___5. Ground test of a motor is tested between two terminals of stator winding(b/n W1 &U1).

Note: Satisfactory rating 3-5 points

Unsatisfactory - below 3 points

You can ask you teacher for the copy of the correct answers.

EEL EMD22	Version:01	Page No.100
Copyright: Ethiopia Federal TVET Agency		



Answer Sheet

Score = _____

Rating: _____

Lab Test-1

Practical demonstration on diagnosing and rectifying electrical faults in ac and dc motors.

PURPOSE: - after performing this operation the trainees will be able to diagnose and rectify faults in systems controlling of ac and dc motors.

Conditions: -

EQUIPMENT AND TOOLS: -Digitalmultimeter , bridge board, combination plier, stripers, brush, soldering gun,

MATERIALS: - wires, coil ,varnish ,insulation paper .

Instructions: You are required to perform the following tasks individually with the presence of your trainer.

PROCEDURE:

Step1.Apply OH &S PPE.

Step2.Open the box where the terminal of the 3 phase motor windings are available and perform

EEL EMD22	Version:01	Page No.101
	Copyright: Ethiopia Federal TVET Agency	



- a. short circuit test between the terminals of two windings of the three coils.
- b. open circuit test between V1 & V2 , U1 & U2 and W1 &W2 of the motors terminals.
- c. Ground test between each windings of the coil &frame ormotor body.(i.e W1 & frame, V1 & frame and U1 & frame)

step 3. Measure the resistance of each windings and comare

step4.Explain the type of faults you diagnosed

step5.Dependng on the type of fault you found and take a remedial action to correct the fault of the motor.

Step 6.perform functional testing and

Step7.Complete and report fault diagnosis and rectification activities.

PRECAUTIONS: - Apply all the necessary safetyequipments.

QUALITY CRITERIA: - the trainees should be able to complete and report fault diagnosis and rectification activities.

EEL EMD22	Version:01	Page No.102
	Copyright: Ethiopia Federal TVET Agency	



REFERENCES

1. <https://www.deakin.edu.au/students/faculties/sebe/abe-students/workshop/rules-safety>
web.inf.ed.ac.uk › policies-procedures
2. <https://dictionary.cambridge.org> › progress report
3. https://en.m.wikipedia.org/wiki/Fault_reporting-- 1. ^ "Opnav Instruction 4790.16: Condition Based Maintenance" .US Navy Operations.Archived from the original on 2013-02-15.Retrieved 2012-08-15.
2. ^ "Opnav Instruction 4790.7: Maintenance Policy for United States Navy Ships" .US Navy Operations.
Archived from the original on 2013-02-15.
Retrieved 2012-08-15.

EEL EMD22	Version:01	Page No.103
	Copyright: Ethiopia Federal TVET Agency	



EEL EMD22	Version:01	Page No.104
	Copyright: Ethiopia Federal TVET Agency	