



ARTIFICIAL INSEMIATION

Level -II

Learning Guide

Unit of Competence: Standardize and sustain 3S

Module Title: Standardizing and sustaining 3S



Learning Guide #1

Unit of Competence: Standardize and sustain 3S

Module Title: Standardizing and sustaining 3S

LG Code: AGR ATI2 M07 0919 LO1-LG-01

TTLM Code: AGR ATI2 TTLM 0919v1

LO 1: Prepare for work

Learning Guide for Standardize and Sustain 3S Level II Version: 1 Revision: 0	Date: September 2019 Author Federal TVET Institute	Page 2 of 64
----------------------------------------------------------------------------------	-------------------------------------------------------	--------------



Instruction Sheet

Learning Guide #1

This learning guide is developed to provide you the necessary information regarding the following content coverage and topics –

- Job requirements
- OHS requirements
- Tools and Equipment Preparation for 3S
- 3S Implementation

This guide will also assist you to attain the learning outcome stated in the cover page. Specifically, upon completion of this Learning Guide, you will be able to –

- Use work instruction, work manual and job requirements.
- Use OHS requirements (Safety policies /Legislation/ regulations/codes of practice, Safe operating procedures, Emergency procedures, Personal protective equipment).
- Prepare tools and equipment for sorting, set in order and shining activities.
- Check if 3S is implemented.

Learning Instructions:

1. Read the specific objectives of this Learning Guide.
2. Follow the instructions described in number 3 to 15.
3. Read the information written in the “Information Sheets 1”. Try to understand what are being discussed. Ask your trainer for assistance if you have hard time understanding them.
4. Accomplish the “Self-check 1” in page 07.
5. Ask from your trainer the key to correction (key answers) or you can request your trainer to correct your work. (You are to get the key answer only after you finished answering the Self-check 1).
6. If you earned a satisfactory evaluation proceed to “Information Sheet 2”. However, if your rating is unsatisfactory, see your trainer for further instructions or go back to Learning Activity #1.
7. Submit your accomplished Self-check. This will form part of your training portfolio.
8. Read the information written in the “Information Sheet 2”. Try to understand what are being discussed. Ask your trainer for assistance if you have hard time understanding them.
9. Accomplish the “Self-check 2” in page 15.
10. Ask from your trainer the key to correction (key answers) or you can request your trainer to correct your work. (You are to get the key answer only after you finished answering the Self-check 2).

Learning Guide for Standardize and Sustain 3S Level II Version: 1 Revision: 0	Date: September 2019	Page 3 of 64
	Author Federal TVET Institute	



11. Read the information written in the “Information Sheets 3. Try to understand what are being discussed. Ask you trainer for assistance if you have hard time understanding them.
12. Accomplish the “Self-check 3” in page 21.
13. Ask from your trainer the key to correction (key answers) or you can request your trainer to correct your work. (You are to get the key answer only after you finished answering the Self-check 3).
14. Read the information written in the “Information Sheets 4. Try to understand what are being discussed. Ask you trainer for assistance if you have hard time understanding them.
15. Accomplish the “Self-check 4” in page 54.
16. Ask from your trainer the key to correction (key answers) or you can request your trainer to correct your work. (You are to get the key answer only after you finished answering the Self-check 3).
17. If you earned a satisfactory evaluation proceed to “Operation Sheet 1” in page 58. However, if your rating is unsatisfactory, see your trainer for further instructions or go back to Learning Activity #1.
18. Do the “LAP test” in page 63 (if you are ready). Request your trainer to evaluate your performance and outputs. Your trainer will give you feedback and the evaluation will be either satisfactory or unsatisfactory. If unsatisfactory, your trainer shall advice you on additional work. But if satisfactory you can proceed to Learning Guide #8.

Learning Guide for Standardize and Sustain 3S Level II Version: 1 Revision: 0	Date: September 2019	Page 4 of 64
	Author Federal TVET Institute	



Information Sheet-1	Job Requirements
----------------------------	-------------------------

Job Requirements

A Job can be defined as:

- A piece of work, especially a specific task done as part of the routine of one's occupation or for an agreed price.
- A post of employment; full-time or part-time position
- Anything a person is expected or obliged to do; duty; responsibility
- An affair, matter, occurrence, or state of affairs.
- The material, project, assignment, etc., being worked upon.
- The process or requirements, details, etc., of working.
- The execution or performance of a task.

The requirements for a job vary according to the nature of the job itself. However, a certain work ethic must be cultivated to succeed in any job and this is fundamental to an individual's sense of himself as a worker, as part of production relations and a fundamental economic being. The basic requirements for a job remain the same no matter what the job is, where it is located or what professional and educational qualifications are required for it. These are as follows:

Discipline: Nothing is possible without discipline. Any job requires a fundamental core of discipline from the worker or the employee and this is a quality which is independent of age, post, stature, job and so on. Discipline is absolutely indispensable and provides the impetus for work that can be strenuous, repetitive, boring and even unsatisfactory at times.

Enthusiasm: Enthusiasm for work is also a pre-requisite for any job. An innate love for the job, which in modern parlance is known as job satisfaction, is a core requirement for any job. The drive to succeed, to innovate, to do well and to make one's profession into one's livelihood is a critical drive which needs to be present in the employee or cultivated as soon as possible. No job, however perfectly carried out, can evoke the feeling of satisfaction of a job well done without the instinct for success.

Qualifications: This is a more material, tactile need for a job which can be conveyed through degrees and certificates. However education is not limited to what is taught in colleges or vocational training courses. It is the burning desire to learn more, to reach the depths of knowledge about a particular field of interest, to complete the job and learn from it that marks the true enthusiast and the truly learned.

Soft Skills: Soft skills include those skills which ensure that a job is executed well, and the employee can carry himself in the proper manner too. For example, good and smooth communication, computer skills, proficiency in language if needed, presentable appearance, the ability to manage crises are all soft skills which are fundamentally important in any job and which must be cultivated consciously.

Learning Guide for Standardize and Sustain 3S Level II Version: 1 Revision: 0	Date: September 2019	Page 5 of 64
	Author Federal TVET Institute	



Thus, the requirements of a job, though specific to it, cover also a general spectrum. These make for better employees and better individuals.

1. Work Instruction

Information about the work

- Describe what workers need to be able to do on the job
 - Work functions
 - Key activities of each work function
 - Performance indicators
- Describe what task to be done or work roles in a certain occupation

Work instruction is a description of the specific tasks and activities within an organization. A work instruction in a business will generally outline all of the different jobs needed for the operation of the firm in great detail and is a key element to running a business smoothly.

In other words it is a document containing detailed instructions that specify exactly what steps to follow to carry out an activity. It contains much more detail than a Procedure and is only created if very detailed instructions are needed. For example, describing precisely how a Request for Change record is created in the Change Management software support tool.

Procedures vs. Work Instructions

Many people confuse “procedures” with “work instructions”. In fact, most people write work instructions and call them procedures. Knowing the differences of procedures vs work instructions can help you understand the documentation process much better and, therefore, procedure documentation.

Procedures describe a process, while a work instruction describes how to perform the conversion itself. Process descriptions include details about the inputs, what conversion takes place (of inputs into outputs), the outputs, and the feedback necessary to ensure consistent results. The PDCA process approach (Plan, Do, Check, Act) is used to capture the relevant information.

Questions that need to be answered in a procedure include:

- Where do the inputs come from (suppliers)?
- Where do the outputs go (customers)?
- Who performs what action when (responsibilities)?
- How do you know when you have done it right (effectiveness criteria)?
- What feedback should be captured (metrics)?
- How do we communicate results (charts, graphs and reports)?
- What laws (regulations) or standards apply (e.g., ISO 9001, 8th EU Directive, IFRS, Sarbanes-Oxley)?

Learning Guide for Standardize and Sustain 3S Level II Version: 1 Revision: 0	Date: September 2019	Page 6 of 64
	Author Federal TVET Institute	



Job Specification

A statement of employee/workers characteristics and qualifications required for satisfactory performance of defined duties and tasks comprising a specific job or function.

Specification Sample

Technical parameters	Gigabyte 3D Rocket II (GH-PCU23-VE)
Heatsink and fan dimensions (L x W x H)	112mm x 112mm x 160mm 92mm x 92mm x 25mm
Heatsink material	aluminum plates on a copper base and four copper heatpipes 6mm in diameter
Fan rotation speed	~1500-3000rpm
Airflow	no data
Noise level	16.0 ~ 33.5 dBA
Nominal voltage	~12V
Fan MTBF	50,000h
Maximum power consumption	~4.6W
Fan bearings	2 frictionless bearings
Full weight	640g
Supported CPU sockets	Socket 478, LGA 775, Socket AM2/754/939/940
Additional	Additional fan in the lower part of the cooler Gigabyte thermal grease Replaceable fluorescent rings
Price, USD	\$60



Work Manual Self- Check 1	Written Test
--------------------------------------	---------------------

Directions: Answer all the questions listed below. Use the Answer sheet provided in the next page:

1. What is job (1 point)
2. What is a job requirement? (2 points)
3. List the requirements of job. (5 points)
4. What is work? (2 points)
5. Describe work instruction by your own words. (5 points)
6. Describe the difference between procedure and work instruction? (5 points)
7. Define job specification? (2 points)
8. Prepare specification samples (10 points)

Note: Satisfactory rating - 18points Unsatisfactory - below 18 points
You can ask you trainer for the copy of the correct answers.



Answer Sheet

Score = _____

Rating: _____

Name: _____

Date: _____

Short Answer Questions

1. _____

2. _____

3. _____

4. _____

5. _____

6. _____

7. _____



8. _____



Information Sheet 2

OHS Requirements

OHS Requirements

OHS requirements are legislation/regulations/codes of practice and enterprise safety policies and procedures. This may include protective clothing and equipment, use of tooling and equipment, workplace environment and safety, handling of material, use of firefighting equipment, enterprise first aid, hazard control and hazardous materials and substances.

Personal protective equipment include those prescribed under legislation/regulations/codes of practice and workplace policies and practices. Safe operating procedures include the conduct of operational risk assessment and treatments associated with workplace organization. Emergency procedures include emergency shutdown and stopping of equipment, extinguishing fires, enterprise first aid requirements and site evacuation.

Occupational safety and health (OSH) also commonly referred to as occupational health and safety (OHS) or workplace health and safety (WHS) is an area concerned with the safety, health and welfare of people engaged in work or employment. The goals of occupational safety and health programs include fostering a safe and healthy work environment. OSH may also protect co-workers, family members, employers, customers, and many others who might be affected by the workplace environment. In the United States the term occupational health and safety is referred to as occupational health and occupational and non-occupational safety and includes safety for activities outside work.

Occupational safety and health can be important for moral, legal, and financial reasons. In common-law jurisdictions, employers have a common law duty (reflecting an underlying moral obligation) to take reasonable care for the safety of their employees. Statute law may build upon this to impose additional general duties, introduce specific duties and create government bodies with powers to regulate workplace safety issues: details of this will vary from jurisdiction to jurisdiction. Good OSH practices can also reduce employee injury and illness related costs, including medical care, sick leave and disability benefit costs.

As defined by the World Health Organization (WHO) "occupational health deals with all aspects of health and safety in the workplace and has a strong focus on primary prevention of hazards." Health has been defined as "a state of complete physical, mental and social well-being and not merely the absence of disease or infirmity. Occupational health is a multidisciplinary field of healthcare concerned with enabling an individual to undertake their occupation, in the way that causes least harm to their health. It contrasts, for example, with the promotion of health and safety at work, which is concerned with preventing harm from any incidental hazards, arising in the workplace.

Since 1950, the International Labour Organization (ILO) and the World Health Organization (WHO) have shared a common definition of occupational health. It was

Learning Guide for Standardize and Sustain 3S Level II Version: 1 Revision: 0	Date: September 2019	Page 11 of 64
	Author Federal TVET Institute	

adopted by the Joint ILO/WHO Committee on Occupational Health at its first session in 1950 and revised at its twelfth session in 1995. The definition reads: "The main focus in occupational health is on three different objectives: (i) the maintenance and promotion of workers' health and working capacity; (ii) the improvement of working environment and work to become conducive to safety and health and (iii) development of work organizations and working cultures in a direction which supports health and safety at work and in doing so also promotes a positive social climate and smooth operation and may enhance productivity of the undertakings. The concept of working culture is intended in this context to mean a reflection of the essential value systems adopted by the undertaking concerned. Such a culture is reflected in practice in the managerial systems, personnel policy, principles for participation, training policies and quality management of the undertaking."

Joint ILO/WHO Committee on Occupational Health: those in the field of occupational health come from a wide range of disciplines and professions including medicine, psychology, epidemiology, physiotherapy and rehabilitation, occupational, occupational medicine, human factors and ergonomics, and many others. Professionals advise on a broad range of occupational health matters. These include how to avoid particular pre-existing conditions causing a problem in the occupation, correct posture for the work, frequency of rest breaks, preventative action that can be undertaken, and so forth.

"Occupational health should aim at: the promotion and maintenance of the highest degree of physical, mental and social well-being of workers in all occupations; the prevention amongst workers of departures from health caused by their working conditions; the protection of workers in their employment from risks resulting from factors adverse to health; the placing and maintenance of the worker in an occupational environment adapted to his physiological and psychological capabilities; and, to summarize, the adaptation of work to man and of each man to his job.

History



Harry McShane, age 16, 1908. Pulled into machinery in a factory in Cincinnati and had his arm ripped off at the shoulder and his leg broken without any compensation. The research and regulation of occupational safety and health are a relatively recent phenomenon. As labor movements arose in response to worker concerns in the wake of the industrial revolution, worker's health entered consideration as a labor-related issue.



In 1833, HM Factory Inspectorate was formed in the United Kingdom with a remit to inspect factories and ensure the prevention of injury to child textile workers. In 1840 a Royal Commission published its findings on the state of conditions for the workers of the mining industry that documented the appallingly dangerous environment that they had to work in and the high frequency of accidents. The commission sparked public outrage which resulted in the Mines Act of 1842. The act set up an inspectorate for mines and collieries which resulted in many prosecutions and safety improvements, and by 1850, inspectors were able to enter and inspect premises at their discretion.

Otto von Bismarck inaugurated the first social insurance legislation in 1883 and the first worker's compensation law in 1884 – the first of their kind in the Western world. Similar acts followed in other countries, partly in response to labor unrest.

Workplace hazards

Although work provides many economic and other benefits, a wide array of workplace hazards also present risks to the health and safety of people at work. These include "chemicals, biological agents, physical factors, adverse ergonomic conditions, allergens, a complex network of safety risks," and a broad range of psychosocial risk factors.

Physical and mechanical hazards



At-risk workers without appropriate safety equipment

Physical hazards are a common source of injuries in many industries. They are perhaps unavoidable in certain industries, such as construction and mining, but over time people have developed safety methods and procedures to manage the risks of physical danger in the workplace. Employment of children may pose special problems. Falls are a common cause of occupational injuries and fatalities, especially in construction, extraction, transportation, healthcare, and building cleaning and maintenance.

An engineering workshop specializing in the fabrication and welding of components has to follow the Personal Protective Equipment (PPE) at work regulations 1992. It is an employer's/workers duty to provide 'all equipment (including clothing affording protection against the weather) which is intended to be worn or held by a person at work which protects him against one or more risks to his health and safety'. In a fabrication and welding workshop an employer would be required to provide face and eye protection, safety footwear, overalls and other necessary PPE.

Machines are commonplace in many industries, including manufacturing, mining, construction and agriculture, and can be dangerous to workers. Many machines involve

Learning Guide for Standardize and Sustain 3S Level II Version: 1 Revision: 0	Date: September 2019	Page 13 of 64
	Author Federal TVET Institute	



moving parts, sharp edges, hot surfaces and other hazards with the potential to crush, burn, cut, shear, stab or otherwise strike or wound workers if used unsafely. Various safety measures exist to minimize these hazards, including lockout-tag out procedures for machine maintenance and roll over protection systems for vehicles.

According to the United States Bureau of Labor Statistics, machine-related injuries were responsible for 64,170 cases that required days away from work in 2008. More than a quarter of these cases required more than 31 days spent away from work. That same year, machines were the primary or secondary source of over 600 work-related fatalities. Machines are also often involved indirectly in worker deaths and injuries, such as in cases in which a worker slips and falls, possibly upon a sharp or pointed object.

The transportation sector bears many risks for the health of commercial drivers, too, for example from vibration, long periods of sitting, work stress and exhaustion. These problems occur in Europe but in other parts of the world the situation is even worse. More drivers die in accidents due to security defects in vehicles. Long waiting times at borders cause that drivers are away from home and family much longer and even increase the risk of HIV infections.

Confined spaces also present a work hazard. The National Institute of Occupational Safety and Health defines "confined space" as having limited openings for entry and exit and unfavorable natural ventilation, and which is not intended for continuous employee occupancy. Spaces of this kind can include storage tanks, ship compartments, sewers, and pipelines. Confined spaces can pose a hazard not just to workers, but also to people who try to rescue them.

Noise also presents a fairly common workplace hazard: occupational hearing loss is the most common work-related injury in the United States, with 22 million workers exposed to hazardous noise levels at work and an estimated \$242 million spent annually on worker's compensation for hearing loss disability. Noise is not the only source of occupational hearing loss; exposure to chemicals such as aromatic solvents and metals including lead, arsenic, and mercury can also cause hearing loss.

Temperature extremes can also pose a danger to workers. Heat stress can cause heat stroke, exhaustion, cramps, and rashes. Heat can also fog up safety glasses or cause sweaty palms or dizziness, all of which increase the risk of other injuries. Workers near hot surfaces or steam also are at risk for burns. Dehydration may also result from overexposure to heat. Cold stress also poses a danger to many workers. Over-exposure to cold conditions or extreme cold can lead to hypothermia, frostbite, trench foot, or chilblains.

Electricity poses a danger to many workers. Electrical injuries can be divided into four types: fatal electrocution, electric shock, burns, and falls caused by contact with electric energy.

Vibrating machinery, lighting, and air pressure (high or low) can also cause work-related illness and injury. Asphyxiation is another potential work hazard in certain situations. Musculoskeletal are avoided by the employment of good ergonomic design and the reduction of repeated strenuous movements or lifts. Ionizing (alpha, beta, gamma, X,



neutron), and non-ionizing radiation (microwave, intense IR, RF, UV, laser at visible and non-visible wavelengths), can also be a potent hazard

In Victoria, workplace health and safety is governed by a system of laws, regulations and compliance codes which set out the responsibilities of employers and workers to ensure that safety is maintained at work.

The Act

The *Occupational Health and Safety Act 2004* (the Act) is the cornerstone of legislative and administrative measures to improve occupational health and safety in Victoria.

The Act sets out the key principles, duties and rights in relation to occupational health and safety. The general nature of the duties imposed by the Act means that they cover a very wide variety of circumstances, do not readily date and provide considerable flexibility for a duty holder to determine what needs to be done to comply.

The Regulations

The *Occupational Health and Safety Regulations 2007* are made under the Act. They specify the ways duties imposed by the Act must be performed, or prescribe procedural or administrative matters to support the Act, such as requiring licenses for specific activities, keeping records, or notifying certain matters.

Guidance

Effective OHS regulation requires that Work Safe provides clear, accessible advice and guidance about what constitutes compliance with the Act and Regulations. This can be achieved through Compliance Codes, Work Safe Positions and non-statutory guidance ("the OHS compliance framework"). For a detailed explanation of the OHS compliance framework, see the Victorian Occupational Health and Safety Compliance Framework Handbook.

Policy

Not every term in the legislation is defined or explained in detail. Also, sometimes new circumstances arise (like increases in non-standard forms of employment, such as casual, labour hire and contract work, or completely new industries with new technologies which produce new hazards and risks) which could potentially impact on the reach of the law, or its effective administration by Work Safe. Therefore, from time to time Work Safe must make decisions about how it will interpret something that is referred to in legislation, or act on a particular issue, to ensure clarity. In these circumstances, Work Safe will develop a policy. A policy is a statement of what Work Safe understands something to mean, or what Work Safe will do in certain circumstances.

Work Manual Self-Check 2	Written Test
---------------------------------	---------------------

Learning Guide for Standardize and Sustain 3S Level II Version: 1 Revision: 0	Date: September 2019	Page 15 of 64
	Author Federal TVET Institute	



Directions: Answer all the questions listed below. Use the Answer sheet provided in the next page:

1. What is OHS represents for (2 point)
2. What is OSH represents for? (1 point)
3. What is WHS represents for. (1 point)
4. What are the goals of OHS? (2 points)
5. List some examples of OHS requirements in your work areas. (10 points)

Note: Satisfactory rating – 09 points Unsatisfactory - below 09 points

You can ask you trainer for the copy of the correct answers.

Learning Guide for Standardize and Sustain 3S Level II Version: 1 Revision: 0	Date: September 2019	Page 16 of 64
	Author Federal TVET Institute	



Answer Sheet

Score = _____

Rating: _____

Name: _____

Date: _____

Short Answer Questions

1. _____

2. _____

3. _____

4. _____

5. _____



Information Sheet 3

Tools and Equipment Preparation for 3S

Tools and Equipment used to implement 3S

You are required to prepare and use tools and equipment to implement sort, set in order and shine activities in to your work station. The following are some tools and equipment that help you in the implementation of 3S.

Tools and materials used to implement Sort activity

Tools and materials are required to implement sort, set in order and shine activities in work stations. The following are some tools and materials used to implement the first pillar of 5S-Sort.

- red tags
- hook
- shelves
- sponge
- pencil
- formats (for recording necessary and unnecessary items, plans etc...)
- sticker
- nails
- chip wood
- broom
- shadow board/ tools board

Tools and materials used to implement set in order

The following are some tools and materials used to implement the second pillar of 5S-Set in order.

Labels	
Signs	
Figures	
Partition lines	

Tools and materials used to implement shine

The following are some tools and materials used to implement the third pillar of 5S-Shine.

- sponges
- brooms
- brushes
- spades
- vacuum cleaners
- waste baskets
- dust bins
- gloves
- dust masks
- detergents
- containers
- oils
- bolts
- screws
- boots shoes
- Etc...







Self-Check 3	Written Test
---------------------	---------------------

Instructions: Perform the following tasks. Write your answers in the answer sheet provided:

1. List at least 10 tools and materials used to implement Sort. (10 points)
2. List at least eight tools and materials used to implement Set in order. (8 points)
3. List at least eight tools and materials used to implement Shine. (8 points)

Note: Satisfactory rating - 08 points Unsatisfactory - below 08 points
You can ask your trainer for the copy of the correct answers.



Answer Sheet

Score = _____

Rating: _____

Name: _____

Date: _____

1. _____

2. _____

3. _____



Information Sheet 4

3S Implementation

SORT

Overview of red tagging

The Red-Tag Strategy is a simple method for identifying potentially unneeded items in the factory or workshop, evaluating their usefulness and dealing with them appropriately. Red-tagging means putting red tags on items in the factory or workshop that need to be evaluated as being necessary or unnecessary. A Red tag is a red colored tag used to identify items no longer needed in a particular work area. The red tags catch people's attention because red is a colour that stands out. An item with a red tag is asking three questions:

- Is this item needed?
- If it is needed, is it needed in this quantity?
- If it is needed, does it need to be located here?

Once these items are identified, they can be held in a "Red Tag Holding Area" for a period of time to see whether they are needed, disposed of, relocated, or left exactly where they are.

Red-tag Holding areas

In order to implement the red-tag strategy effectively, a red-tag holding area must be created. A red-tag holding area is an area set aside for use in storing red-tagged items that need further evaluation. Red-tagging is helpful when the need or frequency of need for that item is unknown. When an item is set aside in a red-tag holding area and watched for an agreed-upon period of time people tend to be more ready to let it go when that time is over.

There are two red-tag holding areas: local and central holding areas. Local red-tag holding area is used to manage the flow of red-tagged items with in a local department or production area. Central red-tag holding area is used to manage the flow of items that cannot or should not be disposed of by individual departments or production area. Usually central red-tag holding area is used by an organization that is launching a companywide red-tagging effort.

Red-tag Holding Area

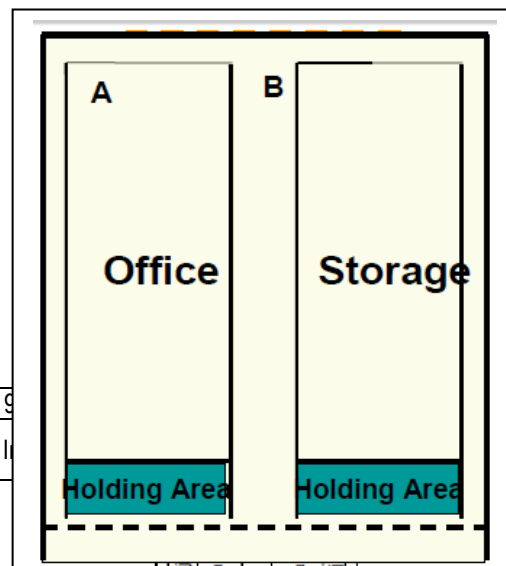

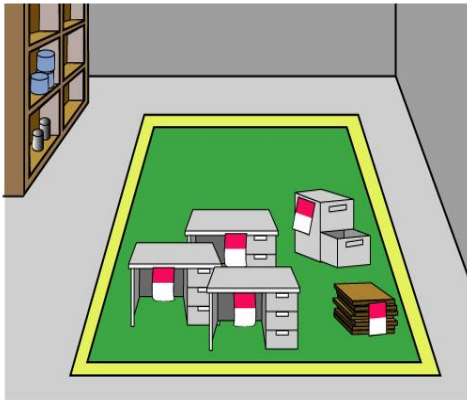

Steps/procedures in Red tagging

The red-tagging process in a department or work area can be broken down into seven steps.

- Step 1: Launch the red-tag project.
- Step 2: Identify the red-tag targets.
- Step 3: Set red-tag criteria.
- Step 4: Make red tags.
- Step 5: Attach red tags.
- Step 6: Evaluate red-tagged items.
- Step 7: Document the results of red-tagging.

Step 1: Launch the red-tag project

Red-tag campaigns are started and coordinated by the upper-level management of a company. Even when a red-tag campaign is companywide, local campaigns need to be organized in each department or production area. This involves

- Organizing a team
- Organizing supplies
- Organizing a time or schedule to perform red-tagging
- Deciding a local-tag holding area
- Planning for disposal of red-tagged items

People from outside a department can be valuable members on a red-tagging team since they tend to see the area with a fresh eye. Hence, it is helpful to partner with other departments or production areas in creating red-tagging teams.

Step 2: Identify red-tag targets

There are two red-tag targets:

- a) Items: in the manufacturing area items like inventory (warehouse and in-process inventory), equipment, and space are targets for red tags. Warehouse inventory include material, parts, products etc.
- b) Areas: It is better to define a smaller area and evaluate it well than to define a larger area and not be able to evaluate it fully in available time.

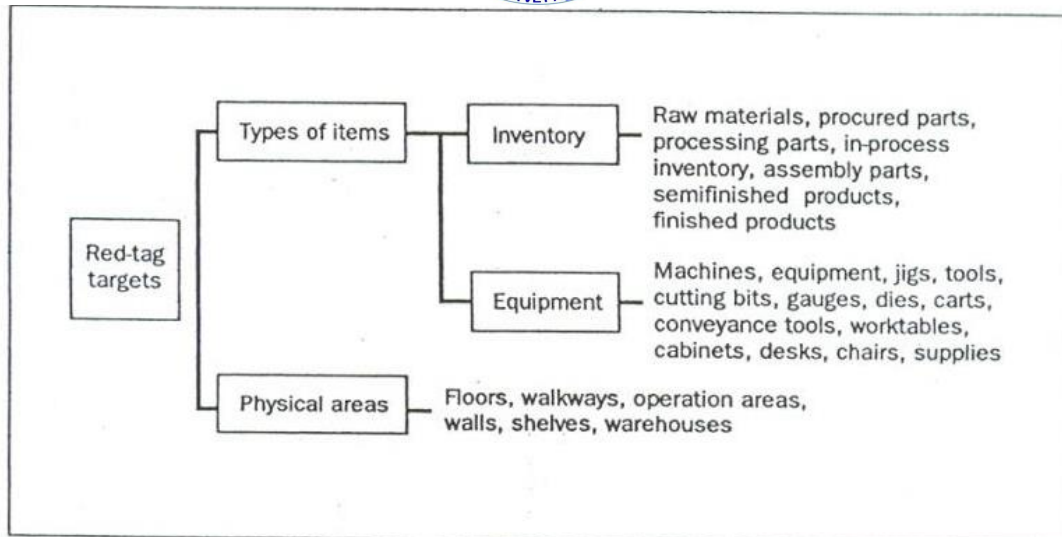

Step 3: Set red-tag criteria

As already mentioned, the most difficult thing about red-tagging is differentiating what is needed from what is not. This issue can be managed by establishing clear-cut criteria for what is needed in particular area and what is not. The most common criterion is the next month's production schedule.

- Items needed for that schedule are kept in that location.
- Items not needed for the schedule can be disposed of or stored in a separate location.

Three main factors determine whether an item is necessary or not. These factors are:

- The usefulness of the item to perform the work at hand. If the item isn't needed it should be disposed of.
- The frequency with which the item is needed. If it is needed infrequently it can be stored away from the work area.
- The quantity of the item needed to perform this work. If it is needed in limited quantity the excess can be disposed or stored away from the work area.

Each company must establish its own red-tagging criteria and each department may customize this standard to meet its local needs.

Step 4: Make red-tags

Each company has specific needs for documenting and reporting the movement, use, and value of materials, equipment, tools, inventory and products. The company's red tags should be designed to support this documentation process.

Various types of information on a red tag may include:

- Category: provides a general idea of the type of item (e.g., a warehouse item or machine). Categories include raw materials, in-process inventory, products, equipment, jigs, tools and dies.
- Item name and manufacturing number.
- Quantity: indicates the number of items included under this red tag.
- Reason: describes why a red tag has been attached to this item.
- Division: includes the name of the division responsible for managing the red-tagged item.



- Value: includes the value of the red-tagged item.
- Date: includes the red-tagging date.



Red Tag

Item Information

Date: _____ Tagged By: _____
Item Name: _____
Location: _____

Category

- Equipment Raw Materials
 Tools & Jigs Work-in-Process
 Finished Goods Other
 Gauges & Instruments
 Consumables
 Machine Parts

Reason for Red Tag

- Not Required Obsolete
 Defect Unknown object
 Scrap

Suggested Action Required

- Return to
 Scrap
 Relocate
 Sell

Comments

Log No. _____

RED TAG			
Category	1. Raw material 2. In-process stock ③ Semi-finished goods 4. Products	5. Machine and other equipment 6. Dies and jigs 7. Tools and supplies 8. Other	
Item name:	Door		
Manufacturing No.:	PX-180X		
Quantity:	2 Units	Value:	\$ (total)

Red Tag		No.
Name of applicant:	Date	
Name of item:	Quantity:	
Part No.:		
Location:		
Classification		
<input type="checkbox"/> 1. Material <input type="checkbox"/> 2. Part <input type="checkbox"/> 3. Inventory in-process <input type="checkbox"/> 4. Product <input type="checkbox"/> 5. Equipment/facilities <input type="checkbox"/> 6. Cutting tool <input type="checkbox"/> 7. Jig <input type="checkbox"/> 8. Fixing <input type="checkbox"/> 9. Others		
A: Reason for item of 1 to 4		
<input type="checkbox"/> a. Miscalculation/mistakes in sales/production plan <input type="checkbox"/> b. Order cancellation <input type="checkbox"/> c. Design/specification change <input type="checkbox"/> d. Design error <input type="checkbox"/> e. Order error <input type="checkbox"/> f. Receipt error (Insufficient inspection)		
<input type="checkbox"/> g. Machining error <input type="checkbox"/> h. Assembly error <input type="checkbox"/> i. Obsolescence, Long time storage <input type="checkbox"/> j. Others		
B: Reason for item of 5 to 9		
<input type="checkbox"/> k. Ageing <input type="checkbox"/> l. Out of order <input type="checkbox"/> m. No longer applicable <input type="checkbox"/> n. Others		

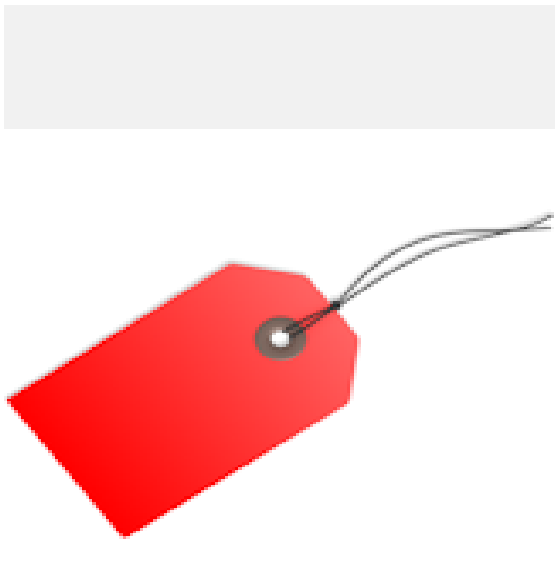

RED TAG

Date Issued: _____ Red Tag File No.: _____

Issued By: _____

Category: (Check appropriate box)

1. Equipment or Machine 5. Other Machine and Supplies
 2. Jigs, Fixtures, Tools, Dies 6. Furniture
 3. Machining Instructions 7. Other
 4. Non-permanent Material (Shavings, Off-cuts, etc.) 8. Scrap

Item Name: _____

Manufacturing No: _____ Issue Tag No.: _____

Quantity: _____ Unit of Measure: _____ Reason Storage With: () No Reason

Reason: (Check appropriate box)

1. Not Used Ever 5. Scrap or Obsolete Material
 2. Broken/Used (over 1/2) 6. Out of Order
 3. Good, Long Term Storage 7. Excess Inventory
 4. Defective or Damaged 8. Other

Reason Method: (Check appropriate box)

1. Design 5. Request in Requirement
 2. Material 6. Request for Replacement/Repair
 3. Space or Area Storage Full 7. Request Replacement
 4. Make in Separate Storage Site

Issue Tag File No. Area Log in Code: _____ Reason for Area Request/Storage Code: _____

Authorized By: _____ Issue Reason: _____

ISSUE: SIGNATURE™ DIE CATALOG NO. 51982

RED TAG

NAME: _____

Item: _____

Date: _____

ACTION REQUIRED: _____

The material used for red tags can be red paper, thick red tape, or others. Red tags can be laminated with plastic or another material to protect them during repeated use.

Step 5: Attach the red tags



The best way to carry out red-tagging is to do the whole target area quickly, if possible, in one or two days. In fact, many companies choose to red-tag their entire factory during a one or two day period. Red-tagging should be a short and powerful event. You should red-tag all items you question, without evaluating what to do with them.

Step 6: Evaluate the red-tagged items

In this step, the red-tag criteria established in step 3 are used to evaluate what to do with red-tagged items. Options include:

- Keep the item where it is.
- Move the item to a new location in the work area.
- Store the item away from the work area.
- Hold the item in the local red-tag holding area for evaluation.
- Dispose of the item.

Disposal methods include:

- Throw it away.
- Sell it.
- Return it to the vendor.
- Lend it out.
- Distribute it to a different part of the company.
- Send it to the central red-tag holding area.

The next table shows disposal methods.

Treatment	Description
Throw it away	Dispose of as scrap or incinerate items that are useless or unneeded for any purpose.
Sell	Sell off to other companies items that are useless or unneeded for any purpose.
Return	Return items to the supply company.
Lend out	Lend items to other sections of the company that can use them on a temporary basis.
Distribute	Distribute items to another part of the company on a permanent basis.
Central red-tag area	Send items to the central red-tag holding area for redistribution, storage, or disposal.

Evaluation format for red-tag items (sample)



Evaluation Form of Red Tag Items							Date of issue: Issued by: 5S promotion office		Remarks
Stage: Seiri		Unused Period (month)	Red tag strategy				Unnecessary item list		
Object	Type		Red tag		Sorter		Required	Not required	
Material	Main	12	<input type="radio"/>		Leader	Manager	<input type="radio"/>		
	Supplement	6	<input type="radio"/>		Leader	Manager	<input type="radio"/>		
	Broken	1		<input type="radio"/>				Dispose	
Parts	Common Use	6	<input type="radio"/>		Leader	Manager	<input type="radio"/>		
	Exclusive use	3	<input type="radio"/>		Leader	Manager	<input type="radio"/>		
Inventory in-process		2	<input type="radio"/>		Leader	Manager	<input type="radio"/>		
Product		3	<input type="radio"/>		Manager	General manager	<input type="radio"/>		
Facility		6	<input type="radio"/>		Manager	General manager	<input type="radio"/>		
Die		6	<input type="radio"/>		Manager	General manager	<input type="radio"/>		
Jig		6	<input type="radio"/>		Leader	General manager	<input type="radio"/>		
Cutting tool		6	<input type="radio"/>		Leader	Manage	<input type="radio"/>		
Tool		3	<input type="radio"/>		Leader	Head of Section	<input type="radio"/>		
Measuring instrument		6	<input type="radio"/>		Leader	Head of Section	<input type="radio"/>		
Carrying equipment		2	<input type="radio"/>		Leader	Head of Section	<input type="radio"/>		

How to evaluate:
Evaluate items based on unused period of them.

How to prepare the form

- 5S committee set the standard by main unneeded item
- Explain contents of this form to each promotion block.
- Compile the form to help Seiri activity such as requirement of red tag and record on unnecessary item list.

Ideally, unnecessary equipment should be removed from areas where daily production activities take place. However, large equipment and equipment or machine attached to the floor may be expensive to move. It is sometimes better to leave this equipment where it is unless it interferes with daily production activities or prevents workshop improvements. Label this unneeded and difficult to move equipment with a “freeze” red tag, which indicates that its use has been “frozen,” but that it will remain in place for the time being.

Step 7: Document the results of red-tagging

Each company or organization needs to create its own system for logging and tracking necessary information as red-tagging takes place. The documentation system may involve a written logbook in each department and in the central red tag holding area. Or it may involve entering data from the red-tags into a computer system. Whatever the system, documenting results is an important part of the red-tagging process. It allows the company to measure the improvement and savings produced as a result of the red-tagging effort. As it is indicated in step 4, the red-tags should be designed to support the documentation process.

Determine in advance approximately how many red-tags each workplace should use. An average of four red-tags per employee should be used. This means a workshop with 30 employees should need about 120 red tags. In addition when you find a shelf full of items which are difficult to decide, we don't have to be tempted to attach one red-tag for the whole shelf. Because this can lead to confusion when we want to dispose of these items in the shelf. Therefore, avoid this temptation and attach individual tags to individual items.



When red-tagging is completed the factory or workshop is usually dotted with empty spaces – a sign of real progress. Then the layout of equipments and worktables can be changed to occupy the free space. Companies or organizations who think they need to build a new factory for a production of new products/ services should first apply the sort activity or the red-tag strategy so that they could get plenty of free space.

Learning Guide for Standardize and Sustain 3S Level II Version: 1 Revision: 0	Date: September 2019	Page 32 of 64
	Author Federal TVET Institute	

Red Tagged Items



Temporary Storage Area (Holding Area)

Disposal of Unnecessary Items

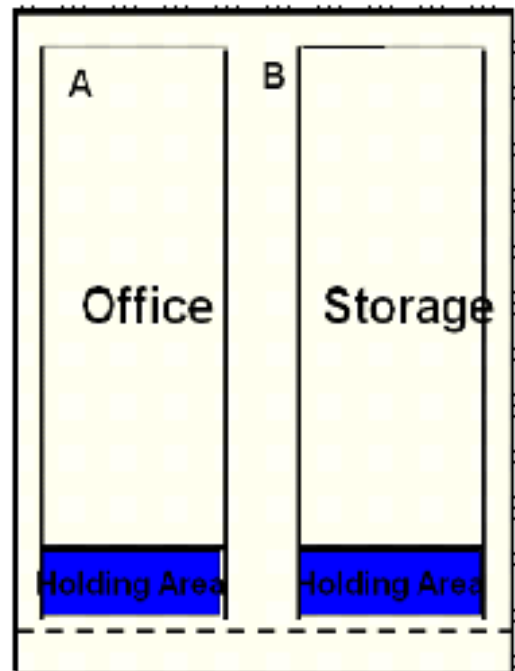

SET IN ORDER

There are some principles for deciding best locations for tools and equipments. Jigs, tools and dies differ from materials, equipments, machinery and parts in that they must be put back after each use. Some of the principles for jigs, tools and dies also apply to parts, equipments, and machinery. These are:

- Locate items in the workplace according to their frequency of use. Place frequently used items near the place of use. Store infrequently used items away from the place of use.
- Store items together if they are used together, and store them in sequence in which they are used.

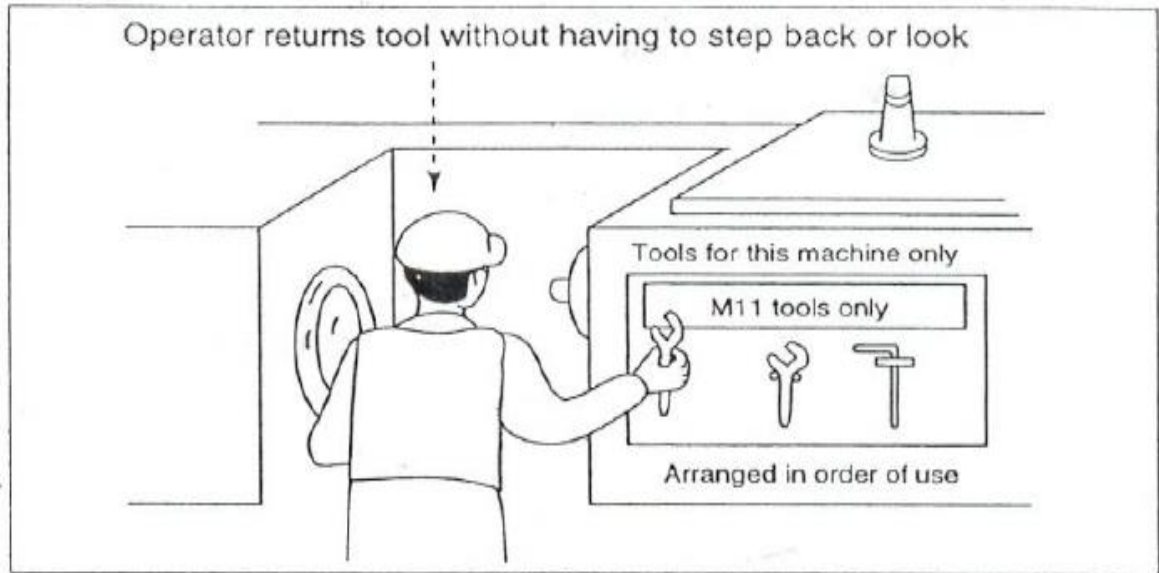

Fig. Tools kept at hand and stored in the order used.

- Device a “just let go” arrangement for tools. This approach involves suspending tools from a retractable cord just within reach so that they will automatically go back in to their correct storage position when released.
- Make storage places larger than the items stored there so that they are physically easy to remove and put back.
- Eliminate the variety of jigs, tools and dies needed by creating a few jigs, tools and dies that serve multiple functions.
- Store tools according to function or product. Function-based storage means storing tools together when they have similar functions. This works best for job-shop production. Product-based storage means storing tools together when they are used on the same product. This works best for repetitive production.

There are principles helpful in deciding the best locations for parts, equipments, and machinery, as well as tools by removing motion wastes. Motion wastes are unnecessary movements created when people move their trunks, feet, arms, and hands more than needed to perform a given operation. These wastes lead to waste of time, energy and effort. These motion wastes can be minimized by locating parts, equipments, and machinery in the best locations possible. More important than removing motion wastes is

asking why it occurs. By asking 'why' we can find the methods of manufacturing that work and approach the zero-waste mark. Eliminating the unnecessary motions from existing operations is called *Motion improvement*. And finding ways to eliminate the whole operations to remove the wastes is called *Radical improvement*.

The principles that are helpful to eliminate or reduce motions that operators make are:

- Principle 1: Start and end each motion with both hands moving at once.
- Principle 2: Both arms should move symmetrically and in opposite directions.
- Principle 3: Keep trunk motions to a minimum.
- Principle 4: Use gravity instead of muscle.
- Principle 5: Avoid zigzagging motions and sudden changes in direction.
- Principle 6: Move with a steady rhythm.
- Principle 7: Maintain a comfortable posture with comfortable motions.
- Principle 8: Use the feet to operate on and off switches for machines where practical.
- Principle 9: Keep materials and tools close and in front.

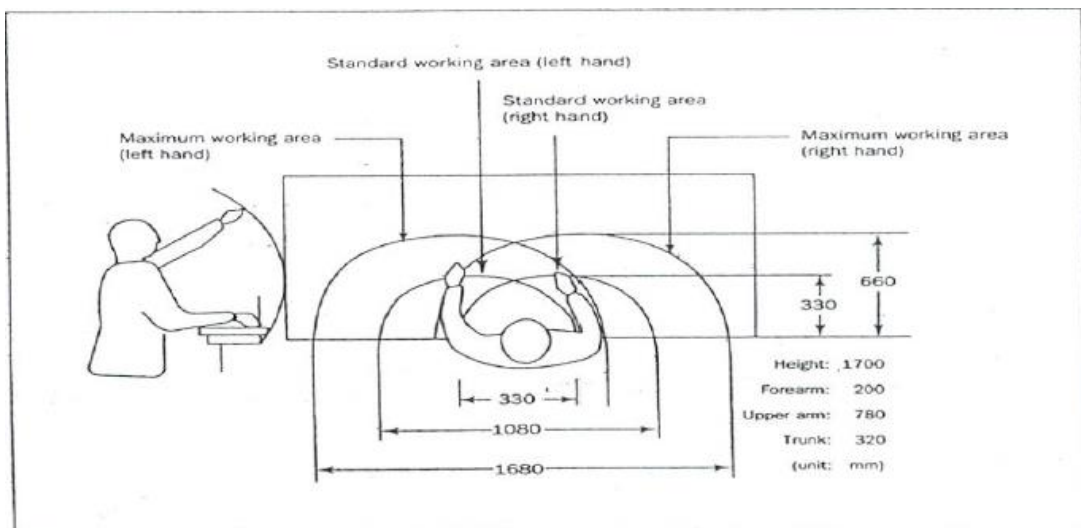

Fig. Guidelines for locating parts, equipments, and machinery to maximize motion efficiency.

- Principle 10: Arrange materials and tools in the order of their use.
- Principle 11: Use inexpensive methods for feeding in and sending out materials.
- Principle 12: Stand at a proper height for the work to be done.
- Principle 13: Make materials and parts easy to pick up.
- Principle 14: Make handles and grips in efficient, easy-to-use shapes and positions.

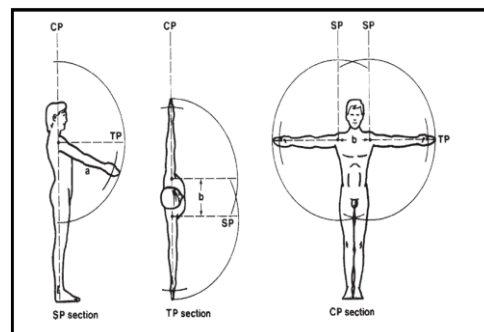
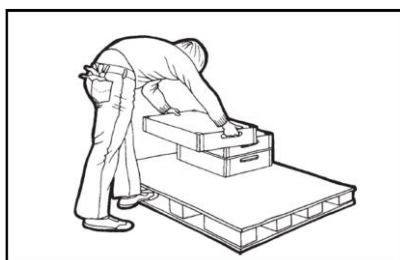

Fig. Motion wastes

Fig. No waste of motion

Example of eliminating motion wastes

Improving the retrieval of parts

The figure below shows an improvement in picking up parts in an assembly work. Before improvement, the worktable was so large that the assembly worker had to stretch to pick up parts. Also, the parts boxes were laid flat at table level, making it difficult to reach inside them. After improvement, the decreased width of the worktable enabled the assembly worker to reach the parts without stretching his arm too far. Also the parts boxes set on an inclined surface to make their contents more accessible.

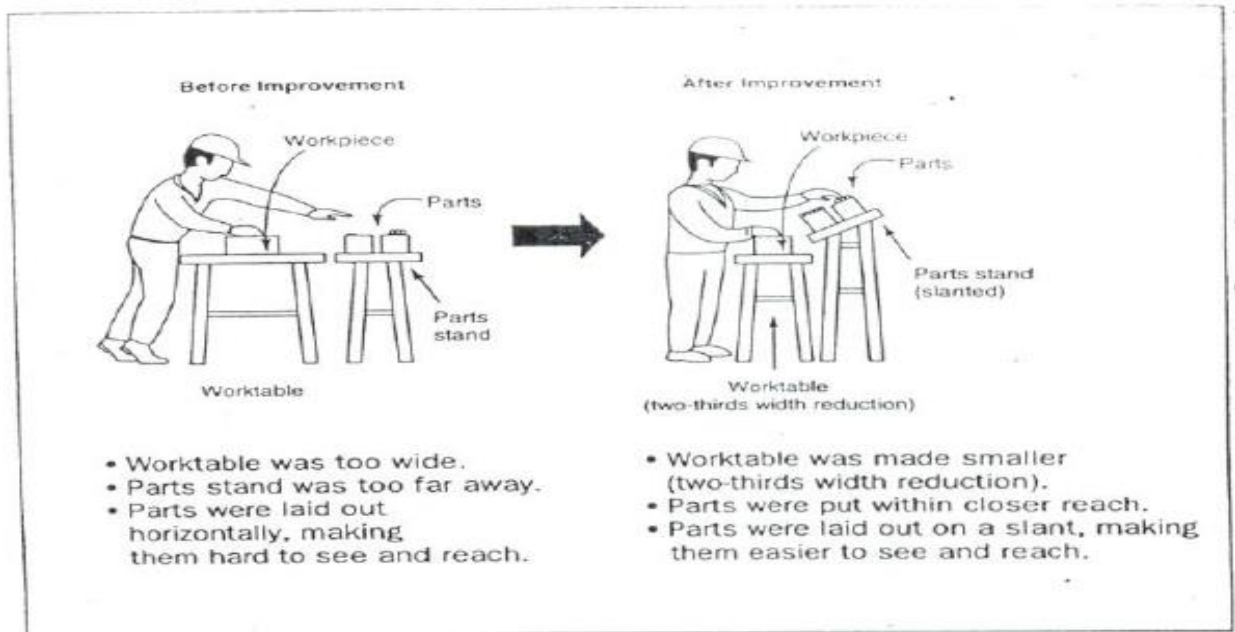

Improvements in picking up parts

Improving the layout of parts

The following figure shows an improvement in how plastic packaging sheets are used. The sheets are moved from a rack behind the operator to a hook in front of the operator and above the production line. This improvement eliminates four seconds of motion waste from each unit of packing work.

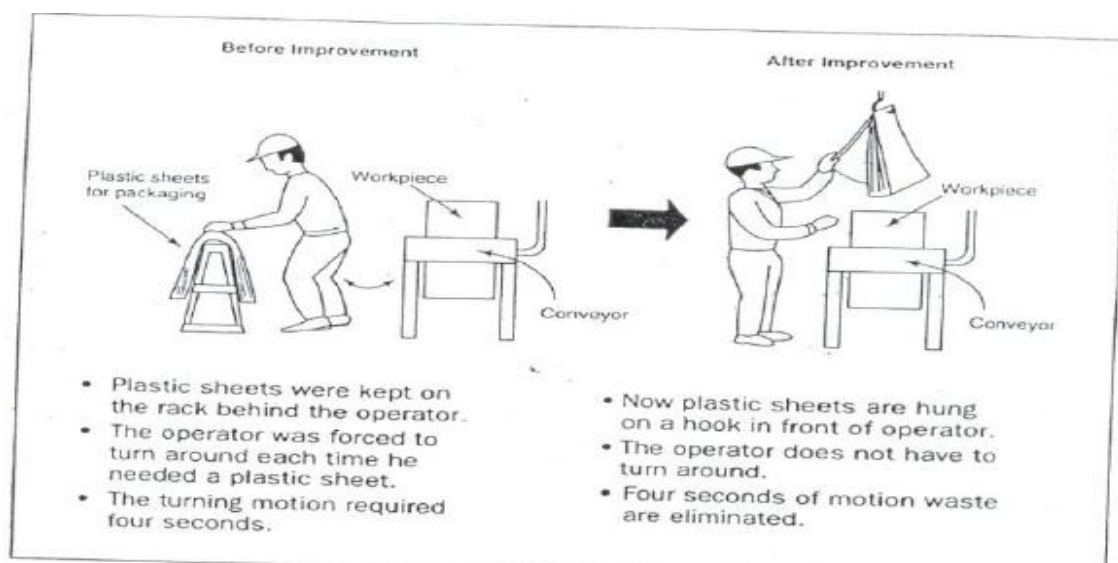

Improvement in parts layout

Evaluating current locations and deciding best locations

The 5S Map is a tool that can be used to evaluate current locations of parts, jigs, tools, dies, equipment, and machinery, and to decide best locations. 5S Map involves creating two maps 'before map' and 'after map'. The 'before map' shows the layout of the workplace before implementing set in order. The 'after map' shows the workplace after implementing set in order. The 5S Map can be used to evaluate the locations in a small or large workplaces, like in a single workstations, on a production line, or in a department.

The steps of using the 5S Map:

1. Make a floor plan or area diagram of the workplace you wish to study. Show the location of specific parts, inventory, tools, jigs, dies, equipment and machinery.
2. Draw arrows on the plan showing the work flow between items in the workplace. There should be at least one arrow for every operation performed. Draw the arrows in the order that the operations are performed, and number them as you go.

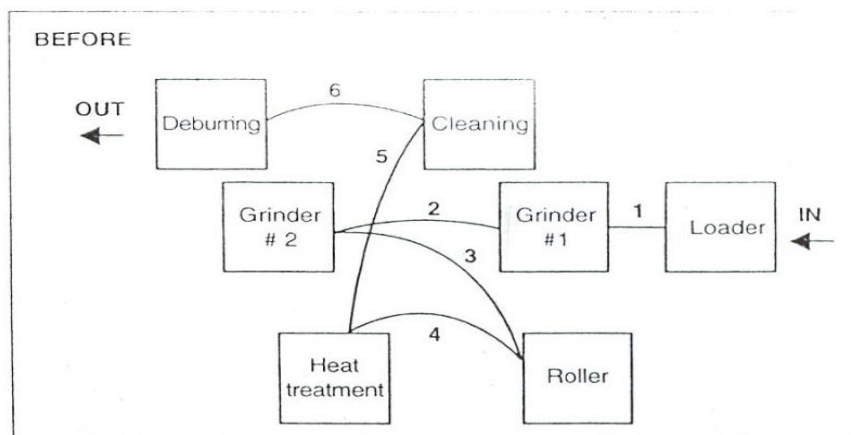

Fig. 5S Map of old layout in machining operations ('before map')

3. Look carefully at the resulting "spaghetti diagram". Can you see places where there is congestion in the work flow? Can you see ways to eliminate waste?
4. Make a new 5S Map to experiment with a better layout for this work place. Again, draw and number arrows to show the flow of operations performed.
5. Analyze the efficiency of the new layout (the after map), based on the principles explained in the above.
6. Continue to experiment with possible layouts (after maps) using the 5S Map until you find one which you think will work well.

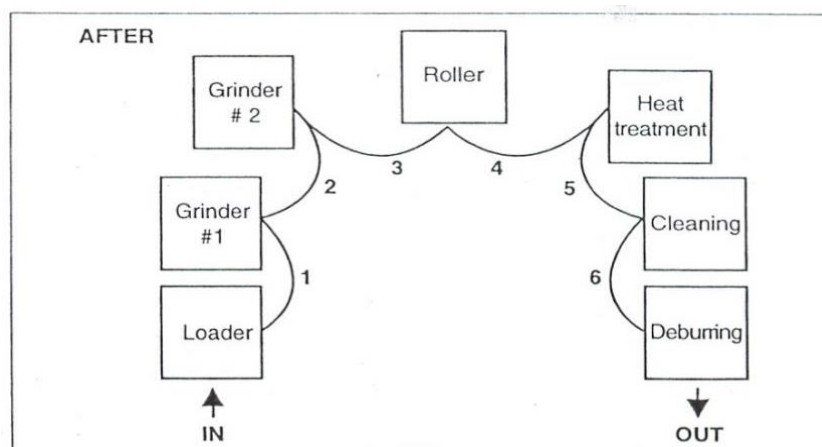



Fig. 5S Map of new layout (the after map) in machining operations

7. Implement this new layout in the work place by moving parts, tools, jigs, dies, equipment, and machinery to their new locations.
8. Continue to evaluate and improve the layout in the workplace.

1.1 Set in order strategies

Once best locations have been decided, it is necessary to mark these locations so that everyone knows what goes where, and how many of each item belongs in each location. There are several strategies for marking or showing what, where and how many.

1.1.1 Motion Economy strategy

Following the principles explained in the above, we can remove motion waste from existing operation. By using human body appropriately, by organizing the workplace and by redesigning of tools and equipments, we can minimize motion waste.

1.1.2 Visual control Strategy

A visual control is any communication device used in the work environment that tells us at a glance how work should be done. There are several strategies for setting in order items so that to easily identify what, where and how many (visual control). These visual control strategies are discussed in the next contents.

1.1.2.1 Signboard strategy

The signboard strategy uses signboards to identify what, where, and how many. The three main types of signboards are:

- Location indicators that show where items go.
- Item indicators that show what specific items go in those places.
- Amount indicators that show how many of these items belong there.

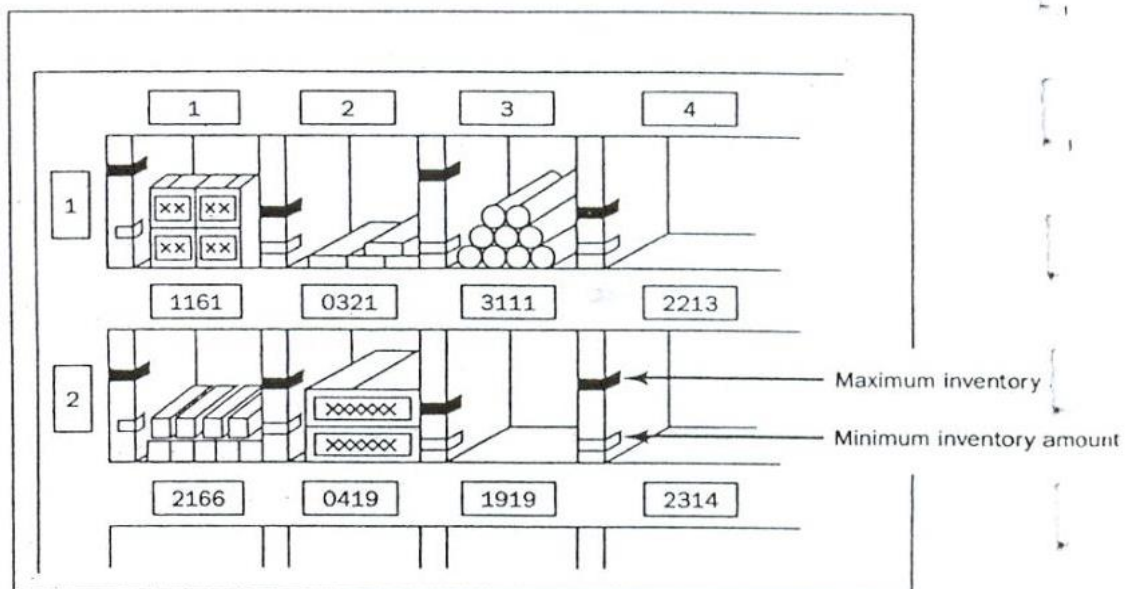

Fig. Amount indicators

Signboards are often used to identify:

- Names of work areas
- Inventory locations
- Equipment storage locations

- Standard procedures
- Machine layout

For example, in order to identify inventory stored on shelves in a warehouse, a whole system of signboards may be used. Every section of shelving may have a signboard identifying the section. Within that section, vertical and horizontal addresses on shelves can be identified with additional signboard. Each item stored on the shelf may also have a signboard showing the “return address” for that item. The “return address” allows the item to be put back in the proper location once it has been removed.

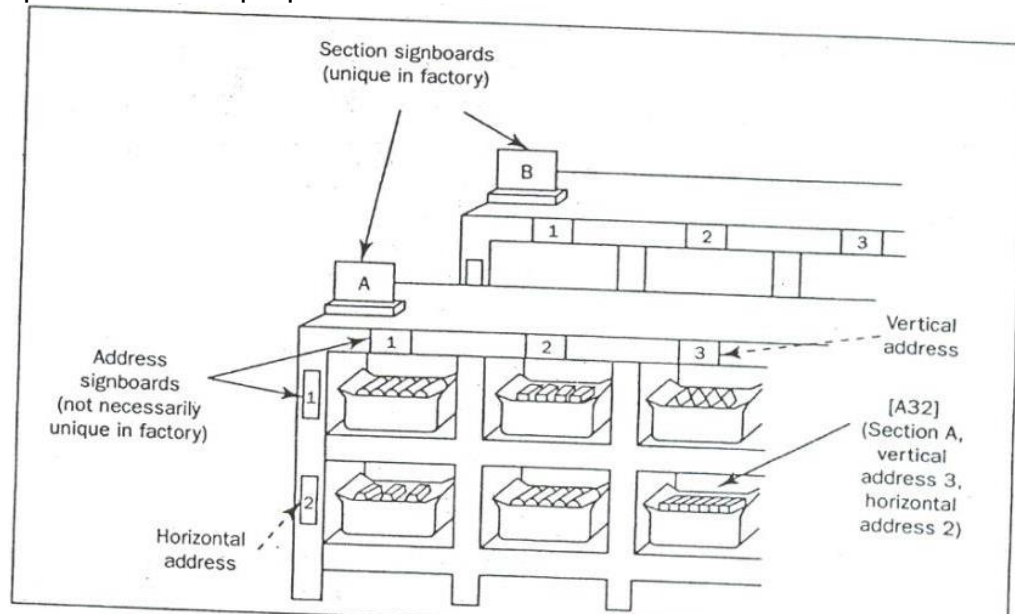

Fig. Location indicators on shelves

The ‘after 5S Map’ discussed before is a kind of signboard. It shows the location of parts, tools, jigs, dies, equipment, and machinery in a given work area after set in order is implemented. When posted in the work place, it is useful in communicating the standard for where items are located.

1.1.2.2 Painting strategy

The painting strategy is a method for identifying locations on floors and walkways. It is called the Painting strategy because paint is the material generally used. But also plastic tape, cut in to any length, can be used. Plastic tape, although more expensive, shows up just as clearly as paint and can be removed if the layout is changed.

The painting strategy is used to divide the factory’s or workshop’s walking areas (walkways) from the working areas (operation areas). When putting lines to divide walkways from operation areas, the following factors should be considered:

- U-shaped cell designs are generally efficient that straight production lines.
- In-process inventory should be positioned carefully for best production flow.
- Floors should be levelled or repaired before we put lines.
- Walkways should be wide enough to avoid twists and turns and for safety and a smooth flow of goods.
- The dividing lines should be between 2 and 4 inches in width.
- Paint colors should be standardized. For example

- operation areas are painted by green;
- walkways are fluorescent orange or red;
- Lines that divide the walkways from operation areas are yellow in color.

Dividing lines can be used to show:

- Cart storage locations,
- aisle directions,
- door range, to show which way a door swings open,
- for worktables,
- tiger marks, to show areas where inventory and equipment should not be placed, or to show hazardous areas.

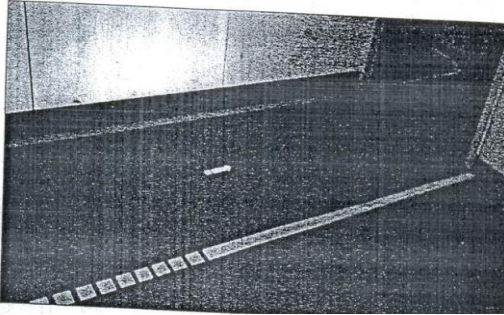

Fig. Aisle direction line

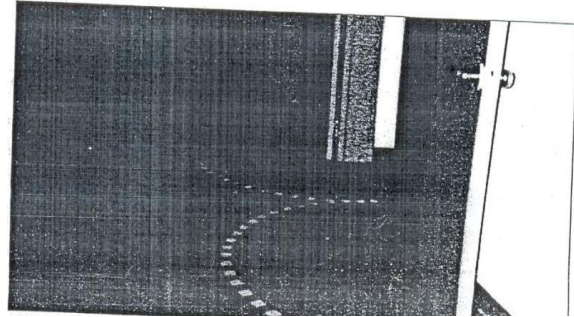

Fig. Door-range line



1.1.2.3 Color-code strategy

Color-coding is used to show clearly which parts, tools, jigs and dies are to be used for which purpose. For example, if certain parts are to be used to make a particular product, they can all be color-coded with the same color and even stored in a location that is painted with that color. Similarly, as shown the picture in below, if different types of lubricants are to be used on different parts of a machine, the supply containers, oil cans, and machine parts can be color-coded to show what is used where.

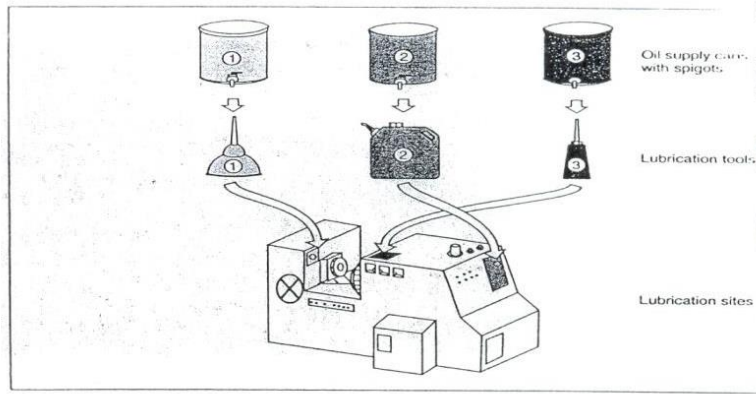
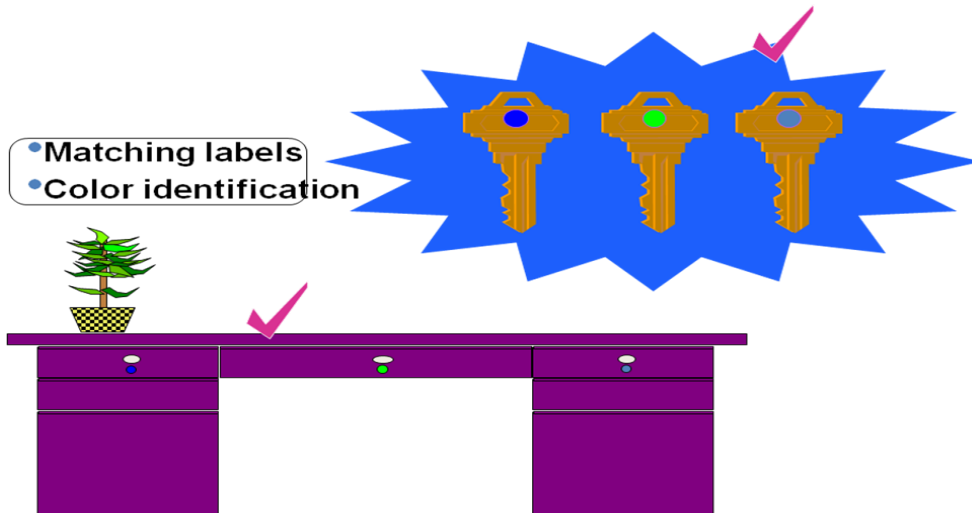
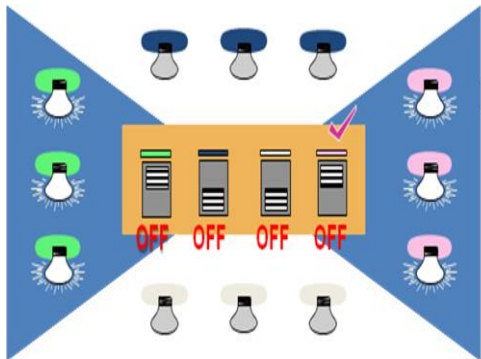

Fig. Color-coding for lubrication



1.1.2.4 Outlining strategy

Outlining is used to show which jigs and tools are stored where. Outlining simply means drawing outlines of jigs and tools in their proper storage positions. When you want to return a tool, the outline provides an additional indication of where it belongs.

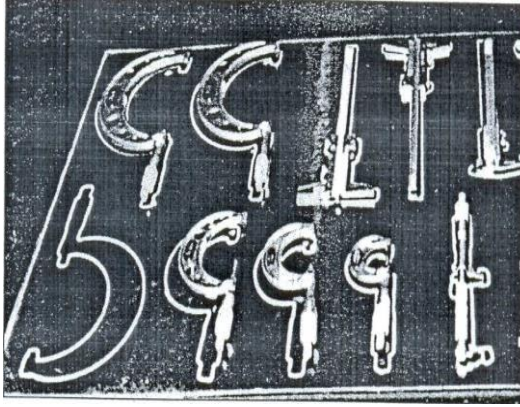
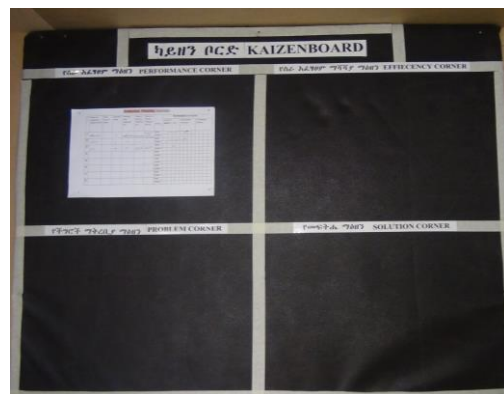
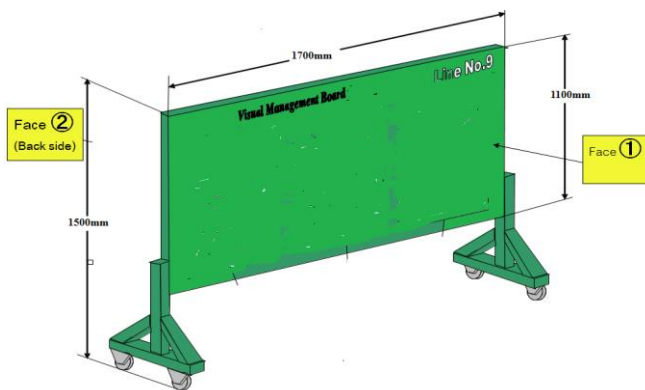

Fig. Outlining of tools to show their locations



1.1.2.5 Visual Management Board (Kaizen board) Strategy



Set In Order Samples

Set In Order-Shadow Board



BEFORE



AFTER



BEFORE



AFTER







SHINE

Shine activities should be taught as a set of steps and rules that employees learn to maintain with discipline.

Step 1: Determine shine target areas

Shine target areas are grouped in to three categories: warehouse item, equipments and space. *Warehouse items* include raw materials, procured subcontracted parts, parts made in-house, and assembly components, semifinished and finished products. *Equipment* includes machines, welding tools, cutting tools, conveyance tools, general tools, measuring instruments, dies, wheels and casters, worktables, cabinets, desks, chairs and spare equipment. *Space* refers to floors, work areas, walkways, walls, pillars, ceilings, windows, shelves, closets, rooms and lights.

Step 2: Determine Shine Assignments

Workplace cleanliness is the responsibility of everyone who works there. Each employee should be assigned specific area to clean. To do this two methods can be used:

- A 5S Assignment Map – shows all the target areas for shine activity and who is responsible for cleaning them. By marking on 5S Map, the shine assignments can be shown.
- A 5S schedule – shows in detail who is responsible for cleaning which areas on which days and times of the day. Then this schedule should be posted in the work area.

Example 1:

General Cleaning Assignment Sheet						
Date of cleaning: Year Month						
Activity area		Target place/object	Group	Leader	Tools	Required number of workers
Zone A	Machining-- Group A area	Lathe	Manufacturing	A	Detergent	25
		Press machine			Waste cloth	
		Floor			Scraper	
	Machining-- Group B area	Resting-place			Broom	
		Pathway			mop	
Zone B	Purchasing area					
	Material area					
Zone C	Painting area					
	Processed products discharge area					

Example 2:

Learning Guide for Standardize and Sustain 3S Level II Version: 1 Revision: 0	Date: September 2019	Page 49 of 64
	Author Federal TVET Institute	



Regular Cleaning Assignment Sheet												
Worksite			Group				5S promoter					
No.	Day	Target place/object	Person in charge						Frequency	Time	Start	Tool
			A	B	C	D	E	F				
1	Mon											
2												
3												
4	Tue											
5												
6												
7	Wed											
8												
9												
10	Thu											
11												
12												
13	Fri											
14												
15												

Step 3: Determine shine methods

Shine activities should be a natural part of the daily work. Shine activities and inspection should be done before a shift starts, during work time and at the end of the shift.

Determining shine methods include:

- *Choosing targets and tools* – define what will be cleaned in each area and what supplies and equipments will be used.
- *Performing the five-minute shine* – cleaning should be practiced daily and should not require a lot of time.
- *Creating standards for shine procedures* – people need to know what procedures to follow in order to use their time efficiently. Otherwise, they are likely to spend most of their time getting ready to clean.

Step 4: prepare tools

The cleaning tools should be placed properly or set in order where they are easy to find, use and return.

Step 5: Start to shine

When implementing the shine procedures, consider the following suggestions:

- Be sure to sweep dirt from floor cracks, wall corners, and around pillars.
- Wipe off dust and dirt from walls, windows, and doors.
- Be thorough about cleaning dirt, scraps, oil, dust, rust, cutting shavings, sand, paint, and other foreign matter from all surfaces.
- Use cleaning detergents when sweeping is not enough to remove dirt.

1.2 Inspection

As discussed earlier, it is natural to do a certain amount of inspection while implementing shine activities. Once daily cleaning and periodic major cleanups become a habit, we can start incorporating systematic inspection procedures in to the shine procedures. Even when equipment in the workplace appears to function normally, it may be developing many problems. Always when machines or other equipment begin to show sign of minor, sporadic malfunctions, the operators not the maintenance people notice it first. Therefore, it is important to consider the operators information about the equipment.

The following types of equipment problems frequently exist in factories:

Learning Guide for Standardize and Sustain 3S Level II Version: 1 Revision: 0	Date: September 2019	Page 50 of 64
	Author Federal TVET Institute	

1. Oil leaks from the equipment on to the floor.
2. Machines are so dirty that operators avoid touching them.
3. Gauge displays and other indicators are too dirty to be read.
4. Nuts and bolts are either loose or missing.
5. Motors overheat.
6. Sparks flare from power cords.
7. V-belts are loose or broken.
8. Some machines make strange noises.

Daily cleaning or inspection can help to find these problems and solve them.



Before Shine



After Shine

1.2.1 Inspection steps

The steps of inspection and shine procedures are parallel. But the steps of inspection give greater emphasis on the maintenance of machines and equipment. These steps are:

Step 1: Determine inspection targets

The targets for inspection are similar to the targets of shine activities. These include machines, equipments, jigs, dies, cutting tools and measuring instruments.

Step 2: Assign inspection activities

In principle, the people who carry out inspection on a particular machine should be the same people who operate the machine. But most often one person can operate several machines at a time (as in multi-process handling). In this case, it is good to involve line supervisors and group leaders in the inspection duties. Once inspection activities are assigned, they have to be written up on a large signboard for the workshop or on small signboards that are attached to each target machine.

Step 3: Determine inspection methods

First all of the items to be inspected should be listed then an inspection checklist should be prepared based on the listed inspection items. The following shows an example of an inspection checklist.

Learning Guide for Standardize and Sustain 3S Level II Version: 1 Revision: 0	Date: September 2019	Page 51 of 64
	Author Federal TVET Institute	

Mechanism	No.	Point	Main Response			
			Clean	Lubricate	Replace	Restore
Lubrication system 	26.	Is there any dirt or dust in the oil inlets?	<input type="radio"/>			
	27.	Do the oil level indicators show adequate levels?		<input type="radio"/>		
	28.	Can the oil level indicators be clearly seen?	<input type="radio"/>			
	29.	Are there any cracks in the oil tank?	<input type="radio"/>			
	30.	Is the bottom of the oil tank dirty?	<input type="radio"/>			<input type="radio"/>
	31.	Is the oil in the tank dirty?			<input type="radio"/>	
	32.	Is there any oil leakage from the tank or pipe joints?			<input type="radio"/>	<input type="radio"/>
	33.	Are oil levels adequate?		<input type="radio"/>		
	34.	Is the correct type of oil being used?			<input type="radio"/>	
	35.	Is there any clogging in the oil pipes?			<input type="radio"/>	<input type="radio"/>
	36.	Is there any dust or dirt at lubrication sites?	<input type="radio"/>			
	37.	Are the lubrication tools dirty?	<input type="radio"/>			

Table: Sample of inspection checklist

Step 4: Implement inspection

When implementing inspection, use all your senses to detect abnormalities. Inspection is not simply a visual activity. There are some ways to detect abnormalities. These are:

- Look closely at how the machine works and watch for slight defects (e.g. oil leakage, debris scattering, deformation, wear, warping, mold, missing items, lopsidedness, inclinations, color changes).
- Listen closely for changes in the sounds the machine makes while operating (e.g. sporadic sounds, odd sounds).
- Use your nose to detect burning smells or other unusual odours (e.g. burning rubber)
- Touch the machine where it is safe during operation and during downtime to detect deviations from normal conditions (e.g. strange vibrations, wobbling, looseness, excessive heat, shifting).

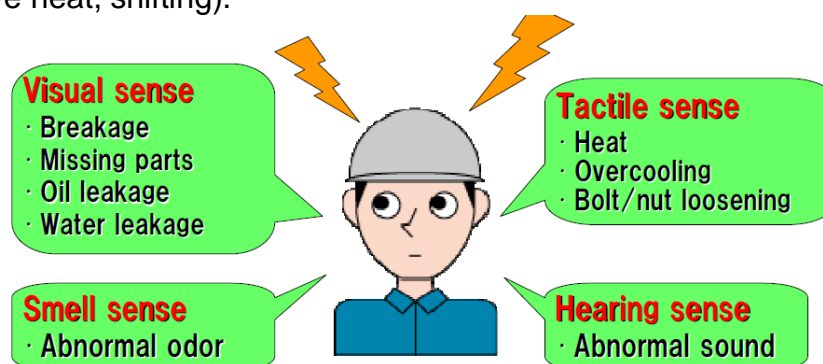

Step 5: Correct equipment problems

All equipment abnormalities or slight defects should be fixed or improved. There are two approaches to do these:

Instant Maintenance: whenever possible, an operator should immediately fix or improve a problem he or she discovers during inspection. But the operators should know what level of maintenance work they can handle by themselves and immediately.

Requested Maintenance: In some cases, a defect or problem may be difficult for the operator to hand alone and immediately. In this situation, the operator should attach a maintenance card to the site of the problem in order to make it visible. He or she can also issue a maintenance kanban to request help from the maintenance department. It is also good to log requested maintenance on to a checklist of needed maintenance activities. Once a requested maintenance is taken care and its result confirmed, the activity should be checked off in the 'confirmation' column of the checklist. The maintenance card should then be retrieved from the machine where it is attached.

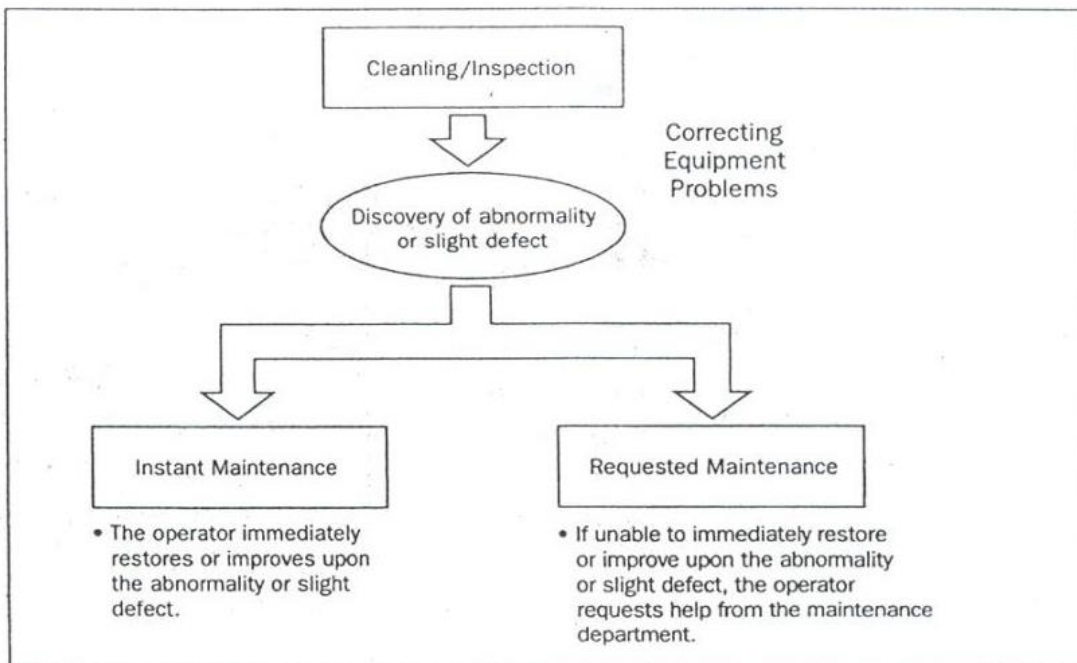

Fig. Two approaches for solving equipment problems



Work Manual Self- Check 3	Written Test
--------------------------------------	---------------------

Directions: Answer all the questions listed below. Use the Answer sheet provided in the next page:

4. Describe 3S (1 point)
5. What is red tagging? (1 point)
6. Describe red tag holding area. (1 point)
7. List steps in red tagging? (7 points)
8. Describe steps to set in order. (5 points)
9. What is motion economy? (5 points)
10. List principles that helps to reduce motion (7 points)
11. List steps to shine activities. (5 points)
12. List types of problems frequently exist in factories. (4 points)
13. Describe shine targets. (5)
14. Describe steps in cleaning/inspection. (4 points)

Note: Satisfactory rating – 27 points Unsatisfactory - below 27 points

You can ask you trainer for the copy of the correct answers.



Answer Sheet

Score = _____

Rating: _____

Name: _____

Date: _____



Short Answer Questions

1. _____

2. _____

3. _____

4. _____

5. _____

6. _____

7. _____



8. _____

9. _____

10. _____

11. _____



Operation Sheet 1	Procedures in Implementing 3S
--------------------------	--------------------------------------

Sequence of 3S

1. Sort

1.1 Plan and procedures for sort activity Sort activity plan sheet (sample)

Preparation date: Year Month Day
Prepared by 5S Committee

Area : M-1

Basic Plan		Sort Activity																																																						
		1st month															2nd month																																							
Activity		18	19	20	21	22	23	24	25	26	27	28	29	30	1	2	3	4	5	6	7	8	9	10	11	12	13	14	15	16	17	18	19	20	21	22	23	24	25	26	27	28	29	30	31											
Determining activity area	Plan																																																							
	Result																																																							
Preparing documentations	Plan																																																							
	Result																																																							
Deciding where to put unnecessary things	Plan																																																							
	Result																																																							
Holding a briefing session	Plan																																																							
	Result																																																							
Red tagging	Plan																																																							
	Result																																																							
Filling out documentations	Plan																																																							
	Result																																																							
Quantification	Plan																																																							
	Result																																																							
General cleaning	Plan																																																							
	Result																																																							

1.1 Implementation





3. Shine

3.1 Plan

Area : M-1

Preparation date: Year

Month

Day

Prepared by 5S Committee

Basic Plan		Seisou Activity																														
		5th month																														
Activity		1	2	3	4	5	6	7	8	9	10	11	12	13	14	15	16	17	18	19	20	21	22	23	24	25	26	27	28	29	30	31
Preparing necessary tools	Plan	■	■																													
	Result																															
Determining activity area	Plan				■	■	■																									
	Result																															
Designing procedures for the Seisou Activity	Plan							■	■																							
	Result																															
General cleaning	Plan												■	■	■	■	■	■	■	■	■	■	■	■	■	■	■	■	■	■	■	
	Result																															
Working out the problems revealed through the general cleaning	Plan																															
	Result																															

Shine activity plan sheet (sample)



3.2 Implementation

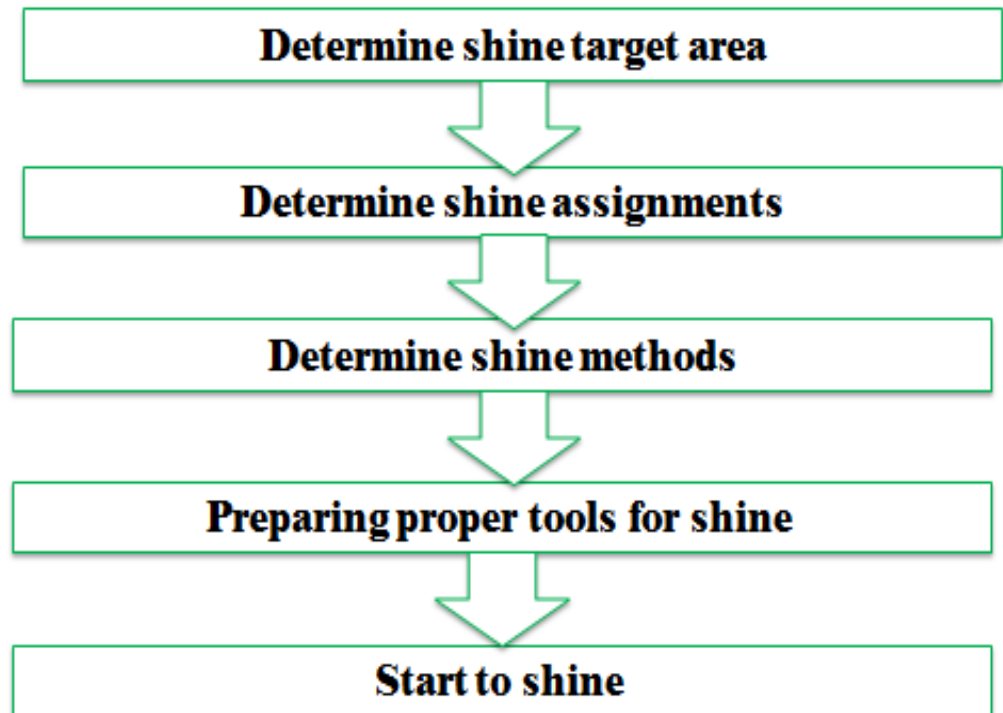



LAP Test	Practical Demonstration
-----------------	--------------------------------

Name: _____ Date: _____

Time started: _____ Time finished: _____

Instructions: Given necessary templates, workshop, tools and materials you are required to perform the following tasks within ----- hours.

Task 1: identify and prepare tools and techniques to the sort activities.

Task 2: identify and prepare tools and techniques to the set in order activities.

Task 3: identify and prepare tools and techniques to the shine activities.

Task 4: using the identified, prepared and given tools and techniques perform 3S to your/ the given work area.

- identify the:

- person -in-charge
- technology workshop
- work station

- consider the:

- OHS procedures
- workplace procedures and standards (work area)
- frequency of maintenance activities

List of Reference Materials

Learning Guide for Standardize and Sustain 3S Level II Version: 1 Revision: 0	Date: September 2019	Page 63 of 64
	Author Federal TVET Institute	



- 5S for operators (1995)
- Journals/publications/magazines
- Reference Book
- Job specifications
- Safety Manual and Guide
- Learning Guide #1

Learning Guide for Standardize and Sustain 3S Level II Version: 1 Revision: 0	Date: September 2019	Page 64 of 64
	Author Federal TVET Institute	



Learning Guide #2

**Unit of Competence: Standardize and sustain
3S**

Module Title: Standardizing and sustaining 3S

LG Code: AGR ATI2 M07 0919 LO2-LG-02

TTLM Code: AGR ATI2 TTLM 0919v1

LO 2: Standardize 3S

Learning Guide for Standardize and Sustain Level II Version: 1 Revision: 0	Date: September, 2019	Page 65 of 29
	Author: Federal TVET Institute	



Instruction Sheet

Learning Guide #2

This learning guide is developed to provide you the necessary information regarding the following content coverage and topics –

- The 4th pillar explanation and how to implement standardize.
- Tools and techniques required to standardize 3s.

This guide will also assist you to attain the learning outcome stated in the cover page. Specifically, upon completion of this Learning Guide, you will be able to –

- Prepare plan for the implementation of standardize
- Prepare and use tools and techniques to standardize 3s
- Report results
- Review standardization

Learning Instructions:

19. Read the specific objectives of this Learning Guide.
20. Follow the instructions described in number 3 to 13.
21. Read the information written in the “Information Sheets 1”. Try to understand what are being discussed. Ask you trainer for assistance if you have hard time understanding them.
22. Accomplish the “Self-check 1” in page 6.
23. Ask from your trainer the key to correction (key answers) or you can request your trainer to correct your work. (You are to get the key answer only after you finished answering the Self-check 1).
24. If you earned a satisfactory evaluation proceed to “Information Sheet 2”. However, if your rating is unsatisfactory, see your trainer for further instructions or go back to Learning Activity #1.
25. Submit your accomplished Self-check. This will form part of your training portfolio.
26. Read the information written in the “Information Sheet 2”. Try to understand what are being discussed. Ask your trainer for assistance if you have hard time understanding them.
27. Accomplish the “Self-check 2” in page 24.

Learning Guide for Standardize and Sustain Level II Version: 1 Revision: 0	Date: September, 2019	Page 66 of 29
	Author: Federal TVET Institute	



28. Ask from your trainer the key to correction (key answers) or you can request your trainer to correct your work. (You are to get the key answer only after you finished answering the Self-check 2).
29. If you earned a satisfactory evaluation proceed to “Operation Sheet 1” in page 27. However, if your rating is unsatisfactory, see your trainer for further instructions or go back to Learning Activity #1.
30. Read the “Operation Sheet 1” and try to understand the procedures discussed.
31. Do the “LAP test” in page 28 (if you are ready). Request your trainer to evaluate your performance and outputs. Your trainer will give you feedback and the evaluation will be either satisfactory or unsatisfactory. If unsatisfactory, your trainer shall advice you on additional work. But if satisfactory you can proceed to Learning Guide #3.

Learning Guide for Standardize and Sustain Level II Version: 1 Revision: 0	Date: September, 2019	Page 67 of 29
	Author: Federal TVET Institute	



Information Sheet 1

The 4th Pillar Explanation and How to Implement Standardize

Definition of the Fourth Pillar

Standardize, the fourth pillar of our visual workplace, differs from Sort, Set in Order, and Shine. This is because it is the method- you use to maintain the first three pillars of 5S. Building on this definition, we may define Standardize the result that exists when the first three pillars-Sort, set in order and Shine-are properly maintained.

Benefits from Standardize

1. Lead to workplace standardization

- prevent setbacks in the first three pillars
- Make implementing them a daily habit
- Ensure that all the three pillars are maintained in their fully implemented state.

2. Lead to work standardization

- Muda elimination
- Quality improvements
- Cost improvements
- Delivery time improvements
- Process improvements

Here are some of the problems that result when we do not implement Standardization well:

- Conditions go back to their previous and undesirable levels even after a companywide 5S implementation campaign.
- At the end of the day, piles of unneeded items are left from the day's production and lie scattered around the production equipment.
- Tool storage sites become disorganized and must be put back in order at the end of the day.

Learning Guide for Standardize and Sustain Level II Version: 1 Revision: 0	Date: September, 2019	Page 68 of 29
	Author: Federal TVET Institute	



- Cutting shavings constantly fall on the floor and must be swept up.
- Even after implementing Sort and Set in order, it does not take long for office workers to start accumulating more stationery supplies than they need.

These problems and others reveal backsliding in gains made from implementing Sort Set in Order, and Shine Activities. The basic purpose of the Standardize pillar is to prevent setbacks in the first three pillars, to make implementing them a daily habit, and to make sure that all three pillars are maintained in their fully implemented state.

How to Implement Standardize

The three steps to making Sort, Set in Order and Shine activities (the three pillars or 3S) a habit are:

Step 1: Decide who is responsible for which activities with regard to maintaining 3S conditions.

Step 2: To prevent backsliding, integrate 3S maintenance duties in to regular work activities.

Step 3: Check on how well 3S conditions are being maintained.

As you read this section, you will discuss some of the tools for implementing Standardize of the Sort, Set in Order, and Shine activities. This is because in order to standardize we must use these same tools in a more systematic way to make sure that the first three pillars are maintained.

Learning Guide for Standardize and Sustain Level II Version: 1 Revision: 0	Date: September, 2019	Page 69 of 29
	Author: Federal TVET Institute	



Self-Check 1	Written Test
---------------------	---------------------

Directions: Answer all the questions listed below. Use the Answer sheet provided in the next page:

9. Define the fourth pillar of 5S? (2 point)
10. Describe the benefits from standardize. (5 points)
11. What by mean standardize leads to work standardization? (5 points)
12. List problems that avoided by implementing standardize activities (10 points)
13. What are the three steps to making the 3S a habit? (8 points)

Note: Satisfactory rating - 16 points Unsatisfactory - below 16 points
You can ask you trainer for the copy of the correct answers.

Learning Guide for Standardize and Sustain Level II Version: 1 Revision: 0	Date: September, 2019	Page 70 of 29
	Author: Federal TVET Institute	



Answer Sheet

Score = _____

Rating: _____

Name: _____

Date: _____

9. _____

10. _____

11. _____

12. _____

13. _____



Information Sheet 2	Tools and Techniques to Standardize 3S
----------------------------	-----------------------------------------------

Common Tools and Techniques to standardize 3S are:

- 5S Job Cycle Charts
- Visual 5S
- The Five Minute 5S
- Standardization level checklist
- 5S checklist
- The five Whys and one How approach(5W1H)
- Suspension
- Incorporation
- Use Elimination

The Three Steps to Make the 3S Activities a Habit/Standardize using the Tools and Techniques of 3S Standardization

1. Assign 3S Responsibilities

When it comes to maintaining three pillar conditions, everyone must know exactly what they are responsible for doing and exactly when, where and how to do it. If people are not given clear 3S job assignments based on their own workplaces, the Sort, Set in Order, and Shine activities will not have much meaning. Similarly, clear 3S instructions must be given to the people who deliver goods from outside suppliers. The delivery sites should be clearly marked and a 5S Map posted to show where each supplier's goods are to be unloaded. At each unloading site, signboards should make it clear whose things go where and in what amount. The suppliers should be made responsible for maintaining 3S conditions at their own unloading sites and encouraged to join in full 5S implementation.



Tools for assigning 3S responsibilities include:

- 5S Maps
- 5S schedules
- 5S job cycle charts, which list the 5S jobs to be done in each area, and set frequency cycle for each job (see the figure below). In the example shown in the figure below, 5S duties are sorted out according to the first three pillars and the scheduling cycle. In the figure, code letters are used for the various cycle periods:

A is for 'continuously,' B for "daily (mornings)," C for "daily (evenings)," D for "weekly," E for "monthly" and F for "occasionally." Each 5S job assignee can then use these charts as 5S Checklists. This particular example shows clearly who is responsible for each job, which area, what to do, and when to do it.

5S Job Cycle Chart		Div./Dept./Section		Production Div. 1, Assembly Dept. A									
		Entered by: Comarella		Date: 1 Feb 1994									
No.	5S Job	Job Cycle											
		Sort	Set in Order	Shine	Standardize	Sustain	A	B	C	D	E	F	
1.	Red-tag strategy (occasional, companywide)	<input type="radio"/>										<input type="radio"/>	
2.	Red-tag strategy (repeated)	<input type="radio"/>				<input type="radio"/>							
3.	Place indicators (check or make)		<input type="radio"/>					<input type="radio"/>					
4.	Item indicators (check or make)		<input type="radio"/>					<input type="radio"/>					
5.	Amount indicators (check or make)		<input type="radio"/>					<input type="radio"/>					
6.	Sweep around line			<input type="radio"/>				<input type="radio"/>					
7.	Sweep within line			<input type="radio"/>				<input type="radio"/>					
8.	Sweep around worktable			<input type="radio"/>				<input type="radio"/>					
9.	Sweep on and under worktable			<input type="radio"/>				<input type="radio"/>					
10.	Sweep work areas and walkways												

Figure: A 5S Job Cycle Chart

2. Integrate 3S Duties into Regular Work Duties



If people carry out three pillar maintenance duties only when they see three pillar conditions slipping, then the five pillar implementation has not yet taken root. Maintenance must become a natural part of everyone's regular work duties. In other words, the five pillars -centered on maintaining 3S conditions-must be part of the normal work flow. We sometimes refer to this as "5S line integration" or establishing a five pillars flow. Visual 5S and Five-Minute 5S are two approaches that help make maintenance work part of the everyday work routine. .

Visual 5S

The Visual 5S approach makes the level of five pillar conditions obvious at a glance. This is particularly helpful in factories that handle a great variety and number of materials.

The main point of Visual 5S is that anyone should be able to distinguish between abnormal and normal conditions at a glance.

As a factory example, consider a drill-press process where Set in order has been applied so that the position and amount of each finished work piece is clearly indicated. As an additional visual aid, the place where the last batch item goes can be marked with a thick red line to indicate that it is time to stop and send the batch to the next process.

Learning Guide for Standardize and Sustain Level II Version: 1 Revision: 0	Date: September, 2019	Page 74 of 29
	Author: Federal TVET Institute	

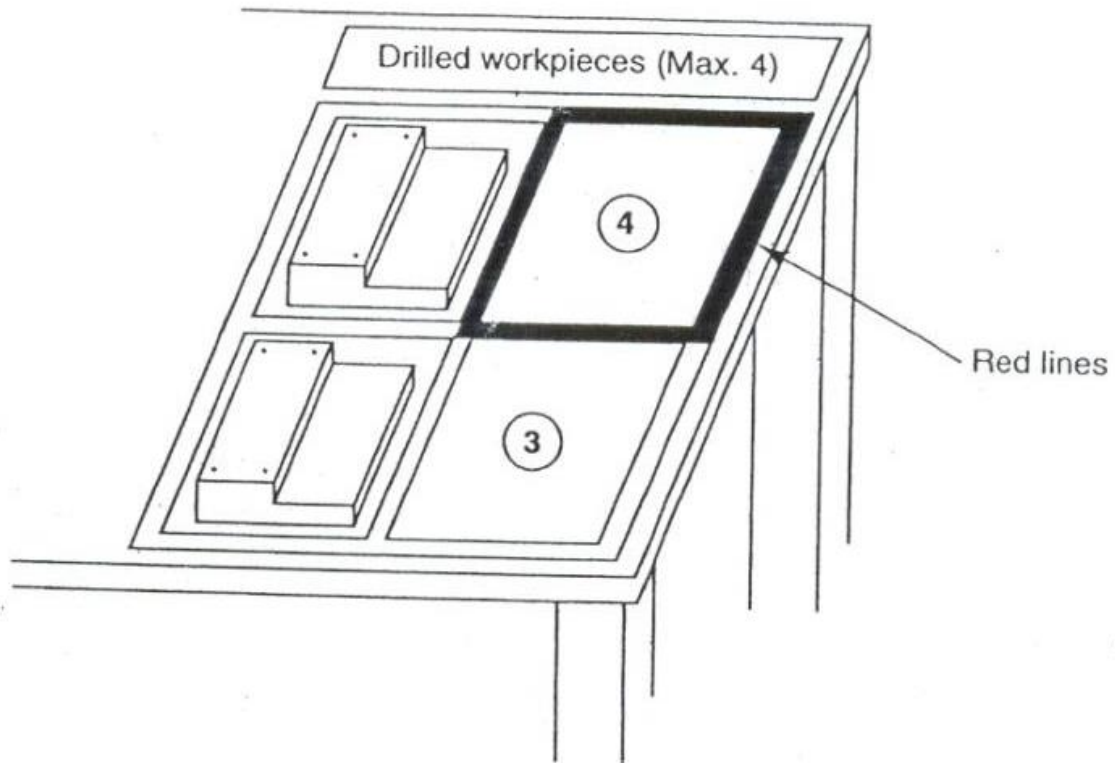

Figure: Visual 5s Method for Indicating Maximum Batch Size



Five-Minute 5S

When using the Visual 5S approach, instant visibility can act as a trigger for taking immediate three pillar action (Sort, Set in Order, and Shine activities) against the discovered abnormalities (i.e., overproduction, disorder, and contamination). We must also deal with the question of how skillfully and efficiently these actions are carried out. Instead of following two hours for removing all of the cutting shavings from the floor, we can set up a half-hour or a one-hour Shine procedure that accomplishes the same task. The term "Five-Minute 5S" is a loose one-the actual time can be three minutes, six minutes, or whatever is appropriate. The point is to make the five pillar work brief, efficient, and habitual. In figure below shows a signboard that was made as part of a Five-Minute 5S campaign.

Five-Minute 5S Campaign	
Today's Five-Minute 5S Work	
Time: 8:30 to 8:35	Person in charge: Smith
1S Sort	Storage site for unprocessed items (Red-tag unneeded items.)
2S Set in Order	Storage site for unprocessed items (Make divider lines and distribute workload.)
3S Shine	Pneumatic three-point setting (Clean out interior dirt.)
4S Standardize	Oil leaks (Find one!)
5S Sustain	(Pause, point, and call.)

Figure: Five-Minute 5s Signboard



3. Check on 3S Maintenance Level

After we have assigned the three pillar jobs and have incorporated the three pillar maintenance into the everyday work routine, we need to evaluate how well the three pillars are being maintained. For this, we can use a Standardization-level Checklist as shown in the figure below.

Standardization-Level Checklist		Dept.: Assembly Dept. 1			Feb. 15, 1994			
		Assigned area			Entered by: McCarthy			Page
No.	Process and checkpoint	Sort	Set in Order	Shine	Total			
1.	Work at Line A, Process 1	1 2 3 (4) 5	1 (2) 3 4 5	1 (2) 3 4 5	8			
2.	"	1 (2) 3 4 5	1 2 (3) 4 5	1 2 (3) 4 5	8			
3.	"	1 (2) 3 4 5	1 (2) 3 4 5	1 (2) 3 4 5	6			
4.	"	1 (2) 3 4 5	1 2 (3) 4 5	1 (2) 3 4 5	7			
5.	"	1 2 (3) 4 5	1 2 (3) 4 5	1 2 3 (4) 5	10			
6.	"	1 2 3 (4) 5	1 2 3 (4) 5	1 2 3 (4) 5	12			
7.	Average and total for Line A	1 2 (2.6) 3 4 5	1 2 (2.8) 3 4 5	1 2 (2.8) 3 4 5	(50)			

Figure: Standardization Level Checklist

To evaluate the effectiveness of the maintenance activities, the evaluator ranks the Sort, Set in order, and Shine levels on a scale of 1 to 5. Such checklists can be made for specific workshop and/or production processes. One example is shown in the Figure below. 5S Checklists like the one in the figure are used to check five pillar levels in the factory as a whole. When a company implements 5S Month of intensive activities, 5S Checklists should be used to make weekly evaluation of five pillar conditions.



Location		Check Item	Check Description	Year and month:					
				1	2	3	4	5	T
Outdoors (overall)		Are storage areas clearly determined?	Areas for piling, pallets, temporary materials storage, delivered goods reception, trash processing, and boxes	0	2	0	2	0	4
		Have paths been clearly defined?	Have white and yellow lines been laid down?	0	2	0	2	0	4
			Are traffic signs used?	0	3	0	3	0	6
			Are there any exposed wires or pipes?	1	3	1	3	1	9
		Are outdoor areas kept clean?	Are ashtrays, trash cans, gardens, entrance areas, windows, and paths kept clean?	1	3	1	3	1	9
Are there any unneeded items?	Are signboards, copy machines, and pathways arranged properly?	1	1	1	1	1	5		
Clerical (overall)		Have temp storage areas been clearly defined?	Have fire-extinguishing equipment and emergency exits been established?	2	3	2			
		Are office areas kept clean?	Are the walls dirty?						

Figure: checklists for an entire factory

The Concept of Prevention

When we find that tools have not been put back correctly, we immediately take care of them. When we find an oil puddle on the floor, we immediately mop it up. Making these actions habit is the foundation of Standardize. However, when the same problems keep on happening over and over again, it is time to take the concept of Standardize to the next level: prevention.

To take this pillar to a higher level, we must ask "why?" Why do unneeded items accumulate (despite Sort procedures)? Why do tools get put back incorrectly (despite Set in order procedure)? Why do floors get dirty (despite Shine procedures)? When we ask "why" repeatedly, we eventually find the source of the problem and can address that source with a fundamental improvement. Such improvements can help us develop Unbreakable standardization, which means:

- Unbreakable sorting



- Unbreakable setting in order
- Unbreakable setting shining

Unbreakable Standardization	=	Unbreakable Sorting + Unbreakable Set in order + Unbreakable Shining
--------------------------------	---	--------------------------------------------------------------------------------------------------

Prevent unneeded items from Accumulating (Preventive Sort Procedures)

The Red-Tag Strategy described sorting out unneeded items. This strategy is a visual control method that enables anyone to see at a glance which items are no longer needed. However, we should note that the Red-Tag Strategy is an after-the-fact approach that deals with unneeded items that have accumulated. No matter how often we implement this strategy, unneeded items will accumulate in the interim.

Nowadays, smart companies are shifting from this type of "alter the-fact" sorting to preventive sorting. Preventive sorting means that instead of waiting until unneeded items accumulate; we find ways to prevent their accumulation. We could also call this approach "unbreakable" sorting because once sort procedures have been implemented, having only needed items in the workplace becomes an "unbreakable" condition.

To achieve unbreakable sorting we must prevent unneeded items from even entering the workplace. These words- «only what is needed" -have a familiar ring to anyone acquainted with the just-in- time (JIT) philosophy and program. To prevent the accumulation of unneeded inventory, we must find a way to procure and produce only those materials that are needed, only when they are needed, and only in the amount needed.

For example, suppose your company is scheduled to produce a certain number of units of a product during a particular month. Ideally, at the beginning of this month,



only the parts needed to produce the scheduled number of units would be delivered to you from your suppliers. For any given part, your company might even receive the part in several deliveries, depending on the type of part and the delivery considerations.

Receiving parts just-in-time for production rather than storing large quantities of parts in advance eliminates many of the potential costs associated with maintaining inventory. As well, receiving parts just-in-time is a preventive measure that avoids the accumulation of parts that needed to be sorted.

Prevent Things from Having to Be Put Back (Preventive Set in Order Procedures)

Preventive setting in order means keeping set in order procedure from breaking down. To achieve preventive setting in order, we must somehow prevent the inefficiency that results from the lack of orderly control of any specific item. There are two ways to do this: (1) make it difficult to put things in the wrong place and (2) make it impossible to put things in the wrong place.

The first method relies heavily on discipline and visual controls. Clearly marked storage sites show at a glance what goes where and in what amount. When it is obvious what goes where and in what amount. When it is also obvious that things are not put back properly. As people practice returning things, such visual setting in order becomes habitual. This condition supports setting in order that is difficult to break. However, there is still a big difference between setting in order that is difficult to break and setting in order that is unbreakable. 'Why settle for the first when the second is possible? But how we achieve unbreakable setting in order?

The 5 Whys and 1How (5W1H) Approach

We begin by asking "why?" until we identify the underlying causes- for every answer we get we must ask "why" again. Usually we ask "why" at least five times to get to the root of the problem. When we do find the underlying cause, we ask "how" we call fix it. Accordingly, this method is called the "5W1H' approach.

Learning Guide for Standardize and Sustain Level II Version: 1 Revision: 0	Date: September, 2019	Page 80 of 29
	Author: Federal TVET Institute	



When we ask "why" setting in order is breakable, we find that one answer is because people make mistakes putting things back. At this point, we need to identify what types of items are not being returned correctly. Once we identify this, the question is how to achieve unbreakable setting in order by making it impossible to return them to the wrong place. If we can somehow eliminate the need to return items at all, we can achieve unbreakable setting in order.

Three techniques for doing this are:

- Suspension
- Incorporation
- Use elimination.

Suspension

In the Suspension technique, tools are literally suspended from above, just within reach of the user. Figure above shows this method in practice. Here a weighted pulley device is used to suspend tools from an overhead rack. When the operator finishes using the tool, he merely releases it and it automatically returns to its proper storage place.

While this technique does not eliminate the need to return items to a specific place, it does effectively eliminate the need for people to return them. People may make mistakes in returning things, but suspension devices do not. This technique achieves unbreakable setting in Order.

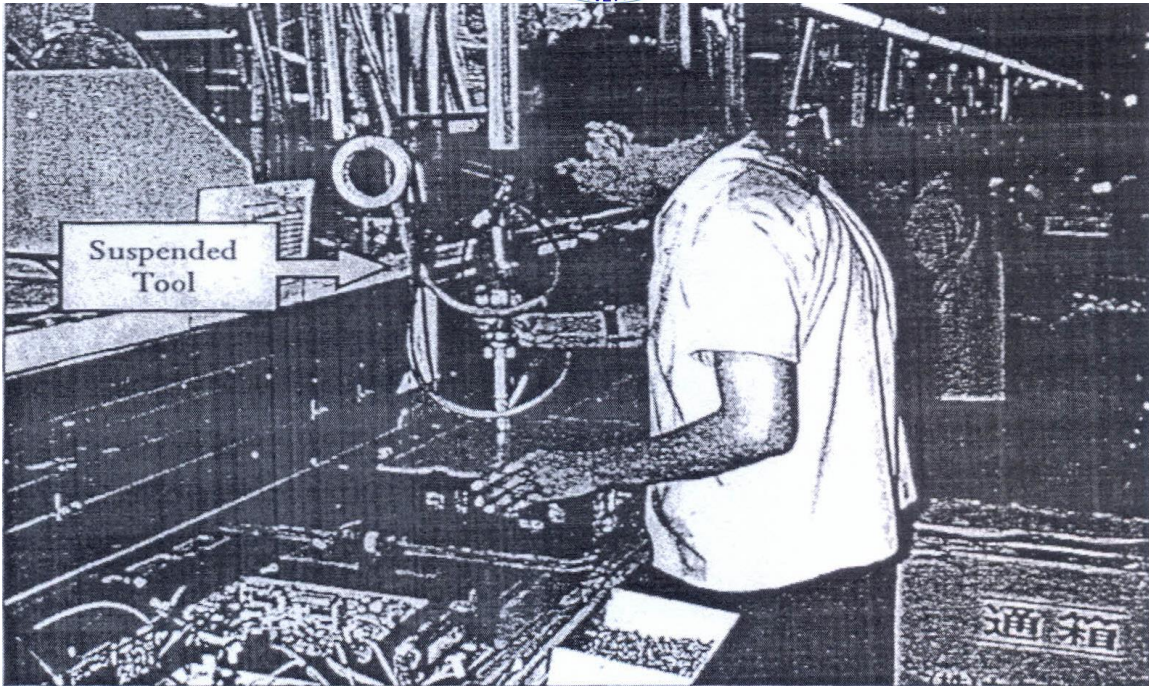

Figure: Tools Suspended from an Overhead Rack



Incorporation

Incorporation means creating a flow of goods or operations in a factory process in which (1) jigs, tools, and measuring instruments are smoothly integrated into the process and (2) such devices are stored where they are used and therefore do not have to be returned after use. The figure below shows an example where a measuring gate has been incorporated into a cutting process for an automobile part. The measuring gate catches any pieces that have not been machined to the correct height. This measuring procedure is an example of "mistake-proofing" (or poka-yoke). The incorporation of the measuring gate into the cutting process means that its storage place is also its place of use. It is therefore used (for full-lot inspection) without having to be put back anywhere.

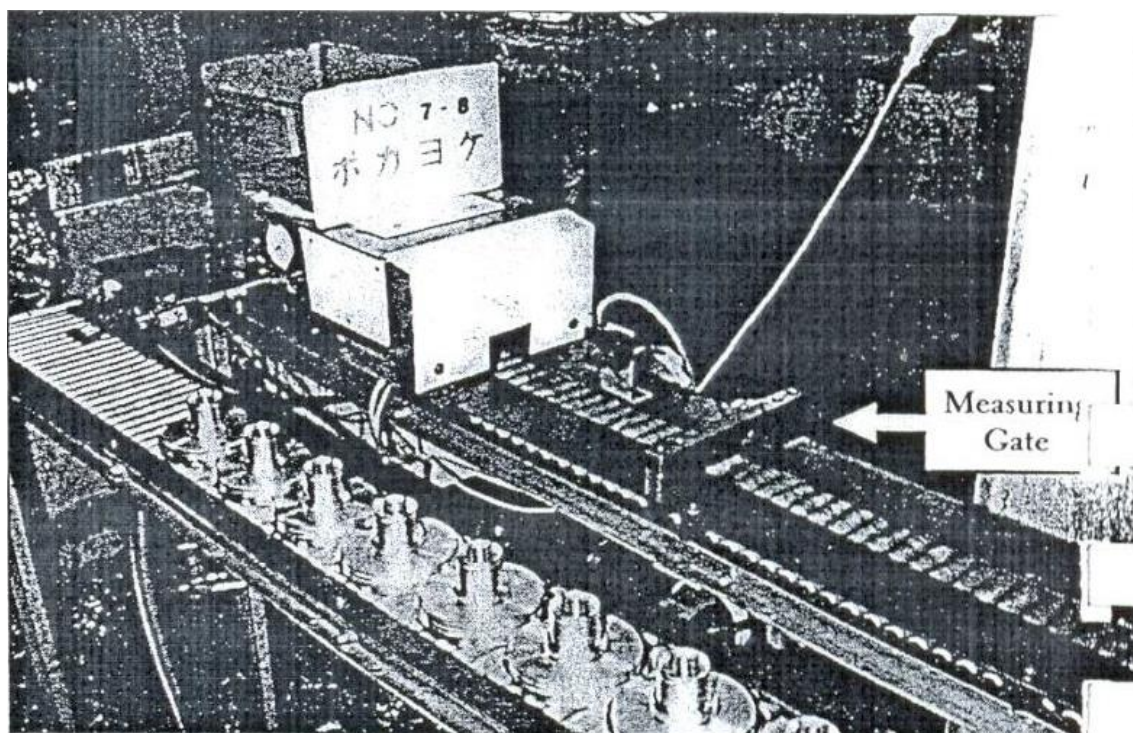

Figure: Incorporating a Measuring Gate into the Process Flow

Use Elimination

Suspending or incorporating jigs, tools, or measuring instruments effectively eliminates the need to return them after each use. However, these items are still being used. The question is whether there is some way to serve the function of the tool without using the jig, tool or measuring instrument. A set in order approach that

Learning Guide for Standardize and Sustain Level II Version: 1 Revision: 0	Date: September, 2019	Page 83 of 29
	Author: Federal TVET Institute	



eliminates the use of a particular jig, tool or measuring instrument is in fact unbreakable setting in order.

There are three techniques for eliminating the use of certain tools:

- Tool unification
- Tool substitution
- Method substitution

Tool unification

Tool unification means combining the functions of two or more tools into a single tool. It is an approach that usually reaches back to the design stage. For example, we can reduce the variety of die designs to unify dies or make all fasteners that require a screw-driver conform to the same kind of screw-driver, flat-tip or Phillips.

Tool substitution

Tool substitution means using something other than a tool to serve the tool's function, thereby eliminating the tool. For example, it is sometimes possible to replace wrench-turned bolt with hand-turned butterfly-grip bolts, thereby eliminating the need for a wrench.

Method substitution

If we substitute ordinary wrench-turned bolts with hand-turned butterfly-grip bolts, we have eliminated the wrench, but we have not eliminated the method (bolt fastening). Bolt fastening is just one way to fasten things. Fastening pins, clamps and cylinders can also be used for this purpose. *We may find we can improve efficiency even more by replacing one method with another. This is "method substitution."*



Learning Guide for Standardize and Sustain Level II Version: 1 Revision: 0	Date: September, 2019	Page 84 of 29
	Author: Federal TVET Institute	



Standards for Location Indicators

Standards for indication of fixed position

● Standards for indication of fixed positions (examples)

	Line color	Line width	Materials	Method	Objects
Indicating square outline 	White Green	5cm	Tape Paint	Indicate on partition line.	Carts, lifts, empty boxes, pallets, inspection boxes, materials, parts, products, defectives, measuring tools
Indicating corners 	White Green	5cm	Tape Paint	Indicate on partition line.	Tables, platforms
Indicating leg positions 	White Green	5cm	Tape Paint	Indicate on partition line.	Tables, platforms



fixed position Indications



Indications on Shelves

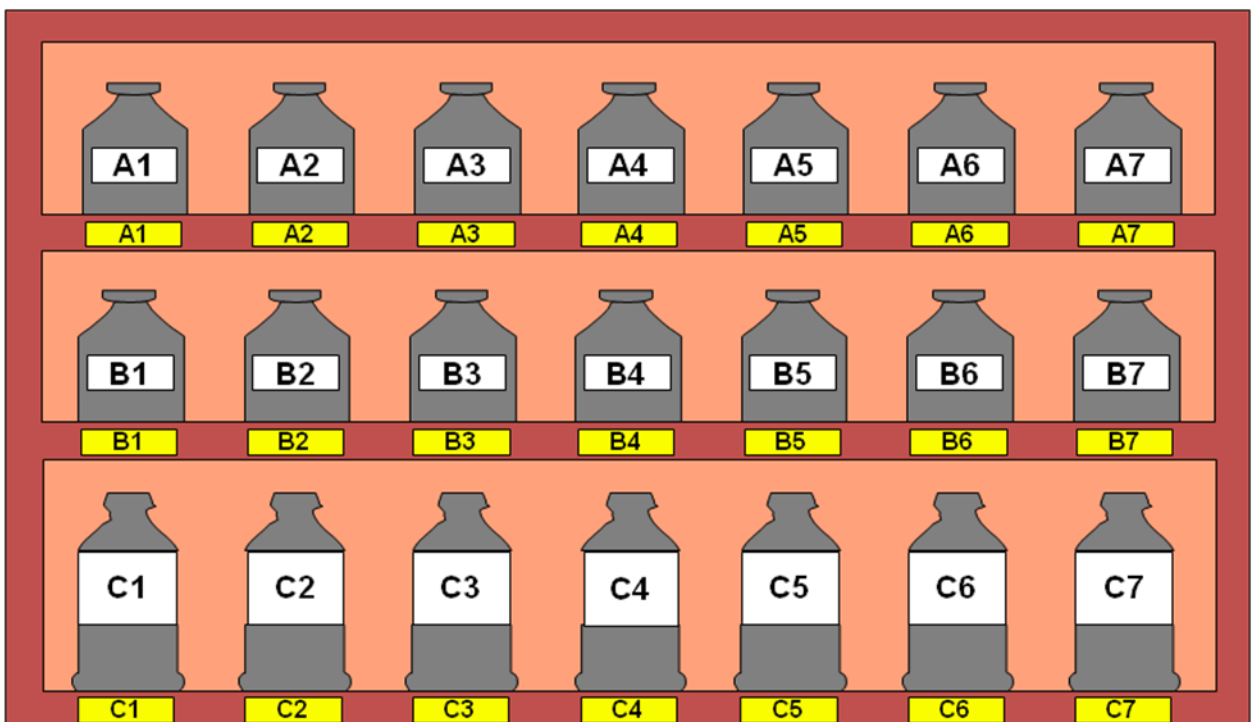



Indication of pathways

Standards of pathways on premise (examples)

	Standards
Width of walkway	80 cm or more
Width of main pathway	1.2 m or more
Color of partition line	Yellow or white
Material for partition	Tape or paint



Prevent Things from Getting Dirty (Preventive Shine Procedures)

Preventive shine Procedures will prevent things from getting dirty to begin with. Anyone who has participated in 5S implementation can tell you that the initial cleanup is very hard work. To minimize the drudgery of cleaning up, the key is to treat contamination problems at their source. The 5Why approach can be applied. In figure out why dirt is being generated, and how this problem can be fixed. For example, instead of mopping up oil puddles, figure out where the oil is leaking from and repair the leak.

1. Question: Why mop the floor every day?

Answer: Because oil collects on the floor.

2. Question: does oil collect on the floor every day?

Answer: Because there's a leak from the drill press machine

3. Question: Why is there a leak from the drill press machine?

Learning Guide for Standardize and Sustain Level II Version: 1 Revision: 0	Date: September, 2019	Page 87 of 29
	Author: Federal TVET Institute	

Answer: Because oil is leaking from a valve.

4. Question: Why is oil leaking from a valve?

Answer: Because it's broken.

5. Question: Why hasn't the valve been replaced?

Answer: because we didn't notice it was broken

6. Question: How can we coordinate getting the valve fixed?

Answer: The maintenance team will order the part and the operator will replace it.

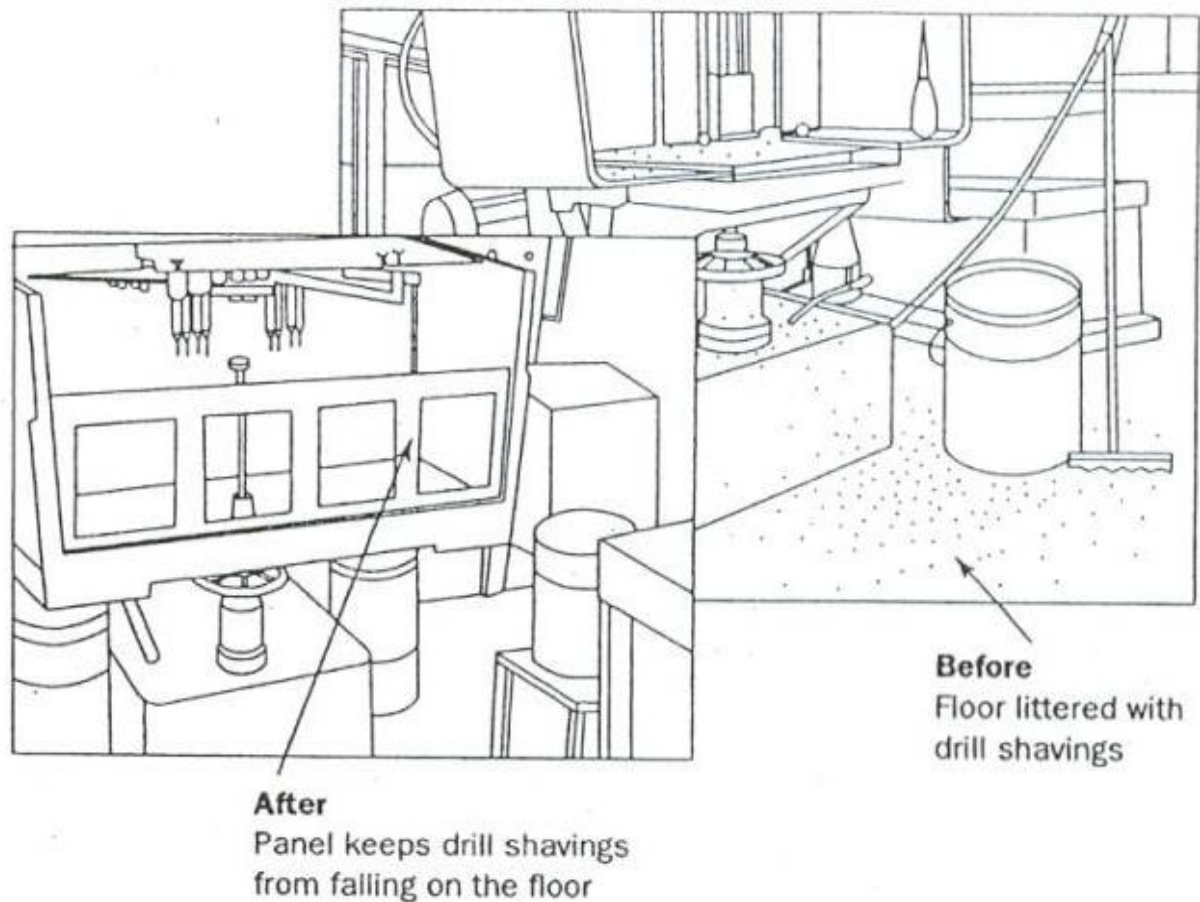

Figure: A Preventive Cleanliness Device of a Drill Press



Summary

The fourth pillar is Standardize, which is the result of properly maintaining the first three pillars Sort, Set in Order, and Shine. The basic purpose of Standardize is to prevent setbacks in the first three pillars to make them a daily habit, and to make sure they are maintained in their fully implemented state.

The first part of implementing the fourth pillar involves making sort, Set in Order, and Shine a habit. The three steps in this process are:

- (1) Assigning the three pillar job responsibilities;
- (2) Integrating three pillar duties in to regular work duties; and
- (3) Checking on the maintenance of the three pillars. When it comes to maintaining three pillar conditions, everyone must know exactly what they are responsible for doing and exactly when, where, and how to do it. The five pillars must become part of the normal work flow. And 5S work must be brief, efficient, and habitual. Some of the tools in making sort, set in order, shine procedure habit are: 5S Job Cycle Charts, Visual 5S, Five –Minute 5S, a Standardization Level Checklist, and 5S Checklist for factories.

The second part of implementing the fourth pillar involves taking standardize to the next level: prevention. Unbreakable standardization means making Sort, Set in Order, and Shine procedure unbreakable. The three aspects of unbreakable standardization are preventive sort procedures, preventive set in order procedures, and preventive shine procedures.

Preventive sorting means that instead of waiting until unneeded items accumulate we find ways to prevent their accumulation. To do this, we must prevent unneeded items from even entering the work place. Preventive setting in order means keeping the set in order procedure from breaking down. We do this by making it difficult or impossible to put things back in the wrong place. Several techniques for accomplishing this are: the 5W and 1H approach, suspension, incorporation, and use elimination. Finally, preventive shining means preventing things from getting dirty. The key to preventive shining is treating contamination problems at their source. The closer you can get to

Learning Guide for Standardize and Sustain Level II Version: 1 Revision: 0	Date: September, 2019	Page 89 of 29
	Author: Federal TVET Institute	



the source of contamination, the better you will be able to implement preventive shining.

Learning Guide for Standardize and Sustain Level II Version: 1 Revision: 0	Date: September, 2019	Page 90 of 29
	Author: Federal TVET Institute	



Self-Check 2

Written Test

Directions: Answer all the questions listed below. Use the Answer sheet provided in the next page:

1. What is the result of implementing 3S without standardization? (4 points)
2. List at least five tools and techniques used to standardize the 3S.
3. What are the tools used to assign 3S responsibilities? (3 points)
4. How the 5 whys and 1 how (5W1H) approach are used to sustain the 3S? (6 points)
5. What is suspension in terms of sustaining of the 3S? (3 points)
6. Define incorporation. (3 points)
7. Describe Use Elimination in sustenance of the 3S. (3 points)
8. What will result implementing 3S without standardization? (4 points)

Note: Satisfactory rating - 17 points Unsatisfactory - below 17 points
You can ask your trainer for the copy of the correct answers.

Learning Guide for Standardize and Sustain Level II Version: 1 Revision: 0	Date: September, 2019	Page 91 of 29
	Author: Federal TVET Institute	



Answer Sheet

Score = _____

Rating: _____

Name: _____

Date: _____

1. _____

2. _____

3. _____

4. _____

5. _____



6. _____

7. _____

8. _____



Operation Sheet 1	Procedures in Implementing Standardize
--------------------------	-----------------------------------------------

Sequence of Standardize

1. Planning for Standardization
2. Assign 3S Responsibilities for everyone in the work place by using the tools by using the tools such as 5S Maps, 5S schedules, 5S job cycle charts
3. Integrate 3S Duties into Regular Work Duties by using the two approaches: visual 5S and five- minute 5S
4. Check on 3S Maintenance Level by using Standardization-level Checklist and 5S checklist and make maintenance/correction on back sliding the 3S.
5. Prevention of back sliding of the first three pillars by using 5W1H approach, suspension, incorporation and use elimination.



LAP Test	Practical Demonstration
-----------------	--------------------------------

Name: _____ Date: _____

Time started: _____ Time finished: _____

Instructions: Given necessary templates, workshop, tools and materials you are required to perform the following tasks within ----- hours.

Task 1: Prepare standard to the sort activities in your workplace.

Task 2: Prepare standard to the set in order activities in your workplace.

Task 3: Prepare standard to the shine activities in your workplace.

- consider the:
 - OHS procedures



List of Reference Materials

- 5S for operators (1995)
- Journals/publications/magazines
- Reference Book
- Job specifications
- Safety Manual and Guide
- Learning Guide #2



Learning Guide for Standardize and Sustain II Version: 1	Date: September, 2109	Page 97 of 41
	Author: Federal TVET Agency	



Learning Guide #3

Unit of Competence: Standardize and sustain 3S

Module Title: Standardizing and sustaining 3S

LG Code: AGR ATI2 M07 0919 L03-LG-03

TTLM Code: AGR ATI2 TTLM 0919v1

L0 3: Sustain 3S

Instruction Sheet	Learning Guide #3
--------------------------	--------------------------

This learning guide is developed to provide you the necessary information regarding the following content coverage and topics:

- The fifth pillar explanation and how to implement sustain.
- Tools and techniques to sustain 5s

Learning Guide for Standardize and Sustain II Version: 1	Date: September, 2109	Page 98 of 41
	Author: Federal TVET Agency	



This guide will also assist you to attain the learning outcome stated in the cover page. Specifically, upon completion of this Learning Guide, you will be able to –

- Prepare plan for the implementation of sustain
- tools and techniques used to sustain 3s
- Review sustain

Learning Instructions:

32. Read the specific objectives of this Learning Guide.
33. Follow the instructions described in number 3 to 13.
34. Read the information written in the “Information Sheets 1”. Try to understand what are being discussed. Ask you trainer for assistance if you have hard time understanding them.
35. Accomplish the “Self-check 1” in page 11.
36. Ask from your trainer the key to correction (key answers) or you can request your trainer to correct your work. (You are to get the key answer only after you finished answering the Self-check 1).
37. If you earned a satisfactory evaluation proceed to “Information Sheet 2”. However, if your rating is unsatisfactory, see your trainer for further instructions or go back to Learning Activity #2.
38. Submit your accomplished Self-check. This will form part of your training portfolio.
39. Read the information written in the “Information Sheet 2”. Try to understand what are being discussed. Ask you trainer for assistance if you have hard time understanding them.
40. Accomplish the “Self-check 2” in page 28.
41. Ask from your trainer the key to correction (key answers) or you can request your trainer to correct your work. (You are to get the key answer only after you finished answering the Self-check 2).

Learning Guide for Standardize and Sustain II Version: 1	Date: September, 2109	Page 99 of 41
	Author: Federal TVET Agency	



42. If you earned a satisfactory evaluation proceed to “Operation Sheet 1” in page 31. However, if your rating is unsatisfactory, see your trainer for further instructions or go back to Learning Activity #1.
43. Read the “Operation Sheet 1” and try to understand the procedures discussed.
44. Do the “LAP test” in page 32 (if you are ready). Request your trainer to evaluate your performance and outputs. Your trainer will give you feedback and the evaluation will be either satisfactory or unsatisfactory. If unsatisfactory, your trainer shall advice you on additional work. But if satisfactory you can proceed to Learning Guide #3.

Learning Guide for Standardize and Sustain II Version: 1	Date: September, 2109	Page 100 of 41
	Author: Federal TVET Agency	



Information Sheet-1	The Fifth Pillar Explanation and How to Implement Sustain
----------------------------	------------------------------------------------------------------

The fifth pillar is Sustain. In the context of the five pillars, to sustain means to make a habit of properly maintaining correct procedures. In your life in general, what do you mean when you talk about sustaining something? Usually, you think of it as drawing on something from inside yourself in order to maintain a course of action-even when forces in your life challenge in this effort.

- *Means making a habit of properly maintaining correct procedures*

Problems Avoided by Implementing Sustain

Here are some of the things that happen in a company when Commitment to the five pillars is not sustained.

1. Unneeded items begin piling up as soon as sorting is completed
2. No matter how well Set in Order is planned and implemented, tools and jigs do not get returned to their designated place after use.
3. No matter how dirty equipment becomes, little or nothing is done to clean it.
4. Terms are left protruding into walkways, causing people to trip and get injured.
5. Dirty machines start to malfunction and produce defective goods.
6. Dark, dirty, disorganized workplaces lower workers' morale.

These 5S related problems and others are likely to occur in any factory or office that lacks a commitment to sustain the five pillar gains over time.

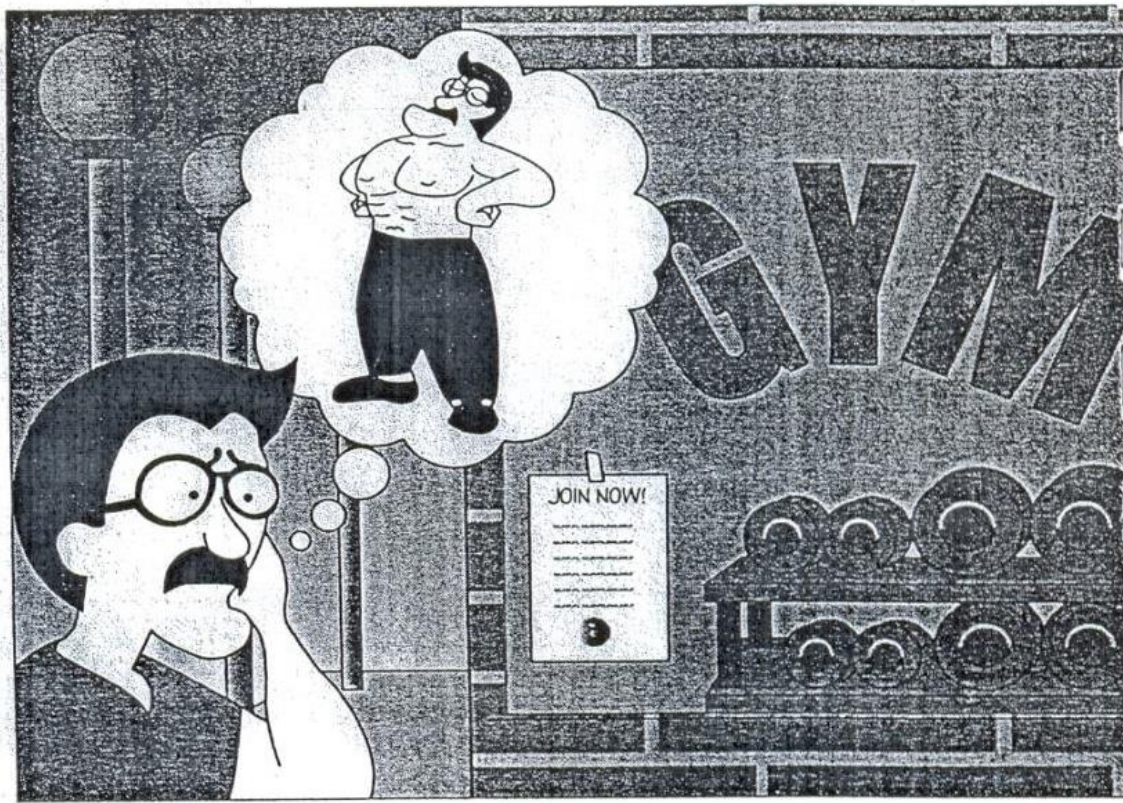

Figure showing contemplating the rewards of sustain behavior

Why Sustain Is Important

Usually you commit yourself to sustain a particular course of action because the rewards for keeping to the course of action are greater than the rewards for departing from it (see figure above). Viewed another way, the consequences of not keeping to the course of action may be greater than the consequences of keeping to it. For example, suppose you want to start an exercise program –say you decide you want to work out at a gym three times a week. You probably have difficulty sustaining this course of action. This is because forces in your life, such as limits on your time and energy as well as the power of inertia, challenge this plan. However, if the rewards of sticking to your exercise program (for example, feeling and looking better) are greater than the rewards of not sticking to it (for example, having more time for other things that you need to do), your commitment will increase and you will probably sustain this program over time.

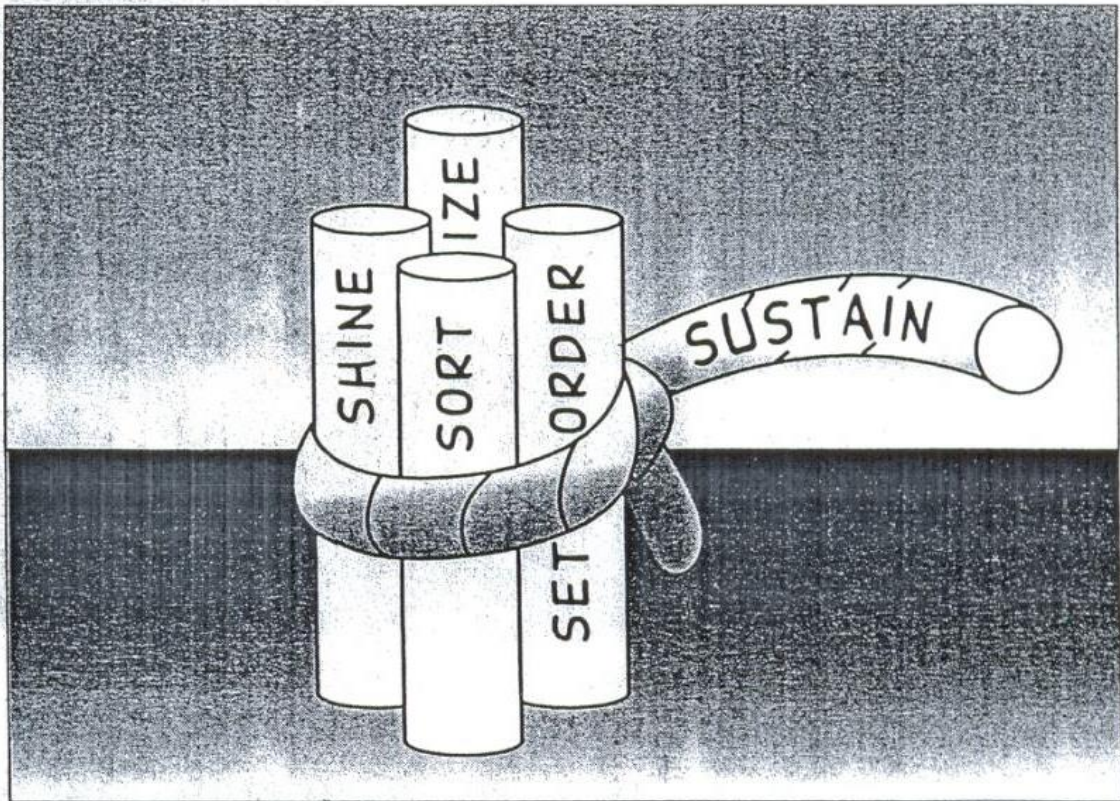

Figure: The sustain pillar holds the first four pillars together.

The same principle applies in your 5S implementation. Without your commitment to sustain the benefits of the 5S activities, implementation of the first four pillars quickly falls apart (see Figure above). However, if the rewards of implementing the first four pillars are greater for you than the rewards of not implementing them, sustaining them through the fifth pillar should be something you take to naturally.

So, what are the rewards for you of implementing the first four pillars? You've probably discovered them for yourself at this point. Implementation of the first four pillars should make your workplace more pleasant to work in, your job more satisfying and communication with your coworkers easier. It should also make your work more efficient and of better quality, which will hopefully lead to reward of your efforts by your company. It's true that the five pillars take time to implement, but this investment of time will bring a great return, for both you and your company.

Learning Guide for Standardize and Sustain II Version: 1	Date: September, 2109	Page 103 of 41
	Author: Federal TVET Agency	



Figure: creating the conditions to sustain your fitness plan

How to Implement Sustain

Creating Conditions to Sustain Your Plans

The implementation of the sustain pillar is different from that of the sort, set in order, shine, or standardize pillars in that the results are not visible and cannot be measured. Commitment to it exists in people's hearts and minds and only that have shows its presence. Because of this it cannot exactly be "implemented" like a technique, However, we can create conditions that encourage the implementation of the sustain pillar.

For instance, going back to our exercise program example, how could you create conditions in your own life that would encourage sustaining your plan to work out at a gym three time a week? You might:

- Join a gym with a friend so you can work out together and encourage each other (see Figure above).
- Create a workout schedule with your friend.
- Make a plan with your spouse to eat dinner later three nights a we so you can go to the gym after work.



- Get extra sleep on the nights before you work out, so that you will not be too tired by the end of the day to follow through with your exercise plan.

These conditions would make it easier for you to sustain your schedule for exercising at the gym three times a week.

Similarly, you and your company can create conditions or structure that will help sustain to the five pillars. The types of conditions that are most useful for this are:

- **Awareness.** You and your coworkers need to understand what the five pillars are and how important it is to sustain them.
- **Time.** You need to have or make enough time in your work schedule to perform 5S implementation.
- **Structure.** You need to have a structure for how and when 5S activities will be implemented.
- **Support.** You need to have support for your efforts from management in terms of acknowledgement, leadership, and resource
- **Rewards and Recognition.** Your efforts need to be rewarded.
- **Satisfaction and Excitement.** The implementation of the five pillars needs to be fun and satisfying for you and the company. This excitement and satisfaction gets communicated from person to person, allowing 5S implementation to build as it involves more people.

Roles in Implementation

In order to sustain 5S implementation in your company, both you and the company management have important roles to play. Part of this role involves creating the conditions that sustain 5S activities. The other part involves demonstrating a commitment to 5S yourself.

The Role of Management

The supervisors and managers in your company have a major role to play in ensuring the success of the five pillars by creating conditions that help sustain 5S activities.

This role includes:

- educating you and your coworkers about 5S concepts, tools, and techniques;
- creating team for implementation

Learning Guide for Standardize and Sustain II Version: 1	Date: September, 2109	Page 105 of 41
	Author: Federal TVET Agency	



- allowing time for implementation and creating schedules for this work
- Providing resources for 5S implementation. such as supplies-s
- acknowledging and supporting 5S efforts
- Encouraging creative involvement by all workers, listening to their ideas, and acting on them.
- creating both tangible and intangible rewards for 5S efforts
- promoting ongoing 5S efforts

Your supervisors and managers also have an important role to play in implementing the fifth pillar in their own work. When they sustain the first four pillars, they perform three very important functions.

- improving the quality and efficiency of their own work
- teaching by example
- demonstrating the company's commitment to 5 implementation

Yours Role

Similarly, you have an important role to play in creating the conditions that Sustain 5S activities. This role includes:

- continuing to learn more about 5S implementation
- helping to educate your coworkers about the 5S
- being enthusiastic about 5S implementation
- helping to promote 5S implementation efforts

You also have an important role to play in order to sustain 5S activities in your own work. This role includes:

- taking the initiative to figure out ways to implement the five pillars in your work on a daily basis
- asking your supervisor or manager for the support or resources you need to implement the five pillars
- participating fully in company 5S implementation efforts
- bringing to your supervisor or manager your creative ideas for promoting or implementing the five pillars
- participating fully in company 5S promotion efforts

Learning Guide for Standardize and Sustain II Version: 1	Date: September, 2109	Page 106 of 41
	Author: Federal TVET Agency	

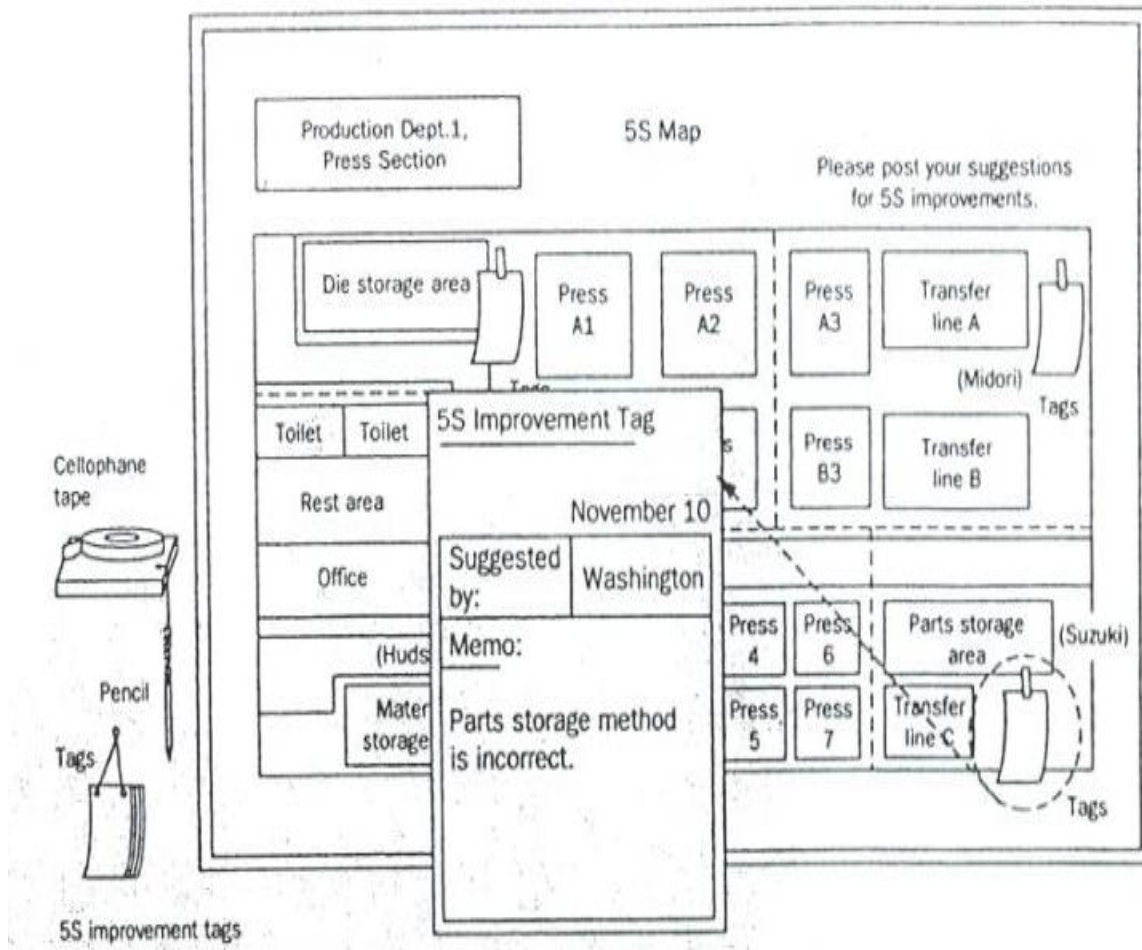

Figure: 5S map used to gather improvement suggestions



Self-Check 1

Written Test

Directions: Answer all the questions listed below. Use the Answer sheet provided in the next page:

14. Define the fifth pillar of 5S? (2 point)
15. List problems avoided by implementing sustain. (6 points)
16. Why sustain is important? (4 points)
17. Explain how to implement sustain? (7points)
18. What are the roles of you and your management in implementation of sustain ? (9points)

Note: Satisfactory rating - 15 points Unsatisfactory - below 15 points
You can ask you trainer for the copy of the correct answers.

Learning Guide for Standardize and Sustain II Version: 1	Date: September, 2109	Page 108 of 41
	Author: Federal TVET Agency	



Answer Sheet

Score = _____

Rating: _____

Name: _____

Date: _____

14. _____

15. _____

16. _____

17. _____

18. _____





Information Sheet-2

Tools and techniques to sustain 5s

Common Tools and techniques to sustain 5s are:

There are many tools and techniques your company can use to help sustain commitment to 5S implementation. We offer these below so you will be aware of them. At some point in your 5S implementation work, you may be called upon to use or even coordinate the use of these techniques. These are:

- 5S slogans
- 5S posters
- 5S photo exhibits & storyboards
- 5S newsletter
- 5S maps
- 5S pocket manuals
- 5S department/benchmarking tours
- 5S months
- 5S audit
- Awarding system
- Big cleaning day
- Patrolling system
 - Top management Patrol
 - 5S Committee members and Promotion office Patrol
 - Mutual patrol
 - Self patrol
 - Checklist patrol
 - Camera patrol



5S Slogans

5S Slogans communicate the themes of the five pillar campaign in your company. They are most effective when they are suggested by you and your coworkers. They can be displayed on buttons, stickers, flags, or posters.

- It encourages all the participants.

Samples of slogan

“Refresh yourself and workplaces by 5S activity.”

“Let’s maintain current 5S activity and KAIZEN for tomorrow”

“We polish “Our Minds” as well us our factories”

5S Posters

Posters displaying 5S Slogans or descriptions of 5S activities can be posted throughout the workplace. They can serve to remind everyone of the importance of the five pillars, or to communicate the results or status of 5S activities.

Samples of poster

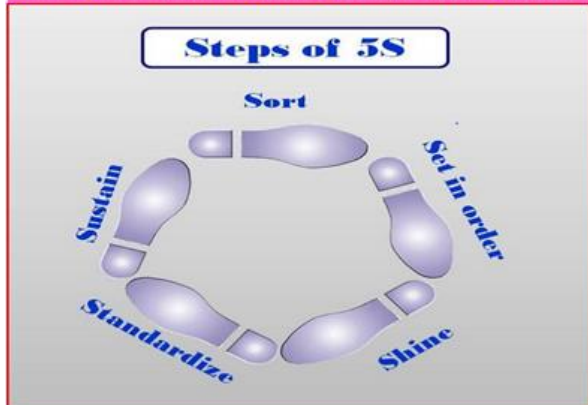



5S Photo Exhibits and Storyboards

When it comes to communication about 5S implementation, the old saying that a "picture is worth a thousand words" is definitely true. Photo Exhibits and Story boards showing the before and after of 5S implementation activities are powerful tools for promoting the five pillars. Photos and Storyboards can also communicate the status of five pillar activities.

5S Newsletters

5S Newsletters are in-house news bulletins centered on five pillar topics. They carry factory reports on 5S conditions and activities. 5S Newsletters are most effective when issued on a regular basis, perhaps once or twice a month and at staff meetings.

5S Maps

5S Maps can also be used to get employees involved in five pillar improvement on an ongoing basis. 5S improvement Maps should be hung in a central location with suggestion cards attached so anyone can suggest improvements.

5S Pocket Manuals

A 5S Pocket Manual can be created that contains five pillar definitions and descriptions, and is small enough to fit into the pocket of work clothes. Shop floor workers, supervisors, and managers can all use 5S Pocket Manuals for easy reference to the 5S essentials.

5S Department Tours

When one department in a company has implemented the five pillars successfully, it can serve as a model area for other departments to come visit. Since "seeing is believing," this technique is extremely effective for promoting 5S implementation throughout a company.

Learning Guide for Standardize and Sustain II Version: 1	Date: September, 2109	Page 113 of 41
	Author: Federal TVET Agency	



55 Months

Companies should designate two, three, or four months every year as "5S Months." During these months, various activities such as 5S seminars, field trips, and contests can be carried out to further promote 5S implementation in the company.

5s Audit

- The purpose of this audit is to outline an approach making 5S a success in industrial as well as our working areas.
- Enable 5S teams to design and establish a simple, effective and visual workplace organization, which creates a professional workplace and culture that is effective, organized and disciplined.
- Continual Improvement internal audit program enhance excellent service delivery
- Audit findings can be used to identify trends and the key issues.

Learning Guide for Standardize and Sustain II Version: 1	Date: September, 2109	Page 114 of 41
	Author: Federal TVET Agency	



5S AUDIT COMMITTEE

FUNCTION

- Develop 5S evaluation criteria, guidelines and stickers
- Develop schemes on measuring impact of audit; Scoring point and achievement level
- Develop guidelines to aid in effective standardization of improvement projects
- Schedule audit activities
- Submit audit summary every month to the Top Management

BASIC REQUIREMENTS

- Headed by a chair person who has more experience in 5S Practices.
- 5S auditors which are officially nominated by management.
- The number of auditors depend on size of companies.
- Knows what to audit especially understanding the 5S principles.
- Have 5S audit planning.
- Have interest and committed to make 5S a success.
- Dynamic and pro-actives.

CHAIRPERSON

--- CHIEF AUDITOR

SECRETARY

**FORMULATING
5S AUDIT
COMMITTEE**

1

2

3

4

**AUDITORS GROUP
(2 PERSON)**



Performing Audit

Preparation

1. All 5S auditors gather at the meeting room ½ hour before audit
2. Briefing by 5S audit chairman :-
 - Activities of the day
 - Highlight any new criteria to be checked
 - Action date on sticker (2 weeks from audit date)
 - Time to report back
3. Wearing 5S auditor tag
4. Every auditor is only allowed to use up to 3 stickers at each audit to each 5S zone. It is purposely not put burden to 5S team to make improvement in very drastic manner.
5. Previous audit summary report will be distributed to the auditors' team as a reference in order to avoid in consistency auditing.

During Audit

1. Bring all audit materials e.g. checklist, stickers, file holder & audit summary report
2. Get the KPT leader or facilitator to accompany auditor
3. Good public Relation
4. Check outstanding matter from the previous audit summary report
5. Proper issue of stickers & justified
6. Propose idea for improvement and justified.
7. Close matter when action has been taken. Remove sticker
8. Issue new sticker when action is not fully satisfied (old sticker still remain) and also for new matter noted
9. Take photo as an example in case of the 5S team has shown very creative idea to make the 5S initiative significantly effective, safe work place, cost saving

Learning Guide for Standardize and Sustain II Version: 1	Date: September, 2109	Page 116 of 41
	Author: Federal TVET Agency	



10. Only use maximum 3 stickers of each type for each working area / zone
11. Listen to the feedback given by workers
12. Provide positive suggestion for improvement if stickers is not appropriate
13. Prepare audit report of each working area on the Audit summary
14. Document must be signed by auditor & team leader
15. Audit to the next area
16. You may take 10 – 15 minutes for one zone.

Twelve Focal Points 5S Auditors Should Examine

- Do the Top and Middle managers support 5S program?
- Are people proud of their workplaces?
- Are workplaces clean and organized?
- Are workplaces safe for people to work in?
- Are machines and equipment clean and well maintained?
- Are items easy to retrieve?
- Are machines and tools conveniently located?
- Are inventories stored for FIFO retrieval?
- Are products free from dust?
- Do people clean daily without prompting?
- Are the uniforms worn by people clean and tidy?
- Is a good image of the enterprise reflected in its people?

Learning Guide for Standardize and Sustain II Version: 1	Date: September, 2109	Page 117 of 41
	Author: Federal TVET Agency	



DEVELOP 5S EVALUATION STICKERS

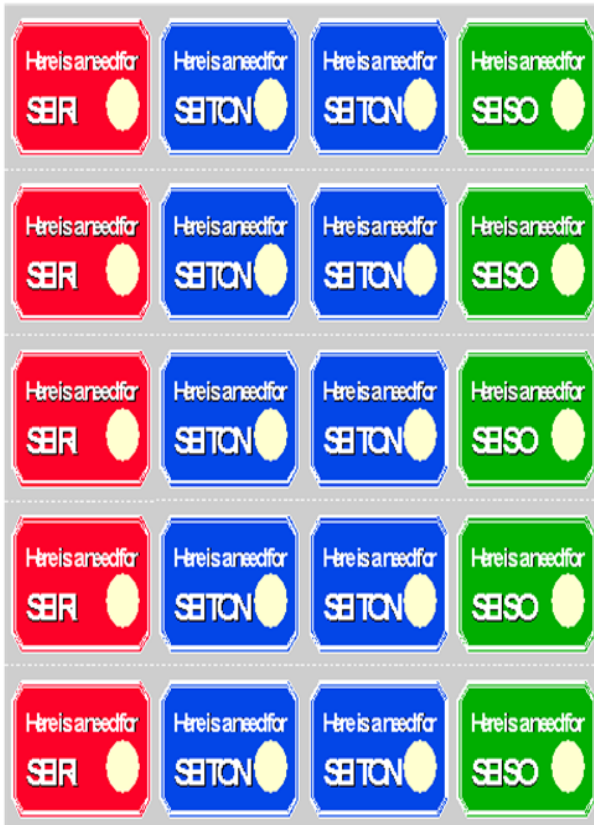



Develop 5S Evaluation Criteria & Guidelines

1. Set up audit checklist criteria according to area of 5S team

ASPECTS	N O	AUDITED ASPECT	SCORE					REMARKS
			5	4	3	2	1	
FLOOR	1	NO DUST ON THE FLOOR						
	2							
	3							
EQUIPMENTS ARRANGEMENT	4	TIDY AND WELL ARRANGED						
	5							
	6							
EQUIPMENTS AND TOOLS	7	IN GOOD CONDITION AND BEING USED						
	8							
	9							



2. Set-up “Audit Summary Report”

Audit Area : Group 5S
Date:

No	Areas of Audit	Improvement Needed			Contoh Cemerlang	Situation During Audit	Proposed Enhancement
		Sort	Set In Order	Shine			

Auditor: a)

Signature:

b)

Signature:



CRITERIA FOR 5S AUDIT RATING

RATING ACCORDING TO SCALE 1 TO 5

Evaluation Scale	5S Practice	5S Theory	Data/Fact
1 (0 - 30 %)	<ul style="list-style-type: none"> Nothing at all and no sense of commitment. Not doing 5S at all. 	<ul style="list-style-type: none"> No knowledge and cannot explain. 	<ul style="list-style-type: none"> No data. No improvement effort.
2 (31 - 50 %)	<ul style="list-style-type: none"> Doing some but not sufficient. Doing before auditors arrival. 	<ul style="list-style-type: none"> There is a knowledge but people do not know how to practice. 	<ul style="list-style-type: none"> There is data but superficial.
3 (51 - 70 %)	<ul style="list-style-type: none"> Doing what is supposed to do but need to put more effort. 	<ul style="list-style-type: none"> Understand and have overall knowledge. 	<ul style="list-style-type: none"> Sufficient data but not in order.
4 (71 - 90 %)	<ul style="list-style-type: none"> Almost ok, but not fully completed yet or insufficient. 	<ul style="list-style-type: none"> Almost ok, but in some are need further improve. 	<ul style="list-style-type: none"> Sufficient data and in order. Able to explain.
5 (91 - 100 %)	<ul style="list-style-type: none"> There is a proper evidence of 5S. 5S culture can be seen. 	<ul style="list-style-type: none"> Completely YES 	<ul style="list-style-type: none"> Orderly stratified data. Can show and answer immediately Visual Control is functional.



Awarding System

- Awarding for 5S promotion results according to evaluation is recommended.

Awards may be:

- For Good performance
- Award for efforts
- Award for good Ideas
- Prize winner
 - ✓ Group
 - ✓ Individual

Big Cleaning Day

It is a cleaning that carried out from two to four hours by the organization.

Example: Before national holidays

Patrolling System

- Top management Patrol
 - Check Up the activities Comprehensively
 - Give emphasis on sustaining of the activity
 - consider committees feedback
- 5S Committee members and Promotion office Patrol
 - Evaluate “5S Check List”
 - Record problems on”5S check findings”
 - Tack picture of 5S problems
- Mutual patrol
 - Check mutually among KPT
- Self patrol
 - 5S leader and members check the results of activity by themselves.
- Checklist patrol
 - Point out the problems by themselves at site as well as evaluate the results and encourage members to urge KAIZEN.

Learning Guide for Standardize and Sustain II Version: 1	Date: September, 2109	Page 122 of 41
	Author: Federal TVET Agency	



- Camera patrol
 - Visibly highlight the problems and progress of the activity using photographs.



SUMMARY

The fifth pillar, sustain, means to make a habit of properly maintaining correct procedures over time. No matter how well implemented the first four pillars are, the 5S system will not work for long without a commitment to sustain it.

In your life in general, why do you commit yourself to sustain a particular course of action? Usually you do this because the rewards of keeping to the course of action are greater than the rewards of not implementing them, sustaining them through the fifth pillar should be something you take to naturally.

Unlike the first four pillars, the sustain pillar cannot be implemented by a set of techniques, nor can it be measured. However, you and your company can create conditions or structures that will help sustain the commitment to 5S implementation.

To sustain 5S activities in your company, both you and the company management have important roles to play. Part of this role involves creating the conditions that sustain 5S activities. The other part involves demonstrating that you are committed to sustain these activities, too. Some of the tools to help sustain 5S activities in your company include: 5S Slogans, 5S Posters, 5S Photo Exhibits and Storyboards, 5S Newsletters, 5S Months, 5S Pocket Manuals, 5S Department Tours, 5S Maps, and 5S Audit

Learning Guide for Standardize and Sustain II Version: 1	Date: September, 2109	Page 124 of 41
	Author: Federal TVET Agency	



Self-Check 2

Written Test

Directions: Answer all the questions listed below. Use the Answer sheet provided in the next page:

1. What are the common tools and techniques to sustain 3S? (13 points)
2. How 5S slogans are used to sustain 3S? (2 points)
3. Why 5S photo exhibits and storyboards are used to implement sustain activities (3 points)
4. Describe 5S newsletters? (2 points)
5. What are the 5S pocket manuals? (3 points)
6. How 5S months are scheduled? (3 points)
7. Describe 5S audit. (4 points)
8. What are the activities performed during preparation of audit and during audit (4 points)
9. Why awarding is necessary in sustain implementation? (2 points)
10. List types of patrolling system. (6 points)

Note: Satisfactory rating - 22 points Unsatisfactory - below 22 points
You can ask you trainer for the copy of the correct answers.

Learning Guide for Standardize and Sustain II Version: 1	Date: September, 2109	Page 125 of 41
	Author: Federal TVET Agency	



Answer Sheet

Score = _____

Rating: _____

Name: _____

Date: _____

1. _____

2. _____

3. _____

4. _____

5. _____



6.

7.

8.

9.

10.



Learning Guide for Standardize and Sustain II Version: 1	Date: September, 2109	Page 128 of 41
	Author: Federal TVET Agency	



Operation Sheet 1

Procedures in Implementing Sustain

Sequence of Sustain

6. Planning
 - Set schedules for sustaining techniques
7. Prepare sustaining Tools and Techniques
8. Implement sustaining activities
9. Feedback comments on the sustain results



LAP Test	Practical Demonstration
-----------------	--------------------------------

Name: _____ Date: _____

Time started: _____ Time finished: _____

Instructions: Given necessary templates, workshop, tools and materials you are required to perform the following tasks within ----- hours.

Task 1: Prepare slogans and posters for your work area.

Task 2: Evaluate your work place by using the 5S check list and use stickers.

Task 3: Prepare audit summary report by using the given template.

• identify the:

- person -in-charge
- technology workshop
- work station

• consider the:

- OHS procedures
- workplace procedures and standards (work area)
- frequency of maintenance activities

Learning Guide for Standardize and Sustain II Version: 1	Date: September, 2109	Page 130 of 41
	Author: Federal TVET Agency	



List of Reference Materials

- 5S for operators (1995)
- Journals/publications/magazines
- Reference Book
- Job specifications
- Safety Manual and Guide
- Learning Guide #3