



# Ethiopian TVET-System



## **Basic Biomedical Equipment Servicing Level II**

Based on May 2011 Occupational Standards

October, 2019



**Module Title: Installing simple biomedical equipment's**

**TTLM Code: EEL BES2 TTLM 0919v1**

**This module includes the following Learning Guides**

**LG14: Interpret work instructions procedures**

**LG Code: EEL BES2 M05 LO1-LG-14**

**LG15: Install simple biomedical equipment and accessories**

**LG Code: EEL BES2 M04 LO2-LG-15**

**LG16: Test installed equipment and accessories**

**LG Code: EEL BES2 M04 LO3-LG-16**



<b>Instruction Sheet</b>	<b>LG14: Interpret work instructions procedures</b>
--------------------------	---

This learning guide is developed to provide you the necessary information regarding the following content coverage and topics –

- Reading and interpreting work instructions
- Selecting tools and testing devices
- Obtaining materials necessary to complete the work

This guide will also assist you to attain the learning outcome stated in the cover page. Specifically, upon completion of this Learning Guide, you will be able to –

- Read and interpret work instructions
- Select tools and testing devices
- Obtain materials necessary to complete the work

**Learning Instructions:**

1. Read the specific objectives of this Learning Guide.
2. Follow the instructions described below 3 to 6.
3. Read the information written in the information “Sheet 1, Sheet 2 and Sheet 3”.
4. Accomplish the “Self-check 1, Self-check 2 and Self-check 3” **in page - 7, 20 and 29** respectively.
5. If you earned a satisfactory evaluation from the “Self-check” proceed to “Operation Sheet 1 and Operation Sheet 2” **in page -31**.
6. Do the “LAP test” **in page – 32** (if you are ready).



### 1.1 Read and interpret work instructions

Installing a safe electrical system begins with a well-planned electrical drawing. Construction projects require work drawings and specifications to guide electricians in installing electrical equipment. Besides being a customer requirement, these plans and drawings provide specific instruction to electricians. Standard symbols and lines are used to represent the different types of material, raceways, conduits, and circuit connections. Reading and interpreting these drawings accurately is therefore an important skill for electricians. This free online course will introduce the learner to some basic electrical drawings. Going a step further, the course also describes the equipment and tools that enable an electrician to test and maintain the installations. Such test equipment includes an ammeter, a galvanometer and a multimeter. Related topics on how a moving-coil meter operates and how to select a meter are also covered. This free course will be of interest to professionals in the areas of construction, electronics and engineering who would like a greater knowledge and understanding of electrical drawings and test equipment.

#### I. Planning & preparing installation activities

Before you begin a project, understand how to shut off power and know how to test that power is off. This section describes the tools and supplies needed for electrical projects. Another section on this site, "Checking Your Electrical System," helps you understand your electrical system -- and spot problems that may need attention. "Basic Techniques" shows how to strip wires, splice wires, and join wires to terminals -- essential skills for safe, secure, and reliable electrical connections. Sections on "Repairs," "Switches & Receptacles," and "Lights & Fans" guide you through basic repairs and upgrades. "Planning New Electrical Service" introduces you to the important preliminary steps for more complex and demanding wiring projects. It also explains how to work with a local building department to ensure that your project meets electrical safety code.

Help extending or adding circuits begins with "Installing Cable & Boxes." The next two sections show specific projects: "Installing New Fixtures" and "Installing Fans & Heaters." The final sections deal with household communication and security, outdoor wiring, and how to connect appliances and new circuits.

Each project includes a list of the tools and materials you'll need and a description of the skills you'll use.



## II. Put your plans on paper

The first step is to make rough drawings that depict the lighting and electrical service you want to achieve. Find typical electrical systems for a kitchen, a bathroom, and a utility room. Installations vary; these pages serve as a guide to help calculate how many circuits of which amperages are needed. Start planning cable runs that can be routed with minimal damage to the walls.

Next determine whether your existing service can support new electrical lines. You may be able to connect to existing circuits. If not you need to add a circuit or two to your existing service panel or install a subpanel or service panel.

## III. Why codes count

The importance of building safety codes can't be overemphasized. First, codes protect everyone in your home from shock and fire. Second, they provide common ground for everyone who works on electrical systems. When someone else works on your home's wiring after you, he or she can understand the system

## IV. Checking and obtaining apparatus Precautions before checking

1. Before testing begins it is essential to establish that the test device including all Leads, probes and connectors is suitably rated for the voltages and currents which May be present on the system under test.
2. **Before any checking is carried out ensure that:**
  - (a). the equipment which is to be worked on is safe for the intended tests; and
  - (b) . The working environment does not present additional dangers. These dangers

Include:

- inadequate space to work safely;
- An insecure footing;
- Insufficient light;
- Potentially flammable gases or vapors;
- explosive or conductive dusts

## V. CHECKING YOUR ELECTRICAL Apparatus IS SAFE

CHECK apparatus DAILY

Damaged or faulty equipment may be unsafe. Many electrical risks can be controlled when you carry out these simple checks every day:

Page 5 of 154	Federal TVET Agency Author/Copyright	TVET program title: Basic Biomedical Equipment Servicing L- II	Version -1 October 2019
---------------	---	---	----------------------------



## EVERY DAY

1. Check that all electrical apparatus is RCD-protected.  
RCD = residual current device
2. Test RCDs using the test button, including RCDs on PSOAs.  
PSOA = portable socket-outlet assembly
3. Look at the general condition of electrical equipment (including cords and leads) before use.
4. Check for visible signs of damage or faults.
5. Make sure that equipment operates the way it's supposed to (eg that the trigger switch On a drill responds to pressure)
6. Check that suitable PPE is being used, along with other controls.  
PPE = personal protective equipment
7. Make sure that leads and cords are arranged, used and stored safely.
8. Check equipment is protected from weather and other environmental hazards.

**Immediately disconnect and remove faulty or damaged equipment. This includes equipment that:**

1. Has given someone a shock
2. Fails testing or inspection
3. Repeatedly blows a fuse or trips a circuit breaker or RCD.

### **1.1.1. Electrical cabling and wiring devices of correct loading**

#### **1.1.1.1 Wires and cables**

Wire and cables are used to conduct electric power from the generated point to the point where it is used. Copper is the material used as conductor in practically all case cables consists of conductors, insulators and sometimes mechanical protectors. The conductor is generally in the form of either a single core or two-core or three-core or multicore.

***Types of wires and cables***; the range of types of cables used in electrical work is very wide: from heavy lead-sheathed and armoured paper-insulated cables to the domestic flexible cable. Some examples of different cables are shown in figure. The practical electrician will meet two common types of cables used in his work. This type shown in the following table.

Page 6 of 154	Federal TVET Agency Author/Copyright	TVET program title: Basic Biomedical Equipment Servicing L- II	Version -1 October 2019
---------------	---	---	----------------------------



<i>Cables</i>	<i>Applications</i>
<p><b>a) Flexible cables ( flexible cord )</b></p> <p>1- P.V.C insulated single core wire.</p> <p>2- Tow core or (twin ) cable. ( two single isulated-stranded wire ).</p> <p>3- Three core ( twisted ).</p>	Domestic and industrial work.
<p><b>b) Sheathed cables</b></p> <p>1- P.V.C sheathed cables.</p> <p>2- Tough rubber sheathed cables ( TRS ).</p> <p>3- Lead alloy P.V.C sheathed ( LAS ).</p> <p>4- P.C.P ( polychloroprene sheathed cable ).</p>	Domestic and industrial wiring.

**Cable Size** The cable size is classified according to current rating, where the rating is defined as: "cable rating" is the amount of current it can be allowed to carry continuously without deterioration.

The basic factor to be considered when selecting the size of a cable is the current of the circuit. Many factors govern the rating of cable:

- Conductor cross-sectional area
- Type of insulation
- Ambient temperature
- Type of protection
- Grouping
- Disposition
- Type of sheath

Also, the current rating of a final sub circuit depends upon the actual connected load. The cable selected to supply this load must be able to withstand at least the rating current absorbed by the load without undue heating.

This rating current is obtained by calculation depending on the nature of the circuit, the power absorbed by the load and the supply voltage. The current is sometimes called the design current, and used to select the size of cable.

**Self-Check -1****Written Test**

**Directions:** Answer all the questions listed below. Use the Answer sheet provided in the next page:

**Part 1. Chose the correct answer**

1. Which one of the following is basic factor to be considered when selecting the size of a cable is the current of the circuit?
  - A. Conductor cross-sectional area
  - B. Type of insulation
  - C. Ambient temperature
  - D. All
2. One of the following is the most common insulator for cables
  - A. Copper
  - B. PVC
  - C. Rubber
  - D. None
3. Cable size is classified according to.....
  - A. Current rating
  - B. Frequency of the supply
  - C. Signal type
  - D. Voltage level
4. Which one of the following are the dangers of working environment?
  - A. inadequate space to work safely
  - B. An insecure footing
  - C. Insufficient light
  - D. all
5. Which one of the following the correct steps of installation activity?
  - A. Planning, preparing and installing
  - B. Preparing, planning and installing
  - C. Planning, installing and preparing
  - D. None

**Note: Satisfactory rating - 3 and 5 point Unsatisfactory - below 3 and 5 points**

You can ask you teacher for the copy of the correct answers.





## Answer Sheet

Score = \_\_\_\_\_

Rating: \_\_\_\_\_

### Part 1. Multiple Chose question

1. ....
2. ....
3. ....
4. ....
5. ....

Name: \_\_\_\_\_

Date: \_\_\_\_\_

### Short Answer Questions

<b>Information Sheet-2</b>	<b>Selecting tools and testing devices</b>
----------------------------	--

Page <b>9</b> of <b>154</b>	Federal TVET Agency Author/Copyright	TVET program title: Basic Biomedical Equipment Servicing L- II	Version -1 October 2019
-----------------------------	---	---	----------------------------



## 2.1 Select tools and testing devices

A tool is any instrument used in doing work. A hand tool is any tool operated by hand to do work. A power tool is operated by some source of power other than human power.

### 2.1.1 Tool Habits

There are good tool habits which will help you perform your work more efficiently as well as safely. A place for everything and everything in its place” is just common sense.

You cannot do an efficient, fast repair job if you have to stop and look around for each tool that you need. The following rules, if applied, will make your job easier. Keep each tool in its proper storage place. A tool is useless if you cannot find it. If you return each tool to its proper place, you will know where it is when you need it. **Keep your tools in good condition.** Keep them free of rust, nicks, burrs, and breaks. **Keep your tool set complete.** If you are issued a tool box, each tool should be placed in it when not in use. **use each tool only on the job for which it was designed.** If you use the wrong tool to make an adjustment, the result will probably be unsatisfactory. **Keep your tools where you easy reach and where they cannot fall on the floor or on machine.** Avoid placing tools anywhere above machinery or electrical apparatus. Serious damage will result if the tool falls into the machinery after the equipment is turned on or running

### Screw driver

Is a tool designed to loosen or tighten screws. Screwdrivers are available in many different shapes, sizes, and materials. Screwdrivers are used for driving or removing screws or with slotted or special heads.

### Slot-Head or standard Screw driver

Is designed for use on screws with slotted heads. This type of screw is often used on the terminals of switches, receptacles, and lamp holders.



### Phillips screwdriver

Is designed for use on screws with an X-shaped insert in their heads.



## PLIERS

Pliers are used to cut and shape electric conductors and to grip a variety of objects.

This has caused many types of pliers to be developed.

**Needle-nose pliers** Forming loops on small conductors Cutting and stripping small conductors

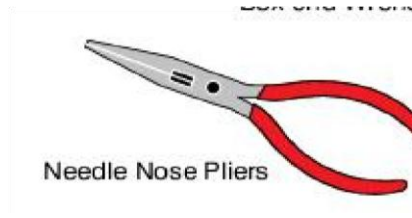

**Diagonal pliers (dykes)** Cutting small conductors

Cutting conductors in limited space



Wire strippers

Pulling and holding



large conductors

Stripping insulation from conductors  
Cutting small conductors



Crimping wire lugs

## Wrench

(side cutters)

Cutting large conductors Forming loops on large conductors

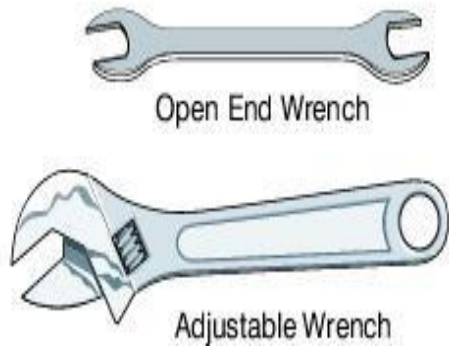

A wrench is a tool specially designed to tighten or loosen nuts, bolts, studs, and pipes. Wrenches are made from steel alloy to prevent breakage.

There are many different types of wrenches. Each type has its own use. By using the proper wrench for the task to be done, you will not break the wrench, damage the equipment, or cause personal injury.

#### HEX KEY WRENCH (or ALLEN KEY)

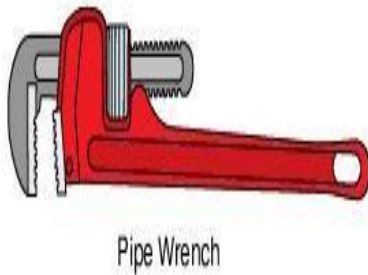

- A. Double open end wrench
- B. Double boxed end wrench
- C. Combination wrench

### 2.1.2 Testing devices

There are many kinds of instrument used for the measurement of electrical/electronic quantities.

For experimental work in the lab, individual voltmeters to measure voltage, ammeters to measure current, and ohmmeters to measure resistance are sometimes used. More often, a single multimeter is usually used to accurately measure voltage, current, or resistance

#### What is a Multimeter?

Multimeter is a device used to measure voltage, resistance and current in electronics & electrical equipment. It is also used to test continuity between 2 points to verify if there is any breaks in circuit or line.

There are two types of multimeter Analog & Digital

- Analog has a needle style gauge
- Digital has a LCD display

EEL BES2	Version:01	Page No.12
	Copyright: Ethiopia Federal TVET Agency	



There are two styles of multimeters

### Switched

Manually switch between ranges to get most accurate reading.

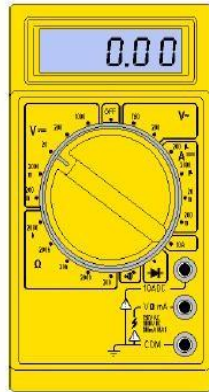

### Auto Range

Switches between ranges automatically for best reading.



Both of these styles work the same

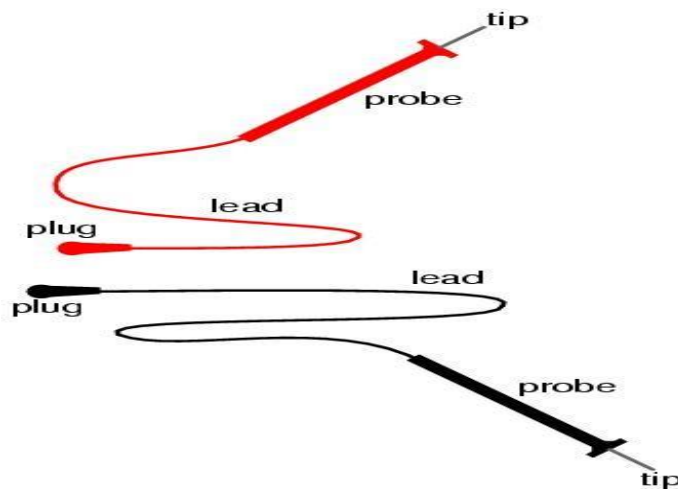

Red meter lead is connected to Voltage/Resistance or amperage port Is considered the positive connection.

Black meter lead is always connected to the common port. Is considered the negative connection

Probes are the handles used to hold tip on the tested connection. Tips Are at the end of the probe and provides a connection point.

EEL BES2	Version:01	Page No.13
	Copyright: Ethiopia Federal TVET Agency	



## Display & Dial Settings

- **Digital Display**  
Shows measured value.

- **Meter Dial**  
Turn dial to change functions.  
Turn dial to OFF position after use.

- **Panel Indicator**  
Shows each function and setting range to turn dial to.

- **Probe Connections**  
Specific for each function.

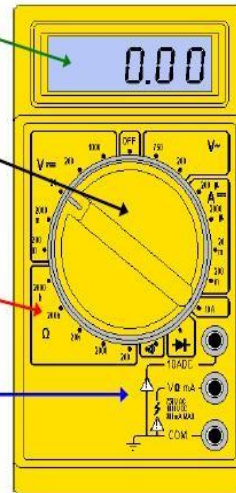

## Measuring Voltage using multimeter

Voltage (V) is the unit of electrical pressure; one volt is the potential difference needed to cause one amp of current to pass through one ohm of resistance. Voltage is broke up into 2 sections AC & DC Alternating Current (AC) is house voltage (110vac) Direct Current (DC) is battery voltage (12vdc) On switched meters use one value higher than your expected value

To measure voltage connects the leads in parallel between the two points where the measurement is to be made.

The multimeter provides a parallel pathway so it needs to be of a high resistance to allow as little current flow through it as possible.

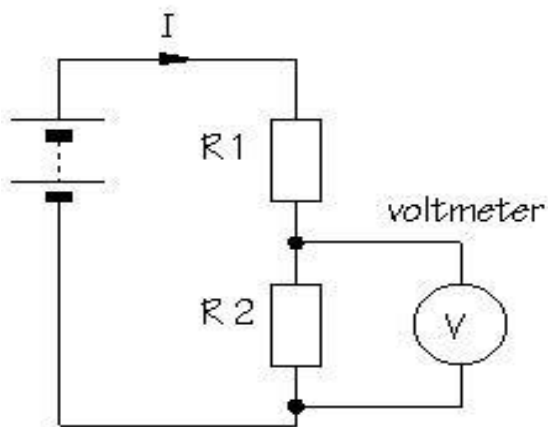

EEL BES2	Version:01	Page No.14
	Copyright: Ethiopia Federal TVET Agency	



## Measuring Resistance and Continuity

Resistance (R) is the opposition to current flow. Resistance is measured in Ohm's. Disconnect power source before testing. Remove component or part from system before testing. Measure using lowest value, if OL move to next level. Testing for continuity is used to test to verify if a circuit, wire or fuse is complete with no open. Audible continuity allows an alarm if circuit is complete. If there is no audible alarm resistance of 1ohm to .1ohm should be present.

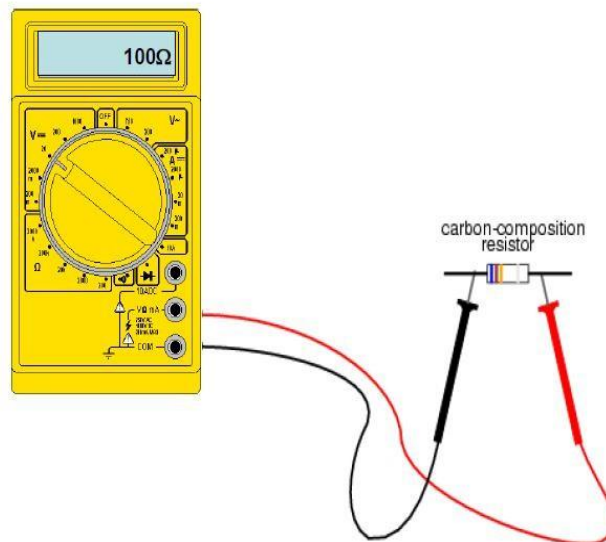

Figure: Measuring Resistance

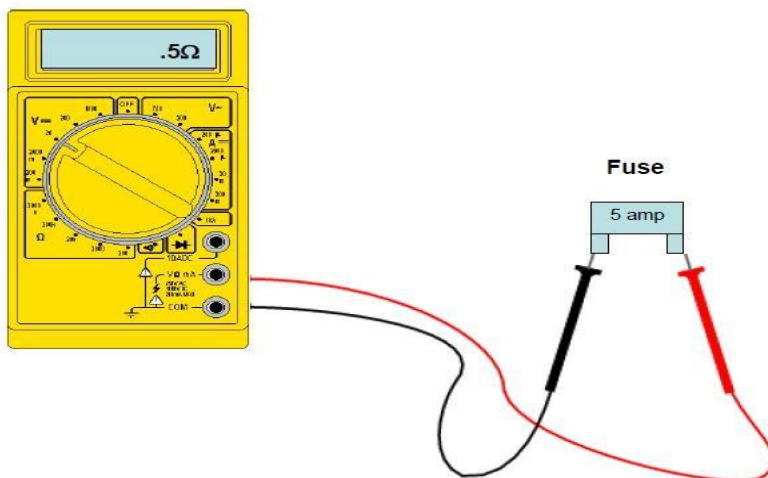

Figure: Measuring or Testing Continuity

## Measuring Current

Current (amps) is the flow of electrical charge through a component or conductor. Current is measured in amps or amperes. Disconnect power source before testing. Disconnect completed circuit at end of circuit. Place multimeter in series with circuit. Reconnect power source and turn ON. Select highest current setting and work your way down.

EEL BES2	Version:01	Page No.15
	Copyright: Ethiopia Federal TVET Agency	

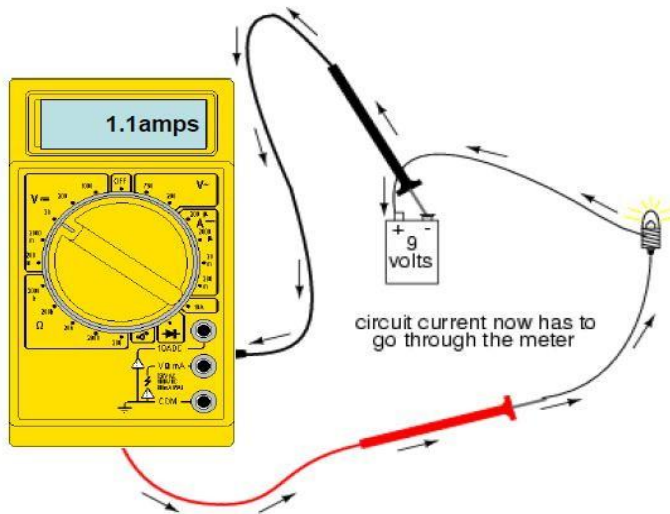
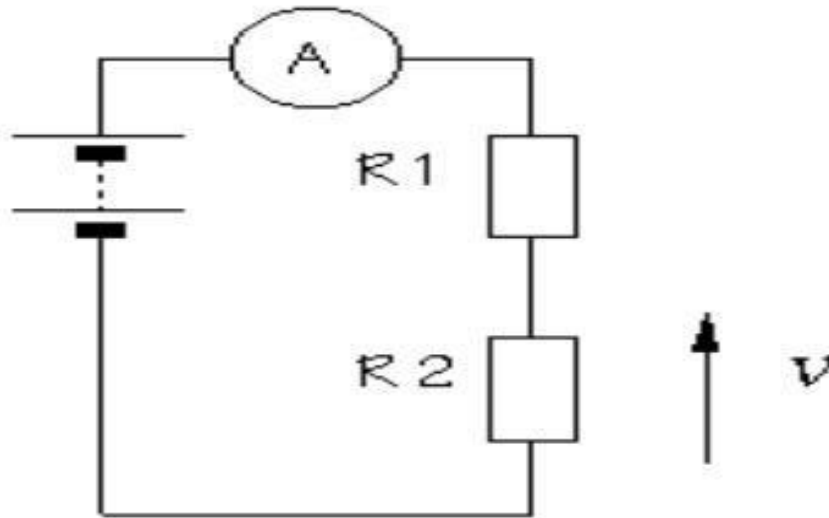

Figure: Measuring Current

## Oscilloscope

An oscilloscope, or scope for short, is an electronic test instrument that is used to observe an electronic signal, typically voltage, as a function of time. In other words it is a voltage versus time plotter. Oscilloscopes come in two basic types, analogue or digital, and support various features and functions useful for measuring and testing electronic circuits. An oscilloscope is a key piece of test equipment for any electronics designer.

### Parts of an Oscilloscope

Internally, an oscilloscope is a fairly complex piece of electronic equipment. Fortunately, its operation is simplified through the use of various features and knowing its internal workings is not key to its use.

EEL BES2	Version:01	Page No.16
	Copyright: Ethiopia Federal TVET Agency	



Despite this, as a good designer, it is important to understand the correct operation of test equipment and any affect it may have on the circuit under test

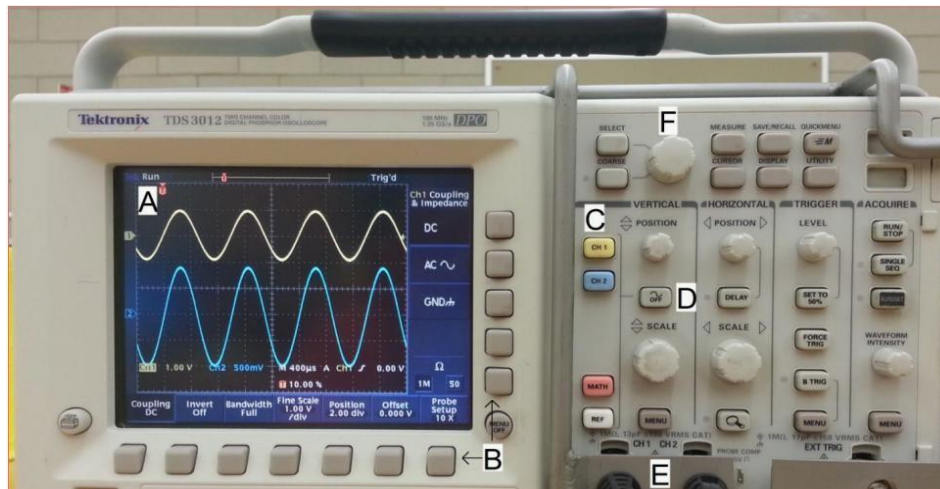

Figure . Oscilloscope features.

- a. **Display:** The main feature of an oscilloscope is its display (Figure 1 A). Analogue versions of oscilloscopes use Cathode Ray Tube (CRT) displays, while digital scopes use LCD (or similar) screens.
- b. **Probes:** The voltage signals that are to be measured must be transferred to the oscilloscope. This is done using oscilloscope probes. Probes are specially designed to minimize noise and interference, while also creating a known load effect on the circuit (so it can be accounted for). Some probes also have protective features to prevent any damage a signal may cause to the oscilloscope (such as overvoltage)



Figure 2. Oscilloscope probe.

Probes, through a cable, are attached to the channel inputs (Figure 1 E) on the oscilloscope using a connector (usually a BNC). The probing end can consist of either a



sharp point (Figure 2 Probe Tip), which can be held against a pin, pad, or other conductor, or a small clip (Figure 2 Attachable Probe Clip), convenient for attaching the probe to a wire or other small circuit feature. In addition, a grounding clip (Figure 2 Probe Ground Clip) is located at the end of a small wire on the probe. The grounding clip is connected, through the oscilloscope, to chassis (hydro) ground (in other words, the clip is always at the reference voltage and cannot be used to measure signals), and should be attached to the ground or common signal of the circuit to be measured. Note the probe is relatively heavy and can generally NOT be supported by the circuit features it may be attached to. Take care when attaching clips.

**a. Channels ;**An oscilloscope channel generally refers to the input (Figure 1 E) of a signal (kind of like tuning in a TV channel, except that you can see more than one channel at a time on a scope). It can also refer to the path of the signal through the oscilloscope. An oscilloscope can have 1 or more channels, and it is common to have 2 or 4. Having multiple channels allows for the simultaneous measurement of multiple signals, making comparisons and other functions easier. Each channel typically has its own set of controls or a common set that is toggled. Channel waveforms can be removed from the display using the Off button (Figure 1 D).

**b. Controls:** The controls of an oscilloscope can be used to adjust almost any aspect of the scope from display parameters to advanced mathematical functions. The controls themselves consist of dials, toggles, buttons, and switches as seen in Figure 1.

### Horizontal and Vertical Scaling and Positioning

The vertical (y) axis of the graticule represents the voltage being measured. The horizontal (x) axis represents time. Each axis is measured in a grid, whose physical spacing is typically 1cm squares, but represents units of voltage and time. These units can be scaled using the dials labeled 'Scale' as seen in Figure 1. In addition, the horizontal and vertical position of a signal can be adjusted using the 'Position' dials as seen in Figure 1.

The current grid scale and position is displayed over the graticule (or beneath it if the context menu is off). In addition, the zero position of each channel is indicated by the numbered marker on the left of the graticule. Note that each channel can have a different vertical scale and position, but all channels share the same horizontal scale and position. To adjust a waveform, it is first selected using the channel select buttons (Figure 1C), and then changed via the appropriate dial (note, some context menu items also require the correct channel to be selected).

### Signal Generator

EEL BES2	Version:01	Page No.18
	Copyright: Ethiopia Federal TVET Agency	



The signal generator is exactly what its name implies: a generator of signals used as a stimulus for electronic measurements. Most circuits require some type of input signal whose amplitude varies over time. The signal may be a true bipolar AC1 signal (with peaks oscillating above and below a ground reference point) or it may vary over a range of DC offset voltages, either positive or negative. It may be a sine wave or other analog function, a digital pulse, a binary pattern or a purely arbitrary wave shape.

The signal generator can provide “ideal” waveforms or it may add known, repeatable amounts and types of distortion (or errors) to the signal it delivers. See Figure 2. This characteristic is one of the signal generator’s greatest virtues, since it is often impossible to create predictable distortion exactly when and where it’s needed using only the circuit itself. The response of the DUT in the presence of these distorted signals reveals its ability to handle stresses that fall outside the normal performance envelope

### Waveform Characteristics

Wave forms have many characteristics but their key properties pertain to amplitude, frequency, and phase:

**Amplitude:** A measure of the voltage “strength” of the waveform. Amplitude is constantly changing in an AC signal. Signal generators allow you to set a voltage range, for example, —3 to +3 volts. This will produce a signal that fluctuates between the two voltage values, with the rate of change dependent upon both the wave shape and the frequency.

**Frequency:** The rate at which full waveform cycles occur. Frequency is measured in Hertz (Hz), formerly known as cycles per second. Frequency is inversely related to the period (or wavelength) of the waveform, which is a measure of the distance between two similar peaks on adjacent waves. Higher frequencies have shorter periods.

**Phase:** In theory, the placement of a waveform cycle relative to a 0 degree point. In practice, phase is the time placement of a cycle relative to a reference waveform or point in time

EEL BES2	Version:01	Page No.19
	Copyright: Ethiopia Federal TVET Agency	

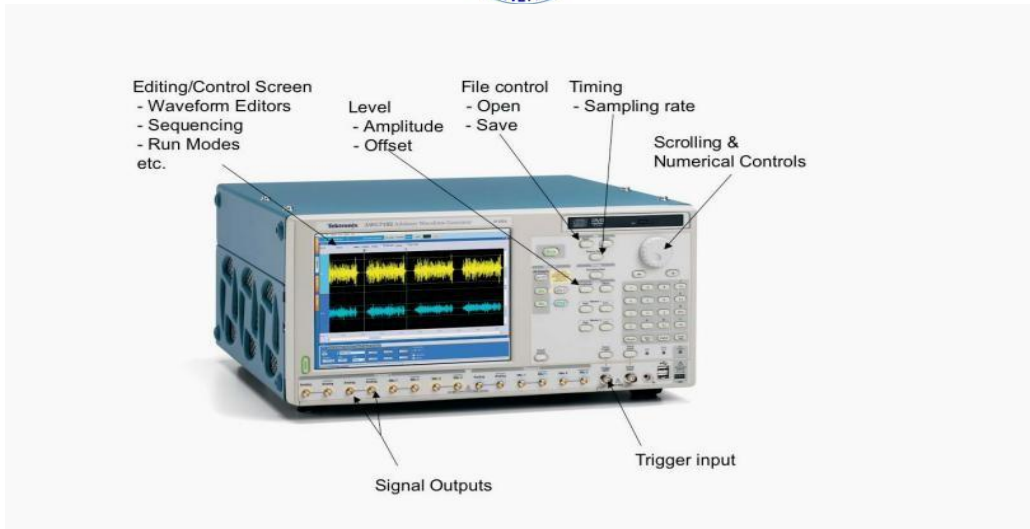

**Calibrators:** A calibrator is equipment used to adjust instrument accuracy, often associated with a specific application.

**Tachometer:** A tachometer is optical measurement equipment. It needs to 'see' the rotating object.



**Oxygen analyzer:** Analyzing the oxygen content in breathing machine, anesthesia machine, infant incubator and concentrator machine.



EEL BES2	Version:01	Page No.20
	Copyright: Ethiopia Federal TVET Agency	



<b>Self-Check -2</b>	<b>Written Test</b>
----------------------	---------------------

**Directions:** Answer all the questions listed below. Use the Answer sheet provided in the next page:

**Part1 Chose the correct answer for the following Questions**

1. .... Is an electronic test instrument that is used to observe an electronic signal?
 

A. Multimeter	C. Oscilloscope
B. Signal generator	D. Tachometer
2. Which one of the following are used for the measurement of electrical/electronic quantities?
 

A. Oscilloscope	C. Tachometer
B. Signal generator	D. Multimeter
3. A single Multimeter is usually used to accurately measure.....
 

A. Voltage	C. Current
B. Resistance	D. All
4. .... Is designed for use on screws with an X-shaped insert in their heads.
 

A. Phillips screwdriver	C. Plier
B. Slot-head screwdriver	D. None
5. The key properties of Waveform Characteristics are.....
 

A. Amplitude	C. Phase
B. Frequency	D. All

**Part 2 Machining Question**

Column A	Column B
1. Tachometer	A) Transfer voltage signals to the oscilloscope
2. To measure voltage	B) Cutting conductors in limited space
3. Probe	C) Measure speed
4. Oxygen analyzer	D) Connects the leads in parallel
5. Diagonal pliers	E) Analyzing the oxygen content

**Note: Satisfactory rating - 3 points**

**Unsatisfactory - below 3 points**

You can ask you teacher for the copy of the correct answers.

EEL BES2	Version:01	Page No.21
	Copyright: Ethiopia Federal TVET Agency	



## Answer Sheet

Score = \_\_\_\_\_

Rating: \_\_\_\_\_

### Part 1 Multiple chose question

1. ....
2. ....
3. ....
4. ....
5. ....

### Part 2 Matching question

1. ....
2. ....
3. ....
4. ....
5. ....

Name: \_\_\_\_\_

Date: \_\_\_\_\_

### Short Answer Questions

EEL BES2	Version:01	Page No.22
	Copyright: Ethiopia Federal TVET Agency	



<b>Information Sheet-3</b>	<b>Obtaining materials necessary to complete the work</b>
----------------------------	---

### 3.1 Obtain materials necessary to complete the work

#### • Insulation Tape (assorted)

**Electrical tape** (or **insulating tape**) is a type of pressure-sensitive tape used to insulate electrical wires and other materials that conduct electricity. It can be made of many plastics, but vinyl is most popular, as it stretches well and gives an effective and long lasting insulation. Electrical tape for class H insulation is made of fiberglass cloth.

#### A selection of color-coded electrical tapes

A wide variety of electrical tapes is available; some for highly specialized purposes. "The primary tapes used in electrical applications are vinyl, rubber, mastic, and varnished cambric. Electricians generally use only black tape for insulation purposes. The other colors are used to indicate the voltage level and phase of the wire. (In fact, the colored tape is referred to as "phasing tape.") This is done on large wire which is available only in black insulation. When wires are phased, a ring of tape is placed on each end near the termination so that the purpose of the wire is obvious. The following table(s) describes the use of electrical tape.

Tape color	Usage (U.S.)	Usage (U.K.)	Usage (International – new)
Black	Insulation Low voltage, phase A	Insulation Low voltage	Low voltage, phase B
Red	Low voltage, phase B	Low voltage, phase A	Sheath, 415 V 3 phase
Blue	Low voltage, phase C	Low voltage, phase C	Low voltage, neutral Sheath, 230 V
Brown	High voltage, phase A		Low voltage, phase A
Orange	High voltage, phase B		Sheath, garden tools
Yellow	High voltage, phase C	Low voltage, phase B	Sheath, 110 V site wiring

EEL BES2	Version:01	Page No.23
	Copyright: Ethiopia Federal TVET Agency	



Green	Earth ground	Earth	
Green with yellow stripe	Isolated ground		Earth
White	Low voltage, neutral		
Grey	High voltage, neutral		Low voltage, phase C



### • Sealing materials

Choosing materials is a task that often requires a lot of investigation and compromises between different desirable properties. This is often a combination between material properties and price. However, looking at the procurement price only is often very misleading, as this does not consider actual life-cycle cost for a given product.

Downtime, equipment failure and repair cost due to a faulty seal is many times higher than the cost of the seal, even in cases when some of the more expensive materials are chosen.

Seal engineering is dedicated to find the best overall sealing solutions and materials with special attention to functionality, reliability and low overall life-cycle cost.

Seals are faced with an ever increasing demand for higher pressure, temperature, functionality and longevity. This means that some of the more “traditional” materials no longer are as well suited as they used to be. Advances in material science are resulting in new and improved materials, suited to meet the increased demands.

As a consequence, both suppliers and customers are forced to evaluate their previous material selection for a given application. The following section will show some of the





advances in material technology, and give some guidelines for selecting the right material for a given application.

### **Thermoplastic elastomers**

Thermoplastic elastomers belong to the elastomer-family of materials. The elastomer-family consists of materials that can be highly expanded by exerting relatively little power. Because of their structure, elastomers have a high retractibility, which means the remaining deformation is very small.

#### **Elastomers**

Elastomers (rubbers) are materials that can be highly expanded by exerting relatively little power. Because of their structure, elastomers have a high retractibility, which means the remaining deformation is very small.

#### **PTFE-based thermoplastics**

In addition to the PTFE-based materials described below, we can manufacture seals and other details in a variety of other PTFE materials with fillers specifically suited for a given application. We have either in stock or with Other PTFE-based materials short delivery time a wide range of PTFE-based materials to offer.

#### **Oil & Gas - Elastomers**

Oil & gas elastomers are optimized for use in harsh environments.

#### **High Performance Plastics**

High Performance Plastics are more chemical resistant and have better mechanical properties than standard plastics and most Engineering Plastics.

#### **Engineering Plastics**

Engineering Plastics is a group of materials that have better mechanical and/or thermal properties than commodity plastics. Seal Engineering has a wide range of such materials on stock.

### **Cables and Wires**

The terms wire and cable are used more or less synonymously in house wiring. Strictly speaking, single wire, may be or covered with insulation is known as a wire and several wires stranded together are termed as wire and conductors covered with insulation are termed as cables.

The necessary requirements of a cable are that it should conduct electricity efficiently, cheaply and safely. This should neither be so small so as to have a large internal voltage drop nor be too large so as to cost too much. Its insulation should be such as to prevent leakage of current in unwanted direction and minimize risk of fire and shock

A cable consists of three parts:

1. The conductor or core: the metal wire or strand of wires carrying the current.

EEL BES2	Version:01	Page No.25
	Copyright: Ethiopia Federal TVET Agency	



2. The insulation or dielectric; a covering of insulating material to avoid leakage current from the conductor.
3. The protective covering for protection of insulation from mechanical damage.

### **Conductor materials used in cables**

Copper and aluminum are the materials used as conductors in power and lighting cables.

1. Copper. Though silver is the best conductor but due to its higher cost it is hardly used anywhere. The next best conductor is, copper. It is cheaper comparatively.
2. Aluminum. Aluminum is frequently used in place of copper for bare electric cables used for long distance power distribution.

The only application of aluminum cable for wiring in buildings is for a continuous bus-bar system of distribution, used sometimes in blocks of flats or office buildings for rising mains and sub-mains of larger sectional area.

#### • **Cables**

General specification of cables: The complete specification of a cable will give the following information:

- i The size of the cable
- ii The type of conductor used in cables (copper or aluminum)
- iii Number of coarse that the cable consists of (i.e. single core, twin core, three cores, twin core with ECC etc.
- iv Voltage grade
- v Type of insulation, taping, braiding and compounding

#### • **Wires**

A wire is a single, usually cylindrical, flexible strand or rod of metal. Wires are used to bear mechanical loads or electricity and telecommunications signals. Wire is commonly formed by drawing the metal through a hole in a die or draw plate. Wire gauges come in various standard sizes, as expressed in terms of a gauge number. The term wire is also used more loosely to refer to a bundle of such strands, as in "multistranded wire", which is more correctly termed a wire rope in mechanics, or a cable in electricity.

Wire comes in solid core, stranded, or braided forms. Although usually circular in cross-section, wire can be made in square, hexagonal, flattened rectangular, or other cross-sections, either for decorative purposes, or for technical purposes such as high-efficiency voice coils in loudspeakers. Edge-wound coil springs, such as the Slinky toy, are made of special flattened wire.

### **Types of Wire:**

All electrical engineers must know about wires and think about using the right design and material for the task at hand. Here are the factors for determining wire design:

EEL BES2	Version:01	Page No.26
	Copyright: Ethiopia Federal TVET Agency	



- Durability (ability to flex repeatedly or be subject to crushing weights)
- Voltage and Current level
- Suspension strength (ability to hold its own weight over long spans between support)
- Underground or underwater
- Temperature of operation (like superconducting wire)
- Cost

### Solid Wire:



### Advantages:

- Less surface area to corrode
- Can be rigid and strong

### Disadvantages:

- Not good if flexed repeatedly, can break if flexed in the same spot
- Not practical for high voltage

### Stranded Wire:

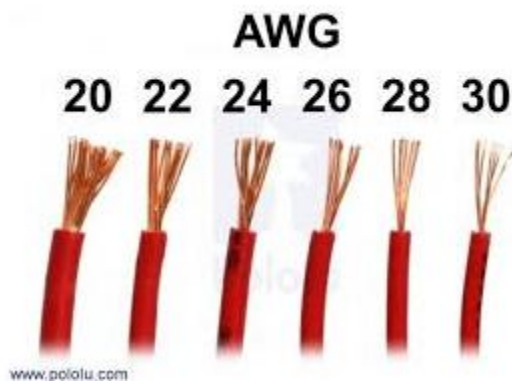

EEL BES2	Version:01	Page No.27
	Copyright: Ethiopia Federal TVET Agency	



## • Soldering Lead

Tin-lead (Sn-Pb) solders, also called soft solders, are commercially available with tin concentrations between 5% and 70% by weight. The greater the tin concentration, the greater the solder's tensile and shear strengths.

1. Has the lowest melting point (183 °C or 361 °F) of all the tin-lead alloys; and
2. The melting point is truly a *point* — not a range.

Soldering is the use of a conductive substance with a low melting point (solder) to electrically connect components together. It is frequently used to join wires to leads of components such as switches or to join components of all kinds to a printed circuit board. The primary tool used for applying solder is a **soldering iron**, a device whose metal tip heats to temperatures well above the melting point of solder. This is used to melt the solder and allow it to flow into a joint.

Soldering is an acquired skill, and it takes practice to become adept. There are many tips, tricks and guidelines on how to produce good soldered joints and this module aims to present them to you.

The first and most important rule of soldering is to choose your tools with care. Both the solder and the iron must be chosen to suit the application. The first two sections below deal with the different kinds of solder and iron and which to choose for what.



## • Wire tie

A **cable tie** (also known as a **hose tie**, or **zip tie**, and by the brand names **Ty-Rap**) is a type of fastener, for holding items together, primarily electrical cables or wires. Because of their low cost and ease of use, cable ties are ubiquitous, finding use in a wide range of other applications. Stainless steel versions, either naked or coated with a rugged plastic, cater for exterior applications and hazardous environments.

The common cable tie, normally made of nylon, has a flexible tape section with teeth that engage with a pawl in the head to form a ratchet so that as the free end of the tape

EEL BES2	Version:01	Page No.28
	Copyright: Ethiopia Federal TVET Agency	



section is pulled the cable tie tightens and does not come undone. Some ties include a tab that can be depressed to release the ratchet so that the tie can be loosened or removed, and possibly reused.

The most common cable tie consists of a flexible nylon tape with an integrated gear rack, and on one end a ratchet within a small open case. Once the pointed tip of the cable tie has been pulled through the case and past the ratchet, it is prevented from being pulled back; the resulting loop may only be pulled tighter. This allows several cables to be bound together into a cable bundle and/or to form a cable tree.

A cable tie tensioning device or tool may be used to apply a cable tie with a specific degree of tension. The tool may cut off the extra tail flush with the head in order to avoid a sharp edge which might otherwise cause injury.

In order to increase resistance to ultraviolet light in outdoor applications nylon containing a minimum of 2% carbon black is used to protect the polymer chains and extend the cable tie's service life. Blue cable ties are supplied to the food industry and contain a metal additive so they can be detected by industrial metal detectors. Cable ties made of ETFE are used in radiation-rich environments. Red cable ties made of ECTFE are used for plenum cabling.

Stainless steel cable ties are also available for flameproof applications—coated stainless ties are available to prevent galvanic attack from dissimilar metals (e.g. zinc-coated cable tray).

Plastic Cuffs are handcuffs based on the cable tie design and are used by law enforcement to restrain prisoners. Cable ties are also sometimes used to prevent hubcaps (also known as wheel trims) from falling off a moving vehicle, and some are sold specifically for this purpose.



EEL BES2	Version:01	Page No.29
	Copyright: Ethiopia Federal TVET Agency	



<b>Self-Check -3</b>	<b>Written Test</b>
----------------------	---------------------

**Directions:** Answer all the questions listed below. Use the Answer sheet provided in the next page:

1. .... is used to insulate electrical wires and other materials that conduct electricity.  
A. Wire tie  
B. Insulation Tape  
C. Soldering Lead  
D. Sealing materials
2. What is the importance of wire tie?  
A. For holding items together electrical cables or wires  
B. Insulate electrical wires  
C. Join wires  
D. All
3. Which one of the following used to limit or resist pressure?  
A. Soldering lead  
B. Wire tie  
C. Sealing materials  
D. Insulation tape
4. One of the following is not the advantage of solid wire.  
A. Less surface area to corrode  
B. Can be rigid and strong  
C. Practical for high voltage  
D. none
5. Select the Conductor materials used in cables  
A. Copper  
B. Aluminum  
C. Lead  
D. A and B

**Note: Satisfactory rating - 3 points**

**Unsatisfactory - below 3 points**

You can ask you teacher for the copy of the correct answers.

EEL BES2	Version:01	Page No.30
	Copyright: Ethiopia Federal TVET Agency	



## Answer Sheet

Score = \_\_\_\_\_

Rating: \_\_\_\_\_

### Part 1 Multiple chose question

1. ....
2. ....
3. ....
4. ....
5. ....

Name: \_\_\_\_\_

Date: \_\_\_\_\_

### Short Answer Questions

EEL BES2	Version:01	Page No.31
	Copyright: Ethiopia Federal TVET Agency	

**Operation Sheet 1****Techniques of Reading and interpreting work instructions****1.1 The techniques for Reading and interpreting work instructions are;**

**Step 1-** Review preliminary activities: check questionnaires, type of data needed, chosen Methods, resources (finance, material and time), etc.

**Step 2-** List out orderly all resource providers including governmental and non-governmental

**Step 3-** Implement the collection of information

**Step 4-** Define resource providers who are available to do the work from the list

**Step 5-** Send the completed documents to supervisor/ concerned body

**Operation Sheet 2****Techniques of Installing and testing cables and wires****Techniques for Install and test cables and wires:**

**Step 1-** Put on helmets, electrical glove ,safety shoos.

**Step 2-** Inspect tools and multimeters are available and functional. Report any problems to the instructor.

**Step 3-** Inspect specifications for cables and wire are with correct loading.

**Step 4-** Check for functionality of receptacles , switches and circuit breakers with the help of multimeter.

**Step 5-** Connect cables to the manin power distribution board with correct lines.

**Step 6-** Extend the lines in(step 5) to the room.

**Step 7-** Connect lines to the circuit breaker.

**Step 8-** Extend wire from circuit breaker to sockets/receptacles

**Step 9-** Install line to switch.

**Step 10-** Check for continuity and ground resistance with the help of multimeter by Putting on the diode symbol dial.

EEL BES2	Version:01	Page No.32
	Copyright: Ethiopia Federal TVET Agency	





<b>LAP Test</b>	<b>Practical Demonstration</b>
-----------------	--------------------------------

Name: \_\_\_\_\_ Date: \_\_\_\_\_

Time started: \_\_\_\_\_ Time finished: \_\_\_\_\_

**Instructions:** Given necessary templates, tools and materials you are required to perform the following tasks within 8-12 hours.

**Task 1:** How do you measure wallout let voltage using Multimeter?

**Task 2:** How do you measure voltage using oscilloscope?

**Task 3:** How do you check ground resistance of receptacle?

**Task 4:** How do you check oxygen purity using analyzer?

**Task 5:** What is the use of signal generator?

EEL BES2	Version:01	Page No.33
	Copyright: Ethiopia Federal TVET Agency	



This learning guide is developed to provide you the necessary information regarding the following content coverage and topics –

- Preparing Equipment and components
- Following OSH policies and procedures
- Using proper PPE according to company requirements
- Selecting electrical cabling and wiring devices:
- Installing equipment in accordance with manufacturer's instructions
- Responding unplanned events or conditions

This guide will also assist you to attain the learning outcome stated in the cover page. Specifically, upon completion of this Learning Guide, you will be able to –

- Prepare Equipment and components
- Follow OSH policies and procedures
- Use proper PPE according to company requirements
- Select electrical cabling and wiring devices:
- Install equipment in accordance with manufacturer's instructions
- Respond unplanned events or conditions

**Learning Instructions:**

7. Read the specific objectives of this Learning Guide.
8. Follow the instructions described below 3 to 6.
9. Read the information written in the information “Sheet 1, Sheet 2, Sheet 3, Sheet 4, Sheet 5 and Sheet 6”.
10. Accomplish the “Self-check 1, Self-check 2, Self-check 3, Self-check 4, Self-check 5 and Self-check 6” **in page -44, 52, 58, 63, 81, and 87** respectively.
11. If you earned a satisfactory evaluation from the “Self-check” proceed to “Operation Sheet 1” **in page -89**.
12. Do the “LAP test” **in page – 90** (if you are ready).



<b>Information Sheet-1</b>	<b>Preparing Equipment and components</b>
----------------------------	---

### 1. Weighing scale (infant/adult)

**Scales** are used to measure the weight of an item. To use a scale, the item which needs to be weighed is put on one side of the scale. Then, weigh stones are put on the other side. Once the scale balances (that is the indicator between the two scales is in the middle), the correct weight was chosen.

There are also modern scales, where the item is simply put on the scale. Its weight can then be read from an electronic or analogue display. Weighing Scales are used to measure the weight of an item.

#### How do digital scales work?

Digital scales are usually considered to be standard weighing scales used in kitchens or bathrooms. These scales are often used personally in the home for weighing out portions of food and monitoring weight by standing on a scale. Digital scales are either battery operated or use power mains supply in order to function.



#### How do digital balances work?

There are a few different technologies that are used in balances, but the majority of modern digital balances (including ours) use a force restoration mechanism, so that's what we'll cover here. Electromagnetic force restoration is often used in analytical balances. The very basic principle that makes a balance a balance and not a scale is still the same: a counteracting force is created to be compared to the unknown mass. The weighing pan is attached to an electromagnetic coil, through which electric current is flowing. The coil floats in a magnetic field created by an amplifier. The amplifier maintains the right current to keep the lever (remember, balance operate on the lever principle) balanced with the mass on the pan. As more weight is applied to the pan, the current is increased to maintain the level's position. The counteracting force that is created is measured and "translated" by various electronics to obtain a readable result. The resulting electrical current is then "translated" into a displayed number that is shown to the user.

EEL BES2	Version:01	Page No.35
	Copyright: Ethiopia Federal TVET Agency	



## 2. Clinical weighing scale

**Clinical weighing scales** are used to measure the weight of an item. To use a scale, the item which needs to be weighed is put on one side of the scale. Then, weigh stones are put on the other side. Once the scale balances (that is the indicator between the two scales is in the middle), the correct weight was chosen.

There are also modern scales, where the item is simply put on the scale. Its weight can then be read from an electronic or analogue display. Weighing Scales are used to measure the weight of an item. To use a scale, the item which needs to be weighed is put on one side of the scale.



## 3. Gooseneck lamp/examining light

A **gooseneck lamp** is a type of light fixture in which a lamp or lightbulb is attached to a flexible, adjustable shaft to allow the user to position the light source without moving the fixture or item to be illuminated. Gooseneck lamps are often used to position a light for reading, or in industry, to provide spot illumination for machining operations. These lamps can come in any color. Gooseneck lamps may be free standing floor lamps, desk lamps, or have magnetic bases in industrial applications.

EEL BES2	Version:01	Page No.36
	Copyright: Ethiopia Federal TVET Agency	



#### 4. Oxygen gauge

It usually features two pressure gauges, one to indicate the pressure in the cylinder (the inlet pressure gauge) and one to indicate the pressure delivered to the application (the outlet pressure gauge). Once the outlet pressure has been set by the user, the regulator will maintain this pressure irrespective of the pressure in the cylinder.



#### Parts of oxygen gauge

1. Inlet pressure gauge,
2. Connection to cylinder valve,
3. Pressure adjusting screw,
4. Outlet pressure gauge,
5. Connection to user equipment

#### 5. Sphygmomanometer

##### The Sphygmomanometer and Its Components

A **sphygmomanometer**, also known as a **blood pressure meter**, **blood pressure monitor**, or **blood pressure gauge**, is a device used to measure blood pressure, composed of an inflatable cuff to collapse and then release the artery under the cuff in a controlled manner, and a mercury or mechanical manometer to measure the pressure. It is always used in conjunction with a means to determine at what pressure blood flow is just starting, and at what pressure it is unimpeded. Manual sphygmomanometers are used in conjunction with a stethoscope.

A sphygmomanometer consists of an inflatable cuff, a measuring unit (the mercury manometer, or aneroid gauge), and a mechanism for inflation which may be a manually operated bulb and valve or a pump operated electrically.

EEL BES2	Version:01	Page No.37
	Copyright: Ethiopia Federal TVET Agency	



## Purpose

The sphygmomanometer is designed to monitor blood pressure by measuring the force of the blood in the heart where the pressure is greatest. This occurs during the contraction of the ventricles, when blood is pumped from the heart to the rest of the body (systolic pressure). The minimal force is also measured. This occurs during the period when the heart is relaxed between beats and pressure is lowest (diastolic pressure).

A sphygmomanometer is used to establish a baseline at a healthcare encounter and on admission to a hospital. Checking blood pressure is also performed to monitor the effectiveness of medication and other methods to control hypertension, and as a diagnostic aid to detect various diseases and abnormalities.



A person with a blood pressure reading of about 140/90 millimeters of Mercury (mmHg) is considered hypertensive. A durable medical instrument called sphygmomanometer is being used in order to gauge the person's blood pressure level. Sphygmomanometer comes in different types. Some of them are designed with mercury manometer or aneroid gauge while others come with oscillometric detector to obtain the systolic and diastolic value. The systolic value (the top number) identifies the pressure of blood that exerts on vessel while the heart is beating while the diastolic value (the bottom number) is the pressure in the vessels between heartbeats.

There are also other essential parts that can be found in sphygmomanometers with manually operated inflation cuff. These include the inflation bulb and air release valve. The inflation bulb is constructed from dip molded latex and it is used as pump so as to inflate the cuff. The air release valve, made of corrosion-proof materials, serves as control in order to keep the air in the cuff or let the air out.

Every component found in the sphygmomanometer plays an important function in order to get the most accurate BP reading. Thus, it is necessary to make sure that your blood pressure device is always in perfect condition. And this can be achieved through proper care and maintenance.

EEL BES2	Version:01	Page No.38
	Copyright: Ethiopia Federal TVET Agency	



## 6. Suction apparatus

### Medical Suction Machines



Medical Suction Machine

In medicine, devices are sometimes necessary to create **suction**. Suction may be used to clear the airway of blood, saliva, vomit, or other secretions so that a patient may breathe. Suctioning can prevent pulmonary aspiration, which can lead to lung infections. In pulmonary hygiene, suction is used to remove fluids from the airways, to facilitate breathing and prevent growth of microorganisms.

In surgery suction can be used to remove blood from the area being operated on to allow surgeons to view and work on the area. Suction may also be used to remove blood that has built up within the skull after an intracranial hemorrhage.

Suction devices may be mechanical hand pumps or battery or electrically operated mechanisms. In many hospitals and other health facilities, suction is typically provided by suction regulators, connected to a central medical vacuum supply by way of a pipeline system. The plastic, rigid Yankauer suction tip is one type of tip that may be attached to a suction device. Another is the plastic, nonrigid French or whistle tip catheter.

In addition to people who have respiratory conditions, people who have either temporary or permanent tracheotomies will often require suctioning as their tracheotomies may cause the creation of mucus secretions that cannot be cleared by the patient.

#### How they work:

Suction machines use a long thin flexible plastic tube known as a catheter to vacuum out the secretions blocking the airways. These secretions are collected in a jar attached to the machine and can be emptied after the suctioning is completed.

#### Cleaning and part replacement:

The collection bottle on suction machines must be cleaned after each use. Because the collection bottles can be made of different materials (glass, plastic etc.), the cleaning directions will be different between suction machine models and the manufacturer will supply directions for each model.

EEL BES2	Version:01	Page No.39
	Copyright: Ethiopia Federal TVET Agency	



The tubing that the catheter is connected to also needs to be cleaned after every use. Generally, the tubing should be rinsed thoroughly after every use by running hot tap water through it followed by a solution of one part vinegar to three parts hot water. Rinse with hot tap water and air dry. Individual manufacturers may have different cleaning directions and the suction machine owner's manual should be consulted.

Suction catheters can also be cleaned but may need to be replaced more often than the other suction machine parts. Check with either the prescriber or catheter supplier for replacement and cleaning guidelines.

### **Bacteria filter replacement**

Suction machines are equipped with bacteria filters to prevent bacteria from the secretions suctioned from escaping the collection bottle. Generally these filters should be replaced every two months or so depending on the amount of use the machine has or any time the collection bottle overflows.

### **Suction machine power requirements**

Suction machines are available as 110 volt systems that run on house current, rechargeable battery systems or a combination of both. Patients who require frequent suction treatments should probably consider a model that offers rechargeable batteries to be safe in the instance of a power failure.



## **7. Laryngoscopy**

Laryngoscopy is endoscopy of the larynx, a part of the throat. It is a medical procedure that is used to obtain a view, for example, of the vocal folds and the glottis. Laryngoscopy may be performed to facilitate tracheal intubation during general anaesthesia or cardiopulmonary resuscitation or for surgical procedures on the larynx or other parts of the upper tracheobronchial tree.

EEL BES2	Version:01	Page No.40
	Copyright: Ethiopia Federal TVET Agency	



## Direct laryngoscopy

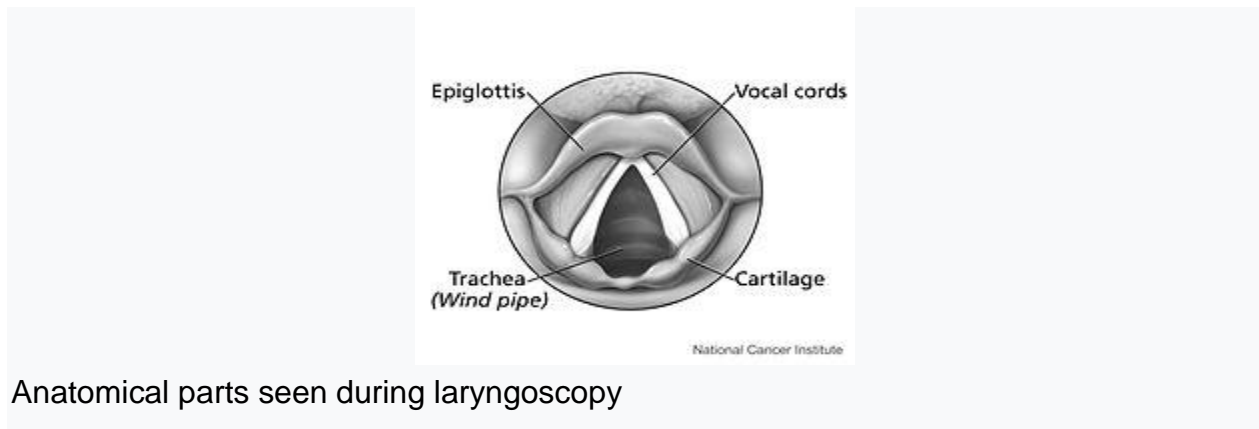

### Anatomical parts seen during laryngoscopy

Direct laryngoscopy is carried out (usually) with the patient lying on his or her back; the laryngoscope is inserted into the mouth on the right side and flipped to the left to trap and move the tongue out of the line of sight, and, depending on the type of blade used, inserted either anterior or posterior to the epiglottis and then lifted with an upwards and forward motion ("away from you and towards the roof "). This move makes a view of the glottis possible. This procedure is done in an operation theatre with full preparation for resuscitative measures to deal with respiratory distress. There are at least ten different types of laryngoscope used for this procedure, each of which has a specialized use for the otolaryngologist and medical speech pathologist. This procedure is most often employed by anaesthetists for endotracheal intubation under general anaesthesia, but also in direct diagnostic laryngoscopy with biopsy. It is extremely uncomfortable and is not typically performed on conscious patients, or on patients with an intact gag reflex.

## Indirect laryngoscopy

Indirect laryngoscopy is performed whenever the provider visualizes the patient's vocal cords by a means other than obtaining a direct line of sight (e.g. a mirror). For the purpose of intubation, this is facilitated by fiberoptic bronchoscopes, video laryngoscopes, fiberoptic stylets and mirror or prism optically-enhanced laryngoscopes.

It is an instrument used for intubation and direct laryngoscopy. It consists of two parts – the blade and the handle. The handle contains the battery container, which acts as an energy source for the light source. The blades are of two varieties:

### 1) Straight blade

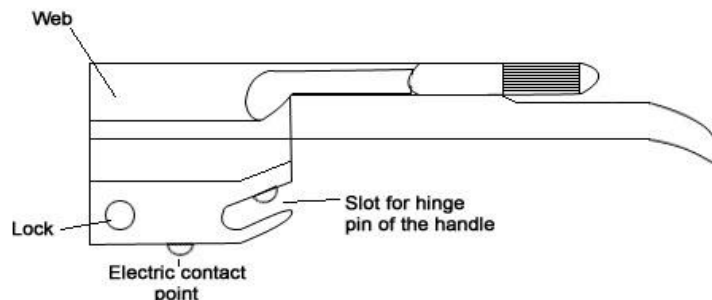

EEL BES2	Version:01	Page No.41
	Copyright: Ethiopia Federal TVET Agency	



## 2) Curved blade

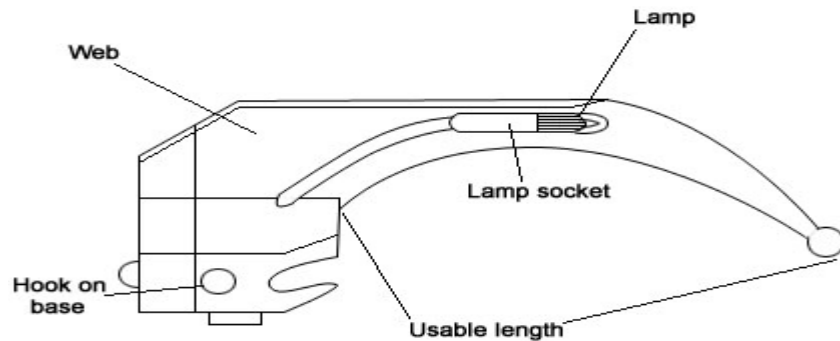

Straight blade is used to depress the tongue whereas the curved blade pushes the epiglottis to one side to visualize the glottis. In infants, the straight blade is preferred whereas in older children (more than 8 years), the curved blade is preferred.

There are various sizes of the laryngoscope available in different numbers e.g. 0,1,2,3,4. The numbers increase with the size of the blade.

Care has to be taken while doing laryngoscopy to prevent injury to the oral structures especially dislocation and aspiration of the tooth. Maximum trauma is caused by utilization of upper anterior teeth or gums as a fulcrum point. Laryngoscopy is also used to pick up any foreign body in the larynx, for passing a bronchoscope / esophagoscope and also for throat packing.

The various parts of the laryngoscope are sterilized separately. The blade is washed under running tap water with detergent giving special attention to cleaning around the light bulb and then boiled/autoclaved/gas sterilized or chemically sterilized with alcohol/glutaraldehyde.

### 8. OR Table

The operating table used for percutaneous nephrolithotomy has to be mobile and modular, with a hydraulic system and adequate dimensions. It has to ensure the dorsal, lateral, or ventral decubitus position of the patient, as well as the lithotomy position, and must allow cranio-caudal and lateral movement. The operating table's surface must be divided into segments that can be independently maneuvered so that the patient's position can be adapted to the intervention's particularities. A system for lifting the lumbar area is also very important. The operating table should be radiotransparent to allow intraoperative fluoroscopic control. An adequate system for draining the irrigation fluid from the working field is also necessary.

### Two main classifications: system and mobile

An operating table system is basically made up of three components: an operating table column, the table top and the transporter. Modern operating table systems are available as both stationary and mobile units. There are a wide range of table tops that can be

EEL BES2	Version:01	Page No.42
	Copyright: Ethiopia Federal TVET Agency	



used for both general surgery and for specialist disciplines. Mobile operating tables, however, tend to be equipped with a specific discipline in mind. The base, column and table top form a unit.



Operating table system with a stationary unit

Since the table column for a stationary operating table system is firmly anchored to the floor, the additional necessary medical devices can easily be brought to the operating area and positioned. These devices include, for example, x-ray equipment, which can easily be slid under the table top. For personnel, the system offers improved leg space since disruptive foot geometry is no longer present.

Additional elements can be adapted to the operating table. This flexibility is very important since it enables the table to be adapted to suit the relevant patient or the surgical discipline.

The advantage of the mobile operating table, on the other hand, is that the position of the table can be changed within the operating room. However, the foot of the table limits the leg space available to the surgical team. The individual segments of the table top can be easily removed and replaced. They also permit x-rays and conduct electricity.

Another special feature of the operating table system is the ability to use appropriate interface modules to establish communication with diagnostics systems, for example, angiography, MR and CT. This is only possible with stationary columns since the systems require a fixed point.

## 9. Cold chain Equipment

### 9.1 Introduction

The equipment and procedures that you will use to keep vaccines within the correct temperature range (between 2°C and 8°C), so that they remain in good condition. Vaccines should be stored carefully at all times, beginning at the factory where they are manufactured and at every stage until the moment they are given to children and mothers. Excess heat or cold will reduce the vaccine potency (strength), increasing the risk that recipients will not be protected against vaccine-preventable diseases.

The cold chain has three main components: equipment for vaccine transport and storage, well-trained personnel, and efficient management procedures.

### 9.2 Cold chain equipment in Health Posts

The common cold chain equipment used in Health Posts are refrigerators, cold boxes, vaccine carriers, ice-packs and foam pads. In this section, the correct use of each of these will be described.

EEL BES2	Version:01	Page No.43
	Copyright: Ethiopia Federal TVET Agency	



### 9.2.1 Refrigerators

A **refrigerator** is a cooling apparatus. Health facility refrigerators may be powered by electricity, kerosene, paraffin, bottled gas or solar energy. Electric refrigerators are usually the least costly to run and the easiest to maintain, but they must have a reliable electricity supply, which is not often possible in rural Health Posts in Ethiopia. Different refrigerators have different capacities for storing vaccines and for freezing and storing ice-packs.



A refrigerator in a Health Post should be able to hold:

- One month's supply of vaccines and diluents in the refrigerator compartment.
- A minimum stock of one to two weeks' supply of vaccines and diluents (i.e. an additional 25% of the standard stock).
- Frozen ice-packs (strong, specially made plastic bottles containing frozen water) standing in the freezer compartment for at least 24 hours to become fully frozen.

Do not put *frozen* ice-packs into the main refrigerator compartment! They could cause the temperature to drop too low and destroy the freeze-sensitive vaccines.

Unfrozen chilled ice-packs in the refrigerator compartment (Figure 6.3); they help to keep the refrigerator cold for a while if there is a power failure. You can also keep ordinary plastic bottles filled with chilled water in the refrigerator for the same purpose.



### 9.2.2 Cold boxes and vaccine carriers

A **cold box** is an insulated container that can be lined with 'conditioned' ice-packs to keep vaccines and diluents cold but not frozen during transportation of vaccine supplies from the health center, or to outreach sites. Cold boxes can also be used for short periods of vaccine storage (from two to seven days, depending on the manufacturer) when the refrigerator is out of order or being defrosted, or if vaccines are being transported in a vehicle for a few days by mobile immunization teams.

EEL BES2	Version:01	Page No.44
	Copyright: Ethiopia Federal TVET Agency	



### 9.2.3 Ice-packs

**Ice-packs** are flat, rectangular plastic bottles filled with water and then either kept at refrigerator temperature (Figure above), or frozen and then conditioned for use in vaccine carriers and cold boxes (Figure above). The number of ice-packs required for a cold box or vaccine carrier varies.

Every Health Post should have a minimum of two sets of ice-packs for each of their cold boxes and vaccine carriers, one in the process of being frozen or refrigerated, and the other conditioned for use in a cold box or vaccine carrier.

#### Box 9.1 Freezing ice-packs

- Fill the ice-packs with water, leaving about 20% air space at the top, and put the cap on tightly.
- Hold each ice-pack upside down and squeeze it to make sure it does not leak.
- Put the ice-packs upright in the freezer compartment of the refrigerator, so that the surface of each ice-pack is touching the evaporator plate, and close the door.
- Leave ice-packs in the freezer for at least 24 hours to freeze solid. After 24 hours they should be ready to use.
- After each vaccination session put the melted ice-packs back in the freezer as soon as possible.

Keep extra unfrozen ice-packs that do not fit in the freezer in the bottom part of the main refrigerator compartment. This helps the water in these chilled ice-packs to freeze relatively quickly when you put them into the freezer, and it also helps to keep this section of the refrigerator cold in case of a power failure.

#### Conditioned ice-packs and chilled water packs

**Conditioned ice-packs** have first been fully frozen, and then removed from the freezer and left at room temperature for a short time (it may take over 30 minutes if the room is cold). Allow the frozen ice-packs to sit at room temperature until the ice begins to melt and water starts to form. Check to see if each ice-pack has been conditioned properly by shaking it and listening for the sound of water moving inside. This prevents the ice-packs from freezing the vaccines inside a cold box or vaccine carrier, and damaging the freeze-sensitive vaccines.

### 9.2.4 Foam pads

A **foam pad** is a piece of soft foam that fits on top of the conditioned ice-packs in a cold box or a vaccine carrier (Figure below). There are some cuts in the foam to allow vaccine vials to be inserted in the pad. During immunization sessions, the foam pad can be used as a temporary lid to keep unopened vaccines inside the carrier cool, while

EEL BES2	Version:01	Page No.45
	Copyright: Ethiopia Federal TVET Agency	



providing a surface to hold and protect opened vaccine vials and keep them cool. Vaccines are protected from heat damage during an immunization session if they are inserted in the foam pad above the ice-packs in the vaccine carrier.



Figure The foam pad in a vaccine carrier has cuts to hold vials and vaccines during an immunization session.

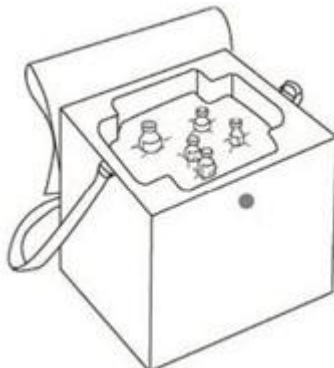

Figure Foam pad with vaccine vials inserted.

### 9.3 Cold chain monitoring equipment in your Health Post

It is important to know about the common cold chain monitoring equipment for keeping a record of the temperature that vaccines and diluents are exposed to during transportation and storage. The items of equipment used are vaccine vial monitors, freeze indicators and thermometers.

#### 9.3.1 Vaccine vial monitors

A **vaccine vial monitor (VVM)** is a label that changes colour when the vaccine vial or ampoule has been exposed to temperatures above 8°C over a period of time. Before opening a vaccine container, the status of the VVM must be checked to see whether the vaccine has been damaged by heat. Manufacturers attach VVMs to vials and ampoules of most vaccines. The VVM is printed on the label or cap, or the neck of ampoules of freeze-dried vaccines (Figure 6.7). It looks like a square inside a circle. As the vaccine vial is exposed to more heat, the square becomes darker.

EEL BES2	Version:01	Page No.46
	Copyright: Ethiopia Federal TVET Agency	



Figure (a) Vaccine Vial Monitors (VVMs) on the neck of an ampoule, or on the label or cap of a vaccine vial. (b) A vial of liquid PCV10 vaccine (Synflorix) with the VVM on the cap

Do not use vaccines that have reached the discard point, even if they have not passed their expiry date!

### 9.3.2 Freeze indicators

**Freeze indicators** are devices used to monitor the exposure of vaccines to freezing. Freeze indicators are packed with batches of freeze-sensitive EPI vaccines, which may be used to protect healthcare workers. The most commonly used type of freeze indicator is the **freeze-tag** (Figure below). This is an irreversible temperature indicator that shows if a product, such as a vaccine, has been exposed to freezing. It consists of an electronic temperature measuring circuit with a liquid crystal display (LCD). A small blinking dot of light in the corner of the display shows that the freeze-tag is functioning correctly.



Figure 6.9 Freeze-tags showing: (a) 'good status' display; (b) 'alarm status' display.

## 10. OR/DR light

A **OR/DR light** – also referred to as an **operating light** or **surgical lighthouse** – is a medical device intended to assist medical personnel during a surgical procedure by illuminating a local area or cavity of the patient. A combination of several surgical lights is often referred to as a “surgical light system”.

EEL BES2	Version:01	Page No.47
	Copyright: Ethiopia Federal TVET Agency	



## 11. Water Bath

A **water bath** is laboratory equipment made from a container filled with heated water. It is used to incubate samples in water at a constant temperature over a long period of time. All water baths have a digital or an analogue interface to allow users to set a desired temperature. Utilisations include warming of reagents, melting of substrates or incubation of cell cultures. It is also used to enable certain chemical reactions to occur at high temperature. Water bath is a preferred heat source for heating flammable chemicals instead of an open flame to prevent ignition. Different types of water baths are used depending on application. For all water baths, it can be used up to 99.9 °C. When temperature is above 100 °C, alternative methods such as oil bath, silicone bath or sand bath may be used.



### What to consider when choosing a water bath?

Things to consider include the bath's temperature range, capacity, whether there is a cooling option, how easy it is to clean, and whether it is a shaking or circulating water bath.

EEL BES2	Version:01	Page No.48
	Copyright: Ethiopia Federal TVET Agency	





## Types of water bath



A shaking water bath in action

### Circulating Water Baths

Circulating the water baths (also called *stirrers*) are ideal for applications when temperature uniformity and consistency are critical, such as enzymatic and serologic experiments. Water is thoroughly circulated throughout the bath resulting in a more uniform temperature.

### Non-Circulating Water Baths

This type of water bath relies primarily on convection instead of water being uniformly heated. Therefore, it is less accurate in terms of temperature control. In addition, there are add-ons that provide stirring to non-circulating water baths to create more uniform heat transfer.

### Shaking Water Baths

This type of water bath has extra control for shaking, which moves liquids around. This shaking feature can be turned on or off. In microbiological practices, constant shaking allows liquid-grown cell cultures grown to constantly mix with the air.

Some key benefits of shaking water bath are user-friendly operation via keypad, convenient bath drains, adjustable shaking frequencies, bright LED-display, optional lift-up bath cover, power switch integrated in keypad and warning and cut-off protection for low/high temperature.

EEL BES2	Version:01	Page No.49
	Copyright: Ethiopia Federal TVET Agency	



## 12. Shaker

A **shaker** is a piece of laboratory equipment used to mix, blend, or agitate substances in a tube or flask by shaking them. It is mainly used in the fields of chemistry and biology. A shaker contains an oscillating board that is used to place the flasks, beakers, or test tubes. Although the magnetic stirrer has lately come to replace the shaker, it is still the preferred choice of equipment when dealing with large volume substances or when simultaneous agitation is required

### Types of shakers

---

#### Vortex shaker

Invented by Jack A. Kraft and Harold D. Kraft in 1962, a vortex shaker is a usually small device used to shake or mix small vials of liquid substance. Its most standout characteristic is that it works by the user putting a vial on the shaking platform and turning it on; thus, the vial is shaken along with the platform. A vortex shaker is very variable in terms of speed adjustment, for the shaking speed can be continuously changed while shaking by turning a switch.

#### Platform shaker

A platform shaker has a table board that oscillates horizontally. The liquids to be stirred are held in beakers, jars, or erlenmeyer flasks that are placed over the table or, sometimes, in test tubes or vials that are nested into holes in the plate. Platform shakers can also be combined with other systems like rotating mixers for small systems and have been designed to be manufactured in laboratories themselves with open source scientific equipment.

#### Orbital shaker

An orbital shaker has a circular shaking motion with a slow speed (25-500 rpm). It is suitable for culturing microbes, washing blots, and general mixing. Some of its characteristics are that it does not create vibrations, and it produces low heat compared to other kinds of shakers, which makes it ideal for culturing microbes. Moreover, it can be modified by placing it in an incubator to create an incubator shaker due to its low temperature and vibrations.

#### Incubator shaker

An incubator shaker (or thermal shaker) can be considered a mix of an incubator and a shaker. It has an ability to shake while maintaining optimal conditions for incubating microbes or DNA replications. This equipment is very useful since, in order for a cell to grow, it needs oxygen and nutrients that require shaking so that they can be distributed evenly around the culture.

EEL BES2	Version:01	Page No.50
	Copyright: Ethiopia Federal TVET Agency	



### 13. Nebulizer

Nebulizers are used to convert liquids into aerosols of a size that can be inhaled into the lower respiratory tract. The process of pneumatically converting a bulk liquid into small droplets is called atomization. Pneumatic nebulizers have baffles incorporated into their design so that most of the droplets delivered to the patient are within the respirable size range of 1–5  $\mu\text{m}$ . Ultrasonic nebulizers use electricity to convert a liquid into respirable droplets. Although the first choice of aerosol generator for the delivery of bronchodilators and steroids is the metered-dose inhaler, nebulizers remain useful for several reasons. First, some drugs for inhalation are available only in solution form. Second, some patients cannot master the correct use of metered-dose inhalers or dry powder inhalers. Third, some patients prefer the nebulizer over other aerosol generating devices. The physiologic benefits of metered-dose inhalers and nebulizers are virtually equivalent, and the choice of device is often based on clinician or patient preference rather than clear superiority of one approach over the other. Although cost savings have been suggested with the use of metered-dose inhalers compared to nebulizers, these benefits may be overestimated.

Nebulizers can be used to deliver a wide range of drugs, in both solution and suspension formulation (i.e., a single nebulizer unit can be used to deliver multiple drugs). Metered dose inhalers (pressurized and dry powder), on the other hand, are specific for a drug-device combination and involve a high cost during the R&D phase and, in the postdevelopment phase, testing is required to obtain regulatory approval. Hence, aerosolized drugs for diseases such as cystic fibrosis are most often delivered via nebulizer.

Nebulizers may not be ideal devices to generate a therapeutically effective aerosol from a novel drug formulation. This could lead to overdosing or underdosing of the lung as nebulizer performance can vary widely when used to aerosolize a drug either not

EEL BES2	Version:01	Page No.51
	Copyright: Ethiopia Federal TVET Agency	



intended to be delivered in an aerosolized form, or designed to be used in a different nebulizer. Off-label use of drug and/or delivery devices with a failure to match the drug to the delivery device can lead to problems.

Drugs such as antibiotics (tobramycin) used in the treatment of *Pseudomonas* spp. lung infections have comparatively high MICs and the large volumes required to achieve a therapeutic concentration at the site of action preclude their use as a pMDI formulation. More potent drugs such as those used in the treatment of asthma require far less total dose; hence the widespread use of pMDI formulations for asthma. Thus nebulizers generating a “wet” aerosol are the device of choice for many drugs.

Jet nebulizers have been used for many years for the treatment of respiratory disease. Drug formulations for jet nebulizers are generally aqueous solutions, although some drugs are dispensed in the form of suspensions (corticosteroids) or viscous solutions (antibiotics). The simplest of the nebulizer designs is the T-piece jet nebulizer. An aerosol is generated by passing air flow through a Venturi in the nebulizer bowl. This forms a low-pressure zone that pulls up droplets through a feed tube from a solution or suspension of drug in the nebulizer bowl, and in turn this creates a stream of atomized droplets, which flow to the mouthpiece. Higher air flows lead to a decrease in particle size and an increase in output. A baffle in the nebulizer bowl is impacted by larger particles, retaining them and returning them to the solution in the nebulizer bowl to be reatomized. There is considerable variation in the performance of nebulizers.<sup>77</sup> In addition, nebulizers require a source of compressed air, which make them bulkier and more inconvenient to use than other inhalation systems.



Here are general instructions on how to use a nebulizer:

EEL BES2	Version:01	Page No.52
	Copyright: Ethiopia Federal TVET Agency	



1. Put the compressor on a flat surface where it can safely reach an outlet.
2. Check to make sure all the pieces are clean.
3. Wash your hands before prepping the medication.
4. If your medication is premixed, place it in the container. If you need to mix it, measure the correct amount, and then place it in the container.
5. Connect the tube to the compressor and the liquid container.
6. Attach the mouthpiece or mask.
7. Turn on the switch and check to see that the nebulizer is misting.
8. Put the mouthpiece in your mouth and close your mouth around it or put the mask securely over your nose and mouth, leaving no gaps.
9. Slowly breath in and out until the medicine is gone. This may take five to 15 minutes.
10. Keep the liquid container upright throughout the treatment.

### **Nebulizer Types**

There are two main types of nebulizers. These are compressed-air nebulizers and ultrasonic nebulizers.

1. Compressed-air nebulizer, as its name suggests, uses compressed air to transport medicine to the lungs. Also called jet nebulizer or atomizer, this device has a compressor that converts medicated solution into vapors. It is the more preferred type for medicines in suspension. Nebulizers that are found in hospitals are usually jet nebulizers. These are generally cheaper than the other type. The downside of a jet nebulizer is its noise and weight. The compressor, aside from being heavy, produces a loud sound. Air-Compressing Nebulizer



2. An ultrasonic nebulizer, on the other hand, contains a transducer instead of a compressor. The transducer is a crystal. It produces ultrasonic sound waves that

EEL BES2	Version:01	Page No.53
	Copyright: Ethiopia Federal TVET Agency	



convert the medicated liquid into vapors. Ultrasonic nebulizers are quiet. The sound levels of the sound waves are higher than what human ears can detect. Also, because they do not have a compressor, ultrasonic nebulizers are not heavy. There are even portable ultrasonic nebulizers that are battery operated. The downside of ultrasonic nebulizers is they are not compatible with some medicines for asthma and other respiratory diseases. There are medicines that become ineffective when they are turned into mist using ultrasonic sound waves. Some could even cause negative effects to the patient.

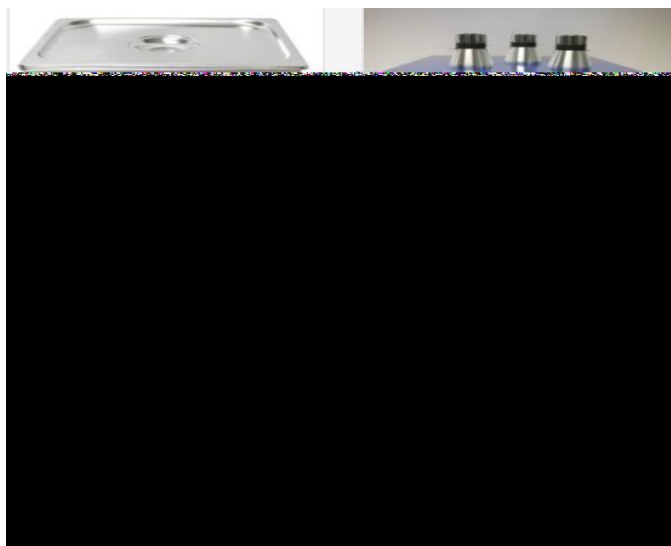

#### 14. Electro muscular stimulator

Benefits of Electric Muscle Stimulation

Electric muscle stimulation (EMS) can help treat musculoskeletal injuries or ailments.

- EMS is a common and effective way to:
  - Relieve discomfort and pain
  - Reduce muscle spasms
  - Restore muscle tone
  - Rehabilitate parts of the body

The orthopedic specialists and physical therapists utilize EMS on those with any of the above-mentioned issues to help restore function, mobility and balance, and reduce pain.

#### How Electric Stimulation Works

Electric stimulation works by attaching stick-on pieces of equipment to the skin and using the control unit to transmit currents to targeted muscle groups. The control unit is where the timer, sensory knobs and other devices are located to produce the electric current. Two lead wires and two to four neurostimulation electrodes are the tools that are attached to the skin to transmit the current. The machine may cause a number of unique sensations when turned on and applied to a specific muscle group.

EEL BES2	Version:01	Page No.54
	Copyright: Ethiopia Federal TVET Agency	



## How Electric Stimulation Feels

Some patients report feeling pins and needles, muscle twitching and/or a dull tingling. These sensations usually only last during the treatment, but there are times patients will feel them up to 30 minutes after the therapy session.

## Added Benefits of EMS

There are many benefits to this kind of therapy. To start, it can help reduce edema (swelling) and expedite the healing process of injured or damaged tissue. Electric muscle stimulation can also help reduce chronic pain. Other benefits include:

- May improve joint pain and swelling
- Prevents and reverses muscle atrophy (loss of muscle mass/tissue)
- Enhances rehabilitation of muscles
- Increases range of motion for tense muscles or tendons
- Reduces stress and discomfort
- Improves blood flow and circulation

Those with pacemakers and heart problems (i.e. palpitations, arrhythmia, heart disease, etc.) should not use this therapy, nor should women who are pregnant.

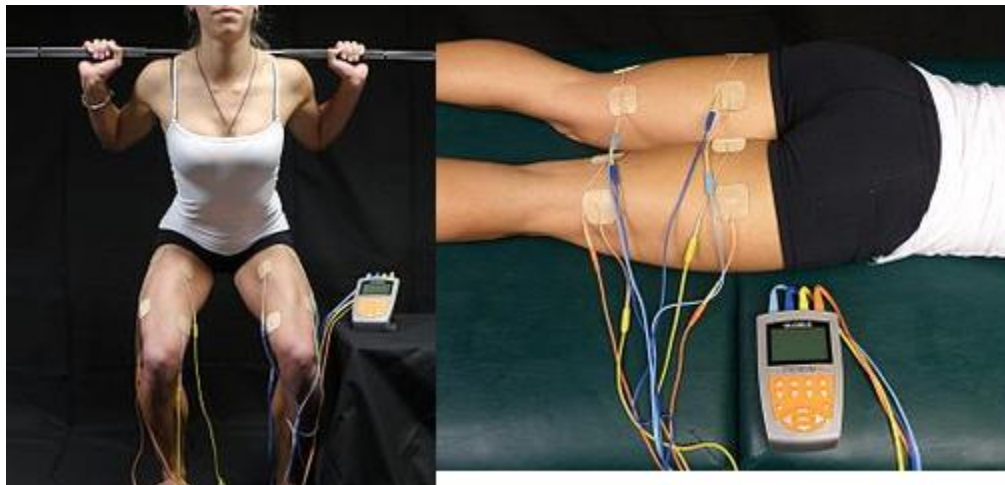

## 15. Uninterruptable Power Supply

### Definition of: UPS

(Uninterruptible Power Supply) A device that provides battery backup when the electrical power fails or drops to an unacceptable voltage level. Small UPS systems provide power for a few minutes; enough to power down the computer in an orderly manner, while larger systems have enough battery for several hours. In mission critical datacenters, UPS systems are used for just a few minutes until electrical generators take over.

UPS systems can be set up to alert file servers to shut down in an orderly manner when an outage has occurred, and the batteries are running out.

EEL BES2	Version:01	Page No.55
	Copyright: Ethiopia Federal TVET Agency	



## Surge Suppression and Voltage Regulation

A surge protector filters out surges and spikes, and a voltage regulator maintains uniform voltage during a brownout, but a UPS keeps a computer running when there is no electrical power. UPS systems typically provide surge suppression and may provide voltage regulation. See surge suppression.

### Standby and Line Interactive

A standby UPS, also called an "offline UPS," is the most common type of UPS found in a computer or office supply store. It draws current from the AC outlet and switches to battery within a few milliseconds after detecting a power failure.

The line interactive UPS "interacts" with the AC power line to smooth out the waveforms and correct the rise and fall of the voltage.

### Online UPS

The online UPS is the most advanced and most costly UPS. The inverter is continuously providing clean power from the battery, and the computer equipment is never receiving power directly from the AC outlet. However, online units contain cooling fans, which do make noise and may require some location planning for the home user or small office.

#### STANDBY UPS (OFFLINE UPS)

on AC power

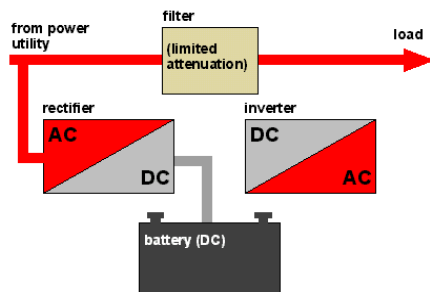

#### ONLINE UPS (DOUBLE CONVERSION)

on AC power

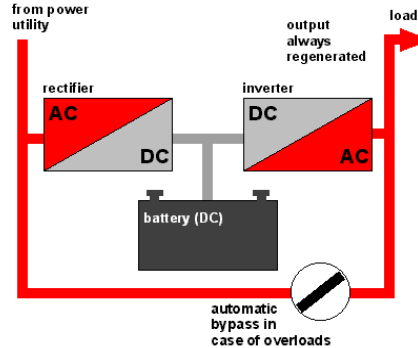

#### LINE INTERACTIVE

on AC power

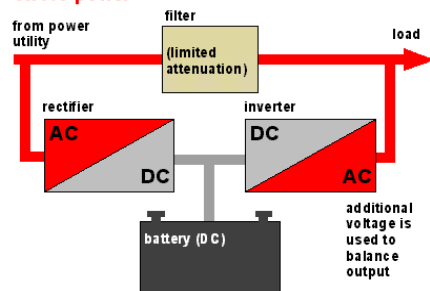

#### POWER FAILURE ALL UPS TYPES

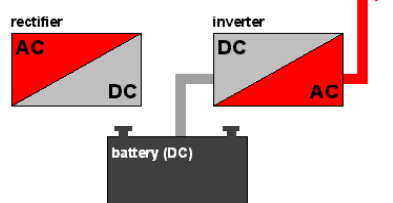

## Three UPS Types

All UPS systems switch to battery when the power fails. The difference is how they handle the power under normal circumstances. Standby units provide limited attenuation whereas line interactive systems will adjust the voltage and smooth out bad harmonics. Online systems are constantly regenerating clean power.

EEL BES2	Version:01	
	Copyright: Ethiopia Federal TVET Agency	
		Page No.56





### Size Does Matter

When the power goes off, the unit on the right will keep more equipment running for a longer time than the one on the left, because the battery is larger. Battery size is an important criterion when selecting UPS systems.

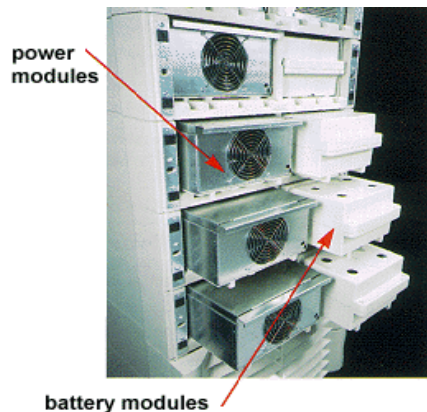

### Backing Up the Backup

All modules share in the total load; thus, any unit can fail and be replaced without jeopardizing the security the UPS was intended to provide in the first place.

### 16. Bag Valve Mask

A **bag valve mask**, abbreviated to **BVM** and sometimes known by the proprietary name **Ambu bag** or generically as a **manual resuscitator** or "self-inflating bag", is a hand-held device commonly used to provide positive pressure ventilation to patients who are not breathing or not breathing adequately. The device is a required part of resuscitation kits for trained professionals in out-of-hospital settings (such as ambulance crews) and is also frequently used in hospitals as part of standard equipment found on a crash cart, in emergency rooms or other critical care settings.

EEL BES2	Version:01	Page No.57
	Copyright: Ethiopia Federal TVET Agency	



Underscoring the frequency and prominence of BVM use in the United States, the American Heart Association (AHA) Guidelines for Cardiopulmonary Resuscitation and Emergency Cardiac Care recommend that "all healthcare providers should be familiar with the use of the bag-mask device." Manual resuscitators are also used within the hospital for temporary ventilation of patients dependent on mechanical ventilators when the mechanical ventilator needs to be examined for possible malfunction or when ventilator-dependent patients are transported within the hospital. Two principal types of manual resuscitators exist; one version is self-filling with air, although additional oxygen (O<sub>2</sub>) can be added but is not necessary for the device to function. The other principal type of manual resuscitator (flow-inflation) is heavily used in non-emergency applications in the operating room to ventilate patients during anesthesia induction and recovery.

Use of manual resuscitators to ventilate a patient is frequently called "**bagging**" the patient [2] and is regularly necessary in medical emergencies when the patient's breathing is insufficient (respiratory failure) or has ceased completely (respiratory arrest). Use of the manual resuscitator force-feeds air or oxygen into the lungs in order to inflate them under pressure, thus constituting a means to manually provide positive-pressure ventilation. It is used by professional rescuers in preference to mouth-to-mouth ventilation, either directly or through an adjunct such as a pocket mask.

### **Standard components**

#### **Mask**



Bag valve mask. Part 1 is the flexible mask to seal over the patients face, part 2 has a filter and valve to prevent backflow into the bag itself (prevents patient deprivation and bag contamination) and part 3 is the soft bag element which is squeezed to expel air to the patient

The BVM consists of a flexible air chamber (the "bag", roughly a foot in length), attached to a face mask via a shutter valve. When the face mask is properly applied and the "bag" is squeezed, the device forces air through into the patient's lungs; when the bag is released, it self-inflates from its other end, drawing in either ambient air or a low pressure oxygen flow supplied by a regulated cylinder, while also allowing the patient's lungs to deflate to the ambient environment (not the bag) past the one way valve.

#### **Bag and valve**

Bag and valve combinations can also be attached to an alternative airway adjunct, instead of to the mask. For example, it can be attached to an endotracheal tube or laryngeal mask airway. Small heat and moisture exchangers, or humidifying / bacterial filters, can be used.

EEL BES2	Version:01	Page No.58
	Copyright: Ethiopia Federal TVET Agency	



A bag-valve mask can be used without being attached to an oxygen tank to provide "room air" (21% oxygen) to the patient, however manual resuscitator devices also can be connected to a separate bag reservoir which can be filled with pure oxygen from a compressed oxygen source – this can increase the amount of oxygen delivered to the patient to nearly 100%.

Bag-valve masks come in different sizes to fit infants, children, and adults. The face mask size may be independent of the bag size; for example, a single pediatric-sized bag might be used with different masks for multiple face sizes, or a pediatric mask might be used with an adult bag for patients with small faces.

Most types of the device are disposable and therefore single use, while others are designed to be cleaned and reused.

## 17. Clinical Oven

Laboratory ovens are convection appliances for general purposes in the scientific and manufacturing industries. Applications include sterilization, experiment management, drying, processing, and testing. **Hot air ovens** are electrical devices which use dry heat to sterilize. They were originally developed by Pasteur. Generally, they use a thermostat to control the temperature. Their double walled insulation keeps the heat in and conserves energy, the inner layer being a poor conductor and outer layer being metallic. There is also an air filled space in between to aid insulation. An air circulating fan helps in uniform distribution of the heat. These are fitted with the adjustable wire mesh plated trays or aluminium trays and may have an on/off rocker switch, as well as indicators and controls for temperature and holding time. The capacities of these ovens vary. Power supply needs vary from country to country, depending on the voltage and frequency (hertz) used. Temperature sensitive tapes or biological indicators using bacterial spores can be used as controls, to test for the efficacy of the device during use.

### Operation

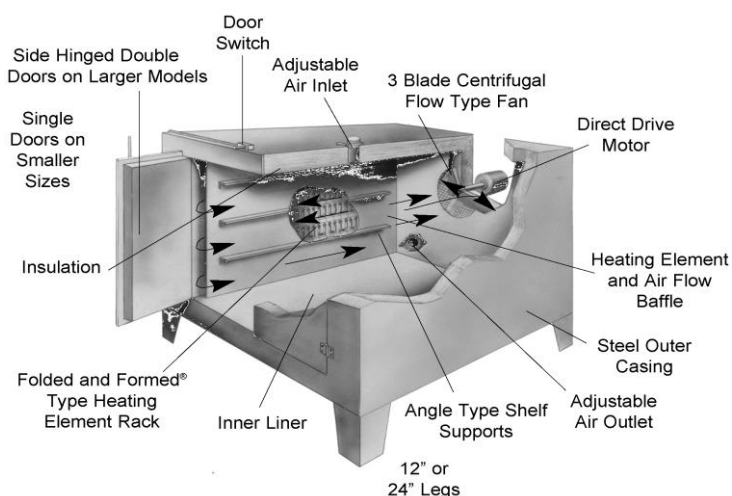

EEL BES2	Version:01	Page No.59
	Copyright: Ethiopia Federal TVET Agency	



A laboratory oven heats its contents via the principle of convection. The heating element is not located within the specimen chamber of the oven, but in a separate external envelope. This prevents radiant heat from affecting the specimen, but the resulting temperature of the oven walls is enough to heat and dehydrate a specimen.

Convective heat transfer is achieved by gravity or mechanical convection. In the former, cooler air is displaced by warmer air and directed towards the heating element until the entire chamber is up to temperature. Since this method has poor uniform heat distribution, energy waste, and a longer preheat time than mechanical convection, mechanical convection lab ovens are favorable. These types heat quicker and more evenly due to blowers and baffles in the oven chamber.



Air intakes and exhausts can be adjusted to withhold or release humidity, and are necessary to expel VOCs and fumes. Insulation reduces the rate of thermal transfer and is responsible for the energy efficiency of the oven. The oven itself is typically steel in construction which helps prevent radiant heat from the oven exterior. A locking door with robust gaskets provides user access to the oven chamber.

The essential functions of a laboratory oven are:

- **Drying:** removing the moisture from the specimen and chamber as efficiently as possible.
- **Baking:** heating a substrate without dehumidifying it.
- **Curing:** the sample is physically or chemically altered by a slow baking and drying process.

### Types

These ovens have a specialized application or characteristic which separates them apart from general-purpose lab ovens.

<i>Name</i>	<i>Description</i>	<i>Image</i>
Vacuum ovens	Vacuum ovens typically process metal components. Brazing, sintering, heat treatment, and case hardening applications are most common. There are no gases in the oven chamber, which prevents convection and oxidation. These ovens are capable of temperature distribution exceeding 1100° C. Metals quench quickly in the oven when an inert gas is introduced after processing. Vacuum ovens are common for batch processing.	
Clean process oven	These stainless-steel, HEPA-filtered lab ovens assist in medical equipment manufacturing (syringes, catheters, stents, pacemakers, and eyesight lenses). They also participate in	

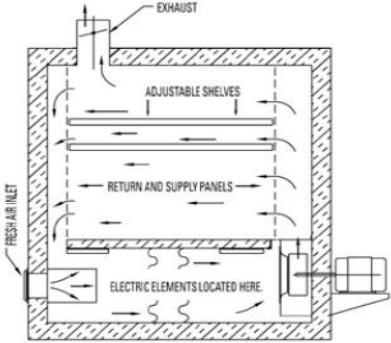

	semiconductor wafer production. Temperatures commonly exceed 260° C. Batch processing and conveyor processing are common.	
<b>Burn-in</b>	Burn-in ovens heat soak semiconductors and microprocessors in temperatures over 260° C, often in a nitrogen or air atmosphere.	
<b>Reach-in</b>	Horizontal airflow creates uniform heating cross all shelves, whereas most lab ovens utilize vertical airflow. This type of oven is excellent for applications which require 100+ air exchanges each hour, but can also be used for general laboratory purposes.	

## 18. Centrifuge

The word *centrifuge* comes from the Latin word *centrum* which means *center* and *figure* which means to *escape*. The centrifuge is designed to use the centrifugal force generated in rotational movements to separate the constitutive elements of a mixture. There is a wide range of centrifuges capable of serving specific industry and research needs.

### PURPOSE OF THE CENTRIFUGE

The centrifuge uses centrifugal force (the force generated when an object rotates around a single point), for separating solids suspended in a liquid by sedimentation, or liquids of diverse density. The rotational movements allow forces much greater than gravity to be generated in controlled periods of time. In the laboratory, centrifuges are generally used in processes such as the separation of solid components from biological liquids through sedimentation and in particular of blood components: red cells, white cells, platelets among others and for conducting multiple tests and treatments.

EEL BES2	Version:01	Page No.61
	Copyright: Ethiopia Federal TVET Agency	



There are several kinds of centrifuges. The most widely used in public health, surveillance and clinical laboratories are the able-top centrifuge, the ultracentrifuge, the hematocrit Centrifuge and the standing centrifuge.

## OPERATION PRINCIPLES

Centrifuges represent a practical application of Newton's law of motion. When a body of mass [m] turns around central point [O], it is subjected to a *centripetal* force [N] directed towards the rotation axis with a magnitude =  $m\omega^2R$ , where [m] is the mass of the body, [R] is the radius and  $\omega$  is the angular speed. Centrifuges possess a rotating axis on which is mounted a rotor with sample receiving compartments. Tangential speed is defined by the following equation:  $V_T = \omega R$ .



## COMPONENTS OF THE CENTRIFUGE

The most important components of a centrifuge are the Following:

The electric/electronic control which generally has the following elements:

1. on and off control, operation time control (timer), rotation speed control (in some centrifuges), temperature control (in refrigerated centrifuges), vibration control (safety mechanism) and brake system.
2. Refrigeration system (in refrigerated centrifuges).
3. Vacuum system
4. Base
5. Lid/cover
6. Casing
7. Electric motor
8. Rotor. There are different types of rotors. The most common are the fixed angle, the swinging buckets, the vertical tube and the almost vertical tube types, which are explained next.

EEL BES2	Version:01	Page No.62
	Copyright: Ethiopia Federal TVET Agency	



## 19. Microscope

The word *microscope* comes from the fusion of the Greek words *micros* which means *small* and *skopien*, *to see* or *examine*. This chapter presents the care and routine maintenance of microscopes used in clinical practice. Depending on the contrast system, microscopes are given different names. Among the most common are the following:

- Clear field optical microscope
- Dark field optical microscope
- Fluorescence optical microscope
- Phase contrast optical microscope
- Interference optical microscope
- Polarized light optical microscope
- Inverted optical microscope
- Stereoscopic microscope

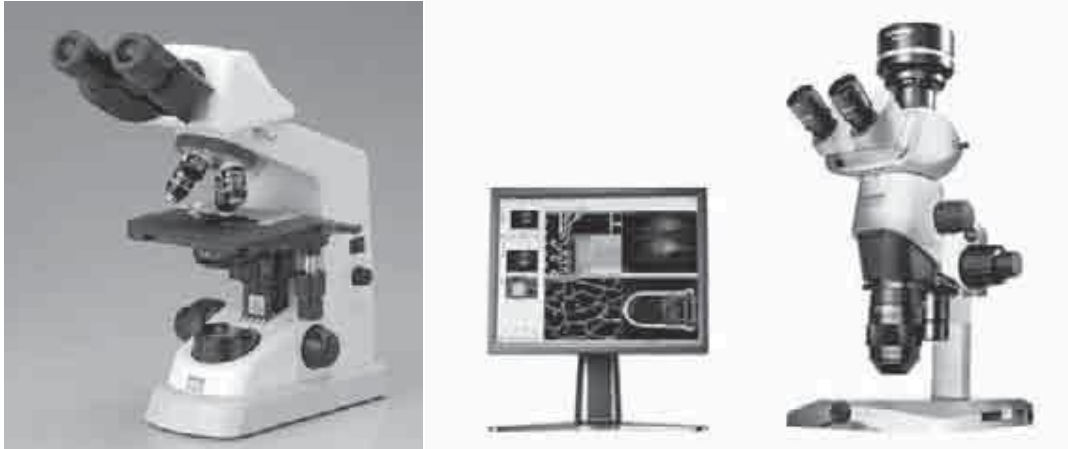

### PURPOSE OF THE EQUIPMENT

The microscope is a precision instrument with optical subsystems (lenses, filters, prisms, condensers); mechanical subsystems controlling the position of the sample in tridimensional space X, Y, Z; electrical (transformers and light source) and electronic subsystems (cameras, video, etc.) interacting to amplify and control the image formation of objects which are not detectable to the human eye. To observe samples, it is essential to prepare these according to techniques which emphasize details to be observed.

The microscope constitutes a diagnostic aid of first order in healthcare, in specialties such as hematology, bacteriology, and parasitology and in the training of human resources (there are microscopes with specialized additions for students to carry out observations directed by a professor). The technical developments applied to microscopes have allowed the design of numerous specialized models by the industry

EEL BES2	Version:01	Page No.63
	Copyright: Ethiopia Federal TVET Agency	



and academia. These play a key role in developing human knowledge and understanding the workings of nature

## OPERATION PRINCIPLES

The microscope is constructed using the physical properties of lenses interacting with light. A lens is an optical element usually made of glass which can refract light. It is of calculated dimensions and in general has parabolic or spherical surfaces. If light rays reaching one surface of the

lens converge in a common point  $F$  when exiting it, such lens is known as positive or convergent. If it disperses the light rays crossing it, it is divergent or negative. Positive lenses (convergent) shown in Figure 41 constitute the building blocks of microscopes.

In Figure 41, it is possible to identify the *focus* [ $F$ ], (the point where the light rays are concentrated) and how light is refracted across the lens. The distance between the lens and the focus is known universally as the *focal distance* [ $D$ ].

Figure summarizes concepts related to the functioning of lenses applied to the design of microscopes.

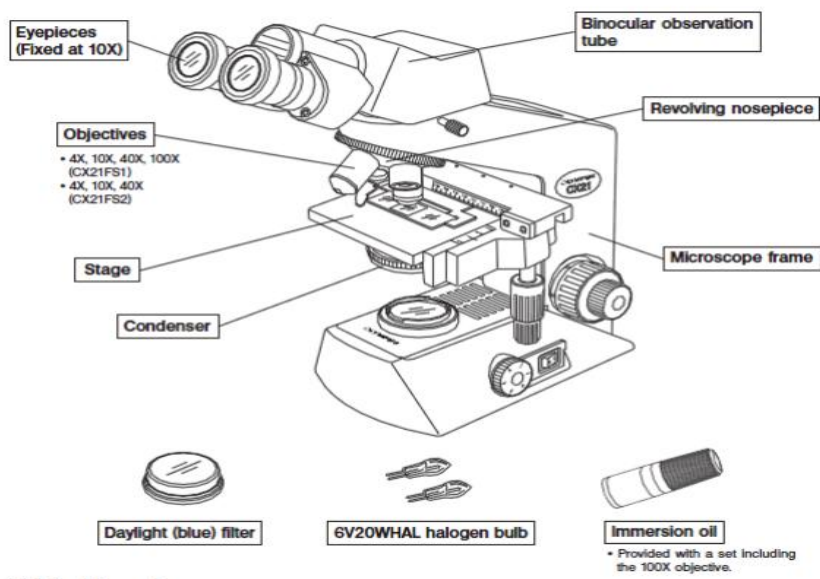

## INSTALLATION REQUIREMENTS

Normally, microscopes use 110 V/60 Hz or 220 V/60 Hz power. Some have a regulated source which allows light

Binocular head

1 Eyepiece

2 Binocular tube

EEL BES2	Version:01	Page No.64
	Copyright: Ethiopia Federal TVET Agency	





- 3 Binocular head
- 2 Revolving objective holders
- 4 Revolving objective holders
- 5 Objectives
- 3 Platform, plate or mechanical stage and condenser
- 6 Condenser
- 7 Aperture diaphragm
- 8 Filter holders
- 9 Wide range lens
- 21 Condenser control
- 23 Platform, plate or mechanical stage
- 4 Illuminator
- 10 Closing glass with filter holders
- 11 Settings lever of the diaphragm's light field
- 12 Concave mirror
- 13 Incandescent light
- 14 Light holder with adjustment ring
- 15 Collector lens
- 16 Mirror
- 5 Microscope's body
- 17 Internal transformer
- 18 Control rheostat
- 19 Feed cable
- 20 Macro/micro metric adjustment knob
- 22 Microscope's arm
- 24 Base

### **Eyepieces**

The most frequent problem affecting eyepieces is the presence of dust and grime, which may be on the external or internal surfaces. Such dust or grime produce shadows interfering with the sample under analysis, especially when high powered lenses are used (40X–100X). If these are external, cleaning the surfaces of the lenses solves the problem. If internal, it is necessary to disassemble the eyepiece, clean the internal surfaces, reassemble and verify the final state. Enters and leaves. If the reflective surface is damaged, the prism can be removed, cleaned, polished or repainted, installed and aligned in the binoculars head.

This kind of maintenance is highly complex and can only be done by specialized laboratories or companies offering this maintenance service. The removal of prisms

EEL BES2	Version:01	Page No.65
	Copyright: Ethiopia Federal TVET Agency	



without training and suitable tools can have a serious impact on the quality of the image and even break the component.

## **Mirrors**

These have reflecting surfaces directly exposed and are susceptible to rust. If repair is necessary, the mirror is dismantled and removed from the binocular head and substituted by a new one, cut, cemented and aligned directly where it is being mounted.

## **Binocular head**

The state of the binocular head has a direct effect on the quality of the microscope's image. Its most important components are the prisms and mirrors. Grime adhered to the optical components of the head affects the quality of the image. This component can even become dirty due to normal work in the laboratory, such as changing the eyepieces, installing accessories (e.g., cameras) or simply by forgetting to place stoppers when the microscope is not in use.

## **Prisms**

These have silver-plated reflective surfaces which can become rusty over time and lose their reflecting capacity. This is a fundamental element of the microscope. If the illumination system does not work well, the microscope is out of order as light intensity and contrast are fundamental to observe samples. Several factors may affect the lighting system; the most common ones are grime and deterioration of the mirrors and lenses, defects in the feed voltage, or the use of bulbs other than those recommended by the manufacturers. The anomalies mentioned produce small shadows in the vision field and insufficient light intensity, or a lack of homogeneity in the lighting.

Internal dust and grime this occurs when the lighting systems are not sealed to prevent dust and particle infiltration. Dust in the system

Produces diffusion and a decrease in the quantity of light projected onto the sample. Large particles produce shadows rendering observations difficult. In order to correct the problem, the illuminator is disassembled, its components cleaned, reassembled and realigned.

## **Incandescent bulb**

The bulb is a consumable component with a determined operational life. Its acquisition must be planned ahead to ensure a replacement is always available in the laboratory or in the institution where the equipment is installed. The bulb installation is done according to the manufacturer's Instructions. Some equipment, such as the

EEL BES2	Version:01	Page No.66
	Copyright: Ethiopia Federal TVET Agency	



fluorescence optical microscope, uses special bulbs (mercury or xenon light) requiring mounting and calibrating procedures which, although simple, must be carried out according to the manufacturer's recommendations. The voltage supplied to the microscope must correspond to that specified by the manufacturer. Otherwise, unnecessary risks which may affect the quality of lighting are taken. Note that some microscopes use internal or external transformers and voltage regulation systems.

### **Condenser**

The condenser controls how the light is concentrated on, or contrasted against the sample under observation. It is composed of optical and mechanical elements. The optical elements are the lenses and the mechanical ones those which allow the control of the position of the lenses and the quantity of light reaching the sample through a mechanical

### **Revolving, objective holder**

The maintenance of the revolving objective holder is simple. It has an internal catch mechanism which allows the objective in use to be aligned with the optical microscope equipment. It simply rotates smoothly until a trip mechanism adjusts the correct position of the next objective. Each manufacturer defines the number of objectives which can be mounted on the revolver. The most common revolvers can hold between three to five objectives. Maintenance seeks to keep the rotating mechanism clean, lubricated and well adjusted. The objectives should receive routine cleaning of their external optical surfaces. Immersion type objectives require that oil is cleaned off after each use to avoid the objective's internal optical structure from being contaminated with oil through capillarity.

## **20. Autoclave**

An autoclave is a device for carrying out steam sterilization, often under pressure. Pressurized steam is a much more effective agent for destroying micro-organisms than hot air. When sterilization is a priority, an autoclave is often the method of choice. Steam is an effective sterilant because it carries enough heat to destabilize and destroy the cell walls or proteins of living material. Air, in contrast, carries less heat and is less reliable in this regard. (For the same reason, a person can withstand a dry sauna at the boiling point of water, 212 degrees F, but would literally cook to death in a steam room at that same temperature.)

Autoclaves are commonly pressurized. The high pressure helps ensure that steam penetrates to any nooks and crannies that might otherwise be missed. Many autoclaves also have a vacuum capability. The vacuum extracts air that may otherwise form protective air pockets that can prevent full sterilization.

An autoclave, in essence, is a hot, steamy, pressurized box, with enough room to hold the items to be sterilized. There are other types of autoclave used in some industrial settings, but the main use is as a sterilization tool.

EEL BES2	Version:01	Page No.67
	Copyright: Ethiopia Federal TVET Agency	



## Parts of an Autoclave

A look at a diagram of an autoclave, available in the references, shows that the device is a more sophisticated operation than simply injecting steam into a hot box. The working of an autoclave depends on these major parts:

- Chamber: The autoclave box that holds the equipment to be sterilized.
- Controls: An interface panel for users to operate the autoclave.
- Trap: A mechanism to remove air, steam and condensate that has begun to cool.
- Safety valve: A fail-safe valve to prevent excess pressure build-up.
- Steam generator: The water heating unit that creates steam and pressure.
- Cooling system: Prior to discharging wastewater, it is cooled to prevent damage to a facility's sewer system.
- Vacuum system: Present in some autoclaves to remove air prior to injecting steam.

## Autoclave Uses

Hospitals and medical offices use autoclaves to sterilize instruments prior to their reuse. Scientists may sterilize their equipment to achieve a high degree of purity in carrying out chemical reactions or growing pure strains of micro-organisms.

Autoclaves may also be used to sterilize waste materials prior to discharge. This not only kills bacteria and viruses, but softens some materials, such as plastics, so that they can be flattened to reduce waste volume.

Industries use autoclaves for specialty applications, such as curing composite materials or growing speciality crystals. The aerospace industry uses enormous autoclaves that can be more than 50 feet long.



The autoclave is a piece of equipment used for sterilizing.

EEL BES2	Version:01	Page No.68
	Copyright: Ethiopia Federal TVET Agency	



The word sterilizing means the destruction or elimination of all forms of life (microbial, including spores) present in inanimate objects by means of physical, chemical or gaseous procedures. The word sterilizer comes from the Latin word sterilize which means not to bear fruit. This chapter will focus exclusively on autoclaves as these are greatly used in public health establishments, clinical and research laboratories. This type of equipment is also known as a sterilizer. Sterilization must be considered as a group of very important interrelated processes for carrying out health services, (sterilization of materials, culture medium, instruments) within rigorous conditions of asepsis. The processes associated in achieving sterile conditions of inanimate objects are the following

1. Cleaning
2. Decontamination
3. Inspection
4. Preparation and packing
5. Sterilization
6. Storage
7. Delivery of materials

### **PURPOSE OF THE AUTOCLAVE**

The autoclave is equipment designed with the aim of reliably eliminating microorganisms, which would otherwise be present on objects used in diagnostic activities, in treatment or surveillance in health institutions (hospitals, laboratories). It is also widely used in the food processing and pharmaceutical industries. In the laboratory, materials and objects are sterilized for the following purposes:

1. To prepare materials for bacteriological cell cultures  
(Test tubes, pipettes, Petri dishes, etc. In order to avoid their contamination).
2. Prepare elements used for taking samples. (All must be in sterile conditions: needles, tubes, containers).
3. Sterilize contaminated material

Autoclaves are available in many sizes. The smallest are the table-top type and the largest are complex equipment that require a great amount of pre-installation for their operation. The volume of the sterilization chamber is taken as a reference and

EEL BES2	Version:01	Page No.69
	Copyright: Ethiopia Federal TVET Agency	



measured in cubic decimetres [dm<sup>3</sup>] or in litres in order to measure the autoclave's size. Depending on how their operation is controlled, it is possible to find manual, semiautomatic or fully automatic models.

## 21. Spectrophotometer



In biological and chemical research, solutions are often quantified by measuring their degree of light absorption at a particular wavelength. A value called the *extinction coefficient* is used to calculate the concentration of the compound. Molecular biology laboratories use spectrophotometers to measure the concentrations of DNA or RNA samples..

Microbiological and molecular biology laboratories frequently use a spectrophotometer to measure the growth of cultures of bacteria. DNA cloning experiments are often done in bacteria, and researchers need to measure the growth stage of the culture to know when to carry out certain procedures. They measure the absorbance, which is known as the optical density (OD), on a spectrophotometer

Before attempting to deal with:

**What** and **how** spectrophotometer works, it is important to discuss **on**:

- light properties
- interaction of light with matter
- Types of light

Electromagnetic energy

EEL BES2	Version:01	Page No.70
	Copyright: Ethiopia Federal TVET Agency	

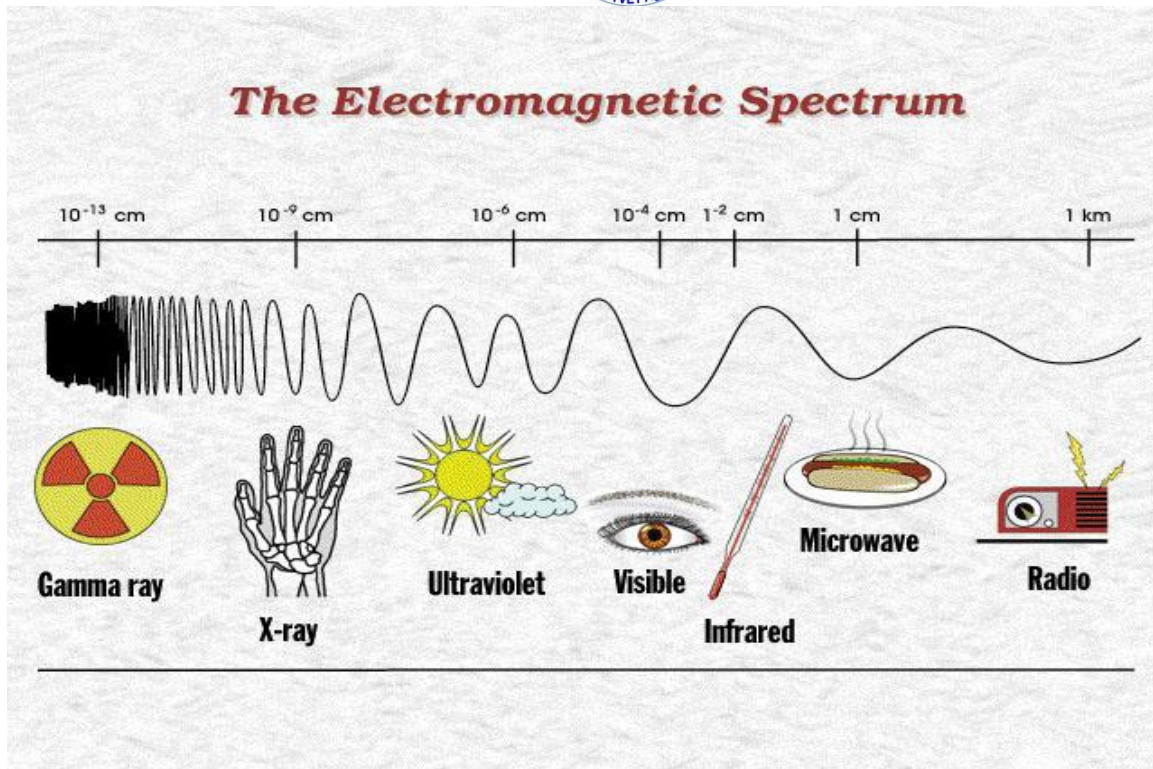

Light

properties

- light is one **form of** electromagnetic energy
- In space, it has a constant velocity of  $3 \times 10^8$  m/s.
- In other medium its velocity will be lower and calculated as:

$$v_o = c/n$$

Where: n = Medium refraction index

Upon interacting with matters light undergoes:

- Reflection
- Diffraction
- Absorption
- Polarization and
- Diffusion

EEL BES2	Version:01	
	Copyright: Ethiopia Federal TVET Agency	
		Page No.71

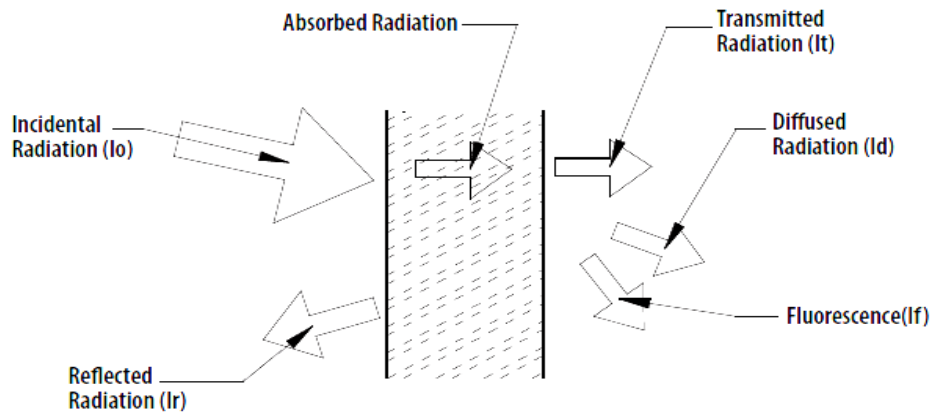

### Relationship of light interaction and matters property

- **concentration** of specific matter in sample and the intensity of light **transmitted** through, is proportional
- Based on transmittance and absorbance concept

$$T = I_t / I_0$$

Where: T = transmittance

$I_0$  = intensity of incident light

### Absorbance property

- The **concentration of light absorbing** molecules in a sample is proportional to the **absorbed light intensity**

$$A = \epsilon LC$$

Where: A = absorbance

$\epsilon$  = absorbance coefficient

L = sample path length

c = concentration of molecules in the sample

### Transmittance and absorbance relationship

$$A = \text{Log}_{10} \frac{1}{T}$$

$$= \text{Log}_{10} \frac{I_0}{I_t}$$

Graphical interpretation of absorbance and transmittance

EEL BES2	Version:01	Page No.72
	Copyright: Ethiopia Federal TVET Agency	



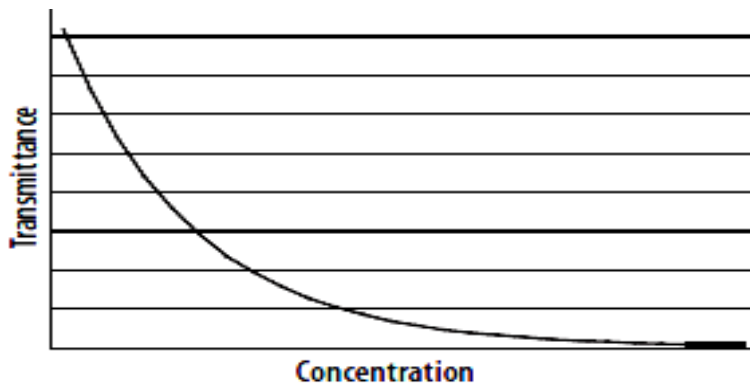
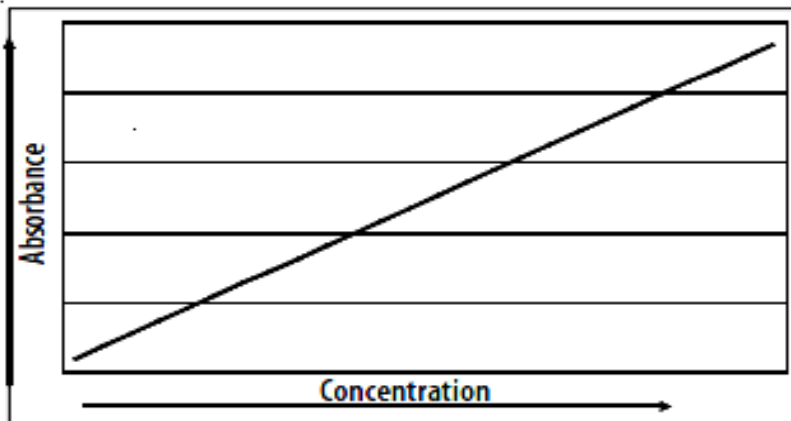

## Spectrophotometer

- Spectrophotometer is medical instrument used in diagnostic and research institute
- Used for qualitative and quantitative analysis of samples
- It uses the properties of light and its interaction with other substances

## Spectrophotometer principle

### Spectrophotometer's important component

- The light source
- The monochromatic
- The sample carrier
- The detector system
- The reading system

### Light source

Light source can be,

- Tungsten lamp for visible light and
- Deuterium lamp for ultraviolet light
- There is also long lasting xenon lamps emitting light in the visible and ultraviolet ranges

EEL BES2	Version:01	Page No.73
	Copyright: Ethiopia Federal TVET Agency	



## Monochromatic

- monochromatic is used to **disperse white light** into waves of different wavelengths
- Radiation used in the sample reading is selected from this dispersed light waves
- Generally monochromatic limits the light radiation produced by the source and confines it to a determined area

## Monochromator diagram

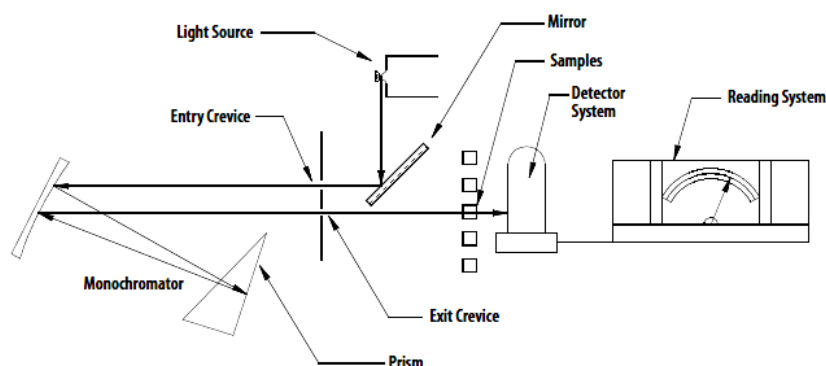

### Sample holder

Holds the sample to be analyzed. There are various sample holder types:

- Microcells
- Micro plates
- Cuvettes
- Test tubes and
- continuous flow cells

Cuvettes are made of glass to read in the range of 340-1000 nm and Others of silica to read in the visible range of 220-340 nm.

### Detector

Designed from:

- Phototubes
- photocells
- photodiodes or
- Photomultipliers

Detection system receives light from the sample and converts it into an electrical signal

## 22. Incubator

The word incubator comes from the Latin word incubare which means to brood. The incubator is designed as a chamber of controlled temperature, atmosphere and humidity for the purpose of maintaining live organisms in an environment suitable for their growth. Among its most common uses are incubation of bacteriological, viral,

EEL BES2	Version:01	Page No.74
	Copyright: Ethiopia Federal TVET Agency	



microbiological and cellular cultures; determination of the biochemical demand for oxygen (BOD) and biological storage. Incubators vary in complexity and design. Some only control temperature while others control the atmospheric composition as well. Some have the capacity to achieve temperature conditions below room temperature with refrigeration systems. Depending on the design and specifications, incubators control temperatures from -10 °C and go up to 75 °C or slightly more. Some incubators have CO<sub>2</sub> injection for achieving special atmospheric conditions at which the growth of diverse species of organisms and cells is favoured.

## OPERATING PRINCIPLES

The incubator uses diverse means of heat transference and environmental control to achieve conditions for specialized laboratory procedures. In general, these have a system of electrical resistors controlled by thermostats or microprocessors. As for the heat transference systems, the incubators use conduction and natural or forced convection.

### 23. Water Distiller

The word *distiller* comes from the Latin word *distillare* which means to vaporize liquids through heat. The water distiller, also called distillation unit or water still, used in the laboratory, purifies running water by means of controlled vaporization and cooling processes. Upon applying thermal energy to water in a liquid phase by a warming process, it is changed into vapour. This allows the water molecules to separate from the molecules of other substances mixed or diluted. The water vapour is collected and passed through a condenser, where it is cooled and returned to the liquid phase. Then, the condensed water is collected into a different storage tank. Distilled water shows pure characteristics compared to running water; it is practically free of contaminating substances.

## PURPOSE OF THE WATER DISTILLER

The water distiller facilitates obtaining very pure water from potable water normally provided by the aqueduct services in urban centers. Distilled water is characterized by a lack of solids in suspension. It is used in multiple applications in centers which provide health services, especially in laboratory units, in washing, sterilization and dietetics. The

More specialized the procedures are in the laboratory, the greater will be the level of purity required. For example: the preparation of reagents or biological material requires water of the highest quality. Distillation is one of the fundamental processes to achieve this (although it may not be the only one required). Water used in laboratories must be free of progeny, with a concentration of total solids no greater than 1 ppm, a pH value between 5.4 and 7.2 and an electrical resistance of at least  $3 \times 10^5$  ohm/cm at 25 °C<sup>1</sup>.

EEL BES2	Version:01	Page No.75
	Copyright: Ethiopia Federal TVET Agency	



<b>Self-Check -1</b>	<b>Written Test</b>
----------------------	---------------------

**Directions:** Answer all the questions listed below. Use the Answer sheet provided in the next page:

**Part 1. Chose the correct answer**

- 1) ..... is used to incubate samples in water at a constant temperature over a long period of time.
 

A. Incubator	C. Cold chain Equipment
B. Water bath	D. Shaker
  
- 2) One of the following is **not** the main components of microscope.
 

A. Incandescent bulb	C. Lid/cover
B. Condenser	D. Eyepiece
  
- 3) Which one of the following is **not** the function of Electric muscle stimulation (EMS) equipment?
 

A. Relieve discomfort and pain	C. Restore muscle tone
B. Reduce muscle spasms	D. measuring pressure
  
- 4) The different parts of laryngoscopes are
 

A. Fiberoptic	C. lamp
B. Video	D. All
  
- 5) One of the following equipment is designed to monitor blood pressure by measuring the force of the blood in the heart where the pressure is greatest.
 

A. Sphygmomanometer	C. EMS
B. Laryngoscopy	D. none

**Part 2 Machining Question**

Column A	Column B
6. Clinical weighing scales	F) Indicate the pressure
7. Oxygen gauge	G) separating solids suspended in a liquid by sedimentation
8. Suction machine	H) Measuring their degree of light absorption
9. Spectrophotometer	I) Measure the weight
10. Centrifuge	J) secretions of mucus

**Note: Satisfactory rating - 3 and 5 points**

**Unsatisfactory - below 3 and 5 points**

You can ask you teacher for the copy of the correct answers.

EEL BES2	Version:01	Page No.76
	Copyright: Ethiopia Federal TVET Agency	



## Answer Sheet

Score = \_\_\_\_\_

Rating: \_\_\_\_\_

### Part 1 Multiple chose question

6. ....

7. ....

8. ....

9. ....

10.....

### Part 2 Matching question

6. ....

7. ....

8. ....

9. ....

10.....

Name: \_\_\_\_\_

Date: \_\_\_\_\_

### Short Answer Questions

EEL BES2	Version:01	Page No.77
	Copyright: Ethiopia Federal TVET Agency	



<b>Information Sheet-2</b>	<b>Following OSH policies and procedures</b>
----------------------------	--

## 2.2 Follow OSH policies and procedures

### 2.2.1 OHS guidelines

#### Occupational Health and Safety procedures for a given work area

Occupational health and safety (OH&S) is the term used to describe the laws and processes that help to protect employees from death, disease and injury while at work.

#### What is hazard?

The Occupational Health and Safety Regulation 2001 define a hazard as ‘anything (including work practices or procedures) that has the potential to harm the health or safety of a person’.

**Hazard:** is also a situation or thing that has the potential to harm a person. Hazards at work may include: noisy machinery, a moving forklift, chemicals, electricity, working at heights, a repetitive job, violence at the workplace etc.

**Risk:** is the possibility that harm (death, injury or illness) might occur when exposed to a hazard.

#### *Hazards can be grouped into five broad areas:*

- **Physical k hazarde.g.** noise, radiation, light, vibration
- Chemical hazard e.g. poisons, dusts
- Psychological hazarde.g. fatigue, violence
- **Biological** e.g. viruses, bacterial infection , parasites
- **Mechanical/electrical hazard** e.g. trips and falls, tools, electrical equipment (micro or macro shock).

**Hazards can arise from:** work environment use of machinery and substances poor work design inappropriate systems and procedures.

#### **Risk management**

Risk management is a proactive process that helps you responds to change and facilitate continuous improvement in your business. It should be planned, systematic and cover all reasonably foreseeable hazards and associated risks. It involves four steps to set out hazards;

**Identify hazards** – find out what could cause harm.

**Assess risks if necessary** – understand the nature of the harm that could be caused by the hazard, how serious the harm could be and the likelihood of it happening.

**Control risks** – implement the most effective control measure that is reasonably practicable in the circumstances.

**Review control measures**-to ensure they are working as planned.

EEL BES2	Version:01	Page No.78
	Copyright: Ethiopia Federal TVET Agency	



## Step 1 – How to identify hazard

Identifying hazards in the workplace involves finding things and situations that could potentially cause harm to people. Hazards generally arise from the following aspects of work and their interaction: physical work environment equipment, materials and substances used work tasks and how they are performed work design.

### How to find hazards

- Inspect the work place
- Consult your workers
- Review available information's

## Step 2 – How to assess risk

A risk assessment involves considering what could happen if someone is exposed to a hazard and the likelihood of it happening. A risk assessment can help you determine: how severe a risk is whether any existing control measures are effective what action you should take to control the risk how urgently the action needs to be taken.

## STEP 3 – How to control risks

The most important step in managing risks involves eliminating them so far as is reasonably practicable, or if that is not possible, minimizing the risks so far as is reasonably practicable. The hierarchy of risk control. The ways of controlling risks are ranked from the highest level of protection and reliability to the lowest as shown in Figure below.

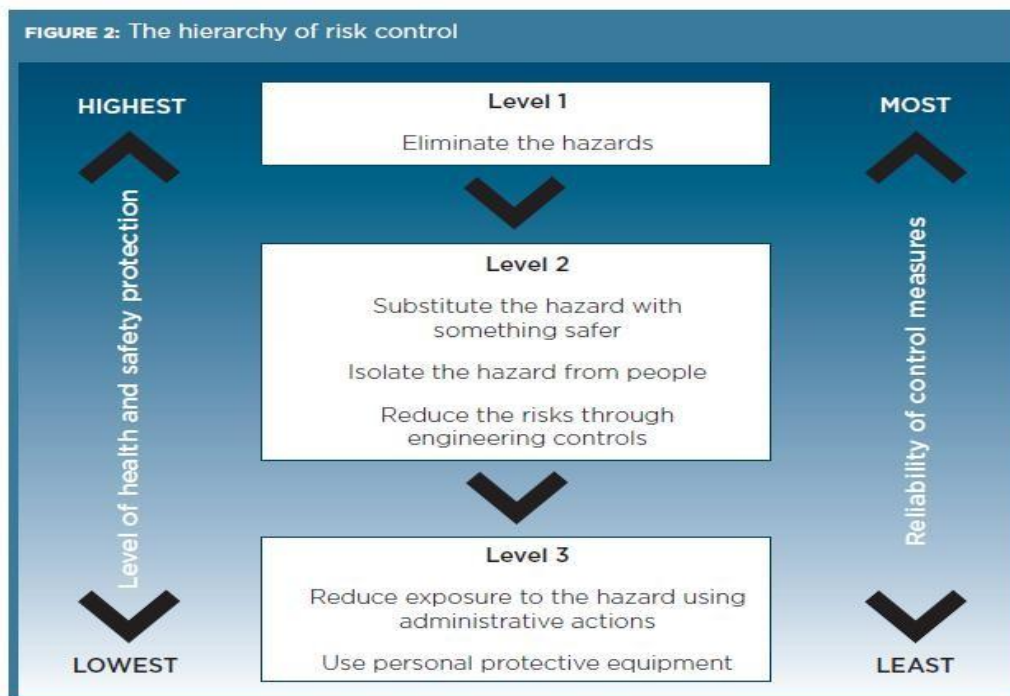

CODE OF PRACTICE | HOW TO MANAGE WORK HEALTH AND SAFETY RISKS

EEL BES2	Version:01	Page No.79
	Copyright: Ethiopia Federal TVET Agency	



### LEVEL- 1 Control measures

You must always aim to eliminate a hazard, which is the most effective control.

If this is not reasonably practicable, you must minimize the risk by working through the other alternatives in the hierarchy. The best way to do this is by, firstly, not introducing the hazard into the workplace. For example, you can eliminate the risk of a fall from height by doing the work at ground level.

### LEVEL- 2 control measures

If it is not reasonably practicable to eliminate the hazards and associated risks, you should minimize the risks using one or more of the following approaches:

#### Substitute the hazard with something safer

For instance, replace solvent-based paints with water-based ones.

#### Isolate the hazard from people

This involves physically separating the source of harm from people by distance or using barriers. For instance, use remote control systems to operate machinery; store chemicals in a fume cabinet. **Use engineering controls**

An engineering control is a control measure that is physical in nature, including a mechanical device or process. For instance, use mechanical devices such as trolleys to move heavy loads; place guards around moving parts of machinery; install residual current devices (electrical safety switches); set work rates on a production line to reduce fatigue.

### LEVEL- 3 control measures

These control measures do not control the hazard at the source. They rely on human behavior and supervision, and used on their own, tend to be least effective in minimizing risks. Two approaches to reduce risk in this way are:

Use administrative controls

Administrative controls are work methods or procedures that are designed to minimize exposure to a hazard.

For instance, develop procedures on how to operate machinery safely, limit exposure time to a hazardous task, and use signs to warn people of a hazard.

### 2.2.2 Ethiopia Electrical Code

Colour identification of bare conductors and cable cores (EELP's Regulation)

Function	Colour identification of core of rubber of PVC insulated
Earthling	White
Live of .c single - phase circuit	Green
Neutral of a.c single - phase or three - phase circuit	Black





Phase R of three - phase a.c circuit	Green
Phase S of three - phase a.c circuit	Yellow
Phase T of three - phase a.c circuit	Red

## 2.2.3 Follow environmental protection legislation and regulations

### MEDICAL CENTRES SAFETY PROGRAM

- ❖ Safety includes a range of hazards including mishaps (an unlucky accident), injuries on the job, and patient care hazards.
- ❖ The most common safety mishaps are “needle sticks” (staff accidentally stick themselves with a needle) or patient injury during care.
- ❖ As a manager, ensure all staff and patients are safe within the facility.
- ❖ Note: it’s everyone’s responsibility!

### Laboratory safety

#### Laboratory Safety Comes First!

- ❖ Hand washing
- ❖ Standard (Universal) precautions
- ❖ Electrical Safety
- ❖ Fire Safety

#### Basic Laboratory Safety Issues

❖ Hand washing	❖ Hair & Jewelry
❖ Smoking	❖ Eye Wash/Safety Showers
❖ Food & Drink	❖ Do Not Mouth Pipette
❖ Eye & Face Protection	❖ Good Housekeeping
❖ Cosmetics	❖ Sharp Objects
❖ Shoes	❖ Hair & Jewelry

#### Basic Rules of Bio Safety

The basic rules of Bio safety are essential to avoid occupational hazards when working in the laboratory.

1. Washing hands following all laboratory activities, following the removal of gloves and immediately after contact with infectious agents.
2. Does not mouth pipette?
3. Use protective laboratory coats and gloves.
4. Do not eat, drink, smoke or store food in the laboratory.
5. Manipulate infectious agent carefully to avoid spills and the production of aerosols and droplets.
6. Decontaminate work surface before and after use, and immediately after spills.
7. Use needles, syringes and other sharps only absolutely necessary.

EEL BES2	Version:01	Page No.81
	Copyright: Ethiopia Federal TVET Agency	



## Rules of Environmental and Safety Compliance

- All personnel working in laboratories must be trained in safe work practices and hazardous waste disposal.
- Maintain an accurate hazardous materials inventory.
- Properly label all hazardous materials.
- Segregate incompatible materials and place in safe storage locations.
- Use fume hood and other appropriate controls when using flammables, toxic or odorous vapors.
- Wear the appropriate protective equipment, such as a laboratory coat, gloves, safety glasses.
- Use non-hazardous material instead of hazardous materials whenever possible.

There are several meeting that are medical equipment managers are required to attend as the organizations technical representative. The following are:

- Patient safety
- Environmental of Care
- Space Utilization Committee
- Equipment Review Board
- Infection Control (optional)
- Safety of our patient/staff is paramount to the success of our organizations mission.
- Goals are developed by experts in patient safety nurses, physicians, pharmacists, risk managers, and other professionals with patient-safety experience in a variety of settings.
- Patient safety is among the most important goals of every healthcare provider, and processes concerned with patient safety provides way for biomedical managers and clinical engineering departments to gain visibility and positively affect their workplace.

## Electrical Safety

- Electrical safety is the containment of limitation of hazardous such as, electrical shock, explosion, fire or damage to equipment and buildings.
- Preventive maintenance programs reduce electrical hazards such as:
  - The physiological effects of electricity.
  - Leakage current
  - Ground fault
  - Electrical short hazard.
  - The use of proper power wiring distribution, and ground system in reducing electrical shock hazards.
  - Specialized electrical safety test equipment

EEL BES2	Version:01	Page No.82
	Copyright: Ethiopia Federal TVET Agency	



## Chemical Safety

- Laboratories use a lot of chemicals that caustic and corrosives
  - Concentrated acids or bases, organic solvents that are noxious and flammable, eye irritants, mutagens, teratogens, etc.
- Spills are possible
  - Wear gloves
  - Clean the outside of the instrument
  - Look for spill marks inside and clean these as well
- Ask lab personnel to help clean up the equipment, especially if you are taking to the shop
- Address any concerns to the Chemical Safety Officer

## Biological Safety

- A biomedical technician will be working with instruments that come in contact with infectious organisms or patient samples, both of which could be hazardous to one's health. All such samples, whether from healthy or sick, are to be considered hazardous
- Wearing proper protection such as lab coats, eye protection and gloves should be made a habit
- Instruments must be decontaminated by the lab personnel before repair is attempted, especially if moving the equipment to the shop
- Some of the instruments may be located within labs and unmovable
- Work with the biological safety officer to ensure your safety

## Levels of Biological Safety

- Depending on the hazard posed by the organism being cultured, different biological safety levels are mandated.
- These safety levels, BSL 1 – BSL 4 specify containment and precautions, with level 1 being least restrained and 4 being highly contained.
- Hazards are generally higher in research lab than in routine clinical labs
- Know the biosafety officer and address questions

## Biohazard Signs and Biosafety Levels



EEL BES2	Version:01	Page No.83
	Copyright: Ethiopia Federal TVET Agency	



<b>Self-Check -2</b>	<b>Written Test</b>
----------------------	---------------------

**Directions:** Answer all the questions listed below. Use the Answer sheet provided in the next page:

**Say true for the correct statement and false for wrong statement**

- 1) All personnel working in laboratories must be trained in safe work practices and hazardous waste disposal.
- 2) Conductors and cable cores (EELP's Regulation) colour code for neutral is white.
- 3) Control measures are not reasonably practicable to eliminate the hazards and associated risks.
- 4) Hazards are generally lower in research lab than in routine clinical labs.
- 5) Risk management is a proactive process that helps you responds to change and facilitate continuous improvement in your business

**Note: Satisfactory rating - 25 points**

**Unsatisfactory - below 25 points**

**You can ask you teacher for the copy of the correct answers.**

EEL BES2	Version:01	Page No.84
	Copyright: Ethiopia Federal TVET Agency	



## Answer Sheet

Score = \_\_\_\_\_

Rating: \_\_\_\_\_

### True or False Questions

1. \_\_\_\_\_

2. \_\_\_\_\_

3. \_\_\_\_\_

4. \_\_\_\_\_

5. \_\_\_\_\_

Name: \_\_\_\_\_

Date: \_\_\_\_\_

### Short Answer Questions

EEL BES2	Version:01	Page No.85
	Copyright: Ethiopia Federal TVET Agency	



<b>Information Sheet-3</b>	<b>Using proper PPE according to company requirements</b>
----------------------------	---

### 2.3 Use proper PPE according to company requirements

#### Use personal protective equipment (PPE)

**Definition:** Devices used to protect employees from injury or illness resulting from contact with chemical, radiological, physical, electrical, mechanical, or other workplace hazards.

The need for PPE and the type of PPE used is based on hazard present; each situation must be evaluated independently. Examples of PPE include ear muffs, respirators, face masks, hard hats, gloves, aprons and protective eyewear. PPE limits exposure to the harmful effects of a hazard but only if workers wear and use the PPE correctly.

Information about suitable controls for many common hazards and risks can be obtained from:

- Codes of practice and guidance material
- Manufacturers and suppliers of plant, substances and equipment used in your workplace.

PPE is used as a last resort to avoid risk in work place.

The use of PPE signifies that the hazard could not be controlled by other methods, such as: administrative controls, engineering or industrial hygiene controls. The use of PPE signals that the hazard still exists in the workplace unprotected individuals in the same area will be exposed.

Failure of PPE means that the worker will be exposed. PPE type depends on hazard to be protected.

#### Head protection

Protective helmets (hard hats) come in a variety of shapes. They may be made of tough polyethylene or polycarbonate, one of the toughest hat materials yet developed. Regular hard hats must be insulated so that personnel may be protected from accidental head contacts with electrical circuits and equipment at comparatively low voltages (less than 2200 volts).

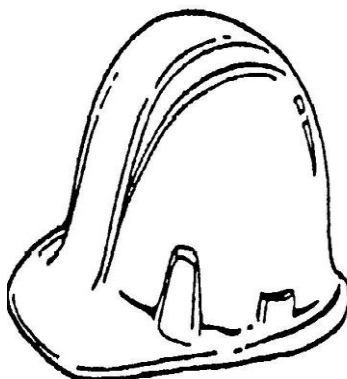



## Eye and Face protection Common Uses:

- Impact Protection
- Chemical Hazards
- Radiation Protection

## Eye and Face Protection device

- welder's goggles
- laser goggles
- UV
- Infrared
- Safety glasses are used to protect the eyes from flying objects.
- Chemical splash goggles protect against fluids by sealing tightly against the face
- Face shields provide highest level of protection

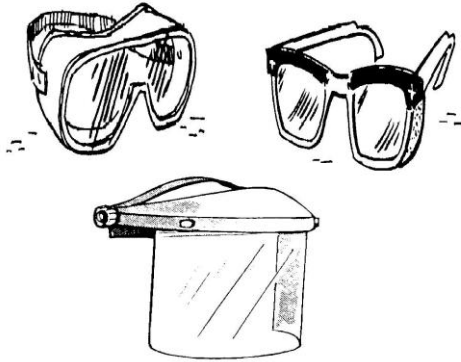

## Hearing Protection

Noise induced hearing loss can occur with exposures >90 dB. All hearing protection devices should have a Noise Reduction Rating (NRR) of decibels they will reduce noise levels.

### Types

- **Ear Plugs** - less expensive, disposable, good ones have fairly high NRRs - sometimes difficult to tell if employees are wearing them
- **Ear Muffs** - more expensive, more durable, typically higher NRRs than plugs, more obvious.

EEL BES2	Version:01	Page No.87
	Copyright: Ethiopia Federal TVET Agency	



### Arm and Hand protection

**Gloves** - Typical Uses Chemical protection Biohazard protection Friction protection Protection from extremes of heat and cold.

#### Types

- Surgical gloves
- Electrical gloves



### Foot and Leg protection

Steel-toed footwear, preferably with metatarsal guards, is used to protect feet from crushing injuries caused by heavy objects

Rubber boots are often used to protect feet from exposure to liquids.

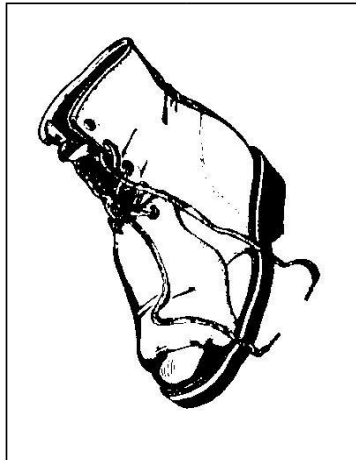

EEL BES2	Version:01	Page No.88
	Copyright: Ethiopia Federal TVET Agency	





## Respiratory protection

Protects users by removing harmful materials that may enter the body via the lungs. Inhalation is one of the quickest, most efficient ways to introduce lethal levels of hazardous materials into the body.

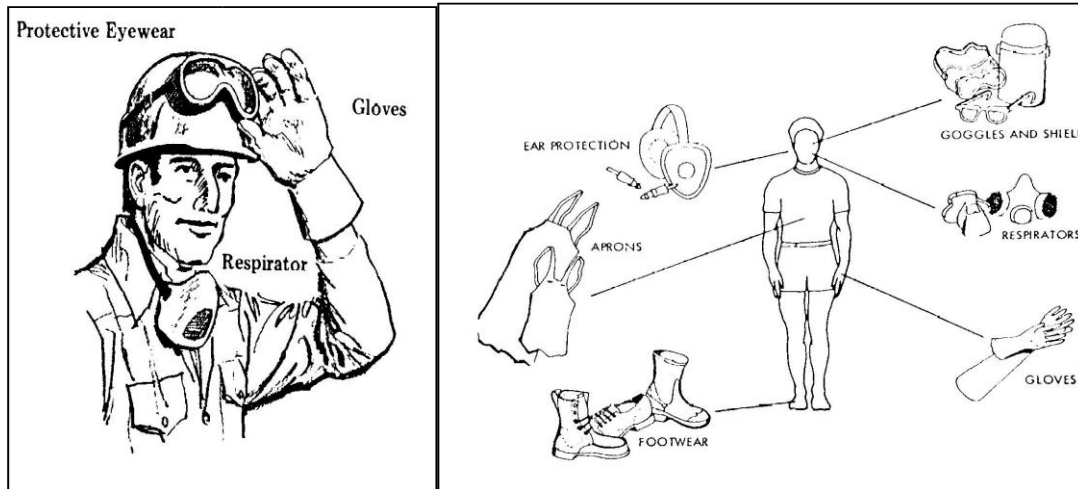

## Selection and Use of Chemical Disinfectants Alcohols (ethanol, isopropanol)

Ethanol or isopropanol in concentrations of 70% - 95% are good general-use disinfectants. They are most effective against lipophilic viruses, less effective against non-lipid viruses, and ineffective against bacterial spores. Because of their quick evaporation rate, it may be difficult to achieve sufficient contact time.

**Disinfectants Defined:** - Disinfecting agents are registered by the Environmental Protection Agency (EPA) as “antimicrobial pesticides” and are substances used to control, prevent, or destroy harmful microorganisms (i.e., bacteria, viruses, or fungi) on inanimate objects and surfaces. These antimicrobial products have traditionally included sanitizers, disinfectants, and sterilants.

EEL BES2	Version:01	Page No.89
	Copyright: Ethiopia Federal TVET Agency	

**Self-Check -3****Written Test**

**Directions:** Answer all the questions listed below. Use the Answer sheet provided in the next page:

1. What are the common uses of Eye and Face protection are
  - A. Impact Protection
  - B. Chemical Hazards
  - C. Radiation Protection
  - D. All
  
2. .... Uses Chemical protection, Biohazard protection, Friction protection from extremes of heat and cold?
  - A. Glove
  - B. Head protection
  - C. Hearing Protection
  - D. Eye and Face protection
  
3. PPE used to protect employees from injury or illness resulting from contact with, electrical, mechanical, or other workplace hazards.
  - A. Chemical
  - B. Radiological
  - C. physical
  - D. All
  
4. One of the following is **not** the protective device?
  - A. welder's goggles
  - B. Infrared
  - C. laser goggles
  - D. None
  
5. Which one of the following are the types of Hearing Protection?
  - A. Ear Plugs
  - B. Ear Muffs
  - C. Ear glove
  - D. A & B

Note: Satisfactory rating - 25 points

Unsatisfactory - below 25 points

You can ask you teacher for the copy of the correct answers.

EEL BES2	Version:01	Page No.90
	Copyright: Ethiopia Federal TVET Agency	



## Answer Sheet

Score = \_\_\_\_\_

Rating: \_\_\_\_\_

### Part 1 Multiple chose question

1. ....
2. ....
3. ....
4. ....
5. ....

Name: \_\_\_\_\_

Date: \_\_\_\_\_

### Short Answer Questions

EEL BES2	Version:01	Page No.91
	Copyright: Ethiopia Federal TVET Agency	



### 1.4 Select electrical cabling and wiring devices

#### 1.4.1 Wire rating

##### **Selection of wires**

The word wire applies to a single electrical conductor. The conductor may be one strand of material or several strands twisted together. Wires are used for carrying current in an electrical installation. There are different types of wires used in electrical installation. It consists of a core, which conducts electricity, and insulation cover, which doesn't conduct.

##### **WIRE SIZE**

A group of wire sizes has been established to cover all wiring needs. The empirical values for the allocation of the core cross-sections; maximum current and application ranges can be read off from the table for domestic installations.

Table-wire size for Domestic installation

Wire cross-section	Max.current	Application range
0.75	6A	Lighting circuits
1	10 A	Lighting circuits
1.5	16 A	Lighting and socket outlet circuits
2.5	20 A	Space heater
4	25 A	Washing machine
6	35 A	Flow type heaters
10	50 A	Sub-distribution
16	63 A	House service circuit

##### THINGS TO BE CONSIDERED WHEN SELECTING THE RIGHT CONDUCTOR SIZE

- 1. Conductor materials:-** copper is the standards. For aluminum or copper clad aluminum the rule of thumb is to use wire two sizes larger than specified for copper.
- 2. Maximum expected current load:-**conductor size (based on ampacity) must be sufficient ton carry the maximum expected load safely.
- 3. Wet or dry location:-** conductor insulation must be suitable to moisture conditions.
- 4. Area air temperature:-** Areas where air temperature are usually above 30<sup>0</sup> C require larger conductors and special insulation.



### 1.4.2 Fuse

On consumer installations, the two types of protection used against over loads and short circuit faults are

1. Fuses

2. Circuit breakers uses operate on the basis of the heating effect ( $I^2 R$ ) of the excess current which melts the fuse element. There are three main types of fuses: - The rewritable, cartridge and the HBC (high rating capacity) fuse; the latter is development of the cartridge type.

Three terms are used in connection with fuses: current rating. This is the maximum current that a fuse will carry indefinitely without undue deterioration of the use- element. using current This is the minimum current that will 'blow' the fuse. Using factor This is the ratio of the minimum fusing current to the current rating.

$$\text{Fusing factor} = \frac{\text{minimum fusing current}}{\text{Current rating}}$$

### 2.4.3 Circuit breakers

It is a device designed to open and close a circuit by non- automatic means, and to open the circuit automatically on a predetermined over current without injury to itself when properly applied within its rating. So a circuit breaker is combination device composed of a manual switch and an over current devices.

Essentially a circuit breaker consists of a carefully calibrated by metallic strip. As current flows through the strip, eat is created and the strip bends. If enough current flows through the strip, it bends enough to release a trip that pens the contacts, interrupting the circuit just as it is interrupted when a fuse blows or a switch is opened. In addition to the bimetallic strip that operates by heat, most breakers have a magnetic arrangement that open the breaker instantly in case of short circuit. A circuit breaker can be considered a switch that opens itself in case of overload.

Circuit breakers are rated in amperes just as fuses are rated. Like fuses, breakers are tested in open air to carry 10% of their rated loads indefinitely without tripping. Most breakers will carry 150% of their rated load for perhaps a minute; 200% for about 20 second.

**Standard rating:** Both fuse and circuit breakers are available in standard ratings of 6,10,16,20,25,35,50,53,80,100,125,160,224,250,300 and large sizes.

Comparison between MCB versus convectional fuses

MCB	Conventional fuses
<p><b>1. Protection</b> MCB instantly switches off the supply automatically if there is a short circuit, overload or earth fault. It thus prevents damage to expensive wiring and the risk of fire.</p>	<p>Some times, fuse wire of proper rating is not used which results in non-disconnection (melting) of fuse wire in the event of short circuit, or power overload. This can lead to electrical accidents, as the tripping is essential in such cases.</p>



<p><b>2. Safety</b> Re-starting power supply after tripping due to over load or short circuit is easy. Just switch on the MCB like switching on a lamp, which any person can do.</p>	<p>TO replace a blown fuse in between live current carrying points is potentially dangerous especially in the dark. The fuse wire may go loose even if replaced and this may be dangerous while fixing the fuse.</p>
<p><b>3. Convenience</b> The MCB needs no maintenance and repairs. It doesn't deteriorate with time.</p>	<p>The system using rewirable is not convenient as the exact size of fuse wire may not be available as the time of wiring. Also complete kit of hand tools has to be kept ready all the time.</p>
<p><b>4. Look</b> The board where MCB is installed gives a beautiful look as it is compact and elegant</p>	<p>The fuse board is not compact one and large enough to be hidden.</p>

#### 1.4.4 Sockets and Plugs

The function of socket outlet is to provide tapping from socket terminals to the electrical fixture such as radio; able fan and heater etc. The socket outlets are of two types: . Two or three pin 5 Amp.

Three pins 15 Amp. The difference between 5 Amps and 15 Amp Sockets are in there sizes which amounts rating. The third terminal is for holding the earth wire. These are available in market as tumbler (for surface wiring) and flush sockets (for concealed conduit wiring). The three pin socket outlets are of two types

- (a) 5 Amp for table fan, table lamps etc.
- (b) 15Amp.sockets for heater, iron etc.





## Answer Sheet

Score = \_\_\_\_\_

Rating: \_\_\_\_\_

### Part 1 Multiple chose question

1. ....
2. ....
3. ....
4. ....
5. ....

Name: \_\_\_\_\_

Date: \_\_\_\_\_

### Short Answer Questions

EEL BES2	Version:01	Page No.96
	Copyright: Ethiopia Federal TVET Agency	





<b>Information Sheet-5</b>	<b>Installing equipment in accordance with manufacturer's instructions</b>
----------------------------	--

## 5.1 Installing equipment in accordance with manufacturer's instructions

### 5.1.1 Install simple biomedical equipment and accessories

#### 1. Oxygen gauge

It usually features two pressure gauges, one to indicate the pressure in the cylinder (the inlet pressure gauge) and one to indicate the pressure delivered to the application (the outlet pressure gauge). Once the outlet pressure has been set by the user, the regulator will maintain this pressure irrespective of the pressure in the cylinder.



Parts of oxygen gauge

1. Inlet pressure gauge,
2. Connection to cylinder valve,
3. Pressure adjusting screw,
4. Outlet pressure gauge,
5. Connection to user equipment

Assembling of these parts is just connecting the gauge with the oxygen cylinder valve.

#### 6. Sphygmomanomètre

A sphygmomanometer is a device that measures blood pressure. It composes of an inflatable rubber cuff, which is wrapped around the arm. A measuring device indicates the cuff's pressure. A bulb inflates the cuff and a valve releases pressure. A stethoscope is used to listen to arterial blood flow sounds.

#### Main part of Sphygmomanomètre

- i. Manometers
- ii. The cuff with inflatable bladder
- iii. The pumping bulb with pressure release valve
- iv. Hand-held BP apparatus with one or two tubes

EEL BES2	Version:01	Page No.97
	Copyright: Ethiopia Federal TVET Agency	



Assembling this machine is just connecting the tube according to the manual.

## 7. Suction Apparatus

It is also called *Aspirators* are medical devices used to extract mucus and other fluids from an individual. It is used for a variety of purposes, including tracheal suctioning and clearing mucus from the mouth and throat. Secretions are displaced by suction catheters and yankauer tips through a tube and then collected into a suction canister. When using a suction device, you will place the suction catheter into a tracheostomy tube, endotracheal tube or directly in the oral cavity to remove the fluids

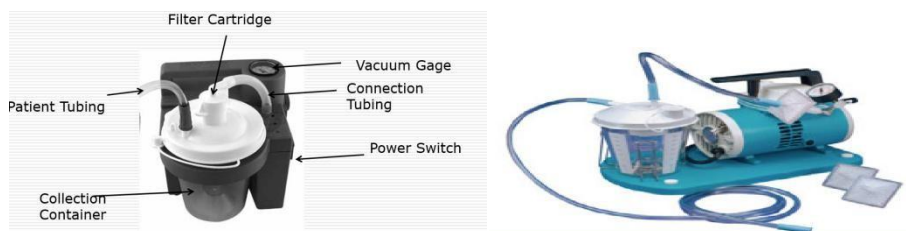

### Installation

- Position the unit close to patient
- Plug into AC power (do not use extension cords)
- Attach first suction tubing from pump suction control to collection bottle outlet
- Attach second suction tubing to collection bottle inlet
- Check all components and connections for tight fit
- Turn suction pump on (on/off electrical switch)
- Crimp tubing coming from the collection bottle inlet
- Adjust suction to desired level while observing vacuum gauge
- Initiate suction procedure

EEL BES2	Version:01	Page No.98
	Copyright: Ethiopia Federal TVET Agency	



## 8. Autoclave

The autoclave is equipment designed with the aim of reliably eliminating microorganisms, which would otherwise be present on objects used in diagnostic activities, in treatment or surveillance in health institutions (hospitals, laboratories). It is also widely used in the food processing and pharmaceutical industries.

### INSTALLATION REQUIREMENTS

To be able to function, autoclaves require the following services

1. A well-ventilated area for removing heat and humidity generated while in operation. It also requires free space around the back and sides, to accommodate technical

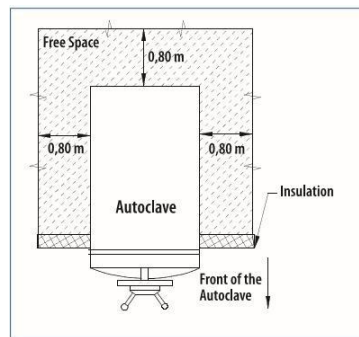

2. An electrical outlet in proportion to the equipment's consumption
3. Water connection proportional to the equipment's consumption in volume and pressure
4. A drainage system designed for collecting hot water.
5. A vapour connection. If the autoclave does not have its own vapour generator, it must be fed from the institution's vapour generating system (machine room, boiler). The supply installation must meet the necessary.

**Note that:** - the specific installation procedure needs to have the installation manual for the specific machine so refer it.

## 9. OR/DR light

Surgical lighting or operating lights, are used in hospital OR room they are used by clinicians, surgeons and procedurals a surgical light illuminates the operative site on a patient for optimal visualization during a procedure.

EEL BES2	Version:01	Page No.99
	Copyright: Ethiopia Federal TVET Agency	



### Installation consideration

1. Sight preparation according
  - 1.1 Consider the Weight of the machine before mounting on mounting surface
  - 1.2 Space for free movement of the machine during surgical procedure
  - 1.3 Height of the machine from patient bed should be considered
2. Electrical installation consideration
  - 2.1 An electrical outlet in proportion to the equipment's consumption
  - 2.2 It is advisable to use UPS
3. Use the installation manual for assembling of the parts
4. Check the intensity of light after installation.

### 10. OR table

Operation table (OR table) is hospital equipment used in the OR room as bed for the patient during surgical procedure.



EEL BES2	Version:01	Page No.100
	Copyright: Ethiopia Federal TVET Agency	



## Installation consideration

1. An electrical outlet for automatic one in proportion to the equipment's consumption
2. The space for free movement of the bed
3. Space consideration for free movement of the doctor
4. Alignment with OR light
5. Use installation manual for assembling of the parts for specific bed.

### 11. Cold chain Equipment

Refrigerators and freezers are used for the conservation of blood and its derivatives, biological liquids and tissues, reagents, chemicals, and stocks.

1. An electrical connection with a ground pole appropriate to the voltage and frequency of the equipment
2. If more than one unit installed depend on the same electrical circuit, it must be verified that the capacity (electrical power) and safety devices are adequate for supplying the amount of power required by these units
3. Directly connect the unit to the electrical outlet. Never connect a unit to an overloaded electrical outlet or one with voltage deficiencies
4. Install the unit on a leveled surface, leaving free space around the equipment, it is customary to leave a free space of 15 cm at the sides and at the back of the unit to facilitate ventilation of the condenser.
5. Avoid installing the unit under direct sunlight or near a heat source such as radiators or heaters. Remember that the greater the difference in temperature is between the environment and the condenser, the more efficient will the heat transference be.
6. Refer installation manual for specific machine.



### 12. Laboratory water Bath

Laboratory water bath is used to heat samples in the lab. Some applications include maintaining cell lines or heating flammable chemicals that might combust if exposed to open flame. A water bath generally consists of a heating unit, a stainless steel chamber

EEL BES2	Version:01	Page No.101
	Copyright: Ethiopia Federal TVET Agency	



that holds the water and samples, and a control interface. Different types of water baths offer additional functionality such as a circulating water bath that keep a more even temperature or a shaking water bath that keeps the samples in motion while they are heated.



### Installation consideration

1. Connect it with the right power outlet
2. Use manual to assemble the parts
3. Keep the machine in the level surface.

### 13. Spectrophotometer

Spectrophotometry, or spectrophotometric analysis, refers to the quantitative determination of the radiant energy ratio of incident to transmitted light beams at a given wavelength.

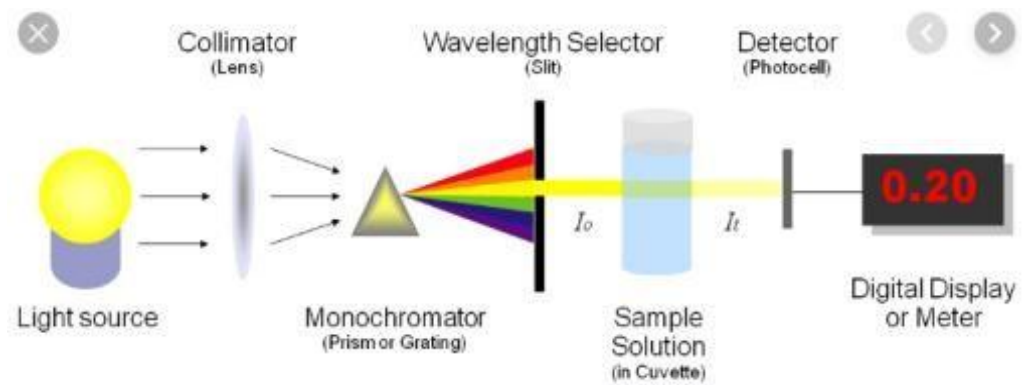

For the correct functioning of a spectrophotometer, the following is required

1. An electric supply source that complies with the norms and standards used in the country.
2. A clean, dust free, environment.
3. A stable work table away from equipment that generate vibrations (centrifuges, agitators).
4. Refer installation and assembly manuals for specific machineries

EEL BES2	Version:01	Page No.102
	Copyright: Ethiopia Federal TVET Agency	



## 14. Bag valve mask

Bag-valve-mask (BVM) ventilation is an essential emergency skill. This basic airway management technique allows oxygenation and ventilation of patients until a more definitive airway can be established and may be used in cases where endotracheal intubation or other definitive control of the airway is not possible.



### Installation consideration

1. Use assembly manual if they have
2. Check tightening at each connection point
3. Check leakage at the bag

## 15. Draying Clinical oven

Drying oven is used in the laboratory for drying and sterilizing glass and metal containers



EEL BES2	Version:01	Page No.103
	Copyright: Ethiopia Federal TVET Agency	



## Installation requirement

1. A large, strong, leveled work table
2. Free space of at least 5 cm around the oven and enough space to place the material to be processed.
3. An electrical outlet with a ground pole of appropriate size for supplying electrical power to the oven
4. Verifying that the electrical circuit has the necessary protection devices for guaranteeing an adequate electrical feed.

## 16. Centrifuge

The centrifuge is designed to use the centrifugal force generated in rotational movements to separate the constitutive elements of a mixture. There is a wide range of centrifuges capable of serving specific industry and research needs.

### OPERATION PRINCIPLES

Centrifuges represent a practical application of Newton's law of motion. When a body of mass [m] turns around central point [O], it is subjected to a *centripetal* force [N] directed towards the rotation axis with a magnitude =  $m\omega^2R$ , where [m] is the mass of the body, [R] is the radius and  $\omega$  is the angular speed. Centrifuges possess a rotating axis on which is mounted a rotor with sample receiving compartments. Tangential speed is defined by the following equation:  $V_T = \omega R$ .



EEL BES2	Version:01	Page No.104
	Copyright: Ethiopia Federal TVET Agency	



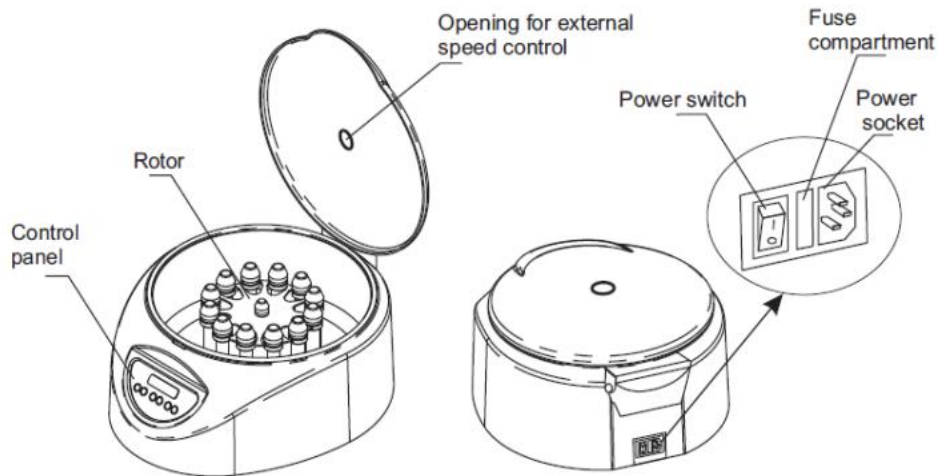

Diagram

## COMPONENTS OF THE CENTRIFUGE

The most important components of a centrifuge are the Following:

The electric/electronic control which generally has the following elements:

1. on and off control, operation time control (timer), rotation speed control (in some centrifuges), temperature control (in refrigerated centrifuges), vibration control (safety mechanism) and brake system.
2. Refrigeration system (in refrigerated centrifuges).
3. Vacuum system
4. Base
5. Lid/cover
6. Casing
7. Electric motor
8. Rotor. There are different types of rotors. The most common are the fixed angle, the swinging buckets, the vertical tube and the almost vertical tube types, which are explained next.

EEL BES2	Version:01	Page No.105
	Copyright: Ethiopia Federal TVET Agency	



## INSTALLATION REQUIREMENTS

Centrifuges require the following for normal operation:

1. An electrical connection with a capacity suitable for the equipment providing stable single phase or trophies type voltage (depending on the model and specific action given by the manufacturer). In general, centrifuges use 110V or 220 V/60 Hz.
2. A clean, dust free environment with a firm levelled floor.
3. If the centrifuge is refrigerated, it needs a free space on the side of the condenser for adequate heat transfer.
4. A cabinet in which the centrifuge accessories such as the alternate rotors can be kept.
5. An electrical connection with a capacity suitable for the equipment providing stable single phase or trophies
6. Obey the recommendation related to reducing the operation speed when working with high density solutions in stainless steel tubes or plastic adaptors. Manufacturers provide the related information.
7. Use titanium rotors if working with saline solutions frequently.
8. Protect the rotors' coating in order to avoid the metal base from deteriorating. Do not use alkaline detergents or cleaning solutions which can remove the protective Im. The rotors generally made of aluminum [Al] are covered by a fi Im of anodized aluminum which protects their metal structure.
9. Use plastic brushes when cleaning the rotor. Metal brushes scratch the protective coating and generate sources for future corrosion. Corrosion is accelerated in operation conditions and shortens the rotor's operational life.
10. If there are spills of corrosive substances, wash the rotor immediately.
11. Air dry the rotor once cleaned and washed with water.
12. Store vertical tube rotors and almost vertical tube rotors with the larger side facing downwards and without their covers.
13. Store rotors in a dry area. Avoid leaving them in the centrifuge.
14. Store swinging buckets rotors without the compartments 'covers.
15. Lubricate spiral and O-rings, according to the manufacturer's recommendation.

EEL BES2	Version:01	Page No.106
	Copyright: Ethiopia Federal TVET Agency	



16. Observe recommendations related to guaranteed times and operational life of each type of rotor.
17. Avoid using rotors whose operational lives have ended.
18. Use a shield if working with radioactive material.
19. Load or unload rotors inside a biological safety cabinet if working with materials classified as Biosafety level II or higher.
20. Never try to open the cover of a centrifuge while it is functioning and never try to stop the rotor by hand.
4. Verify if the tubes are reusable or not. If they are disposable, use them only once.
5. For sterilizing, it is necessary to verify the material from which the tube is made, as not all can stand sterilization by heat. Glass tubes are normally sterilized with vapor at 121 °C for 30 minutes.
6. Store tubes and bottles in a dark, fresh, dry place, far from chemical vapours or ultraviolet radiation sources.
7. Verify maximum filling levels and the sealing of thin wall tubes in order to avoid collapse inside the rotor by the action of the centrifugal force. Comply with manufacturers recommendations.

### **Consideration during assembly and Installation**

1. An electrical connection with a capacity suitable for the equipment providing stable single phase or three phase.
2. Lubricate motor.
3. Inspect power cords and plugs.
4. Inspect controls and switches.
5. Ensure appropriate menu settings for proper use.
6. Ensure tightness of rotor.
7. Check lights and indicators
8. Verify that alarms are operating properly.
9. Ensure interlock is functioning.
10. Use installation manual for specific machine.

### **17. Infant Incubator**

Incubator is designed as a chamber of controlled temperature, atmosphere and humidity for the purpose of maintaining new born baby in environment suitable for their growth.

EEL BES2	Version:01	Page No.107
	Copyright: Ethiopia Federal TVET Agency	



## Installation

1. An electrical connection complying with the electrical standards used in the country.
2. Free space on the sides and back of the equipment to allow a passage for cables and ventilation required for the incubator's normal functioning
3. Install it in an area in the room where the temperature variation is minimal
4. Use installation manual for specific machine.

## 18. Microscope

A microscope is an instrument designed to make fine details by performing the following tasks.

1. produce a magnified image of the specimen (magnification),
2. separate the details in the image (resolution),
3. Render the details visible to the eye, camera, or other imaging device (contrast).

### OPERATION PRINCIPLES

The microscope is constructed using the physical properties of lenses interacting with light. A lens is an optical element usually made of glass which can refract light. It is of calculated dimensions and in general has parabolic or spherical surfaces. If light rays reaching one surface of the lens converge in a common point F when exiting it, such lens is known as positive or convergent. If it disperses the light rays crossing it, it is divergent or negative. Positive lenses (convergent) shown in Figure below constitute the building blocks of microscopes.

EEL BES2	Version:01	Page No.108
	Copyright: Ethiopia Federal TVET Agency	

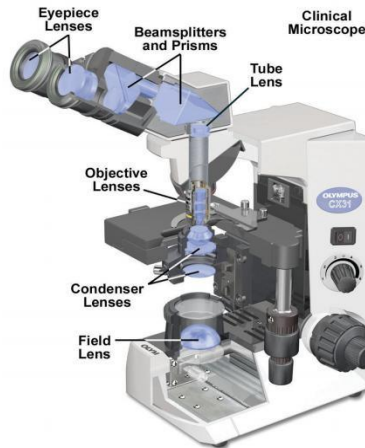

### Installation consideration

1. Verify that the area selected has an electrical outlet compatible with the lighting system of the microscope.
2. Ensure that the area where the microscope is installed is protected from dust and humidity.
3. Confirm that the location of the microscope is far from water supplies or where chemical substances are handled in order to avoid spills or splashing.
4. Install the microscope on a leveled surface of a rigid structure, under which there is sufficient room for the user (the microscopist) to place his/her legs
5. Use assembly procedure manual for specific product.

### 19. Water Distiller

A water distillation system is designed to purify water cheaply, quickly and effectively. To distil water, all you really need is a heat source and a condenser. Since water has a lower boiling point than contaminants and minerals like salt, bacteria, heavy metals, calcium and phosphorus, when you boil untreated water, the water turns into vapor and leaves everything else behind.

#### PURPOSE OF THE WATER DISTILLER

The water distiller facilitates obtaining very pure water from potable water normally provided by the aqueduct services in urban centers. Distilled water is characterized by a lack of solids in suspension. It is used in multiple applications in centers which provide health services, especially in laboratory units, in washing, sterilization and dietetics. The

More specialized the procedures are in the laboratory, the greater will be the level of purity required. For example: the preparation of reagents or biological material requires water of the highest quality. Distillation is one of the fundamental processes to achieve this (although it may not be the only one required). Water used in laboratories must be

EEL BES2	Version:01	Page No.109
	Copyright: Ethiopia Federal TVET Agency	



free of progeny, with a concentration of total solids no greater than 1 ppm, a pH value between 5.4 and 7.2 and an electrical resistance of at least  $3 \times 10^5$  ohm/cm at 25 °C.

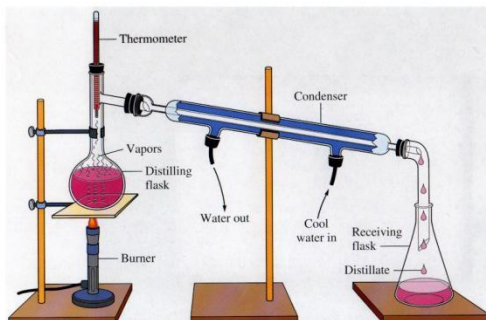

### Installation consideration

1. A well ventilated environment in which the equipment can be installed
2. Connect water inlet connection
3. Connect distilling flask to the condenser
4. Connect the condenser to the distilled water tank
5. Use installation manual for specific machine

### 20. Clinical Wight scale

It is used to monitor patient weight and sudden changes can indicate a worsening condition. We have different type of weight scale, it can be digital or analog. Its key components consist of a strain gauge, a device used to measure the strain of an object, and load cell sensor, an electronic device used to convert a force into an electrical signal. A load cell is also known as a force transducer.



### Assembly consideration

1. Place it in level surface
2. Connect the parts according to installation manual

EEL BES2	Version:01	Page No.110
	Copyright: Ethiopia Federal TVET Agency	



## 21. Gooseneck lamp/examining light

It is portable light source used in the health center to increase the visibility of the patient body part which is under examination.



Installation consideration

1. Plug it in proper power outlet
2. Connect the parts according to the installation manual

## 22. Nebulizer

Nebulizer is a drug delivery device that can dispense medication directly into the lungs in the form of an inhalable mist.



Installation consideration

It is small medical equipment and assembling is just connecting parts according to the manual

## 23. Agitator /shaker

It is medical equipment used in the laboratory to keep the sample or chemical solution in continuous mixing process by creating motion or vibration.

EEL BES2	Version:01	Page No.111
	Copyright: Ethiopia Federal TVET Agency	



### Installation consideration

1. Place the machine on leveled surface
2. Assemble parts according to the manual.

### 24. Electro muscular stimulator

Electric muscle stimulation(EMS) also known as neuromuscular electric stimulation (NMES), muscle stim or e-stim sends electronic pulses to your motor nerves in order to create muscle contractions. Muscle Stimulators work by placing electrode pads on your skin for your muscles to be contracted via electric current.



### Installation consideration

1. Connect parts according to the manual
2. Set input parameters according to the manual
3. Keep the electrode in safe place

EEL BES2	Version:01	Page No.112
	Copyright: Ethiopia Federal TVET Agency	



**Self-Check -5****Written Test**

**Directions:** Answer all the questions listed below. Use the Answer sheet provided in the next page:

**Part #1 Multiple choice**

- \_\_\_\_\_ is a device that measures blood pressure.  
A. Suction apparatus B. Sphygmomanometer C. Oxygen concentrator
- \_\_\_\_\_ are medical devices used to extract mucus and other fluids from an individual.  
A. Autoclave B. Water distiller C. Suction machine
- \_\_\_\_\_ is an instrument designed to make fine details by performing the following tasks such as magnification and resolution.  
A. Water distiller B. suction machine C. microscope
- \_\_\_\_\_ is designed to use the centrifugal force generated in rotational movements to separate the constitutive elements of a mixture.  
A. Micro scope B. Centrifuge C. Oxygen concentrator
- \_\_\_\_\_ is used for the conservation of blood and its derivatives, biological liquids and tissues, reagents, chemicals, and stocks.  
A. Refrigerator B. Sphygmomanometer C. Water distiller

**Part #2 true or False**

- OR/DR light are used in hospital OR room they are used by clinicians, surgeons and proceduralists a surgical light illuminates the operative site on a patient for optimal visualization during a procedure.
- Autoclave is used to heat samples in the laboratory.
- Incubator is designed as a chamber of controlled temperature, atmosphere and humidity for the purpose of maintaining new born baby in environment suitable for their growth.
- Microscope is an instrument designed to produce a magnified image of the specimen.
- Water distiller is medical equipment used in the laboratory to keep the sample or chemical solution in continuous mixing process by creating motion or vibration

**Note: Satisfactory rating - 3 and 5 points**

**Unsatisfactory - below 3 and 5 points**

You can ask your teacher for the copy of the correct answers.

EEL BES2	Version:01	Page No.113
	Copyright: Ethiopia Federal TVET Agency	



## Answer Sheet

Score = \_\_\_\_\_

Rating: \_\_\_\_\_

### Part 1 Multiple chose question

1. ....
2. ....
3. ....
4. ....
5. ....

### Part 2 True or False

1. ....
2. ....
3. ....
4. ....
5. ....

Name: \_\_\_\_\_

Date: \_\_\_\_\_

### Short Answer Questions

EEL BES2	Version:01	Page No.114
	Copyright: Ethiopia Federal TVET Agency	



<b>Information Sheet-6</b>	<b>Unplanned events or conditions are responded to in accordance with established institutional procedures</b>
----------------------------	--

## 6.1 Overview

Unplanned events are accidents or upset events or conditions that are not planned as a part of routine Project activities during any Project phase. Even with the planning and application of mitigation, accidents, malfunctions, and unplanned events could occur during any phase of the Project. These could occur as a result of abnormal operating conditions, wear and tear, human error, equipment failure, and other possible causes. Many accidents, malfunctions, and unplanned events are preventable and can be readily addressed or prevented by good planning, design, equipment selection, hazards analysis and corrective action, emergency response planning, and mitigation.

In this section, the potential accidents, malfunctions, and unplanned events that could occur during any phase of the Project and potentially result in significant adverse environmental effects are described, discussed, and assessed. The focus is on credible accidents that have a reasonable probability of occurrence, and for which the resulting residual environmental effects could be major without careful management.

It is noted that accidents, malfunctions, and unplanned events are evaluated individually, in isolation of each other, as the probability of a series of accidental events occurring in combination with each other is very minimal. These possible events, on their own, generally have a very low probability of occurrence and thus their environmental effects are of low likelihood. They have an even lower probability or likelihood of occurring together – thus their combination is not considered credible, nor of any measurable likelihood of occurrence.

Accidents, malfunctions, and unplanned event scenarios have been conservatively selected that represent higher consequence events that would also address the consequences of less likely or lower consequence scenarios. The accidents, malfunctions, and unplanned events that have been selected based on experience and professional judgment are as follows:

- Worker accident: worker accidents may occur during either construction or operation, and may result in harm, injury, or death to one or more Project workers;
- Fire: consists of a fire in a Project component. The focus is on the consequence, and not the mechanism by which it occurs;
- Electrical Hazardous materials spill: spills of fuel, petroleum products, and/or other chemicals used on site or in Project components; and

### 1. Worker accident

A worker accident has the potential to interact with communities as it may result in harm, injury, or death to workers. All workers will be properly trained in practices to prevent workplace accidents including Workplace Hazardous Materials Information System (WHMIS), first aid, and other applicable training programs. These procedures are designed to prevent serious injury to staff and the general public as well as to

EEL BES2	Version:01	Page No.115
	Copyright: Ethiopia Federal TVET Agency	



minimize the occurrence of unplanned events and minimize any potential damage to the environment.

Interactions between a worker accident and communities will be mitigated by compliance with health and safety legislation, safety by design, and implementation of environmental management measures aimed at protecting human health. Safety risks to workers will be reduced by complying with the requirements of various governing standards including the federal Canada Labour Code, the federal *Transportation of Dangerous Goods Act*.

*Workplace Health and Safety Act* and all associated regulations. Adherence to public safety codes and regulations will help the Project to be carried out in a safe manner to protect workers and the public.

With the application of, and compliance with, these acts, regulations, and standards, including the application of safety and security measures that are known to effectively mitigate the potential environmental effects, the potential environmental effects of a worker accident on communities during construction and operation and maintenance of the Project are assessed as minor.

## 2. Fire

A fire at the Project location could interact with the atmospheric environment (smoke emissions), infrastructure and services (stress on services) communities (potential safety risks to workers), land use and property (potential for substantive loss or damage to property of resources), and the aquatic, wildlife and natural vegetation environments (potential contamination with sediment-laden water used in extinguishing the fire).

A fire may arise from Project heavy equipment or from natural causes such as a lightning strike. In the unlikely event that a fire occurred, the immediate concern for a fire would be for human health and safety. Local air quality conditions may deteriorate through the duration of the fire.

Personnel will take the necessary precautions to prevent fire hazards when at the work site and will keep the site free of all flammable waste. Manitoba Hydro will ensure that personnel are trained in the use of fire-extinguishing equipment. In the unlikely event of a fire, local emergency response will be able to reduce the severity and extent of damage.

The emissions from a fire would likely consist mainly of smoke (particulate matter) and CO<sub>2</sub> but could also include CO, NO<sub>2</sub>, SO<sub>2</sub>, and other products of incomplete combustion. A large fire could create particulate matter levels greater than the ambient air quality standard over distances of several kilometers, but such situations would be of short duration, infrequent, and are not expected to occur because of planned mitigation and prevention measures. The potential residual environmental effects of a fire are therefore assessed as minor.

## 3. Electrical Hazardous

Safety measurements are not limited to your residential places you have to keep these parameters sustain in your office area too. Various electric appliances are being used already in your place where printers, monitors, and other electronic applications are plugged into the non-efficient power cord. This kind of practice can be dangerous.

EEL BES2	Version:01	Page No.116
	Copyright: Ethiopia Federal TVET Agency	



Multiple numbers of employees need to have the proper training to prevent their self and fellows. Numerous accidents are taken place due to faulty equipment or some of the material which is missing. In this blog, I am going to let you know how to keep your workplace safe from severe kind of electrical hazards suggested by Electrical Safety Foundation International. Let's have a look

**Power Cord should be of High quality:**

Power cord which is being considered to utilize must be of some renown brand, should be of high quality. Purchase your product from reputable retailer

**Installation place:**

You need to install power strips in such location where air passage should be at best to scatter heat because too much heat may cause short circuits in wiring that's why this is suggested to keep away from the heating area.

**Avoid overloading in outlets:**

Usually, you may have seen in your workplace where high voltage appliances are plugged into one outlet, so it is suggested to avoid too much overloading

**Inspect Electrical cords:**

It better to keep an eye on electrical wires they shouldn't be cracked or damaged so check electrical cords once in a month.

**Avoid binding and knotting cables:**

You need to avoid binding and knotting the wires because it may produce electric shocks which would be a hazard for your workplace.

**Unused appliances need to be unplugged:**

Unused electrical items need to be unplugged until for further use. Because it will increase the electricity consumption

**Avoid maintaining by yourself:**

You don't need to support this thing by yourself because it can be dangerous for you and it may produce electrical shocks. So you can have the assistance of Electricians Barrow in Furness or nearby areas who know all the safety measurements very well, and they will keep on guiding your employees for do's and don'ts.

**Licensed electricians:**

You need to hire licensed electricians who should have proper information and qualification before playing with wires.

**Don't route power cords under the carpets:**

This is not suggested to install power cords under the rugs. Because employees are rolling the chairs here and there for work purpose and when chairs roll over them it would be risky for your employees.

**Disconnect electrical equipment:**

If there are electrical equipment is malfunctioning, and you feel terrible smell then disconnect all the electrical equipment which is plugged into a socket on urgent basis.

EEL BES2	Version:01	Page No.117
	Copyright: Ethiopia Federal TVET Agency	



These are all the essential safety parameters which you should follow because you are spending probably 7–8 hours daily and some avoidance will put your life at risk. On the other hand, you must ensure your electricians PAT testing from Barrow in Furness for your life safety. Major incidents are figured out due to such dodging acts from the organization, and they take these measurements for granted. So keep your workplace risk free at any cost.

EEL BES2	Version:01	Page No.118
	Copyright: Ethiopia Federal TVET Agency	

**Self-Check -6****Written Test**

**Directions:** Answer all the questions listed below. Use the Answer sheet provided in the next page:

**Part 1 say True or False for the following question**

- 1) A fire at the Project location could interact with the atmospheric environment.
- 2) If there are electrical equipment is malfunctioning, and you feel terrible smell then allow all the electrical equipment which is plugged into a socket on urgent basis.
- 3) Power cord which is being considered to utilize must be of some renown brand, should be of high quality.
- 4) Prevent workplace accidents including Workplace Hazardous Materials Information System (WHMIS), first aid, and other applicable training programs.
- 5) Worker accidents may occur during either construction or operation, and may result in harm, injury, or death to one or more Project workers;

**Note: Satisfactory rating - 3 and 5 points**

**Unsatisfactory - below 3 and 5 points**

You can ask you teacher for the copy of the correct answers.

EEL BES2	Version:01	Page No.119
	Copyright: Ethiopia Federal TVET Agency	



## Answer Sheet

Score = \_\_\_\_\_

Rating: \_\_\_\_\_

### Part 2 True or False

1. ....
2. ....
3. ....
4. ....
5. ....

Name: \_\_\_\_\_

Date: \_\_\_\_\_

### Short Answer Questions

EEL BES2	Version:01	Page No.120
	Copyright: Ethiopia Federal TVET Agency	





Operation Sheet 1	Techniques of installing procedures on simple biomedical equipment and accessories.
-------------------	---

### 1.1. The techniques for installing procedures on simple biomedical equipment and accessories.

**Steps 1-** Put on helmets, electrical glove, safety shoes.

**Step 2-** Make sure that the installation Site meets the requirements listed in the manufacturer's service manuals. This may include;

- Gas line installation.
- Electrical installation
- Water supply installation
- Leveled surface

**Steps 3-** Inspect all lifting and transport are carried out using proper handling equipment to avoid damage Because of the heavy weight of the machines.

**Step 4-** Select needed Tools and testing devices.

**Step 5-** Remove the packing cardboard box and the nylon packing around the machine.

After unpacking check for;

- User and service manuals.
- Power cords
- UPS
- Accessories parts specified on manuals.

**Step 6-** Prepare Equipment and components for correct and sequential installation.

**Step 7-** Install Equipment & accessories in accordance with manufacturer's instructions

provided in the service manuals.

EEL BES2	Version:01	Page No.121
	Copyright: Ethiopia Federal TVET Agency	



<b>LAP Test</b>	<b>Practical Demonstration</b>
-----------------	--------------------------------

**Task 1-** What are the information's you can obtain or gain from service manuals of equipment's

- A. Accessories and spare part lists
- B. Power specifications
- C. Environmental conditions
- D. All can be gained

**Task 2-** Equipment & accessories in accordance with manufacturer's instructions provided in the service manuals.

EEL BES2	Version:01	Page No.122
	Copyright: Ethiopia Federal TVET Agency	



## Instruction Sheet

## LG16: Test installed equipment and accessories

This learning guide is developed to provide you the necessary information regarding the following content coverage and topics –

- Testing equipment in accordance with manufacturer’s instructions
- Undertaking inspections the installed device and conform to manufacturer’s instructions.
- Cleaning and clearing work site
- Preparing report on installation and testing of equipment
- Submitting report according to institution’s procedures.
- Endorsing equipment to appropriate end users

This guide will also assist you to attain the learning outcome stated in the cover page. Specifically, upon completion of this Learning Guide, you will be able to –

- Test equipment in accordance with manufacturer’s instructions
- Undertaking inspections the installed device and conform to manufacturer’s instructions.
- Clean and clearing work site
- Prepare report on installation and testing of equipment
- Submit report according to institution’s procedures.
- Endorse equipment to appropriate end users

### Learning Instructions:

13. Read the specific objectives of this Learning Guide.
14. Follow the instructions described below 3 to 6.
15. Read the information written in the information “Sheet 1, Sheet 2, Sheet 3, Sheet 4 and Sheet 5”.
16. Accomplish the “Self-check 1, Self-check 2, Self-check 3, Self-check 4 and Self-check 5” in **page -5, 14, 24 and 28** respectively.
17. If you earned a satisfactory evaluation from the “Self-check” proceed to “Operation Sheet 1” in **page -30**.
18. Do the “LAP test” in **page – 31** (if you are ready).

EEL BES2	Version:01	Page No.123
	Copyright: Ethiopia Federal TVET Agency	



<b>Information Sheet-1</b>	<b>Testing equipment in accordance with manufacturer's instructions</b>
----------------------------	---

### **1.1 Testing equipment in accordance with manufacturer's instructions**

After finalizing installation equipment & accessories must be tested in accordance with manufacturer's instructions. Installed device are then inspected and conformed to manufacturer's instructions.

Installation of equipment is prepared and tested and submitted according to institution's procedures. Equipment is endorsed to appropriate end user according to institution's requirements.

Electrical cabling and wiring devices with correct loading capacity should be selected according to National Electrical Code.

#### **Electrical safety and test**

If it is misused or poorly installed, electrical equipment can be the cause of injury, death or fire. If it is well maintained, electrical equipment can save lives, improve the quality of lives and reduce capital expenditure.

Electrical equipment and the electrical connections that supply power to it should always therefore be treated with respect and care. Careful consideration should always be given to the placing of equipment. Damp conditions should be avoided and equipment should be positioned in a dry, clean, well-ventilated area on a solid, level base.

Equipment should be as near as possible to the electrical supply and extension leads should be discouraged.

#### **Socket outlets and plugs**

- A convenient and safe socket outlet should be available.
- Socket outlets should be at least 2 m from a sink or wash basin.
- The socket outlet should be adequate for the electrical capacity for the equipment.
- There should be proper grounding in the sockets.
  
- Plugs should match the socket outlets.

EEL BES2	Version:01	Page No.124
	Copyright: Ethiopia Federal TVET Agency	



## Wiring of sockets and plugs

- The wiring of a plug is color coded to help guard against electrical accidents. The colour codes in Ethiopia as per Ethiopian Electricity Rules are as follows
- **Phase (or Live) Red, Blue or Yellow:** This carries the electrical drive current from the supplier to the equipment. It is the most dangerous line. Only qualified staff should work with this.
- **Neutral Black:** This returns the current to the supplier. It should not be connected to Earth.
- **Earth (or Ground) Green OR Green with Yellow lines:** This is used for safety and protection. If equipment is housed in a metal case, the earth line will generally be connected to the case. The earth line in a socket is connected to a pipe or plate buried in the ground.

**Notes on earthing:** The earthing will depend upon the type of equipment being used:

- If there are only two wires in the power cable, no earth connection is required
- If the cable fitted has three conductors then equipment needs to be earthed properly
- Always make sure that the earth wire is longer than the other two so that if the cable is accidentally pulled out of the plug, the earth wire is the last wire to become disconnected.
- The current rating (i.e. the amount and size of equipment they can supply) is measured in Amperes, written A. The rating and size of normally found plugs and sockets are:
  - For low power operations 5 Amperes small size
  - For large power applications 15 Amperes large size
- Mains electricity comes at a specified voltage and is measured in Volts, written V. The voltage in Ethiopia is 220- 240 V for single phase and 440 V for three phase operations. It also is delivered at a specific frequency, measured in Hertz, written Hz. Mains electricity in Ethiopia is at 50 Hz.

## Mains cables

- Electricity is carried to the equipment through the mains cable. Points to be aware of are: No bare metal or internal colored wire should be visible the plastic insulation is there for safety
- Cable should not be repaired with insulating tape water can still get inside
- Long flexible leads are dangerous leads should be as short as possible
- The cable, plug and socket should never be allowed to get wet water can conduct electricity.

EEL BES2	Version:01	Page No.125
	Copyright: Ethiopia Federal TVET Agency	





## Answer Sheet

Score = \_\_\_\_\_

Rating: \_\_\_\_\_

### Part 1 Multiple chose question

1. ....
2. ....
3. ....
4. ....
5. ....

Name: \_\_\_\_\_

Date: \_\_\_\_\_

### Short Answer Questions

EEL BES2	Version:01	Page No.127
	Copyright: Ethiopia Federal TVET Agency	



<b>Information Sheet-2</b>	<b>Undertaking inspections the installed device and conform to manufacturer's instructions.</b>
----------------------------	---

## Inspection and Testing Techniques

The testing of an installation implies the use of instruments to obtain readings. However, a test is unlikely to identify a cracked socket outlet, a chipped or loose switch plate, a missing conduit-box lid or saddle, so it is also necessary to make a visual inspection of the installation.

All new installations must be inspected and tested during erection and upon completion before being put into service. All existing installations should be periodically inspected and tested to ensure that they are safe and meet the regulations of the IEE (Regulations 610–634).

The method used to test an installation may inject a current into the system. This current must not cause danger to any person or equipment in contact with the installation, even if the circuit being tested is faulty. The test results must be compared with any relevant data, including the IEE Regulation tables, and the test procedures must be followed carefully and in the correct sequence, as indicated by Regulation 612.1. This ensures that the protective conductors are correctly connected and secure before the circuit is energized.

### Visual Inspection

The installation must be visually inspected before testing begins. The aim of the visual inspection is to confirm that all equipment and accessories are undamaged and comply with the relevant British and European Standards, and also that the installation has been securely and correctly erected Regulation gives a checklist for the initial visual inspection of an installation, including:

- Connection of conductors;
- Identification of conductors;
- Routing of cables in safe zones;
- Selection of conductors for current carrying capacity and volt drop;
- Connection of single-pole devices for protection or switching in phase conductors only;
- Correct connection of socket outlets, lamp holders, accessories and equipment;
- Presence of fire barriers, suitable seals and protection against thermal effects;
- Methods of 'basic protection' against electric shock, including the insulation of live parts and placement of live parts out of reach by fitting appropriate barriers and enclosures;

EEL BES2	Version:01	Page No.128
	Copyright: Ethiopia Federal TVET Agency	





- Methods of ‘fault protection’ against electric shock including the presence of earthing conductors for both protective bonding and supplementary bonding.
- Prevention of detrimental influences (e.g. Corrosion);
- Presence of appropriate devices for isolation and switching;
- Presence of under voltage protection devices;
- Choice and setting of protective devices;
- Labelling of circuits, fuses, switches and terminals;
- Selection of equipment and protective measures appropriate to external influences;
- Adequate access to switchgear and equipment;
- Presence of danger notices and other warning notices;
- Presence of diagrams, instructions and similar information;
- Appropriate erection method.

### **Approved Test Instruments**

The test instruments and test leads used by the electrician for testing an electrical installation must meet all the requirements of the relevant regulations. The HSE has published Guidance Notes GS 38 for test equipment used by electricians. The IEE Regulations (BS 7671) also specify the test voltage or current required to carry out particular tests satisfactorily.

All test equipment must be chosen to comply with the relevant parts of BS EN 61557.

All testing must, therefore, be carried out using an ‘approved’ test instrument if the test results are to be valid. The test instrument must also carry a calibration certificate, otherwise the recorded results may be void. Calibration certificates usually last for a year. Test instruments must, therefore, be tested and recalibrated each year by an approved supplier. This will maintain the accuracy of the instrument to an acceptable level, usually within 2% of the true value. Let us now look at the requirements of three often used test meters.

### **Continuity tester**

To measure accurately the resistance of the conductors in an electrical installation we must use an instrument which is capable of producing an open circuit voltage of between 4 and 24V ac. or dc, and deliver a short-circuit current of not less than 200mA (Regulation 612.2.1). The functions of continuity testing and insulation resistance testing are usually combined in one test instrument.

EEL BES2	Version:01	Page No.129
	Copyright: Ethiopia Federal TVET Agency	



### **Insulation resistance tester**

The test instrument must be capable of detecting insulation leakage between live conductors and between live conductors and earth. To do this and comply with Regulation 612.3 the test instrument must be capable of producing a test voltage of 250, 500 or 1000V and deliver an output current of not less than 1mA at its normal voltage.

### **Earth fault loop impedance tester**

The test instrument must be capable of delivering fault currents as high as 25A for up to 40ms using the supply voltage. During the test, the instrument does an Ohm's law calculation and displays the test result as a resistance reading.

### **Inspection Requirements**

Verify that selected elements associated with the applicant's program for inspection, test control, and controls of M&TE (as identified in an approved inspection plan) are in accordance with the applicant's approved QA Plan.

#### ***Elements chosen for inspection may include three or more of the following:***

Verify that inspection requirements and acceptance criteria are contained in the applicable design documents approved by the responsible design organization. Verify that inspection activities are documented and controlled by instructions, procedures, drawings, checklists, travelers, or other appropriate means.

- Verify that tests required to verify conformance of an item to specified requirements, and to demonstrate satisfactory performance for service, are planned and executed. Verify that the characteristics to be tested and test methods to be employed are specified. Verify that test results are documented and their conformances with acceptance criteria are evaluated.
- Verify that the applicant has established controls for tools, instruments, gauges, and other M&TE used for quality-affecting activities. Verify that M&TE is controlled, calibrated (at specified periods), and adjusted to maintain accuracy within necessary limits.
- Verify that the applicant has established the requirements to identify the status of inspection and test activities. Verify that the status is indicated either on the items or in documents traceable to the items, where it is necessary to assure that required inspections and tests are performed, and to assure that items that have not passed the required inspections and tests are not inadvertently installed, used, or operated. Verify that the status is maintained through indicators (i.e., physical location and tags, markings, shop travelers, stamps, inspection records,

EEL BES2	Version:01	Page No.130
	Copyright: Ethiopia Federal TVET Agency	



computerized logs, or other suitable means). Verify that authority for application and removal of tags, markings, labels, and stamps is specified. Verify that status indicators provide for indicating the operating status of systems and components of the facility (i.e., tagging valves and switches) to prevent inadvertent operation.

### **Inspection Guidance**

The inspector should refer to the applicant's approved QA Plan for specific requirements and commitments. Verify that the following inspection activities are documented and controlled by instructions, procedures, drawings, checklists, travelers, or other appropriate means:

#### **a. Inspection Planning.**

Verify that documented inspection planning includes the following:

1. Identification of each work operation where inspection is necessary to ensure quality;
2. Identification of documents that are used to perform the inspections;
3. Identification of the characteristics for inspection and the identification of when, during the work process, inspections are to be performed for those characteristics;
4. Identification of inspection or process-monitoring methods employed;
5. Sufficient information from the final inspection, to provide a conclusion regarding conformance of the item to specified requirements;
6. Identification of the functional-qualification level (category or class) of personnel performing inspections;
7. Identification of acceptance criteria;
8. Identification of sampling requirements;
9. Methods to record inspection results; and Selection and identification of the M&TE to be used to perform the inspection to ensure that the equipment is calibrated and is of the proper type, range, accuracy, and tolerance to accomplish the intended function.

#### **b. Selecting Inspection Personnel to Perform Inspections.**

1. Determine that the individual who performs an inspection to verify conformance of an item to specified acceptance criteria is qualified to the requirements specified in the applicant's approved QA Plan.
2. Verify that inspections are performed by personnel other than those who performed or directly supervised the work being inspected. Verify that inspection personnel do not report directly to the immediate supervisor responsible for the work being inspected.

EEL BES2	Version:01	Page No.131
	Copyright: Ethiopia Federal TVET Agency	



**c. Inspection Hold Points.**

1. If mandatory inspection hold points are used to control work, then verify that specific hold points are indicated in documents.
2. When applicable, verify that consent to waive hold points are documented and approved before to continuing work beyond the designated hold point.

**d. In-Process Inspections and Monitoring.**

1. If inspection of processed items is not practicable, then verify that indirect control is provided by the monitoring of processing methods, equipment, and personnel.
2. Verify that both inspection and process monitoring are conducted, when control is inadequate with only one method.
3. Verify that controls are established and documented for the coordination and sequencing of the work at established inspection points during successive stages of the process.

**e. Final Inspection.**

1. Verify that finished items are inspected for completeness, markings, calibration, adjustments, protection from damage, or other characteristics, as required to verify the quality and conformance of the item to specified requirements.
2. Verify that final inspections include a review of the results and resolution of nonconformance's identified by earlier inspections. If modifications, repairs, or replacements of items are performed subsequent to the final inspection, then verify that appropriate re-tests or re-inspections are performed.

**f. Accepting Items.**

Verify that the acceptance of an item is documented and approved by qualified and authorized personnel.

**g. . Inspection Documentation.**

Verify that inspection documentation includes the following:

1. The item inspected, date of inspection, the name of the inspector, or the inspector's unique identifier, who documented, evaluated, and determined acceptability;
2. The name of the data recorder, as applicable, and the type of observation or method of inspection;
3. The inspection criteria, sampling plan, or reference documents used to determine acceptance;
4. Results indicating acceptability of characteristics inspected;
5. M&TE used during the inspection, including the identification number and the most recent calibration date; and
6. Reference to information on actions taken in connection with nonconformance.

Verify that the following test control activities are conducted and documented in accordance with the applicant's approved QA Plan:

EEL BES2	Version:01	Page No.132
	Copyright: Ethiopia Federal TVET Agency	



### **a. Test Planning.**

Verify that test planning includes the following:

1. Identification of documents to be developed to control and perform tests;
2. Identification of items to be tested, test requirements, and acceptance limits, including required levels of precision and accuracy;
3. Identification of test methods to be employed and instructions for performing the test;
4. Identification of test prerequisites addressing, calibration for instrumentation, adequacy of test equipment and instrumentation, qualifications of personnel, condition of test equipment and the item to be tested, suitably controlled environmental conditions, and provisions for data acquisition;
5. Identification of mandatory hold points and methods to record data and results; and
6. Selection and identification of the M&TE to be used to perform the test to ensure that the equipment is of the proper type, range, accuracy, and tolerance to accomplish the intended function.

### **b. Performing Tests.**

Verify that tests are performed in accordance with the applicant's QA procedures, and, as applicable, include the following:

1. Provisions for determining when a test is required, describing how tests are performed, and ensuring that testing is conducted by trained and appropriately qualified personnel.
2. Test objectives and provisions for ensuring that prerequisites for the given test have been met, adequate calibrated instrumentation is available and used, necessary monitoring is performed, and suitable environmental conditions are maintained.
3. Test requirements and acceptance criteria provided or approved by the organization responsible for the design of the item to be tested, unless otherwise designated.
4. Test requirements and acceptance criteria based on specified requirements contained in applicable design or other pertinent technical documents.
5. Potential sources of uncertainty and error.

### **c. Use of Other Testing Documents.**

Other testing documents (e.g., American Society for Testing and Materials specifications, vendor manuals, or other related documents containing acceptance criteria) may be used instead of preparing special test procedures. If the applicant uses other documents, then verify that the information is incorporated directly into the approved test procedure, or incorporated by reference in the approved test procedure.

EEL BES2	Version:01	Page No.133
	Copyright: Ethiopia Federal TVET Agency	



#### **d. Tests Results**

Verify that test results are documented and their conformance with acceptance criteria evaluated by a qualified individual within the responsible organization, to ensure that the test requirements have been satisfied.

#### **e. Test Documentation**

Verify that test documentation includes the following:

1. Item or work product tested, date of test, names of tester and data recorders, type of observation, and method of testing;
2. Test criteria or reference documents used to determine acceptance;
3. Results and acceptability of the test;
4. Actions taken in connection with any nonconformance's noted;
5. The individual evaluating the test results; and M&TE used during the test, including the identification number and the most recent calibration date.

#### **f. Qualification of Test Personnel**

Verify that the individual who directs a test to verify conformance of an item to specified acceptance criteria is qualified in accordance with the applicant's approved QA Plan. Verify that tests are directed by personnel other than those who performed or directly supervised the work being tested. Verify that test directors do not report directly to the immediate supervisor responsible for the work being tested.

EEL BES2	Version:01	Page No.134
	Copyright: Ethiopia Federal TVET Agency	

**Self-Check 2****Written Test**

**Direction:** Answer all the questions listed below. Use the Answer sheet provided in the next page:

**Part 1: Say True for the correct statement and False for the Wrong statement.**

- 1) Insulation leakage tested between live conductors and between live conductors and earth.
- 2) It is not important test result documentation and their conformance with acceptance criteria evaluated by a qualified individual.
- 3) The installation must be visually inspected before testing begins.
- 4) The name of the data recorder is not the part of Inspection Documentation.
- 5) Visual inspection of an installation includes Identification of conductors.

**Note: Satisfactory rating - 3 and 5 points  
points**

**Unsatisfactory - below 3 and 5  
points**

You can ask you teacher for the copy of the correct answers.

EEL BES2	Version:01	Page No.135
	Copyright: Ethiopia Federal TVET Agency	



## Answer Sheet

Score = \_\_\_\_\_

Rating: \_\_\_\_\_

### Part 1 True or False

1. ....
2. ....
3. ....
4. ....
5. ....

Name: \_\_\_\_\_

Date: \_\_\_\_\_

### Short Answer Questions

EEL BES2	Version:01	Page No.136
	Copyright: Ethiopia Federal TVET Agency	





### Information Sheet-3

### Cleaning and clearing work site

#### Procedure in Cleaning Tools and Work Area

Instructions: Bring cleaning solvents, rags and brooms, washing pan, electric fan and safety apparel. Clean tools and work area.

#### Procedure:

##### A. Tools

1. Wear protective clothing and goggles.
2. Gather the tools to be cleaned in the designated area for cleaning.
3. Classify the tools to be cleaned according to how dirty they are.
4. Measure and pour enough amount of cleaning solvent to the washing pan.
5. Submerge the tools in the washing pan.
6. Use paint brush to remove the dirt from the tools.
7. Get the tools from the washing pan and wipe them with rags until dry.
8. Clean and keep all materials used for cleaning.

##### B. Work Area (Application of 5's)

1. Wear protective clothing and goggles.
2. If there is dirt on the floor such as paint, used oil, grease, rust, etc., remove it first using the appropriate cleaning solvent.
3. Use the broom in cleaning the remaining dirt in the work area and an electric fan to facilitate the drying of the floor.
4. *Assessment:* The teacher will assess the students based on the performance criteria listed below.

#### Practice good housekeeping in the workplace

##### Workplace Housekeeping Program

To maintain a safe and healthy workplace, housekeeping must be a priority. According to the Canadian Centre for Occupational Health and Safety, poor housekeeping can present hidden hazards that may cause incidents, including tripping on loose objects in walkways, being hit by falling objects, and slipping on wet or dirty surfaces.

CCOHS recommends establishing a workplace housekeeping program that manages “the orderly storage and movement of materials from point of entry to exit.” The center advises training employees on how to safely work with the products around them. Also, integrate housekeeping responsibilities into jobs by having workers clean up as they go during shifts by removing waste and unused materials and inspecting their work area to ensure cleanup was properly completed.

Additional tips include:

- Ensure all spills are immediately cleaned up. Replace worn, ripped and damaged flooring and place anti-slip flooring in areas that cannot continually be cleaned, such as an entrance.

EEL BES2	Version:01	Page No.137
	Copyright: Ethiopia Federal TVET Agency	



- Maintain clean light fixtures to improve lighting efficiency.
- Keep aisles and stairways clear. Consider installing warning signs and mirrors to help improve sight lines in blind corners.
- Regularly inspect, clean and repair all tools. Do not use damaged tools.

### **Advantages to Maintaining a Clean Workplace**

there are many 'hidden' advantages to maintaining a clean workspace:

- There's a direct correlation between a clean work environment and improved employee health. A clean environment can help reduce worker sick days.
- A regular cleaning program preserves and protects building assets such as carpets, floors, tile surfaces, equipment. It prevents excessive wear and extends lifespans.
- A sparkling workplace can be an excellent marketing tool, whether you're trying to impress prospective clients, lease space or sell the building.
- A clean, healthy building plays extremely well with occupants, creating a welcoming atmosphere, often subconsciously encouraging hard work and collective effort.
- The appearance is one of the major elements that separates one building from another and brings added value.

### **Hazard Assessment**

The Administrator will conduct a job hazard analysis (JHA) of *[insert work area]* for potential hazards. See the attached [Job Hazard Analysis Worksheet](#) for more information. From the JHA, the Administrator will develop hazard and exposure control measures to prevent injuries and illnesses to employees. Certain areas of the building will require different types of cleaning due to differences in the types of hazards. For example, areas requiring differential housekeeping attention include:

- Entryways and lobbies
- Bathrooms
- Hallways and corridors
- Kitchen and cafeteria
- Offices
- Warehouse

### **JHA Revision**

The JHA will be revised or updated whenever new equipment or work processes are introduced to work areas or when reviews of accident records and reevaluation of selected personal protective equipment (PPE) and/or engineering controls warrant such revision.

### **Housekeeping Areas—Safe Work Practices**

Supervisors and workers will implement the following safe work practices for housekeeping in all areas of the facility.

EEL BES2	Version:01	Page No.138
	Copyright: Ethiopia Federal TVET Agency	



## All Working Surfaces

- Keep all walking and working surfaces clean, sanitary, and orderly.
- Keep work surfaces dry.
- Clean up small spills immediately; report large spills to a supervisor.
- Ensure that all walking and working surfaces and passageways are free from protruding nails, splinters, holes, or loose boards.

## Floors

- Provide warning signs for wet floor areas.
- Clean up small spills immediately; report large spills to a supervisor.
- Use no-skid waxes and surfaces coated with grit to create nonslip surfaces in slippery areas such as toilet and shower areas.
- Immediately clean up all spilled hazardous materials or liquids according to hazardous material spill response procedures.
- Immediately repair, cover, or otherwise make safe any holes in the floor or other walking surface.
- Re-lay or stretch carpets that bulge or have become bunched to prevent tripping hazards.
- Promptly remove combustible scrap, debris, and waste, and discard them according to the waste disposal procedures.
- Keep toilets and washing facilities clean and sanitary.
- Eliminate uneven floor surfaces.

## Wet Floors

- Where wet processes are used, ensure that drainage channels are kept clear and that dry standing places such as mats are provided.
- Use waterproof footgear to decrease slip and fall hazards in areas that are frequently wet.
- Restrict or control access to wet floors or cover them with nonslip materials.

## Aisles and Passageways

- Keep aisles and passageways clear and marked as appropriate.
- Tape or otherwise anchor to the floor temporary electrical cords that cross aisles.
- Clean only one side of a passageway at a time.
- Ensure there is safe clearance for walking in aisles where motorized or mechanical handling equipment is operating.
- Store materials or equipment in such a way that sharp projections will not interfere with or protrude into aisles or passageways.
- Clean up small spills immediately, and report large spills to a supervisor.

EEL BES2	Version:01	Page No.139
	Copyright: Ethiopia Federal TVET Agency	



- Arrange aisles or walkways that pass near moving or operating machinery, welding operations, or similar operations so that employees will not be subjected to potential hazards.

### **Elevated Surfaces**

- Pile, stack, or rack material on elevated surfaces in a manner that will prevent the material from tipping, falling, collapsing, rolling, or spreading.
- Use dock boards or bridge plates when transferring materials between docks and trucks or railcars.

### **Entryways and Exits**

All entryways and exits will be kept clean, dry, and clear of all obstructions. Follow the housekeeping requirements in the *Fire Exits* section of this Plan.

### **Stairs**

All stairways will be kept clean, dry, and free of debris. No accumulation of any material will be allowed on stairs or in stairways or stairwells.

### **Lighting**

Ensure that all halls and stairwells are well lighted to help reduce accidents and promote security. Replace light bulbs and/or fixtures as necessary to maintain adequate lighting at all times.

### **Fire and Explosion Prevention**

Flammable and combustible materials and residues will be controlled so that they do not cause or contribute to a fire emergency.

### **Maintenance of Ignition Sources**

Equipment and systems installed on heat- or ignition-producing equipment and processes will be maintained to prevent the accidental ignition of flammable and combustible materials.

### ***Dry Combustibles***

Keep combustibles such as paper, cardboard, wooden pallets, or rags in designated locations away from ignition sources. The accumulation of such material provides a place for a fire to start and spread quickly.

### ***Extension Cords***

- Electric extension cords will be inspected before each use and kept in good condition.
- Employees will not yank cords from electrical outlets.
- Tools and equipment that require grounding will be of the three-wire grounded-connection type.
- Never use extension cords to replace permanent wiring.
- If an extension cord is used for temporary wiring, it must be listed by Underwriters Laboratories or another recognized testing laboratory.

EEL BES2	Version:01	Page No.140
	Copyright: Ethiopia Federal TVET Agency	



- Avoid kinking or excessive bending of the cord; broken strands may pierce the insulated covering and become a shock or short-circuit hazard.

## **Flammable and Combustible Liquid Storage**

### **General Safe Work Practices**

- No open flames, smoking, sparks, or welding will be allowed in storage areas with flammable liquids.
- Electrical equipment must be explosion-proof if flammable or combustible liquid will be stored near such equipment.
- Keep flammable and combustible liquids away from direct sunlight and stored in a cool, dry place.
- The storage area must be well ventilated to prevent vapors from building up; the vents should be from floor to ceiling.
- Store oxidizers and other incompatible materials away from flammable and combustible liquids to prevent a dangerous reaction.
- Use secondary containment methods to make sure any spills are contained.
- Return flammable and combustible liquids to their storage location immediately after use.

### **Containers**

Store flammable and combustible liquids in approved fire-resistant containers with self-closing lids. Ensure that such containers are grounded and bonded during any transfer of flammable or combustible liquids between containers. These containers prevent sparks and other ignition sources from igniting the liquids stored in them. Keep the containers closed when not in use.

**Used rags.** Put rags soaked with flammable or combustible liquids in approved, closed containers. The containers must be kept closed to prevent vapor buildup.

### **Reactive Materials**

Do not store reactive materials near one another. Reactive materials, when mixed, often create an exothermic reaction, which produces heat and could cause these materials to spontaneously combust.

### **Electrical and Hot Equipment**

- Keep combustible materials, dust, and grease away from electrical equipment and hot machinery.
- Maintain a clear access to electrical panels at all times so that they can be opened quickly in case of an emergency that requires the power to a machine or the building to be shut down.

### **Fire Exits**

- Always keep evacuation routes clear.

EEL BES2	Version:01	Page No.141
	Copyright: Ethiopia Federal TVET Agency	



- Don't store boxes or other items in aisles, hallways, or stairwells that lead to emergency exits.
- Ensure that exit doors are kept clear on both sides so that they can be easily opened in an emergency.

### **Fire Extinguishers**

- Fire extinguishers will not be used as hangers for coats, air hoses, electrical cords, or anything else.
- Access to extinguishers will be kept clear at all times.
- Extinguishers will always be kept visible. They will not be blocked by stacks of boxes, forklifts, or other items.

### **Combustible Dust**

Combustible dusts that accumulate on surfaces can cause a deflagration, other fires, or an explosion. Combustible dusts are often either organic or metal dusts that are finely ground into very small particles, fibers, fines, chips, chunks, flakes, or a small mixture of these. These dusts include, but are not limited to:

- Metal dust, such as aluminum and magnesium
- Wood dust
- Coal and other carbon dusts
- Plastic dust and additives
- Bio solids
- Other organic dust, such as sugar, flour, paper, soap, and dried blood
- Certain textile materials

### ***Criteria for Dust Cleanup***

Immediate cleaning and collection of accumulated combustible dust is warranted whenever a layer of combustible dust 1/32-inch thickness (i.e., approximately the thickness of a typical paper clip) accumulates over a surface area of at least 5 percent of the floor area of the facility or any given room.

The 5 percent factor will not be used if the floor area exceeds 20,000 square feet (sq ft), in which case a 1,000 sq ft layer of dust is the upper limit. Accumulations on overhead beams, joists, ducts, the tops of equipment, and other surfaces should be included when determining the dust coverage area. Vertical surfaces will be included if the dust is adhering to them. Likely areas of dust accumulations within a plant are:

- Structural members
- Conduit and pipe racks
- Cable trays
- Floors
- Above the ceiling
- On and around equipment (leaks around dust collectors and ductwork)

EEL BES2	Version:01	Page No.142
	Copyright: Ethiopia Federal TVET Agency	



### **Procedures for Dust Cleanup**

Routinely remove accumulations of combustible dust from elevated surfaces, including the overhead structure of buildings. Accumulations will be removed and collected in dust collectors.

### **Hot Work near Dust Collection Points**

The Administrator or designee will ensure that approved hot work permits are issued for any hot work in areas where hazardous levels of dust accumulations may occur. In addition, anyone who performs combustible dust collection operations near hot work on and around collection points and ductwork must receive written approval to perform such work from the issuer of the hot work permit. Dust collection operations will not be conducted while hot work operations are in progress.

### **Waste Recycling and Disposal**

The Administrator or designee will ensure that the following waste recycling and disposal procedures are implemented in all work areas where such waste is generated:

- Scrap materials will be collected and sorted for recycling or disposal.
- Scrap containers will be placed near areas where the waste is produced to encourage orderly waste recycling or disposal.
- All waste receptacles will be clearly labeled (e.g., recyclable glass, plastic, metal, toxic, flammable).
- All waste containers will be emptied.
- Covered metal waste can will be provided for oily or paint-soaked waste.

### **Hazardous Chemical Spill Control**

The Administrator or designee will implement procedures for the cleanup of large and small hazardous chemical spills at the facility. Large spills will be managed according to the facilities

### **Spill Prevention Safety Plan.**

#### **Spill Prevention**

Regularly cleaning and maintaining machines and equipment are ways to do this. Others are to use drip pans and guards where possible spills might occur.

#### **Small Spills**

The following procedure will be followed by all employees when a small chemical spill less than has occurred:

1. Notify *[insert name]*.
2. If toxic fumes are present, secure the area (with caution tape or cones) to prevent other personnel from entering.
3. Deal with the spill in accordance with the instructions described in the safety data sheet (SDS).
4. Small spills must be handled in a safe manner while wearing the proper PPE.

EEL BES2	Version:01	Page No.143
	Copyright: Ethiopia Federal TVET Agency	



5. Use absorbent material to wipe up greasy, oily, or other liquid spills.
6. Absorbents must be disposed of properly and safely.

### **Electrical Parts and Equipment**

Employees will not perform housekeeping duties near live electrical parts where there is a possibility of contact, unless adequate safeguards such as insulating equipment or barriers are provided. See the Electrical Safety Plan for information about safe work distances and other electrical hazard control procedures. Electrical equipment will be kept free of dust, debris, and grease.

### **Cleaning Materials**

Electrically conductive cleaning materials, including conductive solids such as steel wool, metalized cloth, and silicon carbide, as well as conductive liquid solutions, will not be used near energized parts unless written procedures authorized by the Administrator or designee that will prevent electrical contact are followed.

### **General Storage**

The Administrator or designee will ensure that the following general material storage procedures are implemented:

- Store or stack materials to allow a clear space of 3 feet or more under water sprinkler heads.
- Stack cartons and drums on a firm foundation and cross-tie them where necessary to reduce the chance of their movement.
- Do not allow stored materials to obstruct aisles, stairs, exits, fire equipment, emergency eyewash fountains, emergency showers, or first aid stations.
- All storage areas will be clearly marked.

EEL BES2	Version:01	Page No.144
	Copyright: Ethiopia Federal TVET Agency	



**Self-Check -3****Written Test**

**Directions:** Answer all the questions listed below. Use the Answer sheet provided in the next page:

**Part 1 Choose the correct answer**

- 6) Which one of the following safe work practices for housekeeping in all areas of the facility?
- A. Keep all walking and working surfaces clean
  - B. Provide warning signs for wet floor areas
  - C. Restrict or control access to wet floors
  - D. All
- 7) One of the following is **not** Waste Recycling and Disposal procedure.
- A. Scrap materials will be collected and sorted for recycling or disposal.
  - B. Use waterproof footgear to decrease slip”
  - C. All waste receptacles will be clearly labeled
  - D. All waste containers will be emptied.
- 8) Which one of the following procedures is we use for cleaning Tools?
- A. Wear protective clothing and goggles.
  - B. Gather the tools to be cleaned in the designated area for cleaning.
  - C. Classify the tools to be cleaned according to how dirty they are.
  - D. All

**Note: Satisfactory rating - 3 and 5 points**

**Unsatisfactory - below 3 and 5 points**

You can ask you teacher for the copy of the correct answers.

EEL BES2	Version:01	Page No.145
	Copyright: Ethiopia Federal TVET Agency	



## Answer Sheet

Score = \_\_\_\_\_

Rating: \_\_\_\_\_

### Part 1 Multiple choose

1. ....
2. ....
3. ....
4. ....
5. ....

Name: \_\_\_\_\_

Date: \_\_\_\_\_

### Short Answer Questions

EEL BES2	Version:01	Page No.146
	Copyright: Ethiopia Federal TVET Agency	



<b>Information Sheet-5</b>	<b>Submitting report according to institution's procedures</b>
----------------------------	--

**Report on installation and testing of equipment**

- When equipment arrives, it will be necessary to record the fact and to check that everything has been supplied that was ordered. It will also be necessary to check that the equipment is supplied in the right way.
- The following list will help to record all details, and on the following page a single sheet of checks can be copied or printed for each item of equipment to ensure correct installation is carried out.

Inventory number ..... equipment location .....

Acceptance date ..... Warranty expiry date.....

Maintenance contract with .....

Equipment type .....

Name equipment .....

Type/model .....

Order number ..... Serial number .....

Cost ..... date received .....

Manufacturer ..... Supplier/agent .....

Address ..... Address .....

phone ..... Phone .....

EEL BES2	Version:01	Page No.147
	Copyright: Ethiopia Federal TVET Agency	



**Installation** (refer to manuals)

	<b>Yes/ done</b>	<b>No/ not done</b>	<b>Corrected if applicable</b>
Was installation carried out satisfactorily?			
Were all parts present and correctly fitted?			
Were technical staffs present as learners?			
Was the equipment demonstrated as fully working?			
Were staff trained in operation of the equipment			



<b>Self-Check -5</b>	<b>Written Test</b>
----------------------	---------------------

**Directions:** Answer all the questions listed below. Use the Answer sheet provided in the next page:

**Part 1 say True or False for the following question**

1. Report on installation and testing of equipment is not important.
2. Serial number is one of the content in the reporting format
3. When equipment arrives, it will be necessary to record the fact and to check that everything has been supplied that was ordered.

**Note: Satisfactory rating - 3 and 5 points**

**Unsatisfactory - below 3 and 5 points**

You can ask you teacher for the copy of the correct answers.

EEL BES2	Version:01	Page No.149
	Copyright: Ethiopia Federal TVET Agency	



## Answer Sheet

Score = \_\_\_\_\_

Rating: \_\_\_\_\_

### Part 1 Multiple choose

1. ....
2. ....
3. ....
4. ....
5. ....

Operation Sheet 1	Techniques of Testing installed equipment and accessories.
-------------------	--

### 1.1. The techniques for Testing installed equipment and accessories

**Step 1-** Put on helmets, electrical glove , safety shoos.

**Step 2-** Check that installation of equipment and accessories are carried out satisfactorily

**Step 3-** Inspect all parts present and correctly fitted.

**Step 4-** Check that the ground resistance according to service manual instruction.

**Step 5-** Connect the installed equipment to power supply .

**Step 6-** Enter the Service Mode and select System Configuration from the menu and perform the following activities according to service manual instruction.

EEL BES2	Version:01	Page No.150
	Copyright: Ethiopia Federal TVET Agency	



- Environmental Conditions;
  - ✓ Temperature range.
  - ✓ Humidity level
  - ✓ Altitude
- Select the desired Alarm Limits (Automatic or User Adjustable).
- Change the language ,date,working hours if necessary
- Sensor calibration

**Step 7-** Check that the equipment demonstrated as fully working.

**Step 8-** Inspect are staff trained in operation of the equipment.

EEL BES2	Version:01	Page No.151
	Copyright: Ethiopia Federal TVET Agency	



<b>LAP Test</b>	<b>Practical Demonstration</b>
-----------------	--------------------------------

**Task 1-** What type of test can you conduct/ perform after installation of equipments.

**Task 2-** What are some of the activities you can perform in system menus of an equipment.

**Task 3-** Why calibration is needed and list some calibrator with there use.

EEL BES2	Version:01	Page No.152
	Copyright: Ethiopia Federal TVET Agency	





## Reference

1. "Medical Equipment Maintenance Manual, Ministry of Health and Family Welfare, New Delhi October 2010
2. "Ethiopian Building Code Standard, ELECTRICAL INSTALLATION OF BUILDINGS; EBCS-10 1995.
3. "Blood Pressure Monitor Fundamentals and Design, Rev. 2, 12/2012" by: Santiago Lopez;
4. "Introduction to Medical Electronics Applications; D. Jennings, A. Flint, B.C.H. firton and L.D.M. Nokes
5. "[www.frankshospitalworkshop.com](http://www.frankshospitalworkshop.com)"
6. "Medical Equipment Maintenance Manual, Ministry of Health and Family Welfare, New Delhi October 2010
7. "Ethiopian Building Code Standard, ELECTRICAL INSTALLATION OF BUILDINGS; EBCS-10 1995.
8. "Blood Pressure Monitor Fundamentals and Design, Rev. 2, 12/2012" by: Santiago Lopez;
9. "Introduction to Medical Electronics Applications; D. Jennings, A. Flint, B.C.H. firton and L.D.M. Nokes
10. "[www.frankshospitalworkshop.com](http://www.frankshospitalworkshop.com)"

EEL BES2	Version:01	Page No.153
	Copyright: Ethiopia Federal TVET Agency	



No	Name of trainer	Qualification	Region	E-mail
1	<b>YIDNEKACHEW REGASSA</b>	Electronics and communication technology management lecturer <b>(M.Sc.)</b>	Harar Poly Technic College	<a href="mailto:yidne888@gmail.com">yidne888@gmail.com</a>
2	<b>GEMECHU GERBABA</b>	Industrial automation and control technology management lecturer <b>(M.Sc.)</b>	Nekemte Poly Technic College	<a href="mailto:gamachugarbaba@gmail.com">gamachugarbaba@gmail.com</a>
3	<b>WONDIMU ZEYEDE</b>	Biomedical Engineering Instructor <b>(B.Sc.)</b>	Addis Ababa Tegbared Polytechnic College	<a href="mailto:Wondimzeyu336@gmail.com">Wondimzeyu336@gmail.com</a>
4	<b>TARIKU LEMI</b>	Biomedical Engineering Instructor <b>(B.Sc.)</b>	Adama Polytechnic College	<a href="mailto:tarikulemi888@gmail.com">tarikulemi888@gmail.com</a>
5	<b>BELAY DESTA</b>	Electrical /Electronic Technologist Instructor <b>(B.Sc.)</b>	Dire Dawa Polytechnic College	<a href="mailto:belaysweetdesta@gmail.com">belaysweetdesta@gmail.com</a>
6	<b>LISANEWORK MILKIAS</b>	Power engineering lecturer <b>(M.Sc.)</b>	Arba Minch Polytechnic College	<a href="mailto:llisaneworkmilkias@yahoo.com">llisaneworkmilkias@yahoo.com</a>