



Ethiopian TVET-System



# **BASIC ELECTRICAL/ELECTRONIC EQUIPMENT SERVICING Level I**

Based on May 2011 Occupational standards

October, 2019

EEL BEE1	Version:01 Copyright Info/Author: Ethiopia Federal TVET Agency	Page No.0
----------	---	--------------



## Module Title: Using Hand Tools and Testing Instruments

**TTLM Code: EELBEE1 TTLM 0919v1**

### **This module includes the following Learning Guides**

LG24: Plan and prepare tasks and workstation

LG Code: EEL BEE1 M07 LO1-LG24

LG25: Prepare Hand Tool

LG Code: EEL BEE1 M07LO2-LG25

LG26: Use hand tools and test equipment

LG Code: EEL BEE1 M07LO3-LG26

LG27: Maintain hand tool

LG Code: EEL BEE1 M07LO4-LG27

<b>Instruction Sheet</b>	LG24: Plan and prepare tasks and workstation
--------------------------	--

EEL BEE1	Version:01	Page No.1
	Copyright Info/Autor: Ethiopia Federal TVET Agency	



This learning guide is developed to provide you the necessary information regarding the following content coverage and topics –

- Identifying tasks to be undertaken properly
- Identifying and selecting appropriate hand tools and test instruments
- Making work station ready

This guide will also assist you to attain the learning outcome stated in the cover page. Specifically, upon **completion of this Learning Guide, you will be able to –**

- Identify Tasks to be undertaken properly
- Identify and select Appropriate hand tools and test instruments according to the task requirement
- Make Workstation ready in accordance with job requirements/specifications.

#### **Learning Instructions:**

1. Read the specific objectives of this Learning Guide.
2. Follow the instructions described below 3 to 6.
3. Read the information written in the information “Sheet 1, Sheet 2 , and Sheet 3
4. Accomplish the “Self-check 1, Self-check 2 and, Self-check 3 **in page -4, 34, and 39** respectively.
5. If you earned a satisfactory evaluation from the “Self-check” proceed to “Operation Sheet 1, **in page**
6. Do the “LAP test” **in page – 40** (if you are ready).



## 1.1 Introduction

This manual provides information on the Identifying tasks to be undertaken properly selected hand tools. It will explain the types and uses of a large number of tools, a practical application of a selected group of tools, safety requirements, general care, and limited repair. A user must have, choose, and use the correct tools in order to do the work quickly, accurately, and safely. Without the proper tools and knowledge of how to use them, the user wastes time, reduces efficiency, and may face injury

## 1.2. Classification of Tools and Equipment

**A tool** is a device that can be used to produce an item or accomplish a task, but that is not consumed in the process. It can be considered as extension of the human hand thus increasing speed, power, and accuracy and on the other hands equipment includes any machine powered by electricity.

- **Hand tools** are tools manipulated by hands without using electrical energy such as: puller, hacksaw, pull-push rule, pliers, hammer, and others.
- **Machine/Power tools** are tools manipulated by our hands and with the use of electrical energy such as: electric drill, grinding wheels, vacuum cleaner and others.
- **Pneumatic tools** are tools or instruments activated by air pressure. Pneumatic tools are designed around three basic devices: the air cylinder, the vane motor, and the sprays

## 1.3. Identifying tasks to be undertaken properly

Take time to plan your work, by yourself and with others. Safety planning is an important part of any task. It takes effort to recognize, evaluate, and control hazards. If you are thinking about your work tasks or about what others think of you, it is hard to take the time to plan for safety. But, you must plan! Planning with others is especially helpful. It allows you to coordinate your work and take advantage of what others know about identifying and controlling hazards. The following is a list of some things to think about as you plan.

- Work with your partner-Do not work alone. Both of you must know what to do in an emergency.
- Know how to shut off and de-energize circuits. You must find where circuit breakers, fuses & switches are located. Then, the circuits that you will be working on (even low-voltage circuits)



**MUST BE TURNED OFF!** Test the circuits before beginning work to make sure they are completely de-energized.

- Plan to lock out and tag out circuits and equipment. Make certain all energy sources are locked out and tagged out before performing any work on an electrical circuit or electrical device. Working on energized (“hot”) circuits is one of the most dangerous things any worker could do. If someone turns on a circuit without warning, you can be shocked, burned, or electrocuted. The unexpected starting of electrical equipment can cause severe injury or death.

Before ANY work is done on a circuit, shut off the circuit, lock out and tag out the circuit at the distribution panel, then test the circuit to make sure it is de-energized. Before ANY equipment inspections or repairs even on so called low voltage circuits- the current must be turned off at the switch box, and the switch must be padlocked in the OFF position. At the same time, the equipment must be securely tagged to warn everyone that work is being performed. Again, test circuits and equipment to ensure they are de-energized.

A locked-out switch or feeder panel prevents others from turning on a circuit. The tag informs other workers of your action.

- Remove jewelry and metal objects. Remove jewelry and other metal objects or apparel from your body before beginning work. These things can cause burns if worn near high currents and can get caught as you work.
- Plan to avoid falls- Injuries can result from falling off scaffolding or ladders. Other workers may also be injured from equipment & debris falling from scaffolding & ladders.
- Do not do any tasks that you are not trained to do or that you do not feel comfortable doing!

## 1.2. General Safety Rules

There will undoubtedly be a safety program to follow for the shop or area in which you will be working. The following general safety rules are furnished as a guide.

- **SUPPORT:** your local safety program and take an active part in safety meetings.
- **INSPECT:** tools and equipment for safe conditions before starting work.
- **ADVICE:** your supervisor promptly of any unsafe conditions or practices.
- **LEARN:** the safe way to do your job before you start.
- **THINK:** safety and ACT safety at all times.
- **OBEY:** safety rules and regulations-they are for your protection.
- **WEAR:** proper clothing and protective equipment.
- **CONDUCT:** You properly at all times-horseplay is prohibited.



- **OPERATE:** only the equipment you are authorized to use.
- **REPORT:** any injury immediately to your supervisor.

<b>Self-Check -1</b>	<b>Written Test</b>
----------------------	---------------------

**Directions:** Answer all the questions listed below. Use the Answer sheet provided in the next page:

*I. **Say “TRUE” if the statement is correct and say “FALSE” if the statement is Incorrect.***

1. Safety planning is an important part of any task.
2. The tags do **not** inform other workers of your action.
3. The unexpected starting of electrical equipment can cause severe injury or death.
4. Planning allows you to coordinate your work.
5. The circuits that you will be working on must be turned **ON!**

**Note: Satisfactory rating - 3 and 5 points**

**Unsatisfactory - below 3**

You can ask you teacher for the copy of the correct answers.

Score = \_\_\_\_\_

Rating: \_\_\_\_\_

**Answer Sheet**

Name: \_\_\_\_\_

Date: \_\_\_\_\_



## 1.2 Identify and selecting appropriate hand tools and test instruments

### 1. SCREW DRIVERS

A screwdriver is a device used to insert and tighten screws or to loosen and remove screws. A screwdriver has a head or tips that connect with a screw, a mechanism to apply torque by rotating that tip, and a way to position and support the screwdriver. A typical manual screwdriver is made up of a roughly cylindrical handle, with a shaft fixed to the handle, including a tip shaped to fit a particular type of screw. The handle and shaft support and position the screwdriver, and apply torque when rotated. The blade is made of tempered steel so it will resist wear, bending, and breaking.

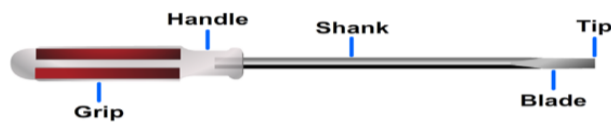

Fig.2.1 parts of screw drivers

Screwdrivers are generally classified as slotted, Phillips head or Robertson (square recess) head, with all three types available with round or square shanks. Quality screwdrivers are judged by the kind of metal in the blade, the finish and amount of grinding on the tip. Material used in the handle, and bar attachment to the handle are other quality indicators. If blade metal is poor quality, it will chip and crumble under pressure. If the tip is improperly ground and flares too much, it will rise out of the screw slot. If the blade is not attached firmly to the handle, it will eventually loosen and slip in the handle.

- **Screwdriver Tips**

A wide range of screwdriver tips are available: regular, cabinet, Phillips, Frearson, Torx®, clutch-head, hex and square-tipped.

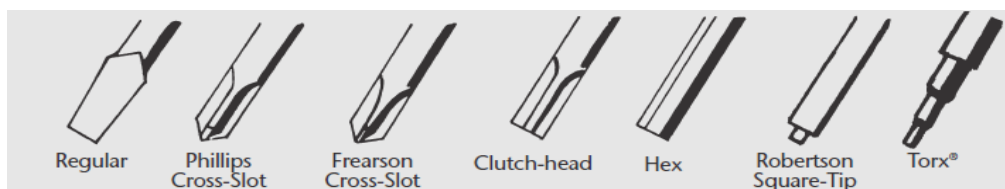

Fig.2.2 Types of Screw Drivers



- **Regular or slotted tips** are used with large, heavy screws. The tip is flared so it is wider than the driver bar. Quality drivers with regular tips should be accurately ground for uniformity. Blades should not taper too sharply from the tip because an improperly tapered tip has a tendency to rise out of the screw slot.
- **Cabinet tips** are similar to regular tips, but they have no flare. They are straight for use with small screws and countersinking screws where regular tips with a flare would mar the wood or material on the side.
- **Phillips head drivers** are used on cross-slotted screw heads with modified, U-shaped slots of uniform width. Sizes range from 0 to 4, with 0 being the smallest.
- **Frearson screw heads** are similar to Phillips. They have cross-slots, but they are V-shaped slots with tapered sides. While a cross-slotted driver will fit many sizes of the type of screw for which it is intended, it is best to use drivers of the proper sizes.
- **Torx® drive system** provides six lobular drive surfaces mated from lobes of the driving and driven elements. Drive surfaces have vertical sides that permit the maximum torque application to assure reliable clamping force.
- **Clutch-head tips** have four points of contact. They lock into the screw head when turned counter-clockwise. The driver is unlocked by turning it in the opposite direction. Because of the many contact points, the tip will not damage the screw head.
- **Hex (hexagonal) tips** are used in repair work in the electronics field, particularly in radio and television repair. They are used to tighten socket set screws and usually come in sets. Some sets are attached to and fold into a metal carrying case. Other variations include T-shaped hex tools with vinyl grips and L shaped keys for greater torque power.
- **Square-tipped (Robertson)** screwdrivers have become more common recently because of increased do-it-yourself decking projects. The screwdrivers have a square head and range in sizes from 0 to 3 and jumbo. The square head on the driver helps grip the screw on all four sides to provide maximum torque.
- **Multi-bit screwdrivers** allow the user to have a number of different types of tips in one tool. Some products keep the interchangeable bits in a self-contained unit.
- **Offset screwdrivers** are designed for removing and inserting screws in places where it is impossible to use a straight shank screwdriver. They are available in many combinations of slotted and Phillips head tips and with ratchet type mechanisms.  
Some screwdrivers are designed with magnetized tips, convenient when guiding screws to holes or otherwise inaccessible areas. They also retrieve dropped screws and nuts. Others





have split-points that can be expanded in width to fill the screw slot and hold screws when guiding into inaccessible areas. A spring clamp that fits over the screw head, holding the bit in the slot, serves a similar purpose. There are even screwdrivers that feature lights on the handles to allow the user to work in dimly lit areas.

- **Specialty Screwdrivers:** This group includes offset screwdrivers, used in places impossible to reach with ordinary drivers, screwdrivers with external screw-gripper or screw-holder blades to start screws in hard-to-reach spots, and offset screwdrivers with ratchets.
- **Hex Nut Drivers** Hex nut drivers are similar to screwdrivers, but have a hex opening more like wrench sockets than screw tips. They are used to drive or remove small hex nuts or bolts and in confined areas such as electronic equipment, car ignitions and plumbing jobs. They come in several sizes and styles, with a fixed size or variable-size "socket" at the end.
- **Spiral-Ratchet Screwdrivers** A spiral-ratchet screwdriver uses a mechanism similar to a push-pull drill. It has an adjustable chuck to permit interchanging of different tips and points. Ratchets drill and remove screws. Pushing straight down on the handle provides driving action.
- **High-Torque Ratchet Screwdrivers** These screwdrivers feature a 360-degree ball as a handle with a ratchet mechanism that eliminates the need to grip and re-grip during the driving process. The wider gripping surface generates more torque than conventional screwdrivers. The amount of additional torque varies with the model. These high-torque ratchet screwdrivers come with interchangeable blades.

SCREW NUMBER	0	1	2	3	4	5	6	7	8	9
REGULAR BLADE WIDTH	3/32"	1/8"	1/8"	1/8"	5/32"	3/16"	3/16"	7/32"	1/4"	1/4"
CROSS-SLOT BLADE	No. 0		No. 1			No. 2				
SCREW NUMBER	10	12	14	16	18	20	24	7/16	1/2	9/16
REGULAR BLADE WIDTH	5/16"	3/8"	3/8"	3/8"	1/2"	1/2"	1/2"	1/2"	1/2"	1/2"
CROSS-SLOT BLADE	No. 3					No. 4				

**Fig. 2.3 Size of Drivers to Use for Different Size Screws**

## 2. PLIERS

Pliers are designed to hold, turn and cut objects. Pliers vary in length from 4" to 20".



Some pliers are available with factory applied, plastic-coated handles, providing an attractive appearance and comfortable grip. However, these pliers should not be relied on for electrical work.

- **Pliers fall into two broad categories:** solid-joint and slip-joint, either of which may have cutters.
- ✓ **Slip-joint pliers** are of two designs: multiple hole and tongue and groove. The slip or adjustable joint enables the tool to adjust to the size of the object being held.
- ✓ **Solid-joint pliers** have a joint fixed with a solid pin or rivet and are not adjustable.
- ✓ **Cutting pliers** can be side, end or diagonal types. Side cutters have a cutting blade on one side only and are available in long-, curved- and short-nose types. End cutters have cutting blades on the end and are used to make sharp, clean cuts close to the surface on wires, bolts and rivets. Diagonal cutters have two cutting blades set diagonally to the joint and/or handles. Some cutting pliers are made with a spring in the handle to open them automatically after each cut, providing ease and comfort for the user.
- **Other pliers commonly found in home improvement stores include:**
  - ✓ **Regular slip-joint pliers:** General utility pliers with two jaw-opening adjustments. Some have a shear-type wire cutter.
  - ✓ **Thin jaw slip-joint pliers:** Like slip-joint, but made with a slim nose to reach into tight places.
  - ✓ **Multiple slip-joint or box-joint pliers:** General utility tool with up to eight adjustments, allowing for jaw openings up to 4-1/2", either multiple hole or tongue and groove. Straight and curved jaws are available. Most common is 10" water pump pliers.
  - ✓ **Crimper stripper pliers:** Multi-purpose electrician's pliers to crimp solder less connectors, strip most common gauge wire, cut and hold or bend wire. They also have sheaving holes that cut common sizes of screws without deforming threads.
  - ✓ **Needle-nose pliers:** Also called long nose pliers, they have a pointed nose for reaching places with restricted clearance, May have side cutters. A standard item for most electrical and electronics work.
  - ✓ **Thin-nose pliers:** Also called bent-nose pliers, since the nose is bent at about an 80-degree angle for reaching around objects.
  - ✓ **Duck bill pliers:** have long, tapered, flat noses for work in restricted areas. Used by jewelers, telephone workers and weavers.
  - ✓ **Midget pliers:** Include straight, chain, round, end-cutting, diagonal-cutting and flat-nose pliers in extra-small sizes.
  - ✓ **End-cutting nippers:** Feature powerful leverage for sharp, clean cuts close to the surface on wires, bolts and rivets.

- ✓ **Lineman's or electrician's pliers:** Heavy duty, side-cutting pliers designed for all regular wire cutting needs. Have gripping jaws in addition to cutting edges. High-leverage lineman's pliers have rivet placed closer to the cutting edges to provide more leverage.
- ✓ **Fence pliers:** Pull and cut staples in fencing. Feature two wire cutters and heavy head for hammering.
- ✓ **Locking pliers:** Adjustable, vise-type locking pliers can be locked on to a work piece, leaving both hands free. They are versatile tools that can be used as pliers, a pipe wrench, an adjustable wrench, wire cutters, a ratchet or a clamp. Locking pliers are available in various sizes and shapes: curved jaw with wire cutter, straight jaw, long nose with wire cutter and bent nose with wire cutter. The locking principle also applies to locking clamps, which come in 4", 6", 11", 18" and 24" sizes. Some locking pliers use a mechanism that allows one-handed release; others require two hands to disengage. In addition, many locking pliers provide a wire-cutting function, some from a full range, and others from a restricted range of jaw settings.

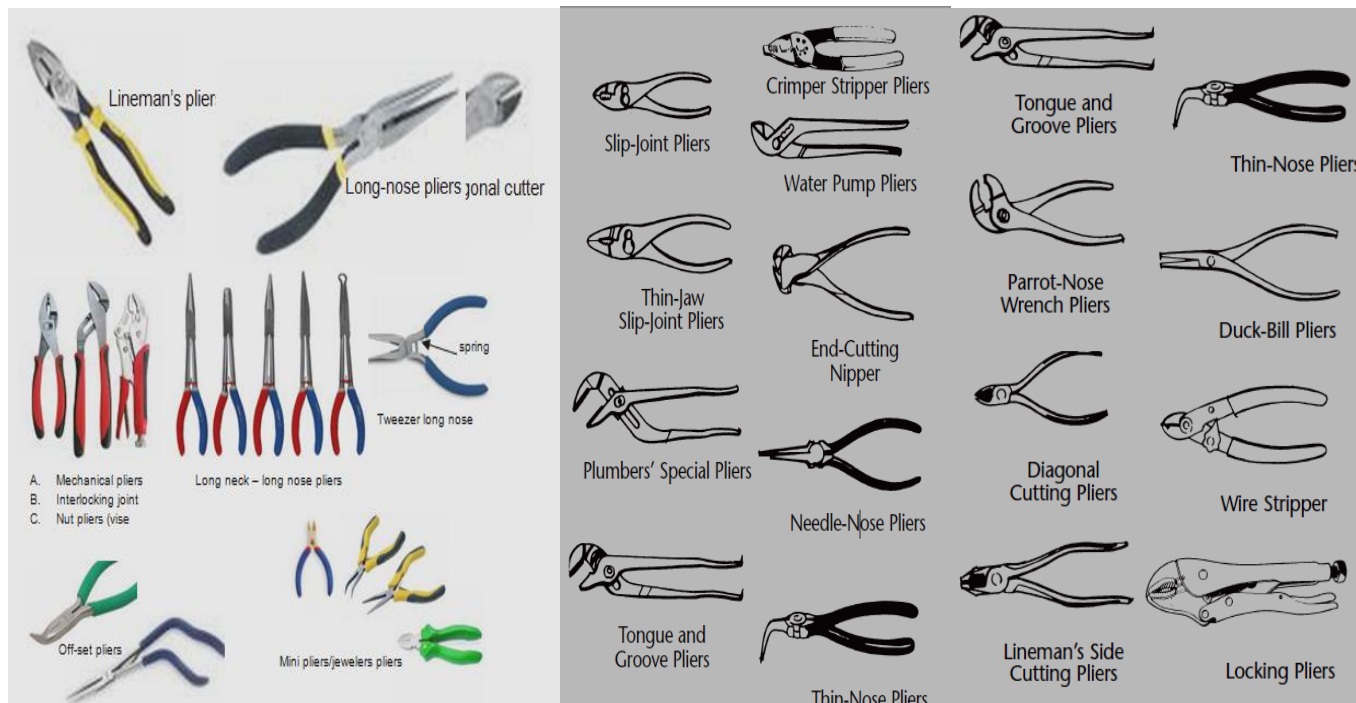

**Fig.2.4. Different type of pliers**

**3. Wire strippers:** Feature adjustable stops to cut insulation without damaging wire.



**Fig.2.5. Multi –purpose wire cutter**

#### 4. HAMMERS

- **Nail Hammers** The two basic nail hammers are curved claw and straight claw.

5. A **curved claw hammer** is used most often in a home for general carpentry and household chores. It should be used only with non-hardened, common or finishing nails. The curved claw offers leverage in removing nails and can also cradle a 2x4.

- A **straight claw (ripping hammer)** is more likely to be used by professionals to rip apart nailed wooden components. It is a slightly heavier tool, used for heavier carpentry, framing and ripping. It should also be used only with non-hardened, common or finishing nails. Common head weights are 7 oz. for light duty driving; 10 oz. and 13 oz. for cabinetmakers and householders; 16 oz. for general usage and 20 oz. for heavy crating or framing. All sizes are available with curved claw while the straight claw comes in 10-, 12-, 16, 20-, 24 28- and 32-oz. weights. Straight claw hammers are now available with milled or checkered faces to grip the nail head and reduce the effect of glancing blows and flying nails. Two innovations in the field of nailing hammers are hammers with interchangeable striking faces and hammers that hold nails. The interchangeable striking faces allow one Hammer to be used for several different applications. The striking face finishes include milled and checkered. The hammer with a nail-holding notch makes it safer and easier to start a nail and also extends the reach of the user. Nail hammers may have handles made of a number of materials—wood, fiberglass, graphite, solid steel or tubular steel. Each offers a different combination of stiffness for efficiently delivering the force of the blow to the target and shock absorption to reduce shock and stress on the user's hand, wrist and arm. Wood



flexes and offers some degree of shock absorption. Stiffer materials such as graphite or steel deliver the full force of the blow but require cushioning in the jacketing and grip to provide long term user comfort. Steel handles are the heaviest, while wood-handled hammers are the lightest and least expensive. Nail hammer handles are available in a variety of lengths from 13" to 18".

- **Ball Peen Hammers** Ball peen (ball pain) hammers are used with small shank, cold chisels for cutting and chipping work, rounding over rivet ends, forming unhardened metal work and similar jobs not involving nails. The striking face diameter should be approximately 3/8" larger than the diameter of the head of the object being struck. The hammer is designed with a regular striking face on one end and a rounded or half ball or peen on the other end taking the place of a claw. The hammer face is heavier than the peen end. Hammer sizes range from 2 oz. to 48 oz. Twelve and 16 oz. are most popular.
- **Hand Drilling Hammers** Hand drilling hammers, weighing between 2 lbs. and 4 lbs., are easy to handle with a powerful punch. They have short handles and are recommended for pounding hardened nails into concrete or for using with tools that drive nails and pins into concrete or brick. They are the only hammers to use with star drills, masonry nails, steel chisels and nail pullers. A larger striking surface, generous bevel and special heat-treating minimize the chance of chipping the striking face.
- **Sledge hammers** Sledgehammers are used for extremely heavy jobs where great force is required. They have long handles ranging from 14" to 36" and heavy heads that weigh from 2 lbs to 20 lbs. Sledges can be double-or single-face. Many sledgehammers are now available with lighter, balanced, reinforced plastic handles for easier use and better weight distribution.
- **Mallets**  
Mallets have rubber, plastic, wooden or rawhide heads and are used to drive chisels or hammer joints together. With the exception of wooden mallets, sizes are specified in either head weight or diameter, such as 2-1/4". Wooden mallets are specified by head diameter only. There are a variety of mallet shapes and sizes for specific tasks. A carpentry mallet with an angled head provides a natural strike resulting in less wrist and arm fatigue. A shop mallet with an octagonal head is used for flat strikes, while a pestle-shaped mallet with a round horizontal strike is generally used with a chisel or other carving tools. A rawhide mallet is used in furniture assembly shaping soft sheet metals or any task that requires non-marring blows.



- Specialty Hammers** Specialty hammers include riveting hammers to set rivets; setting hammers to close and open seams and dress edges in tin work; straight and cross-peen hammers for riveting, stretching and bending metal; scaling and chipping hammers for general chipping in welding and cleaning torch cuts; brick hammers for cutting and setting brick and tile hammers to set tile. Others include soft-face hammers for assembling furniture and wood projects and setting dowels (won't mar the surface with the blow); dead blow hammers that contain lead shot for additional power and reduced tendency to bounce (many feature non-marring and non-sparking striking faces); magnetic tack hammers for furniture upholstery; drywall hammers that score, sheet and set nails for drywall work and finishing hammers for cabinet making, finishing and other fine carpentry and light chores.

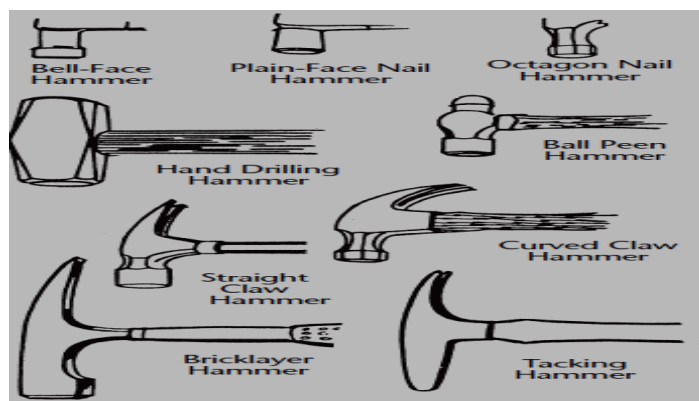

**Fig.2.7. Types of Hammers**

#### 4. WRENCHES

Wrenches can be classified as general use or plumbing wrenches. Top-quality wrenches are forged from fine grade tool steel, machined to close tolerances hardened and tempered for long service life. Most types are sold individually and in sets of various sizes. Because most imported products are made to metric specifications, a set of metric wrenches has become a must in many home workshops.



A wrench's main function is to hold and turn nuts, bolts, caps, screws, plugs and various threaded parts. Applying excessive torque will strip or damage those threads, so quality wrenches are designed to keep leverage and intended load in safe balance. Users should not put "cheaters" on wrenches to increase leverage. The proper size wrench should be used. Too large a reach will spread the jaws of an open-end wrench or damage the points of a box or socket wrench. When possible, a wrench should be pulled, not pushed.

- **Open-end wrenches** provide gripping power on two sides of the head with another side open so the wrench can be placed on a nut, which might not be accessible to a closed or box wrench. Open-end wrenches have different size openings on each end and should fit the nut exactly to prevent mutilating the nut edges.
- **Box (box-end) wrenches** have enclosed heads and provide more leverage by completely enclosing the nut. Some are offset to provide knuckle room and clearance over obstructions. They range in size from 4" to 16" long and are available with either 6- or 12-point rings.
- **Combination wrenches** have a box and an open end on opposite sides of the same wrench. Both ends are usually the same size. They are used for working on machinery and are the most popular of all fixed end wrench styles. Also available is a reversible ratcheting combination wrench that allows the user to quickly tighten nuts and bolts without lifting the wrench off and repositioning it after each rotation.
- **Adjustable wrenches** come in two styles: locking and non-locking. Non-locking styles feature an adjustable end opening with little provision made for slippage. The locking style also has an adjustable head, but uses a locking mechanism to secure jaws in desired position, eliminating the need for constant readjustment. When properly adjusted to a nut or bolt, it will not slip.
- **Pipe (Still son) wrenches** screw pipes into elbows or other threaded devices. Jaws actually bite into the surface to hold it for turning. They should never be used on plated pipe installations because they will badly scar the finish. Aluminum pipe wrenches are popular among professionals because of their lighter weight, but they are more expensive.
- **Socket wrenches** combine an offset handle with a male drive piece that has a spring loaded bearing to lock on various size sockets. They can be used at almost any angle since handles may be attached to the head by a jointed hinge device. Many socket wrenches have a ratchet handle making reversing possible in confined spaces. The most common type is the detachable socket wrench, with square drive for hand use. Common square drive sizes are 1/4", 3/8" and 1/2", and these are normally used in conjunction with a ratchet wrench. Sockets are available with 6-, 8- and 12- point gripping ends, in a full range of inch and metric sizes. A socket wrench combined with a



ratchet wrench makes the job of tightening or loosening nuts and bolts faster and easier than conventional wrenches.

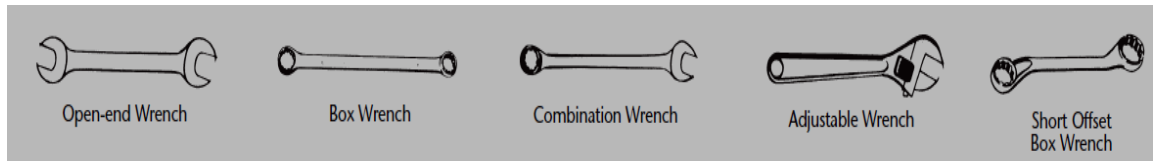

Fig.2.8. Types of Wrenches

- **Flare nut wrenches** are flared to fit hex fittings.
- **Hex-key wrenches** are short, L-shaped tools designed to turn bolts or screws with hexagonal heads. They also come in sets of different-sized wrenches.

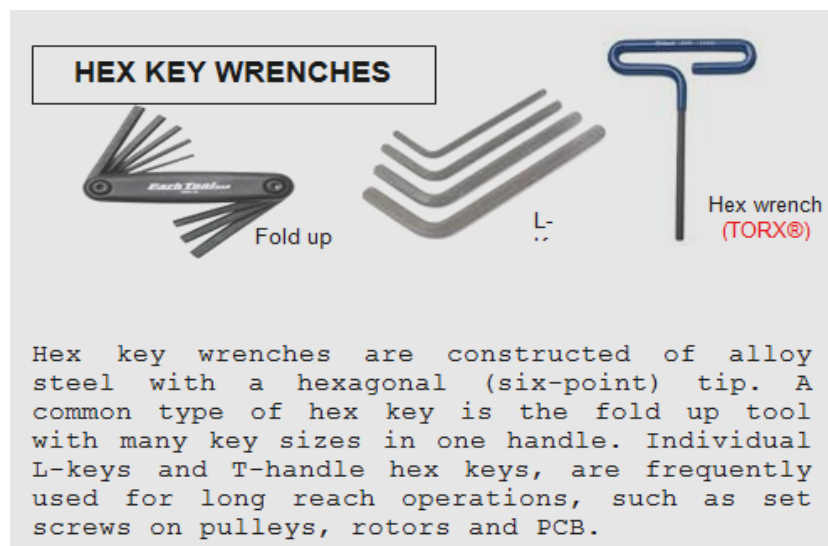

Fig.2.9. type of Hex-key wrenches

- **Ratchet wrenches** are available in 1/4", 3/8" and 1/2" drive sizes and are used with socket wrenches. They are available with a round or teardrop-shaped head and contain a reversing mechanism to facilitate tightening or loosening a fastener. Ratchet wrenches are available in a variety of handle shapes and lengths. Accessories that can provide a drive means to socket wrenches include flex handles, speeder handles and T-handles. Extensions of various lengths and universal joints can be used with ratchet wrenches and socket wrenches to work on fasteners in hard-to reach locations.
- **Locking wrenches** are among the most versatile hand tools found in the home or shop. Through a locking action, jaws can be locked in a holding position with pressure up to 1 ton. They can also be used as hand vises, holding clamps, pipe wrenches and hand-vise pliers. They are available with both curved and straight jaws.
- **Torque wrenches** are designed to permit an operator to determine applied torque on bolts, nuts and other fasteners. They measure torque in ounce-inches, pound-inches and pound-feet,





as well as metric measure. However, many manufacturers express torque in foot-pounds (rather than pound feet) since this nomenclature is more familiar to the average tool user. Two basic hand torque wrenches are audible signal and visual display. The audible signal type signals applied torque by momentarily releasing the wrench for a few degrees of free travel. The release is usually accompanied by a click sound, which gives the wrench its popular names: click torque wrenches or clickers. Torque value is set to a micrometer scale on the handle or preset by an adjusting screw in the handle cavity. The visual display type indicates applied torque on a dial or electronic display. Some models have memory pointers that remain at the maximum reading attained until manually reset. For low-torque application, torque screwdrivers are usually used. They are available in either the release or indicating type. The most widely used torque wrenches have square drives to use standard detachable sockets. Both ratcheting and non-ratcheting types are available. Torque wrenches are used in various operations where proper torque of nuts, bolts and other fasteners is critical, for example, assembly and inspection of get rains and bearings, setting of clutches and brakes, overhaul and experimental work.



**Fig. 2.10. different type of wrenches**

Most technical and servicing work/job requires the use of various types of wrenches. Many fasteners and parts are copper or brass, aluminum and alloy, and therefore, are rather.

- **Proper uses:**

- ✓ Always work with clean threads free of corrosion.
- ✓ Follow the product manufacturer's instructions for specific torque loadings, particularly whether recommendations are for dry, oiled or plated threads.
- ✓ Avoid over tightening a nut or bolt with a conventional wrench before applying a torque wrench.
- ✓ When not in use, set at lowest torque.
- ✓ Never use it as a hammer, pry or conventional wrench.
- ✓ Avoid dropping. If dropped, check accuracy on a torque tester.



- ✓ When using adjustable wrenches, do not
- ✓ Over-torque by applying torque past the release point. Learn the feel of the release rather than relying on the sound.
- ✓ Read torque values on indicating torque wrenches by looking at the dial at 90° to its surface.
- ✓ When in frequent or continuous use, periodically check calibration accuracy..

## 5. CUTTING TOOLS

### • **Punches/Chisels**

**Chisels** are grouped according to the material they cut, either wood, metal, stone or brick. The two main types are wood and cold. Quality **wood chisels** have large, ergonomically shaped handles for a comfortable, sure grip and better control. Blades should be of high-quality carbon, heat-treated steel with precision-ground cutting edge. In addition, woodworking chisels should have crowned steel strike caps to help center the blow. One type of wood chisel—the **butt chisel**—has a short blade that ranges from about 2-1/2" to 3" long. It is used by pattern makers, cabinetmakers, carpenters and do-it-yourselfers for carving and paring, particularly in tight spots. It can be used with hard-faced hammers.

- A **firmer chisel** is square-sided and has a longer blade, usually from 3-1/2" to 6" and is used mainly for cutting deeply into wood. It should be used with soft-faced hammers.
- **Paring chisels** are for light-duty, detailed work such as trimming cabinets.
- **Cold chisels** have several styles—**flat** (the most widely used), **cape**, **diamond-point** and **round-nose**. They should be used only for cutting and chipping cold metal (unhardened steel, cast and wrought iron, aluminum, brass, copper), never masonry.
- **Bricklayer's chisels** should be used when cutting masonry. Cold chisels should be struck only with a hand drilling, ball peen or similar heavy hammer with a face diameter approximately 3/8" larger than the struck tool head. Chisels have wood or plastic handles. Wood handles are available in both tang (the end of the blade or tang fits into the handle) and socket type (a projection from the handle fits into a socket in the blade). Plastic handles fit only tang construction. Like chisels and planes, gouges are used for removing material from a block of wood, plastic or metal. Gouges come in two primary types: inside and outside gouges. All steel chisels and punches (not wood chisels having wooden or plastic handles) are subject to chipping that can cause bodily injury much the same as steel hammer faces. Therefore, applicable safety standards require the warning "Wear Safety Goggles" on each tool. Nearly all domestic manufacturers comply by stamping those words into the shank.



**Fig.2.11. Different type of *Punches/Chisels***

- **Utility Knives** Utility knives are designed to cut heavy materials such as carpet, flooring, roofing, cardboard cartons, laminates and plastic. Blades can be replaced by disassembling the handle or ejecting them by depressing a spring-release button on the handle. Some knives swivel open to permit blade replacement.

Type	Example
Snap-off bladed knives	
Multi-tools	
Pocket knives	
Box cutter utility knife	

**Fig.2.12. Different type of Utility Knives**

- **Bolt Cutters** Heavy-duty cutters cut bolts, threaded rods, cables and other metals from 1/16" to 5/8" thick. They are made from drop-forged tool steel from 12" to 36" long. The longer cutters have greater strength. Special leverage joints allow great pressure to be applied with minimum effort. End-cut cutters operate similarly to end cut pliers, with special jaws available to cut special metals.
- **Snips:** Snips are designed for cutting sheet metal; sheet brass, copper, plastic cloth and many other materials. They are available in five main types:
  - **Straight or regular:** Used for all straight cutting jobs.
  - **Combination** More versatile than regular snips; used for straight and moderately irregular cuts.
  - **Duckbill or circular:** Used for cutting circles or other curved designs.



- **Aviation or compound leverage**—Come right-handed, left-handed or straight. Used for cutting curves or straight. Cut easier because of compound leverage.
- **Offset snips:** Have offset handles to keep hands above work. They are designed especially for long, inside cuts and are available for right or left cutting.

## 6. SAWS

- **Hand Saws** Handsaws have 14" to 26" blades. Fineness of cut depends on the number of cutting teeth (points) per inch and tooth shape. The higher the number of points, the finer the cuttings. A coarse crosscut saw with seven or eight teeth per inch is best for fast, rough work or for use on green wood. A fine-tooth crosscut saw with 10 or 11 teeth per inch is best for smooth, accurate cutting on dry, seasoned wood.

Some handsaws are available with special “aggressive design” teeth—three cutting edges instead of the conventional two. They cut on both the forward and backward stroke, thereby cutting several times faster than saws with traditional teeth. They may also have the teeth induction-hardened to help keep them sharp longer. Saws also come with a wide range of handle styles, but the three most common are **pistol grip, closed handles** and **straight handle**. Pistol grip handles are used primarily on smaller saws that have thinner blades. Closed handles are incorporated more often on larger saws and help to add support to the larger blades. Drywall saws and other small-bladed saws often use straight handles that are in line with the saw’s blade. Most saws require minimal maintenance other than oiling of the blades to prevent rust. They should be hung up by their blade or handle since blades have a tendency to bend when stored flat.

- **Quality features in saws include:**
    - ✓ Tempered alloy blades. Lower-grade steel quickly loses its sharp edge but is easy to sharpen.
    - ✓ Rust-resistant or Teflon™-coated blade finish. Teflon™-coated hand saws reduce many binding and residue buildup problems inherent to wood cutting.
    - ✓ Reduced friction or drag makes for smoother, easier cutting.
    - ✓ Hardwood or sturdy plastic handle. Special aluminum or plate steel nuts and bolts to fasten blade to handle. Cut edge to prevent binding in the cut.
    - ✓ Bevel-filed teeth evenly set in two alternate rows, one row to the right of center, one row to the left; produces a groove or kerfs slightly wider than the thickest part of the blade; prevents or reduces binding while sawing.
7. **Rip Saws** A rip saw has large, chisel-shaped teeth, usually 5-1/2 teeth per inch, and is made to cut with the wood grain. Blade lengths measure from 24" to 28". Teeth are cross filed to ensure that the chisel point is set square to the direction of cutting for best performance. This saw is



best held at a 60° angle to the surface of the board being cut. The ripping action of the saw produces a coarse, ragged cut that makes the saw unsatisfactory for finish work.

- 8. **Crosscut Saws** Most commonly used crosscut saws are 10 to 12-point for fine work and 7- or 8- point for faster cutting. Ten teeth per inch is considered general purpose. Teeth are shaped like knife points to crumble out wood between cuts. Best cutting angle for this saw is about 45°. Blade lengths range from 20" to 28", with 26" the most popular.

- 9. **Hacksaws**

Hacksaws are fine-toothed saws designed to cut metal or plastic. The saws consist of a blade held in a steel frame with relatively high tension.

High-tension models (with tension to 32,000 p.s.i.) are also available. High tension holds the blade more rigidly straight, which enables the user to make fast, straight cuts. Blade life is also increased.

Look for a quick-release blade change mechanism, tension guide and rugged frame on these models. Blades come in several designs, such as course-, medium-, fine- and very fine toothed. Regular or standard blades are used for general-purpose cutting; high speed or bi-metal blades for cutting hard, extra-tough steel. The medium blade has 18 teeth per inch and is good for cutting tool steel, iron pipe and light angle iron. A fine blade, which has 24 teeth per inch, cuts drill rod, thin tubing and medium- weight materials. The very fine blade, with 32 teeth per inch, is used for extra thin materials, light angle irons, channels, wire rope and cable. As a guide to selecting the right blade, find out what material will be cut; then suggest a blade that will have at least three teeth in contact with the material. Frames vary in style and price. Most can be adjusted to hold various blade lengths. Some have both horizontal and vertical positions for blades. Others provide blade storage. A close-quarter (or utility) hacksaw holds and positions a hacksaw blade so it can be used effectively in narrow spaces and slots.

- **Compass or Keyhole Saws**

Compass saws cut curved or straight sided holes. Saw blades are narrow, tapered nearly to a point to fit into most spaces. Blades come in three or four styles that can be changed to fit the job. Some models have induction-hardened teeth for longer life without sharpening.

Keyhole saws are small compass saws with finer teeth that can cut metal. Turret head keyhole blades can be rotated and locked in several positions for easier cutting in tight, awkward spots.

- **Coping Saws**

Coping saws cut irregular shapes, curves and intricate decorative patterns. They consist of a thin blade and a C-shaped steel tension frame. The removable blade is typically 6-1/2" long.

- **Backsaws**

EEL BEE1	Version:01	Page No.20
	Copyright Info/Autor: Ethiopia Federal TVET Agency	



A backsaw is a thick-bladed saw with a stiff, reinforced back to provide the rigidity necessary in precision cutting. It varies in length from 10" to 30" and is found in tooth counts from seven to 14 teeth per inch. They are used with miter boxes to cut miters.

- **Bow Saws**

Bow (buck) saws consist of a tubular steel frame and a saw blade for fast cutting of all woods. The bow saw's frame is important, since the thin blade, usually 3/4" wide must be held under high tension for fast cutting. Advantages of this general-purpose saw are its all-around utility and light weight. In 21", 24" and 30" lengths, bow saws normally have teeth placed in groups. Within each group, distance between teeth varies, ensuring a smooth, vibration less cut. Wide gullies provide ample space for sawdust to accumulate without binding the saw. In the 36", 42" and 48" lengths, the most popular tooth pattern provides for two cutter teeth to each rakes tooth. This combination of teeth ensures maximum cutting ability in these longer lengths, regardless of wood hardness.

Some bow saws are designed to hold hacksaw blades as well as standard bow saw blades. These multi-purpose saws can be used to cut wood, metal or plastic.

- **Specialty Saws**

- ✓ **Wallboard or drywall saws** resemble a kitchen knife in design. They will cut plasterboard in the same fashion as a keyhole saw and are used for sawing holes for electric outlets and switch plates. The saw is self-starting with a sharp point for plunge cuts. It may also have induction teeth for longer life without sharpening.

- ✓ **Veneer saws** are specially designed for sawing thin materials such as wood paneling.

The blade is curved downward at the end, with cutting teeth on the curved part of the back to saw slots or grooves in the panel with minimum damage. Standard saw lengths are 12"-13", with 14 teeth per inch.

- ✓ **Rod saws** are a form of hacksaw-type blade, used in regular hacksaw frames and capable of cutting through most hard materials—spring and stainless steel, chain, brick, glass and tile. The blade consists of a permanently bonded tungsten carbide surface on a steel rod. Because the blade is round, it can cut in any direction.

- ✓ **Pull saws** are similar to most traditional saws except the teeth are designed to cut with a pulling motion. Pull saws cut wood faster and with less effort because of the thinner and more flexible blade. The saws feature teeth diamond- ground on three cutting edges. Because of the flexibility of the blade and the minimal set to the teeth, the saws are excellent for flush cutting. Mini pull saws that cut sharply on the pull stroke are used for precision carpentry.



- ✓ **Retractable** and **folding saws** come in a variety of designs and are engineered for the blades to either retract or fold back into a plastic or wooden handle.
- ✓ **Flooring saws** are designed to precision cut floorboards and baseboards. These short, crosscut saws feature a curved cutting edge on the bottom. Information on saws used for outdoor purposes such as pruning can be found in the Lawn & Garden section.

- **MITRE Boxes**

They are used to help cut exact angles for wood trim and rafters. Better models provide a mechanism for a backsaw. They are made of plastic, hardwood or aluminum.

Quality boxes provide more accuracy for deep cuts and have exact adjustments and calibrations. They have length gauges to aid in duplicating pieces and stock guides to allow for proper cuts on intricate molding. Other features to look for are roller bearings in the saw guide and grips that hold the saw above work so both hands can be used to position the piece.

Some boxes feature magnetic mount guides. The magnets grasp and hold the saw to the MITRE box saw guide or hold the saw blade to the plane of the saw guide. This helps assure an accurate MITRE cut without impairing the saw stroke.

- **Saw Sets**

Most saws become dull with use and need periodic filing and resetting. A saw set is used to reset or bend teeth back to their original position so teeth will make a cut wider than the blade to avoid binding in the cut or kerfs. Most sets are made with a pistol grip and designed so the saw teeth are visible during setting. A good saw set should have enough calibrations to ensure an even set to each tooth. Saw sets can be used on back, hand and small circular saws with 4-16 points.

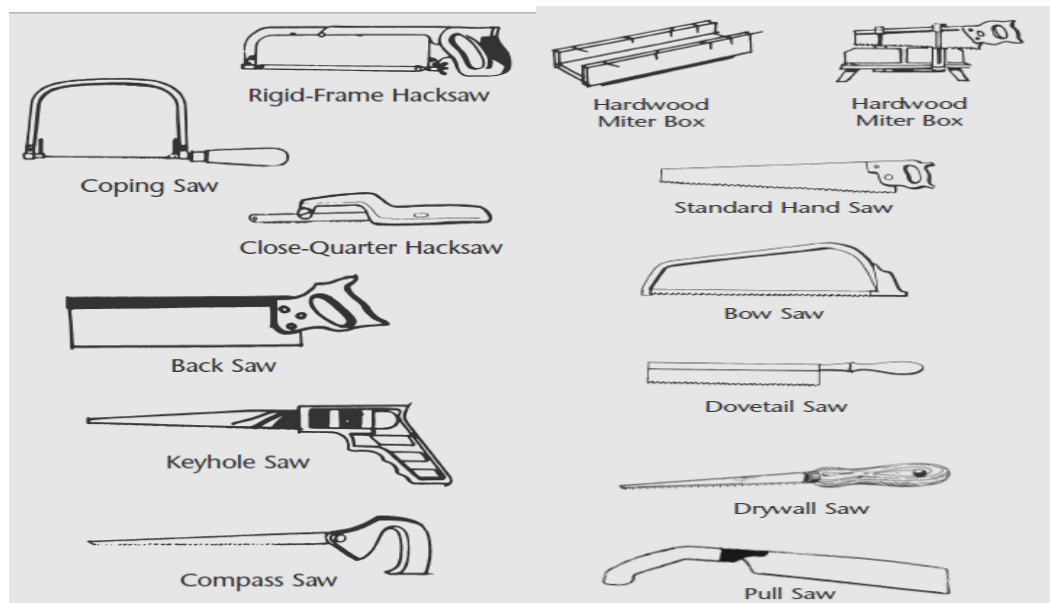



Fig. 2.13. Different Types of Saws

## 10. FASTENING TOOLS

- **Clamps**

Clamps are used in a number of different applications to hold items in place or secure items. Most clamps are constructed from wood, steel, cast iron, high-impact plastic or glass-reinforced nylon, and some have rubber or nylon straps. The most significant innovation to come about recently in the area of clamps is the development of **one-handed bar clamps**.

These clamps work with a pistol grip and allow the user to tighten or loosen the clamp by using just one hand on a trigger switch. They are available in jaw openings from 6" to 50" and a variety of sizes.

- **C-clamps**—the most common type of clamp—consist of a C-shaped frame, made of either forged steel or cast iron, into which an adjustable screw is assembled to change the jaw opening. The size of a C-clamp is measured by its capacity—the dimension of the largest object the frame can accommodate with the screw fully extended. Also important is depth of throat, the distance from the center line of the screw to the inside edge of the frame. C-clamps range from 1" to 12".

- **Bar clamps** have a clamping device built on a flat bar (usually steel). The length of the bar determines the capacity of the clamp, which is the dimension of the largest object that can be accommodated between its clamping jaws. "Reach" is the distance from the edge of the bar to the end of the clamping jaws. Screw pressure applies the final clamping load. Bar clamps are used for clamping large objects, making them popular with woodworkers and hobbyists. **Pipe clamps** can be mounted to standard threaded or unthreaded pipe.

Clamping can be performed from one end or both, and jaws can be positioned at the ends or anywhere along the pipe. Pipe clamps can also be quickly converted from a clamp to a spreader.

- **Thread less pipe clamp** fixtures are designed so ends of pipe don't need threads. A hardened steel set screw holds the head firmly on the pipe, but is easily loosened. The 3/4" size has a crank handle, and depth from screw center to pipe is 11/16". The 1/2" size has a cross pin handle, with depth from screw center to pipe of 7/8".
- A **hand screw clamp** consists of two hardwood clamping jaws adjusted to the work by two steel screw spindles assembled into the jaws. The jaws adjust to a variety of angles and come in a wide range of sizes. They are used for clamping wood, metal, plastic and fabrics. Hand screw adaptors can be used to convert hand screws into miter clamps. Also available are hand screw kits so woodworkers can make their own jaws.



- **Corner clamps** are designed to hold miter or butt joints at a 90° angle. They can be used for gluing picture frames, cabinets, molding and trim.
  - A **spring clamp** consists of two metal jaws to which clamping pressure is applied by use of a steel spring. They are designed for use with thin materials. Spring clamps are versatile enough for home, hobby or professional use indoors or outdoors, holding round or odd-shaped objects. They typically come with 1", 2" or 3" jaw openings.
  - **Web clamps** (also called band clamps) apply even clamping pressures around irregular shapes or large objects and hold tight by means of a spring-loaded locking fixture.
  - A **hold-down clamp** is the screw portion of a "C" clamp, designed to be secured onto any surface, with the screw used to apply clamping pressure.
  - **Edging clamps** are used for installing molding and trim on furniture and countertops, holding work at right angles, and for welding or soldering. They are designed to hold edging strips, molding and trim firmly when fastening to the edge or side of work, leaving hands free.
  - **Welding clamps** are a unique type of bar clamp ideal for quick tacking and other welding jobs. Welding Clamps are available in 6" and 18" jaw opening.
- Heavy-duty **press screws** can be used for deep-reach surface clamping. Available in three different lengths, they can be useful for gluing, welding or other assembly applications.

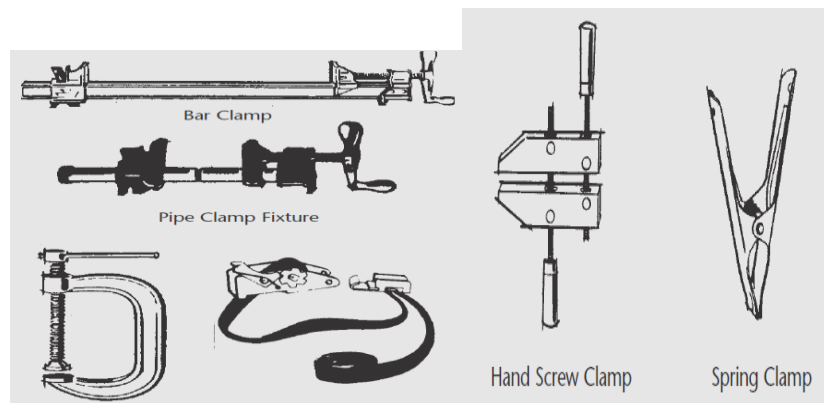

**Fig. 2.14. Types of clamps**

## 11. ELECTRIC DRILL MACHINE

Electric drill should be grounded for safety. The metal frame of the drill should be electrically connected to a good ground. Most electric drills are equipped with a three prong grounded plug. If the circuit to which the drill is connected is not provided with a three prong grounded socket, a grounded adaptor should be used. Some hand drills have the electric motor insulated from the case, and do not need grounding.

- **Mini drill press** – used for drilling small item and PCB for electronic products

- **Improved mini drill press** – fabricated by copying the original drill press using only the double pinion drill, used for small items that needs a controlled rpm movement
- **Drill - Grinder** – the double purpose machine that can be used for both drilling and grinding
- **Pedestal drill press** - A drill press is a fixed style of drill that may be mounted on a stand or bolted to the floor
- **Double pinion/"eggbeater" hand drill** – the later version of the old hand drill, used for drilling small items and wood
- **Hand drill** – the manually operated drill, used commonly used on wood
- **Electric hand drill** – the boring or holing equipment using electricity for easiness of work and having a faster rpm for faster work
- **Cordless/battery operated hand drill** – used for holing or drilling where electricity is not available, but usually used for screw application.



**Fig.2.15.Different type of electric drill machine**

## 12. VISES

The size of a vise is measured by both the jaw width of the vise and the capacity of the vise when the jaws are fully open.

- **Bench vises** are designed for light work in the home, garage and farm. They come in stationary and swivel models, milled and ground jaws, machined to ensure proper operation.
- **Woodworking vises** feature jaws made of wood from 6" to 10" wide. Some woodworking vises have a fast-acting screw arrangement for the rapid positioning of the movable jaw prior to clamping. Smaller vises have continuous screws and are light and easy to clamp on a workbench or sawhorse. A hinged pipe vise is used to hold pipe in position for threading and cutting. Home workshop or **utility vises** have jaws ranging from 3" to 6". Better models feature swivel bases so the vise may be turned to the best angle for each particular job. Some utility vises either have casting pipe jaws or permit special curved-face pipe jaws to be inserted between the regular jaws to add versatility.

- **An angle vise** can be adjusted to a flat position and used as a regular vise. Marked adjustments permit the user to obtain any desired angle. The vise can also be locked into any position with a thumb screw, and bolts can be tightened for permanent positioning.
- **A clamp vise** is a combination fixed and portable vise, featuring a bottom clamp for easy attachment to workbenches, sawhorses or tables.



Fig.2.16. Different type of Vises.

## 2.3. Introduction of Electrical Test Instruments

### I. Ammeter

- An instrument called an ammeter is used to measure current flow in a circuit (Figure 1.10).
- The ammeter is inserted into the path of the current flow, or in series, to measure current. This means the circuit must be opened and the meter leads placed between the two open points.
- Although the ammeter measures electron flow in coulombs per second, it is calibrated or marked in amps or amperes. For most practical applications, the term amps is used instead of coulombs per second when referring to the amount of current flow

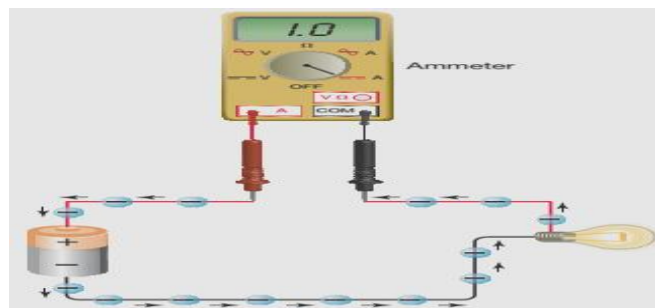

Fig.2.17.Ammeter connected to measure current.

### II. Voltmeter

- ✓ A voltmeter is used to measure the voltage, or potential energy difference of a load or source as illustrated in Figure 2.18. Voltage exists between two points and does not flow through a circuit as current does. It is possible to have voltage without current, but current cannot flow without voltage.



- ✓ A voltmeter is connected across, or in parallel, with the two points.

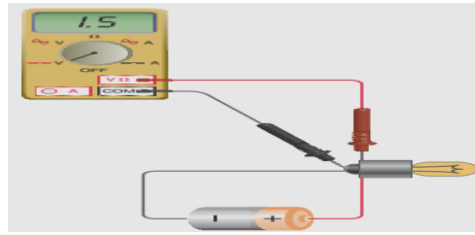

Fig. 2.18. Voltmeter connected to measure vol

### III. Ohmmeter

- An ohmmeter is used to measure resistance, as illustrated in Figure 2.19 . Unlike the voltmeter and ammeter, which use energy in the current to make their measurements, the ohmmeter uses its own power source. For example, a multi-meter contains an ohmmeter that operates by a battery located inside the instrument.
- The ohmmeter applies a known voltage into a circuit, measures the resulting current, and then calculates the resistance. For this reason ohmmeters should never be connected to live circuits!

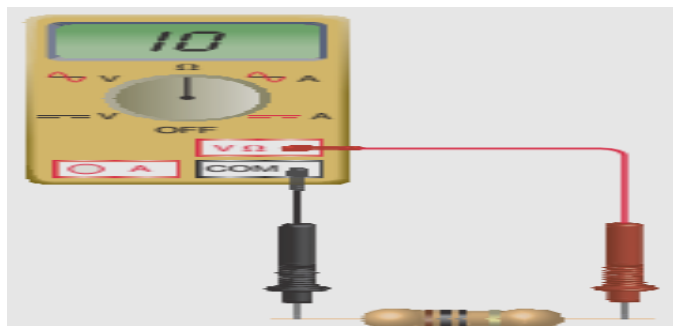
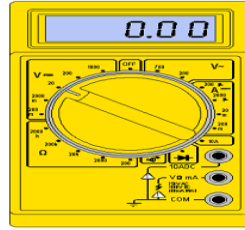

Fig. 2.19. Ohmmeter connected to measure resistance.

### IV. Digital Multi-meter

- DMM is a measuring instrument
- An ammeter measures current
- A voltmeter measures the potential difference (voltage) between two points
- An ohmmeter measures resistance
- A multimeter combines these functions, and possibly some additional ones as well, into a single instrument

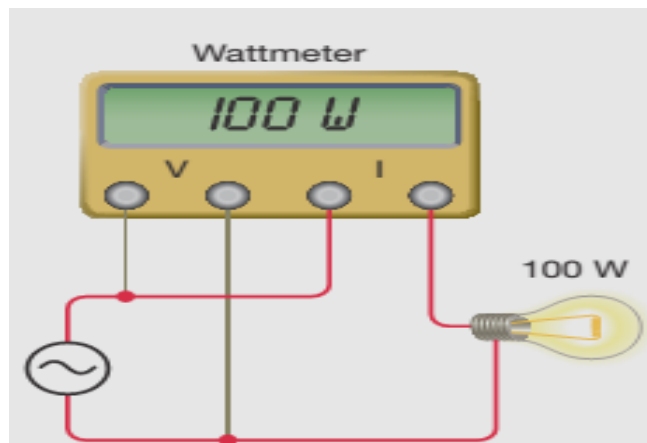

**Fig. 2.20. Digital Multi-meter (DMM)**

- Voltmeter:-connected in Parallel connection
- Ammeter: - Series connection
- Ohmmeter:- connected in parallel Without any power supplied
- Adjust range (start from highest limit if you don't know)

### **V. Wattmeter**

- Power can be measured using a wattmeter. The wattmeter is basically a voltmeter and ammeter combined into one instrument (Fig.2.21).
- The ammeter terminals are connected in series, and the voltmeter terminals are connected in parallel with the circuit in which the power is being measured.
- The wattage rating of a lamp indicates the rate at which the device can convert electric energy into light. The faster a lamp converts electric energy to light, the brighter the lamp will be



**Fig.2.21. Wattmeter connected to measure power**

### **VI. Kilowatt-hour meter (Energy meter)**

- A kilowatt-hour meter connected to a residential electrical system is used to monitor your daily power usage as illustrated in Fig, 2.22.



Fig.2.22.Kilowatt-hour meter

### 2.3.1. Other Types of Testing Equipments

Various testing equipments are also required so that the system could be tested before it is operational. The testing equipments requirement will depend upon the equipment to be tested. However, some of the main testing equipments are listed below.

- **Megger Tester.**

Megger is basically a D.C. generator operated manually and Ammeter calibrated as k Q & m Q is generally used to measure the insulation resistance or continuity in the line. These are available in various voltage ranges such as 500V, 1000Volts. 2500 V megger is also available in motor operated form Now a day's electronic insulator meters are also available which works with 6 cells of 1.5V each and hence do not require hand operation.

It can also measure resistance between 0 - 2 k Q high resistance 0.05 M Q to 100 M Q and A.C. voltage up to 500 V.

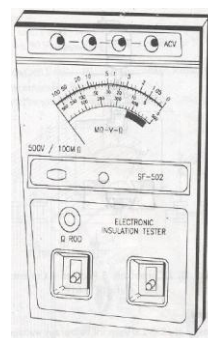

Fig.1.23. MeggerTester A) Digital multimeter B) analog multimeter

- **Earth Tester**

Earth tester is used to measure the earth resistance. The value of earth resistance is small therefore any instrument which measures high resistance such as megger cannot be used for measuring earth resistance.

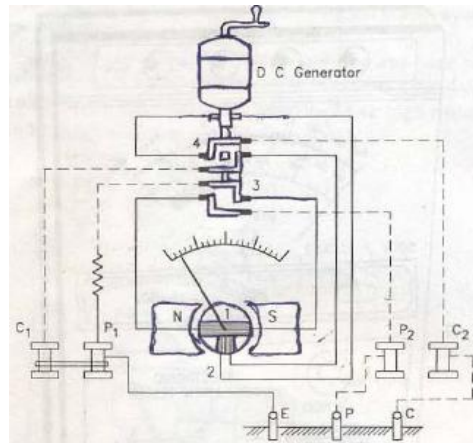

Fig.1.24. Earth Tester (1.Potential coil, 2.Current coil, 3.Rectifier, 4.Current reverser)

- **Test Lamp**

Test lamp consists of a 230/250 V electric bulb of any wattage fitted in an insulated type pendant holder with two lead wires taken out. Test lamp is used to find out the polarity of given wire. It is usually connected, in case of single phase installation between livewire and an earth or neutral wire. However if it is to be connected between two live wires of 3-phase 400 V system than two test lamps of equal wattage and 230/250 V rating each are connected in series. Test lamp will not glow if wire under test is other than live wire.

- **A Voltmeter or Multi-meter**

**Following works can be taken from such meter:**

- ✓ D.C (-) 0 to 10 V scale- To test one or two cells voltage or to test radio voltage up to 10 volts.
- ✓ D.C (-) 0 to 30 V scale - To test 6 cell and 12 cell storage battery or to test hearing aid machine.
- ✓ D.C (-) 0 to 300 V scale - To measure supply voltage and to measure radio D.C voltage.
- ✓ D.C H 0 to 1,000 V scale - It is used for testing the voltage of photo flesh battery.
- ✓ AC (-) 0 to 10 V scale - Bell transformer, night lamp voltage testing.
- ✓ AC (-) 0 to 30 V scale-Used for checking Bell, or Toy train transformer, etc.
- ✓ AC (-) 0 to 300 V scale - House meter voltage, Radio voltage. Ammeter ranges 0 to 30/60 $\mu$ A 60/600mA Ohmmeter to measure up to 2m $\Omega$ .

- **Clip on Ammeter and Voltmeter**



This is used to measure the current and voltage in the line without actually connecting them in the circuit. These are now being replaced by dig - Clamper.

- **Dig - Clampers**

A combined meter for measurement of Voltage, Current; Resistance and Temperature. It gives the reading in digital form. It can measure even under strong magnetic field. It has LED display which provides low power consumption and also has Automatic zero adjustment in display..

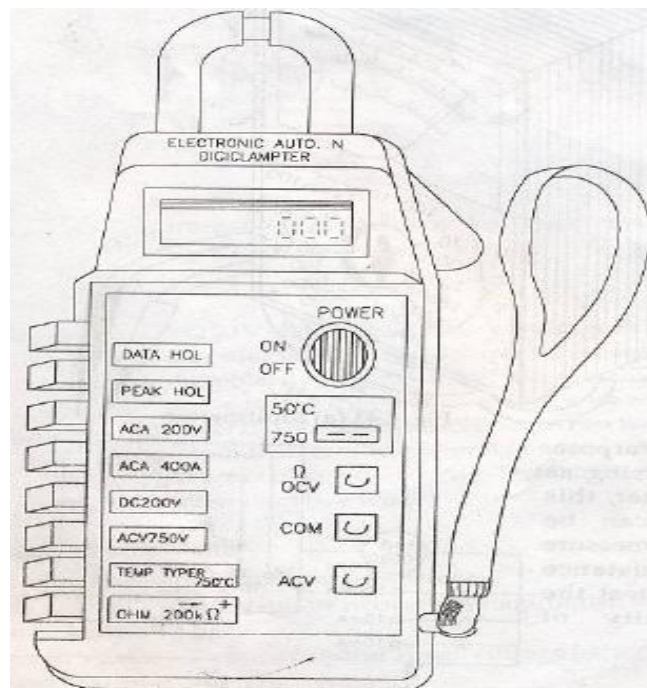

**Fig. 1.25. Dig – Clampers**

- **It can measure dc V, ac V, ac A, Resistance, Temperature:-**

- ✓ Ranges are: D.C. Voltage - 200 V
- ✓ A.c. Voltage - 750 V
- ✓ Resistance - 200 K.Q
- ✓ Alternating current - 200 A, 400 A, 500 A
- ✓ Temperature - 40°C to 1000°C.
- ✓ It works with good accuracy and overload circuit.

- **Accumulator Voltage Tester or Cell Tester & Hydrometer**

This is used to measure the Voltage of the battery. The battery voltage should never be measured on open circuit. The cell tester has built in resistance across its terminals which serve as load while measuring the voltage of the battery /cell.



**Hydrometer** is used to measure the specific gravity of electrolyte of the cell.

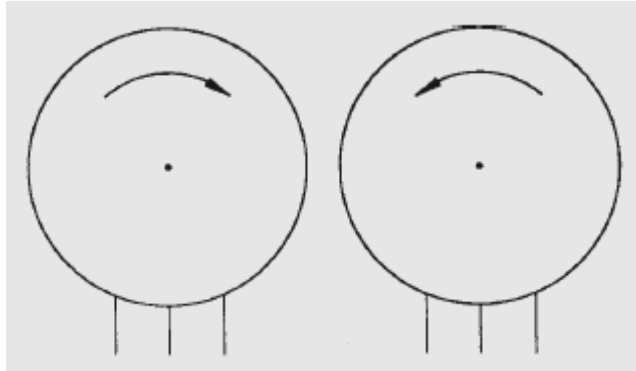

Fig.1.25. Hydrometer

- **Coil Winding Machine**

This machine is used to make coils for winding in motors, generators and transformers.

- **Growlers**

It is an alternating current electromagnet which is used to ***detect and locate the grounded, shorted and open coils in the armature.*** It consists of a coil of a wire wound around an iron core and is connected to a 230 volts A.C. Supply. The core is generally laminated and cut on top so that the armature may fit on it. When growler is connected to AC supply, it will work as a primary winding and the winding of armature as secondary winding. Voltage will be induced in the armature by transformer action. The following tests are carried out by the growler.

- **Locating a grounded coil in armature The Procedure is as follows:**

- ✓ The armature is placed on the growler. Growler is connected to AC supply which works as a primary winding and the winding of armature as secondary winding. E.M.F. is induced in the armature coils.
- ✓ A mill volt meter is connected between each commutator bar and shaft as shown in Fig. below
- ✓ If the meter gives no deflection, then it indicates that the grounded coil is connected to this bar.

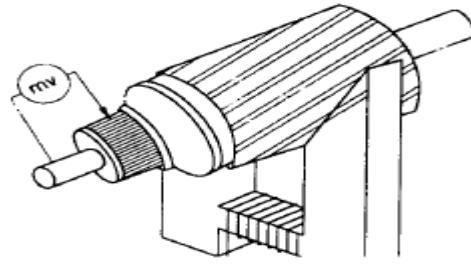

- **Locating a shorted coil in armature The Procedure is as follows:**

- ✓ Place the armature on the growler.
- ✓ Growler coil is connected to A.C supply. Shorted coil in an armature will allow heavy current to pass through it which makes strong flux over the coil side.
- ✓ An hack saw blade is held near teeth of armature core at a distance of 1/2" apart from the teeth.
- ✓ If the coil in this slot is shorted, the blade will vibrate or is attracted towards the armature core and the coil is also heated up. If the blade remains stationary, it is an indication that no short exists in the coil under test.

### 2.3.2. Equipment Required For Outdoor Installation & Maintenance Work

The majority of the accidents, which occur at present, are preventable roughly; causes of accident may be put into three classes: first accidents resulting from lack of supervision or lack of knowledge; second- accidents resulting from personal carelessness; third accidents resulting from the contributory negligence of others. It is essential that safety be considered and practiced in all departments at all times. ~ Lineman is called on to handle a great many jobs, each under different condition (different poles, wire arrangement, installation of equipment and fixtures, etc.). By using different safety devices/tools, great benefits can be realized by linemen.

- **Equipment and Materials**

- ✓ Ropes forming yoke of dead men. Rubber gloves.
- ✓ Ladders. Belt tools.
- ✓ Canvas tool bag containing screw drivers, insulated pliers etc.
- ✓ Axes, saws, soldering equipment.
- ✓ Lineman's Belt.
- ✓ Helmets.
- ✓ Operating rods.
- ✓ Protective clothing and footwear.
- ✓ Portable lamps.

- **'Deadman'Yoke**



The yoke of the headmen should be maintained free from cracks and should be secured firmly to the top of the pole. Where the conditions of any part of dead man is such that it cannot be maintained properly, then new parts should be secured or the whole deadman should be serapped and repaired.

- **Ladder**

Wooden ladders be used in preference to iron ladders. Ladders should be so placed that the horizontal distance from the point of support to the foot of the ladder shall not be less than 1/4th of the length of the ladder and not more than 1/2 of the length of the ladder. In using a ladder, a should not attempt to reach sideways so far as to throw his weight off the ladder. Ladders must never be placed on slanting oily, slippery, or icy footings unless they are securely fastened and protected to prevent slipping or twisting. Ladders must always be placed securely in position before they are put into use. Where ever practicable, ladder shoes should be used to prevent the possibility of ladder slipping.

- **Canvas Tool Bag**

A canvas bag should be used for raising and lowering of all tools to and from the working position on the pole and for the storage of small tools at the working position. No metal should be used in making the bag. The handles of pliers, screw drivers and similar tools may be insulated

**Self-Check -2****Written Test**

**Directions:** Answer all the questions listed below.

**I. CHOSE THE BEST ANSWER**

1. Which of the following tools are used in a number of different applications to hold items?
  - A. clamps
  - B. Chisels
  - C. Calipers
  - D. Reamers
  - A. Drag and push
2. Which of the following tools are used to adjustable stops to cut insulation without damaging wire?
  - A. Cutting nippers
  - B. Wire strippers
  - C. Flat-nose pliers
  - D. Center cut cutters
3. -----is a device used to insert and tighten screws or to loosen and remove screws.
  - A. A screwdriver
  - B. Pliers
  - C. Chisels
  - D. Wrenches
4. Which of the following tools are designed to hold, turn and cut objects?
  - A. Offset screwdrivers
  - B. Pliers
  - C. Multi-bit screwdrivers
  - D. Reamers
5. Which of the following tools have rubber, plastic, wooden or rawhide heads and are used to drive chisels or hammer joints together



A. Sledge hammers    B. Hand Drilling Hammers    C. Mallets    D. Specialty Hammers

**Note: Satisfactory rating - 3 and 5 points**

**Unsatisfactory - below 3 and 5 points**

You can ask your teacher for the copy of the correct answers.

Score = \_\_\_\_\_

Rating: \_\_\_\_\_

Name: \_\_\_\_\_

Date: \_\_\_\_\_

**Information Sheet-3**

**Make work station ready**

### 3.1. Introduction To Work Station Of Electrical Hand Tools

The floor and interior of the operator's station/work station should be made of fire-resistant materials. Machines with an engine performance exceeding 30 kW should have a built-in fire extinguisher system or a location for installing a fire extinguisher that is easily reached by the operator. Also your practical work shop tool preparation must be ready for any electrical work activates at any time.

#### 3.1.1. SAFE WORK PRACTICES

A safe work environment is not enough to control all electric hazards. You must also work safely. Safe work practices help you control your risk of death from workplace hazards. If you are working on electrical circuits or with electrical tools and equipment, you need to use safe work practices.

- Before you begin a task, ask yourself:
- What could go wrong?
- Do I have the knowledge, tools, and experience to do this work safely?

All workers should be very familiar with the safety procedures for their jobs. You must know how to use specific controls that help keep you safe. You must also use good judgment and common sense.

#### 3.1.2. Cleaning

- ✓ Clean the tools immediately after use.



- ✓ Wash the tools using water. A wire brush may be useful to loosen the soil stuck to the blades.
- ✓ Avoid the risk of spreading pathogens while the tools are being cleaned.
- ✓ Coat the blades with light oil like WD-40 on areas prone to rust.

3.1.3. **Lubrication** is the process or technique employed to reduce friction between, and wear of one or both, surfaces in proximity and moving relative to each other, by interposing a substance called a lubricant in between them. The lubricant can be a solid, (e.g. Molybdenum disulfide  $\text{MoS}_2$ ) a solid/liquid dispersion, a liquid such as oil or water, a liquid-liquid dispersion (a grease) or a gas.

With fluid lubricants the applied load is either carried by pressure generated within the liquid due to the frictional viscous resistance to motion of the lubricating fluid between the surfaces, or by the liquid being pumped under pressure between the surfaces. Lubrication can also describe the phenomenon where reduction of friction occurs unintentionally, which can be hazardous such as hydroplaning on a road.

#### 3.1.4. Storage

Store tools in a dry, sheltered environment. Place tools on a rack for easy safety and easy access.

Place similar tools close together so that workers can see easily the available tools.

### 3.4. Storing tools safely in appropriate locations in accordance with manufacturers

#### • Tools Habits

“A place for everything and everything in its place” is just common sense. You cannot do an efficient, fast repair job if you have to stop and look around for each tool that you need. The following rules, if applied, will make your job easier.

- **Keep Each Tool In Its Proper Storage Place.** A tool is useless if you cannot find it. If you return each tool to its proper place, you will know where it is when you need it.

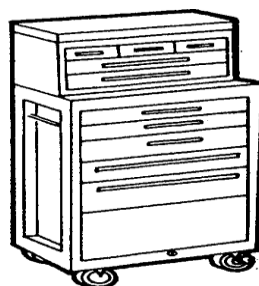

Fig. 3.1. Storing tools box

- **Keep Your Tools In Good Condition.** Keep them free of rust, nicks, burrs, and breaks.



- **Keep Your Tool Set complete.** If you are issued a tool box, each tool should be placed in it when not in use. If possible, the box should be locked and stored in a designated area. Keep an inventory list in the box and check it after each job. This will help you to keep track of your tools.



- **Use Each Tool Only On The Job For Which It Was Designed.** If you use the wrong tool to make an adjustment, the result will probably be unsatisfactory. For example, if you use a socket wrench that is too big, you will round off the corners of the wrench or nut. If this rounded wrench or nut is not replaced immediately, the safety of your equipment may be endangered in an emergency.

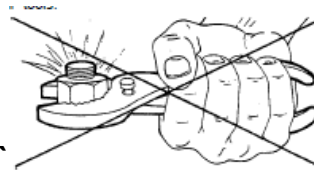

- **Keep Your Tools Within Easy Reach And Where They Cannot Fall On The Floor Or On Machinery.** Avoid placing tools anywhere above machinery or electrical apparatus. Serious damage will result if the tool falls into the machinery after the equipment is turned on or running.

**NOTE: Return broken tools to section chief.**

- **Never Use Damaged Tools.** Notify your supervisor of broken or damaged tools. A battered screwdriver may slip and spoil the screw slot or cause painful injury to the user. A gage strained out of shape will result in inaccurate measurements.

### 3.5 Storage Items

- **Toolboxes**

Steel toolboxes are most popular. Their prices vary according to gauge of steel used, number of trays and whether the box is reinforced in the corners. Some precision tool users use hardwood chests because the wood absorbs rust-producing condensation. Carpenters' toolboxes are specially designed so carpenters can carry hand saws and framing squares in the same box with other tools. The word "carpenter" differentiates this box from a regular toolbox because of the extra tools it will carry. Plastic toolboxes are available in a number of styles. Some are suited for light-duty use, while others are comparable to steel in quality. The highest quality plastic boxes are constructed of polypropylene, and some models can hold up to 75 lbs. of tools. The high quality plastic boxes feature interlocking pinned hinges, tongue-in-groove closure and positive locking latches, as well as padlock eyes and lift-out trays.



- **Tool Chests**

Utility chests store parts, screws, nuts, bolts and other small pieces. These chests are made of either plastic or steel with removable plastic dividers.

- **Tool Caddies**

Plastic revolving tool caddies hold tools and items such as nails, bolts, screws, glue and wire in tiers of circular trays. The caddies are made of a high-impact plastic and feature a ball bearing base plate, allowing the unit to revolve easily.

- **Modular Workshops**

Modular, mobile workshops are increasing in popularity, as users like their adaptability and functionality. Some models feature adjustable leveling feet, adjustable height, detachable casters, latching doors, drawers, hooks for hanging tools, dust collection ports, quick-change tool set-up, lock-down hardware and corner tops. They can hold large and small tools, and can be designed to serve as a shop bench, router station or clamping station.

- **How to Choose and Use Tool Boxes**

The “Types and Uses” section provides you with a list of some of the types of tool boxes. These pages should help you select the right tool box to do the job.



### 3.5.1 Types and Uses

Tool boxes are used for storing tools. They are usually made of steel, but wood and plastics are also used.

Portable tool boxes are used for carrying and storing a variety of hand tools. Both special and common tools, such as mechanic’s, electrician, and carpentry tools can be found in tool boxes. Chest-type tool boxes generally contain larger tools, such as specialized automotive tools or machinist’s tools, requiring a more permanent location. Some larger tool boxes are mounted on wheels so they can be moved easily from place to place. Tool bags are usually made of canvas. Like the boxes, they are available in a variety of sizes and serve similar functions. Examples of tool boxes are illustrated below.



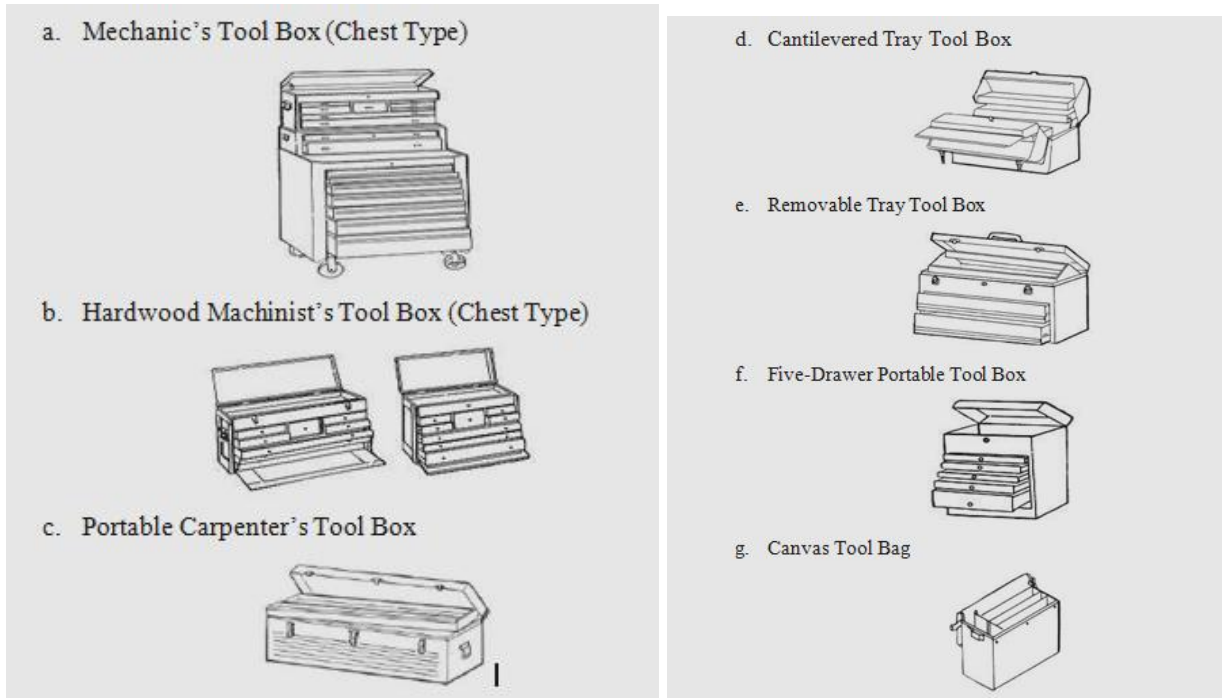

**Fig.3.2.Different Types tool boxes**

<b>Self-Check -3</b>	<b>Written Test</b>
----------------------	---------------------

**Directions:** Answer all the questions listed below.

**CHOOSE THE BEST ANSWER**

1. Which of the following is **not correct** for Storing tools safely in appropriate locations?
  - A. Keep Each Tool In Its Proper Storage Place.
  - B. Keep Your Tools In Good Condition
  - C. Do not Keep Your Tool Set complete
  - D. Never Use Damaged Tools
2. Which one of the following **is not true** for clearing work station ready.
  - A. Clean the tools immediately after use.
  - B. Don't Wash the tools using water.
  - C. Avoid the risk of spreading pathogens while the tools are being cleaned.
  - D. Coat the blades with light oil like WD-40 on areas prone to rust.
3. Which one of the following **is true** when working on electrical circuits
  - A. Before you begin a task, ask yourself:
  - B. What could go wrong?
  - C. Do I have the knowledge, tools, and experience to do this work safely?
  - D. All
4. A safe work environment is not enough to control all electric hazards.



A. True      B. False

5. Tool boxes are **NOT** used for storing tools

A. False      B. True

**Note: Satisfactory rating - 3 and 5 points**

**Unsatisfactory - below 3 and 5 points**

You can ask you teacher for the copy of the correct answers.

Score = _____
Rating: _____

Name: \_\_\_\_\_

Date: \_\_\_\_\_

<b>Operation Sheet -1</b>	<b>Techniques of Identifying and selecting appropriate Electrical hand tools</b>
---------------------------	--

**Techniques for Identifying and selecting appropriate hand tools.**

**Step 1-** Tools and equipment are identified according to classification/ specification and job requirements.

**Step 2-** Follow the product manufacturer's instructions for specific torque loadings, particularly when recommendations are for dry, oiled or plated threads.

**Step 3-** Safety of tools and equipment are observed in accordance with manufacturer's instructions

**Step 4 -** Conditions of PPE are checked in accordance with manufacturer's instructions.

<b>LAP Test</b>	<b>Practical Demonstration</b>
-----------------	--------------------------------

Name: \_\_\_\_\_ Date: \_\_\_\_\_

Time started: \_\_\_\_\_ Time finished: \_\_\_\_\_

**Instructions:** Given necessary templates, tools and materials you are required to perform the following tasks within --- hour.

**Task 1 - Select and identify appropriate Electrical hand tools**



## Instruction Sheet

## LG25: Prepare Hand Tool

This learning guide is developed to provide you the necessary information regarding the following content coverage and topics –

- Checking hand tools for proper operation and safety
- Identifying and marking unsafe or faulty tools for repair.

This guide will also assist you to attain the learning outcome stated in the cover page.

Specifically, **upon completion of this Learning Guide, you will be able to –**

- Check hand tools for proper operation and safety
- Identify and marking unsafe or faulty tools for repair.



### Learning Instructions:

1. Read the specific objectives of this Learning Guide.
2. Follow the instructions described below 3 to 6.
3. Read the information written in the information “Sheet 1, Sheet 2 , and Sheet 3
4. Accomplish the “Self-check 1, and Self-check 2 **in page – 55, and 60** respectively.
5. If you earned a satisfactory evaluation from the “Self-check” proceed to “Operation Sheet 1, **in page**
6. Do the “LAP test” **in page ----** (if you are ready).

#### Information Sheet-1

#### Check hand tools for proper operation and safety

### 2.1 Introduction to Proper Operation of Common Hand Tools and Safety

The skilled technician must be familiar with the proper use of the tools-of-the-trade. As a general rule, higher quality tools tend to be in the higher price ranges but are safer to work with. Cheaper, low-quality tool material and poor design features often put great stress on the tool and the operator.



**NOTE:** always use the right tool for the right job.

## 1. SCREW DRIVER

- Is a tool designed to loosen or tighten screws? Screwdrivers are available in many different shapes, sizes, and materials. Screwdrivers are used for driving or removing screws or bolts with slotted, recessed, or special heads.

## 2. FLAT-HEAD OR STANDARD SCREWDRIVER



- Is designed for use on screws with slotted heads. This type of screw is often used on the terminals of switches, receptacles, and lamp holders.

## 3. PHILLIPS SCREWDRIVER



- Is designed for use on screws with an X-shaped insert in their heads. This type of screw is often used on the outside of electrical appliances because there is less likelihood of the screwdriver head slipping out of the slot and damaging the metal finish of the appliances.

## 4. RATCHET SCREWDRIVER

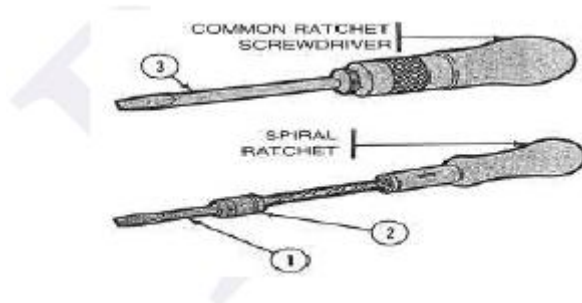

## 5. SQUARE-TIP SCREWDRIVER ( also known Robertson or Scrulox)





- Is designed for use on screws with square-shaped inserts in their heads. This type of screw creates a snug fit with the screwdriver head, allowing the screw to be easily driven into wooden material. Such screws are sometimes used to secure outlet boxes to joists

**Note:** The screwdriver's blade should fit the slot of the fastener. This prevents damage to the screwdriver's blade and fastener's slot, as well as possible injury to the user's hand or surrounding equipment should the tip slip out of the slot.

## 6. PLIERS

- Is used to cut and shape electric conductors and to grip a variety of objects has caused many types of pliers to be developed.

## 7. LINEMAN'S SIDE-CUTTING PLIERS

- Are used for gripping, twisting, and cutting wires. The lineman's side cutting pliers have serrated jaws, a rod-gripping section, side cutters, wire cropper, a fixed pivot, and parallel handles. The flat serrated jaws are used to bend sheet metal and twist electrical wire. The rod-gripping section is used to hold rods and bend small rods. The side cutters are located just above the pivot point, where maximum pressure may be applied. They are ground at an angle permitting sharp flush cuts on electrical wire. A pair of croppers is located above the pivot. They are used to shear larger wire. Lineman's pliers used around electrical circuits have insulated sleeves over the handles to reduce the possibility of electrical shock.

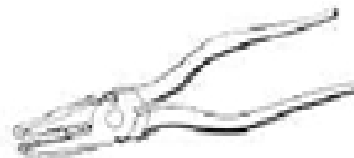

## 8. DIAGONAL-CUTTING PLIERS



- Are designed specifically for cutting wire. They are used for close cutting jobs such as trimming the ends of wire on terminal board connection. The diagonal cutting pliers have a fixed pivot. The jaws are offset by about 15 degrees and are shaped to give enough knuckle clearance while making flush cuts. The diagonal cutting pliers are used for cutting small, light materials such as wire, cotter pins, and similar materials. These pliers are not to be used to hold or grip objects.

## 9. NEEDLE-NOSE PLIERS

EEL BEE1	Version:01 Copyright Info/Autor: Ethiopia Federal TVET Agency	Page No.45
----------	--	---------------



- Are used to make loop ends on wire for connection to terminal screws

### 10. VISE GRIP PLIERS

- Are designed with jaws that can be locked onto the objects.

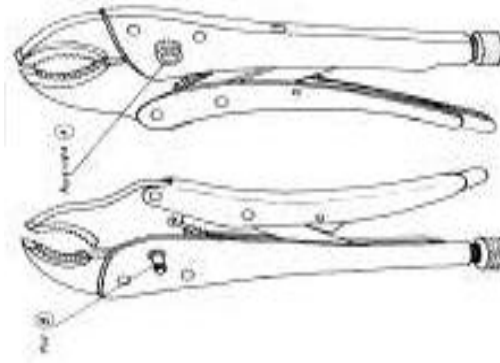

### 11. STRAIGHT- LIP FLAT – JAW TONGS

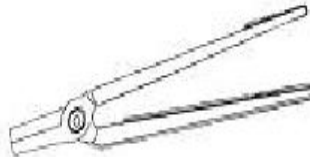

- The straight-lip flat-jaw tongs have two straight jaws, a fixed pivot point, and long, straight handles. These tongs are used to hold bearings and bearing inserts while setting them in place.

### 12. PARALLEL JAW PLIERS

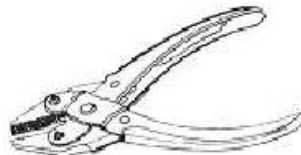

- The parallel jaw pliers are constructed so that the jaws remain parallel to each other throughout the entire distance of travel. It has two jaws, a pivot pin, curved handles, and tension springs. The tension springs are contained within the curved handles and will open the jaws when the handles are released. These pliers are used to grip objects which have flat surfaces.

### 13. END CUTTING PLIERS



- The end cutting pliers are used to crop wire flush to the working surface. They are designed to keep hands and fingers safely away from the wire ends.

#### 14. FLAT-NOSE PLIER

- The flat-nose pliers have flat serrated jaws, a fixed pivot, and curved handles which may have insulated sleeves. These pliers are used to bend light sheet metal and wire.

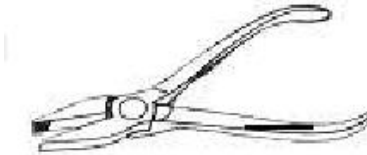

#### 15. BOLT AND CABLE CUTTERS

- Bolt and cable cutters come with a variety of cutting edges which are designed for specific applications. They are shaped like giant shears with short blades and long handles. The handles are hinged at one end. The cutters are at the end of extensions, which are jointed in such a way that the inside joint is forced outwards when the handles are closed. This forces the cutting edges together with great force. Bolt cutters are made in lengths from 18 to 36 inches. The larger ones will cut mild steel bolts and rods up to 1/2-inch diameter.

**WARNING:** BOLT CUTTERS ARE CONSIDERED SECURITY ITEMS. ALWAYS SECURE, THESE TOOLS WHEN NOT IN USE

#### • TYPES AND USES

#### ✓ CENTER CUT CUTTER

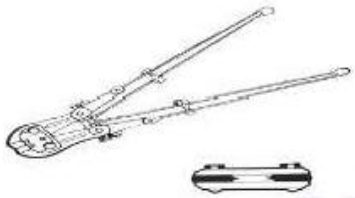

The center cut cutter is used for all general-purpose cutting. The cutting jaws are firmly fixed in line with the handles. The cutting edges are in the center of the jaw between equal levels. The longer the handle, the greater the cutting capacity. The cutting capacities range from 3/16 inch to 1/2 inch for medium steel, and from 5/16 inch to 11/16 inch for soft steel. The handles range from 14-inch to 42-inch lengths.





## 16. CLIPPER CUT CUTTER

The cutting edges of the clipper cut cutter are in line with the handles and beveled almost entirely from one side. These cutters allow very close cutting of projecting ends. The cutting capacities range from  $\frac{1}{4}$  inch to  $\frac{9}{16}$  inch for medium steel, and from  $\frac{5}{16}$  inch to  $\frac{11}{16}$  inch for soft steel. The handles range from 14-inch to 42-inch lengths.

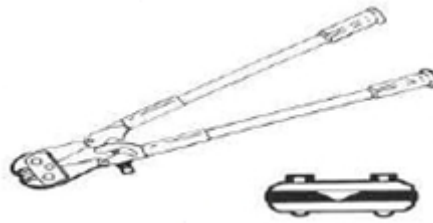

## 17. SHEAR CUT, FLAT BAR, AND STRIP CUTTER

Shear cut, flat bar, and strip cutters are used to cut flat-soft, medium- hard bar, and strip stock. The cutting edges of the jaws pass each other in the manner of scissors, making a complete shear cut. The cutting capacities range from  $\frac{7}{8} \times \frac{5}{32}$  inch to  $1\text{-}\frac{1}{2} \times \frac{9}{32}$  inch for soft and medium steel, and from  $\frac{3}{4} \times \frac{1}{8}$  to  $1\text{-}\frac{7}{16} \times \frac{1}{4}$  inch for hard steel. The handles range from 14-inch to 36-inch length.

### • SAFETY of bolts and electrical cable cutter

- ✓ Wear safety glasses when cutting.
- ✓ When using bolt cutters, make sure your fingers are clear of the jaws and hinges.
- ✓ Take care that the bolt head or piece of rod cut off does not fly and injure you or someone else.
- ✓ When the cutters are brought together rapidly, sometimes a bolt-head or piece of rod being cut off will fly some distance. The harder the material, the more it will fly.
- ✓ If it is necessary to cut electrical cable or wire which is already installed, be sure that the power is disconnected before using the cable cutter on it.
- ✓ Bolt cutters are fairly heavy, so make sure that they are stored in a safe place where they will not fall and injure someone.

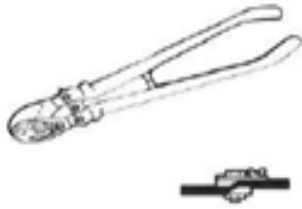

- **CLAMPS**

- ✓ **TYPES AND USES**

1. **C-CLAMPS**

C-clamps are used to hold work which cannot be held in a vise, or which has to be held for

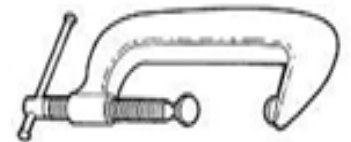

extended periods of time. They are available in a variety of sizes.

2. **HAMMERS**

Hammers are produced in a variety of head weights and are an important part of any tool kit.

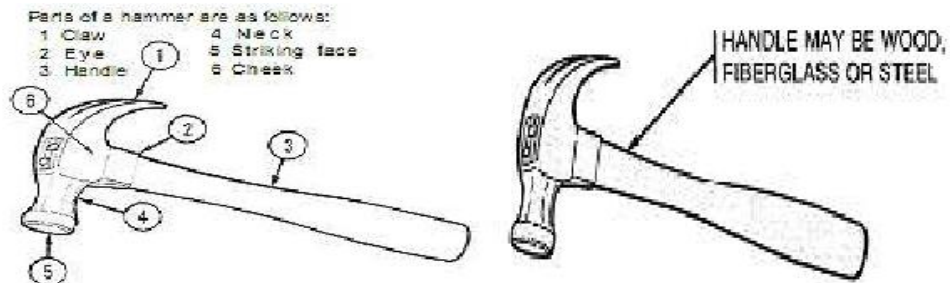

The carpenter hammer is used for driving and pulling nails and tapping wood chisels. There are two types of claws.



- **INSULATION-REMOVING DEVICES**

Wire and cables preparation requires the removal of a certain amount of insulation.

1. **WIRE STRIPPER**

Is used to remove insulation from small-diameter wire



## 2. CABLE INSULATION STRIPPER

Is used to remove the insulating sheath from nonmetallic sheath cable



## 3. KNIVES

Most knives have cutting edges and are used to cut, pare, notch, and trim wood, leather, rubber, and other materials. However, putty knives are used to apply and spread putty when installing glass.

## 4. SHOP KNIFE

The shop knife is used to cut wallboard, paper, cardboard, linoleum, canvas, and upholstery materials. Most shop knives have an aluminum handle and have storage space for five interchangeable blades in the 5-inch handle



### • SAFETY OF INSULATION-REMOVING DEVICES

- ✓ Do not use knives which are larger than can be handled safely to cut work.
- ✓ Use knives only for the purpose for which they were designed.
- ✓ Do not carry open knives in your pocket.
- ✓ Do not leave knives in such a position that they will cause injury to others.
- ✓ Carefully put knives in a sheath or container after use to protect the sharp cutting edges from contacting other hard objects.
- ✓ Always cut away from the body, except when using the draw knife.



## 6. FILES

Files are used for cutting, smoothing off, or removing small amounts of metal, wood, plastic, or other material. Files are made in various lengths, shapes, and cuts. Every file has five parts: the point (1), edge (2), face or cutting teeth(3), heel or shoulder (4) and tang (5). The tang is used to attach the handle on American pattern files. The tang is shaped into a handle and is usually knurled on Swiss pattern files.

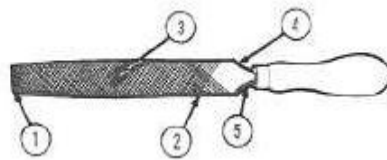

- **Types of File**

1. **ROUND FILE**

Round files taper slightly toward the point. Bastard-cut files 6 inches and longer are double-cut. The second-cut files, 12 inches and longer, are double cut. All others are single-cut. Round files are used for filing circular openings or concave surfaces.

2. **SQUARE FILE**

Square files taper slightly toward the point on all four sides and are double-cut. They are used for filing rectangular slots and keyways.

- **SAFETY operation of FILES**

- ✓ If a file is designed to be used with a handle, do not attempt to use it without the handle. Holding the sharp tang in your hand while filing can cause serious injury.
- ✓ Do not use a file for prying. The tang end is soft and it bends easily.
- ✓ The body of the file is hard and very brittle.
- ✓ A light bending force will cause it to snap.
- ✓ Do not hammer on a file. This is very dangerous because the file may shatter.

- **ELECTRIC DRILLS**

Are used for drilling holes in wood, metal, and concrete. The size of a drill is determined by the chuck size and the power of the motor. The *chuck* is the part of a drill that holds the twist drill bit. A 3/8-inch drill will hold a bit



of any size up to 3/8-inch in diameter. Reversible and battery-powered electric drills are also available.



- **SOLDERING GUN EQUIPMENT**

- ✓ Is a commonly soldering tool for general hand-wired circuits?

- **Micrometer (device)**

- ✓ A **micrometer** is a widely used device in mechanical engineering for precisely measuring thickness of blocks, outer and inner diameters of shafts and depths of slots. Appearing frequently in metrology, the study of measurement, micrometers have several advantages over other types of measuring instruments like the Vernier caliper

- **Types**

The image shows three common types of micrometers, the names are based on their application:

- ✓ Outside Micrometer
- ✓ Inside Micrometer
- ✓ Depth Micrometer
- ✓ Bore Micrometer



**Fig.1.1. outside, inside, and depth micrometers**

An outside micrometer is typically used to measure wires, spheres, shafts and blocks. An inside micrometer is commonly used to measure the diameter of holes and a depth micrometer typically measures depths of slots and steps. The bore Micrometer is typically a three anvil head on a micrometer base used to accurately measure inside



diameters The precision of a micrometer is achieved by a using a fine pitch screw mechanism.

An additional feature of micrometers is the inclusion of a spring-loaded ratchet thimble.

Normally, one could use the mechanical advantage of the screw to force the micrometer to squeeze the material, giving an inaccurate measurement However, by attaching a thimble that will ratchet or friction slip at a certain torque the micrometer will not continue to advance once sufficient resistance is encountered.

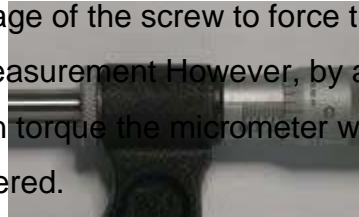

- **Reading an inch-system micrometer**

**Fig.1.2. Micrometer thimble showing 0.276 inch**

The spindle of an inch-system micrometer has 40 threads per inch, so that one turn moves the spindle axially 0.025 inch ( $1 \div 40 = 0.025$ ), equal to the distance between two graduations on the frame. The 25 graduations on the thimble allow the 0.025 inch to be further divided, so that turning the thimble through one division moves the spindle axially 0.001 inch ( $0.025 \div 25 = 0.001$ ). To read a Micrometer, count the number of whole divisions that are visible on the scale of the frame, multiply this number by 25 (the number of thousandths of an inch that each division represents) and add to the product the number of that division on the thimble which coincides with the axial zero line on the frame. The result wills the diameter expressed in thousandths of an inch. As the numbers 1, 2, 3, etc., appear below every fourth sub-division on the frame, indicating hundreds of Thousandths, the reading can easily be taken mentally. Suppose the thimble were screwed out so that graduation 2, and three additional sub-divisions were visible (as shown in the image), and that graduation 1 on the thimble coincided with the axial line on the frame. The reading then would be  $2000 + 0.075 + 0.001$ , or .276 inch.

- **Reading a metric micrometer**

The spindle of an ordinary metric micrometer has 2 threads per millimeter, and thus one complete revolution moves the spindle through a distance of 0.5 millimeter. The longitudinal line on the frame is graduated with 1 millimeter divisions and 0.5 millimeter subdivisions. The thimble has 50 graduations, each being 0.01 millimeter (one-hundredth of a millimeter). To read a metric **being** 0.01 millimeter (one-hundredth of a millimeter). To read a metric micrometer, note the number of millimeter divisions visible on the scale of the sleeve, and add the total to the particular division on the thimble which coincides



with the axial line on the sleeve

Suppose the thimble were screwed out so that graduation 2, and three additional sub-divisions were visible (as shown in the image), and that graduation 1 on the thimble coincided with the axial line on the frame. The reading then would be  $5.00 + 0.5 + 0.28 = 5.78 \text{ mm}$

- **Reading a venire micrometer**

Some micrometers are provided with a venire scale on the sleeve in addition to the regular graduations. These permit measurements within 0.001 millimeter to be made on metric micrometers, or 0.0001 inches on inch-system micrometers. Metric micrometers of this type are read as follows: First determine the number of whole millimeters (if any) and the number of hundredths of a millimeter, as with an ordinary micrometer, and then find a line on the sleeve venire scale which exactly coincides with one on the thimble. The number of this coinciding vernier line represents the number of thousandths of a millimeter to be added to the reading already obtained. Thus, for example, a measurement of 5.783 millimeters would be obtained by reading 5.5 millimeters on the sleeve, and then adding 0.28 millimeter as determined by the thimble. The venire would then be used to read the 0.003 (as shown in the image).

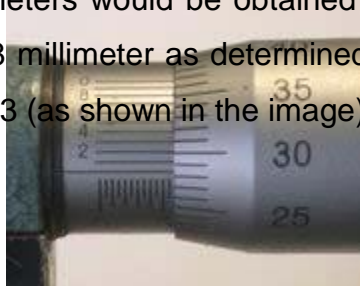

**Fig.1.3. venire micrometer**

- **Inch micrometers are read in a similar fashion** = 0.000393 Note: 0.01 millimeter inch, and 0.002 millimeter = 0.000078 inch (78 millionths) or alternately, 0.0001 inch = 0.00254 millimeters. Therefore, metric micrometers provide smaller measuring increments than comparable inch unit micrometers—the smallest graduation of an ordinary inch reading micrometer is 0.001 inch; the venire type has graduations down to 0.0001 inch (0.00254 mm). When using either a metric or inch micrometer, without a venire, smaller readings than those graduated may of course be obtained by visual interpolation.



<b>Self-Check -1</b>	<b>Written Test</b>
----------------------	---------------------

**Directions:** Answer all the questions listed below.

**I. CHOOSE THE BEST ANSWER**

1. Which of the following tools are a widely used device in mechanical engineering for Measuring thickness of blocks, outer and inner diameters of shafts and depths of slots?  
A. Soldering Pencil    B. Bore micrometer    C. Micrometer    D. Thermo- meter
2. Which of the following is safety of insulation-removing devices is not correct?  
A. Use knives which are larger than can be handled safely to cut work.  
B. Use knives only for the purpose for which they were designed.  
C. Do not carry open knives in your pocket.  
D. Do not leave knives in such a position that they will cause injury to others.
3. Which of the following is used to remove insulation from small-diameter wire  
A. Cable Insulation Stripper    B. Wire Stripper    C. Knives    D. Shop Knife
4. Which of the following is used to remove the insulating sheath from nonmetallic sheath cable  
1. Cable Insulation Stripper    B. Wire Stripper    C. Knives    D. Shop Knife
5. Which of the following is used to cut, pare, notch, and trim wood, leather, rubber, and other materials?  
A. Shop Knife    B. Cable Insulation Stripper    C. Wire Stripper    D. Knives

**Note: Satisfactory rating - 3 and 5 points                      Unsatisfactory - below 3 and 5 points**  
You can ask you teacher for the copy of the correct answers.

Score = _____ Rating: _____
--------------------------------

Name: \_\_\_\_\_

Date: \_\_\_\_\_





<b>Information Sheet-2</b>	<b>Identify and marking unsafe or faulty tools for repair</b>
----------------------------	---

## 2.1. Safety

**Safety:** Hazards may occur due to improper handling of tools and equipments, unsafe work areas, operating machines without knowing how to operate and using materials out of their intended purpose etc...

## 2.2. Marking

Each machine should bear, legibly and indelibly, the following information: **the name and address of the manufacturer, mandatory marks, designation of series and type, the serial number (if any), the engine power (in kW)**, the mass of the most usual configuration (in kg) and, if appropriate, the maximum drawbar pull and maximum vertical load.

Other markings that may be appropriate include: conditions for use, mark of conformity (CE) and reference to instructions for installation, use and maintenance. The CE mark means that the machine meets the requirements of European Community directives relevant to the machine.

- **Warning signs**

When the movement of a machine creates hazards not obvious to a casual spectator, warning signs should be affixed to the machine to warn against approaching it while it is in operation.

- **Verification of safety requirements**

It is necessary to verify that safety requirements have been incorporated in the design and manufacture of an earth-moving machine. This should be achieved through a combination of measurement, visual examination, tests (where a method is prescribed) and assessment of the contents of the documentation that is required to be maintained by the manufacturer. The manufacturer's documentation would include evidence that bought-in components, such as windscreens, have been manufactured as required.

- **Operating manual**



A handbook giving instructions for operation and maintenance should be supplied and kept with the machine. It should be written in at least one of the official languages of the country in which the machine is to be used. It should describe in simple, readily understood terms the health and safety hazards that may be encountered (e.g., noise and hand-arm or whole-body vibration) and specify when personal protective equipment (PPE) is needed. A space intended for the safekeeping of the handbook should be provided in the operator's station.

A service manual giving adequate information to enable trained service personnel to erect, repair and dismantle machinery with minimum risk should also be provided.

- ***Operating conditions***

In addition to the above requirements for design, the instruction handbook should specify conditions that limit use of the machine (e.g., the machine should not travel at a greater angle of inclination than is recommended by the manufacturer). If the operator discovers faults, damage or excessive wear that may present a safety hazard, the operator should immediately inform the employer and shut down the machine until the necessary repairs are completed. The machine must not attempt to lift a load heavier than specified in the capacity chart in the operating manual. The operator should check how the slings are attached to the load and to the lifting hook and if he or she finds that the load is not attached safely or has any concerns about its safe handling, the lift should not be attempted. When a machine is moved with a suspended load, the load should be kept as near to the ground as possible to minimize potential instability, and the travel speed should be adjusted to prevailing ground conditions. A rapid change of speed should be avoided and care should be taken so the load does not begin to swing.

When the machine is in operation, no one should enter the work area without warning the operator. When the work requires individuals to remain within a machine's work area, they should observe great care and avoid unnecessarily moving or remaining under a raised or suspended load. When someone is within the work area of the machine, the operator should be particularly careful and operate the machine only when that person is in the operator's view or his or her location has been signaled to the operator. Similarly, for rotating machines, such as cranes and backhoes, the swing radius behind the machine should be kept clear. If a truck must be positioned for loading in a way such that falling debris might hit the driver's cab,



no one should remain in it, unless it is strong enough to withstand impact of the falling materials.

At the beginning of the shift, the operator should check brakes, locking devices, clutches, steering and the hydraulic system in addition to making a functional test without a load. When checking the brakes, the operator should make certain that the machine can be slowed down rapidly, then stopped and safely held in position.

Before leaving the machine at the end of the shift, the operator should place all operating controls in the neutral position, turn off the power supply and take all necessary precautions to prevent unauthorized operation of the machine. The operator should consider potential weather conditions that might affect the supporting surface, perhaps causing the machine to be frozen fast, tipped over or sunk, and take appropriate measures to prevent such occurrences. Replacement parts and components, such as hydraulic hoses, should be in compliance with the specifications in the operating manual. Before attempting any replacement or repair work in the hydraulic or compressed air systems, the pressure should be relieved. The instructions and precautions issued by the manufacturer should be observed when, for instance, a working attachment is installed. PPE, such as a helmet and safety glasses, should be worn when repair and maintenance work are done.

- ***Positioning a machine for work***

When positioning a machine, the hazards of overturning, sliding and subsidence of the ground beneath it should be considered. When these appear to be present appropriate blocking of adequate strength and surface area should be provided to assure stability.

- ***Overhead power lines***

When operating a machine near overhead power lines, precautions against contact with the energized lines should be taken. In this connection, cooperation with the power distributor is advisable.

- ***Underground pipes, cables and power lines***

Prior to starting a project, the employer has the responsibility to determine if any underground power lines, cables or gas, water or sewer pipes are located within the work site and, if so, to determine and mark their precise location. Specific



instructions for avoiding them must be given to the machine operator, for instance, through a “call before you dig” program.

- **Defective Tools**

Defective tools must be removed from service, tagged “DO NOT USE – Repair required”, and quarantined until they can be repaired by a qualified person.

- **Power Supply**

Use the OEM recommended size, gauge and end connector type of extension cord for line power tools.

- ✓ Ensure corded electrical tools have a 3-wire (grounding) cord and plug, excluding double insulated tools.
- ✓ Ensure on/off switches for power tools are functional and positioned in a manner that is easily accessible by the operator.
- ✓ Ensure Ground Fault Circuit Interrupters (GFCIs) are used and tested in the supply circuit to power tools used outside.

- **Maintenance, Repairs and Storage**

- ✓ Maintenance records must be kept for all active power tools.
- ✓ Chisels, punches, hammers, screwdrivers, etc., must have tips properly dressed.
- ✓ Cracked and/or splintered handles must be replaced.
- ✓ Tools should be clean and any required repairs completed prior to being properly stored.
- ✓ Repairs to tools must be performed by qualified personnel, using OEM parts or equivalent.

- **Ergonomic Considerations**

**Consider ergonomics when selecting and using tools:**

- ✓ Hold the tool close to the body and do not overreach.
- ✓ Keep good balance and proper footing at all times to better control the tool, especially in response to unexpected situations.
- ✓ Secure work with clamps or securing devices, freeing hands to operate the tool.
- ✓ Reduce the settings on power hand tools to the lowest setting possible to complete the task safely. This will reduce tool vibration at the source



<b>Self-Check -2</b>	<b>Written Test</b>
----------------------	---------------------

**Directions:** Answer all the questions listed below.

I. **Say True If The Statements Correct And Say False If The Statements Incorrect.**

1. Marking each machine should bear, legibly and indelibly having the information: ***like name plate and address of the manufacturer,***
2. Hazards may occur due to improper handling of tools and equipments.
3. Defective tools must be removed from service
4. Before leaving the machine at the end of the shift, the operator should place all operating controls in the Phase position.
5. Tools should be clean and any required repairs completed prior to being properly stored.

**Note: Satisfactory rating - 3 and 5 points**

**Unsatisfactory - below 3 and 5 points**

You can ask you teacher for the copy of the correct answers.

Score = \_\_\_\_\_

Rating: \_\_\_\_\_

Name: \_\_\_\_\_

Date: \_\_\_\_\_

<b>Instruction Sheet</b>	<b>LG26: Use hand tools and test equipment</b>
--------------------------	--

This learning guide is developed to provide you the necessary information regarding the following content coverage and topics –



- Using hand tools and test instruments measurement according to tasks undertaken
- Observing all safety procedures in using tools and appropriate personal protective equipment (PPE)
- Reporting events to the supervisor

This guide will also assist you to attain the learning outcome stated in the cover page.

Specifically, **upon completion of this Learning Guide, you will be able to –**

- *Use hand tools and test instruments measurement according to tasks undertaken.*
- *Observe all safety procedures in using tools and appropriate personal protective equipment (PPE)*
- *Report events to the supervisor*

#### **Learning Instructions:**

1. Read the specific objectives of this Learning Guide.
2. Follow the instructions described below 3 to 6.
3. Read the information written in the information “Sheet 1, Sheet 2 , and Sheet 3
4. Accomplish the “Self-check 1, Self-check 2 and, Self-check 3 **in page -88, 94, and 99** respectively.
5. If you earned a satisfactory evaluation from the “Self-check” proceed to “Operation Sheet 1, and Operation Sheet 2, **in page -100** and Operation Sheet 3, **in page -101.**
6. Do the “LAP test” **in page – 101** (if you are ready).



## **.1 Introduction to Using of hand tools according to tasks**

Remember, a worker's efficiency is often a direct result of the condition of the tools being used. Workers are often judged by the manner in which they handle and care for their tools. You should care for hand tools the same way you care for personal property. Always keep hand tools clean and free from dirt, grease, and foreign matter. After use, return tools promptly to their proper places in the tool box. Improve your own efficiency by organizing your tools so that those used most frequently can be reached easily without sorting through the entire contents of the box. Avoid accumulating unnecessary items. Remember, a worker's efficiency is often a direct result of the condition of the tools being used. Workers are often judged by the manner in which they handle and care for their tools. You should care for hand tools the same way you care for personal property. Always keep hand tools clean and free from dirt, grease, and foreign matter. After use, return tools promptly to their proper places in the tool box. Improve your own efficiency by organizing your tools so that those used most frequently can be reached easily without sorting through the entire contents of the box. Avoid accumulating unnecessary items.



## **.2 Measuring Tools And Test Instruments**



Measurement is the process or the result of determining the ratio of a physical quantity, such as a length, time, temperature, etc., to a unit of measurement, such as the meter, second or degree Celsius. The science of measurement is called metrology. The English word measurement originates from the Latin *mēnsūra* and the verb *metiri* through the Middle French *measures*. Electrical measuring tools and instruments are sensitive and delicate so extra care is necessary in handling them. These are used to measure currents, voltages, resistances, wattages and other important elements in electrical works. This topic, will tackle the function/use of each measuring tool and instrument used in doing a electrical task. Different kinds of measuring tools and precision measuring instruments are as follows: Test equipment is necessary for determining proper set-up, adjustment, operation, and maintenance of electrical systems and control panels.

Table 1.1. Measuring Tools and Instruments

EEL BEE1	Version:01	Page No.62
	Copyright Info/Author: Ethiopia Federal TVET Agency	

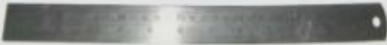

Measuring tool/instrument	Description
	<p><b>Test Light</b> is a pocket size tool used to test the line wire or circuit if there is current in it.</p>
	<p><b>Micrometer</b> is used to measure the diameter of wires/conductors in circular mils. It can measure small and big sizes of wires and cables.</p>

	<p><b>Wire Gauge</b> is used in determining the size of wires/conductors. The gauge ranges from 0 to 60 awg (American wire gauge).</p>
	<p><b>Ruler/foot rule</b> is a measuring tool used to measure length, width and thickness of short flat object and in sketching straight lines</p>
	<p>*A <u>ruler/rule</u> is a tool used in, for example, <u>geometry</u>, <u>technical drawing</u>, engineering, and carpentry, to measure lengths or distances or to draw straight lines. Strictly speaking, the ruler is the instrument used to <b>rule</b> straight lines and the calibrated instrument used for determining length called a measure. However, common usage calls both instruments rulers and the special</p>









	<p>instruments rulers and the special name straight edge is used for an unmarked rule.</p>
	<p><b>Pull-Push Rule</b> is a measuring tool used to measure the length of an object in centimeter and inches</p>

## .2.1 Different types of use Multi – meter (Test instruments ) and their measurements

The Multi-tester or multi-meter is sometimes called the VOM (voltmeter, ohmmeter, and milt-ammeter). It is the best instrument that can measure voltage, resistance and current.

- **It is generally made of two types:**
  - ✓ The analog and
  - ✓ The digital.

### • **Common DMM Symbols**

~	AC Voltage		Ground
	DC Voltage		Capacitor
Hz	Hertz	$\mu\text{F}$	MicroFarad
+	Positive	$\mu$	Micro
-	Negative	m	Milli
$\Omega$	Ohms	M	Mega
	Diode	K	Kilo
	Audible Continuity	OL	Overload

- **Parts Of Analog-Multi-Meter**



**POINTER.** The needle-shaped rod that moves over the scale of a meter.

**Pointer** It is mechanically connected to the moving coil. it indicates the measured values on the multimeter

**RANGE SELECTOR KNOB (Selector switch)** makes it possible to select different functions and range of the meter.

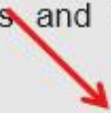

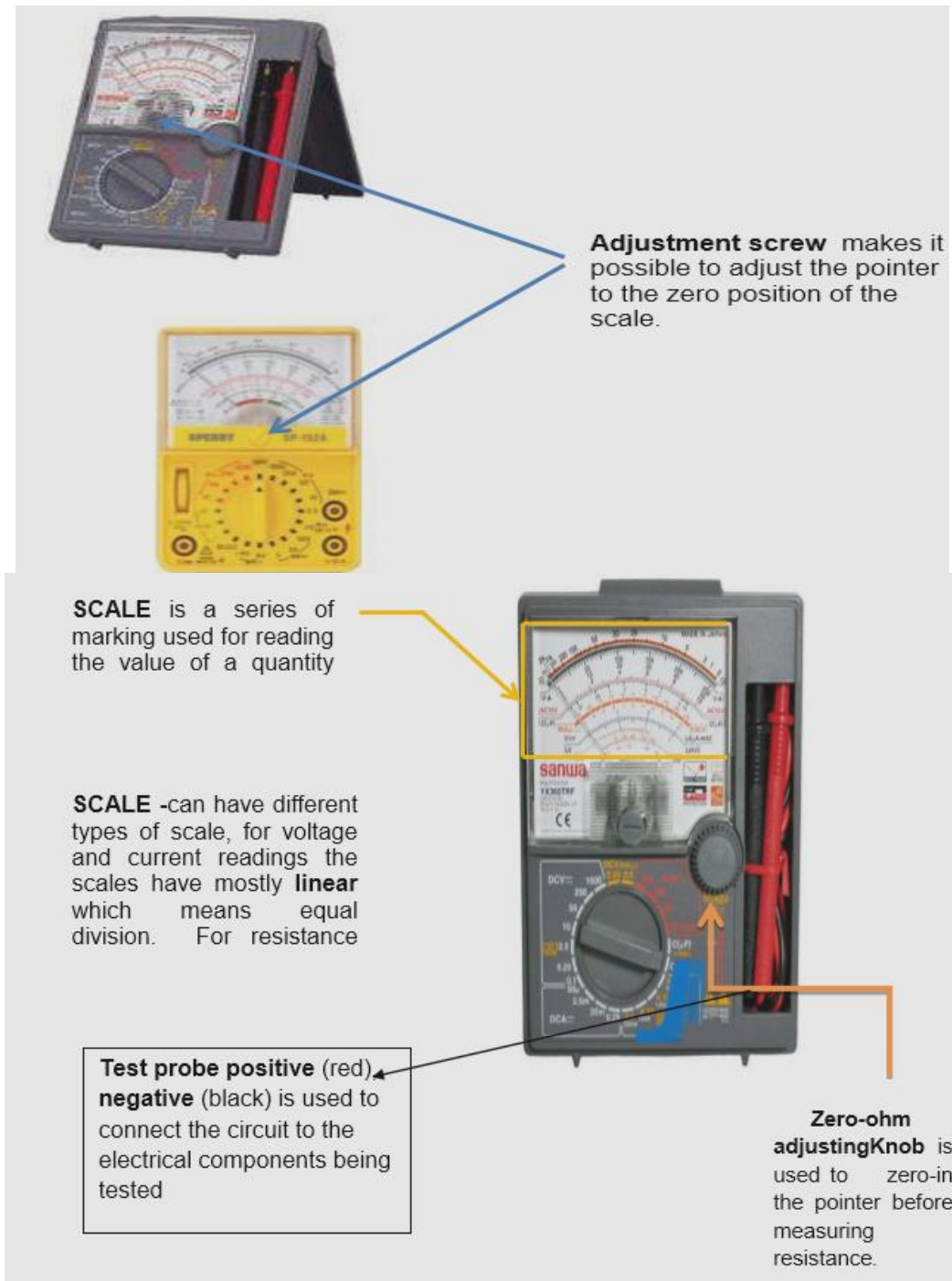

**Fig.1.1. Parts of Analog-Multi-Meter**

### 1.2.2. Proper care and maintenance of the multi-meter

- Read manual of instructions on how to operate the multi-tester.
- In reading the amount of voltage, always start with the highest range to avoid reading voltage higher than the tester setting.



- Be sure that the tester is set to the correct range setting: resistance range when measuring the ohm, voltage range when measuring voltage and ammeter range when measuring the value of electric current.
- Always check the condition of its battery. Worn out batteries will damage the internal setting of the tester.
- When the tester is not in used or will be stored, set the selector switch to 1000V or to OFF position.
- Never drop the tester.
- **How to read the meter scale of the Analog multi-meter**

To read the resistance range of the multi-tester, the given table below will be used.

The unit of measurement to be used to determine its resistance is ohm.

Range	0-2	2-10	10-20	20-50	50-100	100-200
Range x1	0.2	0.5	1	2	5	20
Range x10	2	5	10	20	50	200
Range x1k	20	50	100	200	500	2K
Range x 10k	200	500	1K	2K	5K	20K

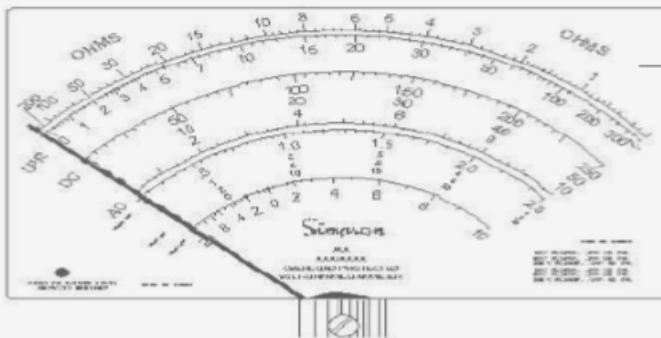

Pointer deflection  
Range setting is X1  
Reading is 2.5ohms

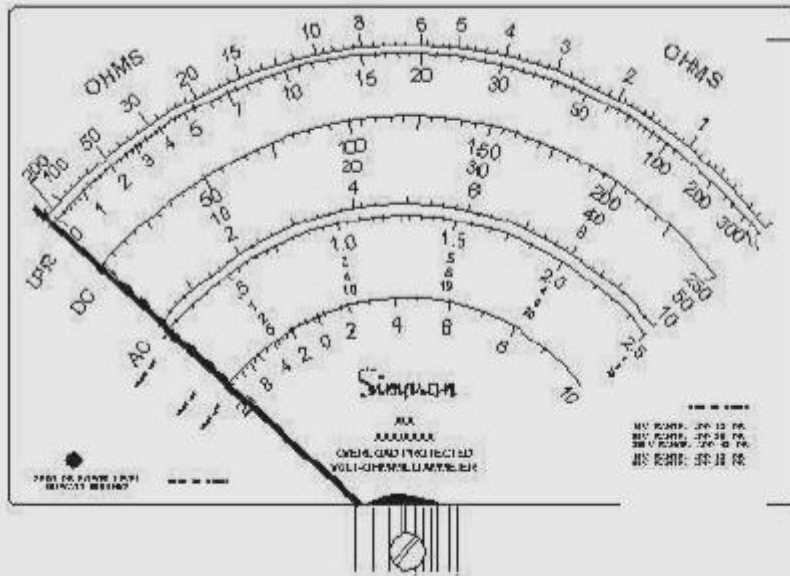

Pointer deflection  
 Range setting is X10  
 Reading is 25 ohms

### Voltage scale

Range	Value/div
Range 10V	0.2V
Range 50V	1V
Range 250V	5V
Range 100V	20V

Voltage scale  
 Range setting is 10 V  
 (used 0-10 scale)  
 Reading is 4.4V



Range	Value/div
Range 10V	0.2V
Range 50V	1V
Range 250V	5V
Range 100V	20V

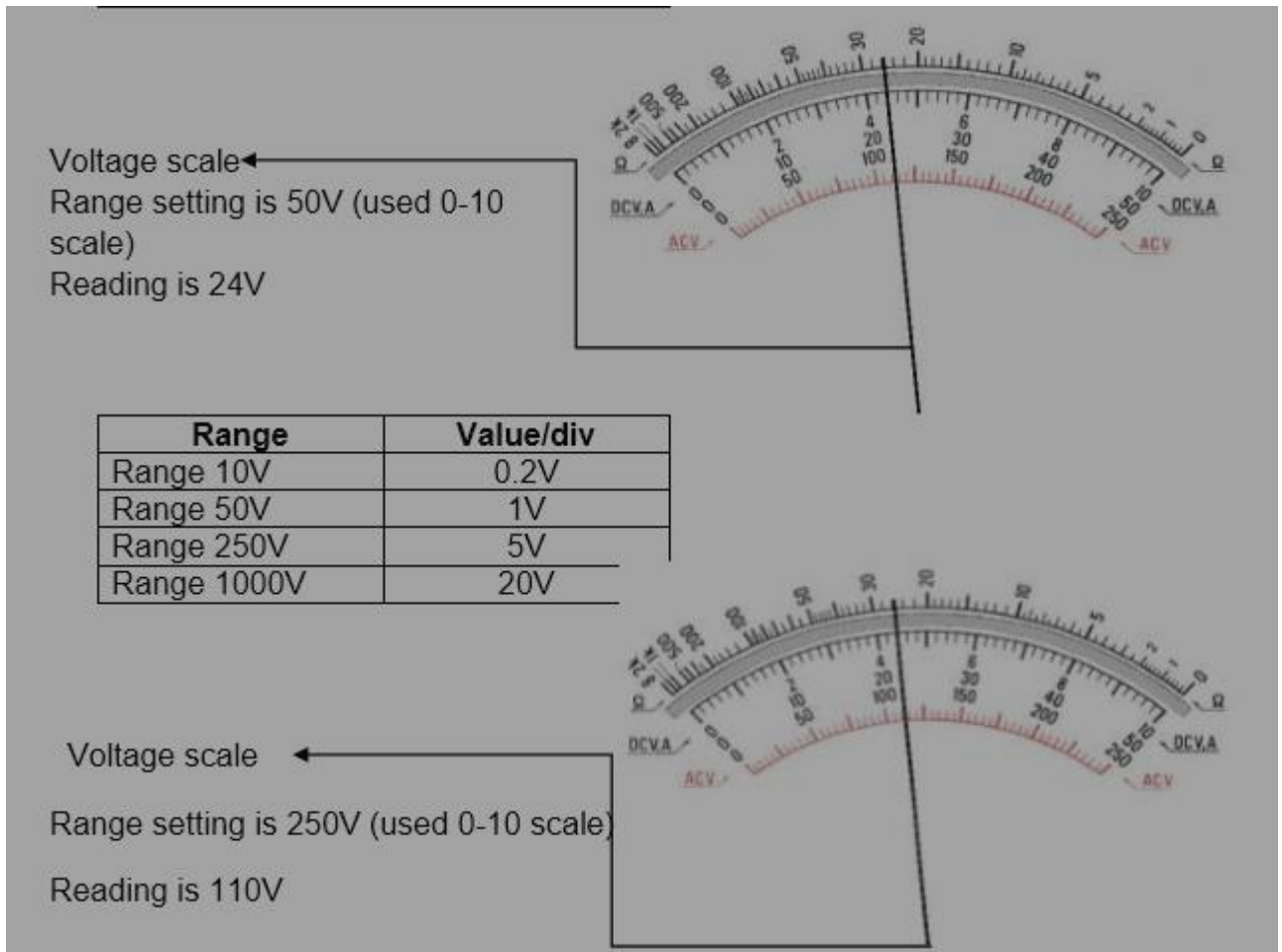

Fig.1.2. reading meter scale of the Analog multi-meter

- **Voltmeters**

For measuring differences of potential (voltage) between two points in an electrical circuit. The instrument is connected in parallel with the circuit being measured. Ranges vary from a few tenths volt to a few thousand volts. Instruments are capable of measuring both **A.C. and D.C voltage**.

- **Ohmmeters**





For measuring the electrical D.C. ohm resistance of a circuit, circuit part, or component. Calibrated from zero ohms to infinite. Measures either series or parallel resistance. An **ohmmeter** is an electrical instrument that measures electrical resistance, the opposition to an electric current. Micro-ohmmeters (micr-ohmmeter or micro ohmmeter) make low resistance measurements. Meg-ohmmeters (also a trademarked device Megger) measure large values of resistance. The unit of measurement for resistance is ohms ( $\Omega$ ).

- **Ammeters**



Measure magnitude of electrical current flow in an electrical circuit. When measuring D.C. currents, some types must be inserted in series with the circuit. A.C. ammeters are of two types. One requires that it be connected in series with the circuit; the other needs only to be clamped around the current carrying conductor.

**Table.1.2. Use of Ammeter, Voltmeter, Clamp - Ammeter and Volt-Ohmmeter**

	<p><b>Ammeter</b> is an instrument used to measure the amount of electrical current intensity in a circuit. The unit of measure is ampere (a). It is connected along or series to the circuit.</p>
	<p><b>Voltmeter</b> is an instrument used to measure electrical pressure or voltage of a circuit. The unit of measure is volt (v). This is connected across or parallel to the circuit.</p>
	<p><b>Clamp Ammeter</b> is also called tong-tester. It is used to measure current flowing in a conductor. It is clamped or hanged in a conductor.</p>
	<p><b>Volt-Ohmmeter (VOM)</b> otherwise called as Multi-tester; is used to measure the voltage, resistance and current of a circuit. It is connected in parallel or series with the circuit depending on what to measure.</p>



- **Use Different type Of Multi - Meter**

A **multi-meter** is a device used to measure voltage, resistance and current in electronics & electrical equipment. It is also used to test continuity b/n two points to verify if there is any break in circuit or line. There are two types of multi-meter: analogue and digital.

- **Analogue has needle style gauge**
- **Digital has LCD display**

There are 2 styles of multi-meter.

- **Switched Manually:** switches b/n ranges to get most accurate reading.

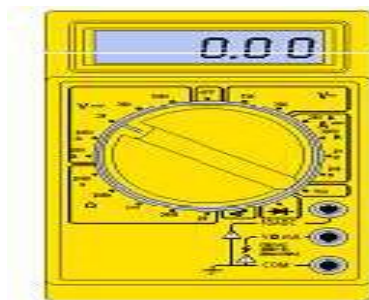

Fig.1.3. DMM multi-meter Switched Manually

- **Auto Range:** Switches b/n ranges automatically for best reading.

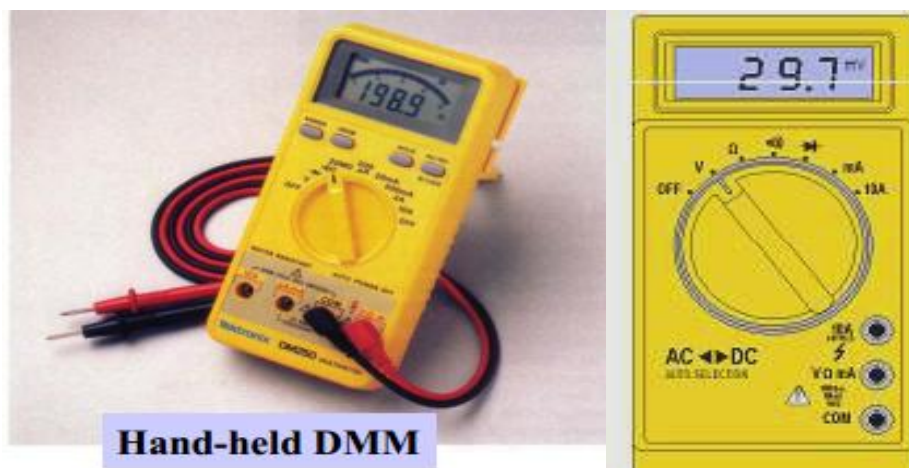

Fig.1.4. DMM multi-meter Auto-Range

- **Meter Leads**

- ✓ **Red meter lead:** Is connected to Voltage/ Resistance or Amperage port. Is considered the positive connection.
- ✓ **Probes:** Are the handles used to hold tip on the tested connection.
- ✓ **Tips:** Are at the end of the probe and provides a connection point.





- ✓ **Black meter lead:** Is always connected to the common port.
- Is considered the negative connection.

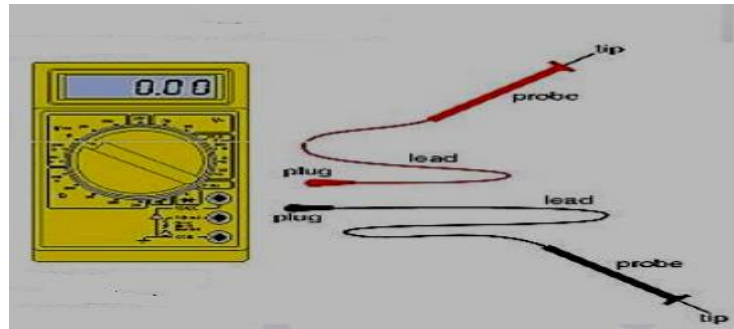

Fig.1.5. DMM multi-meter Leads

- **Display And Dial Settings Of DMM**

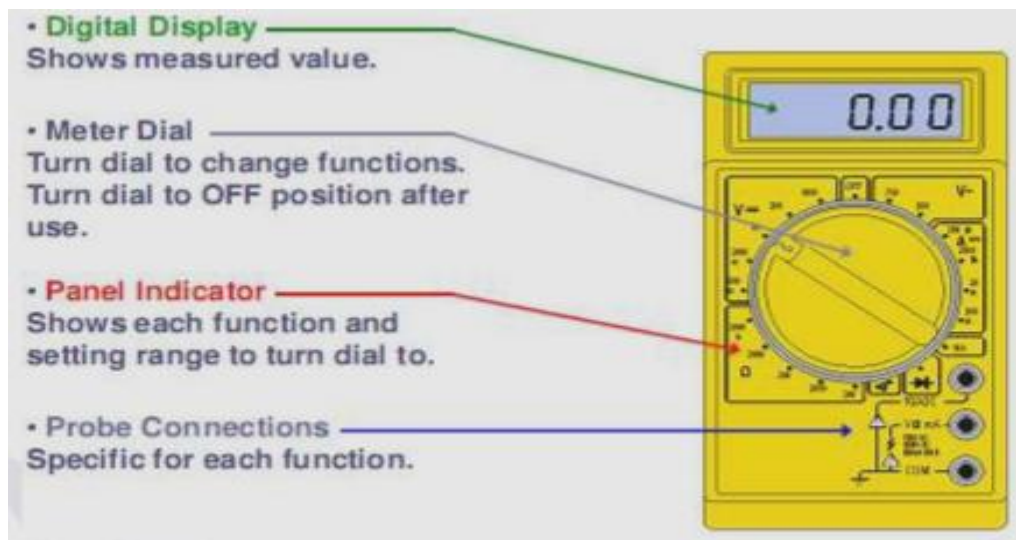

Fig.1.6. Display And Dial Settings Of DMM

These symbols are often found on millimeter and schematics. They are designed to symbolize components and reference values.

- **Measuring Voltage**

- ✓ **Voltage** is the unit of electrical pressure; one volt is the potential difference needed to cause one amp of current to pass through one ohm of resistance.

- **There are two types of voltages: AC & DC**

- ✓ Alternating Voltage (AC) is the house voltage (220v)
- ✓ Direct Current (DC) is the battery voltage (12v dc) .

Be very careful not to touch any other electronic components within the equipment and do not touch the tips to each other while connected to anything else.

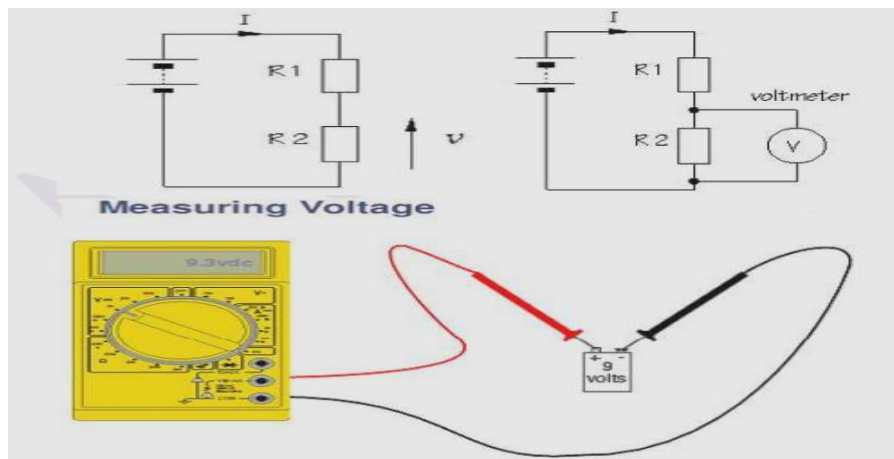

Fig.1.7. Measuring Voltage

## • WATT-METER

**Wattmeter** is used for measuring powers in AC circuits. For DC circuits, powers can be found simply from multiplying voltage by current. The wattmeter is an instrument for measuring the electric power (or the supply rate of electrical energy) in watts of any given circuit. Electromagnetic wattmeter are used for measurement of utility frequency and audio frequency power; other types are required for radio frequency A wattmeter consists of a current coil, connected in series with the line like an ammeter, and a potential coil, connected in parallel with the line like a voltmeter. The connection is shown in the Figure 3. There is a shunt switch for the current coil similar to an ammeter, while the potential coil has no shunt switch.



Fig.1.8. Wattmeter

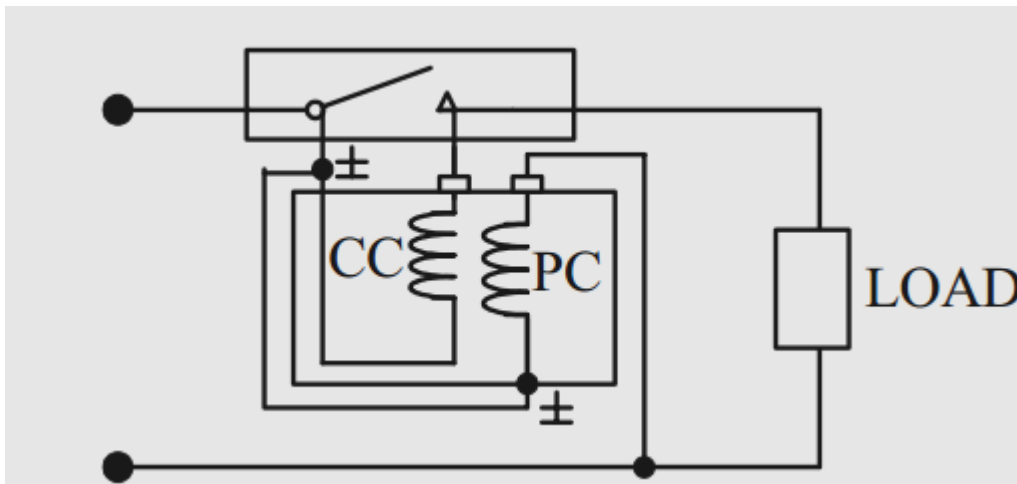

Fig.1.9. Wattmeter connection.

It should be noted that one polarity of the current coil and one polarity of the potential coil have the symbol '±', representing that they are common polarities

- **KWh meter**

- ✓ **KWh meter** is the electric meter that measures the amount of electrical energy in kWh that was consumed in the house. The kWh meter has a counter display that counts units of kilowatt-hour (kWh). The energy consumption is calculated by calculating the difference of the counter's reading in the specified period.



Fig.1.10. KWh meter

- **Cost of electricity bill Kilo watt hours**

The cost of electricity bill is calculated by multiplying the number of kWh that were consumed by the cost of 1kWh. For example, the electricity bill's cost for



consumption of 900kWh per month with cost of 10 cents for 1kWh is  $900\text{kWh} \times 10\text{¢}$   
 $= 9000\text{¢} = 90\$$ .

- **Frequency meter**

A **frequency meter** is an instrument that displays the frequency of a periodic electrical. Various types of frequency meters are used. Many are instruments of the deflection type, ordinarily used for measuring low frequencies but capable of being used for frequencies as high as 900 Hz. These operate by balancing two opposing forces. A **frequency counter** is an electronic instrument, or component of one, that is used for measuring frequency. Frequency counters usually measure the **number of cycles of oscillation**, or pulses per second in a periodic electronic signal. Such an instrument is sometimes referred to as acme-meter, particularly one of Chinese manufacture. Changes in the frequency to be measured cause a change in this balance that can be measured by the deflection of a pointer on a scale. Deflection-type meters are of two types, electrically resonant circuits and radiometers. An example of a simple electrically resonant circuit is a moving-coil meter. In one version, this device has two coils tuned to different frequencies and connected at right angles to one another in such a way that the whole element, with attached pointer, can move. Frequencies in the middle of the meter's range cause the currents in the two coils to be approximately equal and the pointer to indicate the midpoint of a scale. Changes in frequency cause an imbalance in the currents in the two coils, causing them, and the pointer, to move.



Fig.1.11. (A&B). A. Frequency counters from B. Frequency meter

- **Measuring Time and frequency**

Time and frequency measurements follow the conventions used in other areas of metrology. The frequency standard or clock being measured is called the device under test (DUT). A measurement compares the DUT to a standard or reference. The standard should outperform the DUT by a specified ratio, called the test uncertainty



ratio (TUR). Ideally, the TUR should be 10:1 or higher. The higher the ratio, the less averaging is required to get valid measurement results.

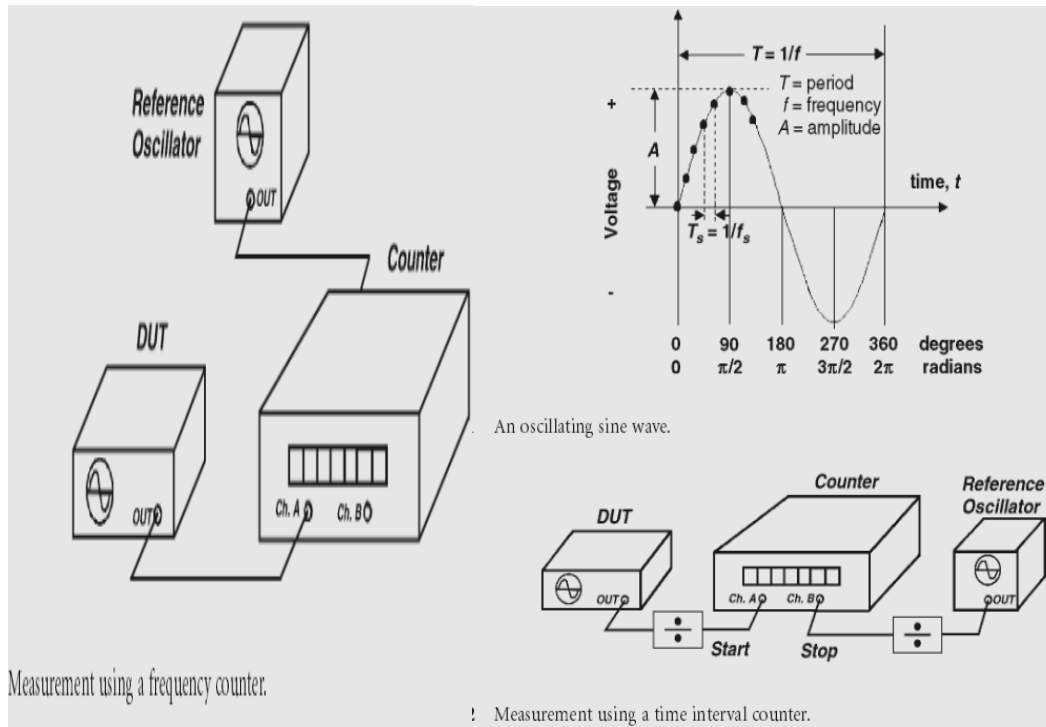

Fig.1.12. (A&B): A) frequency measurements. B). Time.

The test signal for time measurements is usually a pulse that occurs once per second (1 pps). The pulse width and polarity varies from device to device, but TTL levels are commonly used. The test signal for frequency measurements is usually at a frequency of 1 MHz or higher, with 5 or 10 MHz being common. Frequency signals are usually sine waves, but can also be pulses or square wave.

- **LCR meter**

An **LCR meter** is a type of electronic test equipment used to measure the inductance (L), capacitance (C), and resistance (R) of an electronic component.<sup>[1]</sup>

In the simpler versions of this instrument the impedance was measured internally and converted for display to the corresponding capacitance or inductance value. Readings should be reasonably accurate if the capacitor or inductor device under test does not have a significant resistive component of impedance. More advanced designs measure true inductance or capacitance, as well as the equivalent series resistance of capacitors and the Q factor of inductive components.



Fig.1.13. Handheld LCR meter

- **Use of Oscilloscope as test instruments**

**Oscilloscopes** are used in the sciences, medicine, engineering, automotive and the telecommunications industry. General-purpose instruments are used for maintenance of electronic equipment and laboratory work. Special-purpose oscilloscopes may be used for such purposes as analyzing an automotive ignition system or to display the waveform of the heartbeat as an electrocardiogram. The oscilloscope can be adjusted so that repetitive signals can be observed as a continuous shape on the screen. A storage oscilloscope can capture a single event and display it continuously, so the user can observe events that would otherwise appear too briefly to see directly

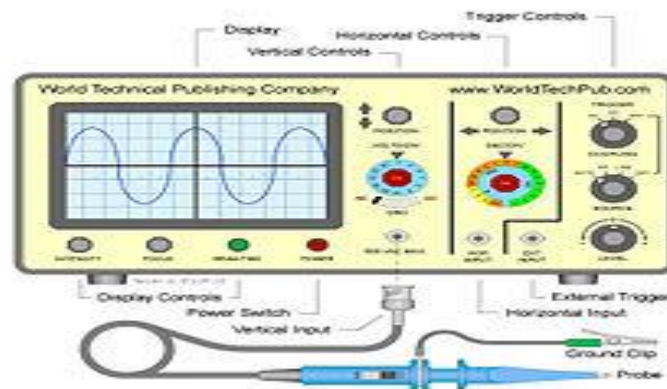

Fig.1.14. Basic oscilloscope

- **Description**

The basic oscilloscope, as shown in the illustration, is **typically divided into four sections**:

- ✓ The display,
- ✓ Vertical controls,
- ✓ Horizontal controls and
- ✓ Trigger controls.



The display is usually a CRT (historically) or LCD panel laid out with horizontal and vertical reference lines called the *graticule*. CRT displays also have controls for focus, intensity, and beam finder. The vertical section controls the amplitude of the displayed signal. This section has a volts-per-division (Volts/Div) selector knob, an AC/DC/Ground selector switch, and the vertical (primary) input for the instrument. Additionally, this section is typically equipped with the vertical beam position knob. The horizontal section controls the time base or "sweep" of the instrument. The primary control is the Seconds-per-Division (Sec/Div) selector switch. Also included is a horizontal input for plotting dual X-Y axis signals. The horizontal beam position knob is generally located in this section. The trigger section controls the start event of the sweep. The trigger can be set to automatically restart after each sweep, or can be configured to respond to an internal or external event. The principal controls of this section are the source and coupling selector switches, and an external trigger input (EXT Input) and level adjustment.

In addition to the basic instrument, most oscilloscopes are supplied with a probe as shown. The probe connects to any input on the instrument and typically has a resistor of ten times the oscilloscope's input impedance. This results in a .1 (-10X) attenuation factor; this helps to isolate the capacitive load presented by the probe cable from the signal being measured. Some probes have a switch allowing the operator to bypass the resistor when appropriate.

- **Front panel controls**

- ✓ **Focus control**

This control adjusts CRT focus to obtain the sharpest, most-detailed trace. In practice, focus must be adjusted slightly when observing very different signals, so it must be an external control. The control varies the voltage applied to a focusing anode within the CRT. Flat-panel displays do not need this control.

- ✓ **Intensity control**

This adjusts trace brightness. Slow traces on CRT oscilloscopes need less, and fast ones, especially if not often repeated, require more brightness. On flat panels, however, trace brightness is essentially independent of sweep speed, because the internal signal processing effectively synthesizes the display from the digitized data.



### ✓ **Astigmatism**

This control may instead be called "shape" or "spot shape". It adjusts the voltage on the last CRT anode (immediately next to the Y deflection plates). For a circular spot, the final anode must be at the same potential as both of the Y-plates (for a centred spot the Y-plate voltages must be the same). If the anode is made more positive, the spot becomes elliptical in the X-plane as the more negative Y-plates will repel the beam. If the anode is made more negative, the spot becomes elliptical in the Y-plane as the more positive Y-plates will attract the beam. This control may be absent from simpler oscilloscope designs or may even be an internal control. It is not necessary with flat panel displays.

### ✓ **Beam finder**

Modern oscilloscopes have direct-coupled deflection amplifiers, which means the trace could be deflected off-screen. They also might have their beam blanked without the operator knowing it. To help in restoring a visible display, the beam finder circuit overrides any blanking and limits the beam deflected to the visible portion of the screen. Beam-finder circuits often distort the trace while activated. These markings, whether located directly on the screen or on a removable plastic filter, usually consist of a 1 cm grid with closer tick marks (often at 2 mm) on the centre vertical and horizontal axis. One expects to see ten major divisions across the screen; the number of vertical major divisions varies. Comparing the grid markings with the waveform permits one to measure both voltage (vertical axis) and time (horizontal axis). Frequency can also be determined by measuring the waveform period and calculating its reciprocal. On old and lower-cost CRT oscilloscopes the graticule is a sheet of plastic, often with light-diffusing markings and concealed lamps at the edge of the graticule. The lamps had a brightness control. Higher-cost instruments have the graticule marked on the inside face of the CRT, to eliminate parallax errors; better ones also had adjustable edge illumination with diffusing markings. (Diffusing markings appear bright.) Digital oscilloscopes, however, generate the graticule markings on the display in the same way as the trace. External graticules also protect the glass face of the CRT from accidental impact. Some CRT oscilloscopes with internal graticules have an unmarked tinted sheet plastic light filter to enhance trace contrast; this also serves to protect the faceplate





of the CRT. Accuracy and resolution of measurements using a graticule is relatively limited; better instruments sometimes have movable bright markers on the trace. These permit internal circuits to make more refined measurements. Both calibrated vertical sensitivity and calibrated horizontal time are set in 1 - 2 - 5 - 10 steps. This leads, however, to some awkward interpretations of minor divisions. Digital oscilloscopes generate the graticule digitally. The scale, spacing, etc., of the graticule can therefore be varied, and accuracy of readings may be improved.

- **Time base controls**

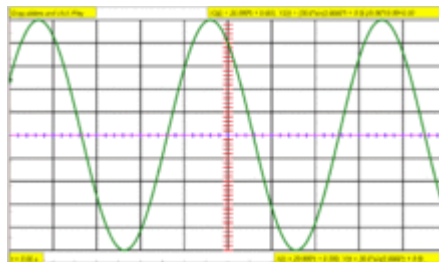

**Fig.1.15. Time Base Controls**

These select the horizontal speed of the CRT's spot as it creates the trace; this process is commonly referred to as the sweep. In all but the least-costly modern oscilloscopes, the sweep speed is selectable and calibrated in units of time per major graticule division. Quite a wide range of sweep speeds is generally provided, from seconds to as fast as picoseconds (in the fastest) per division. Usually, a continuously-variable control (often a knob in front of the calibrated selector knob) offers uncelebrated speeds, typically slower than calibrated. This control provides a range somewhat greater than the calibrated steps, making any speed between the steps available.

- **Hold off control**

Some higher-end analog oscilloscopes have a hold off control. This sets a time after a trigger during which the sweep circuit cannot be triggered again. It helps provide a stable display of repetitive events in which some triggers would create confusing displays. It is usually set to minimum, because a longer time decreases the number of sweeps per second, resulting in a dimmer trace. See Hold\_off for a more detailed description.



- **Vertical sensitivity, coupling, and polarity controls**

To accommodate a wide range of input amplitudes, a switch selects calibrated sensitivity of the vertical deflection. Another control, often in front of the calibrated-selector knob, offers continuously-variable sensitivity over a limited range from calibrated to less-sensitive settings.

Often the observed signal is offset by a steady component, and only the changes are of interest. An input coupling switch in the "AC" position connects a capacitor in series with the input. This passes only the changes (provided they are not too slow ("slow" would mean visible. However, when the signal has a fixed offset of interest, or changes quite slowly, the user will usually prefer "DC" coupling, which bypasses any such capacitor. Most oscilloscopes offer the DC input option. For convenience, to see where zero volts input currently shows on the screen, many oscilloscopes have a third switch position (usually labeled "GND" for ground) that disconnects the input and grounds it. Often, in this case, the user centers the trace with the vertical position control. Better oscilloscopes have a polarity selector. Normally, a positive input moves the trace upward; the polarity selector offers an "inverting" option, in which a positive-going signal deflects the trace downward.

- **Horizontal sensitivity control**

This control is found only on more elaborate oscilloscopes; it offers adjustable sensitivity for external horizontal inputs. It is only active when the instrument is in X-Y mode, i.e. the internal horizontal sweep is turned off.

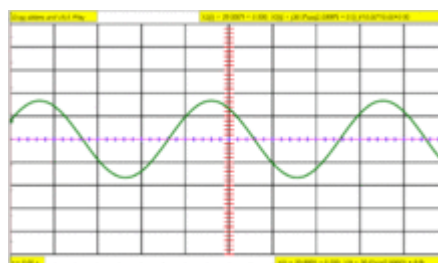
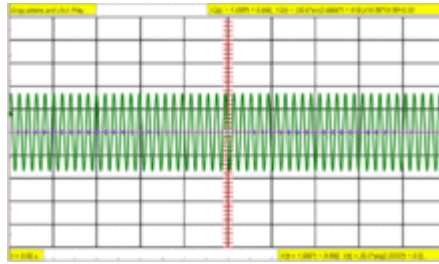

**Fig.1.16. Vertical position control**

The vertical position control moves the whole displayed trace up and down. It is used to set the no-input trace exactly on the center line of the graticule, but also permits offsetting vertically by a limited amount. With direct coupling, adjustment of this control can compensate for a limited DC component of an input.



- **Horizontal position control**

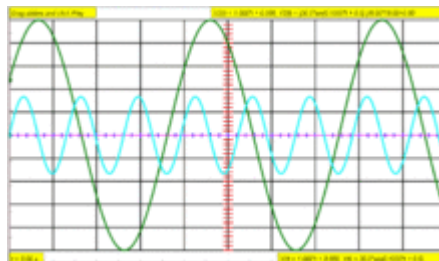

**Fig.1.17. Horizontal position control**

Computer model of Horizontal position control from X offset increasing

The horizontal position control moves the display sidewise. It usually sets the left end of the trace at the left edge of the graticule, but it can displace the whole trace when desired. This control also moves the X-Y mode traces sidewise in some instruments, and can compensate for a limited DC component as for vertical position.

- **Dual-trace controls**



**Fig.1.18. Dual and Multiple-trace Oscilloscopes**

Dual-trace controls green trace =  $Y = 30 \cdot \sin(0.1 \cdot t) + 0.5$  teal trace =  $Y = 30 \cdot \sin(0.3 \cdot t)$

Each input channel usually has its own set of sensitivity, coupling, and position controls, though some four-trace oscilloscopes have only minimal controls for their third and fourth channels.

Dual-trace oscilloscopes have a mode switch to select either channel alone, both channels, or (in some) an X-Y display, which uses the second channel for X deflection. When both channels are displayed, the type of channel switching can be selected on some oscilloscopes; on others, the type depends upon time base setting. If manually selectable, channel switching can be free-running (asynchronous), or between consecutive sweeps. Some Philips dual-trace analog oscilloscopes had a fast analog multiplier, and provided a display of the product of the input channels. Multiple-trace oscilloscopes have a switch for each channel to enable or disable display of the channel's trace.

### .3 Measuring Resistance And Continuity

- **Resistance**

Resistance is the opposition to current. It is measured in ohm.

Testing for continuity is used to verify if a circuit, wire or fuse is complete with no open. Audible continuity allows an alarm if circuit is complete. If there is no audible alarm resistance of 1 ohm to 0.1 ohm should be present.

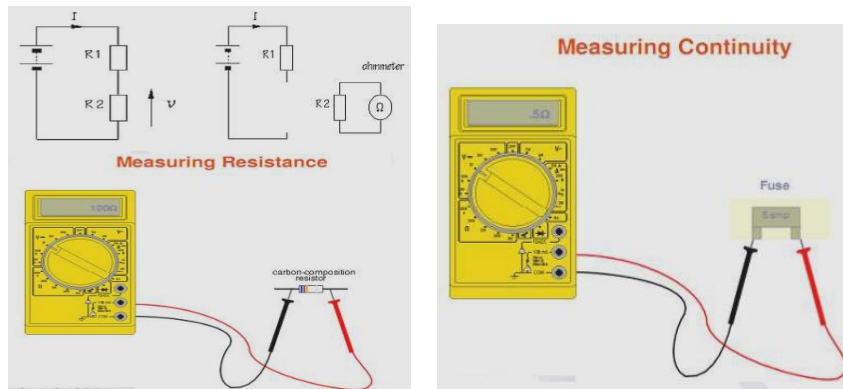

Fig.1.19.(A & B):A)measuring *Resistance*. B) measuring continuity

- **Measuring Current**

Current is the flow of electrical charge through a component or conductor. It is measured in amps or amperes.

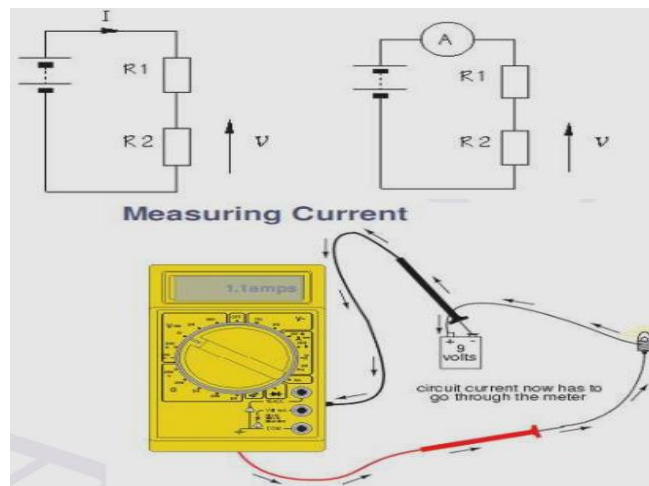

Fig.1.20. Measuring Current



- **Measuring insulation resistance**

Insulation resistance testers can be used to determine the integrity of windings or cables in motors, transformers, switch-gear, and electrical installations. The test method is determined by the type of equipment being tested and the reason for testing. For instance, when testing electrical cabling or switchgear (low-capacitance equipment) the time-dependent capacitive leakage and absorption leakage currents become insignificant and decrease to zero almost instantly. A steady conductive leakage current flow is reached almost instantly (a minute or less) providing perfect conditions for the spot-reading/short- time resistance test.

- **Insulation Resistance & Leakage Currents and Predictive**

- ✓ **Maintenance Tests**

On the other hand, when the equipment to be tested is a long run of cable, large motor, Or generator (high-capacitance equipment) the time-dependent currents will last for hours. These currents will cause the meter readings to change constantly, making it impossible to obtain an accurate steady reading. This condition can be overcome by using a test that establishes a trend between readings, such as the step voltage or dielectric-absorption test. These tests do not depend on a single reading but on a collection of relative readings. It would be a waste of time to perform these tests on low-capacitance equipment since the Time-dependent currents diminishes quickly, resulting in all the measurements being the same.



**Fig.1.21. Measuring insulation resistance**

- **Installation testing**



The most important reason for testing insulation is to insure public and personal safety. By performing a high dc voltage test between de-energized current-carrying (hot), grounded, and grounding conductors, you can eliminate the possibility of having a life-threatening short circuit or short to ground. This test is usually performed after the initial installation of the equipment. This process will protect the system against mis-wired and defective equipment, and it will insure a high quality installation, customer satisfaction, and protect against fire or shock.

- **Maintenance testing**

The second most important reason for insulation testing is to protect and prolong the life of electrical systems and motors. Over the years, electrical systems are exposed to environmental factors such as dirt, Grease, temperature, stress, and vibration. These conditions can lead to insulation failure, resulting in loss of production or even fires. Periodic maintenance tests provide valuable information about the state of deterioration and will help in predicting possible failure of the system. Correcting problems will result not only in a trouble-free system, but will also extend the operating life for a variety of equipment.

- **Measuring power**



Fig.1.22. precision of power measurement Analyzer

Power: A unit of Power equal to one Joule of Energy per Second

DC Source:  $W = V \times A$  and AC Source:  $W = V \times A \times PF$

**Active Power:** Watts  $P = V_{rms} \times A_{rms} PF$ , Also sometimes referred to as True Power or Real Power

**Apparent Power:** Volt-Amps  $S = V_{rms} \times A_{rm}$



<b>Self-Check -1</b>	<b>Written Test</b>
----------------------	---------------------

**Directions:** Answer all the questions listed below.

**I. CHOOSE THE BEST ANSWER**

- Which of the following instrument is used to displays the of a periodic signals of electrical circuit.  
A. *frequency meter*                      B. *energy Meter*                      C. *KWH –Meter*  
D. *digital multi-meter*
- Which of the following **is not true** about Function of Digital multi-meter, in electronics & electrical equipment testing system.  
A. a device used to measure voltage                      B. a device used to measure resistance and current  
C. is a device used to measure Continuity b/n two points                      D. none
- Which of the following is used for measuring differences of potential (voltage) between two points in an electrical circuit?  
A. Ohmmeter                      B. Voltmeters                      C. Ammeters                      D. Wattmeter
- The cost of electricity bill is calculated by multiplying the number of kWh that were consumed by the cost of -----  
A. 1kWh                      B. 2KWH                      C. 3KWH                      D. 1.5KWH
- Which of the following is used for measuring powers in AC circuits?  
A. Ohmmeter                      B. Voltmeters                      C. Wattmeter                      D. Ammeters

**Note: Satisfactory rating - 3 and 5 points                      Unsatisfactory - below 3 and 5 points**  
You can ask you teacher for the copy of the correct answers.

Score = _____
Rating: _____



Name: \_\_\_\_\_

Date: \_\_\_\_\_

<b>Information Sheet-2</b>	Observing all safety procedures in using tools and appropriate personal protective equipment (PPE)
----------------------------	--

## 2.1 Introduction to General Safety Precautions

Read and follow your department's safe work practices guidelines.

Employees and employers have a responsibility to work together and establish safe working practices. Always use the Personal Protective Equipment (PPE) necessary to protect you from exposure to potential hazards, such as;

- ✓ Falling, flying, abrasive or splashing objects.
- ✓ Sharp edges (use caution around when and when not to wear gloves)
- ✓ Harmful dusts, fumes, mists, vapors, or gases.

If a hazardous situation is encountered, immediately bring it to the attention of your supervisor or designated safety coordinator. Keep floors as clean and dry as possible to prevent accidental slips or trips when working with or around hand and power tools.

Clear your workspace of accumulated saw dust, debris, and volatile gases reduces the chance that sparks could cause fire or explosion.

- ✓ Avoid Horse play. Use tools for their intended purpose only.
- ✓ Handle hand tools with care.

### • **When can PPE be used?**

PPE is one of the least effective ways of controlling risks to work health and safety and should only be used:

- ✓ when there are no other practical control measures available (as a last resort)
- ✓ As an interim measure until a more effective way of controlling the risk can be used, or
- ✓ To supplement higher level control measures (as a back-up).





- **What standard of PPE is required?**

**PPE used at a workplace must be:**

- ✓ Selected to minimize risk to work health and safety.
- ✓ Suitable for the nature of the work and any hazard associated with the work.
- ✓ a suitable size and fit and reasonably comfortable for the person wearing it.
- ✓ Maintained, repaired or replaced so it continues to minimize the worker's health and safety risk, and
- ✓ Used or worn by the worker, so far as is reasonably practicable.

- **How do I choose the right PPE for the job?**

Selection processes for choosing the right PPE must involve consultation with workers and their representatives and should also include:

- ✓ A detailed evaluation of the risk and performance requirements for the PPE.
- ✓ compatibility of PPE items where more than one type of PPE is required (for example ear muffs with a hard hat)
- ✓ Consultation with the supplier to ensure PPE is suitable for the work and workplace conditions, and preference for PPE that complies with the relevant Australian Standard or equivalent standard.

- **What Must Be Done to Be Safe?**

Use the three-stage safety model: **recognize, evaluate, and control hazards**. To be safe, you must think about your job and plan for hazards. To avoid injury or death, you must understand and recognize hazards. You need to evaluate the situation you are in and assess your risks. You need to control hazards by creating a safe work environment, by using safe work practices, and by reporting hazards to a supervisor or teacher.

If you do not recognize, evaluate, and control hazards, you may be injured or killed by the electricity itself, electrical fires, or falls. If you use the safety model to recognize, evaluate, and control hazards, you are much safer.

### **1. Recognize hazards**

The first part of the safety model is recognizing the hazards around you. Only then can you avoid or control the hazards. It is best to discuss and plan hazard recognition tasks with your co-workers. Sometimes we take risks ourselves, but



when we are responsible for others, we are more careful. Sometimes others see hazards that we overlook. Of course, it is possible to be talked out of our concerns by someone who is reckless or dangerous.

## 2. Evaluate hazards

When evaluating hazards, it is best to identify all possible hazards first, then evaluate the risk of injury from each hazard. Do not assume the risk is low until you evaluate the hazard. It is dangerous to overlook hazards. Job sites are especially dangerous because they are always changing. Many people are working at different tasks. Job sites are frequently exposed to bad weather. A reasonable place to work on a bright, sunny day might be very hazardous in the rain. The risks in your work environment need to be evaluated all the time. Then, whatever hazards are present need to be controlled.

## 3. Control hazards

Once electrical hazards have been recognized and evaluated, they must be controlled. You control electrical hazards in two main ways: (1) create a safe work environment and (2) use safe work practices. Controlling electrical hazards (as well as other hazards) reduces the risk of injury or death.

- **Personal protective equipment** is vital to the safety of employees that work with hand and power tools. The type of PPE needed is determined by the tool used and the work being performed. Your employer will provide all necessary PPE at no cost to you. You have a responsibility to use the PPE properly and when required

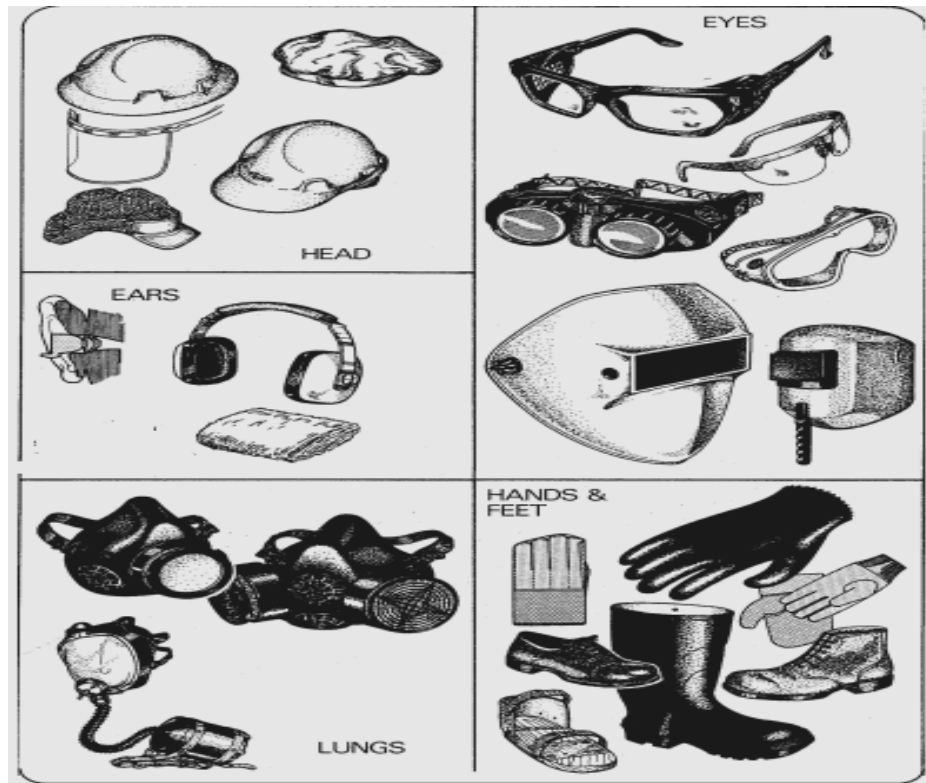

**Fig 2.1. Different Types of PPE.**

- **SAFETY SHOES**

Some safety shoes are designed to limit damage to your toes from falling objects. A steel plate is placed in the toe area of such shoes so that your toes are not crushed if an object impacts there. Other safety shoes are designed for use where danger from sparking could cause an explosion. Such danger is minimized by elimination of all metallic nails and eyelets and by the use of soles that do not cause static electricity.



**Fig. 2.2. Safety shoes**

- **Belts and Straps**

The safety strap and body belt, might be called your extra hands when you work



aloft. The body belt, strapped around your waist, contains various pockets for small tools. The safety strap is a leather or neoprene-impregnated nylon belt with a tongue-type buckle at each end. While you are climbing you will have the safety strap hanging by both ends from the left ring (called a D-ring because of its shape) on the body belt. When you are at working position, you unsnap one end of the safety strap, pass it around the supporting structure so there is no danger of its slipping (at least 18 inches from the top of the part on which it is fastened), and hook it to the right D-ring on the body belt. The safety strap must be placed around a part of the structure that is of sufficient strength to sustain an Abs weight and his or her equipment, and must rest flat against the surface without twists or turns. It must not be placed around any part of a structure that is being removed. Before placing your weight on the strap, determine VISUALLY that the snap and D-ring are properly engaged. Do not rely on the click of the snap-tongue as an indication that the fastening is secure. The body belt and safety strap require inspection before use. Look for loose or broken rivets; cracks, cuts, nicks, tears or wear in leather; broken or otherwise defective buckles, such as enlarged tongue-holes, defects in safety-belt snap hooks and body belt D-rings. If you discover any of these or other defects, turn in your equipment and replace it. Perform maintenance periodically according to applicable procedures. Remember that leather and nylon belts are treated in different manners.

- **Goggles:** Are used to protect the form of the eye .During welding or from flying objects (chips) during grinding and burring materials or wooden surface.
- **Glove:** hand covering for protection warmth, etc usually with separate fingers.



**Fig.2.3. Insulated gloves.**

- **Apron/overall;**-Air port of the overall development & to facilitate tourist traffic.



Fig. 2.4. Apron/overall

- **Eye Protection**

Proper eye protection is of the highest importance for all personnel. Eye protection is necessary because of hazards caused by infrared and ultraviolet radiation, or by flying objects such as sparks, globules of molten metal, or chipped concrete and wood, etc. These hazards are always present during welding, cutting, soldering, chipping, grinding, and a variety of other operations.

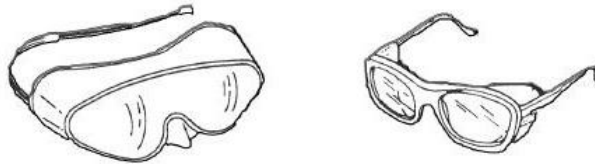

Fig. 2.5. Eye Protection

Self-Check -2	Written Test
---------------	--------------

**Directions:** Answer all the questions listed below.

I. **Say True If The Statements Correct And Say False If The Statements Incorrect.**

1. The first part of the safety model is recognizing the hazards around you.
2. Some safety shoes are **NOT** designed to limit damage to your toes from falling objects.
3. **PPE** is vital to the safety of employees that work with hand and power tools.
4. Proper eye protection is one of the best highest important for all personnel.

II. **Match the items in column “A” to “B”; write the letter only in the space provided.**



	<b>Column – A</b>		<b>Column - B</b>
5	Goggles = C	A	Hold or secured tightly together
6	Gloves = B	B	Connect the parts of much
		C	Protect eye from the acre
		D	hand covering for protection warmth

**Note: Satisfactory rating - 3 and 5 points                      Unsatisfactory - below 3 and 5 points**  
 You can ask you teacher for the copy of the correct answers.

Score = _____
Rating: _____

Name: \_\_\_\_\_

Date: \_\_\_\_\_

<b>Information Sheet-3</b>	<b>Reporting events to the supervisor</b>
----------------------------	---

**3.1. Concepts of reports**

**A report** is a part of a documentation which is sharp and short and specially written for a particular purpose and audience. A report consists of specific and important information which is analyzed and applied to a particular problem or issue, often making recommendations for future action.

• **Characteristics of reports**

Requirements and content of a report may vary business to business and departments to a department. Thus, to understand the information that written, a report has possessed the following;

- ✓ Clear and well-structured format



- ✓ Provides a brief of instruction and guideline
- ✓ Outline of the purpose of report, audience, and issue or problems.
- ✓ Easy to locate and follow.

### 3.2. Reporting emergency situations

An emergency is a situation that poses an immediate risk to health, life, property, or environment. Reporting emergency situations are rare but do occur, so having a plan for handling them is helpful. If the practitioner(s) believe his/her client is in imminent danger of killing or injuring themselves or another person,

- Phone the local police or emergency services immediately
- Stay with the person until help arrives
- Ask what is the root cause of emergency situation
- If the root cause is being known:
  - ✓ Instruct the client to give the object to someone for safekeeping
  - ✓ Discuss who can be notified of the risk and weapon and follow up
  - ✓ Listen, but do not judge, argue, threaten, or yell

### 3.3. Inspection Report

Inspector will prepare a formal report to document the inspection findings. This report will consist of the completed checklist.

All inspection reports will contain the information and be presented in the format described as follows. (See Attachment C for an example report format):

- ✓ **Heading** - This indicates the type of inspection performed, e.g., JOINT AIR COMPLIANCE OVERVIEW INSPECTION REPORT
- ✓ **Facility Identification** - This includes the name, location, telephone number, AIRS Facility Subsystem (AFS) Plant I.D., the date of the inspection and the regional office conducting the inspection.
- ✓ **Participants** - This section includes the name, title and affiliation of each participant.
- ✓ **Inspection Procedures** - This section briefly describes the activities conducted during the inspection.
- ✓ **Process/Facility Description** - This section should contain a description of the process including the Standard Industrial Classification (SIC) number and a description of the facility, its process and air pollution control equipment. The detail included will depend on the facility inspected and the extent to



which information is current and available in the files from previous inspections. Applicable previous inspection information should be referenced.

- ✓ **Discussion of Inspection Procedures** - This section contains discussion of the specific inspection procedures used by the state/local inspector. This section should include specific procedures used by the state/local inspector and comments on those procedures. Any problems, discrepancies and deficiencies, as well as positive aspects should be discussed. The discussion should be based on observations of the inspector's activities and the information contained on the Joint Overview Air Compliance Inspection and Report Checklists.
- ✓ **Summary/Recommendations** - This is based upon the previous sections and should include conclusions which can be made about the state/local agency inspector's activities and state/local agency inspection policies. Both positive and negative comments should be included. Also discuss any influence your actions might have had on the state/local inspector's inspection. This section should be oriented toward improving the state/local agency's air compliance inspections.
- ✓ **Signatures** - The inspector will sign the report. The date signed will be included, e.g.: (Inspector's Name) Environmental Engineer and Date:
- ✓ **Attachments** - These are identified by a number (e.g., Attachment 1) and placed in numerical sequence in the report. They may include: (1) Joint Air Compliance Overview
- ✓ **Inspection Checklist.** (2) Joint Air Compliance Overview Inspection Report Checklist. (3) State/local Agency Inspection Report. (4) Other appropriate documents, i.e., photographs and any documents obtained during the inspection.

### 3.4. What do you need to report?

***The following are reportable, if they arise 'out of or in connection with work':***

- The death of any person, whether or not they are at work
- accidents which result in an employee or a self-employed person dying, suffering a specified injury, being absent from work or unable to do their
- their normal duties for more than seven days





- accidents which result in a person not at work (e.g a patient, service user, visitor) suffering an injury and being taken directly to a hospital for treatment, or if the accident happens at a hospital, if they suffer a specified injury ;
- an employee or self-employed person has one of the specified occupational diseases or is exposed to carcinogens, mutagens and biological agents ;
- Specified dangerous occurrences, which may not result in a reportable injury, but have the potential to do significant harm .

### **3.5. Who should report?**

The 'responsible person' has the duty to notify and report. This may be the employer of an injured person, a self-employed person or someone in control of premises where work is carried out. Who the responsible person is depends on the circumstances of the reportable incident .The employment status of agency workers is not always clear to the agency, the worker, or to the business supplied with labour. In many cases, the employment agency is the legal employer, and is under the same legal obligations as any other employer to report accidents and ill health to their employees. In other cases, for instance where workers are self-employed, the duty is on the host Business to report accidents, as the person in control of the premises where an accident occurs. In practice, agencies should ensure that responsibility for reporting under RIDDOR is clearly assigned to the appropriate person based on the particular facts of the employment relationship. Agencies should ensure that reporting responsibilities are clearly understood by the host businesses and workers. Where different organizations share responsibility for managing staff, the employer is responsible for ensuring adequate arrangements are in place for reporting incidents.

- **When to report**

Although the Regulations specify varying timescales for reporting different types of incidents, it is advisable to report the incident as soon as possible. In cases of a reportable death, specified injury, or dangerous occurrence, you must notify the enforcing authority without delay. You must report within 10 days of the incident. Over-seven-day injuries must be reported within 15 days of the incident. Diseases should be reported as soon as a registered medical practitioner (RMP) notifies you in writing that your employee suffers from a reportable work-related disease.

- **Keeping records**



You must keep a record of any reportable injury, disease or dangerous occurrence for three years. This must include:

- ✓ The date and method of reporting;
- ✓ The date, time and place of the event;
- ✓ Personal details of those involved;
- ✓ The injury;
- ✓ A brief description of the nature of the event or disease. You must still keep a record of all over-three-day injuries. If you are required to keep an accident book, under the Social Security.

**Self-Check -3**

**Written Test**

**Directions:** Answer all the questions listed below.

***I. Say “TRUE” if the statement is correct and say “FALSE” if the statement is Incorrect***

1. You must keep a record of any reportable injury, disease or dangerous occurrence for three years
2. A report is **not** a part of documentation.
3. Specified dangerous occurrences, which may not result in a reportable injury.
4. The ‘responsible person’ has the duty to notify and report.



5. Inspector will **not** prepare a formal report to document the inspection findings.

**Note: Satisfactory rating - 3 and 5 points                      Unsatisfactory - below 3 and 5 points**  
You can ask you teacher for the copy of the correct answers.

Score = _____
Rating: _____

Name \_\_\_\_\_ Date \_\_\_\_\_

<b>Operation Sheet -1</b>	<b>Applying to Use hand measuring instruments/Test Equipments in electronics hand tools</b>
---------------------------	---

**Applying for measuring instruments/Test Equipments in electronics hand tools**

**Steps 1** - Measuring tools and instruments which are selected as per object to be measured.

**Step 2** - Adjust the range of the Instrument to measure current, voltage and resistance and else

**Step 3** - Measurements is obtained according to job requirements performed.



**Step 4** - calculation of resistance, current, and voltage using Ohms Law are obtained.

<b>Operation Sheet-2</b>	<b>Techniques of Observing all safety procedures in using tools and PPE</b>
--------------------------	---

### **Techniques for observing all safety procedures in using tools and PPE**

**Step 1** - Safety of tools and equipment are observed in accordance with manufacturer's instructions

**Step 2** - Conditions of PPE are checked in accordance with manufacturer's instructions

**Step 3** - Workplace hazards and risks are identified and clearly explained.

**Step 4** - Hazards/risks and its corresponding indicators are identified in with the company procedures.

**Step 5** - Contingency measures are recognized and established in accordance with organizational procedures

<b>Operation Sheet-3</b>	<b>Techniques of Reporting events to the supervisor</b>
--------------------------	---

**The techniques for writing reports of events to the supervisor are:**

**Step 1-** Provide nature of the incident/action/measures: Make sure the reliability and validity of

Information sources a like who, when and where

**Step 2-** record the place of the event.

**Step 3-** Description of suspect involved



**Step 4-** Injuries that have occur

**Step 5-** report of any harm involved

**Step 6-** report of material goods involved

<b>LAP Test</b>	<b>Practical Demonstration</b>
-----------------	--------------------------------

**Name:** \_\_\_\_\_ **Date:** \_\_\_\_\_

**Time started:** \_\_\_\_\_ **Time finished:** \_\_\_\_\_

**Instructions:** Given necessary templates, tools and materials you are required to perform the following tasks within --- hour.

**Task 1 -** Perform Measuring Instruments/Test Equipments In Electronic Hand Tools.

**Task 2 –** Perform Observing all safety procedures in using tools and PPE.

**Task 3 -** Report events /incident/action/measures to the supervisor.

<b>Instruction Sheet</b>	LG27: Maintain hand tool
--------------------------	--------------------------



This learning guide is developed to provide you the necessary information regarding the following content coverage and topics –

- Handling tools without damage according to procedure.
- Undertaking Routine maintenance of tools according to standard operational procedures, principles and techniques
  - ✓ Tools: Function, Operation, Common faults(UK)
- Undertaking routine maintenance of tools based on operational procedures, principles and techniques
- Storing tools safely in appropriate locations

This guide will also assist you to attain the learning outcome stated in the cover page.

Specifically, **upon completion of this Learning Guide, you will be able to:-**

- handle Tools without damage according to procedures
- Undertake Routine maintenance of tools according to standard operational procedures, principles and techniques
- store Tools safely in appropriate locations in accordance with manufacturer’s

#### **Learning Instructions:**

1. Read the specific objectives of this Learning Guide.
2. Follow the instructions described below 3 to 6.
3. Read the information written in the information “Sheet 1, Sheet 2 , and Sheet 3
4. Accomplish the “Self-check 1, Self-check 2 and, Self-check 3 **in page -113, 123, and 127** respectively.
5. If you earned a satisfactory evaluation from the “Self-check” proceed to “Operation Sheet 1 & 2 , **in page -128**, to “Operation Sheet -3 **in page -129**
6. Do the “LAP test” **in page – 129** (if you are ready).



## 1.1 . Introduction of handling electrical hand tools without damage.

Handling of electrical hand tools without damage means the way work of keeping something in proper condition. This would imply that maintenance should be actions taken to prevent a device or component from failing or to repair normal equipment degradation experienced with the operation of the device to keep it in proper working order. Properly maintained tools help improve efficiency of operation while minimizing opportunities for injuries and extending tool life. Time spent in tool maintenance (sharpening, cleaning, lubrication etc.) is time well spent. Prior to use, always inspect the tools for defects or damage. Check for loose, bent, or cracked tool handles, mushroomed tool heads, sprung tool joints or worn teeth. If a hand tool fails the initial inspection, inform the crew leader, tag the tool clearly as “defective”, and remove it from service. Allow adequate time at the end of each work day to clean the tools and properly pack and secure for transportation or storage. Maintaining a safe and efficient work environment will help avoid injuries and unnecessary expenditures in the long run.

- **Handling of electrical hand tools /Maintenance/ should be:**

- ✓ Keep metal blades of all tools sharp and well-oiled.
- ✓ Check for loose and worn out parts on tools regularly, and replace if necessary.
- ✓ Identify damaged tools and store them in a designated location to allow either the supervisor or maintenance person to arrange for their repair.
- ✓ Workers should know that the job is not complete until the tools are cleaned and stored in a designated location.

- **There are four principal causes of electrical failure:**

- ✓ Dust and dirt accumulation; moisture.
- ✓ Loose connections; and friction of moving parts.
- ✓ An effective maintenance program should aim to minimize these effects by keeping equipment clean and dry, keeping connections tight and minimizing friction.

- **Tools that are unsafe/faulty can be categorized in to two:**

- ✓ those having minor faults such as loose handle,
- ✓ Rusted hinges, damaged blade, bent ends & dirt edges, Dismantled casing, missing screws etc... & those fully damaged include broken teeth, broken



blade, tool with missing parts, worn tools, burned elements, open circuits inside the tool, frayed or damaged flexible cords etc... The method of identifying faulty and functional tools is done either by visual inspection or by performing different tests using test instruments.

Powered hand tools are visually inspected before use and electrically tested by a competent person as necessary

- **Visual Checks Are Carried Out As Follows:**

- **Tools/appliance**

- ✓ On/off switch is working correctly
- ✓ No signs of damage to casing
- ✓ No loose parts or missing screws
- ✓ Live parts are properly guarded so as not to be inadvertently accessible
- ✓ Ensure equipment is disconnected when not in use

- **Cables**

- ✓ Securely anchored to the plug with no signs of cuts, frays, brittleness, leads kinked or coiled, taped joints, overloading (overheating indicated by color change or smell), cable cores not externally visible.

- **Plug: Securely** anchored no sign of cracked casing, overheating, loose or bent pins.

- **Socket outlet**

- ✓ **No cracks or damage or sign of overheating.**

While identifying malfunctions any tool that is unsafe for work must be marked as faulty and the recommended corrections that must be taken to make the tool functional have to be identified clearly. Damaged tools must be marked and tagged out as damaged and stored in a different place from functional tools in order to protect other people from using them and thus avoid accident & hazards in the work area.

- **Hazards and risks induced by lack of or inadequate maintenance include:**

1. **Hand tools:**

- Mechanical failure or loss of control when using a tool with defective parts. Examples of unsafe tools are hammers with loose or damaged heads,







An important part of the maintenance programme is the inspection programme setting out the frequency of formal inspections to be carried out by competent and trained maintenance technicians.

- **Portable tools must be checked:**

- ✓ Before the tool is put into use for the first time
- ✓ After servicing and changing parts
- ✓ At regular intervals appropriate for each tool.

The period between inspections can vary, depending on the type of tool, the conditions of use and the environment. In Germany there are technical rules and accident prevention regulations that give advices on how to identify and set maintenance intervals for powered portable tools.

- **Factors to consider when making the maintenance plan**

- ✓ Type of tool and power source
- ✓ Manufacturer's instructions and recommendations
- ✓ Age of the tool  Frequency of use and the work cycle of the tool
- ✓ Working environment in which the tool is used (e.g. wet or dusty), or likelihood of mechanical damage
- ✓ Foreseeable misuse of the tool
- ✓ Effects of any modifications or repairs to the tool
- ✓ Analysis of previous records of maintenance.

- **Final check**

When maintenance is complete workers have to check if the maintenance has left the portable tools in a safe and functioning condition:

- ✓ Test the functionality of the tool
- ✓ Replace all guards and safety devices
- ✓ Record your inspection and actions, sign out and pass the tool to the worker or store it safely.

**<http://www.consultnet.ie/Safe%20Use%20of%20Power%20Tools%20R ev0.ppt#>**



- **Basic Maintenance of Electrical Tools and Equipment**

To ensure that your electric tools work when you need them, you must take proper care of them. A good routine of maintenance for your tools is one thing that you can do to make sure that the tool you need is working when you need it

1. **Clean out the Dust.** To make sure that your electric tools are ready to go when you are keep them clean and free of dust. Spend some time to clean out the dust every once in a while on your tools while they are inactive in storage.



Fig. 1.1. Clean out the Dust

2. **Check the Cords.** Look for tear/cut insulator on the power cords on your electric tools. This will ensure that your electric tool can get the power that it needs to function without an accident.



Fig.1.2.Check the Cords.

3. **Use the right tool correctly.** Use tools correctly and for their intended purposes. Follow the safety directions and operating procedures recommended by the manufacturer. When working on a circuit, use approved tools with insulated handles.





Fig.1.3. right tool correctly

- 4. Protect your Tools.** Keep tools and cords away from heat, oil, and sharp objects. These hazards can damage insulation. If a tool or cord heats up, stop using it. Report the condition to a supervisor or instructor immediately.



Fig.1.4. Protect your Tools

- 5. Use double-insulated tools** - Portable electrical tools are classified by the number of insulation barriers between the electrical conductors in the tool and the worker.



Fig.1.5. double-insulated tools

- 6. Storing Your Tools-** Keep your electric tools stored in their original cases and containers. This will keep them free of dust and dirt while they are not being used.



Fig.1.6. Storing tool box



- **Classification of non-functional and functional tools**

Tools are very useful to us in our homes especially to our job. But tools that are no longer functional may cause harm.

- ✓ Make an inventory of functional and non-functional tools in your shop.
- ✓ Classify your tools according to its function.

- **Method of identifying non-functional tools and equipment**

- ✓ **Visual inspection.** It refers to the visual observation of an expert on the appearance of the tools and equipment.
- ✓ **Functionality.** Vibration or extra noise from the operation means problems on parts and accessories started to develop.
- ✓ **Performance.** When there is something wrong with the performance of either hand tools or equipment they need an immediate repair or maintenance.
- ✓ **Power supply (for electrically operated only).** Failure to meet the required power supply, malfunction will occur in the part of hand tools or equipment.
- ✓ **Person's involved.** It refers to the technical person who has the knowledge and skills about the technology.

- **Classifications of tools and equipment according to their uses:**

- ✓ Measuring tools
- ✓ Holding tools
- ✓ Cutting tools
- ✓ Driving tools
- ✓ Boring tools
- ✓ Electrical equipment
- ✓ Miscellaneous tools/instrument/equipment

- **Non-functional tools and equipment** are those that are not able to perform its regular function because of impaired and damaged part. Examples of these are the following.

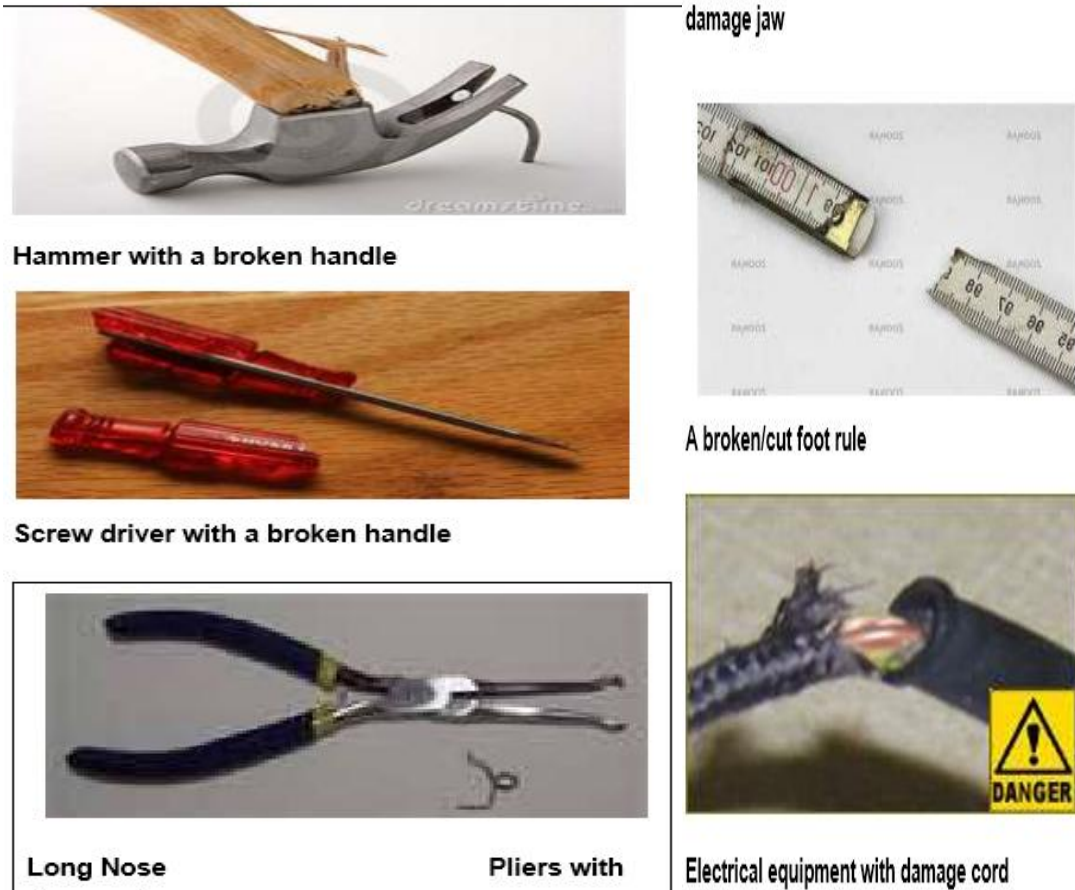

Fig.1.7. Non-functional tools and equipment

- **Functional tools and equipment** are those that are in good condition and can perform its regular functions. Examples of these are the following.



Fig.1.8. Functional tools and equipment



<b>Self-Check -1</b>	<b>Written Test</b>
----------------------	---------------------

**Directions:** Answer all the questions listed below.

**I. CHOOSE THE BEST ANSWER**

1. Which of the following Method of identifying non-functional tools is something wrong with the routine?  
A. Visual inspection      B. Functionality      C. Performance      D. Power supply
2. Which of the following Method of identifying non-functional tools is Vibration or extra noise from the operation?  
A. Visual inspection      B. Functionality      C. Performance      D. Power supply
3. Which of the following Method of identifying non-functional tools refers to the visual observation of an expert on the appearance?  
A. Visual inspection      B. Functionality      C. Performance      D. Person's involved.
4. Which of the following Method of identifying non-functional tools Failure to meet the required power supply,  
A. Visual inspection      B. Functionality      C. Performance      D. Power supply
5. When you need to work by tools the basic Maintenance of Electrical Tools to be sure to check is ----  
A . Clean out the Dust      B. Check the Cords      C. Keep tools and cords away from heat  
D. Check double-insulated tools      E.All

**Note: Satisfactory rating - 3 and 5 points      Unsatisfactory - below 3 and 5 points**  
You can ask you teacher for the copy of the correct answers.

Name \_\_\_\_\_ Date \_\_\_\_\_

Score = _____
Rating: _____



<b>Information Sheet-2</b>	Undertaking routine maintenance of tools based on operational procedures, principles and techniques
----------------------------	---

## 2.1. Introduction of routine maintenance of tools based on operational procedures, principles and techniques

- **Maintenance** can be defined as working on something to keep it in a functioning and safe state and preserving it from failure or decline. The “something” could be a workplace, work equipment, or means of transport. These are:
  1. **Preventive – or proactive – maintenance** is carried out to keep something functional. This type of activity is usually planned and scheduled.
  2. **Corrective – or reactive – maintenance** is repairing something to get it working again. This is an unscheduled, unplanned task, usually associated with greater hazards and higher risk levels. Maintenance is not the exclusive domain of fitters and mechanics. It is the responsibility of almost all workers in every sector and is carried out in almost every working environment. Workers’ health and safety can be affected during the maintenance process, but also by lack of maintenance or inadequate maintenance. Design of equipment and the work area also has a significant impact on the health and safety of workers performing maintenance.
  3. **For the purpose of this e-fact, portable** tools are defined as tools which can be carried by hand. These tools can be divided into non-powered portable (hand) tools and powered portable tools.
  4. **Non-powered portable (hand) tools** include saws, hammers, screwdrivers, pliers, axes and spanners. The greatest hazards posed by these tools result from misuse and improper maintenance. Blunt tools, for example, can make the work more difficult and result in more injuries.
  5. **Powered portable tools** There are several types of power tools, based on the power source they use: electric power operated tools (e.g. circular saws, drill machines), pneumatic power tools (e.g. hammers, chippers, and compressed air guns), liquid fuel (gas) powered tools (e.g. saws), hydraulic





power tools (jacks), and powder-actuated tools (nail guns). Powered portable tools are present in nearly every industry. They help to perform tasks that otherwise would need exhausting manual work. But these everyday tools can cause serious injuries, such as finger or hand injuries or severe eye injuries, when they are not used or maintained properly. Broken (defective) tools, or tools that have been modified unprofessionally can be dangerous. For instance, defective electric-powered tools can cause burns and shocks or even death through electrocution. Pneumatic tools can be very noisy and cause hearing loss. Portable tools are used intensively on construction sites, so that the workers are constantly exposed to hazards associated with their use.

- **Basic preventive maintenance**

- ✓ Lubricants are identified according to types of equipment.
- ✓ Tools and equipment are lubricated according to preventive maintenance schedule or manufacturer's specifications.
- ✓ Measuring instruments are checked and calibrated in accordance with manufacturer's instructions.
- ✓ Tools are cleaned and lubricated according to standard procedures.
- ✓ Defective equipment and tools are inspected and replaced according to manufacturer's specification.
- ✓ Work place is cleaned and kept in safe state in line with OSHC regulations

- **A Lubrication** is the process or technique employed to reduce friction between, and wear of one or both, surfaces in proximity and moving relative to each other, by interposing a substance called a lubricant in between them. The lubricant can be a solid, (e.g. Molybdenum disulfide  $\text{MoS}_2$ ) a solid/liquid dispersion, a liquid such as oil or water, a liquid-liquid dispersion (a grease) or a gas.

**A lubricant** is a substance introduced to lessen friction between moving surfaces. It may also transport external particles. The property of reducing friction is known as lubricity.

With fluid lubricants the applied load is either carried by pressure generated within the liquid due to the frictional viscous resistance to motion of the lubricating



fluid between the surfaces, or by the liquid being pumped under pressure between the surfaces.

Lubrication can also describe the phenomenon where reduction of friction occurs unintentionally, which can be hazardous such as hydroplaning on a road.

- **Types and Uses of lubricants**

1. **Anti-rust lubricant spray** :

- ✓ loosen rusted part
- ✓ cleans and protect
- ✓ drives out moisture



- ✓ stops squeaks
- ✓ free sticky mechanisms

2. **Wire Pulling Lubricant:**

- ✓ does not damage insulation
- ✓ cling to wire and dries to a slippery film
- ✓ suitable for use with wire or cable covered with rubber (t, thw, thn,

etc)



3. **All Purpose Anti Rust Lubricant:**

- ✓ Anti-rust o lubricating o rust removal
- ✓ decontamination
- ✓ conductance

4. **Lubricant Oil and Engine Oil:**

- ✓ Lubricating the gear
- ✓ cleans and protect
- ✓ drives out moisture



## 5. Silicon Lubricant:

- ✓ Heat stable
- ✓ lubricates
- ✓ protects
- ✓ reduces friction
- ✓ water repellent

### • Cleaning

- ✓ Clean the tools immediately after use.
- ✓ Wash the tools using water. A wire brush may be useful to loosen the soil stuck to the blades.
- ✓ Avoid the risk of spreading pathogens while the tools are being cleaned.
- ✓ Coat the blades with light oil like WD-40 on areas prone to rust.

## 2.2. Standard Operating Procedure of electrical hand tools

### • Work Environment

- ✓ Ensure that the floor of a work place is clean to avoid tripping or other possible instances that could lead to a worker losing his or her balance.
- ✓ Keep the workspace clean and tidy to avoid clutter, which may cause accidents.
- ✓ Use clamps to secure a work piece, which is liable to move, into a stable position.
- ✓ Do not carry a sharp or pointed tool in your pocket. Carry tools securely and safely.
- ✓ Keep close track of tools when working at heights. A falling tool can cause serious injury. 6. Pass a tool to another person by the handle; never throw it to them.
- ✓ Store tools properly when not in use.

### • All Tools

- ✓ Use the correct hand tool for the job. Do not use tools for jobs they are not intended for. Do not use your wrench as a hammer. Do not use a screwdriver as a chisel, etc.
- ✓ Keep tools in good condition at all times. Do not use broken or damaged tools, dull cutting tools or screwdrivers with worn tips.
- ✓ Inspect tools for defects before use. Replace or repair defective tools.



- ✓ Do not wear bulky gloves to operate hand tools.
  - ✓ Do not apply excessive force or pressure on tools.
  - ✓ Replace cracked, splintered, or broken handles on files, hammers, screwdrivers, or sledges.
  - ✓ Ensure that the handles of tools like hammers and axes fit tightly into the head of the tool.
  - ✓ Flat head screwdrivers should have square edges on their blade tips and undamaged handles. Phillips and similar screwdrivers should have clearly defined tips without chips missing and undamaged handles.
  - 9. Spanners should be in good condition with undamaged jaws to reduce the risk of slipping.
  - ✓ Torque spanners should be checked for accuracy once a year and adjusted or replaced as required.
- **Cutting Tools**
    - ✓ Keep cutting tools sharp and cover sharp edges with a suitable covering to protect the tool and to prevent injuries from unintended contact.
    - ✓ Snips and wire stripping tools should be tested for performance.
    - ✓ The general condition and sharpness of tools should be visually and physically tested on sample material.
    - ✓ Do not cut towards yourself when using cutting tools. Cut in a direction away from your body.

### 2.3. STANDARD OPERATING PROCEDURE Hand Tools

- **PRE-OPERATIONAL SAFETY CHECKS**

- ✓ Ensure that risk assessment has been read.
- ✓ Ensure no slip/trip hazards are present in workspaces and walkways.
- ✓ Always check the condition of tools prior to use
- ✓ Faulty equipment must not be used.
- ✓ Immediately report suspect equipment or tools.

- **OPERATIONAL SAFETY CHECKS**

- ✓ Use tools that are the right size & right type for your job.
- ✓ Follow the correct procedure for using every tool.
- ✓ Keep your cutting tools sharp and in good condition.
- ✓ . Don't work with oily or greasy hands.



- ✓ Cut away from yourself when using chisels and other edged tools.
- ✓ Handle sharp-edged and pointed tools with care.
- ✓ Always carry pointed tools by your side with the points and heavy ends down.
- ✓ Never carry tools in your pockets.
- ✓ Do not use tools which are loose or cracked.
- ✓ Always place tools or materials where they cannot fall or trip other personnel when not in use.
- ✓ Don't force screws; make sure that the correct screw or fixing for the job is being used.
- ✓ Where possible, secure work with clamps or a vice, freeing both hands to operate the tool used.
- ✓ Keep your balance and proper footing when working, being careful not to overreach.
- **Tool Handles:**
  - ✓ Handles should fit the hand well.
  - ✓ Handles must have a good gripping surface e.g. dimpled, and be made of compressible material e.g. not hard plastic or metal.
  - ✓ Handles must have no sharp edges or areas that dig into the fingers or palm of the hand.
  - ✓ Tool handles should have a grip span about 6 cm and not more than 9 cm.
  - ✓ Where possible, tools such as knives or soldering irons should have a guard/stopper at the front.
- **Impact Force:**
  - ✓ Reduce repeated shocks to the hand and wrist from hand tools with shock absorbing gloves.
  - ✓ Limit torque reaction by using clutch-type tools, shut-off tools and external devices such as torque bars or articulating bars.
- **Saws:**
  - ✓ The work piece should be securely held in a vice or other firm support.
  - ✓ When crosscutting, start the cut with two long slow pulls upwards.
  - ✓ When ripping, start the cut with the finer teeth at the end of the blade.



- ✓ During the cutting process, apply downward force only on the forward cut not when drawing back.
- ✓ As the cut approaches completion, reduce the force applied to the saw to avoid breaking through the material and injuring hand
- **Hand Drills:**
  - ✓ Tighten drills correctly in the chuck.
  - ✓ Before starting the drill, always remove the chuck key (if applicable) from the chuck – never leave the key in the chuck.
  - ✓ Only sharp drill bits should be used. Never use dull, chipped, rounded, or tapered drill bits.
  - ✓ Remove the drill bit before storing drill.
- **Hammers, Mallets and hitting tools:**
  - ✓ Use pliers to hold small nails.
  - ✓ Choose the correct size hammer for the job.
  - ✓ Never hit hammer faces together.
  - ✓ Never ask other people to hold things you are hitting unless using tongs or a chisel holder.
  - ✓ Keep clean and free from oil, glue or debris which might cause the handle to slip or the face to glance from the object being struck.
  - ✓ Make sure the head is wedged securely and that the head and handle are not chipped or broken.
  - ✓ Grasp handle firmly near the end and keep your eye on the point to be struck.
  - ✓ Reduce strain when pulling nails by placing a piece of wood under the hammer to increase leverage.
  - ✓ Don't use a screwdriver, wrench, or other tool as a hammer as this will damage the tool.
- **Punches / Chisels:**
  - ✓ Keep punches and chisels in good condition. Mushroomed heads can chip & cause injuries.
  - ✓ Punches are designed to mark metal and other materials that are softer than the point end, to drive and remove pins, and to align holes.



- ✓ Never use a punch with a mushroomed struck face or with a dull, chipped, or deformed point. Only use cold chisels for cutting, shaping, and removing metal softer than the cutting edge.
- ✓ Factors determining the selection of a cold chisel are the material to be cut, the size and shape of the tool, and the depth of the cut to be made.
- ✓ The cold chisel should be held steadily but with a relatively loose grip and with the palm of the hand facing the user and the point of the chisel directed away.
- ✓ Ball chisels held by one person and struck by another require the use of tongs or a chisel holder to guide the chisel.
- ✓ Metal working chisels can produce flying chips/splinters that can cause injuries to eyes and face.

- **Knives and sharp cutting tools:**

- ✓ Use a knife only for the correct purpose.
- ✓ Keep hands behind the cutting edge at all times.
- ✓ Never cut towards yourself, always cut away from your body.
- ✓ Where possible, use a cutting board underneath the material being cut.
- ✓ Always pass knives to others handle first.
- ✓ Never run with knives or push/shove people around using knives.
- ✓ Ensure knives are kept sharp – blunt knives can be dangerous.
- ✓ To clean, wipe the blade with a cloth keeping the knife's sharp edge turned away from the hand
- ✓ Do not substitute knives for can openers, screwdrivers, or ice picks.
- ✓ Replace or sharpen any cutting tool that has lost its correctly angled cutting edge.
- ✓ Dispose of all broken or blunt blades in a sharps container.
- ✓ Only use wire cutters for cutting light gauge wire or component leads. Do not use to cut sheet metal.
- ✓ Hand shears used for cutting sheet metal should be selected for the type of cut based on the side the waste material lies.

- **Files:**

- ✓ Select the proper file for the work.
- ✓ Ensure that tangs are protected by handles and that teeth are sharp and clean.



- ✓ Ensure the file used is fitted with a smooth, crack-free handle.
- ✓ The correct way to hold a file is to grasp the handle firmly in one hand and use the thumb and forefinger of the other to guide the point. Push the file forward while bearing down on it. Release the pressure and bring the file back to its original position.
- ✓ Don't pry or hammer with a file.
- **Pliers:**
  - ✓ Pliers may be used for gripping and cutting operations, but they are not a substitute for a wrench.
  - ✓ Don't use pliers to turn nuts or bolts.
  - ✓ Replace adjustable pliers if the jaws slip or bind.
  - ✓ Replace pliers if the jaw grooves are worn too much for an effective grip.
- **Wrenches/Spanners:**
  - ✓ Safe use of all wrenches requires that the user always be alert and prepared for the possibility that the wrench may slip, the fastener may suddenly turn free, or the wrench or fastener may break.
  - ✓ Where possible, use penetrating oil to loosen tight nuts.
  - ✓ The user must always inspect the wrench for flaws. Keep jaws sharp and clean. Gripping teeth or smooth jaws should not be worn or damaged.
  - ✓ Place the wrench so the pull on the handle tends to force the jaws further into the nut (lower jaw leads).
  - ✓ Pulling on a wrench is safer than pushing
  - ✓ Open end wrenches have strong jaws and are satisfactory for medium-duty turning.
  - ✓ Replace an open end wrench if the jaws are no longer square.
  - ✓ Box and Socket Wrenches are necessary for a heavy pull. Never overload the capacity of a wrench by using a pipe extension on the handle or be striking the handle with a hammer.
  - ✓ Replace a box end wrench if the box edges aren't sharp or true.
  - ✓ Socket and Adjustable Wrenches should be kept clean of dirt and grime inside the socket to ensure that the tool fits securely on the bolt or nut.
  - ✓ Replace an adjustable wrench if the jaws have noticeable play, the mechanism slips or binds, or the jaws are rounded.





- ✓ Shift wrenches must work freely and adjust properly. Always use the proper size wrench for the job.
- ✓ Replace a socket wrench if the wrench binds, if the locking mechanism no longer holds or the wrench won't easily switch from forward to reverse.
- ✓ Replace individual sockets if they are cracked, they don't stay on the wrench or extension, or if the faces or corners are no longer true.
- **Screw Drivers:**
  - ✓ Select the correct size screw driver for the job.
  - ✓ Don't carry screw drivers in your pocket.
  - ✓ Pass a screw driver to another person handle first.
  - ✓ When using a slotting screwdriver, use the correct size blade for the given slot.
  - ✓ Use Phillips head tools for Phillips head fasteners.
  - ✓ Use Positive head tools for Positive head fasteners.
  - ✓ Don't use screwdrivers as a pry-bar.
  - ✓ Do not use screwdrivers as levers, chisels, or scrapers.

<b>Self-Check -2</b>	<b>Written Test</b>
----------------------	---------------------

**Directions:** Answer all the questions listed below.

**I. Matching Column "A" with column "B" From listed below**

**Column "A"**

**column "B"**

- |                                  |   |
|----------------------------------|---|
| 1. Hand Drills                   | A. Drives out moisture                        |
| 2. Anti-rust lubricant spray     | B. Used to reduce friction                    |
| 3. Wire Pulling Lubricant        | C. water repellent                            |
| 4. Lubricant Oil and Engine Oil: | D. Lubricating the gear                       |
| 5. Silicon Lubricant             | E. cling to wire and dries to a slippery film |
| 6. Hammers                       | F. hold small nails                           |

**H. Tighten drills**



**Note: Satisfactory rating - 3 and 6 points                      Unsatisfactory - below 3 and 6 points**  
You can ask you teacher for the copy of the correct answers.

Score = _____ Rating: _____
--------------------------------

Name \_\_\_\_\_ Date \_\_\_\_\_

Information Sheet-3	<b>Storing Electrical hand tools safely in appropriate locations</b>
---------------------	--

### 3.1. Introduction Store tools and equipment

- **Storage**
  - ✓ Store tools in a dry, sheltered environment.
  - ✓ Place tools on a rack for easy safety and easy access.
  - ✓ Place similar tools close together so that workers can see easily the available tools.
- **Inventory of tools, instruments, and equipment**
  - ✓ They are conducted and recorded as per company practices
  - ✓ Tools are inspected, and replaced after use
  - ✓ Tools and equipment are stored safely in accordance with manufacturer’s specifications or company procedures.
- **Why Maintain Inventory of Tools and Equipment**



The most significant point to think at the start of your career is to acquire branded tools. They must be made out of high-quality steel and manufactured for precision. Special consideration is given to balance so that the tool/equipment will be properly maintained and prevent loses. Since the technician must work with his tools daily, regular inventory of tools/equipment is very significant.

The initial cost of a minimum number of tools is high but there is accompanying warranty guarantees satisfaction and many years of service. It is better, in the long run, to start with a few cautiously selected tools that will take care of your most common needs and then slowly build-up to a complete set. It is sometimes hard to identify and memorize the huge number of tools and equipment in the workshop, maintaining the inventory record is of great value.

### **3.2. Maintaining and Storing Tools & Equipment**

An important aspect of any business is the maintenance and storage of tools and equipment. The investment in tools and equipment is a significant part of the overhead expenses in any operation. Proper selection and maintenance of equipment are important factors in managing business. Selecting the proper tool for the job and using the tool properly will increase efficiency and reduce maintenance problems. Purchase tools, which are well-made and suited to the intended use. Commercial usage may entail more heavy duty demands on equipment.

- **Hand tools:**

- ✓ Clean dirt and debris from tools after each use.
- ✓ Oil metal parts to prevent rust.



- ✓ Lightly sand rough wooden handles and apply linseed oil.
- ✓ Repair loose handles.
- ✓ Sharpen blades of cutting tools.
- ✓ Store tools in a clean dry storage area.
- ✓ Protect surfaces of cutting tools in storage.
- **Power tools:**
  - Read and follow the maintenance schedule in the owner's manual for each piece of power equipment.
  - ✓ Change the oil.
  - ✓ Clean the air filter.
  - ✓ Lubricate moving parts.
  - ✓ Sharpen dull blades or replace worn blades according to the owner's manual.
  - ✓ Replace spark plugs.
  - ✓ Drain oil and gasoline before long-term storage.
  - ✓ Check electric cords and connections on electric-powered tools.
  - ✓ Store tools in a clean dry storage area.
- **Equipment:**
  - ✓ Store equipment in a clean dry storage area.
  - ✓ Rinse and clean spray equipment after each use.
  - ✓ Clean spreaders and check wheel-driven gears.
  - ✓ Clean carts and wheelbarrows after use.



## Sample Proper Arrangement and storage of tools and equipment



You can see in the pictures that all tools and equipment are arranged and stored properly in their own racks. Like for example the screw drivers are arranged by type and sizes, hammers, saws, c-clamps, etc. are in their racks.

Fig. 3.1. Proper arrangement and storage of hand tools and equipments

Self-Check -3

Written Test

**Directions:** Answer all the questions listed below.

**I. Say “TRUE” if the statement is correct and say “FALSE” if the statement is Incorrect**

1. Rinse and clean spray equipment after each use.



2. Store tools in a dry, sheltered environment.
3. Do not Place similar tools close together.
4. Inventory of tools, instruments, and equipment are conducted and recorded as per company practices.
5. An important aspect of any business is the maintenance and storage of tools and equipment

**Note: Satisfactory rating - 3 and 5 points                      Unsatisfactory - below 3 and 5 points**  
You can ask you teacher for the copy of the correct answers.

Name \_\_\_\_\_ Date \_\_\_\_\_

Score = _____
Rating: _____

<b>Operation Sheet -1</b>	<b><i>Techniques of Handling tools without damage according to procedure</i></b>
---------------------------	--

***Techniques for handling tools without damage according to procedure.***

**Step 1** - Tools and materials are checked for damages and manufacturing defects.

**Step 2** - Tools and equipment are identified according to classification/ specification

**Step 3** - Defective equipment and tools are inspected and replaced according to manufacturer's specification

**Step 4** - List down any losses and damages you find while conducting the record.

**Step 5** - Fill out the remarks column of the list forms for any losses/ damages.

**Step 6** - Materials and tools received are handled with appropriate safety devices. .

**Step 7** - Non-functional tools and equipment are segregated and labeled according to classification



**Step 8** - Recommend for replacement of lost tools and equipment and repair of damaged tools and equipment if reparable

<b>Operation Sheet -2</b>	Techniques to undertaking routine maintenance of tools based on operational procedures, principles and techniques
---------------------------	---

### **Techniques for undertaking routine maintenance of tools based on operational procedures, principles and techniques**

**Steps 1** - Lubricants are identified according to types of equipment.

**Step 2** - Tools and equipment are lubricated according to preventive maintenance schedule or manufacturer's specifications.

**Step 3** - Measuring instruments are checked and calibrated in accordance with manufacturer's instructions.

**Step 4** - Tools are cleaned and lubricated according to standard procedures.

**Step 5** - Defective equipment and tools are inspected and replaced according to manufacturer's specification.

**Step 6** - Work place is cleaned and kept in safe state in line with OSHS regulations

<b>Operation Sheet -3</b>	<b>Techniques to arranging and Storing Electrical hand tools safely in appropriate locations.</b>
---------------------------	---

### **Techniques for arranging and Storing Electrical hand tools safely in appropriate locations.**

**Step 1** - Store tools in a dry, sheltered environment.

**Step 2** - Place tools on a rack for easy safety and easy access.

**Step 3** - Place similar tools close together so that workers can see easily the available tools

**Step 4** - Classify the tools and equipment according to their types.

**Step 5** - Arrange the tools by their types in the shelves/racks.

**Step 6** - Place equipment in designated places or location

**Step 7** - place tools, instruments, and equipment as they recorded as per company practices.



**Step 8** - Tools and equipment are stored safely in accordance with manufacturer's specifications.

**Step 9** - Store tools/equipment in a clean and dry storage area.

<b>LAP Test</b>	<b>Practical Demonstration</b>
-----------------	--------------------------------

**Name:** \_\_\_\_\_ **Date:** \_\_\_\_\_

**Time started:** \_\_\_\_\_ **Time finished:** \_\_\_\_\_

**Instructions:** Given necessary templates, tools and materials you are required to perform the following tasks within --- hour.

**Task 1** - set up *handling of tools without damage according to procedure*

**Task 2** - Determine routine maintenance of tools based on operational procedures, principles and techniques

**Task 3** - Perform arranging and Storing Electrical hand tools safely in appropriate locations.





## REFERENCE

- K to 12 Basic Education Curriculum, Technology and Livelihood Education, MARCELO E. TAN, Ed. D. REYNALDO C. CUNANAN
- Basic Electrical/Electronic Equipment Servicing Level I learning Guide # 4 by FTA of ETIOPIA
- Institute of Integrated Electrical Engineers of the Philippines Incorporated. 1992, --- -Philippine Electrical Code
- Max B. Fajardo Jr. & Leo R. Fajardo. 2nd edition, Electrical Layout and Estimate Azares, Efren F. and Recana, Cirilo B. 1999, Practical electricity III; Philippines: Adriana Publishing.
- [www.acmehowto.com/howto/maintenance/electrical hand tools/](http://www.acmehowto.com/howto/maintenance/electrical%20hand%20tools/)
- [www.thefabricator.com/safety/safety\\_article.cfm?id=1095](http://www.thefabricator.com/safety/safety_article.cfm?id=1095)
- K to 12 Basic Education Curriculum, Technology and Livelihood Education, MARCELO E. TAN, Ed. D. REYNALDO C. CUNANAN
- Basic Electrical/Electronic Equipment Servicing Level I learning Guide # 4 by FTA Of ETIOPIA.
- Institute of Integrated Electrical Engineers of the Philippines Incorporated. 1992, --- -Philippine Electrical Code
- Max B. Fajardo Jr. & Leo R. Fajardo. 2nd edition, Electrical Layout and Estimate Azares, Efren F. and Recana, Cirilo B. 1999, Practical electricity III; Philippines: Adriana Publishing.
- [www.acmehowto.com/howto/maintenance/electrical Hand tools/](http://www.acmehowto.com/howto/maintenance/electrical%20Hand%20tools/)
- [www.thefabricator.com/safety/safety\\_article.cfm?id=1095](http://www.thefabricator.com/safety/safety_article.cfm?id=1095)
- - K to 12 Basic Education Curriculum, Technology and Livelihood Education, MARCELO E. TAN, Ed. D. REYNALDO C. CUNANAN
- Basic Electrical/Electronic Equipment Servicing Level I learning Guide # 4 by FTA Of ETIOPIA.
- Institute of Integrated Electrical Engineers of the Philippines Incorporated. 1992, --- -Philippine Electrical Code
- Max B. Fajardo Jr. & Leo R. Fajardo. 2nd edition, Electrical Layout and Estimate Azares, Efren F. and Recana, Cirilo B. 1999, Practical electricity III; Philippines: Adriana Publishing.



- [www.acmehowto.com/howto/maintenance/electrical](http://www.acmehowto.com/howto/maintenance/electrical) Hand tools/
- [www.thefabricator.com/safety/safety\\_article.cfm?id=1095](http://www.thefabricator.com/safety/safety_article.cfm?id=1095)
  
- - K to 12 Basic Education Curriculum, Technology and Livelihood Education, MARCELO E. TAN, Ed. D. REYNALDO C. CUNANAN
- Basic Electrical/Electronic Equipment Servicing Level I learning Guide # 4 by FERDINAND M. MAGTIBAY
- Institute of Integrated Electrical Engineers of the Philippines Incorporated. 1992, --- -Philippine Electrical Code
- Max B. Fajardo Jr. & Leo R. Fajardo. 2nd edition, Electrical Layout and Estimate Azares, Efren F. and Recana, Cirilo B. 1999, Practical electricity III; Philippines: Adriana Publishing.
- [www.acmehowto.com/howto/maintenance/electrical/](http://www.acmehowto.com/howto/maintenance/electrical/)
- [www.thefabricator.com/safety/safety\\_article.cfm?id=1095](http://www.thefabricator.com/safety/safety_article.cfm?id=1095)



## ACKNOWLEDGEMENT

We would like also to express our appreciation to the following Officials and Staff of Ministry of Education who made the development of this Model Teaching Guide/Teaching Training Learning material /TTLM/ possible; Also we thanks **Federal TVET AGENCY (FTA)** wishes to extend thanks and appreciation to the many representatives of business, industry, academic and government agencies who donated their time and expertise to the development of this Model Learning Guide/TTLM/ for the TVET Program of ***Basic Electrical/Electronic Equipment Servicing Level-1***



### The trainers who developed this TTLM

No	Name trainers	work Place/Region	Qualification	Experienc in TVET	Addresses
1	Tesfahun Ayalew	BGRS /Assosa poly TVET College	Msc in El.Comm.Eng	11 Year	<a href="mailto:Technogps44@gmail.com/">Technogps44@gmail.com/</a>
2	Ayano Assefa	Dabube /Arbaminchi poly TVET College	Msc in pow.En	9 Year	<a href="mailto:assefahule@gmail.com">assefahule@gmail.com</a>
3	Zekairas Sisay	Harari - poly TVET College	Bsc in Cont and pow.Eng.	6 year	<a href="mailto:gselam17@gmail.co">gselam17@gmail.co</a>
4	Gashaew Nugisue	Addise Ababa /akaki poly TVET College	Msc in Cont.Eng	9 Year	<a href="mailto:Kena1445@gmail.com">Kena1445@gmail.com</a>
5	Mokennen G/Hawariat	Oromia / Adama poly TVET College	Msc in control technology	27 years	<a href="mailto:Leulmoke45@gmail.com">Leulmoke45@gmail.com</a>
6	Yohannise Fetene	ANRS /Kombolcha poly TVET College	Msc in El.Comm.En	12 Year	-----