



**AAiT**

# High Speed Packet Access

Beneyam Berehanu (PhD)

June 2019

# HSPA

**HSDPA** = High Speed Downlink Packet Access. Release 5 was the first HSDPA release (2005)

**HSUPA** = High Speed Uplink Packet Access. Release 6 was the first HSUPA release (2007)

**HSPA** = High Speed Packet Access = HSDPA + HSUPA

**HSPA+** since release 7

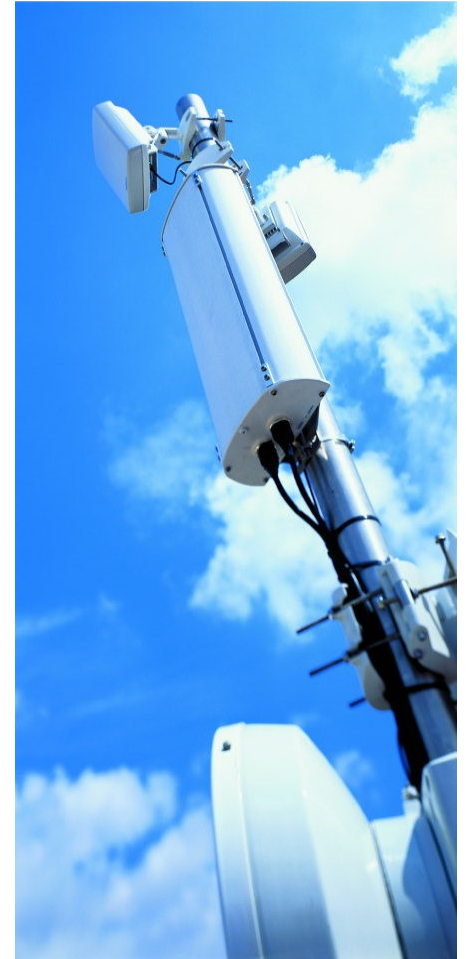

# Contents

- ❖ Main enhancements of HSPA
- ❖ HSPA channels
- ❖ HSPA radio features
- ❖ Downlink multiantenna methods in HSPA
- ❖ Enhancements of HSPA since release 8



# Contents

- ❖ **Main enhancements of HSPA**
- ❖ HSPA channels
- ❖ HSPA Radio features
- ❖ Downlink multiantenna methods in HSPA
- ❖ Enhancements of HSPA+



# HSDPA: Main changes to WCDMA

## ❖ Shared channel transmission introduced

- New transport channel: HS-DSCH (High-Speed Downlink Shared Channel)
- Enables fast and dynamic allocation of radio resources between users
- No soft handover on HS-DSCH

## ❖ Fast channel-aware scheduling

- Controls to which user the HS-DSCH transmission is allocated
- Take into account the radio channel conditions
- Applied in Node B

## ❖ Adaptive modulation and coding (AMC)

- QPSK, 16QAM, 64QAM modulations applied (in WCDMA only QPSK applied)
- QPSK carry 2 bits, 16QAM carry 4 bits and 64QAM carry 6 bits
- Combination of modulation and coding is decided based on channel conditions



# HSDPA: Main changes to WCDMA

- ❖ Fast hybrid automatic repeat request (HARQ)
  - User data can be retransmitted multiple times with different coding
- ❖ Short transmission time interval (TTI):
  - In HSDPA TTI length is 2ms while in WCDMA it was 10ms, 20ms, 40ms or 80ms.
  - Short TTI enables fast allocation of radio resources to match with changing radio conditions.
- ❖ Two additional physical control channels
  - HS-SCCH (High Speed Shared Control Channel, downlink)
  - HS-DPCCH (High Speed Dedicated Physical Control Channel, uplink)
- ❖ No fast power control in HSDPA
- ❖ Two-stream multiple input multiple output (MIMO)



# HSUPA: Main changes to WCDMA

- ❖ New transport channel: Enhanced Dedicated Channel (E-DCH).
  - E-DCH is not shared between users (unlike HS-DSCH in HSDPA)
  - Soft/softer HO is still possible on E-DCH (unlike in HS-DSCH).
- ❖ Otherwise changes similar to HSDPA:
  - Short Transmission Time Interval (2ms, 10ms also used)
  - In addition to BPSK/QPSK the 16QAM has been introduced (release 7).
  - Fast Hybrid Automatic Repeat reQuest (HARQ)
  - Fast scheduling: utilize changes in interference situation. In HSUPA fast power control is applied => scheduler can't utilize channel variations due to fast fading. (like HS-DSCH does). Thus, Node-B wait for a 'good' interference situation until allows high data rate transmission in uplink.
  - Multi code transmission: up to four scrambling codes can be allocated per user.



# Contents

- ❖ Main enhancements of HSPA
- ❖ **HSPA channels**
- ❖ HSPA Radio features
- ❖ Downlink multiantenna methods in HSPA
- ❖ Enhancements of HSPA since release 8





# HSDPA: HS-DSCH

- ❖ Shared channel transmission is key character of HSDPA.
  - Part of the DL radio resources form a common resource pool
  - These resources are dynamically shared between users

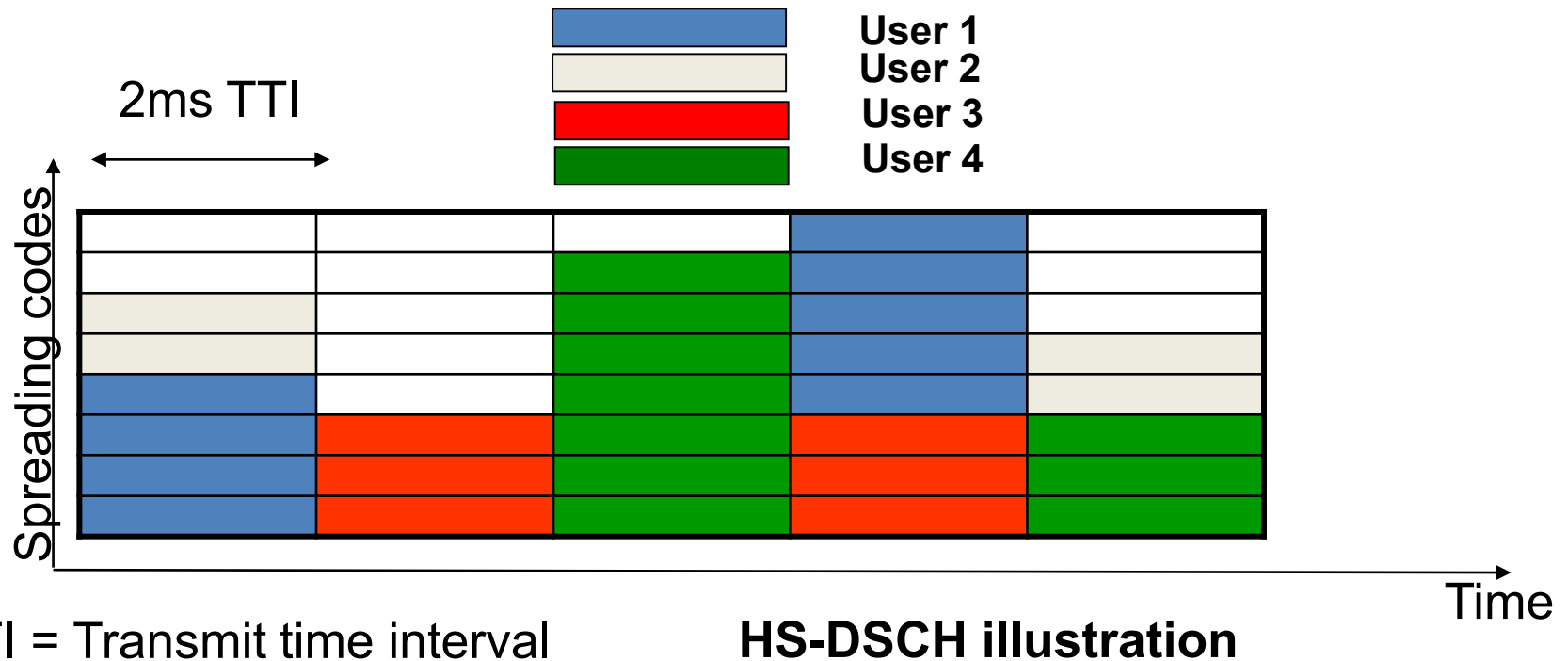

# HSDPA: HS-DSCH

- ❖ There was DSCH already in WCDMA but
  - Power control was applied in WCDMA DSCH
  - Spreading factor was variable
  - Only QPSK modulation was used
  - DSCH was removed from WCDMA because HSDPA HS-DSCH provides better solution.
- ❖ HS-DSCH in HSDPA:
  - No power control (link adaptation, channel aware scheduling and HARQ form a more efficient combination)
  - Spreading factor is fixed (SF=16)
  - Number of codes granted for a user can be changed after each 2ms time interval
  - QPSK, 16QAM and 64 QAM modulations.
  - Up to 15 parallel codes can be assigned to a user (multi-code operation). Yet, some terminals may support only 5 parallel codes.



# Code allocation for HS-DSCH

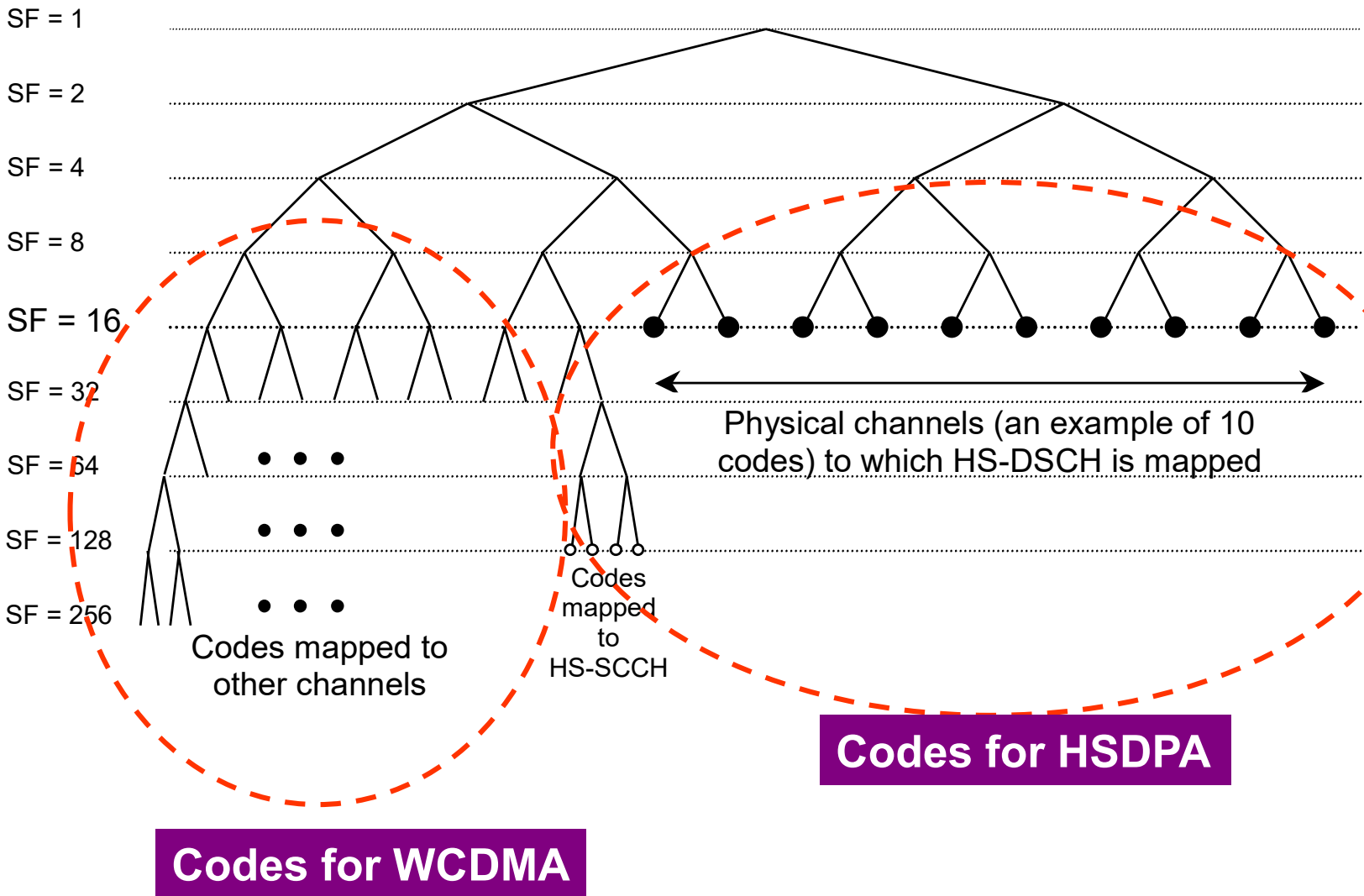

# Power allocation: HS-DSCH vs DCH of WCDMA

- ❖ Common channels typically has a fixed portion of cell power
- ❖ DCH part of the power varies due to power control
- ❖ HS-DSCH has the remaining part of the transmission power

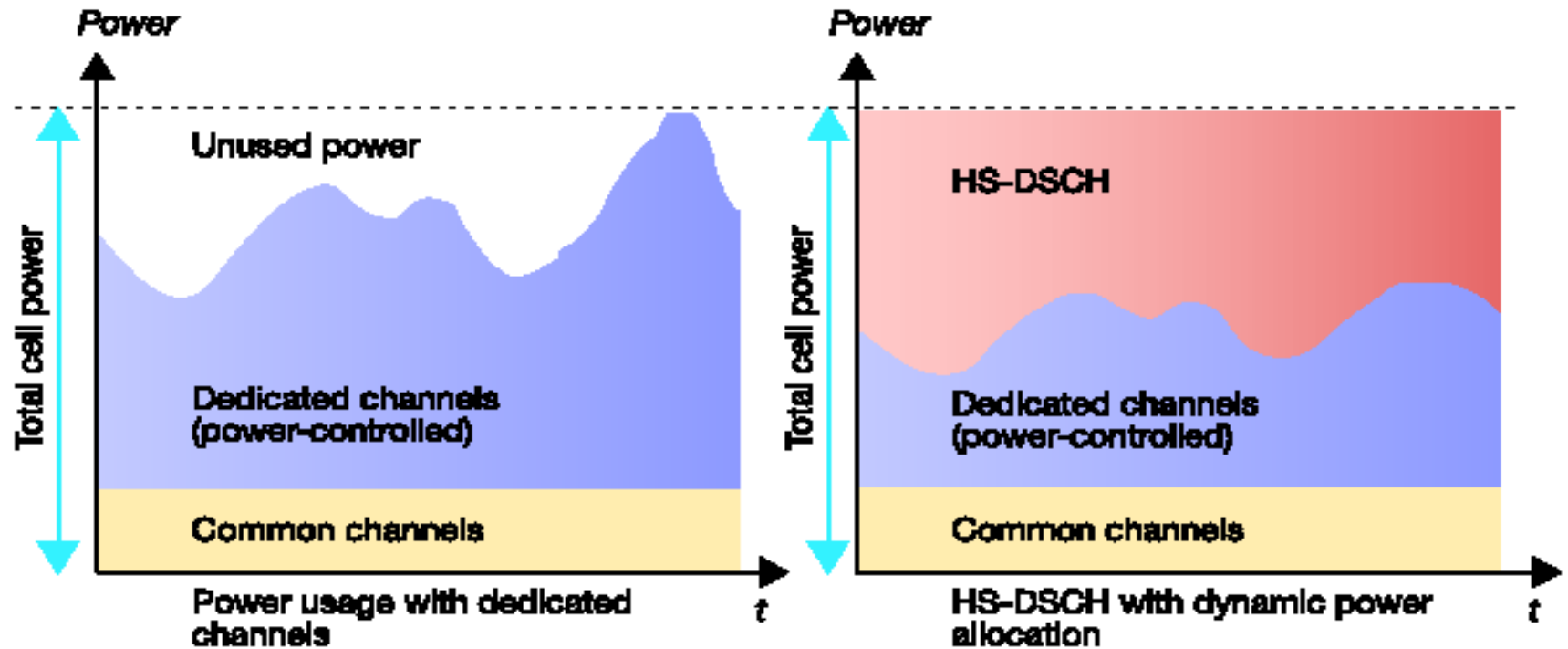

# HSDPA: HS-DSCH vs. DCH (WCDMA)

Feature	DCH	HS-DSCH
Variable spreading factor	Yes	No
Fast power control	Yes	No
Adaptive modulation + coding	No	Yes
Fast L1 HARQ	No	Yes
Fast scheduling	No	Yes
Multi-code operation	Yes	Yes, extended



# HSDPA: Physical Control channels

- ❖ Two control channels introduced to support HSDPA
  - Downlink high speed shared control channel (HS-SCCH)
  - Uplink high speed dedicated physical control channel (HS-DPCCH)
- ❖ HS-SCCH information for UE
  - HS-SCCH contains information that is needed for decoding and possible HARQ combination in case of retransmission. Thus, HS-SCCH carries:
    - Applied modulation and channel coding combination
    - Which spreading codes terminal should despread
    - Other information like ARQ process number etc
- ❖ HS-DPCCH information for Node B
  - ACK/NACK showing whether packet has been correctly received or not. Used for HARQ.
  - Channel Quality Information (CQI): A 5-bit message that indicates which combination of transport block size, modulation type and number of codes that could be received correctly.



# HSUPA: E-DCH and E-DPDCH

- ❖ Most important amendment in HSUPA is the Enhanced Dedicated Channel (E-DCH) that is a transport channel for data transmission in HSUPA link.
  - E-DCH is sent together with WCDMA DCH. Recall that DCH contains data part (DPDCH) and control part (DPCCH). At least DPCCH is always present in HSUPA transmission because it carries control information that is needed for underlying WCDMA operations (recall: TFCI, FBI, TPC).
- ❖ The physical channel that carries user data is the E-DPDCH.



# HSUPA: Control channels

- ❖ The attached control channel is now called as enhanced DPCCH (E-DPCCH). E-DPCCH is transmitted only if E-DPDCH is transmitted.
  - 2ms TTI of E-DPCCH carries E-DPDCH rate information (7 bits), retransmission information for HARQ (2 bits) and 'happy bit (1 bit) that informs Node B scheduler whether device is able to increase data rate or not (user is 'happy' if it can't increase the data rate).
- ❖ E-HICH (E-DCH HARQ indicator channel) is sent in downlink to inform user whether HARQ packet has been correctly received or not
- ❖ In addition there are control channels E-RGCH and E-AGCH that are omitted in this presentation.





# HSUPA: Channels



New E-DPDCH is added when data rate is increased

- ❖ Different scrambling codes are used to separate first and second E-DPDCH
- ❖ Spreading factor up to  $SF=2$  can be used in E-DPDCH
- ❖ At maximum two codes with  $SF=4$  and two codes with  $SF=2$  can be used leading to maximum data rate 5.7Mbps (BPSK/QPSK) and 11.5Mbps (16QAM).



# HSUPA: E-DCH vs. (WCDMA) DCH

Feature	DCH	E-DCH
Variable spreading factor	Yes	Yes
Fast power control	Yes	Yes
Adaptive modulation + coding	No	No
Fast L1 HARQ	No	Yes
Fast scheduling	No	Yes
Multi-code operation	Not used	Yes, extended
Soft handover	Yes	Yes



# Contents

- ❖ Main enhancements of HSPA
- ❖ HSPA channels
- ❖ **HSPA Radio features**
- ❖ Downlink multiantenna methods in HSPA
- ❖ Enhancements of HSPA since release 8



# HSDPA scheduling: multiuser diversity

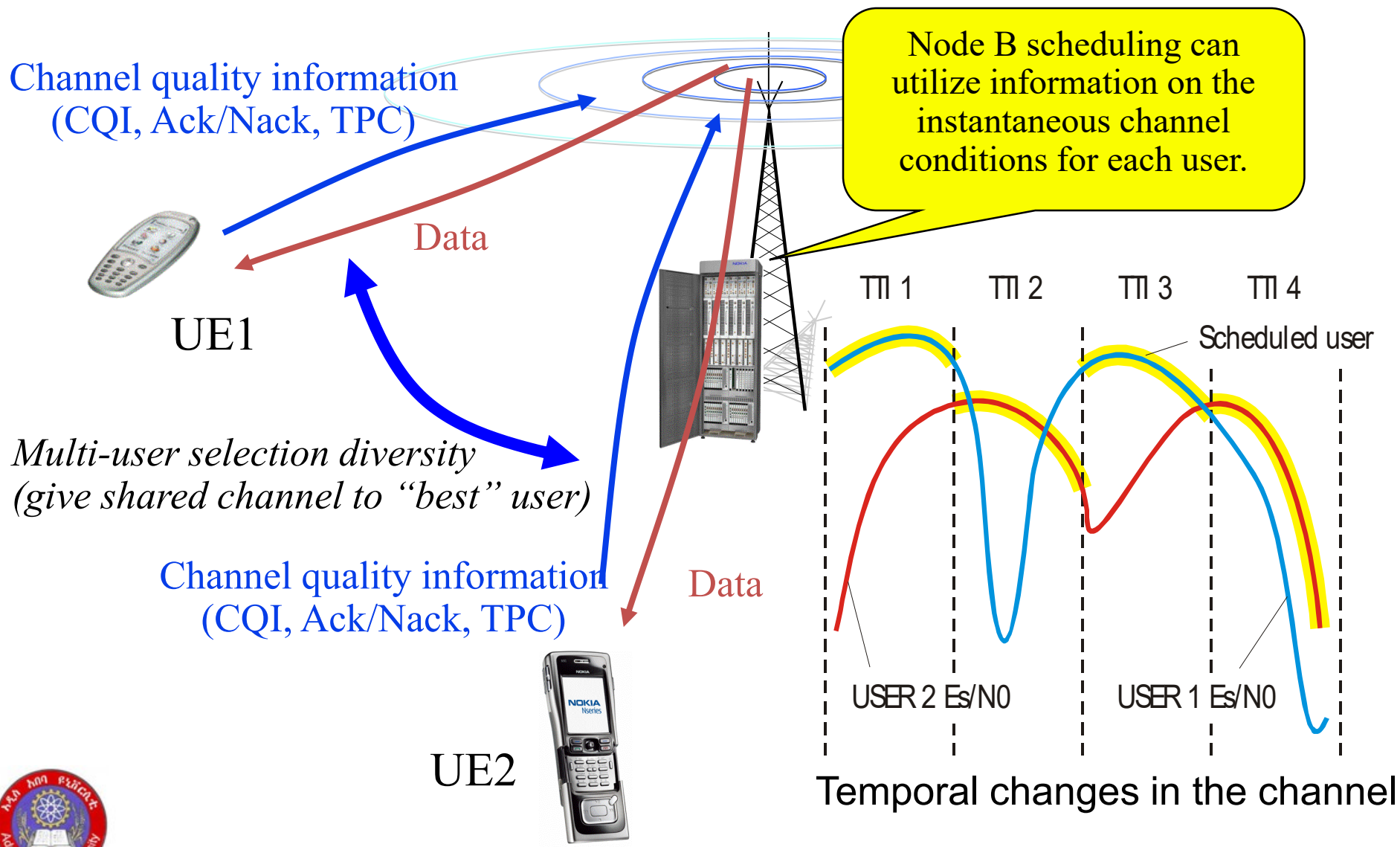

# HSDPA fast scheduling

- ❖ Fast scheduling is also called as
  - Channel dependent scheduling
  - Channel aware scheduling
- ❖ This scheduling utilize multi-user diversity
  - Different users have different fading channel
  - We can send to user who has the best channel conditions (figure of previous slide)
  - Yet, in HSDPA we can get best benefit from fast scheduling only if delay requirement is not tight
  - While scheduling users we face a trade-off between fairness and capacity
  - Fast scheduling gives best performance when there is high load of non real-time data.



# HSDPA scheduling: different factors

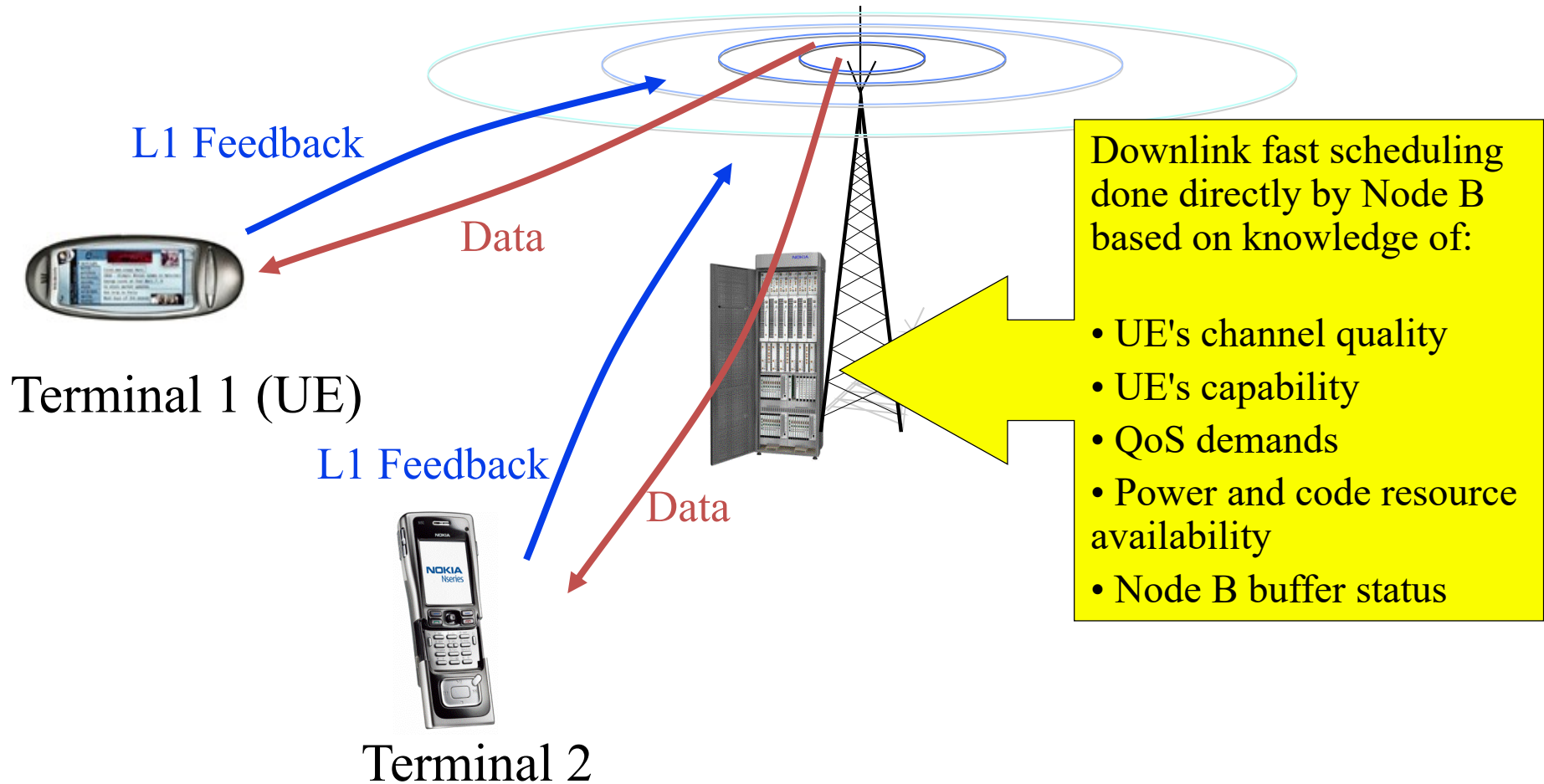

Users may be time and/or code multiplexed

# HSDPA scheduling algorithms

- ❖ **Round-robin (RR):** Scheduling is round robin type if it does not take the instantaneous channel conditions into account. In RR scheduling the users can be ordered into a queue according to parameters that are not depending on channel (buffer status, QoS etc) and scheduled in turns. RR is a fair scheduling algorithm if every user is given the equal time for transmissions but with Round Robin there is no gain from scheduling and overall system capacity is low.
- ❖ **Max C/I (carrier-to-interference):** This scheduling tries to maximize the whole system throughput by always transmitting with highest possible rate to a user with best C/I. This scheduling is not fair since users close to Node B will have highest data rates and users with bad radio link may not be scheduled at all.
- ❖ **Proportional fair (PF):** This algorithm is a trade-off between RR and Max C/I. PF selects the users with best momentary radio link conditions proportioned with the user's average radio conditions. Hence every user is scheduled from time to time when they have the best radio conditions inside a certain time frame. The cell capacity is not as good as for Max C/I.



# HSDPA: Adaptive modulation and coding

- ❖ Variable spreading factor and power control that are used in WCDMA are replaced by adaptive modulation and coding in HSDPA
- ❖ In WCDMA downlink power control dynamics is 20dB while in uplink it is 70dB.
  - DL power control dynamics is limited by intra-cell interference (interference between parallel codes).
  - As a result transmitted powers to users near the cell centre are unnecessary high.
  - In HSDPA adaptive modulation and coding selects higher order modulation and low coding rate for users near the cell centre => less radio resources are needed for those users and less interference is generated. Also significantly higher data rates are available for users near the cell centre.





# HSDPA: Adaptive modulation and coding

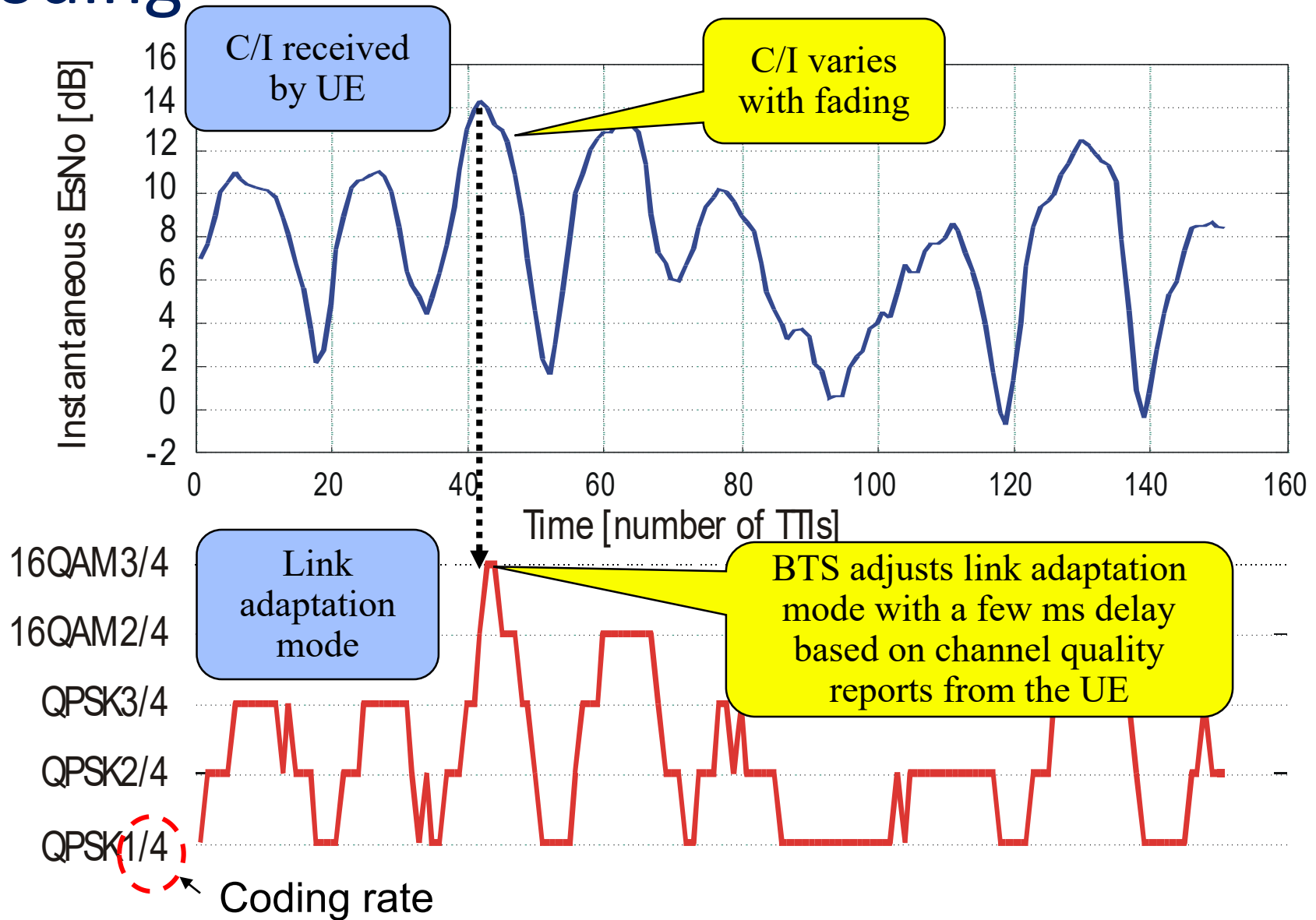

# HARQ

## ❖ Hybrid automatic repeat request (HARQ)

- HARQ is a MAC level protocol that is terminated in Node B and UE. It is a highly effective technique that clearly increases the system efficiency
- In HARQ terminal requests retransmission when data block is erroneously received. Retransmitted and original data blocks are merged using soft combining, i.e. receiver store bits of the first (erroneous) block in a soft form.
- The receiver uses an error-detecting code, a Cyclic Redundancy Check (CRC) to detect if the received packet has errors.
- For HARQ we need ACK/NACK (acknowledgement, negative acknowledgement) information from terminal. This information is send via HS-DPCCH in HSDPA and via E-DPCCH in HSUPA.



# HARQ Procedure

- ❖ The received packet is acknowledged:
  - The receiver sends an ACK if the packet has arrived without errors and a NACK if an error has happened during the decoding process of packet.
- ❖ If the transmitter gets a NACK from the receiver it sends the packet (or some redundancy version of it) again.
  - When receiver detects an erroneous packet, it stores it and sends a NACK. When a retransmitted packet arrives, the UE combines it with the original packet and tries to decode the combination. This is also called soft combining.

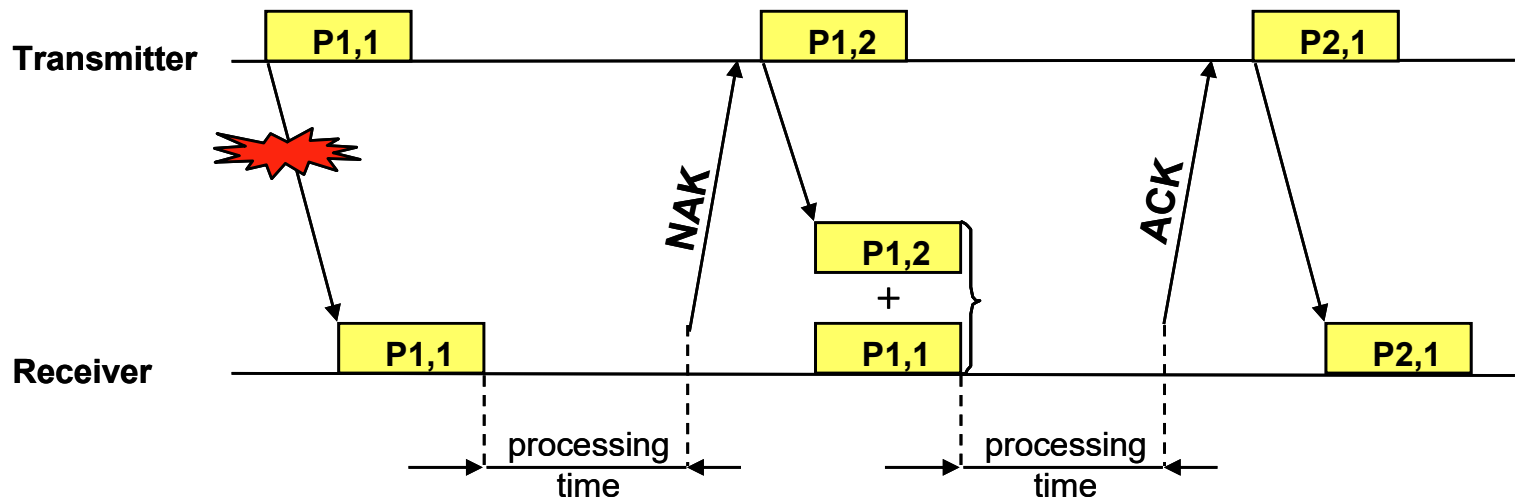

# HARQ Algorithms

- ❖ **Incremental redundancy (IR):** In this method multiple sets of coded bits are generated, each of them representing the same set of information bits. Different retransmissions of the same packet use different set of coded bits and can have more parity bits. This causes ever lowered code rate per retransmission. Hence, we may send first packet without coding but in case of retransmission the code rate for first and second packet is  $\frac{1}{2}$ . If there is still error we can do retransmission again and code rate of three packets drop down to  $\frac{1}{3}$ .
- ❖ **Chase combining:** In this method the retransmissions consists of the same bit set as the original transmission. This can be seen as an additional repetition coding because all of the retransmissions are identical copies of the original transmission. There is no gain from increased redundancy as there is in IR.
- ❖ IR is highly effective method to increase system performance but it assumes that receiver has ability to store 'soft bits'. Therefore it has been more challenging from UE implementation point of view than chase combining.



# HARQ Algorithm

- ❖ Multiple parallel HARQ processes form together the so-called Stop-And-Wait (SAW) structure
- ❖ Maximum number for parallel processes is currently 8
- ❖ For each HARQ process receiver has round 5ms to send ACK/NACK

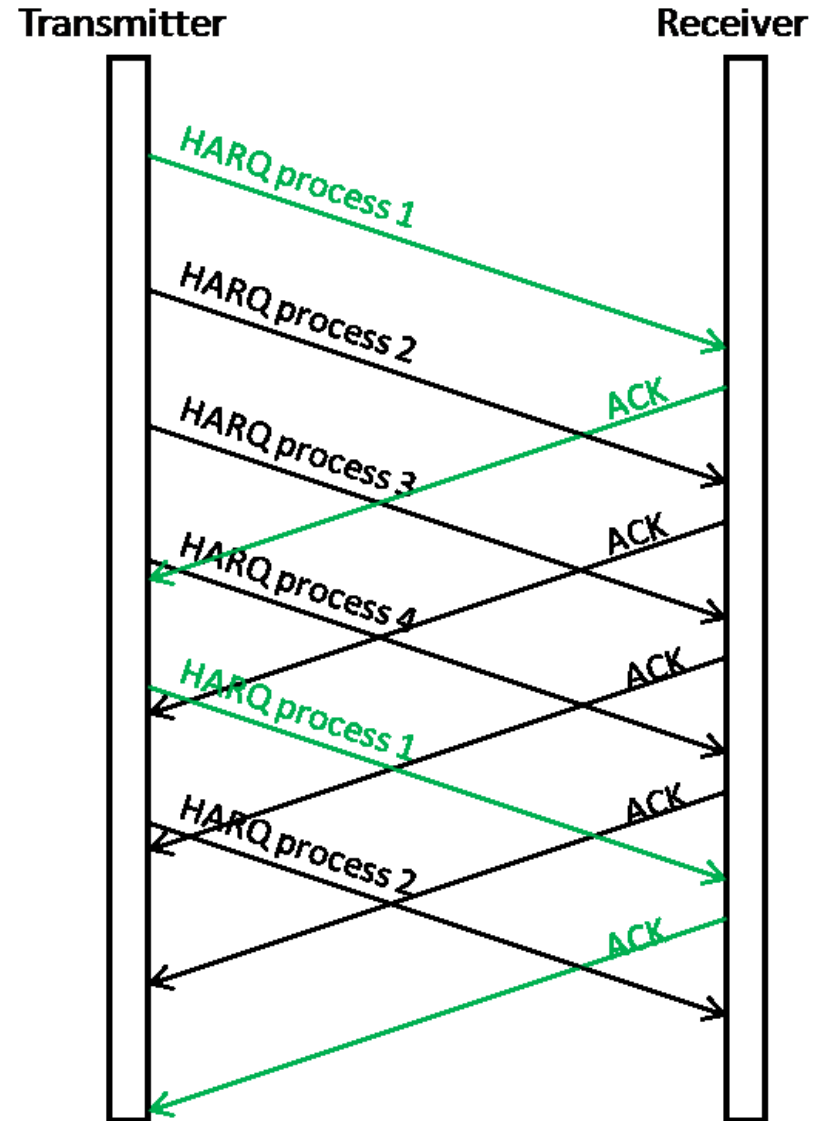

# HSPA changes the scheduler location

- ❖ HSPA transfers some functionalities from RNC to Node B

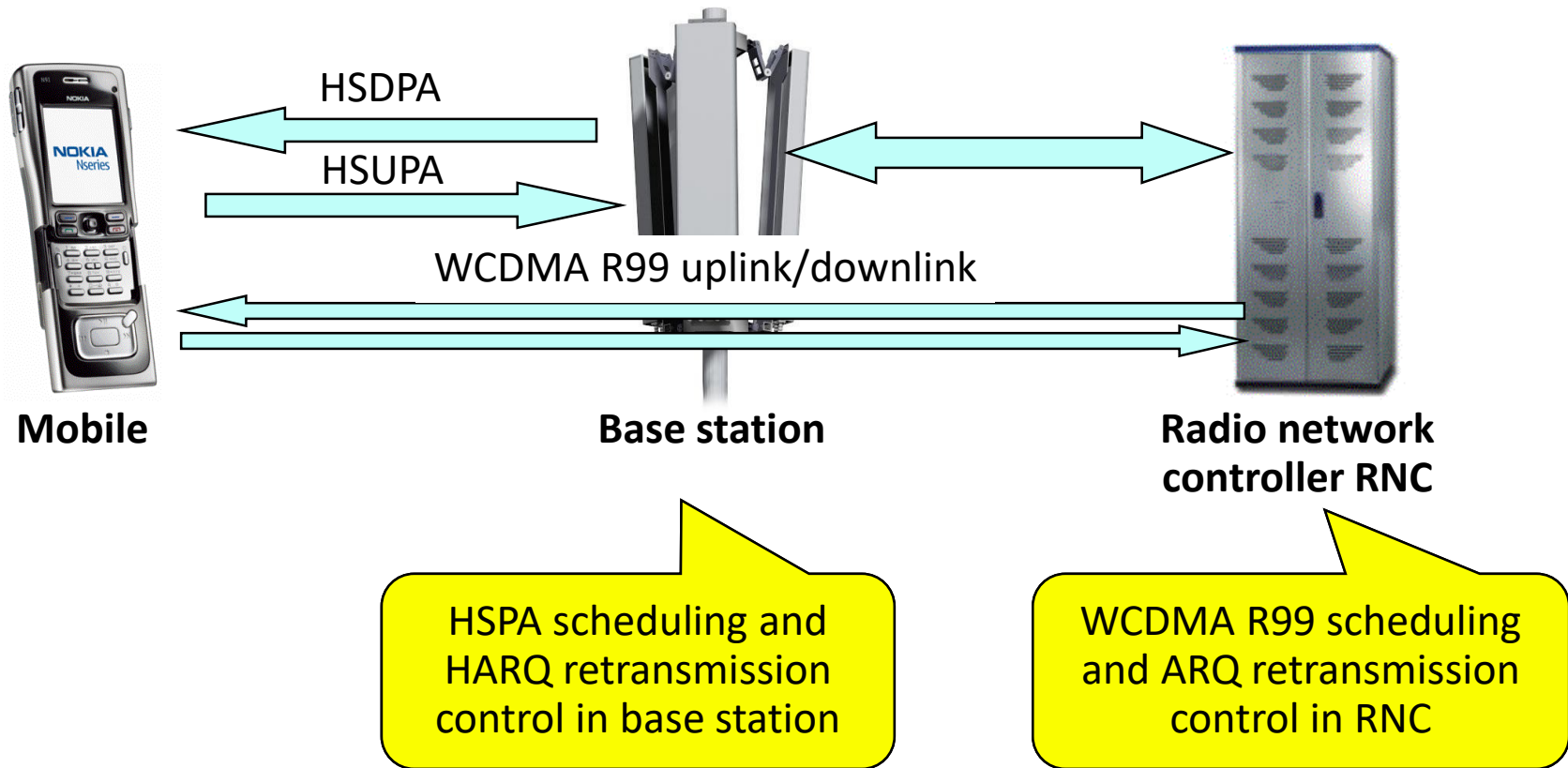

# Discontinuous transmission & reception

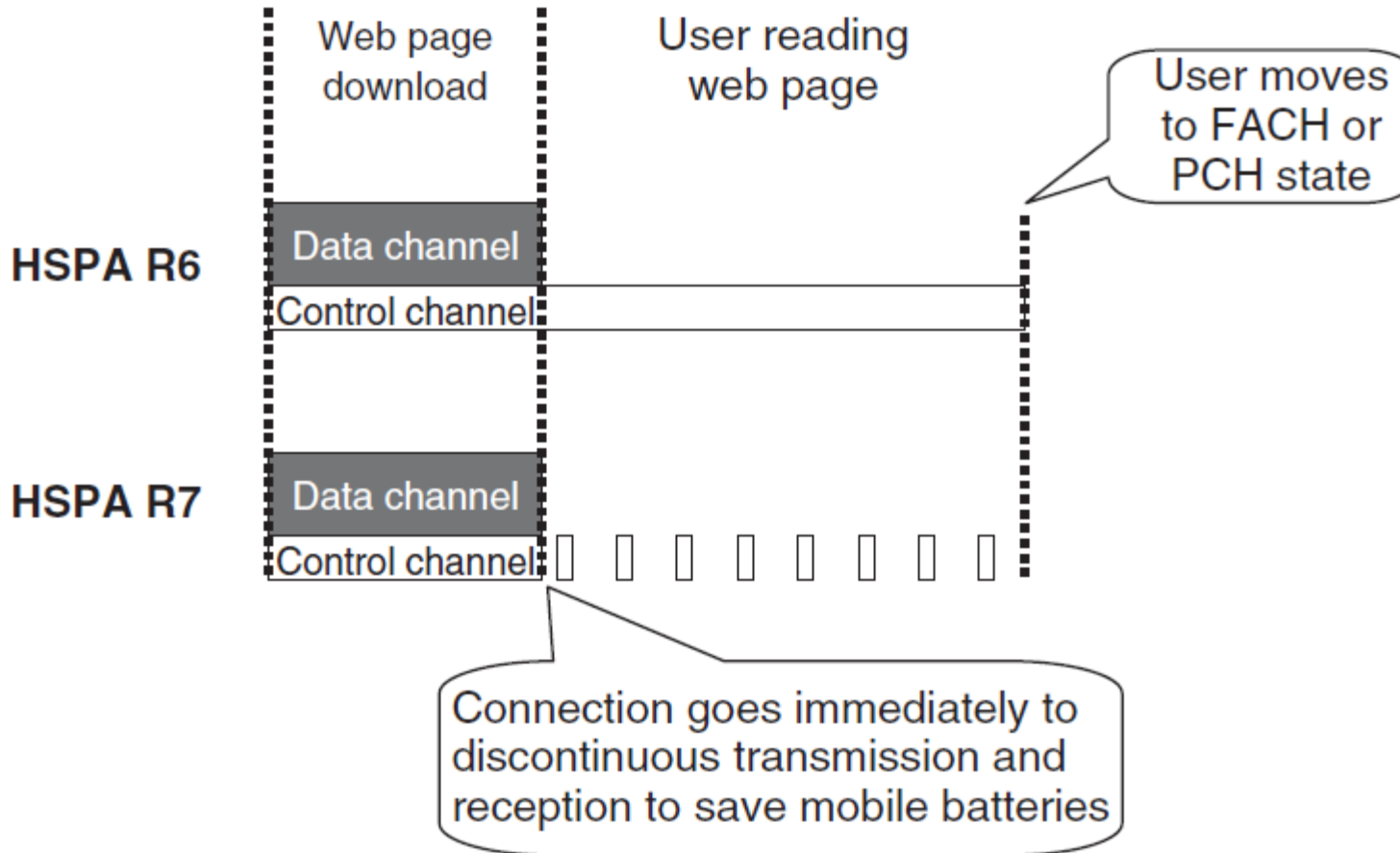

# HSDPA – some UE categories

- ❖ Theoretical peak bit rate up to 14 Mbps in Release 5, 28Mbps in Release 7.

Max. number of HS-DSCH codes	Minimum inter-TTI interval	Data rate	QPSK	16QAM
5	1-3	3.6 Mbps	Yes	Yes
10	1	7.2 Mbps	yes	yes
15	1	10.1 Mbps	Yes	Yes
15	1	14.4 Mbps	yes	Yes
5	1-2	1.8 Mbps	yes	no





# HSUPA – some UE categories

- ❖ Theoretical peak bit rate up to 5.7 Mbps (Release 6) and 11.6 Mbps (Release 7).

Max. number of E-DPDCH codes	TTI length	Smallest E-DPDCH spreading factor	Max. data rate with 2ms TTI
2	2ms, 10ms	4	1.45Mbps
2	2ms, 10ms	2	2.91Mbps
4	2ms, 10ms	2+2	5.76Mbps

Two codes apply SF=2, two codes apply SF=4



# Contents

- ❖ Main enhancements of HSPA
- ❖ HSPA channels
- ❖ HSPA Radio features
- ❖ **Downlink multiantenna methods in HSPA**
- ❖ Enhancements of HSPA since release 8



# HSDPA Closed-loop transmit diversity

Two NodeB antennas needed

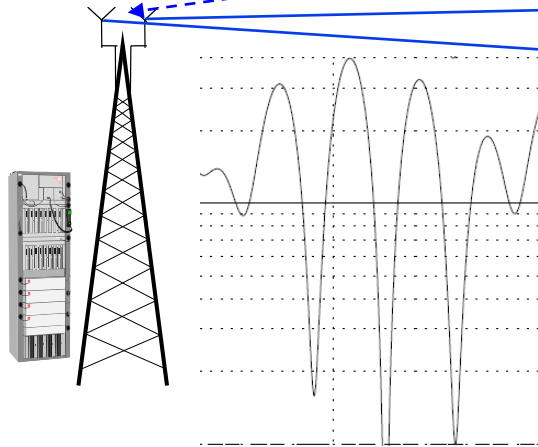

Individual channel

$$r = h_1 s + n$$

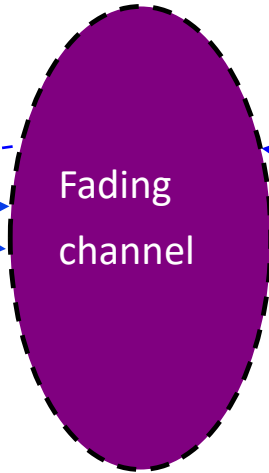

Fading channel

Feedback signal containing Information on weights, one data stream

$w_1, w_2$

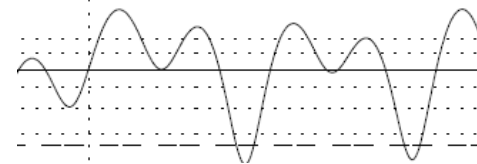

Sum channel



Single UE antenna

$$r = (w_1 h_1 + w_2 h_2) s + n$$

# HSDPA Closed-loop transmit diversity

- ❖ This method is also called as Mode 1 or TxAA.
- ❖ The FBI field in DPCCH contains 1bit/slot for phase adjustments between two transmit antennas
- ❖ The phasing is done by interpolating over two consecutive feedback bits. Thus, in slow mobility environments phasing accuracy is the same as with QPSK.

$$\|h_1 + \hat{w} \cdot h_2\| = \max \left\{ \|h_1 + w_n \cdot h_2\| : w_n = e^{j\pi(n-1)/2}, n = 1, 2, 3, 4 \right\}$$

- ❖ Closed-loop transmit diversity provides both diversity gain (decreased signal variation in the receiver) and coherent combining gain.
- ❖ There was in WCDMA Release 99 also so-called Mode 2 where transmission power was adjusted in different antennas (in Mode 1 TX power is the same in both antennas). Mode 2 was later removed from specifications.



# HSDPA Open loop transmit diversity

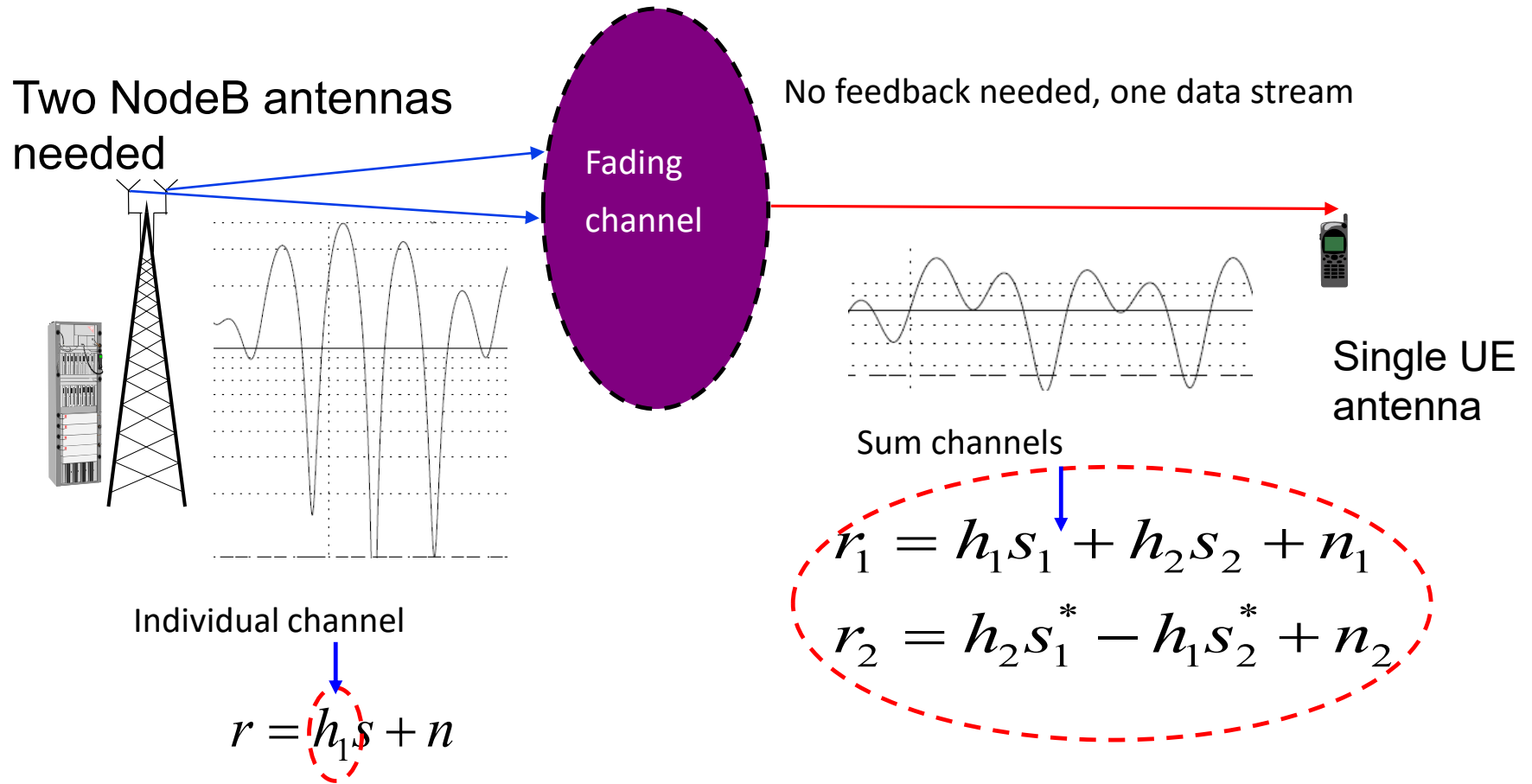

# HSDPA Open loop transmit diversity

- This method is also called as STTD (Space-Time Transmit Diversity) or Alamouti scheme.
- Decoding of the open-loop diversity transmission:

$$R_1 = h_1^* r_1 + h_2 r_2^* = \left( |h_1|^2 + |h_2|^2 \right) s_1 + h_1^* n_1 + h_2 n_2^* = \|h\|^2 s_1 + N_1$$
$$R_2 = h_2^* r_1 - h_1 r_2^* = \left( |h_1|^2 + |h_2|^2 \right) s_2 + h_2^* n_1 + h_1 n_2^* = \|h\|^2 s_2 + N_2$$

- As name of the method indicates, there is no fast feedback used like in Closed-loop transmit diversity.
- Open-loop transmit diversity provides diversity gain (decrease signal variation in receiver) but no coherent combining gain.



# HSDPA Multiple Input Multiple Output (MIMO)

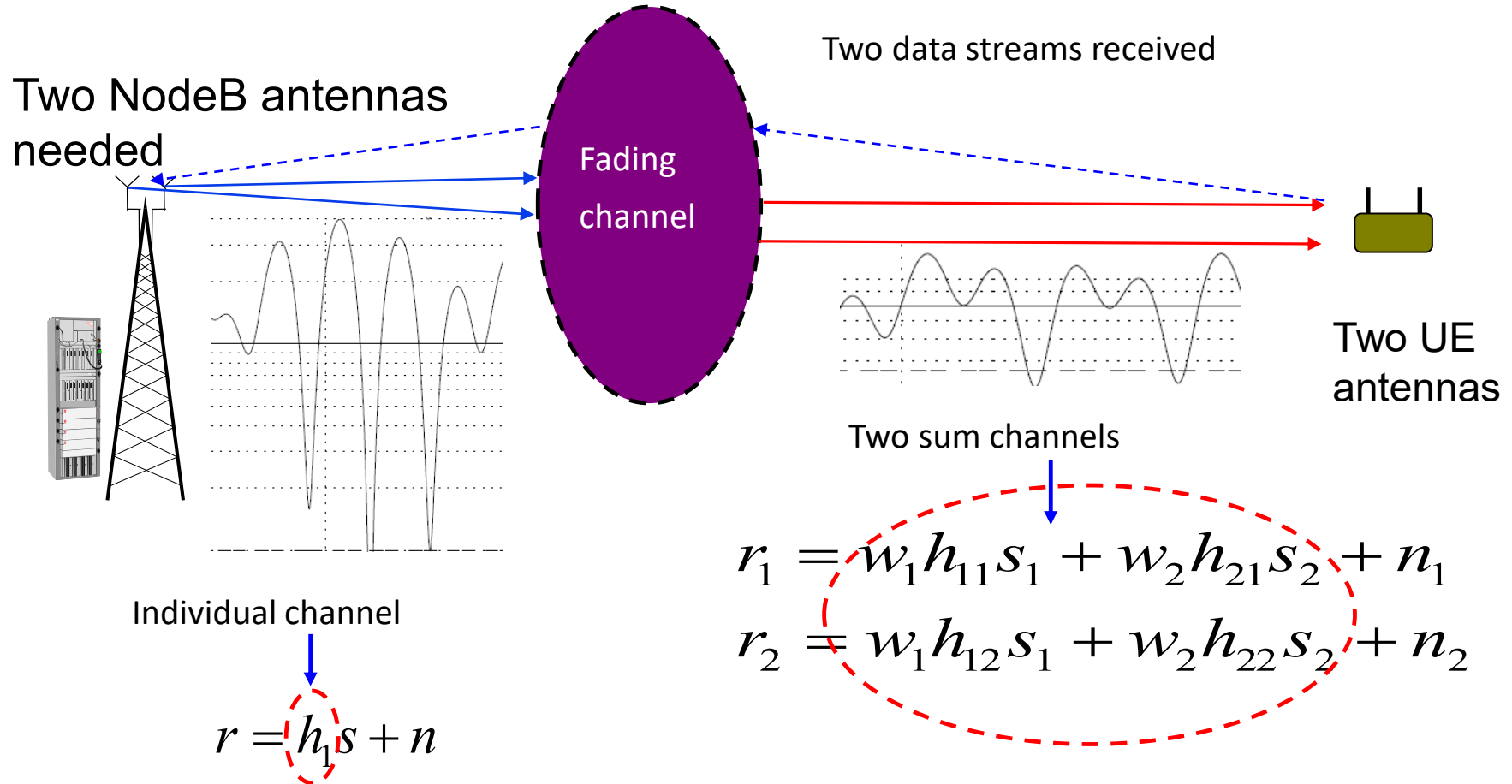

# HSDPA Multiple Input Multiple Output (MIMO)

- ❖ HSDPA MIMO is also called as D-TxAA (Dual stream TxAA).
- ❖ MIMO admit best benefit in cases where received SINR is high.
- ❖ At each TTI the Node B scheduler decides whether to send one or two transport blocks to the UE.
- ❖ By dual stream transmission the peak data rate can be doubled. Yet, this do not mean that MIMO would double the system capacity since two stream transmission is available only in good channel conditions.
- ❖ The switching from single to dual stream transmission is dynamic.
- ❖ In case of single stream transmission receiver combines 4 channels => good protection against fading.





# HSDPA Multiple Input Multiple Output (MIMO)

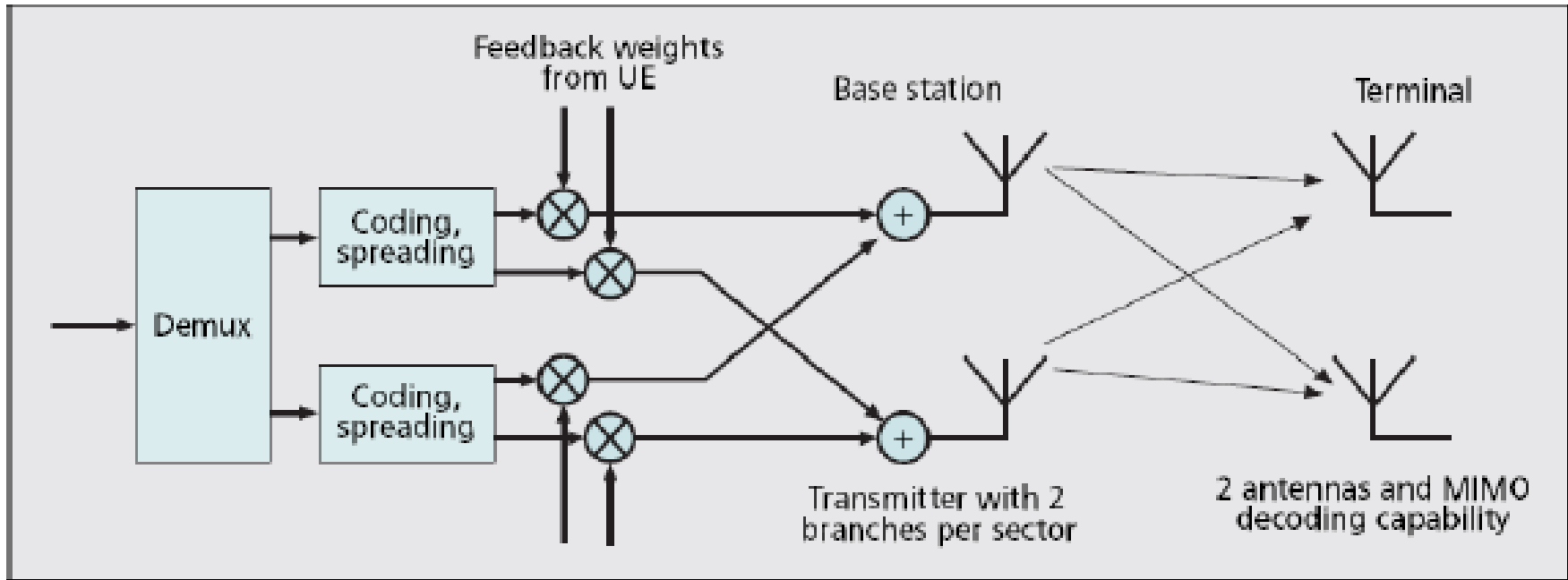

## ❖ Note:

- In both dual stream and single stream transmissions there is same spreading code used in both transmitted streams.
- Transmit weights are selected so that SNR in receiver is maximized.

# Contents

- ❖ Main enhancements of HSPA
- ❖ HSPA channels
- ❖ HSPA Radio features
- ❖ Downlink multiantenna methods in HSPA
- ❖ **Enhancements of HSPA since release 8**



# HSPA evolution

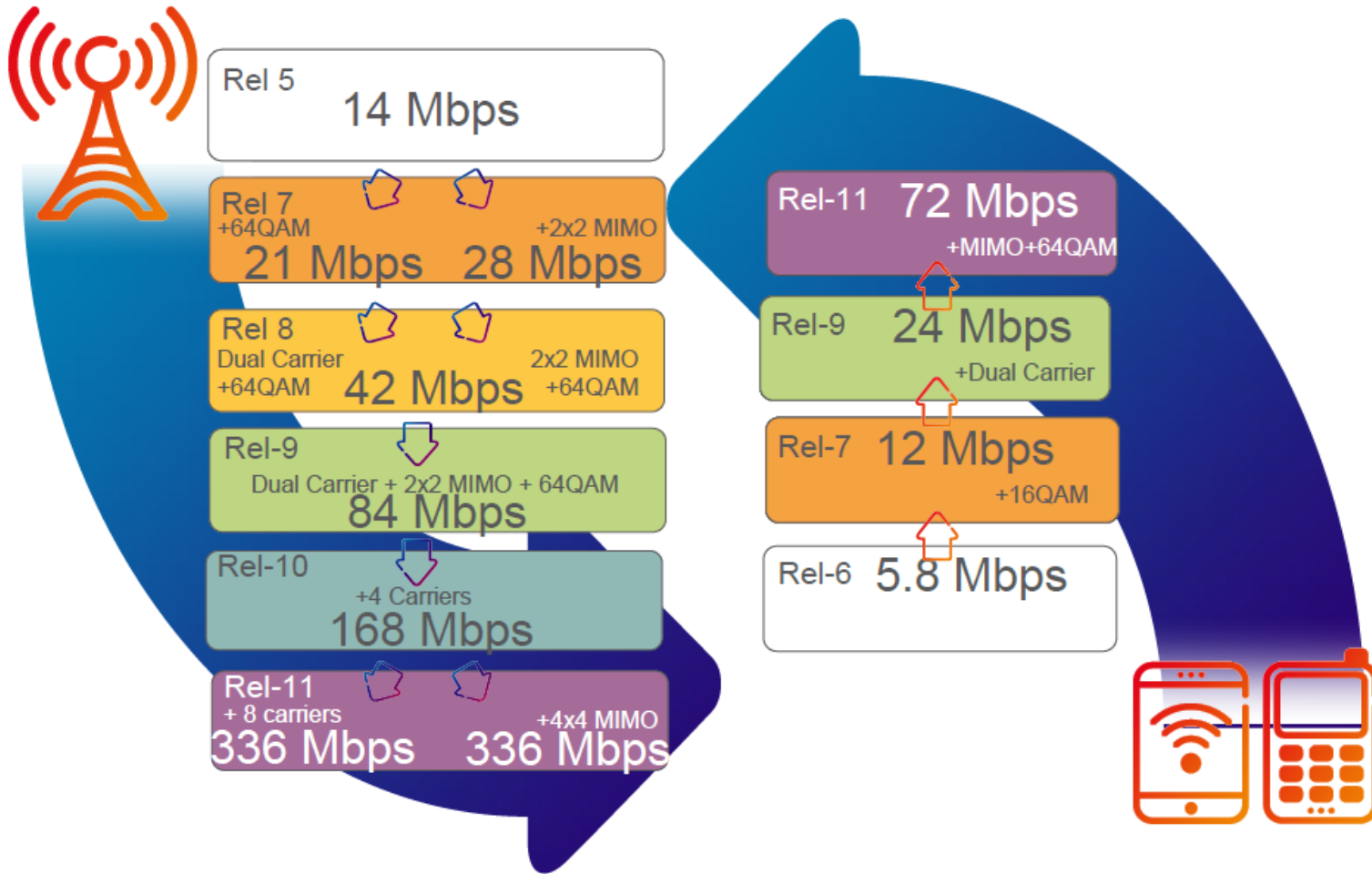

# R8 Enhanced UE DRX cycle of 4

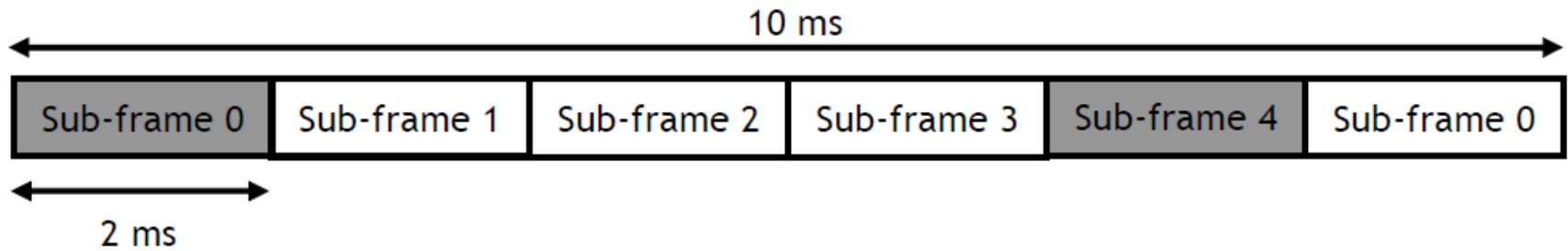

# R8 CS voice over HSPA

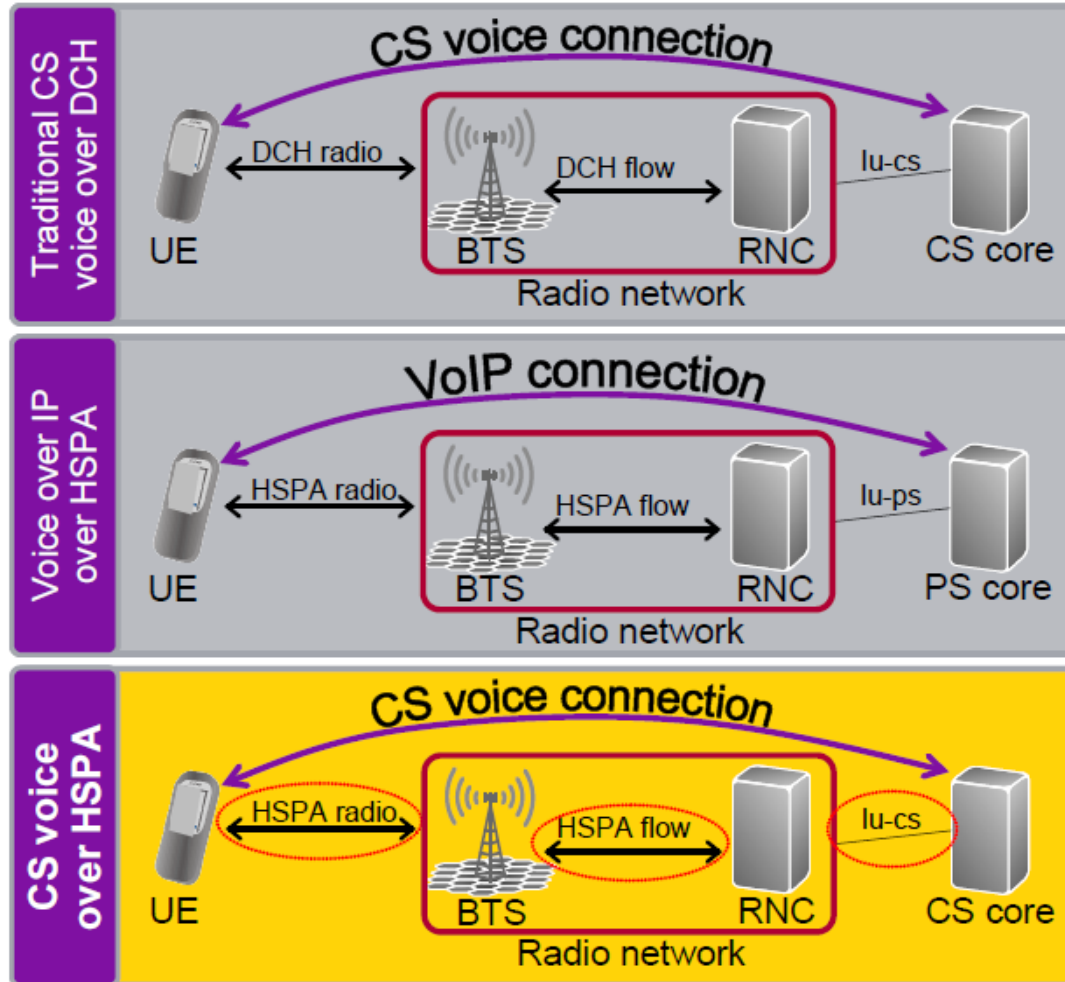

# R9/R10 dual band multi-carrier HSDPA

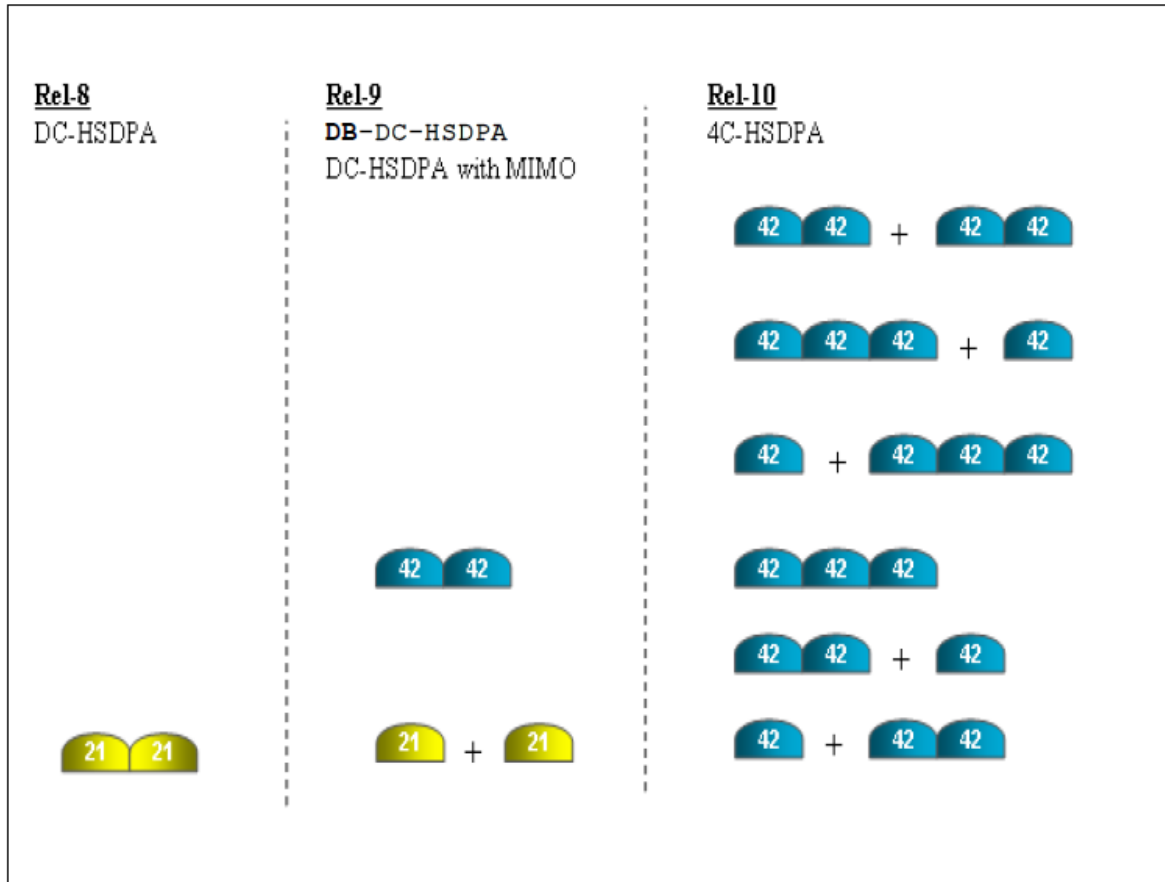

## Release 8:

Band I (2100MHz) and Band VIII (900MHz)

Band II (1900MHz) and Band IV (2100/1700MHz)

Band I (2100MHz) and Band V (850MHz)

