



**AAiT**

# Fundamentals of Cellular NPO

Beneyam Berehanu Haile  
May 2019

# Contents

- ❖ CNPO process
- ❖ Channel models (pathloss and fading)
- ❖ Antennas
- ❖ Noise
- ❖ Interference
- ❖ CNPO tools (WinProp introduced)
- ❖ QoS/QoE measurements and optimization



# Contents

## ❖ CNPO process

- ❖ Channel models (pathloss and fading)
- ❖ Antennas
- ❖ Noise
- ❖ Interference
- ❖ CNPO tools (WinProp introduced)
- ❖ QoS/QoE measurements and optimization



# Overview of cellular NPO

Cellular Network Planning and Optimization:

## 1. Radio Network Planning and Optimization

2. Transmission Network Planning and Optimization

3. Core Network Planning and Optimization

Challenge of cellular NPO:

- to combine all of **customer requirements** in an optimal way and to design a **cost-effective** network
- ❖ Output of CNPO is **Defined Network Design**
- ❖ Output of radio NPO is final BTS configurations and site locations

# Cellular NPO process

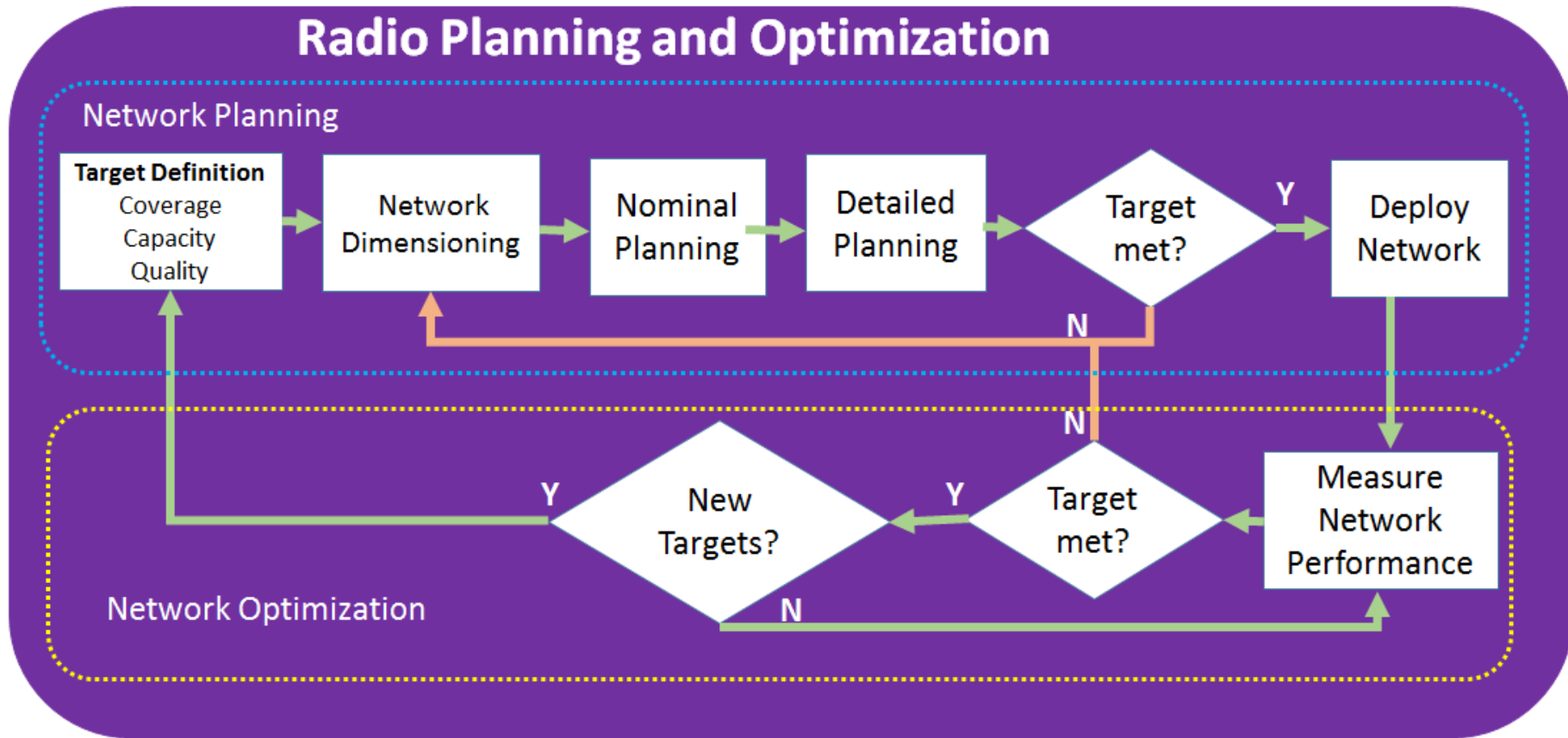

# Planning Criteria/Target definition

- ❖ **Deployment strategy** can be set based on **market analysis** including analysis of
  - Competitor
  - Potential customers
  - User profiles: services required and usage
- ❖ Customer requirements:
  - Coverage requirements: the signal level for outdoor, in-car and indoor with the coverage probabilities
  - Capacity requirements: Number of users/subscribers and traffic demand forecast, Available frequency band
  - Quality targets: call setup success, drop call rate, call blocking
  - Financial limitations
  - Recommended BS locations
  - Future deployment plans
- ❖ **Prioritized planning target** is agreed so that efficient NPO is undertaken through various **optimizations** and **compromises**

# Network dimensioning

- ❖ **Input:** planning targets
- ❖ **Output:** preliminary network plan
  - minimum number of required base stations with specified capacity
- ❖ Link budget tools are applied for dimensioning tasks
  - Various commercial tools are available on the market
- ❖ Technology, product and channel understandings are key

# Nominal planning

- ❖ **Input:** Initial network configuration from dimensioning phase, existing and candidate locations
- ❖ **Output:** Initial idea for site locations
  - Coverage planning: optimal locations meeting the coverage target
  - Capacity planning: Optimal locations meeting the capacity target
- ❖ Planning tool is used for the nominal planning task
- ❖ The result is starting point for **site survey**
- ❖ After site survey potential locations are identified





# Detailed planning

- ❖ **Input:** potential site locations
- ❖ **Output:** coverage, capacity and parameter plans
  - Final site locations and configurations
- ❖ Planning and simulation tools are used for the detailed planning task
  - Usually performed including a digital map with topography and other information
- ❖ Once the plans are verified, network is deployed

# Optimization

- ❖ **Input:** network measurements, customer complains
  - **Network measurement:** Figures and alarms from network management system
  - **User measurement:** drive and test, cloud collected measurements
- ❖ **Output:** update plans
  - System parameter tuning
  - New features
- ❖ Optimization is a continuous process

# Contents

- ❖ CNPO process

- ❖ Channel models (pathloss and fading)

- ❖ Antennas

- ❖ Noise

- ❖ Interference

- ❖ CNPO tools (WinProp introduced)

- ❖ QoS/QoE measurements and optimization



# Average pathloss



# Pathloss models

## 1. Empirical models

- **Okumura-Hata Model**
- Walfish–Ikegami
- COST 231
- ITU P.1546

## 2. Deterministic models

- Ray Tracing Models
- Dominant path model

- ❖ Each model has its own pros and cons
  - Need to understand where we suitably apply each one of them
- ❖ Accuracy of models depends on input level regarding the propagation environment
- ❖ Empirical models are simple to use but less accurate than deterministic models that apply accurate terrain and building databases

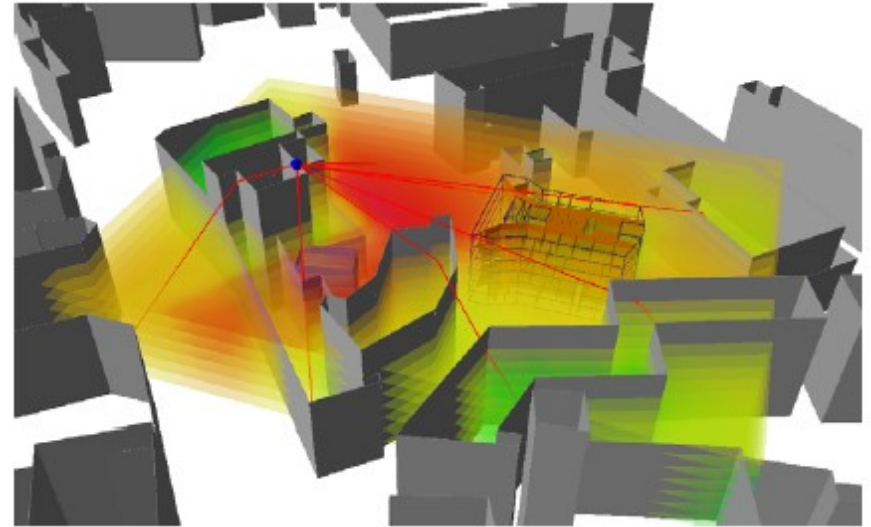

# Okumura-Hata Model

❖ The original Hata model is given by

$$L_{\text{Hata}} = 69.55 + 26.16 \log_{10}(f) - 13.82 \log_{10}(h_{\text{BS}}) \\ - a_i(h_{\text{MS}}) + (44.9 - 6.55 \log_{10}(h_{\text{BS}})) \log_{10}(r),$$

where the parameters (and their corresponding units) are

- $f$  signal carrier frequency [MHz]. May vary between 150 and 1500 MHz
- $h_{\text{BS}}$  Base station (BS) antenna height [m]. May vary between 30m and 200m.
- $h_{\text{MS}}$  Mobile station (MS) antenna height [m]. May vary between 1m and 10m.
- $r$  distance between BS and MS [km]. May vary between 1km and 20km.



# Okumura-Hata Model

- ❖ The correction factor for the mobile antenna height “ $a_i(h_{MS})$ ” depends on the size of the coverage area:
  - Large/dense city (i.e., “ $i = 1$ ”),
  - Medium/small size city (i.e., “ $i = 2$ ”),
  - Suburban area (i.e., “ $i = 3$ ) and
  - Rural/open area (i.e., “ $i = 4$ ”)

Large/dense city,  $i = 1$ .

$$a_1(h_{MS}) = \begin{cases} 8.3 (\log_{10}(1.54h_{MS}))^2 - 1.1, & 150MHz < f < 200MHz, \\ 3.2 (\log_{10}(11.75h_{MS}))^2 - 5.0, & 200MHz < f < 1500MHz. \end{cases}$$

Medium/small size city,  $i = 2$ .

$$a_2(h_{MS}) = 0.8 + (1.1 \log_{10}(f) - 0.7) h_{MS} - 1.56 \log_{10}(f).$$



# Okumura-Hata Model

Suburban area,  $i = 3$ .

$$a_3(h_{MS}) = a_2(h_{MS}) + 2 \left( \log_{10} \left( \frac{f}{28} \right) \right)^2 + 5.4.$$

Rural/open area,  $i = 4$ .

$$a_4(h_{MS}) = a_2(h_{MS}) + 4.78 (\log_{10}(f))^2 - 18.3 \log_{10}(f) + 40.9.$$





# Okumura-Hata Model

- ❖ Later on, Okumura-Hata model was extended to the **1500-2000 MHz** frequencies, in the COST 231 research program
  - The distance interval was also extended
- ❖ ITU-R sector adopted this model in Recommendation P.529

$$L_{\text{Hata},1} = 46.3 + 33.9 \log_{10}(f) - 13.82 \log_{10}(h_{\text{BS}}) \\ - a_i(h_{\text{MS}}) + (44.9 - 6.55 \log_{10}(h_{\text{BS}})) \log_{10}(r) + C_m,$$

where MS antenna height correction factor is the same as in the previous model, and the additional term is given by

$$C_m = \begin{cases} 3dB, & \text{metropolitan centres} \\ 0dB, & \text{elsewhere} \end{cases}$$



# Okumura-Hata Model: PL vs. Range (1)

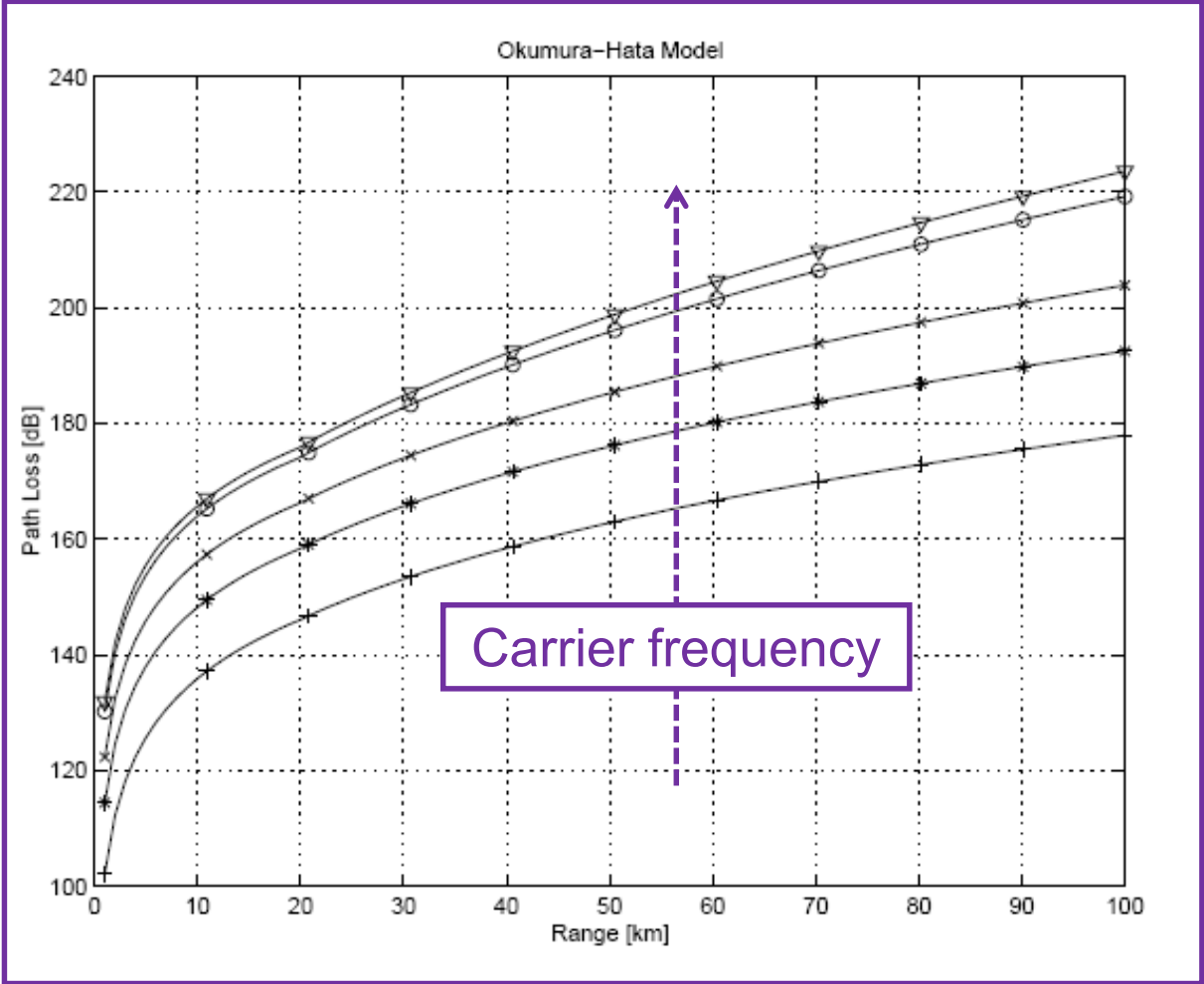

Figure Path loss prediction by Hata model in dense urban area when  $h_{MS} = 2m$  and carrier frequency is 150MHz (+), 450MHz (\*), 900MHz (x), 1800MHz (o), 2100MHz (∇).

# Okumura-Hata Model: PL vs. Range

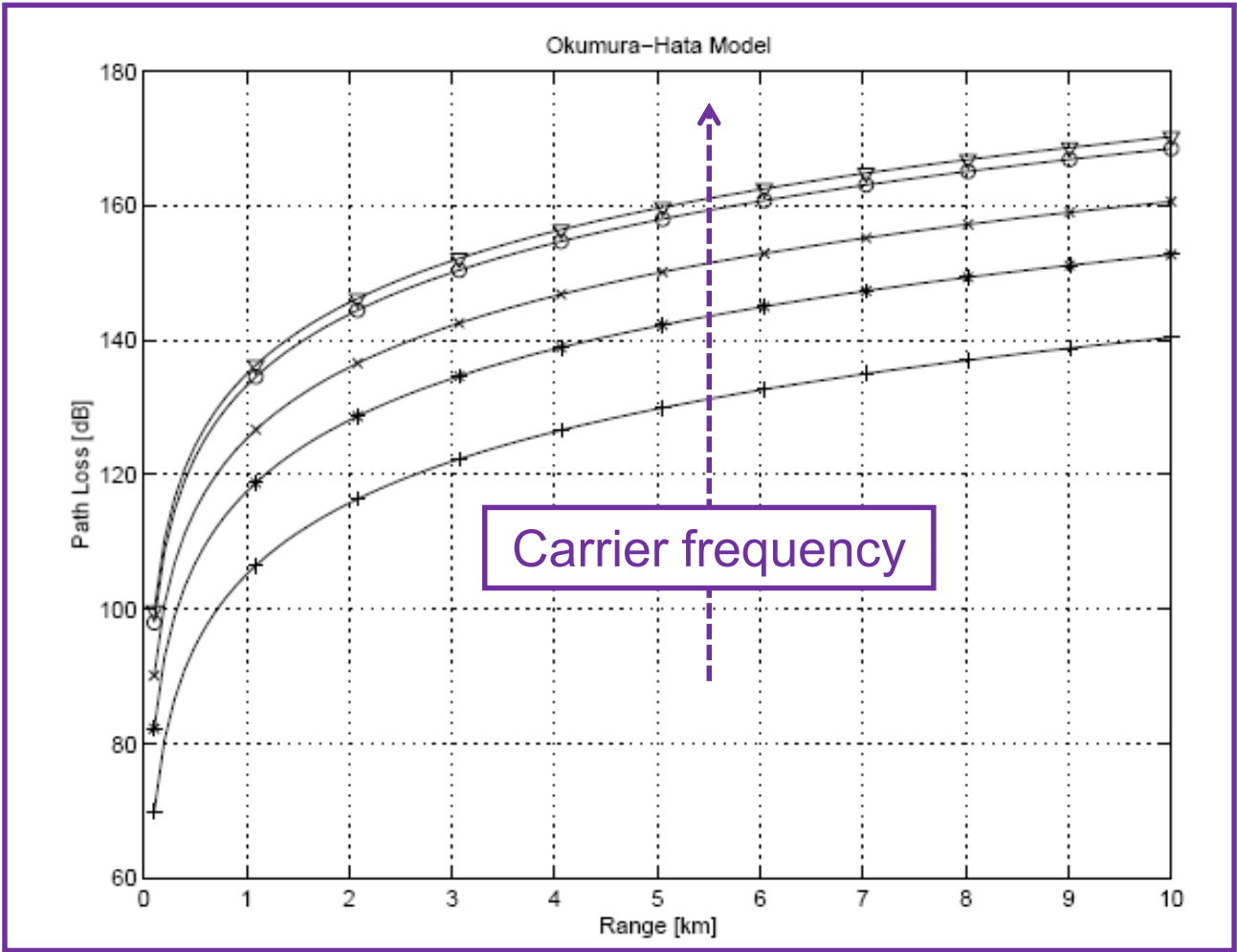

Figure Path loss prediction by Hata model in dense urban area when  $h_{MS} = 2m$  and carrier frequency is 150MHz (+), 450MHz (\*), 900MHz (x), 1800MHz (o), 2100MHz (∇).

# Okumura-Hata Model: PL vs. BS Antenna Height

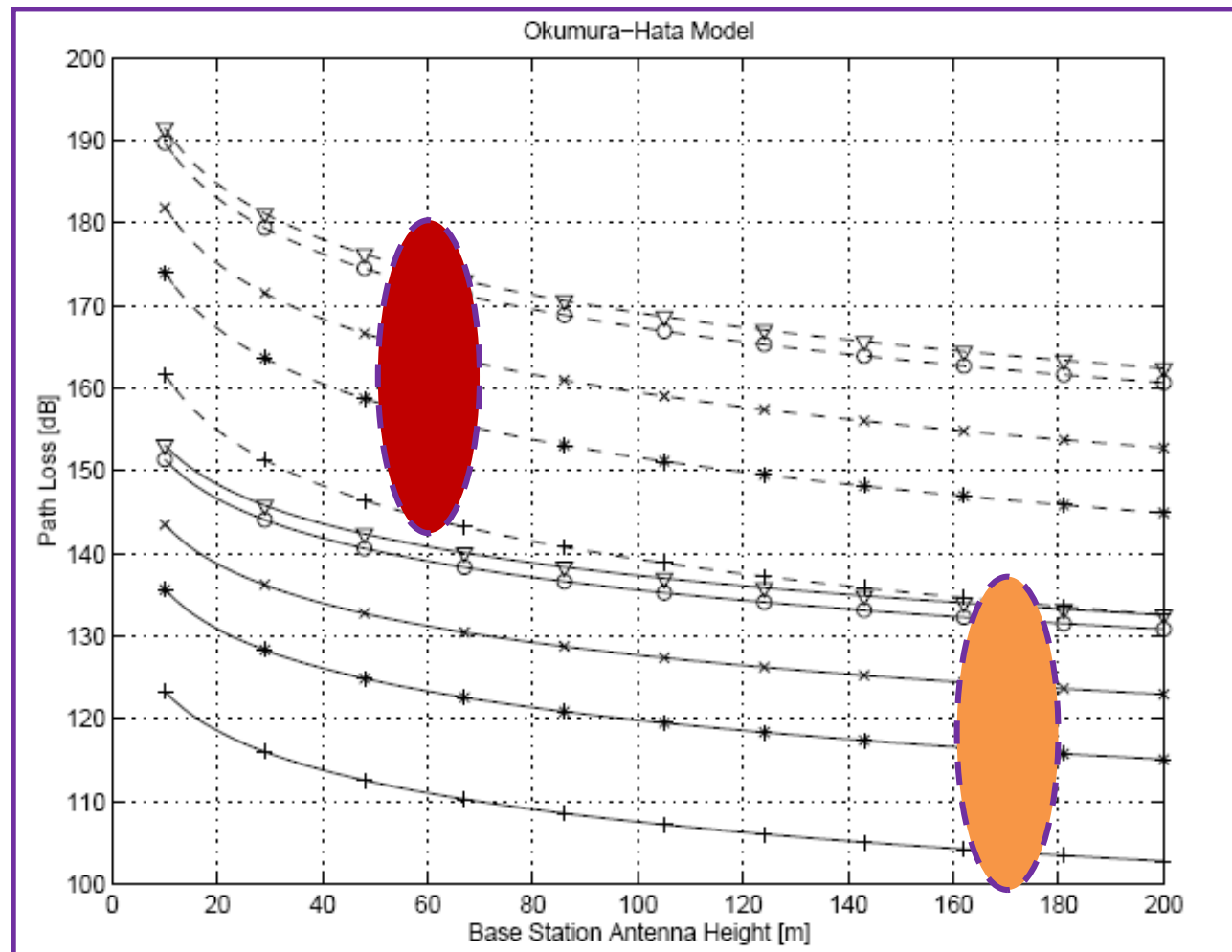

Figure Path loss prediction by Hata model in dense urban area as a function of BS antennas height when  $h_{MS} = 2m$ , (solid curves), (dashed curves) and carrier frequency is 150MHz (+), 450MHz (\*), 900MHz (x), 1800MHz (o), 2100MHz (∇).

# Okumura-Hata Model: PL vs. Range

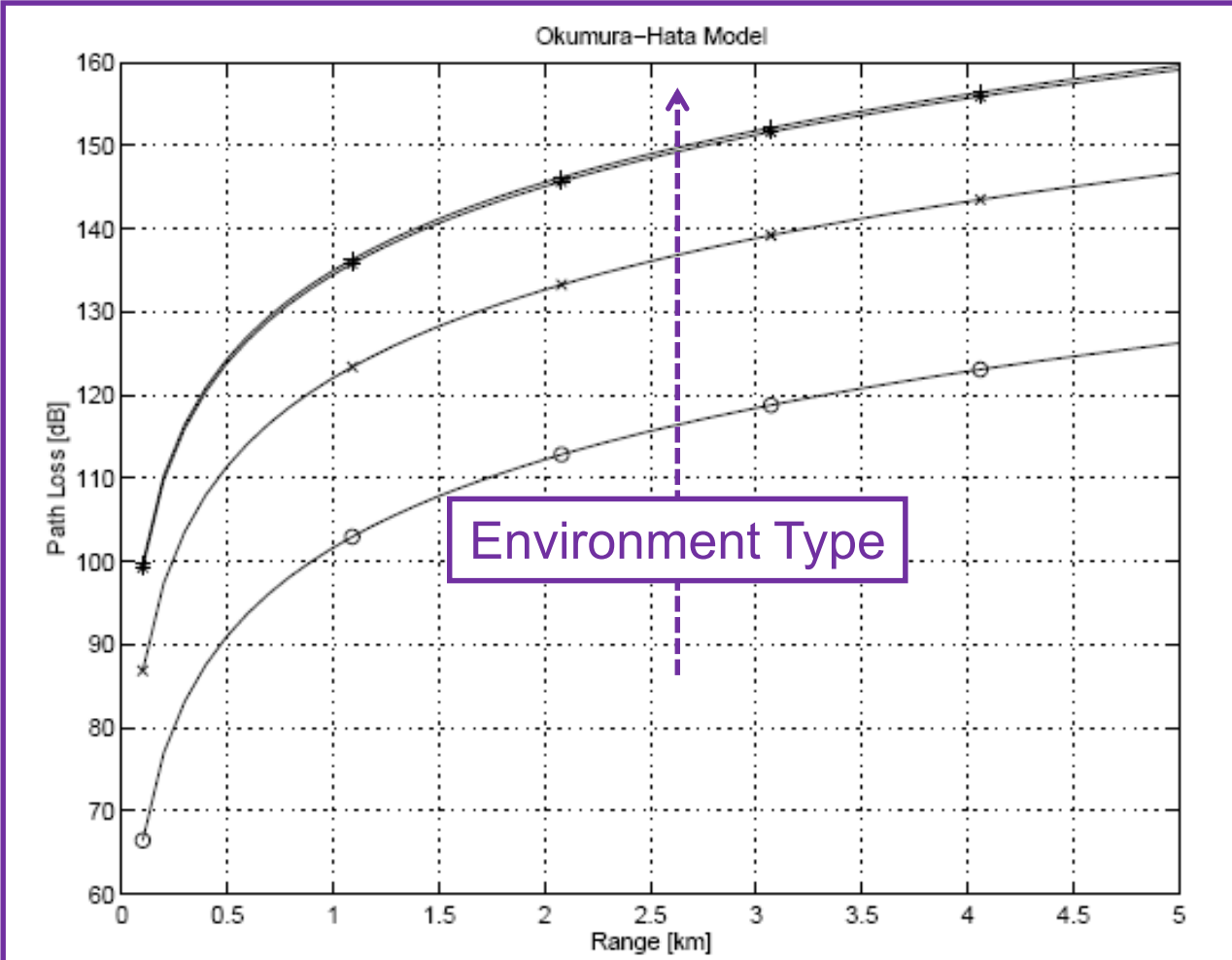

Figure Path loss prediction by Hata model in dense city (+), medium size city (\*), suburban (x) and open area (o),  $h_{MS} = 2m$  and carrier frequency

# Model tuning

- ❖ To customize the used empirical propagation model for the area
- ❖ Tune the model based on measurement data
  - Formulate correction factors
- ❖ A carefully tuned model is the key for efficient coverage planning

## Example correction factor for Okumura-Hata

Clutter type	Correction factor [dB]
Water	-20
Rural	-16
Forest	-10
Suburban	-7
Industrial	-5
Urban	0
Dense urban	+2

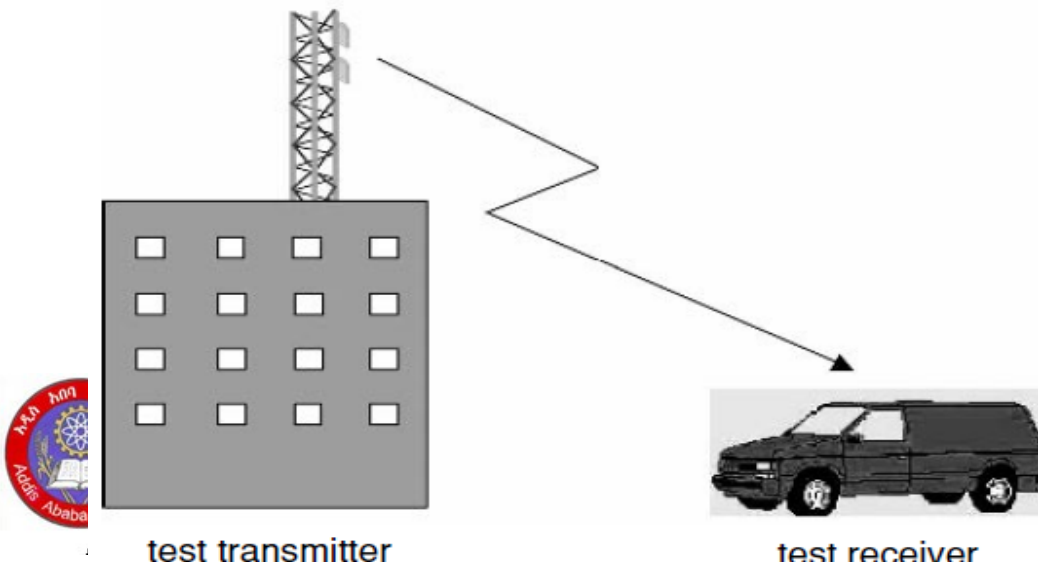
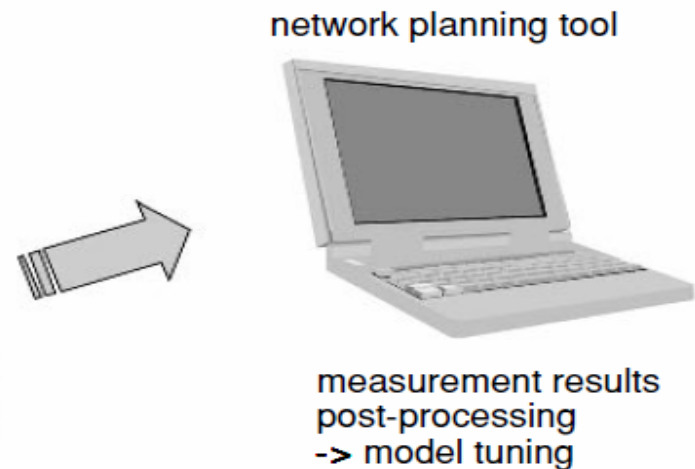

# Shadow fading



# Different types of fading: Shadow fading

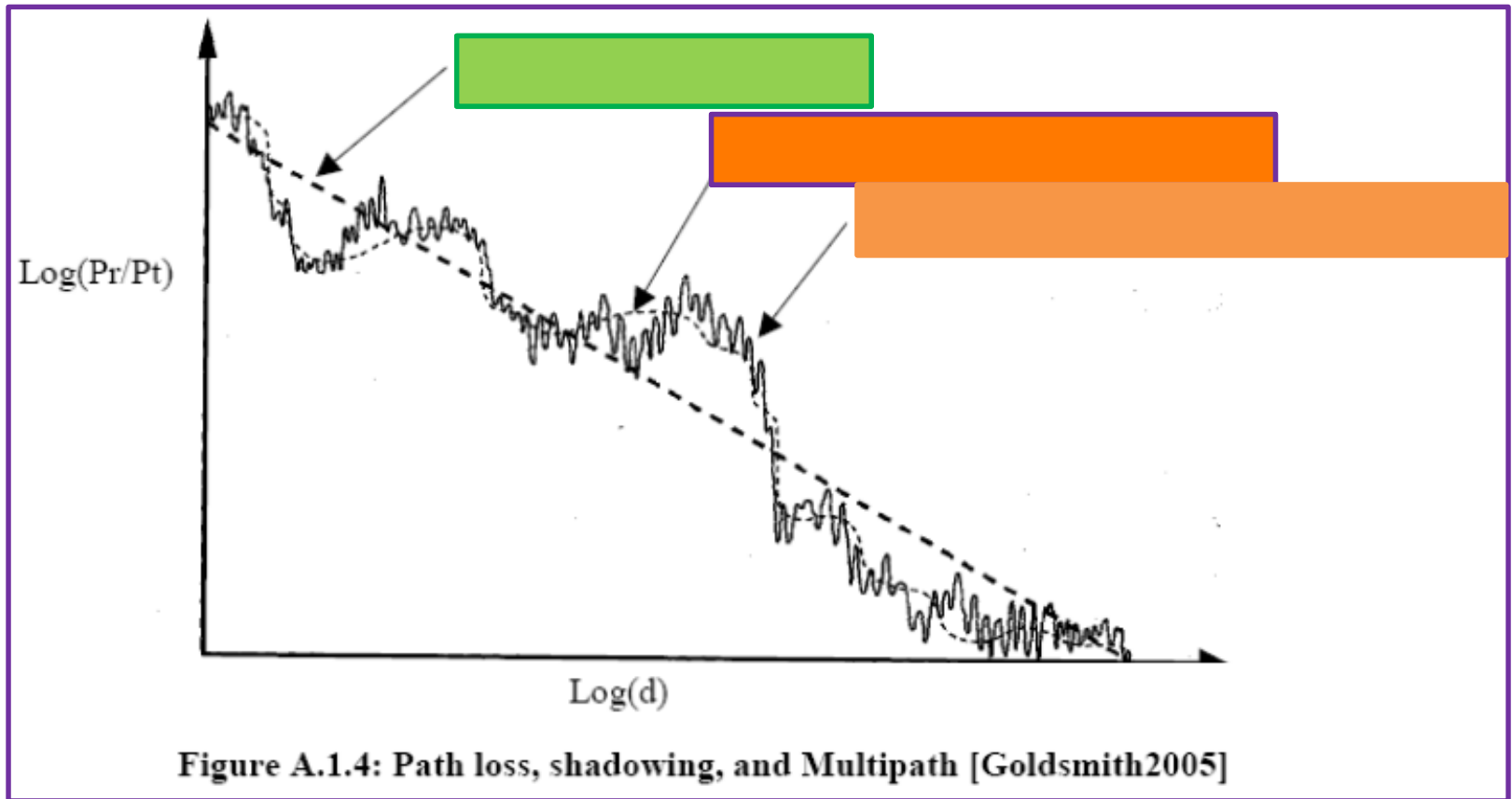

Discussed in previous slides

To be discussed now

To be discussed later



# Shadow fading

- ❖ Obstacles with a size from **tens to hundreds of wavelengths** (on the different propagation paths) cause a variation of the path loss around the average path loss “ $L$ ”
- ❖ This variation is random but, however, it is correlated when measured in nearby locations
- ❖ In many measurements, it has been observed that shadow fading “ $L_s$ ” can be described with a log-normal distribution\*, and the probability density function is given by

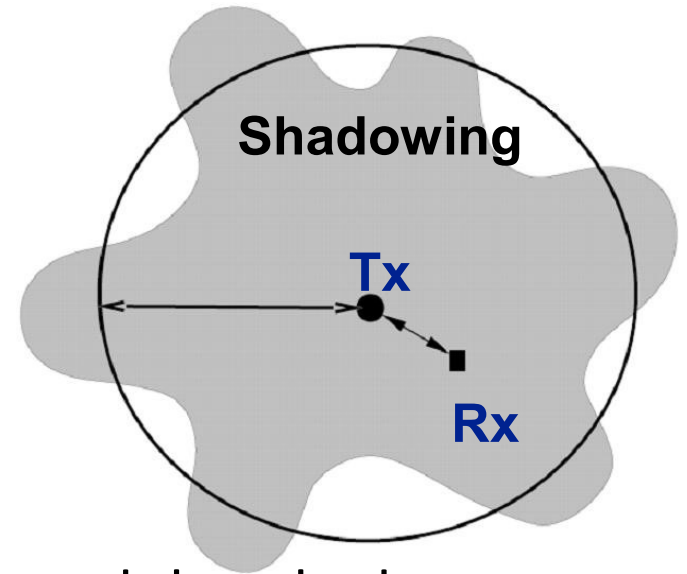

$$f(L_s) = \frac{1}{\sqrt{2\pi}\sigma_s} e^{-\frac{L_s^2}{2\sigma_s^2}}$$

\*Loss measured in logarithmic scale (i.e., [dB]) is normally distributed

# Shadow fading

- ❖ Values obtained in shadow fading measurements\*
  - Carrier frequency: 2.0 GHz

Network area/ Parameter	Standard deviation
Dense urban / Urban	8,5 dB
Sub-urban	7,2 dB
Rural	6,5 dB

\* Values reported in different sources vary generally from 6-10 dB

# Shadow fading

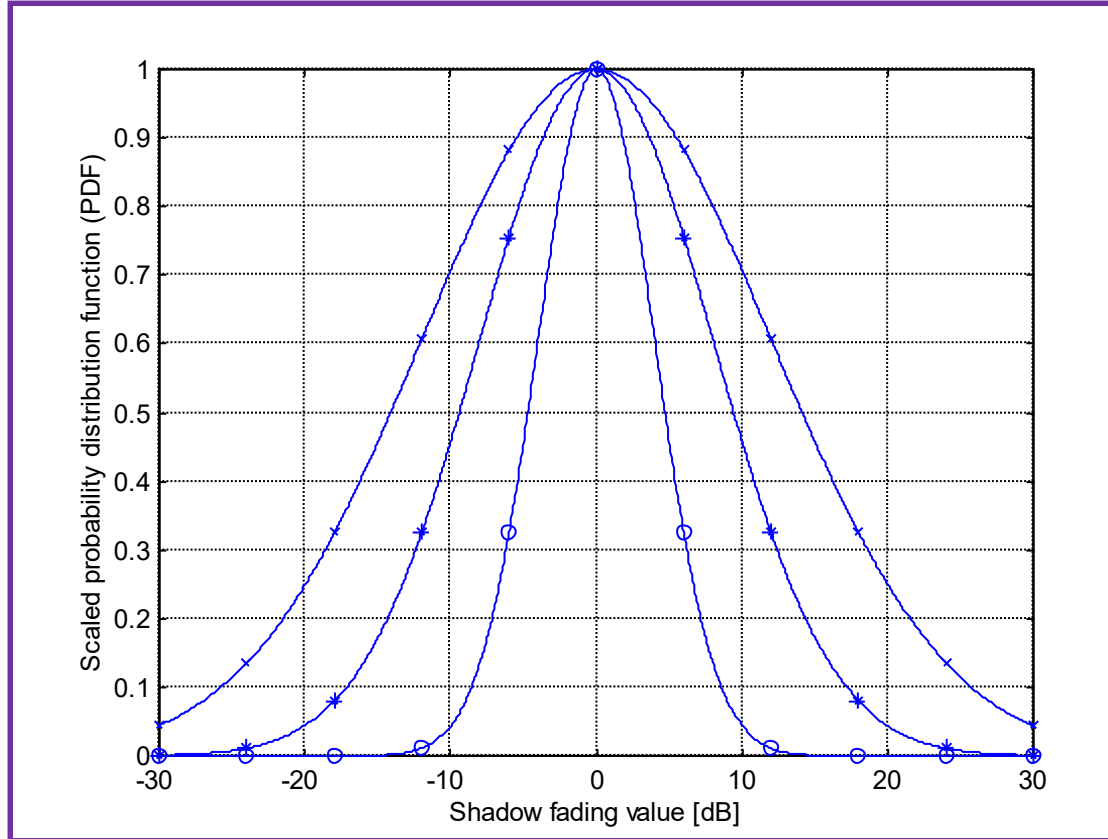

Probability distribution function for shadow fading when SF standard deviation " $\sigma_s$ " is 4 dB (o), 8 dB (\*), and 12dB (x)



# Shadow fading

- ❖ The cumulative distribution function (CDF) is given by

$$P(L_s < L_0) = \int_0^{L_0} f(t) dt = 1 - Q\left(\frac{L_0}{\sigma_s}\right),$$

where “Q(x)” is the Marcum Q-function,

$$Q(x) = \frac{1}{\sqrt{2\pi}} \int_x^{\infty} e^{-\frac{t^2}{2}} dt = \frac{1}{2} \operatorname{erfc}\left(\frac{x}{\sqrt{2}}\right)$$

$\operatorname{erfc}(x)$  = complementary error function

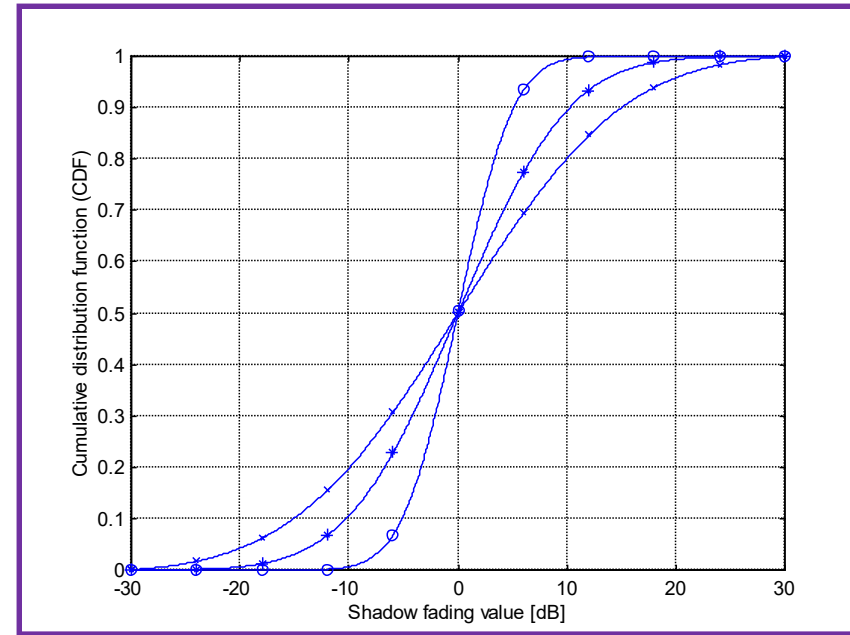

CDF for shadow fading when SF standard deviation “σ<sub>s</sub>” is 4 dB (o), 8 dB (\*), and 12dB (x)

# Impact of shadow fading

- ❖ Total allowed signal attenuation in the system is **155 dB**, and shadow fading margin is **8 dB**
- **Impact:** Cell range would increase from 1.35 km up to 2.2 km, which leads to 166 % increase in coverage

## W-I with parameters

BS antenna height = 25 m  
Roof top height = 15 m  
Carrier frequency = 1950 MHz  
Street width = 12 m  
Building spacing = 60 m  
Street orientation = 90 degrees

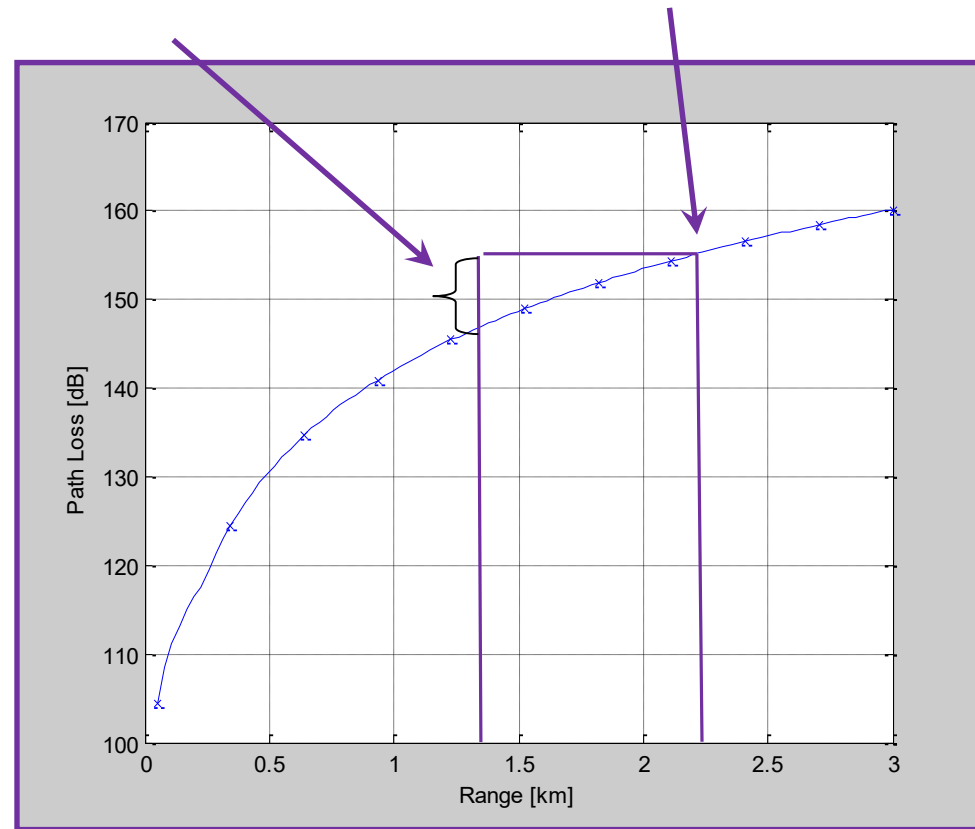

# Combined path loss and shadowing

- ❖ In network planning, a Shadow Fading Margin (SFM) is added on top of average path loss
- ❖ This margin is based on the required target power level (i.e., maximum allowed path loss in the link budget) to guaranteed a given outage probability in the system
- ❖ Let us denote
  - “ $L_{\max}$ ” = maximum allowed attenuation (link budget parameter)
  - “ $P_{\text{out}}$ ” = allowed outage probability at cell edge (QoS of network)
  - “ $L_{\text{tot}}$ ” = Total loss including shadowing and average path loss
- ❖ Then we set

$$(*) \quad P(L_{\text{tot}} > L_{\max}) = P_{\text{out}}$$

$$L_{\text{tot}} = L + L_s$$

“ $L_{\max}$ ” = maximum allowed attenuation (system specific parameter)  
“ $L_{\text{tot}}$ ” = Total loss at cell edge (network design parameter)

# Combined path loss and shadowing

- ❖ From formula (\*) we obtain

$$1 - P(L_s < L_{\max} - L) = P_{out}$$

- ❖ Then, using the Marcum function representation we get

$$Q\left(\frac{L_{\max} - L}{\sigma_s}\right) = P_{out}$$

- ❖ It is common to use the inverse Marcum's function to obtain the (average) path loss that fulfill target requirements, i.e.,

$$L = L_{\max} - \sigma_s Q^{-1}(P_{out})$$

- ❖ Yet, note that the inverse Marcum's function does not exist in closed-form

" $L_{\max}$ " = maximum allowed attenuation (system specific parameter)

" $L_{\text{tot}}$ " = Total loss at cell edge (network design parameter)

# Inverse Marcum's function

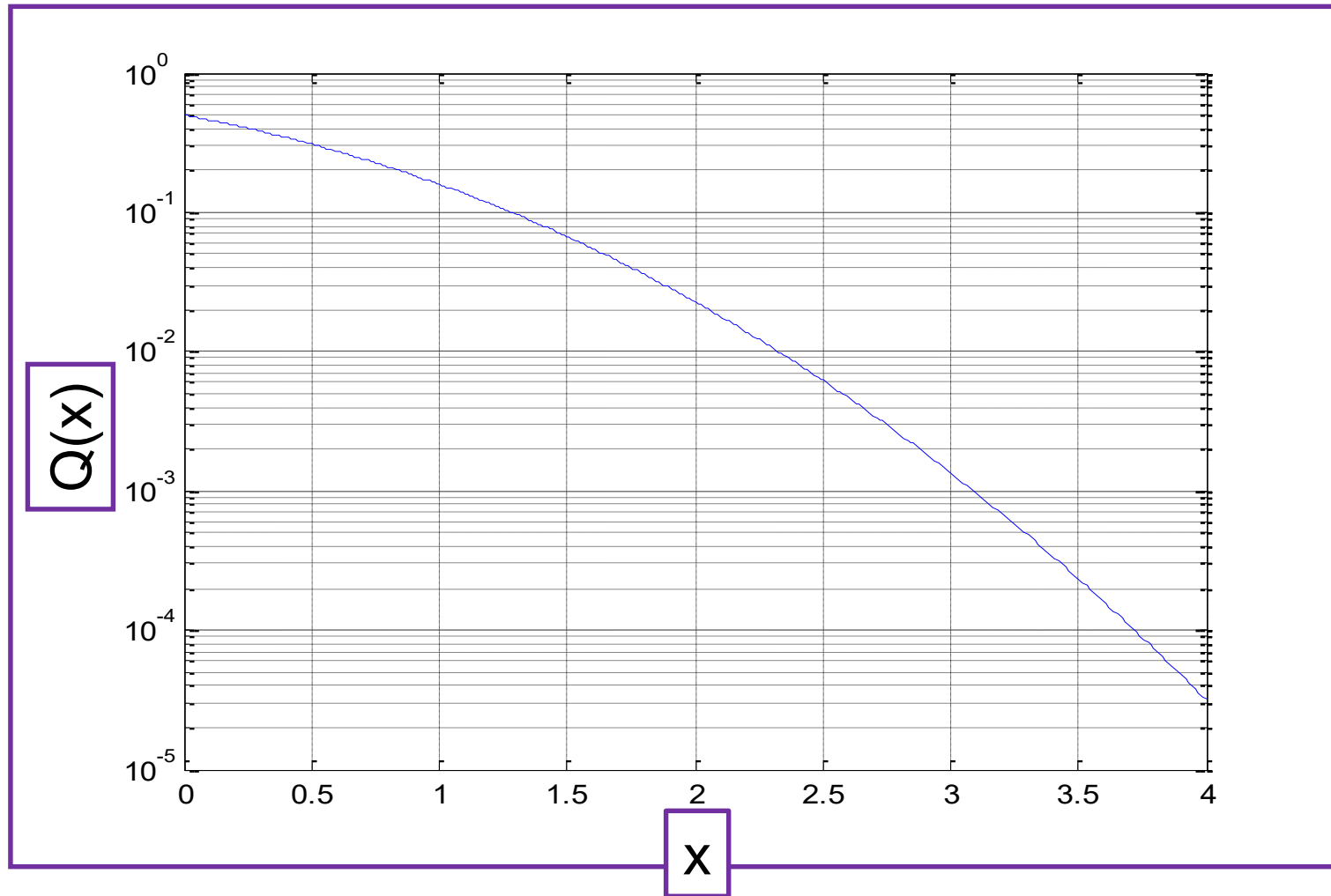



# Combined path loss and shadowing

- ❖ Revisiting the derived formula that combines path loss and shadowing,

$$L = L_{\max} - \sigma_s Q^{-1}(P_{out})$$

- ❖ The (average) path loss on the left-hand side depends on:
  - Distance between transmitter and receiver,
  - Antenna heights of both, transmitter and receiver,
  - Carrier frequency, environment type, ...} Okumura-Hata model
- ❖ The value on the right-hand side depends on:
  - Standard deviation of shadow fading (environment type),
  - Allowed attenuation (system specific parameter: link budget)
  - Outage probability (network target performance: guarantee QoS)

In link budget calculations,  
so-called SF margin is given by

$$M_{SF} = \sigma_s \cdot Q^{-1}(P_{out})$$

# Combined path loss and shadowing

Edge reliability (i.e., “ $P_{out}$ ”) depends on assumed “ $\sigma_{SF}$ ” and shadow fading margin

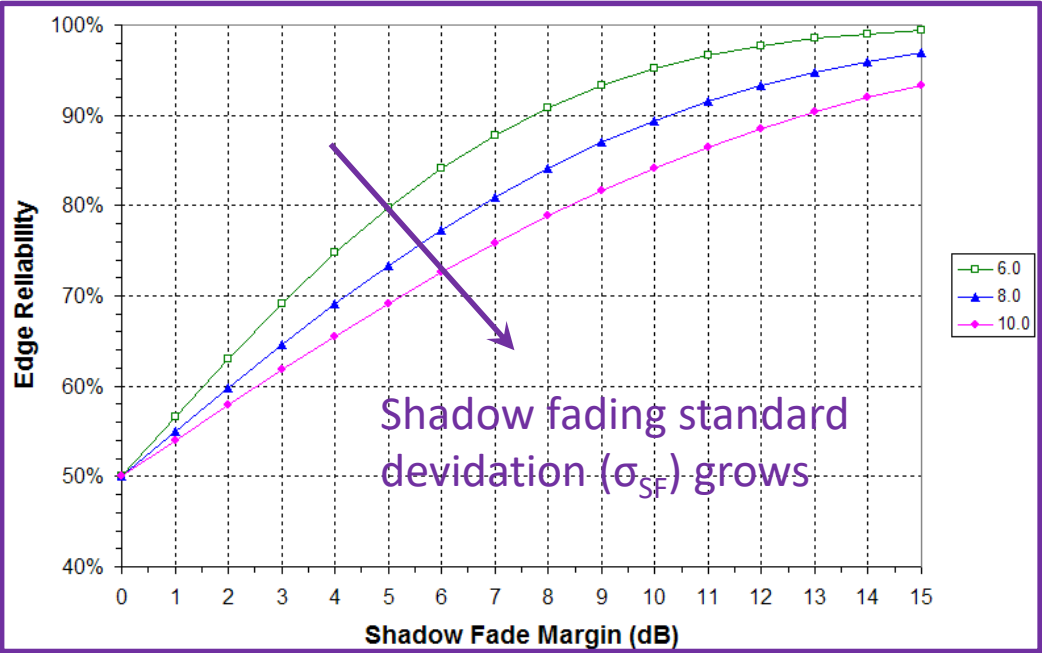
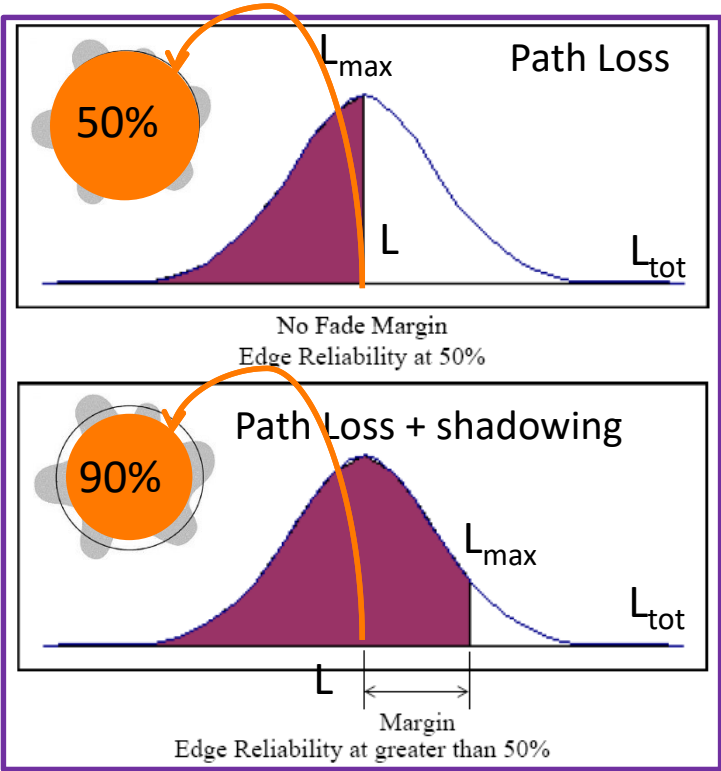

- As “ $\sigma_{SF}$ ” grows for **same fading margin**, the edge reliability is reduced
- As “ $\sigma_{SF}$ ” grows, a **larger fading margin** is required to maintain the same edge reliability

# Basics of multipath fading

# Different types of fading: Multipath fading

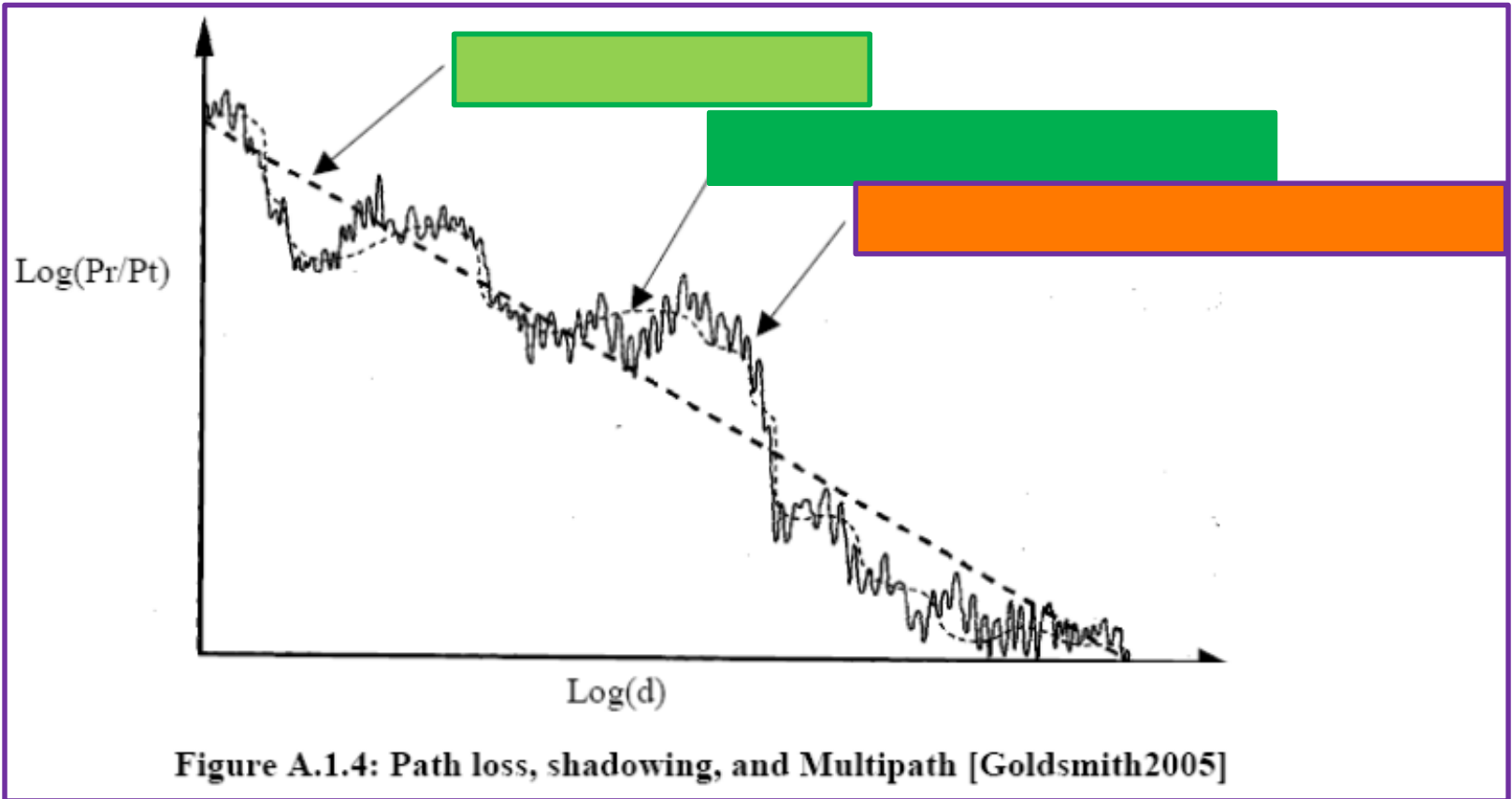

Discussed in previous slides

To be discussed now

# Multipath fading

- ❖ The modeling of a radio channel in urban (and dense urban) environments has become an important task, due to increasing interest towards mobile communications
- ❖ The fundamental problem in mobile communication is that in most practical situations there are obstacles between transmitter and receiver
  - Therefore, direct connections or Line-of-Sight (LOS) connections occur only occasionally
- ❖ So, signal propagation is characterized by
  - Reflection,
  - Scattering, and
  - Diffraction

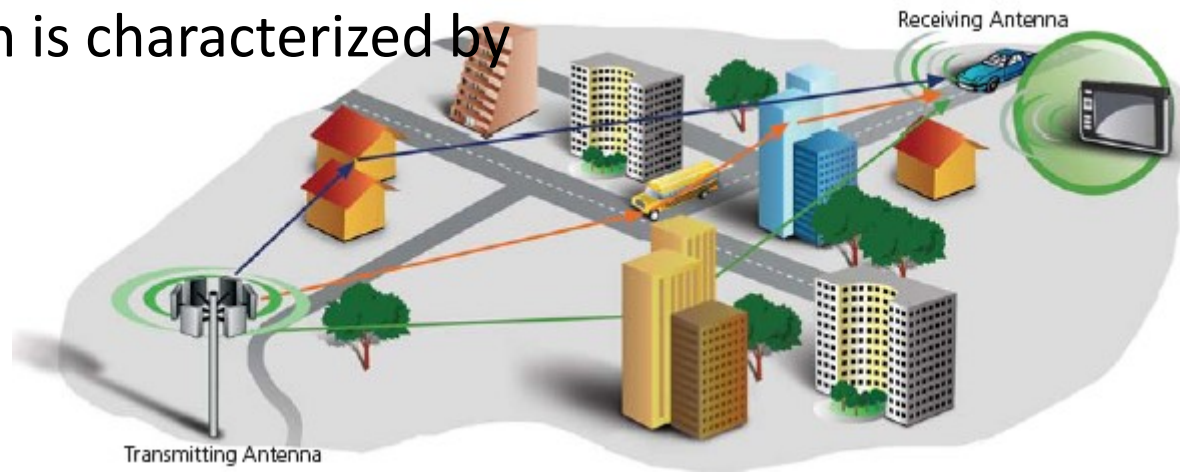

# Multipath fading

- ❖ Thus, signal energy arrives via several paths with different time delays
- ❖ This is called as multipath phenomena

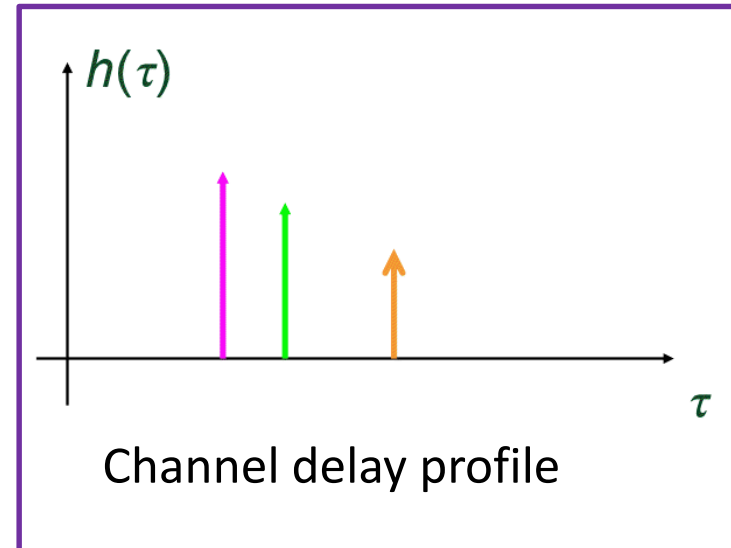
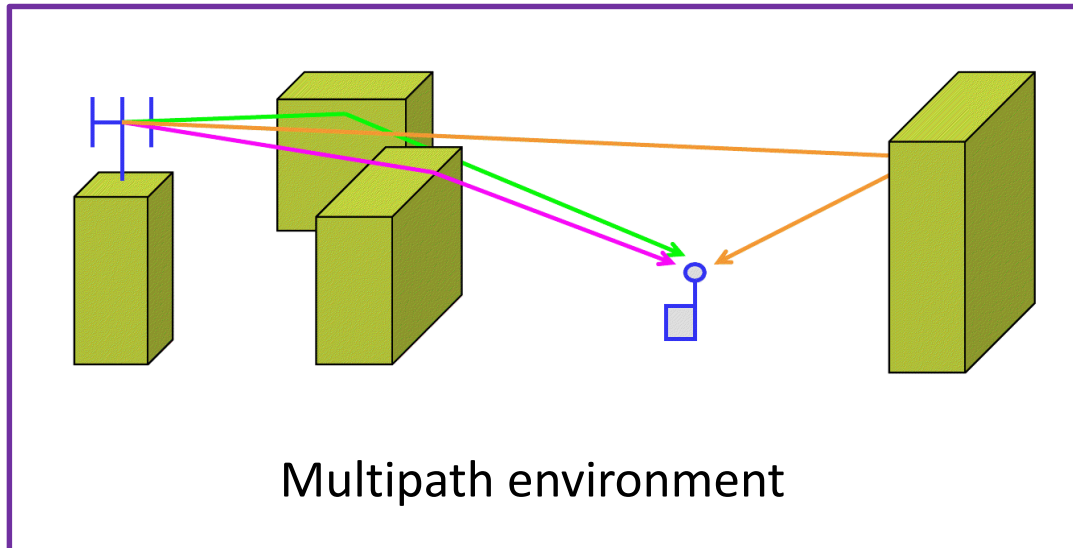

# Multipath fading

- ❖ In multipath fading, the signal components that arrive at the same time sum up vectorially at the receiver antenna
- ❖ So, the strength of the resulting received signal will vary according to the phase value that each (individual) component signal takes

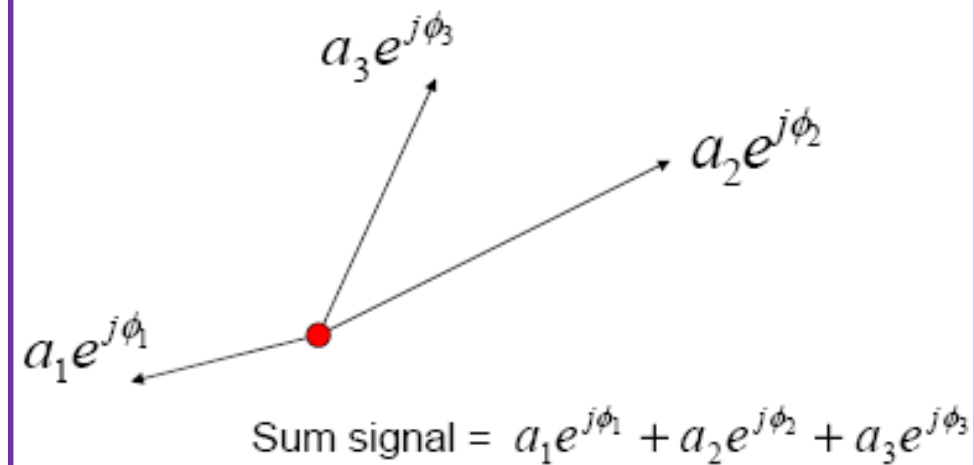
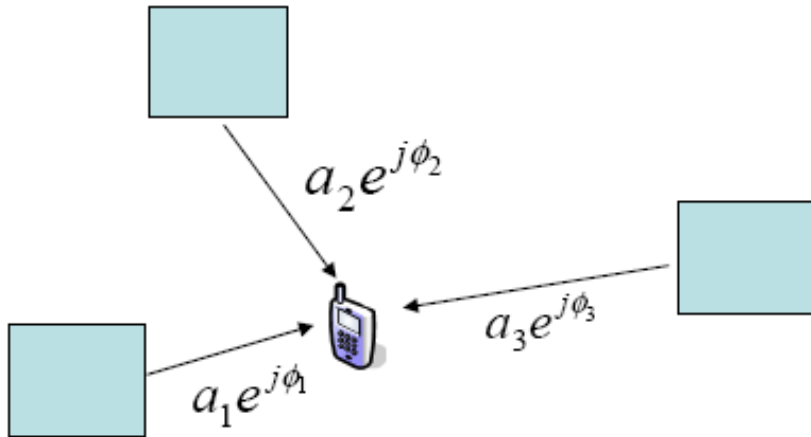

# Multipath fading

- ❖ When the receiver (or the obstacles) change its location (their locations), the sum of component signals may result in a variations in the range of **tens of decibels**
- ❖ This rapid signal variation is known as fast fading, also known as short-term fading

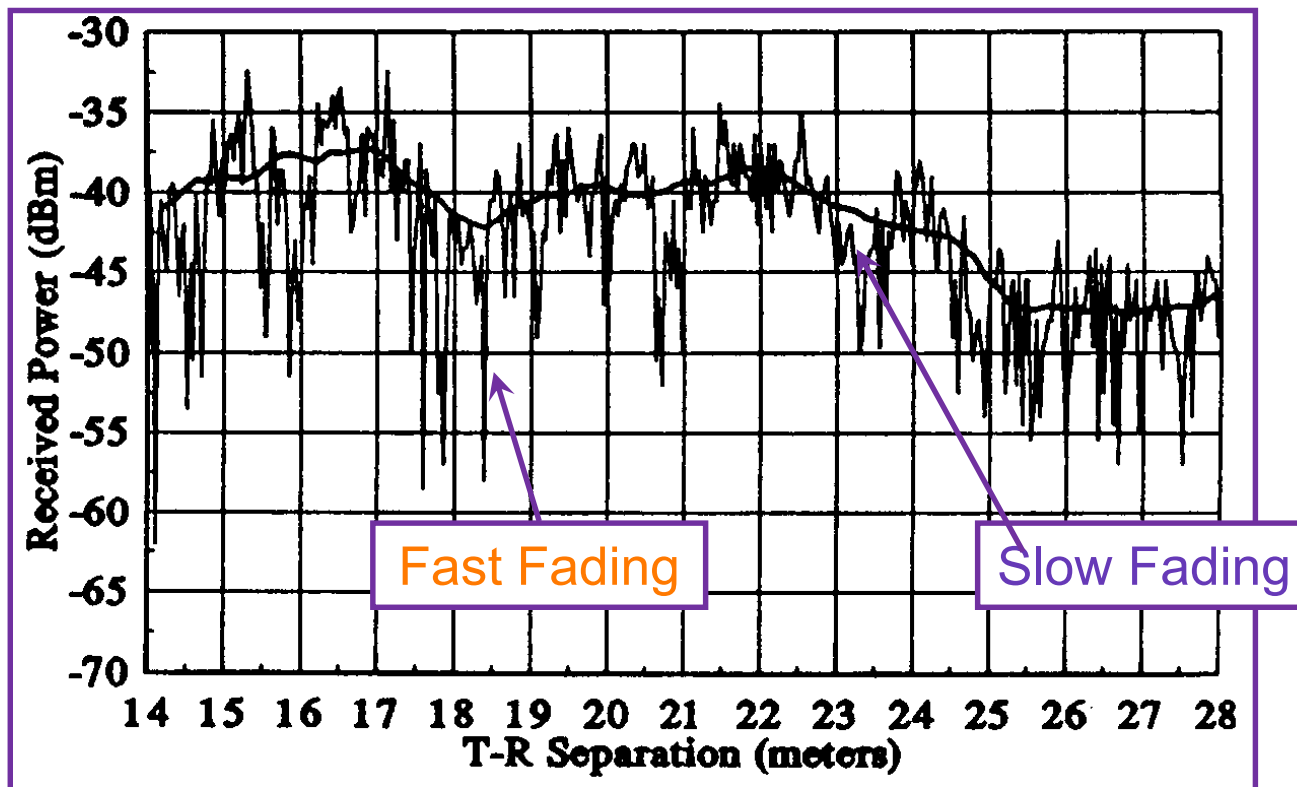



# Model for fast fading: Rayleigh fading

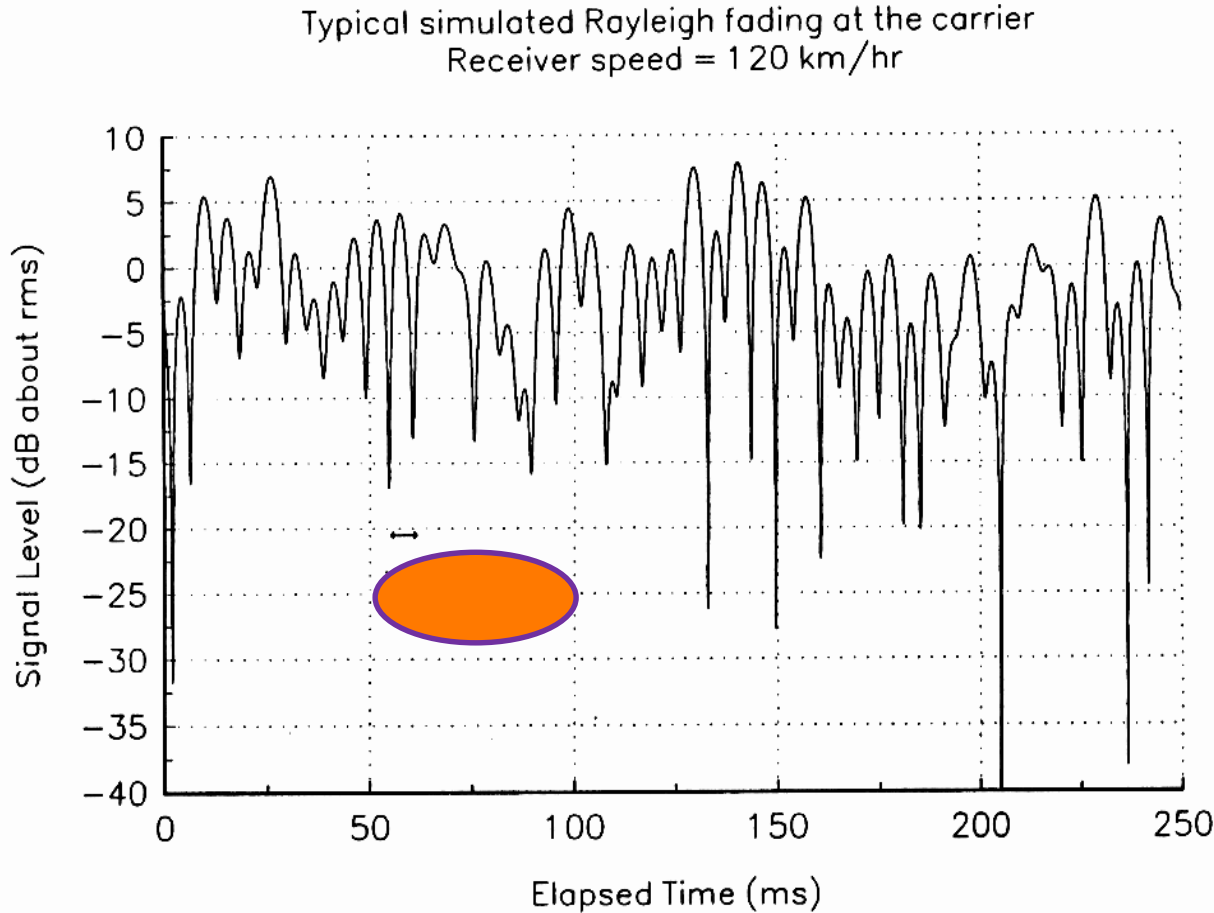

$$p_r(r) = \frac{r}{\sigma^2} e^{-\frac{r^2}{2\sigma^2}}$$

**Figure 5.15** A typical Rayleigh fading envelope at 900 MHz [from [Fun93] © IEEE].

# Power distribution: Exponential distribution

- ❖ It is possible to show that probability density function (PDF) of the signal power attains the form

$$p_{\gamma}(\gamma) = \frac{1}{2\sqrt{\gamma}} p_r(\sqrt{\gamma}) = \frac{1}{2\sqrt{\gamma}} \cdot \frac{\sqrt{\gamma}}{\sigma^2} e^{-\frac{\gamma}{2\sigma^2}} = \frac{1}{\bar{\gamma}} e^{-\frac{\gamma}{\bar{\gamma}}}$$

- ❖ The corresponding cumulative distribution function (CDF) of the signal power is given by

$$P(\gamma < x) = \int_0^x \frac{1}{\bar{\gamma}} e^{-\frac{\gamma}{\bar{\gamma}}} d\gamma = 1 - e^{-\frac{x}{\bar{\gamma}}}$$

# Multipath fading

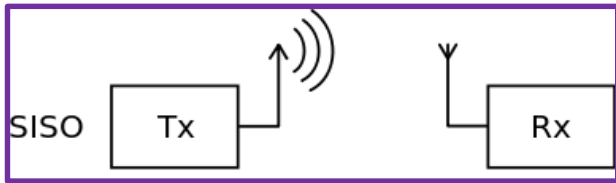
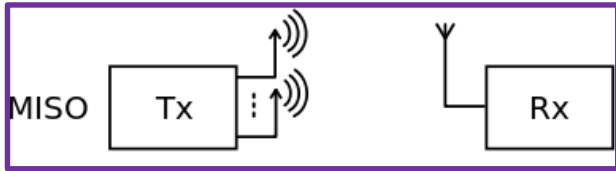

## Shadow fading margin:

Keeps **mean SNR** of cell edge users at acceptable levels

## Fast fading margin:

Keeps the **instantaneous SNR** of a mobile user under control

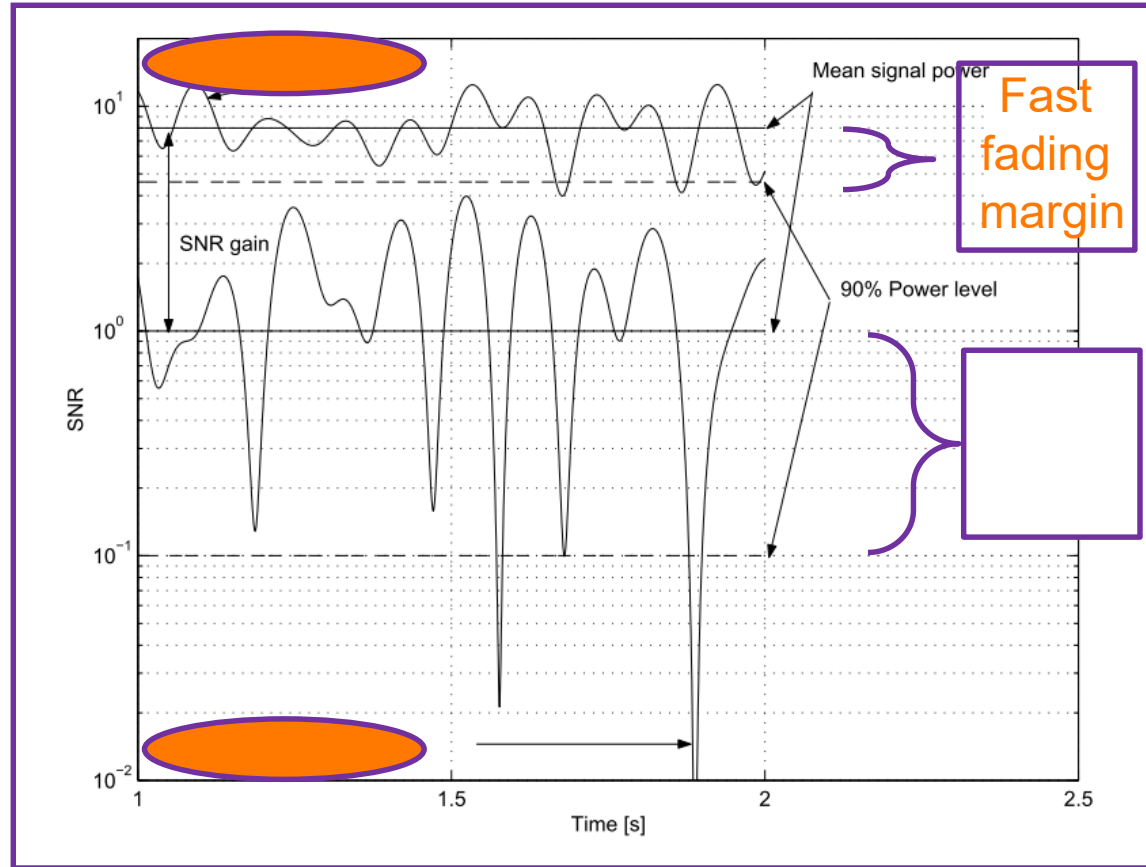

# Contents

- ❖ CNPO process
- ❖ Channel models (pathloss and fading)
- ❖ Antennas
- ❖ Noise
- ❖ Interference
- ❖ CNPO tools (WinProp introduced)
- ❖ QoS/QoE measurements and optimization



# Antenna basics

- ❖ An antenna is the converter between cable bounded electromagnetic waves and free space waves

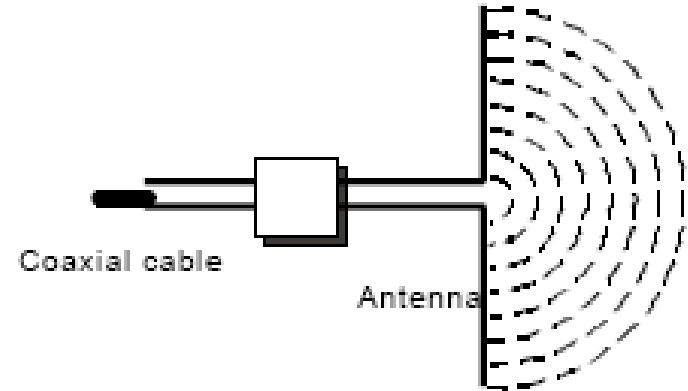

- ❖ In the following we concentrate on the base station antennas
  - This is due the fact that mobile terminal antenna gains are usually small from link budget perspective

# Dipole element

- ❖ Basic radiating element is usually a  $\lambda/2$  dipole
- ❖ The resonance frequency of the dipole is determined by its mechanical length, which is half of the corresponding wave length
- ❖ Relation between frequency and wave length is given by  
 $\lambda = 300/f$ , where  $\lambda$  [m] and  $f$  [MHz]
  - Example :  $f = 900$  MHz  $\Rightarrow \lambda = 0.33$ m and dipole length is 165 mm

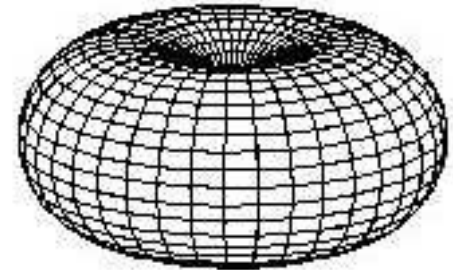

# Radiation pattern

- ❖ The 3-dimensional antenna gain pattern is usually described by a vertical and horizontal cut
  - Vertical polarization: Horizontal pattern = H-plane (magnetic field)
  - Vertical pattern = E-plane (electric field)
- ❖ The half power beam width (power reduced by 3dB) is depicted in the figure as well as the opening angle of the beam determined by the half power points

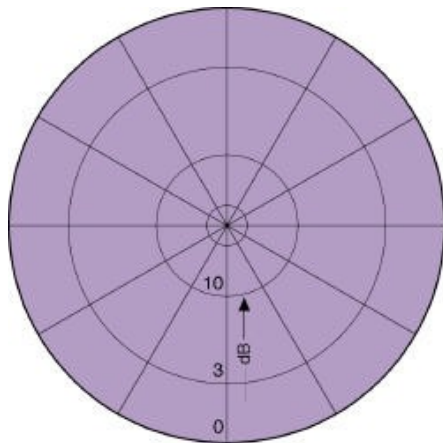

Horizontal pattern

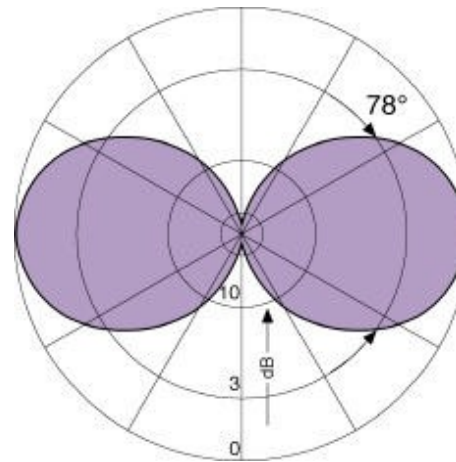

Vertical pattern



Omnidirectional antenna

# Polarization

- ❖ The polarization is defined as the direction of oscillation of the electrical field vector
  - Dipole orientation vertical: Vertical polarization is mainly used in mobile communication
  - Dipole orientation  $\pm 45^\circ$  slanted : cross polarization used for polarization diversity

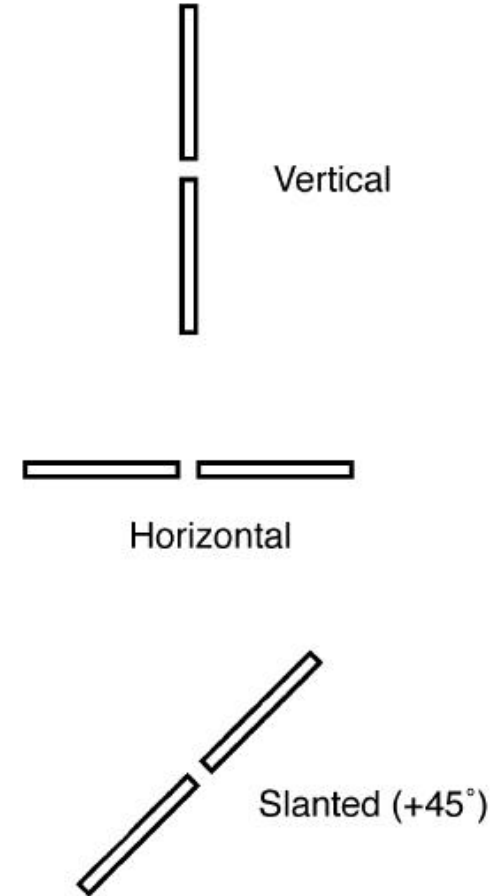



# Directivity and antenna gain

❖ In order to direct the radiated power into a specific area half wave dipoles are arranged vertically and combined in phase

- While doubling the number of dipoles the half power beam width approximately halves
- The gain increases by 3 dB in the main direction

Note: Here antenna gain is measured in dBd's

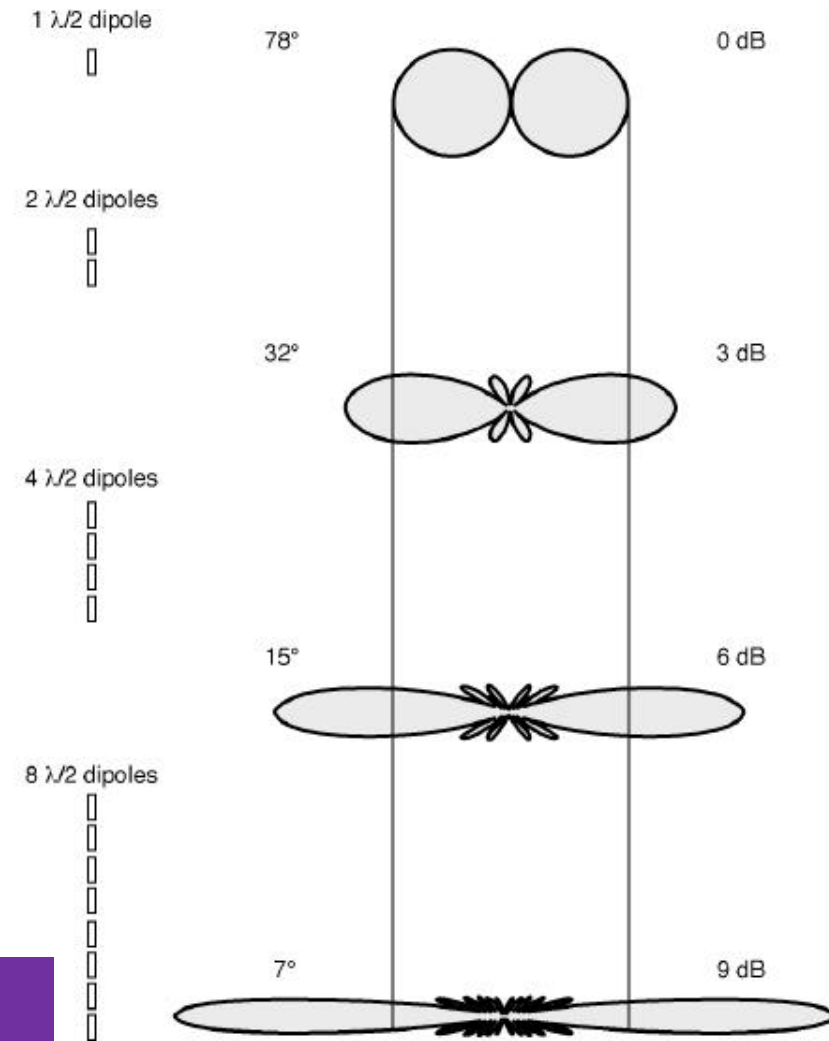

# Antenna gain

- ❖ Most common antenna gain measure is dBi = dB(isotropic). It is the forward gain of a certain antenna compared to the ideal isotropic antenna which uniformly distributes energy to all directions.
- ❖ An other measure that is used is dBd = dB(dipole). It is the forward gain of an antenna compared to a half-wave dipole antenna.

Half wave dipole (dBd) →

$$\text{dBi} = \text{dBd} + 2.15\text{dB}$$

Isotropic radiator (dBi) →

Vertical pattern

Horizontal pattern

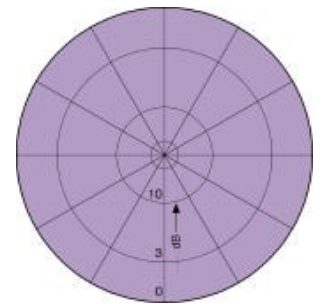
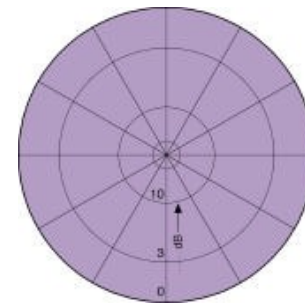
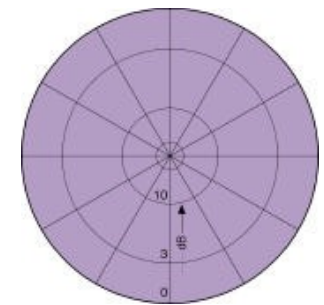
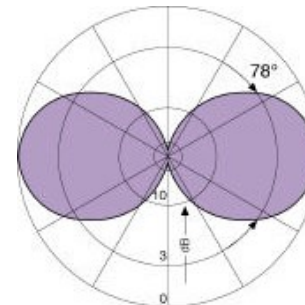

# Omnidirectional antenna

- ❖ Standard omni gain antenna for cellular application. Antenna gain is 11dBi.

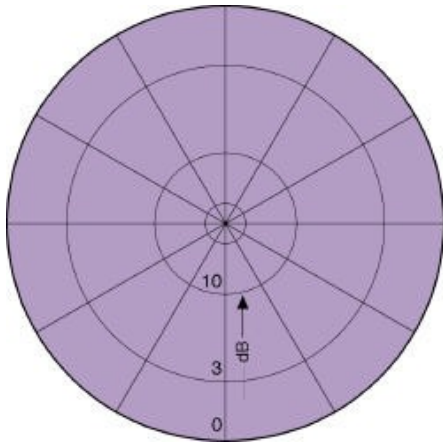

Horizontal pattern

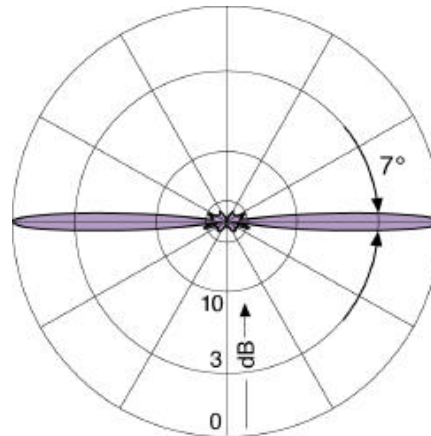

Vertical pattern



# Horizontal beam

- ❖ Like in vertical plane, also in horizontal plane a beam can be created
  - While halving of the beam width the gain is increased by 3 dB
  - The resulting gain of an antenna is the sum of the vertical and horizontal gain

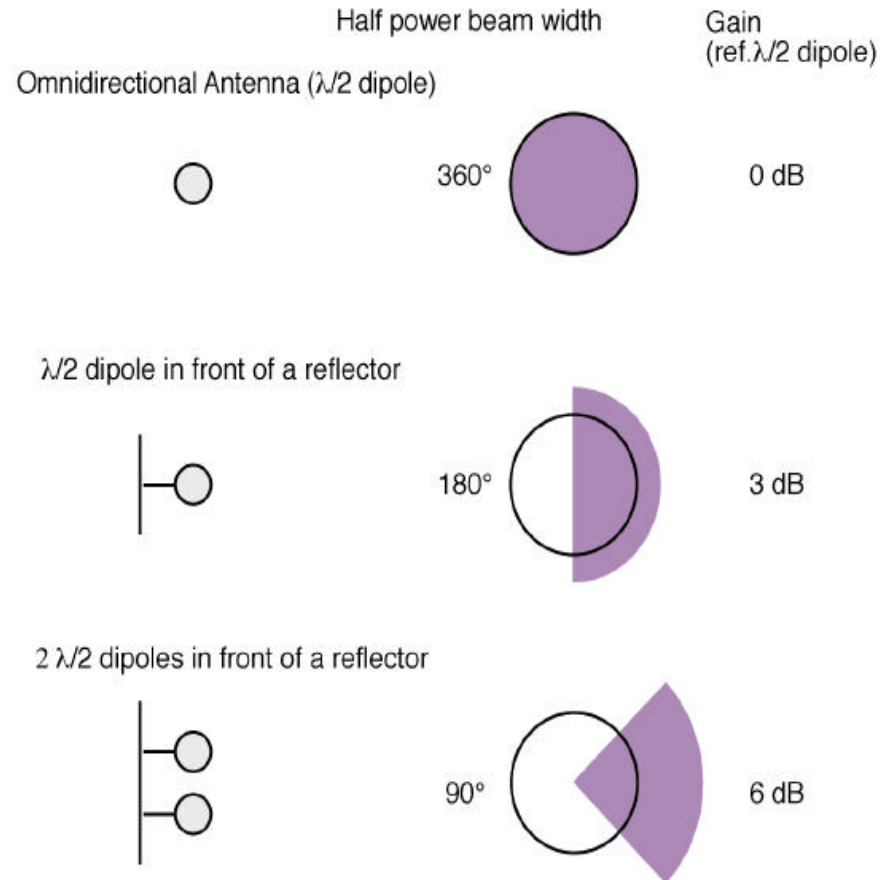

# Panel antenna

- ❖ Standard directional panel antenna for cellular networks: Antenna gain 15.5 dBi, 3dB beam width 65 degrees

– Gain from both planes

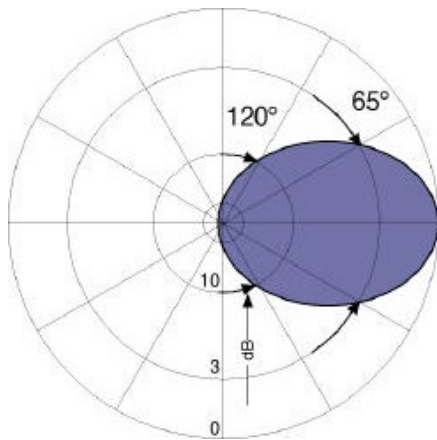

Horizontal pattern

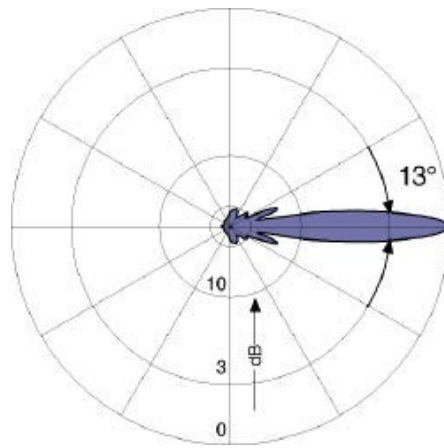

Vertical pattern

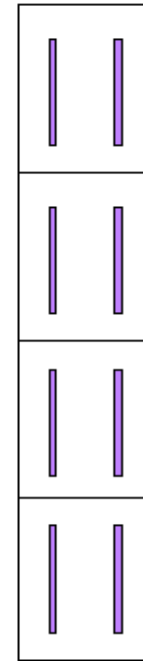

# Kathrein741984

Horizontal Pattern

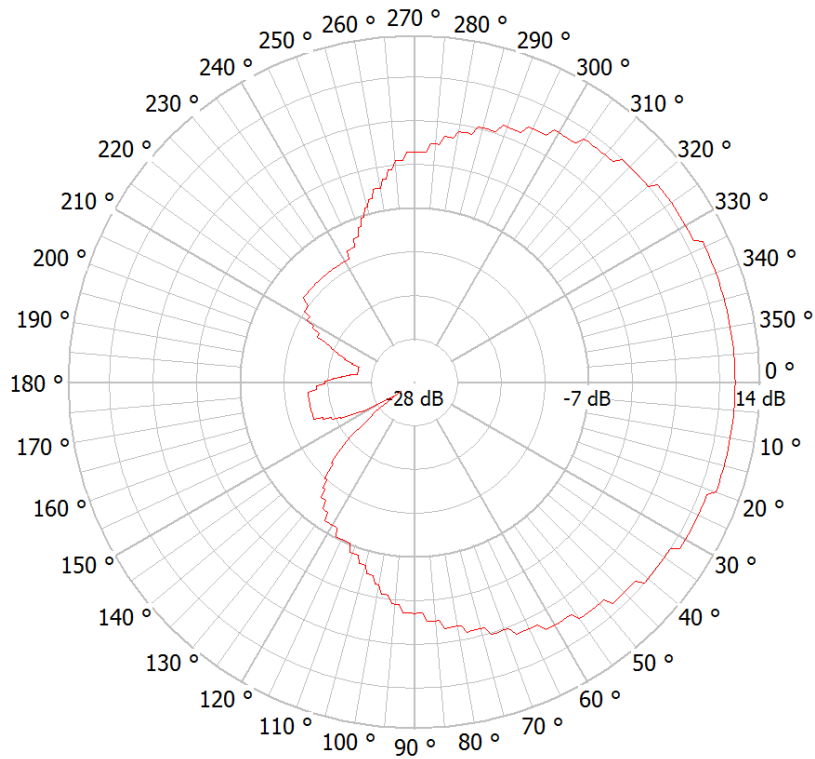

Vertical Pattern

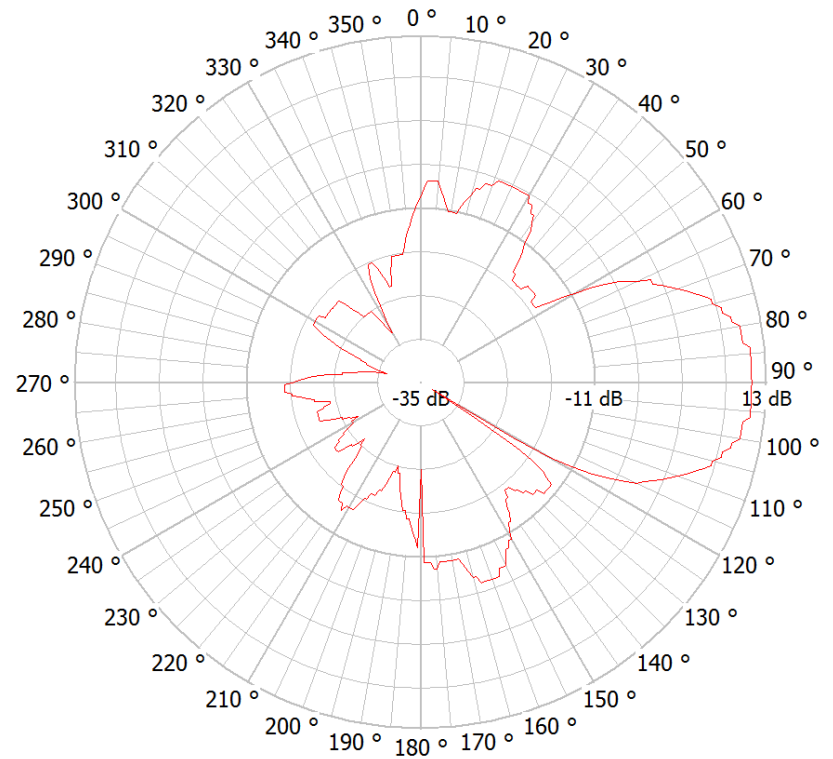

# 3-Sector sites

- ❖ Site = location (premises) for base station, antennas, cables, etc.
- ❖ The use of 3 sectors in each site is the most common approach.
- ❖ Omnidirectional antennas used in cells with low traffic load
- ❖ Here color code refers to coverage areas of different antennas (frequencies can be same or different in different sectors)

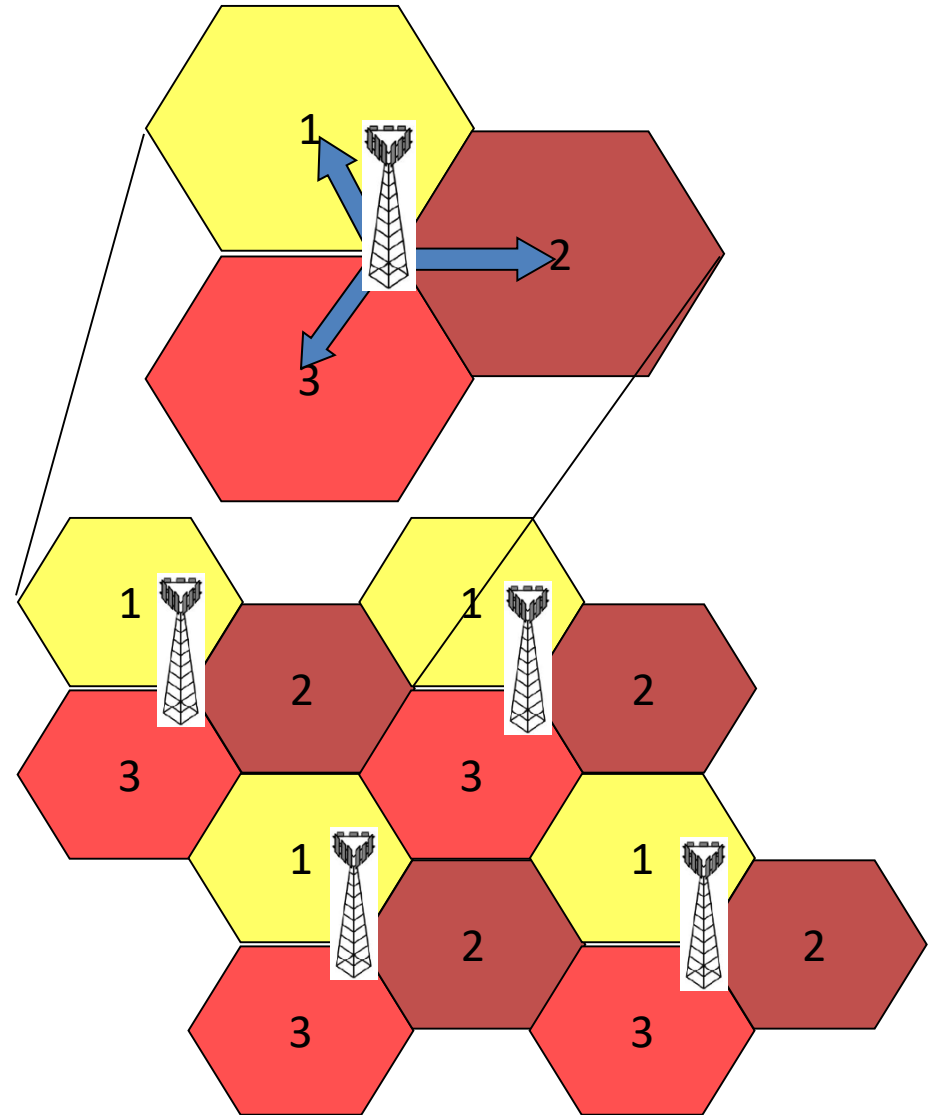



# 3D Radiation pattern/panel antenna

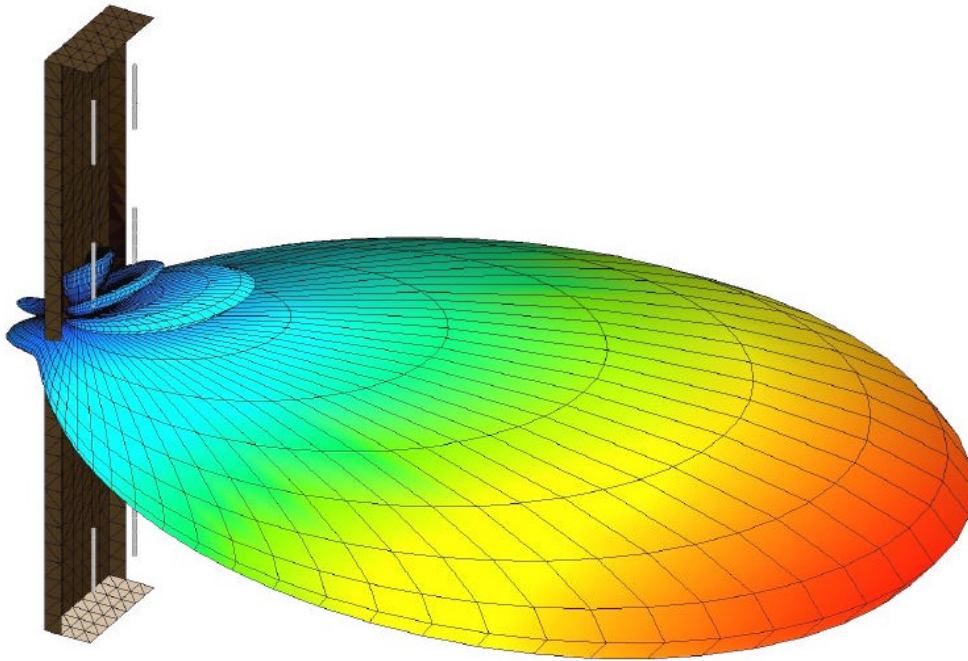

Horizontal pattern

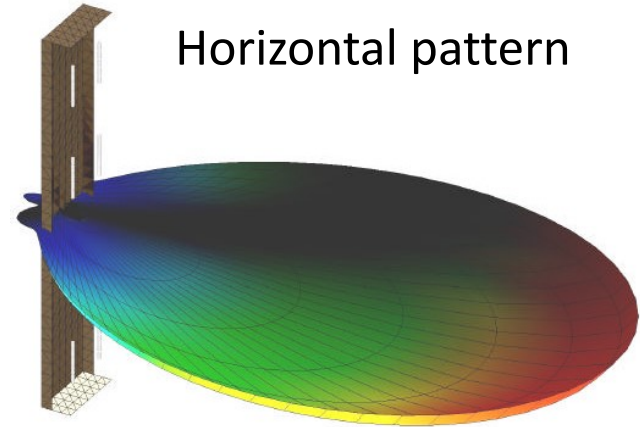

Vertical pattern

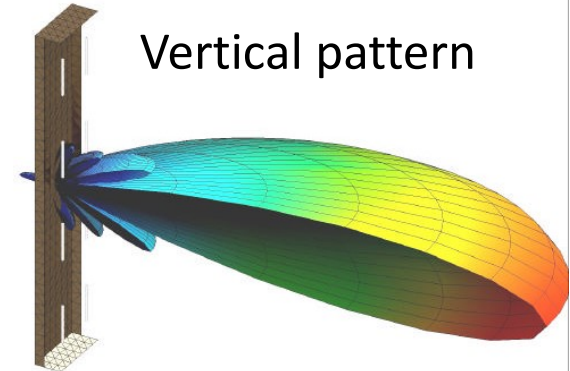



# Example

- ❖ Assume an antenna in which there are 6  $\lambda/2$  dipoles on top of each other so that narrow vertical beam can be formed.
  - What is antenna gain (in dBi's) of an ideal panel antenna when horizontal 3dB beam width is 65 degrees (3-sector site)?
- ❖ Solution.
  - Gain of vertical pattern is  $10 \cdot \log(6) \text{dBd} = 7.78 \text{dBd}$
  - In dBi's the gain of vertical pattern = 9.93dBi
  - Gain from horizontal pattern is  $10 \cdot \log(360/65) = 7.43 \text{dB}$
  - Total antenna gain = 17.36dBi

# Antenna tilting

- ❖ Compared to case where vertical beam is pointing to the horizon the down tilting of the pattern provides the following benefits:
  - The majority of the radiated power is concentrated within the sector
  - The reduction of the power towards the horizon avoids interference problems with the adjacent cells
  - Selected down tilt angle depends on the vertical half power beam width as well as the radio access system.

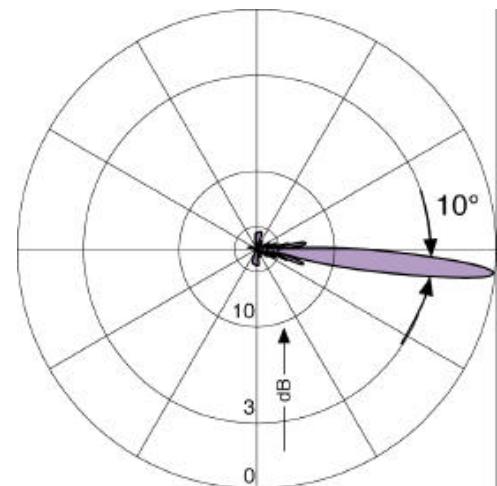
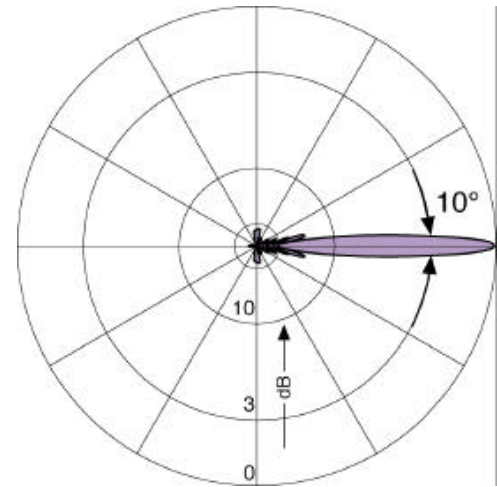

# Mechanical down tilt

- ❖ Mechanical down tilt is used to point the vertical pattern towards desired direction
  - The main impact of down tilt is achieved in main direction
  - Effective down tilt varies across the azimuth.
  - Change is smallest in sideslopes

Mechanical Tilt

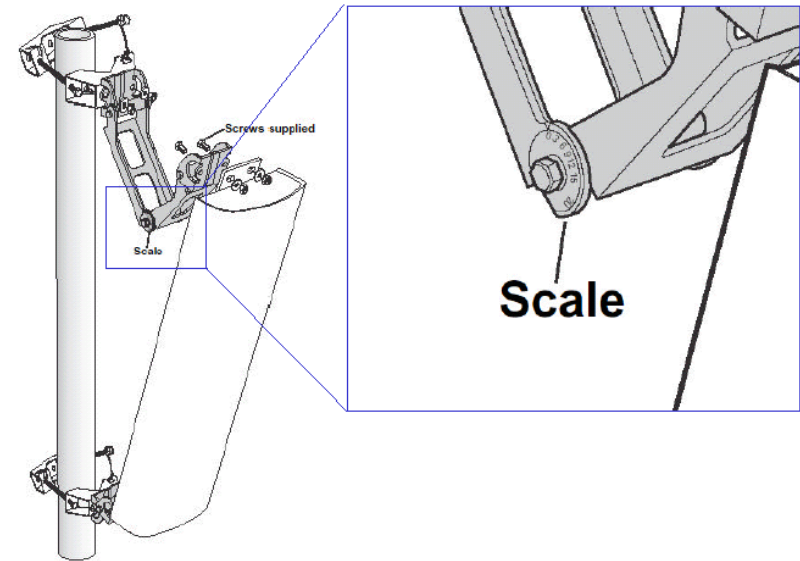

# Mechanical down tilt

- ❖ The effect to the horizontal pattern
  - Largest gain reduction in main direction
  - The form of the horizontal pattern changes
  - It is difficult to consider pattern deformation in network planning.

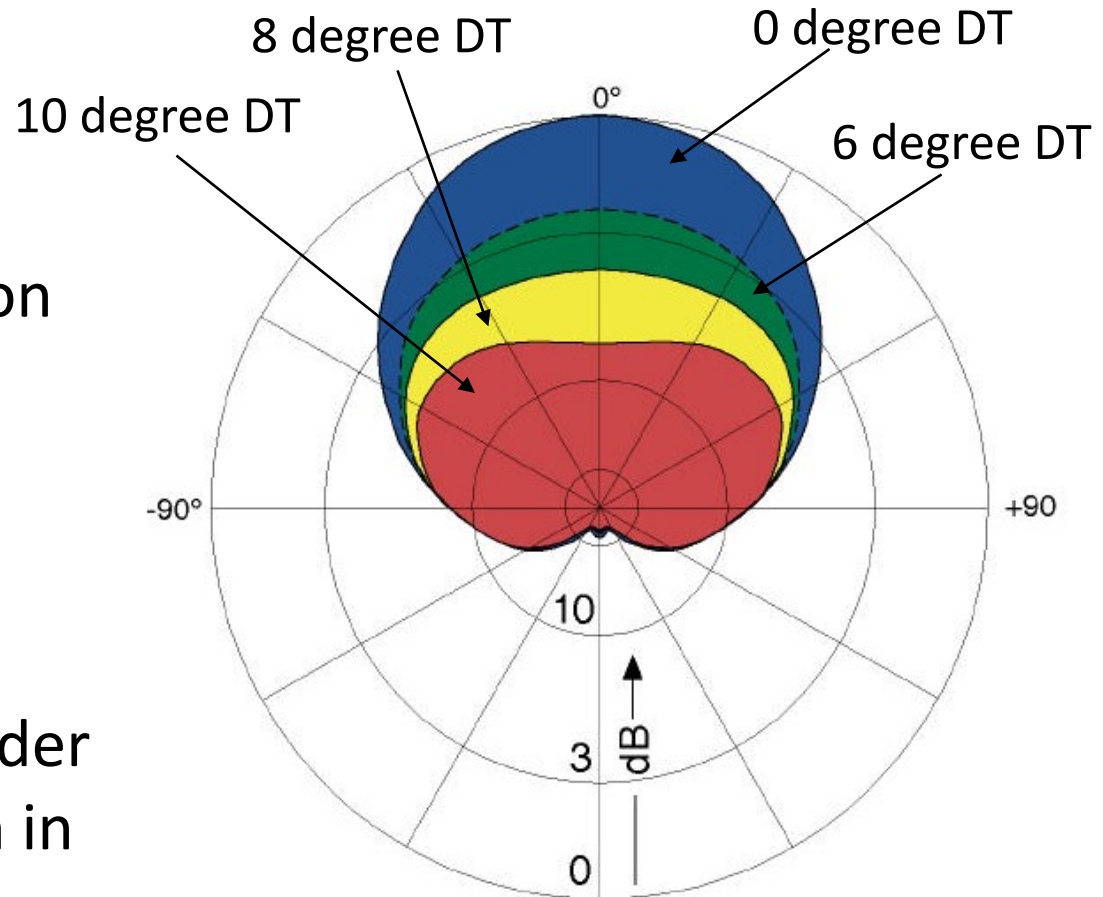

Horizontal pattern 105° / mechanical DT

# Electrical down tilt

- ❖ In electrical down tilt the antenna remains upright position
  - Instead of equal phases on the dipoles, different phase combinations are selected by varying the cable lengths to the dipoles. As a result different vertical patterns is formed.

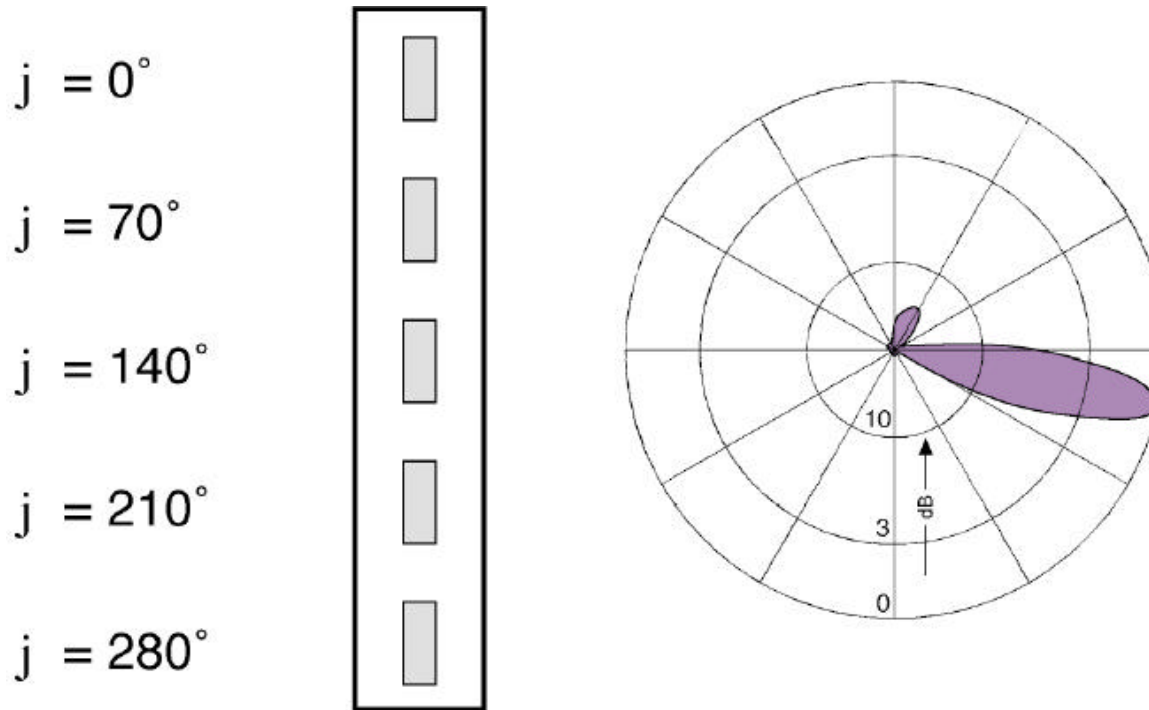

# Electrical down tilt

## ❖ Electrical Downtilt :

- The shape of the horizontal pattern remains constant
- More accurate network planning is enabled
- Maximum electrical DT angle approximately  $14^\circ$ . For higher DT angle a combination of mechanical and electrical DT is recommended

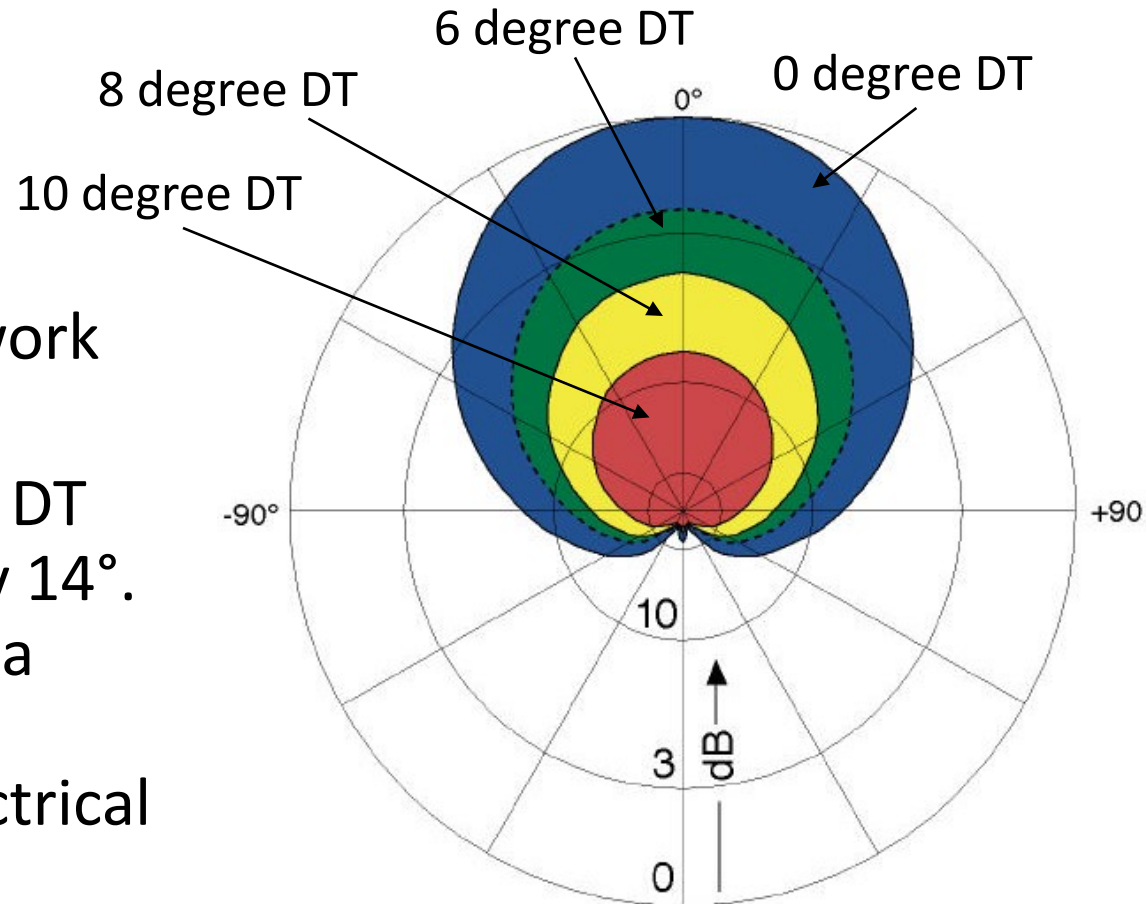

# Diversity antennas

- ❖ Diversity antennas are used in BS to catch two or more uncorrelated signals simultaneously
- ❖ Here 'uncorrelated' means that fast fading in diversity antennas is different => by combining signals from such antennas we obtain diversity.

Diversity antennas for one sector (cell)





# Illustration of diversity reception

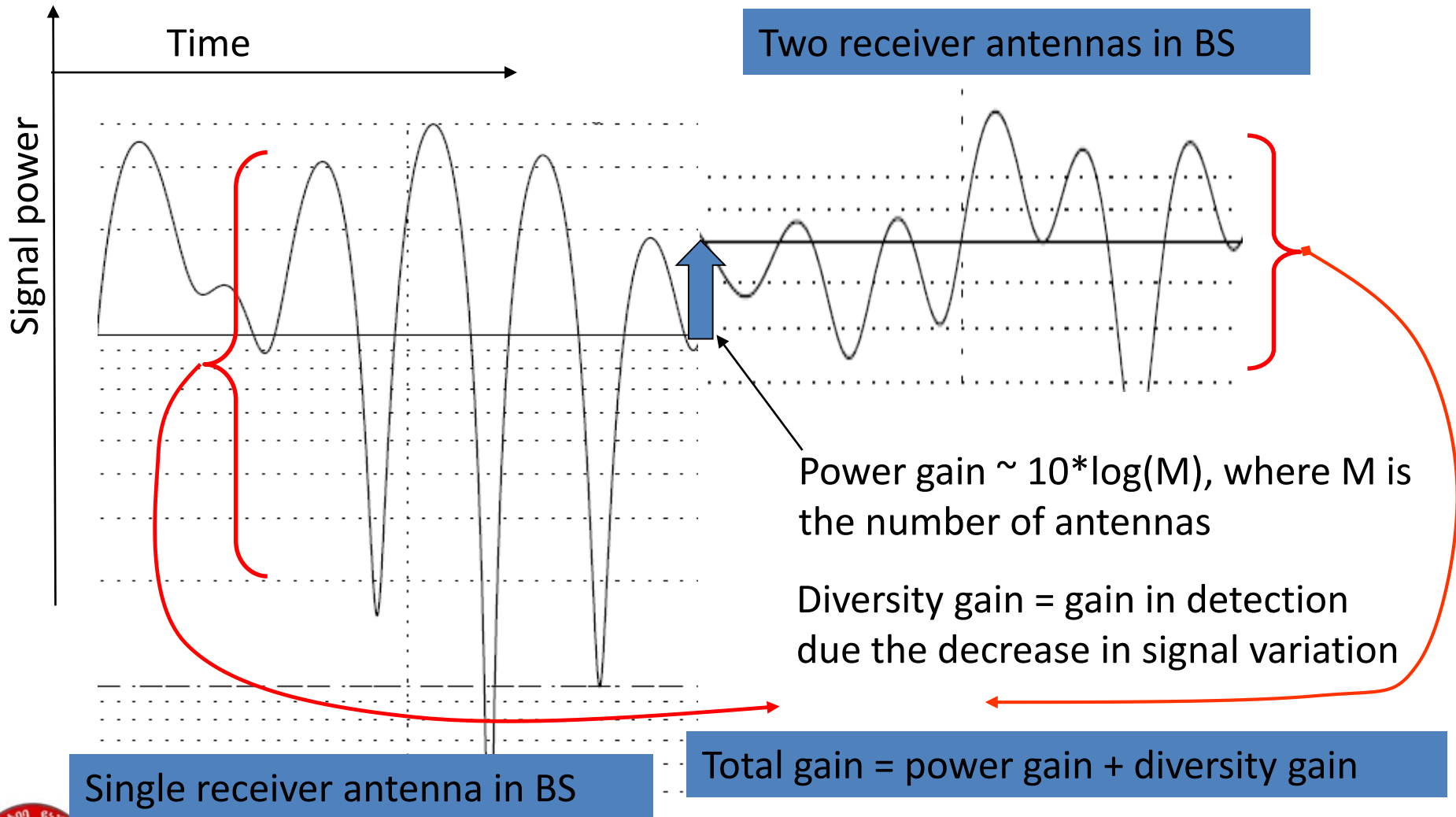



# Space diversity/panel antennas

- ❖ Space diversity admit good performance, but big spacing between antennas is required
  - Towers/masts are relatively expensive
  - By using duplexers the number of antennas can be reduced
  - In some countries it can be difficult to receive permission for large antenna systems.
  - Site prices can be huge.

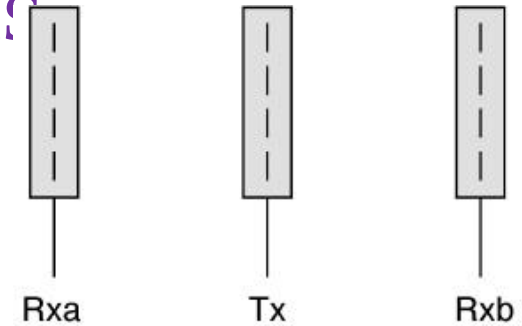

← Diversity spacing →

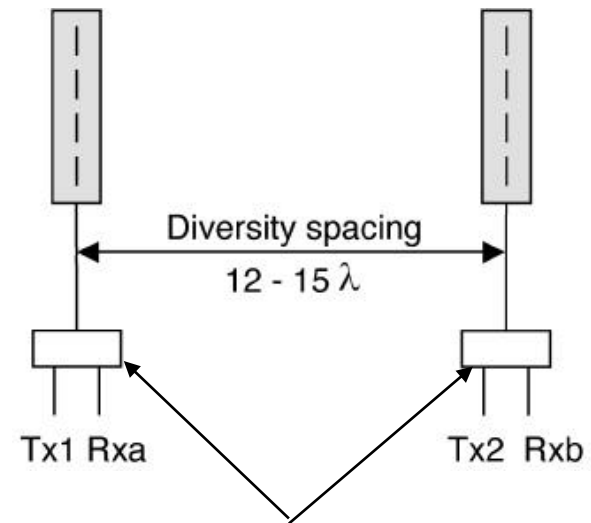

Duplexer is needed to separate RX and TX branches

# Space diversity/range

❖ Recall Okumura-Hata example. Path loss in large city when

- $f = 450$  MHz (□)
- $f = 900$  MHz (\*)
- $f = 1800$  MHz (o)
- $f = 1950$  MHz (x)

❖ Assume that allowed PL is 150dB. Then by antenna diversity (6dB gain) we can increase the cell range

$f = 1800$ MHz: 2.5 km  $\rightarrow$  3.3 km; 74% coverage increase

$f = 900$ MHz: 4.7km  $\rightarrow$  6.7km; 103% coverage increase

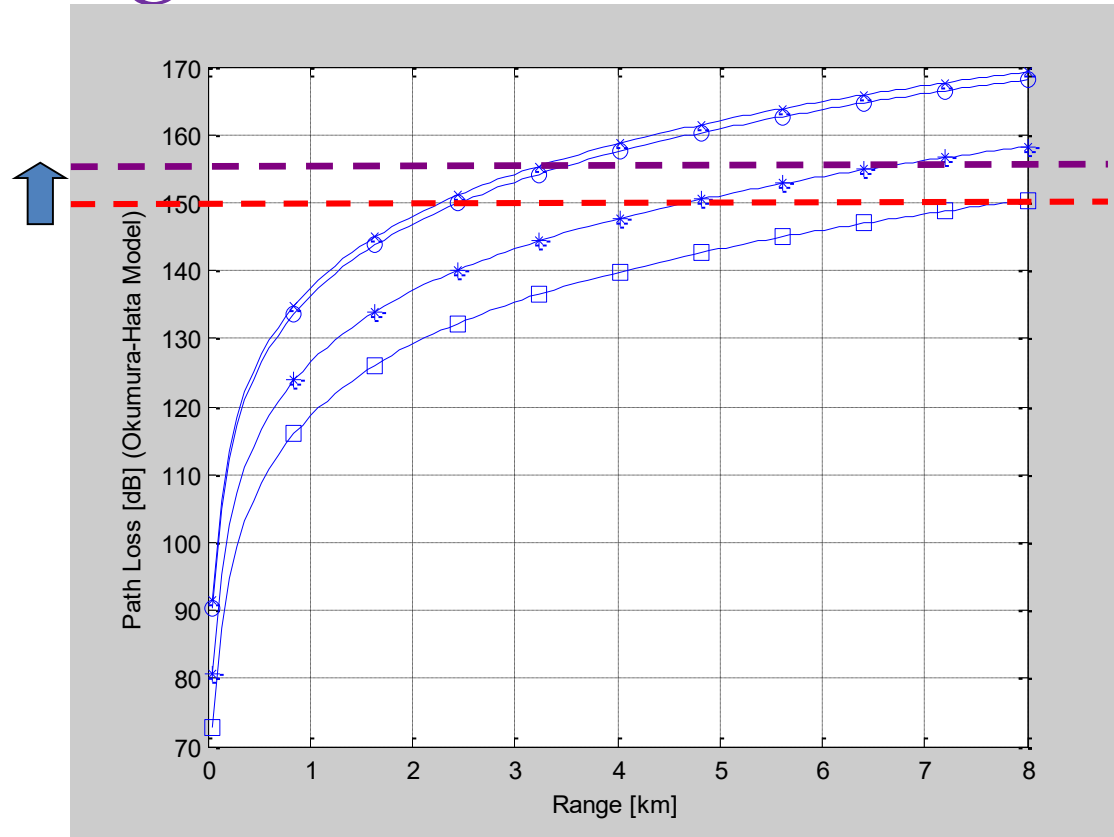

BS height = 30m, MS height = 1.5m



# Space diversity/comments

- ❖ Dimension of the diversity antenna system depends on the carrier frequency. In space diversity we usually need antenna separation larger than  $12\lambda$ 
  - $\lambda = 300/f$ , where  $\lambda$  [m] and  $f$  [MHz] =>
  - $f = 900\text{MHz}$ : separation  $> 12 * 0.33\text{m} = 4\text{m}$  (GSM)
  - $f = 1800\text{MHz}$ : separation  $> 2\text{m}$  (GSM)
- ❖ Diversity reception is commonly used in uplink. Recently diversity reception has been introduced also to mobile terminals.
- ❖ If diversity is used only in uplink then it doesn't necessarily lead to range extensions if downlink becomes a bottleneck

# V/H Polarization diversity

- ❖ Signal contains vertical (V) and horizontal (H) polarization component.
- ❖ V and H polarizations are orthogonal i.e. component signals are not correlating. Yet they may have different mean power
- ❖ In polarization diversity V and H polarized antennas are used. Great advantage is that space separation between diversity branches is not needed.
- ❖ Disadvantage
  - In rural areas power difference between V and H polarization can be large

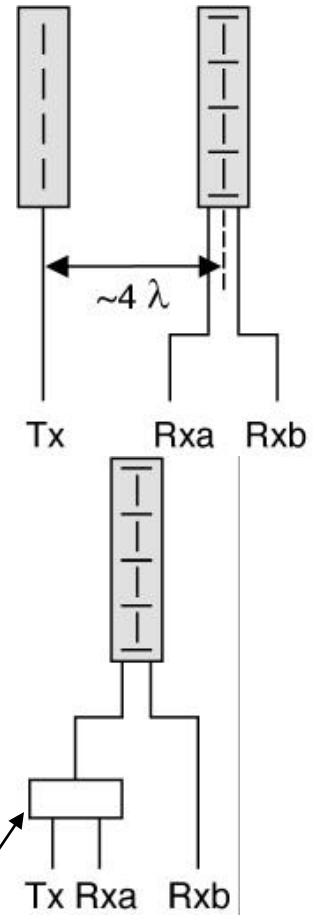

Duplexer is needed to separate RX and TX branches

# X Polarization diversity

- ❖ By rotating V and H polarizations we obtained +/- 45 degrees slanted polarizations
  - Antenna branches admit equal power => 'easier' signal from receiver perspective.
  - X-polarized antennas fit well for both rural and urban environments
- ❖ Both RX and TX can be embedded to the same physical antenna box

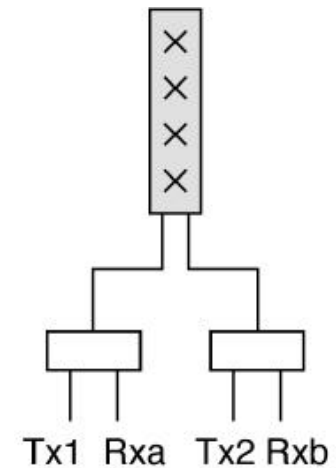
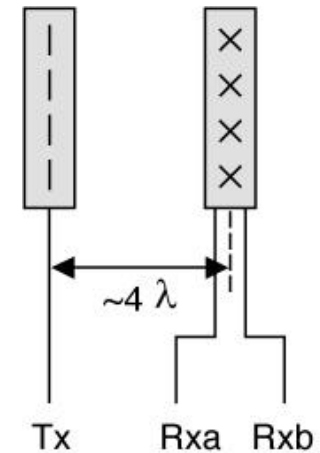

Duplexer needed

# Space vs X-polarization diversity



Space diversity, 2RX, 1 TX per sector, no duplexer

- ❖ Instead of 9 antennas (or 6 when duplexer is used) per site/base station, only 3 X-polarized antennas are required
- ❖ Size is reduced => better opportunities to find good antenna locations
- ❖ Site costs may be reduced (depending on the site contracts and regulations)



X-polarization diversity, 2RX, 1 TX per sector, duplexer



# Dualband antennas



- ❖ Dualband antennas are used when two systems operate on different frequency bands but on same sites.
- ❖ Operators always try to use old sites for new systems (sites can be very expensive)
- ❖ Dualband antennas with diversity
  - Space diversity (left; visual catastrophe)
  - XX-polarization diversity (right)



# Dualband X-polarization

- ❖ Using X-polarized antenna branches, diplexer and duplexer it is possible to design a compact antenna design for 3 sectors
  - 900/1800 MHz (e.g. GSM) ,
  - Two-branch diversity in uplink (X-polarization)
  - Design contains only 3 antennas (still 6 feeder cables)





# Lossy components

- ❖ Combiner (3dB coupler) = device that combines feeds from several TRXs so that they could be sent out through a single antenna. To be taken into account in GSM DL link budget.
- ❖ Duplexer = Used for separating sending and receiving signals to/from antenna. Can be used to decrease the number of antennas.
- ❖ Diplexer = a device that implements frequency domain multiplexing

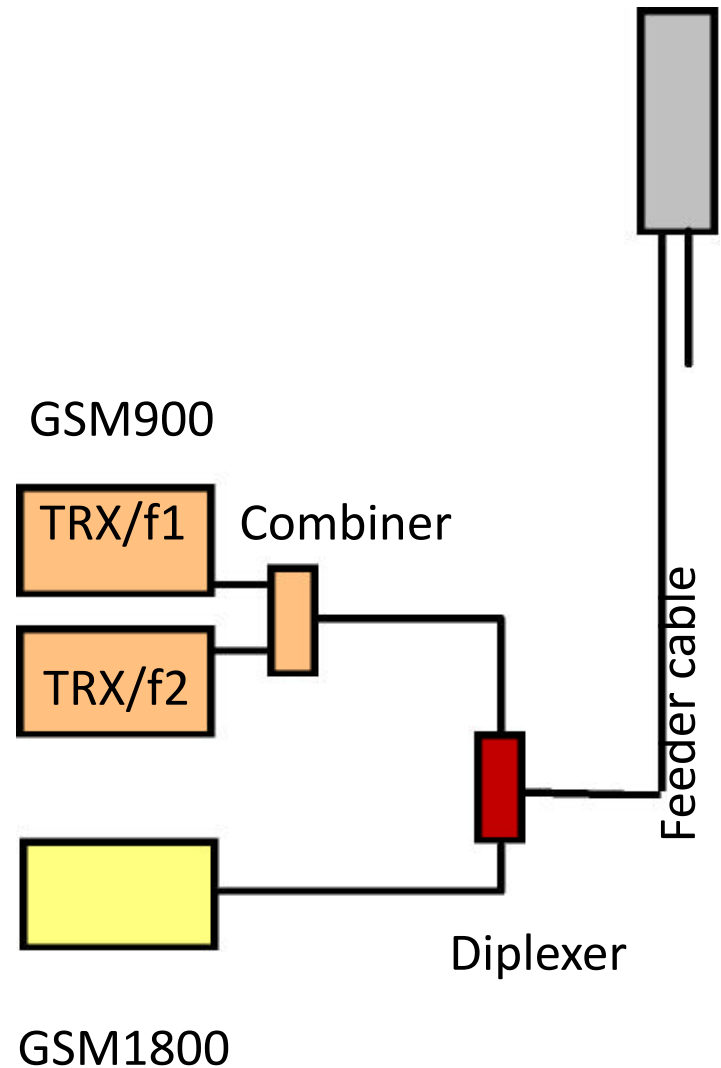

# Contents

- ❖ CNPO process
- ❖ Channel models (pathloss and fading)
- ❖ Antennas
- ❖ Noise
- ❖ Interference
- ❖ CNPO tools (WinProp introduced)
- ❖ QoS/QoE measurements and optimization



# Receiver system noise



- ❖ System noise components
  - Receiver noise (contributed by the different blocks)
  - Feeder line (and other lossy components) noise
  - Noise coming through the antenna
- ❖ The noise components are reduced to a common reference point , e.g. receiver input or antenna output

# Thermal noise

- ❖ Different noises often compared with thermal noise
- ❖ Thermal noise is generated when electrons hit the atoms in a lossy conductor
- ❖ Based on central limit theorem, thermal noise is usually modeled as zero-mean Gaussian random variable
- ❖ In an impedance matched system, power spectral density of thermal noise is

$$S(f) = \frac{hf}{e^{hf/kT} - 1}$$

where  $f$  is frequency,  $h$  is Planck's constant,  $T$  is conductor temperature in Kelvin and  $k$  is Boltzmann's constant= $1.38 \times 10^{-23}$  Ws/K

- ❖ On sufficiently low frequency ( $hf \ll kT$ ),  $S(f) \approx kT$ 
  - Approximation error is less than 1% when  $f < 870$  GHz

# Receiver noise

- ❖ Noise is generated in lossy components, and especially in active components
- ❖ Receiver noisiness is described by:
  - **equivalent noise temperature  $T_e$  , or**
  - **noise factor  $F$  (usually called as 'noise figure' when given in dB)**
- ❖ The noise factor will describe the degradation of the signal to noise ratio in the receiver. The connection between noise factor and noise temperature is given by

$$F = 1 + \frac{T_e}{T_s} \rightarrow T_e = (F - 1)T_s$$

where  $T_s$  is signal source noise temperature and  $T_e$  is the equivalent receiver noise temperature reduced to receiver input

# Receiver noise

The noise figure  $NF = 10\log F$  is usually given in the standard noise temperature 290 K

$$NF = 10 \text{ dB} \rightarrow T = (10 - 1) \cdot 290 = 2610 \text{ K}$$

$$NF = 5 \text{ dB} \rightarrow T = (3.162 - 1) \cdot 290 = 627 \text{ K}$$

$$NF = 1 \text{ dB} \rightarrow T = (1.259 - 1) \cdot 290 = 75 \text{ K}$$

In link budgets the following terminology is usually applied:

- **Thermal noise density** =  $N_0 = 10\log_{10}(k \cdot T_0) [dBm / Hz]$ ,  $T_0$  is the reference temperature
- **Receiver noise figure** =  $NF = 10\log_{10}(F) [dB]$
- **Receiver noise density** =  $N_0 + NF [dBm / Hz]$



# Contents

- ❖ CNPO process
- ❖ Channel models (pathloss and fading)
- ❖ Antennas
- ❖ Noise
- ❖ **Interference**
- ❖ CNPO tools (WinProp introduced)
- ❖ QoS/QoE measurements and optimization



# Received signal model

- ❖ Example of a simple (narrow band) model for received signal

$$r(t) = S_0(t) + n_I(t) + n_W(t)$$

- ❖ Variables in the model  $r = S_0 + n_I + n_W$ 
  - $S_0$  = contains transmitted symbol and impact of channel
  - $n_I$  = interference term
  - $n_W$  = white noise
- ❖ Noise is modeled as complex zero-mean Gaussian. Hence

$$E\{n_W\} = 0, \quad E\{|n_W|^2\} = P_N = \text{Noise power}$$

$$n_W = \text{Re}(n_W) + j \text{Im}(n_W) = X + jY,$$

$$f_X(x) = \frac{1}{\sqrt{\pi \cdot P_N}} e^{-\frac{x^2}{P_N}}, \quad f_Y(y) = \frac{1}{\sqrt{\pi \cdot P_N}} e^{-\frac{y^2}{P_N}}$$

- ❖ The interference distribution is not generally known
- ❖ For wideband example model, refer WCDMA lecture slides 33-37





# Terminology

❖ Terminology (equations refer to example):

➤ Signal to noise power (SNR):

$$SNR = \frac{|S_0|^2}{P_N} = \frac{\text{Power of desired signal}}{\text{Noise power}}$$

➤ Signal to interference and noise power (SINR)

$$SINR = \frac{|S_0|^2}{|n_I|^2 + P_N} = \frac{\text{Power of desired signal}}{\text{Interference power} + \text{Noise power}}$$

➤ Signal to interference power (SIR)

$$SIR = \frac{|S_0|^2}{|n_I|^2} = \frac{\text{Power of desired signal}}{\text{Interference power}}$$

# Remarks on terminology

- ❖ SNR is measure that is mostly used in *noise limited systems/deployments* where interference is not presence or it is ignorable small.
- ❖ SINR is most commonly used measure.
- ❖ SIR can be used for analysis in *interference limited systems/deployments* where interference power is clearly dominating over noise power.
- ❖ In system level simulations it is possible to map SINR to a certain data rate. From network planning perspective SINR is more important than SNR and SIR
- ❖ If distributions of SNR, SINR or SIR are simulated, then formulas of the previous slide are used but in analysis expected powers can be used instead of instantaneous powers.

# Inter-system vs intra-system interference

## Intra-system interference:

- Systems operating on licensed bands: Cellular and most of the broadband wireless systems, GSM/EDGE, WCDMA, HSPA, Mobile WiMAX
- Form of intra-system interference depends on the system design.
- Existence of intra-system interference can be predicted at least statistically.
- Ability of system to control and mitigate of intra-system interference depends on the system design.

## Inter-system interference:

- Systems operating on unlicensed bands (2.5GHz, 5.25GHz bands).
- Wireless local area networks (WLAN),
- Wireless personal area networks (WPAN)
- Form/shape of inter-system interference depends on the interfering system.
- Inter-system interference is unexpected in nature
- Control and mitigation of inter-system interference is extremely difficult or even impossible in most cases.



# Co-channel vs adjacent channel interference

## Interference in cellular networks

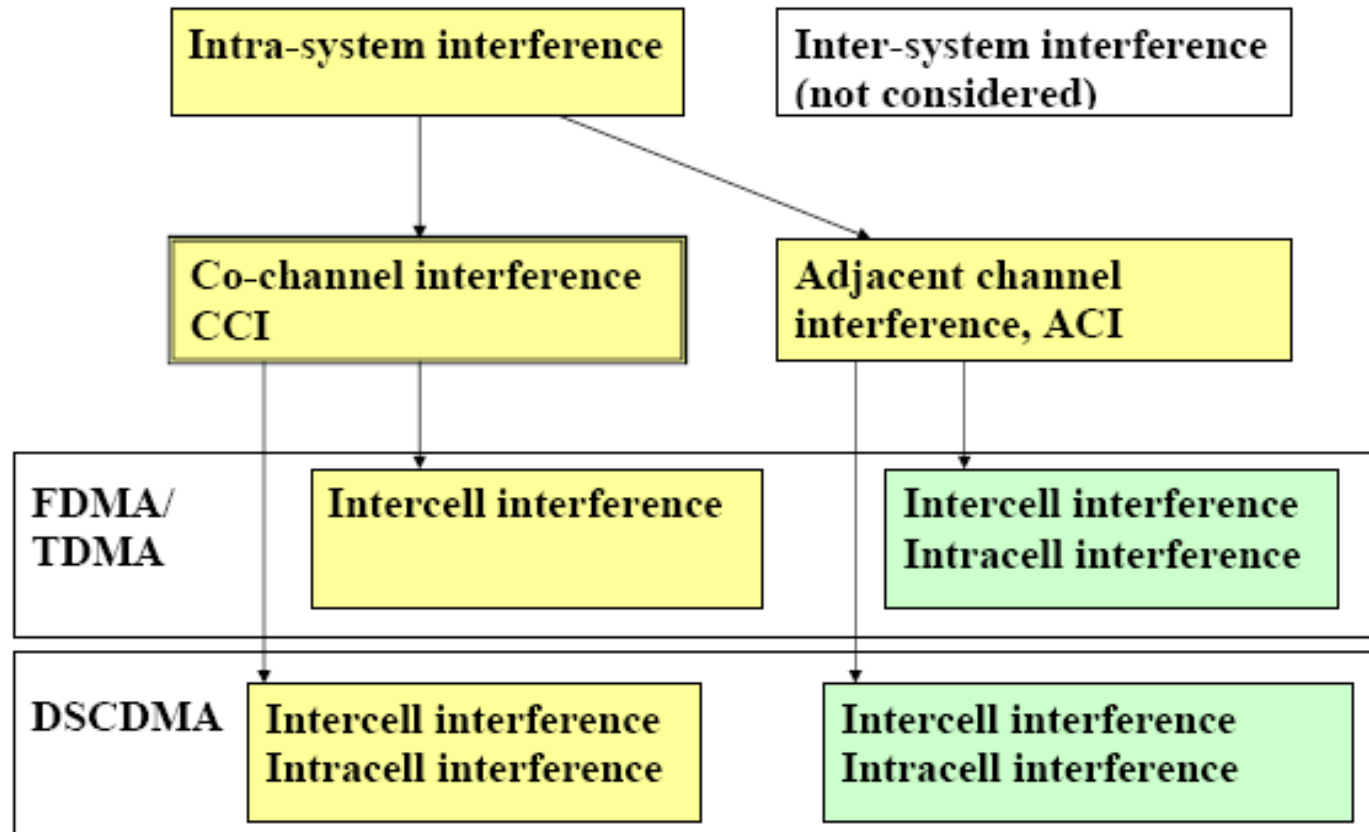

# Co-channel interference (CCI)

- ❖ Co-channel interference arise when same radio resources are used nearby each other at the same time
- ❖ Most commercial radio systems suffer from co-channel interference because not all access points/base stations can use separate radio resources
- ❖ In e.g. cellular networks there is always co-channel interference. By using various radio resource reuse techniques the impact of interference can be partly removed
- ❖ Yet, due to increasing demand for radio resource usage efficiency the reuse distance is decreasing and co-channel interference is becoming the limiting factor for development



# Adjacent channel interference

- ❖ Adjacent-channel interference is interference that is caused by power leakage to an adjacent channel.
- ❖ Adjacent channel interference can be attenuated by adequate filtering
  - For radio systems there are certain RF specifications that put requirements to adjacent channel filtering
- ❖ Adjacent channel interference should be also taken into account in system design planning.
  - In system level adjacent channel interference can be mitigated also through proper frequency planning
- ❖ Adjacent-channel interference is also sometimes called as crosstalk.
  - In analog systems (e.g. NMT) there can be crosstalk (literally) between adjacent channels

# Co-channel/adjacent channel interference

## ❖ In the following we concentrate on co-channel interference.

- Co-channel interference is a system issue: By proper radio system design and planning we can mitigate the co-channel interference partly.
- There will be always trade-off between co-channel interference and system efficiency
- The focus is in co-channel interference that occurs in GSM, WCDMA and HSDPA like wide area systems, i.e. in systems that are designed to provide user access everywhere

## ❖ Adjacent channel interference is more related to implementation technologies.

- In radio systems adjacent channel interference is usually taken into account in specifications regarding to HW requirements.



# General formulation of Co-channel interference (CCI)

❖ General signal formulation:

$$r = S_0 + \sum_{k=1}^K S_k + n_W$$

where  $n_W$  is the white noise term,  $S_0$  is the desired signal and  $S_k$  refers to the interfering signal from  $k$ th transmitter.

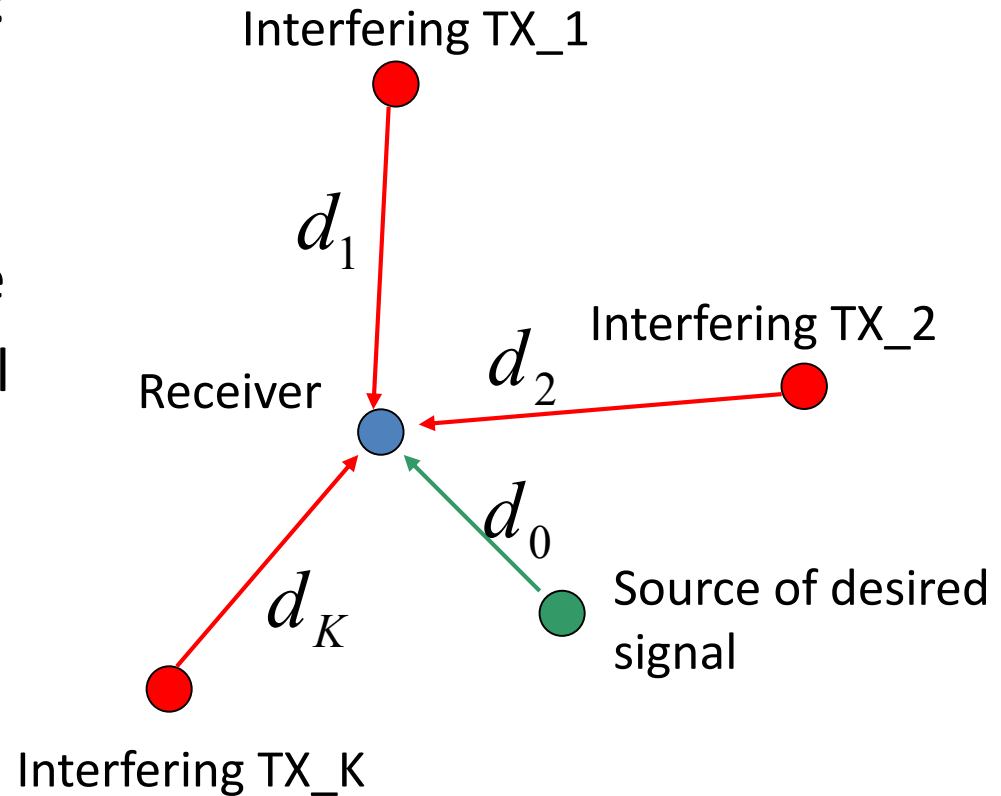



# General formulation of CCI

- ❖ The expected power per symbol is assumed to be 1. Then

$$\begin{aligned} E\{|S_0|^2\} &= P_0^{RX} = P_0^{TX} / L_0 & E\{|n_w|^2\} &= P_N \\ E\{|S_k|^2\} &= P_k^{RX} = P_k^{TX} / L_k \end{aligned}$$

where  $L_0$  refers to path loss between receiver and source of the desired signal,  $L_k$  refers to the path loss between kth interfering transmitter and receiver and  $P_N$  is the power of the white noise.

- ❖ We note that in general the path loss contains the impact from average path loss (distance dependent), shadow fading and fast fading. Thus, we may write

$$L_k = L_k(d_k) / \left( L_k^{SF} \cdot |h_k|^2 \right)$$

# CCI: average path loss

- ❖ The average path loss formula can be different for different transmitter - receiver pairs, i.e.

$$L_k(d_k) = \alpha(k) \cdot d_k^{\beta(k)}$$

where  $\beta(k)$  is the path loss exponent and  $\alpha(k)$  is a constant term. Yet, if path loss parameters are same for all transmitter-receiver pairs then  $\beta(k) = \beta$ ,  $\alpha(k) = \alpha$  and

$$L_k(d_k) = L(d_k) = \alpha \cdot d_k^\beta$$

- ❖ This is typical assumption in system simulations. Hence, all transmitter-receiver pairs are assumed to admit same path loss characteristics
- ❖ More accurate path-loss map can also be obtained from deterministic path loss computation (e.g. Using WinProp)



# CCI: shadow fading

- ❖ The shadow fading follows lognormal distribution, i.e.

$$L_k^{SF} = 10^{\frac{\xi_k}{10}}$$

where  $\xi_k$  is sample from a zero mean Gaussian statistics with standard deviation  $\sigma_k$ . Again, if it is assumed that all transmitter receiver pairs admit the same shadow fading characteristics, then  $\sigma_k = \sigma$

- ❖ Shadow fading in different links is usually correlated. In most studies of cellular systems the correlation between shadow fading between links of close base stations is assumed to be the same (=0.5). The correlation between sectors of the same site is assumed to be 1.0. (link from terminal to different sector antennas of the same site)

# CCI: fast fading

- ❖ Fast fading in different links is uncorrelated and we use normalization

$$E\{|h_k|^2\} = 1$$

- Most frequently assumption is that there is no LOS between transmitters and receiver and thus, amplitude of fast fading signal follows Rayleigh distribution.
- If multiantenna link is applied, then correlation between antennas is assumed. The form of the correlation matrix depends on the antenna system and radio environment.



# General formulation of SINR

- ❖ Now the general SINR formula is given by

$$(*) \text{ SINR} = \frac{P_0^{TX} L_0^{SF} \cdot |h_0|^2 G_0(\theta_0, \phi_0) / L_0(d_0)}{\sum_{k=1}^K P_k^{TX} L_k^{SF} \cdot |h_k|^2 G_k(\theta_k, \phi_k) / L_k(d_k) + P_N}$$

where  $G_k(\theta_k, \phi_k)$  = Combined horizontal and vertical antenna gain  
(contains both transmitter and received antenna gains)

- ❖ Note that in DL (\*) assumes K interfering BS and in UL (\*) assumes K interfering mobile stations.
- ❖ If all BSs in DL use the same antenna type (or all MSs in UL use the same antenna type), then

$$G_k(\theta_k, \phi_k) = G(\theta_k, \phi_k)$$

# SINR-throughput mapping

- ❖ In many cases throughput is more appropriate measure for the system performance. Then we may map the SINR performance to the throughput performance.
- ❖ We can use modified shannon formula

$$(*) TP = A \times BW \times \log_2(1 + B \cdot SINR)$$

Where BW is the system bandwidth and A and B are system specific correction factors

- ❖ The formula (\*) provides an approximation to the Adaptive Modulation and Coding (AMC) schemes (also called as Modulation and Coding Schemes (MCS) applied by the system

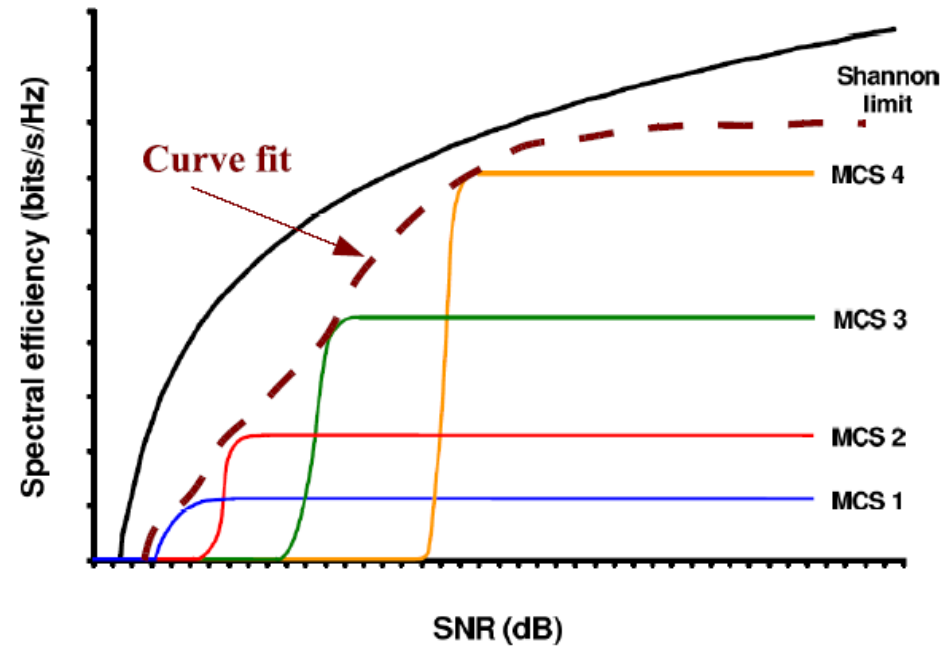

# Contents

- ❖ CNPO process
- ❖ Channel models (pathloss and fading)
- ❖ Antennas
- ❖ Noise
- ❖ Interference
- ❖ CNPO tools (WinProp introduced)
- ❖ QoS/QoE measurements and optimization



# CNPO tools

- ❖ Various commercial mobile network planning and optimization tools
  - Altair WinProp:  
<http://www.altairhyperworks.com/product/FEKO/WinProp-Propagation-Modeling>
  - Forsk Atoll: <http://www.forsk.com/atoll/features/>
  - Aircom Asset: <http://www.teoco.com/products/planning-optimization/asset-radio-planning/>
  - Nokia NetAct Planner
- ❖ Each has its own pros and cons
  - Check their website and make comparison

**WinProp to be introduced in Tutorial section!**

The screenshot displays the WinProp software interface. At the top, the 'WinProp' logo is visible. Below it, the 'ProMan' module is highlighted, which is divided into two main sections: 'Propagation Models' and 'Network Planning'. The 'Propagation Models' section lists: Rural / Suburban, Urban, Indoor, CNP (Urban/Indoor), Tunnel, and Time Variant. The 'Network Planning' section lists: LTE, 3G (UMTS/HSPA, CDMA 2000), 2G & 2.5G (GSM, GPRS, EDGE), WiMAX (Fixed & Mobile, 802.16), W-LAN (IEEE 802.11 a/b/g/n), and Broadcasting (DVB-T, DVB-H,...). Below the ProMan module, four other modules are shown: WallMan (Graphical Editor for 3D Vector Databases), TuMan (Graphical Editor for Tunnel Databases), AMan (Graphical Editor for Antenna Patterns), and CoMan (Simulator for Connectivity). Each module has a small representative image below its name.

WinProp <sup>AVE</sup>			
ProMan			
<b>Propagation Models</b> <ul style="list-style-type: none"><li>- Rural / Suburban</li><li>- Urban</li><li>- Indoor</li><li>- CNP (Urban/Indoor)</li><li>- Tunnel</li><li>- Time Variant</li></ul>	<b>Network Planning</b> <ul style="list-style-type: none"><li>- LTE</li><li>- 3G (UMTS/HSPA, CDMA 2000)</li><li>- 2G &amp; 2.5G (GSM, GPRS, EDGE)</li><li>- WiMAX (Fixed &amp; Mobile, 802.16)</li><li>- W-LAN (IEEE 802.11 a/b/g/n)</li><li>- Broadcasting (DVB-T, DVB-H,...)</li></ul>		
<b>WallMan</b> Graphical Editor for 3D Vector Databases	<b>TuMan</b> Graphical Editor for Tunnel Databases	<b>AMan</b> Graphical Editor for Antenna Patterns	<b>CoMan</b> Simulator for Connectivity



# Contents

- ❖ CNPO process
- ❖ Channel models (pathloss and fading)
- ❖ Antennas
- ❖ Noise
- ❖ Interference
- ❖ CNPO tools (WinProp introduced)
- ❖ QoS/QoE measurements and optimization



# Why QoE measurement?

- ❖ QoE is the actual experience perceived by users
- ❖ Maintaining user QoE is a key for mobile operators,
  - Directly impacts operator business affecting its market share
  - Particularly in competitive market
    - ✓ Reputation for providing a good-quality network will attract new and retain existing subscribers
- ❖ Quality needs to be quantified and measured
  - Key Performance Indicators (KPIs) → Network level quality indicator
  - Key Quality Indicators (KQIs) → Application/service level quality indicator

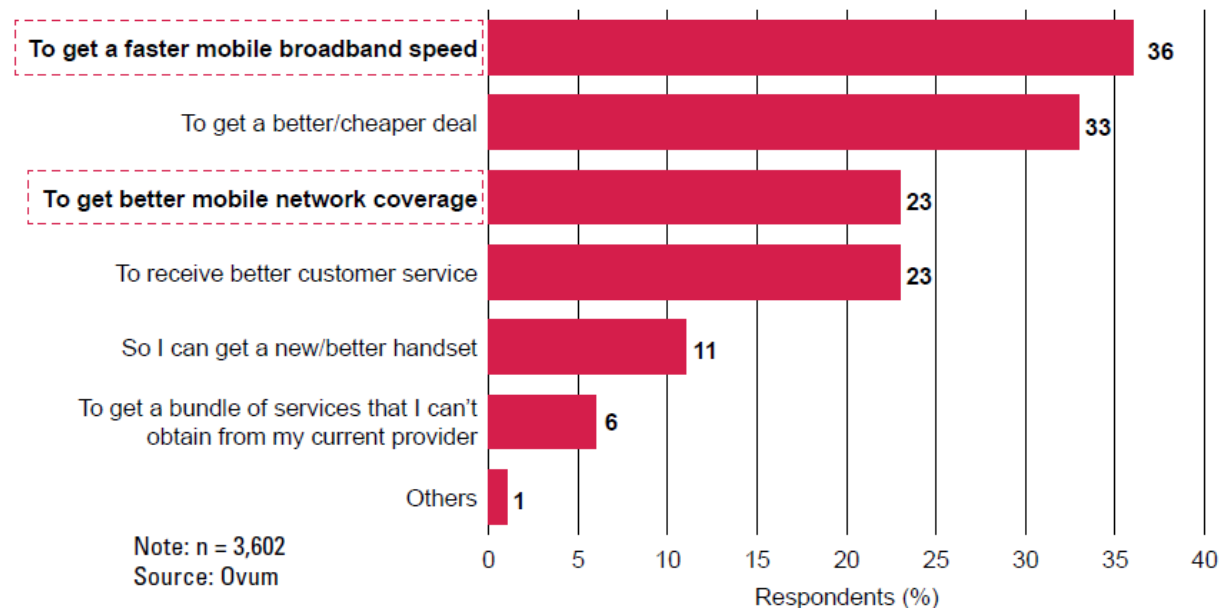

# Quality indicators: KQIs and KPIs

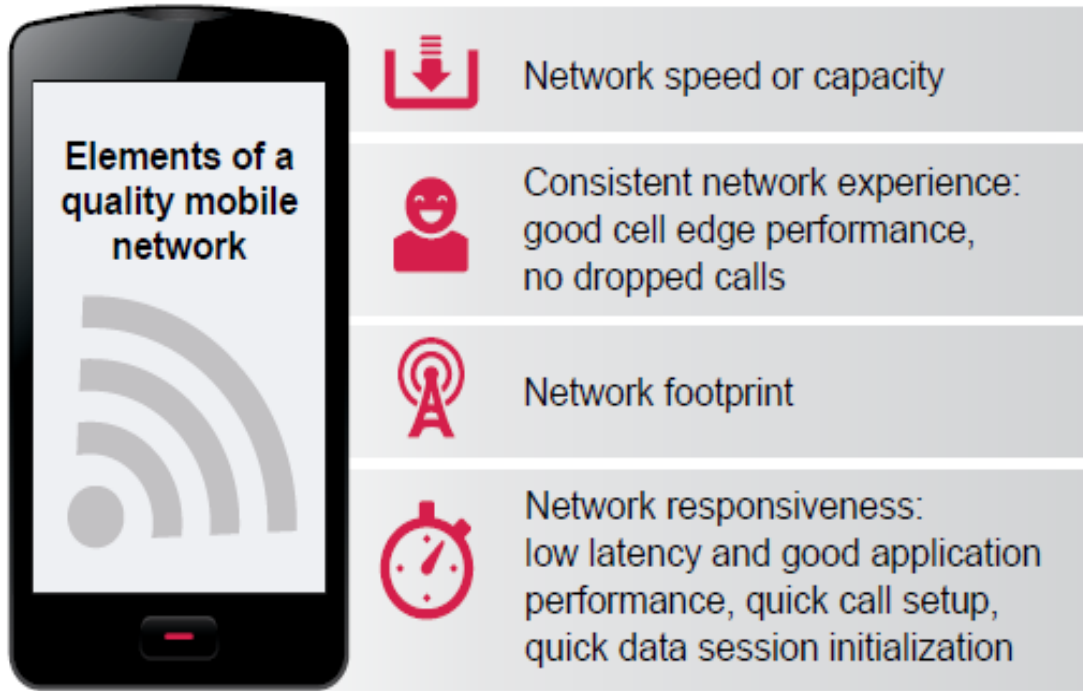

Examples:

KPI: Packet loss, Jitter

KQI: MOS score

Elements of a quality mobile network

Source: Ovum

Operators define different KQIs and KPIs.

Task: Explore the most popular KQIs and KPIs for the different technologies and services, say for Ethio Telecom



# Sources for quality data (1/2)

## 1. Network side measurement:

- ❖ Where quality data measured and obtained from the network side at Network Management System (NMS)
- ❖ + Easy to have 24/7 data
- ❖ + Provides cell-level data used for deep analysis
- ❖ - Lack user location based information
- ❖ - Less marketing value

## 2. Mobile side measurement

- I. Drive and Test: deploying vehicles containing mobile radio network air interface measurement equipment and various selected mobile handset
  - ❖ +Localized data from user perspective
  - ❖ - Costly
  - ❖ - Usually limited scope in terms of time and location

Customer complains are very good input to plan route of drive and test



# Sources for quality data (2/2)

II. Crowdsourcing: users just download free apps from online stores and can conduct performance tests from their mobile devices

- ❖ E.g. Netradar, Speedtest, OpenSignal
- ❖ + Relatively inexpensive
- ❖ - Limited in terms of user adoption, distribution, data consistency
- ❖ - May be synthetic rather than application-focused

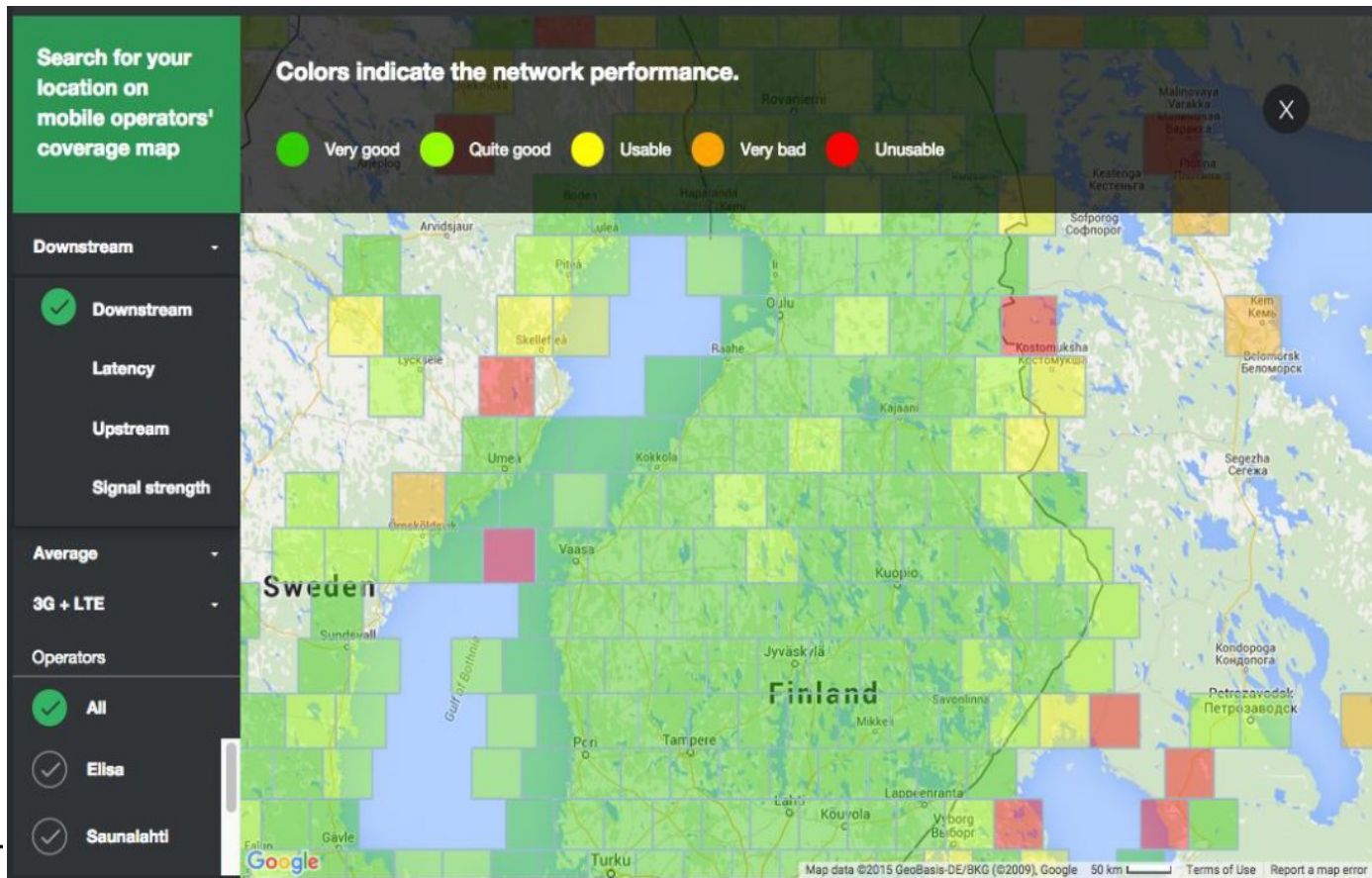

# Optimization

- ❖ Based on quality measurement data and its analysis, operators need to plan short-term and long-term network updates/optimizations
  - According to their business strategy and plan
- ❖ The optimization process is an ongoing operation, which becomes more and more complex as the network matures and becomes larger
  - The first steps of optimization consist mainly of standard cleaning operations such as frequency correction, adjacency handling and site engineering review
  - Then fine-tuning of parameters and a complex cell-by-cell troubleshooting

