

Lecture Notes in Mobility

Marin Marinov *Editor*

# Sustainable Rail Transport

Proceedings of RailNewcastle Talks 2016

 Springer

# **Lecture Notes in Mobility**

**Series editor**

Gereon Meyer, Berlin, Germany

More information about this series at <http://www.springer.com/series/11573>

Marin Marinov  
Editor

# Sustainable Rail Transport

Proceedings of RailNewcastle Talks 2016

 Springer

*Editor*

Marin Marinov  
NewRail, Centre for Railway Research  
Newcastle University  
Newcastle upon Tyne  
UK

ISSN 2196-5544

Lecture Notes in Mobility

ISBN 978-3-319-58642-7

DOI 10.1007/978-3-319-58643-4

ISSN 2196-5552 (electronic)

ISBN 978-3-319-58643-4 (eBook)

Library of Congress Control Number: 2017940814

© Springer International Publishing AG 2018

This work is subject to copyright. All rights are reserved by the Publisher, whether the whole or part of the material is concerned, specifically the rights of translation, reprinting, reuse of illustrations, recitation, broadcasting, reproduction on microfilms or in any other physical way, and transmission or information storage and retrieval, electronic adaptation, computer software, or by similar or dissimilar methodology now known or hereafter developed.

The use of general descriptive names, registered names, trademarks, service marks, etc. in this publication does not imply, even in the absence of a specific statement, that such names are exempt from the relevant protective laws and regulations and therefore free for general use.

The publisher, the authors and the editors are safe to assume that the advice and information in this book are believed to be true and accurate at the date of publication. Neither the publisher nor the authors or the editors give a warranty, express or implied, with respect to the material contained herein or for any errors or omissions that may have been made. The publisher remains neutral with regard to jurisdictional claims in published maps and institutional affiliations.

Printed on acid-free paper

This Springer imprint is published by Springer Nature

The registered company is Springer International Publishing AG

The registered company address is: Gewerbestrasse 11, 6330 Cham, Switzerland

# Preface

Three successful editions of a summer school in rail and logistics co-funded by the Erasmus Intensive Programmes of the European Commission, managed by the British Council in the UK, have established RailNewcastle as a brand. Delivered by NewRail at Newcastle University, North East of England, our first edition was in the summer of 2012, engaging with over 60 students and 20 lecturers from 10 European countries. We kept the pace for three years. More than 300 people interested in rail transport and logistics benefited from this joint venture. As a result of the 1st edition of RailNewcastle, we produced a handbook compiling the teaching material used for the summer school; Marinov M. Introduction: Handbook: An intensive Programme in Railway and Logistics. *Research in Transportation Economics* 2013, 41(1), 1–2.

One of the unique features of the summer school was the group work, which led to the development of excellent student research projects. A collection of outcomes from this learning activity was published by the International Scientific Journal *Transport Problems*; Marinov M. Editorial: introduction to group research projects developed within an intensive programme in railway and logistics. *Transport Problems* 2014, 9, 5–7.

In 2015, after three editions of a summer school, we moved on to a conference. Over 100 participants from all over the world were welcomed by RailNewcastle Conference 2015. The Rail Technology Magazine (RTM) joined in with us as the RailNewcastle Conference media partner. Three keynote speakers delivered excellent and thought-provoking presentations: Prof. John Roberts, UK; Dr. Janene Piip, Australia and David Prescott, UK. The conference was supported by UIC, the International Union of Railways. The last day of the conference was dedicated to the official launch of the UIC global network of railway talents. We hosted the 1st Railway Talents event in Newcastle upon Tyne, which was great success. On the whole, rail-related research developments of good quality were presented during the conference, and as a result a number of special issues in peer-reviewed journals were produced, for example;

- Marinov M. Editorial: Special Issue, RailNewcastle Conference 2015, Urban Rail Transit and Light Rail. *Urban Rail Transit* 2015, 1(2), 69–70.
- Marinov M. Introduction to the Special Issue on Rail Operations, Management and Economics. *Research in Transportation Economics* 2015, 54, 1.

Papers for publication in the Open Access Journal “Social Sciences” were also selected and published. Examples include:

- Yesid Asaff, Viviane V. F. Grubisic, Regis K. Scalice, and Acires Dias, (2015) The Resurgence of Education in Railway and Metro Engineering in Brazil, *Social Sciences* 2015, 4, 806–819; doi: [10.3390/socsci4030806](https://doi.org/10.3390/socsci4030806)
- Anna Fraszczyk, Joseph Dungworth, Marin Marinov (2015) Analysis of Benefits to Young Rail Enthusiasts of Participating in Extracurricular Academic Activities. *Social Sciences* 2015, 4(4), 967–986. doi: [10.3390/socsci4040967](https://doi.org/10.3390/socsci4040967)
- Janene Piip (2015) Leadership Talent: A Study of the Potential of People in the Australian Rail Industry, *Social Sciences* 2015, 4(3), 718–741; doi: [10.3390/socsci4030718](https://doi.org/10.3390/socsci4030718)
- Luca Rizzetto, Gabriele Malavasi, Stefano Ricci, Noemi Montaruli, Nicoletta Abbascià, Riccardo Risica, Giovanni Bocchetti, Federico Gherardi and Alessandra Raffone (2015) A Successful Cooperation between Academia and Industry in Higher Rail Education: The Postgraduate Course in “Railway Infrastructure and Systems Engineering” at Sapienza, *Social Sciences* 2015, 4(3), 646–654; doi: [10.3390/socsci4030646](https://doi.org/10.3390/socsci4030646)

In 2016, we run RailNewcastle Talks’ sessions for academics. Researchers, professionals, students, lecturers and enthusiasts with interest in rail were all welcome to join in. The material collected from these sessions was offered for publication to Springer. We felt comfortable with organising conference proceedings and lecture notes as most of the attendees were active researchers and academics specialising in rail transport. RailNewcastle Talks 2016 was mainly dedicated to rail operations, engineering, logistics, metro systems, vehicles’ interior design, freight and innovation. The crucial topic of rail marketing, jobs and public engagement was also included in the discussion.

When we asked what participants enjoyed most about RailNewcastle Talks 2016, many of them responded that it was highly beneficial and informative when they discussed rail-related topics with their peers and shared their research findings and knowledge across so that they were able to set up avenues for collaborative projects and other joint ventures expected to materialise the near future.

RailNewcastle is an initiative that proves that railways connect people, not only in a physical, but also in a research context. We are proud to say that a few hundred people from across the globe benefited professionally from RailNewcastle activities so far. And we do not intend to stop here. Instead we intend to continue making rail popular at all levels of research, education and outreach in our local university environments and well beyond.

In conclusion, we are most grateful to all participants and contributors to RailNewcastle activities. We are also grateful to Springer for disseminating this

valuable material, which, in addition to research work, could be used as teaching material for a variety of courses on: Rail Operations and Management, Railway System Engineering, Rail Infrastructure, Rail Vehicle Design, Railway Freight Transport, Transport and Logistics, Rail Technology and Mobility, European Railway Systems, Organisation of Railway Transport, Railway Signalling and Control, Railway Planning, Rail Transport for Land Transport Management Graduates, Rail Marketing and Public Engagement, Rail Innovation, Transport Technical Operation and Security, Multimodal, Intermodal, Transport Policies, Interchanges and Terminals Design.

Marin Marinov  
NewRail, Centre for Railway Research  
Newcastle University  
Newcastle upon Tyne, UK

Anna Fraszczyk  
Mahidol University  
Salaya, Thailand



# Contents

<b>1</b>	<b>Sustainable Rail Transport</b> . . . . .	<b>1</b>
	Marin Marinov	
<b>2</b>	<b>Rail Operations and Energy Management</b> . . . . .	<b>7</b>
	Martin Lehnert and Stefano Ricci	
<b>3</b>	<b>Optimisation of Business Processes and Services in the Rail Transport Market from Two Points of View: Economic Efficiency and Management</b> . . . . .	<b>31</b>
	Anna Dolinayova	
<b>4</b>	<b>Infrastructure Access Charges</b> . . . . .	<b>45</b>
	Borna Abramović	
<b>5</b>	<b>Interior Train Design of Commuter Trains: Standing Seats, and Consideration for Persons with Reduced Mobility</b> . . . . .	<b>59</b>
	Emmanuel Matsika	
<b>6</b>	<b>Railway Applications for Monitoring and Tracking Systems</b> . . . . .	<b>77</b>
	Cristian Ulianov, Paul Hyde and Ramy Shaltout	
<b>7</b>	<b>Baggage Handling</b> . . . . .	<b>93</b>
	Bernhard Rüger	
<b>8</b>	<b>Aspects of Rail Infrastructure Design</b> . . . . .	<b>113</b>
	Aleksander Śladkowski and Krzysztof Bizoń	
<b>9</b>	<b>Improving Integrated Travel Planning by Enhancing Travel Planning Model with Rail Station Data</b> . . . . .	<b>147</b>
	Jörn Schlingensiepen, Edwin Naroska and Florin Codrut Nemptanu	
<b>10</b>	<b>Innovation in Rail Freight and Interchanges (or How to Stop Rail Freight Hitting the Buffers)</b> . . . . .	<b>169</b>
	Philip N. Mortimer and Raphael Kling-David	

<b>11</b>	<b>Multimodal, Intermodal and Terminals</b> . . . . .	193
	Giuseppe Pace and Stefano Ricci	
<b>12</b>	<b>Rail Marketing, Jobs and Public Engagement</b> . . . . .	207
	Anna Fraszczyk, Nathalie Amirault and Marin Marinov	
<b>13</b>	<b>New Technologies and ITS for Rail</b> . . . . .	225
	Florin Codrut Nemtanu and Jörn Schlingensiepen	

# Chapter 1

## Sustainable Rail Transport

Marin Marinov

### 1.1 Introduction

Sustainable rail transport appears to be one of the buzz expressions in our time. Many use this expression to justify research grants and promote enduring policies. *What is a sustainable rail transport though? and How do we see its future?* are two questions which could open an endless debate.

Is sustainable—efficient? Is efficient—reliable? Is reliable—sustainable?

How could sustainable driving be ensured by a driver advisory system to optimise train driving between two consecutive stops?

Are there compatible interfaces between train operating companies, so that during their operations people can communicate when they meet in the network?

How critical the importance of data in managing trains in real time is?

How accurate and workable the timetables are?; Has the rail operation been planned properly?

Are there any changes for access to rail lines and other facilities? How these charges are calculated: by implementing simple deterministic models or complex econometrics?

Are there any policies for sustainable development of rail transport? How sound and realistic these policies are?

Sustainable? Does sustainable mean secure? Hence how secure the rail systems are?

How reliable and resilient the rail infrastructure is? What are the issues with track maintenance in extreme weather conditions?

---

M. Marinov (✉)  
NewRail, Centre for Railway Research, Newcastle University,  
Newcastle upon Tyne, UK  
e-mail: [marin.marinov@ncl.ac.uk](mailto:marin.marinov@ncl.ac.uk)  
URL: <http://www.ncl.ac.uk/newrail>

Rails and slippers—how are they fasten? Is this practice sustainable?

Rail fairs, exhibition venues and public engagement events—do we know how to advertise and promote rail?

Satellite and communication systems for real-time tracking of railway assets—what these are? Integrated systems for real-time monitoring of rail vehicles—how do they operate?

Interior passive safety—is the procedure in place sustainable enough to guaranty passenger’s safety all the time?

Redesigning the interchanges to provide a seamless operation and no delays in transshipment;

Longer trains or shorter trains—what is more sustainable and under what condition?

Is rail sustainable enough with a 0.6% fatality rate?

When we travel by train, where we store our bags, our bicycles, our buggies and push chairs?

Are we comfortable when we travel by train? Are we satisfied with the current system?

How to form a partnership approach to strengthen the development and delivery of a safer, more efficient and sustainable rail system.

Electrification versus Bi-mode technology—what is our choice and preference?

These are some of the questions to ask when we talk about sustainable rail transport. Many rail specific components and aspects, operations and processes, policies and practices, equipment and technologies can be changed, replaced and amended to make railways more sustainable. Others, however, sometimes of “supreme” nature are beyond control. Railways are systems that are self-constrained, therefore an understanding of the behaviour of the whole system and its elements help realise the potential for improvements subject to its limits.

The railways are often criticised for providing service that is unreliable, of poor quality or simply not good enough. It feels like that it is a commonly held opinion that the freight railways have difficulties to deliver on time because they cannot stick to the schedule.

Those who know the railways from inside and understand their complex nature would find such criticisms rather ironic. The railways deliver a massive amount of useful work every day, helping so many people to go to work, so that they can contribute to the economy. We now know that freight trains can run thousands of mile, from China to Europe and back again. A single freight train can carry as many as 200 containers and still be on time to deliver for the customer.

Railways are complex physical systems, which are vulnerable to disruptions, technical failures, weather conditions, terrorist attacks, human errors and so on. Hence the starting point is not to criticise railways, but to try and understand how they operate, so that we can develop and implement appropriate solutions. This understanding will not come directly from criticisms, talking shops and opinions, but from the observation, accurate measurement and systematic analysis of this rail component that malfunctions. Hence, the objective of this discussion is to provide an understanding of how railways operate and what we can do for them to be sustainable.

In a free market economy, the success of railways depends on attracting and retaining more passengers and freight. *Sustainable or not* it is for the railways to work towards maximising the utilisation of their assets. Every time that a rail asset stays unutilised for whatever reason is time wasted. Time wasted never returns and in the terms of the economy it translates into money wasted. That is why, a thorough analysis of rail asset management and utilisation of resources is a useful means for understanding the costs and revenues of a railway and the service it provides.

Some of the topics that are not covered in this book include urban freight by rail and whether tram and metro can carry cargo. Sound publications covering these two topics include Motraghi and Marinov (2012), Marinov et al. (2013), Brice et al. (2015), Dampier and Marinov (2015). Urban freight by rail is an integral part of seamless city logistics and deserves careful thought and further research.

This book does not cover comprehensive analytical and simulation modelling studies for analyzing and evaluating rail system performance, utilisation of rail resources and mitigation of delays. The interested reader is referred to Marinov and Viegas (2009), (Marinov and Viegas 2011a, b, c), Woroniuk and Marinov (2013), Wales and Marinov (2015).

Also, this book does not cover rail vehicle dynamics and wheel–rail contact. Instead the interested reader is advised to consult Knothe and Stichel (2017).

This book is not about human factors in rail and acceptance of and/or resistance to new technologies. A practical guide on these and similar topics is presented by Naweed et al. (2013).

This book covers the subject of rail operations and management including traffic management (operational view) on different influence levels in rail, energy-efficient driving and driver advisory systems as well as it discusses methods for energy saving when considering train driving patterns and robust timetabling. The subject of rail economics and infrastructure access charges is also discussed and explained using particular examples (Chaps. 3 and 4).

A chapter on interior train design of commuter trains is included with the aim of discussing the potential for opening up more capacity by introducing the concept of standing up seats (Chap. 5). A consideration is given to the transport of persons with reduced mobility (PRM). It has been now confirmed that passenger comfort diminishes when seating capacity of carriage is reduced.

The implementation of new technologies for real-time management, incl. monitoring, tracking and tracing of railway vehicles can improve the overall rail system reliability and provide better solutions for managing mixed traffic along a rail line and in a network. Therefore, a discussion of Global Navigation Satellite Systems (GNSS) and other applications for rail is presented in Chap. 6.

Sometimes in our studies we tend to forget that when we travel, we travel with luggage. It goes without questioning that railways could offer a better service to passenger's luggage. We argue that more reliable luggage handling systems are needed to ensure comfort to passenger. This is because, as it is investigated in this book, *“luggage is one of the main reasons why people choose their car instead of public transport”*. This is the subject of Chap. 7.

As the railways are a self-constrained system, rail operations and vehicle design are topics which should not be discussed in isolation, without considering the aspects of rail infrastructure. For the purposes of this discussion we look at different types of rail fastening, their technical specifications and geometric models. In particular a test discrete model of SB-3 rail fastening is discussed (Chap. 8).

In urban areas rail should be seen as part of an integrated system, interacting with all other transport modes. In this case concepts such as an integrated travel planner are of interest to ensure that passengers are well informed and relaxed when using public transport. For this an application of RFID technology is discussed in Chap. 9.

The subject of Chap. 10 is rail freight innovation. Specifically, we look at whether rail freight is a competitive, attractive and cost-effective option for shippers in comparison with other transport modes. What are the changes in the freight market and how have Railways been responding to these changes recently. A few new concepts for redesigning freight interchanges are mentioned, followed by a couple of examples of projects as proposed to the Planning Inspectorate and Executive Agency England and Wales.

Aspects of multimodal, intermodal and rail freight terminals are discussed in Chap. 11. Specifically, we now view freight railways as part of a framework of integrated transport network. To study the performance of such an integrated network there is a need for an integrated holistic approach built on the collaboration between international, national organisations and operators. Chap. 11 also looks at challenges associated with security and threats to freight transport, discussing regulations and policies in place for rail—sea interfaces.

The topic of rail marketing, skills shortage, new job positions in the rail industry and public engagement initiatives is elaborated in Chap. 12 of this book. Rail marketing is one of the subject areas, which has not experienced a lot of attention, therefore it is with a positive intention that we bring this important activity of the railway service into the discussion. It is believed that the chapter on rail marketing, jobs and public engagement will trigger high interest and as a result more rail researchers and scholars will consider it as a scientific subject which needs to be developed further.

The last chapter of this book talks about the future of transport. It talks about new technologies and their implementation. It talks about *Digital Railway*; this is the subject of Chap. 13.

## References

- Brice D, Marinov M, Rüger B (2015) A newly designed baggage transfer system implemented using event-based simulations. *Urban Rail Transit* 1(4):194–214
- Dampier A, Marinov M (2015) A study of the feasibility and potential implementation of metro-based freight transportation in Newcastle upon Tyne. *Urban Rail Transit* 1(3):164–182
- Knothe K, Stichel S (2017) Rail vehicle dynamics, 1st edn, vol XVI, 321 p. 152 illus. Springer
- Marinov M, Viegas J (2009) A simulation modelling methodology for evaluating flat-shunted yard operations. *Simul Model Pract Theory* 17(6):1106–1129

- Marinov M, Viegas J (2011a) Tactical management of rail freight transportation services: evaluation of yard performance. *Transp Plann Technol* 34(4):363–387
- Marinov M, Viegas J (2011b) Analysis and evaluation of double ended flat-shunted yard performance employing two yard crews. *J Transp Eng* 137(5):319–326
- Marinov M, Viegas J (2011c) A mesoscopic simulation modelling methodology for analyzing and evaluating freight train operations in a rail network. *Simul Model Pract Theory* 19:516–539
- Marinov M, Giubilei F, Gerhardt M, Özkan T, Stergiou E, Papadopol M, Cabecinha L (2013) Urban freight movement by rail. *J. Transp. Lit.* 7(3):87–116
- Motraghi A, Marinov M (2012) Analysis of urban freight by rail using event based simulation. *Simul Model Pract Theory* 25:73–89
- Naweed A, Dorrian J, Rose J (2013) Evaluation of rail technology, a practical human factors guide. In: Bearman C (ed) CRC Press, 334 pp
- Wales J, Marinov M (2015) Analysis of delays and delay mitigation on a metropolitan railway network using event based simulation. *Simul Model Pract Theory* 52:55–77
- Woroniuk C, Marinov M (2013) Simulation modelling to analyse the current level of utilisation of sections along a rail route. *J Transp Lit* 7(2):235–252

# Chapter 2

## Rail Operations and Energy Management

Martin Lehnert and Stefano Ricci

### 2.1 Motivation and Introduction

A global important ecological and economical aspect is the reduction of energy consumption. This aim has to be fulfilled also in the transport sector. Although the rail transportation is a very ecological transport system itself, it is faced with request to save energy and costs, too. Measures have to be taken to stay competitive with developments in other transport sectors, like road traffic.

Modern traffic management systems can help to decrease energy consumption. Rail operation needs command and control like any complex transport system, anyway. Thus, a modern rail operation and traffic management system can reflect the energy saving and other customer needs beside the common tasks of securing an unobstructed operation corresponding to timetables and handling disruptions.

This chapter will reflect different aspects in that topic. First, a systematic approach on different influence levels of rail traffic management will be outlined. A systematisation of the different tasks in the management process should help students, researchers, professionals and any newcomers to the discipline to get an introduction and a common understanding of the area of rail traffic management. Therefore, a traffic management cycle will be developed and presented while complex mathematical models will be avoided.

Energy-saving methods will be introduced in the second section. A variety of measures will be pointed out which effect by influencing driving behaviour with different strategies, by effective usage of the power train and its zones of best aggregate efficiency and by design issues of the vehicles and fixed infrastructure

---

M. Lehnert (✉)  
Technische Universität Dresden, Dresden, Germany  
e-mail: martin.lehnert@tu-dresden.de

S. Ricci (✉)  
Sapienza Università di Roma, Rome, Italy  
e-mail: stefano.ricci@uniroma1.it



installations. Furthermore, a special attention will be given to apply these measures to Mass Rapid Transit (MRT).

One of these aspects to influence the driving behaviour will be focused in the following section. Driver Advisory Systems (DAS) are an efficient measure and can be integrated in the systematic of rail traffic management from the beginning as well. They can support drivers to ensure energy-efficient driving on the one hand by having all freedom to react to and to consider deviation from usual and planned run on the other hand. The systems will be motivated and systemized. Some examples from daily operation will complete the section.

## 2.2 Influence Levels for Traffic Management in Rail

(By Martin Lehnert)

### 2.2.1 Types of Conflicts on Different Influence Levels

Based on the scope of traffic management, which is to influence and optimise the train operation, a classification in different influence levels of traffic management offered itself. These levels (Fig. 2.1) refer to different size of focused areas and different number and kind of involved vehicles. For each level it is attempted to characterise it with a set of conflict types:

- Level 1: Optimisation of one train running between two consecutive stations. This level is located at the base of the pyramid in Fig. 2.1. It affects the smallest area and refers to conflicts regarding one train running between only two consecutive stations. Conflicts regarding timetable (delays) occur on this level as well as on the level above.

**Fig. 2.1** Influence levels on traffic management



- **Level 2: Optimisation of one train on a line.**  
This level is consecutive to the first level and focusses similarly one train but a wider area, namely a whole line. It can refer to the following types of conflicts:
  - Allocation set conflicts (resources, staff and/or vehicles need to be at a certain position at a certain time but they are not available there and then),
  - Track occupation conflict in the terms of avoiding red signal stops and
  - Conflicts regarding timetable (delay, energy consumption, etc.)

Although in the context of this level the train running behind schedule has no effect on other services, it could cause increased energy consumption or issues with staffing levels.

- **Level 3: Optimisation of all trains running along a line.**  
This level includes more than one train in the management and control process, so it refers to conflicts involved with multiple trains but still running along a line. The kinds of conflicts on this level are in general the same as on the following level, but with smaller consequences and influenced area. In fact, the area is limited to the single line and the train running along this line only. Such scenario can be found in local public transport often. The conflicts can be summarised together with the following level.
- **Level 4: Optimisation of all trains running in a network.**  
On level 4, the management focuses on the whole railway network with many trains running within. The conflicts on this level are between several trains in the network as there are:
  - Track occupation conflicts (train spacing, headway and train order in junctions and network bottlenecks as well as on main track)
  - Connection conflicts for both customer groups (passenger and freight) as well as for staff and rolling stock.
- **Level 5: Intermodal optimisation.**  
This top level of the pyramid takes different transportation systems into account. This is obvious in public passenger transport in fact of the intermodal transport chains. The level refers to all intermodal conflicts in the meaning of at least two transport modes involved, e.g.
  - Intermodal occupation conflicts (e.g. conflict between tram and car at crossings, or between train and car at level crossings)
  - Intermodal connection conflicts (e.g. connections between tram and bus, or between regional train and regional public transport).

While there are commercial solutions for problems on the levels 1 to 3, optimisations at network level (level 4) are still in prototype and for more complex areas under research. In the past 5 years, the problems on level 5 came more and more into focus of research as providers strive for connectivity across all modes of public transport to encourage greater passenger numbers in the future. A key problem with public transport can be a lack of viable connections when a direct

journey is not available and so greater connectivity between transport modes could solve this major problem.

The solutions of mentioned conflicts lay on the mentioned level to reach effective railway traffic. But it is important when surveying traffic management to consider the entire picture and not concentrate on only one or two types of conflict.

## 2.2.2 Traffic Management Cycle

Regarding the definition of management and traffic management (EN ISO 2015; ON-TIME 2012) the transportation process has to be directed, controlled and supervised continuously. This means collecting the relevant traffic data, analysing and comparing it with the requested state, predicting the development in the near future, detecting and solving conflicts and bringing the solution back to the transportation process by influencing the traffic flow in different kinds. Thus, traffic management can be described as a cycle or control loop with various actions (Fig. 2.2).

In all actions the infrastructure manager (IM) and the railway undertakings (RU) are involved in some kind. Additional involvement of the customer can be found during the definition of objectives and during the customer information action.

Regarding to the time the different actions can be grouped in three steps (see Fig. 2.2):

- Actions before operation;
- Actions during operation;
- Actions after operation.

There are two actions in the traffic management cycle, which take place before the operation starts. These are:

- Definition of Objectives;
- Timetable and operation planning.

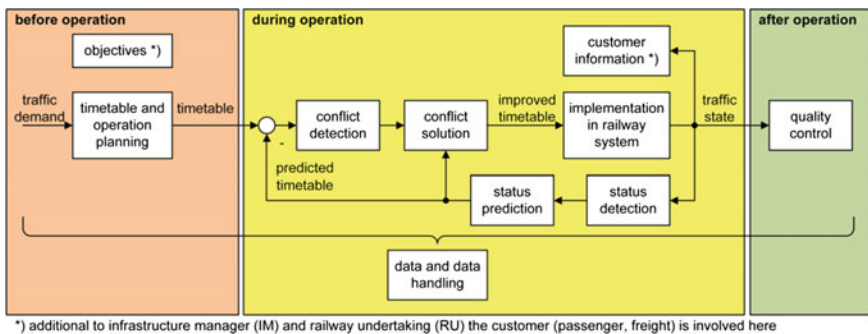


Fig. 2.2 Traffic management cycle (adapted from Jaekel 2013)

Actions in the traffic management cycle that take place during operation include:

- Status detection;
- Status prediction;
- Conflict detection;
- Conflict solution;
- Implementation of the solution in the railway system;
- Customer information;
- Data and data handling.

One more action in the traffic management cycle occurs after the operation completion:

- Quality control.

All actions will be described in the following.

### **2.2.2.1 Objectives**

Objectives need to be set to make a process controllable in a desired direction. The most essential and a process immanent objective is to perform the transport task that has been set. Further objectives include safety, optimal use of infrastructure, punctuality and to minimise resource use (vehicles, staff, energy use, etc.). The order of these objectives depends on the role of the participant in the process. For infrastructure managers an optimal infrastructure usage might have the highest priority. From the view of the customer, here e.g. in the meaning of the passenger, the punctuality and safety might be most important. For the railway undertaking, it is of commercial importance to minimise resource usage and costs while focussing on customer needs.

### **2.2.2.2 Timetable and Operation Planning**

The timetable and operation planning task requires a process of considering supply and demand. When designing a timetable, many variables must be taken into account such as scheduling of resources like staff, vehicles and operating supplies and consumables.

The timetable process is subdivided in several chronological and detailed steps from the demand requests of the railway undertakings to the general routes allocation and the fine planning with the precise train configuration at a certain day. Passenger changes at stations to meet either other rail services or intermodal connections must also be considered when designing an effective timetable.

Last but not least, all decisions in timetable planning result in economic impacts to the participants.

### 2.2.2.3 Status Detection

In the second step, all actions relevant during operation are grouped. This is the core of traffic management cycle. Starting in the cycle with the railway system as the controlled system in the cycle the first action in focus is the status detection—that means the monitoring and constant measurement of current railway operation. These measures include a huge number of physical and operational measured variables and indicators, as there are, for example time, position, speed, track occupation, train integrity or number of passengers, etc. as well as values and interpretations derived from that measurement like the relation to timetable.

The data measurement bases on different technical and physical principles, like optical, mechanical, inductive or magnetic mechanism. Post-measurement, transmission of data and its subsequent processing are necessary, considering the accuracy and time resolution of any data. (Albrecht et al. 2013b)

### 2.2.2.4 Status Prediction

From the data previously gathered, a status prediction must be made which forecasts the state evolution of both traffic (e.g. train positions and speeds) and infrastructure (e.g. route settings, signal aspects, switch positions) within a certain time period ahead named prediction horizon. This can be done in a variety of methods or using a combination of them such as:

- Linear propagation, e.g. for delays: The current delay will be forecasted with the same value for all the following stations. Further influences are not taken into account.
- Predictions, e.g. of traffic state, which takes the behaviour of surrounding trains and current traffic flow as well as further constraints (crew, rolling stock, connection constraints) into account. This is very complex and can be solved by simulation based prediction approaches.
- Stochastically prediction: The knowledge of a huge number of historical realisations of this dedicated train run and if available different influencing factors can be combined and build the fundament for mathematical, stochastically approaches.

On example of effects that can be achieved is shown in (Binder and Albrecht 2012) by predicting the dwell time in subway stations in Hamburg and the use of this information to optimise the operation.

One additional approach of the past years can be summarised with the keyword “big data”. Within that approach a huge amount of data from various sources will be scanned with efficient algorithms and huge computing power in order to deduct correlations. The future will show whether this approaches is successful.

### 2.2.2.5 Conflict Detection

Based on the prediction in the previous step, the conflict detection function is activated. Mostly it is aimed to identify the presence of potential track occupation conflicts, i.e. multiple trains trying to use one of the infrastructure resources (track detection sections) at the same time. These conflicts can be visualised in the blocking time diagram or time–distance graph (Fig. 2.3). For each train the real time–distance graph is displayed until the current time and the prediction in a certain time horizon. Further, the track section occupation times are displayed as boxes around the time–distance line. For conflict-free operation the boxes must not overlap. (Hansen and Pachl 2008)

A train controller used to execute this method by hand utilising a huge amount of expert knowledge. However, nowadays, it is a far more computer-driven process with train controllers still in a responsible role.

Automated conflict detection systems can detect all the types of conflict we have previously considered in this article. Most available algorithms for track conflict detection and resolution work with a sectional, microscopic representation of the infrastructure, like the sequence of track vacancy detection sections a train passes along its run together with its planned occupation and release times (Chen et al. 2010; Corman and Meng 2013; Pellegrini et al. 2014)

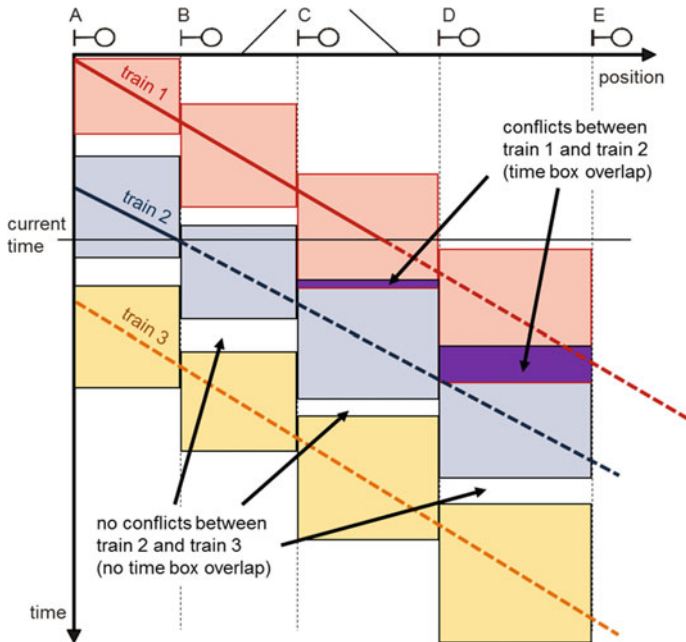


Fig. 2.3 Blocking time diagram with conflict

### 2.2.2.6 Conflict Solution

Using data from the previous step, solutions can be found to any potential conflict. This real-time conflict detection and resolution in rail has been widely in the focus of the last year's research. Specialised mathematical approaches and algorithms have been described in the scientific literature; see e.g. (Corman and Meng 2013) for a review. They are not in the focus of that article and are however still not applied in daily operation in large railway networks. The measures based on these mathematical approaches can be summarised to five basic classes. These are:

- Reordering;
- Re-timing;
- Re-routing;
- Cancellation of a train;
- Provision of substitute transport.

Re-routing means to allocate alternative tracks in stations or on parallel tracks to the trains. Re-timing means to modify the departures and arrivals at stations. Reordering of trains can happen at junctions or in stations, by cancelling or adding non-commercial stops, e.g. for overtaking purpose. These measures are performed frequently, even in case of slight delays. They do not require any intervention of the RU and are usually summarised under the term perturbation management (Albrecht and Dasigi 2014). More radical measures are the cancellation of trains or the provision of substitute transport on rail or with other transport modes.

Usually, solutions involve one of these measures or a combination of several of them.

### 2.2.2.7 Implementation

The previously calculated conflict solutions now need to be implemented. This is done by a combination of methods—both track side solutions and vehicle side solutions.

The trackside solutions relay on:

- Disposition assistance systems for changing routes of the trains to avoid, e.g. track occupation conflicts;
- Changing duty sheets or timetables to avoid, e.g. allocation set conflicts or connection conflicts.

On the vehicle side the solutions are automatic train operation systems, which will generate a huge investment, or a Driver Advisory System (DAS), for e.g. speed advises and energy-efficient driving.

In this step, explicit human involvement is necessary due to three important reasons:

- Expert knowledge cannot be completely systemized;
- From legal aspects mostly an human have to take the responsibility;
- Acceptance of assistant systems has to be ensured.

After the implementation in the railway system, the circle closes back to the continuous status detection.

### 2.2.2.8 Customer Information

One additional step that results from the inner circle of the traffic management is the customer information for both—passengers as well as freight haulier. Communication of any delays or timetable changes to them is absolutely vital. As the customer cannot see the whole process, any changes or measures that affect them must be adequately communicated. From the operator viewpoint, it is better to inform openly than to give space for uncertainties and rumours.

Focussing the passenger transport there are many avenues for communication with passengers in the modern world, e.g. multifunction displays and public address announcement in stations and trains, even online information via websites or apps, message channels or social networks such as Twitter and Facebook. Problems still exist in rural or isolated stations with few systems for communication of delays with passengers. But in general, train operators have few excuses for not providing passengers with accurate information. Besides that, the demand of the passengers to accurate travel information can be described with the triad:

- Information everywhere, e.g. at home, in the train, in stations, especially in connecting stations;
- Information any time when the individual need it, e.g. before and during the journey;
- Information for everyone, independent from the personal abilities of access methods and barriers.

Passengers expect a low-threshold access to up to date information about their trains, connections and journey.

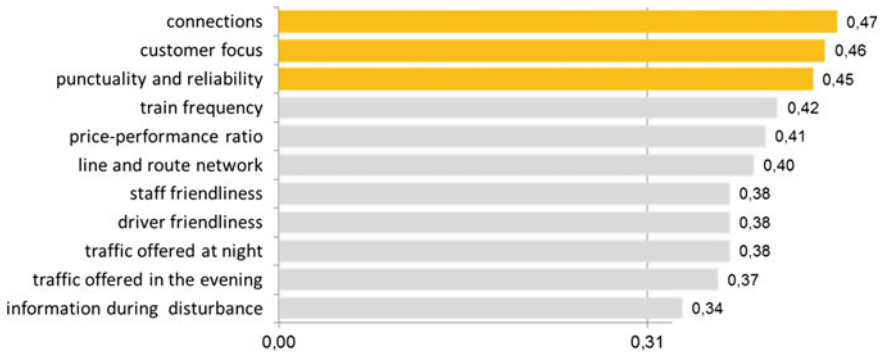
The importance of the passenger information about connections and punctuality to customers can be exemplary shown by the results of a survey among passengers on Dresden's public transport system (Fig. 2.4)

### 2.2.2.9 Data

A big bracket around all before mentioned actions (Fig. 2.2) is the use of data and the importance that this data is accurate. Data in that meaning are all information about infrastructure, timetable, rolling stock, resources and operation. Essentially, data is what connects the traffic management cycle to the real world. Without accurate data, the cycle would be useless.

Furthermore, it should be standard to have the information available as open data in open standard formats in the future. Then the exchange of data can be without difficulty between infrastructure managers (IM) and railway undertakings (RU) as well as





**Fig. 2.4** “What is important?”—A survey among passengers on Dresden’s public transport system (*source* TNS Infratest, DVB Kundenbarometer 2012)

between different RUs or different IMs. So the data can be advanced and ennobled by all involved parties, like IM, RU and customers, to open up additional benefits.

### 2.2.2.10 Quality Control

Quality control is one action in the traffic management cycle that occurs after the focused operation has been completed. This is the step that retrospectively evaluates the actions taken earlier in the cycle. These actions must be constantly evaluated for safety, punctuality, reliability, energy consumption and comfort. Only with this evaluation future responses to problems may be improved and optimised.

In that context, it is clear that traffic management has to be seen in its entirety as a comprehensive task. The cycle, which has been outlined, is an overview of this process.

## 2.3 Energy-Saving Methods

(By Stefano Ricci)

### 2.3.1 Effects of Train Driving Methods

Driver behaviour is one of many factors that could potentially reduce energy consumption (Bocharnikov et al. 2007; Chuang et al. 2009; Goodman et al. 1998; Lagos et al. 2000; Matsika et al. 2013; Rodrigue et al. 2006; Spiegel 2009; UIC 2008, 2010; van Essen et al. 2011; Vastels 2009; Wong and Ho 2004; Working Group Railway Noise 2003).

A variety of research projects in the past 15 years been mainly financed by the EU and UIC (e.g. TRAINER, RAILENERGY, ECORAILS) and looked into changes to driver behaviour and how they could reduce energy consumption.

These studies have identified effective measures including using coasting, limiting top speed without coasting and decreasing acceleration, as stated in De Martinis et al. (1999).

They have also experimented using systems designed to assist the driver in reducing energy consumption by the changing of driver behaviour (see Sect. 2.4).

Work on this sector has shown that the achievable energy saving is anywhere between 10 and 25% (Baldassarra et al. 2011). However, one constraint on this reduction is the possibility of punctuality being penalised.

Coasting and its effect on energy consumption are in Fig. 2.5.

Limiting top speed without coasting and its effect on energy consumption are in Fig. 2.6.

Decreasing acceleration and its effect on energy consumption are in Fig. 2.7. In literature it is hardly discussed whether this measure can really save energy. As De Martinis et al. 1999 mentioned it as probable measure, other authors show that this is not proven by optimal theory or even cannot measured in reality (Fidansoy and Wanjani 2017).

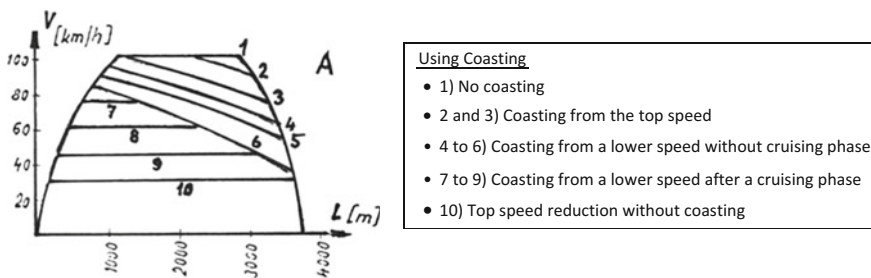


Fig. 2.5 Graph showing relationship between use of coasting and kinematic parameters

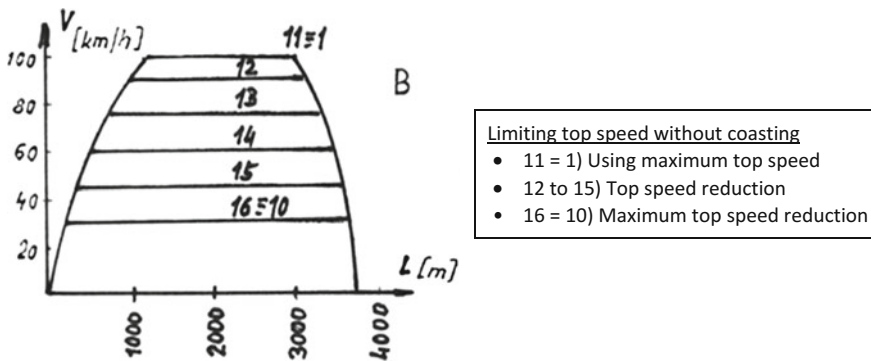


Fig. 2.6 Graph showing relationship between limiting top speed without coasting and kinematic parameters

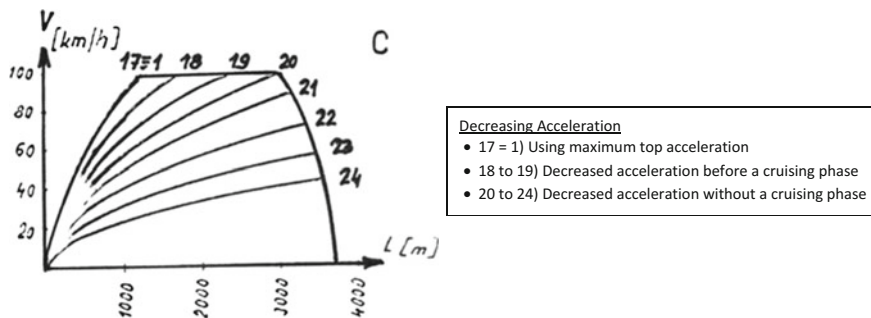


Fig. 2.7 Graph showing relationship between decreasing acceleration and kinematic parameters

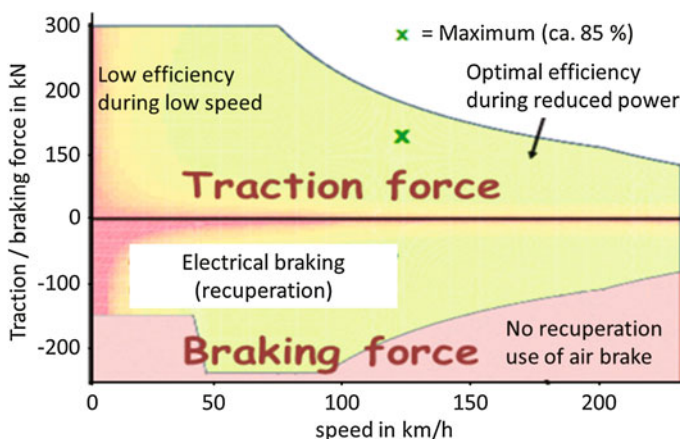


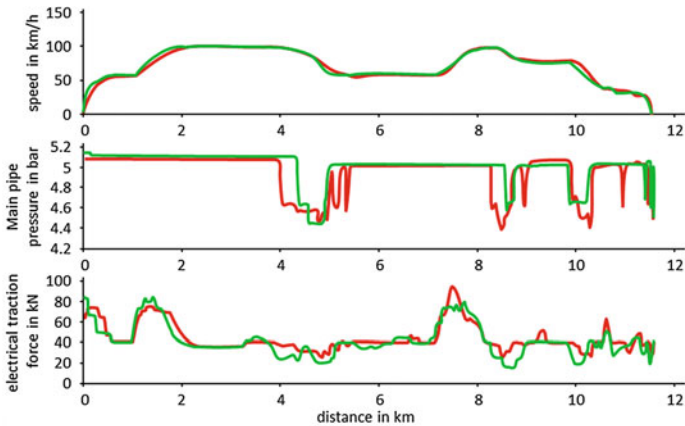
Fig. 2.8 Graph showing relationship between effective use of traction and braking forces and energy consumption (Source SBB)

### 2.3.2 Effective Use of Traction and Braking Forces

Effective uses of traction and braking forces can also lead to a marked reduction in energy consumption.

As shown in Fig. 2.8, a process of minimum consumption on traction and maximum recovery on braking can lead to reductions in energy consumption.

Energetic effectiveness in the graph below increases from red to green areas.



Legend and values  
 — Traveling time: 677 s energy consumption: 114 kWh braking factor: 18 %  
 — Traveling time: 665 s energy consumption: 71 kWh braking factor: 10 %

Driving Style	Energy Consumption	Travel Time	Braking Factor
Green	71 kWh	665 s	10 %
Red	114 kWh	677 s	18 %

Source: Einfluss der Fahrweise auf den Energieverbrauch der Re460; Roth, Schaller; ETH Zürich, Bombardier, SBB

16 **BOMBARDIER**

Fig. 2.9 Graphs and table showing comparison of driving styles and their effects on energy consumption and travel time (Source Bombardier)

### 2.3.3 Potential Effects of Driving Style on Energy Consumption

As can be seen in Fig. 2.9, it is possible to alter driving behaviour to reduce energy consumption without compromising on punctuality or travelling time.

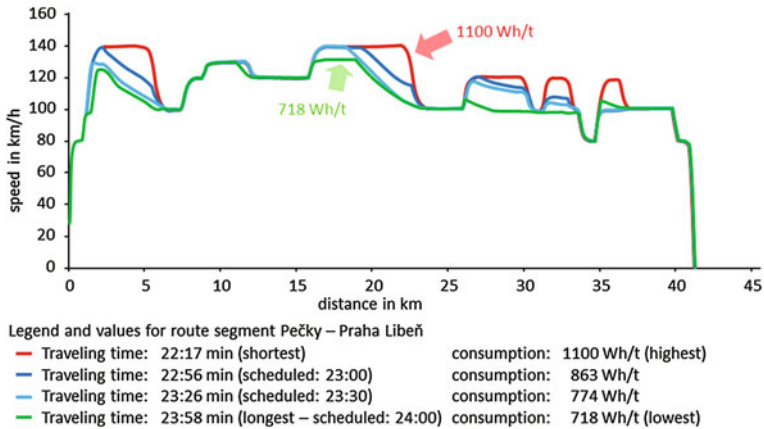
It shows a comparison between driving styles on a 12-km section of track with the most energy-efficient option actually taking 12 s fewer.

The sensibility of energy consumption to driving style is clearly emerging from the fact that the driving profile represented in green used 38% less energy with an almost similar, anyway shorter, travel time in comparison with that portrayed in red.

### 2.3.4 Potential Effects of Driving Style on Travelling Time

However, there are also other possibilities regarding travel time and energy consumption as shown in Fig. 2.10.

It shows a 35% energy reduction is possible with only a 6% longer travel time. A 41-km stretch of track is there used to measure this.



**Fig. 2.10** Graph showing effect of different driving behaviours on energy consumption and travel time of a train between Pečky and Praha Libeň (*source* Ceske Drah)

This investigation shows that the degree of energy reduction is not wedded to the degree of increase in travel time and that in reality small increases in travel time can lead to huge energy savings.

### 2.3.5 Vehicles and Fixed Installations Design Affecting Energy Consumption

Vehicles and fixed installations design is another area, where decreases in energy consumption can be found.

Changes assessed during the ECORAIL's project and their potential energy consumption reductions include (Baldassarra et al. 2011; Cosciotti and Ricci 2013; Ricci et al. 2010):

- Braking energy recovery (up to 20%)
  - Supercapacitors in fixed installations or on board (up to 20%),
  - Heating fluids in fixed installation for production of electric power (up to 20%),
  - Use for auxiliary or comfort functions in diesel-electric stock (2–5%);
- Traction energy saving (up to 10%)
  - Energy storage in diesel-electric vehicles (<10%),
  - Common Rail/ modernised diesel engines (<10%),
  - High-temperature superconductor (HTSC)/ Medium frequency transformer (2–13%),
  - Automatic switch-off of traction groups (2–5%),
  - Ventilation control according to actual demand (2–5%);

- Train mass reduction (up to 10%)
  - Double-decked stock or high/low capacity trains (< 10%),
  - Multiple units instead of loco hauled trains (5–10%),
  - Single-axle bogies or consecutive coaches resting on shared bogies (2–10%),
  - Aluminium car bodies (2–5%),
  - Light interior coach equipment (2–5%).

### 2.3.6 Energy-Saving Criteria in Mass Rapid Transit (MRT)

Mass Rapid Transit’s typical characteristics include:

- High frequency;
- Short sections between stops;
- Short or absent constant speed sections;
- Cyclic theoretical timetable capable of reducing energy consumption;
- Perturbations of theoretical timetable mainly due to stop times in stations (human factors);
- Perturbations dramatically reducible by full automatic operation.

This study will now explore some relevant aspects of Mass Rapid Transit that could assist in the reduction of energy consumption (Açıkbaş and Söylemez 2008; Albrecht 2004; Antognoli et al. 2005; Chang and Sim 1997; Dominguez et al. 2008; Malavasi 1998; Malavasi et al. 2011; Sansó and Girard 1997).

The adoption of a cyclic timetable with

$$\text{Acceleration time} = \text{Deceleration time} = \text{Coasting time} = \text{Stop time at stations}$$

would allow an exchange of energy between braking and accelerating trains.

Train 1 braking simultaneously to train 2 acceleration and so on, facilitates the maximum exchange of energy between trains.

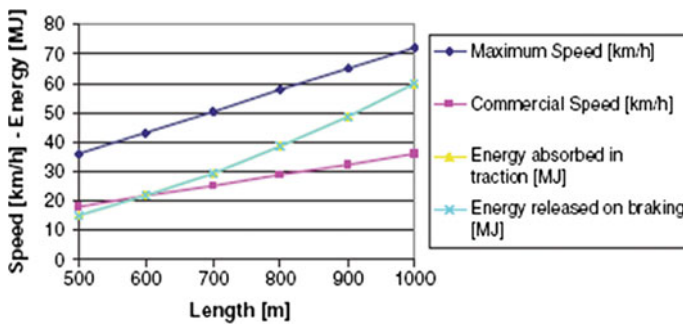


Fig. 2.11 Graph showing effects of section length on energy flows and consumption (yellow line is hidden by overlying light blue one)

Figure 2.11 shows the almost linear increasing trend of maximum and commercial speeds and the quantity of energy used during traction phases with the increase of the section length: the volume of energy consumed also increases, as the braking phase is less able to compensate for the energy released during the traction phase.

## 2.4 Driver Advisory Systems (DAS) for Energy-Efficient Driving

*(By Martin Lehnert)*

### 2.4.1 Motivation for DAS

Driver Advisory Systems (DAS) are part of the railways industries growing move towards automation. They already help railway operators and infrastructure managers to achieve two of their key objectives, safety and punctuality. However there is the third objective where DAS could potentially help with; the economic goal including increased energy efficiency and reduced consumption (Albrecht 2008).

A DAS could potentially provide feedback and support railways to reduce expenditure. It could assist railway undertakings reducing energy consumption by assisting drivers in operating their trains in more energy-efficient ways. Advisory systems could also help infrastructure managers to avoid trains stopping at red signal stops and thus to increase capacity. Such an approach could lead to a significant reduction in fuel and electricity consumption and therefore an increase in energy efficiency and reduction of costs; an outcome which the entire rail industry desires in order to increase its competitiveness with other transport modes (Albrecht 2008).

To provide an overview of DAS the next section focuses mainly on the influence levels of DAS. Then, a further section moves on to showcase some contemporary examples of DAS in action. It will finish by providing some conclusions about DAS and their future use in the rail industry.

### 2.4.2 DAS on Different Influence Levels

#### 2.4.2.1 Overview

DAS can be grouped by several qualities from which one is the optimization scope. Using this systematisation a DAS for energy-optimal control is related to one of three successional levels:

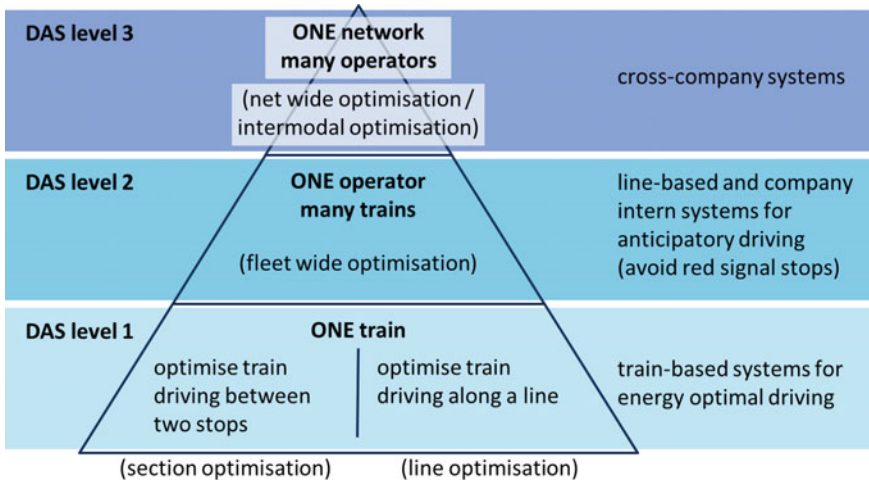
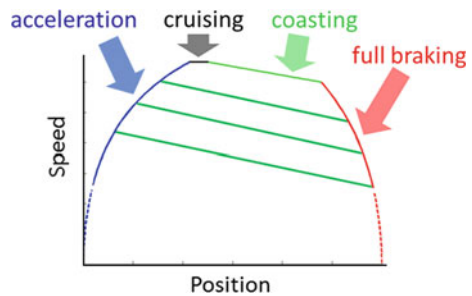


Fig. 2.12 Influence levels for DAS

Fig. 2.13 Regimes for energy-optimal control between two consecutive stations



- (1) DAS regarding only one train (DAS level 1);
- (2) DAS covering many trains (a fleet) of one operator (DAS level 2);
- (3) DAS considering many operators in one network or intermodal optimisation in networks of different transport modes with common connection points (DAS level 3).

The levels are interrelated (Fig. 2.12).

### 2.4.2.2 One Train Level

A first influence level for DAS is for energy-optimal control between two consecutive stations (section optimisation) and along a line (line optimisation) focusing only on one train.



This follows the theory of optimal control, proven many times over; finding the switchover points between the optimal regimes of acceleration, cruising, coasting and braking that produces the desired running time with the minimal energy consumption (Fig. 2.13). In theory the longer the duration of the coasting phase, the higher the energy consumption reduction possible. The DAS interface would then supply the optimum switchover points to the driver with either an acoustical or visual prompt. This would allow an energy-optimum control between two consecutive stations.

In addition to this first part of optimization between two stops, a second part belongs to the one train level: the optimization of driving and dwell times along a line. As explained in the first part, lower energy consumption would be reached by increasing running time between stations. Nevertheless, the overall running time reserve on a line is limited. Use of different algorithms like dynamic programming can optimally distribute the additional time to the sections of a line. Thereby, the guiding principle is to apply the remaining time to the sections so that delays will be caught up to the next important stations but not necessarily to the next station. In result of that principle and by allowing the DAS to calculate optimum time and speeds in sections it could advise to a train not increasing speed to make up for delays until necessary to arrive on time at an important destination. In total this strategies will again potentially reduce energy consumption.

### 2.4.2.3 One Operator Level

DAS Level 2 refers to a fleet wide optimisation of one operator's stock (one operator, many trains in Fig. 2.14). This system would promote energy-efficient driving by a line-based and company internal approach for anticipatory driving to concentrate mainly on avoiding red signal stops.

How this system works can be shown with an easy example of the dynamic adaptation of one train's arrival at a crossing station. If a second train from the same operator supposed to cross at the station is delayed, for the first train the opportunity arises to reduce energy consumption. In Fig. 2.14 the train 2 should be delayed. Instead of additional dwell time at a station for train 1, the time can be used to

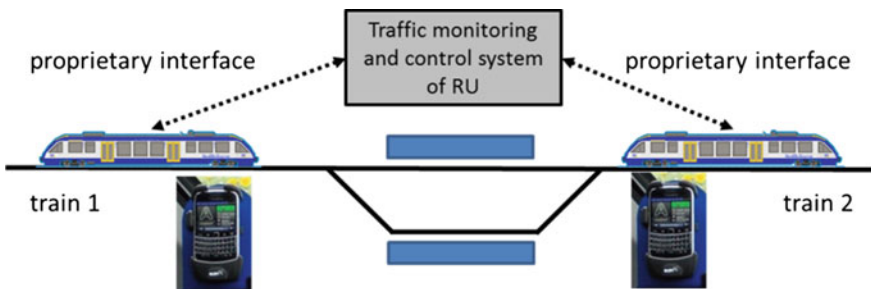


Fig. 2.14 DAS level 2: crossing with delayed train

reduce energy consumption by driving in coasting regime much earlier than in on time conditions. In result the train 1 can also arrive later without negative impact on the crossing process in the station.

On this level, the management and data exchange can be done in the traffic monitoring and control system of the railway undertaking operating both trains.

#### **2.4.2.4 One Network Level**

DAS level 3 refers to a network wide and multi operator optimisation (many trains, many operators, one network) or the intermodal optimisation in networks of different transport modes with common connection points, like level crossings, junctions or intermodal connecting stations. In an abstract way, the intermodal network can be seen as a whole via the links and constrains at the connection point.

This level would involve implementation of the system across many operators on the same network. It could also include intermodal operation across different operators and modes of transport. Currently, cross-company systems are not in operation because information from operators is not shared with their competitors.

In the future, open and standardised interfaces that can process information from both infrastructure managers and various railway operators, respectively different transport mode operators, are necessary. This would allow cross-operator anticipatory and energy-optimised driving involving collaboration between various railway operators and the infrastructure managers.

### **2.4.3 *Driving Advices***

Driving advices can be presented to the driver in different types and frequencies. It is not efficient to offer drivers huge quantities of advice. Instead, advice provided must be simple and easy to implement. Systems must not show contradictory advice. (Albrecht 2013) The way of giving the information to the driver continuously, but not to overflow him, can be seen as one of the key success factors of a DAS regarding the acceptance of the tool and avoiding the ‘turn it off’ syndrome. The approach of involving humans in the process is called ‘control by awareness’ (Golightly et al. 2013) as antonym to the commonly used concept of ‘control by exception’.

From the practical point of view it have to be pointed out that drivers are the people that will be using the system day to day and they must, therefore, have a large say in any systems design. This is especially the case in situations with strongly unionised employees who could possibly introduce difficulties and delays into implementation of a new system.

Examples of advice that a driver advisory system could show includes advice around optimal departure times from a station and advice around when to switchover from acceleration to coasting while driving along a line. These are the

**Table 2.1** Examples for DAS systems with level 1 functions

Developments by universities	Developments by railway undertakings	Developments by railway system suppliers
ENAFlexS, InLineFAS by TU Dresden (Albrecht et al. 2013a)	EcoFassi/EcoTrainbook, EbuLa ESF by Deutsche Bahn (Kusche and Geipert 2010; Netz 2005), GreenSpeed by Danske Statsbaner, RCS/ADL by SBB	Trainguard by Siemens (Rahn et al. 2013), EBI Drive 50 by Bombardier (Dischington 2011), LEADER by Knorr Bremse (Fregien et al. 2013), Metromiser/Energymiser by TTG Technology (TTG Technology 2012), CATO by Transrail (Lagos et al. 2000)

kinds of advice that would be useful to drivers and that can be easily implemented. In contrast, it is common sense, not to give an advice for braking. Choosing the right point to brake sufficiently is a safety issue and should be kept in the competences of the driver. Warnings, in case the driver did not react properly, are tasks for automatic train protection (ATP) and equal systems.

#### 2.4.4 Examples and Experiences

DAS systems at various levels are already available on the market. For a comprehensive overview about DAS and their components it is referred to (Panoua et al. 2013). A few systems shall be mentioned in the following to illustrate their theoretical classification.

At DAS level 1, already many systems commercially are available on the market. They are developed by the universities, the national railway undertakings or the railway system suppliers (Table 2.1)

These systems are proven and offer an energy reduction on traction energy, some systems are specialised on and adapted for their use in regional passenger transport, long distance freight transport, heavy rail, light rail or mass transit.

At DAS level 2 some systems are already available. One example of such a system in covering level 2 is the above-mentioned InLineFAS. It is in daily use at Harz-Elbe Express (central Germany) and ODEG (East Germany) since August 2012 and in further RU in different state of implementation. This system has produced a measured reduction in fuel usage of around 5% and a reduction in electrical energy of even more (Albrecht 2008, 2013). These systems have proven to be a success.

DAS level 3 is much harder to implement. There is no implementation known in the railway field. But a first example of a DAS system classified in that level can be named from the intermodal optimisation part. The system called COSEL runs in

urban light rail in Dresden, Germany. It focuses on the connection point between the tram network and the street network at shared crossings. There is the tram operator on the one hand and the individual cars and the local traffic light authority as a kind of operator on the other hand. The system optimises multimodal traffic quality by avoiding tram red signal stops at the crossing traffic lights using a DAS in the tram, depending on the current road traffic situation. In fact, that DAS system is installed on the trams only; it can work only in one direction at the moment, from road traffic quality to influencing tram driving. However, the system also uses complementary dwell time for additional reduction of energy consumption by around 4% (Gassel and Krimmling 2013).

### **2.4.5 Results for DAS**

In conclusion, this section has shown the potential benefits of increased use of Driver Advisory Systems. DAS operating at level 1 are widely available on the market; however use of DAS at levels 2 or 3 can open up potential for additional savings. From considering the results of existing implementations, the measured total fuel savings at diesel traction would be around 5% and savings potential at electrical traction could potentially be higher. To achieve further savings, systems must be standardised for cross-company usage.

## **2.5 Conclusions**

Several results emerge from the investigations presented in this chapter.

First, traffic management can be organised on different levels, in which many different conflicts can occur. In terms of conflict solution, many approaches are available and published. But it is clear that traffic management has its entirety as a comprehensive task and the cycle, outlined in this article, is an overview of this process. It can help to promote a common understanding of the topic in the future.

Moreover, the chapter has shown that a variety of factors affect energy consumption. These include driver behaviour, traction and braking forces regulation, vehicles and fixed installations design and timetabling (mainly in MRT). It has also demonstrated that the progressive automation of operation is capable of increasing the effectiveness of these factors by reducing deviations from the best driving style and timetabling. The research into the most effective measures to reduce energy consumption in automatic and manual metro operations led more light upon this important topic. However, while discussing the finer details of the railway industries push for reduced energy consumption one must also remember and reflect upon the importance of this task being realised both for economic objectives.

As one important measure Driver Advisory Systems has been focused in the chapter and the potential benefits of their increased use has been shown. The

systems can be systemised in three levels regarding the influence range. While systems on level 1 are widely developed and used, further applications of level 2 systems and the implementation of level 3 systems can open up potential for additional savings. Therefore, systems and interfaces must be standardised for cross-company usage. However, DAS must be optimised to suit train drivers as they would decide about the daily DAS use at the end. The section has shown the potential for increased development of DAS and building on this work, further studies on the potential for implementation of these systems are expected.

## References

- Açıkbaş S, Söylemez MT (2008) Coasting point optimisation for mass rail transit lines using artificial neural networks and genetic algorithms. *IET Electr Power Appl* 2(3):172–182
- Albrecht T (2004) Reducing peaks and energy consumption in rail transit systems by simultaneous train running time control—Computers in Railways IX. WIT Press, Southampton
- Albrecht T (2008) Energy-efficient train operation. In: Hansen IA, Pachtl J (2008) *Railway timetable & traffic*, Eurailpress. DVV Media
- Albrecht T (2013) Human factor challenges in the development of a Driver Advisory System for regional passenger trains. In: Dadashi N et al (eds) *Rail human factors: supporting reliability, safety and cost reduction*, Taylor & Francis, pp 129–138
- Albrecht, T, Dasigi M (2014) ON-TIME—A framework for integrated railway network operation management. In: 5th Conference Transport Research Arena TRA 2014, Paris
- Albrecht T, Binder A, Gassel C (2013a) Applications of real-time speed control in rail-bound public transportation systems. *IET Intel Transp Syst* 7(3):305–314
- Albrecht T, Lüddecke K, Zimmermann J (2013b) A precise and reliable train positioning system and its use for automation of train operation. In: *IEEE international conference on intelligent rail transportation (ICIRT)*, Beijing
- Antognoli M, Malavasi G, Ricci S (2005) Operation automation level in an underground line and service reliability. *Railway Operations Modelling and Analysis*, Delft
- Baldassarra A, Cosciotti E, Ricci S (2011) *Energy Efficiency and Environmental Criteria in the awarding of railway vehicles and services: methodologies of implementation and monitoring*. World Congress on Railway Research, Lille
- Binder A, Albrecht T (2012) Predictive energy-efficient running time control for metro lines. In: CASPT12—conference on advanced systems for public transport, Santiago de Chile, Chile
- Bocharnikov YV, Tobias AM, Roberts C, Hillmansen S, Goodman CJ (2007) Optimal driving strategy for traction energy saving on DC suburban railways. *IET Electr Power Appl* 1(5):675
- Chang, CS, Sim SS (1997) Optimising train movements through coast control using genetic algorithms. In: *IEE Proceedings—Electric power applications*, vol 144, no 1, p 65
- Chen L, Schmid F, Dasigi M, Ning B, Roberts C, Tang T (2010) Real-time train rescheduling in junction areas. In: *Proceedings of the institution of mechanical engineers, Part F: J Rail Rapid Transit* 224(6):547–557
- Chuang HJ, Chen CS, Lin CH, Hsieh CH, Ho CY (2009) Design of optimal Coasting speed for MRT systems using ANN models. *IEEE Trans Ind Appl* 45(6):2090–2097
- Corman F, Meng L (2013) A review of online dynamic models and algorithms for railway traffic control. In: *First IEEE international conference on intelligent railway transportation*, Beijing
- Cosciotti E, Ricci S (2013) Simulation and functional requirements of energy efficient driving. In: *IAROR conference rail*, Copenhagen

- De Martinis V, Gallo M, D'Acerno L (2013) Estimating the benefits of energy-efficient train driving strategies: a model calibration with real data—Urban Transport XIX. WIT Press, Southampton
- Dischington S (2011) Energy savings with ERTMS Level 3—EBI Drive 50 driver assistance system. In: ERESS Customer Forum 'Energy Efficiency—Smart Metering & Billing', Brussels
- Dominguez M, Fernández A, Cucala AP, Cayuela LP (2008) Computer-aided design of ATO speed commands according to energy consumption criteria—Computers in Railways XI. WIT Press, Southampton
- Gassel C, Krimmling J (2013) Effects of cooperative traffic signals on Tramway operation. In: Proceedings of the 3rd international conference on models and technologies for intelligent transportation systems, Dresden, TUD Press, pp 301–310
- Golightly D, Sandblad B, Dadashi N, Andersson AW, Tschirner S, Shaples S (2013) A sociotechnical comparison of automated train traffic control between GB and Sweden. In: Dadashi N et al (eds) Rail human factors—Supporting reliability, safety and cost reduction. CRC Press
- Goodman CJ, Siu LK, Ho TK (1998) A review of simulation models for railway systems. In: International conference on developments in mass transit systems, London, Conference Publication no. 543. OIEE
- Fidansoy Y, Wanjani S (2017) Design Thinking bei der Anwendung der energiesparsamen Fahrweise. *EI – Der Eisenbahningenieur* 68(2):42–44
- Fregien G, Paddison J, Beck M, Kock G (2013) Zeitgemäße Güterwagenausrüstung für hochwertige Transportaufgaben - 41. Tagung Moderne Schienenfahrzeuge, Graz
- Hansen IA, Pachel J (2008) Railway timetable and traffic. Eurailpress, Hamburg
- Jaekel B (2013) Einfluss von Massemodellierung und Algorithmenwahl auf Fahrdynamikrechnungen - 47. Regelungstechnisches Kolloquium, Boppard, Germany
- Kusche M, Geipert S (2010) Ecotrainbook—Driver assistance system. In: 11th UIC sustainability conference, Madrid
- Lagos M, Hellström P, Leander P (2000) Computer-aided train operation: CATO—Computers in Railways VII. WIT Press, Southampton
- Malavasi G (1998) Analysis of rail rapid transit systems by means of simulation models—Urban Transport IV. WIT Press, Southampton
- Malavasi G, Palleschi P, Ricci S (2011) Driving and operation strategies for traction-energy saving in mass rapid transit systems. In: Proceedings of the institution of mechanical engineers. Part F: J Rail Rapid Transit 225(5):475–482
- Matsika E, Ricci S, Mortimer P, Georgiev N, O'Neill C (2013) Rail vehicles, environment, safety and security. *Res Transp Econ* 41(1):43–58
- Netz M (2005) Technische Assistenzsysteme der Deutschen Bahn unterstützen Energie sparendes Fahren. *ETR - Eisenbahntechnische Rundschau* 54(10):595–598
- ON-TIME (2012) Deliverable D1.1—Principles, definitions and requirements—ON-TIME project EU FP7-SCP0-GA-2011-265647, Deliverable ON-T-WP01-DEL-001
- Pellegrini P, Marlière G, Rodriguez J (2014) Optimal train routing and scheduling for managing traffic perturbations in complex junctions. *Transp Res Part B* 59:58–80
- Panoua K, Tzieropoulos P, Emery D (2013) Railway driver advice systems: evaluation of methods, tools and systems. *J Rail Transp Plann Manag* 3(4):150–162
- Rahn K, Bode C, Albrecht T (2013) Energy-efficient driving in the context of a communications-based train control system (CBTC). In: IEEE International conference on intelligent rail transportation (ICIRT), Beijing
- Ricci S, Cosciotti E, Baldassarra A (2010) Integration of technological feedback from the User Platform and the consortium into the guidelines. ECORails Project, Deliverable 7. [www.ecorails.eu](http://www.ecorails.eu)
- Rodrigue JP, Comtois C, Slack B, Rodrigue J (2006) The geography of transport systems. Taylor & Francis, New York
- Sansó B, Girard P (1997) Instantaneous power peak reduction and train scheduling desynchronization in subway systems. *Transp Sci* 31(4):312–323

- Spiegel B (2009) Energy metering an overview of the complete system. Energy Efficiency days 2009, Tours
- Standard EN ISO 9000:2015 (2015) Quality management systems—Fundamentals and vocabulary
- TTG Technology Limited (2012) ENERGYMISER®—Reduce energy bills, emissions and maintenance—Improve on-time arrivals. Product leaflet
- UIC (2008) CER—Rail transport and environment. Facts & Figure
- UIC (2010) UNIFE—Technical Recommendation 100\_001. Specification and verification of energy consumption for railway rolling stock
- Van Essen H, Schroten A, Otten M, Sutter D, Schreyer C, Zandonella R (2011) External costs of transport in Europe. Update study for 2008. CE Delft, Infrac, Fraunhofer ISI, Publication code 11.4215.50
- Vastel D (2009) SNCF energy savings program. Energy Efficiency Days 2009, Tours
- Wong KK, Ho TK (2004) Coast control for mass rapid transit railways with searching methods. In: IEE Proc Electric Power Appl 151(3):365
- Working Group Railway Noise (2003) Position Paper on the European strategies and priorities for railway noise abatement. European Commission, Luxembourg

# Chapter 3

## Optimisation of Business Processes and Services in the Rail Transport Market from Two Points of View: Economic Efficiency and Management

Anna Dolinayova

### 3.1 Introduction

Transport is an important factor in the development of society. Effective systems for passenger and freight transport are one of the important factors affecting a country's economy, the quality of life of its citizens and the development of society, and an improvement in the living standards of the population increases the demand for transport.

The Fourth Railway Package states: “An important aspect of the transport policy is to enhance the role of rail, given the difficulty of reducing oil dependence in other sectors. But this can only be achieved if rail provides efficient and attractive services, and if we eliminate regulatory and market failures, barriers to entry and burdensome administrative procedures which hamper efficiency and competitiveness” (European Commission 2013).

Accordingly, it is important to search for external as well as internal possibilities to increase the competitiveness of rail passenger and freight transport in the transport market.

### 3.2 Rail Transport Markets

The rail transport market is the place where the supply (companies providing rail freight or passenger services) and the demand (transporters, passengers) meet. It includes the size of the service lot—passenger transport in the different train categories and the transporting of many commodities by different train categories.

---

A. Dolinayova (✉)  
University of Zilina, Zilina, Slovakia  
e-mail: anna.dolinayova@fpedas.uniza.sk



In the rail market, a specific relationship exists between the infrastructure manager and the rail operators.

The diversity of rail services can be described as follows:

- the nature of the activities, processes and services—the final result is a product that is not of a material nature but the effect of the transport of goods and people, resulting in the impossibility of storing the product;
- the specificity of the transport infrastructure and vehicles—special vehicles (e.g. tank wagons) are often used;
- continual operation—especially in providing rail infrastructure services;
- the provision of transport service territory in passenger transport—the state must, through transport companies, ensure transport services for all citizens at affordable prices (these are constitutional rights of inhabitants in SR);
- special knowledge—the provision of transport services is a specific activity that requires special knowledge and skills, thereby necessitating interdependence between employees and companies;
- high capital for investments—external sources must be used for investments and in the Slovak Republic EU funding too;
- spatial distribution—services are provided in the global continental area;
- a large number of transport workers—the infrastructure manager (IM) is a natural monopoly in many countries; it follows that IM may not be implemented effectively.

### 3.2.1 *Quantification of the Supply and Demand in the Rail Transport Market*

The quantification of the supply in the rail market can be expressed using different indicators. Seat-kilometres are one of the indicators that allow the realisation of a comparative analysis among transport modes in passenger transport. In rail passenger transport, seat-kilometres may be defined according to Eq. (1):

$$\sum \text{skm}_p = \sum_{i=1}^n D_i \cdot C_i \quad (1)$$

where:

- $\text{skm}_p$  seat-kilometres (supply in sets-km);
- $D_i$  the distance travelled of  $i$ .th connection;
- $C_i$  the capacity of the  $i$ .th connection expressed in the number of seats per train on average;
- $n$  the number of connections.

In view of the fact that a large part of rail passenger services is realised as “service in the public interest” (e.g. in the SR it is more than 95%), the supply is provided by state order (Dolinayova et al. 2016).

The quantification of the supply in rail freight transport is more complex than that in rail passenger transport, because the supply is influenced by other factors besides price, such as the infrastructure of manufacturing companies, the state of the rail infrastructure and so on. The quantification of the supply in rail freight transport can be expressed in the number of trains, train kilometres or gross tonnage kilometres in the track section or the entire rail network.

Knowing the prior and future rail demand is a priority for all rail companies. Their overall economic situation is based on a correct estimate of the demand for rail services. The total previous demand can be determined easily from the business economic information system of the rail companies.

The demand is expressed in rail passenger transport as:

- the number of passengers;
- the transport performance in passenger kilometres.

The operational management company providing the rail passenger services would not be able to function correctly without knowing the demand for individual train connections. If the company uses modern information technologies (e.g. QR codes on tickets), determining that demand is relatively simple (Zitrický et al. 2015).

Estimating the future rail passenger demand is significantly more difficult than estimating the previous demand. It is necessary to take into account possible changes in passenger behaviour. Marketing surveys are the method that is most often used for the estimation of the future rail passenger demand.

The demand for services of the infrastructure manager is the derived demand for rail passenger and freight transport. It is expressed as the sum of the number of implemented planned train paths (according to the timetable) on individual track sections and routes these ad hoc. It is most frequently expressed as the number of trains and respectively train kilometres (Mašek et al. 2015).

### ***3.2.2 Factors that Influence the Demand for Rail Transport Services***

“The neoclassical demand curve entails focusing on the implication of price changes on demand, holding the other factors constant, that is” (Button 2010: p. 80):

$$D = f\{P_a, P_1, \dots, P_n, T, Y, \varepsilon\} \quad (2)$$

where:

$D$	the demand for rail transport services;
$P_a$	the price of rail transport services;
$P_1 \dots P_n$	the price of other transport services;
$T$	tastes;
$Y$	the level of income;
$\varepsilon$	the residual component.

Passengers choose their means of transport in accordance with their own criteria, whereby they attach different levels of importance to different kinds of transport. The factors that influence this decision as well as the demand for concrete services are the following:

- the purpose of travel—the demand is different for business trips, travelling to work and school and other trips;
- transport availability—the transport infrastructure does not allow the use of some transport modes (e.g. absence of a rail line);
- frequency—this markedly influences the demand for urban and regional transport;
- travel time—the demand is influenced by the total travel time, that is, moving to and from the place from where the means of transport leaves, the time spent in the vehicle, the time to change vehicles and the waiting time;
- distance—the demand function is different for long and short distances;
- price—this is a relative factor; for example, passengers who use individual cars make their own decisions only according to the price of fuel and do not take into account other costs, such as the price of the car, maintenance, insurance and so on;
- level of income—in Eastern European countries an increase in the level of income increases the transport demand as a whole but decreases the demand for public transport and increases the demand for individual transport;
- personal preferences—lifestyle, relationship to environment-friendly modes of transport and so on (Dolinayova et al. 2016).

The order of these factors and their importance in the choice of transport means are individual and often vary in different regions, reflecting regional disparities. In regions with a lower standard of living, the most important criterion is cost, while, in regions with a higher standard of living, the most important criteria are the travel time and the quality of the rail passenger service.

The factors that influence the demand for rail freight transport may be classified into three sets (Nedeliaková et al. 2014):

- natural;
- financial;
- qualitative.

The choice of vehicle depends on technical parameters (gross tonnes, loading capacity), the method of loading and unloading, kinds of commodity and so on.

The result of the supply and demand for transport is a modal split. Figure 3.1 shows the modal split in the passenger transport in the Slovak Republic (Statistic of Transport in Slovak Republic 2015).

As can be seen in Fig. 3.1, the modal split in the Slovak Republic is characterised by a large proportion of individual road transport. The decrease in the proportion of rail passenger transport was influenced by free tickets for domestic rail transport for students and pensioners. Compared with 2014, the proportion of rail passenger transport was only 7%.

The situation in freight transport is similar to that in passenger transport. Figure 3.2 shows the modal split in 2005 compared with 2015 (Statistic of Transport in Slovak Republic 2015).

The modal split in freight transport is somewhat simplified by the fact that some transport may take place only for certain types of traffic due to the characteristics of goods and the operational and technical characteristics of the department of transport. However, it is currently dominated by the production of products of which the specific characteristics allow transport by various modes of transport, and the carrier has a choice by comparing the price and quality. The modal split in the Slovak Republic is characterised by a high proportion of road freight transport and an ever-decreasing share of rail freight transport.

The important question is: *How to change?* Activities are needed in two areas:

- policy instruments:
  - European policy;
  - national legal framework for transport;
  - transport authority, etc.

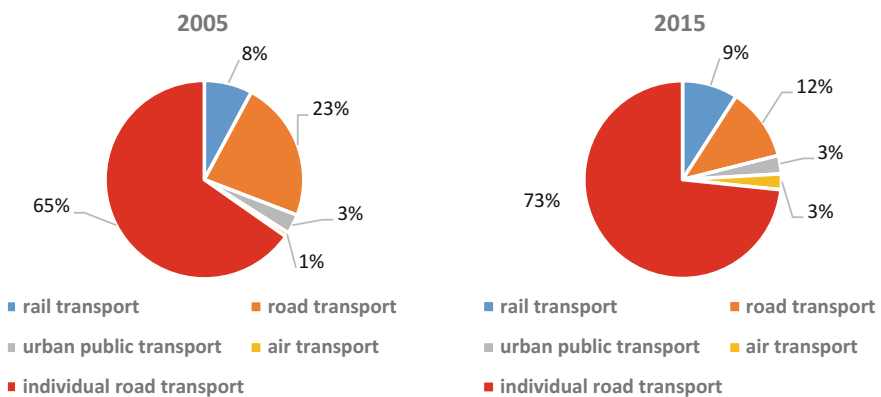
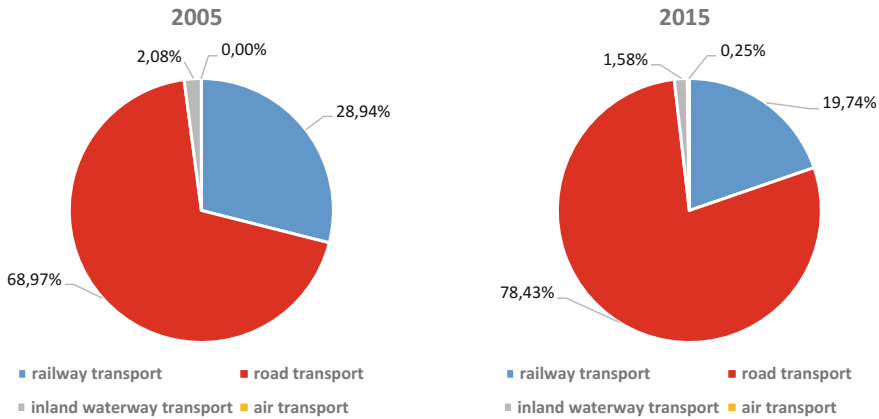


Fig. 3.1 Modal split in rail passenger transport in the Slovak Republic



**Fig. 3.2** Modal split in rail freight transport in the Slovak Republic

- economic instruments:
  - economic efficiency of the infrastructure manager;
  - economic efficiency of rail passenger services;
  - economic efficiency of rail freight services.

### 3.3 Economic Efficiency of Rail Services

Every railway undertaking that provides services on the rail market should change the input factors into output factors to ensure economic efficiency in the production activities. In the short term, it should achieve a profit, and, in the long term, the value of the company should grow.

Economic efficiency is influenced by external market factors (international trade, GDP, inflation, competition, legislation, etc.) and internal factors (management of technological processes, technical equipment, etc.).

#### 3.3.1 Economic Efficiency of Rail Freight Transport

Rail freight operators cannot increase their price in the short term (with respect to the prices of freight transport competition). Economic efficiency can be achieved by the optimization of activities and processes with the aim of reducing costs. Measurements with the basic goal of reducing costs can be classified into:

- operational character—increasing the train capacity utilisation, optimising the wagon type by commodity, decreasing the running of empty wagons, etc.;
- investment character—new wagons, new locomotives, information systems, etc.

To increase the train capacity utilisation, three basic premises must exist:

- the existence of sufficient demand;
- some consumers who do not require just-in-time suppliers;
- sufficient norms of weight and length.

Every change in technology or management of operation causes a change in the natural indicators and thus the value indicators. These measures have an operational character, which means that their implementation does not need fixed capital.

The most common measures in freight transport are:

- an increase in train capacity utilisation;
- optimization of wagon type by commodity;
- a decrease in empty wagon runs.

An increase in the train capacity utilisation (e.g. an increase in the net tonnes of products or number of containers) can be achieved only if sufficient rail infrastructure capacity exists (norms of length and weight).

A change in operating performance due to the increase in the train capacity utilisation is inversely proportional to the train weight. If the weight of the train increases by about  $\Delta$ , the number of train kilometres is reduced. We can define this according to Eq. (3):

$$\sum \text{trkm}^1 = \frac{\sum \text{grtkm}_{z\acute{a}t}^1}{Q_{vl}^1} = \frac{\sum \text{grtkm}_{z\acute{a}t}^0}{Q_{vl}^0 \cdot (1 + \Delta)} = \sum \text{trkm}^0 \cdot \frac{1}{1 + \Delta} \quad (3)$$

where

- $\sum \text{trkm}^1$  train kilometres after the increase;
- $\sum \text{trkm}^0$  train kilometres before the increase;
- $\sum \text{grtkm}_{z\acute{a}t}$  gross tonnage kilometres (beside the locomotive);
- $Q_{vl}^0$  weight of the train before the increase;
- $Q_{vl}^1$  weight of the train after the increase.

Economic indicators change through lower fees for the railway infrastructure (in the EU countries, train kilometres are the basic parameter by which the fees for the railway infrastructure are calculated), increased labour productivity and thus lower labour costs. Some costs can be higher, such as the energy cost (problems with accelerating resistance).

Choosing the right wagon for the commodity (utilisation of the loading capacity or loading volume) entails lower costs for energy, rail infrastructure fees (the part that is dependent on gross tonnes km) and wagons (to transport the same amount of goods requires fewer cars).

Decreasing empty wagon runs is the main factor that can reduce costs. The main reason for runs of empty wagons is inequable distribution of transportation requirements. For this reason runs of empty wagons cannot be excluded from the railway, but rail freight operators should aim to reduce them to the minimum.

The decrease in empty wagon runs is reflected in reduced gross tonnage kilometres, reducing the number of trains and train kilometres. Economic indicators vary significantly as natural indicators. Wagon costs occur throughout the period of circulation of the wagon, but the carrier receives revenue only for running loaded wagons.

New wagons have a better ratio between the deadweight and the wagon length through bumpers and loading length than older wagons. These invoke the possibility to include more wagons in the train, transport more tonnes in one train or transport more shipments (for example containers). New wagons decrease the following costs:

- repair and maintenance of wagons;
- maintenance of locomotives (calculated in net tonnes);
- labour costs (locomotive crew);
- energy (calculated in net tonnes)
- rail infrastructure fees.

New locomotives require high investment, but the direct costs are lower than those for outdated locomotives. Using new locomotives can achieve reduced costs for:

- energy (compared with older locomotives—approximately half the energy consumption);
- repair and maintenance—the possibility of fewer locomotives (new locomotives have greater efficiency and many times banking is not needed);
- rail infrastructure fees (some countries use ecological benefits).

New information systems allow an increase in the effectiveness of managing and controlling processes, an increase in labour productivity, better availability of relevant information and a decrease in employment and can be connected with other information systems (for example the informative system of the infrastructure manager, thus shortening the technological processes).

Using a new information system can reduce:

- labour costs (wages and other labour costs);
- costs of evidence, actualization and information exchange among companies.

Beside the financial effect, a rail company that uses a new information system can achieve other benefits, such as increased service quality (online information about consignments) and the possibility to acquire new customers.

### 3.3.2 Economic Efficiency of Rail Passenger Transport

Due to the character of rail passenger transport, the possibility of reducing the costs by measures in technology or management is bounded (assuming that the companies have optimised the number of employees). Cost reduction can be achieved, for example by:

- optimization of the cycle of locomotive and train crews:
  - decrease the labour costs (whole costs as wages, benefits for working overtime, night work, social levies, expenditure on staff training, etc.);
- formation of trains in accordance with the real demand:
  - decrease the part of rail infrastructure fees (the part dependent on gross tonnage km);
  - decrease the energy costs (lower specific energy consumption).

In rail passenger transport higher cost savings can be achieved with investment in measures like freight. The most common investments are:

- investments in rolling stock, electric multiple units (EMUs) and diesel multiple units (DMUs);
- modernization of ticket sales.

Investments in rolling stock reduce the cost by the same principle as in rail freight transport (excluding the effects of the loading capacity). A significant cost saving arises if the classical train set (locomotives and wagons) is changed to EMUs or DMUs. Cost savings arise mainly due to the change in the gross tonnage of the train, which may be defined according to Eq. (4):

$$\Delta \text{grtkm} = \left( Q_L + \sum_{i=1}^n w_i \cdot (t_i^w + 0,08 \cdot c_i^w) \right) - (Q_{MU} + 0,08 \cdot c_{MU}) \quad (4)$$

where

$\Delta \text{hrt}$  change in the total gross tonnage kilometres;

$Q_L$  locomotive weight;

$w_i$  i.th wagon in the train;

$t_i^w$  i.th wagon weight;

$c_i^z$  capacity of the wagon in number of seats;

$Q_{MU}$  weight of the DMU or EMU;

$c_{MU}$  capacity of the DMU or EMU in number of seats.

Given the change in the gross tonnage of the train, some of the costs for the use of the railway infrastructure can be saved. The other effects that are manifested in the value indicators include:



- a reduction in the traction energy consumption and therefore a reduction in the traction energy cost;
- a reduction in the cost of operation and maintenance of rolling stock;
- the possibility of reducing labour costs (assuming that in multiple units there are fewer members of the train crew).

All these effects need to be evaluated under comparable conditions; that is, the train capacity in seats should be approximately the same in a classical train (locomotives and wagons) and in multiple units. These measures reduce the cost of providing these services on the one hand; on the other hand, they improve the quality of services, which could increase the demand for these services and thus the revenues.

The modernization of ticket sales may be realised as:

- sales via the Internet;
- stationary machines;
- on the train (by train crews).

Using modern ticket sales reduces the labour costs. If the carrier has a leased space for ticket sales, it should reduce the rental cost. When we quantify the financial effects, we should take into account the cost of the purchase not only of the necessary equipment (e.g. stationary machines), but of all the operating expenses incurred during their use (e.g. the cost of repairs and maintenance of such equipment, software updates, etc.).

### **3.4 Modelling the Influence of Train Parameters on the Cost of the Railway Infrastructure and Energy in Rail Passenger Transport in the Conditions of the Slovak Republic**

Passenger trains may be composed of different locomotive types and different numbers and types of wagons. The modelling was carried out for a classical train (locomotives and wagons) and an EMU or DMU.

The fee for the use of the railway infrastructure is described in the Network Statement, and it must be published on the website of the infrastructure manager in every European country. In the Slovak Republic, these fees depend on train kilometres and gross tonnage kilometres. The fee for the minimum access package includes the fee for ordering and allocating capacity, the fee for managing and organising transport and the fee for ensuring the operability of the railway infrastructure. The railway network in Slovakia is divided into six categories (Decree No. 3/2010). Beside the fee for the minimum access package, the railway operator must pay for track access to the service facilities (for using electric power

equipment for the supply of traction voltage and for the use of passenger stations, their buildings and their facilities).

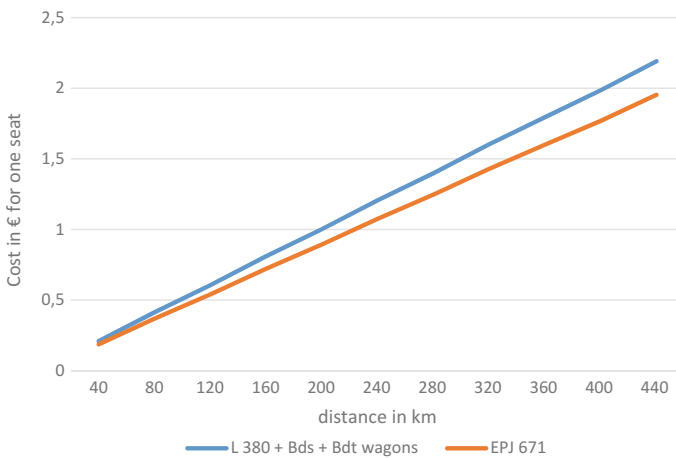
The selected wagons, locomotives and EMUs and their technical characteristics are listed in Table 3.1.

Figures 3.3 and 3.4 show the comparisons of the cost of the railway infrastructure in the Slovak Republic by type of passenger train according to the distance and on electrified and non-electrified tracks.

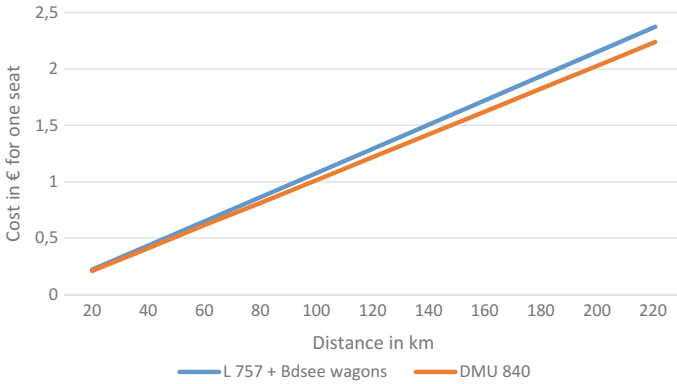
We calculated the costs for the first track category. The costs on electrified tracks were calculated for express trains and the costs on non-electrified track for regional trains. As can be seen in Figs. 3.3 and 3.4, the costs of the railway infrastructure are affected by the train parameters. The costs for non-electrified tracks are higher than those for electrified track because regional trains stop at more stations.

**Table 3.1** Technical parameters of wagons, locomotives, EMU and DMU

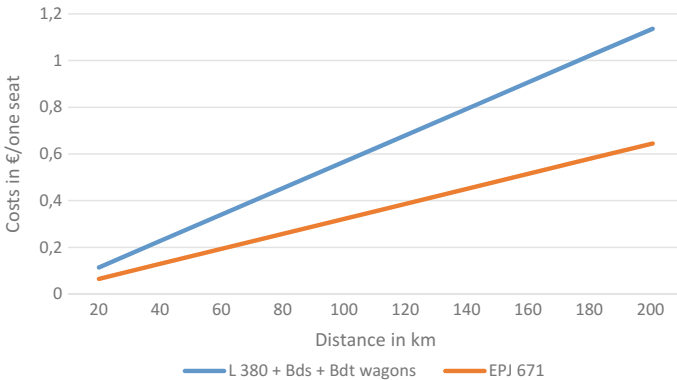
Wagon/EMU	Number of wagons	Seats	Gross tonnage
Bds	1	40	39
Bdt ZS-ZSSK	3	86	40
Locomotive 380	1	–	86
EPJ 671 (EMU)	1	307	166.7
Bdsee	3	40	39
Locomotive 757	1	–	75.4
DMU 840	1	110	58.7



**Fig. 3.3** Cost of the railway infrastructure for electrified tracks



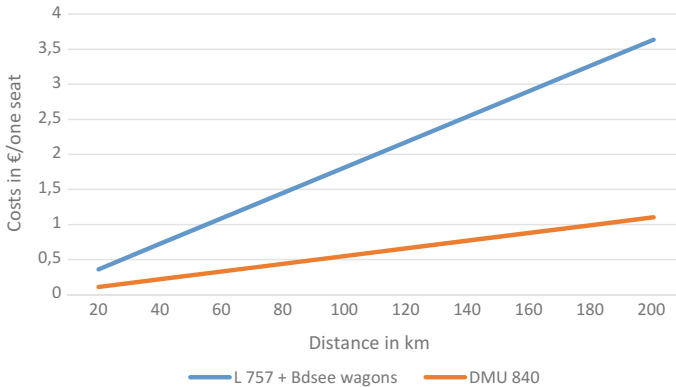
**Fig. 3.4** Cost of the railway infrastructure for non-electrified tracks



**Fig. 3.5** Cost of energy consumption for electrified tracks

Figures 3.5 and 3.6 show the comparisons of the costs of traction fuel and energy in the Slovak Republic by type of passenger train according to the distance and on electrified and non-electrified tracks.

As can be seen in Figs. 3.5 and 3.6, the costs of traction fuel and energy consumption depend on the train parameters. The differences between electrified and non-electrified tracks are large, because the electric traction system has lower specific energy consumption.



**Fig. 3.6** Cost of traction fuel for non-electrified tracks

### 3.5 Conclusion

Currently, the competitiveness of railway transport is one of the most important European policy themes. The EU's interest in increasing the share of railway transport in the market has led to the development of reforms in the form of railway packages. The implementation of these reforms will not be effective if the companies do not use the production factors effectively, meaning that companies will have to increase their economic efficiency.

The economic efficiency of rail companies is affected by external and internal factors. Companies cannot influence the external factors, but it is very important to know them and adapt a strategic and operational plan to these factors. Internal factors are the basis of economic efficiency from the point of view of cost optimization as well as profit optimization. Our research has shown that the optimization of the business processes in rail freight transport (such as increasing the train capacity utilisation and decreasing the runs of empty wagons) has a significant effect on the costs and thus on the economic efficiency. In the case of rail passenger transport, it is recommended the use of EMU or DMU trains instead of classical trains.

**Acknowledgements** *The Chapter is supported by the VEGA Agency by the Project I/0095/16 "Assessment of the quality of connections on the transport network as a tool to enhance the competitiveness of public passenger transport system", that is solved at Faculty of Operations and Economics of Transport and Communication, University of Žilina.*

## References

- Button K (2010) *Transport economics*, 3rd edn. Edward Elgar Publishing, Inc, Massachusetts 511 p
- Decree No. 3/2010 of the office of rail regulation for determining payments for access to rail infrastructure (2010) January 2010. <http://www.urzd.sk/legislativa/VynosURZD-2010-03.pdf>. Accessed 10 Jan 2017
- Dolinayova A, Nedeliakova E, Brumercikova E (2016) *The economics of railway transport. management of rail companies*, 1st edn. EDIS, Zilina, 180 p
- European Commission (2013) *The fourth railway package—completing the single European railway area to foster European competitiveness and growth*. COM (2013) 25 final
- Mašek J, Kendra M, Milinkovič S, Veskovič S, Bárta D (2015) Proposal and application of methodology of revitalisation of regional railway track in Slovakia and Serbia. Part 1: Theoretical approach and proposal of methodology for revitalisation of regional railways. *Transport problems*, 10(Special Edition), pp 85–95
- Nedeliaková E, Nedeliak I, Majerčák P (2014) Research of services quality after the end of transportation in railway freight transport. In: *Management innovation and business innovation: 2nd international conference on management innovation and business (ICMIBI 2014)*, 8–9 December 2014, Bangkok, Thailand. Singapore, Singapore Management and Sports Science Institute, pp 54–61
- Statistic of transport in Slovak Republic (2015). [http://www.telecom.gov.sk/files/statistika\\_vud/preprava\\_nakl.htm](http://www.telecom.gov.sk/files/statistika_vud/preprava_nakl.htm). Accessed 18 Dec 2016
- Zitrický V, Gašparík J, Pečený L (2015) The methodology of rating quality standards in the regional passenger transport. *Transport problems*, 10(Special Edition), pp 59–72

# Chapter 4

## Infrastructure Access Charges

Borna Abramović

### 4.1 Introduction

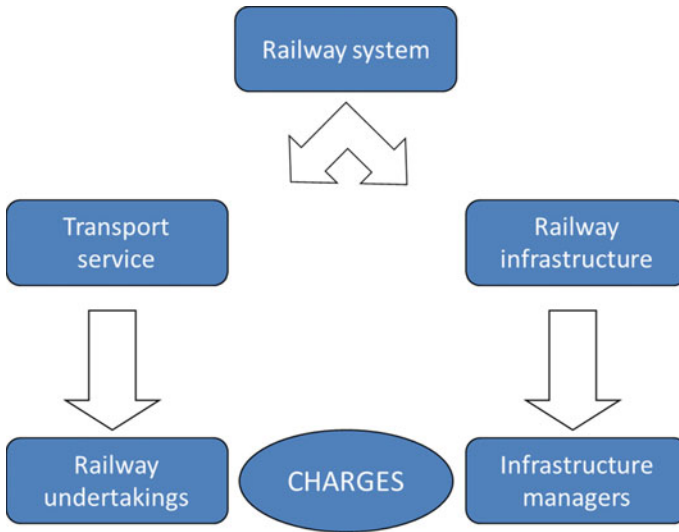
Infrastructure access charges (IACs) and their implications are one of the key difficulties the EU has faced in implementing a liberalised and fully integrated European railway system. This research will consider the current system of rail infrastructure access charges, first outlining their legal basis. It will then continue to examine the network statement and its structure, paying particularly a close attention to its components. The focus will then shift on to a case study of infrastructure access charges and how they are calculated for the case of Croatia. The chapter will then conclude by offering some reflections about the current system of infrastructure access charges and how it could be improved and made more efficient.

In order to achieve these aims, the discussion will touch upon the liberalised access to railway infrastructure since 1991 and the arranged relationships between infrastructure managers (IM) and railway undertakings (RU) and their vertical separation. It will also consider the horizontal separation and ensuing competition between different service providers. Focusing on rail freight, this competition is intense and strong in the entire European Union (Abramović 2012). One of many things that connect infrastructure managers with railway undertakings is infrastructure charges. Figure 4.1 illustrates the separation of railway system and position of infrastructure charges.

Infrastructure charges are a billing model for using rail infrastructure by railway undertakings. The basic principles for constructing such a model must include: (1) simplicity, (2) transparency, (3) neutrality and (4) cost dependency. The simplicity basically indicates that there are no additional hidden or ambiguous calculation terms in the practical application of the model. Also, the term refers to the

---

B. Abramović (✉)  
University of Zagreb, Vukelićeva 4, HR 10000 Zagreb, Croatia  
e-mail: borna.abramovic@fpz.hr



**Fig. 4.1** Railway system and infrastructure charges

clear and logical workings of the calculation. The transparency means that regardless of the undertakings, the charges will be consistent and fair, so the undertakings will be able to check among themselves the amount each has paid for the services. Neutrality is that the infrastructure manager has an equal approach and attitude towards every undertaking. Since the billing model involves charging for various services, the model itself must be based on the actual generated costs for a specific service. This way directly covers the principles of simplicity, transparency and neutrality.

## 4.2 Legal Basis of Infrastructure Charges

The legal basis of the EU railway network is laid out in its four railway packages and is constantly evolving with a framework of directives and regulations. It is important to recognise the difference between a directive and a regulation. A directive is a recommendation that the EU makes regarding best practice and parties can choose which path they will follow. However, a regulation is a legally binding instruction to whomever it concerns and must therefore be followed. In practice, a directive is transferred in national legal act and, on the other hand, a regulation is directly in force (Ljungberg 2013). Due to the complex web of EU regulations and guidelines, we will focus only on the two most relevant directives and regulations regarding infrastructure charges.

The first directive we shall focus on is Directive 2012/34/EU which is defined as a directive recasting the establishment of a single European Railway Area. It aims

to encourage the optimal use of railway infrastructure, which would in turn lead to a reduction in the cost of transport for society. It also clarifies that, to achieve these railway undertakings, we should receive clear and consistent economic signals from capacity allocation and charging schemes which allows railway undertakings to make rational decisions. It sets out two principles of charging:

1. “The charges for the minimum access package and for access to infrastructure connecting service facilities shall be set at the cost that is directly incurred as a result of operating the train service”.
2. “The infrastructure charges referred to in paragraph 3 may include a charge which reflects the scarcity of capacity of the identifiable section of the infrastructure during periods of congestion”.

However it does also lay out some exceptions to the charging principles:

- “In order to obtain full recovery of the costs incurred by the infrastructure manager a Member State may, if the market can bear this, levy mark-ups on the basis of efficient, transparent and non-discriminatory principles, while guaranteeing optimal competitiveness of rail market segments. The charging system shall respect the productivity increases achieved by railway undertakings”.
- “The level of charges shall not, however, exclude the use of infrastructure by market segments which can pay at least the cost that is directly incurred as a result of operating the railway service, plus a rate of return which the market can bear”.
- “For specific future investment projects, or specific investment projects that have been completed after 1988, the infrastructure manager may set or continue to set higher charges on the basis of the long-term costs”.

Despite the detail in this directive, it does not set out how these direct costs should be calculated. Nevertheless, there is a Regulation [2015/909](#) that does. It sets out two methods of calculating the direct unit cost of operating the train service in question. Direct unit cost refers to the direct cost per train kilometres, vehicle kilometres, gross tonne kilometres of a train, or a combination of those. The two methodologies are as follows:

1. “The infrastructure manager shall calculate average direct unit costs for the entire network by dividing the direct costs on a network-wide basis by the total number of vehicle kilometres, train kilometres or gross tonne kilometres forecasted for or actually operated”.
2. “By derogation to Article 3(1) and the first sentence of Article 5(1), the infrastructure manager may calculate direct unit costs by means of robustly evidenced econometric or engineering cost modelling, provided it can demonstrate to the regulatory body that the direct unit costs include only direct costs incurred by the operation of the train service and, in particular, do not include any of the costs referred to in Article 4”. However these costs must be able to be evidenced to an independent regulatory body which will decide if they are fair.



### 4.3 Network Statement and Its Subsections

This research will now focus on the network statement and its subsections. Network statements present information about rail networks, in particular on commercial and legal access conditions. This document is crucial for both main parties representing the railway system: (1) infrastructure manager and (2) railway undertakings. Network statement is the basis for establishing the relationship between both parties involved. All infrastructure managers must publish a network statement on official website that is available free of charge (Bugarinovic and Boskovic 2014). Network statement must contain all the necessary information for railway undertakings for accessing and using the railway infrastructure. Pursuant to the Directive, it must be published in at least two official languages of the Union. In practice, it is usually published in that nation's native language and in English. Contents of the network statement are defined in Annex IV of Directive, so all network statements must have same structures to allow ease of access and the liberalisation of the European rail network. For these reasons, RailNetEurope (RNE (2016)) was founded in January 2004 as a non-profit making association whose aim is to enable fast and easy access to the European rail network, as well as to increase the quality and efficiency of international rail traffic. One of the main goals of RNE is to promote the harmonisation and publication of a user-friendly and customer-oriented network statement. Therefore, the RNE proposed a common structure of network statement, which presents guidelines for the expected content, organisation and other information useful for creating the network statement. The most important benefit of the guidelines is that in different countries respectively different languages users (railway undertakings) can find the same structure.

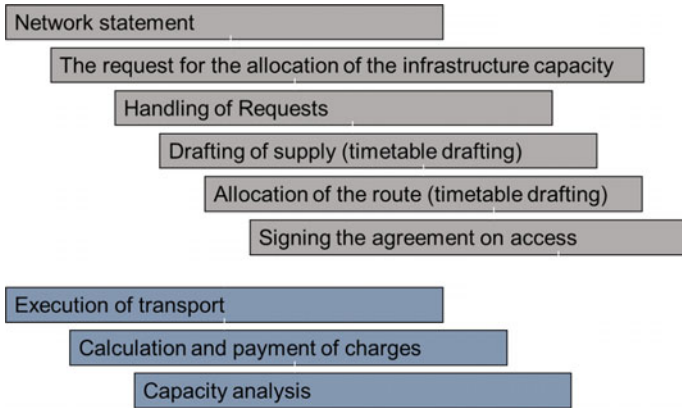
Network statement consists of the following six components or subsections:

1. General information,
2. Access conditions,
3. Infrastructure,
4. Capacity allocation,
5. Services and
6. Charges.

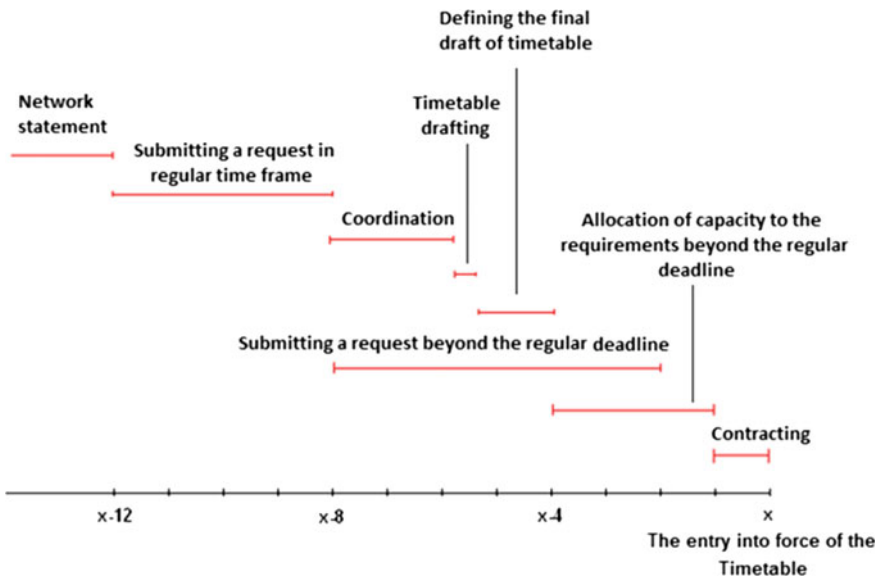
In the interest of brevity, we will focus only on the last three subsections in the network statement.

The subsection about capacity allocation of the network statements is concerned with horizontal separation and the competition between railway undertakings for capacity. It defines how to book capacity and how conflicts are resolved. Due to the growing number of rail undertakings it is very important for this section to be precise and to prevent confusion, even lawsuits, regarding capacity allocation. Capacity allocation process is shown in Fig. 4.2.

A very important aspect of capacity allocation is the timeline. Time is also an important resource, so the capacity allocation process must be done in a certain fixed amount of time. Figure 4.3 shows a timeline of capacity allocation activities.



**Fig. 4.2** Capacity allocation process *Source* Network Statement, HŽ Infrastruktura Ltd 2016



**Fig. 4.3** Timeline of capacity allocation activities *Source* Network Statement, HŽ Infrastruktura Ltd 2016

There is a subsection on services of the network statement, which defines four different services:

1. Minimum access package
2. Access to services facilities and supply of services
3. Additional services
4. Ancillary services

Services 1 and 2 are obligatory services, whereas 3 and 4 are available depending on the strength of the infrastructure manager.

The minimum access package is concerned with the following points:

- Handling of requests for railway infrastructure capacity
- The right to utilise capacity which is granted
- Use of the railway infrastructure, including track points and junctions
- Train control including signalling, regulation, dispatching and the communication and provision of information on train movement
- Use of electrical supply equipment for traction current, where available
- All other information required to implement or operate the service for which capacity has been granted.

The access to service facilities and the supply of services concerns railway undertakings' access to service facilities, such as access to passenger stations, freight terminals and sidings, basically, any facility on the network that is run or controlled by the infrastructure manager.

Additional services can refer to a number of extra services such as a traction current, preheating/preliminary air conditioning of passenger trains, control of transport of dangerous goods and assistance in running exceptional consignment trains.

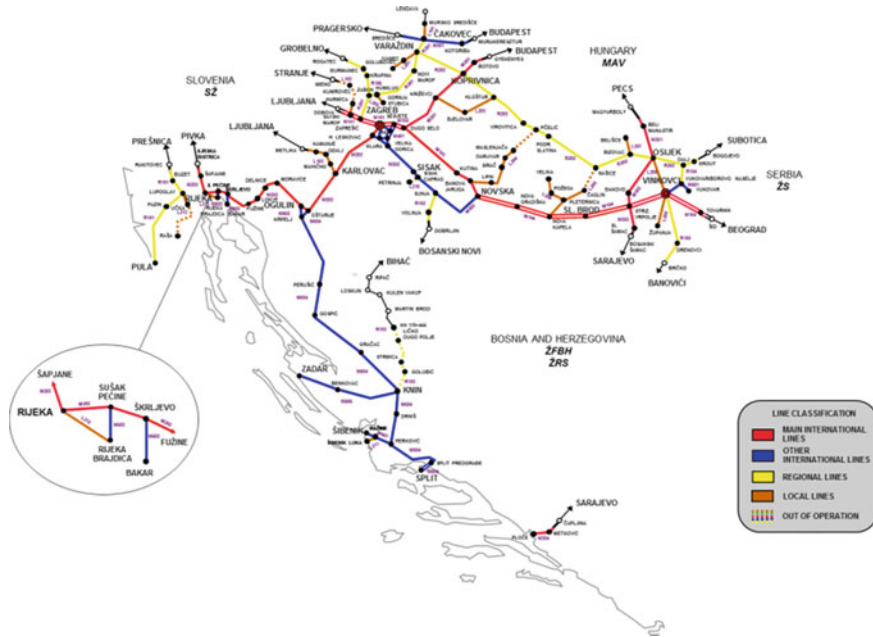
Ancillary services can refer to services such as access to telecommunication networks, provision of supplementary information, technical inspection of rolling stock, ticketing services in passenger stations and heavy maintenance services, supplied in maintenance facilities dedicated to high speed trains or to other types of rolling stock requiring specific facility.

The section on charges simply focuses on the charging principles, charging system, tariffs, financial penalties and incentives, performance scheme, changes to charges and billing arrangements.

A measure that has been incredibly helpful in this section is the use of EICIS (European Infrastructure Charging System) run by RNE, which provides a single online location where any railway undertaking can calculate potential infrastructure charges. This is a hugely liberalising innovation that brings more transparency to a sometimes confusing system.

## 4.4 Case Study

We will now look into some of these guiding principles in action by focusing on one country. In our case study of Croatia, this work will evaluate on how the Croatian network statement operates in practice, in comparison to the guiding principles we have already laid out.



**Fig. 4.4** Railway lines in Croatia *Source* Network Statement, HŽ Infrastructure Ltd 2016

The railway network in Croatia is comprised of 2,722, 2468 km (90.7%) single-track and 254 km double-track lines (9.3%). There are 980 km (36%) of electrified railway lines, 977 of which use the 25 kV/50 Hz electrification system, and only 3 km use 3 kV ((Šapjane–Ilirska Bistrica (SI)). The railway infrastructure of the Republic of Croatia is connected to the railway infrastructure of Slovenia, Hungary, Serbia and Bosnia and Herzegovina (Abramović and Šipuš 2016).

When Croatia became a member of the European Union in 2013, there was a follow-up of directives and regulations of the EU. Compared to the network size, the competition between different railway undertakings is very high. Service providers in passenger transport are protected (closed) and run by the national railway company HŽ Putnički prijevoz (HŽ Passenger transport). On the other hand, the services in freight transport have been liberalised. Currently there are seven active freight railway undertakings. The biggest one, with around 90% market share, is still the national railway company HŽ Cargo (Fig. 4.4).

The network statement of HŽ Infrastructure in chapter 6 Charges lists the following equation for minimum access package [1]:

$$C = ((T + d_m + d_n) \cdot \sum ((L \cdot l) \cdot C_{vlkm})) + (l_{el} \cdot C_{el}) \cdot K, \tag{1}$$

where

- C minimum access package charge
- T train path equivalent

$d_m$	additional charge for train mass
$d_n$	additional charge for the use of tilting technique
$L$	line parameter
$C_{vlkm}$	basic price [kn/trainkm]
$l_{el}$	length of train path with electric traction [km]
$C_{el}$	additional charge on trainkm price for the train path with electric traction
$K$	price correction coefficient

Train path equivalent is the coefficient divided into three groups: (1) passengers train ( $T_{1m}$ ), (2) freights train ( $T_{2n}$ ) and (3) locomotives train ( $T_{31}$ ). Train path equivalent is shown for passenger trains in Table 4.1 and for freight trains in Table 4.2. Train path equivalent for locomotive trains in freight and passenger transport is 0.20.

Line parameter is determined by the integration of three elements which influence the definition of its value and they are: (1) technical line parameter, (2) line operation equivalent and (3) line costs equivalent. Overall there are six line parameters and they are shown in Table 4.3.

The basic price per train kilometre for the use of the minimum access package is 5.99 kn/trainkm + VAT for passenger trains, 14.31 kn/trainkm + VAT for freight trains and 14.31 kn/trainkm + VAT for locomotive trains in passenger and freight transport.

The most problematic part of Eq. (1) is  $K$  which stands for price correction coefficient, since there is no officially methodology on how to calculate this coefficient. Theoretically, lower border is more than 0, but the upper border is infinite.

**Table 4.1** Train path equivalent for passengers train

Train path equivalent	Train type	Value
$T_{11}$	EuroCity, InterCity, express, agency	2.27
$T_{12}$	Fast, semi-fast	1.84
$T_{13}$	Passenger, cross-border	0.95
$T_{14}$	Suburban	1.32
$T_{15}$	Empty train sets	0.91

Source Network Statement 2016, HŽ Infrastructure Ltd

**Table 4.2** Train path equivalent for freights train

Train path equivalent	Train type	Value
$T_{21}$	Trains with individual waggons, trains with single-type loads, intermodal trains, express, fast, direct, block trains	1.13
$T_{22}$	Section trains	0.86
$T_{23}$	Pickup goods trains, circuit-working trains and industrial trains	0.51
$T_{24}$	Trains with empty waggons	0.55

Source Network Statement 2016, HŽ Infrastructure Ltd

**Table 4.3** Line parameter

Category line	Line parameter
L <sub>1</sub>	2.00
L <sub>2</sub>	1.60
L <sub>3</sub>	0.90
L <sub>4</sub>	0.50
L <sub>5</sub>	0.80
L <sub>6</sub>	0.30

Source Network Statement 2016, HŽ Infrastruktura Ltd

The coefficient is established by Ministry of the Sea, Traffic and Infrastructure for each year in advance, but the main problem is that it can be changed throughout the current year. We can, therefore, raise the question of transparency. Hopefully, in the near future this coefficient will be removed from equation.

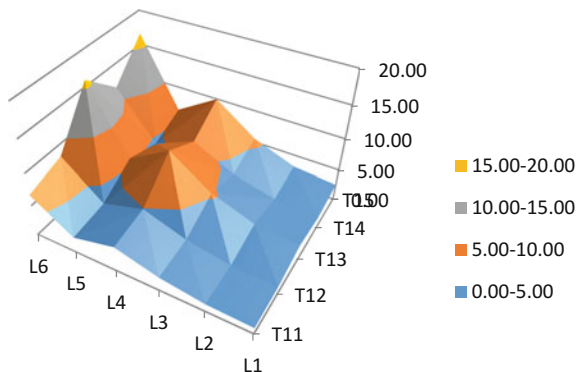
By analysing Eq. (1), we can notice that there is a fixed coefficient product of train path equivalent and category line. In order to establish the limits of product, it can be calculated as matrix. Interesting results arise when the matrix represents the substantial difference between the calculated products. But interesting results can be matrix that represent how much is the different between calculated products. Of course, there are two matrices, one for passenger transport and the other for freight transport.

In passenger transport, the difference between the highest and the lowest product is 16.63. Table 4.4 shows the full calculation of products for passenger transport. To further clarify, Fig. 4.5 represents surface plot of differentness between the highest and the lowest product.

**Table 4.4** Calculation of products for passenger transport

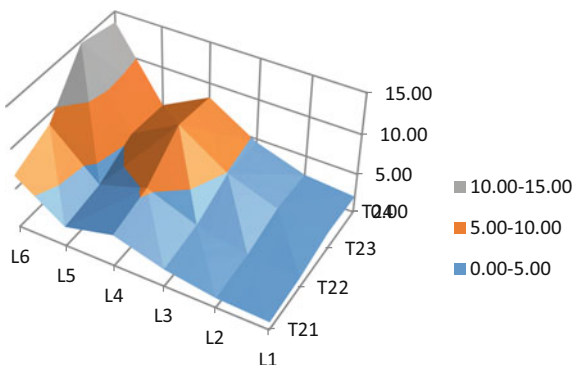
	L <sub>1</sub>	L <sub>2</sub>	L <sub>3</sub>	L <sub>4</sub>	L <sub>5</sub>	L <sub>6</sub>
T <sub>11</sub>	4.54	3.63	2.04	1.14	1.82	0.68
T <sub>12</sub>	3.68	2.94	1.66	0.92	1.47	0.55
T <sub>13</sub>	1.90	1.52	0.86	0.48	0.76	0.29
T <sub>14</sub>	2.64	2.11	1.19	0.66	1.06	0.40
T <sub>15</sub>	1.82	1.46	0.82	0.46	0.73	0.27

**Fig. 4.5** Surface plot of differentness for passenger transport



**Table 4.5** Calculation of products for freight transport

	L <sub>1</sub>	L <sub>2</sub>	L <sub>3</sub>	L <sub>4</sub>	L <sub>5</sub>	L <sub>6</sub>
T <sub>21</sub>	2.26	1.81	1.02	0.57	0.90	0.34
T <sub>22</sub>	1.72	1.38	0.77	0.43	0.69	0.26
T <sub>23</sub>	1.02	0.82	0.46	0.26	0.41	0.15
T <sub>24</sub>	1.10	0.88	0.50	0.28	0.44	0.17

**Fig. 4.6** Surface plot of differentness for freight transport

In freight transport, the difference between the highest and lowest product amounts to 13.70. Table 4.5 represents the full calculation of products for freight transport. For a better understanding, Fig. 4.6 represents surface plot of differentness between the highest and lowest product.

#### 4.4.1 Passenger Transport

Two typical passenger lines were chosen for this research: (1) long distance with electric traction (25 kV/50 Hz) and (2) local with diesel traction.

The long distance line is 203 km long and classified as international line. The line route connects Savski Marof gr. (Slovenia Border) to Tovarnik gr. (Serbian Border), passing through Zagreb and Slavonski Brod along the river Sava.

The local line is 34 km long and classified as local line. The line route connects Varaždin with small village Golubovec passing via towns Ivanec and Lepoglava.

According to Eq. (1), the following calculation was made for passenger transport.

(a) Calculation on line Zagreb–Slavonski Brod:

$$C = ((1.84 + 0 + 0 \cdot \sum((2.00 \cdot 203) \cdot 5.99)) + (203 \cdot 2.05) \cdot 1$$

$$C = 4,890.92kn + VAT(25\%)$$

$$C = 6,113.65kn \cong 804.43\text{€}$$

(b) Calculation on line Varaždin–Golubovec:

$$C = ((0.95 + 0 + 0) \cdot \sum((0.30 \cdot 34) \cdot 5.99)) + (0 \cdot 2.05) \cdot 1$$

$$C = 58.04kn + VAT(25\%)$$

$$C = 72.55kn \cong 9.55\text{€}$$

After the calculation of minimum infrastructure package, we can calculate the overall average price stated per train kilometre for passenger transport. For our case, we need to extract the price of electricity on line Zagreb—Slavonski Brod and the VAT. On line Zagreb—Slavonski Brod the price is 22.04 kn/trainkm or 2.90 €/trainkm and on line Varaždin—Golubovec the price is 1.71 kn/trainkm or 0.23 €/trainkm.

An interesting fact is that in the overall price excluding VAT, the cost of electricity on the line Zagreb—Slavonski Brod amounts to 8.51%.

#### 4.4.2 Freight Transport

In this research two typical freight lines were chosen: (1) domestic line that combined electric and diesel traction and (2) transit line from Savski Marof gr. (Slovenia Border) to Tovarnik gr. (Serbian Border) with electric traction.

The first line is from Šibenik (port on Adriatic) and Kutina (famous fertilisers producer). This line is divided into three sections according to the line classification. The first section goes from Šibenik to Ogulin and covers a distance of 300 km with diesel traction, the second section is from Ogulin to Zagreb Ranžirni kolodvor (marshalling yard), a distance of 109 km and electric traction and the third section connects Zagreb Ranžirni kolodvor to Kutina with a distance of 81 km and electric traction. All three sections have different line parameters: 0.50 first, 1.60 s, and 2.00 third.

The second line is the main international line with the total distance of 327 km with electric traction. The allowed gross mass of train on this line is 2,000 tonnes, so additional charge for train mass must be added in calculation.

According to Eq. (1), the following calculation was made for freight transport.

(c) Calculation on line Šibenik—Kutina:

$$C = ((1.13 + 0 + 0) \cdot \sum((0.50 \cdot 300) + (1.6 \cdot 109) + (2.00 \cdot 81)) \cdot 14.31) + (190 \cdot 2.05) \cdot 1$$

$$C = 8,254.73kn + VAT(25\%)$$

$$C = 10,318.43kn \cong 1,357.69\text{€}$$



(d) Calculation on line Savski Marof gr.—Tovarnik gr.:

$$C = ((1.13 + 0.30 + 0) \cdot \sum((2.00 \cdot 327) \cdot 14.31)) + (327 \cdot 2.05) \cdot 1$$

$$C = 17,566.69kn \cong 2,311.41\text{€}$$

$$C = 14,053.35kn + \text{VAT}(25\%)$$

After calculation of minimum infrastructure package, we can determine the overall average price stated per train kilometre in freight transport. For our case, we need to extract the price for electricity and VAT. This is because only one part of the line Šibenik—Kutina is electrified. On line Šibenik—Kutina, the price is 16.05 kn/trainkm or 2.11 €/trainkm and on line Savski Marof gr.—Tovarnik gr. the price is 40.93 kn/trainkm or 5.39 €/trainkm.

Interestingly, in the overall price excluding VAT the cost of electricity on the line Savski Marof gr.—Tovarnik gr. is 4.77%.

#### 4.4.3 *Analysis of Relation Between IAC and GDP*

A very neutral parameter for measuring the development of infrastructure access charge is gross domestic product (GDP). Using GDP makes it possible to measure the total production of a country. In fact, GDP represents the market value of all the final goods and services produced in a country during one year. In this way the economic power of a country is measured. In comparative analyses, the absolute value of the gross domestic product is not a relevant indicator since absolute values of the economy of one country cannot be compared with those of another country. This would mean that in comparative analyses, the relative parameter has to be used. Such relative parameter is the gross domestic product per capita (GDPc). In our research, we are using data for GDPc from Croatian National Bank (Hrvatska narodna banka (2016)).

Regularly, usually every year, Independent Regulators' Group—Rail (IRG—Rail (2016)) publishes a document entitled Annual Market Monitoring Report. From this document for the purposes of our research, the data of average infrastructure manager revenue from track charges per kilometre for freight and passenger services have been taken.

The comparison of those two sets of data, GDPc and IACs from freight (FT) and passenger services (PT) is shown in Fig. 4.7, from which we can determine the development of infrastructure manager revenue related to GDPc from 2010 until 2013. The charges are indexed to the average revenue in 2010, the index is 100.

It is evident that the infrastructure manager revenue has been growing at an incredible pace, and comparing the movement of GDP, it can be concluded that the

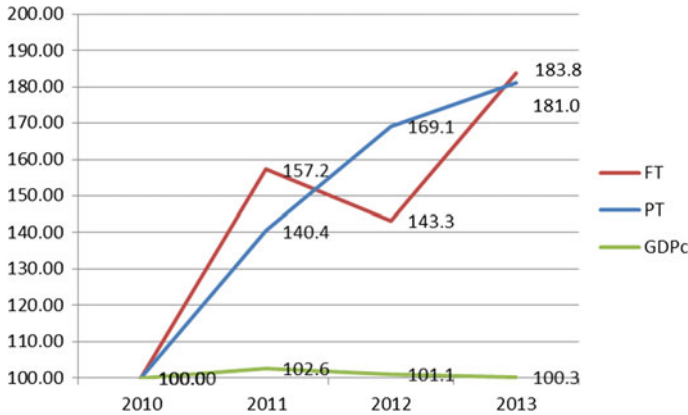


Fig. 4.7 Relation between IACs and GDP

amount of the infrastructure access charge has not adhered to the economic situation. It is suffocating the railway undertakings instead. At that time, the traffic was operated only by national railway undertakings in passenger and freight transport.

### 4.5 Conclusion

This analysis showed that the Croatian network statement is not fit for purpose. Calculations are too complicated. Businesses, looking to utilise rail freight, are not in a position to understand these calculations. The process in Croatia needs to be simplified and made easier to understand. How otherwise is the rail network planning to attract new customers and fully utilise the infrastructure? Accessibility to rail freight must be increased. After all, the network statement is there for railway undertakings to benefit and therefore it must be designed in a way suit them.

The process of infrastructure access charge calculation must be simplified and access to customers improved. A measure that could alleviate the accessibility problems would be to offer all potential customers a software package to calculate infrastructure charges. This would allow customers—railway undertakings—to have a precise idea of the costs associated with rail freight and make a uniformed decision on rail freight in comparison to alternative means of transport. This would satisfy EU Directive 2012/34 which aims to increase the use of railway infrastructure, leading to a reduction of transport costs for society. This is a goal that everyone in the railway business can agree on and therefore efforts must be made to achieve it. There is a little excuse for not solving a problem which has an obvious solution.

## References

- Abramović B (2012) Liberalization of railway market as a challenge for the national operator. In: Proceedings of globalization trends and their impact on the transport system in terms of the EU common market HORIZONS 2012, University of Žilina, Střečno, pp 12–18
- Abramović B, Šipuš D (2016) Analysis of railway infrastructure charges fees on the local passengers lines in Croatia. In: Proceedings of international conferences on traffic and transport engineering ICTTE 2016, Assoc Italiana Ingn Traffico Trasporti Res Ctr Belgrade, Belgrade, pp 918–923
- Bugarinovic M, Boskovic B (2014) A systems approach to access charges in unbundling railways. *Eur J Oper Res* 240(3):848–860
- Commission Implementing Regulation (EU) 2015/909 (2015) on the modalities for the calculation of the cost that is directly incurred as a result of operating the train service of 12 June 2015. <http://eur-lex.europa.eu/legal-content/EN/TXT/HTML/?uri=CELEX:32015R0909&from=EN>
- Croatian National Bank (Hrvatska narodna banka). [www.hnb.hr](http://www.hnb.hr) (accessed on 22 June 2017)
- Directive 2012/34/EU (2012) of the European Parliament and of the Council of 21 November 2012 establishing a single European railway area. <http://eur-lex.europa.eu/legal-content/EN/TXT/HTML/?uri=CELEX:32012L0034&from=EN>
- Independent Regulators' Group—Rail (IRG—Rail). <http://www.irc-rail.eu/> (accessed on 22 June 2017)
- Ljungberg A (2013) Impacts of increased rail infrastructure charges in Sweden. *Res Trans Econ* 39(1):90–103
- Network Statement, HŽ Infrastruktura Ltd. <http://www.hzinfra.hr/network-statement-2016> (accessed on 22 June 2017)
- RailNetEurope (RNE). [www.rne.eu](http://www.rne.eu) (accessed on 22 June 2017)

# Chapter 5

## Interior Train Design of Commuter Trains: Standing Seats, and Consideration for Persons with Reduced Mobility

Emmanuel Matsika

### 5.1 Introduction

Rail transportation has in the recent past expanded more than any other mode of transport, thanks to its green credentials, safety and efficiency. The largest number of train passengers is served by commuter systems.

Commuter trains serve travellers who frequently use rail daily within a commuter belt. Usually, they do not require much additional space for luggage and other accessories. Large cities (especially capitals and economic hubs) tend to have high demand for commutation. In these cities, the demand for transportation has increased over the years. For example, the London rail demand increased year on year from 1994 to 2009 (TfL 2011). One of the major solutions to such increasing demand has been the development of rail networks in the form of light rail (trams), metro (subway) and urban trains systems, collectively called “commuter rail”.

Increasingly, the demand for commuter rail is outstripping the rate of deployment of new capacity due to hurdles such as limitation in the capacity of the rail infrastructure, speed limits, maximum train length, operational requirements (e.g. station to station stopping times) and cost of capitalisation.

Typical seating density in Europe is 2.5–3 passengers per m<sup>2</sup>, while for standing the norm is 4–5 passengers per m<sup>2</sup>. Therefore there is potential for about 50% increase in passenger seating capacity of commuter train by installing semi-seating (or standing seats), which are a subject of this chapter. A standing seat is a seat against which passengers can lean, offering some support in a semi-seated position, with arm rests to better define the passengers’ travel space.

It is important to note that different regions of the world use different standing passenger densities for design purposes. For example, new train design in Hong

---

E. Matsika (✉)

NewRail, Centre for Railway Research, Newcastle University,  
Newcastle upon Tyne, UK

e-mail: emmanuel.matsika@ncl.ac.uk; ematsika@yahoo.com

Kong specify 10 passengers/m<sup>2</sup>, and 8 passengers/m<sup>2</sup> for passenger planning. In the US, a basic 5 passengers/m<sup>2</sup> is considered the worst case allowable planning standard with 6 passengers/m<sup>2</sup> or above for engineering requirements.

Standing seats are not entirely new, as shown in Figs. 5.1 and 5.2. The concept of standing and leaning on a soft padded surface has been applied in current vehicles.

Figure 5.1 shows a typical leaning seat installed in a tram. While this design has separations for passengers to lean on, others are continuously padded surfaces such as the one used in a metro vehicle (Fig. 5.2). Such seats do not have a backrest, head rest and arm rest. They tend to largely be longitudinal seating configuration in order to maximise the standing area characterised by grab poles and grab handles.

The comfort of a commuter depends a lot on whether they are travelling standing or sitting. A higher standing capacity increases revenue potential of a train operator, while reducing the passenger comfort. Ideally all passengers should travel seated, which maximises comfort at the expense of the train operator's desire to maximise passenger capacity.

The level of passenger comfort increases with increasing normal seat capacity, while it reduces with reducing number of seats as the standing capacity increases. This is illustrated in Fig. 5.3 in relative terms. The diagonal lines represent the number of seats, increasing diagonally from right to left. Intersections between the comfort versus standing line and diagonal lines represent the comfort level for a specific number of seating capacity and standing capacity.

Factors that influence the design of standing seats, and the overall seat layout or configuration are presented and discussed in this chapter. While the dimensioning



**Fig. 5.1** Longitudinal leaning seats, with separations (Christie 2012)



Fig. 5.2 Longitudinal leaning seats, without separations (by author)

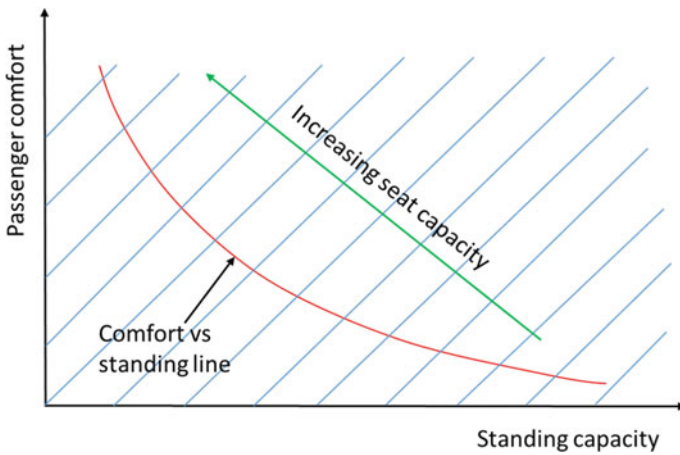
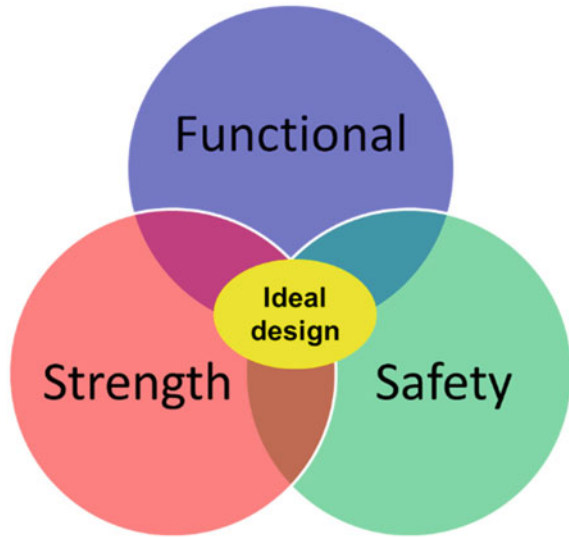


Fig. 5.3 Passenger comfort diminishes with reducing seating capacity

of the standing seats may rely mainly on the occupant anthropometric characteristics, the seat configuration and therefore seating capacity is influenced additionally by requirements such as design for Persons with Reduced Mobility (PRMs),

**Fig. 5.4** Function–strength–safety balance in design of train interiors



specifically wheelchair space. This chapter will discuss a case example of design of a commuter train using standing seats (O'Neill et al. 2014). It will further discuss the effect that provision of wheelchair space could have on the standing seat capacity.

An ideal interior train furniture or component is one that is engineered such that it meets its functional requirements. It must also have the capability to withstand service loads without compromising safety under service conditions and extreme incidents such as emergency braking or crash (Matsika et al. 2014). Figure 5.4 depicts this concept, which is the design philosophy of train interiors (Matsika and Peng, 2015).

## 5.2 Standing Seats

### 5.2.1 Nominal Design

Similarly to the design of ordinary seats, the fundamental consideration is the comfort of the occupant, which takes account of human factors and ergonomics. The basic premise of human factors and ergonomics is *user-centred design*, based on a fundamental understanding of user capabilities, needs and preferences (Czaja and Sharit 2009). The main starting point in the design process is therefore collection of anthropometric data which determines seat dimensions.

Bearing in mind the space limitations imposed by the train interior for transverse seating, Table 5.1 shows nominal standing seat dimensions:

**Table 5.1** Nominal standing seat dimensions (O'Neill et al. 2014)

Dimension	Nominal Value	Remarks
Seat width	500 mm	Can fit an average British, comfortably
Seat pitch	530 mm	Determined by the body depth, allowing for quick and easy ingress and egress
Seat height	600 mm–850 mm (adjustable)	Buttocks height varies between 691 mm and 919 mm for most adults, 5th%ile to 95th%ile
Seat inclination	5°	Based on comfort and common practice
Armrests	Relatively located to support an average person	Retractable using a spring-damper mechanism

### 5.2.1.1 Manufacturing

Current manufacturing techniques used for ordinary seats would be applied, which minimises production costs. With fire protection at the core of the design, it is recommended to use fire-resistant foam, reinforced with a flexible casing; the same design as the head and arm rest. The seat and backrest are made in a similar matter, but with spring reinforcement to ensure increased stiffness. Figure 5.5 shows a CAD image of a standing seat.

Inasmuch as fitting of standing seats would increase the train seating capacity, it has a high potential of increasing the tare load of the vehicle. Therefore, the supporting vertical pole is made out of either high strength steel or new novel composite materials.

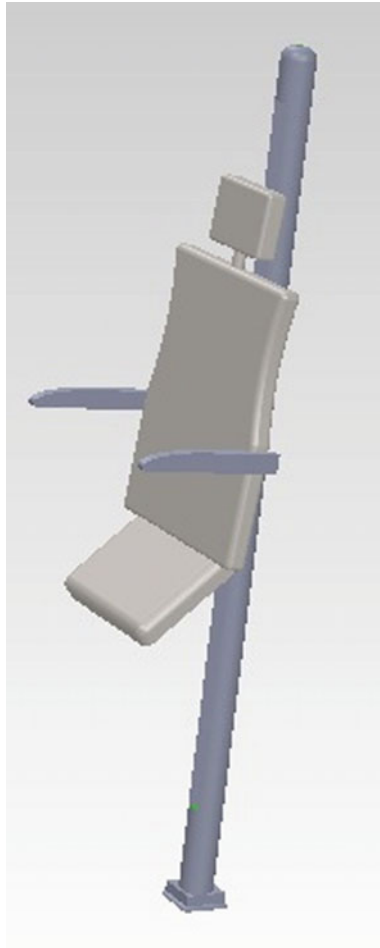
### 5.2.1.2 Passenger Density

Based on the dimensions above (500 mm width and 530 mm seat pitch), the passenger density is about 4 passengers per m<sup>2</sup> (0.25 m<sup>2</sup>/passenger), which is between the normal seating and standing densities. The economic implication is that there would be fewer passengers than the standing capacity. However, the capacity would be higher than if normal seats are fitted. Compared to standing passengers, standing seats provide more comfort, safety and security.

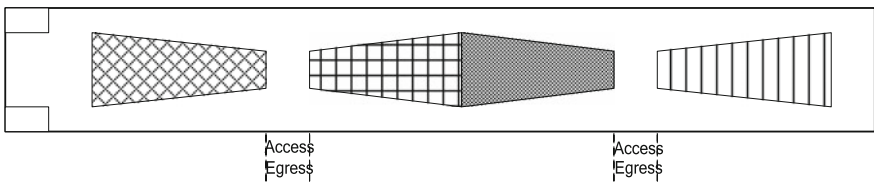
### 5.2.1.3 Seat Layout

The seat layout has a strong effect on the rate of ingress and egress of passengers, which is particularly crucial this being a commuter system. Ideally, a trapezoid seat configuration would greatly address this problem (see Fig. 5.6), especially at peak times. The downside of this system is that it would reduce the number of seats, which directly counters the objective of standing seats—increasing passenger capacity. It is, therefore, recommended that a conventional transverse unidirectional seat layout is adopted (Fig. 5.7), with provision for relatively wide aisles, and luggage racks.



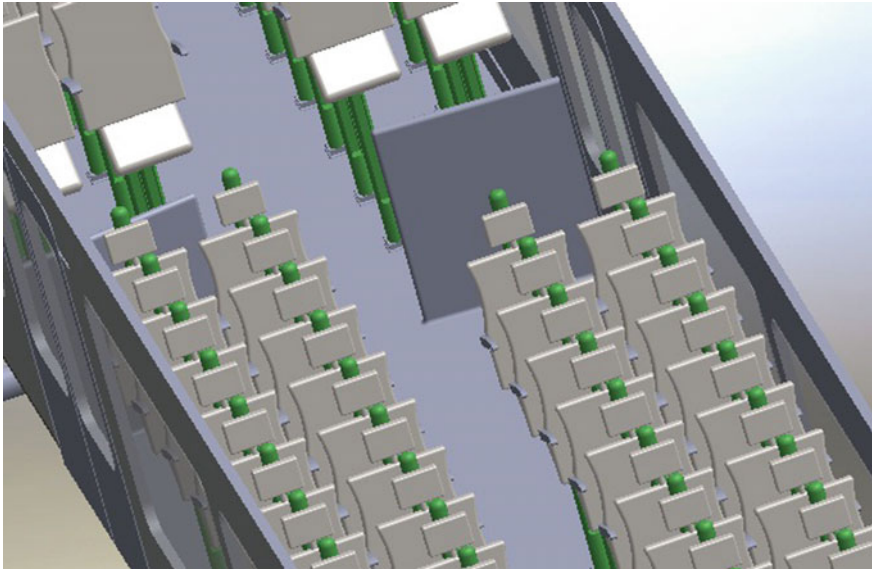


**Fig. 5.5** Standing seat design (O'Neill et al. 2014)



**Fig. 5.6** Trapezoid seat layout

Although most people prefer facing forward (Matsika et al. 2013), the bidirectional motion characteristic of trains makes it difficult to meet this preference. One option is to fit sections of space with some facing one direction, and the other sections facing the other.



**Fig. 5.7** Illustration of vehicle density (O'Neill et al. 2014)

It is noteworthy that this section only deals with able people. Section 5.2.3 presents a consideration for Persons with Reduced Mobility (PRMs), specifically wheelchair users because they need the largest space (highest  $\text{m}^2/\text{passenger}$ ).

## 5.2.2 *Human Factors*

As stated earlier, the design of a standing seat takes into account human factor engineering. However, inherently, it does not possess the level of comfort as that of a normal seat. Nevertheless, it provides superior comfort when compared with standing. Listed in Table 5.2 are factors that should be considered and analysed to ensure acceptable passenger ride quality.

## 5.2.3 *Interior Space Design for Persons with Reduced Mobility*

### 5.2.3.1 **Background**

With the passing of the Disability Discrimination Act (DDA) of 1995 (amended 2005) in the United Kingdom, a number of regulations and codes of practice have been put in place to provide Persons with Reduced Mobility (PRMs) greater access

**Table 5.2** Factors that affect human comfort

Factor	Remarks
Vehicle stability	<i>Flange climb</i> Occurs when the outer wheel experiences a high lateral force against the high rail and the vertical force on that flanging wheel is reduced. This may lead to derailment
	<i>Lateral acceleration (or force)</i> Passenger comfort if the main limiting factor for vehicle lateral acceleration, pegged at $0.8 \text{ m/s}^2$ , which is the human tolerance threshold for discomfort
	<i>Vehicle lateral instability</i> Due to wheel conicity and rail cant, lateral motion can induce large amplitude and well-defined wavelength oscillations known as hunting (Inwicki, 2006)
Air conditioning and Ventilation	Standing seats tend to increase the capacity of a typical commuter train. This has a tendency to reduce the air quality and increase thermal discomfort. The demand for air conditioning is high, considering that not only would the number of passengers increase due to standing seats, but also acknowledging that a seating passenger emits 126 W of heat compared to 167 W for a standing passenger (Águas, 2000). To meet the air quality and thermal comfort requirements, the ANSI/ASHRAE Standard 62-2001 and ISO 7730 Standards should be applied, respectively
Emergency incidents	In traditional trains, the access and egress are via the four doors on the side of the train, as well as at the two ends for during an emergency. The emergency exits on the train are the four doors, with 2100 mm width and 2000 mm height and the windows should prevent breakage and induce passengers to stay in the train in case of an accident, unless there are obvious safety risks in that option. Emergency light plays a role in this, being necessary to provide a level of illumination, even in loss of the auxiliary battery feed, sufficient for passengers to evaluate their environment, to see other passengers and crew, administer first aid where essential, read emergency notices, move safely or encouraging them to stay on board if it is safer to do so, locate emergency exits and equipment and facilitate the safe use of exits during evacuation (RSSB 2008) A whole data transmission system should be equipped in the train. This system includes emergency calls, data transmission as well as voice system within the train. Emergency calls can be of two types: automatic (in case of an accident) and manual

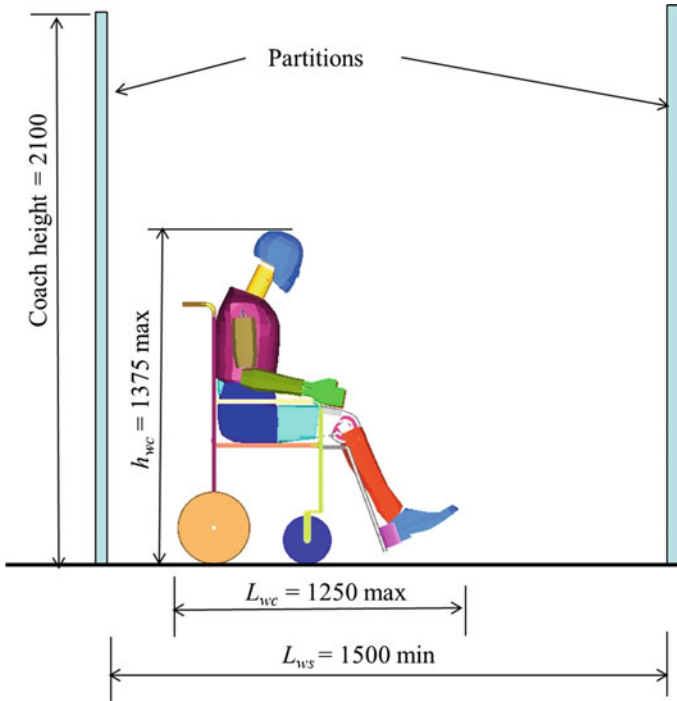
and freedom of using public transport, including railway vehicles. The DDA 1995/2005 has since been incorporated into the Equality Act of 2010. Enactment of such laws has seen an increase in PRMs using public transport, including railway. A PRM is understood to mean any person whose mobility is reduced due to a physical incapacity (sensory or movement restriction), an intellectual deficiency, age, illness or any other cause of disability when using transport and whose situation needs special attention and the adaptation to the person's needs of services made available to all other passengers. PRMs may include: elderly, visually

impaired, hearing impaired, walking impaired and wheelchair users. For the purposes of this chapter, focus will be on wheelchair users because they have the largest space requirements, and have a great impact on seat configuration. They are also increasingly part of the commuting population.

The Equality Act of 2010 requires all station operators to take reasonable steps to ensure that they do not discriminate against disabled people. Train and station operators are required by their operating licences to establish and comply with a disabled people's protection policy (DPPP) which must be approved by Office of Rail and Road (ORR) (DfT 2015). A DPPP sets out the arrangements and assistance that an operator will provide to protect the interests of older and disabled people using its services. Currently, railway transport has great potential over other modes of transport in meeting the sustainability development goals (economic, social and environmental). It is expected that railway transport capacity would increase at a higher rate than other modes of transport. This would result in a rise in the number of people travelling by railway. Wheelchair users are expected to be part of this population. Increasingly, wheelchair users are travelling by railway transport. Taking UK as an example, there has been an increase in the number of disabled people (generally) travelling by railway. According to the UK Association of Train Operating Companies (ATOC), disabled railcard journeys have trebled in the last 15 years. There are now 122,000 railcards in use by disabled people, an increase of more than 40,000 in just 5 years—thanks to the increasingly accessible infrastructure and railway vehicles. As part of accessibility, vehicle interiors are now being engineered to accommodate a wheelchair occupant.

Railway vehicle fixed seats are designed to national and international standards as part of the vehicle dynamic system. By contrast, most wheelchairs are not intended for use as a vehicle seat and have not been designed or tested for crash-worthiness. However, currently, there is a push for wheelchair manufacturers to design them to withstand high crash deceleration. In railway vehicles, consideration of human factors and ergonomics has led to development of standards to provide adequate space in the wheelchair area. To be deemed accessible, a railway vehicle should at least accommodate a reference wheelchair with dimensions as stipulated by the European Commission PRM TSI (the length of the wheelchair,  $L_{wc} \leq 1250$  mm, which includes foot protrusion and the maximum height  $h_{wc}$  1375 mm—(see Fig. 5.8). When on board a railway vehicle, it is recommended that a wheelchair occupant transfers to a vehicle seat. However, the common practice is to park in the wheelchair space, either facing forward or rear, but not sideways. In the event of a crash, the main concern for occupant safety is secondary collision with railway vehicle interior furniture or features.

Wherever a designated wheelchair space is provided, the EC PRM TSI specification sets a length ( $L_{ws}$ ) requirement of 1500–1600 mm (minimum) depending on the seating configuration (Fig. 5.8 shows an Open Space Configuration). To allow for easy manoeuvrability, however, it is recommended that the area should be as large as possible. Nevertheless, train manufacturers build to maximise the number of fixed seats (which would include standing seats). Subsequently, the wheelchair space is typically minimised to between 1500 and 1600 mm long. It is



**Fig. 5.8** A typical open space designated wheelchair space

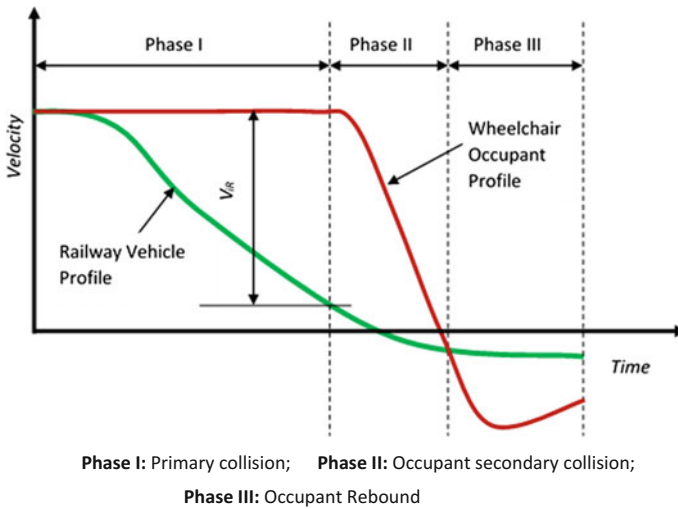
important to note that crashworthiness and wheelchair space requirements have already reduced the number of fixed seats by about ten and six, respectively. The reduction in the number of seats is in contrast with the desire for train operators to run economically because increasing the number of seats maximises space utilisation. To this effect, train manufacturers tend to minimise the wheelchair space rather than maximise it beyond 1600 mm.

In the design of wheelchair space, both accessibility *and* safety (under service and extreme incidents such as emergency braking and crash) should be considered based on the F–S–S balance (as shown in Fig. 5.4).

The following sections will discuss what factors ought to be considered by railway vehicle interior design engineers when developing retrofitted or new-build railway vehicles to improve wheelchair occupant accessibility *and* also safety during emergency braking or crash, which is the worst case safety concern. The factors identified include human-related factors, wheelchair design and railway interior design.

### 5.2.3.2 Wheelchair Occupant Crash Dynamics

During a railway vehicle crash (primary collision), the occupant continues to travel with their initial motion (see Fig. 5.9). This motion continues until the occupant



**Fig. 5.9** Railway vehicle and wheelchair occupant velocity history *Phase I* Primary collision; *Phase II* Occupant secondary collision; *Phase III* Occupant Rebound

makes contact with an object in their trajectory (referred to as secondary collision) at a relative velocity  $V_{IR}$ . Common secondary collision objects include furniture such as partitions, grab poles and tables.

### 5.2.3.3 PRM Human Factors

When dealing with wheelchair occupant transportation in railway vehicles, the starting point is to recognise that although a wheelchair is used as a seat on a railway vehicle, it is a mobility device used by disabled people as an assistive technology—as extension of self (Cooper 1998). This subsequently takes into account human factors engineering (HFE). PRM human-related factors include anthropometry, weight, personal preferences, medical condition and the ability to interact with wheelchair and interior railway vehicle environment.

The occupant's anthropometry is one of the most important factors affecting the occupant's accessibility requirements. It also affects braking or crash kinematics behaviour in that it determines that mass moment of inertia. Missing or not fully developed limbs may influence whether the occupant uses footrests, a situation that determines the pre-crash posture. Wheelchair users with both lower extremities are likely to place their feet on the footrest. This, however, is a personal preference of the occupant.

Crash tests conducted involving wheelchair occupants have shown that placing the feet on the footrest influenced the initial occupant posture and subsequently post-crash occupant kinematics and secondary collision characteristics (Matsika et al. 2014). The occupant's weight influences the secondary collision kinetic

energy. Their ability to interact with the wheelchair and vehicle environment determines the pre-crash orientation and subsequent crash kinematics. Therefore, an optimised crash-safe train environment should put human factors specific to wheelchair occupants at the centre of the design. These factors determine pre-crash occupant posture, which ultimately determines the occupant's secondary collision characteristics and potential injury severity.

#### **5.2.3.4 Direction of Travel**

During frontal crash, an occupant is projected forward with reference to the decelerating railway vehicle. Therefore, the seating orientation and location is important in determining the occupant kinematics and which interior furniture/feature the occupant would impact in a secondary collision. A railway vehicle is bidirectional; therefore, secondary collision would occur either with the front parts of the occupant's body parts if the wheelchair occupant is facing the direction of travel or the rear parts of the occupant's body if they are facing the opposite direction.

#### **5.2.3.5 Wheelchair Characteristics**

Figure 5.10 shows some of the wheelchair parameters that influence user/wheelchair and wheelchair/space interaction. Not indicated are three angles which are critical to the dynamic response of the wheelchair and its occupant during a railway vehicle crash. These are the angles of inclination of the footrest, seat and backrest. Wheelchair occupant crash displacement increases with decreasing footrest inclination, seat and backrest angles. In addition, wheelchair crash motion characteristics are influenced by the coefficient of friction between the wheels and the floor, particularly when the wheelchair brakes are applied.

#### **5.2.3.6 Wheelchair Securement and Occupant Restraints**

Whether the wheelchair is secured and/or the occupant is restrained determines the occupant displacement relative to the interior furniture in the event of braking. Currently, Wheelchair Tie-down Occupant Restraint Systems (WTORS) are not provided in most railway vehicles. Introducing WTORS remains debatable and may have its own challenges to overcome because most wheelchair users feel that since restraints were not provided for other occupants on a railway vehicle seat, neither should WTORS be fitted for wheelchair occupants. Many feel that fitting securement and restraint system may actually impede on their ability to egress in case of an emergency. Some occupants would not use restraints for medical reasons.

In UK, studies carried out by the Rail Safety and Standards Board (RSSB) have found that various organisations and disability groups firmly did not wish to use

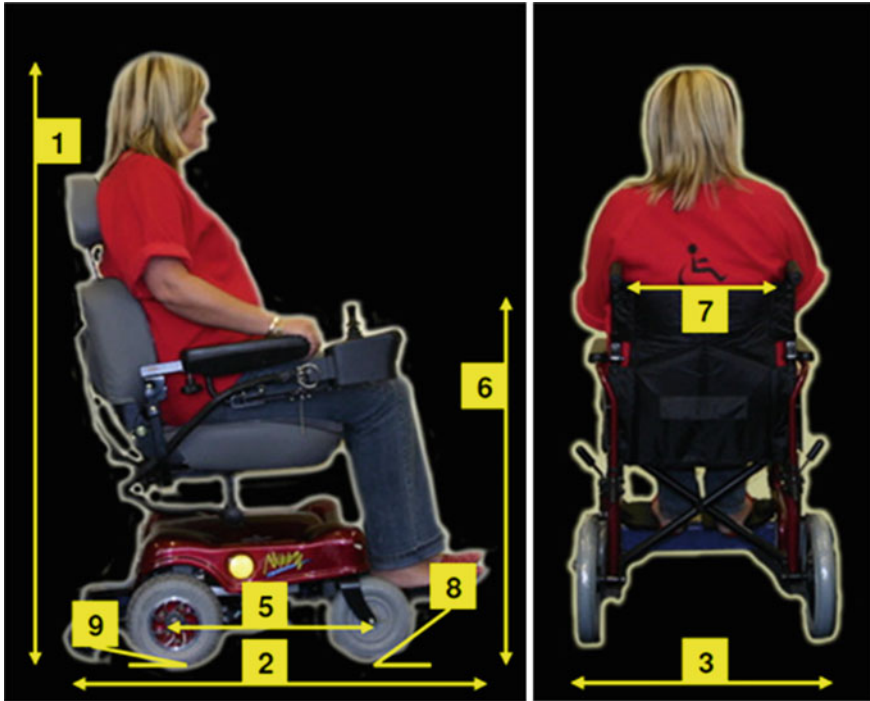


Fig. 5.10 Some of the key parameters of a wheelchair (DfT 2005)

wheelchair securement and occupant restraint systems on board railway vehicles. Most were unwilling to use them because they were considered to be time consuming, and posed potential difficulties with release of such systems in emergency. Therefore, any railway vehicle interior design aimed at improved crashworthiness should consider these challenges.

### 5.2.3.7 Law and Legislation

When developing future legislation and railway vehicle interior design, wheelchair users expect a bottom up approach—this would ensure that most human-related factors are incorporated in the designs. There is therefore need to effectively engage wheelchair users through information dissemination.

### 5.2.3.8 Secondary Collision Objects and Occupant Proximity

The railway vehicle interior design furniture and features surrounding a wheelchair occupant constitute secondary collision objects in the event of a fall, emergency braking or crash. The pre-crash proximity to the occupant, geometry and

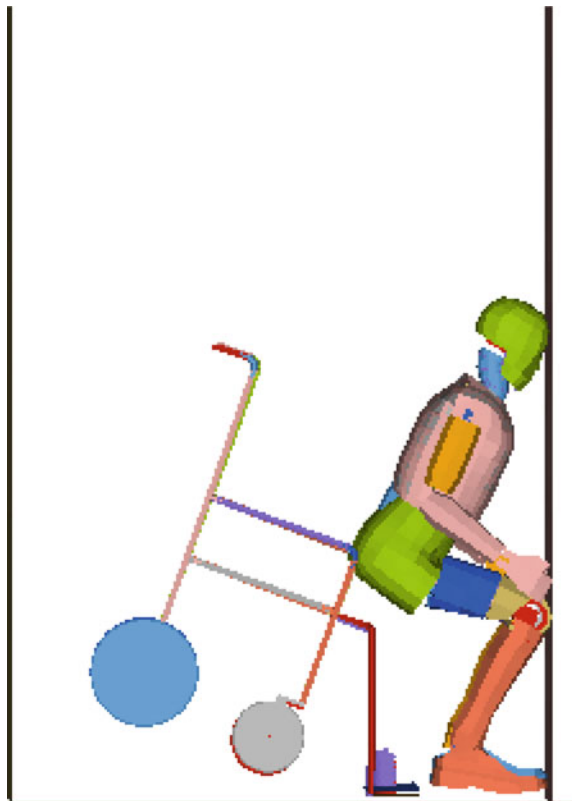


mechanical properties of these objects determine the potential injury severity created by secondary collision. Figure 5.9 above implicitly shows that the higher the initial distance between the occupant and secondary collision object the higher will be the (relative) impact velocity. This would lead to increased injury potential. Therefore, the pre-crash proximity of the occupant prior to the crash determines the relative impact velocity ( $V_{iR}$ ), and injury potential.

The characteristics of occupant secondary collision are strongly dependent on the configuration of the wheelchair space. In the open space configuration, which is typical of commuter trains, frontal collision secondary collision objects in the wheelchair parking space include partitions, grab poles and the floor. Positioning of furniture with respect to a wheelchair occupant influences how and where the furniture collides with occupant. It also determines the occupant displacement and impact velocity; therefore how much kinetic energy the occupant carries.

Figures 5.11 and 5.12 illustrate wheelchair occupant kinematics that may result from secondary collision involving a wheelchair occupant and two common secondary collision objects. Occupant collision with a partition results in kinematics where the feet collide with the partition first, followed by the knees and finally the head. Collision with a grab pole (or a standing seat pole) which is centrally located

**Fig. 5.11** Wheelchair occupant secondary collision with a partition



**Fig. 5.12** Wheelchair occupant secondary collision with a grab pole



in the sagittal plane results in different kinematics where the head makes the first secondary collision. Subsequently, the geometrical and material characteristics of the secondary collision object are key parameters when designing wheelchair space for minimised injury severity.

### 5.2.3.9 Overall Design of Wheelchair Space

Human factors specific to wheelchair users should be the centre of the space design. These factors determine how the user interacts with,

- The wheelchair which also interacts with the wheelchair space.
- Wheelchair securement and/or occupant restraint systems (if any). Such a system should fit with the wheelchair space design as well.
- The actual wheelchair space design (the furniture and features).

This interaction affects the occupant's crash kinematics behaviour that ultimately determines secondary collision injury characteristics. Overall in order to fully define a wheelchair space, both accessibility (space) and safety requirements should be considered, with human-related factors at the centre of the design.

To improve wheelchair railway vehicle safety, the design of the railway vehicle interiors should aim at optimising the dimensions of the wheelchair space rather than maximising them. It reflects a compromise between accessibility which tends to maximise the wheelchair space and safety which improves with reducing initial distance between the occupant and secondary collision objects such as partitions and grab poles. Appropriate geometry and material properties of these objects should also be determined. This would result in an optimum design, which interior design engineers need to target. The design should also incorporate the operational constraints of train operators.

### 5.3 Conclusion

The standing seat design detailed earlier tackles the problem in one of the most important areas of rail design: increased capacity per vehicle and efficiency per passenger.

The example design presented in this Chapter increases the seating capacity of a carriage from around 70 to 108. There is obviously less comfort compared to normal seating carriage. Increased numbers per carriage would require improved environment—thermal and ventilation conditions.

To meet TSI PRM requirements, the layout should include wheelchair space, preferably 2 spaces each 1500 mm long as a minimum. Comparatively, the space requirements for four configurations are shown below:

Standing	0.2m <sup>2</sup> per passenger
Standing seat	0.25m <sup>2</sup> per passenger
Normal seating	0.4m <sup>2</sup> per passenger
Wheelchair user	2.25m <sup>2</sup> per passenger

This means that each wheelchair user uses space equivalent to 9 standing seats, implying that the two spaces provided would take up 18 standing seat spaces. The seating capacity of a carriage then increases from around 70 to 90; representing a 29% increase, as opposed to 54% without any wheelchair space, which gives maximum revenue. If, however, only one wheelchair space is provided, there would be a 41% increase in sitting capacity.

Therefore, when developing the optimal configuration, there are three sets of variables to consider:

- Number of standing seats
- Dimensions and number of wheelchair spaces
- Expected revenue

## References

- Águas M (2000) Conforto Térmico, Lisboa: Instituto Superior Técnico. [http://in3.dem.ist.utl.pt/laboratories/pdf/emee\\_1.pdf](http://in3.dem.ist.utl.pt/laboratories/pdf/emee_1.pdf)
- Christie A (2012) Croydon tramlink shows off its new Stadler Rail ‘Variobahn’ Tram. <http://www.railway-centre.com/latest-news-february-2012.html>
- Cooper RA Wheelchair selection and configuration. Demos Medical Publishing Inc. USA. ISBN 1-888799-18-8.1998
- Czaja SJ, Sharit J (2009) The aging of the population: opportunities and challenges for human factors engineering. *Bridg* 39(1)
- DfT (2005) Report ‘A survey of occupied wheelchairs and scooters’ research conducted on behalf of mobility and inclusion unit of the department for transport. United Kingdom
- DfT (2015) Policy paper Accessible rail transport. UK Department for Transport. Available at <https://www.gov.uk/government/publications/accessible-rail-transport/accessible-rail-transport>
- Inwicki S (2006) Handbook of railway vehicle dynamics. CRC Press. Taylor & Francis Group, P 556
- Matsika E, Chirwa EC, Peng Q (2013) Influence of human related factors on railway vehicle wheelchair occupant crash safety. Joint rail conference – ASME. Knoxville, Tennessee, USA, April 15–18, 2013. Paper No. JRC2013-2406, pp V001T06A002; 11 pages. doi: [10.1115/JRC2013-2406](https://doi.org/10.1115/JRC2013-2406). ISBN: 978-0-7918-5530-0
- Matsika E, Chirwa EC, Peng Q (2014) Kinematics and injury risk of a wheelchair occupant in a railway vehicle crash. *Int J Crashwor* 19(5):446–456. (11)
- Matsika E, Peng Q (2015) Crash safety of a typical bay table in a railway vehicle. *Trans Prob Int Sci J* 10 (Special Edition)
- O’Neill C, Kor E, Viera J, Dong Fang Y (2014) Standing seats for high-capacity trains. *J Trans Probl* 9 (Special Edition)
- Rail Safety and Standards Board (2008) Recommendation for rail vehicle-Emergency Lighting, London
- Transport for London (2011) Rail and underground panel. “TFL’s Recommendations for the high level output specification for 2014–2019 (HLOS2), P 77

# Chapter 6

## Railway Applications for Monitoring and Tracking Systems

Cristian Ulianov, Paul Hyde and Ramy Shaltout

### 6.1 Introduction

This chapter presents some existing and emerging technologies, which have good potential for application to the monitoring and tracking of railway vehicles. The benefits and feasibility of an integrated system that could be used for real-time tracking and condition monitoring of rail vehicles, and monitoring of either passenger trains' interior or freight condition are discussed. The potential benefits for asset management and maintenance, railway operations, freight logistics and management of the passenger environment, along with the possible obstacles to the implementation of such systems, are presented. Data transfer and communication technologies are an integral part of effective tracking and condition monitoring systems. The issues surrounding data capture and transmission to a storage system, powering on-board systems, the analysis of the data and the distribution of the information derived from the data (as well as raw data) are discussed. The advances in the communication tools will help providing the actual condition and tracking of the rail vehicles in real time to customers and entities in charge of maintenance by transmitting all the captured data to effective web-based applications and monitoring platforms that can be accessed through PC, tablets or even smartphones.

Particular attention is paid to the analysis and discussion of the application of satellite navigation systems for real-time tracking of railway assets, and the benefits these systems could bring. This includes an overview of the development of Global Navigation Satellite Systems for rail applications and recent research and innovations.

---

C. Ulianov (✉) · P. Hyde · R. Shaltout  
NewRail Centre for Railway Research, Newcastle University, Stephenson Building,  
Newcastle upon Tyne NE1 7RU, UK  
e-mail: cristian.ulianov@ncl.ac.uk  
URL: <http://www.newrail.org>

The final conclusions outline the potential employment of state-of-the-art ITS technologies and recommendations regarding further research directions and opportunities.

## **6.2 Systems for Real-Time Monitoring of Railway Vehicles**

The condition monitoring of rail vehicles can reduce life-cycle costs by feeding into predictive maintenance programs for both passengers and freight railway vehicles, and can also increase operational reliability. In addition to this, it should be mentioned the increasing pressure to integrate the freight condition monitoring, demanded by logistics companies and clients wishing to track goods and monitor environmental conditions. The rail freight industry is currently struggling to compete with the flexible and efficient road freight industry, which better responds to the requirements and expectations of shippers. Advances in freight and asset monitoring have the potential to increase the competitiveness of rail freight through the better integration with the real-time logistics of customers and increasing the operational efficiencies and reliability of the providers.

Due to new market drivers, there is growing demand from shippers and logistics firms to be able to accurately measure what is happening with their goods. These measures can include traceability and exact locations of cargo, its weight, integrity, temperature, humidity, etc. In short, anything that could potentially affect their goods negatively. Similarly, operators interested in monitoring the interiors of passenger trains and the effects on passengers, so that they can better manage the passenger environment and related systems. The big challenge nowadays is to adapt to this growth of monitoring and to integrate the systems into one. This would enable both the centralisation of the information, and achieving efficiencies of scale by reducing the redundancies of separately developed systems for different parameters, each having their own data collection and communication systems. The European Horizon 2020 initiative Shift2Rail identifies the strategic objectives of developing solutions for competitive freight services for the shippers, by offering innovative cargo status monitoring tools in combination with effective predictive maintenance plans. This would also help in increasing the capabilities for visibility of goods to shippers and end customers by integrating innovative solution for data monitoring with data communications.

### ***6.2.1 Overview of Monitoring Systems***

This section provides a brief overview of potential inspection and monitoring systems, and outlines the current and emerging technologies that operate in the

sector of preventive and predictive maintenance. Considering the market demand for such systems, as well as the obstacles to the implementation, the potential for a new generation of inspection and monitoring systems for both rail freight and passenger services has been clearly identified.

Figure 6.1 shows the critical rolling stock parameters to be monitored in both freight and passenger contexts. However, the vehicle condition monitoring is similar across both areas and there is new interest in monitoring both cargo condition and passengers/interior related parameters.

Figure 6.2 below shows the various types, features and location of the main components of the monitoring systems for rail vehicles. It is key to use smart autonomous sensor network to provide live real-time cargo condition monitoring during the journey. In addition to the smart tracking and tracing tools for cargo safety and identification purposes, the system would integrate smart wireless or

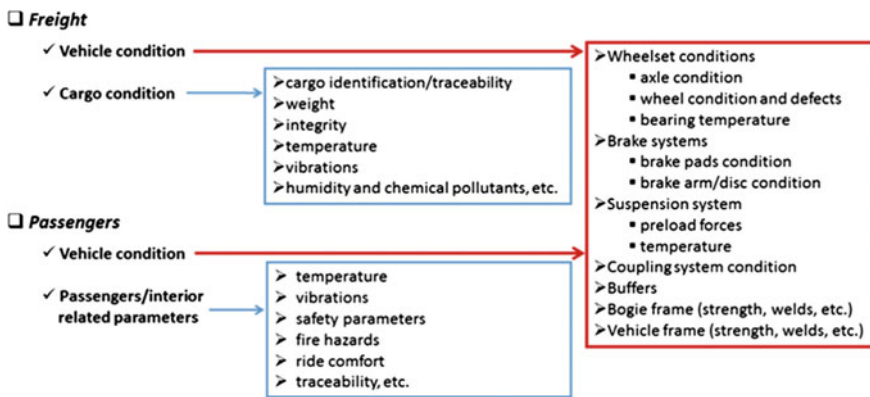


Fig. 6.1 Breakdown of potentially measurable variables for condition monitoring systems

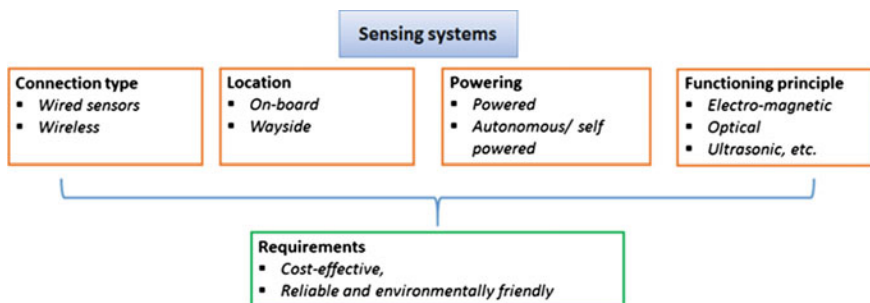


Fig. 6.2 Various types, features and location of the main components of the monitoring systems for rail vehicles

wired sensors for measuring key condition parameters. Through its functions and provided real-time data, the system will enable interventions at potential hazardous and/or critical moments during the transport of goods from one end of the journey to another. For example, the continuous real-time monitoring of hazardous goods such as flammable, explosive or toxic chemicals can increase the safety and security of these goods, and assist in reducing the risks associated with their transport. The system also enables the shipper and receiver to verify that the critical limits on the conditions have been maintained throughout the journey.

The sensors are now relatively advanced and the main challenges in their future development is to make them self-powering or to ensure that they can successfully operate in real time instead of the parameters' data being transferred to a storage system for retrieval at long intervals. The use of self-powering sensors and energy harvesting devices will increase the overall energy efficiency with reduced environmental impact by reducing CO<sub>2</sub> levels. Further sensors could also be developed to measure any variables that are of interest to manufacturers and operators. A main requirement of these sensors is to be cost-effective, reliable and have minimal environmental impact.

Tracking and tracing systems have many benefits such as locating critical transport assets in a variety of situations (crisis situations such as major accident, in case of major failures of existing networks, where state-of-the-art traffic management systems are not in use, or for integrated logistics chains). They can also track the flow of goods from start to finish and support and ensure efficiency in combined operations involving other modes of transports. Tracking and tracing systems require a reliable method of determining the position of the item being tracked. Simple tracing systems (such as a barcode reader in a warehouse) identify an item as being at a specific fixed location at a specific time; for continuous real-time positioning, data on a large-scale global satellite positioning systems are the most effective and suitable for most situations. These can be supplemented by short range radio frequency systems using radio beacons in certain situations such as inside warehouses to overcome the limitations of satellite systems where necessary. There are a number of satellite positioning systems (based on different satellite networks but using the same principles) available to give positions accurate to within 5 m or less, including GPS, EGNOS, GALILEO and EDAS.

To achieve real-time monitoring and tracking, the sensors and tracking systems must then be implemented into a network and communication system. This is a challenge—to integrate a system such as this into the existing railway operating system and provide reliable, safe transmission of passenger/cargo condition data. Such a system must be compatible with current systems such as the European Traffic Management System and must be compliant with all current legislation. Practically, such networks can be deployed either on vehicles or trackside. If systems were placed on vehicles, responsibility would fall on railway operators, whereas with significant trackside infrastructure, significant responsibilities would fall on infrastructure managers which could be problematic. Onboard solutions are more expensive per vehicle but require less infrastructure set-up costs as they are less reliant on local infrastructure (apart from mobile phone coverage) and the costs



scale directly with the number of vehicles fitted. If technologies dependent on wayside infrastructure are used, then the large infrastructure costs are applied to the operation of the vehicles; this makes communication networks reliant on dedicated wayside infrastructure less cost-effective for application to lower number of vehicles.

Another innovative potential aspect of such monitoring and tracking solutions involves the power sources for the systems. On passenger trains, there is generally power available to operate the systems, however on freight trains the power sources are not generally available. Fitting all the freight vehicles in a train with a power generator or connecting them to the locomotive power supply is not a very cost-effective solution, whereas combining systems designed to have low power usage with energy harvesting technologies is a much more viable solution. Modern condition monitoring systems powered from energy harvesting systems installed on the train would be highly efficient and state of the art; when combined with wireless communications systems, they avoid the significant installation costs associated with installing wiring throughout a vehicle. However, it is a significant challenge to develop accurate and reliable systems that would be operable across the entire network. Solar and wind power are potential solutions for energy harvesting, however, these sources are subject to wide variability, high maintenance costs and are vulnerable to physical damage and theft due to their locations on vehicles. Thermoelectric power is a possible alternative, but it is not very effective unless the temperature difference being used is exceptionally large. Electromagnetic waves are another potential power source, but, unfortunately, can only currently generate small amounts of energy, and further advances in technology would be needed to make this source commercially feasible. Micro-generators utilising energy from ambient vibrations of rolling stock are considered as a potential option for an energy harvesting power source, and are already in operation in the United Kingdom for condition monitoring systems involving wireless communication.

The final challenge to the development of an inspection and condition monitoring system is the integration of such a system in a way that meets all of the regulatory and operational requirements. That is to develop an integrated technology to collect real-time information on the location, vehicle and cargo condition and transmit the data in real time to a control unit. The collected data can then be processed and transmitted to a driver or operator or other relevant technologies. The potential benefits of such a system include:

- i. Provision of information about actual vehicle condition, to allow better and more efficient maintenance programs, leading to reduced maintenance and operating costs and greater operational availability and reliability;
- ii. Allowing better management of critical parameters for passenger comfort;
- iii. Provision of accurate information to customers about the location and status of goods;
- iv. Facilitation of decision making and feedback support for customers, train operators, infrastructure managers and entities in charge of maintenance.

### ***6.2.2 Integrated Technologies for Condition-Based Maintenance (CBM) and Predictive Maintenance (PM)***

This section outlines examples of some systems already employed for the purpose of monitoring railway vehicle condition in the context of preventive and predictive maintenance. These include wayside systems which measure specific vehicle parameters as they pass, such as:

- Shoe gear wear detector
- Brake pads wear detector
- Acoustic bearing detector
- Hot box detector
- Wheel inspection systems, etc.

In addition to wayside, onboard systems can be implemented. Monitoring input from both wayside and on board can be combined to produce a comprehensive picture of vehicle condition, based on measurement of critical parameters. The combined vehicle condition data set can be used to verify that the vehicle is currently within operational limits (and take the necessary action to ensure safety and protect the condition of the entire rail system if it is not), and the historic data can be used to establish trends to predict the future condition and plan effective maintenance.

The use of such monitoring and inspection techniques will increase freight logistic capabilities by offering real-time data on freight location and condition, through the use of smart self-powered sensors and communication technologies, towards improved safety, reliability and interoperability of freight service in order to increase its availability to freight customers. These monitoring and inspection techniques will enable the implementation of modern and innovative predictive maintenance analytics, models, and procedures which will increase RAMS and reduce LCC further enhancing the competitiveness and safety of rail freight. This is possible since the predictive maintenance techniques result in the vehicle being maintained effectively whilst minimising the maintenance carried out, reducing premature component replacement, thus utilising the full component life. This minimises the number of maintenance interventions and replacement components required, minimising costs, whilst increasing operational availability.

As can be seen from the technological challenges listed below there are many synergies between systems for freight and passenger environment condition monitoring, and vehicle condition monitoring for maintenance purposes. Therefore, there is the potential to gain further efficiencies by integrating the sensors for different purposes into a common data collection and communication structure.

Practical challenges/obstacles and innovations needed before the implementation of vehicle condition monitoring systems on-board vehicles include:

- Energy harvesting solutions for powering freight condition monitoring sensors and wireless data transmission in a rail environment;
- Low power intelligent sensors for measuring and monitoring key vehicle parameters, with capabilities for wireless powering and data communication;
- Low power wireless communication interface between freight sensors in transit and logistics systems monitoring and tracing the freight;
- Intelligent automated wireless control system for processing data signals received by the receiver unit to determine operational condition and to predict subsequent operational problems associated with the vehicle, cargo or passenger environment conditions;
- Reliable storage system that can offer a flexibility in importing and exporting the huge data and information received from the collection unites on board the rail vehicles;
- A state-of-the-art communication interface for monitoring the rail vehicles that can offer a flexible and easy access to the collected and stored data at any time to allow live monitoring of the vehicle condition, cargo status or passenger conditions.

Figure 6.3 shows a generic model of how such an integrated freight and condition monitoring system would look in practice. Data pertaining to vehicle condition would feedback to operators and infrastructure managers and data relating to

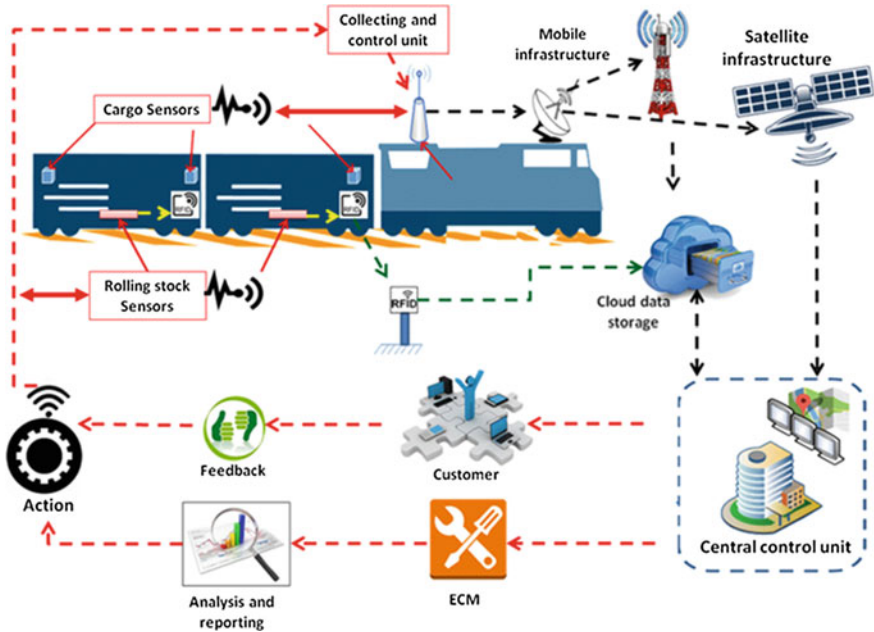


Fig. 6.3 Generic model of an operational integrated freight and condition monitoring system (the Shift2Rail INNOWAG project concept)

freight condition would be sent to the freight operators. Reactions based on this information could then be implemented.

Potential outcomes if such a system was implemented include:

- i. Increase of freight logistic capabilities by offering real-time data on freight location and condition through the use of smart self-powered sensors and communication technologies;
- ii. Improved safety, reliability and interoperability of freight service in order to increase its availability to freight customers;
- iii. Increase of RAMS (Reliability, Availability, Maintainability and Safety) and reduced LCC (Life-cycle cost) by implementing modern and innovative predictive maintenance analytics, models and procedures;
- iv. Contribute to the improvement of interoperability by enabling the use of the captured cargo data and goods condition in real time;
- v. Integrate the power generation, sensor systems and communication systems into a freight monitoring solution capable of making captured information available to a web-based logistic application;
- vi. Enable the data communication via UHF/RFID technologies in a controlled manner, through a central control and collection unit, either to fixed gateways placed on the infrastructure, along the freight line, or directly to satellite or central collecting units.

## **6.3 Satellite and Communication Systems for Real-Time Tracking of Railway Assets**

### ***6.3.1 Overview of Satellite Tracing Applications in Rail***

In the previous section it was mentioned that, for most situations covering large distances, the most effective systems determining the position of an object are those based on the signals received from satellites, Global Navigation Satellite System (GNSS). This section describes the development of GNSS technologies for rail applications. Although the focus in this chapter, so far, was on the fairly recent interest in the use of tracking systems applied to the railway environment for the tracking and monitoring of vehicles and freight, initially the principal interest was in using satellite tracking for rail traffic management. Rail traffic management refers to the objective of managing the flow of rail traffic on a network. Rail Traffic Management systems aim to control the movement of trains, to ensure the safe separation between trains, and to prevent conflicting movements. They are integrated with route setting and timetabling systems and are required to be reliable with numerous fail-safe's built in. Historically, a variety of systems have been used for this goal, such as mechanical signalling, colour light signalling and movement orders, with the train detection component being accomplished by visual means,

track circuits or axle counters. These methods have generally been successful but the European Rail Traffic Management System (ERTMS) and European Train Control System (ETCS) aim to replace existing train control and command systems in Europe. They aim to improve both safety and network capacity and allow interoperability of trains across European rail networks. Any future developments of train control have to be compatible and complementary to ERTMS to be accepted. Currently, there are no developments of ERTMS utilising GNSS that are in widespread use. GNSS is defined as a Global Navigation Satellite System. There are a variety of GNSS systems in operation worldwide such as the Global Positioning System (GPS) developed by the USA which has accuracy to approximately 2.5 m. Other systems include the Russian equivalent of GPS (GLONASS) and European systems such as EGNOS (European Geostationary Navigation Overlay Service), which includes four geostationary satellites augmented with ground stations and a signal integrity component for safety critical applications. An alternative European system currently in development or implementation stages is the Galileo system with 30 satellites—this would provide a next generation GNSS with a positioning accuracy of to within 45 cm.

Having outlined the current state of GNSS systems, it is important to outline its potential uses in the rail sector. These include:

- Traffic Management—Location of trains without need for expensive and extensive lineside infrastructure. This would allow authorisation of train movements based on known locations and tracking of all trains, optimising track capacity and flexibility.
- Fleet management—Locate fleet precisely without dependence on infrastructure and infrastructure management. This would allow rail undertakings to precisely track vehicle usage and mileage, and driver performance.
- Safety and emergency intervention and location—Location of assets in area of incident or hazard, quickly and precisely identify the location of assets involved in an incident and the assets in the area of an incident which are potentially at risk from the consequences of that incident. This kind of system would have been particularly helpful in February 2007 in the Greyrigg train derailment. The train was lost in a 12 miles section of track with no precise indication where the train had left the track as the derailment had damaged nearby signalling equipment. Consequently, it took 34 min for the first emergency services to locate the train. Had these emergency services been provided with a precise location, they would have arrived on the scene much sooner. Another way that a GNSS system would improve safety is to locate hazardous freight at all times with a possible inclusion of condition monitoring.
- Asset management and condition monitoring (offline CM for traceability, online with communication)—with potential uses for the rail industry and freight customers. The rail industry could use GNSS to track the location of defects in rail infrastructure that could be detected by trains in the future. For freight customers, GNSS could allow customers to track the location and condition of

sensitive freight with temperature alarms for perishable items and tamper alarms for valuable freight.

### 6.3.2 *GNSS Technologies for Rail Applications*

This subsection briefly reviews the most relevant past developments of GNSS for rail applications.

- GLORIA project (2000–2002) aimed to mitigate for loss of GNSS signal by using LORAN system (long range navigation system based on terrestrial radio stations). In this system, the GNSS signal was used to calibrate the less accurate LORAN signal so that when GNSS signal was lost, the LORAN position was more accurate. This project aimed to improve reliability and accuracy of position determination, the objective being to improve the market penetration of positioning systems for road and rail applications by reducing limitations. However, this system was not taken up by commercial operators as its performance did not meet expectations; the LORAN system has since been decommissioned.
- GADEROS project (Galileo Demonstrator for Railway Operation System) (2001–2004) was part of the development project for Galileo to ensure an end-user market. It aimed to demonstrate the potential uses of GNSS for the rail industry. This project was successful in its aims as a demonstrator, but further work would be required to establish the safety, dependability and reliability of the GNSS systems.
- LOCOPROL project (Low Cost Satellite Based Train Location System for Signalling and Train Protection for Low Density Railway Lines) (2002–2004) —Use of GNSS to provide an alternative between traditional systems and expensive full implementation of ETCS based systems. It aimed to develop a system of train control based on satellite positioning combined with fail-safe on-board mapping. Showed to be technically compatible with ERTMS/ETCS, however, due to the technology being limited to a single supplier it was not compatible with the open market philosophy of ERTMS and there has been no implementation as of 2016.

As shown by these previous developments, the common problems with GNSS include its inability to meet high safety requirements due to unreliable positioning function of available GNSS and lack of an operating guarantee.

A more recent development in the application of satellite GNSS and communication systems in the rail sector was the SATLOC project which ran from 2012 to 2016. This project aimed to develop and demonstrate innovative GNSS-based safety systems and demonstrate their applications for rail transport, specifically for train control, speed supervision, traffic control and traffic management of low traffic lines. The objective was to contribute to the adoption of EGNOS in rail safety and

to pave the way to the introduction of Galileo. It uses EGNOS GNSS with an odometer and knowledge of track network to reliably determine position of train and integrates that position with a communication protocol and ETCS to provide train control. A real scale application of the system has been carried out on the Brasov–Zarnesti line in Romania, with train control based on ETCS, but with GNSS absolute positioning of trains and with wide-band train–ground communication. The system met all requirements of rail safety and interoperability in compliance with ETCS standards, and the components and infrastructure were significantly cheaper to implement than conventional ERTMS/ETCS systems for low traffic density lines. Also the system provided an increase in traffic capacity compared to legacy signalling systems, however, the level of implementation beyond development project is yet to be seen.

### **6.3.2.1 Rail Application of Satellite Tracking Case Study: SPARTACUS Project**

The authors were directly involved in the SPARTACUS project (Satellite Based Asset Tracking for Supporting Emergency Management in Crisis Operations), which ran from 2013 to 2016, and, at the time of writing, was one of the most recent developments in the application of GNSS to railways. SPARTACUS aimed to design, develop, test and validate in simulated and real-world scenarios, GALILEO-ready tracking/positioning solutions for critical asset tracking and crisis management. Its critical asset tracking element includes tracking of railway assets (vehicles) both for logistical tracking and tracing, and emergency location and support. Unlike other developments, it is not used for regular train control. NewRail had a significant role in specifying the user requirements in the rail sector and testing the system in a railway environment

The system itself consists of GNSS receivers on locomotive and waggons, upgradable to the Galileo system (as shown in Fig. 6.4). Tracking units calculate their position from GNSS and combine with an Inertia Navigation System to provide continuous positioning (even in areas without satellite coverage). These tracking units form low power wireless network to communicate position of all tracking units to a collecting unit on the locomotive (or a marshalling yard). The collecting unit then collects the positions of all units and sends data to the communication unit. This communication unit transmits position data to the database using terrestrial 4G phone network or satellite communication to ensure maximum communication coverage. It also includes a smart link selection function to select the most efficient data link from either the terrestrial or satellite communications link (Figs. 6.5 and 6.6).

SPARTACUS was recently tested on the Barrow Hill test site to evaluate its accuracy and reliability. Example results are shown below in Fig. 6.7.

The results are encouraging for the future development of SPARTACUS system. The results show that the system provided an accurate position with the average locomotive position error being less than 0.5 m and with position data successfully

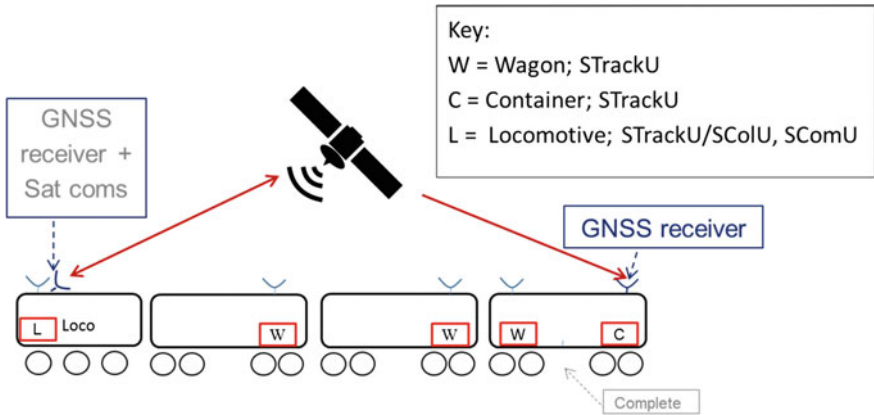


Fig. 6.4 Diagram showing the overall set-up of SPARTACUS system



Fig. 6.5 Set-up of SPARTACUS system on testing train

collected from all units and transmitted to database. These results show a tracking accuracy sufficient for non-train control applications. The next steps in development would be to improve the usability of the prototype system and components to increase attractiveness to market. Further, long-term testing on operational environment and testing in an emergency scenario with emergency services will be the next step in the project. The system also has the potential to be customised (with additional sensors) to transmit more data than just position, including cargo or vehicle condition, using the data handling and communication system developed to integrate additional functionality. A description of the SPARTACUS system, and further details and analysis of the testing program for the system have been recently reported by Hyde et al. (2016) and by Pavkovic et al. (2016).



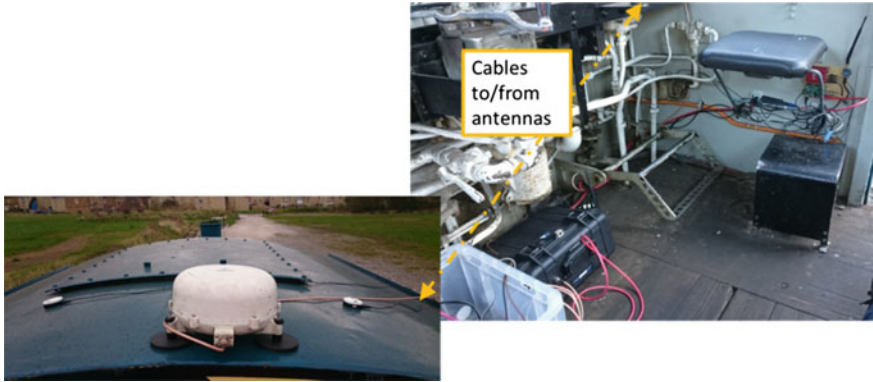


Fig. 6.6 Pictures taken during testing of SPARTACUS system

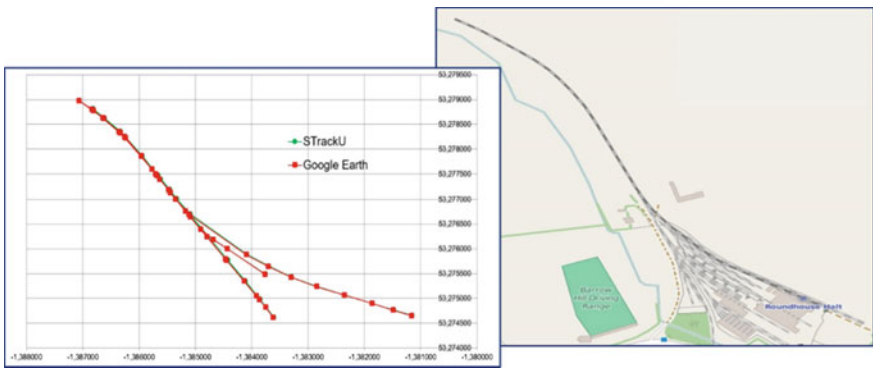


Fig. 6.7 Example results of SPARTACUS testing

### 6.4 Conclusions and Way Forward

In conclusion, the results of this study are broadly positive. There are technologies and systems in development, which have demonstrated the feasibility of the concept of real-time tracking, tracing and condition monitoring of railway vehicles. Indeed, there are such systems, or elements thereof which are currently applied to railway passenger vehicle fleets, although this is not commonplace and there is significant scope for further development. In the rail freight sector, there are currently no commercially available fully integrated systems which allow unpowered vehicles to be continuously tracked and monitored. Therefore, further research and investment are needed, however, before such systems are developed to a point where they become standard practice and suitable for implementation in regular operation and commercially viable, particularly in the rail freight sector. The potential benefits of such systems are clear:

- Provide continuous real-time tracking data to allow goods transported by rail freight to be part of a fully integrated logistics chain, making rail transport more compatible with the effective logistics management systems which many businesses require.
- Increasing the automation level of the operational processes through the integration of smart monitoring systems may provide suitable actions during the freight journey which could open up new markets to rail freight.
- The use of the self-powering sensors and energy harvesting devices may increase the overall energy efficiency of the railway network and reduce the environmental impact by lower CO2 levels.
- The real-time monitoring systems solutions, in addition to the tracking and tracing modules, can improve the system reliability and help harmonising the mixed traffic freight-passenger trains.
- Implementation of effective predictive maintenance programs based on optimised analytical models can reduce the lead time and vehicle downtime and further improve the rail freight cost-efficiency and reliability.
- Predictive maintenance programs based on real-time data collected during the journey would support the optimisation of maintenance operations' planning, improving thus the interoperability and safety of freight rail transport.

Furthermore, this chapter outlines the potential applications of GNSS positioning associated with tracking rail vehicles and detailed the development of GNSS technology in rail applications, as well as detailing recent work in the area and highlighting some of the challenges of applying GNSS and continuous data communication to railway applications. It has been shown that previous attempts to develop GNSS-based tracking system of rail traffic management failed to achieve the necessary positioning accuracy and reliability for rail traffic management. However recent developments, such as the SATLOC and SPARTACUS projects, indicate that GNSS technology might be approaching the accuracy, with the required confidence levels in that accuracy, for the potential advantages of the technology (increased flexibility and reduced fixed infrastructure costs) to be exploited.

In conclusion, this study has shown the potential for the use of GNSS in the rail sector. Unfortunately, due to high constraints on train movements (trains operate within 1.2 m of each other) and operational environment including obstructions to satellite reception, rail is a very challenging sector for satellite based GNSS to achieve the necessary accuracy. This is shown by the low implementation of previous research projects between 2000 and 2010; in some part due to lack of performance and use of declining technologies and in some cases due to the unfeasibility of projects. However, recent projects such as SPARTACUS have the potential to meet performance requirements with relevant technology reaching maturity. The detailed examination of the SPARTACUS project, as well as work in other projects, show some of the challenges of implementing GNSS tracking systems in the rail industry, as well as the potential of GNSS systems to positively contribute to the industry in the future.

## References

- GADEROS project (2004) Galileo demonstrator for railway operation system project summary. <http://www.transport-research.info/project/galileo-demonstrator-railway-operation-system>
- Hyde P, Ulianov C, Pavkovic B (2016) Testing and evaluation of real-time satellite positioning and communication system in rail transport environment. In: Proceedings of international conference on traffic and transport engineering. Belgrade, pp 236–241. ISBN 978-86-916153-3-8
- LOCOPROL project (2004) Low cost satellite based train location system for signalling and train protection for low density railway lines project summary. <http://www.transport-research.info/project/low-cost-satellite-based-train-location-system-signalling-and-train-protection-low-density>
- Pavkovic B, Berbakov L, Ulianov C, Hyde P (2016) Integrated real-time satellite positioning and communication system for railway applications. In: Proceedings of international conference on traffic and transport engineering. Belgrade, pp 227–235. ISBN 978-86-916153-3-8
- SATLOC project (2016) Satellite based operation and management of local low traffic lines project summary. <http://satloc.uic.org/Project-summary>
- SPARTACUS project (2016) Satellite based asset tracking for supporting emergency management in crisis operations project summary. [http://cordis.europa.eu/project/rcn/110848\\_en.html](http://cordis.europa.eu/project/rcn/110848_en.html)

# Chapter 7

## Baggage Handling

Bernhard Rüger

### 7.1 Introduction

The railway finds itself, especially in long-distance travel, in an area of tension between both of its competitors, road travel and air travel. People who travel by air have or at least see no alternative to air travel. This leads to an acceptance by air travellers of comfort constraints which arise due to economic pressures on the airlines. Airlines can afford to arrange the seats in the passenger cabin to achieve a maximum of seating. Since in airline travel reservations as well as the check-in of luggage are compulsory, all seats can therefore actually be used and sold.

For the railway, such restrictions or drastic loss of comfort are not common and are therefore seldom implemented. Depending on travel duration and distance, at least half of railway passengers could use the alternative of auto or air travel. Over 50% of travellers on ÖBB long-distance trains say that they have a driving license and have an auto available at any time. Also, because airline tickets are to some extent inexpensive, the cost argument regarding this mode of transportation is often eliminated. This in turn makes air travel more attractive.

The railway cannot afford to (and should not) ignore the demands and needs of travellers. In order to achieve the high proportion of railway travellers wished for in transport policy, which as a rule also actually contains economic benefits, the railway must bring into play the advantages which it has over other modes of transportation.

However, the tendency in recent years to equip vehicle interiors with the highest possible number of seats contradicts these considerations. This leads not only to a loss of comfort, which approximates the comfort level of air travel, but also in a number of ways constitutes serious operational problems. These problems are often

---

B. Rüger (✉)

Vienna University of Technology & netwiss OG, Research Center  
of Railway Engineering & netwiss OG, Vienna, Austria  
e-mail: bernhard.rueger@tuwien.ac.at; bernhard.rueger@netwiss.at

not considered especially in the purchase of vehicles. The often applied evaluation criterion of the highest possible number of seats and thereby expected lower purchase- and operating costs per passenger is one-dimensional and therefore inadequate since it clearly contradicts reality in more ways than one. The consequences are elucidated in this paper.

Especially in long-distance train travel, but also on many local routes particularly in the service of cruise ship ports and airports, the volume of luggage is often underestimated and not taken seriously in sufficient measure as an influence factor on the criteria of station dwell time, achievable seat occupancy rate, comfort, customer satisfaction and ultimately safety.

## 7.2 Data Base

For nearly 15 years, The Research Centre for Railway Engineering at the Technical University of Vienna has been intensively involved in cooperation with netwiss OG with questions on a scientific level related to the optimization potential of railway carriages. The core of all research and development projects as well as the resulting scientific work is the serious examination of the needs and wishes of travellers as well as with their problems and difficulties in using the train. A substantial contribution to the objectification of the findings is the data collected over a decade concerning passenger behaviour, which has been and will continue to be collected through observation. The goal thereby is to capture the real behaviour of passengers under different marginal conditions uninfluenced by possible personal sentiments which may affect the results of surveys. Surveys formed an additional basis for the scientific analysis.

Thus far, over 10 years, data has been collected on the following areas:

- **Passenger flow analysis:** The boarding and deboarding of approximately 20,000 passengers in approx. 50 different boarding areas and vehicle types were observed. Through video analysis precisely to a tenth of a second it was ascertained how long on average a person needs for boarding and deboarding. Above all, in addition to knowledge about individual time requirements, crucial insight can be gained into the extent to which the entire vehicle design concept affects passenger flow.
- **Passenger surveys:** Approximately 40,000 passengers in just under 10 different countries were surveyed concerning their problems and difficulties as well as their needs and wishes in all phases of travel in a railway vehicle. This related to boarding as well as movement in the train, the search for seating, stowing of luggage and requirements during the trip itself.
- **Passenger behaviour analyses:** The behaviour of approximately 200,000 passengers in more than 60 different vehicle types was analysed with regard to choice of seats, storage of luggage and use of time. From the data, depending on the parameters of age, gender, occupancy rate in the vehicle and space design,

information was accurately derived concerning which seats or seating areas were preferred, how and where luggage was stowed as well as the activities passengers performed.

- **Luggage data collection:** In combination with surveys, the exact anticipated luggage types and volumes per person, per vehicle or per train depending on travel purpose, age and gender as well as group size was determined through counting, exact measurements and weighing of several thousand pieces of luggage

In terms of new vehicle design concepts, the data provides exact conclusions on how the envisaged space design will be used, how the design will affect passenger behaviour regarding seat selection, storing of luggage and performance of activities, and what impact the behaviour will ultimately have on the parameters of passenger boarding and deboarding, proper stowage of luggage and actually achievable seat occupancy.

### 7.3 Luggage Volume

Type, size, weight and number of particular pieces of luggage depend substantially on the parameters of travel purpose in combination with travel duration, age, gender and present group size of the travellers.

More than 10 years of intensive observation shows that the volumes of individual pieces of luggage tend to be larger. This is due to an increase in comfort during transport particularly attributable to the fitting of luggage with rollers. For example, pieces of luggage which weigh 14 kilos and are meant to be carried feel as though they are the same weight as pieces of luggage which weigh 21 kilos but are equipped with two rollers. Fifteen years ago 50% of suitcases taken along on rail travel were not equipped with rollers and therefore had to be carried. Five years ago this percentage amounted to about 5%. In the meantime, nearly 100% of suitcases, so-called trolleys, are equipped with rollers.

In accordance with the comfort enhancement provided by rollers increasingly larger pieces of luggage are being manufactured and used by travellers. This has led not only to an increase in the size of individual pieces of luggage but also to an increase in weight. Meanwhile, the tendency can be seen in luggage manufacturers to equip more and more trolleys with four wheels. As a result, in many transport situations an additional increase in comfort has been achieved. The assumption is that these pieces of luggage will be felt to be even more comfortable and in weight comparison even lighter; therefore, in the near future a further increase in luggage volume and pack weight is to be expected.

Both the increase in weight as well as in size present the rail operator with corresponding challenges. Namely, in the case of boarding the train over steps as well as the frequently necessary lifting of luggage in stowing, the rollers provide no support and accordingly increase the difficulties for travellers.

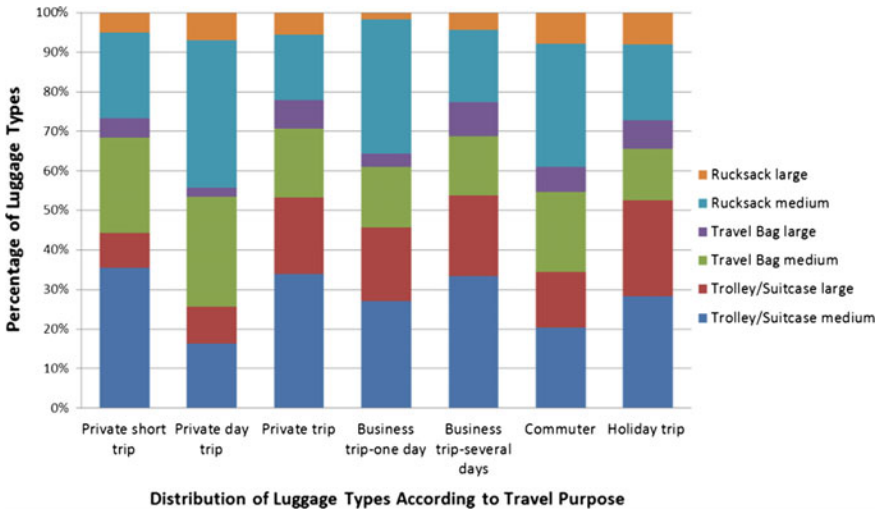


Fig. 7.1 Average luggage distribution per travel purpose (Source Plank 2008)

In order to construct adequate and efficient luggage storage areas, as a first step, knowledge of luggage volume in terms of type, size, weight and number of pieces per person is important. With regard to an efficient overall interior design statements on this cannot and must not be generalised. It appears that there can also be a regionally specific difference in the accompanying luggage. In particular, the total volume to be reckoned with for each carriage is highly dependent on respective routes and their passenger or travel purpose mix. However, due to the existing amount of data very specific remarks can be made about this.

For example, in holiday travel on statistical average 50% of travel luggage pieces are medium and large trolleys (see Fig. 7.1). At the same time, it can be said that on average one piece of luggage per person is taken on holiday. On short trips on statistical average each traveller takes 0.8 pieces of luggage which are 35% medium and 10% large trolleys (see Fig. 7.2). Relevant to necessary luggage accommodation is the most exact knowledge possible of the travel purpose mix which particular vehicles in their area of operation can expect. From this the actual expected average luggage volume per person and thus the corresponding total volume per vehicle can be determined.

For air travellers who use the train for arrival an approximately 20% higher luggage volume is shown than for plain holiday train travel. This fact should be taken into account especially for all trains which eventually serve airports.

As an example of luggage volume, the average travel purpose distribution in Germany was used in a fictional carriage with 84 seats and a 100% occupancy, which led to the luggage volume represented in Table 7.1.

On average travel days, an average of 36 medium and large trolleys and 38 medium and large rucksacks or travel bags were stowed. With regard to luggage

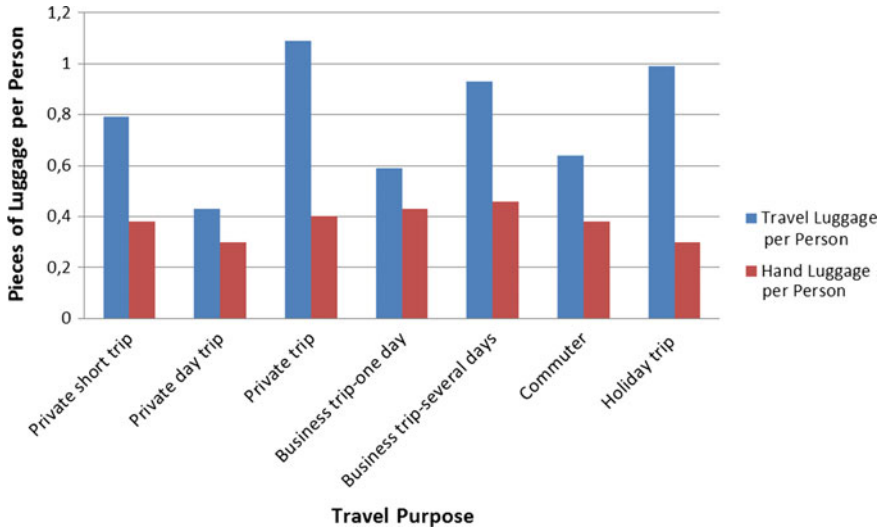


Fig. 7.2 Average luggage volume per person per travel purpose (Source Plank 2008)

Table 7.1 Fictional example: luggage volume for an average travel purpose distribution in Germany with 84 people per carriage (Source Ruger 2010)

Luggage type	Dimensions (cm)	Number with 84 People
Trolley large	approx. 80 × 50x35	13
Trolley medium	up to 70 × 50x30	23
Travel bag/rucksack large	approx. 90 × 40x35	9
Travel bag/rucksack medium	up to 70 × 35x35	29
Hand luggage	up to 55 × 40x25	32

accommodation, the total volume of luggage must subsequently be superimposed on the wished for or actual passenger behaviour concerning the accommodation. For example, to believe that the luggage volume can be accommodated in overhead racks is a fatal mistake. Even if the calculated luggage volume could be stored in overhead racks the majority of travellers would not use the overhead racks. This means in practice much of the luggage would be stowed disruptively (see below)

## 7.4 Luggage Accommodation

### 7.4.1 Passenger Behaviour

Regarding luggage accommodation there are two fundamental principles. Travellers do not want to have to lift their luggage; and for security reasons they want to have



visual contact with their luggage at all times. If these two criteria are not sufficiently taken into account from the very beginning of planning, inefficient and in an “incident” quite dangerous conditions in the vehicles can be expected.

For 88% of passengers visual contact to their luggage is important or very important. This means that luggage must be able to be stowed in close proximity to the traveller. If there is no adequate possibility for this, and the luggage must be stowed at a greater distance, such as in luggage racks near the entrance, for most travellers this results in a corresponding uneasiness and loss of comfort. However from an operational viewpoint, the risk is even greater from luggage which due to a lack of visual contact has been stowed disruptively. Seventy-five percent of travellers indicate explicitly that they are prepared to stow their luggage disruptively in order to meet the need for visual contact.

As a result, luggage is placed on or in front of seats or in aisle areas. This leads to an increase in unusable seats and obstructions to passenger flow.

The second important criterion with regard to planning appropriate luggage racks is the willingness to lift luggage. For example, only 20% of travellers are prepared to lift heavy luggage into the overhead rack; over 50% are under no circumstances ready to do such lifting. With medium sized luggage at least 50% are prepared to lift it into the overhead rack. With regard to luggage racks, at least 50% of travellers are prepared to lift heavy luggage up to waist level (see Fig. 7.3). These specific values make it clear that it is pointless to provide overhead racks with no exception or alternative. Also, the existing number of luggage racks must be adequately dimensioned!

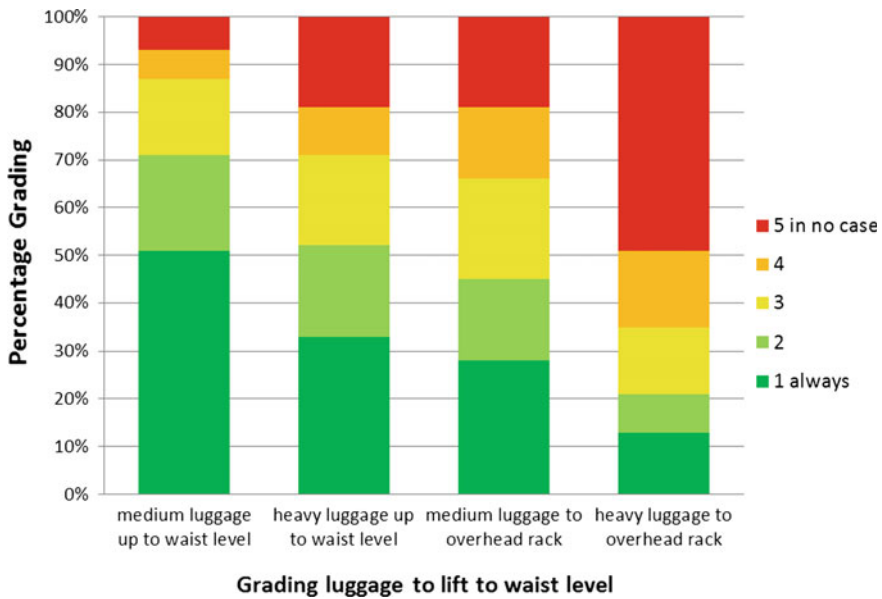


Fig. 7.3 Readiness to lift luggage (Source Plank 2008)

The sampled readiness regarding luggage accommodation has been confirmed by extensive objective observations. Although in some cases up to 50% of the overhead racks are not used, a variety of pieces of luggage are placed on the floor, in front of seats, in the aisle or on seats.

At lower occupancy rates of up to 35%, 30% of medium and large trolleys are placed on or in front of seats or in the aisle. Even at high occupancy rates of over 70%, by which making seats free can be expected, up to 20% of large and medium sized trolleys are placed in these positions. With rucksacks and travel bags nearly the same behaviour has been observed.

### ***7.4.2 Possibilities for Accommodation***

The basic possibilities for luggage accommodation are: overhead racks, luggage racks and spaces between the seat backrests. In part, areas under the seats can also be used. However, as a rule these areas can be used only for those pieces of luggage which fall under the category of hand luggage.

In order to design luggage storage space so that even with a very high occupancy rate, all luggage can be properly accommodated, the following principles must be observed:

- Above-mentioned principles “not lifting” and “visual contact”
- Determination of the actual luggage volume
- Reliable knowledge of the shape of the luggage

In order to efficiently design the most popular storage spaces between the seats and in the luggage racks, knowledge of the shape, size and volume of the luggage is by all means essential. Experience shows that luggage racks which are only a few centimetres, often only 5–10 cm too narrowly dimensioned, or whose shelf heights are too high or too low, can hold up to 50% less luggage than suitably dimensioned shelves!

The same applies to the space behind or between the seat backrests. Here 10–15 cm of too little usable space can lead to 70% less storage space.

In addition to the appropriate sizing of luggage racks and seat spacing, it is also important to ensure a well considered distribution of luggage storage possibilities in the vehicle. These must be distributed as evenly as possible over the vehicle to allow good visual contact to luggage from each seat and not impair the flow of passengers.

## 7.5 Consequences of Unsuitable Luggage Accommodation Possibilities

If the important basic principles of luggage storage space design are not respected, two serious operational consequences can be expected. The passenger boarding and deboarding time in stations will be prolonged and the actual available occupancy rate will decline up to 80%.

### 7.5.1 Passenger Boarding and Deboarding Time

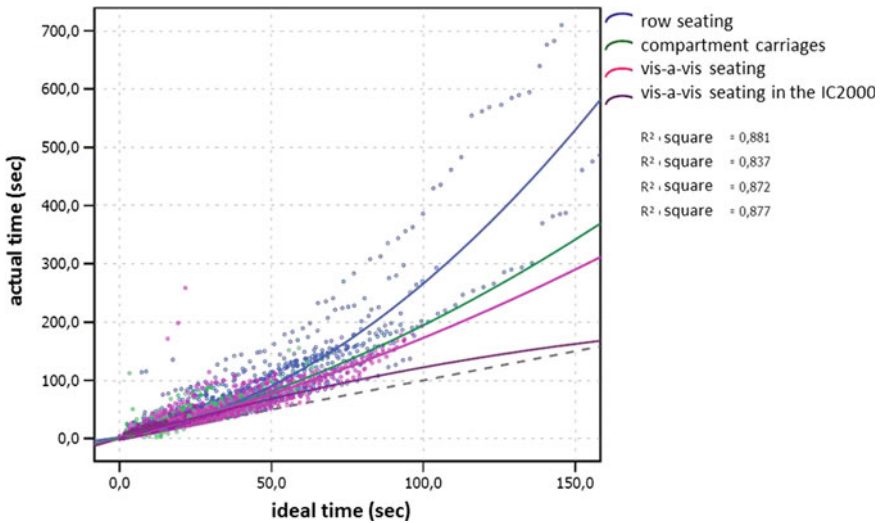
There are many factors which affect passenger boarding and deboarding time. These include passenger related factors which manufacturers and operators have no control over. These factors include age, gender, accompanying luggage and any kind of mobility limitation.

However, the vehicle-side factors are important. On one hand, by correct planning the passenger-side factors can be correspondingly reduced; on the other hand, by improper planning these can be exacerbated. These factors include, for example, the entry height and door width, potentially any existing level entrances, location and number of entrances, the suitability of entrance spaces as collection areas, any restrictions to passenger flow and the overall design of the vehicle interior.

From the perspective of passenger boarding and deboarding time the difference between the best and the worst vehicles currently in use is at a ratio of 1:4. This means in concrete terms that with an assumed passenger boarding and deboarding time of one minute in the best case, the time for the same number of passengers in the worst case can be up to four minutes! It should be noted here that with some exceptions younger generation vehicles which are currently in operation tend to produce higher values.

The influence of interior design between the best and worst case already produces an affect with a ratio of 1:2 (see Fig. 7.4). This means for example, in the best case at a high rate of passenger exchange in conventional vehicle constructions, a passenger boarding and deboarding time of two minutes can be achieved, whereas, in the worst case it requires 4 min.

In Fig. 7.4, fundamental concepts are presented; in such a way, whereby in this example, in row seating practically only overhead racks are available and in vis-a-vis seating luggage can be well stowed between the seat backrests. There is similar data from approximately ten basic vehicle interior categories. All findings show the clear correlation between time demand and luggage storage. The more suitable the design of luggage storage areas, the less time is needed for boarding and deboarding.



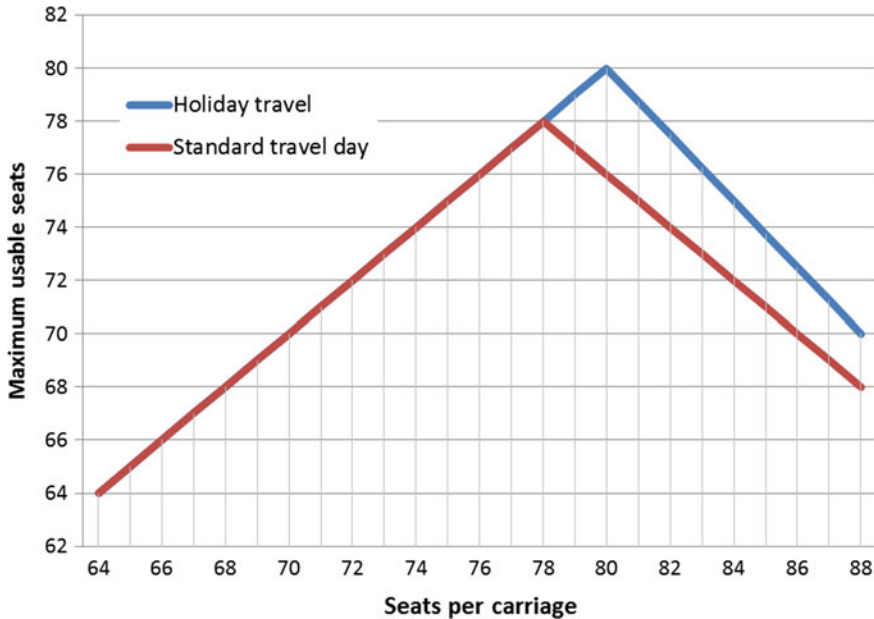
**Fig. 7.4** Time required for the boarding and deboarding process in different interior designs (Source Tuna 2008)

### 7.5.2 Occupancy Rate

From an operational point of view, the second relevant effect of well planned or vice versa insufficiently thought out luggage storage areas, is the actual occupancy rate.

In long-distance traffic, the only significant occupancy rate is the seat occupancy rate. With unsuitable and insufficiently designed luggage storage possibilities, even this can decline noticeably. In conventional passenger carriages with a length over buffers of 26.4 m, a maximum of 80 seats for standard days and 78 seats for travel days are provided (see Fig. 7.5). This number is achieved if the remaining areas are used in suitable form for luggage storage. If this is the case, up to 100% of the seats can be occupied. If there are more seats over these limits, it is at the expense of customer-oriented luggage accommodation; and the actual numbers of available seats as well as the occupancy rate sink drastically. Previous studies by the Research Centre for Railway Engineering at the Technical University of Vienna show that the average achievable occupancy rate in comparable vehicles with 88 seats is only about 80%. This means that on average only 70 of the 88 installed seats can be used (see Fig. 7.5)!

The reason for the sharp decline in occupancy is that there is not enough luggage accommodation capacity available and the existing areas are frequently unsuitably designed. This leads to the fact that part of the luggage is stored not only in the aisle but also on and in front of the seats.



**Fig. 7.5** Maximum possible number of seats in passenger carriages with a length of 26.4 m over buffers (Source Ruger and Ostermann 2015)

### 7.5.3 Operating Efficiency

The consequences of falsely planned luggage storage possibilities presented so far ultimately have significant operating efficiency impacts. The hope or goal to also be more efficient through a greater number of seats is transformed as a general rule into the opposite. Under the premise that the goal is to want to take advantage of the highest number of available seats, the following circumstances always prevail:

**Delays:** Vehicle interiors following the idea of seat maximization inevitably lead to long station stop times. With a high passenger exchange, 4–6 min per station are the result, whereas, ideally designed vehicles require only 1–1.5 min. This fact in the case of a close sequence of stations leads to corresponding delays.

**Declining operating quality:** When they cannot be made up for, the aforementioned delays lead to a decline in operating quality. This is especially important if delays are carried over to connecting or opposite trains, or if the results are missed connections.

**Higher energy consumption:** If it is at all possible to make up for the delays, it is only possible by constant use of maximum line speed, which means a significant additional energy consumption especially at a high rate of speed.

**Lower occupancy rate:** There are seats installed which in practice are not available. At the same time the achievable seat occupancy rate declines up to 20%!

**Declining passenger satisfaction:** The declining seat occupancy rate causes a correspondingly high number of standing passengers, which accordingly reduces passenger satisfaction. Comfort is significantly reduced by the in part “chaotic” conditions in “overcrowded” vehicles. For nearly 18% of travellers, high occupancy together with the already mentioned associated effects means a high stress factor!

### 7.5.4 Safety

The most important criterion which is often overlooked in insufficiently estimated operating efficiency considerations is safety. If in an emergency a train has to be evacuated, a large number of seats at a high occupancy rate in combination with the aforementioned effects present a high safety risk. In air transportation a maximum evacuation time of 90 s must be proven before the certification of an aircraft. In railway transportation there are no such known provisions. However, it is understood that in most vehicles this time cannot be met. In a fully occupied carriage with 88 seats, the absolute exit time of all passengers under ideal conditions (no luggage during the exiting process, no backup because of crowding at the entrance door, only two steps) with the best carriage designs approx. 120 s is required and with the worst constructions, approx. 160 s.

In an incident, rising panic must be considered in which case an orderly exiting process cannot be expected. Above all, in this case improperly stowed luggage would lead to a corresponding safety risk! For this reason alone, it must be ensured that for every installed seat there is also a suitable luggage storage space.

## 7.6 Fundamental Planning Errors

From the past experience, both on the part of the purchaser as well as on the part of the manufacturer, fundamental errors which lead to the inefficient conditions described above can be identified in the planning and ordering process.

**Error 1: Volume calculation:** Every cuboid-like object has a volume and also three definite dimensions. As a rule in tender documents, there is only information on the total volume required for luggage accommodation. For cuboids, the volume is known as the product of width, length and height. This means that an often called for volume of approx.  $0.125 \text{ m}^3$  per passenger can either correspond to the dimensions of a midsized trolley with dimensions of  $50 \times 70 \times 35$  cm, or at the same time, a trolley with dimensions of  $1 \times 4160 \times 30$  cm! Accordingly, it is also common practice to multiply every small cross-sectional area by the available depth and to sum the resulting volumes to a total volume! As a rule, in practice a maximum of 50% of the calculated volumes are available. It is therefore necessary to have precise knowledge of the statistical distribution, shape and dimensions of the luggage!

**Error 2: Disregard of passenger behaviour:** If the principles of “not lifting” and “visual contact” with regard to luggage storage construction are disregarded, the planned storage areas will be only in part accepted by the passengers. In practice this leads to the condition that up to 50% of all storage areas remain unused and yet a larger amount of luggage is stored disruptively.

**Error 3: False awareness of luggage volume:** The actual luggage volume has to be calculated for each route and expected passenger or travel purpose mix. Frequently blanket assumptions are made, or days are taken as a basis for calculation on which only a below average luggage volume can be expected.

**Error 4: False dimensioning:** Meanwhile, luggage accommodation is increasingly being taken into account in vehicles with regard to the installation of luggage racks and the space between the seat backrests. However, here it must be noted that the dimensions of luggage racks are often oriented to seat spacing resulting in very inefficient dimensions. The same can be observed in the spaces between the seat backrests. When dimensioning the respective storage areas it is advantageous to take into account the forms and dimensions of the luggage as well as the storage behaviour of passengers. Seat spacing and luggage racks are often dimensioned a few centimetres too small, which can lead to an actual storage loss of 50% or more.

**Error 5: False evaluation criteria for orders:** In vehicle orders, it can often be observed that evaluation criteria are applied which are not logically understandable. A popular evaluation criterion in tenders is to define the minimum number of seats. Usually, this involves specifications which can be classified as a psychological perception; and thus, they often jump to increments of 100. If for example in the tender as a fictitious number it is predetermined that a train must have 500 seats, then the hands of the manufacturer are already bound in the tender phase; and from the outset actually efficient solutions are not possible. These figures are usually based on a previously calculated maximum number per vehicle and thereby disregard reality. With the fictitious example mentioned it can be expected that a maximum number of 450 seats will actually be available in the train. Thus, it would be much more efficient to make no such requirement, but rather to allow the manufacturers to search for efficient overall solutions. With appropriate solutions it can be expected that vehicle design concepts can be found which in the example mentioned offer approx. 470 seats. Seats, which in the end can actually be used!

## 7.7 Baggage Services

At least for larger baggage items there are different baggage services existing which offer for example an address pick up at home and a baggage deliverable in the hotel. Many of these services are nice add ons but not enough customer friendly. Within a

research project called “GepäckLoS”<sup>1</sup> (engl.: BaggageLess) the needs and expectations and the willingness of use of such services were deeply analysed. Other publications and studies on baggage services, which will not be discussed here, include: Reece and Marinov (2015a, b), Brice et al (2015), Toal and Marinov (2016).

### ***7.7.1 Interest in Baggage Services***

Altogether, 8,800 passengers were questioned in long-distance trains in Austria, Germany and Switzerland. Most of them (78%) were between 18 and 59 years of age. The age group between 18 and 26 made up with 26% of all passengers the largest group. The gender relationship was balanced; 51% were female and 49% male.

One-fourth of all passengers stated as the purpose of their journey, travel to or from work, school or other training programmes. Other travel purposes were longer holidays (18%), short getaways (17%), private issues (16%), business trips for one or more days (12%) and day trips (10%). The passengers are rarely weekly commuters or on a shopping trip. Ninety-eight percent of all passengers had some baggage with them. Handbags and shopping bags also counted as baggage. Large pieces of luggage such as medium and large suitcases as well as travel bags and backpacks were carried by 37% of all passengers. One-third of them felt hindered by their luggage. Most difficulties occurred upon boarding the train, finding a seat and stowing their luggage.

In addition to direct questioning in the trains, there was also an online questionnaire. Patients of the rehabilitation centres in Weyer, Saalfelden, Bad Schallerbach and Bad Hofgastein also participated in the survey. The reason for the survey in the rehabilitation centres was that there is a similar service in Germany, which is often used by patients of such centres.

By direct questioning in trains in Austria, Germany and Switzerland 12% of the participants said that they would use the service “GepäckLoS” during their current journey. Ten percent of them said that they would likely use the service. In addition, persons who answered “likely no” or “no” were asked if they would use the service in general, for example during another journey. Twenty percent answered this question with yes and 27% with likely yes. Twenty-five percent of the respondents of rehabilitation centres, who usually have a lot of luggage because of their long stay, said that they would have used the service for their current stay. Twelve percent said that they would have likely used it. All patients were also asked if they would use the service for general journeys or other rehabilitation stays. Thirty-one percent answered that they would generally use it and 21% would generally likely use it. In the online questionnaire people were only asked if they were interested in using the service in general. “Yes” was the answer of 37% and “likely yes” of 40%.

---

<sup>1</sup>GepäckLoS: Research project to define customers needs and expectations regarding daily baggage handling and on journeys. This project was funded by the Austrian Ministry for Transport, Innovation and Technology and the Austrian Research Promotion Agency.



Through specific analysis of the direct surveys in the train, the parameters influencing the use were determined. Following is a ranking of the top influencing factors concerning the use during the current journey:

- Hindrance because of the luggage

The service would be used by:

- 56% of the passengers who feel hindered at the train station because of their luggage,
- 53% of the passengers having problems boarding the train,
- 49% of the passengers having hindrances during their journey to the train station,
- 42% of the passengers having problems directly in the train.

- Travellers with babies and infants (between 1 and 6 years)

The service would be used by:

- 50% of the travellers with a pram
- 47% of the travellers with babies
- 44% of the travellers with infants between one and six years of age.

- The larger the pieces of luggage, the more likely the service would be used. Forty-nine percent of all passengers with three large pieces of luggage would use the service.
- Forty-eight percent of passengers with physical disabilities, which may cause them to have problems with luggage transport, would use the service during the current journey.
- Forty-three percent of passengers who arrived by taxi at the train station would use the service.

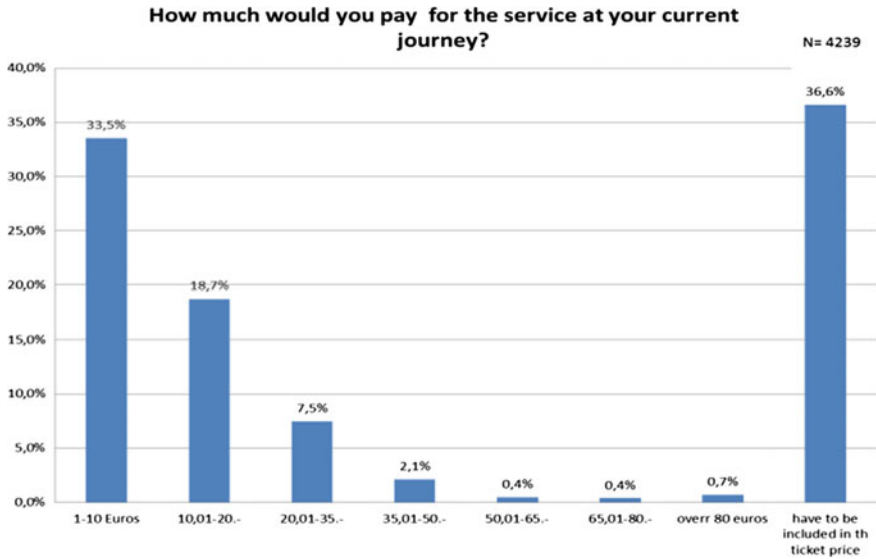
### **7.7.2 Willingness to Pay**

The willingness to pay for the service asked of passengers in the train can be seen in the next chart.

- Travellers with babies and infants (between 1 and 6 years)

More than 10 Euros would be paid for the service by:

- 57% of the travellers with babies,
- 46% of the travellers with a pram,
- 45% of the travellers with infants.



**Fig. 7.6** Representation of the willingness to pay by train passengers (Source GepäckLoS-AP2-Report 2012)

- Forty-eight percent of the passengers taking a bicycle with them would pay more than 10 Euros for the service.
- The willingness to pay increases with the number of large pieces of luggage. Forty-seven percent of the passengers with at least three large pieces of luggage would pay over 10 Euros for the Service.
- Passengers who arrived by taxi or motorcycle had a higher willingness to pay. Forty-three percent of the passengers arriving by taxi and 43% of the passengers arriving by motorcycle would pay more than 10 Euros. But 40% of the passengers arriving by motorcycle thought that the service should be included in the ticket price.
- Passengers who were travelling first class had a higher willingness to pay. Forty-two percent would pay more than 10 Euros (Fig. 7.6).

### 7.7.3 Reasons for not Using the System

It didn't matter whether they would use the system or not, but older passengers had more apprehensions concerning the luggage logistic system. They had, for example, fear of high price, luggage arriving late or not at all and theft or damage. Passengers with physical disabilities, which may cause them problems with luggage transport, had fewer fears than the overall average.

### 7.7.4 Discussion and Findings on Baggage Services

In principle, these surveys showed that the points “shopping” and “travelling” couldn’t be considered as one system. There must be a separation between “shopping” and “travelling” to find and develop the best system for each.

On the whole, regardless of pieces of luggage, age and other points, 22% would have used the described system for their luggage during their current journey. If people felt uncomfortable because of their luggage, they would definitely use the service more often. Fifty-six percent of the passengers who felt hindered at the train station would use the service. Accordingly, the question was, which passengers felt hindered at the train station because of their baggage. The hindrance at the train station was independent of age, gender, nation, travel class, physical disability and baggage. What mattered was if the passengers were travelling with a baby, an infant or also a 7- to 14-year-old child.

However, what is dependent on gender and to some extent on age were the problems in boarding the train. Fifty-three percent of passengers with problems in boarding would use the service. Women (15%) had more problems boarding the train with their luggage than men. Also, older passengers showed a few more difficulties concerning boarding the train. Thirteen percent of the passengers between the ages of 60 and 74 had problems boarding the train.

Forty-two percent of the passengers who had hindrances directly in the train would use the service. There were many differences between certain groups. For example, there were country- and travel class-specific differences. Austrians had fewer problems stowing their luggage in comparison with the Swiss (14%) and Germans (25%). Passengers who were travelling first class had fewer problems stowing their luggage than passengers travelling second class.

Passengers who arrived by taxi were often travelling with large pieces of luggage. At this point environmentally minded thoughts should be introduced. If travellers could check-in their luggage at the residence door or a check-in terminal, they would not have to take a taxi but could instead use public transport.

According to the direct survey, other groups, which would like to use the service, were travellers with a baby (47%), an infant (44%) or a pram (50%).

Although the difference was not that clear (29%), people travelling with another adult or teenager would likely use the service. Especially interesting were the country-specific differences. Passengers who were asked in Switzerland would use the service least (16%). Twenty-three percent of people asked in Austria and 28% of those asked in Germany would use the service.

In addition to the questions about their interest in using the service, passengers were also asked about their willingness to pay. An economically realistic price would not be under ten Euros. Due to this which groups had a higher willingness to pay and which factors had an influence on this was more closely examined.

The group which had the highest willingness to pay were travellers with a baby (57%) or an infant between the ages of one and six (45%). Also the elderly would

**Table 7.2** Needs and demands of potential users in general and particularly for certain user groups (*Source* GepäckLoS-AP2-Report 2012)

	The general public	Travellers with a baby	Elderly travellers	Travellers with large pieces of luggage
Earliest pickup of the luggage	Under 1 h 36%, 6 h 27%, 12 h 12%, 1 day 21%	As late as possible. 42% under 1 h	75–84 years -22% under 1 h	–
Latest delivery of the luggage at the target location	Same time as the person 72%, same day 26%	55% at the same time as the person	48% at the same time as the person	From 3 pieces of luggage: 56,8% at the same time as the person
Location for the pickup of the luggage (actual journey)	45% directly at the residence door, 47% at the train station	50% directly at the residence door, 33% at the train station	The older the person the more they opt for “directly at the residence door” (between 75 and 84 years of age—69%)	Without large pieces of luggage → train station; with large pieces of luggage (from one piece) → directly at the residence door
Location for the delivery of the luggage at the destination (actual journey)	38% at the Hotel, 50% at the train station	40% hotel, 40% train station, 17% another address	The older the person the more they opt for “at the hotel”	–
In which part of the day the pickup and delivery should take place?	57% in the evening, 49% at the weekend, 45% in the forenoon	58% in the forenoon; at the weekend 56%; less in the evening 47%, thereby more in the afternoon 38%	–	The bigger the pieces of luggage, the more there is the wish for a delivery time slot in the forenoon or in the afternoon
Set or chosen time slot	75% chosen time slot	63% chosen time slot	–	70% chosen time slot (from 2 large pieces of luggage)
Size of the time slot	1 h 36%, 2 h 51%	–	–	–

pay a higher price. Thirty-eight percent of passengers between the ages of 75 and 84 would pay more than ten Euros. With 38% they placed only sixth in willingness to pay. More influencing factors on willingness to pay can be found in 2.3.

There are three, possibly four, main user groups deriving from interest and the willingness to pay:

- Travellers with a baby or an infant between the ages of one and six,
- Elderly travellers (at least 60 years old),
- Travellers with large pieces of luggage.

How big the time slot for the delivery or the pickup could be?

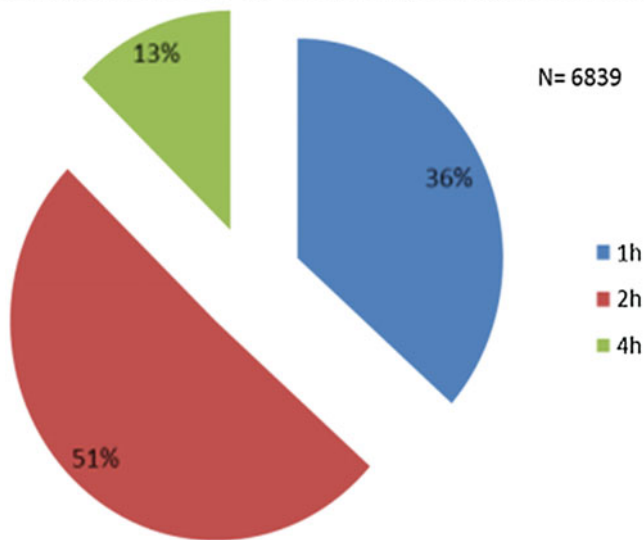


Fig. 7.7 Size of the time slot for the delivery or pickup (Source GepackLoS-AP2-Report 2012)

- People with physical disabilities would surely be an interesting target group. However, their willingness to pay was relatively low. More consideration would be necessary concerning funding a developed system for this group.

According to the results of this survey, the following table shows the needs and demands of the main user groups. In the first column, the results are for the general public. The differences of the main user groups are described in the subsequent columns (Table 7.2 and Fig. 7.7).

In summary, the survey showed that fringe groups were especially interested in using the service. Concerning needs and demands, the results showed that people who are likely to use the service were willing to assume compromises and made smaller demands on the service. For example, all interest groups expressed less demand that the luggage had to be at their destination at the same time they themselves arrived.

With regard to the location for the pickup and delivery, the main groups would particularly like a pickup or delivery directly at the residence door. That would certainly be a sensible configuration since the online survey of people not travelling by train as well as the survey of those in the rehabilitation centres showed pickup or delivery directly at the residence door as being the favourite choice.

In conclusion, one more positive remark about the system should be made. The wish of the public for a pickup/delivery time slot of two hours would certainly be accomplishable.

## 7.8 Conclusions

Fifteen years of research and development as well as participation in numerous vehicle plans make it clear that at all times with vehicle development and orders an overall optimum for vehicle interiors should be sought. Many negative examples make clear that the exclusive pursuit of a maximum number of seats can in practice lead to inefficient and dangerous situations. In particular, luggage storage possibilities must be precisely and thoughtfully planned in order to contribute to efficient overall systems. Experience further shows that it is very critical to lay aside blanket assumptions about design. Each vehicle must be assessed individually in terms of attainable overall efficiency which ultimately leads to an actual maximum seating occupancy.

Requirements for luggage storage must be thoughtfully formulated in the tender. Furthermore, in order to achieve the greatest possible degree of efficiency, where and which luggage storage areas can be installed must be precisely considered in the beginning phase of vehicle planning. Later changes are usually achieved only with great difficulty or with little effect.

Fortunately, in recent times one can discern an awareness regarding these problems. Numerous recent projects confirm that both on the part of the operators as well as the manufacturers, interest in and willingness to develop efficient overall systems have emerged; and that some efficient overall solutions can be developed with negligible additional cost.

## References

- Brice D, Marinov M, Ruger B, (2015) A Newly Designed Baggage Transfer System Implemented Using Event-Based Simulations. *Urban Rail Transit* 1 (4):194-214
- Daniel Connor REECE, Marin MARINOV, (2015) HOW TO FACILITATE THE MOVEMENT OF PASSENGERS BY INTRODUCING BAGGAGE COLLECTION SYSTEMS FOR TRAVEL FROM NORTH SHIELDS TO NEWCASTLE INTERNATIONAL AIRPORT. *Transport Problems* 10 (SE):141-154
- Daniel Connor REECE, Marin MARINOV, (2015) MODELLING THE IMPLEMENTATION OF A BAGGAGE TRANSPORT SYSTEM IN NEWCASTLE UPON TYNE FOR PASSENGERS USING MIXED-MODE TRAVEL. *Transport Problems* 10 (4):149-155
- FLEXICOACH-AP2-Report (2012) FFG-Tender ways2go, 4.Tender project FLEXICOACH- > <http://FLEXICOACH.netwiss.at>
- GepackLoS-AP2-Report (2012) FFG-Tender MdZ, 2.Tender project GepackLoS- > <http://GepaeckLoS.netwiss.at>
- Plank V (2008) Dimensioning of luggage storage areas in passenger trains; Diploma thesis, TU-Vienna, Institute for Railway Engineering, Transport Economics and Cable Railways
- Ruger B, Ostermann N (2015) Der Innenraum von Reisezugwagen—Gratwanderung zwischen Sinn und Effizienz. *ETR—Eisenbahntechnische Rundschau*, 3/2015, 3; S 38–44
- Ruger B, Tauschitz P, Petutschnig B (2010) Boarding assistance system evaluation criteria Report; Report for European Commission; Report-No. Deliverable D2.1

- Toal J, Marinov M (2016) Product design for an on-board check-in system on the Tyne and Wear Metro for passengers travelling to Newcastle International Airport: interim paper. Newcastle upon Tyne: Newcastle University, 2016
- Tuna D (2008) Passenger exchange in passenger transportation. TU-Vienna, Institute for Railway Engineering, Transport Economics and Cable Railways

# Chapter 8

## Aspects of Rail Infrastructure Design

Aleksander Śladkowski and Krzysztof Bizoń

### 8.1 Introduction

The rail fastenings, otherwise called connectors, are the elements of the railway infrastructure, whose task are to connect the rails with sleepers or other supports and to join rails together. The rail fastenings are divided into direct and indirect connectors, rigid and elastic. The parts of elastic fastening rails are the most common: anchors, spring clips, insulating pads, rail pad. Elements of rigid connections are the most common: rigid rail base plates, rail pads, sleeper spikes, rail clamps, clip bolts, nuts, spring washers (Oczykowski 2010).

#### 8.1.1 Direct Rail Fastening

Today, the direct fastenings are very rare using on Polish railways. They can even meet on the lines of local importance, where rail vehicles moving at low speeds and where there is low traffic. The fastening of this type does not provide a constant pressure of the rail to the sleeper. This fastening consists of a rigid rail base plates lying between the rail and the sleeper, and the three fastening screws with the flange. Tightening of the screws through the holes in the pad to wooden sleepers makes that rail is fixed by the pressure which they have on its bolt flanges (Fig. 8.1).

---

A. Śladkowski (✉) · K. Bizoń  
Faculty of Transport, Silesian University of Technology, Katowice, Poland  
e-mail: [aleksander.sladkowski@polsl.pl](mailto:aleksander.sladkowski@polsl.pl)  
URL: <http://sladkowski.com>

K. Bizoń  
e-mail: [krzysztof.bizon@polsl.pl](mailto:krzysztof.bizon@polsl.pl)  
URL: <https://krzysztof.bizon.wordpress.com>





**Fig. 8.1** An example of a direct, rigid fastening of rails to the wooden sleepers (<http://www.transportszynowy.pl/kolprzytw1bezp.jpg>)

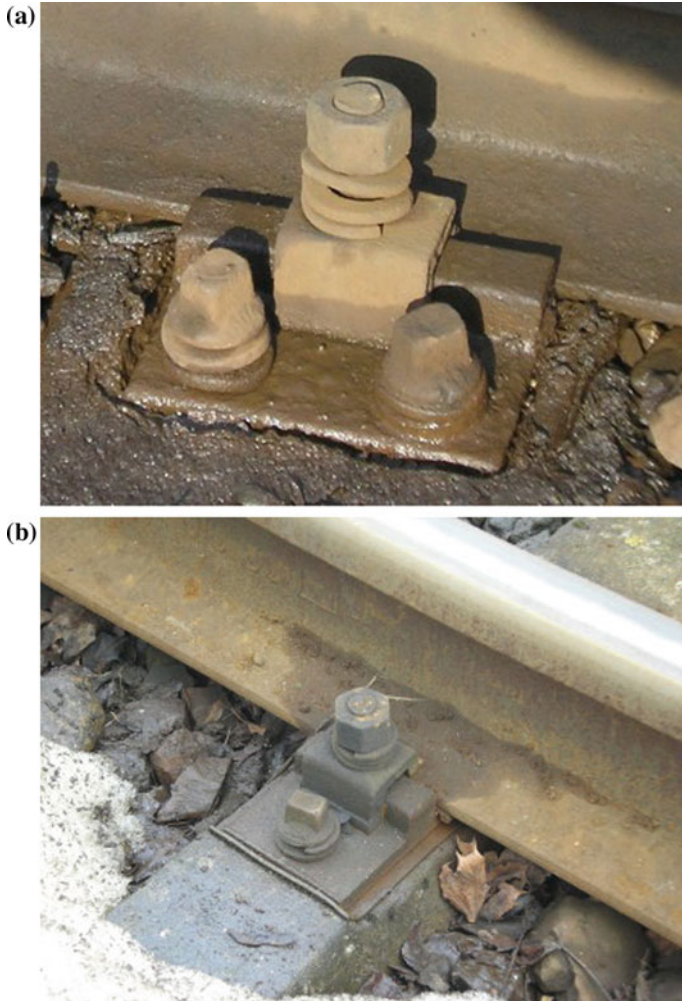
### 8.1.2 Rail Fastening of K-Type

An example of the rigid fastening may be indirect fastening of K-type. This connection is rigid intermediate fastening. This solution is rarely found on railway tracks in Poland. They have been replaced by more modern solutions. However, they can still meet both as fastening of rails to the sleepers of wood and concrete. Once entered into operation new railway lines, the fastening of this type is no longer used.

The disadvantages of K-type fastening may include: the rigidity of this fastening (no damping in a system rail vehicle—track), a large number of parts of the fastening (34 elements), a large mass of the entire unit (about 20 kg), long installation time for one fastening, the required periodic inspection of the tightness of the fixing screws and the possible need for tightening, difficulty in obtaining adequate accuracy of the assembly causing problems in obtaining the required provisions of the gauge (deviation  $\pm 2$  mm), low durability of components (washers).

Fastening of K-type can be used to speed not greater than 120 km/ hour. Examples of K-type fastening to the wooden and concrete sleepers are shown in Fig. 8.2a, b.

In the case of K-fastening to the sleeper made of wood, rib plate is attached to the wooden sleeper with four screws with double spring washers. Rail pad is placed between the rail and the ribbed tie plate. In the ribs of this plate, there are two mounting screws. On screws are mounted clamps fixing the rail to the sleeper. Under the nut of fixing screw, there are triple spring ring. Rail inclination is 1:40.



**Fig. 8.2** Rail fastening of K-type: **a**—to wooden sleeper, **b**—to concrete sleeper ([http://drogizelazne.org/obrazy/przytw\\_K\\_drewno\\_5.JPG](http://drogizelazne.org/obrazy/przytw_K_drewno_5.JPG), [http://drogizelazne.org/obrazy/przytw\\_K\\_beton\\_2.JPG](http://drogizelazne.org/obrazy/przytw_K_beton_2.JPG))

In the case of K-fastening to the concrete sleeper, rib plate is attached to the concrete sleeper with two screws with double spring washers. The sleepers are embedded anchors for the attachment screws. The tie plate is separated from the sleeper by insulating pad. Between the rail and the tie plate there is a rail pad. In the ribs of tie plate, there are two mounting screws. These screws are fitted with clamps to fix the rail to the sleeper. Under the nut of fixing screw, there are triple spring ring. Rail inclination is also 1:40. In the case of K-type fastening to the concrete sleeper, insulating pad are inserted between the sleeper and the fastening elements.

Insulating pad insulates the steel elements of fastening from steel reinforcement elements inside concrete sleeper. This reduces the flow of stray currents.

### ***8.1.3 Rail Fastening of Skl-Type***

Another solution used for fastening on Polish railways is the fastening of Skl-type. This fastening is a middle way between the fastening of K-type, a modern solution of SB-type. Instead of the rigid clamps, which presses the rail to a sleeper (like for fastening of K-type) used here elastic clips which mounting screw presses to the rail foot. For this reason this fastening is called screw-spring or half-spring. Thanks for using of the spring clips, this fastening (Fig. 8.3) gave a partial damping of the rails against the rest elements of the track. Fastening is used with wood or steel sleepers and with reinforced concrete slabs and blocks. This type of fastening is not used for concrete sleepers and prestressed concrete sleepers.

### ***8.1.4 Rail Fastening of SB-Type***

The newest type of fastening rails to the sleepers used on Polish railways is fastenings of SB-type (SB-3, SB-4, SB-7). In 1979, the Central Institute for Research and Technological Development of Railway (later names are: from 1987 Scientific and Technical Center, from 2010 Railway Institute) built the first concept of fastening this type. The first type fastening was called as SB3 and from 15 May 1981 it is protected by the patent issued by the Polish Patent Office (Oczykowski 2010).



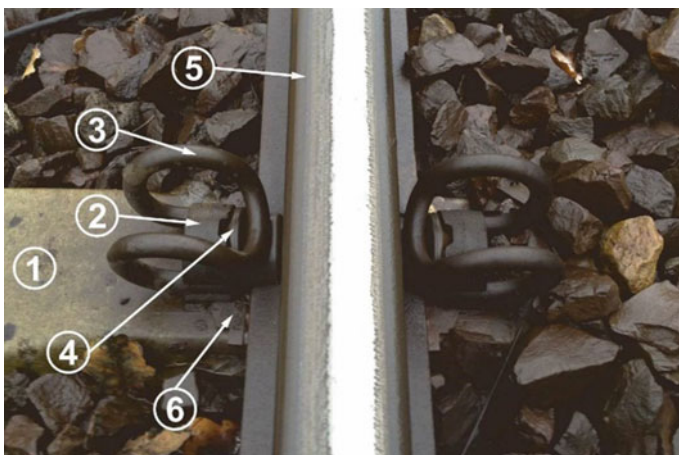
**Fig. 8.3** Rail fastening of Skl-type to the wooden sleeper ([http://drogizelazne.org/obrazy/przytwierdzenie\\_skl\\_1.jpg](http://drogizelazne.org/obrazy/przytwierdzenie_skl_1.jpg))

Rail fastening of SB-type is spring fastening. Clamping bolts used in the previously mentioned fastenings have been replaced by spring elements called spring clips. Spring clips are the main element responsible for the mounting rail to the sleeper. This type of fastenings dedicated for mounting of rails to prestressed concrete sleepers. However, there are solutions that allow you to adapt fastenings type SB with wooden sleepers. Fastening of SB-3 type is one of the most modern types of fasteners which can be used both for rail tracks and tram. SB-type fastening is shown in Fig. 8.4.

In the sleeper 1, (filled with concrete) anchors 2 are mounted. In the anchors 2, spring clips 3 are fixed, which by means of insulating pads 4 pressed the rail 5 to the rail pad 6, which are resting directly on the sleeper.

Elements of fastening type SB and functions that meet are: (Aprobata techniczna AT/07-2014-0111-A1—System przytwierdzeń SB-IF1 2014):

- two anchors made of cast iron are mount on concrete sleeper for attachment arm of elastic spring clips in the openings closed and open and provide the required width of the track and sufficient resistance to lateral movement of the rails,
- two elastic spring clips made of the round rod to provide the desired rail pressure to the sleeper and the possibility of elastic deformation of the rail in a horizontal plane under the influence of lateral forces,
- two inserts insulating made by polyamide, ensure the transfer of the pressure of elastic spring clips on rail foot and increasing resistance to rail longitudinal displacement and ensuring the required resistance between the rail and sleeper,
- rail pads made with high-quality plastic that provides increasing resistance to rail longitudinal displacement and transfer of the pressure of rail foot on the foundation, capable of absorbing energy (reducing the dynamic interactions) and vibration damping.



**Fig. 8.4** Rail fastening of SB-3 type ([http://drogizelazne.org/obrazy/przytwierdzenie\\_skl\\_1.jpg](http://drogizelazne.org/obrazy/przytwierdzenie_skl_1.jpg))

Rail fastening of SB-type are characterised by:

- fast assembly and disassembly,
- damping of vibrations coming from the rolling stock,
- very good electrical isolation limiting to a minimum the traction stray currents,
- high durability,
- the possibility of use on high-speed lines (above 120 km/h),
- small amount of components,
- the reduction of noise and vibration (especially important for passenger trains),
- the possibility of mounting by mechanical means or by hand.

## 8.2 Justification for the Choice of Research Subject and Project Goal

Currently, there are a lot of designs of railway tracks, which are used for underground or tram. Nevertheless, among them the leading place belongs to traditional designs, which are based on the use of rails—sleeper solutions. At the same time,



**Fig. 8.5** Spring fastening of rails for the tram tracks in Prague (<http://www.prazsketramvaje.cz/view.php?cisloclanku=2010031701>)

very important are the methods of fixing rails to the sleepers. There are many technical solutions that use elastic elements (springs) for such fastening. The advantage of such fastening is that it generally do not require additional maintenance or adjustment control. For example figures show the use of the spring fastening of rails for the tram or subway tracks in Prague (Fig. 8.5), Stuttgart (Fig. 8.6), Brasilia (Fig. 8.7), Warsaw (Fig. 8.8).

Already for a long time in Poland for fixing the rails of the main and industrial, rail transport used rail fastenings of SB-3 type. There are a number of modifications of these rail fastenings. The advantage of such structures is fairly simple installation, no need of often monitoring or adjustment. These advantages have resulted in their wide use for the main railways. Currently, there is the implementation of this technical solution also in the industrial transport, tramways and subways. It should be noted that such a structure can be opened and can be concreted or backfilled.

The authors chose to analyse the strength-mount SB-3 due to its widespread use in Poland, the availability of technical documentation, is still ongoing work related to the modification of the shape of the individual parts fixing and studies related to the use of different materials used in the manufacture of non-metallic elements fixing.

The authors have attempted to prepare a computational model of an SB-3 rail fastening using the finite element method (FEM), which would allow a preliminary



**Fig. 8.6** Urban tram line—tunnel stuttgart-ruit/Germany (2000) with spring fastening ([http://www.gerb.in/index.php?id=889&no\\_cache=1&tx\\_photogals\\_elementid=2461&tx\\_photogals\\_image=5&MP=503-614](http://www.gerb.in/index.php?id=889&no_cache=1&tx_photogals_elementid=2461&tx_photogals_image=5&MP=503-614))



**Fig. 8.7** Subway Brasilia—section Galeria dos Estados—Estação Central/Brazil (02/2001) ([http://www.gerbusa.com/index.php?id=888&no\\_cache=1&tx\\_photogals\\_elementid=2459&tx\\_photogals\\_image=3&MP=503-593](http://www.gerbusa.com/index.php?id=888&no_cache=1&tx_photogals_elementid=2459&tx_photogals_image=3&MP=503-593))

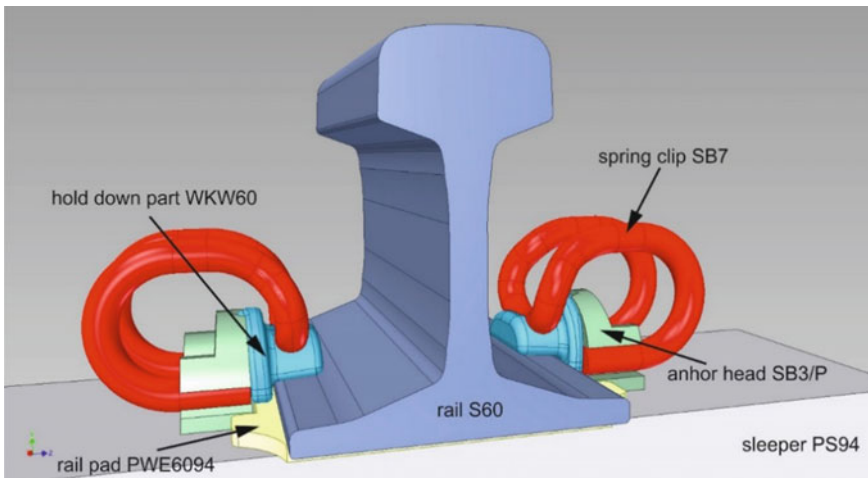
estimate of the parameters on the base of the designated laboratory tests conducted using actual fastening rails to the sleepers. Studies can then use the model of mounting, with the model based on the finite element method, to conduct numerical calculations at the design stage of new developments of fixings. For example, when designing a new shape of elastic clamps, under rail pads, use of new materials, etc.

### 8.3 Specification of Rail Fastenings of SB-3 Type

The SB-type is a family of designs that share similar features and a typical design is shown below in Fig. 8.9. Of course there are some design standards that rail fastenings must adhere to. The system for the anchoring of the rails to the sleepers must satisfy the requirements of seven Polish and European standards (PN-EN 13481 2004) supplemented by eight other standards (PN-EN 13146 2003). The standards of 13481 series specify requirements to be fulfilled by fastening systems for wooden, concrete and steel sleepers, for the pavement without ballast and for crossovers. The standards of 13146 described standardised test methods and criteria



**Fig. 8.8** One of the modifications of the rail fastening of SB-3 type used for tram tracks in Warsaw (2012) (<http://www.garnek.pl/lumiks/20076979/tor-tramwajowy-1435mm-lok#>)



**Fig. 8.9** Components of SB-3 type rail fastening



for uniform assessment of any fastening systems. They concern the following tests (PN-EN 13146 2003; PN-EN 13481 2004):

- determination of the longitudinal resistance of the rails,
- determination of the twisting resistance,
- determination of dynamic loads damping,
- study the effect of repetitive loads,
- determination of the resistance,
- study the impact of extreme environmental conditions,
- determination of the clamping force,
- operational research.

Most of these studies are performed on a specially prepared laboratory equipment. When changes in design of fastenings are made, these standards must be adhered to.

## 8.4 Geometrical Model of Rail Fastening

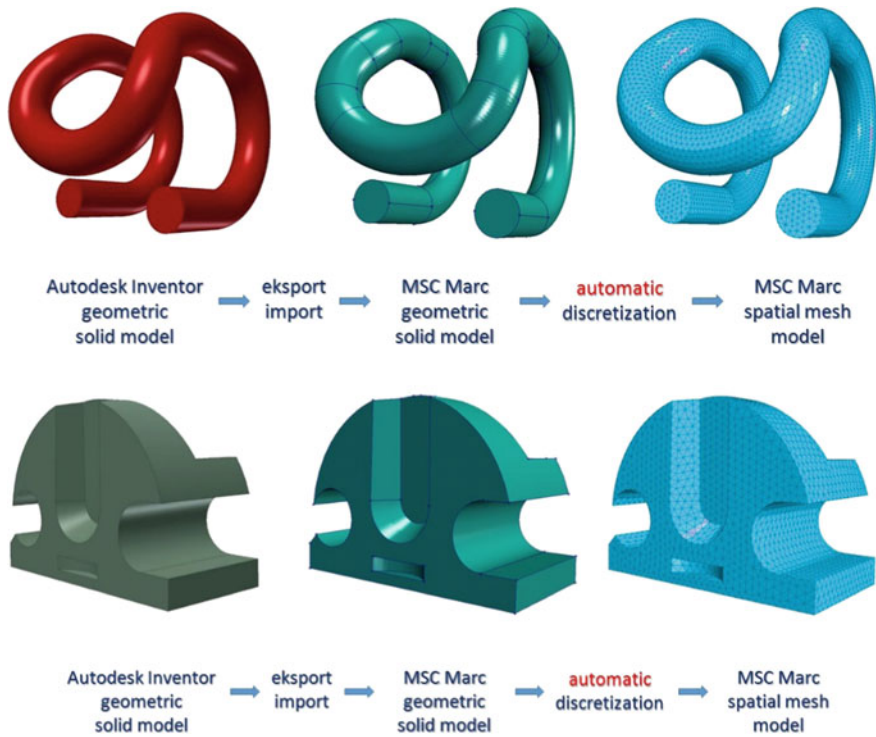
On the basis of the technical documentation, geometrical models of the following components of SB-3 fastening were made (Fig. 8.9):

- spring clip SB7,
- head of the anchor SB3/P,
- hold down part WKW 60,
- rail S60 (fragment),
- rail pad PWE6094,
- sleeper PS94 (fragment).

Geometrical models of the fastening elements were made using Autodesk Inventor Professional. The same programme was used to complete the assembly of all mounting elements. Geometric models of the fastening prepared in Autodesk Inventor Professional have been used only partially during discrete modelling of this assembling. Direct use of geometric, spatial models of fastening elements to generate their discrete models, was not possible due to the lack of full control over the size, shape and number of finite elements for discretization of given geometric model.

## 8.5 Finite Elements Model of Rail Fastening Components

Automatic generation of FE meshes (Fig. 8.10), however, did not provide the compatibility of the position in space of nodes of different FE models belonging to two discrete objects interacting in such a way that at the place of interaction be

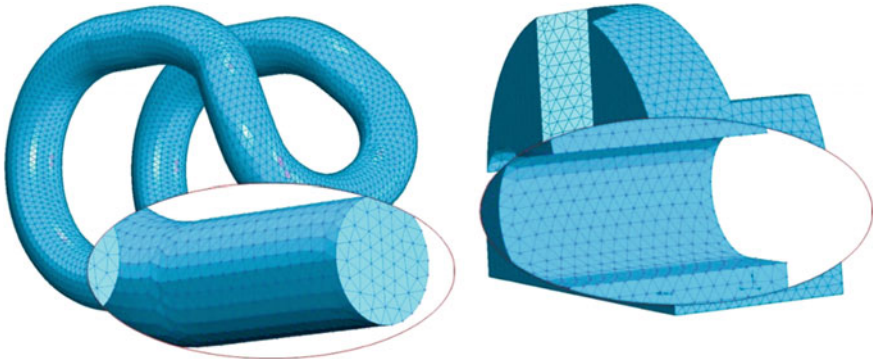


**Fig. 8.10** Automatic generation of FE meshes of example rail fastening parts: **a** FE model of spring clip, **b** FE model of anchor head

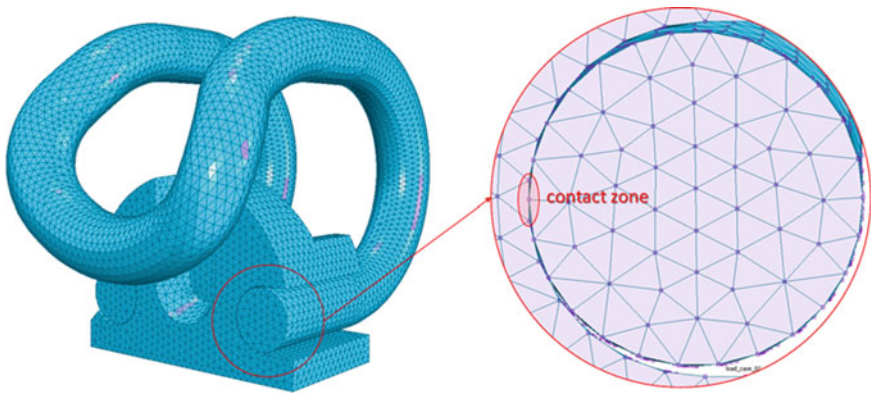
taken into account the phenomenon of contact. Taking into account the phenomenon of contact between the models of discrete cooperating parts requires almost perfect fit position in space of nodes of FE meshes (Sładkowski and Kuminek 2003; Sładkowski 2005; Сладковский 2005; Sładkowski and Sitarz 2005; Wen et al. 2005). In the case of elastic type fastening SB-3, the examples of such interactions may be the interaction in each pair forming this fastening: between elastic clamps and insulating inserts, between rails and insulating inserts, between rails and rail pads and between elastic clamps and anchors heads.

Finite element mesh automatically generated for the elastic spring clip and the head of the anchor is shown in Fig. 8.11. Zoom on the pictures clearly shows that the correct fit of nodes of finite element mesh generated automatically is simply impossible.

Therefore, the presented geometric model of fastening fulfil only the role of information and views, and its use for the construction of discrete fastening model was very limited. The geometrical model used for defining of the relative positions of fastening elements to determine the locations of interaction zones, to determine the size, shape and dimensions of the interface between some elements, etc.



**Fig. 8.11** Automatic generation of FE meshes of spring clip and anchor head

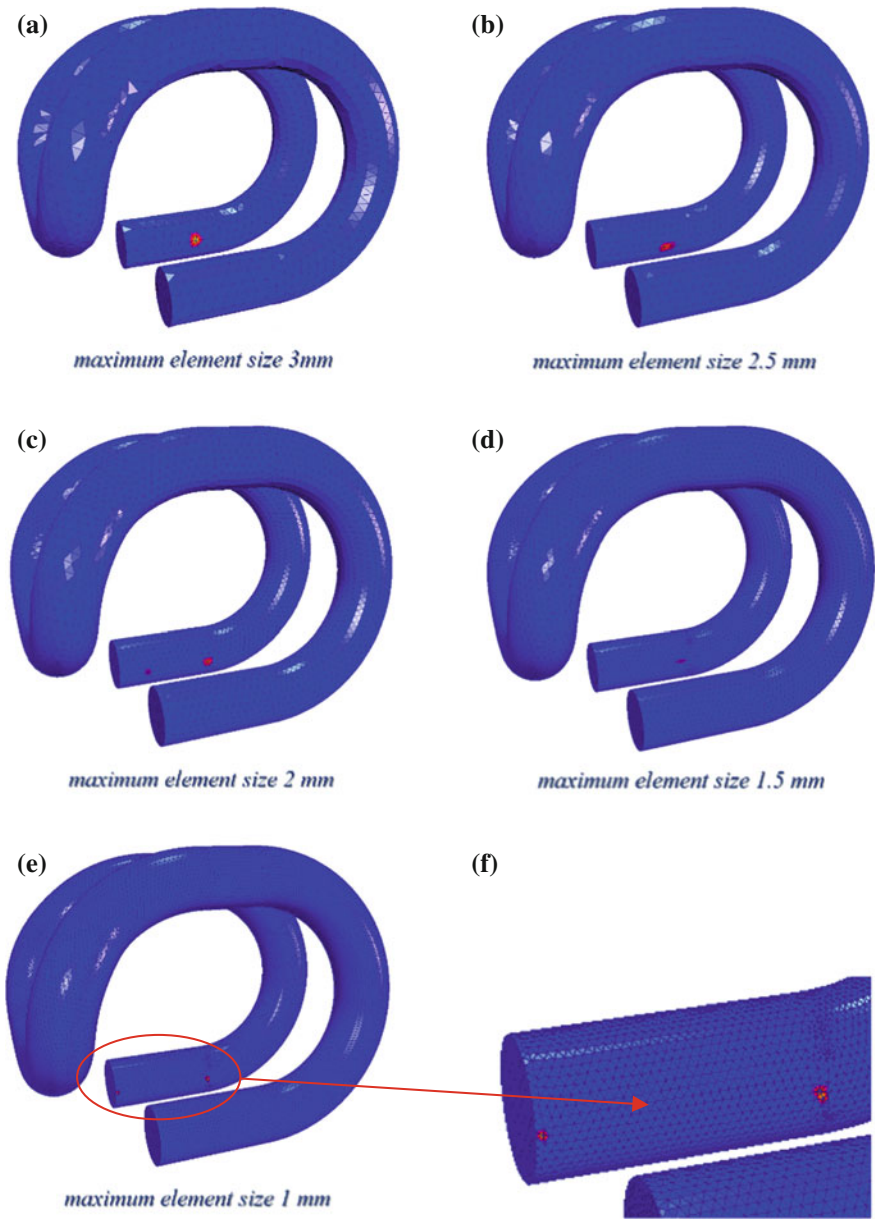


**Fig. 8.12** Uncoordinated nodes in contact zones

Automatic discretization of geometrical models made it impossible to generate a discrete model, which would allow proper interaction elements of fastenings at the area of contact interaction. Randomly generated nodes of finite elements interacting parts not interacted in a proper manner and did not provide proper interaction between fastening elements.

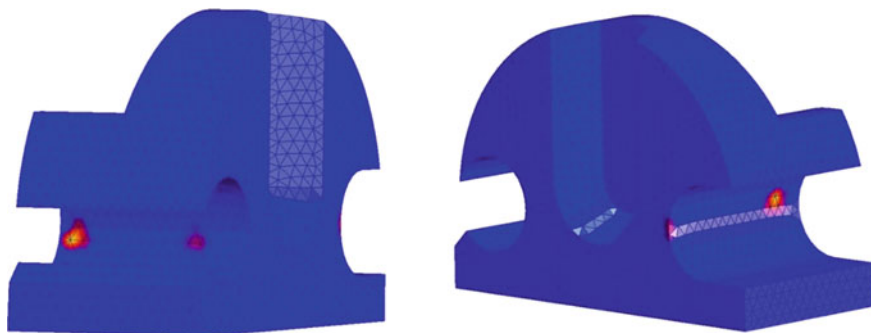
Thus, it can be concluded that the reduction of finite elements size, and accordingly increase the number of degrees of freedom not helps to improve the solutions, but only significantly increases the estimated time. The reason is that when we use automatic mesh generation, the contact nodes of interacting parts are uncoordinated (Fig. 8.12).

To solve these problems, the maximum element size was reduced (Fig. 8.13). Problems occurred in the contact zone area of the model are shown in Figs. 8.14 and 8.15.



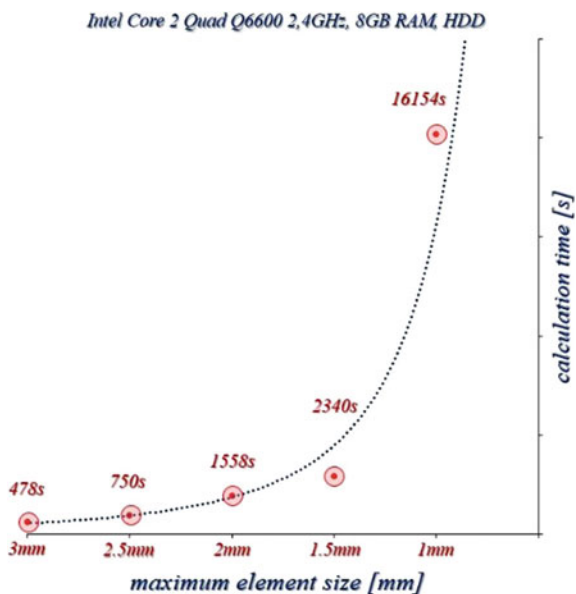
**Fig. 8.13** Normal contact stress on the contact surface of spring clips for different element size

This created additional problems with calculation time as shown in Fig. 8.15; however, the contact problem solution was still wrong.



**Fig. 8.14** Normal contact stress on the contact surface of anchor head

**Fig. 8.15** The increase of the calculation time at reduction of the finite element size

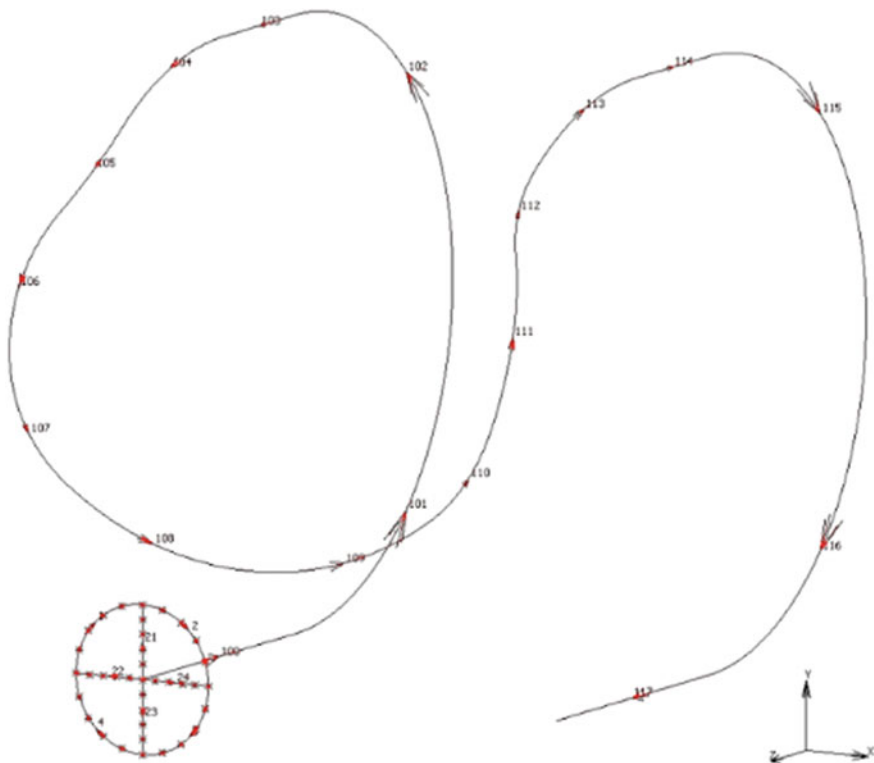


So, the first activity towards solving this problem is to generate the finite element mesh with compatible nodes. This problem can be solved by coordinating geometric modelling and semiautomatic mesh generation. The second problem is the creation of discrete models with reasonable number of finite elements and nodes, and thus a reasonable number of degrees of freedom and thus for a reasonable time to solve the problem by computer. In the linear tasks the number of degrees of freedom for model is not a problem. When we solve nonlinear problems (a task with a large number of zones of contact among the tasks with a high degree of nonlinearity) should strive to ensure the number of degrees of freedom was relatively small. The number of degrees of freedom of model affects the calculation

time. There is a need to find a compromise between the density of the grid (the higher the better because of the accuracy of the calculation) and time to solve the task by the computer (the grid is more dense, the calculation time is longer).

As an example, methodology proceedings may serve an elastic spring element—part of SB-3 rail fastening. Authors used Autodesk Inventor to made basic geometrical model if spring clip (Fig. 8.16). A collection of geometric primitives include a set of curves: guiding, central axis of the spring clip and the cross-sectional contour—a circle divided into four sectors.

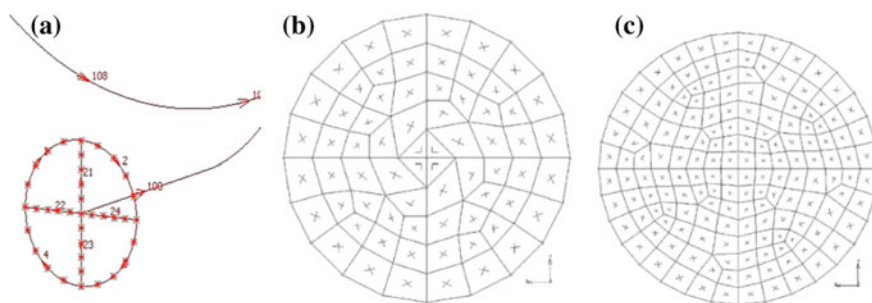
As a basic programme for modelling, FEM was select package MSC.MARC. This software has a number of significant advantages. It is a specialised software for solving nonlinear tasks with regard to the phenomenon of contact. This software is partially open, in the sense that some of the files created during the implementation of the tasks can be modified by the user, and then reintegrated into the main programme. Another advantage is the possibility of creation by users additional procedures and include this procedures to main programme. This way we can, for example, make parameterized task.



**Fig. 8.16** Basic geometry of spring clip

The developed methodology is based on creating text files (batch files) for programme MSC.MARC, which allows control of multiple parameters of the job. For example, the density of the finite element mesh and the location and number of nodes of finite elements. For example, for the cross section of the elastic spring clip on each sector of the closing curve user can define the number of nodes of finite elements (Fig. 8.17a). This way you can somehow control the amount and (to a lesser extent, of course) the location of nodes of finite element mesh. Examples of the results of the written procedures by the user are shown in Fig. 8.17b, c. For comparison, the finite element mesh created after defining five knots on each curve section limiting the sector (Fig. 8.17b) and after defining eight nodes on each boundary curve sector section (Fig. 8.17c). As shown, increasing the number of nodes on each curve 5–8 increases the total number of nodes in a thickness of 77–177. With continuing condition that the size of finite spatial finite element obtained due to stretching shell elements should be similar to meshing with a similar step along the guide curve of the elastic spring clip will lead to that the total number of nodes will be: in the case of five nodes each curve number all nodes will be 37499 in the case of 8 nodes on each sector of the curve limiting the total number of nodes will (rise to) to 86199.

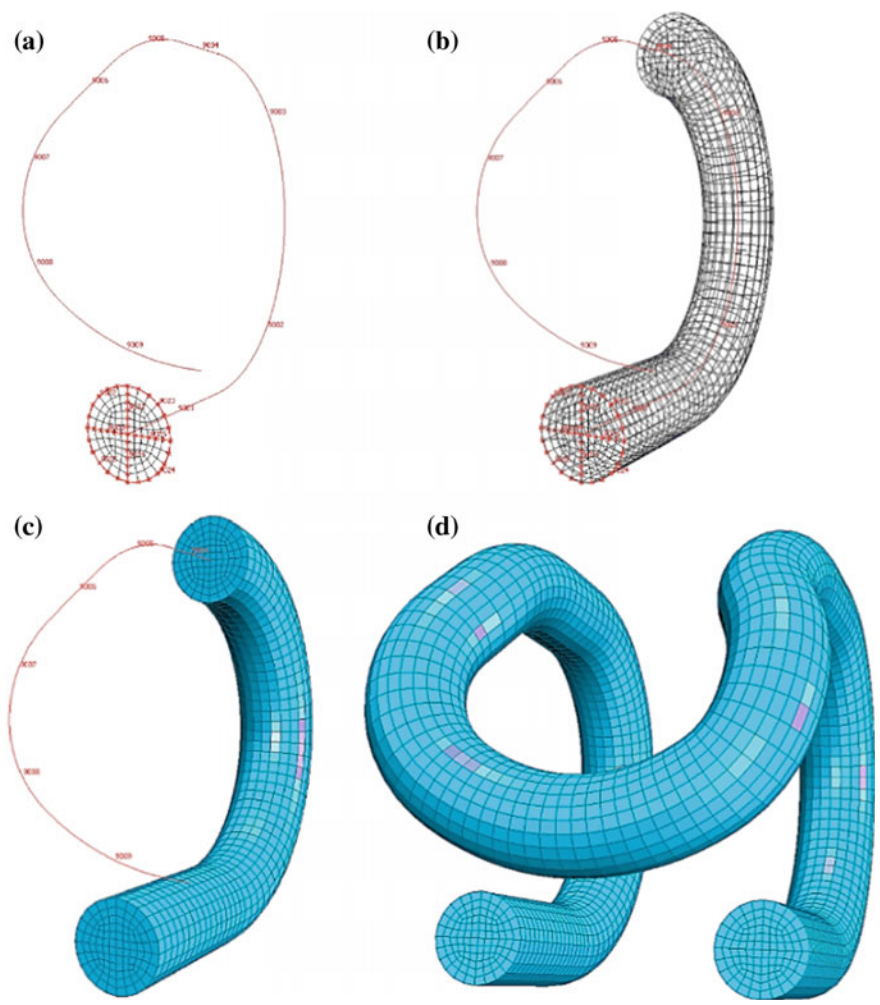
It should be noted that increasing the density of a finite element mesh (to the extent as shown in Fig. 8.17c) results in no significant change in the nature and value of reduced stress. However, the change in the grid density greater results in a significant extension of the calculation time. It should be reasonable to analyse the density of the meshing, so that the number of nodes of finite elements, and hence the degree of freedom is relatively low for each part of rail fastening. For example, strength calculations for meshing are shown in Fig. 8.17c for spring clip, and analogous, for other elements of fastening (corresponding to a mesh imposed for the spring clip) would cause that the task would be insurmountable within a reasonable time and using a standard class computer. On the other hand, the finite element mesh of interacting parts must be generated to be compatible for both elements. This is especially important because of the need to take into account the phenomenon of contact. The fulfilment of these objectives is only possible using



**Fig. 8.17** FE mesh for cross section of spring clip for different number of finite elements

semiautomatic mesh generation of finite elements that allow you to pre-define the zones of contact.

The next step is to generate a spatial finite element mesh based on flat finite element imposed on the circular cross section of the elastic spring clip. When generating a spatial finite element developed methodology also requires control over the number of spatial elements created along the curves forming the central axis of the leading spring clip. During generation a spatial finite element mesh was also possible control over the number of spatial elements created along the curves forming the central axis of the elastic clip. Subsequent steps of forming the spatial finite element mesh along the axis of clip are shown in Fig. 8.18. The central axis



**Fig. 8.18** The steps of creation a discrete model of spring clip

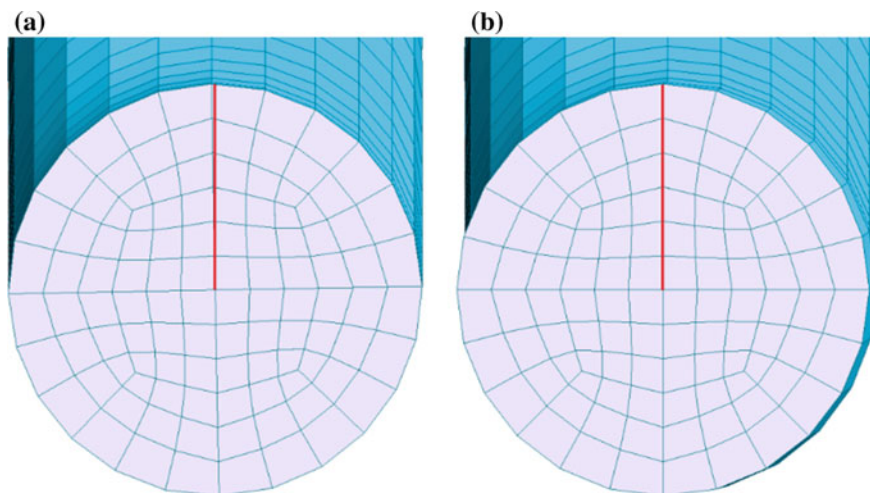


consists of several curves. Spatial finite element mesh was generated separately along each curve. Resulting meshes were merged into one, merging nodes of finite elements lying in common planes of individual pieces of the finite element mesh generated along various curves forming the central axis of the elastic clip.

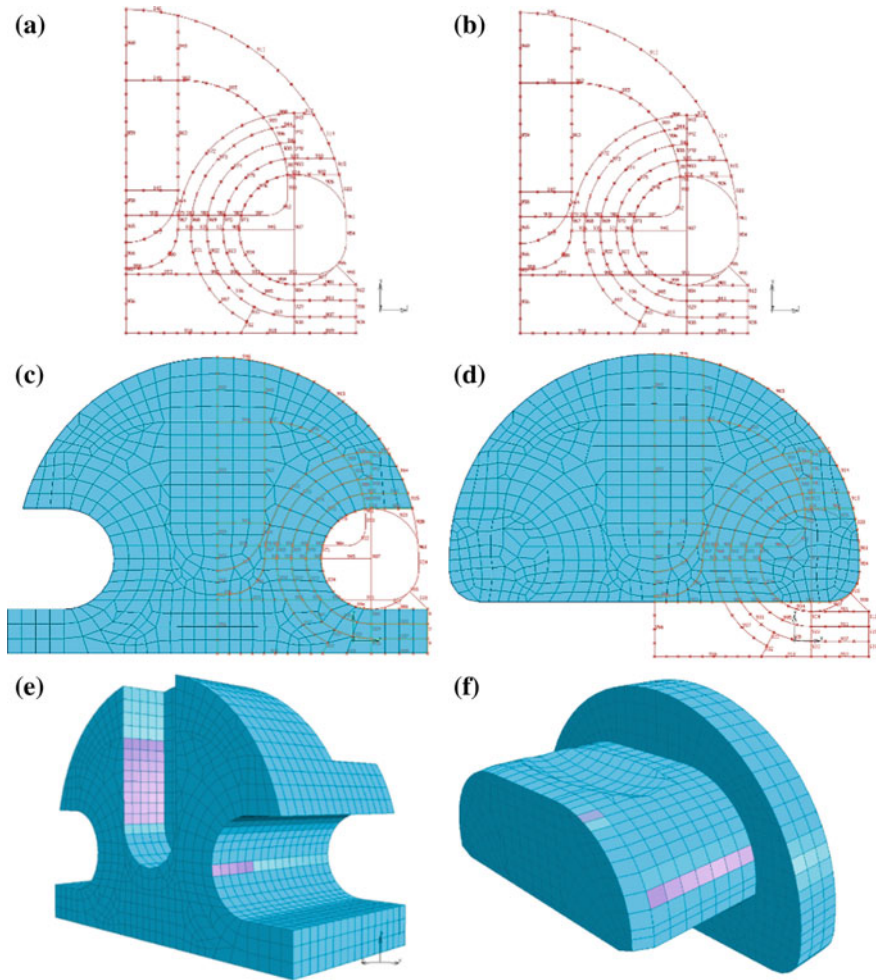
A drawback of the use of the curve leading to the geometric model of the elastic feet was that this curve is not made up of segments and arcs, whereas the predominant part of it are the sections B-spline curves. This results in a kind of lack of control over the location of the flat grid of finite elements around the curve. After a stretch of flat finite elements mesh to spatial finite elements mesh were obtained mesh nodes, in an important cross section, do not lie on a vertical line (Fig. 8.19a). The use of alignments and rotation nodes around the curve leading was considered advisable only in the plane of symmetry of spring clip (Fig. 8.19b). Numerical test calculations was perform both for the case of correction of the position of the nodes, as well as without. The position correction was considered intentional because of subsequent matching nodes lying on the perimeter section of spring clip and nodes of finite elements of hold down part.

Using a similar methodology, a model of the anchor head and hold down part was created (Fig. 8.20).

To create a discreet model of these elements, rectangular projection of all the characteristic points, segments, arcs of both elements to common plane was made (Fig. 8.20a, b). Then, between the rectangular projections of characteristic curves and sections a sectors of planes were made. The resulting clippings planes were discretized by flat finite elements. Prepared flat finite elements meshes (Fig. 8.20c, d) was used to create three-dimensional discrete models of anchor head and hold down part (Fig. 8.20e, f). Selected parts of the flat finite element mesh were pulled



**Fig. 8.19** The position of the nodes in the symmetry plane cross section of spring clip: **a** before the correction position, **b** after adjusting the position



**Fig. 8.20** Steps to create discrete model of the anchor head and hold down part

out in the spatial finite element mesh at the appropriate distance. A great convenience during creation discrete models of both elements was the fact that they have a plane of symmetry.

In the case of the hold down part (Fig. 8.21a), a recess for the toroidal part of the elastic spring clip was made. In the first step of creating cavities, part of the finite element corresponding to the footprint area of the cavity was removed (Fig. 8.21b). Then, the nodes of finite elements from the cavities were “attracted” to the surface of the torus (Fig. 8.21c) having a diameter and a radius corresponding to the dimensions of the recess of the spring clip. This resulted in a discrete model of the hold down part with recess for spring clip (Fig. 8.21d). Inclination of the lower surface of the protruding part of the hold down part was made by “snapping” the

finite element mesh nodes to a segment of the plane (Fig. 8.21e). Clipping plane to which “dragged” the appropriate nodes of finite elements of hold down part, formed with the horizontal plane an angle corresponding to the inclination of the upper surface of the foot of rail, which adjoins hold down part. The slope is suited taper 1:14 (Fig. 8.21f).

In the case of the insulating insert also includes a chamfer of significant size on the end of the elongated projecting portion (Fig. 8.22).

Discrete model of the head of the anchor was made by stretching the flat finite elements to spatial finite elements (Fig. 8.23a–c). Based on a matrix of flat finite element, different areas of the anchor were generated by extending flat finite elements a sufficient distance and in sufficient quantity so that the dimensions of the

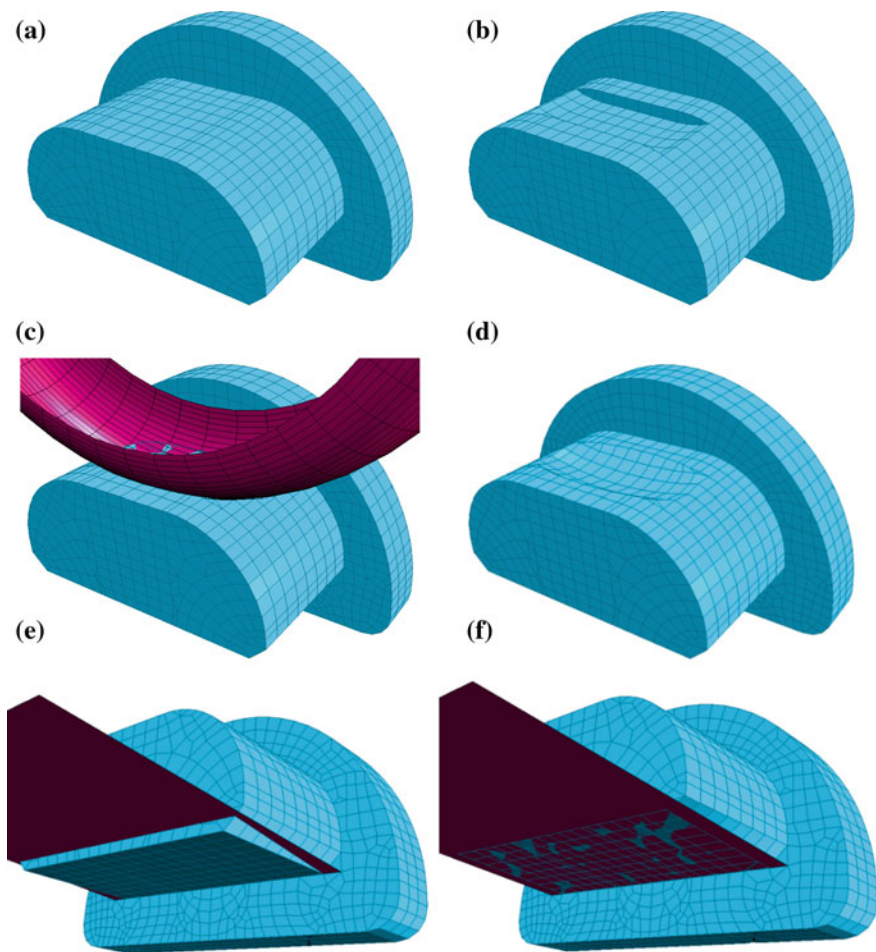
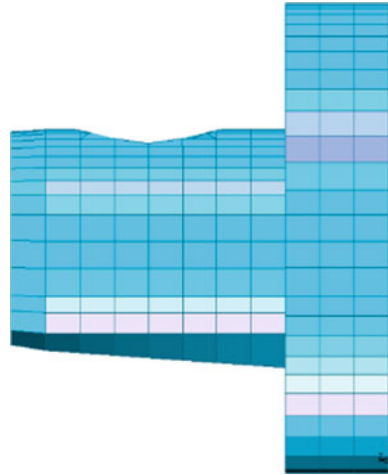


Fig. 8.21 The next steps to create a discrete model of hold down part

**Fig. 8.22** Discrete model of hold down part with visible chamfer of protruding parts

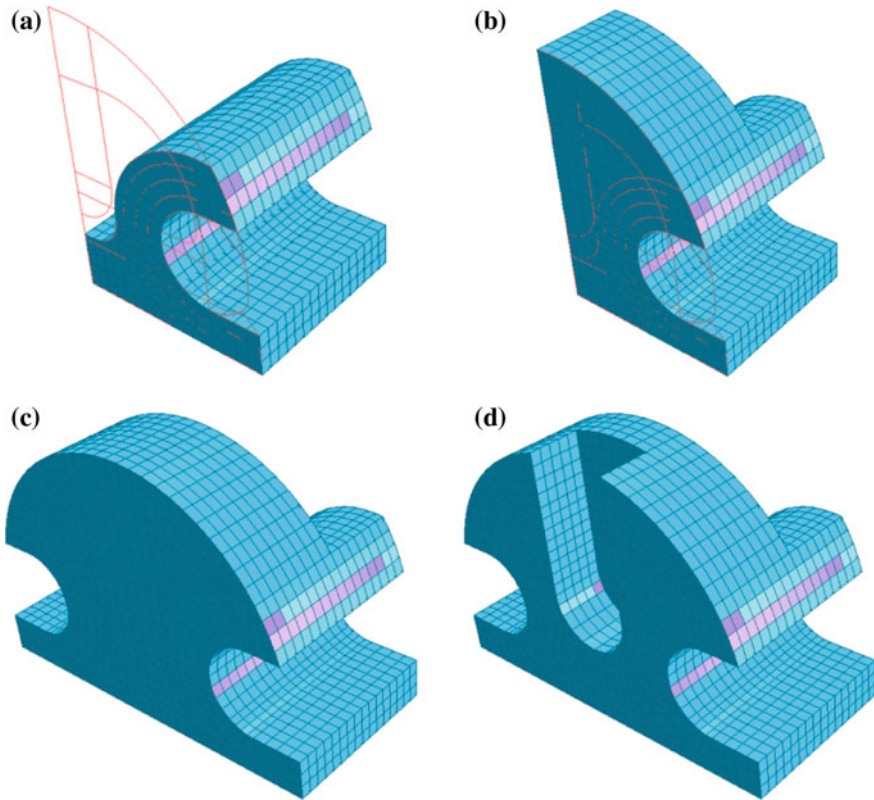


discrete model match the dimensions of the actual object and that the nodes of the finite element took appropriate place in the space to accommodate the phenomenon of contact between the head of the anchor and the hold down part. Due to the adopted by the authors of the symmetry of the shape of the head of the anchor used the opportunity to mirror half of the discrete model in order to obtain a complete discrete model. The final step in creating a model of discrete anchor was to remove part of the finite element and create a solid model of the head anchors with appropriate cutouts (Fig. 8.23d).

Using of developed techniques of semiautomatic mesh generation with simultaneous coordination of contact nodes (Fig. 8.24) allows to find adequate solutions (Fig. 8.25).

Rail discrete model was constructed using a similar method to that described above. Spatial elements generated based on planar finite elements. Symmetry model of rail allowed to generate only half of the discrete model and use the possibilities of mirror to get the full discrete model of rail. But the most important task in the discrete model generation was to ensure the compatibility of the position of the nodes of finite elements belonging to the rail and the hold down part in the zone of contact of both elements. Coincidence of the position of nodes belonging to the model of rail and the model of hold down part, as in the previous cases, it was necessary to define a proper interaction between the two elements including the contact phenomenon.

Rail model began to build the portion of a top surface of the foot of the rail, which adjoins the hold down part. Used for this purpose already existing in the model curves of a certain well previously broken down into finite elements. Actually, we should rather say, for a predetermined number of nodes finite elements belonging, belonging to the selected curves. Appropriate curves were discretized one-dimensional finite elements (Fig. 8.26a). One-dimensional elements were used as template for the generation of grid of two-dimensional, plane finite elements



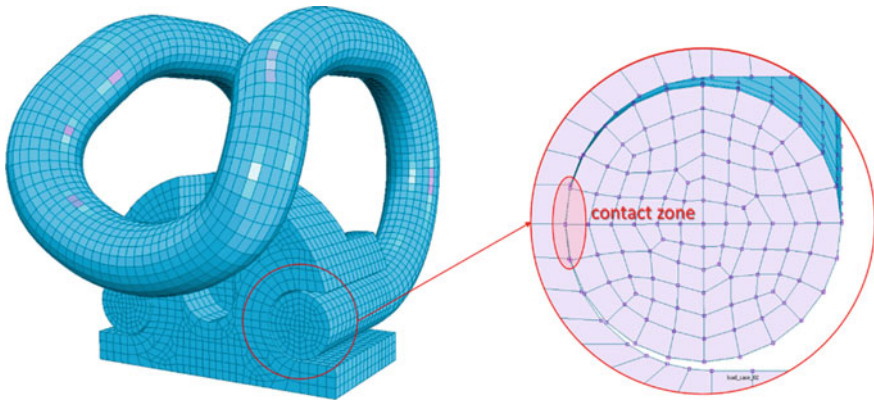
**Fig. 8.23** The steps to create a discrete model of the head of the anchor

(Fig. 8.26b). Two-dimensional plane finite elements used to build the spatial mesh of three-dimensional elements (Fig. 8.26c) forming a portion of the rail foot, which is in contact with the hold down part. Finite element mesh nodes belonging to the discrete model of rail were “matched” to the nodes of spatial elements belonging to the hold down part.

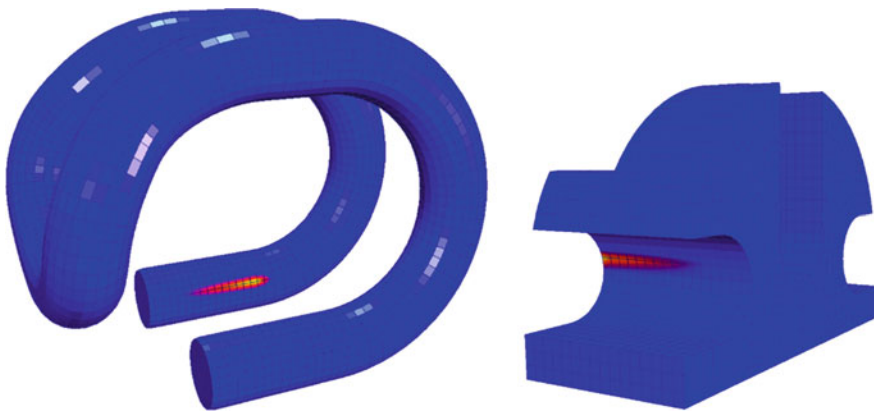
In the next step, a cross-sectional sketch of a rail was used (Fig. 8.26d) and on its base two-dimensional plane finite element mesh was created (Fig. 8.26e), which was then used to construct a spatial discrete model of the rail. Fragment of spatial discrete model of rail (Fig. 8.26f) allowed by the operation of duplication and mirroring to obtain the full discrete model of rail (Fig. 8.27).

In Fig. 8.28, shown zone of contact of rail and hold down part with closely matching nodes of spatial mesh of finite elements.

As mentioned, discrete model of fastening SB-3 was performed using the programme MSC.MARC. Authors used the opportunity to work with the programme MSC.MARC using batch files type *.procedure* (Fig. 8.29). Batch files of type *.procedure* are text files in which each line of text is a command understood by the



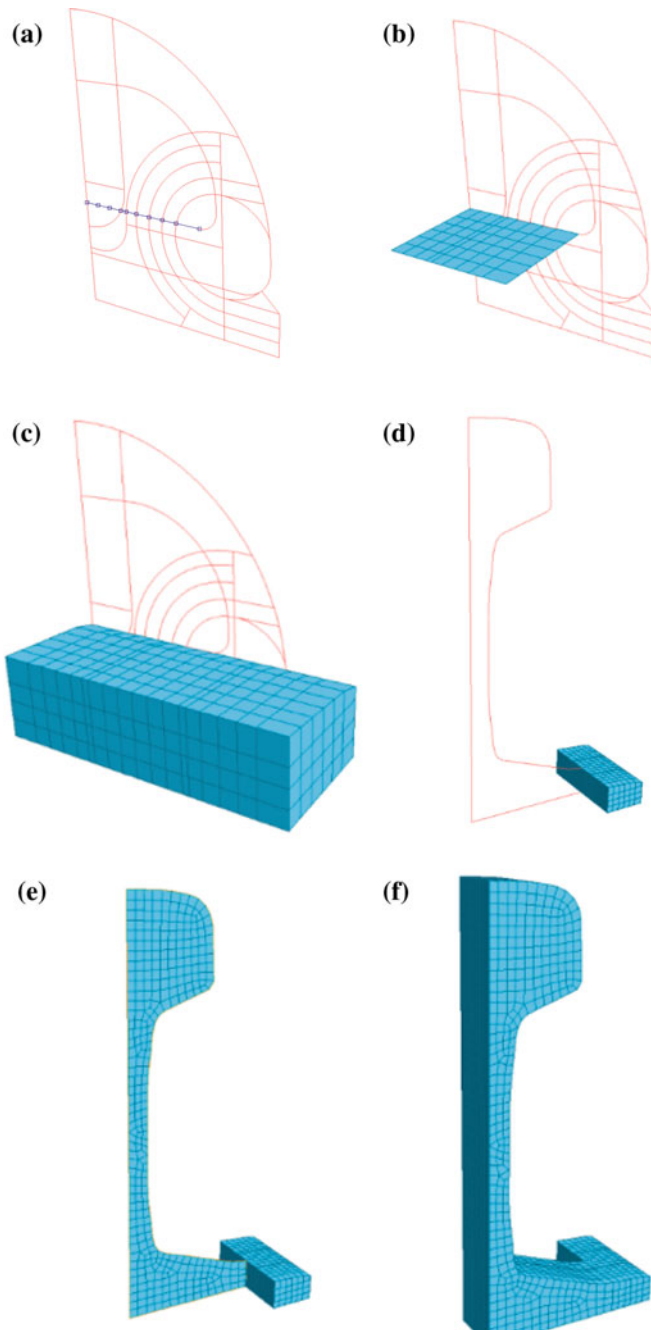
**Fig. 8.24** Coordinated nodes in contact zone



**Fig. 8.25** Normal contact stress on the contact surfaces of interacting parts for coordinated meshes

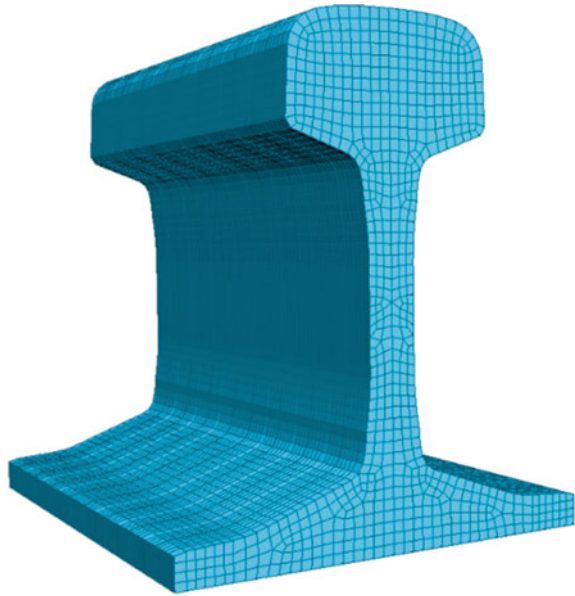
programme MSC.MARC. The programme reads the file *procedure* and executes one after the other commands in the lines. This way of working with causes that it is easy to make changes to the model. Ability to easily and quickly modify the text file, for example, allows you to control the size and shape of the finite element models of forming discrete models of parts of rail fastening. The possibility of such control to adjust the finite element mesh pairs of parts in such a way that the nodes of the elements in contact, occupy the same location in space, in other words have been agreed.

During creation the discrete model of the rail pad used the fact that its components are repeatable (“tummies” and spacing between them). Rail pad has two planes of symmetry (Fig. 8.30).



**Fig. 8.26** The steps to create a discrete model of rail

**Fig. 8.27** Rail discrete model

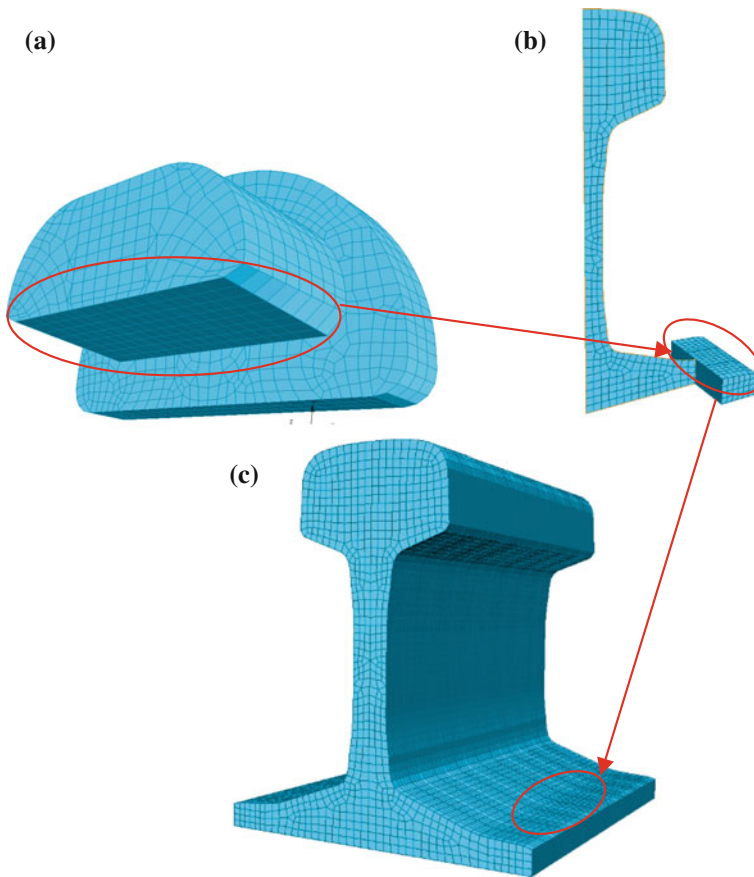


Generation of the discrete model of the rail pad (Sładkowski 2009), started from the plane mesh of two-dimensional finite element (Fig. 8.31a), which was used as a template for the generation of spatial finite elements in the “tummies” of larger size. The next step was to “attracting” nodes lying on the side (vertical) surfaces “tummies” to selected stretches of the surface of the geometric model of the rail pad, so as to obtain a characteristic “barrel” shape “tummies” (Fig. 8.31b). Mesh of spatial elements forming mentioned “tummy” of the rail pad was repeated in such a way that the received discrete model of all “tummies” of larger size (Fig. 8.31c). In the same way they were built models of discrete “tummies” of smaller size. This resulted in a discrete model of all “tummies” of the rail pad (Fig. 8.31d).

Other parts of discrete model of rail pad made on the basis of two-dimensional finite element mesh and stretch them in a grid of spatial elements at an appropriate distance and in sufficient numbers. Other elements of the rail pad (the space under the “tummies”) can be divided into simple, regular geometric solids, which largely facilitated the generation of spatial mesh by their duplication. The individual solid components of the rail pad subjected to discretization and duplicated were combined together to form a discrete model of the rail pad (Fig. 8.32).

In all models, discrete omitted details of the shape of real objects such as small fillets, chamfers with small dimensions. It includes only the tilt planes, chamfers, fillets of significant dimensions. All discrete models built on the same working space as possible to give them a desired position relative to each other, the position intended by the authors (Fig. 8.33). Different colours for discrete components fastening means defined in the MSC Marc separate bodies, between which you can





**Fig. 8.28** a, c The area close to matching interacting nodes on surfaces of the rail and hold down part, b an initial step of creating a discrete model of rail

define the phenomenon of contact. Different colours indicate the body with different material properties. Discrete model of fastening was supplemented with a simplified model of the sleeper.

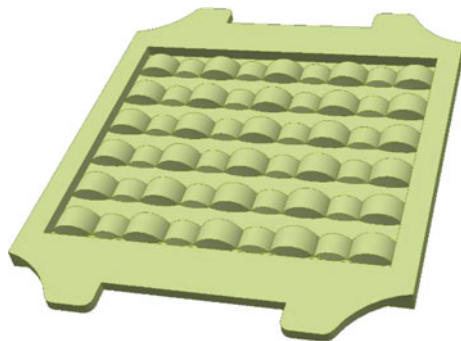
## 8.6 Strength Analysis with the Phenomenon of Contact

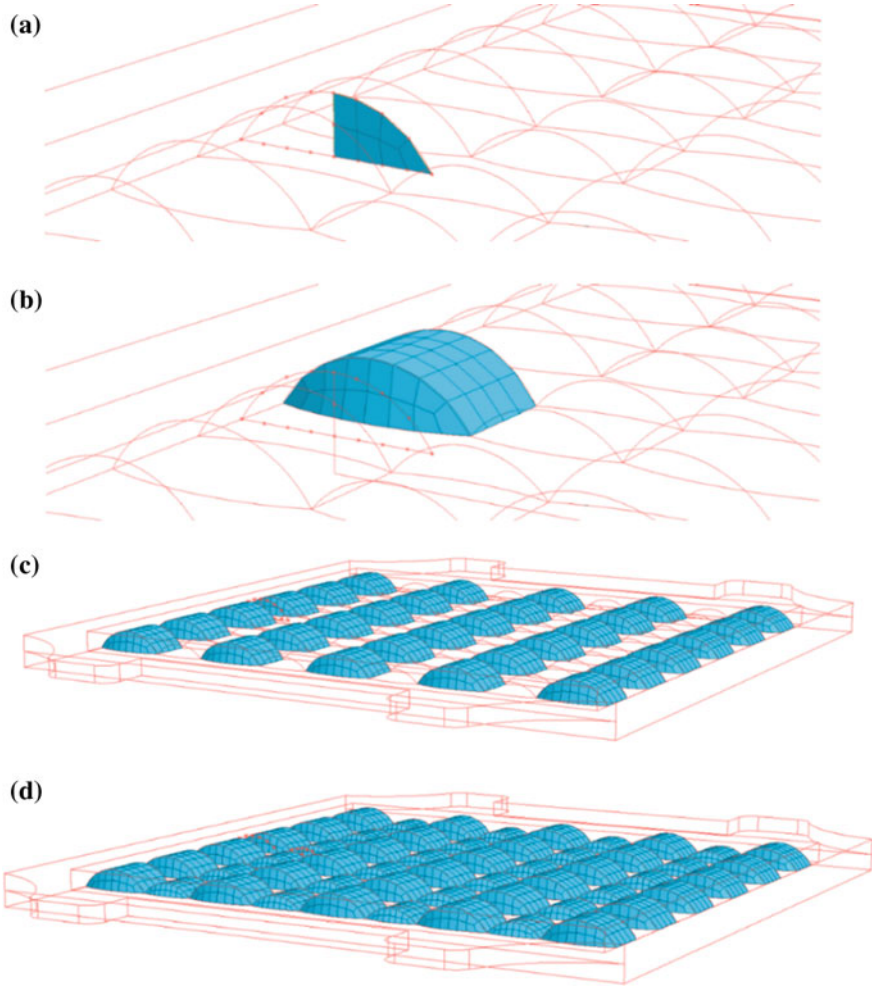
Discreet model of rail fastening type SB-3 (Fig. 8.34a), which is placing discrete models of all elements making up the fastening, was analysed that simulates the work of all parts after their submission in one unit. Strength analysis was done to simulate the conditions of work involving the fastening pressed against the rail by the spring clip through the hold down part to the sleeper, on which rested the rail

```
EdiPad Pro 7 - [C:\Users\Krzych\Desktop\rail_pad_PWE6094_sleeper_PS94_procedure_from_26.proc]
File Edit Project Search Go Block Mark Fold Tools Macros Extra Convert Options View Help
rail_pad_PWE6094_sleeper_PS94_procedure_from_26.proc
1 |
2 | Created by Aleksander Sladkowski and Krzysztof Bizoń
3 |
4 | *set_model_length_unit meter
5 |
6 | *save_as_model "rail_pad_PWE6094_sleeper_PS94_model_from_26.mud" yes » | -SAVED-FOR-THE-FIRST-TIME
7 |
8 | *import-iges "rail_pad_PWE6094_19.igs"
9 |
10 | *sweep_all
11 |
12 | *fill_view
13 | *redraw
14 |
15 | *set_surfaces off
16 | *set_curves on
17 | *set_points off
18 | *redraw
19 |
20 |
21 | » » » » » » » » | BIG ARCH SKETCH
22 | *import dxf "szkic35.dxf"
23 |
24 | *prog_param_renumber:start 2000
25 | *renumber_curve_list
26 | all_visible
27 |
28 | » » » » » » » » | BIG ARCH 2D MESH
29 | *set_curve_div_type_variable I1I2
30 | *set_curve_div_opt_ndiv I2I1_ratio
31 | *set_curve_div_num 4
32 | *set_curve_div_I2I1_ratio 0.65
33 | *apply_curve_divisions 2980 #
34 |
35 | *set_curve_div_type_variable I1I2
36 | *set_curve_div_opt_ndiv I2I1_ratio
37 | *set_curve_div_num 4
38 | *set_curve_div_I2I1_ratio 1
39 | *apply_curve_divisions 2978 #
40 |
..
```

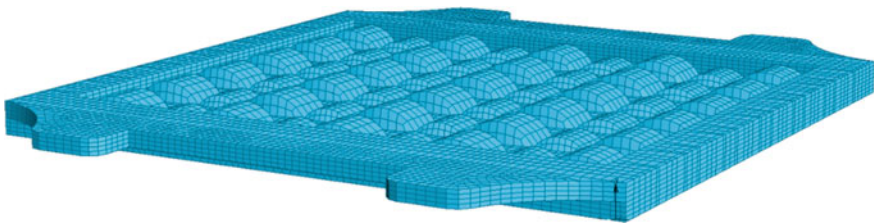
Fig. 8.29 A fragment of one of the text file type *.procedure* used by the authors to build the model of fastenings in the MSC Marc

Fig. 8.30 Solid geometrical model of the rail pad

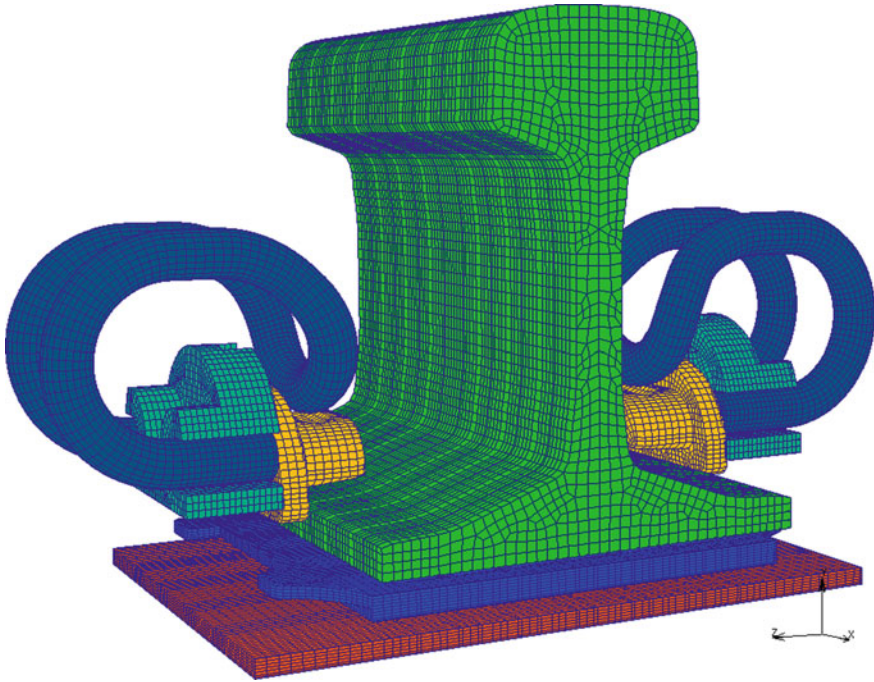




**Fig. 8.31** The steps to create discrete model of rail pad



**Fig. 8.32** Discrete model of rail pad

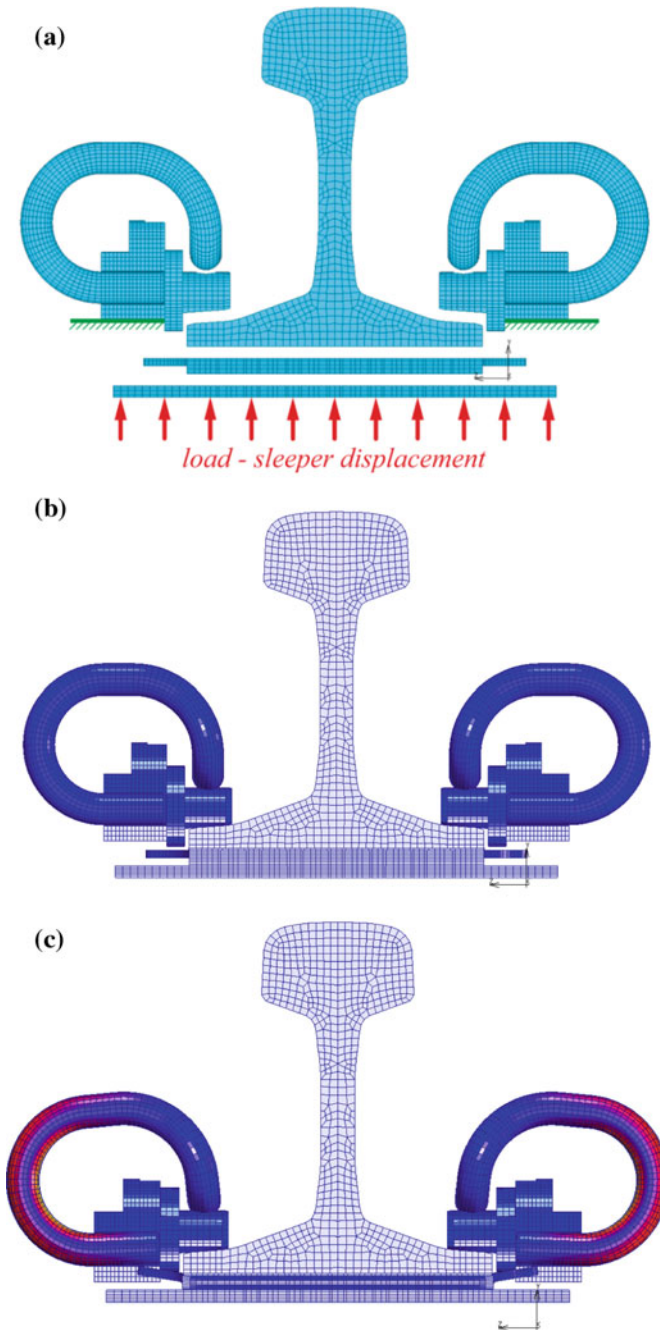


**Fig. 8.33** Discrete model of rail fastening of SB-3 type

pad. Simulation situation described above has been made in defining the vertical displacement sleeper (lifting sleeper). Sleeper moving vertically upwards, influenced the spacer pad, lifting it up (Fig. 8.34b). Rail pad, affected the rail, also lifting it up. Vertically moving rail through the hold down part affected the resilient spring clip, causing its depressurization. Vertical displacement sleeper, and with it the rail pad, rail and hold down part, lasted until the spring clip has reached such a level of expansion that reaches after mounting it in a fastening (Fig. 8.34c). A fixed part in the whole system was the head of the anchor. In fact, it is concreted (completely immobilised) in the sleeper, which lies motionless on the ballast.

## 8.7 Results

Due to the fact that the model of SB-3 fastening will act as the test model, the material properties of fastening parts taken as the constant. The values of properties of materials (steel, cast iron, glass fibre-reinforced polyamide, polyurethane, concrete) is derived from available sources of literature (Koszkul 1995, 1999) and the Internet, for example, sites of producers of the spring clamps. It was defined Young's modulus, Poisson's ratios as well as the coefficients of friction between the

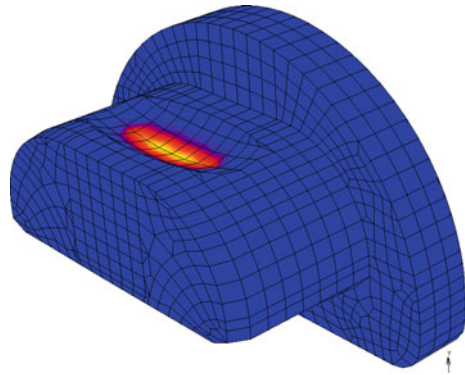


**Fig. 8.34** a Scheme of the way of calculation, b the initial position of the mounting elements (before starting the calculation), c the final position of the mounting elements (after the calculation)

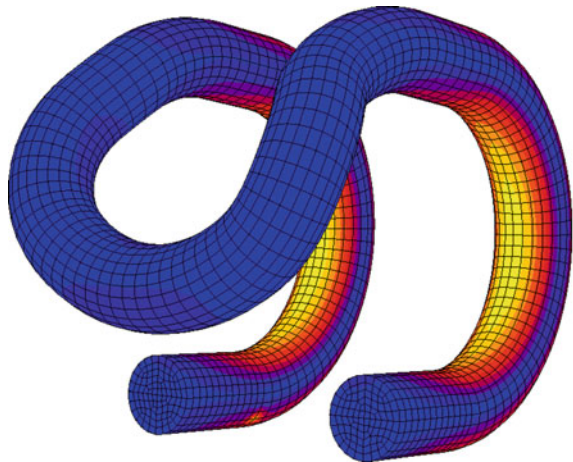
mating (remaining in the contact) parts of the fastening. The assumption of constant values for material properties seems to be particularly high in the case of simplification of the rail pad. Due to the ongoing research to determine the material properties, in particular the material properties of the of the rail pad and hold down part, calculation results obtained using the constructed model should be regarded as estimates, and the model should be regarded as test model. Test calculations resulted in the following results (selected sample results):

- the maximum value of contact stresses in the slot of hold down part was approx. 168 MPa (Fig. 8.35);
- the maximum value of reduced stress in elastic spring clip amounted to approx. 1200 MPa (Fig. 8.36); the yield strength of the material is equal 1600 MPa;
- the maximum value of the contact stresses on the upper surface of the rail flange (under the hold down part) was approx. 28 MPa (Fig. 8.37);
- change the thickness of the rail pad, amounted to approx. 1.9 mm (Fig. 8.38).

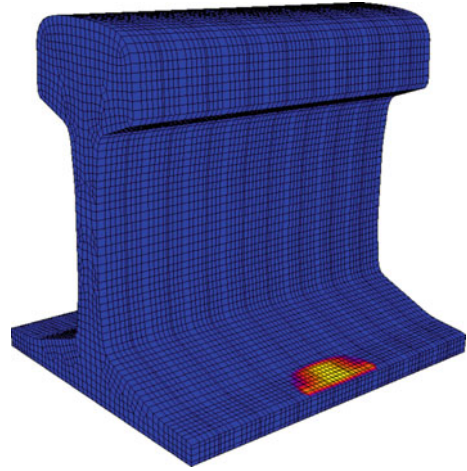
**Fig. 8.35** Distribution of contact stress on the surface of hold down part



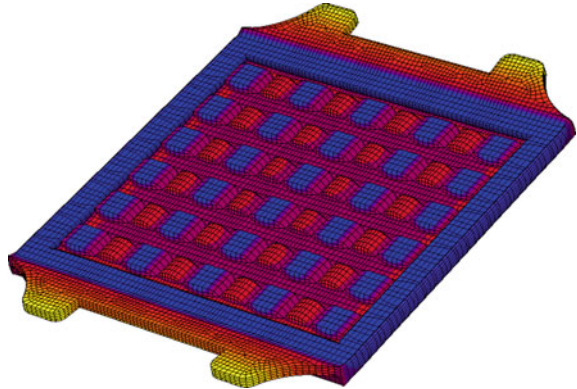
**Fig. 8.36** Distribution of reduced stress on the surface of spring clip



**Fig. 8.37** Distribution of contact stress on the upper surface of the rail foot



**Fig. 8.38** Distribution of vertical displacements of the elastic rail pad



## 8.8 Conclusions

Based on the proposed technique of semiautomatic coordination of contact nodes, the test discrete model of SB-3 rail fastening was developed. Developed model of rail fastening of SB-3 type to the sleepers is a test model. The calculation results obtained using this model should be regarded as estimates and indicative. Fixed values of material properties will be replaced in the future on their variables nonlinear equivalents. Nonlinear material properties of certain parts of rail fastening are investigated by the authors and their implementation is being developed.

Methodology used by the authors and the use of text files such *.procedure* to build the model let them easier to make changes to, for example, material properties, load values, size, shape and number of finite elements that make up the discrete model of rail fastening.

In the developed model number, size, and thus the spatial shape of the solid finite elements, were important not only because of the need for a perfect match mesh nodes of finite element forming the interacting parts, but also because of the calculation time. For inclusion in the model, contact phenomenon to be expected with long time calculations. In the case of analysis rail fastening, zones of mutual contact are a lot. It was necessary to take this into consideration creating a discrete model of fastening to get a solution after a reasonable period of numerical calculations performed by the computer.

## References

- Aprobata techniczna AT/07-2014-0111-A1—System przytwierdzeń SB-IF1 (2014) Warszawa. Instytut Kolejnictwa (In Polish: Technical Approval AT/07-2014-0111-A1—Fastening system SB-IF1.2014. Warsaw: Railway Institute)
- Koszkul J (1995) Materiały niemetalowe. Ćwiczenia laboratoryjne. Skrypt. Częstochowa: Wydawnictwo Politechniki Częstochowskiej (In Polish: Koszkul J (1995) Non-metallic materials. Laboratory exercises. Script. Czestochowa: Publishing House of Czestochowa University of Technology)
- Koszkul J (1999). Materiały polimerowe. Częstochowa: Wydawnictwo Politechniki Częstochowskiej (In Polish: Koszkul J (1995) Polymer materials. Czestochowa: Publishing House of Czestochowa University of Technology) ISBN 83-7193-084-4
- Oczykowski A (2010). Badania i rozwój przytwierdzenia sprężystego SB. Problemy kolejnictwa. 150 pp 121–156 (In Polish: Oczykowski A (2010) Research and development of elastic fastenings SB type. Problems of Railway)
- PN-EN 13146 (1÷8) (2003) (U) Railway applications—Track—Test methods for fastening systems
- PN-EN 13481 (1÷7) (2004) Railway applications—Track—Performance requirements for fastening systems
- Sładkowski A, Kuminek T (2003) Influence of the FE discretization on accuracy of calculation of contact stress in a system wheel—rail. In: Proceedings of 3rd scientific conference “New Trends in Transport and Communications”. Pardubice: Jan Perner Transport Faculty, University of Pardubice pp 13–18. ISBN 80-7194-565-X
- Sładkowski A (2005) Accuracy analysis of the solution of spatial contact problem by means of the FEM, *Mechanika* 3(53) pp 17–21. ISSN 1392-1207
- Сладковский А (2005) Контактное взаимодействие колес и рельсов. Луганск: Русь. 189 p (In Russian: Sładkowski A (2005) Contact interaction of wheel and rail. Lugansk: Rus) ISBN 966-8051-19-X
- Sładkowski A (2009) Modeling of the deformation of elastic pads for rail fastenings. *Transport Problems* 4(1) pp 63–70. ISSN 1896-0596
- Sładkowski A, Sitarz M (2005) Analysis of wheel-rail interaction using FE software, *Wear* 258(7–8) pp 1217–1223. ISSN 0043-1648
- Wen Z, Jin X, Zhang W (2005) Contact-impact stress analysis of rail joint region using the dynamic finite element method, *Wear* 258(7–8) pp 1301–1309. ISSN 0043-1648



# Chapter 9

## Improving Integrated Travel Planning by Enhancing Travel Planning Model with Rail Station Data

Jörn Schlingensiepen, Edwin Naroska and Florin Codrut Nemtanu

### 9.1 Introduction

About 28 million people use the public passenger transport in Germany daily, this shows the good acceptance of a well-meshed traffic system. The Verkehrsverbund Rhein-Ruhr (abbreviated VRR) is the public transport association covering the area of the Rhine-Ruhr conurbation in Germany. It was founded on 1 January 1980, and is Europe's largest body of such kind, covering an area of some 5000 km<sup>2</sup> with more than seven million inhabitants, spanning as far as Dorsten in the north, Dortmund in the east, Langenfeld in the south, and Mönchengladbach and the Dutch border in the west (VRR—Zahlen und Daten <http://www.vrr.de/de/vrr/verbund/zahlen/>).

Today's public transport and travel planners are not easy to use by people having mental problems or are disabled, not only in the VRR area. Travel planning today is powered by online time tables calculating the optimal way to use public transport in terms of time and costs. This is not suitable for a group of travelers having constraints in using vehicles, vehicle types or particular stations for health reasons. On the other hand, since most of those people are not able to drive a car on their own, making public transport available and moreover easily usable enable these people to improve their mobility and their quality of life in general.

---

J. Schlingensiepen (✉)

Institut für Ingenieurinformatik und computergestützte Mathematik, Fulda, Germany  
e-mail: joern@schlingensiepen.com

E. Naroska

Hochschule Niederrhein, Krefeld, Germany  
e-mail: edwin.naroska@hs-niederrhein.de

F.C. Nemtanu

Transport Faculty, Politehnica University of Bucharest, Bucharest, Romania  
e-mail: florin.nemtanu@its-romania.ro

Since this infrastructure is already established it is a good investment to open this service to people which are not able to use it today. And the dense mesh provided by the companies running VRR is the perfect environment to do so.

## 9.2 Project “Mobile”

The project mobile presented in this paper and sponsored by German Federal Ministry for Economic Affairs and Energy aims to open public transport up to people who for whatever reason cannot currently utilize it. The project aims to create a technological platform which can assist members of the public in using public transport, particularly those who are mentally or physically impaired. The project is part of the action to reach the goal of the *UN-Convention on the Rights of Persons with Disabilities* (Convention on the rights of persons with disabilities 2014) the *German Federal Ministry of economy and energy (BMWi)* (Von Tür zu Tür—Föderrichtlinie and Bundesminister für Bildung und Forschung 2011). Within this initiative, a set of projects were started that address different aspects of public transportation.

Therefore, several supporting gadgets that allow also indoor navigation and a system that describes vehicles, stations and personal attributes of mentioned travelers were developed. This allows getting personalized and localized advice during travel and while travel planning. This is implemented by generation of a second graph representing the public transport network not in dimension of time and costs but in preferences and dislike of a given traveler. This second graph is an overlay to the standard graph to get a personalized graph that allows finding a suitable route respecting the constraints of the user. The goal of the project mobile is to provide disabled people with means that support them during traveling in public transport systems (Mobil im Leben—Projektseite <http://mobil-im-leben.org/>; Stockmanns and Koch 2014). Especially, the local transportation system is addressed where a mixture of different transportation means (e.g. bus or tram) is used. As a result, a major problem is to support people while changing vehicles.

During the first assessments within the project, it came out that a major problem of the people is a lack of information and a proper handling of uncertainty. As a result, a major goal of the project is to

- provide traveller routes that meet their individual capabilities, restrictions, needs and preferences; this covers a wide range of issues like avoiding overcrowded buses, inability to use stairs, inability to use complex bus stations, etc.;
- provide travellers timely information about their current schedule (what happens next, when to leave the vehicle, how much time is left until the connecting vehicle arrives, etc.);
- help people locating themselves, especially with respect to bus stations or other locations important for the current journey; this especially addresses identifying

the right bus station on the appropriate side of the street or within a complex bus terminal station;

- identify transportation vehicles in order to decide whether or not to enter a vehicle; this must be done in a way so that the traveller is sure that he enters the right bus or tram; and
- inform people when to prepare and when to leave vehicle during a trip;
- identify stressful situations to the traveller and calming down people when needed.

These findings lead to three problems to solve the following:

- The actual advice generated by the system must be customizable to match the individual needs of the traveller and
- Presentation and interaction with the system must be adaptable to users capabilities. In order to provide the user with appropriate and timely advices and information the system needs
- to know very precisely where the user is.

All problems are addressed in project mobile, e.g. by indoor navigation (Linde et al. 2004, 2005) or personalized user interface design (Ressel 2008; Ressel et al. 2006; Small et al. 2005).

### 9.3 Travel Support Platform

As an ICT backbone the project team created a state-of-the-art platform for mobiles and tablet PC's that encourage public transport use by integrating all modes of transport into one easy to use platform. This aimed to increase efficiency and trust in public transport by providing technical and mobile assistance. This platform is designed for universal use with a focus on people with disabilities in cognition or physical disabilities, aiming to increase their use of public transport while providing them with a comfortable experience. It essentially provides a travel assistant in a technological format. The platform provides the following functions:

- Up-To-Date Information during the journey including current traffic situation and any needed planning or routing changes.
- Individual navigation system taking account personal needs and capabilities.
- Information system providing information about special barriers or special paths on the travel such as steps or areas likely to be busy.
- Navigation system for people with disabilities and all others to allow easy use of public transport.

The platform contains two parts: The back-end, providing personalized information and supervision during a travel, and the travel agent, an application running on a mobile device.

### ***9.3.1 Global and Local Localization***

Most navigation applications use GPS to locate the user. The disadvantage of GPS is that it is not suitable in many situations in the public rail transportation system, such as subway stops or rail stations. But even in a normal street environment the GPS signal is hampered through urban canyons and therefore it often happens that the user is not accurately enough localized.

#### **9.3.1.1 Assisted GPS**

In order to improve the GPS-based localization, various approaches have been developed like assisted GPS (AGPS) or a combination of Wireless LAN with GPS as exploited by Android and discussed in several papers (e.g. Bejuri et al. 2013). While this improves the localization quality in many cases, our experiments showed still an insufficient performance. For example, in our tests with different smartphones GPS/AGPS-based localization often located the user on the wrong side of a street. Unfortunately, to determine whether the user is at the right bus stop—at the right street side—is a very important localization task. Finally, GPS- and WLAN-based solutions (Curran et al. 2011; Chang et al. 2010) are not sufficient to reliably help people navigating indoors as localization must work reliable within complex and highly dynamic environments.

### ***9.3.2 Precise User Location***

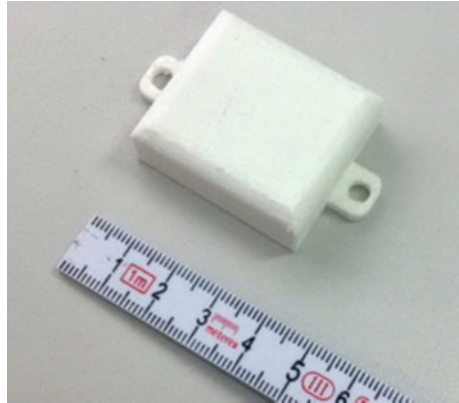
To ensure a precise user location even inside station buildings the platform combines a set of different technologies. This section gives an overview of those technologies.

#### **9.3.2.1 BLE Beacons**

In order to provide a precise user location at all times, the platform would use Bluetooth Low Energy Beacons (BLE Beacons). These beacons send a radio signal that can be detected by a mobile receiver and from this an individual's positioning with respect to the Beacon can be determined. Identification of vehicles or stops can be efficiently achieved by the clear identification of each of them by a UUID (Universally Unique Identifier). These UUIDs can also be used to alert a user if the stop at which they should depart the vehicle is approaching.

To support the localization in such situations, stops, vehicles and optionally other important landmarks are equipped with Bluetooth beacons. These small battery-powered devices are continuously sending advertisement packets with a

**Fig. 9.1** Bluetooth beacon prototype



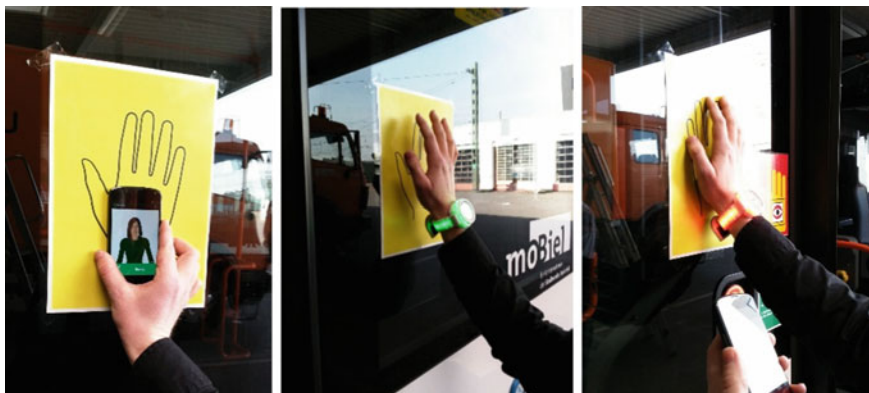
unique ID via Bluetooth low energy. The user end device receives the IDs and the signal strength of the beacons and can determine their own position (see Fig. 9.1).

The same approach is used to find the correct transportation vehicle by equipping buses and trams with these beacons. In addition beacons are connected to the Integrated On-Board Information System and read the current line number and direction of the vehicle in order to generate a unique ID number. As a result, the ID can also encode the route and the current position of the vehicle. Moreover, this information can be exploited by the user while traveling by the bus in order to know when to leave the vehicle. As a result, a passenger can get an overview of current trip progress even if the vehicle is not equipped with displays or the user is in a bad sitting position, so see them.

### 9.3.2.2 RFID

RFID tags can be used in conjunction with wearable gadgets such as smart watches. These gadgets can assist with other functions such as determining a user’s precise location. Further functions that can be integrated into the platform that helps to determine precise user location include RFID tags.

RFID technology has become a major innovation driver (Lahtela et al. 2008; Marcus et al. 2009) and many of the shelf modules are available and ready to be integrated into devices. Hence, stops and vehicles are also equipped with RFID tags to identify them. Due to the short distance interaction that is necessary here, there is a higher level of confidence particularly for uncertain passengers. To this end, a passive RFID tag is attached right next to the entrance door of a bus. The user can use an NFC-equipped smartphone to read out the tag. The navigation system then checks whether the tag belongs to the right bus and informs the user whether or not to enter the bus. In addition, a special bracelet (see Fig. 9.5) can be used that is equipped with a RFID reader: by touching the special “localization plate” attached to the bus, the bracelet identifies the tag and informs the user how to proceed by



**Fig. 9.2** Yellow plates equipped with RFID tags to identify a bus (*left* using to NFC equipped smartphone to read the tag; *middle* special smartwatch with RFID reader showing a “right” bus; *right* special smartwatch with RFID reader showing a “wrong” bus)

green and red lighting. More information about the bracelet is provided in the next section.

In addition, bus stops are also equipped with these kinds of RFID tags so that the user can easily identify the right bus stop. For more difficult navigation situations like dealing with complex bus stations, we also exploited tags as a “way point”. Even many mentally handicapped people could easily spot the special “yellow hand sign plates”. When they touched the plate, they received information about how to continue their way through the station. However, this requires carefully deriving and installing an appropriate set of waypoints in order to support all or at least most of the appropriate routes (Fig. 9.2 shows this application).

#### 9.4 Markers for Long-Distance Detection

In order to identify or detect bus stops or busses or important waypoints from a farther distance an additional approach is under development. This approach uses the smartphone camera in order to search for special optical markers. In contrast to QR codes, these markers can be detected from a distance (experiments indicate that up to 9-meter detection distance can be achieved detecting an optical marker of about 20-cm diameter).

The marker consists of a colored pattern that has been optimized to be easily detectable by machine vision algorithms (see Fig. 9.3). As a result, a smartphone is capable of analyzing a frame in max resolution in less than 100 ms. In contrast to typical marker detection algorithms, this allows detection of markers that are far away and also saves battery due to the reduced computational load.

**Fig. 9.3** Colored optical marker



However, the optical tag does not include a large amount of information like QR codes. Instead, the information is in the range of 16 bits. Nevertheless, as only a limited amount of different objects are to be distinguished and additional information can be used like GPS location or Bluetooth beacons, objects can be typically easily identified using the current context of the user. Bus stops that are several kilometers away can be assigned the same embedded optical marker code, as they can be finally distinguished when taking the current GPS location into account.

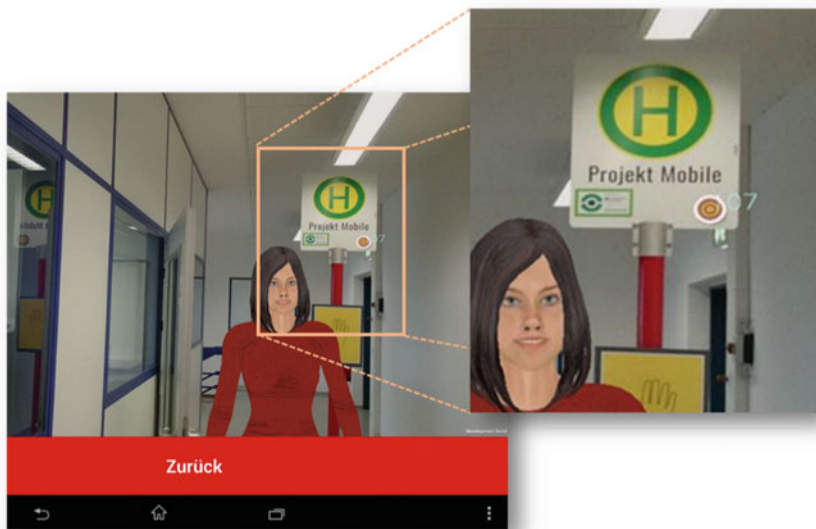
Hence, the optical tags are used to guide the user into the right direction or to inform him or her that a specific bus or bus stop is the wrong one. In order to simplify usage, the camera picture is shown on the display and augmented with additional information as shown in Fig. 9.4.

## 9.5 User Interaction

This section shows some examples of how the platform operates in practice for different potentially troublesome aspects of using public transport.

### 9.5.1 User Interface

The configuration of the platform is highly important and variable. An easily understandable and customizable UI is important. For example, the needs of someone in a wheelchair vary considerably from someone suffering from anxiety. In order to exploit a user interface that it is available to many people, the UI



**Fig. 9.4** Wrong bus stop tagged with an optical marker

developed in the project is mainly smartphone based. Nevertheless, the additional UI devices can be added to the system in order to match the different user needs.

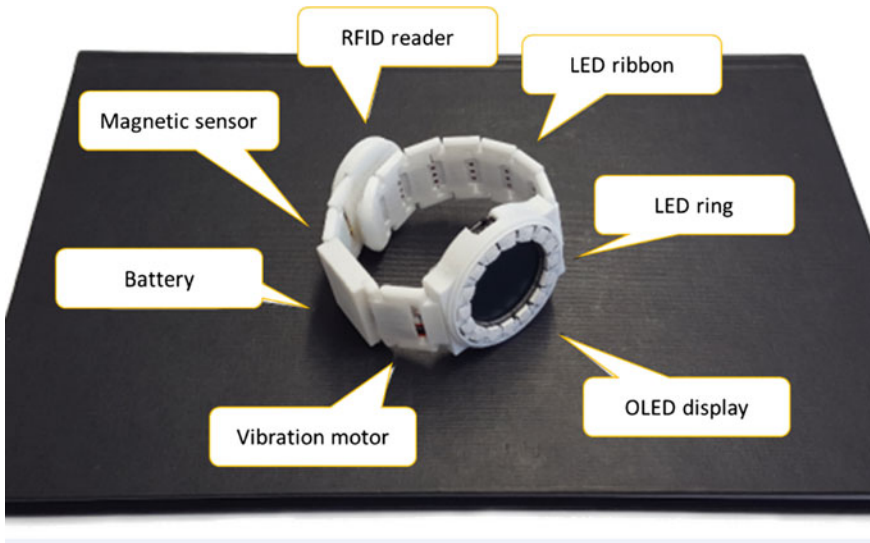
As some users cannot read, a user interface has been developed that uses a virtual character to support communication with the user. The character uses gestures as well as speech to provide information about the current state of the travel. During travel the user interface is designed to visualize content (for easy usage) and to offer user-personalized information.

### 9.5.2 *Wearable Gadget*

In addition to the navigation application on a smartphone or tablet the user of the system can get the latest information for his trip (e.g. when to leave the vehicle) through a “wearable gadget” in form of a self-manufactured portable bracelet. The developed bracelet has a display and a LED ribbon as well as a LED ring to display various information and also a RFID reader.

This own development shown in Fig. 9.5 has proved to be necessary for the target group of mentally limited users. For example, smartwatches have been found as too complicated to use for the clientele. In addition, most displays of current smartwatches are difficult or impossible to read under direct sunlight. The developed wearable gadget allows the display of simple signs and light signals, which are easy to read even in strong sunlight. In addition, the user can be alerted by a





**Fig. 9.5** Smartwatch equipped with RFID reader, LED ribbon and LED ring

vibration. Nevertheless, in addition appropriate applications for Android-based smartwatches have been developed as well. These apps can be used if the user is capable of reliably interacting with a modern smartwatch and can also use other information sources in case the smartwatch cannot be used, e.g. due to direct sunlight.

A first prototype of the bracelet we used to experiment with the signalling functionality is shown in Figs. 9.6 and 9.7. We used coloured LED strips in order to test different signalling methods like using red, green, or yellow colours in combination with animation or flashing sequences. Further the OLED ring was also used to provide directional information as derived from an embedded magnetic compass sensor. In addition, the OLED display is used to show additional and more detailed information like “stations left until departure”.

Finally, an appropriate icon set and information layout have been developed that can be used to show information on the OLEDs bracelet or on a commercial smartwatch as shown in Fig. 9.8.

The integration of the RFID reader allows a contactless identification and validation of stops and transport vehicles over short distances. Compared to our gadget currently there is no smart watch available, which also has a RFID function with the appropriate range. For example, our RFID reader is capable of detection tags within a distance of about 9 cm. As a result, it is sufficient to hold the reader antenna near to the RFID tag. In contrast to this, NFC-equipped smartphones have only a reader distance of about a couple of millimetres. Advantages of this technology are that stops and vehicles only have to be equipped with low-cost, low-maintenance passive tags.



**Fig. 9.6** LED rings and LED ribbon as well as OLED display providing simple information (*left* “right bus stop”; *right* “leave car at next bus stop”)



**Fig. 9.7** *Left* LED ring providing directional information about where to go next; *right* OLED display showed the number of stops left until departure

Due to the high energy demand of the high-luminosity LED display and the RFID reader special attention was given to the energy-efficient use of these technologies in the development. For example, the RFID reader is only enabled when the system has already recognized that the user is close to a possible stop (e.g. by using Bluetooth beacons) and an appropriate hand gesture was detected by a position sensor.

The developed “wearable gadget” is coupled for data transfer via Bluetooth Low Energy using a smartphone or tablet.



Fig. 9.8 Icons to show wrong bus stop, right bus stop and time left until arrival



Fig. 9.9 Augmented reality mock up highlighting proper bus station in the city of Krefeld

### 9.5.3 Augmented Reality

As Mobile also addresses mentally handicapped people, a user interface is needed that can be tailored to the specific needs of our target groups. Augmented reality-based solution plays here a significant role, because information can be visually connected with the appropriate object it is connected to. At the moment we are implementing a user interface that directly overlays a camera's view with relevant information as shown in the mock-up picture in Fig. 9.9.

For example, when pointing with the smartphone camera to the bus stop sign, information about the bus stop (right or wrong one) as well as data such as estimated arrival time is shown in the camera preview. As a result, the traveler can

easily use the smartphone to search the environment for relevant objects like transport vehicles or bus stops.

However, note that not all users from our target group are capable of holding a smartphone in an arbitrary angle or even do not have a free hand available to hold it at all. In order to overcome these issues we also experimented with smart glasses. While we were of course not able to try out all available glasses on the market, our experiments showed that at the time of our experiments the tested subset was (currently) not mature enough to be a reliable support tool for our target user group. To summarize our findings, augmented reality is very promising but is not well suited for all.

## 9.6 Personalized Advices and Travel Planning

An important component of the mobile infrastructure is the back-end system that generates personalized advices based on the current traffic situation and road maps.

The people within the target groups that are addressed in this project differ significantly with respect to their capabilities and needs. In general two major groups are addressed: people with mental problems and people with physical disabilities.

The group of mentally restricted people suffers from a wide range of problems that start from intellectual restrictions like illiteracy or incapacibilities of dealing with concepts of time. These people need a strong support and a user interface that especially addresses their deficiencies. For example, speech output or simple graphical symbols must be used if the traveler cannot read. On the other hand, there are also people that are capable of using a smartphone without any problems but may be easily distracted. As a result, special means are needed to draw their attention towards the current travel-related issues.

For the group of physically disabled people, we especially address temporary restrictions (e.g. caused by the surgery). For these cases, people that usually travel by their own car are temporarily forced to use public transport and often suffer from a lack of knowledge and training how to use public transportation. As a result, information about where to reach the next bus station, which vehicle to enter and when to leave are the major aspects that are to be addressed.

### 9.6.1 *Characteristics*

To allow describing the characteristics of infrastructure and users, an attribution system was developed. There are five kinds of entities that can be described by attributes, while the attribute value may vary depending on the time of day, the day of week or holidays:

- **Users** have different needs and preferences that can be expressed by attributes assigned to this user. We call this image of a user inside the system personal avatar. Users have Tolerance settings describing the user's tolerance to route changes, idle time along the trip, crowded areas, noisy surroundings and visual contact with other people. Movement settings describing the user's motoric capabilities which include the walking speed and endurance as well as the ability to take steps, use escalators or elevators. This includes also the demand of the user to get a free seat or special places at stations or within transport vehicles.
- **Vehicle types** have different attributes describing the way a special type of vehicle can be used, e.g. a low-floor bus can be used by wheelchair users, while a common bus cannot be used. So the most important attributes of vehicle type are height, width, steps and existence of special places.
- **Vehicles** have different attributes describing the way a particular vehicle can be used. Some buses may have identification support, while other do not. In this case users that are reliant on vehicle identification support are not able to use this vehicle.
- **Stations** are the nodes in the network having different attributes describing the way they can be used for start and end of travel or during changing vehicles. In terms of personalized route planning, the most important attributes describing a station are steps, daylight, security and load. The existence of steps without an elevator makes a station unusable for wheelchair users. Daylight and load have to be added to cover needs of users having mental problems and may panic in crowded stations or vehicles or on using an under-bridge. Load attributes dependents on time of use. Since most of the users in our target group are defenseless the attribute security became very important during travel planning.
- **Links** between the nodes are the traffic lines used by the user during traveling a calculated route. In terms of personalized route planning the most important attributes describing a link are the load, security, costs and speed. While costs and speed are usual attributes in route planning, the load and security have to be added to meet user's requirements (see above).
- To allow easier management of attribution of entities, a class system was developed and it consists of the following:
- **Persona** describes a stereotypical user which is similar to real passengers (Costa 2014) and is constructed with different behaviors, profiles and objectives. A persona does not correspond to a real person, but represents a typical user, which is composed of different features and behaviors. Inside the system every user is composed of the different behaviors of persona, where specific needs overwrite the attributes of the assigned persona.
- **Infrastructure Elements** are all elements in the public transport system, like Vehicles, Vehicle Type, Lines, Links, Stations, etc. Those elements provide facility for given needs, and therefore the Infrastructure Elements are designed as a complement to Persona.

- **Classes** of Persona or Infrastructure Elements incorporate entities with similar attributes; this allows easy management of descriptions by implementing classes of stations (main station, hub, terminal, etc.) or disease patterns.

### 9.6.2 Dimensions and Penalty

To allow comparison of routes and find a suitable route for a user, a penalty system was developed to overlay the speed and cost optimal routes with the needs of the user. To calculate this weighted route effort, each infrastructure element used in a route is loaded by a user-specific penalty summand (e.g. stations) or a user-specific penalty factor (e.g. links, vehicle use). The top drawing in Fig. 9.11 shows an example of a graph including overlays penalties.

In reality not all attributes for stations and users are available at run time since the data quality is very poor. Therefore, we developed a system that allows flexible calculation based on the available information, and therefore all attributes are normalized and ordered in dimensions. For example, the need of a user for an elevator instead of stairs and the existence of an elevator in a station are in the same dimension. Inside a dimension the attribute values are normalized, as shown in Table 9.1.

The system to calculate this weight works in four steps:

- Determine the specific descriptions of user's needs from Persona, Class of Persona and personal settings.
- Determine the specific description of possibly used infrastructure element.
- Calculate a penalty factor on the usage of each possibly used infrastructure element.
- Calculate the route efforts while using weighted speed and costs.

As shown in Fig. 9.10 determination of the specific attributes and values for a **user** is done by collecting values for each dimension from the class system, by the

**Table 9.1** Normalized values for attributes

Value	User	Infrastructure element
-8	Try to avoid	Very hard to use
-4	Strong do not like	Hard to use
-2	Do not like	Inconvenient to use
0	No special need	No special service
2	Nice to have	Provide service
4	Recommended	Special facilities to provide
8	Strongly recommended	Perfect
1000	Hard need	-/-

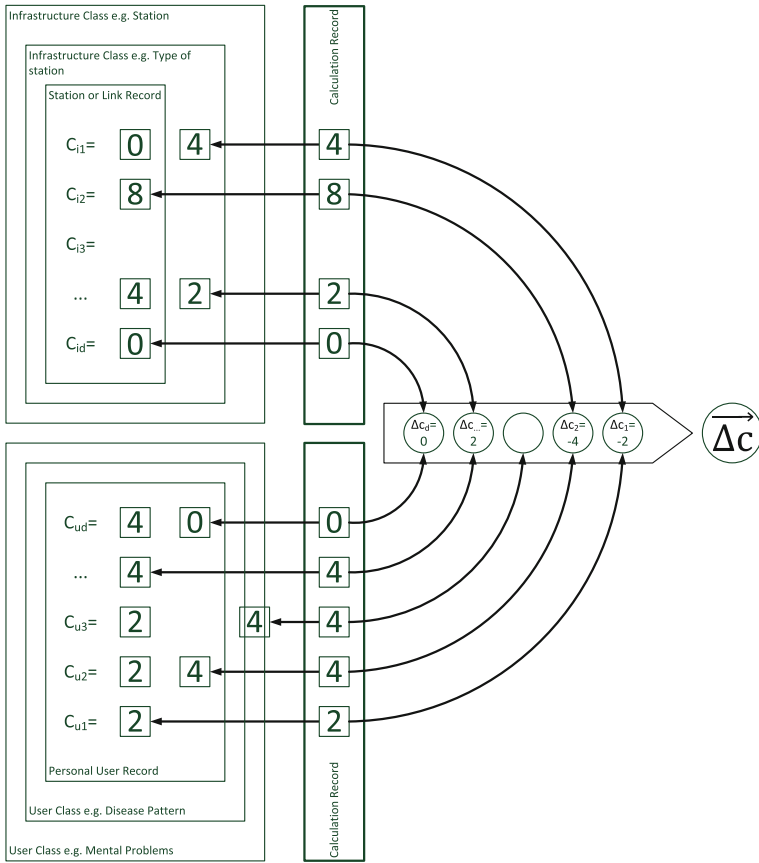


Fig. 9.10 Determination of attribute values

following algorithm: Starting with personal record, if dimension attribute is set take it, go to next dimension, if attribute is not set go on with the record of the class this record is based on. Reaching the root class without getting an attribute means this dimension is not described for this user.

Determination of the specific description of an **infrastructure element** such as station, link or vehicle follows the same algorithm using the records of infrastructure description.

Once the user and infrastructure attributes are determined, the characteristics can be seen as two vectors  $c_u$  for user's characteristics and  $c_i$  for the characteristic of an element. Calculation of penalty factor  $p_{ui}$  (User  $u$  uses infrastructure element  $i$ ) for  $n$  determined dimensions is done by calculation of the normalized distance in  $n$ ; as shown in Eq. 9.1 the distance in dimension  $d$  ( $\Delta c_d$ ) is calculated by the difference of the user attribute in dimension  $d$   $c_{ud}$  and the infrastructure attribute in this dimension  $c_{id}$ :

$$\Delta c_d = c_{ud} - c_{id}. \quad (9.1)$$

The normalized weight factor is the calculated length of the vector normalized by division by maximal distance in the given dimension (see Eq. 9.2):

$$p_{ui} = \frac{|\vec{\Delta c}|}{|\Delta c_{\max}|} = \frac{\sqrt{\sum_{d=1}^n \Delta c_d^2}}{4\sqrt{n}}. \quad (9.2)$$

Calculation of the route efforts usually is done by minimizing two aspects, speed (time consumption) and costs, where most route planners use travel time as a target dimension and add the cost as an informational aspect. In our use case we decided to use travel time as a target dimension as well. This leads to the need to convert the penalty in time to have a value to minimize. Since we get penalty factors from the steps above, we can calculate a weighted travel time. Therefore, all time-consuming usages of transport vehicles are multiplied with the specific penalty factor for this user and vehicle and the usage of static infrastructure elements like stations is considered by adding a summand that is calculated by multiplying the penalty factor with a user-specific constant:

$$t_R = \sum_{x=1}^m t_{vx} + \sum_{x=1}^{\sigma} t_{sx}. \quad (9.3)$$

Equation 9.3 shows the calculation of time consumption for a route ( $t_R$ ) as a sum of time using  $m$  vehicles ( $t_{vx}$ ) and waiting/change vehicles at  $\sigma$  stations ( $t_{sx}$ ):

$$t_{uR} = \sum_{x=1}^m t_{vx} + \sum_{x=1}^{\sigma} t_{sx} + p_{ux} w_u. \quad (9.4)$$

Equation 9.4 shows the calculation of user-specific weighted time consumptions ( $t_{uR}$ ) using calculated penalties ( $p_{ux}$ ) and personal (user specific) weight factor ( $w_u$ ). During route planning both have to be used since the planning of change vehicles has to be done with real travel time and not the weighted travel time.

### 9.6.3 Implementation

The shown approach needs one overlaid graph per user, which is not feasible, since the amount of data for the time table is very huge, thus a two-step solver that calculates a number of suitable routes using a general graph at first step and overlays only those routes with the penalty valid at planned travel time at second step was implanted. The separation of route planning and route evaluation allows implementation and execution for a wider user group.



### **9.6.4 Limitations**

By adding additional scales to route planning a user-specific graph can be generated that can be used to generate user-specific advice. By implementing mechanisms and technology to provide personalized support to the user during travel and travel planning, the utilization of public transport in general and for disabled people in special can be increased; allowing the latter to get more self-determination.

This approach may also help supporting elder people which will become important considering the demographic change and may be the next step towards so-called Smart Cities that provide smart and personalized services to inhabitants (Accenture: Building and Technical Report 2011; European Commission 2006).

Enhancing the current traffic data model with shown penalty mechanism is not enough since in today's travel planning graphs stations are represented by one or a few nodes connected by foot path links. Even if these inner station links are modelled using the penalty approach, the model is not accurate enough to do a proper travel planning for users with special characteristics and therefore special needs. Especially in big train stations the footpath or usage of local people transporter causes more facets that have to be taken into account. Therefore, a more detailed model also covering the local outline of the station and the local equipment like stairways, escalators, elevators, etc. was developed. The next part of this chapter shows the enhancements in the model to cover those aspects.

## **9.7 Navigation in Metro Stations**

As shown in the last paragraph, the level of detail in today's public transport travel planning applications is not high enough to cover all the aspects of using a station.

### **9.7.1 Challenges for Navigation**

Today passenger rail transport systems like tram, rapid transit system, metro and underground are designed in a way trains are barrier free and comfortable. Most trains can be accessed from the platform even with the ground. Also the access to online timetables via already established applications or the travel assistance shown in this chapter is easy and thus choosing the right departure, destination, transfer stations as well as the right track and platform, the right line and the correct train is easy and convenient. Due to the principle of layouting rail stations, in most case reaching the trains is complicated in practice. Usually platforms and transition zones can only be reached by level change via stairs, elevators and escalators.

Beside this today metro stations also fulfil additional functions of urban life. The station provides supply of everyday items to commuters, is the place to consume

stationary or carry out food or the ubiquitous coffee to go. As a result station layouts are very ramified and may change for construction sites, sales events or sales booths are redesigned structurally, so that self-navigation and self-orientation are made more difficult. All this makes navigation within the metro station complex. Especially for tourists, travellers on business and non-locals in general as well as disabled people crossing a station are a challenge.

As already shown in previous publications (Nemtanu et al. 2015) the utilisation of city's functions and the redesign of urban functions is a social task that is important during transformation of cities towards smart cities and keeping them liveable in future times.

### **9.7.2 Requirements**

The main requirement was integration of navigation functions in urban train stations in the basic travel planner developed in the project resp. to integrate them into the timetable information. Current timetable information systems are based on directed graph, in which the lines or their links between stations are represented by edges and the stations are represented as nodes. As described the project mobile data model follows the same approach overlaid and personalized by the penalty system.

Thus the fundamental requirements were identified:

- Identification of stations that are not suitable for transfer (e.g. impassable for wheelchairs or causing long distance walks with luggage.)
- Rating of the personal expense of navigation through a switch station for route planning in the network
- Identification of possible routes through the station and their evaluation regarding personal expenditure of time.

### **9.7.3 Linking Global and Local Navigation**

In order to integrate the local navigation as shown in the introduction in the global travel planner, a three-layer navigation methodology containing the following functional layers was developed; Fig. 9.11 shows an overview about the layers and the managed entities:

- Global Navigation Layer, based on the personalized timetable data (the current back-end solution developed in project mobile)
- Abstract Station Layer, providing interface data to global navigation, and link to
- Station Outline Layer, containing the outline data of the station to allow local navigation.

The **station outline layer** allows storing outline of stations and provides functions to navigate in this plan. These functions are used to navigate in open areas of stations in order to find the best way towards the given target. In order to simplify data acquisition from architectural outlines, the station outline layer provides a local 2D coordinate system using flatten measures.

The **global navigation layer** contains the described personalized graph (see above ‘travel planer’) using nodes, edges and their weight to provide timetable data and routes in real time. In this common model all stations are represented by nodes containing metadata and geographic coordinates to locate each station in a global context. Thus the navigation through a station is not covered by this graph, but roughly approximated by one weight value. In order to model this local navigation the routing graph is sliced in a way that each station is represented by several (entry) nodes representing the track resp. the stopping points of the trains.

To fill the gaps between these nodes an **abstract station layer** was developed. The core element of this layer is an entity called ‘area’. Each area represents a part of the station that is accessible without changing the level. A local outline related to a local coordinate system provided by the station outline layer is attached to each area. Those outlines include position of local beacons like RFID tags, detectable Text and Tags, WLAN-SSID and other detectable elements that help local navigation module to determine user’s position and direction. Local station manager can draw in temporary changes caused by constructions or sales booths.

The entrance and exit points of areas are modelled as global nodes with all attributes related to those nodes (e.g. global position, characteristics of usage). Those nodes may be the described stop points of trains or the passage to another area, e.g. stairs, elevators or escalators. Since this special nodes are also placed in the local outline of the containing area, local navigation between these points can be performed in the local coordinate system. In order to allow global navigation in other words provide routes through this special nodes and let the local navigation module know which are valid next node to navigate to, the nodes are linked by virtual edges. Depending on the stations characteristic and walk distance, these virtual edges have a weight and characteristics of usage like every link in the original models has. Thus the global routing can be performed on this new graph containing the original nodes and edges from the timetable graph and the special nodes and virtual edges from the local station outlines. During global navigation there is no difference between these elements. During the travel the travel agent provides not only the best possible routes but a range of valid routes. This is necessary to ensure that the local navigation app on the smartphone can offer meaningful navigation points even when the connection is lost. After all, the free movement within or between the levels of a station (areas) does not follow the predetermined edges, but the personal preferences of the human traveler..

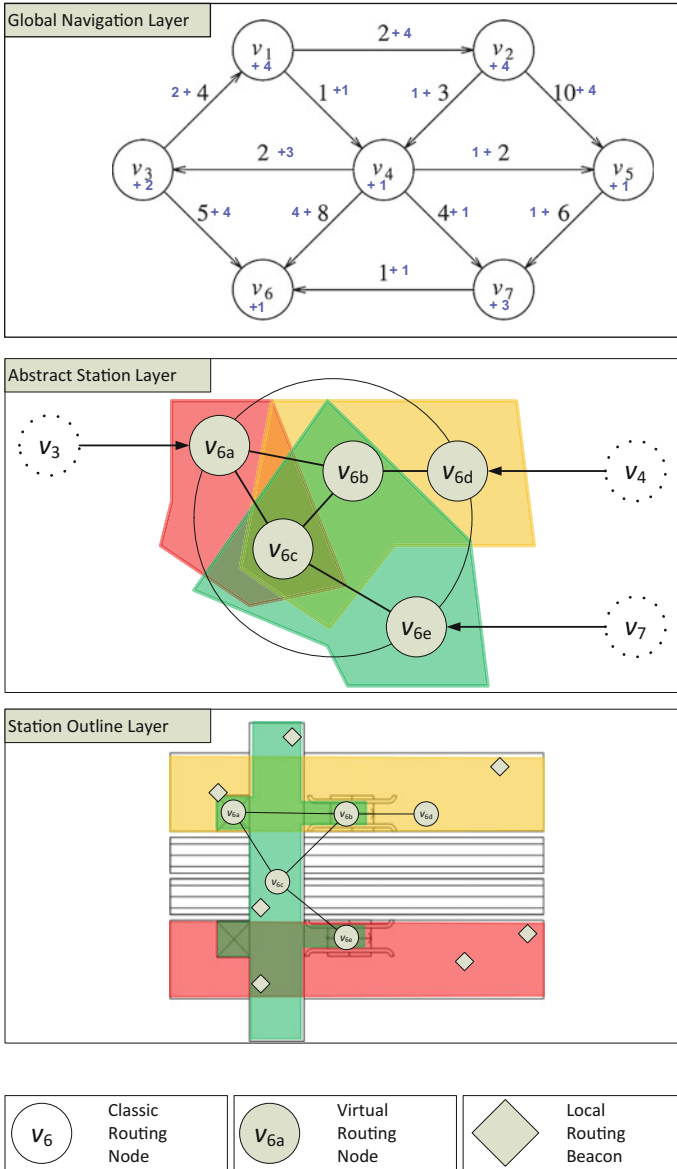


Fig. 9.11 Layers of navigation

## 9.8 Conclusion

The main requirement for a travel agent that provides assistance while routing and traveling by urban railway as well as providing support while changing trains resp. walking through train stations can be fulfilled by the shown system. Especially the main requirement of having only one integrated system giving advice in all situations during a travel can be fulfilled by the introduction of the intermediate layer (Abstract Station Layer) that allows defining entities that are bound to the two domains: local station environment and train timetable.

In conclusion this platform has the potential to be implemented and operational in the future. If it works as intended, it should open public transport to an entire new market and hopefully make a noticeable improvement to some passenger's quality of life and independence. Such use of modern technology to solve existing problems with public transport is highly efficient and allows changes for the better.

Since the development is completed by the end of the project 'mobile' in June 2016, the next step is roll-out the developed prototype to real life.

**Acknowledgements** The results presented in this paper came from the project 'mobile' sponsored by German Federal Ministry for Economic Affairs and Energy that aims to open public transport up to people who for whatever reason cannot currently utilize it. The project aims to create a technological platform which can assist members of the public in using public transport; particularly those who are mentally or physically impaired.

## References

- Accenture: Building and managing an intelligent city. Technical Report (2011), <http://www.accenture.com/SiteCollectionDocuments/PDF/Accenture-BuildingManaging-Intelligent-City.pdf>
- Bejuri WMYW, Saidin WMNWM, Mohamad MMB, Sapri M, Lim KS (2013) Ubiquitous positioning: integrated GPS/Wireless LAN positioning for wheelchair navigation system. In: Lecture notes in computer science, vol 7802, pp 394–403
- Chang N, Rashidzadeh R, Ahmadi M (2010) Robust indoor positioning using differential Wi-Fi access points. *IEEE Trans Consum Electron* 56(3):1860–1867
- Convention on the rights of persons with disabilities, United Nations, New York 2014
- Costa J (2014) Personas: putting the focus back on the user. *Des Res* 8
- Curran K, Furey E, Lunney T, Santos J, Woods D, Mc Caughey A (2011) An evaluation of Indoor location determination technologies. *J Locat Based Serv* 5(2):61–78. ISSN: 1748-9725. doi:10.1080/17489725.2011.562927 (Taylor & Francis)
- European Commission (2006) Communication from the commission to the council and the European parliament on thematic strategy on the urban environment. [http://ec.europa.eu/environment/urban/pdf/com\\_2005\\_0718\\_en.pdf](http://ec.europa.eu/environment/urban/pdf/com_2005_0718_en.pdf)
- Lahtela A, Hassinen M, Jylha V (2008) RFID and NFC in healthcare: safety of hospitals medication care. In: *Pervasive computing technologies for healthcare, 2008. PervasiveHealth 2008*. Second international conference, Jan 30 2008–Feb 1 2008, pp 241–244
- Linde H, Naroska E, Stromberg G, Sturm T (2004) TDOA localization of unsynchronized nodes. In: *Proceedings of the 13th IST mobile and wireless communications summit 2004*

- Linde H, Naroska E, Stromberg G (2005) Low cost resolution enhancement in hyperbolic localization. In: Proceedings of 2nd joint workshop on positioning, navigation and communication 2005 (WPNC'05) & 1st Ultra-Wideband Expert Talk (UET'05), March 2005, Hannover, Germany
- Marcus A, Davidzon G, Law D, Verma N, Fletcher R, Khan A, Sarmenta L (2009) Using NFC-enabled mobile phones for public health in developing countries. In: NFC'09 Proceedings of the 2009 first international workshop on near field communication, IEEE Computer Society Washington, DC, pp 30–35
- Mobil im Leben—Projektseite, <http://mobil-im-leben.org/>
- Nemtanu FC, Nemtanu MI, Schlingensiepen J (2015) The impact of corporate social responsibility on smart cities. In: Proceedings of European conference on business & management 2015 (EBMC15)
- Ressel C (2008) Modellbasierte Generierung von personalisierten und adaptiven Benutzungsschnittstellen für integrierte Wohnumgebungen. Josef Eul Verlag
- Ressel C, Ziegler J, Naroska E (2006) An approach towards personalized user interfaces for smart homes. 2nd IET International Conference on Intelligent Environments
- Small J, Schallau P, Brown K, Appleyard R (2005) Web accessibility for people with cognitive disabilities. In: Conference for human-computer interaction (CHI 2005), New York
- Stockmanns G, Koch F (2014) Gut versorgt bedeutet Lebensqualität für ALLE: Innovative Ansätze zur Versorgung von Menschen mit Einschränkungen. In: REHACare Congress Von Tür zu Tür—Föderrichtlinie, Bundesminister für Bildung und Forschung, 2011
- VRR—Zahlen und Daten <http://www.vrr.de/de/vrr/verbund/zahlen/>

# Chapter 10

## Innovation in Rail Freight and Interchanges (or How to Stop Rail Freight Hitting the Buffers)

Philip N. Mortimer and Raphael Kling-David

### 10.1 Introduction

Historically the term “innovation” with the actual meaning was used for the first time by Schumpeter at the first half of the twentieth century defining as product, process or organisational changes, stressing that they do not necessarily originate from new scientific discoveries (Schumpeter 1934). In modern society the need to “innovate” has become a routine common currency in numerous reports, studies, papers, policy statements, projects and reviews (EC 2013a, b, Van Binsbergen et al. 2013; Klitkou et al. 2013) focused on the future of the rail freight sector in Europe. Innovation appears to be offered as some sort of panacea and that by “being innovative” will somehow magically transform the capabilities and capacity of the rail freight system to become more attractive, more competent, more competitive and cost-effective. It will not! Innovation can take many forms including better use and management of existing resources, technology sets, systems and methods. “Better” has to be a measurable benefit in terms of enhanced operational and commercial performance, increased revenue and profitability, reduced cost and resource inputs, enhanced reliability, availability and responsiveness to users immediate and longer term requirements. It has to be measurable in terms of relevant KPIs and competitive measures. Gibbons et al. (1994) definition of innovation emphasised that the technology must satisfy the market needs.

---

P.N. Mortimer  
TruckTrain@ Developments Ltd., Bognor Regis, UK  
e-mail: pmtrucktrain@tiscali.co.uk

R. Kling-David (✉)  
Inno4less Ltd., Gateshead, UK  
e-mail: rap@lowc.eu

R. Kling-David  
Mechanical and Systems Engineering School, Newcastle University,  
Newcastle upon Tyne, UK

If quantifiable benefits cannot be derived from the innovation measures proposed or adopted, then they will count for little or be seen effectively as novelties with little chance of making any real and lasting market impact.

Innovation can and does take many forms. It can be incremental, with modest enhancements in technical, operational and commercial activities and this is the type of innovation which has generally typified the rail freight sector. It might simply include enhancing and integrating existing methods, systems and technology applications and ensuring they are applied in a more consistent or robust manner to that for which they were originally intended and bringing synergistic competitive advantages or it can induce breakthrough innovation, leading to disruption in the market. Considering the need to strengthen the competitiveness of the railways to improve their logistics performance, increase capacity and provide more reliable rail services the European Commission (EC 2013a, b) is tripling its financing for rail research and innovation from €155 million to €450 million (2014–2020).

The rail sector has benefitted from wider generic initiatives within the railway domain including modern track (cwr) and signalling systems (UIC 2016) and traction technologies although the true cost-effectiveness of these often remained opaque (EC 2001, 2004, 2007, 2013b) within the railway administrations when these new technology sets were implemented. Compared to the competing trucking sector rail has, however, routinely and regularly retained technology sets and assets well beyond their commercial and economic limits. Trucks, by comparison, are turned over in front-line service in 5–7 years and then replaced with new upgraded assets. Rail appears to be locked into the unquestioning retention of assets for 20+ years with the obvious negative implications on operational suitability and commercial relevance to evolving freight transport requirements. Road freight technical development has consistently been a major driver in terms of increasing the weight and volume capabilities of trucks and trailers and their increased levels of sophistication. Rail has not responded partially because of complex and time consuming hierarchical certification and inter-operability rules but also because of an increasing level of risk aversion as the sector has moved from being state sponsored into a more commercially driven situation. Who now encourages, sponsors and supports innovation at a generic and detailed level within the rail sector is unclear. One of the negative consequences of the longer life cycle of railway rolling stock is the time taken for the implementation of the technology. A locomotive for example, with a useful life of 30 years will have to compete along its useful life with several versions of truck technologies which will have been improved with lower operational costs and emissions of carbon and other gaseous emissions. This long life discourages technological development on the part of manufacturers concerned about the return of investment in the development of technology and partly harms operators. The Rail Research UK Association workshop (RRUKA 2012) looking at the train design and specification for reduced whole life system cost considered the economies of scale and also addressed some of the obsolescence strategies.



Generic innovation can and should be disruptive in terms of the impact of a particular concept, initiative or adoption of new technologies and operating regimes. By the same token the adoption of new technology sets (e.g. new traction technologies) or management methods may catalyse further initiatives leading to the attainment of much higher levels of reliability, capability and availability for enhanced service delivery and revenue generation on a lowered cost base not previously deemed feasible. The key is to identify the impact of innovative initiatives and to secure their fullest exploitation to commercial and competitive success in a recognised and identified market sector or sectors. Of equal if not more importance is the need to assess the impact of innovative measures being considered or developed on the shippers and wider cargo interests including current non-users of rail freight services. Rail also has to abandon the “not invented here” constraint and to seek cues and options in terms of innovative systems, operational methods and technologies from other sectors and domains where these can be productively deployed. The slavish retention of existing technical, commercial, operational and management models is unlikely to allow the sector to successfully re-position itself and to compete head on with competent, aggressive and near universal road transport services.

## 10.2 Innovation within the Rail Freight Sector

This section sets the scene for the development of a broad strategy for innovation within the rail freight sector. This strategy should simultaneously include commercial/economic, technical, operational and managerial aspects of innovation and not be a series of disparate random shots in the dark in the vague hope that something positive might be achieved.

The integration of innovation as an integral component of management activity and focus is essential. It is not an optional binary function. It needs to be continuous, active, commercially focused and not an exercise in purely technically led activities. The rail sector is littered with far too many false starts surrounded with triumphalism that have yielded little. Innovation and its application need to be an integral part of a wider and credible commercial strategy including much more in the way of contact with the market about its current, medium- and long-term requirements of transport service providers. Ferreira and Sigut's (1995) paper described a model using discrete-event simulation in intermodal freight terminal comparing the performance of conventional intermodal terminals with Road-Railer terminals.

The rail sector cannot continue to support a supply-side position with a “take it or leave it” attitude to shippers and their requirements. To maintain this would be an arrogant and ultimately untenable approach to new and developing markets for rail freight transport services. Unfortunately, this has been the stance the rail freight sector has assumed in Europe by indifference or design and paid the price in terms of the loss of market share (ECA 2016) to more flexible, cost-effective and agile

competing modes. An ORR survey (2010) looking at the main barriers to using rail for domestic movements identified a strong relation between the modal decision and access to the rail network as can be seen in Table 10.1.

Rail has lost its contact with the growing and demanding markets for high-value time-sensitive products and commodities and preferred to support the movement of

**Table 10.1** Barriers to using rail for domestic movements

	%
<i>Overall</i>	
Access to the rail network	71
Total costs	69
Route availability	55
Availability of suitable rail equipment (e.g. wagons)	51
<i>Producers</i>	
Access to rail network	78
Total Costs	67
Availability of suitable rail equipment	50
<i>Logistics company</i>	
Total costs	69
Route availability	69
Access to rail network	63
<i>Port/Rail terminal operators</i>	
Total costs	71
Access to the rail network	71
Route availability	65
<i>Users</i>	
Total costs	71
Access to rail network	67
Route availability	52
<i>Non-users</i>	
Access to rail network	89
Availability of suitable rail equipment	78
Route availability	67
<i>Bulk</i>	
Total costs	60
Access to the rail network	60
Availability of suitable rail equipment (e.g. wagons)	40
<i>Non bulk</i>	
Access to the rail network	79
Route availability	79
Total costs	68
Location of logistic hubs	68

Multiple response—respondents could provide more than one answer—totals sum to more than 100

low-value bulk commodities in the naïve belief that this is something “it does best”. Wrong! The abrupt and precipitate loss of major market volumes, particularly coal, in response to climate change and carbon emissions concerns and legislative restrictions, exposed the weaknesses in rail’s strategic positioning and excessive reliance on high-volume commodity flows which have now been dramatically cut back. This over dependence has ripped away significant levels of traffic volume and revenue leaving rail poorly positioned to approach and attract other traffic governed by wholly different imperatives. It faces strong competition from very competent, aggressive and near universal road transport. Road vehicles have become progressively larger and more sophisticated in response to shipper’s needs, which were recognised and responded to quickly. Rail failed to follow this path, yet its inherent characteristics should have allowed it to respond adequately and compete by exploiting speed, volume, weight and energy efficiency endowments. In addition, rail cannot rely on the discomfiture of its primary competition in the form of restricted driver hours, driver shortages, fuel cost escalation and increasingly constrained access to cities to gain markets.

Rail has also systematically failed to convert its inherent and much vaunted endowments in terms of energy efficiency, speed, weight and volume capabilities within a controlled and secure operating environment to commercial success and market share gains. Rail has surrendered traffic in the face of competition such that it is deemed or deems itself to be uncompetitive particularly over short and medium distance sectors. Whilst some of this traffic loss has resulted from rapidly changing geographical and commercial location options and the massive development of government-sponsored road infrastructure rail has not responded by seeking to exploit its inherent advantages. This has been a strategic weakness. It has not fundamentally addressed its high-cost base and low asset productivity and the need to move significantly from these weak positions.

What rail freight needs to address are issues focused on the development of attractive and competitive service offers to a much wider range of shippers and cargo interests. Rail has shied away from the complexities and demands of the high-value time-sensitive logistics sector because it was unable or unwilling to design and deliver the sort of products and services shippers demand. Shippers have used road transport because rail largely failed to adapt and to innovate to succeed within this market segment, which is driven by continuing pressures on cost, performance and relevant and appropriate products. 24/7 capabilities are an essential requirement for domestic and international traffic and have been accommodated by road transport but these imperatives have not been fully recognised or reflected within the rail freight sector.

Shippers now demand unfailingly high levels of reliability and consistency linked to the delivery of attractive services and products on a cost base that has to be competitive with road transport on a relevant KPI (e.g. cost per pallet delivered). This has to be supported by transit security and tracking (from the point of loading to the end delivery point). Shippers and receivers need to know with certainty where their cargo is and its planned arrival time. Any delays or disruption need to be advised to the relevant parties such that any terminal and final delivery activities can

be modified and updated. Disruption response is something rail has been poor at yet it operates within highly controlled information-rich environment. It needs competent and interventionist management to support 24/7 operations, rapid responses to cargo enquiries and offers linked to asset management and status systems. These are basic requirements, yet rail has largely failed to move towards them on a systematic basis.

The innovation focus must be driven by the constant and forensic monitoring and recognition of shipper's operational and commercial needs and requirements in the short, medium and long term. These will include hardware, software and management disciplines. There will be a need for the adoption of a continuous process of product and service development to support strategic and customer-specific traffic applications as an integral component of rail freight management. This also needs to be supported by the development and maintenance of much more focused and well-founded continuous active traffic solicitation to secure and retain business.

E-freight project (2011) propose a multimodal National Single Window (NSW) that provides a common interface for all regulatory information in a standardised format and an information exchange framework to sharing of information between the stakeholders (BESTFACT 2015). This sort of initiative should assist in rail becoming perceived as a more user-friendly option.

Rail faces competition within its own domain in terms of priorities for appropriate train paths, schedules and routes. The retention and advocacy of larger freight trains compounds these problems given the huge differentiation in power-to-weight ratios, acceleration and braking and need for appropriate passing loops if the big train model is retained and reinforced. This is not a credible option for widespread adoption and deployment. For the evolving time-sensitive high-value freight market, trains with wholly different characteristics and configurations will be needed. Regular unfailingly reliable replenishment is required rather than irregular large deliveries. This fundamental point seems to have completely escaped railway administrations.

At a generic level it needs to be looking at a rail equivalent of the near universal tri-axle semi-trailer for unitised traffic applications where an intermodal option is a real and credible option. The tri-axle semi-trailer is often the preferred or mandated module of choice for shippers for domestic and international traffic within Europe so rail needs to match this either in the form of adequate container sizes or the ability to transport trailers between terminals without compromising the trailer size and the available railway infrastructure. This would perforce need to link to the movement of such modules through terminals to minimise handling time and cost to maintain competitiveness with mono-modal road freight. Terminal operations need to be seamless with train to truck movements and vice versa reflecting shipper's priorities rather than the train operator's preference. The focus needs to be on transport and not trains per se.

For cargo which does not lend itself for commercial, technical and operational reasons to the use of intermodal technologies, the use of smart hi-cube rail vehicles optimised to accommodate pallets, roll cages or stillages could be a fruitful option.

These would need to be actively managed for example on point to point and hub and spoke applications to maximise their revenue earning potential. The operation of such hi-cube vehicles possibly on a push-pull basis perhaps in shorter formations (8–10 vehicles plus traction) at passenger train speeds for high-value time-sensitive traffic between highly automated terminals could potentially be a very competitive option. The key to this option is to maintain the “churn rate” of the assets with minimal unproductive time or application into revenue earning service.

Going beyond this into purpose built short, fast, self-propelled bidirectional trains for unitised cargo (containers and swap bodies) or configured for high-value logistics traffic may point the way to securing a major share of business governed by demanding imperatives beyond the capabilities of conventional train technologies and their application. Rail cannot realistically continue to promote the retention of technical, commercial and operational models which have limited application or minimal relevance to markets.

The rail freight sector may also have to consider innovative means of developing direct rail access for unitised and wagon-based traffic and commodities to replace or reactivate infrastructure which has been deleted or abandoned. The complexities of electrical power supplies and signalling systems currently make splicing into these very expensive, disruptive and time consuming which could prevent rail from capitalising on new traffic opportunities. The development of a flexible “tool box” of components able to facilitate access to new sidings and spurs without compromising the operation of trains on the main line could underpin this concept and give rail a huge advantage in terms of accessing cities increasingly bereft of rail freight facilities.

The concept could also be used to allow new and simple logistics terminals and facilities to be rail linked on a more cost-effective basis thereby allowing rail into active traffic participation and competition. Many new logistics sites have been developed and continue to be developed without a rail link on the basis of cost and implied complexity. If rail is to offset the huge losses it has sustained as coal traffic has fallen away, then it needs to access growing markets on an innovative cost-effective and efficient basis.

## 10.3 Case Studies

### 10.3.1 *TruckTrain*®

The availability of statistics portraying the steady erosion of rail’s market share in terms of originating tonnage, tonne/km (production and revenue in national and the pan-European market), provided the catalyst to consider what alternative technical, commercial, operational and managerial models the rail sector would need to develop if it was to arrest and reverse the decline in market relevance and also to address the needs of evolving markets at a national and international level within

Europe. The cost base of existing train services and competing road transport was examined to identify the scale of the underlying negative difference and how this might be addressed in terms of a different train size, configuration and productivity capability. Where large and consistent flows of cargo are required to be routinely operated then the present train technology, operational and commercial models may be entirely adequate to fulfil shippers' requirements. Even here road transport can be and is a competitive option and rail cannot rest on its laurels on the assumption that this type of traffic will always remain within its gift. Increasingly rail will need to secure and retain market share on merit including reliability, consistency in service, cost competitiveness and appropriate products and services, which endow measurable benefits and advantages to shippers. To achieve this and to secure a relevant long-term market position rail needed to bring down its production costs to levels comparable to inter-urban road freight and to drive up asset productivity and utilisation by factor and not modest incremental levels as can be seen in Fig. 10.1.

For the growing market in inter-urban freight and logistics, rail's existing product and service offers were quickly identified as being largely irrelevant or non-competitive for segments of the market driven by wholly different and more demanding imperatives than rail was able to provide. In effect rail had to reinvent a commercial, technical, operational and managerial model which was able to provide and sustain a rail/intermodal option that was attractive, competitive and relevant to shippers. The key to securing this ambitious target was to drive up rail asset productivity and revenue earning time through much more intensive service application and minimal down time for servicing and maintenance. Locomotive



**Fig. 10.1** TruckTrain® concept vehicle



**Fig. 10.2** IRIS project proof of concept trial at barking terminal

hailed trains for shorter formations (<10 wagons) were identified in an economic analysis as *not* being a cost-effective option.

For shippers and cargo interests, shorter trains supporting regular and routine replenishment rather than large and intermittent deliveries were identified as the basis for a credible response. Deleting the locomotive became the obvious corollary with train formations being self-propelled, bidirectional and capable of speeds to allow operation within fast moving streams of passenger trains without inflicting delay on any following traffic. Figure 10.2 illustrates the rapid turnaround in terminals (<60 min from arrival to departure) that was proved to be feasible under a series of trials under an EU sponsored project (IRIS 2001).

High daily mileage and minimal down time for servicing and any re-fuelling through the use of innovative rail measures widely adopted and routinely used in the aviation and trucking sectors is a requirement backed up by remote condition monitoring of the train's technical and commercial vital signs. The train becomes effectively "self-aware" leading to greater levels of availability, revenue generating time, and achieves parity with road transport through this enhanced mix of capabilities and competence. The trains would make maximum use of existing certificated components but also introduce high levels of innovation in relation to main structural components, running gear and support systems. This type of train is not designed to displace conventional locomotive hauled trains where these are appropriate, cost-effective and attractive to certain categories of user. For traffic operated under much tighter imperatives in relation to unfailingly high routine levels of service, the use of the short fixed formation train concept endowed with high power and speed capability together with bidirectional performance emerged as a credible option for development.



**Fig. 10.3** IRIS proof of concept trial train in transit from Birmingham to Southampton

Demonstration trials, as can be seen in Fig. 10.3, were undertaken as a proof of concept in the UK as part of an EU-funded project (IRIS 2001) using modified track maintenance vehicles and container wagons. This was successful and had the added advantage of pointing out key technical, operational and engineering issues which would need to be addressed for a purpose built train. Ongoing work to validate the concept and examine in detail requirements in terms of design, materials, engineering certification, component integration as well as specialised studies into ride and suspension have all been undertaken to the point where these are well understood. The core design lends itself to use in domestic applications in Europe for unitised cargo and in a modified configuration for palletised traffic with both designed to operate at high levels of productivity and reliability.

Further work on means of identifying train paths at short notice within national and international systems is a current focus of attention together with simulation activities to enhance the train–terminal–truck–shipper/receiver interfaces and the ability to respond in the event of delay and disruption.

### **10.3.2 *TopHat*®**

This is a wholly separate project designed to make rail a more attractive option for the intermodal movement of tri-axle semi-trailers and to secure the modal shift option set out in the EU White paper of 2011 (EC 2011). Road transport dominates domestic national and international/cross-border traffic within Continental Europe. It has achieved this on the basis of agility, responsiveness, flexibility, availability on



a near universal basis as well as cost-effectiveness. It has completely outperformed rail particularly in the growing high-value time-sensitive market segments which rail has been unwilling or unable to retain and develop. Road transport's success has come at the expense of emissions, congestion, high levels of accident involvement and attrition of urban and rural landscapes. It is still almost exclusively dependent on relatively cheap and available liquid hydrocarbon fuels. The external costs to society flowing from this are high but they are not reflected in the cost base of the sector or in pricing offers to the market largely driven by bottom-line considerations as the key requirement.

Of the ~800,000+ trailers in operation in Europe only a small proportion (~5%) are rail capable. These rely on the use of a grapple arm system to lift trailers complete with road wheels on/off trains. The cycle time using this equipment is longer than that for a comparable container and requires additional terminal manpower to execute the transfer. The grapple arm system for lifting the trailers can and does inflict damage to trailers and the cargo contents resulting in large claims and also the loss of earning time whilst trailers are under inspection and repair. Recently developed sling systems allow the use of un-modified semi-trailers to be lifted on/off trains but the cycle time is slower than the grapple arm and requires more manpower to affect the transfer.

Whilst containers have been strongly advocated as the intermodal solution in Europe, they have not found the wide levels of acceptance or routine use for domestic and intra-European traffic their advocates had hoped for. This partially reflects the rapidly evolving capabilities, sophistication and capacity of semi-trailers and the hugely expanded road/motorway infrastructure where they have been widely deployed to capture traffic rail appeared unwilling or unable to compete for. Containers require chassis pools at the loading and arrival terminals. Deep-sea shipping containers are limited in internal volume compared to tri-axle semi-trailers. The use of a larger module (45' long × 9'6") European dimensioned container partially offsets this limitation but for traffic mandated to move in trailers are not relevant.

For cargo interests, forwarders, shippers and hauliers involved with high-value time-sensitive traffic and commodities, the use of tri-axle semi-trailers as an industry workhorse is nearly universal. Much of this traffic is beyond the reach of existing rail services and operations on technical, operational and commercial grounds. If rail is to secure the level of traffic the 2011 White Paper (EC 2011) aspires to then it has to compete for traffic that at present is road-borne and secure it on merit. Rail cannot rely on the discomfiture of road transport through issues such as congestion, driver skill shortages, increasing constraints on access to cities and enforced compliance on emissions. To break this deadlock the ability to move full-sized semi-trailers much more readily between road and rail modes is essential. The present technology to transfer trailers poses real limitations on the likely level of take up.

The notion of using a top-lifting solution emerged from various projects and studies as a credible option and after consultation with equipment manufacturers including trailer builders, lifting equipment manufacturers and European rail vehicle owners/lessors. In addition, contact was established with shippers, forwarders and hauliers to gauge their response to the concept and to identify what advantages it confer. Various EU/EC sponsored intermodal projects (SAIL 2002) seeking to develop integrated corridors for the movement of cargo across borders in Europe were used to identify major potential traffic and commodity flows where top-lifting tri-axle semi-trailers could be deployed to positive effect.

The key identified gains come from the ability to use semi-trailers as a more versatile cargo module in both all-road and rail/intermodal applications. Terminals will be able to use existing container (ISO) lifting equipment and dispense with the need for incremental equipment required for grapple arm lifting. Trailers will be able to be operated much more freely and effectively on mixed configuration trains including containers, swap bodies and trailers. The top-lifting trailer, as can be seen in Fig. 10.4, provides an intermodal option for hauliers at a very modest capital cost at the time of manufacture. Rail benefits by being able to participate in traffic flows for which, at present, it has no realistic product or service capability. The top-lifting trailer acts as a catalyst to secure positive modal shift to rail and to secure wider energy efficiency, economic and environmental gains. It is an example of incremental innovation that potentially yields much more.



**Fig. 10.4** Mock-up of a full-sized top-lifting tri-axle semi-trailer using 40' ISO lifting points

## 10.4 Rail Freight Terminals and Strategic Rail Freight Interchanges

Rail freight terminals play a crucial role in the rail system concentrating flows and optimising the rail operation throughout the network, and therefore they need to be efficiently managed to reduce unnecessary cost and minimise potential delays in the daily service provided by the freight trains. According to Bontekoning and Priemus (2004), in Europe, shunting operations in conventional terminals take 10–50% of the total train transit time. Crainic and Laporte (1997) argue that the freight wagons spent most of their lifetime in rail freight terminals. The impact of freight shunting operations on yard performance has been studied in detail by Marinov and Viegas (2009) who used mesoscopic simulation modelling methodology which was implemented using SIMUL 8 computer package. A similar methodology has been developed and implemented in order to understand freight train performance in a railway network (Marinov and Viegas 2011). Scheduled vs unscheduled operations have been studied in particular. The simulation models confirmed that the impacts of the unstructured operation (unscheduled) are significant higher in the rail yards, suggesting that scheduled operations have a positive impact in the rail efficiency.

Due to changes in operating patterns and in the international freight market the requirements of the clients and yard activities indicate needs and demands for new terminal concept. The land-terminal concepts have been previously proposed in the literature (Frémont and Franc 2010; Woxenius and Bergqvist 2011); however, the strategic rail freight interchanges concept (SRFI) introduces new features and services, working as a multi-purpose structure; the SRFI not only operate as the previous land-terminals providing the link between rail/road, but also offering additional service (e.g. warehousing, monitoring, container handling facilities, manufacturing and processing activities). The BILK intermodal terminal in Budapest is an excellent example of closely located cargo-related terminal functions.

DfT (2011) point out that the main advantages of the SRFI are the potential reduction in road congestion and carbon emissions, contributing to a greener transport system. Also it was pointed out that the SRFI enable more efficient rail freight logistics supporting economic growth and employment generation. The Strategic Rail Authority (SRA 2004) suggests a likely size of and requirements of different interchanges (Table 10.2 adapted from SRA 2004).

Significantly, the SRA categories omitted the option of small austere terminals for intermodal exchanges between road and rail with a minimal level of provision and possibly using trailer mounted cranes for lifting and delivery/collection services between train-related activities.

**Table 10.2** Rail freight interchanges requirements

Type of RFI	Function	Likely size	Transport requirements
Strategic	Major interchange with significant intermodal warehousing, located at nationally strategic sites proximate to major conurbations	100–400 Ha	Requires high-quality links to motorway and trunk road network. Rail links need high capacity and good loading gauge
Non-strategic subregional	Large interchange with significant intermodal and warehousing, located at important sites within regions	20–250 Ha	Requires high-quality links to motorway and trunk road network. Rail links need sufficient capacity and good loading gauge
Intermodal only	Interchange handling only intermodal traffic, often located at key points in urban areas	10–30 Ha	Requires good links to urban road and trunk road network. Rail links require sufficient loading gauge
Rail linked warehouse	Single warehouse unit providing rail services	10–30 Ha	Requires good links to urban road and trunk road network
Bulk terminal	Bespoke terminal for single bulk product types such as aggregates and minerals often linked to a manufacturing or processing facility. Also includes car automotive terminals and waste terminals	5–10Ha	Road and rail links need to be appropriate to bulk commodity often heavy loads. Aggregates and minerals terminals often require urban location to serve construction industries and road maintenance

## 10.5 Reshaping the Network for High Value: UK Study

The changes observed in the global market for freight suggest that there is a need to redesign the rail freight operating model. The conventional rail cargo is declining in most European countries and the railways are struggling to compete with the road in the time-sensitive market. Therefore, significant changes are required to satisfy the customer requirements, specifically for finished and semi-finished products.

Solutions for seamless intermodal logistics are crucial to improving the rail competitiveness. The Innovation towards new logistics' models include accessible and fast trans-shipments, new vehicle designs and materials and new business models. The focus of the solution presented in this section is on terminal operation and technologies looking at the British railway system. However, the same methodology can be applied to other rail networks around Europe.

We first analyse the commodity trend to understand the changes in the rail freight market. According to ORR (2016) the total of freight lifted fell from 110.5 million tonnes in 2014–15 to 86.0 million tonnes in 2015–16. The decline of the freight transported has been influenced by the massive and precipitated decrease of

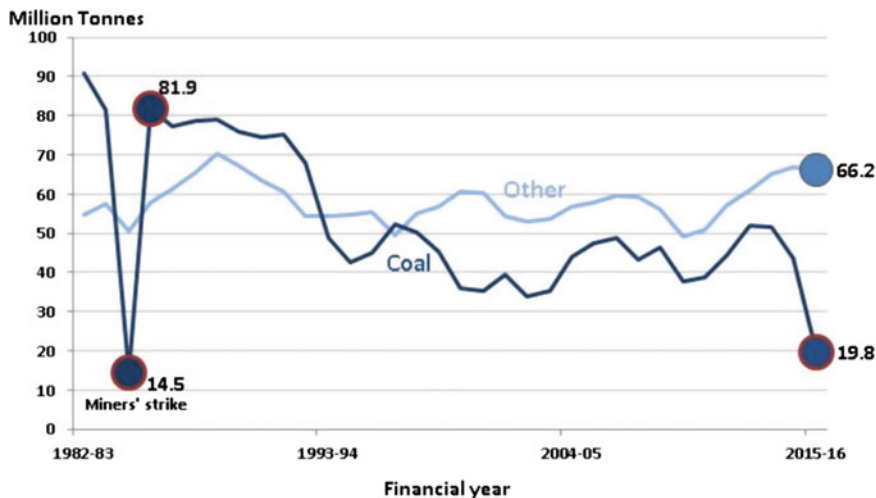


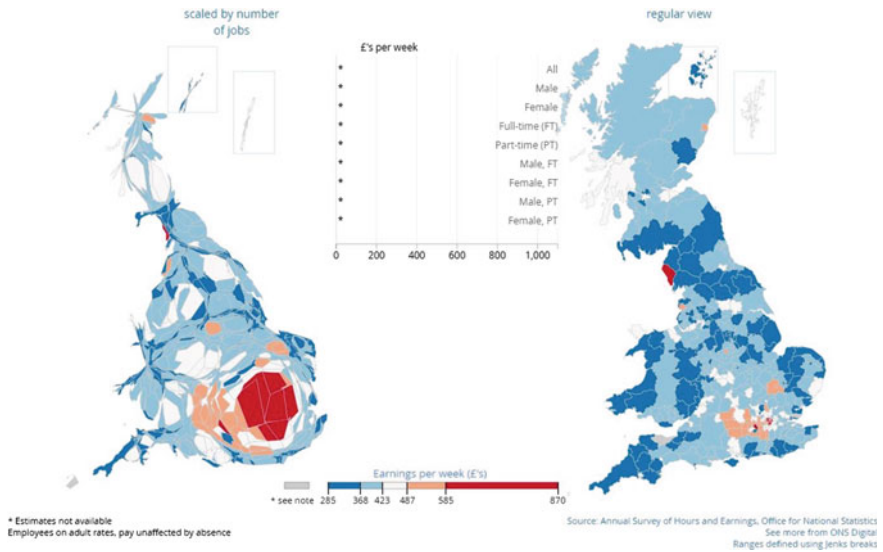
Fig. 10.5 The decline of coal transport in UK (ORR 2016)

coal (54.6%) in comparison with the previous years. Figure 10.5 illustrates the decline of coal.

Several transport forecasts (NetworkRail 2010; ORR 2010; DfT 2016; Kent Council 2005; NetworkRail 2007) indicate a decline in coal tonnage per annum as a result of the reducing demand of coal and the changes in freight charges for coal access. The Intermodal flows are now critical to ensure the future growth of rail freight. Considering the trends clearly showing the decline of coal by rail then the network could potentially be used to transport general cargo where this is commercially attractive to shippers. The existing coal terminals land-related large facilities could be redesigned as a Hub for the concentration of intermodal flows.

Figure 10.6 shows the economic power of the London region suggesting that the Kingsbury (London) and Peterborough coal terminals for example could be reshaped to receive a high number of incoming freight services. Redundant coal sites could be identified to assume a similar role as well (Fig. 10.7).

The 2007 Freight Route Utilisation Strategy (NetworkRail 2007) estimated the transport demand for 2014–15 and the impacts of the new London Gateway port analysing the effect on traffic from the Felixstowe and Harwich Bath side Bay. According to the rail usage of the lines, the number of trains moved daily suggests that there is an operational viability of an increased number of trains without affecting the current efficiency of the service. The container terminal using state of the art on terminal operations include automatic transshipment and high-efficiency cranes within transit scanning devices. The Noel Megahub terminal (Fig. 10.8), for instance, operates by using six parallel rail tracks and a large number of adjacent cranes, each covering terminal function (Terminet 2000). This technology is substitute for conventional shunting yards and intermodal transport as it reduces trans-shipment costs.



**Fig. 10.6** Economic power of the regions based on the employment survey

A design for a fast transshipment small terminal is suggested for intermediate points in order to improve the capacity and minimise investments. David and Marinov (2016) introduce a low-cost road–rail interchange design in order to meet the shippers’ requirements. The paper examines the potential of merging container flows to improve efficiency according to the physical internet concept (Montreuil et al. 2012.) The low-cost trans-shipment equipments are positioned over two lines and the semi-trailers and containers are positioned alongside the wagons. Figure 10.9 illustrates a small interchange yard concept. The key advantages of the design proposed are the fast trans-shipment and non-intensive area usage enabling efficient and cost-effective service to shippers backed up by security and good disruption response.

Considering the costs of new infrastructure previous studies confirmed the effectiveness of upgrade the existing system. Abbott and Marinov (2015) discuss the challenges and strategies for rail interchanges creation by redesigning the current railway infrastructure to enable the interchange of rolling stock between a conventional line and high-speed line. The study found that there is a cost saving from delaying the purchase of high-speed trains and the increased functionality of the rail network, despite the high capital cost of the rail yards.

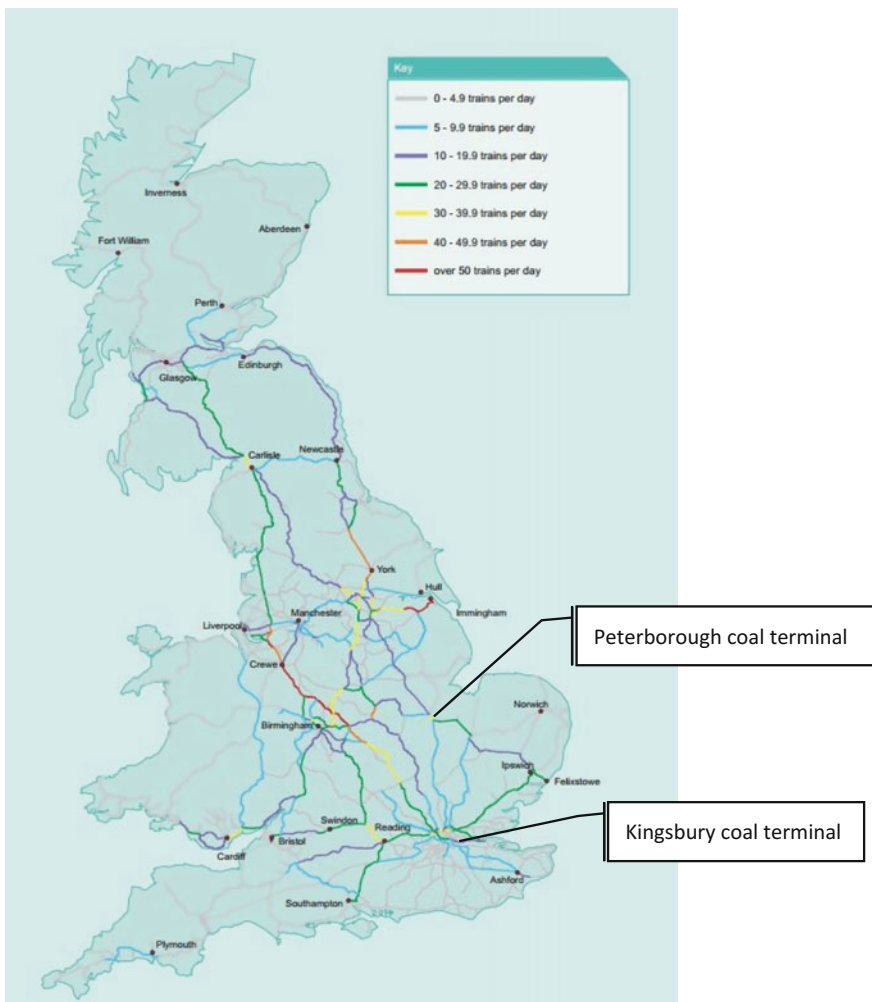


Fig. 10.7 Network rail freight route utilisation strategy (2007)

### 10.6 Potential Impact Analysis

For analysing the potential impacts of progressive growth of the container flows into the network, it is important to consider the infrastructure capacity and containers characteristics. Containers have standardised sizes 2500 mm (2600 mm refrigerated containers). Although the heights vary considerably, the most common are 9' or 9'6", which require the usage of lower deck wagons due restriction imposed by British tunnels and platforms. Typically, 9'6" × 2500 mm loads are referred to as gauge W10 and 9'6" × 2600 mm as gauge W12 (RSSB 2013).

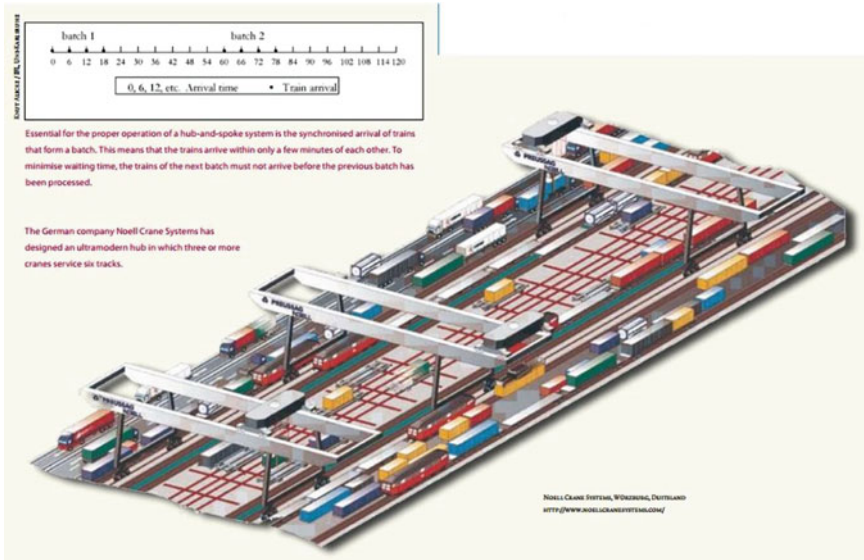


Fig. 10.8 The Noel Megahub (Terminet 2000)

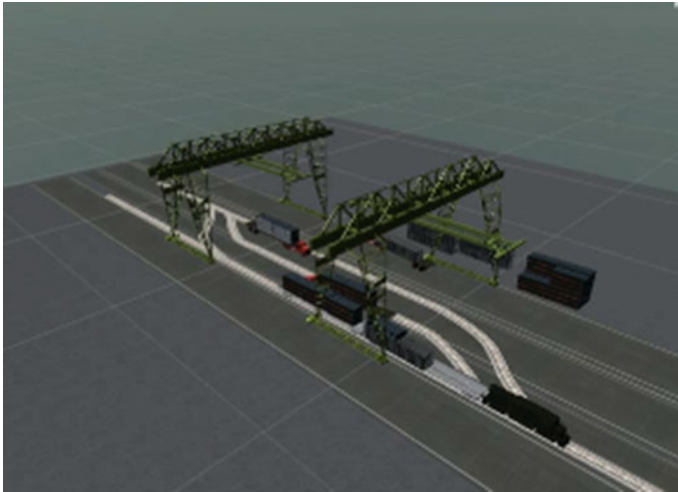


Fig. 10.9 Fast interchange proposed for physical internet operation

Despite the gauge constrain in terms of connectivity the British rail infrastructure is well connected covering the most important cities. The train utilisation in Great Britain, however, is still 20–25% lower than the median performers amongst four European comparators (McNulty 2011) suggesting that improvements are required in order to archive a significant economic benefit with the modal shift.



**Table 10.3** Potential benefit impacts of intermodal flow growth

Growth projections 2030	Tonnes lifted—low constrained forecast	Tonnes lifted—medium constrained forecast	Tonnes lifted—high constrained forecast	Tonnes lifted—FMS forecast unconstrained
Ports intermodal (deep-sea containers arriving in the UK via ports)	22	31.81	45.69	41.76
Productivity benefits (billion pounds/year)	£ 0.48	£ 0.69	£ 0.99	£ 0.91
Road externalities (billion pounds/year)	£ 1.05	£ 1.52	£ 2.19	£ 2.00
<b>Total gains (billion pounds/year)</b>	<b>£ 1.53</b>	<b>£ 2.21</b>	<b>£ 3.18</b>	<b>£ 2.91</b>

In comparison with the rail transport, the Eddington Report (2006) estimated that road congestion reduces the British GDP by between £7bn and £8bn per annum. According to Rail Delivery Group (2015) KPMG estimated in 2013 that rail freight delivers gains £1.6 billion per year (£1.1 in productivity benefits and 0.5 in road externalities reduction). Table 10.3 indicates the potential gains of Port intermodal flow forecasted for 2030 (ARUP 2016).

Considering the need for new interchanges, four strategic rail freight interchange projects have been proposed to the Planning Inspectorate and Executive Agency England and Wales.

### **10.6.1 East Midlands Gateway Rail Freight Interchange**

The Strategic Rail Freight Interchange environmental statement scoping report (Roxhill 2012) proposed to comply with The Infrastructure Planning Regulations 2009 (Environmental Impact Assessment 2009 Regulations) presents an intermodal freight infrastructure connecting the terminal to the Nottingham to Birmingham with focus on freight. With Up to 557,414 the East Midlands Gateway Rail Freight Interchange is designed to accommodating 12 to 16 trains up to 775 m long per day. A new rail line and new road infrastructure are widespread in three zones:

Zone A development area of 516,968 m<sup>2</sup> and between 7 and 17 warehousing units;

Zone B development area of 38,508 m<sup>2</sup> and between 1 and 2 warehousing units;

Zone C rail interchange area of 1,938 m<sup>2</sup> and between 2 and 4 warehousing units.

The contribution of the SRFI includes economic (subregional and regional) and social potential impact on the local labour with direct and indirect employment generation, commuting with road improvements, housing and public services;

The development has been granted beside controversy opinion of Castle Donington Parish Council (CDPC) that the DIRFT Stage III proposals for Daventry present 40% larger area potentially delivering the SRFI for the Midlands, more economically and quickly solution (Planning Inspectorate 2012).

### ***10.6.2 Northampton Gateway Rail Freight Interchange***

The Interchange for Northampton Gateway proposal submitted by Roxhill consists of an intermodal freight terminal with 468,000 m<sup>2</sup> of warehousing plus 155,000 m<sup>2</sup> additional floorspace in a mezzanine.

A new road infrastructure includes a bypass to the village of Roade and improvements to Junction 15 of the M1 (Northampton and South Northamptonshire district). The project is expected to be submitted to the Planning Inspectorate Q3/Q4 2017 due the conclusion of The Secretary of State that “the proposal has not indicated whether the proposed development is likely to have significant impacts on another European Economic Area (EEA) State” (The Planning Inspectorate 2016a).

### ***10.6.3 Rail Central Interchange***

Rail Central Interchange submitted by Ashfield Land Management is located in Northamptonshire (approximately 20 km northwest of Milton Keynes). With up to 8,000,000 sq ft (743,200 m<sup>2</sup>) of storage and distribution buildings, the SRFI includes a range of different buildings (service depot, HGV facilities, lorry park facility, hotel and restaurants). The scoping opinion (Planning Inspectorate 2016b) concludes that potential cumulative impacts need to be identified; therefore, the proposal is expected to be submitted to the Planning Inspectorate Summer 2017.

### ***10.6.4 West Midlands Interchange***

Four Ashes Ltd proposal (Ramboll Environ 2016) for the West Midlands Interchange includes the rail freight terminal with container storage, connections to the West Coast Main Line (WCML), and Heavy Goods Vehicle parking. The 800,000 m<sup>2</sup> of warehousing, ancillary service buildings and Parking will be rail



**Fig. 10.10** West Midlands interchange (East terminal option)

served to receive up to 10 trains per day within 795 m reception sidings handling up to 775 m train length maximising train efficiency.

Two layout options were presented for interchange in W10 gauge (West Terminal Option and the East Terminal Option illustrated in Fig. 10.10) with access to the main line from both directions.

Geographically, the West Midlands interchange is located at Staffordshire, approximately 10 km to the north of Wolverhampton, immediately to the west of Junction 12 of the M6. Due to further clarifications required by The Planning Inspectorate (2016c) the project is expected to be submitted to the Planning Inspectorate Q3 2017.

## 10.7 Conclusion

Significant social and economic impact can be achieved by significantly increasing the performance of the railway. Improvements on the links and terminals such as East Midlands Gateway Rail Freight Interchange, estimated in over £300 million, are economically viable considering the return of the investment contributing to logistics cost reductions. The existing network and actual terminals also present an

opportunity for redesign of the rail infrastructure, increasing rail freight volumes and by helping the Government to achieve a significant reduction in road congestion and carbon emissions.

The introduction of innovative rail technologies in terminal services has a positive impact on the modal shift from road to rail, attracting more demand and potentially reducing operational costs and carbon emissions. Innovation has to be an integral component of rail systems' management and be commercially focused. It cannot be treated as an option extra/nice to have component.

The rail freight sector has strong endowments in terms of energy efficiency, speed, operation with a controlled environment, security and safety. It needs to exploit these in new ways to regain access to markets currently dominated by road transport. If it is to do this, it cannot maintain the existing technical, operational and commercial models in the vague hope or aspiration that these will be attractive. More of the same is not a tenable option.

## References

- Abbott D, Marinov M (2015) An event based simulation model to evaluate the design of a rail interchange yard, which provides service to high speed and conventional railways. *Simul Model Pract Theory* 52:15–39
- ARUP for DfT (2016) Future potential for modal shift in the UK rail freight market. [www.arup.com/railfreightmarket](http://www.arup.com/railfreightmarket)
- BESTFACT (2015) Best practice handbook. [http://www.bestfact.net/wp-content/uploads/2016/01/BESTFACT\\_D24\\_BPH\\_final.pdf](http://www.bestfact.net/wp-content/uploads/2016/01/BESTFACT_D24_BPH_final.pdf)
- Bontekoning Y, Priemus H (2004) Breakthrough innovations in intermodal freight transport. *Trans Plan Technol* 27(5):335–345. doi:10.1080/0308106042000273031
- Crainic T, Lapore G (1997) Planning models for freight transportation-. *Eur J Oper Res* 97: 409–438
- David R, Marinov M (2016) Physical internet concept for designing the rail freight interchange of the future. In: 11th world congress on railway research WCRR 2016. Milan, Italy
- DfT (2011) Strategic rail freight interchange policy guidance, department for transport, London. [https://www.gov.uk/government/uploads/system/uploads/attachment\\_data/file/4377/strategic-rail-freight-interchange.pdf](https://www.gov.uk/government/uploads/system/uploads/attachment_data/file/4377/strategic-rail-freight-interchange.pdf)
- DfT (2016) Rail freight strategy moving britain ahead. department for transport, London. [https://www.gov.uk/government/uploads/system/uploads/attachment\\_data/file/363718/rail-trends-factsheet-2014.pdf](https://www.gov.uk/government/uploads/system/uploads/attachment_data/file/363718/rail-trends-factsheet-2014.pdf)
- EC (2011) Roadmap to a single European transport area—towards a competitive and resource efficient transport system. <http://eur-lex.europa.eu/legal-content/EN/ALL/?uri=CELEX:52011DC0144>
- EC (2001) First railway package of 2001 white paper: a strategy for revitalising the Community's railways
- EC (2004) Second railway package of 2004 DIRECTIVE 2004/49/EC
- EC (2007) Directive 2007/58/EC of the European Parliament and of the Council
- EC (2013a) EU triples funding for rail innovation press release. [http://europa.eu/rapid/press-release\\_IP-13-1250\\_en.htm](http://europa.eu/rapid/press-release_IP-13-1250_en.htm)
- EC (2013b) The fourth railway package—completing the single European railway area to foster European competitiveness and growth

- ECA (2016) European Court of Auditors: Rail freight transport in the EU: still not on the right track-Special Report no 8. [http://www.eca.europa.eu/Lists/ECADocuments/SR16\\_08/SR\\_RAIL\\_FREIGHT\\_EN.pdf](http://www.eca.europa.eu/Lists/ECADocuments/SR16_08/SR_RAIL_FREIGHT_EN.pdf)
- e-Freight (2011) D3.2—Reference solutions for next generation national single window. <https://goo.gl/ukWZLJ>
- Ferreira L, Sigut J (1995) Measuring the performance of intermodal freight terminals. *Trans Plan Technol* 17(3):269–280
- Frémont A, Franc P (2010) Hinterland transportation in Europe: combined transport versus road transport. *J Trans Geogr* 18(4):548–556
- Four Ashes (2016) West Midlands interchange formal EIA scoping opinion request-Project Number UK15-22821\_Scoping
- Gibbons M et al. (1994) *The new production of knowledge: the dynamics of science and research in contemporary societies*. Sage, London, p 51
- IRIS (2001) Innovative rail intermodal services. <http://www.transport-research.info/sites/default/files/project/documents/iris.pdf>
- Kent Council (2005) Strategic planning policy and overview committee transport with a 25–30 year time line. [https://www.kent.gov.uk/\\_\\_data/assets/pdf\\_file/0017/12860/transport-2530-year.pdf](https://www.kent.gov.uk/__data/assets/pdf_file/0017/12860/transport-2530-year.pdf)
- Klitkou A, Coenen L, Andersen PD, Fevolden A, Hansen T (2013) Role of demonstration projects in innovation: transition to sustainable energy and transport. In: *Papers-4th international conference on sustainability transitions*
- Marinov M, Viegas J (2009) A simulation modelling methodology for evaluating flat-shunted yard operations. *Simul Model Pract Theory* 17(6):1106–1129
- Marinov M, Viegas J (2011) A mesoscopic simulation modelling methodology for analyzing and evaluating freight train operations in a rail network. *Simul Model Pract Theory* 19:516–539
- McNulty SR (2011) Realising the potential of GB Rail: final independent report of the Rail Value for Money study. Department for Transport and Office of Rail Regulation, London
- Montreuil B, Meller RD, Ballot E (2012) Physical internet foundations. In: *Proceedings of INCOM 2012 symposium, Bucharest, Romania, 2012/05/23-25*
- NetworkRail (2007) Freight route utilisation strategy. <http://archive.nr.co.uk/browse%20documents/rus%20documents/route%20utilisation%20strategies/freight/freight%20rus.pdf>
- NetworkRail (2010) Value and importance of rail freight. Network Rail, London
- ORR (2010) Rail freight user survey: final report. [http://orr.gov.uk/\\_\\_data/assets/pdf\\_file/0005/5459/freight-user-survey-2010.pdf](http://orr.gov.uk/__data/assets/pdf_file/0005/5459/freight-user-survey-2010.pdf)
- ORR (2016) Freight rail usage 2015-16 Q4 statistical release. [http://orr.gov.uk/\\_\\_data/assets/pdf\\_file/0012/22008/freight-rail-usage-2015-16-quarter-4.pdf](http://orr.gov.uk/__data/assets/pdf_file/0012/22008/freight-rail-usage-2015-16-quarter-4.pdf)
- Planning Inspectorate (2012) SCOPING OPINION proposed East Midlands gateway: Strategic Rail Freight Interchange
- Planning Inspectorate (2016a) Scoping opinion proposed northampton gateway strategic rail freight interchange-planning inspectorate reference: TR050006
- Planning Inspectorate (2016b) Scoping opinion-proposed rail central strategic rail freight interchange
- Planning Inspectorate (2016c) Scoping opinion- proposed West Midlands interchange planning inspectorate reference: TR050005
- Ramboll Environ (2016) West Midlands interchange-formal EIA scoping opinion request
- Roxhill (2012) East Midlands gateway: strategic rail freight interchange—environmental statement scoping report—November 2012
- RRUKA (2012) The half cost train (COF-HCT). <https://www.sparkrail.org/Lists/Records/DispForm.aspx?ID=2239>
- RSSB (2013) *The V/S SIC guide to British gauging practice*
- Rail Delivery Group (2015) Freight Britain continuity and certainty for rail freight. [https://www.raildeliverygroup.com/files/Publications/2015-02\\_freight\\_britain.pdf](https://www.raildeliverygroup.com/files/Publications/2015-02_freight_britain.pdf)
- Schumpeter J (1934) *The theory of economic development*. Harvard University Press

- SAIL (2002) Semi trailers in advance intermodal logistics. [http://www.transport-research.info/sites/default/files/project/documents/20060727\\_155501\\_77237\\_SAIL\\_Final\\_Report.pdf](http://www.transport-research.info/sites/default/files/project/documents/20060727_155501_77237_SAIL_Final_Report.pdf)
- The Infrastructure Planning (2009) Environmental impact assessment 2009 regulations. [http://www.legislation.gov.uk/uksi/2009/2263/pdfs/uksi\\_20092263\\_en.pdf](http://www.legislation.gov.uk/uksi/2009/2263/pdfs/uksi_20092263_en.pdf)
- Terminet project (2000) Final report. <http://www.transport-research.info/sites/default/files/project/documents/terminet.pdf>
- UIC (2016) Future railway mobile communication system user requirements specification. [http://www.uic.org/IMG/pdf/frmcs\\_user-requirements.pdf](http://www.uic.org/IMG/pdf/frmcs_user-requirements.pdf)
- Van Binsbergen A, Konings R, Tavasszy L, van Duin R (2013) Mega-projects in intermodal freight transport: innovation adoption. In: International handbook on mega-projects, p 209
- Woxenius J, Bergqvist R (2011) Comparing maritime containers and semi-trailers in the context of hinterland transport by rail. *J Transp Geogr* 19(4):680–688

# Chapter 11

## Multimodal, Intermodal and Terminals

Giuseppe Pace and Stefano Ricci

### 11.1 Introduction and Scope

The chapter looks at rail freight terminals, rail—sea interfaces, in particular, as part of a multimodal, or integrated transportation network. Terminals are key infrastructure for linking individual transport modes and governing and managing their interchange in a manner that creates a seamless and sustainable transportation system. Therefore, their performance is critical for maximising transport efficiency and modes integration. This chapter analyses rail terminals' performance from two dimensions, one related to the operational performance and the other related to the critical security challenges, and the constraints imposed by security management.

Section 11.2 includes definitions and assets typologies, Sect. 11.3 deals with methods and models for operational performances; Sect. 11.4 describes potential key performance indicators, Sect. 11.5 identifies security threats in rail—sea terminals operation, Sect. 11.6 sketches the regulation framework on port security and finally Sect. 11.7 introduces security measures for prevention and mitigation of negative impacts.

---

G. Pace (✉)

Institute of Studies on Mediterranean Societies, National Research Council, Naples, Italy  
e-mail: giuseppe.pace@cnr.it

S. Ricci

Sapienza Università di Roma, Rome, Italy  
e-mail: stefano.ricci@uniroma1.it

## 11.2 Rail Freight Terminals: Definitions and Assets Typologies

Rail terminals are an integral part of multimodal transport. Although there have been many discussions about rail terminals (Marinov et al. 2013), currently there is no existing universal definition for a rail terminal. A first categorisation considers the markets they service: passenger and freight terminals, with the third intermediate typology of shunting yards. Rail freight terminals generally represent bottlenecks in intermodal logistics chains; hence, the reason for the attempt to measure the operational performance of rail terminals (Bektas and Crainic 2007). For the purposes of this study, the rail terminal will be defined according to its specific working aims as “Terminal able to multimodal (Rail–Road, Rail–Sea) or mono-modal (Rail–Rail) LO–LO or RO–RO handling of Intermodal Transport Units (ITU = containers, swap bodies, semitrailers) and/or vehicles” (Reis et al. 2013). Finally, the study takes into account another classification for rail–sea terminals, based on their location and connection to the port (Reis et al. 2013):

- On-dock, where freight move directly from the dock, or the storage areas to a railcar, using the terminal’s own equipment;
- Near dock, where freights clear the terminal’s gate using the local road system;
- Satellite (or Shuttle), which can be qualified as an inland terminal.

## 11.3 Assessment of Performances: Methods and Models

Suitable methods are available to assess the performance of terminals. A dedicated and extended literature on this topic represents the typical processes in the terminal as a combination of “Waiting” and “Operation” phases.

The literature defines two broad families of methods for assessing the performances of terminals (Ricci 2014):

1. Analytical methods: stochastic representation of sequential multi-operation processes by algorithms (e.g. queuing theory) (Quattrini 2009; Ballis and Abacoumkin 2001);
2. Simulation models: events driven systematic reproduction of multi-operation processes basing on stochastic inputs (e.g. asynchronous discrete event simulators) (Marinov and Viegas 2009; Baldassarra et al. 2010, 2012; Mangone and Ricci 2014).

The methodological families above are here detailed.



### 11.3.1 Analytical Methods

Figure 11.1 shows a general approach for an analytical method.

Figure 11.2 shows the specialised structures depending on terminal typology (a rail–rail terminal can refer to a marshalling yard).

Figure 11.3 shows the simplified working process with the example of a Rail–Sea Terminal.

Figure 11.4 shows an example of data input in an analytical method.

The analytical methods of assessing rail terminals operational performance have huge potential in certain areas (Woxenius 1998, 2007). For example, they allow the calculation of key parameters concerning operation and the quantification of waiting and operational phase’s duration. It also leads to the estimation of capacity of single substations and the terminal as a whole and the evaluation of global and partial utilisation rates.

Furthermore, it allows assessment of alternative operational frameworks and new technologies. It can also help to calculate costs involved in terminal operation, which can affect terminals competitiveness cost-wise with other terminals (Ortuzar and Willumsen 2011; Nelldal 2012; Kordnejad 2014).

However, one disadvantage could be an overly prescriptive approach that cannot take every potential factor on-board.

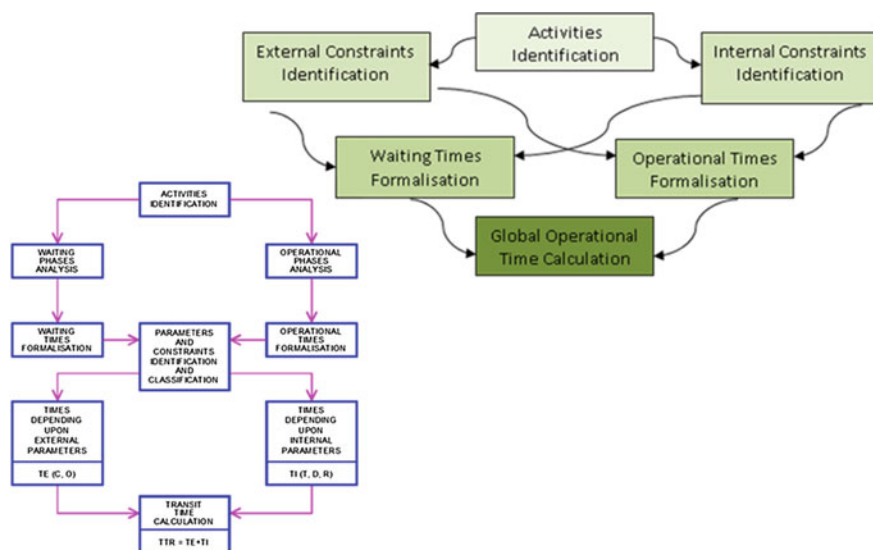


Fig. 11.1 General approaches for analytical modelling

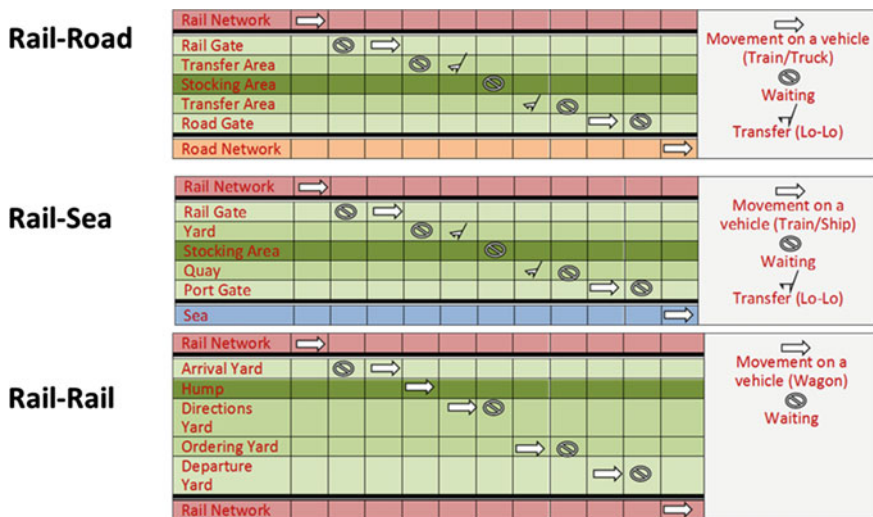


Fig. 11.2 Specialised structures of each typology of rail terminal

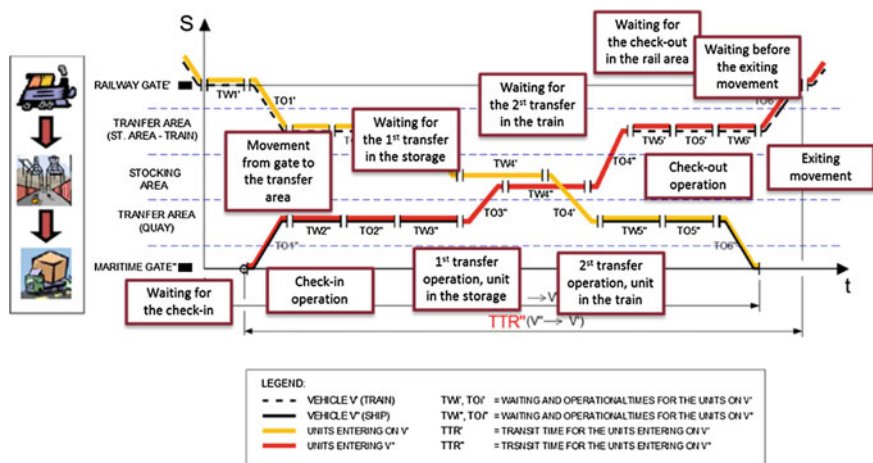


Fig. 11.3 Diagram showing simplified working process within rail–sea terminals

### 11.3.2 Simulation Model

The simulation model has an alternative general approach. Similarly, to the analytical approach through, it is basing around an events driven approach. The simulation model focuses more on changes of state driven by events, shown in Figs. 11.5 and 11.6.

Mean time between 2 arriving trucks	2,00 min	Coefficient for taking into account the amount of transversal movements	0,62
Mean time between 2 arriving trains	57,00 min	Mean distance from gate to transfer area (truck)	700,00m
Mean number of units/train	41,00	Mean distance departure signal of the station – transfer area	1750,0m
Mean unit length	8,55 m	Distance between tracks (road, rail and storage) in the transfer area	4,82 m
Number of railway traffic directions	11,00	Mean distance from transfer area to gate (truck)	1751,7m
Time for unit data exchange (unit on the truck)	3,00 min	Number of data operators teams on the tracks	4,00
Time for unit data exchange (single unit on the train)	0,07 min	Number of gates	3,00
Mean unit loading time	1,00 min	Number of tracks in the transit area	9,00
Time for transfer planning (unit on the truck)	0,75 min	Number of transfer devices	6,00
Time for transfer planning (unit on the train)	2,00 min	Average internal truck speed	333,00m/min
Mean unit unloading time	1,00 min	Average train shunting speed	300,00m/min
Mean longitudinal transfer speed	120,00m/min	Number of operative rail track	14,00
Mean transversal transfer speed	80,00 m/min	Mean number of operative track in transfer area	5
Coefficient for taking into account the reciprocal initial position of crane and unit to be loaded	0,25	Average rate of arrivals (train)	0,017
	Supplied Data	Average rate of served (train)	0,70
	Assumed Data	Power gantry drive	100 Kw
		Power main hoist	19 Kw
		Power trolley drive	32 kw

Fig. 11.4 Example of data input and output in an analytical model

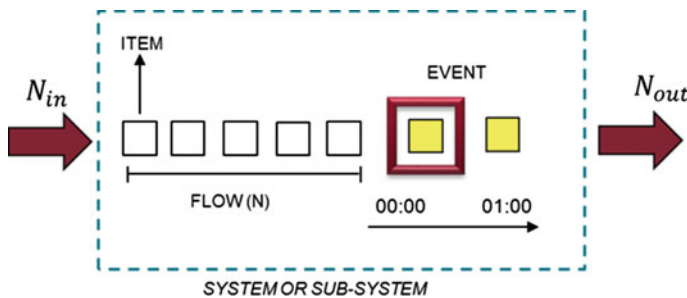


Fig. 11.5 Simulation model process

<b>ITEM</b>	<ul style="list-style-type: none"> <li>Dynamic elements moving within the system through the OBJECTs following a specific location</li> <li>Divided by classes</li> <li>Animated during simulation</li> </ul>	
<b>OBJECT</b>	<ul style="list-style-type: none"> <li>Fixed element</li> <li>Holding the ITEMs</li> <li>Transforming the ITEMs</li> </ul>	
<b>PATH</b>	<ul style="list-style-type: none"> <li>Links between ITEMs and OBJECTs</li> <li>Determining a logical sequence of events</li> <li>Defined for each class of ITEMs</li> <li>Same class of ITEMs able to use various PATHs</li> </ul>	
<b>FLOW</b>	<ul style="list-style-type: none"> <li>Multiple PATH for a defined class of ITEMs</li> <li>ITEMs moving in parallel inside a FLOW and various PATHs</li> </ul>	

Fig. 11.6 Example of simulation model process



Fig. 11.7 Outputs from simulation models

The model is capable to alter the active pre- and post-conditions governing the systems behaviour.

Figure 11.7 shows an example of outputs using the simulation model.

The simulation model approach has potential in various areas. For example, it has the ability to work with data of various typologies and sizes of terminals, handling systems, number of operators, etc. It also has the ability to quantify global performances and role of various operations for bottleneck identification. A final advantage is its potential to work where and when, for various reasons, analytical methods either operate with difficulty or fail to operate at all.

### 11.4 Identification of Key Performance Indicators

It is obviously paramount, when trying to assess the performance of an intermodal terminal, to identify Key Performance Indicators (KPIs) in order to allow comparison of their performances (Davidsson et al. 2007).

In Fig. 11.8 there is an example of KPIs. These indicators are not universal but provide a good basis to work. Analytical and simulation model allows calculating these indicators, with various effectiveness.

<b>Total Transit Time (ITU)</b>	Total Transit Time (ITU)	$TTR = \sum_{i=1}^n TW_i + \sum_{j=1}^m T_j$	Time period from the arrival of the freight unit (or vehicle) to the terminal gate from road (an external transport infrastructure) to the exit of the unit (or vehicle) from the terminal towards road or railway network. <ul style="list-style-type: none"> <li>• TTR<sub>v</sub> = vehicle total transit time (Ship and train);</li> <li>• TTR<sub>ITU</sub> = Unit total transit time;</li> <li>• TW = waiting time;</li> <li>• TO = operational time.</li> </ul>	Analytical Method
<b>Total Transit Time (vehicle)</b>				
<b>Utilisation Rate of Handling Equipment</b>				
<b>Utilisation Rate of Storage ITU</b>				
<b>Energy Consumption rate</b>				
<b>Equipment Performance</b>				
<b>Equipment haul</b>	Equipment Performance	$E_p = \frac{n_{ITU}}{h}$	It is the potentiality of handling equipment. <ul style="list-style-type: none"> <li>• n<sub>ITU</sub> = number of handled intermodal transport unit;</li> <li>• h = hour.</li> </ul>	Simulation model
<b>Truck Waiting Rate</b>				
<b>Terminal Occupancy</b>				
<b>Maintainability indicator</b>	System utilization rate	$q = \frac{\lambda}{\mu}$	It is the queuing theory. It is useful to measure the correct sizing of different sidings. <ul style="list-style-type: none"> <li>• q = system utilization;</li> <li>• λ = average rate of arrivals;</li> <li>• μ = average rate of served.</li> </ul>	Simulation model
<b>Reliability indicator</b>				
<b>System utilization rate</b>				
<b>Personnel distribution rate</b>				

Fig. 11.8 List and some examples of used KPIs

### 11.5 Security Challenges in Port Rail Terminal Operation

Guaranteeing an extended mobility to people and freight “has become an international priority” (Szylioxicz et al. 2016) and new safety and security measures have been implemented everywhere on various transport modes. Nonetheless, if for safety is enough to define safety standards measures and controlling their appliance, in the field of transport security there is a need of international continuous and coordinated measures, involving planning, training and intelligence. The terrorist attacks of 9/11 emphasised the transport interfaces as new security challenges. Favoured by terrorists for the huge impact due to their crowded nature, passenger transport infrastructure are an apparently easy and vulnerable target, becoming sensitive objectives of terrorism, often with devastating political, social and economic consequences. In addition, terrorism could soon turn its attention to attacks to freight transport of any mode. A successful attack to the global freight system could have devastating consequences both domestically and internationally. Obviously, transport infrastructure must face other traditional security threats, such as “piracy, theft, smuggling and other organised criminal activity” (Mangan et al. 2012), but those new challenges, linked to terrorism, cannot be managed separately by each transport infrastructure and demand for a more comprehensive and collaborative approach, which integrates all modes and claims for a common global transport security strategy.

Today, security is a major concern for governments, in order to guarantee that people maintain their mobility behaviours, and trade continue to flow smoothly and economically. In transport, security needs mainly affect:

- Infrastructure (government agencies, providers, operators, etc.)
- People (visitors, users, workers, clients, etc.)
- Economy (services, production, import, export, etc.)

Each transport mode has different security challenges and corresponding regulations and procedures, as well as interfaces between modes, such as harbours and airports, have developed their security measures. These security challenges are multiplied and greatly complicated by numerous and costly new problems of coordination and integration, reinforcing a modal thinking, which develops approaches in “silos” since the infrastructure planning and design, with not homogeneous levels of security. Many security procedures can vary by country, provider and operator, which multiplies integration and coordination problems. In addition, for many operators security is an additional cost, which brings to resistance to security measures, competitive advantage/disadvantage and negative operational impacts. Moreover, virtually all governmental agencies involved in security function in a reactive way, by responding to major incidents with mandatory requirements, that is, shutting the gate after the horse has bolted. In the freight segment, in contrast to passenger transport, there is little or no political urgency to develop proactive mandatory security requirements, especially for cargo security, where criminal acts are perceived to be “victimless crimes”. However, a successful attack on the global freight transport system would have many economic “victims” and stronger security measures are urgently needed.

Examining security challenges faced by the transportation system, a key threat is posed by a terrorist attacks to transportation hubs, which feature as national and international icons and whose destruction would have great symbolic significance. Another deadly threat is posed by potential chemical and biological attacks with numerous agents that could cause disease, capable of deployment in an intermodal passenger hub provoking potential death and panic. Cyber-attacks also have the potential to be just as deadly, with the global trade strongly based on internet. Supply chains generating data and information are at particularly severe threat of disruption and theft. There are various kinds of cyber threats; the majority can be prevented by some basic principles and precautions. Piracy and immigration are the final threats mentioned in this not exhaustive list and, in reality, the number of threats to safe and efficient freight transport are endless. This is why security must be addressed a more proactive and dynamic way, by finding security deficiencies before they are exploited.

## **11.6 Regulation Framework on Port Security**

Currently, there is a wide range of regulations dealing with security issues in both ports and railways. However, none of the current regulations specifically is aimed at developing security measures in an intermodal sense. After 9/11, the U.S. Customs and Border Protection’s (CBP) has developed a cargo enforcement strategy in two layers. The first layer is represented by the US Custom-Trade Partnership against Terrorism (C-TPAT) (2001), a voluntary government–business initiative to build cooperative relationships improving the overall international supply chain and US border security. The CBP offers benefits to certified C-TPAT member categories and, at the same time, improves the security of private companies’ supply chains

with respect to terrorism. With the C-TPAT, the CBP recognises that the highest level of cargo security is reachable only through close cooperation with the main stakeholders of the international supply chain such as importers, carriers, consolidators, licensed customs brokers and manufacturers. The second layer is the US Container Security Initiative (CSI) (2002), an integrated security approach sea–land for containers that is part of the US Maritime Transportation Security Act. CSI addresses the threat to border security and global trade posed by the potential for terrorist use of a maritime container to deliver a weapon. CSI proposes a security regime to ensure all containers that pose a potential risk for terrorism are identified and inspected at foreign ports before they are placed on vessels destined for the US. Currently, 58 operational CSI ports in North America, Europe, Asia, Africa, the Middle East and Latin and Central America pre-screen over 80% of all maritime containerized cargo imported into the US. Through CSI, US Customs and Border Protection's (CBP) officers work with host customs administrations to establish security criteria for identifying high-risk containers. Those administrations use non-intrusive inspection (NII) and radiation detection technology to screen high-risk containers before they are shipped to US ports.

At the international level, the mandatory security regulation for ports is the IMO International Ship and Port Facility (ISPS) Code (International Maritime Organisation 2002), which applies to all countries members of the International Maritime Organisation (IMO). The ISPS Code objectives are to enable the prevention and detection of security threats and the Code applies to ships engaged in international trade, including passenger ships, cargo ships of 500 gross tons and upwards, mobile offshore drilling units, and the port facilities serving such ships. The ISPS Code addresses only the port facility–ship–port facility part of maritime. The Code establish roles and responsibilities concerning maritime security for governments, local administrations, ship and port industries at the national and international level, collates and promulgates security-related information, and provides a methodology for security assessments so as to have in place plans and procedures to react to changing security levels (Mangan et al. 2012).

In Europe, ISPS Code was incorporated in EC Regulation (EC) No 725/2004 of the European Parliament and of the Council of 31 March 2004, on enhancing ship and port facility security (European Commission 2004). The Regulation states that port facilities must have in place “measures designed to prevent unauthorised access to the port facility, to ships moored at the facility and to restricted areas of the facility” (EC Regulation (EC) No 725/2004). In particular, it defines the following mandatory requirements:

- The appointment of a single national authority (contracting government) by 1 January 2004
- The making of ship and port facility security assessments and the appointment of ship, port facility and company security officers by 1 March 2004
- The approval of the ship and port facility security plans by 1 May 2004 by designated/port authority
- The issuing of the international ship security certificates by 1 June 2004 by contracting government.

In 2005, the European Commission introduced the Directive 2005/65/EC on enhancing port security, which expands maritime security requirements beyond the boundaries of the port facility in order to cover the whole port area. This directive defines the port as “any specified area of land and water, with boundaries defined by the Member State in which the port is situated, containing works and equipment designed to facilitate the commercial maritime transport operations”. Key requirements include establishing port security authorities, designating a port security officer, carrying out a port security assessment and implementing a port security plan. The aim of the directive is to enhance security measures already taken at port facility level through means that include coordination throughout the port of preventive measures and incident response plans and the alignment of efforts of relevant agencies with a role in the security and safety of a port. It requires ports to include in their security plans requirements to identity checks of seafarers, authority of officials, port workers, regular and occasional visitors and persons residing within the port. EU also reproduces the US C-TPAT, by establishing the EU Authorised Economic Operator (AEO) as a voluntary security initiative, for which are eligible manufactures, importers, exporters, brokers, carriers, consolidators, intermediaries, ports, airports, terminal operators, integrated operators, warehouses and distributors within EU.

More difficulties EU finds in reflecting the U.S. Rail Security Regulations, introduced in 2008 with requirements for a wide range of rail operations. After long negotiation, the EU is only able to adopt a Staff Working Document on Transport Security (European Commission 2012) and set up an EU Expert Group for Land Transport Security (forum to discuss issues with both Member States and stakeholders).

As can be seen from this list of regulations, security measures consider only the ship/port facility, whereas the definition of port facility can be narrowed to consist of wharves, berths, quays and anchorages, that is, locations where only the loading and unloading of ships takes place. Rail terminals are excluded from this narrow definition and therefore remain vulnerable as can be neatly shown by Fig. 11.9.

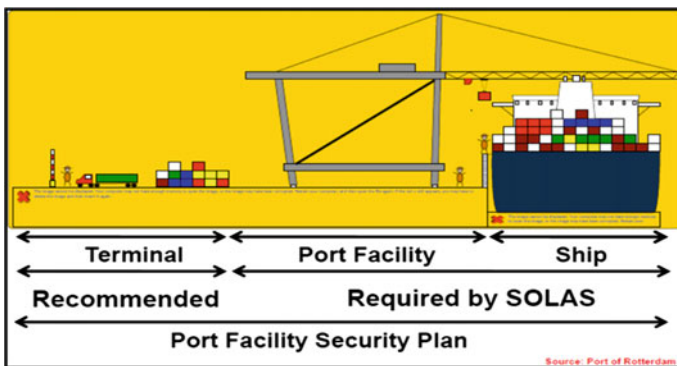


Fig. 11.9 Diagram depicting security in rail–sea interfaces, Port of Rotterdam



## 11.7 Relevant Security Issues: Preventing and Mitigating Measures

Ports have several terminals of the same or different nature (container, ro-ro, passengers, rail, etc.), which can be located in the port area (maritime terminals) whereas others are located in the hinterland (inland terminals) (Reis et al. 2013).

The location of rail terminals greatly affects security measures in the port areas. The study focuses on the three different typologies—on-dock, near dock and satellite.

Security requirements are different for each typology. On-dock rail terminals, in particular, are well covered, as they are contained within the port premises and, therefore, subject to security regulations already applied in ports. In contrast, near-dock terminals present a different security challenge. Freight has to leave the port facility and use the local road network in order to arrive at the terminal. This causes opportunities to exploit security deficiencies in an intermodal context. Satellite terminals, the load centre and the trans-modal terminal all qualify as forms of inland port, and must have their own security system, which are not covered by port regulations and are similarly vulnerable.

The different typologies demand for different levels of collaboration and cooperation between infrastructure managers and operators. On-dock rail terminals need to organise access control and train crew identification and training, while near dock have two security options: a detached limited security interface, with the rail line responsible for rail site security; a shared complex security interface, which must be multilayered and facility shared with multiple users and access points.

### 11.7.1 Technology

Many forms of technology assist the security management in rail–sea interfaces. Security for access control can assist with this by permitting access to authorised people and controlling access by non-authorised people to restricted areas. Forms of access control technology include:

- Various forms of gates, fences, bollards or security netting controlled by security guards.
- Systems for identifying authorised people and vehicles such as biometrics or identification systems. More advanced identification systems based on biometrics such as fingerprint or retinal scans are in development and will soon replace outdated and vulnerable identification card systems.
- Detection systems such as Closed Circuit Television (CCTV). Increasingly common and more modern systems include motion detection systems and X-Ray and Gamma Ray detection systems.

### 11.7.2 *Security in Intermodal Terminals*

The security in and around intermodal terminals must take into account local and global factors, and any planning approach cannot cover all potential risks, but only minimises the effects of security-related attacks. Rarely, ports are specifically planned and designed in a security effective way. Most of the time, security is defined a posteriori on an existing infrastructure. The planning approach varies according the above mentioned interface typology, and takes into account the EC Regulation, which demands for “ship and port facility security assessments” and the approval of security plans (EC Regulation (EC) No 725/2004). Some commercialised toolkit provides structure for on-deck Rail terminal risk assessment (Port of Rotterdam), defines action plans with recommendations for the improvement of risk control, and automatically generates Port Facility Security Plans. Main security topics are:

- Access to the Port Facility
- Areas with no or restricted access
- Monitoring the Port Facility
- Handling of Cargo
- Ship’s Stores
- Unaccompanied Baggage

Toolkits simplify legislation, guarantee uniformity and comparability, improve efficiency in cost and time and offer efficient data gathering, analysis and benchmark opportunities. However, they are not enough relevant for near dock and satellite rail terminals, and for specific urban ports, whereas more detailed, dynamic and collaborative approaches are requested.

In general, when designing a security system for a rail–sea interface, the planning process must take into account many connected and unconnected factors. These factors include:

- Infrastructure—including location effectiveness, typology, rail access coordination and rail crew identification.
- Operators—including incentives and sanctions to encourage security conscious behaviour. Exchange of information and voluntary control.
- Training—across different modes and stakeholders and including all security technology.

In order to avoid security deficiencies, the planning should also consider and solve common threats to security in intermodal interfaces. These threats include:

- Collaboration, both within and between nodes, to ensure the overall efficiency.
- Intermodality, as an additional threat to security measures and potential weak points in security ring.

### ***11.7.3 Possible Security Measures***

Possible security measures to implement vary depending on terminal type. However, many measures can be generalised and adopted in all types of terminal. It is clear that the installation of X-Ray (or Radiation Portal Monitor) machines should proceed and would cause an increase of security levels. Near-dock terminals present their own set of security challenges. However, many of these challenges can be resolved by clear organisation and division of responsibilities. In order to resolve potential security continuity issues, will the same port security operator operate the rail terminal? Alternatively, would the Rail operator/provider be responsible for rail site security? If these responsibilities are clearly divided and organised then challenges, involving security in separate terminal facilities, will decrease markedly.

## **11.8 Closing Remarks**

In conclusion, due to rail freight terminals positions as strategic rings of integrated logistic chains, there is obviously a need for robust and reliable methods to assess performances either by using algorithms and/or simulation.

There is a continuing need to collect real operation data for validation and to identify key performance indicators and the most reliable methods to calculate them.

This research could also allow interested parties checking real world effects on innovations, with appropriate methods.

This would lead to the identification of the most effective innovative technologies and operational measures and lead to measurable increases in the performances of rail freight terminals.

To deal with the security challenges, there must be an increased level of cooperation between states with clear agreements on responsibilities for security, as well as a coordination among all economic stakeholders involved. Work must continue on the simplification of a global strategy aimed at reducing the overlapping of authority between international, national and non-governmental organisations and increased coordination of international, national and domestic stakeholders. These stakeholders must then co-operate on joint threat assessments, training of officers, joint inspections, piracy prevention and all other relevant areas; building on established research and innovation partnerships to find common answers to the challenges related to the integrated transport systems security.

One thing is clear: security procedures and measures should not be based on the response to single episodes, but they should rather rely on a strategic vision, which integrates security as one of the most important elements of the sustainable transportation, since the infrastructure planning and design phase. Otherwise, a dramatic and damaging security breach will continue to be more likely than it necessarily needs to be.

## Reference

- Baldassarra A, Impastato S, Ricci S (2010) Intermodal terminal simulation for operations management. *Eur Transp* 46:86–99
- Baldassarra A, Margiotta A, Marinacci C, Ricci S (2012) Containers management simulation in short sea shipping. In: International research conference on short sea shipping 2012, Estoril
- Ballis A, Abacoumkin C (2001) An expert system approach to intermodal terminal design. *Transp Res*
- Bektas T, Crainic TG (2007) An overview of intermodal transport. Université de Montreal. Publication CRT 07–03. Centre de Recherche sur les Transport, Montreal, Canada
- Davidsson P, Persson JA, Woxenius J (2007) Measures for increasing the loading space utilization of intermodal line train systems. In: Proceedings of the 11th WCTR, Berkeley
- European Commission (2004) Regulation (EC) No 725/2004 on enhancing ship and port facility security, EC, Brussels
- European Commission (2012) Staff Working document on transport security, EC, Brussels
- International Maritime Organisation (2002) IMO international ship and port facility (ISPS) code. In: Conference resolution and related amendments to the 1974 SOLAS convention
- Kordnejad B (2014) Intermodal transport cost model and intermodal distribution in urban freight. *Proced Soc Behav Sci* 125:358–372
- Mangan J et al (2012) Global logistics and supply chain management. Wiley, Chichester (UK)
- Mangone A, Ricci S (2014) Modelling of port—freight village systems and loading units' tracking functions. *IF—Ingegneria Ferroviaria*. 1
- Marinov M, Viegas J (2009) A simulation modelling methodology for evaluating flat-shunted yard operations. *Simul Model Pract Theory* 17(6):1106–1129
- Marinov M, Sahin I, Ricci S, Vasic-Franklin G (2013) Railway operations, time-tabling and control. *Res Transp Econ* 41(1):59–75
- Nelldal BL (2012) VEL-Wagon cost calculations. Seventh Framework Programme European Commission, Stockholm, Sweden
- Ortuzar JD, Willumsen LG (2011) Modelling transport. 4th edn. Wiley, West Sussex, UK, pp 466–468
- Quattrini A (2009) Intermodal freight terminal: a synthetic model for the evaluation of operational performance. PhD thesis. Sapienza Università di Roma
- Reis V et al (2013) Rail and multi-modal transport, *Research in Transportation Economics* n. 41, Elsevier
- Ricci S (2014) Systematic approach to functional requirements for future freight terminals. Transport Research Arena, Paris
- Szyliowicz JS et al (2016) Multimodal transport security. Frameworks and Policy Applications in Freight and Passenger Transport, Edward Elgar, Cheltenham (UK)
- Woxenius J (1998) Evaluation of small-scale intermodal transshipment technologies. In: Bask AH, Vepsa-lainen PJ (eds) Proceedings of the 10th NOFOMA Conference on opening markets for logistics, Helsingfors, pp 404–417
- Woxenius J (2007) Alternative transport network designs and their implications for intermodal transshipment technologies. *Eur Transp* 35:27–45

# Chapter 12

## Rail Marketing, Jobs and Public Engagement

Anna Fraszczyk, Nathalie Amirault and Marin Marinov

### 12.1 Introduction

Railways have been offering their transport services to the public and freight sectors for the last two centuries. Rail vehicles design, rail operations, rail management and many other aspects of the railway system have been based on the same principles for many decades. However, in the twenty-first century the rules of the game are changing. The numbers of rail passengers are falling in most of the European countries, with an exception of the United Kingdom (Fraszczyk et al. 2016). New technologies such as high-speed rail and driverless metros are developing fast and taking over traditional rail solutions. In freight, large containers transporting bulk goods, such as, e.g. coal or other heavy materials are losing their market share. New high value and low-density goods (e.g. mobile phones, pharmaceuticals) are now of interest more than ever before (SPECTRUM 2015). In addition, issues like, e.g. ageing rail force in Europe or deficit of rail engineers in Asia, where technology has been purchased from abroad for decades, present a challenge on how to recruit talented individuals, train them and retain within the railway sector. These issues present a challenge to the railway industry to rethink their strategies of running their “business as usual” as well as an opportunity to innovate.

---

A. Fraszczyk (✉)

Faculty of Engineering, Mahidol University, Salaya, Thailand  
e-mail: anna.fra@mahidol.ac.th

N. Amirault (✉)

Unit Expertise Development, UIC, Paris, France  
e-mail: amirault@uic.org

M. Marinov

NewRail, Centre for Railway Research, Newcastle University, Newcastle upon Tyne, UK  
e-mail: marin.marinov@newcastle.ac.uk

© Springer International Publishing AG 2018

M. Marinov (ed.), *Sustainable Rail Transport*, Lecture Notes in Mobility,  
DOI 10.1007/978-3-319-58643-4\_12

207

In response to some of the challenges, the railway industry has been facing recently, a number of new rail marketing and public engagement initiatives emerged.

In this rail context, public engagement essentially entails public participation in taking decisions that concern projects on infrastructure and aspects of railways that generally affect the public. Moreover, it is a two-way process, where involved parties interact and listen to each other in order to achieve mutual benefits (National Co-ordinating Centre for Public Engagement 2017). An example of a public engagement activity is a public consultation on a new rail/metro line development. Unlike public engagement, public outreach entails activities and projects that inform the public about a rail organisation's involvement with the community (e.g. a railway company supporting Railway Children's charity) or influence in the community (e.g. Women in Rail) and serve in various aspects of the industry (Oxford Dictionaries 2017). In a broader sense, rail outreach can include activities such as, e.g. informing young people and professionals outside of the industry about possible careers in the sector.

As can be seen there is a significant difference in definitions between public engagement and public outreach. However, to avoid confusion, and to follow terminology used by the railway sector (e.g. Network Rail's community engagement objectives; Network Rail 2014) the term "public engagement" will be used in this chapter to describe both types of activities.

The chapter is organised as follows. Section 12.2 presents the concept of a marketing mix in the rail context with "7Ps" briefly explained. The next three sections present rail-marketing strategies from different perspectives. Section 12.3 discusses marketing strategies to promote rail as a service to potential users with examples of rail campaigns and events. Sections 12.4 and 12.5 showcase rail as a career path to potential pool of talents with examples of one-off events and long-term programmes targeting talents from the sector and from outside, respectively. The final section, Sect. 12.6 focuses on skills and jobs for railways of the future, where new skills and talents will be needed due to forthcoming technology innovations. The case studies presented in the chapter, with their success stories and challenges faced, provide valuable lessons for the rail industry and organisations considering organisation of or involvement in similar activities in the future.

## 12.2 Marketing Mix in a Rail Context

Marketing includes variety of actions, from market research to advertising to selling products or services, all falling under the umbrella of managing a profitable relationship between a company and a customer (ESCAP 1998; Kotler and Armstrong 2012; Oxford Dictionaries 2017). In the rail context this means promoting and selling rail services (e.g. first class train ticket between Newcastle and London or rail freight services between a mine and a power station) and products (e.g. a new tram or a new freight wagon).

**Table 12.1** Examples of products and services in the railway sector

Infrastructure manager sells:	Train operator sells:
<ul style="list-style-type: none"> <li>• slots—to (freight and passenger) operators</li> <li>• maintenance contracts—to external companies</li> <li>• not needed asset (buildings)—to buyers</li> <li>• etc.</li> </ul>	<ul style="list-style-type: none"> <li>• tickets—to passengers</li> <li>• advertising space—to companies</li> <li>• rolling stock—to other operators</li> <li>• etc.</li> </ul>
Producer sells:	Other players
<ul style="list-style-type: none"> <li>• rolling stock (locos, trams)—to operators</li> <li>• software—to education/training providers</li> <li>• equipment—to infrastructure managers and operators</li> <li>• etc.</li> </ul>	<ul style="list-style-type: none"> <li>• Magazines</li> <li>• Charities</li> <li>• Training/education providers</li> <li>• Heritage</li> <li>• etc.</li> </ul>

Beyond train tickets, the railway sector sells a variety of products and services to its customers that perhaps are less visible to a rail passenger. Table 12.1 shows examples of products and services in the railways.

As in any other sector, the focus of marketing activities is on customer satisfaction and profitability (ESCAP 1998). In other words, the main two goals of all (rail) marketing actions are (Kotler and Armstrong 2012):

- to keep and grow current customers by delivering satisfaction (e.g. monitor customer satisfaction with rail services and offer discounts to loyal users);
- to attract new customers by promising superior value (e.g. discounts for new freight service users).

The two marketing goals in the railway sector are usually achieved by considering a marketing mix model. The marketing mix is the range of activities needed to achieve voluntary and profitable exchanges of products or services between two parties (e.g. a passenger and a train operator). The mix includes seven items, also called “7Ps” (ESCAP 1998): Product, Price, Promotion, Place, People, Process and Physical evidence.

**Product** is usually a service offered to individuals (passenger transport service) or companies (freight transport service), but in a broader sense of the railway sector a product is also for example a new railway vehicle offered to railway operators or a railway software offered to academia.

**Price** is the value, usually in monetary terms, paid by a customer for a product (or a service) purchased (e.g. trainset price or ticket price in £).

**Promotion** includes variety of activities such as advertising, sales and Public Relations (e.g. an advert in a magazine, social media campaign).

**Place** represents location of selling points and distribution channels for services and products (e.g. railway station, social media).

**People** such as railway staff or potential rail talents are the railways most valuable asset critical in meeting marketing goals while dealing with customers.

**Processes** change as technology and customer expectations evolve and are designed to meet customers’ needs (e.g. an online ticket sale, an on-board comfort).

**Physical evidence** relates to variety of facilities linked to a rail service or a product, such as, access to a railway station facilities or a level of comfort provided by trains, which influences overall customer satisfaction with the service or the product provided.

Considering all “7Ps” in the process of planning rail marketing activities guarantees that each of the items will get the attention needed and will not be overlooked. The marketing mix holistic view at marketing activities also helps to see a bigger picture and evaluate delivered actions (e.g. promotional campaigns, accessibility of services) with their reasons for a success or a failure.

### 12.3 Targeting Rail Customers

People who use trains to travel within a city (by a metro or a tram), on a short distance (by train) or on a long distance (by a conventional train, or High Speed Train) are all called passengers. However, passengers are not the only customers of the railway services as railways offer their tracks and wagons to move freight, too. Therefore, both passengers and freight customers contribute to the railway sector and are targeted by marketing strategies. Various marketing tools are used to maximise rail companies’ profit and Table 12.2 gives three examples of these.

**Table 12.2** Examples of rail marketing strategies

Type of rail services promoted	Metro	Long distance train	Rail freight services
Title	Tyne and Wear metro special offers	Skyfall train	Tesco freight train
Audience	General public	General public	General public, freight operators
Scale	Local, Tyne and Wear	National	National
Country	United Kingdom	United Kingdom	United Kingdom
Frequency	Ongoing	One-off campaign	Ongoing
Description	A range of money-saving offers to help customers make the most of their Metro ticket. Includes discounts on services and free travel to cultural events (e.g. with a theatre play ticket)	A campaign promoting a train service between Edinburgh and London with trainset covered with a “007” themed mega stickers from a new James Bond film	Intermodal service offered by a partnership between DRS, Stobart Rail and Tesco in the UK
Tools	Discounts, free travel	Video, “Skyfall 007” branded train	“Less CO2 Rail” branded containers
Website	<a href="http://www.nexus.org.uk/metro/offers">www.nexus.org.uk/metro/offers</a>	<a href="http://goo.gl/5KVAJG">goo.gl/5KVAJG</a>	<a href="http://goo.gl/NgUCfX">goo.gl/NgUCfX</a>
Social media	Twitter: @My_Metro	n/a	n/a



It must be noticed that social media expansion also provided new tools for companies to use when engaging with the public and communicating their messages to potential customers. Most of the large rail companies and train operators will have a social media presence (e.g. Twitter, Facebook, LinkedIn, Instagram) and update their customers on a regular basis on the level of service offered, delays, events, campaigns, job offers, etc.

## 12.4 Targeting Rail Talents from the Sector

Due to declared shortages in rail skilled workforce across the world (NSARE 2013; Panteia and PwC 2015; Rail Technology Magazine 2016; Rail Professional Asia Pacific 2016) a list of rail initiatives with a talent in mind has been expanding over the last decade. Many of those activities have been designed in order to help recruit talented individuals from outside of the rail industry and retain them within the industry and they tend to focus on a specific audience: graduates, academics and/or professionals. This group of interested parties will be discussed in more details in Sect. 12.5.

The railway sector recognises that in order to keep rail talents within the industry it needs to improve the image of the sector and offer staff more opportunities to grow. The activities targeting rail talents who already joined the railway sector can take different forms and use different tools, depending on a scale and a budget. Examples of such activities include a 2-day paid event “Next Generation Rail” in the United Kingdom or an online platform “UIC e-Learning”, with courses currently under development, initiated by the International Union of Railways (UIC) for their members across the world.

A greater engagement of staff in the company’s activities and skills development supported by an employer aim to create a stronger bond between an employee and employer, but also create a space for employees’ skills and personal development for the benefit of both, the company and individuals. Table 12.3 shows examples of such activities targeting people already within the sector, from graduates through to academics and professionals (Table 12.3).

Many other activities targeting rail students, academics and professionals have been taking place around the world. For example, RailNewcastle intensive programme and conference, coordinated by Newcastle University, created a friendly atmosphere for knowledge exchange and promotion of careers in the rail industry (Marinov and Ricci 2012; Marinov 2013; 2015a, b; Fraszczyk et al. 2015b). It appears that many students around the world are not aware about the extensive benefits the rail industry has to offer to its employees.

UIC has been supporting rail talent and skills development in a number of ways. Their flagship project called Railway Talents (UIC Talent) started in 2014 and is aimed at attracting and retaining the talents into the rail industry. As the backbone of the project, UIC wishes to establish a strong and sustainable foundation for

**Table 12.3** Examples of rail talent recruitment and skills development activities

Targeted audience	Graduates (and professionals)	Academics	Professionals (and academics)
Title	UIC e-Learning	RailSkills (researcher links event with Brazil)	Next generation rail
Scale	International	Two partner countries	National
Country	Worldwide	UK–Brazil	UK
Frequency	Ongoing	One-off	Annual
Description	An online platform with rail-related e-Courses delivered by rail professionals and academics. (The project is under developments, December 2016)	A 5-day event for early career researchers from Brazil and the UK to exchange knowledge about rail research, update soft skills and plan future academic collaborations	A 2-day event for young rail professionals from academic and industry to showcase their work and network with colleagues
Tools	Online platform	Event, presentations, talks, group activities, networking, dinners, technical visits	Event, presentations, talks, group activities, networking, dinner, technical visits
Website	<a href="http://www.railtalent.org">www.railtalent.org</a>	N/A	<a href="http://www.rruka.org.uk">http://www.rruka.org.uk</a>
Social media	Twitter:@uic	N/A	Twitter:@RRUK_A

fostering international cooperation among the young and experienced talents in the railway industry.

One important aim of the project is also to facilitate the process of knowledge, values and experience sharing between different generations of railway people, as well as to stimulate the active dialogue between cultures and generations.

According to a report published by the European Transport Research Alliance (2014, p. 12): “The multidisciplinary nature of the Transport industry requires competencies from multiple bodies of knowledge, matching with the multidisciplinary character of mobility systems”.

After having identified a number of specific challenges, the reports makes a series of recommendations, one of them calling for the creation of (European Transport Research Alliance 2014, p. 23):

- “New courses and programmes (more flexible and not focusing on fundamental disciplines only);
- Specialisation courses offering higher flexibility, tailored contents, operational and practical subjects; and through offering well designed and coordinated at European level;
- Lifelong Learning and Vocational Training courses.”

How to provide these new courses and programmes in a sector, which is in constant evolution, is a burning question. Also, issues on how to make these learning opportunities accessible to all, whether full-time students or busy professionals, need to be recognised. To address those challenges, the UIC Talent project is currently exploring the potential of online learning (e-Learning) as a mean to attract and develop talents in the rail sector.

Using two learning modules as a test bed, the UIC Talent team is currently designing a learning environment with the goal of providing learning opportunities that are as follows:

- **Flexible**—different paths are available to achieve one’s own learning objectives. When participants register to a learning event or programme, they usually come with their own agenda. The level of engagement can range from interested to committed, from “I would like to know more about this subject” to “I need to get that certificate for my career”. Some participants only interested in a very specific part of a programme might leave once they have received what they came for. Others who join as interested can become committed once they start interacting with the learning material, the other participants and the tutor.
- **Self-paced**—learn at one’s own pace and in one’s own time.
- **Authentic**—develop competencies through challenging and meaningful learning activities.
- **Collaborative**—benefit from the collective intelligence of a community of practice.
- **Reflective**—connect learning to previous learning and future actions.
- **Evolutive**—the course grows over time through the contributions of the participants.
- **Recognised**—credentials (badges, certificates, etc.) enrich participants’ professional profile.

The development of the UIC e-Learning platform is a key component of the UIC Talent project, the initiative aiming at preparing a new generation of railway talents working on domestic and international challenges. The e-Learning courses are developed in cooperation with several stakeholders, namely RailUniNet. Another initiative within the UIC Talent project is the design of an e-Careers website, to support the railway industry in their continuous search for best talents.

In addition, other examples of events targeting rail talents within the sector include, e.g.:

- NSAR-Connect (UK);
- INNOTRANS Career Concept (Germany);
- Next Generation Rail (UK);
- RailExchange, United Kingdom and Thailand.

## 12.5 Targeting Talents from Outside of the Rail Sector

Public (customer) engagement (and outreach), as mentioned in Sect. 1, is an important two-way process aimed at achieving benefits for both the public and the company involved.

From a railway company's perspective, a well-organised public engagement is essential for at least for two reasons:

- it helps to build a positive brand as it shows that a company cares about something/someone (e.g. "Adopt a Station" scheme in Scotland);
- it gives people (customers and non-customers) an opportunity to "meet" the company and its employees and learn more about it.

Network Rail, a rail infrastructure manager in the United Kingdom, set three objectives for their community (public) engagement activities (Network Rail 2014, p. 24):

1. "To contribute time and money to good causes through the charitable giving and actions of employees;
2. To address key social issues through strategic national social programmes and partnerships;
3. To invest in the local communities within which we operate".

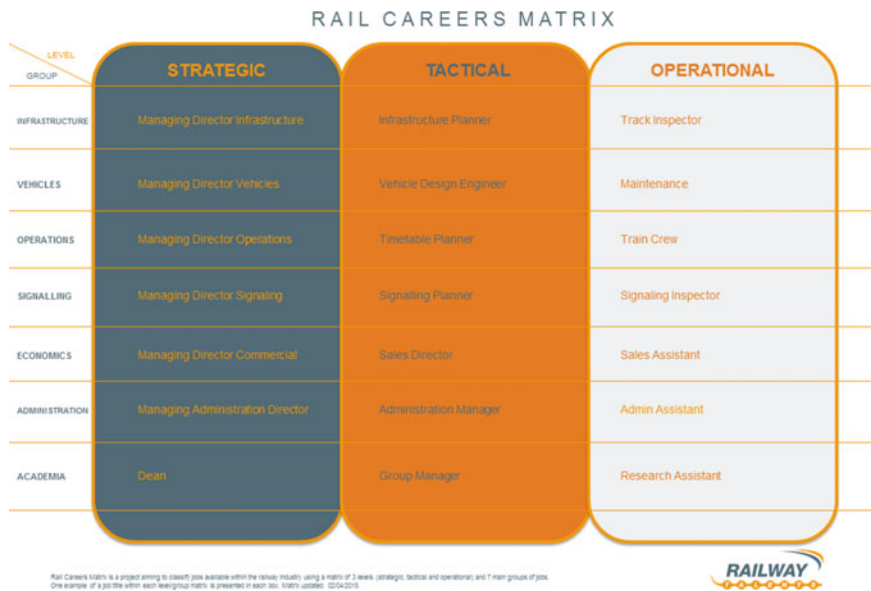
The three objectives show clearly the direction of Network Rail's public engagement activities, which aims to benefit charities and national programmes (e.g. STEM programmes in schools), but also maximise social benefits of the railway network to local communities and to the company itself. In a longer run, the company's image can be potentially improved and a stronger brand image with a serious social responsibility action can be created.

Other rail membership-based organisations as well as individual companies run events, campaigns and initiatives directly targeting customers as well as potential clients in order to introduce them to the world of career in the rail sector. Scope of the outreach activities vary and are dependent on a desired scale and a budget. Variety of careers in the railways is showcased on Fig. 12.1 as well as in Table 12.4.

Rail Careers Matrix distinguishes between three levels and eight job categories (Fig. 12.1). The Matrix was developed within the UIC Talent project and is publicly available on the project's website ([www.railtalent.org](http://www.railtalent.org)).

Richness of railway jobs is also visible in Table 12.4, which features examples of four job families and job titles in the railways. However, Sheldon and Wallace (2014) identified the total of 24 job families with 121 related jobs in the railway sector, which shows the scale of this "hidden" career path.

More recently, the railway industry is becoming more active online in promoting careers in the railways. Online initiatives such as Rail Careers portal in Australia ([www.caricareers.net.au](http://www.caricareers.net.au)), Global Rail Jobs ([www.globalrailjobs.com](http://www.globalrailjobs.com)) website for jobseekers or the UIC e-Careers, currently under development, all aim to give a free



**Fig. 12.1** Rail careers matrix developed by Railway Talents project source: (Railway Talents 2017)

**Table 12.4** Examples of job families in the railways

Rail job family	Job title
Engineering	<ul style="list-style-type: none"> <li>• Signalling engineer</li> <li>• Electrical engineer</li> <li>• Civil engineer</li> <li>• Environmental engineer</li> <li>• etc.</li> </ul>
Trades and technicians	<ul style="list-style-type: none"> <li>• Infrastructure workers</li> <li>• Cable jointer</li> <li>• Electrical lines worker</li> <li>• Telecommunications worker</li> <li>• etc.</li> </ul>
Operations	<ul style="list-style-type: none"> <li>• CCTV operator</li> <li>• Fire officer</li> <li>• Timetable officer</li> <li>• Train driver</li> <li>• etc.</li> </ul>
Corporate support	<ul style="list-style-type: none"> <li>• Accounts officer</li> <li>• Public relations officer</li> <li>• Web designer</li> <li>• Rail safety investigator</li> <li>• etc.</li> </ul>

Source based on Sheldon and Wallace (2014)

and transparent access to the world of rail job vacancies to talented people from outside of the sector. However, more variety of appropriate marketing tools should be used for a better promotion of such services if they want to attract talents who

**Table 12.5** Examples of rail outreach and public engagement activities

Type of initiative	Event	Organisation	Project
Title	Rail careers week	Women in rail	Railway Talents
Audience	School children, general public	Women, men, railway staff	Talents in and beyond railway sector, general public
Scale	National	National	International
Country	Australia	United Kingdom	Worldwide
Frequency	Annual	Ongoing	Ongoing
Description	A week full of activities organised by rail industry to showcase variety of careers in the railways	An organisation promoting and supporting women working in the railway sector	A project run by International Union of Railways focusing on promotion and retention of talents in the rail industry worldwide
Tools	Events, technical visits, video	Events, mentoring, social media network	Website, training, social media network, Railway Talents' Ambassadors and RailUniNet sub-projects
Website	<a href="http://railcareers.net.au">http://railcareers.net.au</a>	<a href="http://www.womeninrail.org">www.womeninrail.org</a>	<a href="http://www.railtalent.org">www.railtalent.org</a>
Social media	Twitter: @AustRail	Twitter: @WomeninRail	Twitter: @railwaytalents

would perhaps not think about a career in the railway sector. Therefore, substantial increase in visibility of those portals must be achieved if recruitment results are expected to reach the pool of talents globally.

An active engagement of railway industry in career events, professional organisations and skills development projects can only help to promote railway careers to the right audience. Examples of such activities are presented in Table 12.5.

Another good example of an outreach activity targeting students from outside of the world of rail is a research placement scheme at NewRail, Newcastle University, which runs since 2012. The scheme has been offered to both, A-level Maths students (age 17+) and university students (age 19+; any course) who applied either for a Nuffield Research Placement or a Newcastle Work Experience job. Over a period of 4–6 summer weeks, students work on a Maths project with a rail flavour. They learn IBM SPSS software and the basics of data collection, cleaning and analyses. As an outcome a number of papers with students' input have been written and published in scientific journals or presented at conferences (e.g. Fraszczyk et al. 2015a, b, 2016). While being on a placement, students apply their Maths knowledge, but also improve their rail competences and soft skills, including teamwork and work ethics.

Other examples of public engagement/outreach activities targeting audience from outside the railway sector are as follows:

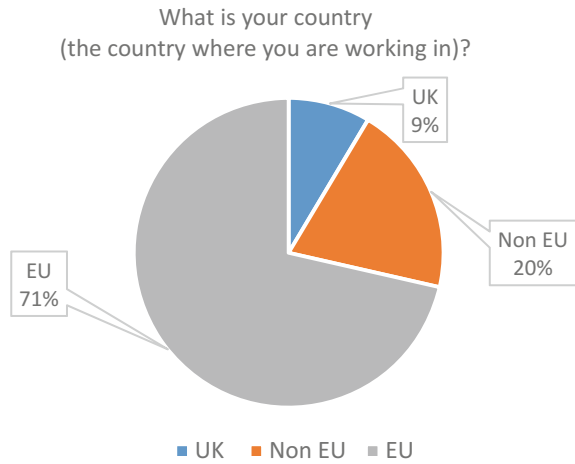
- Enjoyment to Employment (UK)
- Rail Safety Week (Australia)
- Railway Talents' Ambassadors (International)
- Rail Week (UK)
- LA Metro Entry Level Trainee Programme (US)
- Railway Talents (International)
- IMECHE Rail Challenge (UK)
- Routes into Rail (UK)
- Young Rail Ambassadors (UK)
- Adopt a Station (Scotland)
- Amtrak National Train Day (US)
- Rail Day and Railroad Night (US)
- iRail competition (UK)
- GenYRail (UK)
- Youth Transport School (US)
- Station Master game (International)
- Women in Rail (UK)
- Young Rail Professionals (UK)
- Level Crossing Awareness Day (International)
- SNCF Girls Day (France)
- UIC e-Careers (International)

## 12.6 Skills and Jobs for Rail

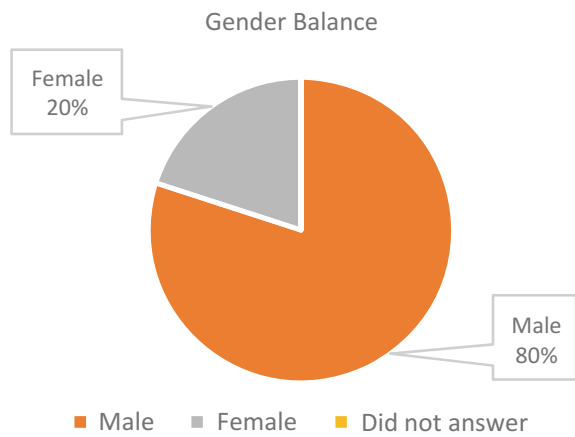
We live in a time of change. Industrial revolution has taken its place, brought many developments into fruition and paved the way towards the era of electronics and wireless communication. It did not come without a price though. It is a commonly held opinion that due to industrial revolution in the past there is now pollution and climate change. As a result, actions have been taken to reduce pollution and influence climate change by developing and promoting environmentally friendly technologies and transport modes. Due to its credentials the railways have taken a top position. The rail operation now is not the same as it was before. The whole railway industry is in the verge of modernisation now, following current changes in the international transport market. These changes require new skills as they create new jobs and job categories. Once new jobs have been created, old jobs are no longer needed.

In the quest of gaining a better understanding about this situation a short scale survey on the rail skills and jobs has been organised within the SKILLFUL project (Skillful 2017). 35 responses have been collected. Geographical coverage of respondents was well spread but still dominated by EU member states, as shown in Fig. 12.2.

**Fig. 12.2** Geographical coverage of respondents



**Fig. 12.3** Gender ratio of respondents



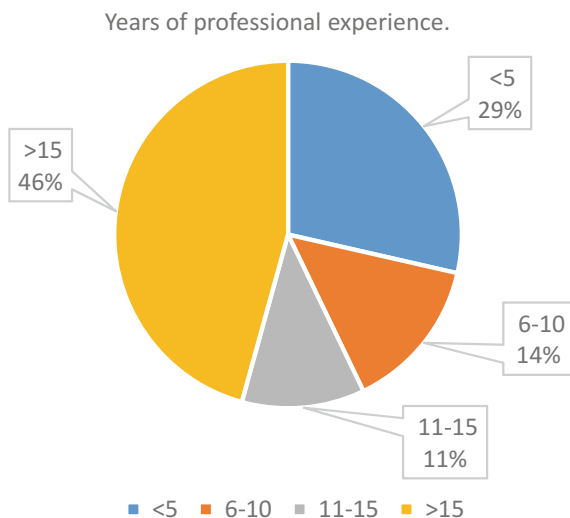
Gender ratio of the survey’s respondents is 28 males versus 7 females (Fig. 12.3).

Professional areas of respondents include:

- Operations, Management and Engineering
- Research
- Logistics & OR
- Spatial Planning
- EU Integration
- Business and Adult Education
- Electronics, Telematics, Ground Penetrating Radar
- Safety and Security
- Project Management



**Fig. 12.4** How many years have you worked in the rail industry?



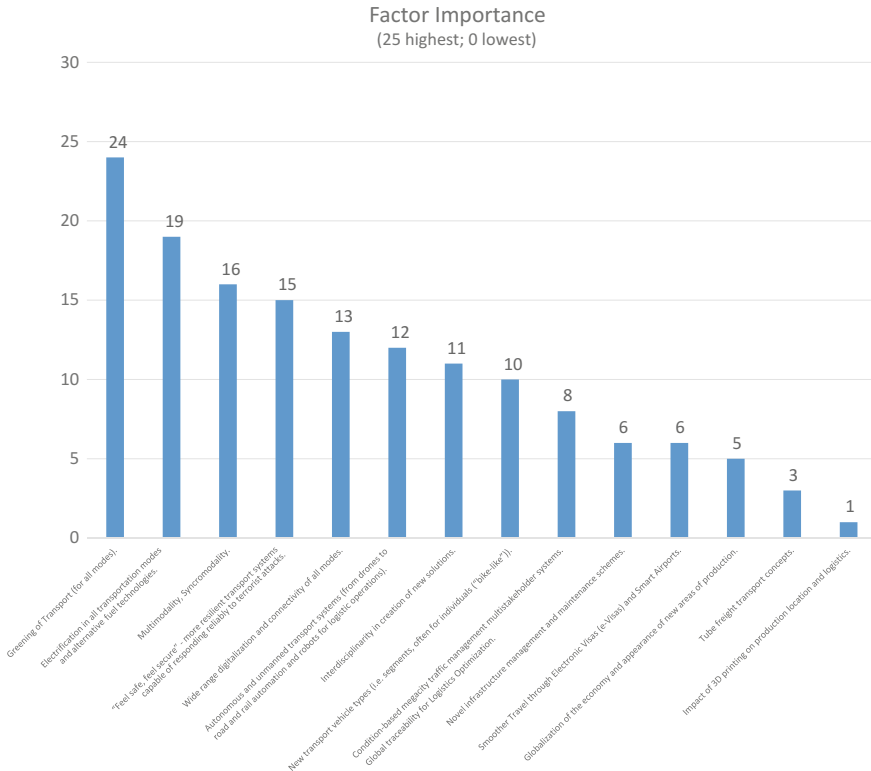
Years of professional experience amongst the respondents are rather good with slight dominance of respondents who have worked in the sector for more than 15 years (Fig. 12.4).

As for respondent work positions, they include:

- Directors
- Postdoc Fellows
- Teaching Assistants
- Consultants
- Senior Researchers
- Researchers
- University Teachers/Professors
- General/Technical Manager
- Industry/Others

The respondents were asked to identify the most crucial factors causing changes in the entire transport sector. Some suggestions were given as shown in Fig. 12.5. The responses collected suggest that the top five crucial factors are:

1. Greening of Transport (for all modes).
2. Electrification in all transportation modes and alternative fuel technologies.
3. Multimodality, Syncromodality.
4. “Feel safe, feel secure”—more resilient transport systems capable of responding reliably to terrorist attacks.
5. Wide range digitalization and connectivity of all modes, followed by autonomous and unmanned transport systems (from drones to road and rail automation and robots for logistic operations).



**Fig. 12.5** Potential factors causing changes in the transport sector

Factors that appear to have less importance for upcoming changes in the transport sector are as follows:

- Globalisation of the economy and appearance of new areas of production.
- Tube freight transport concepts.
- Impact of 3D printing on production location and logistics.

The respondents were asked to identify the potential jobs and work positions, which are likely to vanish in the near future. The outcome of the survey suggests that the job categories, which are most likely to vanish, include: Drivers (train, tube, bus, taxi, subway–tramway), Human drivers (Truck, taxi, tram, train, etc.), Assistant Engine Drivers, Shunting Drivers, Train Drivers in short distance, HGV/Freight vehicles.

This change will be caused by: complete automation, robotics, application of ICT, automatic and remote shunting (partly reality), driverless trains, AI and IoE. For short distance public transport, there will be no drivers, hence, no rostering required. Automatic or semi-automatic train driving with human intervention in the event of failure will be in operation instead.

Next job categories, which are likely to vanish, include: Ticket sellers, Tickets vendors, Sales, Street Sellers, Small retail sellers, Ticketing, Tool stations. Causes for this include the implementation of ticket vending machines, modern technology, automatic payment, smart payments, digitalisation, multimodality and syncromodality, mega cities and multi-stakeholder.

A job category which includes: Manual Operators, Factory workers, Machine Operators, Warehouse Operatives, Conductor, Shunter, Loaders/unloaders (Terminals/warehouses) and simple manual jobs can be easily replaced by automation and monitoring, therefore, is also likely to vanish due to: automation, robotics, digitalisation, AI, 3D printing, IoE, IT, automatisisation, automated transport, greening, electrification/battery technology.

As some jobs will vanish, new jobs and work positions will emerge. Hence the respondents were asked to identify those jobs and job positions, which are likely to emerge in the near future. Job category, which is most likely to emerge, according to the respondents, includes: Supply chain manager/Controller, Urban logistics manager, Local Transport brokers, Global Freight Forwarder/Manager, Intermodal, Multimodal Transport Managers and Experts and Specialists.

The reasons for this job category to emerge are: New requirements for intermodal and multimodal operation/service, providing one stop shop solutions to customers, sustainability, cities expansion, displacement of people, open urban data, Improved remote control over transport fleets (IT) and robotics/automation, open urban data, expert systems, new data business models, need for real-time mobility without owning a private car, globalisation, digitalisation, multimodality and syncromodality, interdisciplinarity, mega cities and multi-stakeholder system.

Next job category, which is most likely to emerge, includes: Systems admin, AI experts, Digital Transformation Expert/consultant, ICT-based Jobs, Big Data experts, Data Analyst. People who will be working within this job category will need to be equipped with knowledge about AI, re-engineering process, identifying technological gaps, and coordinating with business units, IT-based system admin handling exceptions, handling and analysing big data sets, large datasets analysis to improve and optimise transport provision and public transport services.

Reasons for this job category to emerge are: automation of customer, order and production process, digitalisation, low investment with high returns. Innovators developing and maintaining automated system, RST architect, transport and railway engineers, automation engineers will be new jobs coming into light soon. For this job category to emerge it is necessary to reshape the existing transport system, implement new technologies and bring new solutions for more reliable services to ease people's travel choices and decisions. The current need for reliable public transport, which is more competitive and user friendly in order to encourage more people to use it will be met by the implementation of unmanned transport systems, digitalization, interdisciplinary solutions for a safer and more secure automated transport service.

It is very likely for some current jobs and work positions to experience transformation. As a result the respondents were asked to identify those jobs, which are

likely to change. Hence, service delivery, public transport operations and management, airport operators, marshalling operators, actual manual operator, supply chain management, terminal workers, train personnel, fleet manager, dispatchers are jobs which are very likely to change in the near future.

These jobs are likely to experience transformation because of: automation, real-time management, unmanned transport, 3D printing, globalisation, digitalization, interdisciplinary, multimodality and syncromodality, mega cities and multi-stakeholder system, safety and security, continuing competitive service and product developments from other modes. There is also a need for more analysis and fleet e-management, flexibility and real-time adaptation to changes, autonomous/digitalization, development of novel infrastructure, speed connectivity. Ageing society has also been identified as one of the reasons for such transformations.

These transformations will lead to self-operating system handling maintenance, product and service delivery using ICT, data science, data analysis and visualisation, e-fleet management, digital interface with autonomous vehicles and robots. More understanding of information technology, systemic view, multidisciplinary approach for customer's orientation will be in place.

For Product managers, Logistics Specialist, ICT Solutions, Multiple vehicle management, Freight e-management there will be changes as well. This is because of integration in supply chain management, digitalisation, data acquisition and analysis. Demand for sustainable "green" freight delivery, reduction of long distance containerisation, emergence of circular economy. New competences will be required in supply chain, combining data from multiple origins and using predictive analytics, cloud-based solutions, big data, security, development of ICT competencies, data analysis, multimodality, sustainability.

The job of transport planners has also been identified as one that is going to change in the near future. This job category includes: Planners, Train scheduling, Scheduler, Transport systems planner/designer. Reasons for this are: developments in IT and integrated planning, open urban data, big data, Internet of things, globalisation, digitalization, interdisciplinary, multimodality and syncromodality, mega cities and multi-stakeholder system, novel infrastructure.

It has been suggested that a self-planning system-employing dynamic approaches for route planning; using real-time O-D matrices and simulation will be developed. This system will be based on: systemic view, multidisciplinary approach and will be fully customer-orientated.

As the job of transport planners will experience changes, so will the job of maintenance staff. Specifically Maintenance Engineer, Fleet Maintenance workers and managers, Onsite/Outdoor maintenance staff. Autonomous and unmanned systems, electrification, novel infra, safety and security, data acquisition and analysis, new maintenance standards for clean vehicles, automation were identified as causes for such a change to happen.

Hence, maintenance staff will need to be equipped with skills to master and operate with ICT tools, expertise in diagnosing and rectifying faults in advanced

electronic sensor and control systems and networks (both wired and wireless), e-vehicles, ICT, real-time controls, GSM-radio, higher IT skills or skills to deal with expected automation.

## 12.7 Conclusions

This chapter summarised and presented crucial concepts, models and current developments in rail marketing and public engagement as well as rail jobs: present and future. It is the comprehension of the authors that this area has not been developed enough and therefore would require significant attention in the near future if the railways are to improve their position in the media and promote themselves as a reliable transport service provider and preferred employer.

**Acknowledgements** The SKILLFUL project funded by the European Commission. The SPECTRUM project funded by the European Commission. The Railway Talents project funded and managed by UIC.

## References

- Economic and Social Commission for Asia and the Pacific (1998) Marketing the railway product in Asia and the Pacific region. United Nations. <http://www.unescap.org/sites/default/files/marketing-fulltext.pdf>. Accessed 1 Feb 2017
- European Transport Research Alliance (2014) Education and training issues for the transport researchers of the future European Research Area (ERA/T). [http://www.etralliance.eu/Portals/0/ETRA%20report%20on%20Education%20and%20Training%20issues\\_final.pdf](http://www.etralliance.eu/Portals/0/ETRA%20report%20on%20Education%20and%20Training%20issues_final.pdf). Accessed 1 Feb 2017
- Fraszczek A, Brown P, Duan S (2015a) Public perception of driverless trains. *Urban Rail Transit* 1(2):78–86
- Fraszczek A, Dungworth J, Marinov M (2015b) Analysis of benefits to young rail enthusiasts of participating in extracurricular academic activities. *Soc Sci* 4(4):967–986
- Fraszczek A, Lamb T, Marinov M (2016) Are railways really that bad? An evaluation of rail systems performance in Europe with a focus on passenger rail. *Transp Res Part A Policy Pract* 94:573–591
- Kotler P, Armstrong G (2012) Principles of marketing, Fifteenth edn. Pearson, New York
- Marinov M (2013) Introduction: handbook: an intensive programme in railway and logistics. *Res Transp Econ* 41(1):1–2
- Marinov M (2015a) Editorial: Special Issue, Rail Newcastle Conference 2015, *Urban Rail Transit and Light Rail*. *Urban Rail Transit* 2015, 1(2): 69–70
- Marinov M (2015b) Introduction to the special issue on rail operations, management and economics. *Res Transp Econ* 54: 1
- Marinov M, Ricci S (2012) Organization and management of an innovative intensive programme in rail logistics. *Proc Soc Behav J* 46:4813–4816
- National Co-ordinating Centre for Public Engagement (2017). [www.PublicEngagement.ac.uk](http://www.PublicEngagement.ac.uk). Accessed 1 Feb 2017
- Network Rail (2014) Network Rail Sustainability Update 2014—Community. <http://www.slideshare.net/GarethLlewellyn/network-rail-sustainability-update-2014>. Accessed 1st Feb 2017

- NSARE (2013) Forecasting the skills challenge. Report
- Oxford Dictionaries (2017). <https://en.oxforddictionaries.com>. Accessed: 27th Jan 2017
- Panteia and PwC (2015) Analysis of the trends and prospects of jobs and working conditions in transport. [https://www.panteia.nl/uploads/sites/2/2016/12/ReqNo\\_JRC95093\\_Final-report-Panteia-Report-1.pdf](https://www.panteia.nl/uploads/sites/2/2016/12/ReqNo_JRC95093_Final-report-Panteia-Report-1.pdf). Accessed 1st Feb 2017
- Rail Professional Asia Pacific (2016) Ditsapol Padungkul. September 2016 issue, pp 12–17
- Rail Technology Magazine (2016) A one industry call for skills development. December 2016/January 2017 issue, pp 24–25
- Railway Talents (2017) Rail careers matrix <http://railtalent.org/rail-careers-matrix>. Accessed 1st Feb 2017
- Sheldon N, Wallace M (2014) Report on the career pathways guide for the Australasian rail industry. CRC
- SKILLFUL (2017). <http://www.skillfulproject.eu>. Accessed 3rd Feb 2017
- SPECTRUM (2015) Electronic handbook. <http://www.spectrumrail.info/handbook/mobile/index.html#p=1>. Accessed 27 Jan 2017

# Chapter 13

## New Technologies and ITS for Rail

Florin Codrut Nemtanu and Jörn Schlingensiepen

### 13.1 Introduction to ITS

The technical progress has a huge influence in promoting new solutions and concepts and the transport market is facing a new era. This era is defined by ITS and new technologies applied in the transport sector and the increase in efficiency.

Before discussing the usage of Intelligent Transport Solutions in the transport industry it is important to define what can be known as an ITS. The definition of ITS is “Intelligent Transport Systems: These are applications of electronics, IT and communication technologies in the field of transport, that result in the increase of efficiency and the reduction of negative effects from the transport system (pollution, waste time, accidents, etc.)”. From this definition, it is important to note that ITS and their applications are very much multidisciplinary approaches involving electronics, IT and communication technologies, computer science, artificial intelligence, social sciences and psychology to name just few areas (the technical and operational requests of infrastructure operators and drivers are fundamental during the design phase of the system).

The integration of Intelligent Transport Solutions among the transport systems is one of the biggest challenges for their implementation. This integration has two main directions: the integration of transport modes (multimodal transport system, multimodal interchanges, etc.) and the integration of information (this will be included services and businesses). These integration could be done based on the common architecture of the transport system which will include not only the traditional component of transport systems (as vehicles and infrastructures are) but

---

F.C. Nemtanu (✉)

Transport Faculty, Politehnica University of Bucharest, Bucharest, Romania

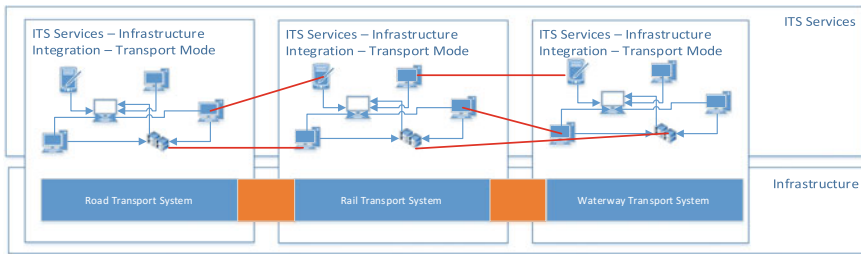
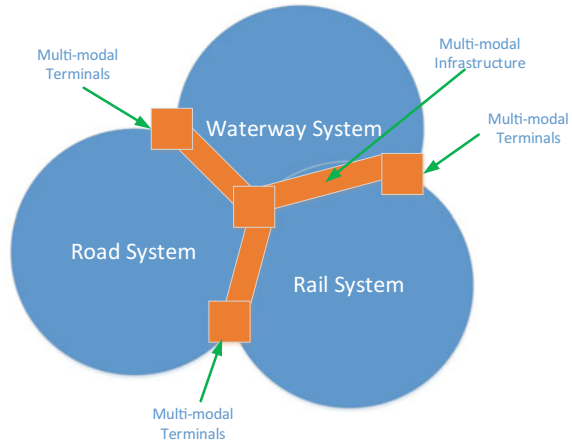
e-mail: florin.nemtanu@upb.ro

J. Schlingensiepen

Technical University Ingolstadt, Ingolstadt, Germany

e-mail: joern.schlingensiepen@thi.de

**Fig. 13.1** The integration of transport modes/systems



**Fig. 13.2** Horizontal and vertical integration of transport modes

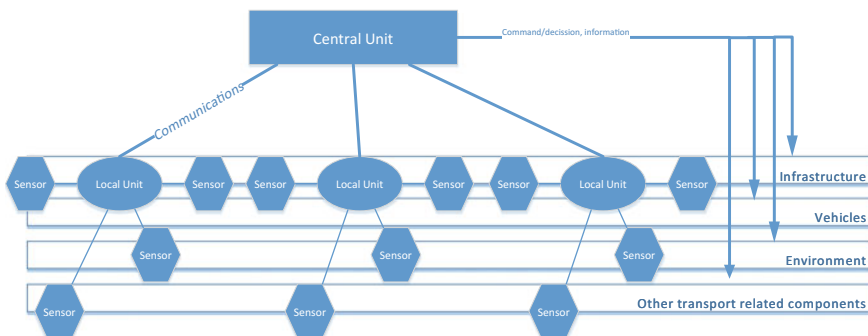
also new elements like intelligent infrastructure, smart interfaces, etc. (Nemtanu and Minea 2005; Schlingensiepen et al. 2015).

ITS are specific to all transport modes (road, rail, waterway, etc.) and it is important to consider their uses in transport based on a single system view Fig. 13.1, an integrated view (ITS for multimodal transport systems). ITS also play many different roles in transport systems for example in rail transport, ITS for operation, maintenance, information, management, asset management and so on Fig. 13.2. Management, operation and traveller information are services provided by intelligent transport services. Intelligent transport solutions also assist with aspects of safety and vary considerably in their geographic coverage with some solutions covering local transport and others covering regional or national areas depending upon their design.

Some solutions are fully automated and some are partly automated. From this brief discussion around the variety of solutions, Intelligent Transport Solutions are incredibly wide ranging in both their coverage and fields of application.

The development of ITS starts with a network of sensors which can collect data from transport processes and related phenomena Fig. 13.3. All collected data are





**Fig. 13.3** The main components of a generic ITS

transmitted to a centre, using the communication system, which processes all data in terms of supporting transport decision-making process and information systems.

The authors presented the use of ITS on the Road and on Inland Waterways as examples for Rail applications and the starting point for integration and combination of different transport modes.

## 13.2 Digital Railway

ITS for railway will pave the way for digital railway. Digital railway could be defined as the effect of digitalisation of rail operations and processes in terms of increasing the efficiency of railway sector and to facilitate multimodality approach of transport system to improve the mobility (at vary levels: continental, national, regional or urban). The first step in digitalisation of railway was done through the new electronic interlocking systems and ERTMS (Franklin et al. 2013).

The main advantages of digital railway are as follows:

- Increasing the capacity of the railway network (more trains);
- Better railway connections—integration inside of transport modes;
- Facilitating multimodality;
- Increasing the reliability;
- Decreasing the costs.

The main barriers in the development of digital railway are as follows:

- The shortage of professionals and skilled staff;
- The digital security issue;
- Initial investment costs;
- The lack of multimodal approach of transport digitalisation.

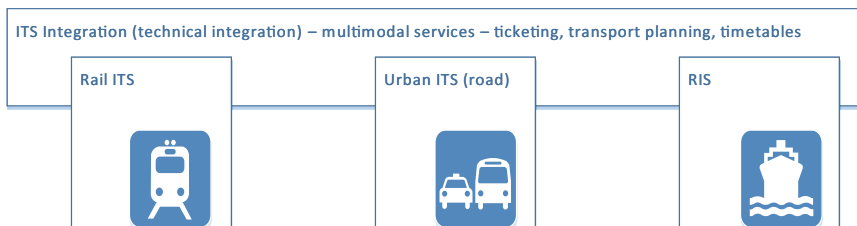
The following paragraphs will describe some new technological concepts which can support and accelerate the digitalisation of railway sector as part of a digital transport system.

### 13.3 ITS for Road and Inland Waterways

Intelligent Transport Systems concept was defined for road transport in the first place and afterwards the concept was extended for all transport modes. From rail transport perspective, it is important to understand the applications of ITS for road transport to find new solutions for rail transport as well as to find solution for multimodal transport system Road–Rail. There are numerous examples of the application of ITS on the roads. These can briefly be split into two categories, urban and interurban.

**Urban ITS**—uses of ITS in urban settings include Urban Traffic Control (traffic management, travel time information, air quality, multimodal integration and law enforcement), Public transport management (ticketing, traveller information) and Park and Ride. This urban ITS could be considered for both road and rail transport systems and the integration could be facilitated by the implementation of intelligent transport solutions in both transport systems. The recommendation of the authors is to integrate transport systems at the beginning (in the design phase) in terms of facilitating multimodal approaches. Urban ITS are also important in terms of transport terminals and the ITS supporting terminals and the movement of freight and passengers from one transport mode to another one Fig. 13.4.

**Interurban ITS**—use of ITS in interurban settings includes Traffic Management Centre's (traffic management, travel time information, incident management), sensor networks, information provision, communications and freight and logistics (Road user charging, intelligent truck parking, abnormal freight transport). Rolling motorway or highway could be a good example of integration between road and rail transport systems. For this kind of combined transport systems, the most important thing is the efficiency in terms of time (the duration of the trip using two or more



**Fig. 13.4** Integration of transport modes in urban area (technical integration)

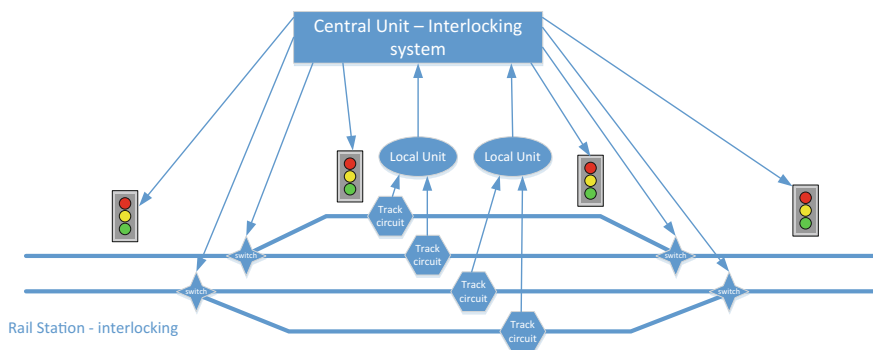
transport modes) and the cost (total cost of the transport for A to B, for both/all transport modes involved).

ITS are also used frequently on Inland Waterways with RIS (River Information Services) being the main example of utilisation of ITS on Inland Waterways. These services are defined as “modern traffic management systems enhancing a swift electronic data transfer between water and shore through in-advance and real-time exchange of information”. This shows that other transport modes are already using ITS in everyday operations. This discussion will now move onto the use of ITS in rail and potential developments in the future. RIS are mainly developed to provide information services to all ships (inland water ways, maritime and the transition between rivers and seas), and it is a good example and a best practice to be applied in Rail systems as well as to integrate these solutions with solutions from other transport modes.

### 13.4 ITS for Rail

Railway Companies have already used a considerable amount of ITS in their network. Some traveller information services and ticketing systems use ITS. However, the largest current utilisations of ITS in the rail system are interlocking (Fig. 13.5) and the European Railway Traffic Management System (ERTMS). All the uses of ITS in rail are safety orientated; safety is inevitably the main aim of any innovation in Rail. For example, most ITS have safety fail safes in case of failure built in or feature a 2 out of 3, computer interlocking system. The ITS for rail systems started a lot of time ago with interlocking, signalling, train protection and other applications of electronics in railway transport systems.

The track circuit is considered the main sensor of the interlocking system is in charge to detect the presence of the train on a specific track part where the circuit is



**Fig. 13.5** Simplified structure of an interlocking solution (based on Fig. 13.3 The main components of a generic ITS)

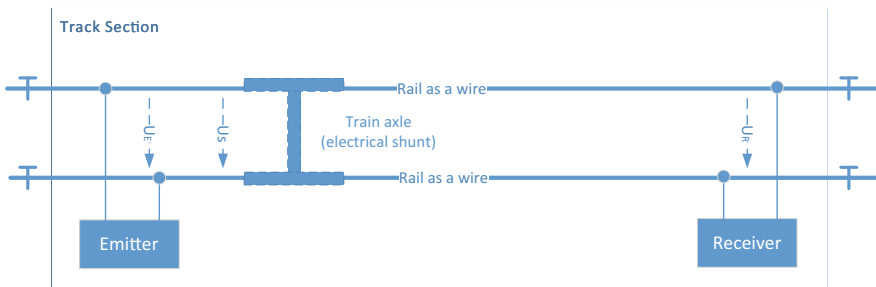
installed (Franklin et al. 2013). Central unit collects the data related to the presence of the train and makes decision about the route, the direction and the speed of the trains around the station. The decision is applied using signals and switches. This is a universal structure for ITS based on the network of sensors, communications and data processing units.

The track circuit is considered the main sensor at this moment and will be replaced by new technologies like GNSS and ERTMS. The main role of the track circuit is to ensure the train detection and the information of available railway resources (in this case free tracks which will be included in the new routes).

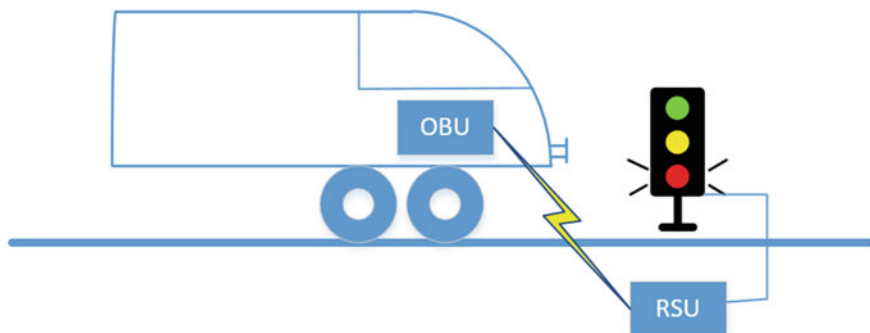
The principle of the track circuit as well as the role of it in railway system will be implemented using new technologies. The main aspect is to provide information about the availability of the track as well as the integrity of the trains.

The principle of a track circuit is to build an electrical circuit with an emitter, a receiver and a pair of wires (the rails are used as wires). The emitter will transmit an electrical signal (the voltage  $U_E$  in Fig. 13.6) to the receiver (the voltage  $U_R$ ) based on pair of wires. If the signal is received by the receiver the track section is free (the absence of the train). If the signal is not received by the receiver, the train is passing this section and the section is not able to be used by another train. Another important role of the track circuit is to check the integrity of the rails (if the rail is broken, the “wire” is broken and the receiver will not receive any signal; this case is similar with a track section occupied by a train—Fail Safe approach). The integrity and the functionality of the track circuit are also checked by track circuit itself (if the emitter is turn off the receiver will consider the track occupied by a train and will send this information to a specific signal and the signal will display RED).

The track circuit is the main sensor and the principle of the functionality of this circuit could be implemented based on new technologies. Three main conditions should be taken into consideration when a sensor is replaced with another one: the new one must be more reliable (the mean time to failure MTF must be increased), the new sensor should be at least at the same level of safety as the replaced sensor is, and the cost of introducing the new sensor should be lower than the cost of the previous one.



**Fig. 13.6** Track circuit (principle)



**Fig. 13.7** Train protection

The train protection is important to avoid the presence of two trains on the same track section. This train protection could be done using two principles: based on fix track circuit with the detection of the train on a fix track section and based on virtual or moving track section (moving block)—the section will be defined as a virtual section and if the distance between trains is going under a safety limit the train protection will act the breaks of the train.

In Fig. 13.7 is presented the first principle (this is used at this moment on majority railway networks) and this is based on the existence of two main components: RSU (Rail Side Unit; in ERTMS this component is called LEU—Lineside Electronics Unit) this is installed on rail side and has the main functions to collect information from the signal and to send this information to the train (OBU) and OBU (On-Board Unit)—this is installed on the board of the train and has the main functions to receive information from the RSU and to stop the train (if the situation asks this—the train is passing a RED signal).

## 13.5 ERTMS

European Railway Traffic Management System is a new concept and all European countries (not only European countries, Australia has a good trend in developing this system) are working to implement this system and to mitigate their system to this new concept (EC 2016; UNIFE 2016).

The ERTMS is a major example of the use of ITS in rail and a good example in terms of applying the standards in ITS. It has two main components:

- ETCS—European Train Control System: movement authorities, train protection, signalling
- GSM-R—Global System for Mobile Communication—Railway—this system is similar with GSM but is more oriented on railway transport and its constrictions, especially related to safety problem (UIC 2016).

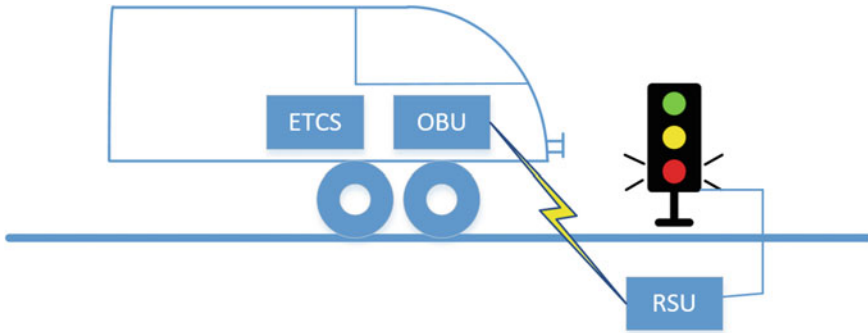


Fig. 13.8 ETCS level 0

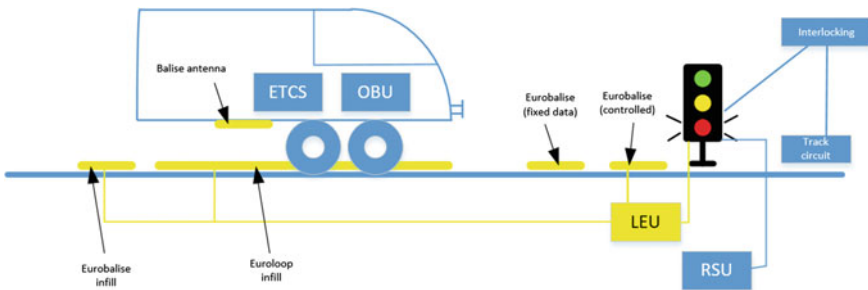


Fig. 13.9 ETCS level 1

ETCS is specified at four different main levels:

- Level 0: ETCS-compliant locomotives or rolling stock interact with lineside equipment that is non-ETCS compliant, Fig. 13.8. Level 0 is a transition step from existing interlocking and signalling system to ERTMS (this step is focused on trains and rolling stock).

ETCS level 0 is the case of trains equipped with ETCS which are passing the railway network without any ETCS implementation. This step is present at the migration from actual state of development to ETCS-compliant railway network. This level is a consequence of multistep implementation of ETCS and the fact that the trains must be able to pass all types of railway sections.

- Level 1: ETCS is installed on lineside (possibly superimposed with legacy systems) and on board; spot transmission of data from track to train via ETCS balises, Fig. 13.9. The system can manage both trains, with and without ETCS on board.

This level is also important for migration to ETCS. The legacy systems are interfaced with ETCS-compliant trains and ETCS is working in parallel with the existing systems. The data is transmitted only in spots.

- Level 2: Same as level 1, but ETCS data transmission is continuous; the currently used data carrier is GSM-R, Fig. 13.10.

Another component of ERTMS is involved in this level, GSM-R. GSM-R is a mobile communication network which is similar with GSM but it is adapted to safety conditions and the context of railway transport system. Radio Block Centre (RBC) is in charge with the movement of trains and the communication support is provided by GSM-R. There are also Eurobalises but, their role is only for position calibration. The transmission of data is continuous; there is a permanent communication link between the trains and the RBC or lineside equipment. Track circuit and other trackside sensor are the main components to detect the position of the train (as well as the integrity of the train).

- Level 3: Same as level 2, but train location and train integrity supervision no longer rely on trackside equipment such as track circuits or axle counters, Fig. 13.11.

The level 3 is similar with level 2 but the position of the train is detected by the train itself (as well as the integrity of the train). These functions are very important because the RBC must establish a reliable communication link with the train to receive the position and the integrity information from the train.

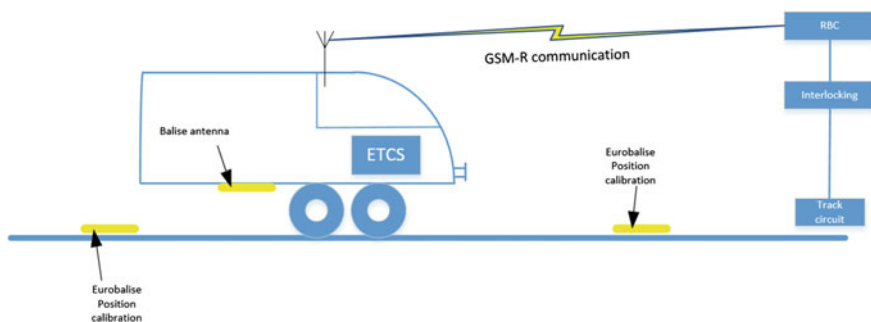


Fig. 13.10 ETCS level 2

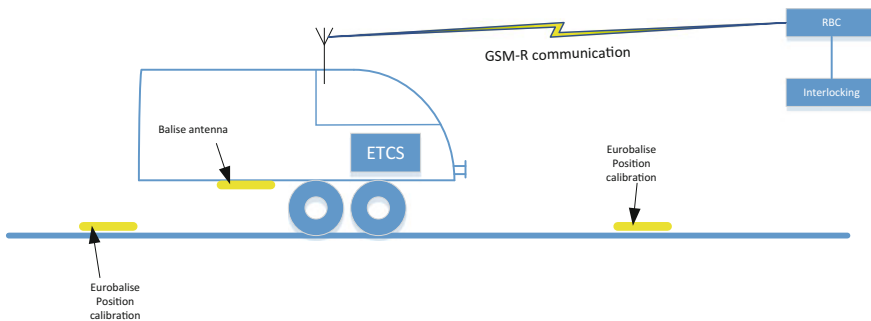


Fig. 13.11 ETCS level 3

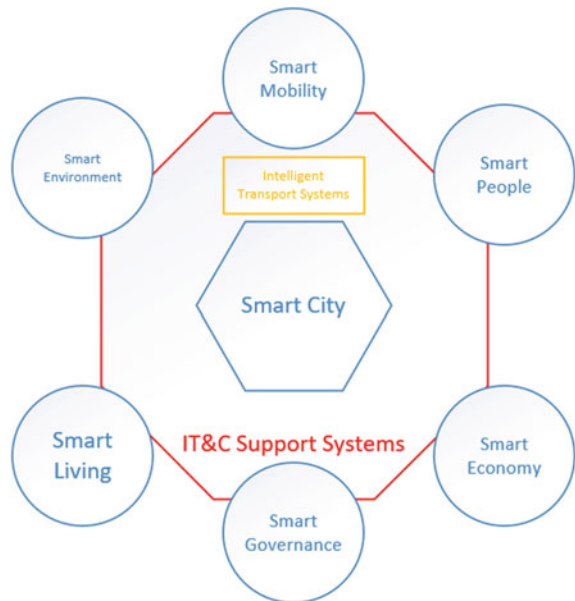
### 13.6 Smart Mobility

Smart mobility is a key concept for the future. Smart mobility refers not only to the transport of people and goods but to mobility of people and goods as a high-level service. Smart mobility is also one of the six main components of a “smart” city, Fig. 13.12: mobility, people, economy, governance, environment and living (TU—Wien 2014; Nemtanu et al. 2016a, b). Mobility is defined as the ability to move or be moved freely or easily. Smart mobility has two main components: the smart technological system which will provide support for implementing the smart mobility and the smart approach of smart mobility as integrated part of a smart city (based on this approach the smart mobility is integrated will all components of a smart city).

ITS for all transport modes is the support system which can provide services having as objective the implementation of smart mobility in urban area.

The smart mobility as a component of a smart city should relate to all smart components of this type of city (this is the external view point on smart mobility). Smart mobility should strongly relate to smart economy, mobility services are part of this smart economy and the capital and market resources should be involved in the development of smart mobility. Smart people is another important component, human beings are involved in mobility not only as users or passengers but also as operators, staff and administrators (smart mobility should facilitate the smartness of people through increasing the accessibility as well as the access of people to a wide area of urban resources).

**Fig. 13.12** The components of a smart city





Smart governance is also involved in smart mobility in terms of leading the mobility activities and the mobility as part of the urban system. Transport systems and mobility services for people and goods have a strong impact on the environment. The smart environment approach should integrate all urban subsystems in a single concept and should decide for all components of the urban system. Smart living is mainly a result of all components and the quality of life could be measured in urban area based on several key indicators, the mobility and the accessibility are mainly the indicators which could affect the quality of life and smart living in the city.

Another view point on smart mobility is internal one, on the components of the mobility system which is in charge with the provision of smart mobility. This mobility system is mainly formed by urban transport system and it must include all transport modes. The integration of these transport modes is also a measure of the smartness of the mobility in urban area and this aspect relates to all components of a smart city, Fig. 13.13.

The smart city is based on IT&C support systems for all components. Intelligent Transport Systems could be considered as part of these support systems. There are two main approach of the integration of different components:

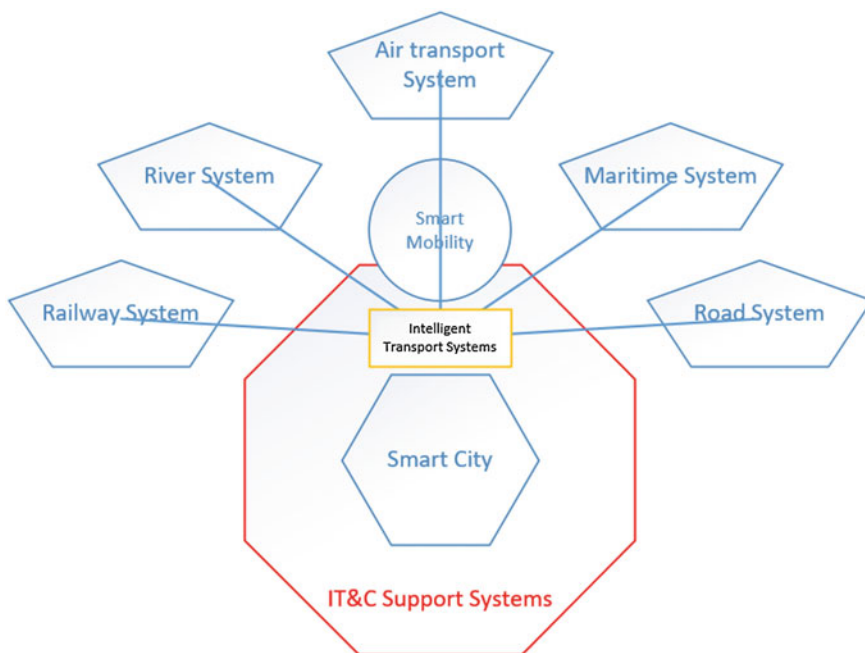


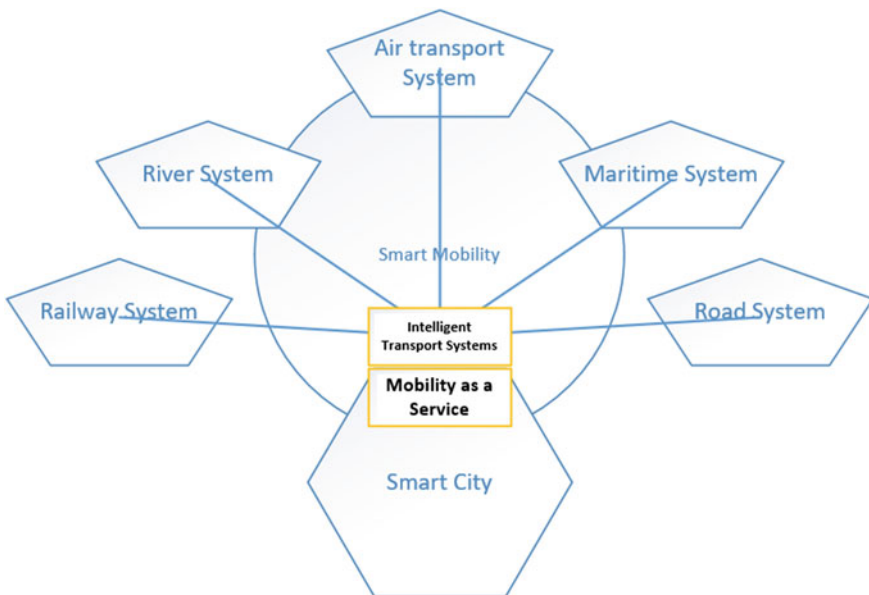
Fig. 13.13 Smart mobility and integrated transport system

- The integration of ITS components from all transport modes—the main scope is to have an integrated ITS for integrated or multimodal transport systems.
- The integration of ITS with all IT&C support systems—the objective is to have an integrated smart city support systems for all six components.

### 13.7 Mobility as a Service

Recent moves have been made towards Mobility-as-a-Service (MaaS) which is a concept related closely to the smart city approach [9]. MaaS describes a shift away from personally owned modes of transport and towards mobility solutions that are consumed as a service. This is enabled by combining transport services from public and private transport providers through a unified gateway that creates and manages the trip which users can pay for with a single account. Users can pay per trip or a monthly fee for a limited distance. New European initiatives such as MaaS Finland, ERTICO ITS Europe and Maas Alliance have attempted to implement this system in real life, Fig. 13.14.

Intelligent Transport Systems are defined as middleware in this new concept of Mobility as a Service and the main role is to collect information from all transport modes, included railway, and to provide ITS services for MaaS applications and systems (Nemptanu 2014; Nemptanu et al. 2016). Mobility as a Service is a service of



**Fig. 13.14** MaaS and smart mobility/smart city (ITS as middleware)

smart mobility in a smart city. Railway operators could have a main role in the development of MaaS through the involvement as MaaS operator and the MaaS support system could be developed around railway infrastructure and systems. Railway public transport could be considered as a backbone for MaaS, especially for conurbation and metropolitan areas.

### 13.8 Cloudification

The advent of cloud computing also provides opportunities for the transport industry. It provides access to all services at any time without the necessary direct link with hardware that was previously needed. It allows users of software to use a virtual computer and not a physical computer (as well as other virtual resources, storage, etc.). You can now use software online (Microsoft Office) and even use the cloud for data storage. The cloudification of logistics is a good study case of this process (Nemtanu et al. 2015), Fig. 13.15. That means the support of logistics processes is provided by applications and systems from cloud. However, a disadvantage in this development is potential lack of physical access to hardware which is not along with the user of the cloud services. Advantages though, include price (of virtual machines) and access to all types of services through the web. The cloudification of railway transport will facilitate the access of all passengers to railway transport services (Pacheco et al. 2016) and will pave the way for MaaS and other new approaches related to the mobility of people and goods.

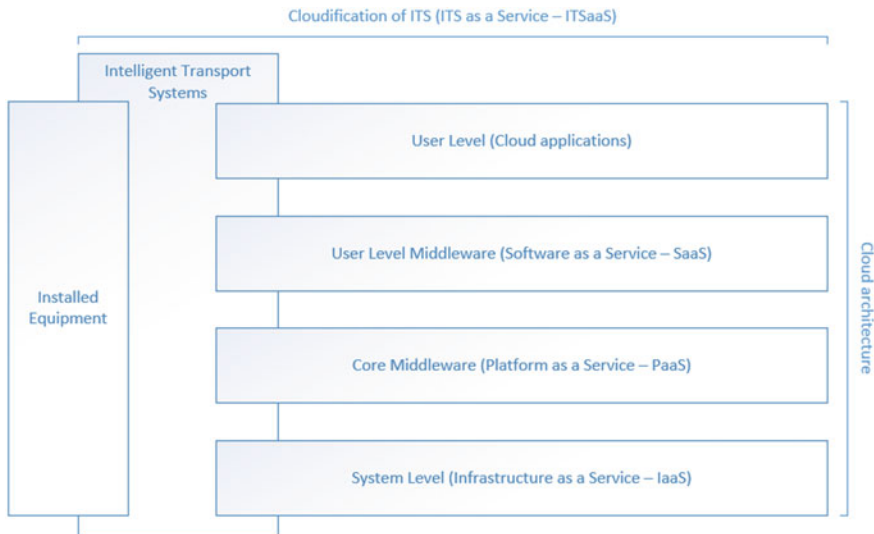


Fig. 13.15 Cloudification of ITS

ITS for all transport modes have two components: installed equipment which is basely the existing systems and some components in cloud (the cloudified components are more accessible in terms of cost and time). Based on the figure which is showing the cloudification of ITS, the concept of ITS as a Service could be also defined as ITS Services which are available without any infrastructure development from the user side and which are working in the same manner as a physical system. Railway systems could be also developed in cloud and new approaches and methods of ensuring the safety level could be implemented to support this.

### 13.9 Gamification

Gamification is defined as “the application of typical elements of game playing (e.g. point scoring, competition with others, and rules of play) to other areas of activity, typically as an online marketing technique to encourage engagement with a product or service”. In this case, the transport domain is the product or service. Objectives can include adaptation and more effective human–machine interaction, increased awareness and eco-driving. For example, drivers of any vehicle linked to this service can be rated on their eco-driving level with scores uploaded to a server. They can then be ranked based on scores and there is the potential to reward those who rank highest. In the case of eco-driving it also offers railway operators a means to assess each driver’s performance and target retraining appropriately to those drivers who are not driving efficiently.

The gamification is using the game related techniques and methods in non-gaming systems to improve user experience and user engagement (the main objective is to improve the efficiency and the productivity of the system where user is involved) (Deterding et al. 2011).

Gamification is the application of game elements and digital game design techniques to non-game problems, such as business and social impact challenges, Fig. 13.16.

The main role of gamification in railway systems as well as in any other transport systems is to optimise the activities and processes where human beings are involved. Based on similar approaches like games have, gamification of railway system will introduce new components in Human–Machine Interface (HMI) which will increase the efficiency of the system. The main implementation of gamification in transport system is, at this moment, in eco-driving (the drivers are playing a game during their driving activity and the main objective is to reduce the consumption and the environmental impact of their vehicles).

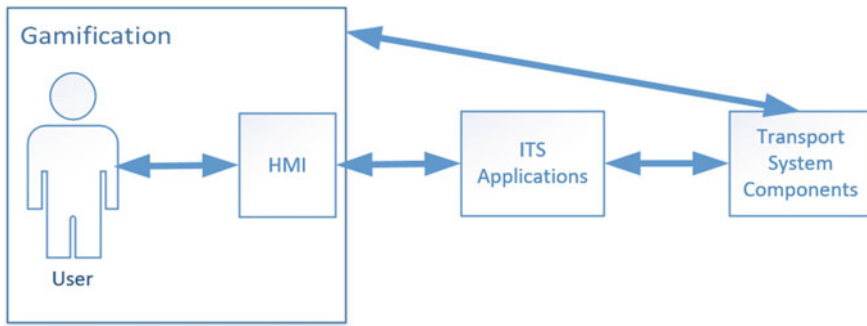


Fig. 13.16 Gamification in transport systems

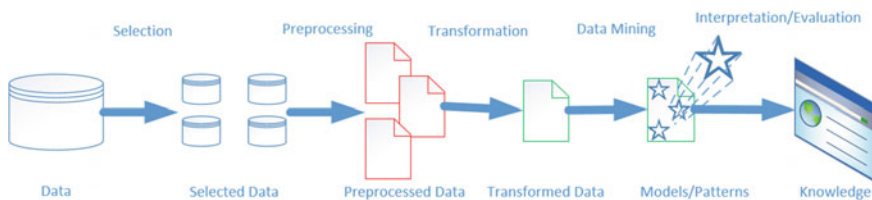


Fig. 13.17 Data mining process (based on data (Fayyad et al. 1996))

### 13.10 Data Mining

Data mining refers to an improved method of data collection, involving huge volumes of data being collected. The process then searches for patterns, relations and correlation within the data. The process of data mining has the following components:

- Selection of data from data sources in terms of defining the data base for data mining—databases, flat files, newswire feeds, etc.
- Preprocess data—collect data and specific data (it depends of the user’s requests), clean data and store data
- Transformation of data in a format which is suitable for data mining methods and techniques.
- Search for patterns or models and relations between data—queries, rules, statistics, etc.
- Interpretation and evaluation of the results—this is most important to underline the role of data mining

Data mining turns a large collection of data into knowledge and this new domain of data processing and manipulation was possible due the evolution and progress of information technologies and computer science (Han et al. 2012), Fig. 13.17.

Data mining is and could be used in railway systems as well as in any other transport systems. The data collected by sensors from tracks, trains and other railway components will be processed based on the process presented in Fig. 13.17, and the results of applying this process is to find some new links between existing data. One example of applying data mining is to find a relation between the failure of the communication systems of the railway interlocking system and the frequency of the maintenance activities on these systems.

### 13.11 Big Data

In big data, the number of sensors is increased, with various new data sources with interfaces between them leading to a process of data exchange. For example, in Road ITS, a variety of sensors are taking measurements every few seconds about traffic, etc. The volumes of data that are collected in the world every day is inestimable and therefore big data and data mining must operate concurrently so this huge volume of data can be efficiently used, Fig. 13.18. Behind this huge volume of data, a lot of different relations and correlations exists and all of them could be used to increase the efficiency of transport systems as well as the efficiency and the impact of ITS systems implemented and installed in railway systems.

In railway transport, every installed system as well as all components which can manipulate data could be a source for digital data. All these sources of data will provide a huge volume of data and there is a strong request for manipulating and processing them (the data could be unstructured or structured, it depends on the

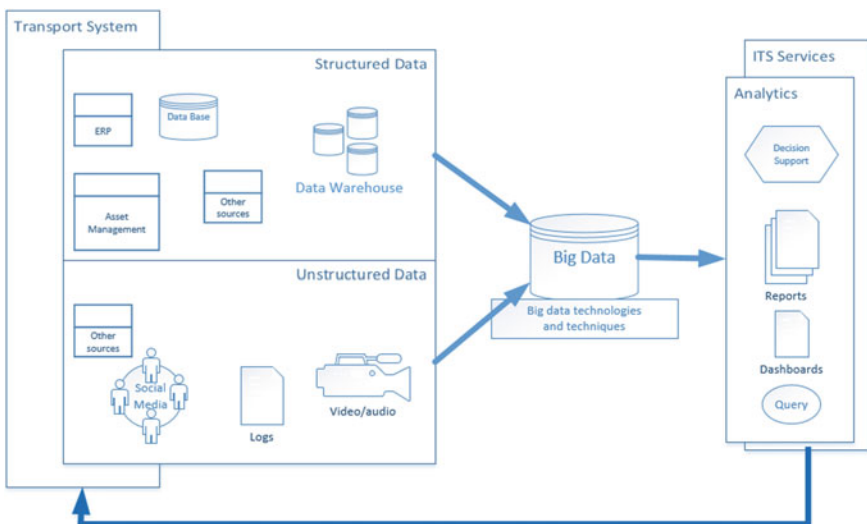


Fig. 13.18 Big data and ITS

source of data). This is the domain of big data and the solution is to use big data techniques and technologies to increase the level of services through accurate and reliable data and information as well as a quick response in time (real-time information). The big data concept has three main characteristics (3Vs): volume, variety and velocity. All these characteristics (the big data) will affect the way to take the decision in railway transport as well as in all transport systems. The prediction of the evolution of transport and traffic processes could be done based on big data solutions (Lv et al. 2014). The usage of big data in public transport was already done in several countries and in (Oort and Cats 2015) is presented the case of Sweden and Netherlands.

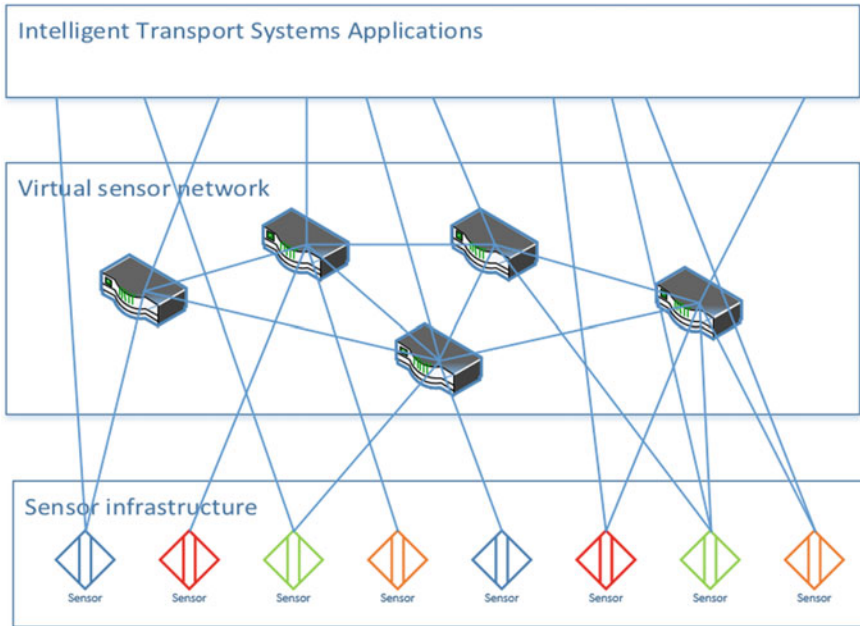
### 13.12 Network of Sensors

This refers to various new sensors being installed often “smart” sensors or sensors with connectivity. For example, modern smartphones can be classified as complex sensors. Smart sensors must be linked together in a huge network such as Google which uses the public’s smartphones as sensors relating to traffic. The main role of the network (network of sensors) is to collect real-time data from various processes and phenomena in terms of supporting the decision-making process in transport activity.

The network of sensors could be expended by virtualisation and virtualised sensors could be used in other applications, in this case for railway transport systems, Fig. 13.19. ITS for rail could work based on the sensors installed along the trackside and railway transport system components but also based on virtual sensor network which will provide data from various sensor without any direct connection to these sensors.

A well-known multimodal safety system is road–rail crossing signalling system which is based on rail sensors (for the detection of the trains) and which commands road traffic signals based on the information collected by rail sensors. These rail sensors could be integrated in a network of sensors and the information collected by them could be available for any other ITS applications and the railway system could play as a virtualisation service provider and could send the information from the sensors, as information from virtual sensors to any other railway system and transport system.

Application of wireless sensor network in vehicle location has already demonstrates that the sensor networks have multiple and wide application areas and they are suitable also for railway systems and applications (Postigo-Malaga et al. 2016).



**Fig. 13.19** Network of sensors

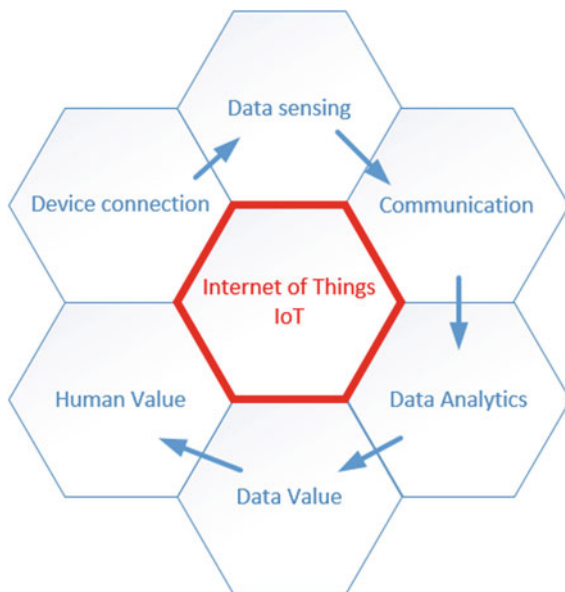
### 13.13 Internet of Things

The Internet of things is defined as “a development of the Internet, in which everyday objects have network connectivity, allowing them to send and receive data” (Buyya and Dastjerdi 2016; McEwen and Cassimally 2013; Chaouchi 2013), Fig. 13.20. For example, even objects such as refrigerators and washing machines are often now Internet enabled to increase connectivity. Such a development would have been unthinkable only a decade ago. Every component of the rail infrastructure or rolling stock will be able to establish an Internet connection and to exchange data with other similar components and the new concept will generate new approaches and solutions in terms of safety, environment protection and sustainability.

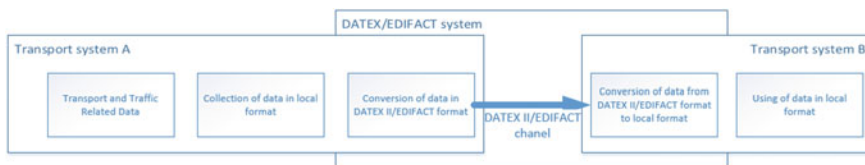
Every component of the railway infrastructure (for instance, signals) should be able to be connected to the Internet and communicate with other entities about the state or the functionality (a connection between the signal and the maintenance company will provide information about the state of the signal and the need for maintenance intervention).

The IoT is defined by connected devices (sometimes with embedded intelligence) the role of this devices is to collect data and to send this data over the Internet (using the communication systems). Next step is to do data analytics (Artificial Intelligence, Big Data, etc.) to find values for all data collected. The data





**Fig. 13.20** Internet of Things—Value chain (based on (i-Scoop 2016))



**Fig. 13.21** DATEX II/EDIFACT systems

value should be transformed into the human value. This chain should be applied also in railway transport, all railway related elements should be integrated in IoT to provide human value for these applications (some examples could be: safety, efficiency, cost effective, etc.).

### 13.14 Data Exchange

Data exchange refers to the exchange of data between systems in the same domain and the exchange of data between systems from different domains. The main challenge is to find a common understanding for data when the sender and the receiver have different data systems. The main solution is to find an intermediate language and to translate from one data system to another one.

The EDIFACT standard provides (Krathu et al. 2013; Janner et al. 2006), Fig. 13.21:

- A set of syntax rules to structure data
- An interactive exchange protocol (I-EDI)
- Standard messages which allow multicounty and multi-industry exchange.

DATEX 2 provides an alternative standard and model for data exchange. This is a good example of the application of standards in transport (road transport) and the effect is to pave the way for integration of different systems as well as the interoperability between systems, subsystems and modules (Wei-feng et al. 2008; Raines and Rowley 2008).

DATEX II is an example of using XML in data exchange solutions for road transport system. This example could be used also in railway system, the model of implementation should be the same.

After the implementation of ETCS level 3, no track circuit or trackside sensor will be installed and the presence of the train on a specific railway section must be sent by train to RBC (Radio Block Centre) but also to other transport modes where this information is relevant. The solution should be a XML implementation similar with DATEX II.

### 13.15 Implementation

As seen in the previous paragraphs, new technology helps to maximise utilisation and make the best from the current infrastructure in terms of providing better (e.g. faster, more punctual, etc.) services with a limited need of investments. From the perspective of the users this might not be enough to accept the big amount of private data collected in the systems. And from the perspective of the stakeholder in the transport system that makes investment in these new technologies uncomely. Thus, an approach doing the integration of systems step-by-step with focus on the user's demands is needed. The main benefit for the users must be that the systems are not only self-aware, but aware of the user and his needs. An example can be travel assistance, that does not only follow general optimization strategies like minimising time and cost, but also take in count users habits or health constraints, like it was shown with a personal travel assistance that takes account of users with mental or physical disabilities (Schlingensiepen et al. 2015a, b) or the approach of "smelly roads" that finds optimal walking routes, not only in terms of the shortest path, but also on terms of nice surroundings (Quercia et al. 2014). Thus, principles were defined in (Doyle Cottrill et al. 2016) as situation aware systems integration a term that describes the integration or interaction between different stakeholders in a system to fulfil a practical purpose that allows to justify investments of money and divulgation of privacy.

Since there is a good change, the full integration respective to centralization of all functions and data will fail because of the high complexity, the authors propose to following this approach: The integration of systems starts with integration of data for a given use case, this shall be done by enhancing department-to-department

(D2D) cooperation and coordination, via improved D2D communication and data exchange, through a common formal semantic vocabulary. So, each stakeholder shall use its own well-known sensors, models and data enriched by information provided by other parties. Since transportation is a main function, the authors already mention it as an example: Transport, energy generation and construction are three “departments” within a City that manage functions which generate urban emissions as a side effect. Currently there is no (as far we know) communication or coordinating control between them. It is well known that cities regularly break air pollution limits, even in Europe. It may be possible for “Transport” to adjust regional traffic flows to alleviate this pollution, but this takes no account of the other ca. 50% of pollution which is generated by other utilities. Currently it is not known how these departments can communicate and combine together to produce a holistic solution to the problem. In fact, there is likely to be little shared knowledge between them. Enabling D2D communication on a shared vocabulary, could significantly tackle this challenge.

This examples show how the new technology shown in this chapter can be utilised in real life without premise the full integration of all services in a so-called smart city. The challenge we are facing today is to identify the practical use cases that allow step-by-step integration and provide user benefits for each step. Since the investments in rail are very big and so the time span to return on investment is very long this is much needed. As seen in the example of ERTMS the standard itself is quite old but the progress is still limited to dedicated routes, where a use case like connecting industrial areas or implementing a green transit was identified and addressed by railway companies, politics and costumers.

## 13.16 Conclusions

This chapter has shown the widespread use of ITS in road, inland waterway and rail businesses and discussed the possibility to integrate all transport modes based on intelligent transport systems as middleware. New and developing technologies could make the use of ITS even more widespread.

New sensors could lead to a virtual track circuit, new technologies for communication (such as more advanced GSM-R) could assist communication across the rail network and the development of new approaches (mobility as a service, cloud services, big data and data mining) could provide new opportunities and innovation in rail and will pave the way for new applications and the development of smart way to solve the problem of mobility. New services based around Wi-Fi and real-time information can also be developed.

More research around the potential ITS innovations and their usage must be conducted to benefit the wider rail industry and create more value resulting from these new solutions. These can then hopefully become solutions whose benefits outweigh their costs.

In the future, there will be new support technologies for mobility and transport and new approaches. These will fit into new designs for transport systems which will be radically redesigned to allow inclusion of new technology. This will allow connected vehicles, people and things and give everyone access to information. This will provide access to potential new markets. The railway transport will be a main part of new smart transport systems (one example is Mobility as a Service). This requests new concepts and models. The integration of all components as well as the integration of all transport modes in a single transport system that provides support for mobility in a smart manner is key for a sustainable development of transport.

## References

- Buyya R, Dastjerdi AV (2016). *Internet of things: principles and paradigms*. Elsevier
- Chaouchi H (2013) *The internet of things: connecting objects*. Wiley
- Deterding S, et al. (2011) *Gamification. using game-design elements in non-gaming contexts*. In Proceedings of the 2011 annual conference extended abstracts on Human factors in computing systems—CHI EA'11. New York, New York, USA: ACM Press, p. 2425. <http://portal.acm.org/citation.cfm?doid=1979742.1979575>. Accessed 8 Feb 2017
- Doyle Cottrill C, et al. (2016) Computational challenges in cooperative intelligent urban transport (Dagstuhl Seminar 16091). *DROPS-IDN/5891* 6(2)
- EC (2016) *ERTMS—European Rail Traffic Management System—European Commission*. [https://ec.europa.eu/transport/modes/rail/ertms\\_en](https://ec.europa.eu/transport/modes/rail/ertms_en). Accessed 8 Feb 2017
- Fayyad U, Piatetsky-Shapiro G, Smyth P (1996) *From data mining to knowledge discovery in databases*
- Franklin F, Nemtanu F, Teixeira P.F (2013) Rail infrastructure, ITS and access charges. *Res. Transp. Econ.*, 41(1)
- Han J, Kamber M, Pei J (Computer scientist) (2012) *Data mining: concepts and techniques*. Elsevier/Morgan Kaufmann
- i-Scoop (2016) What is the internet of things? Internet of things definitions and segments. <https://www.i-scoop.eu/internet-of-things/>. Accessed 8 Feb 2017
- Janner T, et al. (2006) From EDI to UN/CEFACT: an evolutionary path towards a next generation e-business framework. In: *The 5th international conference on e-business 2006 (NCEB 2006)*, Bangkok, Thailand. <http://www.sit.kmutt.ac.th/nceb2006/index.php>, p. 8
- Krathu W, et al. (2013) Identifying inter-organizational key performance indicators from EDIFACT messages. In: *2013 IEEE 15th conference on business informatics*. <http://ieeexplore.ieee.org>, pp. 276–283
- Lv Y, et al. (2014) Traffic flow prediction with big data: a deep learning approach. *IEEE Trans Intell Transp Syst*, pp. 1–9. <http://ieeexplore.ieee.org/lpdocs/epic03/wrapper.htm?arnumber=6894591>. Accessed 5 Oct 2016
- McEwen A, Cassimally H (2013) *Designing the internet of things*. Wiley
- Nemtanu FC, Minea M, et al. (2016) development of the romanian cities based on a european smart city concept. In: *STRATEGICA 2016—Opportunities and risks in the contemporary business environment*. researchgate.net, pp. 1029–1039. [https://www.researchgate.net/profile/Alexandra\\_Zbucnea/publication/309357116\\_Strategica\\_2016\\_Opportunities\\_and\\_risks\\_in\\_the\\_contemporary\\_business\\_environment/links/580adc0e08ae74852b530799.pdf#page=1025](https://www.researchgate.net/profile/Alexandra_Zbucnea/publication/309357116_Strategica_2016_Opportunities_and_risks_in_the_contemporary_business_environment/links/580adc0e08ae74852b530799.pdf#page=1025)
- Nemtanu FC, Schlingensiepen J, et al. (2016) Mobility as a service in smart cities. In: *ICEIRD 2016—Responsible entrepreneurship vision, development and ethics*. Bucharest: SNSPA, pp. 425–435

- Nemtanu FC, Minea M (2005) The development of its architecture for urban transport new components and new relations. *Zeszyty Naukowe. Transport/Politechnika Śląska*, pp 317–325
- Nemtanu FC, Nemtanu MI (2014) CSR in smart city & smart mobility. In: 4th organisational governance conference—Bucharest, Romania
- Nemtanu FC, Schlingensiepen J, Buretea DL (2015) Cloudification of urban logistics. In *SCM4ECR*, ed. Supply chain management for efficient consumer response on-line conference—2015. Targoviste
- v. Oort N, Cats O (2015) Improving public transport decision making, planning and operations by using big data: cases from Sweden and the Netherlands. In: 2015 IEEE 18th international conference on intelligent transportation systems, pp 19–24
- Pacheco J, et al. (2016) Secure and Resilient cloud services for enhanced living environments. *IEEE Cloud Comput* 3(6):44–52. <http://ieeexplore.ieee.org/document/7802536/>. Accessed 8 Feb 2017
- Postigo-Malaga M, et al. (2016) Vehicle location system and monitoring as a tool for citizen safety using wireless sensor network. In: 2016 IEEE ANDESCON, pp 1–4
- Quercia D, Schifanella R, Aiello LM (2014) The shortest path to happiness. In: Proceedings of the 25th ACM conference on hypertext and social media - HT'14. ACM Press, New York, pp. 116–125. <http://dl.acm.org/citation.cfm?doid=2631775.2631799>. Accessed 13 Feb 2017
- Raines A, Rowley P (2008) Coordinated traffic management through data exchange. In: Road transport information and control—RTIC 2008 and ITS United Kingdom Members' Conference, IET. <http://ieeexplore.ieee.org>, pp 1–4
- Schlingensiepen J, Naroska E, Bolten T et al (2015a) Empowering people with disabilities using urban public transport. *Procedia Manufac* 3:2349–2356
- Schlingensiepen J, Naroska E, Christen O, et al. (2015) Utilize public transport for disabled people. In: Proceedings of the ITS world congress 2015. Bordeaux
- Schlingensiepen J, Mehmood R, Nemtanu FC (2015c) Framework for an autonomic transport system in smart cities. *Cybern Inf Technol* 15(5):50–62
- Wien TU (2014) European smart cities 3.0 (2014). <http://www.smart-cities.eu/?cid=2&ver=3>. Accessed 6 Feb 2017
- UIC (2016) GSM-R—International union of railways (UIC). <http://www.uic.org/gsm-r>. Accessed 8 Feb 2017
- UNIFE (2016) ERTMS|The European railway traffic management system. <http://www.ertms.net/>. Accessed 8 Feb 2017
- Wei-feng L, Wei C, Jian H (2008) Research on a DATEX II based dynamic traffic information publish platform. In: 2008 second international symposium on intelligent information technology application. <http://ieeexplore.ieee.org>, pp. 412–416