

Edited by Erik De Clercq

 WILEY-VCH

# Antiviral Drug Strategies

Volume 50

Series Editors:  
R. Mannhold,  
H. Kubinyi,  
G. Folkers

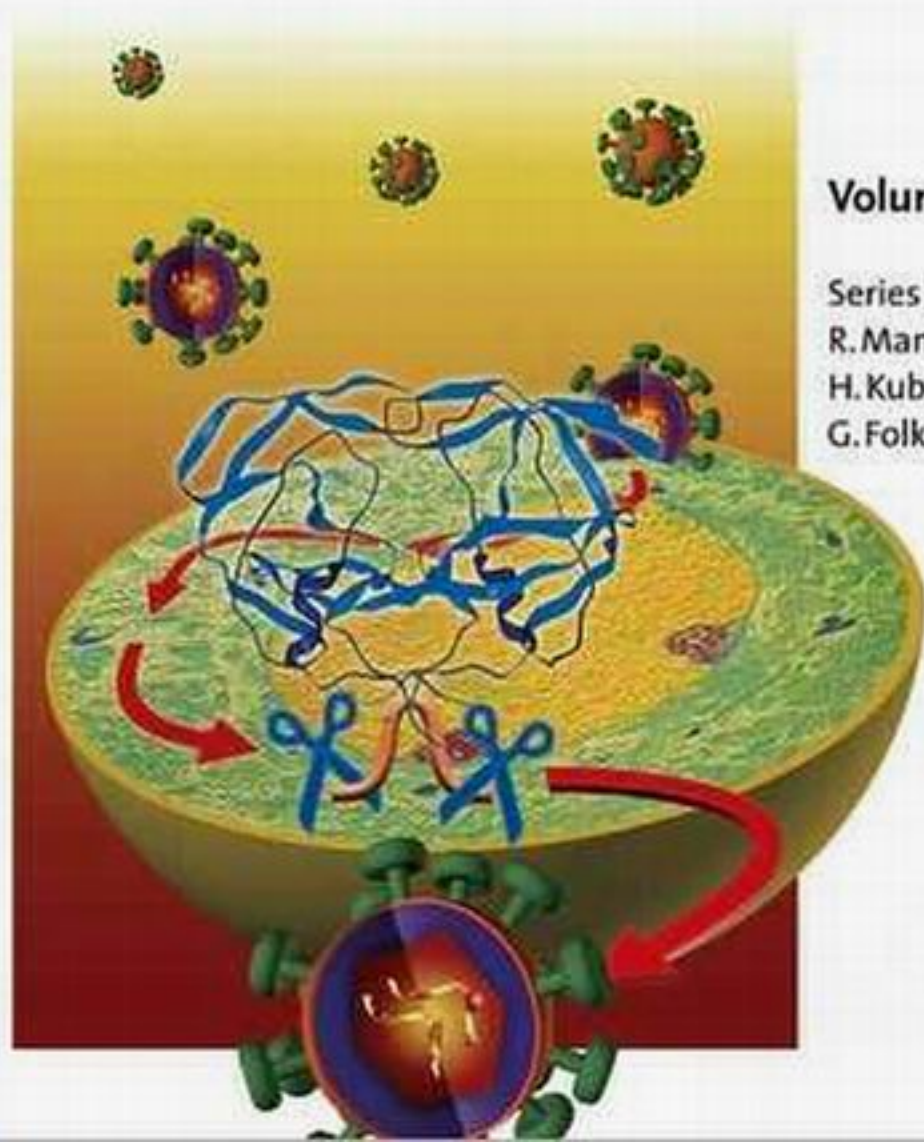

*Edited by*  
*Erik De Clercq*

**Antiviral Drug Strategies**

## ***Methods and Principles in Medicinal Chemistry***

Edited by R. Mannhold, H. Kubinyi, G. Folkers

Editorial Board

H. Buschmann, H. Timmerman, H. van de Waterbeemd, T. Wieland

### ***Previous Volumes of this Series:***

Klebl, Bert / Müller, Gerhard / Hamacher, Michael (Eds.)

#### **Protein Kinases as Drug**

#### **Targets**

2011

ISBN: 978-3-527-31790-5

Vol. 49

Sotriffer, Christopher (Ed.)

#### **Virtual Screening**

#### **Principles, Challenges, and Practical Guidelines**

2011

ISBN: 978-3-527-32636-5

Vol. 48

Rautio, Jarkko (Ed.)

#### **Prodrugs and Targeted Delivery**

#### **Towards Better ADME Properties**

2011

ISBN: 978-3-527-32603-7

Vol. 47

Smit, Martine J. / Lira, Sergio A. /  
Leurs, Rob (Eds.)

#### **Chemokine Receptors as Drug Targets**

2011

ISBN: 978-3-527-32118-6

Vol. 46

Ghosh, Arun K. (Ed.)

#### **Aspartic Acid Proteases as Therapeutic Targets**

2010

ISBN: 978-3-527-31811-7

Vol. 45

Ecker, Gerhard F. / Chiba, Peter (Eds.)

#### **Transporters as Drug Carriers**

#### **Structure, Function, Substrates**

2009

ISBN: 978-3-527-31661-8

Vol. 44

Faller, Bernhard / Urban, Laszlo (Eds.)

#### **Hit and Lead Profiling**

#### **Identification and Optimization of Drug-like Molecules**

2009

ISBN: 978-3-527-32331-9

Vol. 43

Sippl, Wolfgang / Jung, Manfred (Eds.)

#### **Epigenetic Targets in Drug Discovery**

2009

ISBN: 978-3-527-32355-5

Vol. 42

Todeschini, Roberto / Consonni, Viviana

#### **Molecular Descriptors for Cheminformatics**

#### **Volume I: Alphabetical Listing /**

#### **Volume II: Appendices, References**

2009

ISBN: 978-3-527-31852-0

Vol. 41

van de Waterbeemd, Han /  
Testa, Bernard (Eds.)

#### **Drug Bioavailability**

#### **Estimation of Solubility, Permeability, Absorption and Bioavailability**

Second, Completely Revised Edition

2008

ISBN: 978-3-527-32051-6

Vol. 40

*Edited by*  
*Erik De Clercq*

## **Antiviral Drug Strategies**



WILEY-VCH Verlag GmbH & Co. KGaA

#### Series Editors

**Prof. Dr. Raimund Mannhold**

Molecular Drug Research Group  
Heinrich-Heine-Universität  
Universitätsstrasse 1  
40225 Düsseldorf  
Germany  
mannhold@uni-duesseldorf.de

**Prof. Dr. Hugo Kubinyi**

Donnersbergstrasse 9  
67256 Weisenheim am Sand  
Germany  
kubinyi@t-online.de

**Prof. Dr. Gerd Folkers**

Collegium Helveticum  
STW/ETH Zurich  
8092 Zurich  
Switzerland  
folkers@collegium.ethz.ch

#### Volume Editor

**Prof. Dr. Erik De Clercq**

Rega Inst. Medical Research  
University of Leuven  
Minderbroedersstraat 10  
3000 Leuven  
Belgium

#### Cover Description

Recent approaches on how to combat virus infections, i.e. HIV, HCV, HSV, HCMV and influenza virus.  
HIV-Protease, PDB code 3k4v (F. M. Olajuyigbe et al., ACS Med. Chem. Lett. 2010 asap, DOI: 10.1021/ml100046d); protein backbone generated with LigandScout 3.0, inte:ligand

All books published by Wiley-VCH are carefully produced. Nevertheless, authors, editors, and publisher do not warrant the information contained in these books, including this book, to be free of errors. Readers are advised to keep in mind that statements, data, illustrations, procedural details or other items may inadvertently be inaccurate.

**Library of Congress Card No.:** applied for

#### British Library Cataloguing-in-Publication Data

A catalogue record for this book is available from the British Library.

#### Bibliographic information published by the Deutsche Nationalbibliothek

The Deutsche Nationalbibliothek lists this publication in the Deutsche Nationalbibliografie; detailed bibliographic data are available on the Internet at <http://dnb.d-nb.de>.

© 2011 Wiley-VCH Verlag & Co. KGaA,  
Boschstr. 12, 69469 Weinheim, Germany

All rights reserved (including those of translation into other languages). No part of this book may be reproduced in any form – by photoprinting, microfilm, or any other means – nor transmitted or translated into a machine language without written permission from the publishers. Registered names, trademarks, etc. used in this book, even when not specifically marked as such, are not to be considered unprotected by law.

**Typesetting** Thomson Digital, Noida, India

**Printing and Binding** betz-druck GmbH, Darmstadt

**Cover Design** Schulz Grafik-Design, Fußgönheim

Printed in the Federal Republic of Germany  
Printed on acid-free paper

**ISBN Print:** 978-3-527-32696-9

**ISBN eBook:** 978-3-527-63595-5

**ISBN ePDF:** 978-3-527-63597-9

**ISBN ePub:** 978-3-527-63596-2

**ISBN Mobi:** 978-3-527-63598-6

## Contents

**List of Contributors** XIII

**Preface** XVII

**A Personal Foreword** XIX

- 1 Outlook of the Antiviral Drug Era, Now More Than 50 Years After Description of the First Antiviral Drug** 1  
*Erik De Clercq*
- 1.1 Introduction: The Prehistory 1
- 1.2 Key Events in Antiviral Drug Development 2
- 1.3 Antiviral Drugs: Current State of the Art 4
- 1.4 Antiviral Drugs Active against Herpesviruses (i.e., HSV, VZV, and so on) 4
- 1.5 Antiviral Drugs Active against Retroviruses (HIV) 8
- 1.6 Antiviral Drugs Active against Hepatitis B Virus 12
- 1.7 Antiviral Drugs Active against DNA Viruses at Large 13
- 1.8 Antiviral Drugs for Influenza A Virus Infections 14
- 1.9 Antiviral Drugs for Hepatitis C Virus 15
- 1.10 Antiviral Drugs for Poxviruses (i.e., Variola, Vaccinia, and so on) 17
- 1.11 Further Options to Treat Virus Infections 19
- 1.12 Conclusions 19  
References 20
- 2 Inhibition of HIV Entry** 29  
*José A. Esté*
- 2.1 Introduction 29
- 2.2 The HIV Glycoproteins 30
- 2.2.1 Structure of the HIV-1 Glycoprotein gp120 30
- 2.2.2 Structure of the HIV-1 Transmembrane Glycoprotein gp41 31
- 2.3 Mechanism of HIV Entry 32
- 2.3.1 Virus Attachment 32
- 2.3.2 Coreceptors: Virus Tropism and Infectivity 33

2.3.3	Virus–Cell Fusion	33
2.3.4	Endocytosis of HIV	33
2.4	Inhibition of HIV Entry	34
2.4.1	Inhibitors of Virus Attachment	34
2.4.1.1	Polyanions as Inhibitors of HIV Attachment	34
2.4.1.2	Small-Molecule Inhibitors of the gp120–CD4 Interaction	36
2.4.2	Postattachment Inhibitors	37
2.4.3	CCR5 Antagonists	38
2.4.3.1	Maraviroc	38
2.4.3.2	Vicriviroc	39
2.4.3.3	Pro-140	39
2.4.3.4	Resistance to CCR5 Antagonists	39
2.4.4	CXCR4 Antagonists	40
2.4.5	Inhibitors of HIV Fusion: Enfuvirtide	41
2.5	Concluding Remarks	42
	References	42

### **3 Targeting Integration Beyond Strand Transfer: Development of Second-Generation HIV Integrase Inhibitors** 51

*Arnout R.D. Voet, Marc De Maeyer, Frauke Christ, and Zeger Debyser*

3.1	HIV: The Causative Agent of AIDS	51
3.1.1	Replication Cycle of HIV	51
3.1.2	Highly Active Antiretroviral Therapy	52
3.2	The Integration Step: A Complex Mechanism with Different Possibilities for Inhibition	53
3.2.1	HIV-1 Integrase	53
3.2.1.1	The Structural Organization of HIV-1 Integrase	54
3.2.2	HIV-1 IN as a Target for HAART	55
3.2.2.1	Integrase Strand Transfer Inhibitors	55
3.2.2.2	Integrase Binding Inhibitors	57
3.3	DNA Binding Inhibitors	59
3.4	Multimerization Inhibitors	60
3.5	Targeting Integrase Cofactor Interactions	62
3.6	Conclusion	64
	References	65

### **4 From Saquinavir to Darunavir: The Impact of 10 Years of Medicinal Chemistry on a Lethal Disease** 73

*Marie-Pierre de Béthune, Anik Peeters, and Piet Wigerinck*

4.1	Introduction	73
4.2	The HIV Protease as a Target for AIDS	73
4.3	The Early Protease Inhibitors	74
4.4	The Medical Need for a “Next”-Generation PI	78
4.5	How Can We Explain the Superior Antiviral Activity of Darunavir?	85

4.6	Clinical Development of Darunavir	86
4.7	Conclusions and Future Developments	87
	References	87
<b>5</b>	<b>Acyclic and Cyclic Nucleoside Phosphonates</b>	<b>91</b>
	<i>Richard L. Mackman and Tomas Cihlar</i>	91
5.1	Introduction	91
5.2	Nucleoside Phosphonate Strategy for Antivirals	92
5.3	Acyclic Nucleoside Phosphonates	95
5.3.1	Main Classes and their Structure–Activity Relationships	95
5.3.1.1	HPMP Analogues	95
5.3.1.2	PME Analogues	95
5.3.1.3	PMP and FPMP Analogues	97
5.3.2	Additional Examples of Antiviral ANPs	98
5.4	Cyclic Nucleoside Phosphonates	99
5.4.1	Main Classes and their Structure–Activity Relationships	100
5.4.1.1	Tetrahydrofuran Core	100
5.4.1.2	Cyclopentane and Cyclopentene Cores	103
5.4.2	Examples of CNPs Targeting Viral RNA Polymerases	104
5.5	Prodrugs of Nucleoside Phosphonates	107
5.5.1	Phosphonoesters	107
5.5.2	Phosphonoamidates	109
5.6	Clinical Applications of Antiviral Nucleoside Phosphonates	111
5.6.1	Cidofovir (Vistide <sup>®</sup> )	112
5.6.2	Adefovir Dipivoxil (Hepsera <sup>®</sup> )	112
5.6.3	Tenofovir Disoproxil Fumarate (Viread <sup>®</sup> )	113
5.7	Conclusions	115
	References	115
<b>6</b>	<b>Helicase–Primase Inhibitors: A New Approach to Combat Herpes Simplex Virus and Varicella Zoster Virus</b>	<b>129</b>
	<i>Subhajit Biswas and Hugh J. Field</i>	
6.1	Introduction	129
6.2	The Role of Helicase Primase in the Replication of HSV	130
6.3	Selective Inhibitors of Helicase Primase as Antiherpesvirus Antivirals	131
6.4	HPIs are Effective in Cell Culture and <i>In Vivo</i>	133
6.5	Effects of HPIs on the Establishment and Reactivation from Latency	134
6.6	HPIs: The Biochemical Basis for the Proposed Mechanism of Action	134
6.7	HSV Acquired Resistance to HPIs	135
6.8	Patterns of Cross-Resistance	136
6.9	Further Insight into Mode of HPI Interaction with the HSV HP Complex from the Study of Resistance Mutations	139



6.10	The Frequency and Origin of HPI-Resistance Mutations	140
6.11	UL5 Lys356Asn: a Mutation Conferring High Resistance to HPI	141
6.12	The Origin of Resistance Mutations at High Frequency	142
6.13	Conclusions	142
	References	144
<b>7</b>	<b>Cyclophilin Inhibitors</b>	<b>147</b>
	<i>Grégoire Vuagniaux, Arnaud Hamel, Rafael Crabbé, Hervé C. Porchet, and Jean-Maurice Dumont</i>	
7.1	Introduction	147
7.2	Cyclophilin Overview	148
7.3	Cyclophilin Inhibitors Currently in Clinical Development	148
7.3.1	Chemical Structure	149
7.3.2	CypA PPIase Inhibition and Lack of Immunosuppressive Activity	149
7.4	Cyclophilin and HIV	149
7.4.1	Cyclophilin Inhibitors against HIV-1	151
7.4.1.1	<i>In Vitro</i> Anti-HIV-1 Activity	151
7.4.1.2	Resistance Profile	152
7.4.1.3	<i>In Vivo</i> Activity	152
7.4.1.4	Putative Mechanism of Action of Cyclophilin Inhibitors against HIV-1	152
7.4.1.5	Clinical Activity of Debio 025 against HIV-1	153
7.4.2	No Activity against Simian Immunodeficiency Virus	154
7.4.3	Activity against HIV-2	154
7.5	Cyclophilin and Hepatitis C	155
7.5.1	Putative Role of Cyclophilin in HCV Replication	155
7.5.2	Activity of Cyclophilin Inhibitors in HCV	157
7.5.3	Resistance Profile	158
7.6	Clinical Results in HCV	159
7.6.1	Debio 025	159
7.6.1.1	Randomized, Double-Blind, Placebo-Controlled Study in HIV-1/HCV Coinfected or HIV-1 Monoinfected Patients	159
7.6.1.2	Randomized, Double-Blind, Placebo-Controlled, Escalating Dose Ranging Study of Debio 025 in Combination with Pegasys in Treatment-Naïve Patients with Chronic Hepatitis	159
7.6.2	Study of Debio 025 in Combination with PEG-IFN $\alpha$ 2 and Ribavirin in Chronic HCV Genotype 1 Nonresponding Patients	162
7.6.3	Adverse Events	167
7.6.4	NIM811 and SCY635	167
7.7	Activity against Other Viruses	167
7.8	New Noncyclosporine Cyclophilin Inhibitors	168
7.8.1	Peptides and Peptidomimetics	168
7.8.2	CsA Bis-Urea Derivatives	169
7.8.3	Dimedone-Like Molecules	169

7.8.4	Quinoxaline Derivatives	169
7.8.5	Diarylurea Derivatives	170
7.8.6	Other Acylurea Derivatives	171
7.9	Conclusion	173
	References	173
<b>8</b>	<b>Alkoxyalkyl Ester Prodrugs of Antiviral Nucleoside Phosphates and Phosphonates</b>	<b>181</b>
	<i>James R. Beadle and Karl Y. Hostetler</i>	
8.1	Introduction	181
8.2	Enhancing the Oral Activity of Antiviral Compounds: Overview of the Development of Alkoxyalkyl Esterification Approach	182
8.3	Alkylglycerol and Alkoxyalkyl Prodrugs of Phosphonoformate: Enhanced Antiviral Activity and Synergism with AZT	185
8.4	Alkoxyalkyl Esters of Nucleoside 5'-Monophosphates	185
8.5	Oral Prodrugs of Acyclic Nucleoside Phosphonates	189
8.5.1	Cidofovir	189
8.5.1.1	Activity against Poxviruses <i>In Vitro</i>	189
8.5.1.2	Activity against Other Double-Stranded DNA Viruses <i>In Vitro</i>	190
8.5.1.3	Efficacy of Alkoxyalkyl Esters of ANPs in Animal Models of Disease	191
8.5.2	Alkoxyalkyl Esters of (S)-HPMPA	191
8.5.3	Alkoxyalkyl Esters of Tenofovir (HDP-(R)-PMPA)	196
8.5.4	Hexadecyloxypropyl Adefovir and Prodrugs of Other ANPs and Antivirals	197
8.6	Intraocular Delivery of Antiviral Prodrugs for Treatment or Prevention of Cytomegalovirus Retinitis	198
8.6.1	1-O-Octadecyl- <i>sn</i> -glycero-3-phosphonoformate (ODG-PFA)	198
8.6.2	Hexadecyloxypropyl Ganciclovir 5'-Monophosphate (HDP-P-GCV)	199
8.6.3	Hexadecyloxypropyl Esters of Cyclic Cidofovir and Cyclic (S)-HPMPA	200
8.7	Conclusion	201
	References	201
<b>9</b>	<b>Maribavir: A Novel Benzimidazole Ribonucleoside for the Prevention and Treatment of Cytomegalovirus Diseases</b>	<b>209</b>
	<i>Karen K. Biron</i>	
9.1	Cytomegalovirus Diseases: Unmet Challenges	209
9.2	Maribavir: Antiviral Activity	210
9.3	Maribavir: Mechanisms of Action and Resistance	212
9.4	Preclinical Studies	214
9.5	Clinical Development of Maribavir: Early Phase I	215
9.6	Clinical Development in a Transplant Population	218

9.7	Summary and Conclusions	220
	References	221
<b>10</b>	<b>Anti-HCMV Compounds</b>	<b>227</b>
	<i>Graciela Andrei and Robert Snoeck</i>	
10.1	Introduction	227
10.2	Anti-HCMV Drugs in Clinical Use	229
10.2.1	Classes of Anti-HCMV Drugs	229
10.2.2	Toxicity Associated with Approved Anti-HCMV Drugs	231
10.2.3	Resistance to Anti-HCMV Antivirals	233
10.3	Need for New Anti-HCMV Drugs	234
10.4	Novel Viral Targets	235
10.4.1	Viral Entry Inhibitors	235
10.4.1.1	$\beta$ -Peptides	235
10.4.1.2	Dendrimers	235
10.4.1.3	Amphipathic DNA Polymers	237
10.4.1.4	Thiourea Derivatives	237
10.4.1.5	Phosphorothioate-Modified Oligonucleotides	237
10.4.2	Inhibitors of Viral Genome Replication	238
10.4.2.1	DNA Polymerase Inhibitors	238
10.4.2.2	Helicase/Primase Inhibitors	245
10.4.2.3	Inhibitors of Protein-Protein Interactions	246
10.4.3	Viral Gene Expression Inhibitors	248
10.4.3.1	Small Interfering RNAs	248
10.4.4	Inhibitors of Virion Assembly and Egress	248
10.4.4.1	Inhibitors of DNA Cleavage/Packaging	248
10.4.4.2	UL97 Protein Kinase (pUL97) Inhibitors	252
10.4.4.3	Viral Protease Inhibitors	256
10.4.5	Additional New Inhibitors of HCMV	256
10.4.5.1	Agonist for HCMV-Encoded Chemokine Receptors	256
10.4.6	HCMV Inhibitors with a Mechanism of Action not Fully Unraveled	258
10.4.6.1	CMV423	258
10.4.6.2	Berberine Chloride, Arylsulfone Derivatives, Lipophilic Alkyl Furano Pyrimidine Dideoxy Nucleosides, and 4''-Benzoyl-Ureido-TSAO Derivatives	258
10.4.6.3	Leflunomide	259
10.4.6.4	Artesunate	260
10.5	Cellular Targets	260
10.5.1	Inhibitors of Cyclin-Dependent Kinases	261
10.5.2	Inhibitors of Cyclooxygenase 2	262
10.5.3	Proteasome Inhibitors	263
10.6	Conclusions	265
	References	266

<b>11</b>	<b>Lethal Mutagenesis as an Unconventional Approach to Combat HIV</b>	<b>283</b>
	<i>Pinar Iyidogan and Karen S. Anderson</i>	
11.1	Introduction	283
11.2	Viral Fitness and Intrinsic Mutagenesis in RNA Viruses and Retroviruses	284
11.3	Fundamentals of Lethal Mutagenesis	286
11.4	Mutagenic Pharmaceuticals as Antiviral Agents	288
11.4.1	Ribavirin	288
11.4.2	5-OH-dC	290
11.4.3	5-AZC	291
11.5	KP-1212: From Bench to Clinic	292
11.6	Challenges and Advantages of Lethal Mutagenesis Compared to Conventional Strategies	294
11.7	Concluding Remarks and Future Perspectives	296
	References	298
<b>12</b>	<b>Recent Progress in the Development of HCV Protease Inhibitors</b>	<b>307</b>
	<i>Nagraj Mani, Bhisetti G. Rao, Tara L. Kieffer, and Ann D. Kwong</i>	
12.1	Introduction	307
12.2	HCV Therapy	307
12.2.1	The Role of HCV Protease	308
12.2.2	HCV Protease Inhibitor Design	310
12.2.3	Similarities and Differences in HCV Protease Inhibitors	310
12.2.4	Antiviral Potency and the Emergence of Resistance	316
12.3	Mechanism of Resistance and Cross-Resistance to NS3 Protease Inhibitors	316
12.3.1	Pattern of Resistance to Covalent Linear Protease Inhibitors	316
12.3.2	Pattern of Resistance to Noncovalent Protease Inhibitors	318
12.3.3	Cross-Resistance between Linear and Macrocyclic HCV Protease Inhibitors	318
12.4	Antiviral Potency and Clinical Efficacy of HCV Protease Inhibitors	319
12.4.1	Telaprevir	319
12.4.2	Boceprevir	320
12.4.3	Safety Profile of Protease Inhibitors	321
12.5	Future Directions	321
	References	322
<b>13</b>	<b>Antiviral RNAi: How to Silence Viruses</b>	<b>329</b>
	<i>Karin J. von Eije and Ben Berkhout</i>	
13.1	The Discovery of RNA Interference	329
13.2	Therapeutic Application of the RNAi Mechanism	329
13.3	Mammalian Viruses and the RNAi Mechanism	331

13.4	Basic Design of an RNAi Therapy against Viruses	332
13.5	Selecting Optimal Targets	332
13.6	Prevention of Viral Escape	334
13.7	Multiplexing siRNAs	335
13.8	Delivery Issues	335
13.9	Potential Risks of an RNAi Therapy	336
13.10	Example of an Acute Infection: RSV	337
13.11	Example of a Chronic Infection: HIV-1	337
13.12	Future Perspective	338
	References	340
<b>14</b>	<b>Neuraminidase Inhibitors as Anti-Influenza Agents</b>	<b>351</b>
	<i>Willard Lew, Michael Z. Wang, Xiaowu Chen, James F. Rooney, and Choung Kim</i>	
14.1	Introduction	351
14.2	Influenza Neuraminidase as a Drug Target	353
14.3	Neuraminidase Active Site and Inhibitor Binding	354
14.4	Small-Molecule Inhibitors of Influenza Neuraminidase	355
14.4.1	Zanamivir (Relenza) and Related Compounds	355
14.4.2	Laninamivir (CS-8958): A Long-Acting Neuraminidase Inhibitor	358
14.4.3	Oseltamivir (Tamiflu)	359
14.5	Mechanism of Resistance	364
14.6	Influenza Neuraminidase Inhibitors Based on Other Scaffolds	364
14.6.1	Peramivir (BCX-1812, RWJ-270201)	364
14.6.2	ABT-675	366
14.7	Clinical Use of Neuraminidase Inhibitors	367
14.8	Concluding Remarks	369
	References	370
<b>15</b>	<b>From TIBO to Rilpivirine: The Chronicle of the Discovery of the Ideal Nonnucleoside Reverse Transcriptase Inhibitor</b>	<b>377</b>
	<i>Erik De Clercq</i>	
15.1	Introduction	377
15.2	The TIBO Derivatives	378
15.3	From Loviride to Rilpivirine	380
15.4	Rilpivirine: How Does It Act?	381
15.5	Clinical Proof of Concept	383
15.6	Pharmacokinetics and Drug–Drug Interactions	383
15.7	Potency and Resilience to NNRTI Resistance	384
15.8	Conclusion	385
	References	385

## List of Contributors

**Karen S. Anderson**

Yale University School of Medicine  
Department of Pharmacology  
333 Cedar Street  
New Haven  
CT 06520-8066  
USA

**Graciela Andrei**

K.U. Leuven  
Rega Institute for Medical Research  
Department of Microbiology and  
Immunology  
Laboratory of Virology and  
Chemotherapy  
Minderbroedersstraat 10  
3000 Leuven  
Belgium

**James R. Beadle**

University of California, San Diego  
Department of Medicine  
Division of Infectious Disease  
9500 Gilman Drive  
La Jolla  
CA 92093-0676  
USA

**Ben Berkhout**

University of Amsterdam  
Center for Infection and Immunity  
(CINIMA)  
Department of Medical Microbiology  
Laboratory of Experimental Virology  
K3-110, Meibergdreef 15  
1105 AZ Amsterdam  
The Netherlands

**Karen K. Biron**

Pathfinder Pharmaceuticals, Inc.  
413 E. Chapel Hill Street  
Durham, NC 27701  
USA

**Subhajit Biswas**

University of Cambridge  
Department of Medicine  
Level 5, Addenbrooke's Hospital  
Hills Road  
Cambridge  
CB2 0QQ  
UK

***Xiaowu Chen***

Gilead Sciences, Inc.  
333 Lakeside Drive  
Foster City  
CA 94404  
USA

***Frauke Christ***

K.U. Leuven  
Division of Molecular Medicine  
Laboratory for Molecular Virology  
and Gene Therapy  
Kapucijnenvoer 33  
3000 Leuven  
Flanders  
Belgium

***Tomas Cihlar***

Gilead Sciences, Inc.  
333 Lakeside Drive  
Foster City  
CA 94404  
USA

***Rafael Crabbé***

Debiopharm S.A.  
Forum “après-demain”  
Chemin Messidor 5-7  
CP 5911  
1002 Lausanne  
Switzerland

***Marie-Pierre de Béthune***

Tibotec BVBA  
Generaal de Wittelaan L 11B 3  
2800 Mechelen  
Belgium

***Zeger Debyser***

K.U. Leuven  
Division of Molecular Medicine  
Laboratory for Molecular Virology and  
Gene Therapy  
Kapucijnenvoer 33  
3000 Leuven  
Flanders  
Belgium

***Erik De Clercq***

K.U. Leuven  
Rega Institute for Medical Research  
Minderbroedersstraat 10  
3000 Leuven  
Belgium

***Jean-Maurice Dumont***

Debiopharm S.A.  
Forum “après-demain”  
Chemin Messidor 5-7  
CP 5911  
1002 Lausanne  
Switzerland

***José A. Esté***

Universitat Autònoma de Barcelona  
Hospital Universitari Germans Trias i  
Pujol  
Retrovirology Laboratory IrsiCaixa  
Ctra. De Canyet s/n  
08916 Badalona  
Spain

***Hugh J. Field***

University of Cambridge  
Department of Veterinary Medicine  
Madingley Road  
Cambridge  
CB 30ES  
UK

**Arnaud Hamel**

Debiopharm S.A.  
Forum “après-demain”  
Chemin Messidor 5-7  
CP 5911  
1002 Lausanne  
Switzerland

**Karl Y. Hostetler**

University of California, San Diego  
Department of Medicine  
Division of Infectious Disease  
9500 Gilman Drive  
La Jolla  
CA 92093-0676  
USA

**Pinar Iyidogan**

Yale University School of Medicine  
Department of Pharmacology  
333 Cedar Street  
New Haven  
CT 06520-8066  
USA

**Tara L. Kieffer**

Vertex Pharmaceuticals Incorporated  
130 Waverly Street  
Cambridge  
MA 02139  
USA

**Choung Kim**

Gilead Sciences, Inc.  
333 Lakeside Drive  
Foster City  
CA 94404  
USA

**Ann D. Kwong**

Vertex Pharmaceuticals Incorporated  
130 Waverly Street  
Cambridge  
MA 02139  
USA

**Willard Lew**

Gilead Sciences, Inc.  
333 Lakeside Drive  
Foster City  
CA 94404  
USA

**Richard L. Mackman**

Gilead Sciences, Inc.  
333 Lakeside Drive  
Foster City  
CA 94404  
USA

**Marc De Maeyer**

K.U. Leuven  
Department of Chemistry  
Laboratory for Biomolecular Modeling  
Celestijnenlaan 200G  
3001 Heverlee  
Flanders  
Belgium

**Nagraj Mani**

Vertex Pharmaceuticals Incorporated  
130 Waverly Street  
Cambridge  
MA 02139  
USA

**Anik Peeters**

Tibotec BVBA  
Generaal de Wittelaan L 11B 3  
2800 Mechelen  
Belgium

**Hervé C. Porchet**

Debiopharm S.A.  
Forum “après-demain”  
Chemin Messidor 5-7  
CP 5911  
1002 Lausanne  
Switzerland



***Bhisetti G. Rao***

Vertex Pharmaceuticals Incorporated  
130 Waverly Street  
Cambridge  
MA 02139  
USA

***James F. Rooney***

Gilead Sciences, Inc.  
333 Lakeside Drive  
Foster City  
CA 94404  
USA

***Robert Snoeck***

K.U. Leuven  
Rega Institute for Medical Research  
Department of Microbiology and  
Immunology  
Laboratory of Virology and  
Chemotherapy  
Minderbroederstraat 10  
3000 Leuven  
Belgium

***Arnout R.D. Voet***

K.U. Leuven  
Department of Chemistry  
Laboratory for Biomolecular Modeling  
Celestijnenlaan 200G  
3001 Heverlee  
Flanders  
Belgium

***Karin J. von Eije***

University of Amsterdam  
Center for Infection and Immunity  
(CINIMA)  
Department of Medical Microbiology  
Laboratory of Experimental Virology  
K3-110, Meibergdreef 15  
1105 AZ Amsterdam  
The Netherlands

***Grégoire Vuagniaux***

Debiopharm S.A.  
Forum “après-demain”  
Chemin Messidor 5-7  
CP 5911  
1002 Lausanne  
Switzerland

***Michael Z. Wang***

Gilead Sciences, Inc.  
333 Lakeside Drive  
Foster City  
CA 94404  
USA

***Piet Wigerinck***

Galapagos NV  
Generaal de Wittelaan L 11A3  
2800 Mechelen  
Belgium

## Preface

The World Community Grid, an association connecting numerous individual computers to generate massive computational power for ligand docking, has recently focused on antiviral drug research. Whether this strategy will succeed or not, the mission signifies a large public and scientific interest and medical need in the development of new antiviral drugs. The naïve dream of eradicating and providing a sustained cure to infectious diseases is over. Viruses are active and fast drivers of evolution and the human body as a habitat is one of their favorable playgrounds to achieve adaptations, which unfortunately turn out to be pathogenic for our species in many cases.

Hence, we face the same situation as in the field of antibiotics, a situation that has been described metaphorically as the race of the Red Queen. In Lewis Carroll's classic, *Through the Looking-Glass*, the Red Queen, a living chess piece that Alice meets, has to run in place as quickly as she can to simply stay in the same place. In order to get anywhere else, she says, you must run twice as fast. Continuous effort has to be made to compete with viral evolutionary strategy. Stagnation in viral research results in a loss of terrain.

Here, the book by Erik De Clercq provides an evaluation of the situation. Historical aspects of half a century of antiviral research pave the way for the most recent strategies ranging from new small-molecule inhibitors to complex gene therapeutic interferences with viral replication.

There are few who would be more qualified to provide a synopsis of ups and downs, successes and pitfalls of viral research. Erik has been awarded the Descartes Prize for anti-HIV strategies, published a well-praised book on viral biological warfare and made the Rega Institute and the University of Leuven a renowned hot spot of antiviral research. From the 1980s, a long list of important scientific contributions stands witness to his research in the fields of chemotherapy of virus infections and malignant diseases, molecular mechanism of action of antiviral and antitumor agents, enzyme targets for antiviral and antitumor agents, nucleoside and nucleotide analogues for various targets in viral replication, gene therapy strategies using virus-encoded thymidine kinase, and tumor cell differentiation inducers.

Erik De Clercq has gathered leading experts from industry and academia to report on their views and their achieved innovations in the field of antiviral drug strategies.

The 15 chapters cover a broad range of efforts to cope with viral pathogenic effects by using the arsenal within the realm of medicinal chemistry. The book may also provide a certain basis for self-reflection about the gains and losses and how to learn from the conceptually related fields of antibiotic and antitumor research.

The series editors are indebted to the authors and the editor who made this comprehensive book possible. We are convinced that the book represents an important contribution to the body of knowledge in the field of antiviral research.

We also want to express our gratitude to Nicola Oberbeckmann-Winter, Heike Nöthe and Frank Weinreich of Wiley-VCH for their invaluable support to this project.

November 2010  
Düsseldorf  
Weisenheim am Sand  
Zurich

*Raimund Mannhold*  
*Hugo Kubinyi*  
*Gerd Folkers*

## A Personal Foreword

When my good friend Hugo Kubinyi asked me to put together this book, I was very reluctant for several reasons: why should I, a retired professor, undertake this initiative and knock as I had done so many times before, often in vain, at the doors of young(er) and (more) active colleagues who had much more in mind and at hand than contributing to an old colleague's book. . . but Hugo was so persuasive and persistent I could not refuse to engage myself in putting together one more book. Here are the fruits of this endeavor. I do not know whether I will (be able or willing to) ever repeat the exercise, but I was pleased to note that most of those whom I contacted instantly replied they would help. I am immensely grateful to all those who contributed to this volume. In present times, with increasing demands on the goodwill of capable scientists, this is not obvious. This explains why I am so thankful to all of you who did contribute.

This book is not a comprehensive coverage on antiviral drugs, rather a snapshot on the current state of the art; even so, it brings a flavor of present-day research on antiviral drug strategies, and it does not afford the final solution to the antiviral drugs, not even the beginning thereof, but, hopefully, the end of the beginning. Antivirals are today where antibiotics stood exactly 30 years ago. The first antiviral (idoxuridine) dates back to 50 years and the first antibiotic (penicillin) to 80 years ago. In our further conquest of antivirals, we should learn from the successes and failures of antibiotics research. This book is just meant to add a small contribution to the continuously evolving conquest of science in the field of antiviral research that has since its conception always been in the shadow of its big brother, antibiotics, but I trust one day antivirals will be in the same limelight as antibiotics were 30 years before them, and hopefully researchers in the antiviral field will in the meantime have learned from both the successes and the failures of the antibiotic experts.

Quo vadis, antivirals? Fifty years after idoxuridine and, shortly thereafter, trifluridine, were recognized as antiviral agents specifically active against herpes simplex virus (HSV), and twenty-five years after the first antiretroviral drug azidothymidine was described, the antiviral drug area has come of age. Old viruses have remained, new ones have emerged, but the ingenuity and perseverance in creating and developing new approaches have continued unabatedly. With this book, my colleagues, contributors to this endeavor, want to pay tribute to the field of antiviral

research and leave an enduring stamp on the never vanishing hope of finding the ideal antiviral(s).

The chapters presented in this volume on antiviral drug strategies are as follows:

1. Outlook of the antiviral drug era, now more than 50 years after description of the first antiviral drug
2. Inhibition of HIV entry
3. Targeting integration beyond strand transfer: Development of second-generation HIV integrase inhibitors.
4. From saquinavir to darunavir: The impact of 10 years of medicinal chemistry on a lethal disease
5. Acyclic and cyclic nucleoside phosphonates
6. Helicase–primase inhibitors: A new approach to combat herpes simplex and varicella zoster virus
7. Cyclophilin inhibitors
8. Alkoxyalkyl ester prodrugs of antiviral nucleoside phosphates and phosphonates
9. Maribavir: A novel benzimidazole ribonucleoside for the prevention and treatment of cytomegalovirus diseases
10. Anti-HCMV compounds
11. Lethal mutagenesis as an unconventional approach to combat HIV
12. Recent progress in the development of HCV protease inhibitors
13. Antiviral RNAi: How to silence viruses
14. Neuraminidase inhibitors as anti-influenza agents
15. From TIBO to rilpivirine: The chronicle of the discovery of the ideal nonnucleoside reverse transcriptase inhibitor

July 2010  
Leuven

*Erik De Clercq*

# 1

## Outlook of the Antiviral Drug Era, Now More Than 50 Years After Description of the First Antiviral Drug

Erik De Clercq

### 1.1

#### Introduction: The Prehistory

More than 50 years ago, the synthesis of IDU (iododeoxyuridine), a thymidine analogue, was described by Prusoff [1]. This compound would later become the first antiviral drug to be licensed for (topical) use in the treatment of herpes simplex virus (HSV) infections of the eye. In this sense, the advent of IDU marked the birth of the antiviral drug era. There are now about 50 licensed antiviral compounds, half of them are used for the treatment of AIDS, of which the viral origin was first recognized 27 years ago [2, 3] (2008 Nobel Prize for Medicine or Physiology was awarded to Françoise Barré-Sinoussi and Luc Montagnier for their discovery of human immunodeficiency virus and to Harald zur Hausen for demonstrating the link between human papilloma virus (HPV) and cervical cancer).

Was IDU truly the first antiviral? In retrospect, the antiviral chemotherapy era had a rather slow and unremarkable start. The first compounds quoted to have antiviral activity (against vaccinia virus) were the thiosemicarbazones [4, 5]. These compounds were also found effective against vaccinia virus infection in mice and rabbits [6–8], and one of the thiosemicarbazones, that is, *N*-methylisatin- $\beta$ -thiosemicarbazone, even entered clinical studies for the prophylaxis of smallpox [9] just when the smallpox vaccination took over and made any further attempts to develop an antipoxvirus drug apparently superfluous.

Then came the benzimidazole derivatives as inhibitors of influenza virus multiplication [10, 11], but despite the reported effectiveness of the 5,6-dichloro-1- $\beta$ -D-ribofuranosyl benzimidazole (DRB) [10, 11] against influenza virus multiplication, it was not pursued further as a potential anti-influenza virus agent. Another benzimidazole derivative, 2-(1-hydroxybenzyl)benzimidazole (HBB), was found active against the multiplication of poliovirus (and other enteroviruses) [12–14], but with the successful implementation of the poliovirus vaccine, just as we had witnessed for smallpox, interest in developing an antiviral drug for poliovirus infections vanished.

IDU, soon to be followed by TFT (trifluorothymidine), could be considered as the third, and successful, attempt to herald the antiviral chemotherapy era. IDU was first

considered as a potential antitumor agent [15] before it was shown by Herrmann to be active against HSV and vaccinia virus [16]. That IDU and TFT finally became antiviral drugs for the topical treatment of HSV eye infections, in particular HSV keratitis, is due to the pioneering work of Kaufman [17, 18].

## 1.2

### Key Events in Antiviral Drug Development

Table 1.1 presents the key events in antiviral drug discovery, 1959 being the year when IDU was first described [1]. Ribavirin was the first low molecular weight compound described as a broad-spectrum antiviral agent (in 1972) by Sidwell *et al.* [19]. The combination of ribavirin with (pegylated) interferon- $\alpha$  has now become a standard treatment [20] for patients with chronic hepatitis C. That virus infections could be specifically tackled, without harm to the host cell, was heralded by the advent (in 1977) of acyclovir [21, 22], which is today still considered as the gold standard for the treatment of HSV infections. Two years after the discovery of HIV, in 1985, the first antiretrovirus agent (to become a drug 2 years later), AZT (zidovudine) was described [23], and this opened the search for, and development of, a wealth of new 2',3'-dideoxynucleoside analogues, now collectively referred to as nucleoside reverse transcriptase inhibitors (NRTIs).

In 1986, we described the first of a new class of broad-spectrum anti-DNA virus agents [24], namely, acyclic nucleoside phosphonates, several of which are active against the HIV and HBV reverse transcriptase and, therefore, referred to as nucleotide reverse transcriptase inhibitors (NtRTIs). Then followed in December 1989 and 1990 the description of a new concept for inhibiting the HIV-1 reverse transcriptase by nonnucleoside analogues (i.e., HEPT [25, 26] and TIBO [27]), giving rise to a still growing class of antiviral drugs, the nonnucleoside reverse transcriptase inhibitors (NNRTIs). With saquinavir, the year 1990 marked the birth of the rational design of HIV protease inhibitors (HIV PIs), which, in the mean time, has yielded 10 licensed drugs.

In 1992, we described an unusual class of compounds, the bicyclams as HIV inhibitors interacting with a viral uncoating event [28]. These compounds (prototype: AMD3100) would be, later on, shown to act as CXCR4 antagonists. Together with the CCR5 antagonists (the only licensed anti-HIV drug of this class of compounds being maraviroc), CXCR4 and CCR5 antagonists can be considered coreceptor inhibitors (CRIs), targeted at the coreceptor usage of X4 and R5 HIV strains, respectively. The year 1993 marked the description of two totally different strategic options: (i) that of DP-178, which later on would become known as enfuvirtide as an HIV fusion inhibitor (FI) [29] and (ii) that of 4-guanidino-Neu5Ac2en, which later on would become known as zanamivir as a neuraminidase-based inhibitor (NAI) of influenza virus replication [30]. Then followed in 1998 the seminal observation that HSV replication could be inhibited at the DNA helicase–primase level by a 2-aminothiazole (T157602) [31] that would later give impetus to the development of helicase–primase inhibitors (HPIs) as potential anti-HSV drugs.





Although considered an attractive target for two decades or so, the HIV integrase became a realistic target only when Hazuda *et al.* [32] demonstrated in 2000 it to be inhibited by the so-called diketo acids, which have yielded one integrase inhibitor (INI) that has already been formally approved (raltegravir) and another one under development (elvitegravir). Also described in 2000 was a pestivirus inhibitor (VP32947) [33] that hallmarked the search for inhibitors targeted at the RNA-dependent RNA polymerase (RdRp) of not only pestiviruses but also hepaciviruses (nonnucleoside RNA replicase inhibitors (NNRRIs)). In 2003, Lamarre *et al.* published their pioneering observation that hepatitis C virus (HCV) replication could be inhibited by ciluprevir [34], which (although the compound itself was not further developed) generated the search for other HCV PIs. Also in 2003, Migliaccio *et al.* [35] reported that 2'-C-methyl-substituted ribonucleosides were inhibitory to the replication of HCV and other flaviviruses by acting as nonobligate chain terminators, thus inciting the search for nucleoside RNA replicase inhibitors (NRRIs).

While, since the days of methisazone, interest in developing antivirals for poxvirus infections (i.e., smallpox) died, the advent in 2005 of ST-246 testifies to the renewed interest in this area [36], and this is further demonstrated by the observations that poxvirus infections can be successfully suppressed through inhibitors of tyrosine kinases (Gleevec [37] and CI-1033 [38]).

### 1.3

#### Antiviral Drugs: Current State of the Art

Most of the antiviral agents that have been approved, and are used in the treatment of virus infections, are targeted at HIV, HBV, HCV, influenza virus, HSV, and other herpesviruses such as varicella zoster virus (VZV) and cytomegalovirus (CMV). More compounds for the treatment of HIV, HBV, HCV, HSV, VZV, CMV, and influenza virus and several other viral infections, for example, poxvirus (e.g., variola, vaccinia, and monkeypox), respiratory syncytial virus, hemorrhagic fever virus (e.g., Lassa, Rift Valley, Ebola, yellow fever, and dengue), and enterovirus (e.g., polio, Coxsackie, and Echo), either are in clinical or preclinical development or still have to be developed. The antiviral compounds that have been approved by the US FDA (Food and Drug Administration) are listed in Table 1.2.

### 1.4

#### Antiviral Drugs Active against Herpesviruses (i.e., HSV, VZV, and so on)

Starting from IDU and TFT, many more 5-substituted 2'-deoxyuridines were synthesized [39], the most prominent antiviral drug of this class of compounds being (*E*)-5-(2-bromovinyl)-2'-deoxyuridine (BVDU) [40]. Although selectively active against both HSV-1 and VZV, BVDU has been developed specifically for the treatment of VZV infections (i.e., herpes zoster) [41].

**Table 1.2** Antiviral drugs approved by the US FDA.

Registered brand name	Generic name	Manufacturer
Anti-HIV compounds		
Nucleoside reverse transcriptase inhibitors		
Retrovir	Zidovudine (AZT)	GlaxoSmithKline
Videx <sup>®</sup> , Videx <sup>®</sup> EC	Didanosine (ddI)	Bristol–Myers Squibb
Hivid <sup>®</sup>	Zalcitabine (ddC)	Roche
Zerit <sup>®</sup>	Stavudine (d4T)	Bristol–Myers Squibb
Epivir <sup>®</sup> , Zeffix <sup>®</sup>	Lamivudine (3TC)	GlaxoSmithKline
Ziagen <sup>®</sup>	Abacavir (ABC)	GlaxoSmithKline
Emtriva <sup>®</sup>	Emtricitabine ((–)FTC)	Gilead Sciences
Combivir <sup>®</sup>	Lamivudine + zidovudine	GlaxoSmithKline
Trizivir <sup>®</sup>	Abacavir + lamivudine + zidovudine	GlaxoSmithKline
Epzicom <sup>®</sup>	Abacavir + lamivudine	GlaxoSmithKline
Nucleotide reverse transcriptase inhibitors		
Viread <sup>®</sup>	Tenofovir disoproxil fumarate	Gilead Sciences
Truvada <sup>®</sup>	Tenofovir disoproxil fumarate + emtricitabine	Gilead Sciences
Atripla <sup>®</sup>	Tenofovir disoproxil fumarate + emtricitabine + efavirenz	Gilead Sciences and Bristol–Myers Squibb
Nonnucleoside reverse transcriptase inhibitors		
Viramune <sup>®</sup>	Nevirapine	Boehringer Ingelheim
Rescriptor <sup>®</sup>	Delavirdine	Pfizer
Sustiva <sup>®</sup> , Stocrin <sup>®</sup>	Efavirenz	Bristol–Myers Squibb
Intelence <sup>®</sup>	Etravirine	Tibotec
Protease inhibitors		
Fortovase <sup>®</sup>	Saquinavir	Roche
Norvir <sup>®</sup>	Ritonavir	Abbott
Crixivan <sup>®</sup>	Indinavir	Merck
Viracept <sup>®</sup>	Nelfinavir	Pfizer
Agenerase <sup>®</sup> , Prozei <sup>®</sup>	Amprenavir	GlaxoSmithKline
Kaletra <sup>®</sup>	Lopinavir + ritonavir	Abbott
Reyataz <sup>®</sup>	Atazanavir	Bristol–Myers Squibb
Lexiva <sup>®</sup>	Fosamprenavir	GlaxoSmithKline
Aptivus <sup>®</sup>	Tipranavir	Boehringer Ingelheim
Prezista <sup>®</sup>	Darunavir	Tibotec
Viral entry inhibitors		
Coreceptor inhibitors		
Selzentry <sup>®</sup> , Celsentri <sup>®</sup>	Maraviroc	Pfizer
Fusion inhibitors		
Fuzeon <sup>®</sup>	Enfuvirtide (T-20)	Roche

(Continued)

Table 1.2 (Continued)

Registered brand name	Generic name	Manufacturer
Integrase inhibitors		
Isentress <sup>®</sup>	Raltegravir	Merck
Anti-HBV compounds		
Epivir <sup>®</sup> , Zeffix <sup>®</sup>	Lamivudine (3TC)	GlaxoSmithKline
Hepsera <sup>®</sup>	Adefovir dipivoxil	Gilead Sciences
Baraclude <sup>®</sup>	Entecavir	Bristol-Myers Squibb
Tyzeka <sup>®</sup> , Sebivo <sup>®</sup>	Telbivudine	Idenix Pharmaceuticals
Viread <sup>®</sup>	Tenofovir disoproxil fumarate	Gilead Sciences
Intron A <sup>®</sup>	Interferon- $\alpha$ -2b	Schering-Plough
Pegasys <sup>®</sup>	Pegylated interferon- $\alpha$ -2a	Roche
Antiherpesvirus compounds		
HSV and VZV inhibitors		
Zovirax <sup>®</sup>	Acyclovir (ACV)	GlaxoSmithKline
Zelitrex <sup>®</sup> , Valtrex <sup>®</sup>	Valaciclovir (VACV)	GlaxoSmithKline
Denavir <sup>®</sup> , Vectavir <sup>®</sup>	Penciclovir (PCV)	Novartis
Famvir <sup>®</sup>	Famciclovir (FCV)	Novartis
Herpid <sup>®</sup> , Stoxil <sup>®</sup> , Idoxene <sup>®</sup> , Virudox <sup>®</sup>	Idoxuridine (IDU, IUdR)	Yale University
Viroptic <sup>®</sup>	Trifluridine (TFT)	King Pharmaceuticals
Zostex <sup>®</sup> , Brivirac <sup>®</sup> , Zerpex <sup>®</sup>	Brivudin (BVDU) <sup>a</sup>	Berlin Chemie/Menarini
CMV inhibitors		
Cymevene <sup>®</sup> , Cytovene <sup>®</sup>	Ganciclovir (GCV)	Roche
Valcyte <sup>®</sup>	Valganciclovir (VGCV)	Roche
Foscavir <sup>®</sup>	Foscarnet	Astra Zeneca
Vistide <sup>®</sup>	Cidofovir (CDV)	Pfizer
Vitravene <sup>®</sup>	Fomivirsen	Novartis
Anti-influenza virus compounds		
Symmetrel <sup>®</sup> , Mantadix <sup>®</sup> , Amantan <sup>®</sup>	Amantadine	Endo Pharmaceuticals
Flumadine <sup>®</sup>	Rimantadine	Forest Laboratories
Relenza <sup>®</sup>	Zanamivir	GlaxoSmithKline
Tamiflu <sup>®</sup>	Oseltamivir	Roche
Virazole <sup>®</sup> , Virazid <sup>®</sup> , Viramid <sup>®</sup>	Ribavirin	Valeant Pharmaceuticals
Anti-HCV compounds		
Rebetol <sup>®</sup>	Ribavirin	Schering-Plough
Copegus <sup>®</sup>	Ribavirin	Roche
Pegasys <sup>®</sup>	Pegylated interferon- $\alpha$ -2a	Roche
Roferon A <sup>®</sup>	Interferon- $\alpha$ -2a	Roche
Intron A <sup>®</sup>	Interferon- $\alpha$ -2b	Schering-Plough
PEG-Intron <sup>®</sup>	Pegylated interferon- $\alpha$ -2b	Schering-Plough
Rebetron <sup>®</sup>	Interferon- $\alpha$ -2b + ribavirin	Schering-Plough

a) Not formally approved by the US FDA.

BVDU owes its antiviral selectivity to a specific phosphorylation by the HSV-1- and VZV-encoded thymidine kinase, just as acyclovir does, but compared to acyclovir, BVDU is a much more potent inhibitor of VZV replication. If BVDU is further converted to a bicyclic furano[2,3-*d*]pyrimidine nucleoside analogue (BCNA) carrying an aliphatic side chain interrupted by a phenyl moiety [42, 43], as in Cf 1743, the compound becomes exquisitely and exclusively active against VZV.

Although BVDU and acyclovir belong, respectively, to the pyrimidine and purine nucleoside analogues, they share, structurally, the same carboxamide pharmacophore (Figure 1.1), which may explain why they are both specifically recognized as substrate by the HSV- and VZV-encoded thymidine kinases. The same pharmacophore is found in other acyclic guanosine analogues such as ganciclovir and

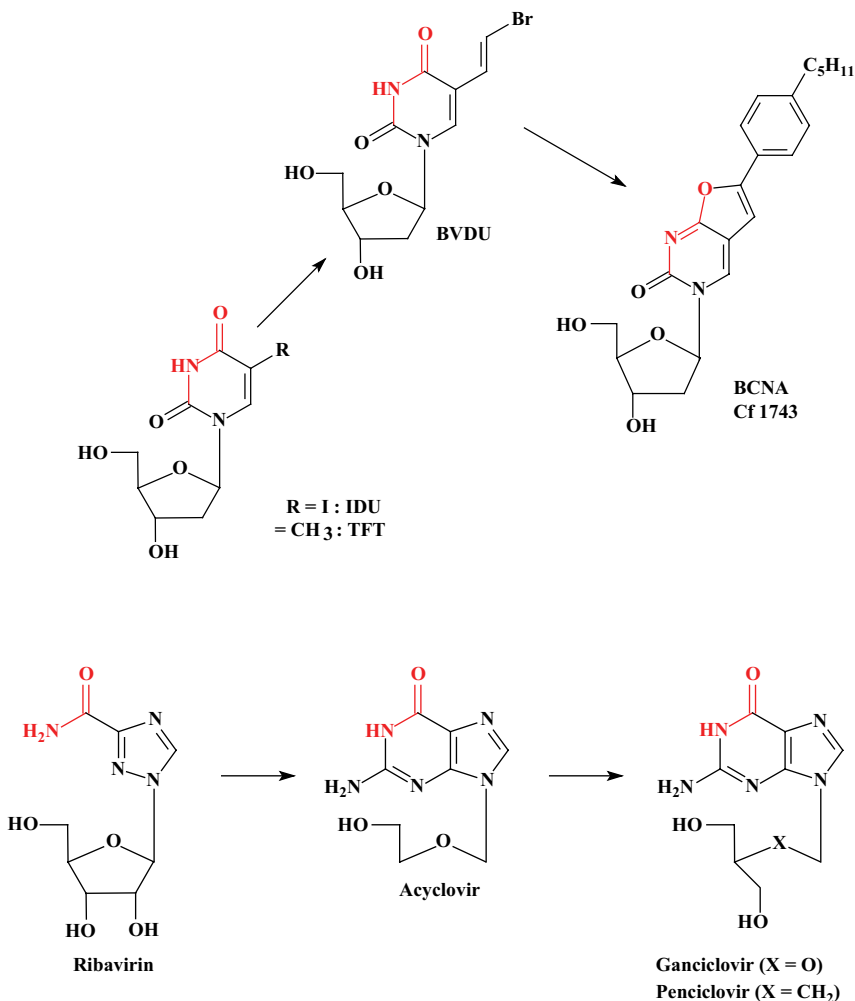
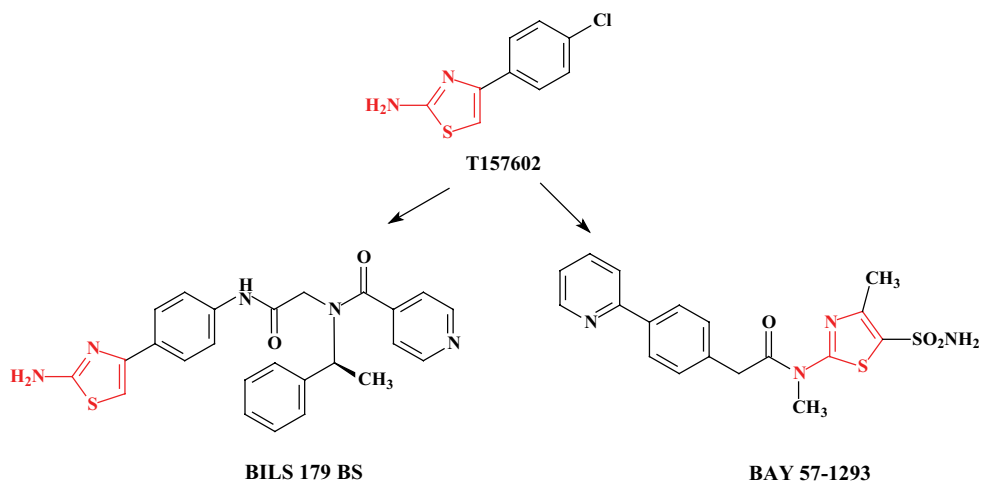

Figure 1.1 Pharmacophores in antitherpesvirus agents.



**Figure 1.1** (Continued)

peniclovir, again explaining the specificity of these compounds against HSV and VZV. Remarkably, the same pharmacophore is also found in ribavirin, which was described as a broad-spectrum antiviral agent, 5 years before acyclovir was reported (see Table 1.1), but in the case of ribavirin, the presence of the ribofuranosyl moiety primarily directs its antiviral activity spectrum toward RNA viruses due to an inhibitory action at the level of the IMP dehydrogenase [44–46].

While BVDU and acyclovir interact in their active triphosphate form with the viral DNA polymerase, the first phosphorylation step by the viral thymidine kinase required only to initiate the activation process, the HPIs seem to be directly targeted at the HSV helicase–primase UL5–UL8–UL52 complex [47]. The first HPI reported to inhibit HSV replication via interaction with the helicase component of this complex [31] was the 2-aminothiazole T-157602. The HPIs that were subsequently described and also found to be more effective than acyclovir and famciclovir against HSV infections in murine models of HSV-1 and HSV-2 infection [48–51], namely, BILS 179BS and BAY 57-1293, are also built upon the 2-aminothiazole scaffold (Figure 1.1). HPIs represent an exciting new avenue in the development of antivirals active against herpesviruses [47], but whether they represent an alternative (or additional) strategy to acyclovir (and acyclic guanosine analogues in general) will depend on their exact spectrum of antiviral activity, whether or not encompassing VZV (an issue that presently can only be speculated upon), and the readiness by which they elicit resistance mutations [52, 53] (an issue that needs continued vigilance).

## 1.5

### Antiviral Drugs Active against Retroviruses (HIV)

The best known class of the antiretroviral agents is that of the nucleoside reverse transcriptase inhibitors, now containing seven members – zidovudine, didanosine,

zalcitabine, stavudine, lamivudine, abacavir, and emtricitabine – that are on the market [54]. What all these compounds have in common is that they are 2',3'-dideoxynucleoside analogues (Figure 1.2, NRTIs), which through the absence of a 3'-hydroxyl group inevitably act as chain terminators at the reverse transcriptase level. The last three of the series, namely, lamivudine (3TC, originally described as its racemic form, BCH-189) [55], abacavir (1592 U89) [56], and emtricitabine ((-)

### NRTIs

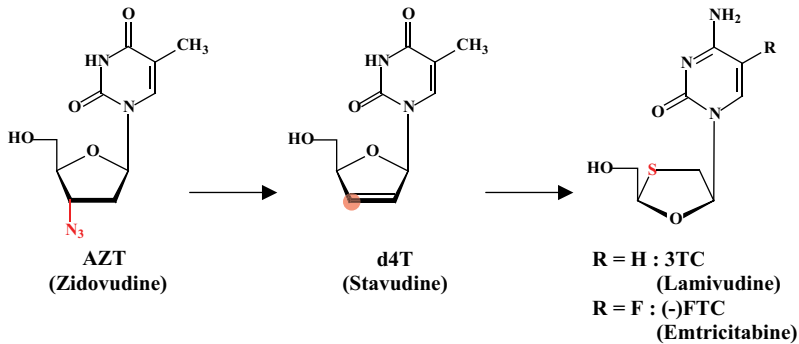

### NtRTIs

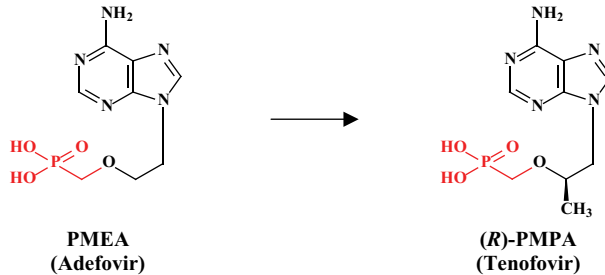

### NNRTIs

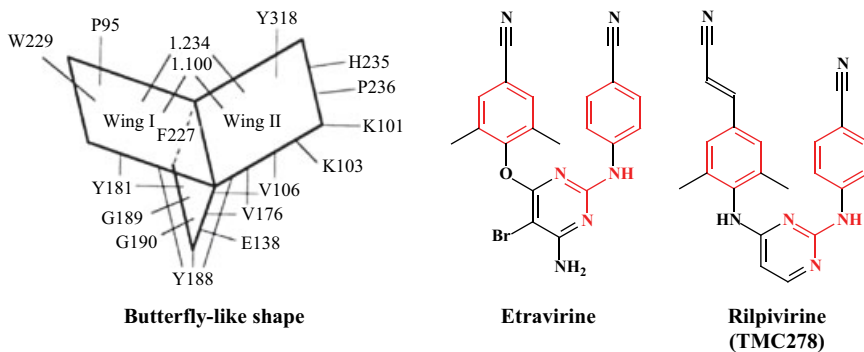
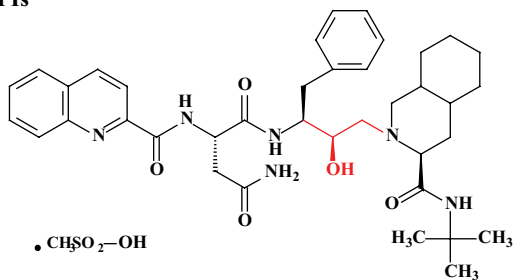
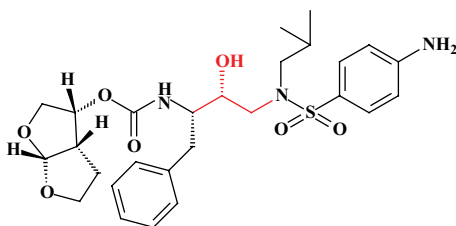

Figure 1.2 Pharmacophores in antiretrovirus agents.

**PIs**



**Saquinavir**



**Darunavir  
(TMC-114)**

**INIs**

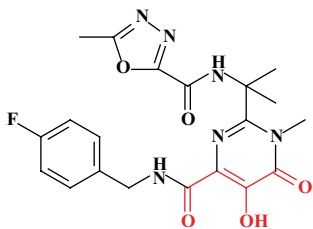

**Raltegravir  
(MK-0518)**

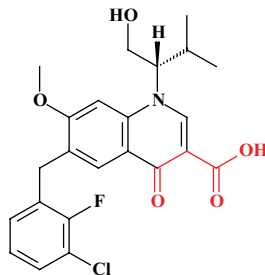

**Elvitegravir  
(GS-9137)**

**CRIs (R5 strains)**

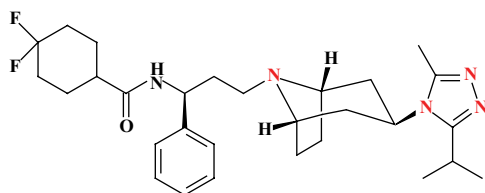

**Maraviroc**

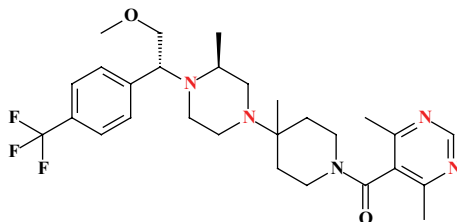

**Vicriviroc  
(SCH-D)**

**Figure 1.2 (Continued)**

FTC [57, 58], correspond to the (–)- or L-enantiomeric form (whereas the first four have the natural D-form).

NtRTIs should be clearly distinguished from the NRTIs as they contain a

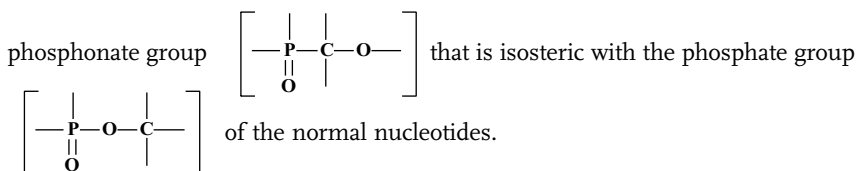

To this class of compounds belong adefovir and tenofovir (Figure 1.2, NtRTIs) [59], used in their oral prodrug forms, adefovir dipivoxil and tenofovir disoproxil fumarate (TDF), in the treatment of hepatitis B virus (HBV) and HIV infections, respectively. TDF has since 2008 also been licensed for the treatment of HBV infections [60]. TDF is also commercially available, in combination with emtricitabine (Truvada<sup>®</sup>), and in combination with emtricitabine and efavirenz (Atripla<sup>®</sup>), for the treatment of HIV infections.

The HEPT and TIBO derivatives were the first nonnucleoside reverse transcriptase inhibitors to be described [61]. This class has now yielded an abundance of compounds, four of which have been formally approved (nevirapine, delavirdine, efavirenz, and etravirine) and a fifth is forthcoming (rilpivirine). All these compounds have a butterfly-like shape (Figure 1.2, NNRTIs), a term first coined by Ding *et al.* [62], and it has also been shown by crystallographic analysis [63].

All protease inhibitors (PIs) that have been licensed for clinical use (from saquinavir to darunavir, Figure 1.2, PIs) [54], with the exception of tipranavir, are built upon the hydroxyethylene scaffold  $[-\text{CH}(\text{OH})-\text{CH}_2-]$ , which can be considered peptidomimetic and thus imitates the peptide linkage that has to be cleaved by the viral protease during the viral protein maturation process. PIs are generally used in combination with other antiretroviral classes. Given their common scaffold they may be expected to give similar potency, side effects, and resistance profiles.

Of the fusion inhibitors (FIs), the first and still the only FI used in the treatment of HIV-1 infections is enfuvirtide (structure as given in Ref. [64]), a 36-amino acid peptide, for which proof of concept in the clinic was provided by Kilby *et al.* [65] and the clinical efficacy further demonstrated by Lalezari *et al.* [66] and Lazzarin *et al.* [67]. Limitations to the widespread use of enfuvirtide are its parenteral administration (subcutaneous injection twice daily), the local induration it may cause, and the cost.

Of the coreceptor inhibitors, none is likely to be available soon for the treatment of X4 HIV infections (instead, the CXCR4 antagonist AMD3100 has been developed, and recently licensed, as a stem cell mobilizer for autologous transplantation in patients with hematological malignancies such as non-Hodgkin's lymphoma or multiple myeloma [68]). Several CCR5 antagonists have been described for the treatment of R5 HIV infections [69]: only one (maraviroc) has been licensed for clinical use and a second one (vicriviroc) is forthcoming. It is difficult to discern what these compounds have in common structurally, except for the presence of a number of basic nitrogens (Figure 1.2, CRIs).



In HIV integrase inhibitors, the prime structural determinant is undoubtedly the diketo acid group, which was already evident in the first “diketo acid” derivative (L-731988) that was described [32] and which subsequently [70] led via L-870810 to raltegravir (MK0518) that has been licensed for clinical use after its clinical efficacy was clearly demonstrated [71, 72]. Next in line is elvitegravir (GS-9137), a quinolone 3-carboxylic acid derivative (which can also be considered a “diketo acid” derivative) (Figure 1.2, INIs). Being also a quinolone derivative, elvitegravir could theoretically act as a transcription inhibitor, but it has been ascertained that elvitegravir, just like L-870810, acts as a genuine INI [73]. Both raltegravir and elvitegravir are assumed to interfere with the strand transfer reaction of the HIV integrase, the mutations Q148K and T66I conferring the highest resistance to both drugs [74].

## 1.6

### Antiviral Drugs Active against Hepatitis B Virus

There are at present seven drugs approved by the US FDA for the treatment of hepatitis B virus: interferon- $\alpha$ -2b (Intron A), lamivudine (3TC), adefovir dipivoxil, entecavir, peginterferon- $\alpha$ -2a (Pegasys), telbivudine, and tenofovir disoproxil fumarate (a few others, that is, clevudine (L-FMAU), emtricitabine ((-)-FTC), valtorcitabine (valLdC), amdoxovir (DAPD), and racivir, are still under development). The anti-HBV agents have been reviewed recently [75]. Two of these compounds (lamivudine and tenofovir) are also used for the treatment of HIV infections, and as both HIV and HBV depend for their replication on a virus-associated reverse transcriptase (RT), it is not surprising that some of the RT inhibitors that are active against HIV are also active against HBV, and vice versa. However, there are exceptions; that is, entecavir and telbivudine (Figure 1.3) are specific inhibitors of HBV replication. They both are assumed to interact with the viral DNA polymerase, but how they do so has not been fully explained. Entecavir, if it is incorporated into the viral DNA, has to act as an obligatory chain terminator, but this is not necessarily so for telbivudine since the latter contains a 3'-hydroxyl group, theoretically allowing further chain elongation.

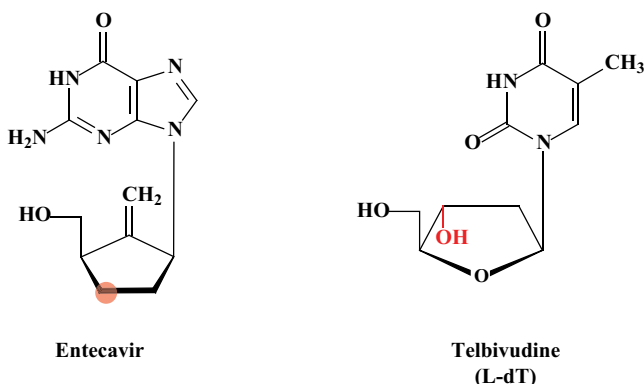

**Figure 1.3** Pharmacophores in anti-HBV agents.

## 1.7

## Antiviral Drugs Active against DNA Viruses at Large

For the majority of DNA virus infections there is no specific (formalized) treatment, including polyoma-, papilloma-, and adenovirus, the herpesviruses Epstein–Barr virus (EBV) and human herpesvirus type 6 (HHV-6), and the whole family of poxviridae (including the orthopoxviruses variola, vaccinia, monkeypox, and cowpox), the parapoxviruses (i.e., orf), and mollusciviruses (i.e., molluscum contagiosum virus). Cidofovir, which has been formally licensed only for the treatment of CMV retinitis in AIDS patients, could be used “off label” for the treatment of other herpesvirus infections as well as polyoma-, papilloma-, adeno-, and poxvirus infections. The problem with cidofovir and all other acyclic nucleoside phosphonates, however, is that they have poor, if any, oral bioavailability, and to overcome this problem, alkoxyalkyl (i.e., hexadecyloxypropyl (HDP) and octadecyloxyethyl (ODE)) esters of cidofovir have been synthesized with high efficacy in the oral treatment of various (experimental) orthopoxvirus infections in mice [76, 77], as reviewed by Hostetler [78].

The parent compound of the acyclic nucleoside phosphonates is (*S*)-HPMPA (Figure 1.4) that was first described [24] in 1986. Then followed (*S*)-HPMPC [79] and, more recently, (*R*)-HPMPO-DAPy [80] and (*S*)-HPMP-5-azaC [81], and the HDP and ODE prodrugs of (*S*)-HPMP-5-azaC [82]. (*R*)-HPMPO-DAPy (Figure 1.4) proved more effective than postexposure smallpox vaccination in a lethal model of monkeypox virus infection in cynomolgus monkeys [83], and (*S*)-HPMP-5-azaC (Figure 1.4) proved to be a more potent and more selective antiviral agent than cidofovir (*S*)-HPMPC [84]. The new acyclic nucleoside phosphonates (*R*)-HPMPO-DAPy and (*S*)-HPMP-5-azaC, and alkoxyalkyl esters thereof, offer a wealth of potential applications in the broad field of DNA (pox, adeno, polyoma, papilloma, and herpes) virus infections, which have so far remained largely untapped.

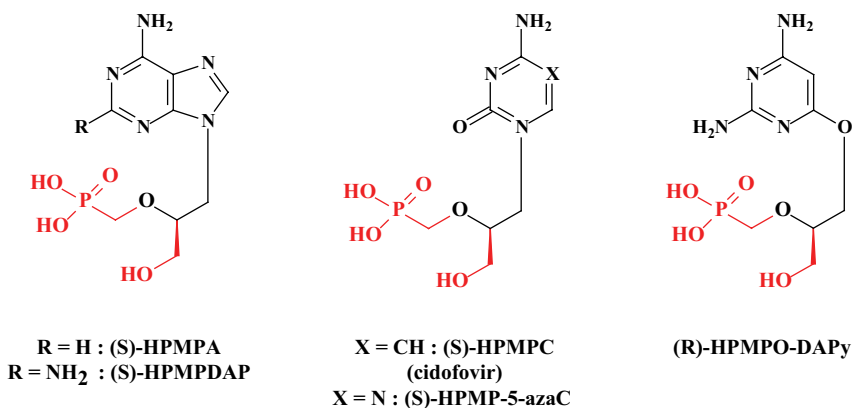

Figure 1.4 Pharmacophores in broad-spectrum anti-DNA virus agents.

## 1.8 Antiviral Drugs for Influenza A Virus Infections

Ever since amantadine was discovered as an inhibitor of influenza A virus replication [85], it has been considered a potential strategy for the therapy and prophylaxis of influenza A virus infections [60], but amantadine has also become notorious for rapidly leading to resistance development, probably a consequence of the specificity of its interaction with the M2 protein of influenza A virus. Various other strategies have been considered in the war against influenza [86], among which are ribavirin, viramidine, siRNAs, and phosphorothioate oligonucleotides, interferon (inducers), and viral RdRp inhibitors [87]. The most fascinating [88, 89] of the RdRp inhibitors is undoubtedly T-705.

At present, the neuraminidase inhibitors are still considered the most likely candidates to be used not only to curtail the annual recurrences of seasonal influenza (A (H1N1), A (H3N2), and influenza B) but also to prevent pandemics with any influenza A virus infection, whether avian (i.e., influenza A H5N1) or any new influenza A (H1N1) strain, such as the recent “Mexican” variant.

Neuraminidase inhibitors do have a very specific interaction with the viral neuraminidases (sialidase) [86] (Figure 1.5), “trapping” the newly formed virions

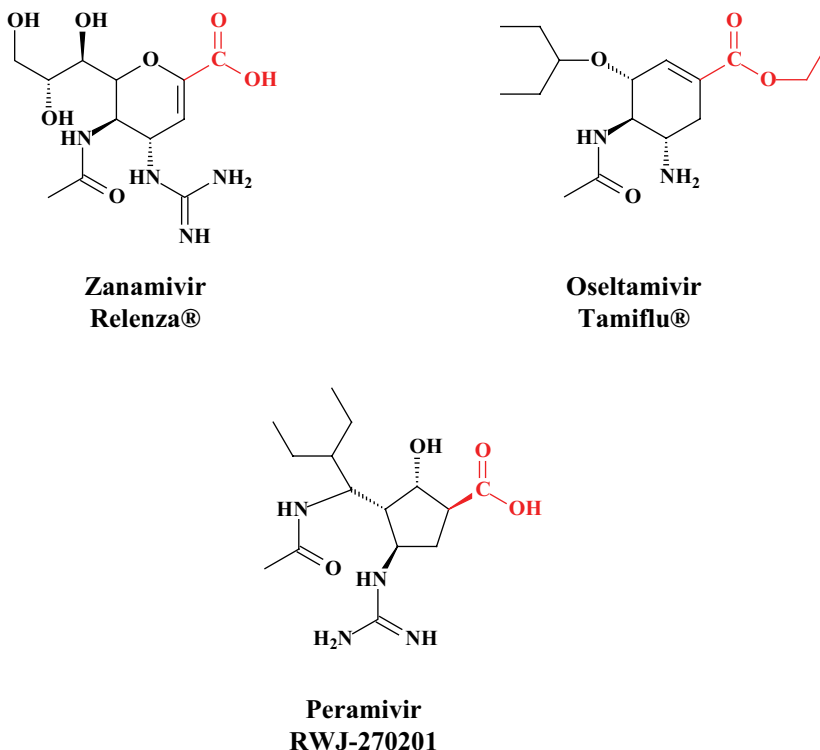

Figure 1.5 Pharmacophores in neuraminidase (sialidase) inhibitors.

at the cell surface, thus preventing the release of these progeny influenza virions from the cells (in which they have been formed) [87]. Unfortunately, influenza A seems to readily develop resistance against neuraminidase inhibitors such as oseltamivir (Tamiflu®) [89]. On the one hand, this points to the specificity of oseltamivir as an antiviral agent and, on the other hand, it argues for a close surveillance of the possible emergence of resistance with the extended use of neuraminidase inhibitors such as oseltamivir.

## 1.9

### Antiviral Drugs for Hepatitis C Virus

Standard care for hepatitis C nowadays consists of the administration of pegylated interferon- $\alpha$ -2a, in combination with ribavirin. Yet, specific anti-HCV agents are under development that are targeted at either the HCV (serine) protease or HCV RdRp. The most advanced among the HCV protease inhibitors are telaprevir [90] and boceprevir [91, 92]. The efficacy of telaprevir, in combination with pegylated interferon and ribavirin, in the treatment of hepatitis C has recently been demonstrated [93, 94]. The first HCV PI to be described and to show antiviral activity in humans was ciluprevir (BILN 2061) [34]. While ciluprevir and a successor thereof, TMC-435350 [95], do have a macrocyclic structure (not shown), telaprevir and boceprevir are built upon a (poly)peptide scaffold.

Like the HIV RT, the HCV RdRp can be targeted at both the catalytic site (by NRRIs) and the allosteric site (by NNRRIs). A characteristic of the anti-HCV activity of NRRIs is the presence of the 2'-C-methyl pharmacophore, as in 2'-C-methyladenosine, 2'-C-methylguanosine, 2'-C-methylcytidine, 7-deaza-2'-C-methyladenosine, and 2'-deoxy-2'-fluoro-2'-C-methylcytidine (Figure 1.6, NRRIs). 2-C-Methyl-substituted ribonucleosides are active not only against hepaciviruses such as HCV but also against pestiviruses, such as bovine viral diarrhea virus (BVDV), and flaviviruses, such as yellow fever and West Nile [35]. They act as nonobligate chain terminators of the RdRp [35]. The first NRRI to enter the clinic was valopicitabine (NM 283: 3'-valine ester of 2'-C-methylcytidine). It was also the first to be discontinued for further development. An exception to the rule that the nucleoside analogues active against HCV should contain a 2'-C-methyl group is the 4'-azidocytidine (R1479) [96], and like valopicitabine, this compound has apparently not been further developed.

Resulting from the first wave of NNRRIs were thiophene, 2-carboxylic acid, benzimidazole, and benzothiadiazine derivatives [97], further extended by various other derivatives among which was the benzofuran derivative HCV-796 [98]. The latter proved, in fact, highly active against the HCV replicon system [99], but its further development has apparently been stopped. One of the most potent anti-HCV agents (in development) acting as an NNRRI is GS-327073 (Figure 1.6, NNRRIs). It has an EC<sub>50</sub> of 0.002–0.004  $\mu$ M in the HCV (genotype 1b) replicon system. GS-327073 is based upon the 5-[(4-bromophenyl)methyl]-2-phenyl-5H-imidazo[4,5-c]pyridine BPIP skeleton, which was akin to VP 32947 [33] first identified as a potent

and selective inhibitor of the replication of pestiviruses such as BVDV [100]. BPIP was from the start recognized as an inhibitor of RdRp, the “finger” domain of the enzyme being its target. Further chemical modifications of the BPIP skeleton led to the identification of GS-327073 as a potent and selective NNRRIs of the HCV RdRp, again with the “finger” domain being the target site [101].

## PIs

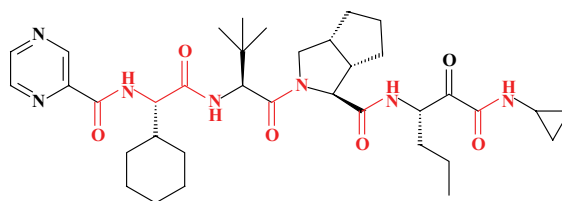

**Telaprevir  
(VX-950)**

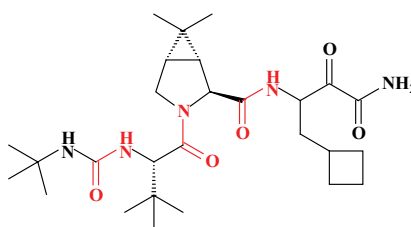

**Boceprevir  
(SCH-503034)**

## NRRIs

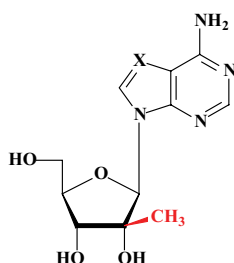

X = N : 2'-C-methyladenosine

X = CH : 7-deaza-2'-C-methyladenosine

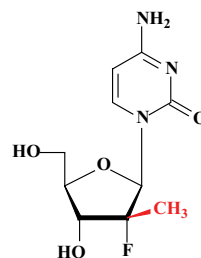

2'-Deoxy-2'-fluoro-2'-C-methylcytidine  
(R-7128)

**Figure 1.6** Pharmacophores in anti-HCV agents.

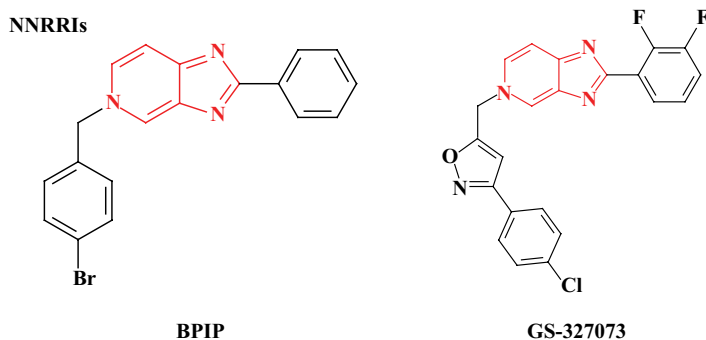

Figure 1.6 (Continued)

### 1.10

#### Antiviral Drugs for Poxviruses (i.e., Variola, Vaccinia, and so on)

Poxviruses (such as variola, vaccinia, cowpox, and monkeypox) are the largest of all viruses and contain the largest set of genes encoding for specific viral proteins that could be considered targets for chemotherapeutic intervention. At present, cidofovir (*S*)-HPMPC) has remained the only drug that could be used, albeit off label, both for the therapy and short-term prophylaxis of smallpox (should it, for example, occur in the context of a bioterrorist attack) and monkeypox and for the treatment of the complications of vaccinia that could arise in immunosuppressed patients inadvertently inoculated with the smallpox vaccine [60, 102]. If needed, cidofovir could be used in its oral prodrug form (i.e., hexadecylpropyl (HDP)-cidofovir), now known as CMX001. In the mean time, a new compound ST-246 (Figure 1.7) has come along, developed by SIGA Technologies Inc., which appears to inhibit variola virus and other orthopoxvirus infections by inhibiting the F13L phospholipase involved in extracellular virus production [36, 60, 103]. ST-246 acts synergistically with CMX001 [104], which throws open interesting prospects for this drug combination in the treatment of orthopoxvirus infections. Most important would be to know whether ST-246 is efficacious against smallpox, or the complications of smallpox vaccination such as eczema vaccinatum. A recent case of severe eczema vaccinatum in a household contact of a smallpox vaccinee illustrates the importance of the complications of smallpox vaccination and the possible impact ST-246 may have in such case(s) [60, 105].

In addition to specifically viral protein-targeted agents (such as ST-246), a number of compounds that interfere with cellular signal transduction, by inhibiting protein tyrosine kinases, such as STI-571 (Gleevec) [37] and 4-anilinoquinazoline CI-1033 [38], have been reported to strongly inhibit poxvirus (i.e., vaccinia virus) infections *in vivo*. These observations point to the options still available to treat poxvirus infections *in vivo*.

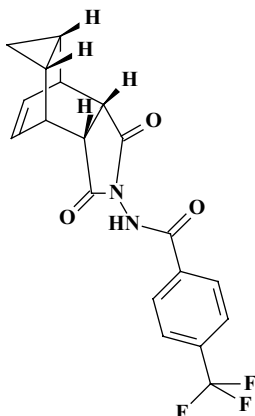

**ST-246**  
**[4-Trifluoromethyl-*N*-(3,3a,4,4a,5,5a,6,6a-octahydro-1,3-dioxo-4,6-ethenocycloprop[*f*]isoindol-2-(1*H*-y)benzamide**

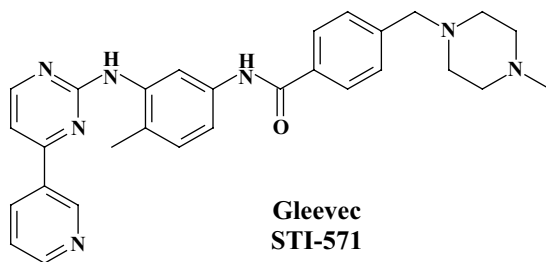

**Gleevec**  
**STI-571**

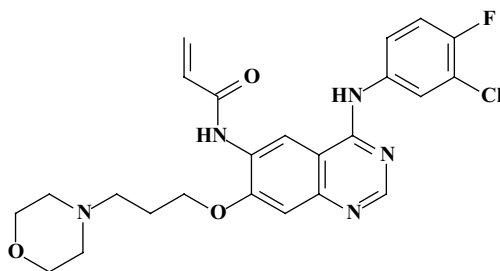

**4-Anilinoquinazoline**  
**CI-1033**

**Figure 1.7** Inhibitors of poxvirus replication.

## 1.11

### Further Options to Treat Virus Infections

Other, still, investigational strategies for the treatment of HIV and HCV infections have been described recently [98]. The farthest developed in the clinic (phase II) is a nonimmunosuppressive derivative of cyclosporin A, Debio-025 (structure as shown in Ref. [106]), a cyclophilin binding agent that has potent activity against both HCV [107] and HIV-1 [108]. Debio-025 has shown potent anti-HCV activity in patients coinfecting with HCV and HIV-1 [109].

For the treatment of poliovirus, and other enterovirus, and rhinovirus infections, a large variety of antipicornavirus agents have been described [106], the last in the series being a protein 3A inhibitor, TTP-8307 [110]. None of these compounds, however, has been developed from a clinical viewpoint. Likewise, increasingly significant attempts have been undertaken to find specific inhibitors for flavivirus (such as dengue virus) and other hemorrhagic fever virus infections [89], and for these virus infections, a “druggable” candidate compound is still eagerly awaited.

While the search for new therapeutic options to treat influenza virus infections has been continuously spurred by the emergence of new virus strains with pandemic “allures,” relatively little effort has been made to find or develop new therapeutics for respiratory syncytial virus (RSV) infections. Of significant potential in this regard might be a benzodiazepine, RSV604 (structure as shown in Ref. [111]), which seems to be targeted at the RSV nucleocapsid protein and has proceeded to phase II clinical trials [111].

## 1.12

### Conclusions

In addition to the some 50 antivirals that have been formally approved, now exactly 50 years after the first antiviral drug (IDU) was synthesized, the number of potential antiviral drug candidates is steadily growing [112]. Most of the antiviral drug development efforts have been focused on HIV, followed by HCV and HBV, and influenza virus coming next because of its capricious incidence. Also, hemorrhagic fever virus (and related encephalitis) infections, because of their global impact, should and have received accrued attention from a therapeutic viewpoint.

Other virus infections, such as herpes simplex and polio, have received relatively little attention because it has been felt they are sufficiently contained by established procedures, acyclovir therapy and vaccination, respectively. The methodology to design new antiviral drug strategies has gradually shifted from “serendipitous” screening to “rational” structure-based drug design, although in most instances this rational approach boiled down to the sheer chemical modification of a known scaffold or building on further from a known pharmacophore.

Surprisingly, the combination drug strategy that has been diligently worked out for HIV, primarily to prevent HIV drug resistance development, has not (yet) been exploited or even explored for other viruses such as HBV, HSV, or influenza. For



HCV, as for HIV, it is believed that it will be necessary to combine different drugs acting by different mechanisms, but before this could be done, the individual drugs have to be identified and approved.

Most of the antiviral drugs now in, or considered for, clinical use are targeted at specific viral events, enzymes (i.e., polymerases, proteases), or processes (i.e., virus–cell fusion). The observation that protein kinase inhibitors such as Gleevec and anilinoquinazolines have antiviral activities (e.g., against poxviruses) should signal a broader applicability of these protein kinase inhibitors. Potential usefulness in the treatment of virus infections may also extend to various other protein kinase inhibitors (such as flavopiridol and rapamycin) [113].

### Acknowledgment

I thank Mrs. Christiane Callebaut for her proficient editorial assistance.

### References

- 1 Prusoff, W.H. (1959) Synthesis and biological activities of iododeoxyuridine, an analog of thymidine. *Biochimica et Biophysica Acta*, **32**, 295–296.
- 2 Popovic, M., Sarin, P.S., Robert-Gurroff, M., Kalyanaraman, V.S., Mann, D., Minowada, J., and Gallo, R.C. (1983) Isolation and transmission of human retrovirus (human T-cell leukemia virus). *Science*, **219**, 856–859.
- 3 Barré-Sinoussi, F., Chermann, J.C., Rey, F., Nugeyre, M.T., Chamaret, S., Gruest, J., Dautoguet, C., Axler-Blin, C., Vézinet-Brun, F., Rouzioux, C., Rozenbaum, W., and Montagnier, L. (1983) Isolation of a T-lymphotropic retrovirus from a patient at risk for acquired immune deficiency syndrome (AIDS). *Science*, **220**, 868–871.
- 4 Hamre, D., Bernstein, J., and Donovick, R. (1950) Activity of *p*-aminobenzaldehyde, 3-thiosemicarbazone on vaccinia virus in the chick embryo and in the mouse. *Proceedings of the Society for Experimental Biology and Medicine*, **73**, 275–278.
- 5 Hamre, D., Brownlee, K.A., and Donovick, R. (1951) Studies on the chemotherapy of vaccinia virus. II. The activity of some thiosemicarbazones. *Journal of Immunology (Baltimore, MD: 1950)*, **67**, 305–312.
- 6 Thompson, R.L., Price, M.L., and Minton, S.A., Jr. (1951) Protection of mice against vaccinia virus by administration of benzaldehyde thiosemicarbazone. *Proceedings of the Society for Experimental Biology and Medicine*, **78**, 11–13.
- 7 Thompson, R.L., Minton, S.A., Jr., Officer, J.E., and Hitchings, G.H. (1953) Effect of heterocyclic and other thiosemicarbazones on vaccinia infection in the mouse. *Journal of Immunology (Baltimore, MD: 1950)*, **70**, 229–234.
- 8 Thompson, R.L., Davis, J., Russell, P.B., and Hitchings, G.H. (1953) Effect of aliphatic oxime and isatin thiosemicarbazone on vaccinia infection in the mouse and in the rabbit. *Proceedings of the Society for Experimental Biology and Medicine*, **84**, 496–499.
- 9 Bauer, D.J., Kempe, C.H., and Downie, A.W. (1963) Prophylactic treatment of smallpox contacts with *N*-methylisatin  $\beta$ -thiosemicarbazone. *Lancet*, **ii**, 494–496.
- 10 Tamm, I., Folkers, K., Shunk, C.H., and Horsfall, F.L., Jr. (1954) Inhibition of influenza virus multiplication by *N*-

- glycosides of benzimidazoles. *The Journal of Experimental Medicine*, **99**, 227–250.
- 11 Tamm, I. and Tyrrell, D.A.J. (1954) Influenza virus multiplication in the chorioallantoic membrane *in vitro*: kinetic aspects of inhibition by 5,6-dichloro-1- $\beta$ -D-ribofuranosyl-benzimidazole. *The Journal of Experimental Medicine*, **100**, 541–562.
  - 12 Tamm, I. and Nemes, M.M. (1959) Selective inhibition of poliovirus multiplication. *The Journal of Clinical Investigation*, **38**, 1047–1048.
  - 13 Eggers, H.J. and Tamm, I. (1962) On the mechanism of selective inhibition of enterovirus multiplication by 2-( $\alpha$ -hydroxybenzyl)-benzimidazole. *Virology*, **18**, 426–438.
  - 14 Eggers, H.J. and Tamm, I. (1963) Inhibition of enterovirus ribonucleic acid synthesis by 2-( $\alpha$ -hydroxybenzyl)-benzimidazole. *Nature*, **197**, 1327–1328.
  - 15 Prusoff, W.H. (1960) Studies on the mechanism of action of 5-iododeoxyuridine, an analog of thymidine. *Cancer Research*, **20**, 92–95.
  - 16 Herrmann, E.C., Jr. (1961) Plaque inhibition test for detection of specific inhibitors of DNA containing viruses. *Proceedings of the Society for Experimental Biology and Medicine*, **107**, 142–145.
  - 17 Kaufman, H.E. (1962) Clinical cure of herpes simplex keratitis by 5-iodo-2'-deoxyuridine. *Proceedings of the Society for Experimental Biology and Medicine*, **109**, 251–252.
  - 18 Kaufman, H.E. and Heidelberger, C. (1964) Therapeutic antiviral action of 5-trifluoromethyl-2'-deoxyuridine in herpes simplex keratitis. *Science*, **145**, 585–586.
  - 19 Sidwell, R.W., Huffman, J.H., Khare, G.P., Allen, L.B., Witkowski, J.T., and Robins, R.K. (1972) Broad-spectrum antiviral activity of virazole: 1- $\beta$ -D-ribofuranosyl-1,2,4-triazole-3-carboxamide. *Science*, **177**, 705–706.
  - 20 Manns, M.P., Foster, G.R., Rockstroh, J.K., Zeuzem, S., Zoulim, F., and Houghton, M. (2007) The way forward in HCV treatment: finding the right path. *Nature Reviews Drug Discovery*, **6**, 991–1000.
  - 21 Elion, G.B., Furman, P.A., Fyfe, J.A., de Miranda, P., Beauchamp, L., and Schaeffer, H.J. (1977) Selectivity of action of an antitherapeutic agent, 9-(2-hydroxyethoxymethyl)guanine. *Proceedings of the National Academy of Sciences of the United States of America*, **74**, 5716–5720.
  - 22 Schaeffer, H.J., Beauchamp, L., de Miranda, P., Elion, G.B., Bauer, D.J., and Collins, P. (1978) 9-(2-Hydroxyethoxymethyl) guanine activity against viruses of the herpes group. *Nature*, **272**, 583–585.
  - 23 Mitsuya, H., Weinhold, K.J., Furman, P.A., St. Clair, M.H., Lehrman, S.N., Gallo, R.C., Bolognesi, D., Barry, D.W., and Broder, S. (1985) 3'-Azido-3'-deoxythymidine (BW A509U): an antiviral agent that inhibits the infectivity and cytopathic effect of human T-lymphotropic virus type III/lymphadenopathy-associated virus *in vitro*. *Proceedings of the National Academy of Sciences of the United States of America*, **82**, 7096–7100.
  - 24 De Clercq, E., Holý, A., Rosenberg, I., Sakuma, T., Balzarini, J., and Maudgal, P.C. (1986) A novel selective broad-spectrum anti-DNA virus agent. *Nature*, **323**, 464–467.
  - 25 Baba, M., Tanaka, H., De Clercq, E., Pauwels, R., Balzarini, J., Schols, D., Nakashima, H., Perno, C.-F., Walker, R.T., and Miyasaka, T. (1989) Highly specific inhibition of human immunodeficiency virus type 1 by a novel 6-substituted acyclovir derivative. *Biochemical and Biophysical Research Communications*, **165**, 1375–1381.
  - 26 Miyasaka, T., Tanaka, H., Baba, M., Hayakawa, H., Walker, R.T., Balzarini, J., and De Clercq, E. (1989) A novel lead for specific anti-HIV-1 agents: 1-[(2-hydroxyethoxy)methyl]-6-(phenylthio)thymine. *Journal of Medicinal Chemistry*, **32**, 2507–2509.
  - 27 Pauwels, R., Andries, K., Desmyter, J., Schols, D., Kukla, M.J., Breslin, H.J., Raeymaeckers, A., Van Gelder, J., Woestenborghs, R., Heykants, J., Schellekens, K., Janssen, M.A.C., De Clercq, E., and Janssen, P.A.J. (1990) Potent and selective inhibition of HIV-1

- replication *in vitro* by a novel series of TIBO derivatives. *Nature*, **343**, 470–474.
- 28 De Clercq, E., Yamamoto, N., Pauwels, R., Baba, M., Schols, D., Nakashima, H., Balzarini, J., Debyser, Z., Murrer, B.A., Schwartz, D., Thornton, D., Bridger, G., Fricker, S., Henson, G., Abrams, M., and Picker, D. (1992) Potent and selective inhibition of human immunodeficiency virus (HIV)-1 and HIV-2 replication by a class of bicyclams interacting with a viral uncoating event. *Proceedings of the National Academy of Sciences of the United States of America*, **89**, 5286–5290.
  - 29 Wild, C., Greenwell, T., and Matthews, T. (1993) A synthetic peptide from HIV-1 gp41 is a potent inhibitor of virus-mediated cell–cell fusion. *AIDS Research and Human Retroviruses*, **9**, 1051–1052.
  - 30 von Itzstein, M., Wu, W.Y., Kok, G.B., Pegg, M.S., Dyason, J.C., Jin, B., Van Phan, T., Smythe, M.L., White, H.F., Oliver, S.W., Colman, P.M., Varghese, J.N., Ryan, D.M., Woods, J.M., Bethell, R.C., Hotham, V.J., Cameron, J., and Penn, C.R. (1993) Rational design of potent sialidase-based inhibitors of influenza virus replication. *Nature*, **363**, 418–423.
  - 31 Spector, F.C., Liang, L., Giordano, H., Sivaraja, M., and Peterson, M.G. (1998) Inhibition of herpes simplex virus replication by a 2-amino thiazole via interactions with the helicase component of the UL5–UL8–UL52 complex. *Journal of Virology*, **72**, 6979–6987.
  - 32 Hazuda, D.J., Felock, P., Witmer, M., Wolfe, A., Stillmock, K., Grobler, J.A., Espeseth, A., Gabryelski, L., Schleif, W., Blau, C., and Miller, M.D. (2000) Inhibitors of strand transfer that prevent integration and inhibit HIV-1 replication in cells. *Science*, **287**, 646–650.
  - 33 Baginski, S.G., Pevear, D.C., Seipel, M., Sun, S.C., Benetatos, C.A., Chunduru, S.K., Rice, C.M., and Collett, M.S. (2000) Mechanism of action of a pestivirus antiviral compound. *Proceedings of the National Academy of Sciences of the United States of America*, **97**, 7981–7986.
  - 34 Lamarre, D., Anderson, P.C., Bailey, M., Beaulieu, P., Bolger, G., Bonneau, P., Bös, M., Cameron, D.R., Cartier, M., Cordingley, M.G., Faucher, A.M., Goudreau, N., Kawai, S.H., Kukolj, G., Lagacé, L., LaPlante, S.R., Narjes, H., Poupard, M.A., Rancourt, J., Sentjens, R.E., St George, R., Simoneau, B., Steinmann, G., Thibeault, D., Tsantrizos, Y.S., Weldon, S.M., Yong, C.L., and Llinàs-Brunet, M. (2003) An NS3 protease inhibitor with antiviral effects in humans infected with hepatitis C virus. *Nature*, **426**, 186–189.
  - 35 Migliaccio, G., Tomassini, J.E., Carroll, S.S., Tomei, L., Altamura, S., Bhat, B., Bartholomew, L., Bosserman, M.R., Ceccacci, A., Colwell, L.F., Cortese, R., De Francesco, R., Eldrup, A.B., Getty, K.L., Hou, X.S., LaFemina, R.L., Ludmerer, S.W., MacCoss, M., McMasters, D.R., Stahlhut, M.W., Olsen, D.B., Hazuda, D.J., and Flores, O.A. (2003) Characterization of resistance to non-obligate chain-terminating ribonucleoside analogs that inhibit hepatitis C virus replication *in vitro*. *The Journal of Biological Chemistry*, **278**, 49164–49170.
  - 36 Yang, G., Pevear, D.C., Davies, M.H., Collett, M.S., Bailey, T., Rippen, S., Barone, L., Burns, C., Rhodes, G., Tohan, S., Huggins, J.W., Baker, R.O., Buller, R.L., Touchette, E., Waller, K., Schriewer, J., Neyts, J., De Clercq, E., Jones, K., Hruby, D., and Jordan, R. (2005) An orally bioavailable antipoxvirus compound (ST-246) inhibits extracellular virus formation and protects mice from lethal orthopoxvirus challenge. *Journal of Virology*, **79**, 13139–13149.
  - 37 Reeves, P.M., Bommarious, B., Lebeis, S., McNulty, S., Christensen, J., Swimm, A., Chahroudi, A., Chavan, R., Feinberg, M.B., Veach, D., Bornmann, W., Sherman, M., and Kalman, D. (2005) Disabling poxvirus pathogenesis by inhibition of Abl-family tyrosine kinases. *Nature Medicine*, **11**, 731–739.
  - 38 Yang, H., Kim, S.K., Kim, M., Reche, P.A., Morehead, T.J., Damon, I.K., Welsh, R.M., and Reinherz, E.L. (2005) Antiviral chemotherapy facilitates control of poxvirus infections through inhibition of cellular signal transduction. *The Journal of Clinical Investigation*, **115**, 379–387.
  - 39 De Clercq, E. (1980) Antiviral and antitumor activities of 5-substituted 2'-

- deoxyuridines. *Methods and Findings in Experimental and Clinical Pharmacology*, **2**, 253–267.
- 40 De Clercq, E., Descamps, J., De Somer, P., Barr, P.J., Jones, A.S., and Walker, R.T. (1979) (E)-5-(2-Bromovinyl)-2'-deoxyuridine: a potent and selective anti-herpes agent. *Proceedings of the National Academy of Sciences of the United States of America*, **76**, 2947–2951.
- 41 De Clercq, E. (2004) Discovery and development of BVDU (brivudin) as a therapeutic for the treatment of herpes zoster. *Biochemical Pharmacology*, **68**, 2301–2315.
- 42 McGuigan, C., Barucki, H., Carangio, A., Blewett, S., Andrei, G., Snoeck, R., De Clercq, E., Balzarini, J., and Erichsen, J.T. (2000) Highly potent and selective inhibition of varicella-zoster virus by bicyclic furopyrimidine nucleosides bearing an aryl side chain. *Journal of Medicinal Chemistry*, **43**, 4993–4997.
- 43 De Clercq, E. (2003) Highly potent and selective inhibition of varicella-zoster virus replication by bicyclic furo[2,3-d]pyrimidine nucleoside analogues. *Medicinal Research Reviews*, **23**, 253–274.
- 44 Streeter, D.G., Witkowski, J.T., Khare, G.P., Sidwell, R.W., Bauer, R.J., Robins, R.K., and Simon, L.N. (1973) Mechanism of action of 1- $\beta$ -D-ribofuranosyl-1,2,4-triazole-3-carboxamide (Virazole), a new broad-spectrum antiviral agent. *Proceedings of the National Academy of Sciences of the United States of America*, **70**, 1174–1178.
- 45 Leyssen, P., Balzarini, J., De Clercq, E., and Neyts, J. (2005) The predominant mechanism by which ribavirin exerts its antiviral activity *in vitro* against flaviviruses and paramyxoviruses is mediated by inhibition of IMP dehydrogenase. *Journal of Virology*, **79**, 1943–1947.
- 46 Leyssen, P., De Clercq, E., and Neyts, J. (2008) Molecular strategies to inhibit the replication of RNA viruses. *Antiviral Research*, **78**, 9–25.
- 47 Biswas, S. and Field, H.J. (2008) Herpes simplex virus helicase–primase inhibitors: recent findings from the study of drug resistance mutations. *Antiviral Chemistry & Chemotherapy*, **19**, 1–6.
- 48 Crute, J.J., Grygon, C.A., Hargrave, K.D., Simoneau, B., Faucher, A.M., Bolger, G., Kibler, P., Liuzzi, M., and Cordingley, M.G. (2002) Herpes simplex virus helicase–primase inhibitors are active in animal models of human disease. *Nature Medicine*, **8**, 386–391.
- 49 Kleymann, G., Fischer, R., Betz, U.A., Hendrix, M., Bender, W., Schneider, U., Handke, G., Eckenberg, P., Hewlett, G., Pevzner, V., Baumeister, J., Weber, O., Henninger, K., Keldenich, J., Jensen, A., Kolb, J., Bach, U., Popp, A., Mäben, J., Frappa, I., Haebich, D., Lockhoff, O., and Rübsamen-Waigmann, H. (2002) New helicase–primase inhibitors as drug candidates for the treatment of herpes simplex disease. *Nature Medicine*, **8**, 392–398.
- 50 Betz, U.A., Fischer, R., Kleymann, G., Hendrix, M., and Rübsamen-Waigmann, H. (2002) Potent *in vivo* antiviral activity of the herpes simplex virus primase–helicase inhibitor BAY 57–1293. *Antimicrobial Agents and Chemotherapy*, **46**, 1766–1772.
- 51 Biswas, S., Jennens, L., and Field, H.J. (2007) The helicase primase inhibitor, BAY 57-1293 shows potent therapeutic antiviral activity superior to famciclovir in BALB/c mice infected with herpes simplex virus type 1. *Antiviral Research*, **75**, 30–35.
- 52 Biswas, S., Smith, C., and Field, H.J. (2007) Detection of HSV-1 variants highly resistant to the helicase–primase inhibitor BAY 57-1293 at high frequency in 2 of 10 recent clinical isolates of HSV-1. *The Journal of Antimicrobial Chemotherapy*, **60**, 274–279.
- 53 Biswas, S., Kleymann, G., Swift, M., Tiley, L.S., Lyall, J., Aguirre-Hernández, J., and Field, H.J. (2008) A single drug-resistance mutation in HSV-1 UL52 primase points to a difference between two helicase–primase inhibitors in their mode of interaction with the antiviral target. *The Journal of Antimicrobial Chemotherapy*, **61**, 1044–1047.
- 54 De Clercq, E. (2009) Anti-HIV drugs: 25 compounds approved within 25 years after the discovery of HIV. *International Journal of Antimicrobial Agents*, **33**, 307–320.

- 55 Soudeyns, H., Yao, X.I., Gao, Q., Belleau, B., Kraus, J.L., Nguyen-Ba, N., Spira, B., and Wainberg, M.A. (1991) Anti-human immunodeficiency virus type 1 activity and *in vitro* toxicity of 2'-deoxy-3'-thiacytidine (BCH-189), a novel heterocyclic nucleoside analog. *Antimicrobial Agents and Chemotherapy*, **35**, 1386–1390.
- 56 Daluge, S.M., Good, S.S., Faletto, M.B., Miller, W.H., St. Clair, M.H., Boone, L.R., Tisdale, M., Parry, N.R., Reardon, J.E., Dornsife, R.E., Averett, D.R., and Krenitsky, T.A. (1997) 1592U89, a novel carbocyclic nucleoside analog with potent, selective anti-human immunodeficiency virus activity. *Antimicrobial Agents and Chemotherapy*, **41**, 1082–1093.
- 57 Hoong, L.K., Strange, L.E., Liotta, D.C., Koszalka, G.W., Burns, C.L., and Schinazi, R.F. (1992) Enzyme-mediated enantioselective preparation of pure enantiomers of the antiviral agent 2',3'-dideoxy-5-fluoro-3'-thiacytidine (FTC) and related compounds. *The Journal of Organic Chemistry*, **57**, 5563–5565.
- 58 Schinazi, R.F., Boudinot, F.D., Ibrahim, S.S., Manning, C., McClure, H.M., and Liotta, D.C. (1992) Pharmacokinetics and metabolism of racemic 2',3'-dideoxy-5-fluoro-3'-thiacytidine in rhesus monkeys. *Antimicrobial Agents and Chemotherapy*, **36**, 2432–2438.
- 59 De Clercq, E. and Holý, A. (2005) Acyclic nucleoside phosphonates: a key class of antiviral drugs. *Nature Reviews Drug Discovery*, **4**, 928–940.
- 60 De Clercq, E. (2009) Another ten stories in antiviral drug discovery (partC): “old” and “new” antivirals, strategies, and perspectives. *Medicinal Research Reviews*, **29**, 611–645.
- 61 De Clercq, E. (2004) Non-nucleoside reverse transcriptase inhibitors (NNRTIs): past, present and future. *Chemistry Biodiversity*, **1**, 44–64.
- 62 Ding, J., Das, K., Moereels, H., Koymans, L., Andries, K., Janssen, P.A., Hughes, S.H., and Arnold, E. (1995) Structure of HIV-1 RT/TIBO R 86183 complex reveals similarity in the binding of diverse nonnucleoside inhibitors. *Nature Structural Biology*, **2**, 407–415.
- 63 Chimirri, A., Grasso, S., Monforte, A.M., Monforte, P., and Zappala, M. (1995) Thiazobenzimidazoles as non-nucleoside HIV-1 RT inhibitors. Abstracts of the II Congresso Congiunto Italiano-Spagnolo di Chimica Farmaceutica/II Congresso Conjunto Italiano-Espanol de Quimica Terapeutica, Ferrara, Italy, 30 August–3 September 1995, ML20.
- 64 Matthews, T., Salgo, M., Greenberg, M., Chung, J., DeMasi, R., and Bolognesi, D. (2004) Enfuvirtide: the first therapy to inhibit the entry of HIV-1 into host CD4 lymphocytes. *Nature Reviews Drug Discovery*, **3**, 215–225.
- 65 Kilby, J.M., Hopkins, S., Venetta, T.M., DiMassimo, B., Cloud, G.A., Lee, J.Y., Alldredge, L., Hunter, E., Lambert, D., Bolognesi, D., Matthews, T., Johnson, M.R., Nowak, M.A., Shaw, G.M., and Saag, M.S. (1998) Potent suppression of HIV-1 replication in humans by T-20, a peptide inhibitor of gp41-mediated virus entry. *Nature Medicine*, **4**, 1302–1307.
- 66 Lalezari, J.P., Henry, K., O'Hearn, M., Montaner, J.S., Piliro, P.J., Trottier, B., Walmsley, S., Cohen, C., Kuritzkes, D.R., Eron J.J., Jr., Chung, J., DeMasi, R., Donatucci, L., Drobnes, C., Delehanty, J., and Salgo, M. (2003) Enfuvirtide, an HIV-1 fusion inhibitor, for drug-resistant HIV infection in North and South America. *The New England Journal of Medicine*, **348**, 2175–2185.
- 67 Lazzarin, A., Clotet, B., Cooper, D., Reynes, J., Arastéh, K., Nelson, M., Katlama, C., Stellbrink, H.J., Delfraissy, J.F., Lange, J., Huson, L., DeMasi, R., Wat, C., Delehanty, J., Drobnes, C., and Salgo, M. (2003) Efficacy of enfuvirtide in patients infected with drug-resistant HIV-1 in Europe and Australia. *The New England Journal of Medicine*, **348**, 2186–2195.
- 68 De Clercq, E. (2009) The AMD3100 story: the path to the discovery of a stem cell mobilizer (Mozobil). *Biochemical Pharmacology*, **77**, 1655–1664.
- 69 Westby, M. and van der Ryst, E. (2005) CCR5 antagonists: host-targeted antivirals for the treatment of HIV infection. *Antiviral Chemistry & Chemotherapy*, **16**, 339–354.

- 70 Hazuda, D.J., Young, S.D., Guare, J.P., Anthony, N.J., Gomez, R.P., Wai, J.S., Vacca, J.P., Handt, L., Motzel, S.L., Klein, H.J., Dornadula, G., Danovich, R.M., Witmer, M.V., Wilson, K.A., Tussey, L., Schleif, W.A., Gabryelski, L.S., Jin, L., Miller, M.D., Casimiro, D.R., Emini, E.A., and Shiver, J.W. (2004) Integrase inhibitors and cellular immunity suppress retroviral replication in rhesus macaques. *Science*, **305**, 528–532.
- 71 Steigbigel, R.T., Cooper, D.A., Kumar, P.N., Eron, J.E., Schechter, M., Markowitz, M., Loutfy, M.R., Lennox, J.L., Gatell, J.M., Rockstroh, J.K., Katlama, C., Yeni, P., Lazzarin, A., Clotet, B., Zhao, J., Chen, J., Ryan, D.M., Rhodes, R.R., Killar, J.A., Gilde, L.R., Strohmaier, K.M., Meibohm, A.R., Miller, M.D., Hazuda, D.J., Nessler, M.L., DiNubile, M.J., Isaacs, R.D., Nguyen, B.Y., and Tepler, H. (2008) Raltegravir with optimized background therapy for resistant HIV-1 infection. *The New England Journal of Medicine*, **359**, 339–354.
- 72 Cooper, D.A., Steigbigel, R.T., Gatell, J.M., Rockstroh, J.K., Katlama, C., Yeni, P., Lazzarin, A., Clotet, B., Kumar, P.N., Eron, J.E., Schechter, M., Markowitz, M., Loutfy, M.R., Lennox, J.L., Zhao, J., Chen, J., Ryan, D.M., Rhodes, R.R., Killar, J.A., Gilde, L.R., Strohmaier, K.M., Meibohm, A.R., Miller, M.D., Hazuda, D.J., Nessler, M.L., DiNubile, M.J., Isaacs, R.D., Tepler, H., and Nguyen, B.Y. (2008) Subgroup and resistance analyses of raltegravir for resistant HIV-1 infection. *The New England Journal of Medicine*, **359**, 355–365.
- 73 Daelemans, D., Lu, R., De Clercq, E., and Engelman, A. (2007) Characterization of a replication-competent, integrase-defective human immunodeficiency virus (HIV)/simian virus 40 chimera as a powerful tool for the discovery and validation of HIV integrase inhibitors. *Journal of Virology*, **81**, 4381–4385.
- 74 Marinello, J., Marchand, C., Mott, B.T., Bain, A., Thomas, C.J., and Pommier, Y. (2008) Comparison of raltegravir and elvitegravir on HIV-1 integrase catalytic reactions and on a series of drug-resistant integrase mutants. *Biochemistry*, **47**, 9345–9354.
- 75 Férir, G., Kaptein, S., Neyts, J., and De Clercq, E. (2008) Antiviral treatment of chronic hepatitis B virus infections: the past, the present and the future. *Reviews in Medical Virology*, **18**, 19–34.
- 76 Quenelle, D.C., Collins, D.J., Herrod, B.P., Keith, K.A., Trahan, J., Beadle, J.R., Hostetler, K.Y., and Kern, E.R. (2007) Effect of oral treatment with hexadecyloxypropyl-[(S)-9-(3-hydroxy-2-phosphonylmethoxypropyl)adenine] [(S)-HPMPA] or octadecyloxy-ethyl-(S)-HPMPA on cowpox or vaccinia virus infections in mice. *Antimicrobial Agents and Chemotherapy*, **51**, 3940–3947.
- 77 Beadle, J.R., Wan, W.B., Ciesla, S.L., Keith, K.A., Hartline, C., Kern, E.R., and Hostetler, K.Y. (2006) Synthesis and antiviral evaluation of alkoxyalkyl derivatives of 9-(S)-(3-hydroxy-2-phosphonomethoxypropyl)adenine against cytomegalovirus and orthopoxviruses. *Journal of Medicinal Chemistry*, **49**, 2010–2015.
- 78 Hostetler, K.Y. (2009) Alkoxyalkyl prodrugs of acyclic nucleoside phosphonates enhance oral antiviral activity and reduce toxicity: current state of the art. *Antiviral Research*, **82**, A84–A88.
- 79 De Clercq, E., Sakuma, T., Baba, M., Pauwels, R., Balzarini, J., Rosenberg, I., and Holý, A. (1987) Antiviral activity of phosphonylmethoxyalkyl derivatives of purine and pyrimidines. *Antiviral Research*, **8**, 261–272.
- 80 Holý, A., Votruba, I., Masojdová, M., Andrei, G., Snoeck, R., Naesens, L., De Clercq, E., and Balzarini, J. (2002) 6-[2-(Phosphonomethoxy)alkoxy]pyrimidines with antiviral activity. *Journal of Medicinal Chemistry*, **45**, 1918–1929.
- 81 Krečmerová, M., Holý, A., Piskala, A., Masojdová, M., Andrei, G., Naesens, L., Neyts, J., Balzarini, J., De Clercq, E., and Snoeck, R. (2007) Antiviral activity of triazine analogues of 1-(S)-[3-hydroxy-2-(phosphonomethoxy)propyl]cytosine (cidofovir) and related compounds. *Journal of Medicinal Chemistry*, **50**, 1069–1077.
- 82 Krečmerová, M., Holý, A., Pohl, R., Masojdová, M., Andrei, G., Naesens, L., Neyts, J., Balzarini, J., De Clercq, E., and

- Snoeck, R. (2007) Ester prodrugs of cyclic 1-(S)-[3-hydroxy-2-(phosphonomethoxy)propyl]-5-azacytosine: synthesis and antiviral activity. *Journal of Medicinal Chemistry*, **50**, 5765–5772.
- 83 Stittelaar, K.J., Neyts, J., Naesens, L., van Amerongen, G., van Lavieren, R.F., Holý, A., De Clercq, E., Niesters, H.G., Fries, E., Maas, C., Mulder, P.G., van der Zeijst, B.A., and Osterhaus, A.D. (2006) Antiviral treatment is more effective than smallpox vaccination upon lethal monkeypox virus infection. *Nature*, **439**, 745–748.
- 84 Naesens, L., Andrei, G., Votruba, I., Krecmerová, M., Holý, A., Neyts, J., De Clercq, E., and Snoeck, R. (2008) Intracellular metabolism of the new antiviral compound 1-(S)-[3-hydroxy-2-(phosphonomethoxy)propyl]-5-azacytosine. *Biochemical Pharmacology*, **76**, 997–1005.
- 85 Davies, W.L., Grunert, R.R., Haff, R.F., McGahen, J.W., Neumayer, E.M., Paulshock, M., Watts, J.C., Wood, T.R., Hermann, E.C., and Hoffmann, C.E. (1964) Antiviral activity of 1-adamantanamine (amantadine). *Science*, **144**, 862–863.
- 86 von Itzstein, M. (2007) The war against influenza: discovery and development of sialidase inhibitors. *Nature Reviews Drug Discovery*, **6**, 967–974.
- 87 De Clercq, E. (2006) Antiviral agents active against influenza A viruses. *Nature Reviews Drug Discovery*, **5**, 1015–1025.
- 88 Furuta, Y., Takahashi, K., Kuno-Maekawa, M., Sangawa, H., Uehara, S., Kozaki, K., Nomura, N., Egawa, H., and Shiraki, K. (2005) Mechanism of action of T-705 against influenza virus. *Antimicrobial Agents and Chemotherapy*, **49**, 981–986.
- 89 De Clercq, E. (2010) Yet another ten stories on antiviral drug discovery (part D): paradigms, paradoxes and paraductions. *Medicinal Research Reviews*, **30** (4), 667–707.
- 90 Lin, C., Lin, K., Luong, Y.P., Rao, B.G., Wei, Y.Y., Brennan, D.L., Fulghum, J.R., Hsiao, H.M., Ma, S., Maxwell, J.P., Cottrell, K.M., Perni, R.B., Gates, C.A., and Kwong, A.D. (2004) *In vitro* resistance studies of hepatitis C virus serine protease inhibitors, VX-950 and BILN 2061: structural analysis indicates different resistance mechanisms. *The Journal of Biological Chemistry*, **279**, 17508–17514.
- 91 Venkatraman, S., Bogen, S.L., Arasappan, A., Bennett, F., Chen, K., Jao, E., Liu, Y.T., Lovey, R., Hendrata, S., Huang, Y., Pan, W., Parekh, T., Pinto, P., Popov, V., Pike, R., Ruan, S., Santhanam, B., Vibulbhan, B., Wu, W., Yang, W., Kong, J., Liang, X., Wong, J., Liu, R., Butkiewicz, N., Chase, R., Hart, A., Agrawal, S., Ingravallo, P., Pichardo, J., Kong, R., Baroudy, B., Malcolm, B., Guo, Z., Prongay, A., Madison, V., Broske, L., Cui, X., Cheng, K.C., Hsieh, Y., Brisson, J.M., Prelusky, D., Korfmacher, W., White, R., Bogdanowich-Knipp, S., Pavlovsky, A., Bradley, P., Saksena, A.K., Ganguly, A., Piwinski, J., Girijavallabhan, V., and Njoroge, F.G. (2006) Discovery of (1R,5S)-N-[3-amino-1-(cyclobutylmethyl)-2,3-dioxopropyl]-3-[2(S)-[[[(1,1-dimethylethyl)amino]carbonyl]-amino]-3,3-dimethyl-1-oxobutyl]-6,6-dimethyl-3-aza-bicyclo [3.1.0]hexan-2(S)-carboxamide (SCH 503034), a selective, potent, orally bioavailable hepatitis C virus NS3 protease inhibitor: a potential therapeutic agent for the treatment of hepatitis C infection. *Journal of Medicinal Chemistry*, **49**, 6074–6086.
- 92 Malcolm, B.A., Liu, R., Lahser, F., Agrawal, S., Belanger, B., Butkiewicz, N., Chase, R., Gheys, F., Hart, A., Hesk, D., Ingravallo, P., Jiang, C., Kong, R., Lu, J., Pichardo, J., Prongay, A., Skelton, A., Tong, X., Venkatraman, S., Xia, E., Girijavallabhan, V., and Njoroge, F.G. (2006) SCH 503034, a mechanism-based inhibitor of hepatitis C virus NS3 protease, suppresses polyprotein maturation and enhances the antiviral activity of alpha interferon in replicon cells. *Antimicrobial Agents and Chemotherapy*, **50**, 1013–1020.
- 93 McHutchison, J.G., Everson, G.T., Gordon, S.C., Jacobson, I.M., Sulkowski, M., Kauffman, R., McNair, L., Alam, J., and Muir, A.J. (2009) Telaprevir with peginterferon and ribavirin for chronic HCV genotype 1 infection. *The New*

- England Journal of Medicine*, **360**, 1827–1838.
- 94 Hézode, C., Forestier, N., Dusheiko, G., Ferenci, P., Pol, S., Goeser, T., Bronowicki, J.P., Bourlière, M., Gharakhanian, S., Bengtsson, L., McNair, L., George, S., Kieffer, T., Kwong, A., Kauffman, R.S., Alam, J., Pawlotsky, J.M., and Zeuzem, S. (2009) Telaprevir and peginterferon with or without ribavirin for chronic HCV infection. *The New England Journal of Medicine*, **360**, 1839–1850.
- 95 Raboisson, P., de Kock, H., Rosenquist, A., Nilsson, M., Salvador-Oden, L., Lin, T.I., Roue, N., Ivanov, V., Wähling, H., Wickström, K., Hamelink, E., Edlund, M., Vrang, L., Vendeville, S., Van de Vreken, W., McGowan, D., Tahri, A., Hu, L., Boutton, C., Lenz, O., Delouvroy, F., Pille, G., Surleraux, D., Wigerinck, P., Samuelsson, B., and Simmen, K. (2008) Structure–activity relationship study on a novel series of cyclopentane-containing macrocyclic inhibitors of the hepatitis C virus NS3/4A protease leading to the discovery of TMC435350. *Bioorganic & Medicinal Chemistry Letters*, **18**, 4853–4858.
- 96 Klumpp, K., Lévêque, V., Le Pogam, S., Ma, H., Jiang, W.R., Kang, H., Granycome, C., Singer, M., Laxton, C., Hang, J.Q., Sarma, K., Smith, D.B., Heindl, D., Hobbs, C.J., Merrett, J.H., Symons, J., Cammack, N., Martin, J.A., Devos, R., and Nájera, I. (2006) The novel nucleoside analog R1479 (4'-azidocytidine) is a potent inhibitor of NS5B-dependent RNA synthesis and hepatitis C virus replication in cell culture. *The Journal of Biological Chemistry*, **281**, 3793–3799.
- 97 De Francesco, R. and Migliaccio, G. (2005) Challenges and successes in developing new therapies for hepatitis C. *Nature*, **436**, 953–960.
- 98 De Clercq, E. (2007) The design of drugs for HIV and HCV. *Nature Reviews Drug Discovery*, **6**, 1001–1018.
- 99 Paeshuyse, J., Vliegen, I., Coelmont, L., Leyssen, P., Tabarrini, O., Herdewijn, P., Mittendorfer, H., Easmon, J., Cecchetti, V., Bartenschlager, R., Puerstinger, G., and Neyts, J. (2008) Comparative *in vitro* anti-hepatitis C virus activities of a selected series of polymerase, protease, and helicase inhibitors. *Antimicrobial Agents and Chemotherapy*, **52**, 3433–3437.
- 100 Paeshuyse, J., Leyssen, P., Mabery, E., Boddeker, N., Vrancken, R., Froeyen, M., Ansari, I.H., Dutartre, H., Rozenski, J., Gil, L.H., Letellier, C., Lanford, R., Canard, B., Koenen, F., Kerkhofs, P., Donis, R.O., Herdewijn, P., Watson, J., De Clercq, E., Puerstinger, G., and Neyts, J. (2006) A novel, highly selective inhibitor of pestivirus replication that targets the viral RNA-dependent RNA polymerase. *Journal of Virology*, **80**, 149–160.
- 101 Vliegen, I., Paeshuyse, J., De Burghgraeve, T., Lehman, L.S., Paulson, M., Shih, I.H., Mabery, E., Boddeker, N., De Clercq, E., Reiser, H., Oare, D., Lee, W.A., Zhong, W., Bondy, S., Pürstinger, G., and Neyts, J. (2009) Substituted imidazopyridines as potent inhibitors of HCV replication. *Journal of Hepatology*, **50**, 999–1009.
- 102 De Clercq, E. (2002) Cidofovir in the treatment of poxvirus infections. *Antiviral Research*, **55**, 1–13.
- 103 Bailey, T.R., Rippin, S.R., Opsitnick, E., Burns, C.J., Pevear, D.C., Collett, M.S., Rhodes, G., Tohan, S., Huggins, J.W., Baker, R.O., Kern, E.R., Keith, K.A., Dai, D., Yang, G., Hrubby, D., and Jordan, R. (2007) N-(3,3a,4,4a,5,5a,6,6a-Octahydro-1,3-dioxo-4,6-ethenocycloprop[*f*]isoindol-2-(1*H*)-yl)carboxamides: identification of novel orthopoxvirus egress inhibitors. *Journal of Medicinal Chemistry*, **50**, 1442–1444.
- 104 Quenelle, D.C., Prichard, M.N., Keith, K.A., Hrubby, D.E., Jordan, R., Painter, G.R., Robertson, A., and Kern, E.R. (2007) Synergistic efficacy of the combination of ST-246 with CMX001 against orthopoxviruses. *Antimicrobial Agents and Chemotherapy*, **51**, 4118–4124.
- 105 Vora, S., Damon, I., Fulginiti, V., Weber, S.G., Kahana, M., Stein, S.L., Gerber, S.I., Garcia-Houchins, S., Lederman, E., Hrubby, D., Collins, L., Scott, D., Thompson, K., Barsion, J.V., Regnery, R., Hughes, C., Daum, R.S., Li, Y., Zhao, H., Smith, S., Braden, Z., Karem, K., Olson, V., Davidson, W., Trindade, G., Bolken, T.,



- Jordan, R., Tien, D., and Marcinak, J. (2008) Severe eczema vaccinatum in a household contact of a smallpox vaccinee. *Clinical Infectious Diseases*, **46**, 1555–1561.
- 106 De Clercq, E. (2009) Antiviral drug discovery: ten more compounds, and ten more stories (part B). *Medicinal Research Reviews*, **29**, 571–610.
- 107 Paeshuyse, J., Kaul, A., De Clercq, E., Rosenwirth, B., Dumont, J.-M., Scalfaro, P., Bartenschlager, R., and Neyts, J. (2006) The non-immunosuppressive cyclosporin DEBIO-025 is a potent inhibitor of hepatitis C virus replication *in vitro*. *Hepatology (Baltimore, MD)*, **43**, 761–770.
- 108 Ptak, R.G., Gally, P.A., Jochmans, D., Halestrap, A.P., Ruegg, U.T., Pallansch, L.A., Bobardt, M.D., de Béthune, M.-P., Neyts, J., De Clercq, E., Dumont, J.-M., Scalfaro, P., Besseghir, K., Wenger, R.M., and Rosenwirth, B. (2008) Inhibition of human immunodeficiency virus type 1 replication in human cells by Debio-025, a novel cyclophilin binding agent. *Antimicrobial Agents and Chemotherapy*, **52**, 1302–1317.
- 109 Flisiak, R., Horban, A., Gally, P., Bobardt, M., Selvarajah, S., Wiercinska-Drapalo, A., Siwak, E., Cielniak, I., Higersberger, J., Kierkus, J., Aeschlimann, C., Grosgrin, P., Nicolas-Métral, V., Dumont, J.-M., Porchet, H., Crabbé, R., and Scalfaro, P. (2008) The cyclophilin inhibitor Debio-025 shows potent anti-hepatitis C effect in patients coinfecting with hepatitis C and human immunodeficiency virus. *Hepatology (Baltimore, MD)*, **47**, 817–826.
- 110 De Palma, A.M., Thibaut, H.J., van der Linden, L., Lanke, K., Heggermont, W., Ireland, S., Andrews, R., Arimilli, M., Al-Tel, T.H., De Clercq, E., van Kuppeveld, F., and Neyts, J. (2009) Mutations in the nonstructural protein 3A confer resistance to the novel enterovirus replication inhibitor TTP-8307. *Antimicrobial Agents and Chemotherapy*, **53**, 1850–1857.
- 111 Chapman, J., Abbott, E., Alber, D.G., Baxter, R.C., Bithell, S.K., Henderson, E.A., Carter, M.C., Chambers, P., Chubb, A., Cockerill, G.S., Collins, P.L., Dowdell, V.C., Keegan, S.J., Kelsey, R.D., Lockyer, M.J., Luongo, C., Najjarro, P., Pickles, R.J., Simmonds, M., Taylor, D., Tys, S., Wilson, L.J., and Powell, K.L. (2007) RSV604, a novel inhibitor of respiratory syncytial virus replication. *Antimicrobial Agents and Chemotherapy*, **51**, 3346–3353.
- 112 De Clercq, E. (2008) Emerging antiviral drugs. *Expert Opinion on Emerging Drugs*, **13**, 393–416.
- 113 Cohen, P. (2002) Protein kinases: the major drug targets of the twenty-first century? *Nature Reviews Drug Discovery*, **1**, 309–315.

## 2

### Inhibition of HIV Entry

José A. Esté

#### 2.1

##### Introduction

Current guidelines for treatment of human immunodeficiency virus (HIV) aim for a maximal and durable suppression of plasma viremia, that is, <50 RNA copies/ml, as the most important goal of antiretroviral therapy. Effective inhibition of virus replication prevents the selection of drug resistance mutations, preserves the CD4 T cell count, and confers overall clinical benefits to patients [1]. No single antiretroviral agent is able to induce stable and effective suppression of virus replication, and combinations of three or more drugs are required for highly active antiretroviral therapy (HAART).

For a long time, only two viral targets were recognized: the reverse transcriptase (RT) and the protease (P). However, there are now 25 approved single antiretroviral drugs in 6 mechanistic classes that can be used to design multiple combination regimens and that include nucleoside/nucleotide reverse transcriptase inhibitors (N(t)RTIs), nonnucleoside reverse transcriptase inhibitors (NNRTIs), protease inhibitors (PIs), integrase inhibitors (INIs), and HIV entry and fusion inhibitors. Preferred regimens for treatment-naïve patients use combinations of two N(t)RTIs and either a NNRTI or a PI [1]. Unfortunately, antiretroviral treatment failure is not uncommon, being the major causes of drug failure, the emergence of drug-resistant virus, and patient adherence to treatment. The advent of new drug treatment options allows the incorporation of at least two active drugs in most treatment regimens that are used for the management of treatment-experienced patients in order to reestablish maximal virologic suppression.

The HIV entry process has long been considered as an attractive target for intervention, as blocking HIV entry into its target cell leads to suppression of viral infectivity. In fact, some of the first attempts to block virus replication *in vitro* and *in vivo* aimed at blocking virus entry by targeting virus interaction with its principal cellular receptor CD4. It was not until 2003 when enfuvirtide (T-20, Fuzeon<sup>®</sup>) and later, in 2005, maraviroc (Selzentry<sup>®</sup>), a coreceptor inhibitor, were approved by the US Food and Drug Administration (FDA), thus becoming the firsts of their class. Human

immunodeficiency virus type 1 (HIV-1) entry is now considered a validated target for antiretroviral therapy [2].

This chapter will review the winding path from discovery of cell surface receptors and coreceptors of HIV to the development of HIV entry inhibitors that are now used in the clinic. Their mechanisms of action and their therapeutic value against HIV infection and AIDS are discussed.

## 2.2

### The HIV Glycoproteins

#### 2.2.1

##### Structure of the HIV-1 Glycoprotein gp120

The first steps of HIV entry involve the binding of a viral surface protein (SU) to receptors (CD4) and coreceptors (CCR5 or CXCR4) on the plasma membrane of the host cell. Two SU glycoproteins are generated after endoproteolysis of the precursor protein (gp160) encoded by the HIV-1 *env* gene [3]. The larger of these (gp120) is derived from the amino-terminal portion of the precursor, lies entirely outside the envelope lipid bilayer, mediates receptor binding, and drives the fusion process. The smaller, derived from the carboxyl-terminal portion of gp160, is the transmembrane protein (gp41) mediating both the oligomerization of the complex into multimers and the membrane fusion [4].

The viral SU protein gp120 is characterized by an overall high degree of genetic variability between HIV isolates. Evaluation of the amino acid sequence of different HIV strains led to the identification of five variable, V1–V5, and four constant, C1–C4, regions in gp120. The predicted sequence of gp120 shows 18 cysteine residues that are highly conserved in diverse HIV-1 strains; disulfide bonds are presumed to play a critical role in the structure and function of these viral proteins: the disulfide bonding pattern of gp120 delineates the protein into several functional regions, which include a conformation-dependent domain for recognition of the CD4 receptor [5].

The regions of HIV-1 gp120 interacting with the CD4 receptor have been deduced from the site-specific mutations in the *env* gene that demonstrate that a limited number of conserved amino acids in different regions of gp120 are required for efficient binding to CD4 [6]. Both primary sequence and conformational features of the envelope (Env) glycoprotein gp120 produce a configuration that recognizes the CD4 receptor in a selective fashion and with high affinity. Many of the points of contact between gp120 and CD4 are made using the peptide backbone of gp120 amino acids. This allows HIV-1 to alter the residues that form the CD4 binding domain, changing the antigenic structure of the site (that normally involves the amino acid side chains) while retaining the capacity to bind CD4.

The region of gp120 that binds HIV coreceptors has been revealed by the crystal structure of gp120 [7–9]. The residues involved are located within the conserved stem of the V1/V2 structure, near the base of the V3 loop, and in other regions folded into proximity. The V3 sequence usually contains 34–36 amino acids arranged in a

disulfide loop involving cysteine 296 and cysteine 331 [4]. This domain plays an important role in governing several biological properties of the virus, including cell tropism, cytopathicity, fusogenicity, and coreceptor use [10]. Research with viruses containing chimeric V3 loops of gp120 highlights the functional importance of V3 in the use of coreceptors for HIV cell entry. Sequences in the V3 may determine the fusogenic activity of Env with cells expressing different coreceptors and the V3 loop appears to be required in assays measuring physical interaction between gp120 and CCR5 [11]. It is therefore likely that the V3 loop contains determinants involved in coreceptor binding.

The amino acid sequence of the V3 loop is highly variable, except for a short stretch at the tip of the loop, whose sequence (GPGR/G) has been found in most European and North American isolates [4]. Certain features of gp120, including carbohydrate groups (approximately half the molecular mass of gp120 is composed of oligosaccharides [12]), on its outer surface and its variable loops made it flexible and irregular in shape, and hence very difficult to crystallize. High-resolution structural information has been obtained for the core domain of gp120 bound to a CD4 fragment (comprising the two N-terminal immunoglobulin domains) and a Fab 17b antibody that is an inhibitor of coreceptor binding [13]. However, the core domains of gp120 are truncated versions of the envelope glycoprotein. The crystallized gp120 derivatives have been deglycosylated and they lacked 52 N-terminal and 19 C-terminal residues and 67 residues forming the V1/V2 loop and 32 residues of the V3 loop. In addition, all sugar groups beyond the linkages between the two core *N*-acetylglucosamine residues were removed. Unfortunately, the gp120 crystal structures lack the V3 loop, and assumptions on its real conformation have to rely on data obtained from crystal structures of V3 peptide–antibody complexes and the existing data on the cross-reactivity of antibodies. When complexed with antibodies, the V3 loop can adopt at least two different conformations for the highly conserved GPGR sequence at the tip, mimicking  $\beta$ -hairpins found in chemokines. Thus, one of the conformations shows structural and sequence similarity to CCL3 (MIP-1 $\alpha$ ), CCL4 (MIP-1 $\beta$ ), and CCL5 (RANTES- $\beta$ ) hairpin structures implicated in CCR5 binding, while the other resembles a  $\beta$ -hairpin found in CXCL12 (SDF-1), a CXCR4 ligand [14].

### 2.2.2

#### **Structure of the HIV-1 Transmembrane Glycoprotein gp41**

Virus fusion is mediated by the transmembrane glycoprotein of HIV-1 (TM, gp41) that is anchored in the virus membrane and has a nonpolar fusion peptide at its N-terminus. HIV-1 gp41 and gp120 remain noncovalently associated and form oligomers on the cell surface and on the virions. Although dimers and tetramers of Env were visualized [15], several structural studies have shown that the TM of HIV-1 and other retroviruses forms trimers [16]. The gp41 ectodomain of HIV is apparently required to maintain the retroviral envelope complex as a trimer [17, 18]. The primary function of gp41 is to mediate fusion between the viral and cellular membranes following receptor binding. The HIV-1 TM protein is composed of monomers of 345 amino acids, which contain an N-terminal ectodomain, a

transmembrane domain, and a C-terminal intraviral segment that interacts with the viral matrix protein (MA or p17 in HIV-1). The extraviral domain (ectodomain) comprises an N-terminal hydrophobic fusion peptide, an adjacent coiled coil forming sequence, a short disulfide-bonded loop, and a C-terminal segment containing  $\alpha$ -helical elements.

## 2.3

### Mechanism of HIV Entry

HIV enters cells by a three-step process: virus attachment, coreceptor interaction, and virus–cell fusion (Figure 2.1). The first two steps involve the binding of SU gp120 to CD4 (a member of the immunoglobulin superfamily), thereby anchoring the virus into the cell surface and allowing additional interactions with a coreceptor protein (usually a member of the chemokine receptor family). The third step involves SU gp41 that brings virus and cell membranes in apposition and drives the fusion pore formation and the internalization process.

#### 2.3.1

##### Virus Attachment

The initial interaction between HIV and a target cell may be facilitated by nonspecific interactions between positively charged domains on the gp120 protein and negatively charged proteoglycans on the cellular membrane [19–21] or by specific interactions with cell surface lectin binding proteins such as DC-SIGN. Such attachment factors, although not needed for infection, can enhance the efficiency of virus infection [22]. The primary receptor for HIV is CD4 that is expressed on monocytes, macrophages, and on subsets of T cells and dendritic cells. HIV interaction with CD4 occurs at a

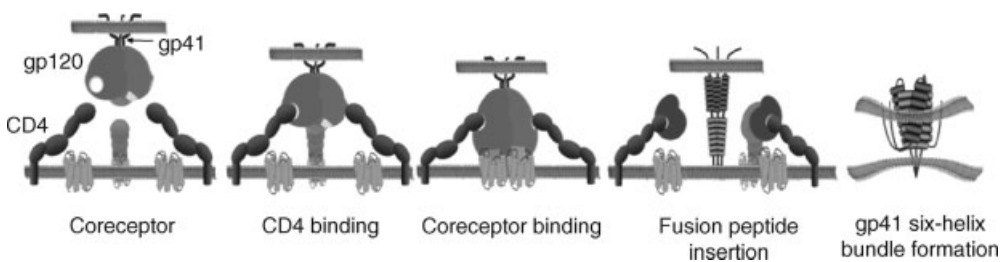

**Figure 2.1** Mechanism of virus entry. Depiction of viral (gp120 and gp41) and cellular (CD4 and coreceptor) components of viral entry. Upon CD4 binding, gp120 undergoes conformational changes (CD4 binding site shown in as a white circle). CD4-induced epitopes – including the V3 region – can now

bind to chemokine receptors. Thereafter, gp41 is released into a fusogenic conformation and its N- and C-terminal helices form a hairpin structure leading to the approximation of viral and cellular membranes finally resulting in membrane fusion.

structurally conserved surface on gp120 that is formed by epitopes that are discontinuous in their primary amino acid sequence [7].

### 2.3.2

#### **Coreceptors: Virus Tropism and Infectivity**

The major coreceptors used by HIV-1 are CCR5 and CXCR4. The expression of CCR5 or CXCR4 on different CD4<sup>+</sup> target cells determines their permissiveness to infection by the corresponding CCR5-using (R5) or CXCR4-using (X4) HIV-1 strain. In addition, there are HIV-1 strains that may use both CCR5 and CXCR4, referred to as dual tropic (D) R5X4 strains, and there are patients that have mixtures (M) of R5 and X4 HIV-1 isolates. D or M isolates are indistinguishable in HIV coreceptor phenotype assays.

R5 viruses are preferentially transmitted over X4 viruses and are almost exclusively associated with acute infection, irrespective of the route of transmission [23, 24]. The basis of this preferential selection is unclear, but multiple barriers to infection by X4 viruses have been proposed [25]. R5 viruses also predominate during most of the chronic stage of the disease. Eventually, X4 variants emerge in 40–60% of HIV-1-positive individuals. X4 variants have been associated with expanded cell tropism, increased virus replication rate, a faster disease progression, and the onset of AIDS [26, 27].

### 2.3.3

#### **Virus–Cell Fusion**

After CD4 virus attachment and coreceptor engagement, a series of conformational changes in gp120 allow gp41 to reorient parallel to the viral and cellular membranes and promote the events leading to virus and cell membrane fusion. Thereafter, the current working model to explain membrane fusion assumes the formation of a transient intermediate in which gp41 spans both the viral and the cell membranes [28]. This intermediate constitutes a target for gp41-derived inhibitory peptides. It is believed that a six-helix bundle gp41 structure forms before fusion and serves to bring the membranes into close apposition, allowing fusion pore formation and virus internalization.

### 2.3.4

#### **Endocytosis of HIV**

The entry process of HIV has traditionally been thought to occur at the plasma membrane of the cell, but recent evidence suggests that endocytosis of viral particles may be required for full fusion [29, 30] through a clathrin- and dynamin-dependent process [31–33]. These data are important for the consideration of entry inhibitors since an endocytic process would presumably impede the delivery of effective drug concentrations to their targets at the appropriate stages of entry [19].

## 2.4 Inhibition of HIV Entry

The multistep process of virus entry, namely, virus attachment and binding to CD4, coreceptor engagement, and gp41-dependent fusion, has long been considered as an attractive target for drug development. A number of compounds have been developed to specifically target each of these steps leading to virus entry. Maraviroc (MVC, Selzentry) (Figure 2.2) and enfuvirtide (T-20, Fuzeon) (Figure 2.3) are part of antiretroviral regimens for drug-experienced patients and other agents are at different stages of clinical development [19].

### 2.4.1 Inhibitors of Virus Attachment

Soluble CD4 (sCD4) was one of the first anti-HIV agents to be tested as *in vivo* [34, 35]. Despite its potent activity against laboratory-adapted HIV strains, clinical isolates are considerably less sensitive to sCD4 [36], presumably because the escape variants have a decreased affinity for CD4 and do not attach to CD4 as firmly as the wild-type virus. Factors affecting sensitivity of primary HIV isolates to sCD4 are the number of Env molecules on the viral surface and the number of Env molecules required for attachment and fusion. These factors appear to be different for the laboratory-adapted strains and clinical isolates [37]. The naturally resistant phenotype of clinical isolates of HIV halted the development of sCD4 as an anti-HIV agent.

Interfering with gp120 binding to CD4<sup>+</sup> cells has been a successful topical approach to block HIV transmission [38], suggesting a positive prospect for the development of viral entry inhibitors to prevent transmission of HIV in humans.

#### 2.4.1.1 Polyanions as Inhibitors of HIV Attachment

Sulfated polysaccharides have been some of the first described inhibitors of infection by enveloped viruses such as cytomegalovirus, herpes simplex virus, and HIV. Agents

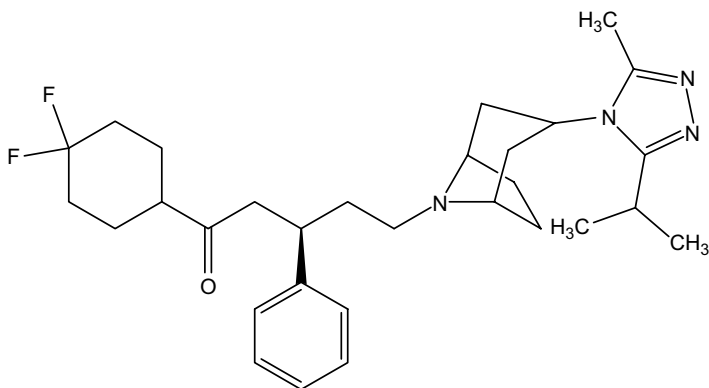

Figure 2.2 Maraviroc.

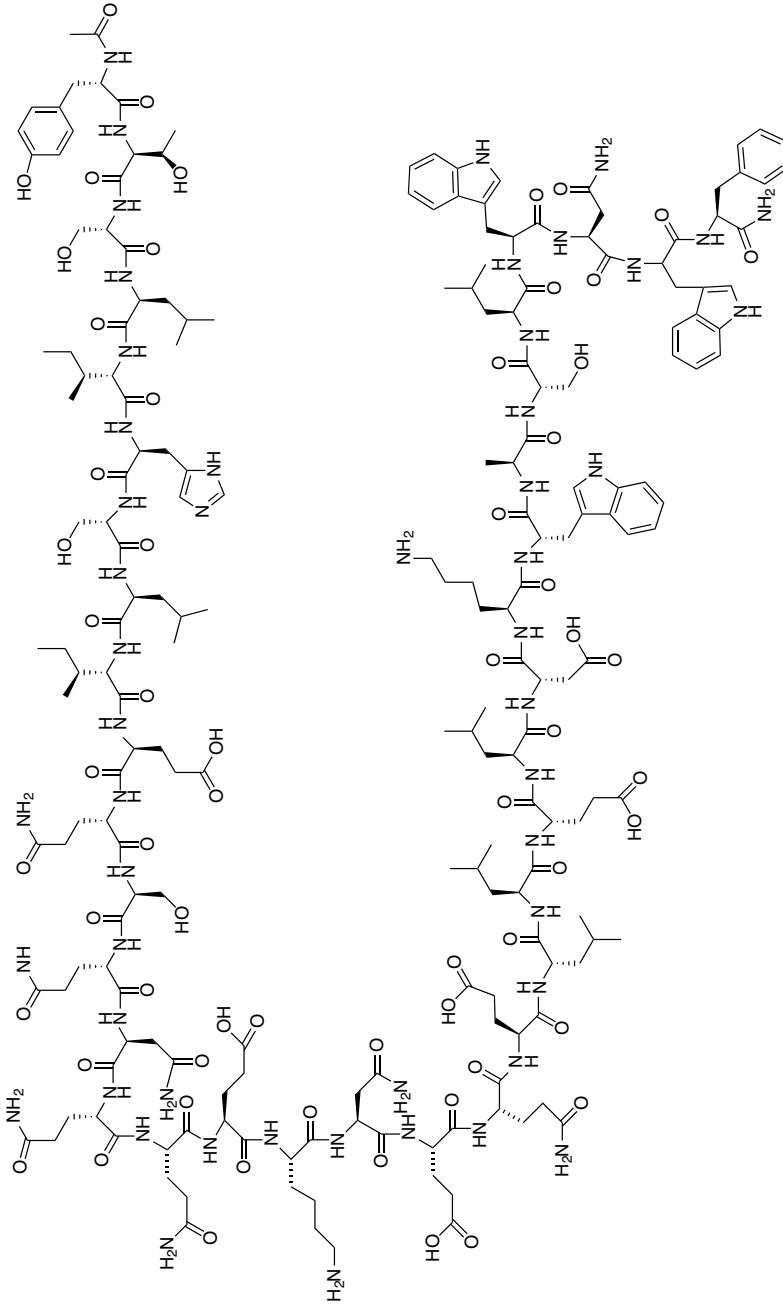
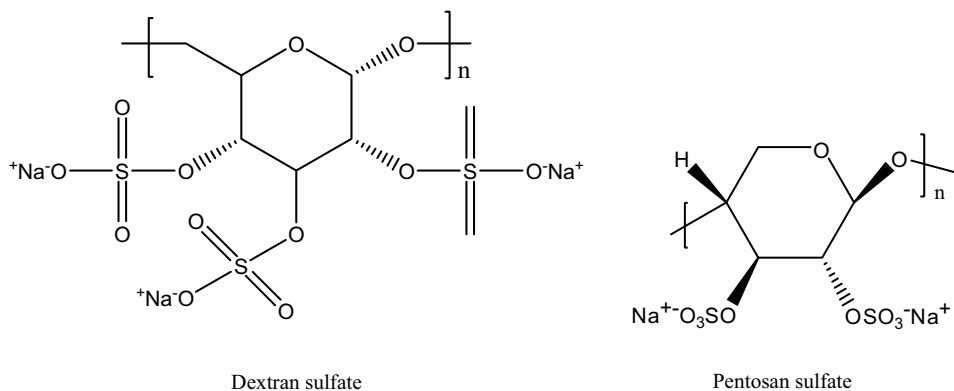

Figure 2.3 Enfuvirtide.





**Figure 2.4** Prototype polyanions with anti-HIV activity.

such as dextran sulfate (DS) or pentosan sulfate (Figure 2.4) have been shown to block infection of HIV-1 at micromolar or submicromolar concentrations [39]. The heterogeneous nature of these agents has hindered elucidation of properties required for their anti-HIV activity. It is now well recognized that polyanionic compounds of widely diverging structure and size can block the replication of HIV in cell culture by interfering with the attachment of virus to the cell surface. The only common structural denominator appears to be the presence of a sufficient number and adequate density of negative charges. On the basis of the structure and the positive charge distribution of the V3 loop of gp120 and the development of HIV resistance to several polyanions [40], it has been predicted that negatively charged compounds will bind to the gp120 and the V3 loop of X4 HIV strains.

Polyanionic compounds, especially those of natural origin, could serve as a less expensive approach for the development of microbicides [38, 41]. PRO 2000 is a polyanionic compound under development as a topical antimicrobial gel for the potential prevention of HIV-1 transmission. It has been shown that PRO 2000 binds to HIV-1 gp120 and interferes with virus attachment to and fusion with CD4(+) T cells. A phase 2, placebo-controlled trial was conducted in Malawi, South Africa, Zambia, Zimbabwe, and the United States to evaluate the safety and effectiveness of 0.5% PRO 2000 vaginal gel for the prevention of HIV infection in women. In this study, 0.5% PRO 2000 gel was 36% protective against HIV compared to no gel ( $p = 0.04$ ). Although not statistically significant in the intent to treat analysis, these results suggested that women in the 0.5% PRO 2000 gel arm had a 30% lower rate of HIV acquisition compared to controls [42].

#### 2.4.1.2 Small-Molecule Inhibitors of the gp120–CD4 Interaction

The prototype inhibitors of the interaction between gp120 and CD4, BMS-378806 (Figure 2.5) and its analogues, have shown potent activity against several subtype B HIV-1 strains. Although BMS-378806 binds to a specific region within the CD4 binding pocket of gp120 [43], two distinct and excluding mechanisms of action have

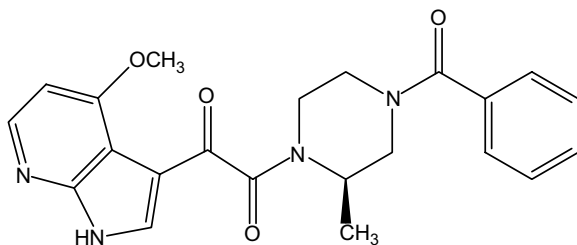

**Figure 2.5** BMS-378806.

been proposed for this family of compounds: inhibition of envelope CD4 receptor binding [44] and induction of conformational changes in the gp120–gp41 glycoproteins that block the exposure of gp41 without significantly affecting CD4 binding [45]. Evidence of antiviral activity *in vivo* is provided by a proof of concept study with the related compound, BMS-488043 (Figure 2.6), which resulted in 1 log<sub>10</sub> reductions in plasma HIV-1 RNA in treatment-naive subjects [46]. However, relatively high doses were required (1800 mg), and this compound has not been further developed [47].

#### 2.4.2

##### Postattachment Inhibitors

Ibalizumab (TNX-355) is a humanized monoclonal antibody that binds CD4, the primary receptor for HIV-1, and inhibits the viral entry process. TNX-355 does not block the attachment of virus to CD4 [48], but appears to prevent the correct presentation of gp120 to the coreceptors [47].

In a pilot phase I study, a reduction of viral load up to 1.5 log<sub>10</sub> was achieved after intravenous infusion of TNX-355 [49]. A phase 2 study showed that TN-355 and an optimized background regimen (OBR) resulted in significant greater reductions in plasma HIV-1 RNA compared to OBR alone [47]. An additional dose–response study of ibalizumab in combination with OBR in patients with HIV-1 ([www.clinicaltrials.gov](http://www.clinicaltrials.gov)) should further elucidate the effectiveness of this agent.

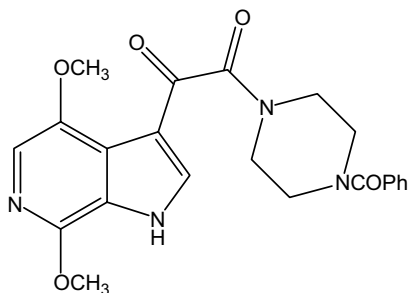

**Figure 2.6** BMS-488043.

## 2.4.3

**CCR5 Antagonists**

The discovery of chemokine receptors as primordial virus receptors, the capacity of chemokines to block HIV entry, and the observation that host defects in CCR5 expression severely limit acute infection [50] or disease progression [51] provided a rationale for the development of HIV coreceptor-targeted agents as antiretroviral drugs [52, 53]. For what may be considered a fast track development of a new target, the anti-HIV field went from target discovery in 1996 [54] to the description of the first low molecular weight antagonist of CCR5 in cell culture [55], to clinical evaluation of new candidate drugs in less than 10 years.

2.4.3.1 **Maraviroc**

Maraviroc (Selzentry) is a potent anti-HIV agent that was developed through an extensive medicinal chemistry program from a lead compound containing an imidazopyridine group [56]. Maraviroc inhibits CCL3–CCL5 binding to CCR5-expressing cells and blocks CCR5 signaling events following chemokine binding and intracellular calcium redistribution, but fails to induce CCR5 internalization [56]. This demonstrates that maraviroc is an inhibitor (functional antagonist or inverse agonist) of the CCR5 receptor. Maraviroc has antiviral activity at a low nanomolar concentration and a prolonged CCR5 physical and functional occupancy [57, 58]. Analysis of pharmacokinetic data indicates that drug absorption is rapid but variable, with maximal concentration generally occurring between 1 and 4 h after dosing [58]. Maraviroc is a substrate of CYP3A4, and as such susceptible to interactions with CYP3A4 inhibitors such as PIs or inducers such as NNRTIs (<http://www.tthhivclinic.com/pdf/CCR5-int.pdf>).

Maraviroc has potent antiviral activity against all CCR5-tropic HIV-1 viruses tested (geometric mean 90% inhibitory concentration of 2.0 nM), including 200 clinically derived HIV-1 envelope recombinant pseudoviruses, 100 of which were derived from viruses resistant to existing drug classes [56]. Combined analysis [59, 60] of phase 3 trials with maraviroc plus OBR showed a significantly greater virologic suppression compared to OBR alone: 43, 53 and up to 61% of patients receiving maraviroc achieved undetectable VL (HIV-1 RNA < 50 copies/ml) depending on the number (one, two, or three, respectively) of active drugs in the OBR. Conversely, only 29% of patients reached undetectable VL in the placebo plus OBR group that included three active drugs. Authors also showed a significant difference in mean CD4 cell count from baseline reaching + 56 cells/ $\mu$ l.

Viral tropism has to be tested before considering the use of maraviroc or any other CCR5 antagonist in antiretroviral drug regimens. Phenotypic and, more recently, genotypic tools have been demonstrated to estimate HIV-1 tropism in most cases and predict viral response [61]. Maraviroc has been approved for treatment of antiretroviral-experienced patients. However, maraviroc (300 mg twice daily) in combination with zidovudine and lamivudine failed to demonstrate noninferiority when compared to the combination of efavirenz plus zidovudine and lamivudine in drug-naïve patients [47].

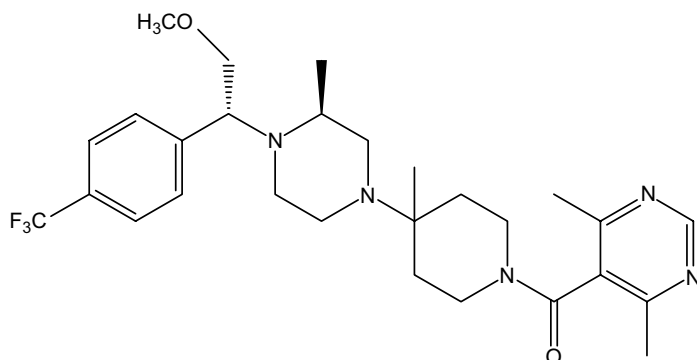

**Figure 2.7** Vicriviroc.

#### 2.4.3.2 Vicriviroc

The piperazine-based CCR5 antagonist vicriviroc, SCH417690 [62] (Figure 2.7), is an orally bioavailable small-molecule CCR5 antagonist that blocks signaling by the CC chemokines at nanomolar concentrations and prevents infection of target cells by CCR5-tropic HIV-1 isolates [63]. Data from a 14-day monotherapy trial demonstrated a reduction of plasma HIV-1 RNA by approximately 1.0–1.5  $\log_{10}$  copies/ml [64]. A phase 2b trial of vicriviroc in treatment-naïve HIV-1-infected patients was discontinued due to increased rates of virologic failure in the vicriviroc arms compared to the control arm [63]. Nevertheless, a placebo-controlled phase 2b study conducted in antiretroviral-experienced patients demonstrated potent suppression (ranged from 1.5 to 1.9  $\log_{10}$  copies/ml) of HIV-1 by vicriviroc (given at 5, 10, or 15 mg daily) in combination with an OBR [65]. Phase III studies using a 30 mg dose in R5-tropic treatment-experienced patients have completed 48 weeks, but data are not yet available [66]. These results will further elucidate the role of vicriviroc in the treatment of HIV-1-infected individuals.

#### 2.4.3.3 Pro-140

Antibodies that block the CCR5 receptor and prevent HIV infection have also been developed. PRO-140 is a humanized mouse anti-CCR5 antibody that prevents gp120 from engaging CCR5 but does not block CCR5 ligand activity. It has demonstrated potent efficacy against CCR5-tropic HIV strains both *in vitro* and in HIV-infected adults [67]. It is currently in phase II clinical trials [19].

#### 2.4.3.4 Resistance to CCR5 Antagonists

Resistance to CCR5 agents has been described both *in vitro* and in patients failing CCR5 drug-containing antiretroviral regimens [10, 68]. In the majority of patients, treatment failure is accompanied by a switch in virus coreceptor use from CCR5 (R5) to CXCR4 (X4), apparently through the emergence of preexisting X4 variants, which went undetected by current diagnostic tests [69, 70], that are favorably selected under CCR5 drug pressure. In cell culture, HIV may be forced to switch coreceptor usage when passaged in cells expressing high levels of CXCR4 and low/undetectable levels

of CCR5 [71]. However, most reports suggest that when R5 virus are passed in the presence of CCR5 agents, resistance develops in the absence of coreceptor switch [72–75]. Two mechanisms of resistance have been described for CCR5 drugs: competitive resistance, identified by an increase in the concentration of the inhibitor required to block HIV replication by 50% ( $EC_{50}$ ), and noncompetitive resistance in which increasing the inhibitor concentration does not lead to complete inhibition of virus replication; the  $EC_{50}$  remains unchanged and resistance is manifested by a decrease in the maximal HIV-1 inhibition achieved by the compound (maximal plateau inhibition, MPI) [10].

HIV-1 variants made resistant to most CCR5 drugs, including maraviroc [72] and vicriviroc [75–77], use the noncompetitive mechanism in which virus may use CCR5 in the presence of the inhibitor (coreceptor-bound inhibitor model) [10, 72, 75]. CCR5 drug cross-resistance profiles are also complex and not all the viruses resistant to a compound appear to be cross-resistant to a structurally related molecule. The most common genetic route to resistance involves sequence changes in the gp120 V3 region, but virus with mutations in other regions of gp120 or, surprisingly, in gp41 has been described [78, 79]

#### 2.4.4

##### CXCR4 Antagonists

The first low molecular weight anti-HIV agents targeting a coreceptor was the bicyclam AMD3100 (Figure 2.8), a potent antagonist of CXCR4 [80, 81]. Since then, a number of agents have been tested and some have advanced to clinical trials, but most of them have failed. The latest AMD11070 was evaluated in a pilot monotherapy study (eight and two patients receiving 200 and 100 mg b.i.d., respectively) in patients with X4 or dual/mixed-tropic HIV. No significant changes in HIV-1 VL or CD4 cell count were noted. Four of nine patients evaluated achieved a reduction in X4 virus population. The median change in X4 virus population at the end of treatment was  $-0.22 \log_{10}$  relative units. Three of four patients who responded to therapy showed a tropism shift from dual/mixed-tropic viruses to exclusively R5 virus by day 10. These results demonstrate the activity of AMD11070. However, development of AMD11070 is currently suspended because of liver histology changes and animal hepatotoxicity [82].

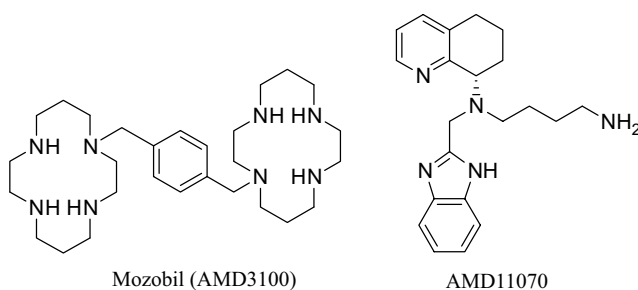

**Figure 2.8** CXCR4 antagonists.

Despite the apparent lack of success of CXCR4 antagonists as anti-HIV agents, the clinical evaluation of AMD3100 helped to recognize these agents as potent hematopoietic stem cell mobilizers. AMD3100 (plerixafor, Mozobil<sup>®</sup>) is now indicated in combination with granulocyte colony-stimulating factor (G-CSF) to mobilize hematopoietic stem cells to the peripheral blood for collection and subsequent autologous transplantation in patients with non-Hodgkin's lymphoma and multiple myeloma [83].

#### 2.4.5

##### **Inhibitors of HIV Fusion: Enfuvirtide**

Enfuvirtide (Fuzeon, T-20, ENF) is a synthetic peptide that mimics amino acids 127–162 of HIV-1 gp41, a key domain involved in membrane fusion. It has potent antiviral activity *in vitro* against a broad spectrum of HIV-1 isolates, including multidrug-resistant virus [84]. Enfuvirtide was the first entry inhibitor approved for use in treatment-experienced patients [84–86]. The approved dose in adults is 90 mg b.i.d. that results in a profile of relatively flat steady-state plasma concentration. As a peptide, ENF is rapidly degraded in the digestive track and is administered by subcutaneous injection [87, 88].

The phase III clinical ENF versus OBR trials were randomized, open-label, multinational studies of 997 triple class-experienced patients with documented resistance to at least one member in each of the N(t)RTI, NNRTI, and PI classes. The trials compared treatment with ENF (90 mg b.i.d.) in combination with OBR and a background regimen alone [89, 90]. Combined analysis at week 48 showed that a higher proportion of week-24 responders maintained their response to treatment than those in the control group in each responder category: HIV-1 RNA level  $\geq 1.0 \log_{10}$  change from baseline,  $< 400$  and  $< 50$  copies/ml [91, 92].

The RESIST trials [93, 94] and the POWER trials [95, 96] examining the safety and efficacy of tipranavir and darunavir, respectively, two new PI approved for treatment of drug-experienced patients in combination with OBR, underscore the role of ENF in optimizing virological response to novel treatment combinations. Individuals taking ENF with tipranavir were able to achieve more than  $1.5 \log_{10}$  reductions in VL from baseline out to 24 weeks even if they had five or more baseline PI mutations. At week 48, the use of enfuvirtide in the OBR was also associated with a greater proportion of patients, 48.5% reaching the primary efficacy endpoint of VL reduction of  $1.0 \log_{10}$  copies/ml from baseline compared to 20% in the group not receiving tipranavir ( $p < 0.0001$ ). Treatment with darunavir in combination with enfuvirtide-containing ORB led to 81% of patients achieving the primary efficacy endpoint of VL reduction of  $1.0 \log_{10}$  copies/ml from baseline compared to 23% that did not receive darunavir [96]. Similar results have been obtained with raltegravir, a new HIV integrase inhibitor approved for treatment of drug-experienced and drug-naive patients [97–99].

The emergence of drug resistance, as for other classes of antiretrovirals, hampers the outcome of ENF-containing regimens. Genotypic drug resistance in virus isolated from patients failing therapy develops mostly in or around a 3-amino acid

(glycine–isoleucine–valine (GIV)) motif in the HR1 region of gp41 confirming *in vitro* data on the mechanism of action of enfuvirtide [100]. Clinical resistance appears not to affect the susceptibility of HIV-1 to other viral entry inhibitors [101] and, most importantly, enfuvirtide may retain partial antiviral activity in the presence of resistance mutations [86, 102] resulting in sustained CD4<sup>+</sup> T cell responses [103–105].

## 2.5

### Concluding Remarks

To date, 31 antiretroviral drug products as either single agents or fixed-dose drug combinations have been granted marketing approval, providing physicians with a wide range of options for constructing efficacious combination therapies [106]. Entry inhibitors represent an important option for the treatment of HIV infection and AIDS. The timely introduction of enfuvirtide provided a relevant alternative to patients failing antiretroviral regimens based solely on combinations of reverse transcriptase and protease inhibitors. Importantly, enfuvirtide has played a pivotal role in optimizing the response to new drug combinations. Many other entry inhibitors targeting virus attachment, gp120–CD4 interaction, and virus coreceptors have been evaluated, but they have not progressed through clinical development. Conversely, CCR5 antagonists maraviroc and vicriviroc showed significant efficacy and safety but drug resistance, particularly through the emergence of preexisting CXCR4-using HIV-1 variants that may limit wider use of this class of agents in clinical practice.

### References

- 1 Panel on Antiretroviral Guidelines for Adults and Adolescents (2008) *Guidelines for the Use of Antiretroviral Agents in HIV-1-Infected Adults and Adolescents*, Department of Health and Human Services.
- 2 Esté, J.A. and Teienti, A. (2007) HIV entry inhibitors. *Lancet*, **370**, 81–88.
- 3 Gallaher, W.R., Ball, J.M., Garry, R.F., Martin-Amedee, A.M., and Montelaro, R.C. (1995) A general model for the surface glycoproteins of HIV and other retroviruses. *AIDS Research and Human Retroviruses*, **11**, 191–202.
- 4 Gallaher, W.R. (1987) Detection of a fusion peptide sequence in the transmembrane protein of human immunodeficiency virus. *Cell*, **50**, 327–328.
- 5 Sattentau, Q.J. and Moore, J.P. (1991) Conformational changes induced in the human immunodeficiency virus envelope glycoprotein by soluble CD4 binding. *The Journal of Experimental Medicine*, **174**, 407–415.
- 6 Kowalski, M., Potz, J., Basiripour, L., Dorfman, T., Goh, W.C., Terwilliger, E., Dayton, A., Rosen, C., Haseltine, W., and Sodroski, J. (1987) Functional regions of the envelope glycoprotein of human immunodeficiency virus type 1. *Science*, **237**, 1351–1355.
- 7 Kwong, P.D., Wyatt, R., Robinson, J., Sweet, R.W., Sodroski, J., and Hendrickson, W.A. (1998) Structure of an HIV gp120 envelope glycoprotein in complex with the CD4 receptor and a neutralizing human antibody. *Nature*, **393**, 648–659.

- 8 Wyatt, R. and Sodroski, J. (1998) The HIV-1 envelope glycoproteins: fusogens, antigens, and immunogens. *Science*, **280**, 1884–1888.
- 9 Wyatt, R., Kwong, P.D., Desjardins, E., Sweet, R.W., Robinson, J., Hendrickson, W.A., and Sodroski, J.G. (1998) The antigenic structure of the HIV gp120 envelope glycoprotein. *Nature*, **393**, 705–711.
- 10 Moore, J.P. and Kuritzkes, D.R. (2009) A pièce de resistance: how HIV-1 escapes small molecule CCR5 inhibitors. *Current Opinion in HIV and AIDS*, **4**, 118–124.
- 11 Mosier, D.E. (2009) How HIV changes its tropism: evolution and adaptation? *Current Opinion in HIV and AIDS*, **4**, 125–130.
- 12 Moore, J.P. and Binley, J. (1998) HIV: envelope's letters boxed into shape. *Nature*, **393**, 630–631.
- 13 Speck, R.F., Wehrly, K., Platt, E.J., Atchison, R.E., Charo, I.F., Kabat, D., Chesebro, B., and Goldsmith, M.A. (1997) Selective employment of chemokine receptors as human immunodeficiency virus type 1 coreceptors determined by individual amino acids within the envelope V3 loop. *Journal of Virology*, **71**, 7136–7139.
- 14 Wu, L., Gerard, N.P., Wyatt, R., Choe, H., Parolin, C., Ruffing, N., Borsetti, A., Cardoso, A.A., Desjardins, E., Newman, W., Gerard, C., and Sodroski, J. (1996) CD4-induced interaction of primary HIV-1 gp120 glycoproteins with the chemokine receptor CCR-5. *Nature*, **384**, 179–183.
- 15 Earl, P.L., Doms, R.W., and Moss, B. (1990) Oligomeric structure of the human immunodeficiency virus type 1 envelope glycoprotein. *Proceedings of the National Academy of Sciences of the United States of America*, **87**, 648–652.
- 16 Zhu, P., Chertova, E., Bess, J., Jr., Lifson, J.D., Arthur, L.O., Liu, J., Taylor, K.A., and Roux, K.H. (2003) Electron tomography analysis of envelope glycoprotein trimers on HIV and simian immunodeficiency virus virions. *Proceedings of the National Academy of Sciences of the United States of America*, **100**, 15812–15817.
- 17 Zhang, C.W., Chishty, Y., Hussey, R.E., and Reinherz, E.L. (2001) Expression, purification, and characterization of recombinant HIV gp140. The gp41 ectodomain of HIV or simian immunodeficiency virus is sufficient to maintain the retroviral envelope glycoprotein as a trimer. *The Journal of Biological Chemistry*, **276**, 39577–39585.
- 18 Zhu, P., Winkler, H., Chertova, E., Taylor, K.A., and Roux, K.H. (2008) Cryoelectron tomography of HIV-1 envelope spikes: further evidence for tripod-like legs. *PLoS Pathogens*, **4**, e1000203.
- 19 Tilton, J.C. and Doms, R.W. (2010) Entry inhibitors in the treatment of HIV-1 infection. *Antiviral Research*, **85**, 91–100.
- 20 Moulard, M., Lortat-Jacob, H., Mondor, I., Roca, G., Wyatt, R., Sodroski, J., Zhao, L., Olson, W., Kwong, P.D., and Sattentau, Q.J. (2000) Selective interactions of polyanions with basic surfaces on human immunodeficiency virus type 1 gp120. *Journal of Virology*, **74**, 1948–1960.
- 21 Mondor, I., Ugolini, S., and Sattentau, Q.J. (1998) Human immunodeficiency virus type 1 attachment to HeLa CD4 cells is CD4 independent and gp120 dependent and requires cell surface heparans. *Journal of Virology*, **72**, 3623–3634.
- 22 Geijtenbeek, T.B., Kwon, D.S., Torensma, R., van Vliet, S.J., van Duijnhoven, G.C., Middel, J., Cornelissen, I.L., Nottet, H.S., KewalRamani, V.N., Littman, D.R., Figdor, C.G., and van Kooyk, Y. (2000) DC-SIGN, a dendritic cell-specific HIV-1-binding protein that enhances trans-infection of T cells. *Cell*, **100**, 587–597.
- 23 van't Wout, A.B., Kootstra, N.A., Mulder-Kampinga, G.A., Albrecht-van Lent, N., Scherpbier, H.J., Veenstra, J., Boer, K., Coutinho, R.A., Miedema, F., and Schuitemaker, H. (1994) Macrophage-tropic variants initiate human immunodeficiency virus type 1 infection after sexual, parenteral, and vertical transmission. *The Journal of Clinical Investigation*, **94**, 2060–2067.
- 24 Zhu, T., Mo, H., Wang, N., Nam, D.S., Cao, Y., Koup, R.A., and Ho, D.D. (1993) Genotypic and phenotypic characterization of HIV-1 patients with



- primary infection. *Science*, **261**, 1179–1181.
- 25 Margolis, L. and Shattock, R. (2006) Selective transmission of CCR5-utilizing HIV-1: the ‘gatekeeper’ problem resolved? *Nature Reviews Microbiology*, **4**, 312–317.
  - 26 Koot, M., Keet, I.P., Vos, A.H., de Goede, R.E., Roos, M.T., Coutinho, R.A., Miedema, F., Schellekens, P.T., and Tersmette, M. (1993) Prognostic value of HIV-1 syncytium-inducing phenotype for rate of CD4<sup>+</sup> cell depletion and progression to AIDS. *Annals of Internal Medicine*, **118**, 681–688.
  - 27 Connor, R.I., Sheridan, K.E., Ceradini, D., Choe, S., and Landau, N.R. (1997) Change in coreceptor use correlates with disease progression in HIV-1-infected individuals. *The Journal of Experimental Medicine*, **185**, 621–628.
  - 28 Eckert, D.M. and Kim, P.S. (2001) Mechanisms of viral membrane fusion and its inhibition. *Annual Review of Biochemistry*, **70**, 777–810.
  - 29 Hubner, W., McNerney, G.P., Chen, P., Dale, B.M., Gordon, R.E., Chuang, F.Y., Li, X.D., Asmuth, D.M., Huser, T., and Chen, B.K. (2009) Quantitative 3D video microscopy of HIV transfer across T cell virological synapses. *Science*, **323**, 1743–1747.
  - 30 Blanco, J., Bosch, B., Fernández-Figueras, M.T., Barretina, J., Clotet, B., and Esté, J.A. (2004) High level of coreceptor-independent HIV transfer induced by contacts between primary CD4 T cells. *The Journal of Biological Chemistry*, **279**, 51305–51314.
  - 31 Miyachi, K., Kim, Y., Latinovic, O., Morozov, V., and Melikyan, G.B. (2009) HIV enters cells via endocytosis and dynamin-dependent fusion with endosomes. *Cell*, **137**, 433–444.
  - 32 Bosch, B., Blanco, J., Pauls, E., Clotet-Codina, I., Armand-Ugón, M., Grigorov, B., Muriaux, D., Clotet, B., Darlix, J., and Esté, J.A. (2005) Inhibition of coreceptor independent cell-to-cell human immunodeficiency virus type 1 transmission by a CD4-immunoglobulin G2 fusion protein. *Antimicrobial Agents and Chemotherapy*, **49**, 4296–4304.
  - 33 Bosch, B., Grigorov, B., Senserrich, J., Clotet, B., Darlix, J.L., Muriaux, D., and Esté, J.A. (2008) A clathrin–dynamin-dependent endocytic pathway for the uptake of HIV-1 by direct T cell–T cell transmission. *Antiviral Research*, **80**, 185–193.
  - 34 Hussey, R.E., Richardson, N.E., Kowalski, M., Brown, N.R., Chang, H.C., Siliciano, R.F., Dorfman, T., Walker, B., Sodroski, J., and Reinherz, E.L. (1988) A soluble CD4 protein selectively inhibits HIV replication and syncytium formation. *Nature*, **331**, 78–81.
  - 35 Deen, K.C., McDougal, J.S., Inacker, R., Folena-Wasserman, G., Arthos, J., Rosenberg, J., Maddon, P.J., Axel, R., and Sweet, R.W. (1988) A soluble form of CD4 (T4) protein inhibits AIDS virus infection. *Nature*, **331**, 82–84.
  - 36 Klasse, P.J. and Moore, J.P. (1996) Quantitative model of antibody- and soluble CD4-mediated neutralization of primary isolates and T-cell line-adapted strains of human immunodeficiency virus type 1. *Journal of Virology*, **70**, 3668–3677.
  - 37 Daar, E.S., Li, X.L., Moudgil, T., and Ho, D.D. (1990) High concentrations of recombinant soluble CD4 are required to neutralize primary human immunodeficiency virus type 1 isolates. *Proceedings of the National Academy of Sciences of the United States of America*, **87**, 6574–6578.
  - 38 Buckheit, R.W., Watson, K.M., Morrow, K.M., and Ham, A.S. (2010) Development of topical microbicides to prevent the sexual transmission of HIV. *Antiviral Research*, **85**, 142–158.
  - 39 Esté, J.A., Schols, D., De Vreese, K., Van Laethem, K., Vandamme, A.M., Desmyter, J., and De Clercq, E. (1997) Development of resistance of human immunodeficiency virus type 1 to dextran sulfate associated with the emergence of specific mutations in the envelope gp120 glycoprotein. *Molecular Pharmacology*, **52**, 98–104.
  - 40 Menéndez-Arias, L. and Esté, J.A. (2004) HIV-resistance to viral entry inhibitors. *Current Pharmaceutical Design*, **10**, 1845–1860.

- 41 López, S., Armand-Ugon, M., Bastida, J., Viladomat, F., Esté, J.A., Stewart, D., and Codina, C. (2003) Anti-human immunodeficiency virus type 1 (HIV-1) activity of lectins from Narcissus species. *Planta Medica*, **69**, 109–112.
- 42 Karim, S.A., Coletti, A., Richardson, B., Ramjee, G., Hoffman, I., Chirenje, M., Taha, T., Kapina, M., Maslankowski, L., and Soto-Torres, L. (2009) Safety and effectiveness of vaginal microbicides buffer gel and 0.5% PRO 2000/5 gel for the prevention of HIV infection in women: results of the HPTN 035 trial. 16th Conference on Retroviruses and Opportunistic Infections, Montreal, Canada, February 8–11, 2009, p Abstract 48LB.
- 43 Teixeira, C., Serradji, N., Maurel, F., and Barbault, F. (2009) Docking and 3D-QSAR studies of BMS-806 analogs as HIV-1 gp120 entry inhibitors. *European Journal of Medicinal Chemistry*, **44**, 3524–3532.
- 44 Lin, P.F., Blair, W., Wang, T., Spicer, T., Guo, Q., Zhou, N., Gong, Y.F., Wang, H.G., Rose, R., Yamanaka, G., Robinson, B., Li, C.B., Fridell, R., Deminie, C., Demers, G., Yang, Z., Zadjura, L., Meanwell, N., and Colonno, R. (2003) A small molecule HIV-1 inhibitor that targets the HIV-1 envelope and inhibits CD4 receptor binding. *Proceedings of the National Academy of Sciences of the United States of America*, **100**, 11013–11018.
- 45 Madani, N., Perdigoto, A.L., Srinivasan, K., Cox, J.M., Chruma, J.J., LaLonde, J., Head, M., Smith, A.B., 3rd, and Sodroski, J.G. (2004) Localized changes in the gp120 envelope glycoprotein confer resistance to human immunodeficiency virus entry inhibitors BMS-806 and #155. *Journal of Virology*, **78**, 3742–3752.
- 46 (2004) Attachment inhibitor may hold promise for future. BMS-488043 demonstrates safety. *AIDS Alert*, **19**, 57–58.
- 47 Kuritzkes, D.R. (2009) HIV-1 entry inhibitors: an overview. *Current Opinion in HIV and AIDS*, **4**, 82–87.
- 48 Jacobson, J.M., Kuritzkes, D.R., Godofsky, E., DeJesus, E., Larson, J.A., Weinheimer, S.P., and Lewis, S.T. (2009) Safety, pharmacokinetics, and antiretroviral activity of multiple doses of ibalizumab (formerly TNX-355), an anti-CD4 monoclonal antibody, in human immunodeficiency virus type 1-infected adults. *Antimicrobial Agents and Chemotherapy*, **53**, 450–457.
- 49 Kuritzkes, D.R., Jacobson, J., Powderly, W.G., Godofsky, E., DeJesus, E., Haas, F., Reimann, K.A., Larson, J.L., Yarbough, P.O., Curt, V., and Shanahan, W.R., Jr. (2004) Antiretroviral activity of the anti-CD4 monoclonal antibody TNX-355 in patients infected with HIV type 1. *The Journal of Infectious Diseases*, **189**, 286–291.
- 50 Liu, R., Paxton, W.A., Choe, S., Ceradini, D., Martin, S.R., Horuk, R., MacDonald, M.E., Stuhlmann, H., Koup, R.A., and Landau, N.R. (1996) Homozygous defect in HIV-1 coreceptor accounts for resistance of some multiply-exposed individuals to HIV-1 infection. *Cell*, **86**, 367–377.
- 51 Dean, M., Carrington, M., Winkler, C., Huttley, G.A., Smith, M.W., Allikmets, R., Goedert, J.J., Buchbinder, S.P., Vittinghoff, E., Gomperts, E., Donfield, S., Vlahov, D., Kaslow, R., Saah, A., Rinaldo, C., Detels, R., and O'Brien, S.J. (1996) Genetic restriction of HIV-1 infection and progression to AIDS by a deletion allele of the CKR5 structural gene. Hemophilia Growth and Development Study, Multicenter AIDS Cohort Study, Multicenter Hemophilia Cohort Study, San Francisco City Cohort, ALIVE Study. *Science*, **273**, 1856–1862.
- 52 Schols, D. (2006) HIV co-receptor inhibitors as novel class of anti-HIV drugs. *Antiviral Research*, **71**, 216–226.
- 53 Kilby, J.M. and Eron, J.J. (2003) Novel therapies based on mechanisms of HIV-1 cell entry. *The New England Journal of Medicine*, **348**, 2228–2238.
- 54 Feng, Y., Broder, C.C., Kennedy, P.E., and Berger, E.A. (1996) HIV-1 entry cofactor: functional cDNA cloning of a seven-transmembrane, G protein-coupled receptor. *Science*, **272**, 872–877.
- 55 Baba, M., Nishimura, O., Kanzaki, N., Okamoto, M., Sawada, H., Iizawa, Y., Shiraiishi, M., Aramaki, Y., Okonogi, K., Ogawa, Y., Meguro, K., and Fujino, M.

- (1999) A small-molecule, nonpeptide CCR5 antagonist with highly potent and selective anti-HIV-1 activity. *Proceedings of the National Academy of Sciences of the United States of America*, **96**, 5698–5703.
- 56 Dorr, P., Westby, M., Dobbs, S., Griffin, P., Irvine, B., Macartney, M., Mori, J., Rickett, G., Smith-Burchnell, C., Napier, C., Webster, R., Armour, D., Price, D., Stammen, B., Wood, A., and Perros, M. (2005) Maraviroc (UK-427,857), a potent, orally bioavailable, and selective small-molecule inhibitor of chemokine receptor CCR5 with broad-spectrum anti-human immunodeficiency virus type 1 activity. *Antimicrobial Agents and Chemotherapy*, **49**, 4721–4732.
- 57 Watson, C., Jenkinson, S., Kazmierski, W., and Kenakin, T. (2005) The CCR5 receptor-based mechanism of action of 873140, a potent allosteric noncompetitive HIV entry inhibitor. *Molecular Pharmacology*, **67**, 1268–1282.
- 58 Fätkenheuer, G., Pozniak, A.L., Johnson, M.A., Plettenberg, A., Staszewski, S., Hoepelman, A.I., Saag, M.S., Goebel, F.D., Rockstroh, J.K., Dezube, B.J., Jenkins, T.M., Medhurst, C., Sullivan, J.F., Ridgway, C., Abel, S., James, I.T., Youle, M., and van der Ryst, E. (2005) Efficacy of short-term monotherapy with maraviroc, a new CCR5 antagonist, in patients infected with HIV-1. *Nature Medicine*, **11**, 1170–1172.
- 59 Fätkenheuer, G., Nelson, M., Lazzarin, A., Konourina, I., Hoepelman, A.I., Lampiris, H., Hirschel, B., Tebas, P., Raffi, F., Trottier, B., Bellos, N., Saag, M., Cooper, D.A., Westby, M., Tawadrous, M., Sullivan, J.F., Ridgway, C., Dunne, M.W., Felstead, S., Mayer, H., and van der Ryst, E. (2008) Subgroup analyses of maraviroc in previously treated R5 HIV-1 infection. *The New England Journal of Medicine*, **359**, 1442–1455.
- 60 Gulick, R.M., Lalezari, J., Goodrich, J., Clumeck, N., DeJesus, E., Horban, A., Nadler, J., Clotet, B., Karlsson, A., Wohlfeiler, M., Montana, J.B., McHale, M., Sullivan, J., Ridgway, C., Felstead, S., Dunne, M.W., van der Ryst, E., and Mayer, H. (2008) Maraviroc for previously treated patients with R5 HIV-1 infection. *The New England Journal of Medicine*, **359**, 1429–1441.
- 61 Rose, J.D., Rhea, A.M., Weber, J., and Quiñones-Mateu, M.E. (2009) Current tests to evaluate HIV-1 coreceptor tropism. *Current Opinion in HIV and AIDS*, **4**, 136–142.
- 62 Tagat, J.R., McCombie, S.W., Nazareno, D., Labroli, M.A., Xiao, Y., Steensma, R.W., Strizki, J.M., Baroudy, B.M., Cox, K., Lachowicz, J., Varty, G., and Watkins, R. (2004) Piperazine-based CCR5 antagonists as HIV-1 inhibitors. IV. Discovery of 1-[(4,6-dimethyl-5-pyrimidinyl)carbonyl]-4-[4-{2-methoxy-1(R)-4-(trifluoromethyl)phenyl}ethyl-3(S)-methyl-1-piperazinyl]-4-methylpiperidine (Sch-417690/Sch-D), a potent, highly selective, and orally bioavailable CCR5 antagonist. *Journal of Medicinal Chemistry*, **47**, 2405–2408.
- 63 Strizki, J.M., Tremblay, C., Xu, S., Wojcik, L., Wagner, N., Gonsiorek, W., Hipkin, R.W., Chou, C.C., Pugliese-Sivo, C., Xiao, Y., Tagat, J.R., Cox, K., Priestley, T., Sorota, S., Huang, W., Hirsch, M., Reyes, G.R., and Baroudy, B.M. (2005) Discovery and characterization of vicriviroc (SCH 417690), a CCR5 antagonist with potent activity against human immunodeficiency virus type 1. *Antimicrobial Agents and Chemotherapy*, **49**, 4911–4919.
- 64 Schürmann, D., Fätkenheuer, G., Reynes, J., Michelet, C., Raffi, F., van Lier, J., Caceres, M., Keung, A., Sansone-Parsons, A., Dunkle, L.M., and Hoffmann, C. (2007) Antiviral activity, pharmacokinetics and safety of vicriviroc, an oral CCR5 antagonist, during 14-day monotherapy in HIV-infected adults. *AIDS (London, England)*, **21**, 1293–1299.
- 65 Gulick, R.M., Su, Z., Flexner, C., Hughes, M.D., Skolnik, P.R., Wilkin, T.J., Gross, R., Krambrink, A., Coakley, E., Greaves, W.L., Zolopa, A., Reichman, R., Godfrey, C., Hirsch, M., and Kuritzkes, D.R. (2007) Phase 2 study of the safety and efficacy of vicriviroc, a CCR5 inhibitor, in HIV-1-infected, treatment-experienced patients: AIDS clinical trials group 5211. *The Journal of Infectious Diseases*, **196**, 304–312.

- 66 Kümmerle, T., Lehmann, C., Hartmann, P., Wyen, C., and Fätkenheuer, G. (2009) Vicriviroc: a CCR5 antagonist for treatment-experienced patients with HIV-1 infection. *Expert Opinion on Investigational Drugs*, **18**, 1773–1785.
- 67 Jacobson, J.M., Saag, M.S., Thompson, M.A., Fischl, M.A., Liporace, R., Reichman, R.C., Redfield, R.R., Fichtenbaum, C.J., Zingman, B.S., Patel, M.C., Murga, J.D., Pemrick, S.M., D'Ambrosio, P., Michael, M., Kroger, H., Ly, H., Rotshteyn, Y., Buice, R., Morris, S.A., Stavola, J.J., Maddon, P.J., Kremer, A.B., and Olson, W.C. (2008) Antiviral activity of single-dose PRO 140, a CCR5 monoclonal antibody, in HIV-infected adults. *The Journal of Infectious Diseases*, **198**, 1345–1352.
- 68 Menéndez-Arias, L. (2010) Molecular basis of human immunodeficiency virus drug resistance: an update. *Antiviral Research*, **85**, 210–231.
- 69 Poveda, E., Seclén, E., González, M.d.M., García, F., Chueca, N., Aguilera, A., Rodríguez, J.J., González-Lahoz, J., and Soriano, V. (2009) Design and validation of new genotypic tools for easy and reliable estimation of HIV tropism before using CCR5 antagonists. *The Journal of Antimicrobial Chemotherapy*, **63**, 1006–1010.
- 70 Rose, J.D., Rhea, A.M., Weber, J., and Quiñones-Mateu, M.E. (2009) Current tests to evaluate HIV-1 coreceptor tropism. *Current Opinion in HIV and AIDS*, **4**, 136–142.
- 71 Moncunill, G., Armand-Ugón, M., Pauls, E., Clotet, B., and Esté, J.A. (2008) HIV-1 escape to CCR5 coreceptor antagonism through selection of CXCR4-using variants *in vitro*. *AIDS (London, England)*, **22**, 23–31.
- 72 Westby, M., Smith-Burchnell, C., Mori, J., Lewis, M., Mosley, M., Stockdale, M., Dorr, P., Ciaramella, G., and Perros, M. (2007) Reduced maximal inhibition in phenotypic susceptibility assays indicates that viral strains resistant to the CCR5 antagonist maraviroc utilize inhibitor-bound receptor for entry. *Journal of Virology*, **81**, 2359–2371.
- 73 Westby, M., Lewis, M., Whitcomb, J., Youle, M., Pozniak, A.L., James, I.T., Jenkins, T.M., Perros, M., and van der Ryst, E. (2006) Emergence of CXCR4-using human immunodeficiency virus type 1 (HIV-1) variants in a minority of HIV-1-infected patients following treatment with the CCR5 antagonist maraviroc is from a pretreatment CXCR4-using virus reservoir. *Journal of Virology*, **80**, 4909–4920.
- 74 Trkola, A., Kuhmann, S.E., Strizki, J.M., Maxwell, E., Ketas, T., Morgan, T., Pugach, P., Xu, S., Wojcik, L., Tagat, J., Palani, A., Shapiro, S., Clader, J.W., McCombie, S., Reyes, G.R., Baroudy, B.M., and Moore, J.P. (2002) HIV-1 escape from a small molecule, CCR5-specific entry inhibitor does not involve CXCR4 use. *Proceedings of the National Academy of Sciences of the United States of America*, **99**, 395–400.
- 75 Pugach, P., Marozsan, A.J., Ketas, T.J., Landes, E.L., Moore, J.P., and Kuhmann, S.E. (2007) HIV-1 clones resistant to a small molecule CCR5 inhibitor use the inhibitor-bound form of CCR5 for entry. *Virology*, **361**, 212–228.
- 76 Tsibris, A.M., Sagar, M., Gulick, R.M., Su, Z., Hughes, M., Greaves, W., Subramanian, M., Flexner, C., Giguél, F., Leopold, K.E., Coakley, E., and Kuritzkes, D.R. (2008) *In vivo* emergence of vicriviroc resistance in a human immunodeficiency virus type 1 subtype C-infected subject. *Journal of Virology*, **82**, 8210–8214.
- 77 Ogert, R.A., Wojcik, L., Buontempo, C., Ba, L., Buontempo, P., Ralston, R., Strizki, J., and Howe, J.A. (2008) Mapping resistance to the CCR5 coreceptor antagonist vicriviroc using heterologous chimeric HIV-1 envelope genes reveals key determinants in the C2-V5 domain of gp120. *Virology*, **373**, 387–399.
- 78 Anastassopoulou, C.G., Ketas, T.J., Klasse, P.J., and Moore, J.P. (2009) Resistance to CCR5 inhibitors caused by sequence changes in the fusion peptide of HIV-1 gp41. *Proceedings of the National Academy of Sciences of the United States of America*, **106**, 5318–5323.
- 79 Berro, R., Sanders, R.W., Lu, M., Klasse, P.J., and Moore, J.P. (2009) Two HIV-1

- variants resistant to small molecule CCR5 inhibitors differ in how they use CCR5 for entry. *PLoS Pathogens*, **5**, e1000548.
- 80 Schols, D., Esté, J.A., Henson, G., and De Clercq, E. (1997) Bicyclams, a class of potent anti-HIV agents, are targeted at the HIV coreceptor fusin/CXCR-4. *Antiviral Research*, **35**, 147–156.
- 81 De Clercq, E. (2003) The bicyclam story. *Nature Reviews. Drug Discovery*, **2**, 581–587.
- 82 Moyle, G., DeJesus, E., Boffito, M., Wong, R.S., Gibney, C., Badel, K., MacFarland, R., Calandra, G., Bridger, G., and Becker, S. (2009) Proof of activity with AMD11070, an orally bioavailable inhibitor of CXCR4-tropic HIV type 1. *Clinical Infectious Diseases*, **48**, 798–805.
- 83 De Clercq, E. (2009) The AMD3100 story: the path to the discovery of a stem cell mobilizer (Mozobil). *Biochemical Pharmacology*, **77**, 1655–1664.
- 84 Matthews, T., Salgo, M., Greenberg, M., Chung, J., DeMasi, R., and Bolognesi, D. (2004) Enfuvirtide: the first therapy to inhibit the entry of HIV-1 into host CD4 lymphocytes. *Nature Reviews. Drug Discovery*, **3**, 215–225.
- 85 Fletcher, C.V. (2003) Enfuvirtide, a new drug for HIV infection. *Lancet*, **361**, 1577–1578.
- 86 Morse, C. and Maldarelli, F. (2007) Enfuvirtide antiviral activity despite rebound viremia and resistance mutations: fitness tampering or a case of persistent braking on entering? *The Journal of Infectious Diseases*, **195**, 318–321.
- 87 Patel, I.H., Zhang, X., Nieforth, K., Salgo, M., and Buss, N. (2005) Pharmacokinetics, pharmacodynamics and drug interaction potential of enfuvirtide. *Clinical Pharmacokinetics*, **44**, 175–186.
- 88 Kilby, J.M., Lalezari, J.P., Eron, J.J., Carlson, M., Cohen, C., Arduino, R.C., Goodgame, J.C., Gallant, J.E., Volberding, P., Murphy, R.L., Valentine, F., Saag, M.S., Nelson, E.L., Sista, P.R., and Dusek, A. (2002) The safety, plasma pharmacokinetics, and antiviral activity of subcutaneous enfuvirtide (T-20), a peptide inhibitor of gp41-mediated virus fusion, in HIV-infected adults. *AIDS Research and Human Retroviruses*, **18**, 685–693.
- 89 Lalezari, J.P., Henry, K., O’Hearn, M., Montaner, J.S., Piliero, P.J., Trottier, B., Walmsley, S., Cohen, C., Kuritzkes, D.R., Eron, J.J., Jr., Chung, J., DeMasi, R., Donatacci, L., Drobnes, C., Delehanty, J., and Salgo, M. (2003) Enfuvirtide, an HIV-1 fusion inhibitor, for drug-resistant HIV infection in North and South America. *The New England Journal of Medicine*, **348**, 2175–2185.
- 90 Lazzarin, A., Clotet, B., Cooper, D., Reynes, J., Arastéh, K., Nelson, M., Katlama, C., Stellbrink, H.J., Delfraissy, J.F., Lange, J., Huson, L., DeMasi, R., Wat, C., Delehanty, J., Drobnes, C., and Salgo, M. (2003) Efficacy of enfuvirtide in patients infected with drug-resistant HIV-1 in Europe and Australia. *The New England Journal of Medicine*, **348**, 2186–2195.
- 91 Nelson, M., Arastéh, K., Clotet, B., Cooper, D.A., Henry, K., Katlama, C., Lalezari, J.P., Lazzarin, A., Montaner, J.S., O’Hearn, M., Piliero, P.J., Reynes, J., Trottier, B., Walmsley, S.L., Cohen, C., Eron, J.J., Jr., Kuritzkes, D.R., Lange, J., Stellbrink, H.J., Delfraissy, J.F., Buss, N.E., Donatacci, L., Wat, C., Smiley, L., Wilkinson, M., Valentine, A., Guimaraes, D., Demasi, R., Chung, J., and Salgo, M.P. (2005) Durable efficacy of enfuvirtide over 48 weeks in heavily treatment-experienced HIV-1-infected patients in the T-20 versus optimized background regimen only 1 and 2 clinical trials. *Journal of Acquired Immune Deficiency Syndromes*, **40**, 404–412.
- 92 Trottier, B., Walmsley, S., Reynes, J., Piliero, P., O’Hearn, M., Nelson, M., Montaner, J., Lazzarin, A., Lalezari, J., Katlama, C., Henry, K., Cooper, D., Clotet, B., Arastéh, K., Delfraissy, J.F., Stellbrink, H.J., Lange, J., Kuritzkes, D., Eron, J.J., Jr., Cohen, C., Kinchelov, T., Bertasso, A., Labriola-Tompkins, E., Shikhman, A., Atkins, B., Bourdeau, L., Natale, C., Hughes, F., Chung, J., Guimaraes, D., Drobnes, C., Bader-Weder, S., Demasi, R., Smiley, L., and Salgo, M.P. (2005) Safety of enfuvirtide in combination with an optimized

- background of antiretrovirals in treatment-experienced HIV-1-infected adults over 48 weeks. *Journal of Acquired Immune Deficiency Syndromes*, **40**, 413–421.
- 93 Hicks, C.B., Cahn, P., Cooper, D.A., Walmsley, S.L., Katlama, C., Clotet, B., Lazzarin, A., Johnson, M.A., Neubacher, D., Mayers, D., and Valdez, H. (2006) Durable efficacy of tipranavir–ritonavir in combination with an optimised background regimen of antiretroviral drugs for treatment-experienced HIV-1-infected patients at 48 weeks in the Randomized Evaluation of Strategic Intervention in multi-drug reSistant patients with Tipranavir (RESIST) studies: an analysis of combined data from two randomised open-label trials. *Lancet*, **368**, 466–475.
- 94 Cahn, P., Villacian, J., Lazzarin, A., Katlama, C., Grinsztejn, B., Arastéh, K., López, P., Clumeck, N., Gerstoft, J., Stavrianeas, N., Moreno, S., Antunes, F., Neubacher, D., and Mayers, D. (2006) Ritonavir-boosted tipranavir demonstrates superior efficacy to ritonavir-boosted protease inhibitors in treatment-experienced HIV-infected patients: 24-week results of the RESIST-2 trial. *Clinical Infectious Diseases*, **43**, 1347–1356.
- 95 Katlama, C., Esposito, R., Gatell, J.M., Goffard, J.C., Grinsztejn, B., Pozniak, A., Rockstroh, J., Stoehr, A., Vetter, N., Yeni, P., Parys, W., and Vangeneugden, T. (2007) Efficacy and safety of TMC114/ritonavir in treatment-experienced HIV patients: 24-week results of POWER 1. *AIDS (London, England)*, **21**, 395–402.
- 96 Clotet, B., Bellos, N., Molina, J.M., Cooper, D., Goffard, J.C., Lazzarin, A., Wörhrmann, A., Katlama, C., Wilkin, T., Haubrich, R., Cohen, C., Farthing, C., Jayaweera, D., Markowitz, M., Ruane, P., Spinoza-Guzman, S., and Lefebvre, E. (2007) Efficacy and safety of darunavir–ritonavir at week 48 in treatment-experienced patients with HIV-1-infection in POWER1 and 2: a pooled subgroup analysis of data from two randomised trials. *Lancet*, **369**, 1169–1178.
- 97 Lennox, J.L., DeJesus, E., Lazzarin, A., Pollard, R.B., Madruga, J.V., Berger, D.S., Zhao, J., Xu, X., Williams-Diaz, A., Rodgers, A.J., Barnard, R.J., Miller, M.D., DiNubile, M.J., Nguyen, B.Y., Leavitt, R., and Sklar, P. (2009) Safety and efficacy of raltegravir-based versus efavirenz-based combination therapy in treatment-naive patients with HIV-1 infection: a multicentre, double-blind randomised controlled trial. *Lancet*, **374**, 796–806.
- 98 Cooper, D.A., Steigbigel, R.T., Gatell, J.M., Rockstroh, J.K., Katlama, C., Yeni, P., Lazzarin, A., Clotet, B., Kumar, P.N., Eron, J.E., Schechter, M., Markowitz, M., Loutfy, M.R., Lennox, J.L., Zhao, J., Chen, J., Ryan, D.M., Rhodes, R.R., Killar, J.A., Gilde, L.R., Strohmaier, K.M., Meibohm, A.R., Miller, M.D., Hazuda, D.J., Nessler, M.L., DiNubile, M.J., Isaacs, R.D., Teppler, H., and Nguyen, B.Y. (2008) Subgroup and resistance analyses of raltegravir for resistant HIV-1 infection. *The New England Journal of Medicine*, **359**, 355–365.
- 99 Steigbigel, R.T., Cooper, D.A., Kumar, P.N., Eron, J.E., Schechter, M., Markowitz, M., Loutfy, M.R., Lennox, J.L., Gatell, J.M., Rockstroh, J.K., Katlama, C., Yeni, P., Lazzarin, A., Clotet, B., Zhao, J., Chen, J., Ryan, D.M., Rhodes, R.R., Killar, J.A., Gilde, L.R., Strohmaier, K.M., Meibohm, A.R., Miller, M.D., Hazuda, D.J., Nessler, M.L., DiNubile, M.J., Isaacs, R.D., Nguyen, B.Y., and Teppler, H. (2008) Raltegravir with optimized background therapy for resistant HIV-1 infection. *The New England Journal of Medicine*, **359**, 339–354.
- 100 Wei, X., Decker, J.M., Liu, H., Zhang, Z., Arani, R.B., Kilby, J.M., Saag, M.S., Wu, X., Shaw, G.M., and Kappes, J.C. (2002) Emergence of resistant human immunodeficiency virus type 1 in patients receiving fusion inhibitor (T-20) monotherapy. *Antimicrobial Agents and Chemotherapy*, **46**, 1896–1905.
- 101 Ray, N., Harrison, J.E., Blackburn, L.A., Martin, J.N., Deeks, S.G., and Doms, R.W. (2007) Clinical resistance to enfuvirtide does not affect susceptibility of human immunodeficiency virus type 1 to other classes of entry inhibitors. *Journal of Virology*, **81** (7), 3240–3250.

- 102 Deeks, S.G., Lu, J., Hoh, R., Neilands, T.B., Beatty, G., Huang, W., Liegler, T., Hunt, P., Martin, J.N., and Kuritzkes, D.R. (2007) Interruption of enfuvirtide in HIV-1-infected adults with incomplete viral suppression on an enfuvirtide-based regimen. *The Journal of Infectious Diseases*, **195**, 387–391.
- 103 Raffi, F., Katlama, C., Saag, M., Wilkinson, M., Chung, J., Smiley, L., and Salgo, M. (2006) Week-12 response to therapy as a predictor of week 24, 48, and 96 outcome in patients receiving the HIV fusion inhibitor enfuvirtide in the T-20 versus Optimized Regimen Only (TORO) trials. *Clinical Infectious Diseases*, **42**, 870–877.
- 104 Poveda, E., Rodés, B., Lebel-Binay, S., Faudon, J.-L., Jimenez, V., and Soriano, V. (2005) Dynamics of enfuvirtide resistance in HIV-infected patients during and after long-term enfuvirtide salvage therapy. *Journal of Clinical Virology*, **34**, 295–301.
- 105 Barretina, J., Blanco, J., Bonjoch, A., Llano, A., Clotet, B., and Esté, J.A. (2004) Immunological and virological study of enfuvirtide-treated HIV-positive patients. *AIDS (London, England)*, **18**, 1673–1682.
- 106 Esté, J.A. and Cihlar, T. (2010) Current status and challenges of antiretroviral research and therapy. *Antiviral Research*, **85**, 25–33.

### 3

## Targeting Integration Beyond Strand Transfer: Development of Second-Generation HIV Integrase Inhibitors

*Arnout R.D. Voet, Marc De Maeyer, Frauke Christ, and Zeger Debyser*

### 3.1

#### HIV: The Causative Agent of AIDS

##### 3.1.1

#### Replication Cycle of HIV

The acquired immunodeficiency syndrome (AIDS) is caused by the human immunodeficiency virus (HIV). AIDS is characterized by a severe immunodeficiency resulting from the infection and depletion of cells carrying the CD4 receptor (T lymphocytes, monocyte/macrophages, and dendritic cells). Much like other viruses, the HIV replication cycle is characterized by a series of events leading to production of new HIV particles (for a detailed review, see Refs [1–3]). The entry of the virus into the cells is initiated by the recognition of the viral surface protein gp120 by the cellular CD4 receptor. Next, gp120 undergoes conformational changes to bind to the chemokine coreceptor CCR5 (present on the surface of macrophages) or CXCR4 (present on the surface of T lymphocytes). As a consequence of this interaction, the viral gp41 molecule attaches to the cellular membrane and initiates the fusion of the virus with the cell. Once the virion enters the cells, the process of uncoating is initiated during which the proteins forming the capsid dissociate and expose the viral nucleocapsid to the cellular environment, initiating reverse transcription. Reverse transcription of the viral RNA genome results in the production of a double-stranded cDNA copy. This viral DNA is flanked by two long terminal repeat (LTR) sequences. Together with the viral enzymes RT and integrase (IN) as well as the viral structural proteins matrix (MA), viral protein R (Vpr) and a number of cellular proteins, the preintegration complex (PIC) is formed. The exact composition of the PIC remains unclear. Via its interaction with the nuclear import factor transportin-SR2, the PIC is actively transported into the nucleus through the nucleopore [4]. In the nucleus, the viral IN catalyzes the integration reaction resulting in the formation of the provirus that remains present during the entire life span of the infected cell. Therefore, the integration step is considered as the point of no return. Inhibiting viral replication prior to this crucial



point is considered as one of the challenges in antiviral drug development. After integration of the viral cDNA, HIV genes undergo the same biological processes as cellular genes: the promoter in the 5'-LTR promotes mRNA synthesis by cellular RNA polymerase II. The transcription of proviral DNA initially produces multiple spliced transcripts, resulting in the expression of the early proteins Tat, Rev, and Nef. Upon binding of Tat to the TAR element in the 5'-LTR, the rate of transcription by RNA polymerase II is dramatically increased. At this moment, the presence of Rev allows accumulation of full-length and single-spliced mRNA. This results in the production of Gag, Gag–Pol, and Env (poly)proteins. The viral proteins and a viral RNA dimer assemble at the cell membrane and the immature viral particles are released from the cell into the bloodstream by budding or by cell lysis. The final step in the replication cycle is the maturation of the virions. Initial autocleavage of the Pol protein results in a protease that further cleaves the Gag and Gag–Pol polyproteins into their single protein components that form mature virions. These mature virions are infectious and do initiate new replication cycles by fusion with other host cells. Alternatively, integration can also lead to a state of latency in which the promoter activity of the LTR is silenced, establishing a viral reservoir [5].

### 3.1.2

#### **Highly Active Antiretroviral Therapy**

Antiretroviral therapy for the treatment of HIV infection has been a success story in drug development. A large and increasing number of antiretroviral agents are currently available for the treatment of HIV-infected patients. Highly active antiretroviral therapy (HAART) consists of a combination of typically three to four antivirals, including one protease inhibitor combined with nonnucleoside reverse transcriptase inhibitor (NNRTI) and nucleoside reverse transcriptase inhibitors (NRTI). HAART is usually effective in reducing the HIV levels in the plasma to undetectable levels and in gradually increasing CD4 cell counts [6, 7]. Currently, 25 agents are on the market belonging to different classes. Clinically approved drugs target viral entry/fusion, reverse transcription, proteolytic cleavage, and integration. Inhibitors of maturation are in late clinical development [8, 9].

Due to the error-prone nature of the retroviral RT enzyme and the absence of proofreading activity, mutations are likely to occur during cDNA synthesis. This low fidelity in combination with the short generation time of the virus (2.5 days) gives rise to the genotypic diversity of the retroviral population and antiviral drug resistance [10, 11]. Most mutations will not affect the viral fitness and others result in noninfectious viral strains. However, some of the generated mutant strains will show a lower susceptibility toward the antiviral agents used, resulting in a selective advantage and (partial) resistance against a given antiviral. Since these variants are less susceptible to the selective pressure of the drug, they have an advantage over the wild-type strains and the viral population will rapidly evolve toward a resistant strain. Additional mutations will result in ever-increasing resistance against the drug or will compensate for the reduced fitness induced by the previous resistance mutations.

### 3.2

#### The Integration Step: A Complex Mechanism with Different Possibilities for Inhibition

##### 3.2.1

##### HIV-1 Integrase

HIV IN catalyzes the integration events in a series of consecutive steps (Figure 3.1) [12, 13]. Once the reverse transcription yields a viral cDNA copy, flanked by two LTRs, IN multimers bind to the conserved attachment (*att*) sites present in the LTRs. These *att* sites are characterized by a highly conserved CAGT

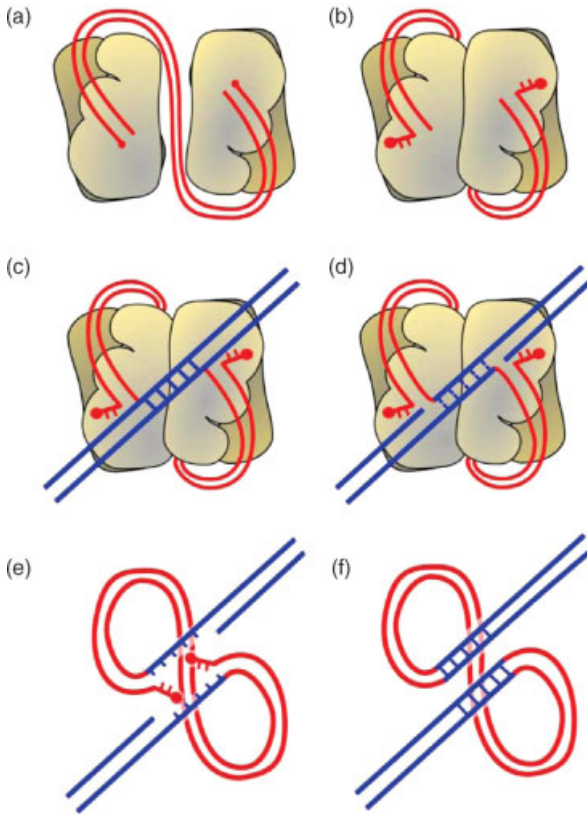

**Figure 3.1** Enzymatic mechanism of the integration reaction. The integration mechanism of the HIV-1 genome (red) into the human genome (blue) as mediated by the integrase multimeric complex (gray-brown). After binding of the integrase to the viral DNA (a), the terminal GT is cleaved in the 3'-processing step leaving two unpaired CA nucleotides at the 5'-end (b). In the second step, the strand transfer reaction

(c–d), the human DNA is attacked by both viral 3'-ends at a distance of 5 bp (c) and the viral cDNA is covalently linked to the human genome (d). After the strand transfer step, the integration complex falls apart (e) and the 5 bp gap flanking the viral genome is repaired by cellular proteins (f). This final step is carried out by cellular enzymes and is usually referred to as the gap repair step (e–f).

at the 3'-ends of each LTR. Subsequently, IN cleaves the terminal dinucleotides resulting in 3'-CA-OH overhangs. This 3'-processing reaction occurs in the cytoplasm within the PIC [13]. After translocation of the PIC to the nucleus, the viral cDNA is joined to the host cell DNA during the strand transfer reaction. During this process, each free hydroxyl end attacks a 5'-phosphate in each strand of a chromosome resulting in covalent linkage of the viral to the human DNA. This reaction is concerted and occurs in both strands of the DNA with a distance of 5 bp (base pair) [14, 15]. Although productive interaction of HIV-1 IN with the *att* sites is highly sequence specific, the selection of integration sites in the human DNA shows minimal sequence specificity. Still, integration does not occur at random and certain chromosomal features are favored since integration occurs primarily in transcriptionally active units [16]. The mechanism for the selection of active transcription units may be related to the accessibility of chromatin, cell cycle effects, and/or the interaction with a cellular tethering protein. Recently, it was shown that the human protein LEDGF/p75 is involved in this targeting process [16]. The integration pathway is completed by removal of the two unpaired 5'-terminal -GT dinucleotides and the repair of the single-stranded gaps. The exact mechanism of this step, also referred to as gap repair, remains unknown and is most likely mediated by cellular enzymes, although retroviral proteins have also been implicated [17].

#### 3.2.1.1 The Structural Organization of HIV-1 Integrase

HIV-1 IN is a 288-amino acids (32 kDa) protein that can be subdivided into three domains [18]: the N-terminal domain (NTD, aa 1–51), the central or catalytic core domain (CCD, aa 52–211), and the C-terminal domain (CTD, aa 212–288). High-resolution structures have been solved for the separate domains, the NTD–CCD and the CCD–CTD. However, despite intensive efforts, the overall structure of HIV-1 integrase remains unresolved to date.

The Zn finger-containing NTD is a dimer in solution. It does not have any affinity for DNA by itself and *in vitro* experiments indicate the necessity of  $\text{Zn}^{2+}$  for the correct folding, multimerization, and enzymatic activity [19, 20]. The CCD forms a dimer in solution and is involved in IN–DNA binding. A similar structural organization is observed in proteins with homologous activity such as the simian immunodeficiency virus integrase (SIV-IN) [21], Rous sarcoma virus integrase (RSV-IN), and Tn5 transposase [22], respectively. These proteins have a conserved DDE motif in common that is essential for enzymatic activity. The DDE motif of HIV-1 IN (D64, D116, and E152) coordinates  $\text{Mg}^{2+}$ . Similar studies with other transposases such as the Tn5 transposase suggest that a second  $\text{Mg}^{2+}$  is coordinated after viral cDNA binding in the active site. A positively charged surface area located next to the active site is most likely involved in viral cDNA binding. The C-terminal domain forms, alike the NTD and CTD, dimers in solution. This domain is sometimes referred to as the DNA binding domain, since the presence of positively charged amino acids allows (unspecific) DNA binding.

Despite many efforts, the correct overall structure of IN at atomic resolution remains unknown. The closest information is given by the crystal structures of the

NTD–CCD and the CCD–CTD, which can be combined into a model of a full-length monomer [23, 24]. Since all domains are resolved as dimers, it can be assumed that the lowest stable organization of IN occurs at the dimeric level. Recent cryo-EM single-particle reconstruction yielded two models of a tetrameric HIV integration complex [25, 26].

### 3.2.2

#### HIV-1 IN as a Target for HAART

##### 3.2.2.1 Integrase Strand Transfer Inhibitors

Next to the classical antiviral targets RT and protease, IN has received considerable interest over the past decades. IN catalyzes the last of the early replication steps, the irreversible insertion of the viral genome into the host genome. Moreover, in contrast to RT and protease, there is no functional homologue of IN present in human cells lowering the risk for potential side effects. Because of the multistep nature and complexity of the integration reaction, several functions of IN can be targeted: (1) binding of IN to the viral cDNA ends, (2) integrase multimerization, (3) 3'-processing step, (4) strand transfer step, and (5) interaction with cellular cofactors (Figure 3.2). Despite these multiple mechanisms and two decades of intensive efforts in antiviral drug discovery targeting IN, only recently the first IN inhibitor, raltegravir (MK-0518), was approved for clinical use [27]. A second compound, elvitegravir (GS-9137) awaits FDA approval. A major difficulty encountered when designing and optimizing integrase inhibitors is the lack of a full-length structure of the integration complex.

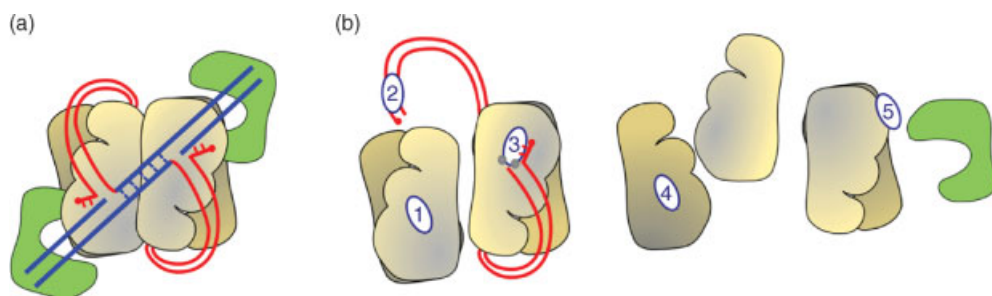

**Figure 3.2** The complexity of the integration complex and its reactions allows several inhibitory strategies. (a) The structure of full-length HIV-1 integrase in complex with DNA and its cofactor LEDGF/p75 remains unknown, but current results indicate that at least a tetramer of integrase is required (gray-brown) that interacts with the viral cDNA (red) and the human DNA (blue). This interaction is mediated by the cellular cofactor LEDGF/p75 (green). (b) Analysis of this structure suggests different inhibitory pathways to prevent successful

integration. Compounds binding to integrase (site 1) or viral cDNA (site 2) prevent integration at the 3'-processing level and subsequent steps. Compounds binding in the cavity formed by the processed viral cDNA and the integrase (site 3) are inhibitors of the strand transfer step. Currently, this is the only class of molecules approved for HAART. Other options are inhibition of multimer formation (site 4) or binding of a cellular cofactor such as LEDGF/p75 (site 5).

In addition, integration is a single event in contrast to reverse transcription and proteolytic cleavage. Finally, there is no real substrate to serve as a template for drug design in contrast to deoxynucleotides for RT or peptides for PR [28].

Among the first reported HIV-1 IN inhibitors were polyhydroxylated aromatic compounds. Their antiviral activity in cell culture was confounded by inherent cellular toxicity. Interestingly, many of these early compounds share a diketo moiety with the subsequently discovered integrase strand transfer inhibitors (INSTIs) [29]. Other HIV-1 IN inhibitors, such as L-chicoric acid and G-quartets, also inhibit HIV-1 IN *in vitro* and effectively inhibit HIV replication in cell culture. However, later studies revealed that the antiviral activity is mainly due to the inhibition of viral entry and not integration [30–32].

To date, the most successful class of integrase inhibitors is formed by diketo acids and analogues. These drugs were initially developed at Merck and all act as INSTIs [33]. Only after binding and processing viral DNA, INSTIs bind to integrase and specifically block strand transfer. Since the publication of the first diketo acid [33], many other INSTIs from different chemical classes have been developed: naphthyridines, pyrimidinone carboxamides, bicyclic pyrimidones, and pyrrolloquinolones [34–38]. These molecules share a dimetal chelating entity in their pharmacophore (Figure 3.3). Recently, the pyrimidinone carboxamide MK-0518 (raltegravir or Isentress™) [39] was approved by the US FDA (Food and Drug Administration) as the first integrase inhibitor to be included in combination regimens in patients with failing HAART. For a review on the evolution of the first diketo acids into the current known inhibitors, we refer to Serrao *et al.* [40]. A second INSTI, developed by Gilead, elvitegravir (GS-9137), also shows promising results in advanced clinical trials and awaits approval by the federal agencies [27]. What makes elvitegravir especially interesting is the fact that when the drug is boosted with ritonavir, the half-life and bioavailability of the compound are increased drastically allowing a once-daily treatment (in contrast to the two pills-a-day regimen of raltegravir) [41]. However, raltegravir and elvitegravir induce identical resistance mutations in the clinic. This highlights the requirement to develop new integrase inhibitors insensitive to these mutations and likely binding other parts of the enzyme [42, 43]. These inhibitors will be referred to as second-generation inhibitors.

The detailed mechanism of action of these INSTIs remains unclear as detailed structural information is missing. However, based on structural information of homologous proteins, the highly conserved pharmacophore of the inhibitors, and their resistance profile, INSTIs likely act by chelating  $Mg^{2+}$  in the integration complex, in a pocket created by the integrase and the processed viral cDNA. The most promising structural information comes from molecular modeling of the strand transfer inhibitors in a complex of HIV-1 IN with the 3'-processed viral cDNA substrate [44].

Although at present only inhibitors of strand transfer have made the transition from bench to bedside, it is clear that the other integration steps are equally interesting as targets for second-generation integrase inhibitors especially since it can be expected that cross-resistance may be avoided. Therefore, we will review the alternative pathways for the inhibition of the integration process, indicating the

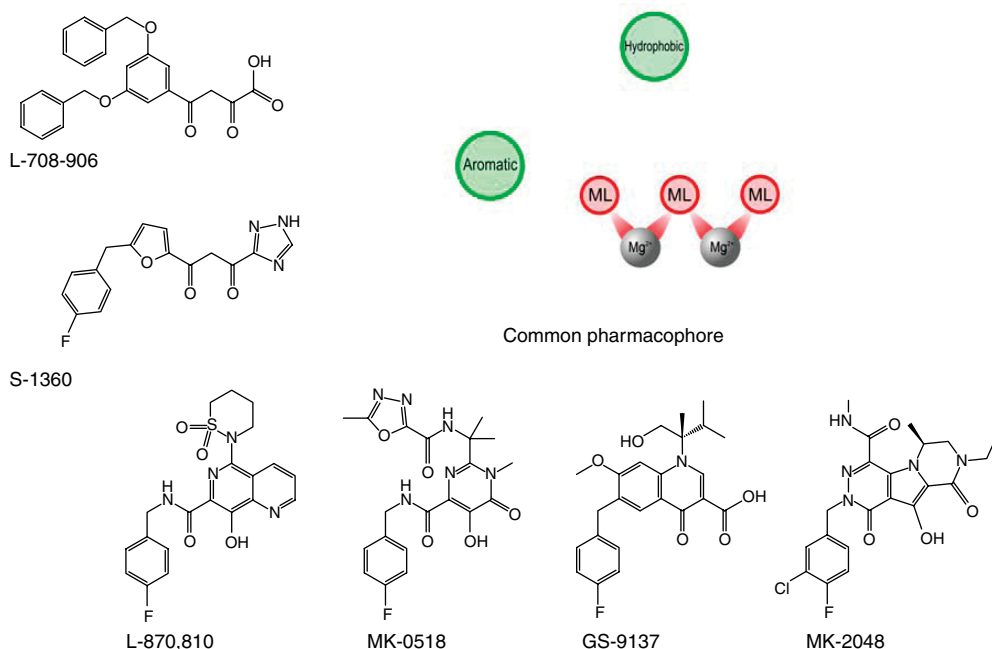

**Figure 3.3** Structures of strand transfer inhibitors. Integrase strand transfer inhibitors (INSTIs) are so far the most successful class of integrase inhibitors. The first molecule reported was L-708,906, a diketo acid [33]. S-1360 is an analogue in which the acid is replaced by an isosteric moiety [102]. Later on L-870,810, a naphthyridine, was reported [34]. From a clinical viewpoint, MK-0518 (raltegravir) and GS-9137

(elvitegravir) are the most successful strand transfer inhibitors reported to date [8, 41]. MK-2048 [103] has been developed as a second-generation strand transfer inhibitor. All inhibitors show a common pharmacophore with a double metal chelating feature (ML) composed of aromatic and hydrophobic groups.

opportunities for the development of inhibitors that can block replication of viral strains that have developed resistance to raltegravir and/or elvitegravir.

### 3.2.2.2 Integrase Binding Inhibitors

While INSTIs act at the strand transfer step, IN binding inhibitors (INBIs) act prior to the 3'-processing step by inhibiting the binding of viral cDNA to the active site. This prevents the subsequent cleavage and strand transfer reactions. Another potential mechanism is based on allosteric binding of an inhibitor to integrase and inhibition of the 3'-processing reaction at the enzymatic level (Figure 3.4).

The first reported compounds with this mechanism were the pyranodipyrimidine (5*H*-pyrano[2,3-*d*:6,5-*d'*]dipyrimidines) derivatives (PDPs) (see Figure 3.4, V-165) [45]. The compounds were initially identified in a semiautomated cell culture-based screen as inhibitors of HIV replication at noncytotoxic concentrations. Integrase inhibition assays *in vitro* identified the compounds as integrase inhibitors and a clear structure–activity relationship was demonstrated for the derivatives.

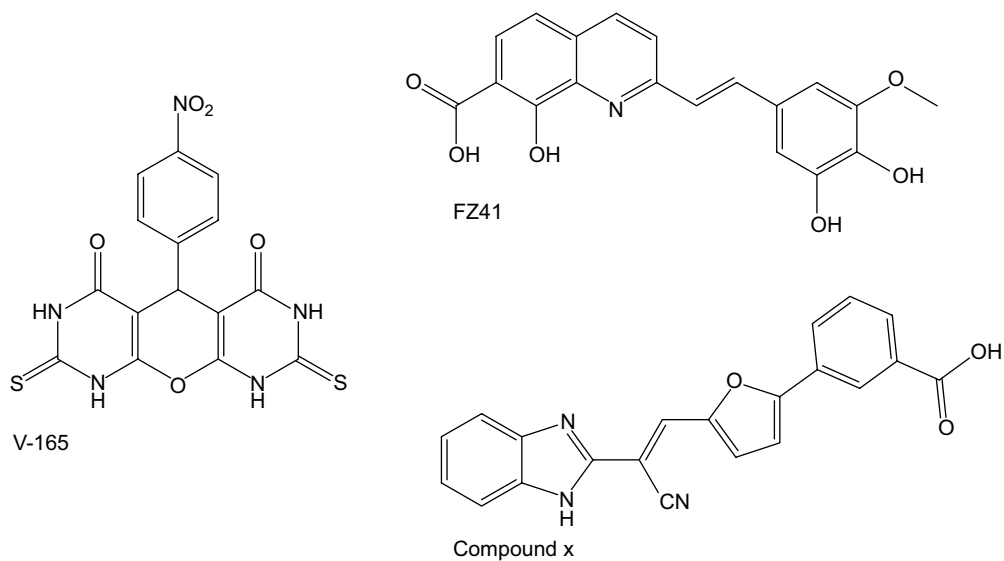

**Figure 3.4** Integrase DNA binding inhibitors (INBIs). Inhibitors that inhibit integration by preventing binding of the viral cDNA to integrase or by binding into the DNA binding groove of integrase are referred to as the integrase binding inhibitors (INBIs). As a result, 3'-processing and consecutive strand transfer will also be inhibited. One of the first published

compound classes is that of the pyranodipyrimidines of which V-165 is the most potent congener [45]. Other compounds include the styrylquinolines of which FZ41 is the most potent representative [47]. More recently, some new hit compounds were identified by virtual screening [51].

V-165, the most potent derivative, inhibits HIV-1 integration at low micromolar concentrations ( $EC_{50} = 8.9 \mu\text{M}$ ), which is 14-fold below its cytotoxic concentration. *In vitro* inhibition of the 3'-processing reaction occurs in the submicromolar range ( $IC_{50} = 0.9 \mu\text{M}$ ). Resistance development to V-165 was analyzed in cell culture. Although mutations selected early on in the resistance development were located in the integrase gene, numerous mutations in the RT and viral envelope genes were also detected in the further process suggesting a complex mode of action against different viral targets [46]. Clinical development of PDPs has not been pursued partly due to poor solubility of the compounds.

A second class of INBIs are the styrylquinoline derivatives (SQLs) [47]. Their structure is characterized by the presence of a quinoline and an ancillary aromatic ring linked by a spacer, typically a (*trans*) ethene moiety (see Figure 3.4, FZ41). The SQLs were designed on the basis of the HIV-1 IN resemblance with other polynucleotidyl transferases containing two divalent metal cations in their active site. While this metal chelating property is identical with the INSTI pharmacophore, the hydrophobic moiety of the INSTIs is absent. The most potent styrylquinolines like FZ41 inhibit HIV-1 integrase *in vitro* at micromolar concentrations ( $IC_{50} = 1\text{--}4 \mu\text{M}$ ) and block HIV in cell culture at low micromolar concentrations (4–10  $\mu\text{M}$ ) [48]. Different modes of action have been reported for SQLs. They bind to HIV-1 IN and

prevent the association with viral cDNA [49]; they also inhibit the *in vitro* strand transfer activity of an immobilized integrase/DNA complex [49]. Alternatively, modification of PIC activity or prevention of nuclear import during the HIV replication cycle has been put forward as a mode of action [48–50]. Increased potency of SQLs and clarification of the mechanism of action will be necessary before embarking on clinical drug development.

Another series of INBIs was identified by a computer-aided drug design strategy [51]. A three-dimensional ligand-based pharmacophore model was generated starting from molecules known to inhibit the 3'-processing step. Subsequently, the pharmacophore hit molecules were docked to the integrase region involved in DNA binding. This model was used to screen a commercial small-molecule database. After *in silico* validation, 12 compounds were selected and their antiviral activity was evaluated in *in vitro* assays. Among those, compound *x*, characterized by a completely new scaffold, showed very moderate *in vitro* activity inhibiting the overall integration reaction ( $IC_{50} = 164 \mu\text{M}$ ). Lead optimization increased the activity to the lower micromolar range, but, unfortunately, antiviral activity at subcytotoxic concentrations in cell culture could so far not be achieved [51, 52].

Since different classes of molecules are able to inhibit the integrase activity at the 3'-processing level by competing with the viral cDNA substrate, this appears to be a valid strategy. As these compounds, like the INSTIs, bind closely to the active site, they might be susceptible to the same INSTI-induced resistance. A quest for more potent, more specific, and less toxic derivatives of these INBIs should, therefore, be pursued prior to preclinical development.

### 3.3

#### DNA Binding Inhibitors

A second class of 3'-processing inhibitors acts on the viral DNA itself instead of the protein. Since IN binds to the highly conserved viral *att* sequences of the LTRs, these sequences can be considered putative targets for drug discovery. Compounds that specifically bind to the extremities of the viral cDNA could act as antagonists of the binding of IN or the PIC to the viral DNA. DNA intercalating compounds belong to this class but, without sequence specificity, they are too toxic limiting their application in HAART [53–55]. As a consequence, sequence specificity of DNA binding inhibitors (DBINs) is an indispensable prerequisite for antiviral drug development. Analysis of the sequences of LTR ends of HIV reveals a conserved AT-rich stretch (around 10 bp away from the DNA ends). Therefore, compounds such as netropsin, distamycin, and polyamides that are known to bind tightly to AT sequences of B-DNA are potential antivirals (Figure 3.5) [56–59]. These compounds can bind as monomers or dimers into the minor groove of viral DNA. In 1998, Neamati *et al.* tested a series of AT-selective minor groove binders [60]. *In vitro*, the majority of monomeric DNA binders were active in the range of 50–200  $\mu\text{M}$ , whereas the dimers were active in the nanomolar range. Antiviral testing showed the most potent compounds to be active in the low micromolar range ( $EC_{50} = 0.3\text{--}3 \mu\text{M}$ ). When the AAAAT sequence in the



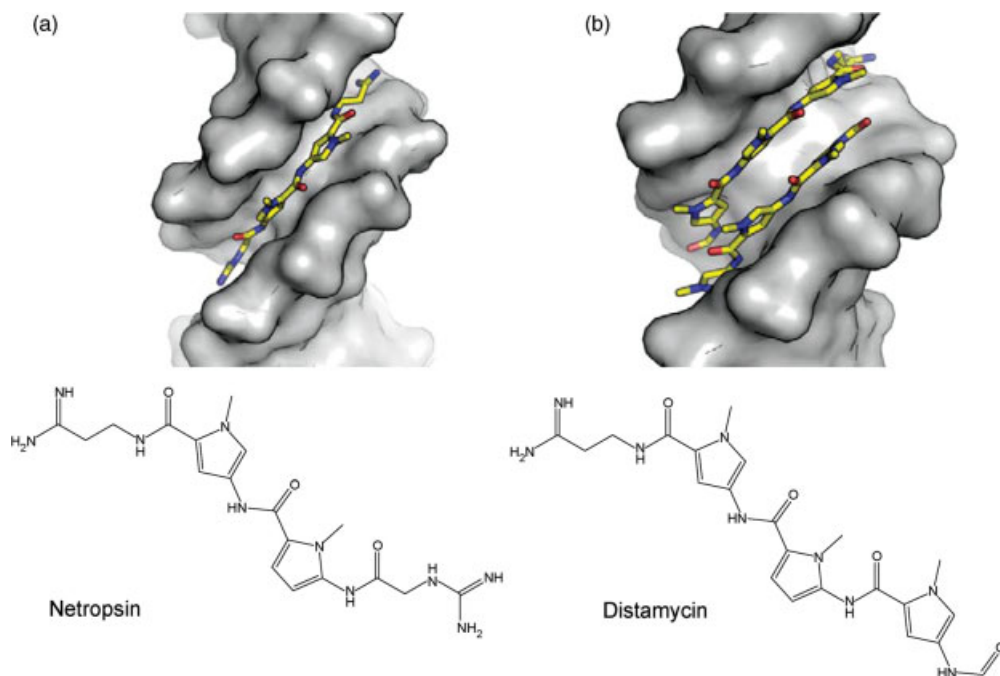

**Figure 3.5** DNA binding molecules can inhibit integrase activity. The binding of the viral cDNA to integrase can be considered as a target since both ends of the viral cDNA consist of identical, highly conserved sequences. Compounds recognizing this sequence might therefore

inhibit integration. Previously, compounds such as netropsin (a) or distamycin (b) were reported to inhibit integration *in vitro* [57–60]. These compounds bind in the minor groove of an AT-rich sequence. Compounds can bind as a monomer (a) or as a dimer (b).

substrate DNA was replaced by GGGG, a 200-fold decrease in *in vitro* activity was shown for the bisdistamycins [60]. Specific binding to the HIV-1 LTR ends remains a potential inhibitory mechanism. Further optimization and design of such inhibitors can be stimulated by including pharmacophore models describing DNA sequence specificity, as described by Spitzer *et al.* [61, 62].

### 3.4 Multimerization Inhibitors

Given the complexity of the integration reaction during which both viral cDNA ends need to come together to be integrated in a concerted fashion into the human genome, it does not come as a surprise that the functional integration complex depends on IN multimerization. Indeed, structural biology has revealed that each of the separate HIV-1 IN domains is capable of forming dimers, and more recently electron microscopy tomography indicated that a dimer of dimers (tetramer) is the most probable conformation of the full-length protein [25, 26].

Mutagenesis studies with IN indicate that integrase activity can be inhibited by manipulation of its multimeric state [63, 64]. Several groups have reported peptide-based inhibitors derived from IN that display this mode of action. The first dimerization inhibitors with a promising activity ( $IC_{50} = 2 \mu\text{M}$ ) were designed in 1995 by Lutzke *et al.* [65]. Sourgen *et al.* later described peptides derived from HIV-1 integrase (residues 147–175) with *in vitro* micromolar activity against 3'-processing, strand transfer, and autointegration activities ( $IC_{50} = 14 \mu\text{M}$  for the best peptide) [66]. Later, two independent groups reported peptide inhibitors mimicking the amino acids of the CCD dimer interface as inhibitors of HIV-1 integrase. Maroun *et al.* described two peptides named INH1 (a mimic of the  $\alpha 1$  helix of the CCD, amino acids 93–107) and INH5 (a mimic of the  $\alpha 5$  helix, amino acids 167–187). Although both sequences were derived from the integrase CCD dimer interface, INH5 was the better inhibitor with *in vitro* activities in the nanomolar range. An altered association–dissociation equilibrium of the whole enzyme and catalytic cores was consistent with an effect on multimerization [67]. Zhao *et al.* identified similar peptides by synthesizing the five interfacial peptides ( $\alpha 1$ ,  $\alpha 3$ ,  $\alpha 5$ ,  $\alpha 6$ , and  $\beta 3$ ) derived from the CCD dimer interface of HIV-1 IN. Of these five peptides, three peptides ( $\alpha 1$ ,  $\alpha 5$ , and  $\alpha 6$ ) showed integrase inhibitory activity in the micromolar range and were able to disrupt the IN dimer (see Figure 3.6a and b) [68]. Antiviral activity of these peptides was not reported. Other groups also described peptide inhibitors, but their mechanism of action remains unclear [69–74].

The peptide inhibitors of multimerization provide a proof of concept for exploiting this novel target. Not only IN activity but also PIC stability may be affected. As peptides are usually poor drugs due to poor cellular uptake, the quest for small molecules inhibiting the multimerization of IN should be pursued. Classically, disruption of a protein–protein interaction has been considered to be challenging because of the large protein interfaces, the absence of clear pockets, and the lack of a

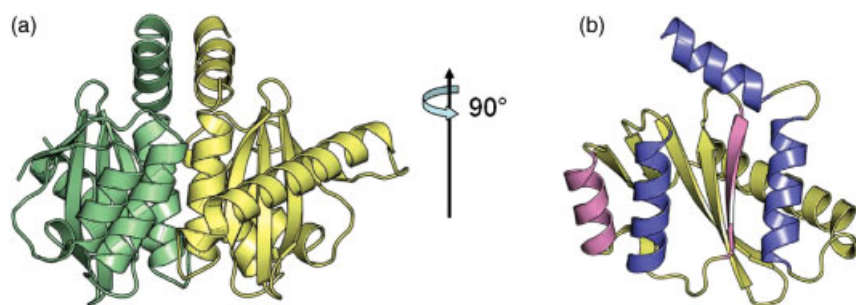

**Figure 3.6** Integrase dimerization as a druggable target. Biophysical approaches have demonstrated that the CCD of integrase is present as a dimer (in solution as well as in crystal structures). This dimer is displayed by the green and yellow monomers (a). The monomeric CCDs are depicted after a  $90^\circ$

rotation (b). Disruption of the dimer effectively inhibits the integrase reactions. Some alpha-helical peptides derived from the peptide interface successfully inhibit multimerization and catalytic activity (b, blue segments), whereas others (b, pink segments) are inactive [68, 69].

substrate (serving as scaffold) for the design of inhibitors. Despite these obstacles, several groups have already reported inhibition of protein–protein interactions by small molecules (for a review, see Ref. [75]). Small molecules have been found that inhibit HIV-1 protease dimerization, calcium-insensitive nitric oxide synthase (iNOS) dimerization, and tumor necrosis factor-alpha (TNF $\alpha$ ) trimerization [76–78].

### 3.5

#### Targeting Integrase Cofactor Interactions

Despite the limited genome size, HIV-1 needs to perform a multitude of complex functions during its replication cycle. Therefore, the virus has to rely on cellular proteins (cellular cofactors) to complete productive replication (for a review, see Ref. [79]). Since integration is one of the most complex steps during the HIV-1 replication cycle, involving different catalytic steps in different cellular compartments, it does not come as a surprise that this process is assisted by cellular cofactors. These include integrase interactor 1 (ini1) [80], high mobility group protein A1 (HMGA1) [81], and barrier-to-autointegration factor (BAF) [82]. The first cellular cofactor unambiguously shown to be important for integration is LEDGF/p75 [83–85]. LEDGF/p75 was initially identified as an integrase interacting partner by CoIP from cellular lysates overexpressing HIV-1 integrase [83]. LEDGF/p75 tightly associates with HIV-1 IN and stimulates integration. More recently, transportin-SR2 (TRN-SR2, transportin 3) was discovered as another binding partner of HIV-1 integrase [4]. TRN-SR2 apparently functions during the nuclear import of the viral PIC. Both LEDGF/p75 and TRN-SR2 are interesting targets for future antiviral therapy [86].

LEDGF/p75, a 60 kDa protein, was first described in 1998, after copurification with the transcriptional coactivator PC4 [87]. Next to LEDGF/p75, a smaller highly homologous protein was also identified, namely, p52. Singh *et al.* originally identified LEDGF/p75 as a growth factor in lens epithelium and hence named it lens epithelium-derived growth factor (LEDGF) [88]. In the years following the discovery of LEDGF/p75, many different roles were attributed to this protein, although, in contrast to its name, it is neither a growth factor nor specific for lens epithelium. Next to a role in stress response and a putative role in oncogenesis [89, 90], the cofactor is of major importance during HIV replication. The crucial role of LEDGF/p75 in HIV replication was evidenced via different approaches, including mutagenesis, RNAi, transdominant expression of the integrase binding domain (IBD) of LEDGF/p75, and knockout studies. In LEDGF/p75 knockout cell lines, single round HIV-1 replication is drastically reduced [91]. The interaction between IN and LEDGF/p75 is specific for lentiviruses [92]. More recent observations revealed that LEDGF/p75 is responsible for integration in transcriptionally active regions of chromatin supporting the hypothesis that LEDGF/p75 acts as a tethering factor determining the sites of integration in the viral genome [16]. These observations were confirmed by *in vitro* experiments demonstrating stimulation of the catalytic activity of integrase as well as an increased affinity for DNA upon binding of LEDGF/p75 [92].

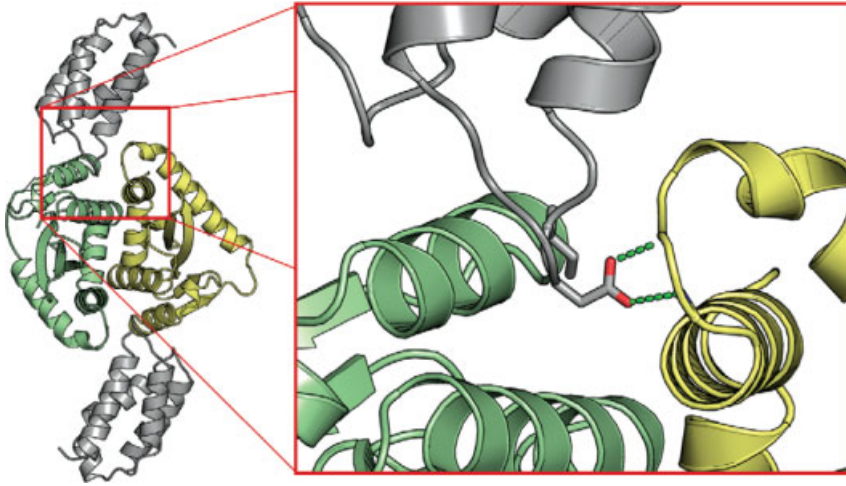

**Figure 3.7** LEDGF/p75–IN interaction as a novel drug target. The IBD of LEDGF (gray) binds in a cavity formed by dimeric integrase CCD (green and yellow) [94, 95]. The recognition and binding of LEDGF/p75 to the integrase dimer is mediated by a loop of LEDGF/p75 that binds in a cavity in the integrase dimer interface.

Key interactions involve Ile365 (hydrophobic) and Asp366 that forms a double hydrogen bridge with the integrase backbone (blowup). This crystal structure (2B4) reveals a pocket suitable for accommodating a small molecule, but predicts that dimerization inhibitors would also impede binding of the cellular cofactor.

The interface between LEDGF/p75 and HIV-1 IN was investigated by mutagenesis revealing the critical amino acids in the CCD of IN (W131 and Q168) [93]. Mutagenesis of the IBD of LEDGF/p75, the NMR solution structure of the IBD, and the cocrystal structure of IBD bound to the IN CCD all demonstrated the tight and well-structured interaction of both proteins [94, 95]. The cocrystal revealed the IBD to bind in a pocket formed by two HIV-1 IN CCD monomers. The critical amino acids mediating this protein–protein interaction have been mapped by mutagenesis studies [93].

A proof of concept that the LEDGF/p75–IN interaction can be regarded as a novel target for antiviral therapy was provided by overexpression of the C-terminal fragment of LEDGF/p75, lacking the chromatin binding domain, in cell lines (Figure 3.7). A strong block of HIV replication prior to the integration step was evidenced in these cells [96]. Next, Hombrouck *et al.* selected virus strains resistant against the inhibition by the C-terminal fragment of LEDGF/p75 [97]. Two mutations in the LEDGF/p75 binding pocket in integrase were selected, A128T and E170G. This work provided strong evidence that the LEDGF/p75–IN interaction could be regarded as a new site for developing second-generation integrase inhibitors. A small-molecule inhibitor of this protein–protein interaction was recently reported [98]. In a yeast two-hybrid screen, a benzoic acid derivative, named D77, was identified as an inhibitor of the HIV-1 IN–LEDGF/p75 interaction. D77 binds to integrase and displayed moderate antiviral activity in cell culture [98]. Unfortunately, the cytotoxicity of this compound confounds its potential for clinical development.

Hou *et al.* successfully identified several compounds that inhibit the HIV-1 IN–LEDGF/p75 interaction using a luminescent proximity assay (AlphaScreen™) based high-throughput screen of 700 000 compounds [99]. About 100 compounds were found to be active, but structures remain undisclosed. One compound also inhibited integrase activity at low micromolar concentration ( $IC_{50} = 1.6 \mu\text{M}$ ). However, antiviral activity of the compounds was not reported.

Using rational and computer-aided drug design, we have recently identified several compound classes active in an AlphaScreen protein–protein interaction assay [100]. The hit molecules were optimized and during a hit-to-lead process, compounds with antiviral activity were developed. These compounds do inhibit the integrase–LEDGF/p75 interaction. As no cross-resistance with known IN inhibitors such as raltegravir and elvitegravir is observed, these molecules are so far the best candidates for developing second-generation IN inhibitors.

### 3.6

#### Conclusion

The recent approval of the strand transfer integrase inhibitor raltegravir (MK-0518) has put integrase in the picture for the antiviral therapy of AIDS. Initially, it was believed that resistance would develop at a slow pace, but administration of raltegravir in the clinic has proven otherwise [101]. This boosted the efforts to identify second-generation integrase inhibitors with superior pharmacokinetics, such as once-daily dosing, or inhibitors with a mode of action different from INSTIs to prevent cross-resistance. Since resistance selection is one of the most striking events during HAART, it is necessary to build an arsenal of drugs with different mechanisms of action. The prototypical example of a dual therapy is the effective combination of nonnucleoside reverse transcriptase inhibitors and nucleoside reverse transcriptase inhibitors, each displaying a different resistance profile.

With the support of cellular cofactors, integrase catalyzes a highly complex set of reactions to finally insert the viral genome into the host cell genome. We reviewed the recent efforts to target the different steps highlighting the potential to make the transition from bench to bedside in treating HIV infections more efficiently. Next to the inhibition of the integrase catalytic functions (3'-processing and strand transfer), we propose to target IN complex formation (DNA binding and multimerization). Several groups in academia and industry, including ours, have engaged in the development of compounds targeting the LEDGF/p75–IN interaction, demonstrating a high expectation to develop small molecules against this target for future antiviral therapy.

#### Acknowledgments

Support was provided by the Research Fund of the University of Leuven (IDO/06/006), the CellCoVir SBO grant (60813) of the IWT; the FWO grant G.0530.08; and the

EC grant THINC (HEALTH-F3-2008-201032). A.V. is supported by a fellowship from the Institute for the Promotion of Innovation through Science and Technology in Flanders (IWT-Vlaanderen). F.C. is funded by an IOF (Industrial Research Fund) mandate of the K.U. Leuven. The authors have no other relevant affiliations or financial involvement with any organization or entity with a financial interest in or financial conflict with the subject matter or materials discussed in the present text apart from those disclosed.

## References

- 1 Gomez, C. and Hope, T.J. (2005) The ins and outs of HIV replication. *Cellular Microbiology*, **7**, 621–626.
- 2 Greene, W.C. and Peterlin, B.M. (2002) Charting HIV's remarkable voyage through the cell: basic science as a passport to future therapy. *Nature Medicine*, **8**, 673–680.
- 3 Tozser, J. (2003) Stages of HIV replication and targets for therapeutic intervention. *Current Topics in Medicinal Chemistry*, **3**, 1447–1457.
- 4 Christ, F., Thys, W., De Rijck, J., Gijssbers, R., Albanese, A., Arosio, D., Emiliani, S., Rain, J.C., Benarous, R., Cereseto, A., and Debyser, Z. (2008) Transportin-SR2 imports HIV into the nucleus. *Current Biology*, **18**, 1192–1202.
- 5 Alexaki, A., Liu, Y., and Wigdahl, B. (2008) Cellular reservoirs of HIV-1 and their role in viral persistence. *Current HIV Research*, **6**, 388–400.
- 6 Gulick, R.M., Mellors, J.W., Havlir, D., Eron, J.J., Gonzalez, C., McMahon, D., Richman, D.D., Valentine, F.T., Jonas, L., Meibohm, A., Emini, E.A., and Chodakewitz, J.A. (1997) Treatment with indinavir, zidovudine, and lamivudine in adults with human immunodeficiency virus infection and prior antiretroviral therapy. *The New England Journal of Medicine*, **337**, 734–739.
- 7 Hammer, S.M., Squires, K.E., Hughes, M.D., Grimes, J.M., Demeter, L.M., Currier, J.S., Eron, J.J., Jr., Feinberg, J.E., Balfour, H.H., Jr., Deyton, L.R., Chodakewitz, J.A., and Fischl, M.A. (1997) A controlled trial of two nucleoside analogues plus indinavir in persons with human immunodeficiency virus infection and CD4 cell counts of 200 per cubic millimeter or less. AIDS Clinical Trials Group 320 Study Team. *The New England Journal of Medicine*, **337**, 725–733.
- 8 Bailey, A.C. and Fisher, M. (2008) Current use of antiretroviral treatment. *British Medical Bulletin*, **87**, 175–192.
- 9 Wilson, L.E. and Gallant, J.E. (2009) HIV/AIDS: the management of treatment-experienced HIV-infected patients – new drugs and drug combinations. *Clinical Infectious Diseases*, **48**, 214–221.
- 10 Coffin, J.M. (1995) HIV population dynamics *in vivo*: implications for genetic variation, pathogenesis, and therapy. *Science*, **267**, 483–489.
- 11 Wei, X., Ghosh, S.K., Taylor, M.E., Johnson, V.A., Emini, E.A., Deutsch, P., Lifson, J.D., Bonhoeffer, S., Nowak, M.A., Hahn, B.H., Saag, M.S., and Shaw, G.M. (1995) Viral dynamics in human immunodeficiency virus type 1 infection. *Nature*, **373**, 117–122.
- 12 Kulkosky, J. and Skalka, A.M. (1994) Molecular mechanism of retroviral DNA integration. *Pharmacology & Therapeutics*, **61**, 185–203.
- 13 Bushman, F.D. and Craigie, R. (1991) Activities of human immunodeficiency virus (HIV) integration protein *in vitro*: specific cleavage and integration of HIV DNA. *Proceedings of the National Academy of Sciences of the United States of America*, **88**, 1339–1343.
- 14 Engelman, A., Mizuuchi, K., and Craigie, R. (1991) HIV-1 DNA integration: mechanism of viral DNA cleavage and DNA strand transfer. *Cell*, **67**, 1211–1221.
- 15 Gerton, J.L., Herschlag, D., and Brown, P.O. (1999) Stereospecificity of reactions

- catalyzed by HIV-1 integrase. *The Journal of Biological Chemistry*, **274**, 33480–33487.
- 16 Ciuffi, A. (2008) Mechanisms governing lentivirus integration site selection. *Current Gene Therapy*, **8**, 419–429.
  - 17 Yoder, K.E. and Bushman, F.D. (2000) Repair of gaps in retroviral DNA integration intermediates. *Journal of Virology*, **74**, 11191–11200.
  - 18 Engelman, A., Bushman, F.D., and Craigie, R. (1993) Identification of discrete functional domains of HIV-1 integrase and their organization within an active multimeric complex. *The EMBO Journal*, **12**, 3269–3275.
  - 19 Asante-Appiah, E., Seeholzer, S.H., and Skalka, A.M. (1998) Structural determinants of metal-induced conformational changes in HIV-1 integrase. *The Journal of Biological Chemistry*, **273**, 35078–35087.
  - 20 Asante-Appiah, E. and Skalka, A.M. (1997) A metal-induced conformational change and activation of HIV-1 integrase. *The Journal of Biological Chemistry*, **272**, 16196–16205.
  - 21 Chen, Z., Yan, Y., Munshi, S., Li, Y., Zugay-Murphy, J., Xu, B., Witmer, M., Felock, P., Wolfe, A., Sardana, V., Emini, E.A., Hazuda, D., and Kuo, L.C. (2000) X-ray structure of simian immunodeficiency virus integrase containing the core and C-terminal domain (residues 50-293): an initial glance of the viral DNA binding platform. *Journal of Molecular Biology*, **296**, 521–533.
  - 22 Steiniger-White, M., Bhasin, A., Lovell, S., Rayment, I., and Reznikoff, W.S. (2002) Evidence for “unseen” transposase–DNA contacts. *Journal of Molecular Biology*, **322**, 971–982.
  - 23 Chen, J.C., Krucinski, J., Miercke, L.J., Finer-Moore, J.S., Tang, A.H., Leavitt, A.D., and Stroud, R.M. (2000) Crystal structure of the HIV-1 integrase catalytic core and C-terminal domains: a model for viral DNA binding. *Proceedings of the National Academy of Sciences of the United States of America*, **97**, 8233–8238.
  - 24 Wang, J.Y., Ling, H., Yang, W., and Craigie, R. (2001) Structure of a two-domain fragment of HIV-1 integrase: implications for domain organization in the intact protein. *The EMBO Journal*, **20**, 7333–7343.
  - 25 Michel, F., Crucifix, C., Granger, F., Eiler, S., Mouscadet, J.F., Korolev, S., Agapkina, J., Ziganshin, R., Gottikh, M., Nazabal, A., Emiliani, S., Benarous, R., Moras, D., Schultz, P., and Ruff, M. (2009) Structural basis for HIV-1 DNA integration in the human genome, role of the LEDGF/P75 cofactor. *The EMBO Journal*, **28**, 980–991.
  - 26 Ren, G., Gao, K., Bushman, F.D., and Yeager, M. (2007) Single-particle image reconstruction of a tetramer of HIV integrase bound to DNA. *Journal of Molecular Biology*, **366**, 286–294.
  - 27 Grant, P. and Zolopa, A. (2008) Integrase inhibitors: a clinical review of raltegravir and elvitegravir. *Journal of HIV Therapy*, **13**, 36–39.
  - 28 De Clercq, E. (2001) New developments in anti-HIV chemotherapy. *Current Medicinal Chemistry*, **8**, 1543–1572.
  - 29 Neamati, N., Marchand, C., and Pommier, Y. (2000) HIV-1 integrase inhibitors: past, present, and future. *Advances in Pharmacology*, **49**, 147–165.
  - 30 Cherepanov, P., Este, J.A., Rando, R.F., Ojwang, J.O., Reekmans, G., Steinfeld, R., David, G., De Clercq, E., and Debyser, Z. (1997) Mode of interaction of G-quartets with the integrase of human immunodeficiency virus type 1. *Molecular Pharmacology*, **52**, 771–780.
  - 31 Lin, Z., Neamati, N., Zhao, H., Kiryu, Y., Turpin, J.A., Aberham, C., Strebel, K., Kohn, K., Witvrouw, M., Pannecouque, C., Debyser, Z., De Clercq, E., Rice, W.G., Pommier, Y., and Burke, T.R., Jr. (1999) Chicoric acid analogues as HIV-1 integrase inhibitors. *Journal of Medicinal Chemistry*, **42**, 1401–1414.
  - 32 Pluymers, W., Neamati, N., Pannecouque, C., Fikkert, V., Marchand, C., Burke, T.R., Jr., Pommier, Y., Schols, D., De Clercq, E., Debyser, Z., and Witvrouw, M. (2000) Viral entry as the primary target for the anti-HIV activity of chicoric acid and its tetra-acetyl esters. *Molecular Pharmacology*, **58**, 641–648.
  - 33 Hazuda, D.J., Felock, P., Witmer, M., Wolfe, A., Stillmock, K., Grobler, J.A., Espeseth, A., Gabryelski, L., Schleif, W.,

- Blau, C., and Miller, M.D. (2000) Inhibitors of strand transfer that prevent integration and inhibit HIV-1 replication in cells. *Science*, **287**, 646–650.
- 34 Hazuda, D.J., Anthony, N.J., Gomez, R.P., Jolly, S.M., Wai, J.S., Zhuang, L., Fisher, T.E., Embrey, M., Guare, J.P., Jr., Egbertson, M.S., Vacca, J.P., Huff, J.R., Felock, P.J., Witmer, M.V., Stillmock, K.A., Danovich, R., Grobler, J., Miller, M.D., Espeseth, A.S., Jin, L., Chen, I.W., Lin, J.H., Kassahun, K., Ellis, J.D., Wong, B.K., Xu, W., Pearson, P.G., Schleif, W.A., Cortese, R., Emini, E., Summa, V., Holloway, M.K., and Young, S.D. (2004) A naphthyridine carboxamide provides evidence for discordant resistance between mechanistically identical inhibitors of HIV-1 integrase. *Proceedings of the National Academy of Sciences of the United States of America*, **101**, 11233–11238.
- 35 Jin, H., Cai, R.Z., Schacherer, L., Jabri, S., Tsiang, M., Fardis, M., Chen, X., Chen, J.M., and Kim, C.U. (2006) Design, synthesis, and SAR studies of novel and highly active tri-cyclic HIV integrase inhibitors. *Bioorganic & Medicinal Chemistry Letters*, **16**, 3989–3992.
- 36 Muraglia, E., Kinzel, O., Gardelli, C., Crescenzi, B., Donghi, M., Ferrara, M., Nizi, E., Orvieto, F., Pescatore, G., Laufer, R., Gonzalez-Paz, O., Di Marco, A., Fiore, F., Monteagudo, E., Fonsi, M., Felock, P.J., Rowley, M., and Summa, V. (2008) Design and synthesis of bicyclic pyrimidinones as potent and orally bioavailable HIV-1 integrase inhibitors. *Journal of Medicinal Chemistry*, **51**, 861–874.
- 37 Pace, P., Spieser, S.A., and Summa, V. (2008) 4-Hydroxy-5-pyrrolinone-3-carboxamide HIV-1 integrase inhibitors. *Bioorganic & Medicinal Chemistry Letters*, **18**, 3865–3869.
- 38 Zhao, G., Wang, C., Liu, C., and Lou, H. (2007) New developments in diketone-containing inhibitors of HIV-1 integrase. *Mini Reviews in Medicinal Chemistry*, **7**, 707–725.
- 39 Summa, V., Petrocchi, A., Bonelli, F., Crescenzi, B., Donghi, M., Ferrara, M., Fiore, F., Gardelli, C., Gonzalez Paz, O., Hazuda, D.J., Jones, P., Kinzel, O., Laufer, R., Monteagudo, E., Muraglia, E., Nizi, E., Orvieto, F., Pace, P., Pescatore, G., Scarpelli, R., Stillmock, K., Witmer, M.V., and Rowley, M. (2008) Discovery of raltegravir, a potent, selective orally bioavailable HIV-integrase inhibitor for the treatment of HIV-AIDS infection. *Journal of Medicinal Chemistry*, **51**, 5843–5855.
- 40 Serrao, E., Odde, S., Ramkumar, K., and Neamati, N. (2009) Raltegravir, elvitegravir, and metoogravir: the birth of “me-too” HIV-1 integrase inhibitors. *Retrovirology*, **6**, 25
- 41 Al-Mawsawi, L.Q., Al-Safi, R.I., and Neamati, N. (2008) Anti-infectives: clinical progress of HIV-1 integrase inhibitors. *Expert Opinion on Emerging Drugs*, **13**, 213–225.
- 42 Kobayashi, M., Nakahara, K., Seki, T., Miki, S., Kawachi, S., Suyama, A., Wakasa-Morimoto, C., Kodama, M., Endoh, T., Oosugi, E., Matsushita, Y., Murai, H., Fujishita, T., Yoshinaga, T., Garvey, E., Foster, S., Underwood, M., Johns, B., Sato, A., and Fujiwara, T. (2008) Selection of diverse and clinically relevant integrase inhibitor-resistant human immunodeficiency virus type 1 mutants. *Antiviral Research*, **80**, 213–222.
- 43 Shimura, K., Kodama, E., Sakagami, Y., Matsuzaki, Y., Watanabe, W., Yamataka, K., Watanabe, Y., Ohata, Y., Doi, S., Sato, M., Kano, M., Ikeda, S., and Matsuoka, M. (2008) Broad antiretroviral activity and resistance profile of the novel human immunodeficiency virus integrase inhibitor elvitegravir (JTK-303/GS-9137). *Journal of Virology*, **82**, 764–774.
- 44 Ferro, S., De Luca, L., Barreca, M.L., Iraci, N., De Grazia, S., Christ, F., Witvrouw, M., Debyser, Z., and Chimirri, A. (2009) Docking studies on a new human immunodeficiency virus integrase–Mg–DNA complex: phenyl ring exploration and synthesis of 1*H*-benzylindole derivatives through fluorine substitutions. *Journal of Medicinal Chemistry*, **52**, 569–573.
- 45 Pannecouque, C., Pluymers, W., Van Maele, B., Tetz, V., Cherepanov, P., De Clercq, E., Witvrouw, M., and Debyser, Z. (2002) New class of HIV integrase inhibitors that block viral replication in



- cell culture. *Current Biology*, **12**, 1169–1177.
- 46 Hombrouck, A., Hantson, A., van Remoortel, B., Michiels, M., Vercammen, J., Rhodes, D., Tetz, V., Engelborghs, Y., Christ, F., Debyser, Z., and Witvrouw, M. (2007) Selection of human immunodeficiency virus type 1 resistance against the pyranodipyrimidine V-165 points to a multimodal mechanism of action. *The Journal of Antimicrobial Chemotherapy*, **59**, 1084–1095.
  - 47 Mekouar, K., Mouscadet, J.F., Desmaele, D., Subra, F., Leh, H., Savoure, D., Auclair, C., and d'Angelo, J. (1998) Styrylquinoline derivatives: a new class of potent HIV-1 integrase inhibitors that block HIV-1 replication in CEM cells. *Journal of Medicinal Chemistry*, **41**, 2846–2857.
  - 48 Bonnenfant, S., Thomas, C.M., Vita, C., Subra, F., Deprez, E., Zouhiri, F., Desmaele, D., D'Angelo, J., Mouscadet, J.F., and Leh, H. (2004) Styrylquinolines, integrase inhibitors acting prior to integration: a new mechanism of action for anti-integrase agents. *Journal of Virology*, **78**, 5728–5736.
  - 49 Deprez, E., Barbe, S., Kolaski, M., Leh, H., Zouhiri, F., Auclair, C., Brochon, J.C., Le Bret, M., and Mouscadet, J.F. (2004) Mechanism of HIV-1 integrase inhibition by styrylquinoline derivatives *in vitro*. *Molecular Pharmacology*, **65**, 85–98.
  - 50 Mousnier, A., Leh, H., Mouscadet, J.F., and Dargemont, C. (2004) Nuclear import of HIV-1 integrase is inhibited *in vitro* by styrylquinoline derivatives. *Molecular Pharmacology*, **66**, 783–788.
  - 51 Tintori, C., Manetti, F., Veljkovic, N., Perovic, V., Vercammen, J., Hayes, S., Massa, S., Witvrouw, M., Debyser, Z., Veljkovic, V., and Botta, M. (2007) Novel virtual screening protocol based on the combined use of molecular modeling and electron–ion interaction potential techniques to design HIV-1 integrase inhibitors. *The Journal of Chemical Information and Modeling*, **47**, 1536–1544.
  - 52 Pasquini, S., Mugnaini, C., Tintori, C., Botta, M., Trejos, A., Arvela, R.K., Larhed, M., Witvrouw, M., Michiels, M., Christ, F., Debyser, Z., and Corelli, F. (2008) Investigations on the 4-quinolone-3-carboxylic acid motif. 1. Synthesis and structure–activity relationship of a class of human immunodeficiency virus type 1 integrase inhibitors. *Journal of Medicinal Chemistry*, **51**, 5125–5129.
  - 53 Brodin, P., Pinskaya, M., Volkov, E., Romanova, E., Leh, H., Auclair, C., Mouscadet, J.F., and Gottikh, M. (1999) Branched oligonucleotide–intercalator conjugate forming a parallel stranded structure inhibits HIV-1 integrase. *FEBS Letters*, **460**, 270–274.
  - 54 Carteau, S., Mouscadet, J.F., Goulaouic, H., Subra, F., and Auclair, C. (1993) Effect of topoisomerase inhibitors on the *in vitro* HIV DNA integration reaction. *Biochemical and Biophysical Research Communications*, **192**, 1409–1414.
  - 55 Fesen, M.R., Kohn, K.W., Leteurtre, F., and Pommier, Y. (1993) Inhibitors of human immunodeficiency virus integrase. *Proceedings of the National Academy of Sciences of the United States of America*, **90**, 2399–2403.
  - 56 Kopka, M.L., Yoon, C., Goodsell, D., Pjura, P., and Dickerson, R.E. (1985) Binding of an antitumor drug to DNA, Netropsin and C-G-C-G-A-A-T-T-BrC-G-C-G. *Journal of Molecular Biology*, **183**, 553–563.
  - 57 Kopka, M.L., Yoon, C., Goodsell, D., Pjura, P., and Dickerson, R.E. (1985) The molecular origin of DNA-drug specificity in netropsin and distamycin. *Proceedings of the National Academy of Sciences of the United States of America*, **82**, 1376–1380.
  - 58 Lown, J.W. (1988) Lexitropsins: rational design of DNA sequence reading agents as novel anti-cancer agents and potential cellular probes. *Anti-Cancer Drug Design*, **3**, 25–40.
  - 59 Luck, G., Zimmer, C., Reinert, K.E., and Arcamone, F. (1977) Specific interactions of distamycin A and its analogs with (A–T) rich and (G–C) rich duplex regions of DNA and deoxypolynucleotides. *Nucleic Acids Research*, **4**, 2655–2670.
  - 60 Neamati, N., Mazumder, A., Sunder, S., Owen, J.M., Tandon, M., Lown, J.W., and Pommier, Y. (1998) Highly potent synthetic polyamides, bisdistamycins, and lexitropsins as inhibitors of human

- immunodeficiency virus type 1 integrase. *Molecular Pharmacology*, **54**, 280–290.
- 61 Spitzer, G.M., Wellenzohn, B., Laggner, C., Langer, T., and Liedl, K.R. (2007) DNA minor groove pharmacophores describing sequence specific properties. *The Journal of Chemical Information and Modeling*, **47**, 1580–1589.
- 62 Spitzer, G.M., Wellenzohn, B., Markt, P., Kirchmair, J., Langer, T., and Liedl, K.R. (2009) Hydrogen-bonding patterns of minor groove-binder-DNA complexes reveal criteria for discovery of new scaffolds. *The Journal of Chemical Information and Modeling*, **49**, 1063–1069.
- 63 Berthoux, L., Sebastian, S., Muesing, M.A., and Luban, J. (2007) The role of lysine 186 in HIV-1 integrase multimerization. *Virology*, **364**, 227–236.
- 64 Kalpana, G.V., Reicin, A., Cheng, G.S., Sorin, M., Paik, S., and Goff, S.P. (1999) Isolation and characterization of an oligomerization-negative mutant of HIV-1 integrase. *Virology*, **259**, 274–285.
- 65 Puras Lutzke, R.A., Eppens, N.A., Weber, P.A., Houghten, R.A., and Plasterk, R.H. (1995) Identification of a hexapeptide inhibitor of the human immunodeficiency virus integrase protein by using a combinatorial chemical library. *Proceedings of the United States of America*, **92**, 11456–11460.
- 66 Sourgen, F., Maroun, R.G., Frere, V., Bouziane, M., Auclair, C., Troalen, F., and Femandjian, S. (1996) A synthetic peptide from the human immunodeficiency virus type-1 integrase exhibits coiled-coil properties and interferes with the *in vitro* integration activity of the enzyme. Correlated biochemical and spectroscopic results. *European Journal of Biochemistry*, **240**, 765–773.
- 67 Maroun, R.G., Gayet, S., Benleulmi, M.S., Porumb, H., Zargarian, L., Merad, H., Leh, H., Mouscadet, J.F., Troalen, F., and Femandjian, S. (2001) Peptide inhibitors of HIV-1 integrase dissociate the enzyme oligomers. *Biochemistry*, **40**, 13840–13848.
- 68 Zhao, L., O'Reilly, M.K., Shultz, M.D., and Chmielewski, J. (2003) Interfacial peptide inhibitors of HIV-1 integrase activity and dimerization. *Bioorganic & Medicinal Chemistry Letters*, **13**, 1175–1177.
- 69 Desjobert, C., de Soultrait, V.R., Faure, A., Parissi, V., Litvak, S., Tarrago-Litvak, L., and Fournier, M. (2004) Identification by phage display selection of a short peptide able to inhibit only the strand transfer reaction catalyzed by human immunodeficiency virus type 1 integrase. *Biochemistry*, **43**, 13097–13105.
- 70 Femandjian, S., Maroun, R.S., Amekraz, B., and Jankowski, C.K. (2001) Self-association of an amphipathic helix peptide inhibitor of HIV-1 integrase assessed by electro spray ionization mass spectrometry in trifluoroethanol/water mixtures. *Rapid Communications in Mass Spectrometry*, **15**, 320–324.
- 71 Hu, J.P., Gong, X.Q., Su, J.G., Chen, W.Z., and Wang, C.X. (2008) Study on the molecular mechanism of inhibiting HIV-1 integrase by EBR28 peptide via molecular modeling approach. *Biophysical Chemistry*, **132**, 69–80.
- 72 Krajewski, K., Long, Y.Q., Marchand, C., Pommier, Y., and Roller, P.P. (2003) Design and synthesis of dimeric HIV-1 integrase inhibitory peptides. *Bioorganic & Medicinal Chemistry Letters*, **13**, 3203–3205.
- 73 Singh, S.B., Herath, K., Guan, Z., Zink, D.L., Dombrowski, A.W., Polishook, J.D., Silverman, K.C., Lingham, R.B., Felock, P.J., and Hazuda, D.J. (2002) Integramides A and B, two novel non-ribosomal linear peptides containing nine C(alpha)-methyl amino acids produced by fungal fermentations that are inhibitors of HIV-1 integrase. *Organic Letters*, **4**, 1431–1434.
- 74 Krebs, D., Maroun, R.G., Sourgen, F., Troalen, F., Davoust, D., and Femandjian, S. (1998) Helical and coiled-coil-forming properties of peptides derived from and inhibiting human immunodeficiency virus type 1 integrase assessed by <sup>1</sup>H-NMR: use of NH temperature coefficients to probe coiled-coil structures. *European Journal of Biochemistry*, **253**, 236–244.
- 75 Fry, D.C. (2008) Drug-like inhibitors of protein–protein interactions: a structural examination of effective protein mimicry.

- Current Protein & Peptide Science*, **9**, 240–247.
- 76 He, M.M., Smith, A.S., Oslob, J.D., Flanagan, W.M., Braisted, J.C., Whitty, A., Cancilla, M.T., Wang, J., Lugovskoy, A.A., Yoburn, J.C., Fung, A.D., Farrington, G., Eldredge, J.K., Day, E.S., Cruz, L.A., Cachero, T.G., Miller, S.K., Friedman, J.E., Choong, I.C., and Cunningham, B.C. (2005) Small-molecule inhibition of TNF- $\alpha$ . *Science*, **310** 1022–1025.
- 77 McMillan, K., Adler, M., Auld, D.S., Baldwin, J.J., Blasko, E., Browne, L.J., Chelsky, D., Davey, D., Dolle, R.E., Eagen, K.A., Erickson, S., Feldman, R.I., Glaser, C.B., Mallari, C., Morrissey, M.M., Ohlmeyer, M.H., Pan, G., Parkinson, J.F., Phillips, G.B., Polokoff, M.A., Sigal, N.H., Vergona, R., Whitlow, M., Young, T.A., and Devlin, J.J. (2000) Allosteric inhibitors of inducible nitric oxide synthase dimerization discovered via combinatorial chemistry. *Proceedings of the National Academy of Sciences of the United States of America*, **97**, 1506–1511.
- 78 Zutshi, R. and Chmielewski, J. (2000) Targeting the dimerization interface for irreversible inhibition of HIV-1 protease. *Bioorganic & Medicinal Chemistry Letters*, **10**, 1901–1903.
- 79 Van Maele, B., Busschots, K., Vandekerckhove, L., Christ, F., and Debysers, Z. (2006) Cellular co-factors of HIV-1 integration. *Trends in Biochemical Sciences*, **31**, 98–105.
- 80 Morozov, A., Yung, E., and Kalpana, G.V. (1998) Structure–function analysis of integrase interactor 1/hSNF5L1 reveals differential properties of two repeat motifs present in the highly conserved region. *Proceedings of the National Academy of Sciences of the United States of America*, **95**, 1120–1125.
- 81 Li, L., Yoder, K., Hansen, M.S., Olvera, J., Miller, M.D., and Bushman, F.D. (2000) Retroviral cDNA integration: stimulation by HMG I family proteins. *Journal of Virology*, **74**, 10965–10974.
- 82 Lin, C.W. and Engelman, A. (2003) The barrier-to-autointegration factor is a component of functional human immunodeficiency virus type 1 preintegration complexes. *Journal of Virology*, **77**, 5030–5036.
- 83 Cherepanov, P., Maertens, G., Proost, P., Devreese, B., Van Beeumen, J., Engelborghs, Y., De Clercq, E., and Debysers, Z. (2003) HIV-1 integrase forms stable tetramers and associates with LEDGF/p75 protein in human cells. *The Journal of Biological Chemistry*, **278**, 372–381.
- 84 Llano, M., Saenz, D.T., Meehan, A., Wongthida, P., Peretz, M., Walker, W.H., Teo, W., and Poeschla, E.M. (2006) An essential role for LEDGF/p75 in HIV integration. *Science*, **314**, 461–464.
- 85 Maertens, G., Cherepanov, P., Plumeyers, W., Busschots, K., De Clercq, E., Debysers, Z., and Engelborghs, Y. (2003) LEDGF/p75 is essential for nuclear and chromosomal targeting of HIV-1 integrase in human cells. *The Journal of Biological Chemistry*, **278**, 33528–33539.
- 86 Thys, W., Busschots, K., McNeely, M., Voet, A., Christ, F., and Debysers, Z. (2009) LEDGF/p75 and transportin-SR2 are cellular cofactors of HIV integrase and novel targets for antiviral therapy. *Future Medicine*, **3**, 171–188.
- 87 Ge, H., Si, Y., and Roeder, R.G. (1998) Isolation of cDNAs encoding novel transcription coactivators p52 and p75 reveals an alternate regulatory mechanism of transcriptional activation. *The EMBO Journal*, **17**, 6723–6729.
- 88 Singh, D.P., Kimura, A., Chylack, L.T., Jr., and Shinohara, T. (2000) Lens epithelium-derived growth factor (LEDGF/p75) and p52 are derived from a single gene by alternative splicing. *Gene*, **242**, 265–273.
- 89 Singh, D.P., Fatma, N., Kimura, A., Chylack, L.T., Jr., and Shinohara, T. (2001) LEDGF binds to heat shock and stress-related element to activate the expression of stress-related genes. *Biochemical and Biophysical Research Communications*, **283**, 943–955.
- 90 Huang, T.S., Myklebust, L.M., Kjarland, E., Gjertsen, B.T., Pendino, F., Bruserud, O., Doskeland, S.O., and Lillehaug, J.R. (2007) LEDGF/p75 has increased expression in blasts from chemotherapy-resistant human acute myelogenous leukemia patients and protects leukemia

- cells from apoptosis *in vitro*. *Molecular Cancer*, **6**, 31
- 91 Shun, M.C., Raghavendra, N.K., Vandegraaff, N., Daigle, J.E., Hughes, S., Kellam, P., Cherepanov, P., and Engelman, A. (2007) LEDGF/p75 functions downstream from preintegration complex formation to effect gene-specific HIV-1 integration. *Genes & Development*, **21**, 1767–1778.
- 92 Busschots, K., Vercammen, J., Emiliani, S., Benarous, R., Engelborghs, Y., Christ, F., and Debyser, Z. (2005) The interaction of LEDGF/p75 with integrase is lentivirus-specific and promotes DNA binding. *The Journal of Biological Chemistry*, **280**, 17841–17847.
- 93 Busschots, K., Voet, A., De Maeyer, M., Rain, J.C., Emiliani, S., Benarous, R., Desender, L., Debyser, Z., and Christ, F. (2007) Identification of the LEDGF/p75 binding site in HIV-1 integrase. *Journal of Molecular Biology*, **365**, 1480–1492.
- 94 Cherepanov, P., Ambrosio, A.L., Rahman, S., Ellenberger, T., and Engelman, A. (2005) Structural basis for the recognition between HIV-1 integrase and transcriptional coactivator p75. *Proceedings of the National Academy of Sciences of the United States of America*, **102**, 17308–17313.
- 95 Cherepanov, P., Sun, Z.Y., Rahman, S., Maertens, G., Wagner, G., and Engelman, A. (2005) Solution structure of the HIV-1 integrase-binding domain in LEDGF/p75. *Nature Structural & Molecular Biology*, **12**, 526–532.
- 96 De Rijck, J., Vandekerckhove, L., Gijssbers, R., Hombrouck, A., Hendrix, J., Vercammen, J., Engelborghs, Y., Christ, F., and Debyser, Z. (2006) Overexpression of the lens epithelium-derived growth factor/p75 integrase binding domain inhibits human immunodeficiency virus replication. *Journal of Virology*, **80**, 11498–11509.
- 97 Hombrouck, A., De Rijck, J., Hendrix, J., Vandekerckhove, L., Voet, A., De Maeyer, M., Witvrouw, M., Engelborghs, Y., Christ, F., Gijssbers, R., and Debyser, Z. (2007) Virus evolution reveals an exclusive role for LEDGF/p75 in chromosomal tethering of HIV. *PLoS Pathogens*, **3**, e47
- 98 Du, L., Zhao, Y., Chen, J., Yang, L., Zheng, Y., Tang, Y., Shen, X., and Jiang, H. (2008) D77, one benzoic acid derivative, functions as a novel anti-HIV-1 inhibitor targeting the interaction between integrase and cellular LEDGF/p75. *Biochemical and Biophysical Research Communications*, **375**, 139–144.
- 99 Hou, Y., McGuinness, D.E., Prongay, A.J., Feld, B., Ingravallo, P., Ogert, R.A., Lunn, C.A., and Howe, J.A. (2008) Screening for antiviral inhibitors of the HIV integrase–LEDGF/p75 interaction using the AlphaScreen luminescent proximity assay. *Journal of Biomolecular Screening*, **13**, 406–414.
- 100 Christ, F., Voet, A., Marchand, A., Nicolet, S., Desimmié, B., Marchand, D., Bardiot, D., Van der Veken, N., Van Remoortel, B., Strelkov, S., De Maeyer, M., Chaltin, P., and Debyser, Z. (2010) Rational design of small-molecule inhibitors of the LEDGF/p75-integrase interaction and HIV replication. *Nature Chemical Biology*, **6**, 442–448.
- 101 Malet, I., Delelis, O., Valantin, M.A., Montes, B., Soulie, C., Wirden, M., Tchertanov, L., Peytavin, G., Reynes, J., Mouscadet, J.F., Katlama, C., Calvez, V., and Marcelin, A.G. (2008) Mutations associated with failure of raltegravir treatment affect integrase sensitivity to the inhibitor *in vitro*. *Antimicrobial Agents and Chemotherapy*, **52**, 1351–1358.
- 102 Billich, A. (2003) S-1360 Shionogi-GlaxoSmithKline. *Current Opinion in Investigational Drugs*, **4**, 206–209.
- 103 Vacca, J., Wai, J., Fisher, T., Hazuda, D., Miller, M., Felock, P., Witmer, M., Gabryelski, L., and Lyle, T. (2007) Discovery of MK-2048: subtle changes confer unique resistance properties to a series of tricyclic hydroxypyrrole integrase strand transfer inhibitors. 4th International AIDS Society (IAS) Conference, July 22–25, 2007, Sydney, Australia



## 4

# From Saquinavir to Darunavir: The Impact of 10 Years of Medicinal Chemistry on a Lethal Disease

*Marie-Pierre de Béthune, Anik Peeters, and Piet Wigerinck*

### 4.1

#### Introduction

Improving the life of patients through scientific innovation is the most important motivational driver for researchers in medical and pharmaceutical research groups. Over the past 25 years, the enthusiasm and creativity of researchers worldwide have created one of the recent success stories of the pharmaceutical sector: a new lethal infectious disease – AIDS (acquired immune deficiency syndrome) was transformed into a manageable chronic disease with good life expectancy for those patients who have access to accurate diagnostics and combination therapy consisting of two or three drugs.

In the past 25 years, 25 novel drugs have been discovered, developed, and introduced into therapy – an unprecedented effort within the medical history. Also, the diversity in terms of mechanism of actions is unique. Six different classes of drugs have been developed and registered: the nucleosides (including a nucleotide analogue), the protease inhibitors (PIs), the nonnucleoside reverse transcriptase inhibitors, a fusion inhibitor, a chemokine receptor antagonist, and an integrase inhibitor. Apart from the chemokine receptor antagonist, all of them act as direct antivirals; they inhibit the virus replication by binding to one of the viral proteins, thereby inhibiting their function. This success did not come overnight; many small steps were taken through the combined efforts of dedicated scientists around the world.

### 4.2

#### The HIV Protease as a Target for AIDS

The disease AIDS was described for the first time in the early 1980s of the previous century by the US Centers for Disease Control and Prevention. Within a couple of years, it was generally accepted that a novel infectious disease (AIDS) had emerged; this novel disease was transmitted via blood and sexual contact and soon it took on pandemic allures. As causative agent of this infectious disease, a novel retrovirus was discovered and described as HIV (human immunodeficiency virus) [1, 2].

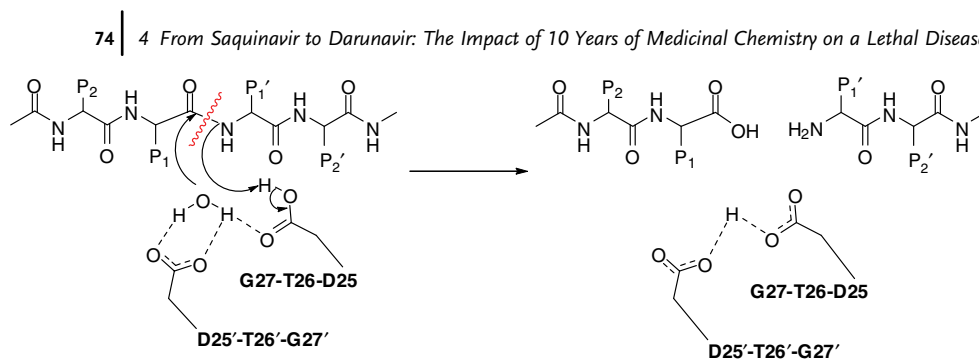

**Figure 4.1** The catalytic mechanism of the HIV protease enzyme.

The protease enzyme plays a critical role at the end of the viral life cycle; it cleaves virally encoded polyprotein chains into their individual constituents that are required for a fully functional virus. The protease enzyme cleaves amide bonds of peptides via a generally accepted mechanism depicted in Figure 4.1. Fully functional viral proteins are the result. In the presence of inhibitors of the enzyme, this cleavage process is inhibited and noninfectious particles are formed resulting in a full blockage of the viral replication.

HIV protease is a small enzyme: it is a homodimer and each sequence contains 99 amino acids only. It is an aspartic protease: the catalytic activity of the enzyme depends on the aspartic acid on position 25; in the homodimer form of the enzyme, these two amino acids work together (Figure 4.1). Other essential amino acids contributing to the active site are Thr26 and Gly27. In the standard nomenclature, substrate/inhibitor residues are designated as P3, P2, P1, P1', P2', P3', and so on to indicate the binding to the corresponding enzyme subsites S3, S2, S1, S1', S2', S3'. The amino acids Asp25 and Asp25' in the cleavage site are located between S1 and S1'.

The first protease inhibitors were not discovered via random screening; scientists went to the drawing boards and started rational drug design projects based on the transition-state mimetic concept of this aspartic acid protease enzyme. Most of these early programs were executed by people with a solid background in the renin field. Renin is another aspartic protease enzyme and was heavily investigated by a number of pharmaceutical groups in search for better antihypertensive drugs. Protease inhibitors were not the first class of HIV drugs to be developed. By the moment the early progress of protease research was reported, the first nucleoside (zidovudine, AZT) had already been approved. The protease inhibitors were competing head to head with the nonnucleoside inhibitors to become the second class of HIV drugs.

### 4.3

#### The Early Protease Inhibitors

The hydroxyethylene and hydroxyethylamine scaffolds proved to be good transition-state mimics. Many early attempts were focused around mimicking the Asn-Phe-Pro substrate. This resulted in piperidine- and piperazine-based systems, as many

scientists thought that a cyclic group mimicking proline was essential. With the exception of nelfinavir, the first-generation PIs had substituents extending into S3 or S3' pocket of the enzyme (Figure 4.2). The medicinal chemists used most of the available space within the enzyme to build up affinity. The major hurdle proved to be cell penetration and oral bioavailability, both characteristics were “designed in” via ionizable weakly basic groups: for indinavir [3], the classical piperazine group proved to be sufficient; for saquinavir [4], and subsequently nelfinavir [5], the more challenging fully saturated isoquinoline heterocyclic piperazine was used (Figure 4.2). Thanks to these ionizable groups, salts of the molecules could be made and the inhibitors reached the minimal aqueous solubility that is required to get oral bioavailability from the gastrointestinal tract. Exception to this rule is ritonavir [6], it does not contain any weakly acidic or basic functional group and requires a complex formulation. Once absorbed into the body, ritonavir has good pharmacokinetic properties, resulting from very strong inhibition of a series of P-450 enzymes; it is blocking its own metabolism and elimination. Indinavir is also a quite strong inhibitor and inducer of P-450 enzymes. While strong P-450 inhibition/induction is an unacceptable property for drug candidates in other diseases, the urgent need for novel inhibitors prevailed and these compounds were quickly tested in patients.

The start of the clinical development of the PIs coincided with the growing knowledge on the role of resistance in the failures of patients on nucleoside treatments. As the protease enzyme is a dimer, many researchers were convinced that resistance would develop much slower because every mutation has to fit twice. As such the PIs would become the only HIV drug class used as monotherapy. The first clinical results with saquinavir were very good: high-dose monotherapy in HIV patients induced an impressive plasma viral load drop of  $1.5 \log_{10}$  HIV-1 RNA copies/ml, slowly rebounding during the rest of the trial, a clear drawback was that suboptimal doses lead to resistance [7]. These early successes in terms of clinical outcome pushed saquinavir as the first PI to the market; it was approved in 1995, despite an absolute oral bioavailability of only 4%. The next important clinical breakthrough was obtained when the combination of indinavir with zidovudine and lamivudine was tested in antiretroviral treatment-naïve patients [8]. This combination suppressed the plasma viral load below the limit of detection in 80% of the patients, resulting in clearly improved life expectancy and long-term perspectives for the patients [9]. This type of triple combination of drugs became the standard of HIV treatment and was described as tritherapy or highly active antiretroviral therapy (HAART) [10].

Soon after the initial euphoria of the improved survival, the enormous challenge ahead of treating patients lifelong became clear [11]. The novel challenge had two sides: an efficacy side as an important number of patients did not show continued suppression of the virus despite the combination therapy, and a safety side as the toxicities resulting from the administration of these treatment regimens were limiting the long-term use of a number of combinations. It became clear that the criteria applied while looking for the “life-saving” drugs were insufficient for selecting drugs aimed at long-term suppression of the virus.

In terms of safety, acute toxicity of PIs was not an issue; however, frequently described side effects following chronic administration of HIV PIs consisted of



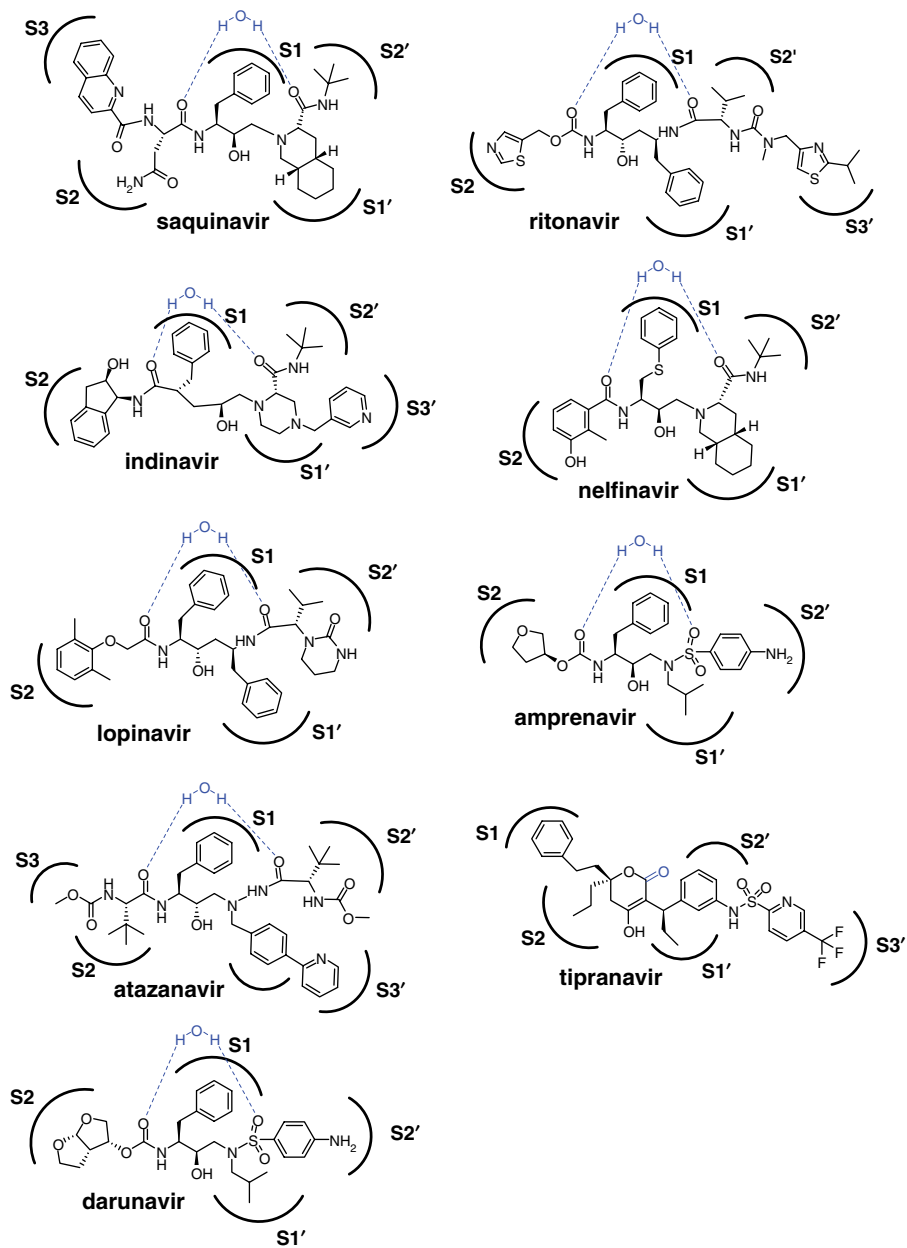

**Figure 4.2** The different approved HIV protease inhibitors (fosamprenavir (= phosphorylated amprenavir) not shown).

diarrhea, skin rashes, hyperlipidemia, and lipodystrophy. The diarrhea (more generally described as gastrointestinal (GI) toxicity) is the most disturbing one for patients taking these medications chronically. The hyperlipidemia is linked with serious cardiovascular events and is worrying on the long term. Unfortunately, these side effects are not specific, that is, not linked to a proven biological mechanism, and eliminating them by improved drug design is quite difficult. Some of the toxicities (lipodystrophy) were caused by the combination of the first-generation PIs with the early nucleosides. The frequency of such side effects diminished as soon as second-generation nucleosides and PIs were used.

On the efficacy side, a durable response in patients on PIs was clearly linked to achieving continuous high plasma levels. Insufficient plasma drug exposure frequently led to therapy failure and the selection of drug-resistant viruses. A second efficacy problem was the cross-resistance observed among the viruses isolated from patients that had failed a PI. These viruses turned out to be resistant to all other first-generation PIs. As soon as a patient had failed a first PI, he/she could not be treated with another PI. Exception to this rule was nelfinavir: resistant viruses from patients on nelfinavir carried a specific mutation (D30N) that did not affect the activity of any other PI.

Overcoming the resistance problem by medicinal chemistry was an achievable goal. Continued efforts resulted in a series of molecules with highly diverse P2 and P2' ligands. Some of them like the tetrahydrofuran and the *p*-aminosulfonyl groups of amprenavir [12] made H-bonds to the backbone of the enzyme, others like the 2,6-dimethylphenoxyacetyl of lopinavir [13] optimized lipophilic binding. Amprenavir and lopinavir remained clearly active on a number of mutated viruses that appeared quite frequently. Remarkably, their chemical structures are small and do not extend into the S3 or S3' pocket of the enzyme. Improving the spectrum of the PIs alone was not sufficient; the field needed drugs with vastly improved pharmacokinetic properties. The plasma concentrations of successful HIV drugs need to be a factor of 5–10 higher than the EC<sub>50</sub> values (corrected for plasma protein binding) around the clock. Unfortunately, the design of compounds with improved PK properties never achieved the preset goals.

As none of the designs were successful, the Abbott group took a completely unconventional approach. Their novel drug candidate lopinavir was combined with a low dose of ritonavir. Ritonavir, their first HIV PI, showed strong inhibition of PGP pumps and P-450 enzymes. For lopinavir, the results were spectacular; in the absence of ritonavir, only low plasma levels of lopinavir could be obtained in animals and volunteers [13]. In the presence of ritonavir, twice daily administration of lopinavir resulted in sustained high plasma levels for 24 h. The clinical results were very good: a large fraction of the patients on lopinavir/ritonavir-based treatment showed complete suppression of the virus for years. As a consequence, the combination lopinavir/ritonavir was extensively used in patients. Drawbacks of such combination are clearly a very extensive list of drug–drug interactions and a number of precautions need to be taken when other common drugs are coadministered. The HIV field has taken a pragmatic approach, has accepted the consequences, and is clearly an exception compared to most other chronic diseases.

Amprenavir, discovered by Vertex scientists, is a different story [12]. Inspired by results from the Searle group [14], they introduced the synthetically straightforward aryl sulfonamide substituent as P2 ligand. Amprenavir showed good inhibition of a number of frequently observed PI mutants. The low solubility of amprenavir (0.04 mg/ml) is a clear drawback, patients had to take 12 capsules twice a day. After a couple of years, amprenavir was replaced by the prodrug amprenavir monophosphate (fosamprenavir). Both have the same antiviral activity, but the phosphate prodrug has clearly superior solubility characteristics and patients have to take two pills only, every day. In patients, hardly any phosphate can be detected in plasma, most of the prodrug is cleaved while passing the intestinal tract [15].

From 2000 onward, the leading PI treatment became the lopinavir/ritonavir combination. With the extensive use, potential improvements over this combination also became apparent: a broader spectrum resulting in improved virologic control in PI-resistant patients, lesser effects on plasma lipids, and decreased GI toxicity.

Part of these goals was realized with atazanavir [16], a potent PI with limited activity against resistant viruses. Chemically, atazanavir is a peptidomimetic. It is the only diaza-peptide-based HIV PI. The chemical structure includes two carbamate groups and as such looks like a chemical intermediate. It has a large P1' substituent, a 2-pyridyl group is added to the *para*-position of the phenyl group, extending into the S3' pocket. This different binding mode results in activity against a number of PI mutants *in vitro*. Atazanavir has by far the best PK properties of the whole class: once-daily dosage without ritonavir results in sufficiently high plasma levels over 24 h. In addition, atazanavir does not cause an increase of plasma lipids in patients, a clear side effect of even low doses of ritonavir. Today, atazanavir is frequently used in patients that start their first PI-based treatment, especially in patients with increased risk for cardiovascular complications. While *in vitro* atazanavir is clearly active on a number of PI-resistant viruses, this never resulted in a sustained clinical response in PI-resistant patients. As a consequence, it is not an option for patients that have failed PI-based regimens.

Special among the PIs is tipranavir. The molecule is not derived from a peptide or design effort, but the early hit came out of an enzymatic screening effort. A coumarin derivative displayed micromolar activity in an enzymatic screening assay and weak inhibition in a cellular assay. An intensive structure–activity relationship (SAR) program resulted in the final molecule, tipranavir [17], the only nonpeptide-like HIV PI approved for use in patients. Tipranavir is also special because in cellular assays it is not that potent ( $EC_{50} > 100$  nM), but it is active against most of the PI-resistant strains. Despite the fact that the molecule is not derived from a peptide, it does not have very good PK properties and in patients coadministration of a high dose of ritonavir is required.

#### 4.4

##### The Medical Need for a “Next”-Generation PI

The lopinavir/ritonavir combination proved to be a major step forward especially in patients who had never been exposed to PI-based regimens. Unfortunately, within

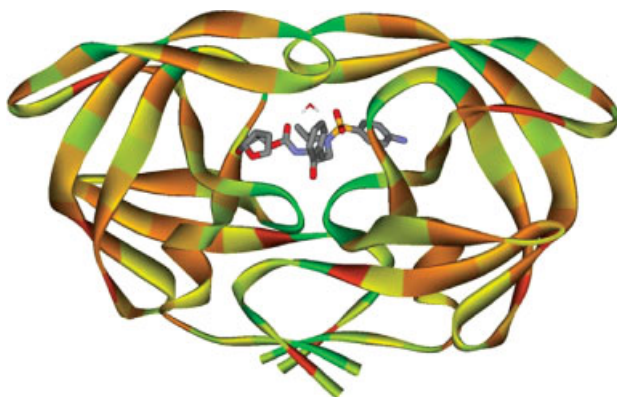

**Figure 4.3** Darunavir and flap water in ribbon structure of HIV-1 protease, colored by mutation frequency.

the total patient population, there was a growing group who had failed more than one PI-based regimen. For these patients, few treatment options were available as, due to the cross-resistance among the PIs, none of the licensed PIs could suppress the resistant viruses. With an increasing length of treatment, the resistance patterns of the viruses became extremely complex in terms of number of mutations and combinations of mutations. Often, isolated PI-resistant viruses carried more than 15 mutations for a total sequence of 99 amino acids.

In Figure 4.3, the protease enzyme is presented as a ribbon with all amino acids colored by mutation frequency, based on the genotype of more than 50 000 clinical samples. The catalytic site, located at the contact between the two ribbons in the bottom of the pocket, is the most conserved area. Also, in the flap water region, the mutation frequency is lower than 1%. Other amino acids that are less relevant for the natural protease activity can be mutated in more than 30% of the clinical samples. Inhibitors making interactions with these promiscuous amino acids will be more susceptible to mutations.

It was this diversity we at Tibotec were facing back in 1998 when we decided to go and look for PIs with an improved spectrum. Rather than looking for PIs that covered a few more mutations, we decided to look for real broad-spectrum compounds.

With this complexity, a drug design exercise was not an attractive option. A panel of 19 strains that covered all the frequently observed PI resistance-associated mutations was assembled [18] and analogues of existing drugs (Table 4.1) were evaluated. The activity of the drugs is represented as  $pEC_{50}$ : a value of 9 corresponds to an  $EC_{50}$  of 1 nM, a value of 8 to an  $EC_{50}$  of 10 nM. It is clear from the table that none of the registered drugs at that moment was active on most of the strains in this panel. Exception must be made for tipranavir that was still in development and showed the same activity across the panel.

Three evaluation criteria were put forward: (1) high potency against the wild-type and a panel of multi-PI-resistant HIV-1 clinical strains, (2) a limited drop of activity against the worst virus in the panel, (3) favorable pharmacokinetic properties after

**Table 4.1** Activities of HIV PIs on the panel of 18 highly PI-resistant HIV-1 clinical isolates.

pEC <sub>50</sub>	WT	M1	M2	M3	M4	M5	M6	M7	M8	M9	M10	M11	M12	M13	M14	M15	M16	M17	M18
APV	7.4	6.9	6.7	6.8	6.8	6.6	6.2	7.0	6.7	6.7	6.8	7.4	7.5	6.7	6.7	6.1	8.0	6.4	6.9
SQV	8.0	5.6	6.0	6.2	6.1	6.0	6.9	6.0	5.9	6.2	6.0	6.9	6.4	7.1	7.4	6.0	8.2	6.3	7.6
IDV	7.5	6.0	5.9	5.9	6.1	6.1	5.8	5.6	6.2	6.6	5.9	6.3	6.9	6.6	6.0	6.3	7.9	6.3	6.6
RTV	7.2	5.0	5.0	5.0	5.5	5.6	5.8	5.0	5.4	5.6	5.5	5.5	6.1	5.2	5.4	5.1	7.5	5.7	5.5
NFV	7.5	5.5	5.3	5.3	5.7	5.6	5.0	5.6	5.6	6.1	5.3	5.9	6.4	6.3	6.0	5.6	6.4	5.5	6.2
ATV	8.5	6.7	6.8	6.8	7.0	7.2	5.5	6.9	6.5	7.5	7.1	7.4	7.6	7.5	7.6	6.9	8.8	6.9	7.7
LPV	8.1	6.5	6.5	6.4	7.1	7.3	7.9	6.7	7.0	6.7	6.8	7.5	7.1	6.9	7.1	7.3	8.7	7.2	6.9
TPV	6.8	5.5	6.0	6.0	6.3	6.2	5.9	6.1	6.2	6.6	5.8	6.2	7.4	6.6	6.7	6.3	7.3	7.2	6.7

Antiviral activity is expressed as pEC<sub>50</sub> values in the cellular replication assay. A value of 6 corresponds to an EC<sub>50</sub> value of 1 μM, and a value of 8 to an EC<sub>50</sub> value of 10 nM. WT, wild type; M1–M18 represent the highly PI-resistant HIV-1 clinical isolates; APV, amprenavir; SQV, saquinavir; IDV, indinavir; RTV, ritonavir; NFV, nelfinavir; ATV, atazanavir; LPV, lopinavir; TPV, tipranavir. *Color coding*: green – pEC<sub>50</sub> values ≥ 8.0, yellow – pEC<sub>50</sub> values ≥ 7.0 and < 8.0, orange – pEC<sub>50</sub> values < 7.0.

oral administration in at least one animal species. In addition, we would look at the influence of plasma proteins on the anti-HIV activity of the compounds, at the metabolic stability of the compounds in the presence of liver microsomes, and at the profile of *in vitro* selection of drug-resistant virus in the presence of increasing concentrations of the inhibitors.

The internal program got a major boost when compound **1** (Table 4.2) was submitted for evaluation. This compound had been described as a potent, non-peptidic, highly druggable HIV PI [19] and had been sent to numerous pharmaceutical labs for evaluation. Most of the labs confirmed the potency against the wild-type virus, but turned down the compound because of the lack of metabolic stability. The evaluation at Tibotec was purely virologically based, and the compound performed impressively. Compound **1** was more potent against the wild-type virus than any described competitor. Even more impressive was the activity on all the resistant strains; the difference between the wild-type virus and the average on the mutants was only 0.36; the shift for the worst mutant was 1.62 log. The activity of compound **1** on each of the mutants was better than the activity of any of the reference drugs against the wild-type virus.

Without any doubt, the results proved the fact that PIs with a much broader spectrum were feasible. A relatively minor modification had enormous consequences on the antiviral spectrum. The compound had been synthesized by the group of Ghosh as part of a broad search for less peptide-like PIs [19]. The compound was a close analogue of amprenavir, but had the “exotic” bis-tetrahydrofuran or bis-THF as P2 ligand. This heterocycle was designed to mimic the asparagine side chain of saquinavir [20] and could make the same H-bonds with the backbone NH atoms of Asp29 and Asp30 (Figure 4.4).

Consequently, the search for analogues was initiated. First of all, the bis-THF moiety and the central core were kept constant and the metabolically labile methoxy group was replaced. The activity of the analogues is depicted in Figure 4.5. The

**Table 4.2** Antiviral activities of darunavir and close analogues.

Compound	R1	R2	R3	R4	pEC <sub>50</sub> WT	pEC <sub>50</sub> Mut Avg	pEC <sub>50</sub> Worst Mut
1	H	<i>i</i> -Butyl	H	O-Me	9.23	8.87	7.61
2	H	<i>i</i> -Butyl	H	H	8.56	7.17	6.78
3	H	<i>i</i> -Butyl	H	I	8.82	8.62	7.48
4	H	<i>i</i> -Butyl	H	NO <sub>2</sub>	8.61	7.66	7.34
5	H	<i>i</i> -Butyl	H	CN	8.28	7.01	6.80
6	H	<i>i</i> -Butyl	H	COCH <sub>3</sub>	8.71	7.86	7.50
7	H	<i>i</i> -Butyl	H	CH <sub>3</sub>	8.28	7.22	6.88
8	H	<i>i</i> -Butyl	H	OH	8.20	8.21	7.63
9(darunavir)	H	<i>i</i> -Butyl	H	NH <sub>2</sub>	8.39	8.51	8.13
10	H	<i>i</i> -Butyl	H	–CH <sub>2</sub> NH <sub>2</sub>	8.15	8.24	7.80
11	H	<i>i</i> -Butyl	NH <sub>2</sub>	H	8.36	7.99	6.82
12	H	<i>i</i> -Butyl	–OCH <sub>2</sub> –	O'	9.16	8.82	7.56
13	H	<i>i</i> -Butyl	H	NH <sub>2</sub>	7.97	7.82	7.22
14	Vinyl	<i>i</i> -Butyl	H	O-Me	7.34	7.07	6.54
15	Ethyl	<i>i</i> -Butyl	H	O-Me	6.33	5.08	5.00
16	Allyl	<i>i</i> -Butyl	H	O-Me	6.53	NA	NA
17	H	CH <sub>2</sub> -cyclohexyl	H	O-Me	8.80	8.11	6.88
18	H	CH <sub>2</sub> -cyclopropyl	H	O-Me	8.41	7.12	6.38
19	H	Allyl	H	O-Me	7.97	6.10	5.68
20	H	CH <sub>2</sub> -pyrid-2-yl	H	O-Me	7.60	5.97	5.42
21	H	Ethyl- <i>N</i> -pyrrolidine	H	O-Me	5.71	NA	NA

Antiviral activity is expressed as pEC<sub>50</sub>.

WT, wild type; Mut Avg, average antiviral activity on a panel of five strains; Worst Mut, lowest pEC<sub>50</sub> obtained in the panel.

R1–R4 refer to the positions illustrated in Figure 4.6.

activity on the wild-type virus is colored blue, the average activity on the mutant panel of viruses in green, the worst mutant activity (= the lowest activity observed for a compound in the panel of viruses) for that compound in orange. The methoxy group was removed and compound 2 was obtained. The compound was still very potent against the wild-type virus. A pEC<sub>50</sub> of 8.56 is as good as any commercial PI. However, for the mutants, almost a 100-fold (1.8 log) drop in activity was observed, comparable to the approved drugs and considered as noninteresting. In fact, a number of phenyl-substituted analogues (2, 4–7, represented as circles in Figure 4.5) were synthesized for which the activity on the mutants is >1 log weaker compared to the wild type. The lowest average activity on the mutants was observed with the *p*-CN group 5, followed by the unsubstituted phenyl 2, the *p*-CH<sub>3</sub> analogue 7, the *p*-nitro group 4, and the *p*-acetyl group 6. These compounds have lipophilic substituents on the phenyl group and displayed a “poor” resistance profile. A more interesting group is represented by the *p*-OH 8, *p*-NH<sub>2</sub> 9, and *p*-CH<sub>2</sub>NH<sub>2</sub> 10 analogues (Figure 4.5, squares). They are not the most potent compounds, but their activity against the mutants is almost as strong as the activity against the wild type; on top the worst mutant is within 1 log of the activity against the wild type. These substituents are small, polar, and can form both

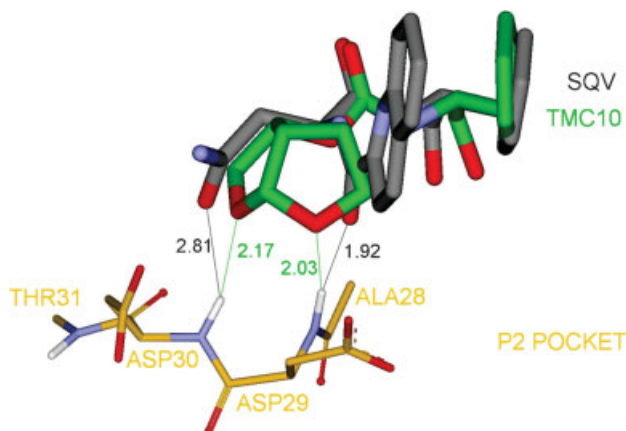

**Figure 4.4** Overlay of compound **1** and saquinavir in the pocket of the protease enzyme.

H-donating and H-accepting bonds to the enzyme. From the beginning, they were considered as having the “best spectrum.” A third group consists of *p*-MeO **1**, *p*-Iodo **3**, and the 3,4-dioxolane **12** analogues (Figure 4.5, diamonds). These are clearly the most potent ones of the group; the difference between the activity against the wild-type virus and the mutants is small, but there is >1 log difference between the wild-type and the worst mutants. In fact, the *meta*-NH<sub>2</sub>**11** analogue also has a similar profile and is less potent, but belongs to this group. The SAR in this pocket clearly shows that both the type of substituents and the interaction potential with the enzyme strongly determine the antiviral spectrum for a panel of resistant viruses.

The two stereoisomers (mirror images) of the bis-THF moiety were separated and compared (compounds **9** and **13**). As in many SARs, one of the isomers performed better; in this case also, the “less active” isomer **13** performed quite well. In fact, it proved to be the second-best P2 ligand during the 5-year research program. Only on some mutants the isomer **13** was 10-fold less active. Developing the drug as a mixture of the two diastereoisomers was considered being attractive from a scale-up and cost of goods point of view; however, patients infected with highly mutated viruses would

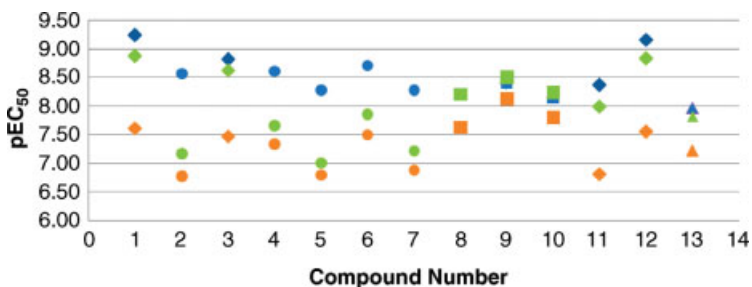

**Figure 4.5** Representation of the antiviral activity of the different compounds on the WT (blue) and the average over a panel of protease-resistant mutants (green) and on their worst mutant (orange).

receive only half of the optimal dose. Moreover, the full PK and toxicological programs would become extremely complicated. Quite early on, the decision was made to progress with the most active isomer only.

A quite promising compound was the phenol analogue **8**; it was considered in three ways: as a drug candidate itself, as a salt with potentially improved solubility and bioavailability properties, or as a potential major metabolite from the methoxy compound **1**. Unfortunately, the plasma exposures of compound **8** after oral and systemic dosing to rats either as the phenol or as a salt were extremely low. Also, the plasma levels after dosing of the methoxy precursor **1** proved to be too low to be of any interest.

The *para*-CH<sub>2</sub>NH<sub>2</sub> substituent was new to the SAR in the S2 pocket; unfortunately, primary amines show seldom good drug-like properties. For compound **10**, the addition of human serum caused a dramatic decrease (>25x) of the *in vitro* antiviral activity. While shifts of a factor 3–5 are not uncommon, shifts >10 caused by the addition of human serum were a concern and shifts >25 a stopping rule.

While the synthesis of the bis-tetrahydrofuran moiety is short and straightforward [20], it is not possible to make large series of close analogues. The bis-THF rings with an extra ethyl **15**, vinyl **14**, and allyl **16** group were synthesized. Addition of a vinyl group **14** lowered the activity on all viruses about 100-fold; allyl **16** and ethyl **15** were even worse and resulted in >1000-fold drop of activity.

While the phenyl group was kept constant for synthetic reasons (Figure 4.6), the isopentyl chain could be modified quite easily: however, when shortening the length, the activity on all the viruses dropped quickly. Purely aliphatic and branched cycloalkyl groups were also evaluated. The cyclohexylmethyl analogue **17** showed very good antiviral activity (modest drop with 0.5 log) and inhibited all the viruses of the panel. The smaller methylcyclopropyl **18** was 10-fold less active compared to the isobutyl; further reduction of the alkyl fragment to allyl **19** resulted in a 1.5 (wild type) to 2 log (mutants) reduction of the antiviral activity.

An attempt was made to improve the solubility of the molecules by incorporating weakly basic substituents that allowed salt formation. The 2-methyl pyridine analogue **20** maintained some activity against the wild type (–1.7 log) and against the mutants (–2 logs), the ethylpyrrolidine **21** was 10 000 times less active against the wild type and virtually inactive (pEC<sub>50</sub> < 5) against the mutants. The conclusion was very clear, the S1' pocket required bulky, lipophilic chains. The binding in that pocket is a clear driver of affinity, but did not discriminate between the wild type and the mutants.

From the whole set, three compounds were retained: aniline **9**, the original lead **1**, and the metabolically more stable 3,4-dioxolane **12**. They were fully profiled and compared to amprenavir.

The original lead **1** had similar solubility and permeability characteristics as amprenavir and the addition of plasma proteins had hardly any influence on the antiviral activity. Unfortunately, the metabolic stability was very low and the systemic exposure after oral dosing to rats and dogs turned out to be very low. As a consequence, it was a poor candidate in terms of covering the required plasma exposure and was dropped.

Compound **12** showed almost identical antiviral activity compared to the Ghosh compound; it was well absorbed after oral administration, remained in the plasma for





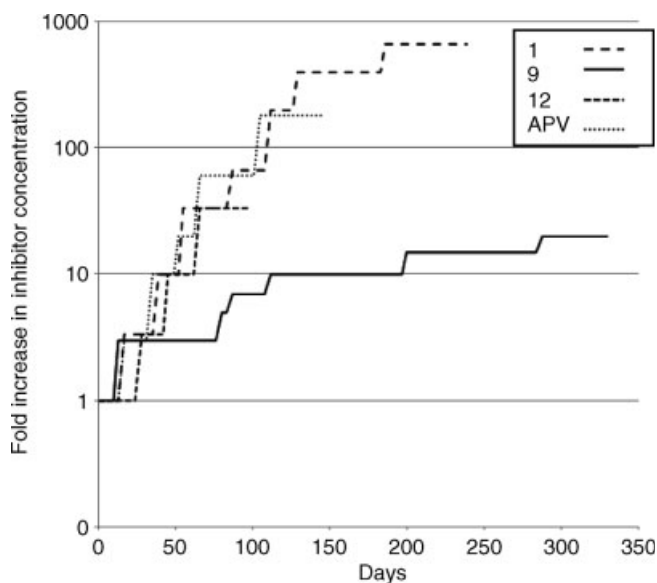

**Figure 4.7** *In vitro* resistance selection experiment starting from the wild-type virus with amprenavir and compounds **1**, **9**, and **12**. The X-axis represents the day in the experiment, the Y-axis the fold increase of inhibitor concentration.

The data of the experiment were very revealing, especially **9** performed extremely well in two ways. Even after 12 months, no virus with a 100-fold decreased susceptibility could be detected. For the three other compounds in the experiment, within 100 days viruses were isolated that were 100-fold less sensitive compared to the virus at the start of the experiment. Moreover, none of the classic PI mutations could be detected. Viruses with decreased sensitivity to **9** remained fully sensitive to the other commercially available PIs. Whether these resistance selection experiments are really predictive for the clinical situation remains an open question that will be difficult to answer. In reality, the data were very surprising and convincing. They aligned the full team behind **9** or darunavir (TMC114, PREZISTA™) as the selected drug candidate.

#### 4.5

##### How Can We Explain the Superior Antiviral Activity of Darunavir?

Darunavir was compared to amprenavir by X-ray protein cocrystallizations and thermodynamic methods using wild-type protease enzyme and the enzyme that carries mutations V82T and I84V [21].

The second tetrahydrofuran has a double impact: an extra hydrogen bond is made with the NH backbone of Asp29 and, furthermore, the existing H-bond with the Asp30 is shorter (2.54 versus 2.11 Å, data for compound **9**). These hydrogen bonds are very short and this translates into a 100-fold stronger binding. The biochemical

binding affinity of darunavir to the wild-type enzyme is in the femtomolar range, with  $K_d = 4.5 \times 10^{-12}$  M, much stronger than any other HIV PI [22]. This superior binding did not translate into a shift in activity in the cellular models, but indicates that once the compound is binding to the enzyme it will hardly dissociate.

Moreover, as the binding of the bis-tetrahydrofuran oxygen occurs with the backbone NH atoms, most mutations will not affect the affinity. Only a mutation to proline will disturb the binding; this is not a likely mutation as the folding of the peptide will be influenced. Although mutations on position 30 are observed, no mutation to proline was known. We tried hard in the lab but failed to construct site-directed mutants with the amino acid proline in positions 29 and/or 30.

The amino acids 82 and 84 are part of the lipophilic S1/S1' pockets of the protease enzyme. In the wild-type enzyme, their side chains valine and isoleucine are part of the shell of the lipophilic pocket. They are not directly or indirectly involved in the binding of the bis-THF ring. They were chosen as darunavir had been tested against many strains carrying these mutations and these viruses remained fully sensitive in the cellular assays. In theory, darunavir should be less active against a virus carrying these mutations. At the biochemical level, this double mutation has a clear impact on the binding energy; it decreases the binding of both amprenavir ( $K_d = 2.0 \times 10^{-9}$  M) and darunavir ( $K_d = 6.0 \times 10^{-11}$  M) with a factor of 10. There seems to be a nonlinear relationship between biochemical affinity and inhibition of the viral growth in the cellular assays. Thanks to its femtomolar affinity, darunavir seems to have a kind of binding buffer that makes it almost insensitive to a few mutations.

## 4.6

### Clinical Development of Darunavir

Darunavir performed excellently during all stages of drug development. It fulfilled all the promises scientists believed in, based on its excellent antiviral and pharmacokinetic profile. The formulation consists of pills containing 300, 400, or 600 mg of active ingredient that have to be taken together with a low dose of ritonavir and food. Darunavir was tested in three distinct patient populations. In patients that had clinically failed multiple classes of antiretroviral drugs including PIs, it has set a new standard in the field: up to 45% of patients had plasma viral loads dropping below the level of detection [23]. Based on these phase IIB data, the FDA granted accelerated approval to darunavir in June 2006. In less treatment-experienced patients, darunavir/ritonavir was superior compared to the lopinavir/ritonavir combination [24]. More patients reached the level of undetectability, less virological failures were present, and less patients developed primary PI or nucleoside analogue resistance-associated mutations [25]. Finally, in antiretroviral treatment-naïve patients, darunavir/ritonavir again showed superiority compared to lopinavir/ritonavir at week 96 [26]. The efficacy of darunavir/ritonavir has also been assessed in children and adolescents, with results comparable to those observed in adult patients [27]. Currently, darunavir, in combination with low-dose ritonavir and other antiretroviral agents, is approved for the treatment of HIV infection in adults and pediatric patients aged 6 and above [28].

More recently, data of two independent trials assessing darunavir/ritonavir as a single agent (maintenance monotherapy) in patients stably virologically suppressed have been presented. They showed that darunavir/ritonavir monotherapy performs as well as that of HAART in those patients [29, 30].

#### 4.7

#### Conclusions and Future Developments

In 10 years, the HIV PI field went through a major evolution: from saquinavir, a life-saving drug with only 4% of bioavailability and originally tested as a monotherapy, to darunavir, a drug that is becoming the chronic PI therapy of choice for patients infected with viruses that carry none or many mutations. The superior antiviral properties of darunavir are the result of a number of distinct high-affinity interactions with strictly conserved parts of the viral enzyme.

Where are the remaining challenges? First of all, the daily dosage of each of these regimens remains high: 400–1200 mg/day. Improvements in terms of pharmacokinetic properties should be possible, with reducing the full PI-based HIV treatments to a single pill a day. Moreover, most of the PIs require boosting with a low dose of ritonavir. Will these objectives be realized with a next round of medicinal chemistry optimization on the current templates? Few scientists believe it. Ten years ago, only a few people believed that finding a PI that would inhibit most of the multi-drug-resistant strains was only a few atoms away.

#### References

- 1 Barré-Sinoussi, F., Chermann, J.C., Rey, F., Nugeyre, M.T., Chamaret, S., Gruest, J., Dauguet, C., Axler-Blin, C., Vézinet-Brun, F., Rouzioux, C., Rozenbaum, W., and Montagnier, L. (1983) Isolation of a T-lymphotropic retrovirus from a patient at risk for acquired immune deficiency syndrome (AIDS). *Science*, **220**, 868–871.
- 2 Gallo, R.C., Sarin, P.S., Gelmann, E.P., Robert-Guroff, M., Richardson, E., Kalyanaraman, V.S., Mann, D., Sidhu, G.D., Stahl, R.E., Zolla-Pazner, S., Leibowitch, J., and Popovic, M. (1983) Isolation of human T-cell leukemia virus in acquired immune deficiency syndrome (AIDS). *Science*, **220**, 865–867.
- 3 Vacca, J.P., Dorsey, B.D., Schleif, W.A., Levin, R.B., McDaniel, S.L., Darke, P.L., Zugay, J., Quintero, J.C., Blahy, O.M., Roth, E., Sardana, V.V., Schlabach, A.J., Graham, P.I., Condra, J.H., Gotlib, L., Holloway, M.K., Lin, J., Chen, I.-W., Vastag, K., Ostovic, D., Anderson, P.S., Emimi, E.A., and Huff, J.R. (1994) L-735,524: an orally bioavailable human immunodeficiency virus type 1 protease inhibitor. *Proceedings of the National Academy of Sciences of the United States of America*, **91**, 4096–4100.
- 4 Roberts, N.A., Martin, J.A., Kinchington, D., Broadhurst, A.V., Craig, J.C., Duncan, I.B., Galpin, S.A., Handa, B.K., Kay, J., Kröhn, A., Lambert, R., Merret, J., Mills, J., Parkes, K., Redshaw, S., Ritchie, A., Taylor, D., Thomas, G., and Machin, P. (1990) Rational design of peptide-based HIV proteinase inhibitors. *Science*, **248**, 358–361.
- 5 Kaldor, S.W., Kalish, V.J., Davies, J.F., 2nd, Shetty, B.V., Fritz, J.E., Appelt, K., Burgess, J.A., Campanale, K.M., Chirgadze, N.Y., Clawson, D.K., Dressman, B.A., Hatch,

- S.D., Khalil, D.A., Kosa, M.B., Lubbehusen, P.P., Muesing, M.A., Patick, A.K., Reich, S.H., Su, K.S., and Tatlock, J.H. (1997) Viracept (nelfinavir mesylate, AG1343): a potent, orally bioavailable inhibitor of HIV-1 protease. *Journal of Medicinal Chemistry*, **40**, 3979–3985.
- 6 Kempf, D.J., Marsh, K.C., Denissen, J.F., McDonald, E., Vasavanonda, S., Flentge, C.A., Green, B.E., Fino, L., Park, C.H., Pong, X.P., Wideburg, N.E., Saldivar, A., Ruiz, L., Kati, W.M., Sham, H.L., Robins, T., Stewart, K.D., Hsu, A., Plattner, J.J., Leonard, J.M., and Norbeck, D.W. (1995) ABT-538 is a potent inhibitor of human immunodeficiency virus protease and has high oral bioavailability in humans. *Proceedings of the National Academy of Sciences of the United States of America*, **92**, 2484–2488.
  - 7 Schapiro, J.M., Winters, M.A., Stewart, F., Efron, B., Norris, J., Kozal, M.J., and Merigan, T.C. (1996) The effect of high-dose saquinavir on viral load and CD4<sup>+</sup> T-cell counts in HIV-infected patients. *Annals of Internal Medicine*, **124**, 1039–1050.
  - 8 Smith, D., Berrey, M.M., Robertson, M., Mehrotra, D., Markowitz, M., Perrin, L., Clumeck, N., Lazzarin, A., Burckhardt, B., Weber, R., Corey, L., and Cooper, D.A. (2000) Virological and immunological effects of combination antiretroviral therapy with zidovudine, lamivudine and indinavir during primary human immunodeficiency virus type 1 infection. *The Journal of Infectious Diseases*, **182**, 950–954.
  - 9 Gulick, R.M., Mellors, J.W., Havlir, D., Eron, J.J., Meibohm, A., Condra, J.H., Valentine, F.T., McMahon, D., Gonzalez, C., Jonas, L., Emimi, E.A., Chodakewitz, J.A., Isaacs, R., and Richman, D.D. (2000) 3-Year suppression of HIV viremia with indinavir, zidovudine, and lamivudine. *Annals of Internal Medicine*, **133**, 35–39.
  - 10 Bartlett, J.A., DeMasi, R., Quinn, J., Moxham, C., and Rousseau, F. (2001) Overview of the effectiveness of triple combination therapy in antiretroviral-naïve HIV-1 infected adults. *AIDS (London, England)*, **15**, 1369–1377.
  - 11 d'Arminio Monforte, A., Lepri, A.C., Rezza, G., Pezzotti, P., Antinori, A., Phillips, A.N., Angarano, G., Colangeli, V., De Luca, A., Ippolito, G., Caggese, L., Soscia, F., Filice, G., Gritti, F., Narciso, P., Tirelli, U., and Moroni, M. (2000) Insights into the reasons for discontinuation of the first highly active antiretroviral therapy (HAART) regimen in a cohort of antiretroviral naïve patients. I.CO.N.A. Study Group. Italian Cohort of Antiretroviral-Naïve Patients. *AIDS (London, England)*, **14**, 499–507.
  - 12 Adkins, J.C. and Faulds, D. (1998) Amprenavir. *Drugs*, **55**, 837–842.
  - 13 Sham, H., Kempf, D.J., Molla, A., Marsh, K.C., Kumar, G.N., Chen, C.M., Kati, W., Stewart, K., Lal, R., Hsu, A., Betebenner, D., Korneyeva, M., Vasavanonda, S., McDonald, E., Saldivar, A., Wideburg, N., Chen, X., Niu, P., Park, C., Jayanti, V., Grabowski, B., Granneman, G., Sun, E., Japour, A.J., Leonard, J.M., Plattner, J.J., and Norbeck, D.W. (1998) ABT-378, a highly potent inhibitor of the human immunodeficiency virus protease. *Antimicrobial Agents and Chemotherapy*, **42**, 3218–3224.
  - 14 Bryant, M., Getman, D., Smidt, M., Marr, J., Clare, M., Dillard, R., Lansky, D., DeCrescenzo, G., Heintz, R., Houseman, K., Reed, K., Stolzenbach, J., Talley, J., Vazquez, M., and Mueller, R. (1995) SC-52151, a novel inhibitor of the human immunodeficiency virus protease. *Antimicrobial Agents and Chemotherapy*, **39** (10), 2229–2234.
  - 15 Becker, S. and Thornton, L. (2004) Fosamprenavir: advancing HIV protease inhibitor treatment options. *Expert Opinion on Pharmacotherapy*, **5**, 1995–2005.
  - 16 Bold, G., Fässler, A., Capraro, H.G., Cozens, R., Klimkait, T., Lazdins, J., Mestan, J., Poncioni, B., Rösel, J., Stover, D., Tintelnnot-Blomley, M., Acemoglu, F., Beck, W., Boss, E., Eschbach, M., Hürlimann, T., Masso, E., Roussel, S., Ucci-Stoll, K., Wyss, D., and Lang, M. (1998) New aza-dipeptide analogues as potent and orally absorbed HIV-1 protease inhibitors: candidates for clinical development. *Journal of Medicinal Chemistry*, **41**, 3387–3401.
  - 17 Turner, S.R., Strohbach, J.W., Tommasi, R.A., Aristoff, P.A., Johnson, P.D.,

- Skulnick, H.I., Dolak, L.A., Seest, E.P., Tomich, P.K., Bohanon, M.J., Horng, M.M., Lynn, J.C., Chong, K.T., Hinshaw, R.R., Watenpaugh, K.D., Janakiraman, M.N., and Thaisrivongs, S. (1998) Tipranavir (PNU-140690): a potent, orally bioavailable nonpeptidic HIV protease inhibitor of the 5,6-dihydro-4-hydroxy-2-pyrone sulfonamide class. *Journal of Medicinal Chemistry*, **41**, 3467–3476.
- 18 D'Aquila, R.T., Schapiro, J.M., Brun-Vézinet, F., Clotet, B., Conway, B., Demeter, L.M., Grant, R.M., Johnson, V.A., Kuritzkes, D.R., Loveday, C., Shafer, R.W., and Richman, D.D. (2003) Drug resistance mutations in HIV. *Topics in HIV Medicine*, **11**, 92–96.
- 19 Ghosh, A.K., Kincaid, J.F., Cho, W., Walters, D.E., Krishnan, K., Hussain, K.A., Koo, Y., Cho, H., Rudall, C., Holland, L., and Buthod, J. (1998) Potent HIV protease inhibitors incorporating high-affinity P2-ligands and (R)-(hydroxyethylamino)sulfonamide isostere. *Bioorganic & Medicinal Chemistry Letters*, **8**, 687–690.
- 20 Ghosh, A.K., Thompson, W.J., Fitzgerald, P.M.D., Culberson, J.C., Axel, M.G., McKee, S.P., Huff, J.R., and Anderson, P.S. (1994) Structure-based design of HIV-1 protease inhibitors: replacement of two amides and a 10 $\pi$ -aromatic system by a fused bis-tetrahydrofuran. *Journal of Medicinal Chemistry*, **37**, 2506–2508.
- 21 King, N.M., Prabu-Jeyabalan, M., Nalivaika, E.A., Wigerinck, P., de Béthune, M.-P., and Schiffer, C.A. (2004) Structural and thermodynamic basis for the binding of TMC114, a next-generation human immunodeficiency virus type 1 protease inhibitor. *Journal of Virology*, **78**, 12012–12021.
- 22 Dierynck, I., De Wit, M., Gustin, E., Keuleers, I., Vandersmissen, J., Hallenberger, S., and Hertogs, K. (2007) Binding kinetics of darunavir to human immunodeficiency virus type 1 protease explain the potent antiviral activity and high genetic barrier. *Journal of Virology*, **81**, 13845–13851.
- 23 Clotet, B., Bellos, N., Molina, J.M., Cooper, D., Goffard, J.C., Lazzarin, A., Wöhrmann, A., Katlama, C., Wilkin, T., Haubrich, R., Cohen, C., Farthing, C., Jayaweera, D., Markowitz, M., Ruane, P., Spinosa-Guzman, S., and Lefebvre, E. (2007) Efficacy and safety of darunavir–ritonavir at week 48 in treatment-experienced patients with HIV-1 infection in POWER 1 and 2: a pooled subgroup analysis of data from two randomised trials. *Lancet*, **369**, 1169–1178.
- 24 Madruga, J.V., Berger, D., McMurchie, M., Suter, F., Banhegyi, D., Ruxrungtham, K., Norris, D., Lefebvre, E., de Béthune, M.-P., Tomaka, F., De Pauw, M., Vangeneugden, T., and Spinosa-Guzman, S. (2007) Efficacy and safety of darunavir–ritonavir compared with that of lopinavir–ritonavir at 48 weeks in treatment-experienced, HIV-infected patients in TITAN: a randomised controlled phase III trial. *Lancet*, **370**, 49–58.
- 25 De Meyer, S., Lathouwers, E., Dierynck, I., De Paepe, E., Van Baelen, B., Vangeneugden, T., Spinosa-Guzman, S., Lefebvre, E., Picchio, G., and de Béthune, M.-P. (2009) Characterization of virologic failure patients on darunavir/ritonavir in treatment-experienced patients. *AIDS (London, England)*, **23**, 1829–1840.
- 26 Mills, A.M., Nelson, M., Jayaweera, D., Ruxrungtham, K., Cassetti, I., Girard, P.M., Workman, C., Dierynck, I., Sekar, V., Abeele, C.V., and Lavreys, L. (2009) Once-daily darunavir/ritonavir vs. lopinavir/ritonavir in treatment-naïve, HIV-1-infected patients: 96-week analysis. *AIDS (London, England)*, **23**, 1679–1688.
- 27 Bologna, R., Rugina, S., Cahn, P., Flynn, P., Blanche, S., Van Baelen, B., De Greef, R., Lavreys, L., Van De Castele, T., and Spinosa-Guzman, S. (2008) Safety and efficacy of darunavir co-administered with low-dose ritonavir in treatment-experienced children and adolescents at week 24. Presented at the 15th Conference on Retroviruses and Opportunistic Infections, February 3–6, 2008, Boston, MA, USA, Abstract 78LB.
- 28 PREZISTA™, prescribing information [http://www.accessdata.fda.gov/drugsatfda\\_docs/label/2009/021976s010lbl.pdf](http://www.accessdata.fda.gov/drugsatfda_docs/label/2009/021976s010lbl.pdf) (accessed November 29, 2009).
- 29 Arribas, J., Horban, A., Gerstoft, J., Fatkenheuer, G., Nelson, M., Clumeck, N.,

- Pulido, F., Hill, A., Van Delft, Y., Moecklinghoff, C., and Stark, T. (2009) The MONET trial: darunavir/ritonavir monotherapy shows non-inferior efficacy to standard HAART, for patients with HIV RNA<50 copies/mL at baseline. Presented at the 5th IAS Conference on HIV Pathogenesis, Treatment and Prevention, July 19–22, 2009, Cape Town, South Africa.
- 30 Katlama, C., Valentin, M.A., Algate-Genin, M., Duvivier, C., Lambert-Niclot, S., Girard, P.M., Molina, J.M., Hosten, B., Pakianather, S., Peytavin, G., Marcelin, A.G., and Flandre, P. (2009) Efficacy of darunavir/ritonavir as single-drug maintenance therapy in patients with HIV-1 viral suppression: a randomized open-label non-inferiority trial, MONOI-ANRS 136. Presented at the 5th IAS Conference on HIV Pathogenesis, Treatment and Prevention, July 19–22, 2009, Cape Town, South Africa.

## 5

### Acyclic and Cyclic Nucleoside Phosphonates

*Richard L. Mackman and Tomas Cihlar*

#### 5.1

##### Introduction

Nucleoside phosphonates are a unique class of nucleoside-based antiviral therapeutics that have emerged over the past decade as important drugs in the fight against several viral diseases. This class of drugs are bioisosteres of the nucleoside monophosphate metabolites in which the 5'-O-P bond of the monophosphate metabolite **1**, for example, is replaced with a 5'-C-P bond, exemplified by **2** (Figure 5.1). Indeed, phosphonate **2** along with its thymidine analogue was among the first nucleoside phosphonate analogues to be synthesized in the late 1960s [1, 2]. Almost 20 years later, a pivotal discovery was made concerning the acyclic phosphonate (*S*)-HPMPA (**3**) that was found to broadly inhibit DNA viruses [3]. At that time, it was unlikely that the pioneers could have imagined the tremendous impact their discovery would have on the future of antiviral therapy. Three nucleoside phosphonate drugs, namely, cidofovir (**4**), tenofovir disoproxil fumarate (TDF; **5**), and adefovir dipivoxil (ADV; **6**), have now been approved as antiviral agents and several other analogues have progressed into the clinic. The replacement of the ribose core of the phosphonate **2** with acyclic structures exemplified in **3–6** is the basis for the subclass referred to as acyclic nucleoside phosphonates (ANPs), in contrast to analogues containing the cyclic core, which are referred to as cyclic nucleoside phosphonates (CNPs).

Success in the approval of phosphonate antivirals was not achieved easily; the development of nucleoside phosphonates as effective oral drugs required overcoming challenges of potency, selectivity, toxicity, and oral bioavailability [4]. Here, we describe the concept behind nucleoside phosphonate antivirals and contrast this with nucleosides to establish the advantages and disadvantages of nucleoside phosphonates in the treatment of viral infections. The structure–activity relationships (SAR) for both acyclics and cyclics are summarized separately due to the abundance of literature for each series. The remarkable success achieved with the nucleoside phosphonates in the inhibition of retroviruses and DNA viruses has recently spurred



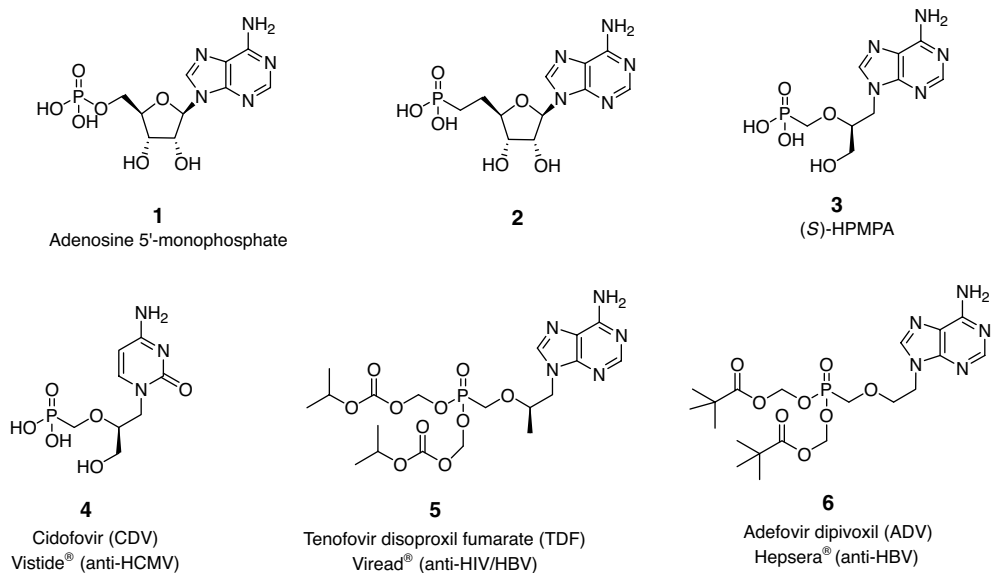

**Figure 5.1** Nucleoside phosphonate antivirals, early examples and approved drugs.

interest in their applications to RNA viruses such as HCV. Initial research efforts in this field have highlighted challenges in the application of the phosphonates to this category of viruses. Since the phosphonates are charged species at physiological pH, prodrugs are often required for an efficient oral delivery of the target molecules *in vivo*. This has led to a broad array of prodrug designs. Finally, the accumulation of the SAR and the wide range of prodrug concepts has resulted in the approval of three drugs, and the clinical highlights of each of these antiviral therapeutics will conclude the chapter.

## 5.2

### Nucleoside Phosphonate Strategy for Antivirals

Nucleoside phosphonates are bioisosteres of nucleoside monophosphates, chemically distinct due to replacement of the 5'-O-P bond for the 5'-C-P bond. This change, albeit small, has a profound impact on the physical and chemical properties of nucleoside phosphonates compared to nucleoside monophosphates, leading to favorable antiviral properties. To appreciate the advantages and disadvantages afforded by the phosphonate bond bioisosteres, understanding the mechanism of action for the majority of antiviral nucleoside-based therapeutics is essential (Figure 5.2). Parent nucleosides, for example, AZT 7, are inactive, but inside the cytoplasm of target cells, a viral or host kinase adds a phosphate to the 5'-OH

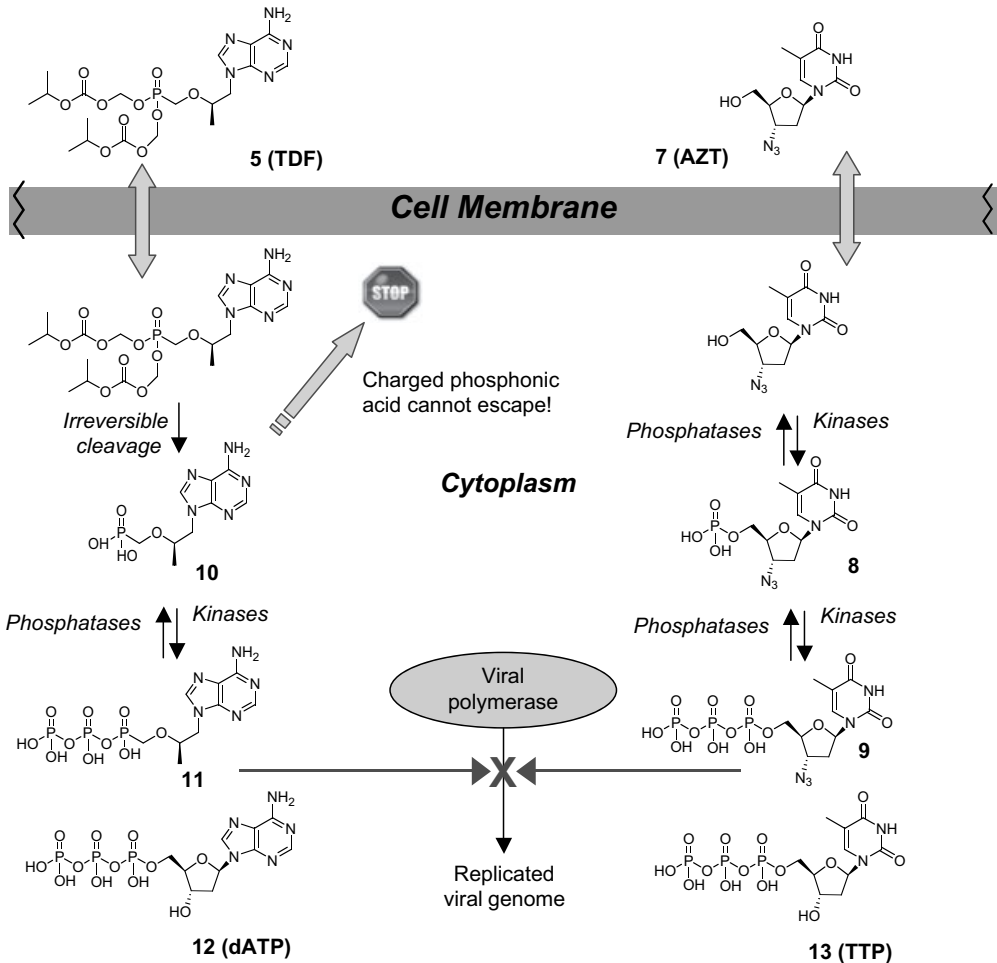

**Figure 5.2** Intracellular metabolic pathways of TDF (nucleoside phosphonate prodrug) and AZT (nucleoside).

group to generate the monophosphate metabolite, **8**. Subsequently, two sequential phosphorylation steps are carried out by host kinases to generate the active triphosphate (TP) metabolite **9**.

Often, the first monophosphate step in nucleoside metabolism is rate limiting, so the nucleoside phosphonate bioisostere tenofovir **10**, generated upon prodrug cleavage of TDF **5** inside the cell, effectively bypasses this step and requires only metabolism by two host kinases to the diphosphosphonate (DP) **11** metabolite or triphosphate equivalent. The active metabolites then compete with the natural pool of intracellular nucleotides, dATP **12** for diphosphosphonate **11** and dTTP **13** for

triphosphate **9**, for binding to the viral polymerase active site, and for most inhibitors binding is rapidly followed by polymerization to incorporate the inhibitor at the terminal of the growing polynucleotide chain. After incorporation, if subsequent polymerization is hindered by the lack of a 3'-OH in the inhibitor, for example, AZT **7** (obligate chain terminator) or by steric factors after one or more sequential incorporations (nonobligate chain terminator), or unfavorable effects on the stability of the downstream polymerization process (delayed chain terminator), then viral replication can be effectively blocked. Consequently, the inhibition of the viral polymerase can be correlated with the concentration of TP or DP metabolite generated inside the virus-infected cell and the inherent inhibition of the polymerase ( $IC_{50}$ ) as a result of the binding and incorporation properties of the metabolite.

Intracellular phosphorylases cleave the O-P bonds formed, leading to the breakdown of triphosphates to their nucleosides that can be eliminated from the target cell. In contrast, the nucleoside phosphonate C-P bond is enzymatically and chemically stable to hydrolysis. Due to the charged nature at physiological pH, the phosphonic diacid has limited passive permeability, which coupled with the greater stability provides a pool of substrate for continual metabolism. As a consequence, the levels of phosphono-DP that can be achieved are often higher than nucleoside TP, and the half-life of the active DP metabolite often exceeds 24 h, superior to many nucleoside TPs [5]. This is a significant advantage, since the sustained levels allow more effective viral inhibition and prevention of viral resistance when dosed infrequently. All the FDA-approved oral antiviral phosphonates are dosed once daily or less frequently due to the long intracellular half-lives of the active species. In summary, two significant advantages of the nucleoside phosphonates are (i) the ability to bypass the first rate-limiting phosphorylation step and (ii) the long half-life of the active DP species as a result of the charged nature of the phosphonic diacid.

For both nucleosides and nucleoside phosphonate analogues, their participation as substrates for at least two host kinases and inhibition of the viral polymerase are essential. The physicochemical differences invoked by the C-P bond change, although small, can impact the ability of nucleoside phosphonates to interact with these enzymes. For example, the  $pK_a$  of the phosphonic diacid containing the C-C-P linkage is higher than the phosphate diacid resulting in substantially different degrees of ionization at physiological pH [6]. The C-P bond is also longer than the O-P bond by  $\sim 0.2$  Å and has a different bond angle due to the absence of lone electron pairs that are present on the oxygen of the monophosphates [7]. Assessing the impact of these differences on substrate properties for kinases, and the target polymerase, is tricky at best, but nonetheless a necessary consideration in the successful development of nucleoside phosphonate drugs. One oft-perceived disadvantage of the charged phosphonic diacid is that target cell permeability and *in vivo* oral delivery require prodrugs to mask the charge. However, this can be turned to an advantage if the prodrug can be designed to preferentially target delivery of the parent compound to infected cells. In summary, the nucleoside phosphonates have several distinct advantages

over their monophosphate counterparts that can be leveraged into powerful antiviral drugs.

### 5.3

#### Acyclic Nucleoside Phosphonates

The concept of ANPs emerged in mid-1980s [3] when the initial design of bioisosteric nucleoside phosphonates [1, 8] was applied to clinically validated antiviral acyclic nucleosides such as acyclovir or ganciclovir. Extensive exploration of ANPs has led to the identification of four basic subtypes bearing distinct 2'-substituents in the aliphatic linker that define the antiviral spectrum (Table 5.1) [9–11]. While the character of nucleobase does not significantly change the antiviral spectrum within each ANP class, it has a profound effect on the activity of individual ANPs. In general, purine analogues (particularly adenine, guanine, and 2,6-diaminopurine) are more active than pyrimidines with the exception of cidofovir. This is likely related to differences in the intracellular phosphorylation to the active diphosphate metabolites.

#### 5.3.1

##### Main Classes and their Structure–Activity Relationships

###### 5.3.1.1 HPMP Analogues

The (*S*)-1-(3-hydroxy-2-phosphonylmethoxypropyl) (HPMP) series was the first described class of ANPs with broad-spectrum activity against various DNA viruses including papillomaviruses, herpesviruses, adenoviruses, and poxviruses (Table 5.1) [10, 11]. The adenine analogue (HPMPA) also inhibits hepatitis B virus (HBV) [12]. On the other hand, 2,6-diaminopurine analogue (HPMPDAP) is a particularly potent inhibitor of HSV-1 and -2 *in vitro* [13] and the cytosine analogue (HPMPC, 4) is the most active ANP against human cytomegalovirus (HCMV) [14, 15]. The diphosphate of HPMPC acts as a competitive inhibitor and substrate of HCMV DNA polymerase [16]. Two or more consecutively incorporated HPMPC molecules terminate viral DNA synthesis [17]. *In vivo* antiviral activity of HPMPC and other HPMP analogues has been demonstrated in a wide range of animal models [18–20]. Since HPMPC does not require the initial phosphorylation by a viral kinase, unlike acyclic nucleosides, it remains active against HSV and HCMV strains with drug resistance mutations in the viral TK and UL97 genes, respectively [21, 22]. HPMPC (cidofovir) advanced into clinical development for the treatment of cytomegalovirus retinitis in patients with advanced HIV disease and became the first clinically approved ANP (Section 5.6.).

###### 5.3.1.2 PME Analogues

9-(2-Phosphonylmethoxyethyl)adenine (PMEA, adefovir) is a prototype compound of PME series that lacks the 2'-substituent (Table 5.1). Among nucleosides and nucleotides, adefovir is a unique example of an agent with broad-spectrum antiviral

Table 5.1 Main ANP classes and their antiviral activity spectrum [10–13, 27].

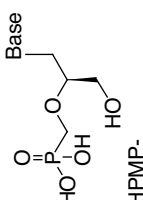
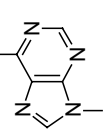
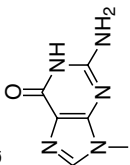
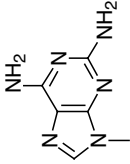
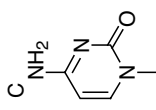
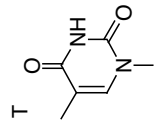
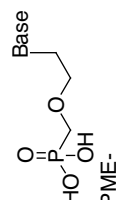
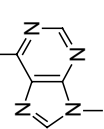
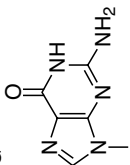
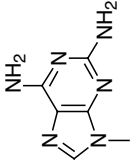
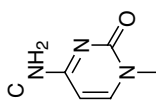
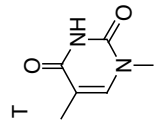
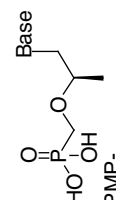
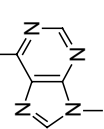
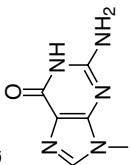
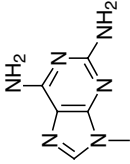
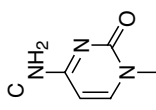
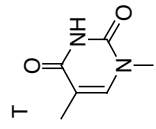
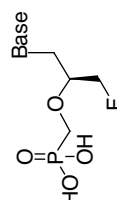
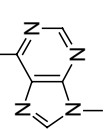
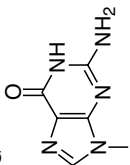
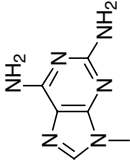
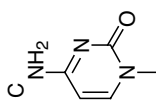
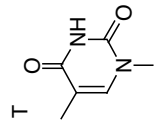
ANP class	Base				
	Purine analogues			Pyrimidine analogues	
 HPMP-	<p><b>A</b></p>  Polyomaviruses Papillomaviruses Adenoviruses Herpesviruses Poxviruses Hepadnaviruses  Herpesviruses Hepadnaviruses Retroviruses  Hepadnaviruses Retroviruses  Hepadnaviruses Retroviruses	<p><b>G</b></p>  Polyomaviruses Papillomaviruses Adenoviruses Herpesviruses Poxviruses  Potent antiproliferative agent  Hepadnaviruses Retroviruses	<p><b>DAP</b></p>  Polyomaviruses Papillomaviruses Adenoviruses Herpesviruses Poxviruses  Herpesviruses Hepadnaviruses Retroviruses  Hepadnaviruses Retroviruses	<p><b>C</b></p>  Polyomaviruses Papillomaviruses Adenoviruses Herpesviruses Poxviruses  Inactive  Inactive  Inactive	<p><b>T</b></p>  Inactive  Inactive  Inactive
 PME-	<p><b>A</b></p>  Polyomaviruses Papillomaviruses Adenoviruses Herpesviruses Poxviruses Hepadnaviruses  Herpesviruses Hepadnaviruses Retroviruses  Hepadnaviruses Retroviruses	<p><b>G</b></p>  Polyomaviruses Papillomaviruses Adenoviruses Herpesviruses Poxviruses  Potent antiproliferative agent  Hepadnaviruses Retroviruses	<p><b>DAP</b></p>  Polyomaviruses Papillomaviruses Adenoviruses Herpesviruses Poxviruses  Herpesviruses Hepadnaviruses Retroviruses  Hepadnaviruses Retroviruses	<p><b>C</b></p>  Polyomaviruses Papillomaviruses Adenoviruses Herpesviruses Poxviruses  Inactive  Inactive  Inactive	<p><b>T</b></p>  Inactive  Inactive  Inactive
 PMP-	<p><b>A</b></p>  Polyomaviruses Papillomaviruses Adenoviruses Herpesviruses Poxviruses Hepadnaviruses  Herpesviruses Hepadnaviruses Retroviruses  Hepadnaviruses Retroviruses	<p><b>G</b></p>  Polyomaviruses Papillomaviruses Adenoviruses Herpesviruses Poxviruses  Potent antiproliferative agent  Hepadnaviruses Retroviruses	<p><b>DAP</b></p>  Polyomaviruses Papillomaviruses Adenoviruses Herpesviruses Poxviruses  Herpesviruses Hepadnaviruses Retroviruses  Hepadnaviruses Retroviruses	<p><b>C</b></p>  Polyomaviruses Papillomaviruses Adenoviruses Herpesviruses Poxviruses  Inactive  Inactive  Inactive	<p><b>T</b></p>  Inactive  Inactive  Inactive
 FPMP-	<p><b>A</b></p>  Polyomaviruses Papillomaviruses Adenoviruses Herpesviruses Poxviruses Hepadnaviruses  Herpesviruses Hepadnaviruses Retroviruses  Hepadnaviruses Retroviruses	<p><b>G</b></p>  Polyomaviruses Papillomaviruses Adenoviruses Herpesviruses Poxviruses  Potent antiproliferative agent  Hepadnaviruses Retroviruses	<p><b>DAP</b></p>  Polyomaviruses Papillomaviruses Adenoviruses Herpesviruses Poxviruses  Herpesviruses Hepadnaviruses Retroviruses  Hepadnaviruses Retroviruses	<p><b>C</b></p>  Polyomaviruses Papillomaviruses Adenoviruses Herpesviruses Poxviruses  Inactive  Inactive  Inactive	<p><b>T</b></p>  Inactive  Inactive  Inactive

activity not only against DNA viruses, such as herpesviruses and hepadnaviruses, but also against retroviruses including HIV [10, 11]. In primary peripheral blood mononuclear cells (PBMCs), adefovir is active against various subtypes of HIV-1 clinical isolates [23]. In addition, adefovir maintains its potency against a variety of clinical isolates from multiple HBV genotypes [24] and clinically relevant nucleoside-resistant HBV mutants [25, 26]. Adefovir dipivoxil (Hepsera<sup>®</sup>), an oral dialkoxyester prodrug of adefovir, has been approved for the clinical treatment of chronic HBV infection (Section 5.6). Adefovir is also active *in vitro* against multiple types of herpesviruses [27–29] with the highest potency against Epstein–Barr virus [30]. Similar to cidofovir, adefovir does not require virus-encoded enzymes for its intracellular activation and therefore retains its antiviral activity against kinase mutant herpesviruses [27, 29]. Adefovir diphosphate is a potent competitive inhibitor of DNA polymerases from HSV-1 [31] and HCMV [29]. The inhibition of HSV-1 ribonucleotide reductase by adefovir diphosphate has also been described [32].

The guanine analogue in the PME series (PMEG) is a unique molecule because of its potent cytostatic and antiproliferative activity observed both *in vitro* and *in vivo*. PMEG is active against a wide range of both solid and hematological tumor cells including those transformed by papillomavirus [33]. PMEG acts through its diphosphate, a potent inhibitor of mammalian replicative DNA polymerases [34]. *N*<sup>6</sup>-cyclopropyl-PMEDAP (cPrPMEDAP) has improved pharmacological properties and undergoes efficient intracellular deamination to PMEG. In recent years, two amidate prodrugs of cPrPMEDAP emerged as clinical candidates for the treatment of hematological malignancies (GS-9219) [35] and HPV-associated proliferative disorders (GS-9191) [36].

### 5.3.1.3 PMP and FPMP Analogues

Further investigation of SAR on the phosphonate linker yielded two closely related subtypes of potent ANPs: 9-(2-phosphonylmethoxypropyl) (PMP) and 1-(3-fluoro-2-phosphonylmethoxypropyl) (FPMP) analogues (Table 5.1). These two ANP classes are not active against any DNA virus with the exception of hepadnaviruses, but are excellent inhibitors of retroviruses including HIV-1 [13, 37]. Thus, these molecules exhibit yet another distinct antiviral profile among ANPs. In general, PMP analogues are more potent antivirals than the corresponding FPMP analogues. Notably, 2,6-diaminopurine from the PMP series (PMPDAP) is perhaps the most potent inhibitor of HIV-1 identified thus far among ANPs [13].

Adenine analogue in the PMP series (PMPA, tenofovir) is probably the most extensively studied ANP since its oral prodrug tenofovir disoproxil fumarate **5** (TDF; Viread<sup>®</sup>) has been approved for the treatment of HIV and HBV (Section 5.6). Parent tenofovir inhibits HIV-1 in a variety of host cell types including T-cell lines [38], PBMCs [23], and macrophages [39]. While the anti-HIV activity of nucleosides such as zidovudine or stavudine is compromised in resting PBMCs, tenofovir is not affected by cell activation status since its phosphorylation does not depend on cell cycle-regulated nucleoside kinases [40]. Tenofovir is a more potent inhibitor of HIV-1 clinical isolates than adefovir [23] and retains its activity against a broad spectrum of HIV-1 strains resistant to nucleoside analogues [41, 42].

Tenofovir diphosphate **11** is a competitive inhibitor of HIV reverse transcriptase (RT) with respect to dATP [43]. It is also a substrate for RT and its incorporation into DNA results in obligate chain termination due to the lack of a 3'-like hydroxyl. The overall efficacy of any DNA terminating RT inhibitor is also affected by the ability of the target polymerase to catalyze the reverse reaction (excision) [44]. HIV RT is able to excise tenofovir from DNA albeit with less efficiency than some nucleosides such as zidovudine [45]. This difference is significant as it likely compensates for the lower binding affinity of tenofovir diphosphate to HIV RT compared to zidovudine triphosphate.

The *in vitro* activity of tenofovir against HBV is comparable to that of adefovir, which is in agreement with the similar phosphorylation rates in hepatic cells and the similar inhibitory potency of their active metabolites against HBV polymerase [46–48]. Studies have shown that both tenofovir and adefovir are active against lamivudine-resistant HBV strains [26].

Although tenofovir differs from adefovir by only a single methyl group in the aliphatic linker, it exhibits improved *in vitro* antiretroviral activity and lower cytotoxicity in various cell types including renal proximal tubular cells [49], a profile that was key in supporting its development after adefovir failed to meet the clinical safety and efficacy criteria for the treatment of HIV infection.

### 5.3.2

#### Additional Examples of Antiviral ANPs

The phosphonate approach was also directly applied to acyclic nucleosides such as acyclovir and ganciclovir (Figure 5.3). Despite having the linker extended by one

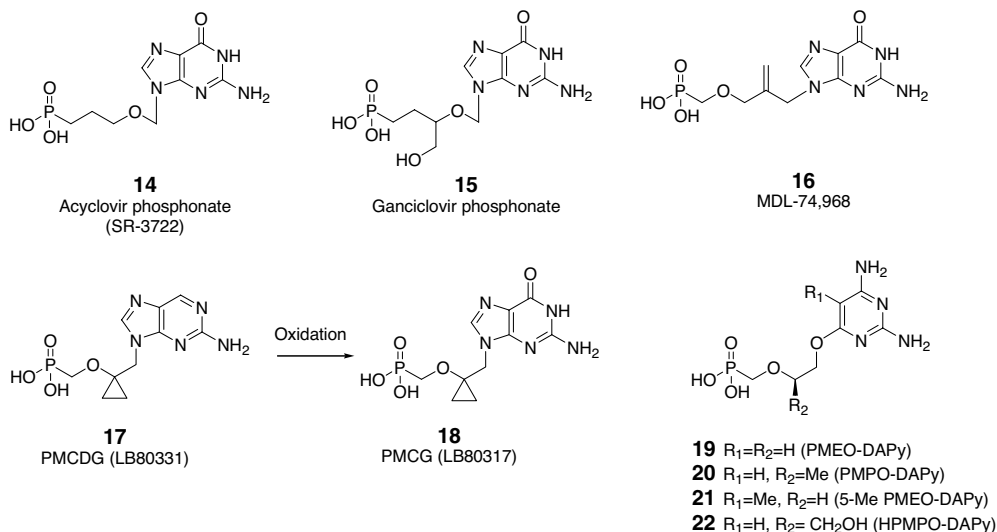

Figure 5.3 Additional examples of antiviral ANPs.

atom, both acyclovir phosphonate **14** (SR-3722) and ganciclovir phosphonate **15** exhibit *in vitro* and *in vivo* activity against herpesviruses, especially cytomegalovirus [50–52]. MDL-74,968 **16** represents another example of an ANP with a longer linker. The compound inhibits HIV-1 and HIV-2 both in T-cell lines and in PBMCs with a potency similar to that of adefovir and dideoxyinosine, but is less toxic in uninfected cells [53].

ANPs with a variety of additional modifications in the aliphatic linker have been explored. Among these, 9-(2-phosphonomethoxycyclopropyl)deoxyguanine **17** (PMCDG; LB80331) undergoes intracellular oxidation by aldehyde and/or xanthine oxidase, yielding the corresponding guanine analogue **18** (PMCG; LB80317) that is further converted to active diphosphate [54]. Both the PMCDG and the PMCG are potent inhibitors of HBV retaining their activity against lamivudine-resistant HBV strains [55].

More recent exploration of structurally simplified ANPs yielded a new series of phosphonates containing an O6-substituted 2,4-diaminopyrimidine (DAPy) base that mimics the natural purine [56]. Compounds with the O6-DAPy base have been synthesized in PME, PMP, and HPMP series, yielding PMEO, PMPO, and HPMPO analogues, respectively. PMEO-DAPy **19** and PMPO-DAPy **20** are both active against HIV and HBV [56, 57]. HIV RT recognizes PMEO-DAPy diphosphate as an adenine analogue and catalyzes its incorporation against T or U in the template [58]. More recently, PMEO derivatives with various 5-substituted DAPy bases were prepared and several of them, for example, 5-CN, 5-Me, 5-Br, and 5-CHO derivatives, were identified as potent inhibitors of HIV-1 and/or HBV replication [59, 60]. 5-Me-PMEO-DAPy **21** in particular has shown promising activity against some of the nucleoside-resistant strains of HIV-1 and was more effective than adefovir in inhibiting retroviruses *in vivo* [61]. As expected, HPMPO-DAPy **22** exhibits a similar antiviral activity spectrum as HPMPA and HPMP, including activity against adenoviruses [62], poxviruses [63], and herpesviruses [64]. Potent antipoxvirus activity of HPMPO-DAPy has also been observed in an animal model using monkeypox virus infection [20].

## 5.4

### Cyclic Nucleoside Phosphonates

The cyclic phosphonates are distinguished from the ANPs by the attachment of the nucleobase and phosphonate linker at different positions on a ring, ranging from 3- to 7- or 8-atom rings. The rings can contain unsaturated bonds and one or more heteroatoms, resulting in a large number of potential analogues. Since the natural ribose and deoxyribose nucleotides are based on the five-atom tetrahydrofuran core, it is not surprising that majority of CNPs contain this same core. It could be argued that the CNPs would be ideal bioisosteres of the natural nucleoside monophosphates due to their close structural similarity, but after many years of effort, especially toward the design of HIV antivirals, significant challenges have emerged. To date, only one compound from the CNP class, GS-9131 (Section 5.5.2), has reached clinical evaluation.



## 5.4.1

## Main Classes and their Structure–Activity Relationships

## 5.4.1.1 Tetrahydrofuran Core

Early antiviral CNPs were designed as direct analogues of the known HIV inhibitors AZT **7**, ddC **23**, and d4T **24** (Figure 5.4). These examples illustrate some of the challenges encountered in cyclic phosphonate inhibitor design. Attachment of the phosphonomethyl group onto the 5'-OH group of AZT (**25**) or ddC (**26**) resulted in significantly reduced anti-HIV activity compared to the nucleosides [65] suggesting that the increase of one bond length between the  $\alpha$ -phosphorus atom and the nucleobase is detrimental. In contrast, conversion of 5'-O to 5'-C leading to the

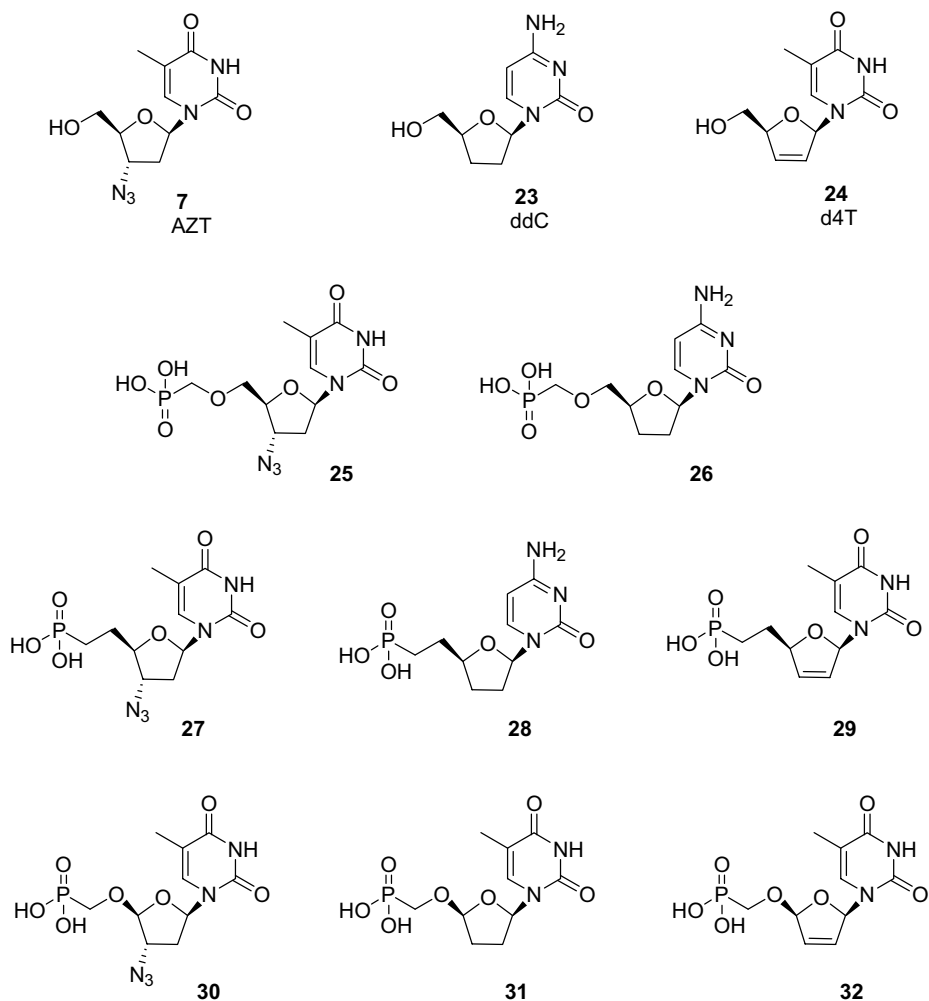
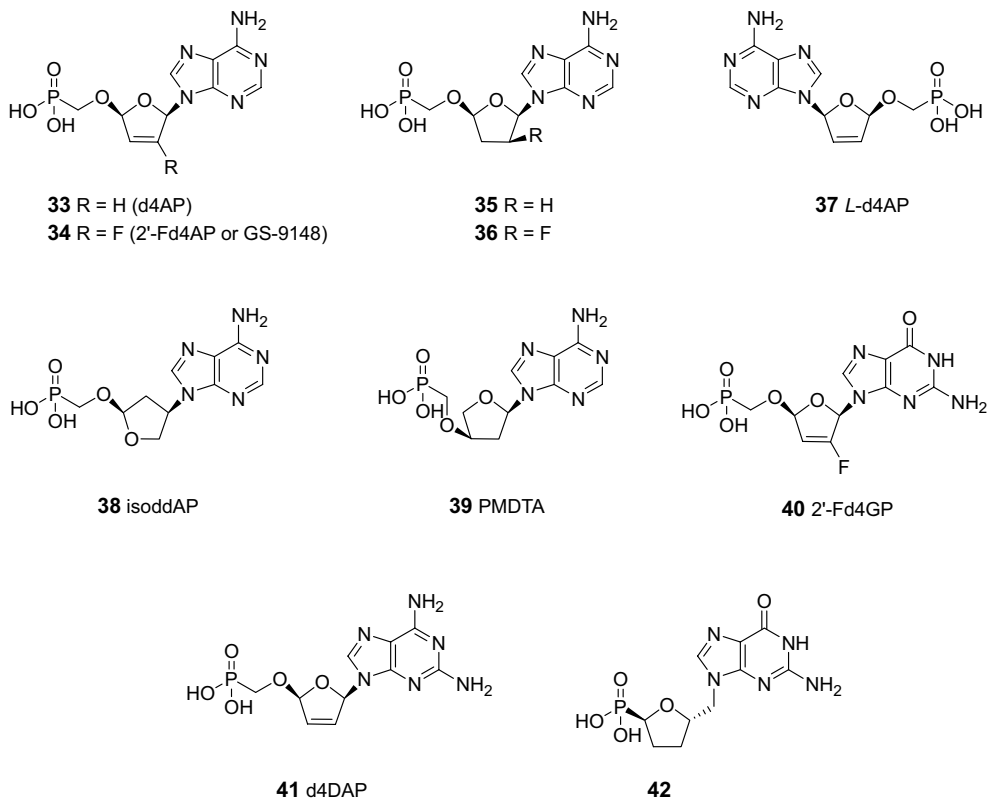

Figure 5.4 Pyrimidine CNPs.

saturated C–C linked analogues **27–29** [66–69] provided analogues with a better distance approximation and similarity to the HIV inhibitors **7**, **23** and **24**, but, once again, these inhibitors were also weakly active toward HIV in cell culture. Because the antiviral activity depends on cell penetration properties and intracellular metabolism, followed by inhibition of the target polymerase, it is difficult to interpret the reason behind the lack of activity without examining the active metabolites. In a pivotal transient kinetics study, the binding and incorporation of **27** DP by HIV RT was examined; inhibitor binding ( $K_D$ ) to HIV RT was retained, but the rate of incorporation was dramatically reduced [67]. Clearly, the subtle electronic and conformational differences of the nucleoside phosphonate led to inefficient polymerization. One reason underlying this observation could have been the higher  $pK_a$  of the phosphonic acid, so substitution of the  $\beta$ -carbon with oxygen, for example, analogues **30–32**, effectively reduces the  $pK_a$  of the phosphonic acid close to the range observed for the monophosphate diacids [6]. In this series, only **32** (d4TP) was found to be a potent anti-HIV inhibitor, whereas the corresponding AZT **30** and ddT **31** phosphonate analogues were inactive [68, 70]. An in-depth study established that **32** DP was a potent inhibitor of HIV RT, but the reduced analogue **31** DP was significantly less active [70]. NMR conformational studies led to the proposal that the oxygen-linked analogues introduce a second anomeric center in the saturated furanose analogues that perturbs the conformation of the ring unfavorably for RT inhibition, whereas the rigidity of the unsaturated furanose ring of **32** reduces anomeric effects. The RT inhibition of d4TP-diphosphate was only sevenfold lower than d4T-TP and established that given the correct electronic, conformational, and inhibitor structure, the cyclic nucleoside phosphonates can be effective bioisosteres of the corresponding nucleoside monophosphates [68, 70].

A similar activity trend toward HIV RT was found for purine analogues on the tetrahydrofuranose core provided that the linker to the phosphonates contained the  $\beta$ -oxygen (Figure 5.5). Compound **33** (d4AP) and its 2'-F derivative **34** (2'-Fd4AP; GS-9148) were both active against HIV-1, but the saturated analogues **35** and **36** were less potent due to reduced inhibition of HIV RT [71, 72]. The 2'-F analogue **34** was a result of rational drug design based on **33** derivatives. The nonfluorinated analogue **33** was one of the most potent anti-HIV nucleoside phosphonates and showed a promising resistance profile toward selected clinical RT mutants [72]. Its active DP metabolite demonstrated HIV RT inhibition comparable to tenofovir-DP, but showed a poor selectivity due to its strong interaction with the host mitochondrial DNA polymerase  $\gamma$  (pol  $\gamma$ ) [72]. On the basis of differences in the active sites of RT and pol  $\gamma$ , **34** was rationally designed to reduce binding to the mitochondrial polymerase while retaining the optimal potency and resistance profile [72, 73]. Since the 2'-F d4A-TP was a potent inhibitor of HIV RT, this provided support for the rational addition of the 2'-F substitution. Furthermore, studies on 2'-F nucleosides had shown that the fluorine reduced inhibition of pol  $\gamma$  [74]. Diphosphate of **34** indeed showed potent inhibition of HIV RT and was a substantially less effective inhibitor of pol  $\gamma$  [72]. A high-resolution X-ray structure provided detailed insight into the interactions of **34** diphosphate with the active site of HIV RT [75] (Figure 5.6). Another strategy was to prepare the L-analogue of d4AP **37**, which was equally successful in improving



**Figure 5.5** Purine CNPs.

selectivity for HIV RT versus pol  $\gamma$  [73]. Although both **34** and **37** were potent and selective inhibitors of HIV, only **34** demonstrated activity against many of the clinically relevant RT mutant isolates, superior in many cases to all the approved anti-HIV nucleoside/nucleotide analogues [72] (Figure 5.7).

Continuing the SAR, alternative placements of the nucleobase or phosphonates linker on the ring have also been explored. Moving the nucleobase site results in *iso*-analogue **38** [71], while moving the phosphonomethoxy leads to threose analogue PMDTA **39** [76] (Figure 5.5). Both of these analogues exhibit good anti-HIV activity. Very few modified adenine or guanine analogues have been prepared due to their synthetic challenge; some exceptions include the 2'F guanine analogue **40**, which was less potent toward HIV and more cytotoxic [77] compared to the adenine analogue **34**, and the diaminopurine analogue **41** [78]. Another interesting guanine analogue, **42**, incorporated a methylene bridge between the base and the ring, while removing one atom from the phosphonate chain to retain the optimal length [79]. The analogue was found to demonstrate anti-HCMV activity. In general, many purine analogues on the furanose core that bear the presence of a  $\beta$ -oxygen in

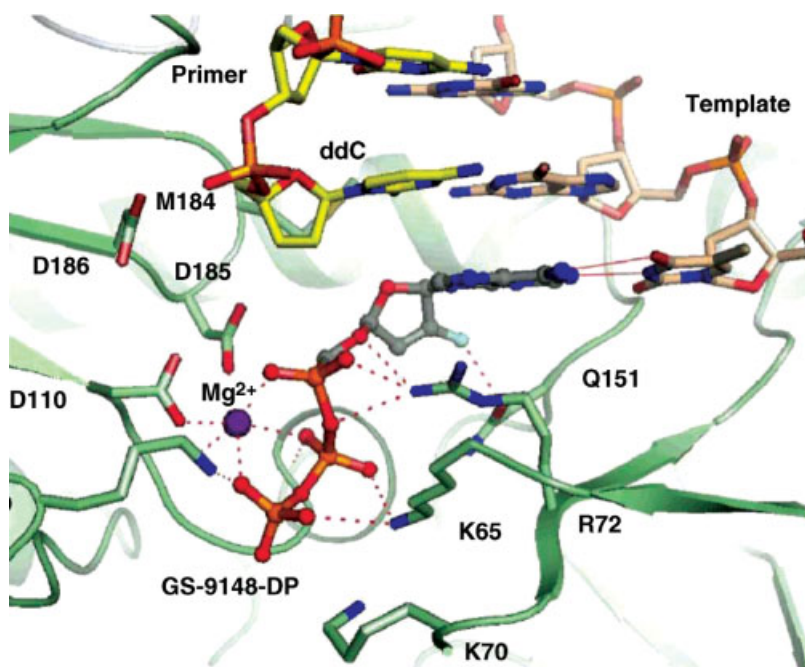
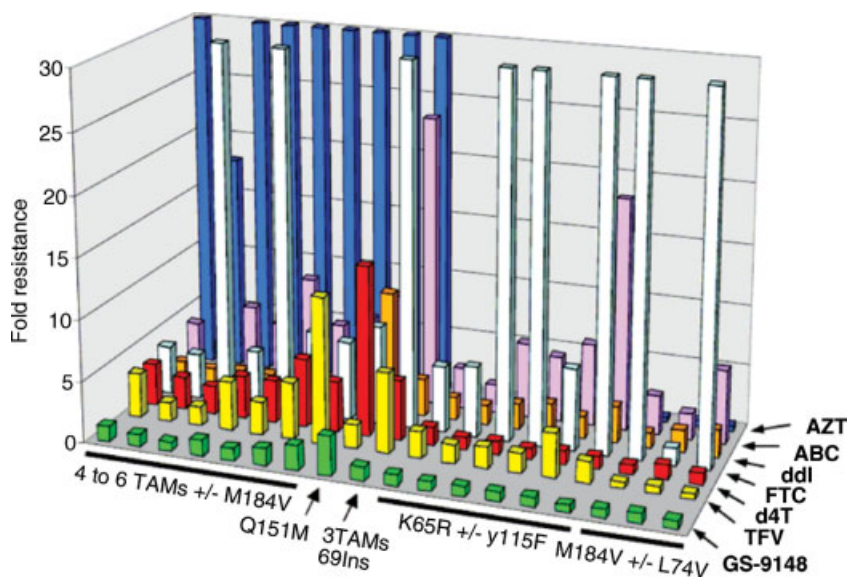

**Figure 5.6** X-ray crystal structure of GS-9148 diphosphate in the active site of HIV-1 RT [75]. Dashed lines represent key interactions of the inhibitor with amino acid residues and metal ion in the active site of RT. To prevent the incorporation of GS-9148, the DNA primer is terminated with ddC.

the phosphonate linker have antiviral activity, more so than their pyrimidine counterparts that may reflect their improved phosphorylation properties.

#### 5.4.1.2 Cyclopentane and Cyclopentene Cores

Replacement of the furanose core by cyclopentane or cyclopentene has been a common practice in the design of nucleoside therapeutics to improve chemical and enzymatic stability. Examples of antiviral carbacyclic nucleosides include abacavir **43** (approved for HIV), entecavir **44** (approved for HBV), and cyclobutyl G **45** (Figure 5.8). Abacavir is converted enzymatically to the guanosine monophosphate analogue; hence the carbacyclic guanine phosphonate **46** represents a promising bioisostere. Indeed, DP metabolites of both enantiomers were reported to be potent HIV RT inhibitors validating the approach, but the parent phosphonate **46** had weak antiviral activity suggesting limited cellular permeability and/or metabolism [80, 81]. Other nucleobase-modified analogues with the same cyclopentene core, for example, **47** and **50**, were also reported to be weakly active against HIV [82–85]. Recently, an attempt to improve anti-HIV activity by introducing a 4'-group to occupy a known pocket in the active site of RT (e.g., **48** and **49**) was successful, resulting in a potent RT inhibition by DP metabolites [86]. However, it was demonstrated that anti-HIV activity of these analogues was still limited by intracellular metabolism.



**Figure 5.7** Comparison of the resistance profiles of GS-9148 and clinically approved nucleoside (tide) HIV RT inhibitors [72].

More carbocyclic examples include analogues based on the saturated cyclopentane core, such as the guanine analogue **51**, thymidine analogues **52** and **53**, cyclopropyl-modified analogue **54**, and 1,2-substituted cyclopentane **55** [80, 81, 87]. Only the last analogue was reported to have some anti-HIV activity, but the DP metabolites of the thymidine analogues **52** and **53** did possess potent RT inhibitory properties, suggesting once again that a major issue with the lack of antiviral activity for carbocyclic analogues is their metabolic properties.

Finally, several examples of different size carbocyclic cores have been reported. Neither the cyclobutyl G phosphonate **56** nor the cyclohexyl analogue **57** did demonstrate antiviral activity [88, 89]. The structurally interesting cyclopropyl analogues **58** and **59** were largely inactive toward the viruses tested, except **59** that did show some activity against varicella zoster virus [90, 91]. Overall, despite much work in carbocyclic nucleoside phosphonates as exemplified by the broad range of examples discussed in this chapter, it is clear that antiviral activity is difficult to achieve primarily due to inefficient metabolic activation.

#### 5.4.2

##### Examples of CNPs Targeting Viral RNA Polymerases

In recent years, there has been increased interest in the discovery of nucleoside therapeutics that inhibit viral RNA polymerases, especially HCV polymerase. However, no nucleoside or nucleoside phosphonate therapeutic has been approved for the treatment of any RNA virus, apart from the broad-spectrum agent ribavirin **60**

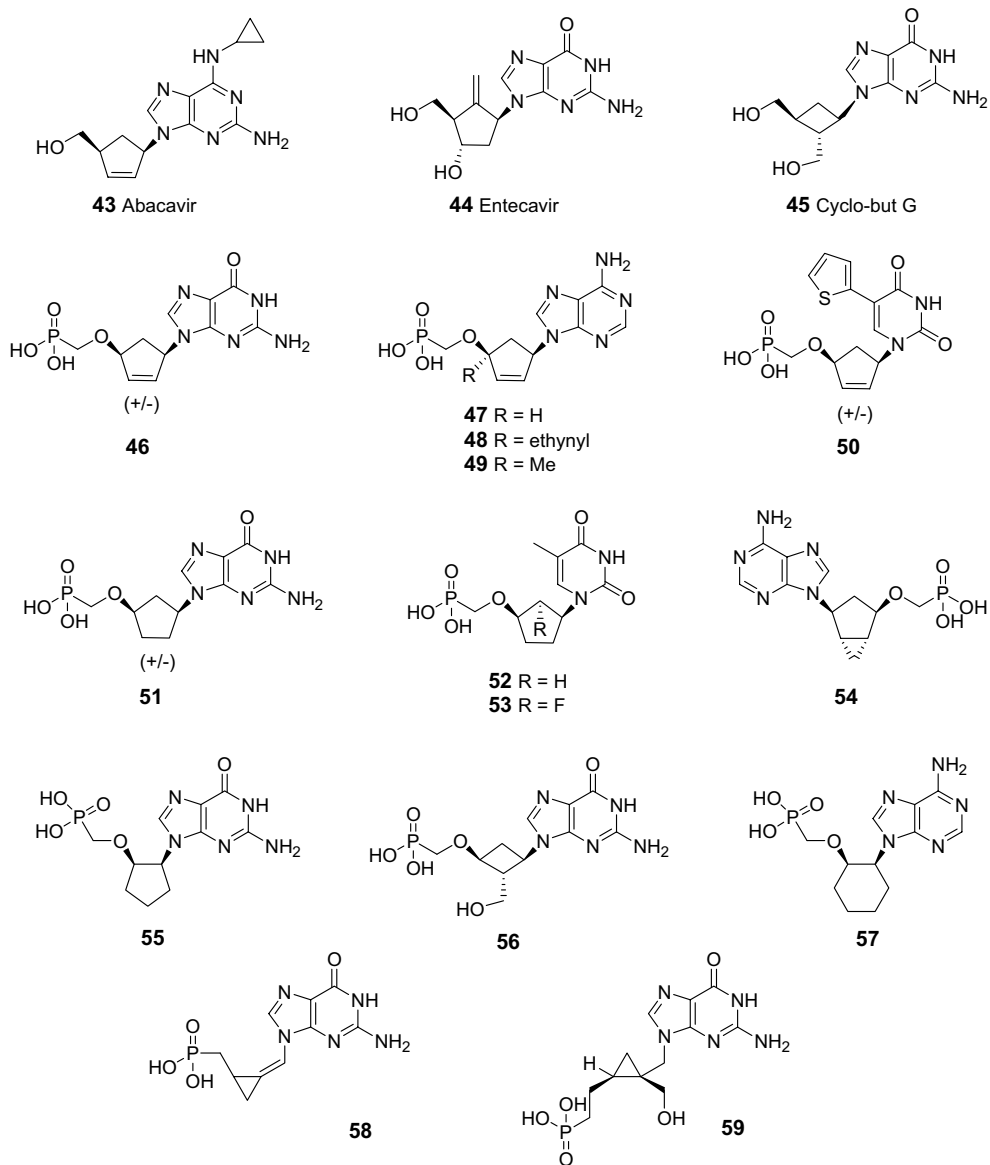

**Figure 5.8** Carbocyclic nucleoside phosphonates.

(Figure 5.9) [92] whose mechanism of action is likely multifactorial including the inhibition of the enzyme IMP dehydrogenase. Several ribavirin phosphonate analogues **61**–**65** have been prepared and evaluated as potential antiviral agents [93–97].

The carbon–carbon-linked phosphonates **61** and **62** were weaker inhibitors of IMPDH compared to ribavirin **60**. The 3'-deoxy analogues **63**–**65** were designed as potential substrates and RNA chain terminators, but all of them were essentially

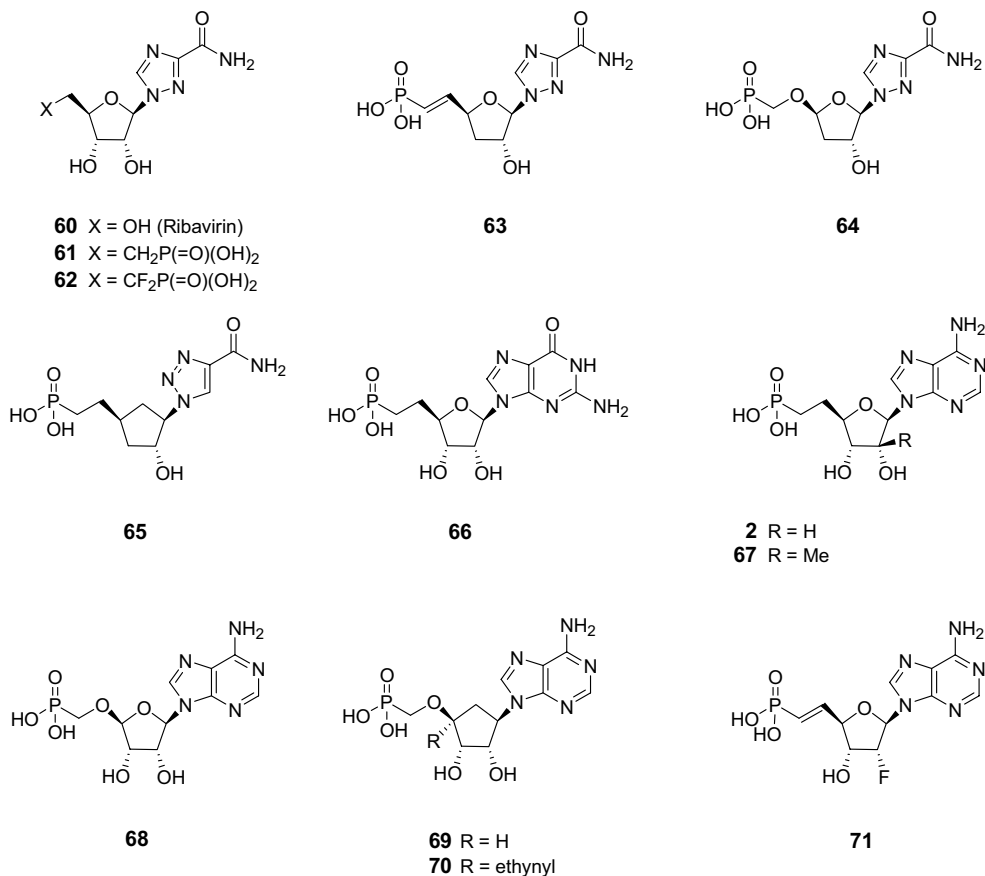

**Figure 5.9** CNPs targeting viral RNA polymerases.

inactive against HCV or very weak inhibitors of the HCV polymerase *in vitro* [94, 96, 97]. Ribose-based phosphonate analogue **66** was reported to be inactive against respiratory syncytial virus and parainfluenza [98]. Faced with the lack of activity toward RNA viruses, a seminal report in 2005 highlighted some of the potential challenges in designing nucleoside phosphonates for RNA viruses [99]. Using the DP metabolite of one of the earliest carbon–carbon-linked nucleoside phosphonates **2**, incorporation by HCV RNA polymerase was demonstrated [99]. Its kinetic rate of incorporation by HCV polymerase was only ~10-fold lower than the natural substrate ATP, but addition of the 2′C-Me group (analogue **67**) dramatically reduced incorporation. The fact that the carbon–carbon-linked phosphonates were effective substrates for RNA polymerase was in stark contrast to the SAR established for HIV RT where such analogues were inefficiently incorporated as described in Section 5.4.1. Interestingly, the β-oxygen-containing analogue **68**, perhaps expected to be a better substrate, was in fact more than 10-fold worse than **2**. Clearly, the SAR that governed the design of CNPs for HIV RT needs to be reexamined for HCV

polymerase and potentially other viral RNA polymerases. Two more examples are the carbocyclic analogues **69** and **70**, which were also found to be poor substrates for HCV polymerase [99, 100]. One of the most effective anti-HCV nucleoside phosphonates reported is a prodrug of **71** that demonstrated anti-HCV activity below 10  $\mu\text{M}$  [97]. In summary, many opportunities exist to continue the exploration of CNPs targeting RNA polymerases and if successful, rather like the example of HIV, their unique properties would lead to effective and convenient therapeutics. However, it is clear that the path forward is challenging, and the understanding that was developed for the DNA polymerases cannot be applied in designing optimal inhibitors of RNA polymerases.

## 5.5

### Prodrugs of Nucleoside Phosphonates

Wide varieties of prodrugs have been explored to optimize the pharmacological profiles of nucleoside phosphonates. Due to their charge, phosphonic diacids exhibit only limited cellular permeability and oral bioavailability [101, 102]. Masking lipophilic functionalities is required for enhanced potency and improved oral delivery. The initial efforts focused on phosphonoesters and subsequently additional strategies including phosphonoamidates have been explored with successful proof of concept in clinic. The most relevant examples of various prodrug approaches are discussed below and additional ones can be found in published literature [103–105].

#### 5.5.1

##### Phosphonoesters

Intramolecular cyclization of HPMP analogues is the simplest example of an ester prodrug strategy for ANPs. The cyclic prodrug of cidofovir **72** (cHPMPC) (Figure 5.10) shows antiviral potency similar to that of parent cidofovir [106] and is relatively stable in plasma, but undergoes intracellular conversion to parent cidofovir by cCMP-hydrolase [107]. Similarly, cyclic ganciclovir phosphonate **73** is a potent inhibitor of HCMV [52]. Although cyclization has only a marginal effect on permeability and oral bioavailability of ANPs, it impacts their safety profile by reducing renal accumulation and nephrotoxicity compared to the parent phosphonates [52, 106] as a result of reduced interactions with renal organic anion transporters [108].

Efforts on the orally bioavailable diester prodrugs of ANPs culminated in the clinical development and regulatory approval of adefovir dipivoxil **6** [ADV; bis(POM)PMEA] and tenofovir disoproxil fumarate **5** [TDF; bis(POC)PMPA]. Both TDF and ADV show efficient intracellular conversion to the respective diphosphates [109] and 10–100-fold improved *in vitro* activity against HIV-1 and HBV compared to parent ANPs [46, 109–111]. Bioavailability of parent tenofovir and adefovir in humans markedly increases following the oral administration of their prodrugs [112, 113]. Clinical applications of TDF and ADV for the treatment of HIV and HBV infections are discussed in detail in Section 5.6.



## Phosphonoester prodrugs

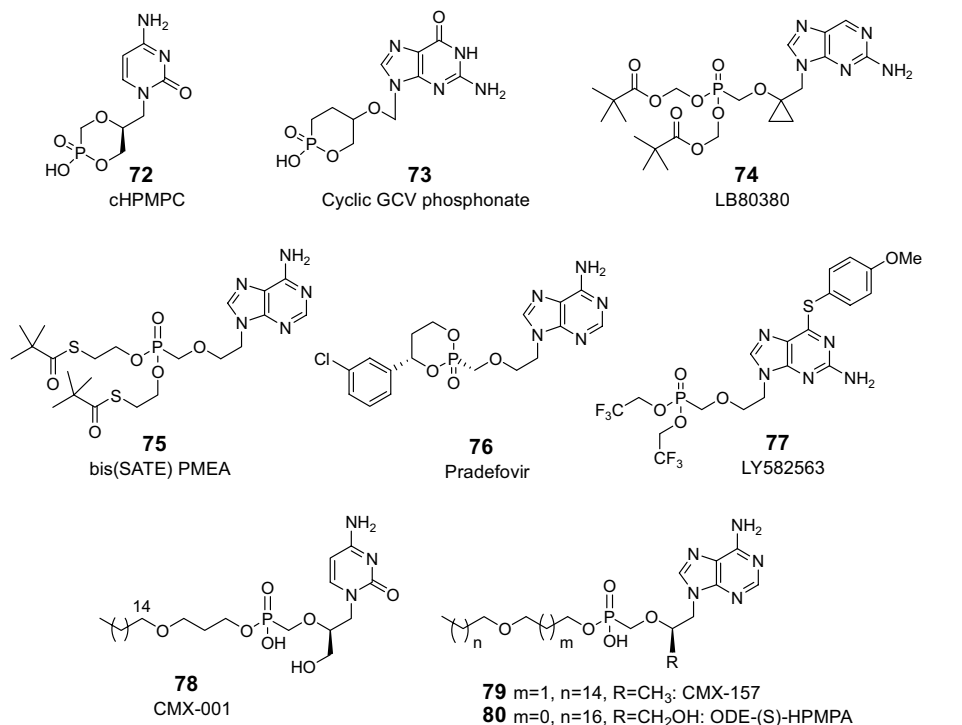

## Phosphonoamidate prodrugs

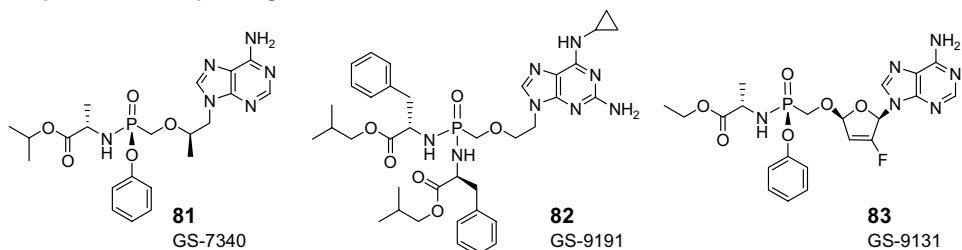

**Figure 5.10** Phosphonoester and phosphonoamidate prodrugs.

Bis(POM) prodrugs have also been successfully used in conjunction with PMCDG, resulting in prodrug **74** (LB80380) that exhibits good oral availability [54] and efficacy in animal models of HBV infection [55]. In the initial phase I/II study, the treatment of HBV-infected patients with 30–240 mg LB80380 for 4 weeks resulted in HBV DNA reduction of 3–3.7  $\log_{10}$  [114]. In a subsequent study, LB80380 was also found clinically effective in subjects infected with lamivudine-resistant HBV variants [115]. No major adverse effects were observed after the 12 week therapy.

Bis(*S*-acyl-thioethyl) (SATE) prodrugs represent another approach for symmetrical phosphonodiester. Among prodrugs with various acyl groups prepared in conjunction with adefovir (PMEA), bis(*t*-Bu-SATE) **75** showed *in vitro* antiviral potency, comparable to that of bis(POM) prodrug, and improved serum stability [116]. However, this approach has not progressed to clinic, in part, because of potential liability associated with the prodrug degradation products.

Pradefovir (MB-06866) **76** is a cyclic diester prodrug of adefovir specifically activated by liver CYP450-mediated oxidative metabolism [117]. Preclinical evaluation of pradefovir indicated preferential liver targeting and reduced kidney accumulation of adefovir [118]. Pharmacokinetic studies confirmed the conversion of pradefovir to adefovir in humans [119]. Data from a phase II study showed that doses of 10–30 mg of pradefovir are more efficacious compared to 10 mg of ADV, without significant changes in kidney function markers [120]. Further clinical development was terminated because of the potential for carcinogenicity observed in animal studies. LY582563 (MCC-478) **77** is a bis-trifluoroethylester prodrug of an ANP with potent *in vitro* anti-HBV activity, but no inhibition of HIV-1 [121, 122]. The effect of various 6-arylthio substitution on the activity, toxicity, and PK parameters of this class of prodrugs has been evaluated [123]. Several metabolites of LY582563 have been identified, but no data is available indicating that the diphosphate is the active species inhibiting HBV DNA polymerase [121]. In phase I studies, LY582563 demonstrated clinical efficacy in HBV-infected patients [124].

Alkoxyalkyl esters are lipophilic, permeable, and plasma-stable prodrugs mimicking natural phospholipids. These prodrugs have been successfully explored in conjunction with many ANPs and exhibited substantially enhanced antiviral activity compared to parent phosphonates [125]. In general, alkoxyalkyl esters of ANPs show good oral bioavailability, antiviral efficacy in animal models, and reduced renal accumulation [126–128]. Hexadecyloxypropyl-cidofovir **78** (CMX-001) is under clinical development for the treatment of various viral infections including those caused by cytomegalovirus and BK virus in immunocompromised patients, and poxvirus with potential applications in biodefense [129]. Similarly, hexadecyloxypropyl-tenofovir **79** (CMX-157) exhibits potent *in vitro* activity against both HIV and HBV, has good oral bioavailability, and its high doses were well tolerated in rats and monkeys with the dose-limiting toxicity being of gastric nature [130, 131]. CMX-157 is a clinical development candidate for the treatment of HIV. Recently, anti-HCV activity of octadecyloxyethyl-HPMPA (ODE-(*S*)-HPMPA) **80** has been described albeit with a substantially reduced potency compared to that of ANP alkoxyalkyl esters against other viruses [132].

### 5.5.2

#### Phosphonoamidates

The design of nucleoside phosphonoamidates stemmed directly from the original work of McGuigan *et al.* on phosphoramidate pronucleotides (ProTides) [133], a technology originally designed to bypass the first phosphorylation step of nucleosides by directly delivering their monophosphates into cells. In monophosphonoamidates,

the phosphonate moiety is usually derivatized by phenol and an esterified amino acid that forms a P–N bond through its  $\alpha$ -NH<sub>2</sub> group, whereas the phosphonate in bis-amidates is substituted with two identical esterified amino acids. The design and profiling of phosphonoamidates and bis-amidates are reviewed in detail elsewhere [134, 135].

The synthesis and antiviral activity of amidate prodrugs of tenofovir and adefovir were first described by Ballatore *et al.* [136]. Mono- and bis-amidate prodrugs of tenofovir have been explored independently to enhance the *in vivo* delivery of parent nucleotide into target lymphatic tissues. Mono(*i*Pr-*L*-Ala) amidate **81** (GS-7340, Figure 5.10) showed the most favorable pharmacological properties with approximately 1000-fold increased *in vitro* potency against HIV-1 compared to tenofovir [137]. Notably, GS-7340 is more stable in plasma than TDF, but undergoes fast hydrolysis in lymphocytes, resulting in enhanced intracellular delivery of tenofovir metabolites. When administered orally to dogs, GS-7340 produced 15–30-fold higher levels of tenofovir in PBMCs and lymphatic tissues than the equimolar dose of TDF, without changing the liver, kidney, and systemic exposure to tenofovir [137]. Eventually, GS-7340 progressed into a phase I clinical evaluation where it showed better efficacy than TDF in a 14 day monotherapy study in treatment-naïve HIV-infected patients.

Intracellular activation pathways of GS-7340 and other tenofovir phosphonoamidates have been extensively studied. It was initially assumed that the hydrolysis of amino acid ester, which is the first step in the activation of amidates, is mediated by esterases. However, the characterization of an enzymatic activity isolated from human PBMCs led to the identification of lysosomal carboxypeptidase cathepsin A as the main enzyme hydrolyzing GS-7340 (Figure 5.11) [138]. Various additional proteases have also been shown to hydrolyze tenofovir amidates, indicating that phosphonoamidates are, in fact, peptidomimetic prodrugs [139]. The hydrolysis of GS-7340 by proteases leads to the formation of tenofovir–Ala conjugate. Two potential routes have been proposed for the subsequent P–N bond cleavage of tenofovir–Ala conjugate, spontaneous hydrolysis in acidic compartments (i.e., lysosomes and endosomes) or enzymatic hydrolysis by cellular phosphoramidases. One of the candidate enzymes capable of hydrolyzing the P–N bond of phosphoramidates is Hint 1 [140].

Among other phosphonoamidates, various asymmetrical mono- and symmetrical bis-amidate prodrugs of PMEA, cPrPMEDAP, and cHPMPC have been prepared and shown to improve the *in vitro* antipoxvirus activity of parent phosphonates. The most potent compound identified in the series was bis(Bu-*L*-Ala)cPrPMEDAP [141]. In addition to their antiviral activity, various bis-amidates of cPrPMEDAP are highly active antiproliferative agents. Bis(*i*Bu-*L*-Phe) **82** (GS-9191, Figure 5.10) has selective activity against HPV-transformed cells and exhibits potent effects in animal models of papillomavirus infection [36]. Topical GS-9191 is under clinical development for the treatment of genital warts.

More recently, amidates of a cyclic nucleoside phosphonate GS-9148 **34** have been extensively explored because of the favorable pharmacological profile of this analogue, including its activity against a wide range of nucleoside-resistant HIV strains, low mitochondrial toxicity [72], and reduced renal accumulation [142]. A rational

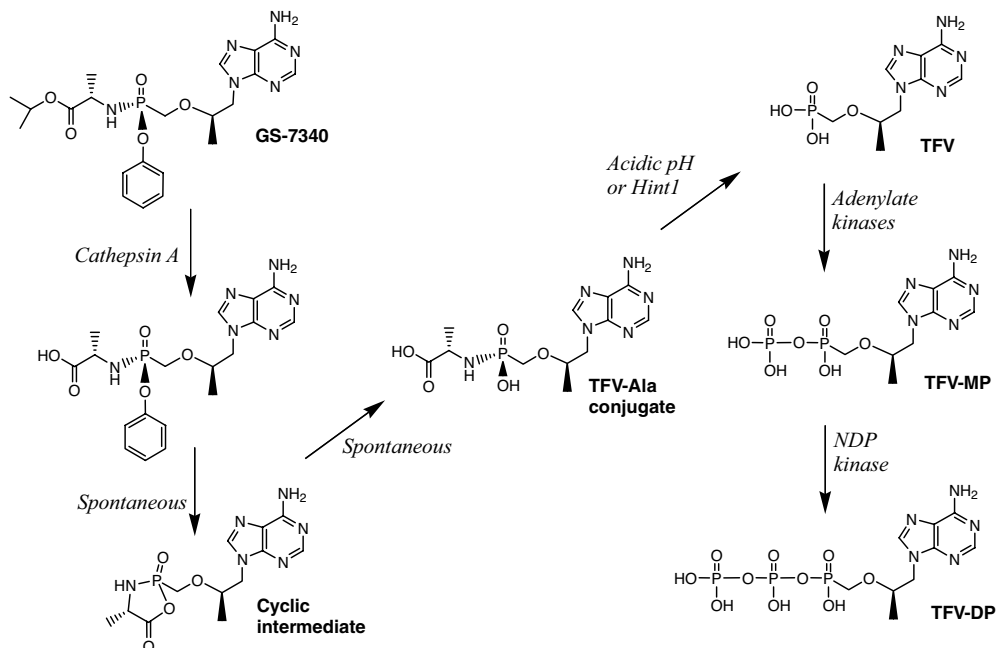

**Figure 5.11** Intracellular metabolic activation pathways of GS-7340.

approach was taken to design suitable amidates by targeting cathepsin A for selective activation and maximizing intestinal and hepatic stability for effective oral delivery into lymphatic tissues. In general, bis-amidates were excellent substrates for cathepsin A, but showed limited intestinal and hepatic stability due to their higher lipophilicity [135], resulting in low *in vivo* oral bioavailability. Mono(ethyl-L-Ala) amidate **83** (GS-9131, Figure 5.10) was not as effective in enhancing the *in vitro* antiviral activity of GS-9148 as some other more lipophilic monoamidates, but it delivered high intracellular levels of GS-9148 metabolites into PBMCs *in vivo* [72]. Following the oral administration of GS-9131 to dogs at a dose of 3 mg/kg, the intracellular concentration of GS-9148 diphosphate in PBMCs approached 10  $\mu\text{M}$ , a level approximately 20-fold higher compared to that of tenofovir diphosphate detected in PBMCs of patients treated with the standard clinical dose of TDF [72, 143]. In addition, prolonged intracellular retention of GS-9148 diphosphate with a half-life of more than 24 h suggested the possibility of once-daily dosing [72, 143]. On the basis of these characteristics, GS-9131 progressed into phase I clinical evaluation.

## 5.6

### Clinical Applications of Antiviral Nucleoside Phosphonates

Three acyclic nucleoside phosphonates have been approved for clinical use as antiviral agents. Cidofovir was the first in the class to reach regulatory approval in

1996 for the treatment of HCMV retinitis in AIDS patients. Subsequently, tenofovir disoproxil fumarate and adefovir dipivoxil have been licensed for the treatment of HIV and HBV infections, respectively. Finally, TDF also obtained commercial approval in 2008 for use as anti-HBV therapy. During the past decade, several other nucleoside phosphonates or their prodrugs have been tested in clinic and although their development did not progress toward commercial approval, these studies provided important proofs of novel drug design concepts.

### 5.6.1

#### **Cidofovir (Vistide®)**

Together with ganciclovir and foscarnet, cidofovir is one of the three viral DNA polymerase inhibitors approved for the treatment of CMV retinitis, a major opportunistic complication in patients with late-stage HIV infection. In clinical trials, cidofovir given by i.v. infusion at 3–5 mg/kg once a week in the induction and every other week in maintenance phase significantly delayed the progression of CMV retinitis in previously untreated patients [144] and patients with relapsing disease [145]. The dose-limiting adverse effect of cidofovir is renal toxicity manifested by symptoms similar to Fanconi syndrome, including elevated levels of serum creatinine and the presence of metabolites and proteins in urine [144, 145]. Studies focused on the mechanism of this adverse effect demonstrated effective interaction of cidofovir with renal organic anion transporter type 1 (OAT1) that leads to a selective drug accumulation in renal proximal tubular cells [108]. For this reason, cidofovir treatment requires coadministration of probenecid, an inhibitor of OAT1. One of the advantages of cidofovir is its activity against both CMV strains with resistance to ganciclovir due to UL97 mutations and CMV strains resistant to foscarnet [22, 146]. The availability of oral ganciclovir, coupled with recent advancements in HIV therapy that has virtually eliminated CMV retinitis among HIV patients, has significantly reduced the clinical use of i.v. cidofovir for the management of CMV infection. However, the broad anti-DNA virus activity still remains an attractive feature of cidofovir. Successful applications of cidofovir for the clinical treatment of various disorders such as JC virus-associated progressive multifocal leukoencephalopathy, various papillomavirus-induced lesions, molluscum contagiosum, and other indications have been reported [10]. In addition, cidofovir is the only clinically approved drug active against smallpox and therefore has been explored for potential biodefense applications [147].

### 5.6.2

#### **Adefovir Dipivoxil (Hepsera®)**

Adefovir dipivoxil (ADV) was initially explored in the clinic for the treatment of HIV infection. However, oral treatment of nucleoside-experienced patients with up to 120 mg ADV showed only moderate efficacy and a high incidence of drug-related nephrotoxicity [148]. Similar to cidofovir, this adverse effect is caused by adefovir accumulation in renal proximal tubules via the interaction with OAT1 [108]. Taking

advantage of the improved potency of adefovir against HBV compared to HIV, clinical development of ADV for the treatment of chronic hepatitis B was subsequently initiated at lower doses. Two pivotal phase III studies that served as the basis for drug approval were conducted in HBeAg<sup>+</sup> and HBeAg<sup>-</sup> chronic HBV patients [149, 150]. ADV at 10 mg resulted in histological improvements, viral load reduction, and normalization of serum transaminases in both patient populations and did not have any clinical evidence of nephrotoxicity. The majority of patients showed maintenance or further improvement in liver necroinflammation and fibrosis, HBV suppression, and biochemical response for up to 240 weeks [151]. The clinical benefit of ADV was substantially more durable than that of lamivudine, primarily due to the reduced frequency of resistance development. In phase III studies, no resistance mutations were observed following the first year of therapy. The cumulative probability of resistance emergence due to mutations in HBV polymerase gene was 3 and 29% after 2 and 5 years of therapy, respectively [151].

In lamivudine-resistant patients with compensated liver disease, the clinical effects of switching from lamivudine to ADV monotherapy or adding ADV to lamivudine were compared in a 1 year study [152]. The results indicated that ADV was as effective in lamivudine-resistant patients as in the HBeAg<sup>+</sup> and HBeAg<sup>-</sup> patients infected with the wild-type HBV. In liver transplant patients, the efficacy of ADV was similar to other HBV patient populations confirming that decompensated liver disease does not compromise the drug metabolic activation and efficacy [153, 154]. ADV therapy represents an important proof of concept for nucleoside phosphonate treatment in a wide range of patients infected with chronic hepatitis B, but its use has gradually declined following the approval of tenofovir disoproxil fumarate for the same indication.

### 5.6.3

#### **Tenofovir Disoproxil Fumarate (Viread®)**

Clinical efficacy of tenofovir against HIV was initially established using intravenous administration of the parent nucleoside phosphonate [155]. Subsequently, oral prodrug tenofovir disoproxil fumarate (TDF) was explored in a phase I/II dose-range finding study [113]. The results established 300 mg once daily as the optimal dose with the median plasma viral load decline of 1.2 log following a 28 day monotherapy. In phase III studies, TDF added to a stable suboptimal antiretroviral regimen showed a safety profile similar to that of placebo and produced a significant viral load reduction in two cohorts of patients with multiple nucleoside resistance mutations [156, 157]. Randomized trials in treatment-naïve patients established durable efficacy and safety of TDF in combination with lamivudine/efavirenz [158] and emtricitabine/efavirenz [159, 160]. The efficacy and safety of TDF/emtricitabine/efavirenz once-a-day regimen were superior to both zidovudine/lamivudine/efavirenz [159] and abacavir/lamivudine/efavirenz [161]. In 2004, a coformulation of TDF and emtricitabine (Truvada®) was approved, representing the first once-daily fixed dose combination of two antiretrovirals. Two years later, the combination of TDF/emtricitabine/efavirenz (Atripla™) received regulatory approval as the first and thus far the only available

one-pill once daily complete fixed dose antiretroviral regimen. TDF also showed durable efficacy and safety in combination with HIV protease inhibitors (PIs), both in treatment-naïve [162] and -experienced patients [163]. The extensive clinical experience demonstrating the long-term efficacy and safety of TDF led to a recommendation of TDF + emtricitabine in combination with a specific third agent as the preferred regimen for the first-line antiretroviral therapy [164].

The susceptibility of HIV to tenofovir can be reduced by specific mutations in RT. Early studies established K65R as the primary RT mutation selected by tenofovir *in vitro* [165]. Low-frequency emergence of K65R was found in multiple clinical studies both in treatment-naïve and in NRTI-experienced patients exposed to TDF. Notably, less than 3% of patients treated for 3 years with a TDF-containing first-line regimen developed K65R [158]. Overall prevalence of K65R in treatment-experienced patients remains low [166]. In addition to K65R, certain combinations of thymidine analogue mutations are associated with diminished clinical response to TDF [167]. In contrast, the presence of M184V mutation in RT increases the susceptibility to tenofovir and slightly enhances the clinical efficacy of TDF [167]. Because of its favorable resistance profile, tenofovir is frequently used for the treatment of nucleoside-experienced patients with various mutations in RT.

In comparison with some antiretroviral nucleosides, particularly thymidine analogues, chronic treatment with TDF causes significantly fewer lipid abnormalities [158]. Similar to other acyclic nucleoside phosphonates, renal tubular dysfunction is the primary adverse effect in TDF-treated patients [168]. However, compared to cidofovir and ADV, the incidence and severity of TDF-associated nephrotoxicity is substantially lower. No significant difference in renal safety between TDF and control arms was reported in registrational clinical trials [169], but case reports and analyses of some observational cohorts of TDF-treated patients showed a low incidence of renal dysfunction that is manifested primarily as reduced creatinine clearance with the main confounding factors being low CD4<sup>+</sup> cell counts, decreased baseline renal function, and diabetes [170]. Recent data suggested that TDF-treated patients experiencing the renal dysfunction have higher plasma levels of tenofovir [171].

Studies on the mucosal transmission of HIV in nonhuman primate models showed promising effects of nucleoside/nucleotide RT inhibitors in preventing or substantially reducing infection over the course of multiple exposures [172]. On the basis of these observations, a number of placebo-controlled trials to assess the clinical efficacy of preexposure prophylaxis (PrEP) are being conducted, primarily in countries with a high incidence of new HIV infections. In most of these studies, topical tenofovir or oral TDF alone or in combination with emtricitabine are being tested [173, 174].

In addition to HIV, TDF exhibits clinical efficacy against chronic HBV infection that was first reported in lamivudine-resistant HIV/HBV coinfecting patients [175–177]. Based on these results, two pivotal phase III studies in patients with HBeAg<sup>+</sup> and HBeAg<sup>-</sup> chronic hepatitis B have been conducted to compare the efficacy of 300 mg TDF and 10 mg ADV. After 48 weeks, the efficacy of TDF was significantly better in both populations of patients. The difference was particularly significant in HBeAg<sup>+</sup> patients with 73 and 13% patients achieving viral suppression

(< 400 copies/ml) on TDF and ADV, respectively [178]. After 3 years of TDF therapy, a sustained response with viral load suppression in 87 and 71% patients with HBeAg<sup>-</sup> and HBeAg<sup>+</sup> status, respectively, was observed in conjunction with good renal safety and no resistance development [179, 180]. Notably, 8% patients treated with TDF for 3 years experienced the loss of HBsAg, a surrogate marker for the cure of HBV infection [179]. In 2008, TDF was approved for the treatment of chronic hepatitis B and is being investigated in multiple HBV patient populations either alone or in combination with emtricitabine.

## 5.7

### Conclusions

Much progress has been made since the concept of bioisosteric nucleoside phosphonates first emerged more than 40 years ago. The exploration of the therapeutic potential of nucleoside phosphonates expanded tremendously in the late 1980s after the potent broad-spectrum antiviral activity of the acyclic analogues was discovered. In the past decade, the clinical development and regulatory approval of TDF and ADV followed by their extensive use across multiple populations of HIV- and HBV-infected patients have firmly established nucleoside phosphonates as clinically efficacious antiviral agents. Although the application of prodrug strategies is necessary for effective oral delivery of these agents, they possess unique features such as improved catabolic stability that enhances their intracellular retention relative to nucleosides, offering the advantage of less frequent dosing. The successful therapeutic application of nucleoside phosphonates culminated in 2006 with the commercial approval of Atripla, a one-pill once-a-day fixed dose antiretroviral regimen with potent and durable clinical efficacy that has set new standards for the management of HIV-infected patients. Following the initial successful application of ADV for chronic HBV, TDF is now replacing ADV because of its significantly improved efficacy. Clinical benefits provided by acyclic nucleoside phosphonates greatly stimulated additional discovery efforts that have led to the design of novel structural classes of both acyclic and cyclic analogues and their prodrugs, some of which remain attractive clinical candidates for the treatment of HIV, HBV, and various types of proliferative disorders. Although a large variety of inhibitors have been identified that are active against DNA viruses and retroviruses, the design of nucleoside phosphonates with potent activity toward RNA viruses, especially HCV, is a great challenge that still remains to be successfully addressed.

### References

- 1 Jones, G.H. and Moffatt, J.G. (1968) The synthesis of 6'-deoxyhomonucleoside-6'-phosphonic acids. *Journal of the American Chemical Society*, **90**, 5336–5338.
- 2 Rammler, D.H., Yengoyan, L., Paul, A.V., and Bax, P.C. (1967) Nucleoside phosphonic acids. II. The synthesis of 5'-deoxythymidine 5'-phosphonic acid and



- its pyrophosphate derivatives. *Biochemistry*, **6**, 1828–1837.
- 3 De Clercq, E., Holý, A., Rosenberg, I., Sakuma, T., Balzarini, J., and Maudgal, P.C. (1986) A novel selective broad-spectrum anti-DNA virus agent. *Nature*, **323**, 464–467.
  - 4 Lee, W.A. and Martin, J.C. (2006) Perspectives on the development of acyclic nucleotide analogs as antiviral drugs. *Antiviral Research*, **71**, 254–259.
  - 5 Hawkins, T., Veikley, W., St Claire, R.L., 3rd, Guyer, B., Clark, N., and Kearney, B.P. (2005) Intracellular pharmacokinetics of tenofovir diphosphate, carbovir triphosphate, and lamivudine triphosphate in patients receiving triple-nucleoside regimens. *Journal of Acquired Immune Deficiency Syndromes*, **39**, 406–411.
  - 6 Kim, C.U., Luh, B.Y., Misco, P.F., Bronson, J.J., Hitchcock, M.J., Ghazzouli, I., and Martin, J.C. (1990) Acyclic purine phosphonate analogues as antiviral agents: synthesis and structure–activity relationships. *Journal of Medicinal Chemistry*, **33**, 1207–1213.
  - 7 Engel, R. (1977) Phosphonates as analogs of natural phosphates. *Chemical Reviews*, **1977**, 349–367.
  - 8 Holý, A. (1967) Synthesis of 5'-deoxyuridine 5'-phosphonic acid. *Tetrahedron Letters*, **10**, 881–884.
  - 9 De Clercq, E., and Holý, A. (2005) Acyclic nucleoside phosphonates: a key class of antiviral drugs. *Nature Reviews Drug Discovery*, **4**, 928–940.
  - 10 Naesens, L., Snoeck, R., Andrei, G., Balzarini, J., Neyts, J., and De Clercq, E. (1997) HPMPC (cidofovir), PMEA (adefovir) and related acyclic nucleoside phosphonate analogues: a review of their pharmacology and clinical potential in the treatment of viral infections. *Antiviral Chemistry & Chemotherapy*, **8**, 1–23.
  - 11 Holý, A., Votruba, I., Merta, A., Cerný, J., Veselý, J., Vlach, J., Sedivá, K., Rosenberg, I., Otmar, M., Hrebabecký, H., Trávnicek, M., Vonka, V., Snoeck, R., and De Clercq, E. (1990) Acyclic nucleotide analogues: synthesis, antiviral activity and inhibitory effects on some cellular and virus-encoded enzymes *in vitro*. *Antiviral Research*, **13**, 295–311.
  - 12 Heijntink, R.A., Kruining, J., de Wilde, G.A., Balzarini, J., De Clercq, E., and Schalm, S.W. (1994) Inhibitory effects of acyclic nucleoside phosphonates on human hepatitis B virus and duck hepatitis B virus infections in tissue culture. *Antimicrobial Agents and Chemotherapy*, **38**, 2180–2182.
  - 13 Balzarini, J., Holý, A., Jindrich, J., Naesens, L., Snoeck, R., Schols, D., and De Clercq, E. (1993) Differential antiherpesvirus and antiretrovirus effects of the (S) and (R) enantiomers of acyclic nucleoside phosphonates: potent and selective *in vitro* and *in vivo* antiretrovirus activities of (R)-9-(2-phosphonomethoxypropyl)-2,6-diaminopurine. *Antimicrobial Agents and Chemotherapy*, **37**, 332–338.
  - 14 Snoeck, R., Sakuma, T., De Clercq, E., Rosenberg, I., and Holý, A. (1988) (S)-1-(3-Hydroxy-2-phosphonylmethoxypropyl)cytosine, a potent and selective inhibitor of human cytomegalovirus replication. *Antimicrobial Agents and Chemotherapy*, **32**, 1839–1844.
  - 15 Neyts, J., Snoeck, R., Schols, D., Balzarini, J., and De Clercq, E. (1990) Selective inhibition of human cytomegalovirus DNA synthesis by (S)-1-(3-hydroxy-2-phosphonylmethoxypropyl)cytosine [(S)-HPMPC] and 9-(1,3-dihydroxy-2-propoxymethyl)guanine (DHPG). *Virology*, **179**, 41–50.
  - 16 Xiong, X., Smith, J.L., Kim, C., Huang, E.S., and Chen, M.S. (1996) Kinetic analysis of the interaction of cidofovir diphosphate with human cytomegalovirus DNA polymerase. *Biochemical Pharmacology*, **51**, 1563–1567.
  - 17 Xiong, X., Smith, J.L., and Chen, M.S. (1997) Effect of incorporation of cidofovir into DNA by human cytomegalovirus DNA polymerase on DNA elongation. *Antimicrobial Agents and Chemotherapy*, **41**, 594–599.
  - 18 Bidanset, D.J., Rybak, R.J., Hartline, C.B., and Kern, E.R. (2004) Efficacy of ganciclovir and cidofovir against human cytomegalovirus replication in SCID

- mice implanted with human retinal tissue. *Antiviral Research*, **63**, 61–64.
- 19 Bravo, F.J., Stanberry, L.R., Kier, A.B., Vogt, P.E., and Kern, E.R. (1993) Evaluation of HPMPC therapy for primary and recurrent genital herpes in mice and guinea pigs. *Antiviral Research*, **21**, 59–72.
  - 20 Stüttelaar, K.J., Neyts, J., Naesens, L., van Amerongen, G., van Lavieren, R.F., Holý, A., De Clercq, E., Niesters, H.G., Fries, E., Maas, C., Mulder, P.G., van der Zeijst, B.A., and Osterhaus, A.D. (2006) Antiviral treatment is more effective than smallpox vaccination upon lethal monkeypox virus infection. *Nature*, **439**, 745–748.
  - 21 Maudgal, P.C. and De Clercq, E. (1991) Effects of phosphonylmethoxyalkyl-purine and -pyrimidine derivatives on TK<sup>+</sup> and TK<sup>-</sup> HSV-1 keratitis in rabbits. *Antiviral Research*, **16**, 93–100.
  - 22 Smith, I.L., Cherrington, J.M., Jiles, R.E., Fuller, M.D., Freeman, W.R., and Spector, S.A. (1997) High-level resistance of cytomegalovirus to ganciclovir is associated with alterations in both the UL97 and DNA polymerase genes. *The Journal of Infectious Diseases*, **176**, 69–77.
  - 23 Palmer, S., Margot, N., Gilbert, H., Shaw, N., Buckheit, R., Jr., and Miller, M. (2001) Tenofovir, adefovir, and zidovudine susceptibilities of primary human immunodeficiency virus type 1 isolates with non-B subtypes or nucleoside resistance. *AIDS Research and Human Retroviruses*, **17**, 1167–1173.
  - 24 Chen, R.Y., Edwards, R., Shaw, T., Colledge, D., Delaney, W.E., 4th, Isom, H., Bowden, S., Desmond, P., and Locarnini, S.A. (2003) Effect of the G1896A precore mutation on drug sensitivity and replication yield of lamivudine-resistant HBV *in vitro*. *Hepatology (Baltimore, MD)*, **37**, 27–35.
  - 25 Westland, C.E., Yang, H., Delaney, W.E., 4th, Wulfsohn, M., Lama, N., Gibbs, C.S., Miller, M.D., Fry, J., Brosgart, C.L., Schiff, E.R., and Xiong, S. (2005) Activity of adefovir dipivoxil against all patterns of lamivudine-resistant hepatitis B viruses in patients. *Journal of Viral Hepatitis*, **12**, 67–73.
  - 26 Yang, H., Qi, X., Sabogal, A., Miller, M., Xiong, S., and Delaney, W.E., 4th (2005) Cross-resistance testing of next-generation nucleoside and nucleotide analogues against lamivudine-resistant HBV. *Antiviral Therapy*, **10**, 625–633.
  - 27 De Clercq, E., Sakuma, T., Baba, M., Pauwels, R., Balzarini, J., Rosenberg, I., and Holý, A. (1987) Antiviral activity of phosphonylmethoxyalkyl derivatives of purine and pyrimidines. *Antiviral Research*, **8**, 261–272.
  - 28 Snoeck, R., Andrei, G., and De Clercq, E. (1996) Patterns of resistance and sensitivity to antiviral compounds of drug-resistant strains of human cytomegalovirus selected *in vitro*. *European Journal of Clinical Microbiology & Infectious Diseases*, **15**, 574–579.
  - 29 Xiong, X., Flores, C., Fuller, M.D., Mendel, D.B., Mulato, A.S., Moon, K., Chen, M.S., and Cherrington, J.M. (1997) *In vitro* characterization of the anti-human cytomegalovirus activity of PMEA (adefovir). *Antiviral Research*, **36**, 131–137.
  - 30 Lin, J.C., De Clercq, E., and Pagano, J.S. (1987) Novel acyclic adenosine analogs inhibit Epstein-Barr virus replication. *Antimicrobial Agents and Chemotherapy*, **31**, 1431–1433.
  - 31 Merta, A., Votruba, I., Rosenberg, I., Otmár, M., Hrebabecký, H., Bernaerts, R., and Holý, A. (1990) Inhibition of herpes simplex virus DNA polymerase by diphosphates of acyclic phosphonylmethoxyalkyl nucleotide analogues. *Antiviral Research*, **13**, 209–218.
  - 32 Cerný, J., Votruba, I., Vonka, V., Rosenberg, I., Otmár, M., and Holý, A. (1990) Phosphonylmethyl ethers of acyclic nucleoside analogues: inhibitors of HSV-1 induced ribonucleotide reductase. *Antiviral Research*, **13**, 253–264.
  - 33 Andrei, G., Snoeck, R., Piette, J., Delvenne, P., and De Clercq, E. (1998) Antiproliferative effects of acyclic nucleoside phosphonates on human papillomavirus (HPV)-harboring cell lines compared with HPV-negative cell lines. *Oncology Research*, **10**, 523–531.
  - 34 Kramata, P., Downey, K.M., and Paborsky, L.R. (1998) Incorporation and excision of 9-(2-

- phosphonylmethoxyethyl)guanine (PMEG) by DNA polymerase delta and epsilon *in vitro*. *The Journal of Biological Chemistry*, **273**, 21966–21971.
- 35 Reiser, H., Wang, J., Chong, L., Watkins, W.J., Ray, A.S., Shibata, R., Birkus, G., Cihlar, T., Wu, S., Li, B., Liu, X., Henne, I.N., Wolfgang, G.H., Desai, M., Rhodes, G.R., Fridland, A., Lee, W.A., Plunkett, W., Vail, D., Thamm, D.H., Jeraj, R., and Tumas, D.B. (2008) GS-9219: a novel acyclic nucleotide analogue with potent antineoplastic activity in dogs with spontaneous non-Hodgkin's lymphoma. *Clinical Cancer Research*, **14**, 2824–2832.
  - 36 Wolfgang, G.H., Shibata, R., Wang, J., Ray, A.S., Wu, S., Doerrfler, E., Reiser, H., Lee, W.A., Birkus, G., Christensen, N.D., Andrei, G., and Snoeck, R. (2009) GS-9191 is a novel topical prodrug of the nucleotide analog 9-(2-phosphonylmethoxyethyl)guanine with antiproliferative activity and possible utility in the treatment of human papillomavirus lesions. *Antimicrobial Agents and Chemotherapy*, **53**, 2777–2784.
  - 37 Balzarini, J., Holý, A., Jindrich, J., Dvorakova, H., Hao, Z., Snoeck, R., Herdewijn, P., Johns, D.G., and De Clercq, E. (1991) 9-[(2RS)-3-fluoro-2-phosphonylmethoxypropyl] derivatives of purines: a class of highly selective antiretroviral agents *in vitro* and *in vivo*. *Proceedings of the National Academy of Sciences of the United States of America*, **88**, 4961–4965.
  - 38 Mulato, A.S. and Cherrington, J.M. (1997) Anti-HIV activity of adefovir (PMEA) and PMPA in combination with antiretroviral compounds: *in vitro* analyses. *Antiviral Research*, **36**, 91–97.
  - 39 Balzarini, J., Aquaro, S., Perno, C.F., Witvrouw, M., Holý, A., and De Clercq, E. (1996) Activity of the (*R*)-enantiomers of 9-(2-phosphonylmethoxypropyl)-adenine and 9-(2-phosphonylmethoxypropyl)-2,6-diaminopurine against human immunodeficiency virus in different human cell systems. *Biochemical and Biophysical Research Communications*, **219**, 337–341.
  - 40 Shirasaka, T., Choekijchai, S., Yamada, A., Gosselin, G., Imbach, J.L., and Mitsuya, H. (1995) Comparative analysis of anti-human immunodeficiency virus type 1 activities of dideoxynucleoside analogs in resting and activated peripheral blood mononuclear cells. *Antimicrobial Agents and Chemotherapy*, **39**, 2555–2559.
  - 41 Miller, M.D., Margot, N.A., Hertogs, K., Larder, B., and Miller, V. (2001) Antiviral activity of tenofovir (PMPA) against nucleoside-resistant clinical HIV samples. *Nucleosides, Nucleotides & Nucleic Acids*, **20**, 1025–1028.
  - 42 Harrigan, P.R., Miller, M.D., McKenna, P., Brumme, Z.L., and Larder, B.A. (2002) Phenotypic susceptibilities to tenofovir in a large panel of clinically derived human immunodeficiency virus type 1 isolates. *Antimicrobial Agents and Chemotherapy*, **46**, 1067–1072.
  - 43 Cherrington, J.M., Allen, S.J.W., Bischofberger, N., and Chen, M.S. (1995) Kinetic interaction of the diphosphates of 9-(2-phosphonylmethoxyethyl)adenine and other anti-HIV active purine congeners with HIV reverse transcriptase and human DNA polymerases  $\alpha$ ,  $\beta$ , and  $\gamma$ . *Antiviral Chemistry & Chemotherapy*, **6**, 217–221.
  - 44 Meyer, P.R., Matsuura, S.E., So, A.G., and Scott, W.A. (1998) Unblocking of chain-terminated primer by HIV-1 reverse transcriptase through a nucleotide-dependent mechanism. *Proceedings of the National Academy of Sciences of the United States of America*, **95**, 13471–13476.
  - 45 White, K.L., Margot, N.A., Ly, J.K., Chen, J.M., Ray, A.S., Pavelko, M., Wang, R., McDermott, M., Swaminathan, S., and Miller, M.D. (2005) A combination of decreased NRTI incorporation and decreased excision determines the resistance profile of HIV-1 K65R RT. *AIDS (London, England)*, **19**, 1751–1760.
  - 46 Delaney, W.E., 4th, Ray, A.S., Yang, H., Qi, X., Xiong, S., Zhu, Y., and Miller, M.D. (2006) Intracellular metabolism and *in vitro* activity of tenofovir against hepatitis B virus. *Antimicrobial Agents and Chemotherapy*, **50**, 2471–2477.
  - 47 Gaillard, R.K., Barnard, J., Lopez, V., Hodges, P., Bourne, E., Johnson, L., Allen, M.I., Condreay, P., Miller, W.H.,

- and Condey, L.D. (2002) Kinetic analysis of wild-type and YMDD mutant hepatitis B virus polymerases and effects of deoxyribonucleotide concentrations on polymerase activity. *Antimicrobial Agents and Chemotherapy*, **46**, 1005–1013.
- 48 Xiong, X., Flores, C., Yang, H., Toole, J.J., and Gibbs, C.S. (1998) Mutations in hepatitis B DNA polymerase associated with resistance to lamivudine do not confer resistance to adefovir *in vitro*. *Hepatology (Baltimore, MD)*, **28**, 1669–1673.
- 49 Cihlar, T., Ho, E.S., Lin, D.C., and Mulato, A.S. (2001) Human renal organic anion transporter 1 (hOAT1) and its role in the nephrotoxicity of antiviral nucleotide analogs. *Nucleosides, Nucleotides & Nucleic Acids*, **20**, 641–648.
- 50 Barnard, D.L., Huffman, J.H., Sidwell, R.W., and Reist, E.J. (1993) Selective inhibition of cytomegaloviruses by 9-(3'-ethylphosphono-1'-hydroxymethyl-1'-propyloxy-methyl)guanine. *Antiviral Research*, **22**, 77–89.
- 51 Smee, D.F., Sugiyama, S.T., and Reist, E.J. (1994) Nucleotide analogs related to acyclovir and ganciclovir are effective against murine cytomegalovirus infections in BALB/c and severe combined immunodeficient mice. *Antimicrobial Agents and Chemotherapy*, **38**, 2165–2168.
- 52 Smee, D.F. and Reist, E.J. (1996) Potent anti-murine cytomegalovirus activity and reduced nephrotoxicity of ganciclovir cyclic phosphonate. *Antimicrobial Agents and Chemotherapy*, **40**, 1964–1966.
- 53 Bridges, C.G., Taylor, D.L., Ahmed, P.S., Brennan, T.M., Hornsperger, J.M., Nave, J.F., Casara, P., and Tynms, A.S. (1996) MDL 74,968, a new acyclonucleotide analog: activity against human immunodeficiency virus *in vitro* and in the hu-PBL-SCID.beige mouse model of infection. *Antimicrobial Agents and Chemotherapy*, **40**, 1072–1077.
- 54 Yuen, M.F., Lee, S.H., Kang, H.M., Kim, C.R., Kim, J., Ngai, V., and Lai, C.L. (2009) Pharmacokinetics of LB80331 and LB80317 following oral administration of LB80380, a new antiviral agent for chronic hepatitis B (CHB), in healthy adult subjects, CHB patients, and mice. *Antimicrobial Agents and Chemotherapy*, **53**, 1779–1785.
- 55 Fung, J., Lai, C.L., and Yuen, M.F. (2008) LB80380: a promising new drug for the treatment of chronic hepatitis B. *Expert Opinion on Investigational Drugs*, **17**, 1581–1588.
- 56 Balzarini, J., Pannecouque, C., De Clercq, E., Aquaro, S., Perno, C.F., Egberink, H., and Holý, A. (2002) Antiretroviral activity of a novel class of acyclic pyrimidine nucleoside phosphonates. *Antimicrobial Agents and Chemotherapy*, **46**, 2185–2193.
- 57 De Clercq, E., Andrei, G., Balzarini, J., Leysen, P., Naesens, L., Neyts, J., Pannecouque, C., Snoeck, R., Ying, C., Hocková, D., and Holý, A. (2005) Antiviral potential of a new generation of acyclic nucleoside phosphonates, the 6-[2-(phosphonomethoxy)alkoxy]-2,4-diaminopyrimidines. *Nucleosides, Nucleotides & Nucleic Acids*, **24**, 331–341.
- 58 Herman, B.D., Votruba, I., Holý, A., Sluis-Cremer, N., and Balzarini, J. (2010) The acyclic 2,4-diaminopyrimidine nucleoside phosphonate acts as a purine mimetic in HIV-1 reverse transcriptase DNA polymerization. *The Journal of Biological Chemistry*, **285**, 12101–12108.
- 59 Hocková, D., Holý, A., Masojdková, M., Andrei, G., Snoeck, R., De Clercq, E., and Balzarini, J. (2003) 5-Substituted-2,4-diamino-6-[2-(phosphonomethoxy)ethoxy]pyrimidines-acyclic nucleoside phosphonate analogues with antiviral activity. *Journal of Medicinal Chemistry*, **46**, 5064–5073.
- 60 Ying, C., Holý, A., Hocková, D., Havlas, Z., De Clercq, E., and Neyts, J. (2005) Novel acyclic nucleoside phosphonate analogues with potent anti-hepatitis B virus activities. *Antimicrobial Agents and Chemotherapy*, **49**, 1177–1180.
- 61 Balzarini, J., Schols, D., Van Laethem, K., De Clercq, E., Hocková, D., Masojdková, M., and Holý, A. (2007) Pronounced *in vitro* and *in vivo* antiretroviral activity of 5-substituted 2,4-diamino-6-[2-(phosphonomethoxy)ethoxy]pyrimidines. *The Journal of Antimicrobial Chemotherapy*, **59**, 80–86.
- 62 Naesens, L., Lenaerts, L., Andrei, G., Snoeck, R., Van Beers, D., Holý, A.,

- Balzarini, J., and De Clercq, E. (2005) Antiadenovirus activities of several classes of nucleoside and nucleotide analogues. *Antimicrobial Agents and Chemotherapy*, **49**, 1010–1016.
- 63 Duraffour, S., Snoeck, R., Krecmerova, M., van Den Oord, J., De Vos, R., Holý, A., Crance, J.M., Garin, D., De Clercq, E., and Andrei, G. (2007) Activities of several classes of acyclic nucleoside phosphonates against camelpox virus replication in different cell culture models. *Antimicrobial Agents and Chemotherapy*, **51**, 4410–4419.
- 64 Andrei, G., Fiten, P., Froeyen, M., De Clercq, E., Opendakker, G., and Snoeck, R. (2007) DNA polymerase mutations in drug-resistant herpes simplex virus mutants determine *in vivo* neurovirulence and drug–enzyme interactions. *Antiviral Therapy*, **12**, 719–732.
- 65 Jie, L., Van Aerschot, A., Balzarini, J., Janssen, G., Busson, R., Hoogmartens, J., De Clercq, E., and Herdewijn, P. (1990) 5'-O-Phosphonomethyl-2',3'-dideoxynucleosides: synthesis and anti-HIV activity. *Journal of Medicinal Chemistry*, **33**, 2481–2487.
- 66 Tanaka, H., Fukui, M., Haraguchi, K., Masaki, M., and Miyasaka, T. (1989) Cleavage of a nucleosidic oxetane with carbanions: Synthesis of a highly promising candidate for anti-HIV agents – a phosphonate isostere of AZT 5'-phosphate. *Tetrahedron Letters*, **30**, 2567–2570.
- 67 Freeman, G.A., Rideout, J.L., Miller, W.H., and Reardon, J.E. (1992) 3'-Azido-3',5'-dideoxythymidine-5'-methylphosphonic acid diphosphate: synthesis and HIV-1 reverse transcriptase inhibition. *Journal of Medicinal Chemistry*, **35**, 3192–3196.
- 68 Kim, C.U., Bronson, J.J., Ferrara, L.M., and Martin, J.C. (1992) Synthesis and HIV activity of phosphonate isosteres of d4T monophosphate. *Bioorganic & Medicinal Chemistry Letters*, **2**, 367–370.
- 69 Secrist, J.A., III, Riggs, R.M., Comber, R.N., and Montgomery, J.A. (1992) Synthesis of phosphonate analogs of dideoxyadenosine (ddA)-, dideoxycytosine (ddC)-, dideoxyinosine (ddI)-, and deoxythymidine (ddT) 5'-monophosphates. *Nucleosides, Nucleotides & Nucleic Acids*, **11**, 947–956.
- 70 Mackman, R.L., Zhang, L., Prasad, V., Boojamra, C.G., Douglas, J., Grant, D., Hui, H., Kim, C.U., Laflamme, G., Parrish, J., Stoycheva, A.D., Swaminathan, S., Wang, K., and Cihlar, T. (2007) Synthesis, anti-HIV activity, and resistance profile of thymidine phosphonomethoxy nucleosides and their bis-isopropylloxymethylcarbonyl (bisPOC) prodrugs. *Bioorganic and Medicinal Chemistry*, **15**, 5519–5528.
- 71 Mackman, R.L., Boojamra, C.G., Prasad, V., Zhang, L., Lin, K.Y., Petrakovsky, O., Babusis, D., Chen, J., Douglas, J., Grant, D., Hui, H.C., Kim, C.U., Markevitch, D.Y., Vela, J., Ray, A., and Cihlar, T. (2007) Synthesis, anti-HIV activity, and resistance profiles of ribose modified nucleoside phosphonates. *Bioorganic & Medicinal Chemistry Letters*, **17**, 6785–6789.
- 72 Cihlar, T., Ray, A.S., Boojamra, C.G., Zhang, L., Hui, H., Laflamme, G., Vela, J.E., Grant, D., Chen, J., Myrick, F., White, K.L., Gao, Y., Lin, K.Y., Douglas, J.L., Parkin, N.T., Carey, A., Pakdaman, R., and Mackman, R.L. (2008) Design and profiling of GS-9148, a novel nucleotide analog active against nucleoside-resistant variants of human immunodeficiency virus type 1, and its orally bioavailable phosphonoamidate prodrug, GS-9131. *Antimicrobial Agents and Chemotherapy*, **52**, 655–665.
- 73 Boojamra, C.G., Mackman, R.L., Markevitch, D.Y., Prasad, V., Ray, A.S., Douglas, J., Grant, D., Kim, C.U., and Cihlar, T. (2008) Synthesis and anti-HIV activity of GS-9148 (2'-Fd4AP), a novel nucleoside phosphonate HIV reverse transcriptase inhibitor. *Bioorganic & Medicinal Chemistry Letters*, **18**, 1120–1123.
- 74 Tsai, C.H., Doong, S.L., Johns, D.G., Driscoll, J.S., and Cheng, Y.C. (1994) Effect of anti-HIV 2'-beta-fluoro-2',3'-dideoxynucleoside analogs on the cellular content of mitochondrial DNA and on lactate production. *Biochemical Pharmacology*, **48**, 1477–1481.

- 75 Lansdon, E.B., Samuel, D., Lagpacan, L., Brendza, K.M., White, K.L., Hung, M., Liu, X., Boojamra, C.G., Mackman, R.L., Cihlar, T., Ray, A.S., McGrath, M.E., and Swaminathan, S. (2010) Visualizing the molecular interactions of a nucleotide analog, GS-9148, with HIV-1 reverse transcriptase–DNA complex. *Journal of Molecular Biology*, **397**, 967–978.
- 76 Wu, T., Froeyen, M., Kempeneers, V., Pannecouque, C., Wang, J., Busson, R., De Clercq, E., and Herdewijn, P. (2005) Deoxythreosyl phosphonate nucleosides as selective anti-HIV agents. *Journal of the American Chemical Society*, **127**, 5056–5065.
- 77 Mackman, R.L., Lin, K.Y., Boojamra, C.G., Hui, H., Douglas, J., Grant, D., Petrakovsky, O., Prasad, V., Ray, A.S., and Cihlar, T. (2008) Synthesis and anti-HIV activity of 2'-fluorine modified nucleoside phosphonates: analogs of GS-9148. *Bioorganic & Medicinal Chemistry Letters*, **18**, 1116–1119.
- 78 Kim, C.U., Luh, B.Y., and Martin, J.C. (1992) Synthesis and anti-HIV activity of 9-[(2R,5R)-2,5-dihydro-5-(phosphonomethoxy)-2-furanyl]-2,6-diaminopurine. *Bioorganic & Medicinal Chemistry Letters*, **2**, 307–310.
- 79 Bedard, J., May, S., Lis, M., Tryphonas, L., Drach, J., Huffman, J., Sidwell, R., Chan, L., Bowlin, T., and Rando, R. (1999) Comparative study of the anti-human cytomegalovirus activities and toxicities of a tetrahydrofuran phosphonate analogue of guanosine and cidofovir. *Antimicrobial Agents and Chemotherapy*, **43**, 557–567.
- 80 Bronson, J.J., Ferrara, L.M., Martin, J.C., and Mansuri, M.M. (1992) Synthesis and biological activity of carbocyclic derivatives of the potent antiviral agent 9-[2-(phosphonomethoxy)ethyl]guanine (PMEG). *Bioorganic and Medicinal Chemistry*, **2**, 685–690.
- 81 Coe, D.M., Roberts, S.M., and Storer, R. (1992) The potential of carbocyclic nucleosides for the treatment of AIDS: synthesis of some diphosphorylphosphonates possessing potent activity against HIV-coded reverse transcriptase. *Journal of the Chemical Society, Perkin Transactions 1*, 2695–2704.
- 82 Merlo, V., Reece, F.J., Roberts, S.M., Gregson, M., and Storer, R. (1993) Synthesis of optically active 5'-noraristeromycin: enzyme-catalysed kinetic resolution of 9-(4-hydroxycyclopent-2-enyl)purines. *Journal of the Chemical Society, Perkin Transactions 1*, 1717–1718.
- 83 Dyatkina, N.B., Theil, F., and Janta-Lipinski, M.V. (1995) Stereocontrolled synthesis of the four stereoisomeric diphosphorylphosphonates of carbocyclic 2',3'-dideoxy-2',3'-didehydro-5'-noradenosine. *Tetrahedron*, **51**, 761.
- 84 Khandazhinskaya, A.L., Shirokova, E.A., Skoblov, Y.S., Victorova, L.S., Goryunova, L.Y., Beabealashvili, R.S., Pronyaeva, T.R., Fedyuk, N.V., Zolin, V.V., Pokrovsky, A.G., and Kukhanova, M.K. (2002) Carbocyclic dinucleoside polyphosphonates: interaction with HIV reverse transcriptase and antiviral activity. *Journal of Medicinal Chemistry*, **45**, 1284–1291.
- 85 Popescu, A., Hornfeldt, A.-B., Gronowitz, S., and Johansson, N.G. (1994) Synthesis and antiviral activity of some carbocyclic 5-substituted uracil derivatives. *Models in Chemistry*, **131**, 499–511.
- 86 Boojamra, C.G., Parrish, J.P., Sperandio, D., Gao, Y., Petrakovsky, O.V., Lee, S.K., Markevitch, D.Y., Vela, J.E., Laflamme, G., Chen, J.M., Ray, A.S., Barron, A.C., Sparacino, M.L., Desai, M.C., Kim, C.U., Cihlar, T., and Mackman, R.L. (2009) Design, synthesis, and anti-HIV activity of 4'-modified carbocyclic nucleoside phosphonate reverse transcriptase inhibitors. *Bioorganic and Medicinal Chemistry*, **17**, 1739–1746.
- 87 Saneyoshi, H., Vu, B.C., Hughes, S.H., Boyer, P.L., Sarafianos, S.G., and Marquez, V.E. (2008) Synthesis of conformationally locked carbocyclic nucleoside phosphonates to probe the active site of HIV-1 RT. *Nucleic Acids Symposium Series (Oxford)*, **52**, 623–624.
- 88 Liboska, R., Masojdová, M., and Rosenberg, I. (1996) Carbocyclic phosphonate-based nucleotide analogs related to PME A II. Racemic *cis*-configured derivatives. *Collection of Czechoslovak Chemical Communications*, **61**, 778–790.

- 89 Norbeck, D.W., Sham, H.L., Rosenbrook, W., Herrin, T., and Plattner, J. (1992) Synthesis and activities of the phosphonate isostere of the monophosphate of ( $\pm$ )cyclobut-G. *Nucleosides, Nucleotides & Nucleic Acids*, **11**, 1383–1391.
- 90 Guan, H.-P. Qiu, Y.-L., Ksebati, M.B., Kern, E.R., and Zemlicka, J. (2002) Synthesis of phosphonates derivatives of methylenecyclopropane nucleoside analogues by alkylation-elimination method and unusual opening of cyclopropane ring. *Tetrahedron*, **58**, 6047–6059.
- 91 Onishi, T., Sekiyama, T., and Tsuji, T. (2005) Synthesis of phosphonate analogues of the antiviral cyclopropane nucleoside A-5021. *Nucleosides, Nucleotides & Nucleic Acids*, **24**, 1187–1197.
- 92 Streeter, D.G., Witkowski, J.T., Khare, G.P., Sidwell, R.W., Bauer, R.J., Robins, R.K., and Simon, L.N. (1973) Mechanism of action of 1-D-ribofuranosyl-1,2,4-triazole-3-carboxamide (Virazole), a new broad-spectrum antiviral agent. *Proceedings of the National Academy of Sciences of the United States of America*, **70**, 1174–1178.
- 93 Fuertes, M., Witkowski, J.T., Streeter, D.G., and Robins, R.K. (1974) Synthesis and enzymatic activity of 1,2,4-triazole-3-carboxamide 6'-deoxyhomoribonucleoside-6'-phosphonic acid and related compounds. *Journal of Medicinal Chemistry*, **17**, 642–645.
- 94 Saito, Y., Escuret, V., Durantel, D., Zoulim, F., Schinazi, R.F., and Agrofoglio, L.A. (2003) Synthesis of 1,2,3-triazolo-carbanucleoside analogues of ribavirin targeting an HCV in replicon. *Bioorganic and Medicinal Chemistry*, **11**, 3633–3639.
- 95 Wang, G., Sakthivel, K., Rajappan, V., Bruice, T.W., Tucker, K., Fagan, P., Brooks, J.L., Hurd, T., Leeds, J.M., and Cook, P.D. (2004) Synthesis of azole nucleoside 5'-monophosphate mimics (P1Ms) and their inhibitory properties of IMP dehydrogenases. *Nucleosides, Nucleotides & Nucleic Acids*, **23**, 317–337.
- 96 Booramra, C.G., Chen, J.M., Huang, A.X., Kim, C.U., Lin, K.-Y., Mackman, R.L., Oare, D.A., Perry, J.K., Saunders, O.L., Swaminathan, S., and Zhang, L. (2008) Antiviral phosphinate compounds. WO2008005542
- 97 Chen, J.M., Huang, A.X., Mackman, R.L., Parrish, J.P., Perry, J.K., Saunders, O.L., and Sperandio, D. (2008) Nucleoside analogs for antiviral treatment. WO2008100447
- 98 Martin, J.C. and Verheyden, J.P.H. (1988) Synthesis of 4'-(hydroxymethyl) guanosine and a phosphonate analogue of guanylic acid. *Nucleosides, Nucleotides & Nucleic Acids*, **7**, 365–374.
- 99 Koh, Y.H., Shim, J.H., Wu, J.Z., Zhong, W., Hong, Z., and Girardet, J.L. (2005) Design, synthesis, and antiviral activity of adenosine 5'-phosphonate analogues as chain terminators against hepatitis C virus. *Journal of Medicinal Chemistry*, **48**, 2867–2875.
- 100 Mackman, R.L., Booramra, C.G., Chen, J., Feng, J., Gao, Y., Laflamme, G., Lee, S., Mabery, E., Markevitch, D., Parrish, J., Perry, J., Petrakovsky, O., Ray, A.S., Shih, I.-H., Sperandio, D., Vela, J., and Cihlar, T. (2008) Synthesis and antiviral activity of 4'-modified carbocyclic nucleoside phosphonates. *Collection Symposium Series*, **10**, 191–195.
- 101 Cundy, K.C., Barditch-Crovo, P., Petty, B.G., Ruby, A., Redpath, M., Jaffe, H.S., and Lietman, P.S. (1999) Clinical pharmacokinetics of 1-[(S)-2-hydroxy-2-oxo-1,4,2-dioxaphosphorinan-5-yl]methyl]cytosine in human immunodeficiency virus-infected patients. *Antimicrobial Agents and Chemotherapy*, **43**, 271–277.
- 102 Wachsmann, M., Petty, B.G., Cundy, K.C., Jaffe, H.S., Fisher, P.E., Pastelak, A., and Lietman, P.S. (1996) Pharmacokinetics, safety and bioavailability of HPMPC (cidofovir) in human immunodeficiency virus-infected subjects. *Antiviral Research*, **29**, 153–161.
- 103 Hecker, S.J. and Erion, M.D. (2008) Prodrugs of phosphates and phosphonates. *Journal of Medicinal Chemistry*, **51**, 2328–2345.
- 104 Mackman, R. and Cihlar, T. (2004) Prodrug strategies in the design of

- nucleoside and nucleotide antiviral therapeutics. *Annual Reports in Medicinal Chemistry*, **39**, 305–322.
- 105 Krise, J.P. and Stella, V.J. (1996) Prodrugs of phosphates, phosphonates, and phosphonates. *Advanced Drug Delivery Reviews*, **19**, 287–310.
- 106 Bischofberger, N., Hitchcock, M.J., Chen, M.S., Barkhimer, D.B., Cundy, K.C., Kent, K.M., Lacy, S.A., Lee, W.A., Li, Z.H., Mendel, D.B. *et al.* (1994) 1-[(S)-2-hydroxy-2-oxo-1,4,2-dioxaphosphorinan-5-yl)methyl] cytosine, an intracellular prodrug for (S)-1-(3-hydroxy-2-phosphonylmethoxypropyl)cytosine with improved therapeutic index *in vivo*. *Antimicrobial Agents and Chemotherapy*, **38**, 2387–2391.
- 107 Mendel, D.B., Cihlar, T., Moon, K., and Chen, M.S. (1997) Conversion of 1-[(S)-2-hydroxy-2-oxo-1,4,2-dioxaphosphorinan-5-yl)methyl]cytosine to cidofovir by an intracellular cyclic CMP phosphodiesterase. *Antimicrobial Agents and Chemotherapy*, **41**, 641–646.
- 108 Ho, E.S., Lin, D.C., Mendel, D.B., and Cihlar, T. (2000) Cytotoxicity of antiviral nucleotides adefovir and cidofovir is induced by the expression of human renal organic anion transporter 1. *Journal of the American Society of Nephrology*, **11**, 383–393.
- 109 Robbins, B.L., Srinivas, R.V., Kim, C., Bischofberger, N., and Fridland, A. (1998) Anti-human immunodeficiency virus activity and cellular metabolism of a potential prodrug of the acyclic nucleoside phosphonate 9-R-(2-phosphonomethoxypropyl)adenine (PMPA), bis (isopropylloxymethylcarbonyl) PMPA. *Antimicrobial Agents and Chemotherapy*, **42**, 612–617.
- 110 Arimilli, M., Kim, C., and Bischofberger, N. (1997) Synthesis, *in vitro* biological evaluation, and oral bioavailability of 9-[2-(phosphonomethoxy)propyl]adenine (PMPA) prodrugs. *Antiviral Chemistry & Chemotherapy*, **8**, 557–564.
- 111 Starrett, J.E., Jr., Tortolani, D.R., Russell, J., Hitchcock, M.J., Whiterock, V., Martin, J.C., and Mansuri, M.M. (1994) Synthesis, oral bioavailability determination, and *in vitro* evaluation of prodrugs of the antiviral agent 9-[2-(phosphonomethoxy)ethyl]adenine (PMEA). *Journal of Medicinal Chemistry*, **37**, 1857–1864.
- 112 Barditch-Crovo, P., Toole, J., Hendrix, C.W., Cundy, K.C., Ebeling, D., Jaffe, H.S., and Lietman, P.S. (1997) Anti-human immunodeficiency virus (HIV) activity, safety, and pharmacokinetics of adefovir dipivoxil (9-[2-(bis-pivaloyloxymethyl)-phosphonylmethoxyethyl]adenine) in HIV-infected patients. *The Journal of Infectious Diseases*, **176**, 406–413.
- 113 Barditch-Crovo, P., Deeks, S.G., Collier, A., Safrin, S., Coakley, D.F., Miller, M., Kearney, B.P., Coleman, R.L., Lamy, P.D., Kahn, J.O., McGowan, I., and Lietman, P.S. (2001) Phase I/II trial of the pharmacokinetics, safety, and antiretroviral activity of tenofovir disoproxil fumarate in human immunodeficiency virus-infected adults. *Antimicrobial Agents and Chemotherapy*, **45**, 2733–2739.
- 114 Yuen, M.F., Kim, J., Kim, C.R., Ngai, V., Yuen, J.C., Min, C., Kang, H.M., Shin, B.S., Yoo, S.D., and Lai, C.L. (2006) A randomized placebo-controlled, dose-finding study of oral LB80380 in HBeAg-positive patients with chronic hepatitis B. *Antiviral Therapy*, **11**, 977–983.
- 115 Yuen, M.F., Han, K.H., Um, S.H., Yoon, S.K., Kim, H.R., Kim, J., Kim, C.R., and Lai, C.L. (2010) Antiviral activity and safety of LB80380 in hepatitis B e antigen-positive chronic hepatitis B patients with lamivudine-resistant disease. *Hepatology (Baltimore, MD)*, **51**, 767–776.
- 116 Benzaria, S., Pelicano, H., Johnson, R., Maury, G., Imbach, J.L., Aubertin, A.M., Obert, G., and Gosselin, G. (1996) Synthesis, *in vitro* antiviral evaluation, and stability studies of bis(S-acyl-2-thioethyl) ester derivatives of 9-[2-(phosphonomethoxy)ethyl]adenine (PMEA) as potential PMEA prodrugs with improved oral bioavailability. *Journal of Medicinal Chemistry*, **39**, 4958–4965.
- 117 Lin, C.C., Fang, C., Benetton, S., Xu, G.F., and Yeh, L.T. (2006) Metabolic activation of pradefovir by CYP3A4 and its potential as an inhibitor or inducer. *Antimicrobial Agents and Chemotherapy*, **50**, 2926–2931.



- 118 Reddy, K.R., Matelich, M.C., Ugarkar, B.G., Gomez-Galeno, J.E., DaRe, J., Ollis, K., Sun, Z., Craig, W., Colby, T.J., Fujitaki, J.M., Boyer, S.H., van Poelje, P.D., and Erion, M.D. (2008) Pradefovir: a prodrug that targets adefovir to the liver for the treatment of hepatitis B. *Journal of Medicinal Chemistry*, **51**, 666–676.
- 119 Lin, C.C., Xu, C., Teng, A., Yeh, L.T., and Peterson, J. (2005) Pharmacokinetics of pradefovir and PMEA in healthy volunteers after oral dosing of pradefovir. *Journal of Clinical Pharmacology*, **45**, 1250–1258.
- 120 Lin, C., Xu, C., Yeh, L., Sullivan-Bolyai, J., and Xu, Y. (2006) Pharmacokinetics and pharmacodynamics of pradefovir, a liver-targeting prodrug of PMEA in HBV patients. *Journal of Hepatology*, **44**, S16.
- 121 Kamiya, N., Kubota, A., Iwase, Y., Sekiya, K., Ubasawa, M., and Yuasa, S. (2002) Antiviral activities of MCC-478, a novel and specific inhibitor of hepatitis B virus. *Antimicrobial Agents and Chemotherapy*, **46**, 2872–2877.
- 122 Ono-Nita, S.K., Kato, N., Shiratori, Y., Carrilho, F.J., and Omata, M. (2002) Novel nucleoside analogue MCC-478 (LY582563) is effective against wild-type or lamivudine-resistant hepatitis B virus. *Antimicrobial Agents and Chemotherapy*, **46**, 2602–2605.
- 123 Sekiya, K., Takashima, H., Ueda, N., Kamiya, N., Yuasa, S., Fujimura, Y., and Ubasawa, M. (2002) 2-Amino-6-arylthio-9-[2-(phosphonomethoxy)ethyl]purine bis(2,2,2-trifluoroethyl) esters as novel HBV-specific antiviral reagents. *Journal of Medicinal Chemistry*, **45**, 3138–3142.
- 124 Wise, S., Soon, K., Lowe, S., Teng, C., Pan, A., and McGill, J. (2002) A Safety and pharmacodynamic dose ranging study of LY582563 (MCC-478), a novel nucleotide analogue prodrug, in chronic hepatitis B patients. *Gastroenterology*, **122**, 452 (Abs T1360).
- 125 Hostetler, K.Y. (2009) Alkoxyalkyl prodrugs of acyclic nucleoside phosphonates enhance oral antiviral activity and reduce toxicity: current state of the art. *Antiviral Research*, **82**, A84–A88.
- 126 Ciesla, S.L., Trahan, J., Wan, W.B., Beadle, J.R., Aldern, K.A., Painter, G.R., and Hostetler, K.Y. (2003) Esterification of cidofovir with alkoxyalkanols increases oral bioavailability and diminishes drug accumulation in kidney. *Antiviral Research*, **59**, 163–171.
- 127 Quenelle, D.C., Collins, D.J., Pettway, L.R., Hartline, C.B., Beadle, J.R., Wan, W.B., Hostetler, K.Y., and Kern, E.R. (2008) Effect of oral treatment with (S)-HPMPA, HDP-(S)-HPMPA or ODE-(S)-HPMPA on replication of murine cytomegalovirus (MCMV) or human cytomegalovirus (HCMV) in animal models. *Antiviral Research*, **79**, 133–135.
- 128 Quenelle, D.C., Collins, D.J., Wan, W.B., Beadle, J.R., Hostetler, K.Y., and Kern, E.R. (2004) Oral treatment of cowpox and vaccinia virus infections in mice with ether lipid esters of cidofovir. *Antimicrobial Agents and Chemotherapy*, **48**, 404–412.
- 129 Parker, S., Touchette, E., Oberle, C., Almond, M., Robertson, A., Trost, L.C., Lampert, B., Painter, G., and Buller, R.M. (2008) Efficacy of therapeutic intervention with an oral ether-lipid analogue of cidofovir (CMX001) in a lethal mousepox model. *Antiviral Research*, **77**, 39–49.
- 130 Lanier, R., Lampert, B., Trosta, L., Almonda, M., and Painter, G. (2009) Development of hexadecyloxypropyl tenofovir (CMX157) for HIV: potential for use as a microbicide and therapeutic. 22nd International Conference on Antiviral Research, Abstr 89, Miami Beach, FL, USA.
- 131 Painter, G.R., Almond, M.R., Trost, L.C., Lampert, B.M., Neyts, J., De Clercq, E., Korba, B.E., Aldern, K.A., Beadle, J.R., and Hostetler, K.Y. (2007) Evaluation of hexadecyloxypropyl-9-R-[2-(phosphonomethoxy)propyl]-adenine, CMX157, as a potential treatment for human immunodeficiency virus type 1 and hepatitis B virus infections. *Antimicrobial Agents and Chemotherapy*, **51**, 3505–3509.
- 132 Wyles, D.L., Kaihara, K.A., Korba, B.E., Schooley, R.T., Beadle, J.R., and Hostetler, K.Y. (2009) The octadecyloxyethyl ester of (S)-9-[3-hydroxy-2-(phosphonomethoxy)propyl]adenine is a potent and selective inhibitor of hepatitis C virus replication in

- genotype 1A, 1B, and 2A replicons. *Antimicrobial Agents and Chemotherapy*, **53**, 2660–2662.
- 133 Cahard, D., McGuigan, C., and Balzarini, J. (2004) Aryloxy phosphoramidate triesters as pro-tides. *Mini-Reviews in Medicinal Chemistry*, **4**, 371–381.
- 134 Cihlar, T. (2008) Amidate prodrugs of nucleoside phosphonates: from design to *in vivo* proof of concept. *Collection Symposium Series*, **10**, 45–53.
- 135 Mackman, R.L., Ray, A.S., Hui, H.C., Zhang, L., Birkus, G., Booramra, C.G., Desai, M.C., Douglas, J.L., Gao, Y., Grant, D., Laflamme, G., Lin, K.-Y., Markevitch, D.Y., Mishra, R., McDermott, M., Pakdaman, R., Petrakovsky, O.V., Vela, J.E., and Cihlar, T. (2010) Discovery of GS-9131: design, synthesis and optimization of amidate prodrugs of the novel nucleoside phosphonates HIV reverse transcriptase (RT) inhibitor GS-9148. *Bioorganic and Medicinal Chemistry*, **18** (10), 3606–3617.
- 136 Ballatore, C., McGuigan, C., De Clercq, E., and Balzarini, J. (2001) Synthesis and evaluation of novel amidate prodrugs of PMEA and PMPA. *Bioorganic & Medicinal Chemistry Letters*, **11**, 1053–1056.
- 137 Lee, W.A., He, G.-X., Eisenberg, E., Cihlar, T., Swaminathan, S., Mulato, A., and Cundy, K.C. (2005) Selective intracellular activation of a novel prodrug of the human immunodeficiency virus reverse transcriptase inhibitor tenofovir leads to preferential distribution and accumulation in lymphatic tissue. *Antimicrobial Agents and Chemotherapy*, **49**, 1898–1906.
- 138 Birkus, G., Wang, R., Liu, X., Kutty, N., MacArthur, H., Cihlar, T., Gibbs, C., Swaminathan, S., Lee, W., and McDermott, M. (2007) Cathepsin A is the major hydrolase catalyzing the intracellular hydrolysis of the antiretroviral nucleotide phosphonoamidate prodrugs GS-7340 and GS-9131. *Antimicrobial Agents and Chemotherapy*, **51**, 543–550.
- 139 Birkus, G., Kutty, N., He, G.X., Mulato, A., Lee, W., McDermott, M., and Cihlar, T. (2008) Activation of 9-[(R)-2-[[[(S)-1-(isopropoxycarbonyl)ethyl]amino]phenoxyphosphinyl]-methoxy]propyl]adenine (GS-7340) and other tenofovir phosphonoamidate prodrugs by human proteases. *Molecular Pharmacology*, **74**, 92–100.
- 140 Chou, T.F., Baraniak, J., Kaczmarek, R., Zhou, X., Cheng, J., Ghosh, B., and Wagner, C.R. (2007) Phosphoramidate pronucleotides: a comparison of the phosphoramidase substrate specificity of human and *Escherichia coli* histidine triad nucleotide binding proteins. *Molecular Pharmacology*, **4**, 208–217.
- 141 Keith, K.A., Hitchcock, M.J., Lee, W.A., Holý, A., and Kern, E.R. (2003) Evaluation of nucleoside phosphonates and their analogs and prodrugs for inhibition of orthopoxvirus replication. *Antimicrobial Agents and Chemotherapy*, **47**, 2193–2198.
- 142 Cihlar, T., Laflamme, G., Fisher, R., Carey, A.C., Vela, J.E., Mackman, R., and Ray, A.S. (2009) Novel nucleotide human immunodeficiency virus reverse transcriptase inhibitor GS-9148 with a low nephrotoxic potential: characterization of renal transport and accumulation. *Antimicrobial Agents and Chemotherapy*, **53**, 150–156.
- 143 Ray, A.S., Vela, J.E., Booramra, C.G., Zhang, L., Hui, H., Callebaut, C., Stray, K., Lin, K.Y., Gao, Y., Mackman, R.L., and Cihlar, T. (2008) Intracellular metabolism of the nucleotide prodrug GS-9131, a potent anti-human immunodeficiency virus agent. *Antimicrobial Agents and Chemotherapy*, **52**, 648–654.
- 144 Lalezari, J.P., Stagg, R.J., Kuppermann, B.D., Holland, G.N., Kramer, F., Ives, D.V., Youle, M., Robinson, M.R., Drew, W.L., and Jaffe, H.S. (1997) Intravenous didanosine for peripheral cytomegalovirus retinitis in patients with AIDS: a randomized, controlled trial. *Annals of Internal Medicine*, **126**, 257–263.
- 145 Lalezari, J.P., Holland, G.N., Kramer, F., McKinley, G.F., Kemper, C.A., Ives, D.V., Nelson, R., Hardy, W.D., Kuppermann, B.D., Northfelt, D.W., Youle, M., Johnson, M., Lewis, R.A., Weinberg, D.V., Simon, G.L., Wolitz, R.A., Ruby, A.E., Stagg, R.J., and Jaffe, H.S. (1998) Randomized, controlled study of the safety and efficacy of intravenous didanosine for the treatment of relapsing cytomegalovirus retinitis in patients

- with AIDS. *Journal of Acquired Immune Deficiency Syndromes and Human Retrovirology*, **17**, 339–344.
- 146 Cihlar, T., Fuller, M.D., and Cherrington, J.M. (1998) Characterization of drug resistance-associated mutations in the human cytomegalovirus DNA polymerase gene by using recombinant mutant viruses generated from overlapping DNA fragments. *Journal of Virology*, **72**, 5927–5936.
- 147 Bray, M. and Roy, C.J. (2004) Antiviral prophylaxis of smallpox. *The Journal of Antimicrobial Chemotherapy*, **54**, 1–5.
- 148 Kahn, J., Lagakos, S., Wulfsohn, M., Chong, D., Miller, M., Cherrington, J., Hardy, D., Beall, G., Cooper, R., Murphy, R., Basgoz, N., Ng, E., Deeks, S., Winslow, D., Toole, J.J., and Coakley, D. (1999) Efficacy and safety of adefovir dipivoxil with antiretroviral therapy: a randomized controlled trial. *The Journal of the American Medical Association*, **282**, 2305–2312.
- 149 Marcellin, P., Chang, T.T., Lim, S.G., Tong, M.J., Sievert, W., Shiffman, M.L., Jeffers, L., Goodman, Z., Wulfsohn, M.S., Xiong, S., Fry, J., and Brosgart, C.L. (2003) Adefovir dipivoxil for the treatment of hepatitis B e antigen-positive chronic hepatitis B. *The New England Journal of Medicine*, **348**, 808–816.
- 150 Hadziyannis, S.J., Tassopoulos, N.C., Heathcote, E.J., Chang, T.T., Kitis, G., Rizzetto, M., Marcellin, P., Lim, S.G., Goodman, Z., Wulfsohn, M.S., Xiong, S., Fry, J., and Brosgart, C.L. (2003) Adefovir dipivoxil for the treatment of hepatitis B e antigen-negative chronic hepatitis B. *The New England Journal of Medicine*, **348**, 800–807.
- 151 Hadziyannis, S.J., Tassopoulos, N.C., Heathcote, E.J., Chang, T.T., Kitis, G., Rizzetto, M., Marcellin, P., Lim, S.G., Goodman, Z., Ma, J., Brosgart, C.L., Borroto-Esoda, K., Arterburn, S., and Chuck, S.L. (2006) Long-term therapy with adefovir dipivoxil for HBeAg-negative chronic hepatitis B for up to 5 years. *Gastroenterology*, **131**, 1743–1751.
- 152 Peters, M.G., Hann, H.W., Martin, P., Heathcote, E.J., Buggisch, P., Rubin, R., Bourliere, M., Kowdley, K., Trepo, C., Gray, D.F., Sullivan, M., Kleber, K., Ebrahimi, R., Xiong, S., and Brosgart, C.L. (2004) Adefovir dipivoxil alone or in combination with lamivudine in patients with lamivudine-resistant chronic hepatitis B. *Gastroenterology*, **126**, 91–101.
- 153 Schiff, E., Lai, C.L., Hadziyannis, S., Neuhaus, P., Terrault, N., Colombo, M., Tillmann, H., Samuel, D., Zeuzem, S., Villeneuve, J.P., Arterburn, S., Borroto-Esoda, K., Brosgart, C., and Chuck, S. (2007) Adefovir dipivoxil for wait-listed and post-liver transplantation patients with lamivudine-resistant hepatitis B: final long-term results. *Liver Transplantation*, **13**, 349–360.
- 154 Schiff, E.R., Lai, C.L., Hadziyannis, S., Neuhaus, P., Terrault, N., Colombo, M., Tillmann, H.L., Samuel, D., Zeuzem, S., Lilly, L., Rendina, M., Villeneuve, J.P., Lama, N., James, C., Wulfsohn, M.S., Namini, H., Westland, C., Xiong, S., Choy, G.S., Van Doren, S., Fry, J., and Brosgart, C.L. (2003) Adefovir dipivoxil therapy for lamivudine-resistant hepatitis B in pre- and post-liver transplantation patients. *Hepatology (Baltimore, MD)*, **38**, 1419–1427.
- 155 Deeks, S.G., Barditch-Crovo, P., Lietman, P.S., Hwang, F., Cundy, K.C., Rooney, J.F., Hellmann, N.S., Safran, S., and Kahn, J.O. (1998) Safety, pharmacokinetics, and antiretroviral activity of intravenous 9-[2-(R)-(phosphonomethoxy)propyl]adenine, a novel anti-human immunodeficiency virus (HIV) therapy, in HIV-infected adults. *Antimicrobial Agents and Chemotherapy*, **42**, 2380–2384.
- 156 Schooley, R.T., Ruane, P., Myers, R.A., Beall, G., Lampiris, H., Berger, D., Chen, S.S., Miller, M.D., Isaacson, E., and Cheng, A.K. (2002) Tenofovir DF in antiretroviral-experienced patients: results from a 48-week, randomized, double-blind study. *AIDS (London, England)*, **16**, 1257–1263.
- 157 Squires, K., Pozniak, A.L., Pierone, G., Jr., Steinhart, C.R., Berger, D., Bellos, N.C., Becker, S.L., Wulfsohn, M., Miller, M.D., Toole, J.J., Coakley, D.F., and Cheng, A. (2003) Tenofovir disoproxil fumarate in nucleoside-resistant HIV-1 infection: a randomized trial. *Annals of Internal Medicine*, **139**, 313–320.

- 158 Gallant, J.E., Staszewski, S., Pozniak, A.L., DeJesus, E., Suleiman, J.M., Miller, M.D., Coakley, D.F., Lu, B., Toole, J.J., and Cheng, A.K. (2004) Efficacy and safety of tenofovir DF vs stavudine in combination therapy in antiretroviral-naive patients: a 3-year randomized trial. *The Journal of the American Medical Association*, **292**, 191–201.
- 159 Arribas, J.R., Pozniak, A.L., Gallant, J.E., DeJesus, E., Gazzard, B., Campo, R.E., Chen, S.S., McColl, D., Holmes, C.B., Enejosa, J., Toole, J.J., and Cheng, A.K. (2008) Tenofovir disoproxil fumarate, emtricitabine, and efavirenz compared with zidovudine/lamivudine and efavirenz in treatment-naive patients: 144-week analysis. *Journal of Acquired Immune Deficiency Syndromes*, **47**, 74–78.
- 160 Gallant, J.E., DeJesus, E., Arribas, J.R., Pozniak, A.L., Gazzard, B., Campo, R.E., Lu, B., McColl, D., Chuck, S., Enejosa, J., Toole, J.J., and Cheng, A.K. (2006) Tenofovir DF, emtricitabine, and efavirenz vs. zidovudine, lamivudine, and efavirenz for HIV. *The New England Journal of Medicine*, **354**, 251–260.
- 161 Sax, P.E., Tierney, C., Collier, A.C., Fischl, M.A., Mollan, K., Peeples, L., Godfrey, C., Jahed, N.C., Myers, L., Katzenstein, D., Farajallah, A., Rooney, J.F., Ha, B., Woodward, W.C., Koletar, S.L., Johnson, V.A., Geiseler, P.J., and Daar, E.S. (2009) Abacavir-lamivudine versus tenofovir-emtricitabine for initial HIV-1 therapy. *The New England Journal of Medicine*, **361**, 2230–2240.
- 162 Johnson, M.A., Gathe, J.C., Jr., Podzamczar, D., Molina, J.M., Naylor, C.T., Chiu, Y.L., King, M.S., Podsadecki, T.J., Hanna, G.J., and Brun, S.C. (2006) A once-daily lopinavir/ritonavir-based regimen provides noninferior antiviral activity compared with a twice-daily regimen. *Journal of Acquired Immune Deficiency Syndromes*, **43**, 153–160.
- 163 Johnson, M., Grinsztejn, B., Rodriguez, C., Coco, J., DeJesus, E., Lazzarin, A., Lichtenstein, K., Wirtz, V., Rightmire, A., Odeshoo, L., and McLaren, C. (2006) 96-Week comparison of once-daily atazanavir/ritonavir and twice-daily lopinavir/ritonavir in patients with multiple virologic failures. *AIDS (London, England)*, **20**, 711–718.
- 164 Zolopa, A.R. (2010) The evolution of HIV treatment guidelines: current state-of-the-art of ART. *Antiviral Research*, **85**, 241–244.
- 165 Wainberg, M.A., Miller, M.D., Quan, Y., Salomon, H., Mulato, A.S., Lamy, P.D., Margot, N.A., Anton, K.E., and Cherrington, J.M. (1999) *In vitro* selection and characterization of HIV-1 with reduced susceptibility to PMPA. *Antiviral Therapy*, **4**, 87–94.
- 166 Weber, J., Chakraborty, B., Weberova, J., Miller, M.D., and Quinones-Mateu, M.E. (2005) Diminished replicative fitness of primary human immunodeficiency virus type 1 isolates harboring the K65R mutation. *Journal of Clinical Microbiology*, **43**, 1395–1400.
- 167 Miller, M.D. (2004) K65R, TAMs and tenofovir. *AIDS Reviews*, **6**, 22–33.
- 168 Szczech, L.A. (2008) Renal dysfunction and tenofovir toxicity in HIV-infected patients. *Topics in HIV Medicine*, **16**, 122–126.
- 169 Izzedine, H., Hulot, J.S., Vittecoq, D., Gallant, J.E., Staszewski, S., Launay-Vacher, V., Cheng, A., and Deray, G. (2005) Long-term renal safety of tenofovir disoproxil fumarate in antiretroviral-naive HIV-1-infected patients: data from a double-blind randomized active-controlled multicentre study. *Nephrology, Dialysis, Transplantation*, **20**, 743–746.
- 170 Gallant, J.E., Parish, M.A., Keruly, J.C., and Moore, R.D. (2005) Changes in renal function associated with tenofovir disoproxil fumarate treatment, compared with nucleoside reverse-transcriptase inhibitor treatment. *Clinical Infectious Diseases*, **40**, 1194–1198.
- 171 Rodriguez-Novoa, S., Labarga, P., D'Avolio, A., Barreiro, P., Albalade, M., Vispo, E., Solera, C., Siccardi, M., Bonora, S., Di Perri, G., and Soriano, V. (2010) Impairment in kidney tubular function in patients receiving tenofovir is associated with higher tenofovir plasma concentrations. *AIDS (London, England)*, **24**, 1064–1066.
- 172 Garcia-Lerma, J.G., Paxton, L., Kilmarx, P.H., and Heneine, W. (2010) Oral pre-exposure prophylaxis for HIV prevention.

- Trends in Pharmacological Sciences*, **31**, 74–81.
- 173 Cohen, M.S., Kaleebu, P., and Coates, T. (2008) Prevention of the sexual transmission of HIV-1: preparing for success. *Journal of the International AIDS Society*, **11**, 4.
- 174 Karim, S. and Baxter, C. (2009) Antiretroviral prophylaxis for the prevention of HIV infection: future implementation challenges. *HIV Therapy*, **3**, 3–6.
- 175 van Bommel, F., Wunsche, T., Schurmann, D., and Berg, T. (2002) Tenofovir treatment in patients with lamivudine-resistant hepatitis B mutants strongly affects viral replication. *Hepatology (Baltimore, MD)*, **36**, 507–508.
- 176 Benhamou, Y., Tubiana, R., and Thibault, V. (2003) Tenofovir disoproxil fumarate in patients with HIV and lamivudine-resistant hepatitis B virus. *The New England Journal of Medicine*, **348**, 177–178.
- 177 Nunez, M., Perez-Olmeda, M., Diaz, B., Rios, P., Gonzalez-Lahoz, J., and Soriano, V. (2002) Activity of tenofovir on hepatitis B virus replication in HIV-co-infected patients failing or partially responding to lamivudine. *AIDS (London, England)*, **16**, 2352–2354.
- 178 Marcellin, P., Heathcote, E.J., Buti, M., Gane, E., de Man, R.A., Krastev, Z., Germanidis, G., Lee, S.S., Flisiak, R., Kaita, K., Manns, M., Kotzev, I., Tchernev, K., Buggisch, P., Weilert, F., Kurdas, O.O., Shiffman, M.L., Trinh, H., Washington, M.K., Sorbel, J., Anderson, J., Snow-Lampart, A., Mondou, E., Quinn, J., and Rousseau, F. (2008) Tenofovir disoproxil fumarate versus adefovir dipivoxil for chronic hepatitis B. *The New England Journal of Medicine*, **359**, 2442–2455.
- 179 Heathcote, E.J., Gane, E., deMan, R., Lee, S., Flisiak, R., Manns, M., Tchernev, K., Kurdas, O.O., Schiffman, M., Marcellin, P., Sorbel, J., Anderson, J., Mondou, E., and Rousseau, F. (2009) Three years of tenofovir disoproxil fumarate (TDF) in HBeAg-positive patients with chronic hepatitis B (Study 102). 60th Annual Meeting of the American Association for the Study of Liver Diseases, Boston, MA, USA (Abst. 483).
- 180 Marcellin, P., Buti, M., Krastev, Z., Germanidis, G., Kaita, K., Kotzev, I., Buggisch, P., Weilert, F., Trinh, H., Gurel, S., Heathcote, E.J., Sorbel, J., Anderson, J., Mondou, E., and Rousseau, F. (2009) Three years of tenofovir disoproxil fumarate (TDF) in HBeAg-negative patients with chronic hepatitis B (Study 102). 60th Annual Meeting of the American Association for the Study of Liver Diseases, Boston, MA, USA (Abst. 481).

## 6

# Helicase–Primase Inhibitors: A New Approach to Combat Herpes Simplex Virus and Varicella Zoster Virus

Subhajit Biswas and Hugh J. Field

### 6.1

#### Introduction

Members of the *Herpesviridae* have coevolved with their human and animal hosts over hundreds of thousands of years [1, 2]. Herpesviruses cause life-long infections characterized by latency with reactivation from time to time. Among the human herpesviruses, the alphaherpesviruses – herpes simplex virus 1 (HSV-1) and 2 (HSV-2) and varicella zoster virus (VZV) – represent major causes of morbidity. However, since the discovery of idoxuridine in 1959, a variety of antiviral drugs have been developed to prevent or treat the lesions caused by primary or recurrent infection by these viruses [3]. Idoxuridine is a nucleoside analogue that inhibits herpesvirus DNA polymerase albeit with relatively low specificity.

Subsequently, several other nucleoside analogues have been developed as herpesvirus antivirals, most notably acyclovir (ACV) in 1978. Acyclovir and another guanosine analogue, penciclovir (PCV), have the advantage of high selectivity for virus-infected cells and very low toxicity. Both these nucleoside analogues, however, suffer from low oral bioavailability. This constraint was partially overcome by the orally bioavailable prodrugs valaciclovir (VACV) and famciclovir (FCV) that are rapidly converted to ACV and PCV, respectively, *in vivo*.

Over the past decades, these and similar compounds have been reasonably successful in treating the clinical signs of herpesvirus primary or recurrent disease. Furthermore, daily suppressive therapy for many months or years has been quite successful in preventing clinical recurrences. However, nucleoside analogues are not completely efficacious and therapy could be more effective [4]. Thus, therapy may not completely prevent the clinical signs of labial and genital herpes, and the serious long-term consequences of zoster can still occur in the face of treatment. In addition, virus shedding and transmission to a new susceptible host is not always prevented. In particular, current nucleoside analogues do not eradicate latent virus. Although resistance has not been a notable limitation on therapy in immunocompetent individuals, it is recognized as a serious problem in immunocompromised patients where approximately 5% isolates show resistance [3], and this may rise to 30% in

certain groups such as allogeneic stem cell recipients [5]. For these reasons there remains a need for better drugs leading to more effective interventions. To date, the most effective antiherpesvirus antivirals are nucleoside or nucleotide analogues or pyrophosphate analogues, all of which ultimately target HSV or VZV DNA polymerase activity. This chapter will describe the attack on an exciting target elsewhere in the herpesvirus DNA replication process by a new series of antivirals known as the helicase–primase inhibitors (HPIs).

## 6.2

### The Role of Helicase Primase in the Replication of HSV

All herpesviruses contain a double-stranded DNA genome of 120–290 kb encoding more than 70 proteins [1]. The gene products of HSV include several enzymes that are directly or indirectly involved in genome replication occurring within the nucleus of the infected cell. These include the origin binding protein (OBP or UL9), a single-strand DNA binding protein (ICP8 or UL29), a three-subunit helicase primase (HP) comprising UL5, UL8, and UL52, a two-subunit DNA polymerase (UL30 and UL42), thymidine kinase (TK or UL23), and a two-subunit ribonucleotide reductase (UL39 and UL40) [6]. As mentioned above, these functions, particularly DNA polymerase activity, are important targets for selective inhibitors of HSV and VZV including the nucleoside analogues, which, in the case of ACV and PCV, are first converted to the nucleoside monophosphate by HSV TK. After further phosphorylation by means of cellular kinases, ACV- and PCV-triphosphates then bind to DNA polymerase and cause inhibition of DNA synthesis and, in turn, block virus replication. Before DNA polymerase can actively incorporate nucleotides into a growing strand of DNA, two other essential steps are required. First, the double-stranded genome is a substrate for initial unwinding by the 3′–5′ helicase activity of the N-terminus of OBP [7], followed by subsequent unwinding by the 5′–3′ helicase activity of the HP complex [8]. Second, DNA synthesis is primed on the lagging strand by HSV primase (the product of *UL52*) (Figure 6.1).

The helicase–primase complex (UL5/8/52) exhibits several enzymatic activities, including the 5′–3′ helicase, a single-stranded DNA-dependent NTPase, and primase activities. Recent studies are unraveling the exact role(s) of each subunit of the HP heterotrimer. It was previously known that a subcomplex consisting of the UL5 and UL52 subunits is sufficient for the helicase and primase activities [9], while the presence of UL8 stimulates these activities. Photochemical cross-linking studies to dissect the function of each subunit in DNA binding and phosphodiester bond formation has recently revealed that UL52 contains the entire primase active site needed for phosphodiester bond formation, while UL5 contributes minimally to primer synthesis. However, UL52 provides certain key amino acids needed for helicase activity by UL5. In the same study, UL8 was shown to increase the rate of primer synthesis by UL5-UL52, but has no detectable role in the DNA unwinding activity [10]. Furthermore, UL8 also interacts with other replication proteins, including UL9, UL30, and ICP8, suggesting the role of UL8 in modulating protein–protein

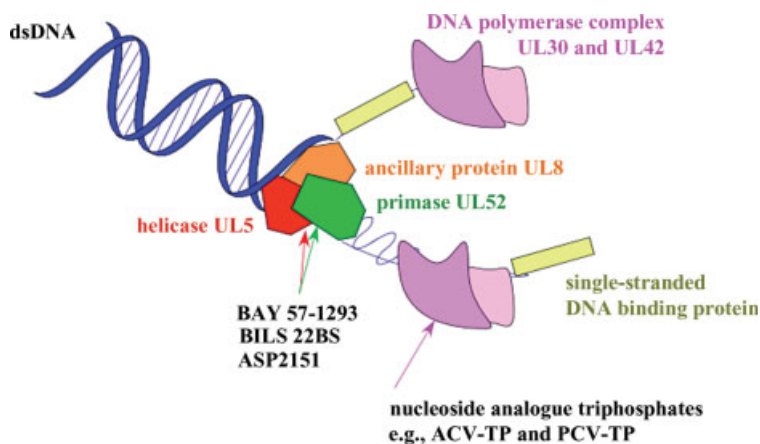

**Figure 6.1** Schematic mechanism of inhibition of herpesvirus DNA replication by nucleoside analogues or helicase–primase inhibitors. The HP complex, as shown in the figure, comprises HSV viral replication proteins UL5, UL8, and UL52. The HP complex unwinds HSV double-stranded DNA at the replication fork and UL52 primes both the lagging-strand and the leading-strand DNA synthesis. The single-stranded DNA binding protein binds to single-stranded template DNA (straight blue lines). HSV DNA polymerase and its accessory protein UL42, promote leading- and lagging-strand DNA

synthesis (wavy thin blue lines to the right). The HP complex, as shown in the figure, comprises HSV viral replication proteins UL5, UL8, and UL52. The HP complex unwinds HSV double-stranded DNA at the replication fork and UL52 primes both the lagging-strand and the leading-strand DNA synthesis. The single-stranded DNA binding protein binds to single-stranded template DNA (straight blue lines). HSV DNA polymerase and its accessory protein UL42, promote leading- and lagging-strand DNA

interactions at the replication fork [6]. Thus, HP is an essential step in the DNA replication of all herpesviruses required before DNA synthesis can commence and the HSV HP complex is required continuously during virus DNA synthesis [11].

### 6.3

#### Selective Inhibitors of Helicase Primase as Antiherpesvirus Antivirals

Characterization of herpesvirus DNA replication enzymes provided several new targets for screening potential inhibitors. Following high-throughput screens of compound libraries, it was discovered that several dihalo-substituted derivatives of the *N*2-phenylguanines and 2-anilinoadenines inhibited the DNA unwinding activity of the helicase component of the HP complex [12]. In the same publication, the primase activity was shown to be strongly inhibited by 3, 4- and 3, 5-dichloroanilino derivatives of adenine and 2-aminopyrimidines. The compounds were inhibitors of HSV in culture, albeit with poor selectivity. From the initial hits, lead compounds were then optimized [13]. Subsequently, several small-molecule inhibitors of HSV were described that were highly selective inhibitors of HP [13–16]. Among the first to



be reported were BILS 45 BS and BILS 179 BS. The subsequent lead compound, BILS 22 BS (Figure 6.2) was shown to be highly active *in vitro* and *in vivo*; however, its development was discontinued. A different series of compounds in the same class was reported by Kleymann *et al.* [14] and the lead compound, BAY 57-1293, is under clinical development (Figure 6.2). In fact, in a recent press release, it has been reported that three phase I studies have been completed with BAY 57-1293 and the drug was generally well tolerated and showed high and long-lasting exposures in human subjects [17].

The first report of the preclinical efficacy of ASP2151 (Figure 6.2), another novel HPI, has been announced recently [18, 19]. ASP2151 was shown to be orally effective and more potent compared to VACV in reducing cutaneous lesions in HSV-1-infected hairless mice [18]. All well-known HPIs, including those under clinical development, are active against HSV-1 and HSV-2 showing similar potency. Among these, ASP2151 is the only reported HPI, to date, with activity against VZV. ASP2151 is 30–76 times more potent against VZV than ACV as tested by plaque reduction assays in HEF cells [19]. ASP2151 is undergoing phase II clinical trials in man for the treatment of HSV-2 and VZV.

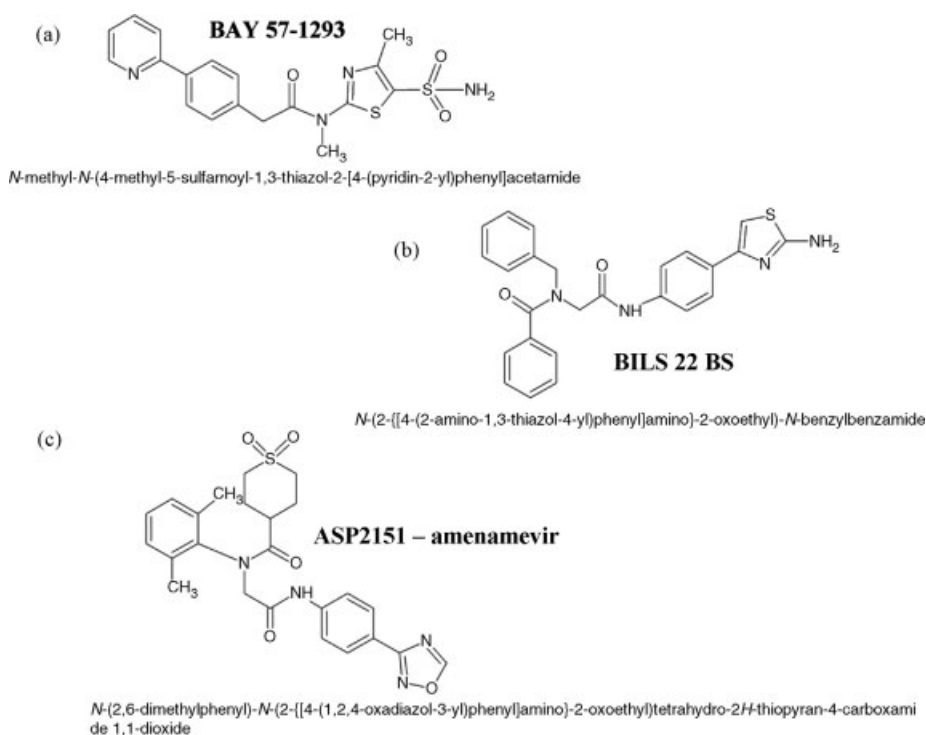

**Figure 6.2** Structural formulae for three most studied helicase–primase inhibitors. (a) BAY57-1293, (b) BILS 22 BS, and (c) ASP2151. The molecular weights are (a) 402, (b) 449, and (c) 452 g/mol.

## 6.4

### HPIs are Effective in Cell Culture and *In Vivo*

HPIs in general are highly potent against HSV. For instance, BAY 57-1293 was reported to be highly active against HSV in cell culture with an  $IC_{50}$  of 0.01–0.03  $\mu\text{M}$  based on conventional plaque or cytopathic effect reduction assays [14]. This was confirmed in our own laboratory using plaque reduction assays, and it was shown that laboratory strains of HSV-1 and a series of recent clinical isolates were all sensitive with an  $IC_{50} \leq 0.05 \mu\text{M}$  by means of plaque reduction in Vero cells [20], confirming the compound to be more potent than the nucleoside analogue ACV or PCV. This promising activity of HPIs was reflected in various rodent HSV infection models [13, 14, 16, 21–23]. The efficacy of BAY 57-1293 has been rehearsed in at least two comprehensive reviews [21, 22]. When tested in murine infection models of disseminated or zosteriform herpes; or by means of the guinea pig model of genital herpes or a rabbit keratitis model, in all cases, HPIs showed potent antiherpes activity [24–27]. Representative HPIs were claimed to significantly reduce time to healing and prevent immediate recurrence of disease after cessation of treatment [13, 25]. Furthermore, HPIs were claimed to be more efficacious than the present therapies (e.g., VACV) when the initiation of treatment was delayed in mice [13, 25], guinea pig [24], or rabbits [27]. The compound BAY 57-1293 was also shown to be at least equally effective or superior to a much higher dose of FCV in the neck–ear zosteriform HSV-1 murine infection model [26]; furthermore, the same study showed that BAY 57-1293 was also effective in immunocompromised (athymic nude) mice. Hence, it was shown in these studies that an oral dose of 15 mg/kg once per day for 4 days starting 1 day after virus inoculation cleared infectious virus from the skin of the neck, from ear pinna, and from neural tissues and there was no evidence of virus recurrence on cessation of therapy. Lower doses of BAY 57-1293 were tested and the  $ED_{50}$  in this and similar infection models was found to be 3–5 mg/kg day for once daily oral dosing or 0.5 mg/kg for thrice daily oral dosing ([25], S. Biswas, unpublished observations). No toxic signs were reported in any animal infection model studies published to date; however, it is worth mentioning that BAY 57-1293 bears structural resemblance to the diuretic drug, acetazolamide, and can inhibit carbonic anhydrase [14]. Chronic toxicity study with BAY 57-1293 showed that this HPI resulted in a dose-dependent transitional hyperplasia of the urinary bladder epithelium in rodents, but not in other animals or humans. The authors suggested that a plasma concentration of 100–300  $\mu\text{M}$  BAY 57-1293 in rats inhibited rodent carbonic anhydrase leading to the observed hyperplasia [14].

Finally, one of the claimed advantages of HPIs is a low resistance rate in cell culture [13, 14, 16, 23], although our data suggest that we should be more careful and make further studies before arriving at any definitive conclusion about the resistance rate (see below). Nevertheless, this class of drugs was proposed to have significant potential for the treatment of HSV disease in humans, including those resistant to current medications [14, 28].

## 6.5

### Effects of HPIs on the Establishment and Reactivation from Latency

The “Holy Grail” for any antiherpesvirus therapy must be to have an impact on the problem of latent infection. The nucleoside analogues used to date for the treatment of acute HSV or VZV infections and for the suppression of recurrent lesions do not eradicate latency and have not prevented the recurrence of lesions on cessation of therapy [29–33]. Experiments in laboratory animal infection models suggest that very early ACV treatment (within a few hours of exposure to the infection) may reduce the establishment of latency. Furthermore, in a series of publications [34, 35], it was claimed that FCV was superior to VACV in this respect and it was shown to be possible to impact on the establishment of latency when treatment was delayed for several days [36]. However, no method has so far been able to completely prevent the colonization of neurons with HSV, and it was shown using molecular methods for the detection of HSV nucleic acids that FCV therapy commencing before exposure and applied continuously could not prevent ganglionic neurons from becoming infected [37]. These results are consistent with the mechanism of action of nucleoside analogues. Although it is too early to prove the situation with HPIs, in theory they would be expected to be similarly incapable of preventing or curing latent infections. However, preliminary data are somewhat encouraging: it was reported in a study using guinea pigs infected with HSV-2 that BAY 57-1293 reduced the viral load in sacral dorsal root ganglia and frequency and severity of recurrences [24]. Similar results were claimed in mice suggesting the suppression of reactivation from latency and reduction of viral load in the trigeminal ganglia [27]. It remains to be seen whether or not these encouraging preliminary reports will stand up to further investigation and it is likely that only after several years of use in the clinic sufficient data will be available to determine whether therapy can have any beneficial effect on the seemingly intractable problems of establishment, maintenance, reactivation, and recurrence of latent infection.

## 6.6

### HPIs: The Biochemical Basis for the Proposed Mechanism of Action

Kleymann *et al.* [14] used time-of-addition studies to investigate the mechanism of action of the potent inhibitor BAY 57-1293. It was reported that the initial stages of HSV infection were not prevented and the expression of HSV immediate early genes was initiated in the presence of the inhibitor. However, PCR, Southern-blot, and *in situ* hybridization methods demonstrated complete inhibition of viral DNA synthesis [14]. As for the nucleoside analogue inhibitors, the target for the new compounds appeared to be one or more of the enzymes involved in the replication of the HSV genome. However, unlike the ACV and similar inhibitors, the specific target in this case appeared to be the HP complex and support for this was provided by direct evidence from HSV enzyme studies.

The HP complex comprises a complicated system of several interacting proteins. Thus, while elegant biochemical and biophysical assays are being used to dissect the

natural functions, they have not yet provided a complete picture. Nevertheless, studies with the BILS series of compounds (the early putative HPIs) showed that, as a class, they individually inhibited the helicase-, primase-, and single-strand DNA-stimulated ATPase activities at submicromolar concentrations. However, the basal ATPase activity was unaffected [13]. This was interpreted as meaning that the inhibitors did not function by displacing ATP from the enzyme-active sites. DNA-docking assays to determine the release of a fluorescein-tagged single-strand DNA from the DNA–HP complex provided further evidence that the compounds directly inhibited the linked unwinding and priming by DNA-dependent ATPase [13]. It was further suggested that the compounds (in the BILS series, at least) caused an increased affinity of the enzyme complex for DNA thus preventing propagation of HSV–HP catalytic cycles. Strong evidence to confirm the proposed novel biochemical mechanisms of antiviral action was obtained from the study of drug-resistant mutants and this will be dealt with in the next section.

It may be concluded, therefore, that the HPIs differ fundamentally from nucleoside analogues with regard to their mechanism of inhibition in that the antiviral activity of the commonly used nucleoside analogues is based upon a two-step process: successive phosphorylation of the compound in virus-infected cells by virus-encoded TK (to form monophosphates) and cellular kinases (to form triphosphates) and subsequent inhibition of the DNA polymerase by the nucleoside triphosphates. Furthermore, DNA polymerization takes place downstream of virus dsDNA unwinding by the HP complex. In contrast, HPIs directly curtail DNA unwinding in one step by binding to the HP complex. This is one possible reason for the increased potency of HPIs compared to nucleoside analogue inhibitors.

## 6.7

### HSV Acquired Resistance to HPIs

The ability to isolate mutants with acquired resistance to a novel inhibitor is by itself evidence for a selective antiviral action. Furthermore, the location of resistance mutations is likely to reflect sites of interaction between the compound and the virus-coded proteins. HPI-resistant mutants were obtained by culturing HSV in the presence of HPI and the critical mutations were found at several loci in UL5 (helicase subunit) and at a single locus in UL52 (primase), thus proving the selective antiviral target (reviewed in Refs [38] and [39]).

In our laboratory, a collection of resistant mutants were obtained mostly by a single passage of plaque-purified laboratory wild-type viruses, HSV-1 SC16 and PDK (originally known as strain CI 101) in the presence of BAY 57-1293, and these resistant mutants were characterized. The location of the mutations was determined by sequencing and they were found to cluster just downstream from the fourth functional domain of the UL5 protein as defined by Zhu and Weller [8]. In addition to these common resistance loci (HSV-1 UL5 amino acid positions: Gly352, Met355, or Lys356), we have recently reported an additional mutation, Asn342Lys that lies at the N-terminus boundary of the predicted helicase motif IV [40]. An analogous mutation

in VZV ORF55 (putative helicase) has also been reported to lower the susceptibility of VZV to ASP2151 [19]. The validity of HSV-1 mutations at Asn342, Gly352, Met355, and Lys356 was tested by marker transfer to wild-type background confirming that point mutations resulting in single amino acid substitutions in the UL5 protein produced viable drug-resistant viruses for the BAY [14, 39–41] and BILS [23] series of HPIs. It was further shown that several of the resistance-conferring mutations (e.g., Gly352Arg or Asn342Lys) were associated with impaired growth in tissue culture and reduced virulence in a murine HSV-1 infection model [40–42].

Other substitutions, most notably Lys356Asn that conferred more than 5000-fold resistance to BAY 57-1293, showed normal growth in cell culture and retained virulence in the infection model. Another notable example of an apparently “fit” HPI-resistant mutant is the UL5:Lys356Gln mutant that conferred 100-fold resistance to BAY 57-1293 and was associated with increased growth characteristics in Vero cells [41]. This mutation was at least equally fit compared to the wild type; in fact, it produced somewhat higher lesion scores in mice at early time points [42]. There have been very few reports of HSV mutants that exceed the parental virus in fitness. However, Pesola and Coen [43] reported that an HSV-1 UL6 mutant selected for resistance to a thiourea compound was more virulent than the wild type, on the basis of greater mortality and morbidity. Unlike most TK-defective ACV-resistant mutants, the HPI-resistant mutants, tested *in vivo*, to date, are capable of reactivation from latency [23, 41, 42]. The locations of these and other HP-resistance mutations reported by ourselves and others are shown in Table 6.1. To date, only a single HPI-resistance mutation has been located in the primase at UL52 Ala899Thr.<sup>1)</sup>

An interesting observation regarding HPI-resistance mutations is that simultaneous substitutions at HSV-1 Asn342, Gly352, Met355, or Lys356 amino acid position have never been encountered. From this it can be speculated that the HPI binding pocket formed involving these amino acids can accept substitutions at any one position at a given time, whereas multiple substitutions may distort the drug binding pocket to the extent that the HP activity is disrupted, rendering the virus nonviable. However, this proposition needs experimental validation. It is notable that double resistance mutations were, however, encountered when the individual mutations were located separately in *UL5* and *UL52* genes [39].

## 6.8 Patterns of Cross-Resistance

As expected, viruses resistant to nucleoside analogues by virtue of resistance mutations in TK or DNA polymerase remain fully sensitive to HPI in tissue culture and *in vivo* ([28], S. Sukla, unpublished observations). Conversely, none of the HPI-resistant viruses tested, to date, is coresistant to ACV or PCV [14, 23, 41]. These results

1) The location of UL52 primase mutation in HSV-1 F was reported as Ala897Thr (not Ala899Thr) by Kleymann *et al.* [14] because of an apparent deletion of two N-terminus amino acids Asn695 and Asp696 as revealed by sequencing UL52 of the HSV-1 F isolate (G. Kleymann, personal communication).

Table 6.1 Herpesvirus helicase and/or primase mutations conferring resistance to various HPIs.

Herpesvirus strain (mutant)	Drug	Fold resistance	Nucleotide substitution ULS (UL52)	Nucleotide Position (sense strand) (UL52)	Amino acid change in ULS (UL52)	Amino acid Position in ULS (UL52)	Growth properties in tissue culture and (pathogenicity in animal models)	Reference
HSV-1 KOS (K22 <sup>1</sup> )	BILS 22 BS	2500	AAG → AAT	1068	K → N	356	Same as w/t	[23]
HSV-1 KOS (K22 <sup>5</sup> )	BILS 22 BS	316	GGT → GTT	1055	G → V	352	Same as w/t	
HSV-1 KOS (K138 <sup>3</sup> )	BILS 138 BS	38 <sup>a</sup>	GGT → TGT	1054	G → C	352	Same as w/t	
HSV-1 (Two out of 3 resistant isolates)	T157602	n/r	AAG → AAT	1068	K → N	356	n/r	[16]
HSV-2 G (R1)	T157602	n/r	ATG → ACG	1061	M → T	354 <sup>b</sup>	n/r	
HSV-2 G (R4; R6 (Two out of 4 resistant isolates))	T157602	n/r	AAG → AAT	1065	K → N	355 <sup>b</sup>	n/r	
HSV-2 G (R3)	T157602	n/r	GAG → GAT	1197	E → D	399 <sup>b</sup>	n/r	
HSV-1F	BAY 44-5138	> 333	ATG → GTG	1063	M → V	355	n/r	[14]
			GTT → ATT	1984	V → I	662		
			(GCG → ACG)	(2689)	(A → T)	(897 <sup>c</sup> )		
BAY 54-6322		> 500000	AAG → AAT	1068	K → N	356	n/r	
BAY 54-6322		> 2000	(GCG → ACG)	(2689)	(A → T)	(897 <sup>c</sup> )	n/r	
BAY 57-1293		> 400	GGT → GTT	1055	G → V	352	n/r	
BAY 57-1293		> 5	ATG → ACG	1064	M → T	355	Slower than w/t (not reported)	[14]
BAY 57-1293		> 150	AAG → CAG	1066	K → Q	356	n/r	
BAY 57-1293		> 1000 <sup>c</sup>	AAG → AAT <sup>c</sup>	1068	K → N	356	Same as w/t (virulent)	[14, 25]

(Continued)

Table 6.1 (Continued)

Herpesvirus strain (mutant)	Drug	Fold resistance	Nucleotide substitution UL5 (UL52)	Nucleotide Position (sense strand) (UL52)	Amino acid change in UL5 (UL52)	Amino acid Position in UL5 (UL52)	Growth properties in tissue culture and (pathogenicity in animal models)	Reference
HSV-1 SC16 <sup>d)</sup>	BAY 57-1293	100	AAG → CAG	1066	K → Q	356	Faster than w/t (virulent)	[41]
	BILS 22 BS	36						
HSV-1 SC16 <sup>b)</sup>	BAY 57-1293	3333	GGT → CGT	1054	G → R	352	Slower than w/t (less virulent)	[39]
	BILS 22 BS	360						
HSV-1 SC16	BAY 57-1293	124	AAG → ACG	1067	K → T	356	n/r	[39, 46]
HSV-1 PDK c1-1	BAY 57-1293	43	(GCG → ACG)	(2695)	(A → T)	(899)	n/r	[39]
HSV-1 PDK c1-1	BAY 57-1293	2500	AAG → ACG	1067	K → T	356	n/r	
			(GCG → ACG)	(2695)	(A → T)	(899)		
HSV-1 PDK c1-1	BAY 57-1293	43	AAC → AAA	1026	N → K	342	Slower than w/t (less virulent)	[40]
VZV CaQu (C2151 <sup>†</sup> m)	ASP2151	n/r	n/r	n/r	N → K (ORF 55)	336 (ORF 55)	n/r	[19]

n/r: not reported.

a) Fold resistance to BILS 22 BS. The virus was selected to BILS 138 BS.

b) HSV-1 has one leucine more at position 20 in UL5 protein.

c) G. Kleymann, personal communication.

d) The SC16 mutant was selected to BAY 57-1293.

are expected and are consistent with the distinctly different antiviral targets for the two classes of antiviral compounds. These results are important in relation to the future clinical use of HPIs, particularly in immunocompromised patients where clinical resistance to nucleoside analogues has been frequently encountered.

When BAY 57-1293-resistant mutants were tested among different HPIs, a pattern of cross-resistance between the HPIs was observed with one notable exception (Table 6.1, column 2). It was found that HSV-1 containing the primase mutation, UL52:Ala899Thr, which conferred 43-fold resistance to BAY 57-1293, remained fully sensitive to BILS 22 BS. Furthermore, the double mutant containing both UL52 Ala899Thr and UL5 Lys356Thr produced a pattern of cross-resistance suggesting that BAY 57-1293 interacts simultaneously with both components of the HP complex to achieve maximum potency [39], confirming a similar idea proposed by Kleymann [15]. Thus, the BILS series of compounds and possibly ASP2151 (S. Biswas, unpublished observations) appear to differ from BAY 57-1293 in this respect [15, 39]. The surprising sensitivity of the primase mutant to BILS 22 BS (and ASP2151) suggests that the primase mutation (Ala899Thr) may not prevent these compounds from inhibiting primase activity. Alternatively, BILS 22 BS or ASP2151 may not need to interact with UL52 in order to achieve full potency. Unlike BAY 57-1293, BILS 22 BS does not have the sulfonamide moiety, which is thought to be involved in interaction with primase [22]. Although previous reports [23] indicate that BILS 22 BS inhibits DNA helicase, RNA primase, and ATPase activities of the HSV helicase–primase holoenzyme, it is also known that these activities are interdependent: inhibiting one will inhibit the other(s). A third possibility is that BILS 22 BS and BAY 57-1293 interact with UL52 primase at different sites. However, there is no evidence, to date, to support this proposition because so far we know of no other mutation in UL52 (except for Ala899Thr or its equivalent Ala897Thr in strain HSV-1 F [14]) that has been reported to confer resistance to any HPI [39]. Thus, different series of HPI appear to have subtle but possibly important differences in their mode of interaction with the HP complex. Better understanding of these differences will be an important step in the development of HPIs for therapy.

## 6.9

### Further Insight into Mode of HPI Interaction with the HSV HP Complex from the Study of Resistance Mutations

As discussed in the previous sections, the relative inhibitory concentrations required for overcoming particular mutations in the UL5 helicase component and UL52 primase suggested that BAY 57-1293 possibly interacts with both UL5 and UL52 to exert its antiviral activity; inferring that interaction with UL5 or UL52 alone is not sufficient to achieve maximum potency [39]. This leads to the question as to whether or not single molecules of BAY 57-1293 interact simultaneously with both proteins or different molecules interact with the two components independently. If the bindings were independent, BAY 57-1293, at concentrations more than 100 times the  $IC_{50}$  for wild type, would have overcome both the 100-fold resistance conferred by the single



UL5 mutation (Ala356Thr) and the lesser 43-fold resistance due to the UL52 mutation (Ala899Thr). However, we observed this not to be the case since the UL5-UL52 double mutant was 2500-fold resistant to BAY 57-1293, which is more than 17 times the sum of the two individual resistance components (43-fold and 100-fold). Furthermore, if the sites were independent, neither of the single mutations could confer resistance. It was suggested from these pieces of evidence that molecules of BAY 57-1293 interact simultaneously with both UL5 and UL52 [39]. This idea is further strengthened by close interdependence suggested between UL5 and UL52 for helicase and primase activities [6, 10]. For instance, the Lys103Ala mutation in UL5 helicase motif I abolishes helicase activity but increases the primase activity by 15-fold [44]; again, the Leu986Phe mutation in UL52 reduces the primase activity by 25% but enhances the helicase and single-stranded DNA-dependent ATPase activities [45].

From the published data, together with our own unpublished observations, it appears that an  $\alpha$ -helical region of HSV-1 UL5 (Phe-351-Gly-Asn-Leu-Met-Lys356), close to helicase motif IV [22] and the region of UL52 primase, containing the residue Ala899 form an important site of interaction between these two enzymes and an interaction pocket with HPI [40]. One study has suggested that the site of interaction between UL5 and UL52 acts as an interface for binding the HP complex to the viral DNA [45]. Thus, it is likely that BAY 57-1293 possibly interacts with the HP complex at its DNA binding site and stabilizes the interaction between the HSV HP complex and the nucleic acid, as mentioned previously for other HPis (see Section 6.3).

As mentioned above, the Asn342Lys mutation in HSV-1 UL5 predicted that the helicase motif IV is associated with HPI resistance, slower virus growth in cell culture, and reduced virulence. Comparative modeling and docking studies predicted the Asn342 position to be physically distant from the HPI interaction pocket formed by UL5 and UL52 (Figure 6.3). We suggested this mutation results in steric/allosteric modification of the HPI binding pocket, conferring an indirect resistance to the HPis. Slower growth and moderately reduced virulence suggest that this mutation might also interfere with the HP activity [40]. These findings should stimulate further in-depth three-dimensional study of drug–enzyme interactions to resolve these issues.

## 6.10

### The Frequency and Origin of HPI-Resistance Mutations

It has been stated that the frequency at which drug-resistant viruses can be selected in the presence of HPis in cell culture is an order of magnitude lower compared to nucleoside analogues [14, 16, 23], thus providing a theoretical advantage of HPis in this respect. We showed that this is not necessarily the case. It proved possible to select BAY 57-1293-resistant HSV-1 (Met355Thr variant in strain SC16 and Ala899Thr in strain PDK) from two laboratory working stocks at the rates of  $10^{-4}$  [46]. Furthermore, when a series of recent clinical isolates were screened for HPI resistance in cell culture, 2 of the 10 of these also contained the resistance mutation Lys356Asn at high frequency [20]. The UL5 motif IV Asn342 mutation that confers approximately 40-fold resistance to BAY 57-1293 was originally isolated from one of the two clinical isolates that also contained the Lys356Asn mutation. However,

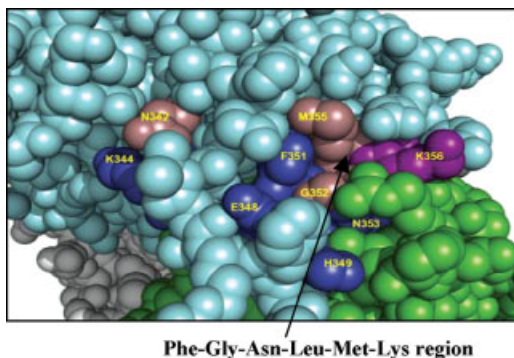

**Figure 6.3** Predicted structure (ball model) of HSV-1 UL5 based on homology with known structure of *E. coli* helicase. Space-fill representation of the structure of HSV-1 UL5 component of the helicase–primase complex showing the positions of the Gly-Asn-Leu-Met-

Lys region, Asn342 and Lys344. Asn342 is spatially apart from the Gly-Asn-Leu-Met-Lys region, interacting with helicase inhibitors. Green, gray, and light-blue denote different domains of the structure of HSV-1 UL5. (Reproduced with permission from Ref. [40].)

it should be pointed out that the same isolates were fully sensitive to BAY 57-1293 as determined by conventional plaque reduction assay. The presence of the resistance mutations as a minor fraction in wild-type populations may not be of particular significance in relation to the future clinical use of HPI except, perhaps, in immunocompromised patients.

## 6.11

### UL5 Lys356Asn: a Mutation Conferring High Resistance to HPI

It is intriguing to note that the HPI-resistance mutation (UL5:Lys356Asn) observed at relatively high frequency in 2 of the 10 HSV-1 clinical isolates was identical: a mutation that confers more than 5000-fold resistance to BAY 57-1293. Interestingly, it was pointed out previously [16] that following selection using an alternative HPI (T157602) the Lys-Asn mutation was more frequently encountered in both HSV-1 and -2 (two out of three HSV-1 variants and two of four HSV-2 variants). It was also reported in the same paper that this mutation was the most efficient of those tested in achieving marker rescue of wild-type virus in the presence of an inhibitory concentration of HPI (T157602). The same Lys356Asn mutation was also observed in HSV-1 F and KOS strains [14, 23] following selection with BAY 57-1293 and BILS 22 BS, respectively.

This particular Lys-Asn substitution confers the highest resistance to HPI among all observed resistance mutations studied to date. Furthermore, variants carrying this mutation have been shown to have similar growth properties in cell culture [14, 23] and pathogenicity in murine infection models compared to wild type [25]. This is in contrast to the most commonly encountered mutants resistant to nucleoside analogues such as ACV and PCV. Viruses resistant to such compounds are most frequently thymidine-kinase defective and these variants are usually less pathogenic *in vivo* [47, 48]. It is evident that more than 10 different mutations involving 5 different

amino acid residues in UL5 confer HPI resistance (Table 6.1). Among these, it is not clear why the Lys356Asn mutation is frequently selected. This could be simply because of its relatively highest resistance to HPis or perhaps the mutation is favored for some other reason(s) [38].

Recently we have demonstrated that mice infected with deliberate mixtures of wild-type HSV-1 and the UL5 Lys356Asn mutant (in ratio of 1/50 or 1/500) could be effectively treated with optimum single daily dose of BAY 57-1293; however HPI-resistance could be detected in a few mice infected with the 1/50 mixture following therapy [49]. The pre-existence of the highly resistant UL5 Lys356Asn mutant that is not associated with any obvious loss of fitness at relatively high frequency in some isolates suggests that this mutant may be encountered in the clinic. This may be particularly relevant to patient groups where frequent resistance to nucleoside analogues has already been encountered.

## 6.12

### The Origin of Resistance Mutations at High Frequency

The detection of relatively high frequency of HPI-resistance mutations in laboratory and clinical isolates raised the question as to whether the presence of the compounds during the selection procedure could influence the rate of mutation. However, this possibility was ruled out for the following reasons: (i) plaque purification of the wild-type virus reduced the frequency of drug-resistance mutations to less than  $10^{-6}$ , (ii) the continued presence of a fully inhibitory concentration of HPis during the selection procedure did not affect the detection of resistant variants in a single passage, and (iii) finally, the resistance mutations were detected by means of PCR as high-frequency polymorphisms in some virus isolates before exposure of the virus to any HPI. An intentional mismatch primer PCR (IMP-PCR) was designed to detect as few as 10 pfu of several of the single base substitutions known to confer HPI resistance including Lys356Asn [50] in as many as  $10^5$  pfu wild-type virus. This strategy readily detected a low proportion of the particular resistance mutations in deliberate mixtures. Four of thirty clinical isolates were found to contain the target drug-resistance mutations as detectable subpopulations. This may be important from the point of view of the biology of herpesvirus infections. However, as discussed above, it is not likely to have an impact on the outcome of HPI therapy.

## 6.13

### Conclusions

HPis are promising candidates for herpesvirus chemotherapy. They are potent antivirals that specifically inhibit the virus helicase–primase activity. They have a target different from that of the widely used herpes antivirals (e.g., ACV or PCV) that target the virus DNA polymerase. The perceived advantages of HPis over nucleoside analogues are (1) higher potency, (2) efficacy on delayed therapy, (3) possible superior

impact on the establishment and reactivation of latent virus, and (4) lower rate of resistance generation compared to existing antiherpes antivirals.

However, unlike the majority of nucleoside analogue-resistant mutants, many HPI-resistant mutants are fit virus in cell culture and animal infection models. Preliminary *in vitro* experiments using combination therapy comprising nucleoside analogues and HPI have suggested a synergistic effect [15]. HPis when given in combination with ACV or PCV should also minimize the risk of resistance generation in patients. Experience with antiviral therapy for different viruses, for example, HIV, suggests that combination therapy for herpesvirus infections in immunocompromised patients may be of benefit particularly against the problem of resistance generation.

During almost five decades since the introduction of herpesvirus antivirals, an enormous body of information has been published on all aspects of the nucleoside analogue ACV and related compounds. Increasingly, other virus targets (notably HIV, influenza, and the hepatitis viruses) began to compete for research interest. In the meantime, we have become used to the existence of nucleoside analogues such as acyclovir, taking for granted their moderate efficacy and, perhaps, there is a tendency to overlook their limitations. We believe that the HPis represent an important new step in the development of herpes antivirals. Indeed, had HPI been discovered even 20 years ago, they might have aroused much more excitement than currently. Hopefully, this chapter will provide some encouragement to those seeking major improvements in herpesvirus therapy and prophylaxis.

The HPis have increased potency over nucleoside inhibitors and early indications suggest that HPis may have an impact on herpesvirus latency. Arguing against the encouraging aspects of these new compounds, there are the unknown consequences of HPI drug-resistance mutations that occur with higher than expected frequency in some virus isolates. The roles of such mutations, some of which confer high resistance without compromising virus fitness, have yet to be determined. More attention needs to be given to the development and judicious use of combinations of HPis with nucleoside analogues. Hopefully, this chapter will serve as a wake-up call to herpes virologists who may now be stimulated to conduct research on new approaches to herpesvirus antivirals including the HPis.

### **Declaration of Interests**

During the period of research on helicase–primase inhibitors described in the chapter, HJF and SB received a small grant-in-aid from Arrow Therapeutics, London. HJF and SB have on-going research collaboration with AiCuris GmbH and Co. KG, Wuppertal, Germany from whom they have also received financial support.

### **Acknowledgments**

SB thankfully acknowledges support from the Cambridge Commonwealth Trust by means of a Cambridge Nehru Scholarship and the Isaac Newton Trust, Trinity College, Cambridge.

## References

- 1 Davison, A.J., Eberle, R., Ehlers, B., Hayward, G.S., McGeoch, D.J., Minson, A.C., Pellett, P.E., Roizman, B., Studdert, M.J., and Thiry, E. (2009) The order herpesvirales. *Archives of Virology*, **154**, 171–177.
- 2 McGeoch, D.J., Dolan, A., and Ralph, A.C. (2000) Toward a comprehensive phylogeny for mammalian and avian herpesviruses. *Journal of Virology*, **74**, 10401–10406.
- 3 Field, H.J. (2001) Herpes simplex virus antiviral drug resistance: current trends and future prospects. *Journal of Clinical Virology*, **21**, 261–269.
- 4 Harmenberg, J.G., Awan, A.R., Alenius, S., Stahle, L., Erlandsson, A.C., Lekare, G., Flink, O., Augustsson, E., Larsson, T., Wikstrom, A.C., Stierna, P., Field, H.J., Larsson, A.G., and Oberg, B. (2003) ME-609: a treatment for recurrent herpes simplex virus infections. *Antiviral Chemistry & Chemotherapy*, **14**, 205–215.
- 5 Frobort, E., Cortay, J.C., Ooka, T., Najioullah, F., Thouvenot, D., Lina, B., and Morfin, F. (2008) Genotypic detection of acyclovir-resistant HSV-1: characterization of 67 ACV-sensitive and 14 ACV-resistant viruses. *Antiviral Research*, **79**, 28–36.
- 6 Weller, S.K. (2006) HSV-1 DNA replication, in *Alphaherpesviruses: Molecular and Cellular Biology* (ed. R.M. Sandri-Goldin), Caister Academic Press.
- 7 Martinez, R., Shao, L., and Weller, S.K. (1992) The conserved helicase motifs of the herpes simplex virus type 1 origin-binding protein UL9 are important for function. *Journal of Virology*, **66**, 6735–6746.
- 8 Zhu, L. and Weller, S.K. (1992) The six conserved helicase motifs of the UL5 gene product, a component of the herpes simplex virus type 1 helicase-primase, are essential for its function. *Journal of Virology*, **66**, 469–479.
- 9 Dodson, M.S. and Lehman, I.R. (1991) Association of DNA helicase and primase activities with a subassembly of the herpes simplex virus 1 helicase-primase composed of the UL5 and UL52 gene products. *Proceedings of the National Academy of Sciences of the United States of America*, **88**, 1105–1109.
- 10 Cavanaugh, N.A., Ramirez-Aguilar, K.A., Urban, M., and Kuchta, R.D. (2009) Herpes simplex virus-1 helicase-primase: roles of each subunit in DNA binding and phosphodiester bond formation. *Biochemistry*, **48**, 10199–10207.
- 11 Zhu, L. and Weller, S.K. (1988) UL5, a protein required for HSV DNA synthesis: genetic analysis, overexpression in *Escherichia coli*, and generation of polyclonal antibodies. *Virology*, **166**, 366–378.
- 12 Crute, J.J., Lehman, I.R., Gambino, J., Yang, T.F., Medveczky, P., Medveczky, M., Khan, N.N., Mulder, C., Monroe, J., and Wright, G.E. (1995) Inhibition of herpes simplex virus type 1 helicase-primase by (dichloroanilino) purines and pyrimidines. *Journal of Medicinal Chemistry*, **38**, 1820–1825.
- 13 Crute, J.J., Grygon, C.A., Hargrave, K.D., Simoneau, B., Faucher, A.-M., Bolger, G., Kibler, P., Liuzzi, M., and Cordingley, M.G. (2002) Herpes simplex virus helicase-primase inhibitors are active in animal models of human disease. *Nature Medicine*, **8**, 386–391.
- 14 Kleymann, G., Fischer, R., Betz, U.A., Hendrix, M., Bender, W., Schneider, U., Handke, G., Eckenberg, P., Hewlett, G., Pevzner, V., Baumeister, J., Weber, O., Henninger, K., Keldenich, J., Jensen, A., Kolb, J., Bach, U., Popp, A., Maben, J., Frappa, I., Haebich, D., Lockhoff, O., and Rubsamen-Waigmann, H. (2002) New helicase-primase inhibitors as drug candidates for the treatment of herpes simplex disease. *Nature Medicine*, **8**, 392–398.
- 15 Kleymann, G. (2003) New antiviral drugs against herpesviruses. *Herpes*, **10**, 46–47.
- 16 Spector, F.C., Liang, L., Giordano, H., Sivaraja, M., and Peterson, M.G. (1998) Inhibition of herpes simplex virus replication by a 2-amino thiazole via interactions with the helicase component of the UL5-UL8-UL52 complex. *Journal of Virology*, **72**, 6979–6987.
- 17 www.aicurus.com (accessed November 9, 2009).
- 18 Katsumata, K., Chono, K., Kontani, T., Sudo, K., Shimizu, Y., and Suzuki, H. (2009) Efficacy of acute oral treatment with ASP2151 or valacyclovir (VACV) against cutaneous infection with herpes simplex virus (HSV) type 1 in mice. Poster V-1742 Interscience Conference on Antimicrobial

- Agents and Chemotherapy, September 12–15, 2009, San Francisco, USA.
- 19 Suzuki, H., Chono, K., Katsumata, K., Kobayashi, M., Kontani, T., Sudo, K., Shimizu, Y., and Takakura, S. (2009) ASP2151, a novel helicase-primase inhibitor, possesses antiviral activity against varicella-zoster virus as well as herpes simplex virus type 1 and 2. Poster V-1741 Interscience Conference on Antimicrobial Agents and Chemotherapy, September 12–15, 2009, San Francisco, USA.
  - 20 Biswas, S., Smith, C., and Field, H.J. (2007) Detection of HSV-1 variants highly resistant to the helicase-primase inhibitor BAY 57-1293 at high frequency in two of ten recent clinical isolates of HSV-1. *The Journal of Antimicrobial Chemotherapy*, **60**, 274–279.
  - 21 Kleymann, G. (2004) Helicase-primase: targeting the Achilles heel of herpes simplex viruses. *Antiviral Chemistry & Chemotherapy*, **15**, 135–140.
  - 22 Kleymann, G. (2005) Agents and strategies in development for improved management of herpes simplex virus infection and disease. *Expert Opinion on Investigational Drugs*, **14**, 135–161.
  - 23 Liuzzi, M., Kibler, P., Bousquet, C., Harji, F., Bolger, G., Garneau, M., Lapeyre, N., McCollum, R.S., Faucher, A.M., Simoneau, B., and Cordingley, M.G. (2004) Isolation and characterization of herpes simplex virus type 1 resistant to aminothiazolylphenyl-based inhibitors of the viral helicase-primase. *Antiviral Research*, **64**, 161–170.
  - 24 Baumeister, J., Fischer, R., Eckenberg, P., Henninger, K., Rübsamen-Waigmann, H., and Kleymann, G. (2007) Superior efficacy of helicase-primase inhibitor BAY 57-1293 for herpes infection and latency in the guinea pig model of human genital herpes disease. *Antiviral Chemistry & Chemotherapy*, **18**, 35–48.
  - 25 Betz, U.A.K., Fischer, R., Kleymann, G., Hendrix, M., and Rübsamen-Waigmann, H. (2002) Potent *in vivo* antiviral activity of the herpes simplex virus primase-helicase inhibitor BAY57-1293. *Antimicrobial Agents and Chemotherapy*, **46**, 1766–1772.
  - 26 Biswas, S., Jennens, L., and Field, H.J. (2007) The helicase primase inhibitor, BAY57-1293, shows potent therapeutic antiviral activity superior to famciclovir in BALB/c mice infected with herpes simplex virus type 1. *Antiviral Research*, **75**, 30–35.
  - 27 Kaufman, H.E., Varnell, E.D., Gebhardt, B.M., Thompson, H.W., Atwal, E., Rübsamen-Waigmann, H., and Kleymann, G. (2008) Efficacy of a helicase-primase inhibitor in animal models of ocular herpes simplex virus type 1 infection. *Journal of Ocular Pharmacology and Therapeutics*, **24**, 34–42.
  - 28 Duan, J., Liuzzi, M., Paris, W., Liard, F., Browne, A., Dansereau, N., Simoneau, B., Faucher, A.M., and Cordingley, M.G. (2003) Oral bioavailability and *in vivo* efficacy of the helicase-primase inhibitor BILS 45 BS against acyclovir-resistant herpes simplex virus type 1. *Antimicrobial Agents and Chemotherapy*, **47**, 1798–1804.
  - 29 Field, H.J., Bell, S.E., Elion, G.B., Nash, A.A., and Wildy, P. (1979) Effect of acycloguanosine treatment on acute and latent herpes simplex infections in mice. *Antimicrobial Agents and Chemotherapy*, **15**, 544–561.
  - 30 Darby, G. and Field, H.J. (1983) Latency and acquired resistance: problems in chemotherapy of herpes infections. *Pharmacology & Therapeutics*, **23**, 217–251.
  - 31 Blyth, W.A., Harbour, D.A., and Hill, T.J. (1980) Effect of acyclovir on recurrence of herpes simplex skin lesions in mice. *The Journal of General Virology*, **48**, 417–419.
  - 32 Nesburn, A.B., Willey, D.E., and Trousdale, M.D. (1983) Effect of intensive acyclovir therapy during artificial reactivation of latent herpes simplex virus. *Proceedings of the Society for Experimental Biology and Medicine*, **172**, 316–323.
  - 33 Peacock, J.E., Kaplowitz, L.G., Sparling, P.F., Durack, D.T., Gnann, J.W., and Whitley, R.J. (1988) Intravenous acyclovir therapy of first episodes of genital herpes: a multicenter double-blind, placebo-controlled trial. *The American Journal of Medicine*, **85**, 301–306.
  - 34 Thackray, A.M. and Field, H.J. (1998) Famciclovir and valaciclovir differ in the prevention of herpes simplex virus type 1 latency in mice: a quantitative study. *Antimicrobial Agents and Chemotherapy*, **42**, 1555–1562.
  - 35 Field, H.J. and Thackray, A.M. (1998) Valaciclovir and famciclovir: differences

- between two similar guanosine analogue prodrugs emerge from laboratory models. *International AntiViral News*, **4**, 23–27.
- 36 Thackray, A.M. and Field, H.J. (1996) Differential effects of famciclovir and valaciclovir on the pathogenesis of herpes simplex virus in a murine infection model including reactivation from latency. *The Journal of Infectious Diseases*, **173**, 291–299.
- 37 Field, H.J. and Thackray, A.M. (2000) Early therapy with valaciclovir or famciclovir reduces but does not abrogate herpes simplex virus neuronal latency. *Nucleosides, Nucleotides & Nucleic Acids*, **19**, 461–470.
- 38 Biswas, S. and Field, H.J. (2008) Herpes simplex virus helicase-primase inhibitors: recent findings from the study of drug-resistance mutations. *Antiviral Chemistry & Chemotherapy*, **19**, 1–6.
- 39 Biswas, S., Kleymann, G., Swift, M., Tiley, L.S., Lyall, J., Aguirre-Hernández, J., and Field, H.J. (2008) A single drug-resistance mutation in HSV-1 UL52 primase points to a difference between two helicase-primase inhibitors in their mode of interaction with the antiviral target. *The Journal of Antimicrobial Chemotherapy*, **61**, 1044–1047.
- 40 Biswas, S., Núñez Miguel, R., Sukla, S., and Field, H.J. (2009) A mutation in helicase motif IV of herpes simplex virus type 1 UL5 that results in reduced growth *in vitro* and lower virulence in a murine infection model is related to the predicted helicase structure. *The Journal of General Virology*, **90**, 1937–1942.
- 41 Biswas, S., Jennens, L., and Field, H.J. (2007) Single amino acid substitutions in the HSV-1 helicase protein that confer resistance to the helicase-primase inhibitor BAY 57-1293 are associated with increased or decreased virus growth characteristics in tissue culture. *Archives of Virology*, **152**, 1489–1500.
- 42 Biswas, S., Tiley, L.S., Zimmermann, H., Birkmann, A., and Field, H.J. (2008) Mutations close to functional motif IV in HSV-1 UL5 helicase that confer resistance to HSV helicase-primase inhibitors, variously affect virus growth rate and pathogenicity. *Antiviral Research*, **80**, 81–85.
- 43 Pesola, J.M. and Coen, D.M. (2007) *In vivo* fitness and virulence of a drug-resistant herpes simplex virus 1 mutant. *The Journal of General Virology*, **88**, 1410–1414.
- 44 Chen, Y., Carrington-Lawrence, S.D., Bai, P., and Weller, S.K. (2005) Mutations in the putative zinc-binding motif of UL52 demonstrate a complex interdependence between the UL5 and UL52 subunits of the human herpes simplex virus type 1 helicase/primase complex. *Journal of Virology*, **79**, 9088–9096.
- 45 Chen, Y., Livingston, C.M., Carrington-Lawrence, S.D., Bai, P., and Weller, S.K. (2007) A mutation in the human herpes simplex virus type I UL52 zinc finger motif results in defective primase activity but can recruit viral polymerase and support viral replication efficiently. *Journal of Virology*, **81**, 8742–8751.
- 46 Biswas, S., Swift, M., and Field, H.J. (2007) High frequency of spontaneous helicase-primase inhibitor (BAY 57-1293) drug-resistant variants in certain laboratory isolates of HSV-1. *Antiviral Chemistry & Chemotherapy*, **18**, 13–23.
- 47 Coen, D.M., Kosz-Vnenchak, M., Jacobsen, J.G., Leib, D.A., Bogard, C.L., Schaffer, P.A., Tyler, K.L., and Knipe, D.M. (1989) Thymidine kinase negative herpes simplex virus mutants establish latency in mouse trigeminal ganglia but do not reactivate. *Proceedings of the National Academy of Sciences of the United States of America*, **86**, 4736–4740.
- 48 Field, H.J. and Wildy, P. (1978) The pathogenicity of thymidine kinase-deficient mutants of herpes simplex virus in mice. *Journal of Hygiene*, **81**, 267–277.
- 49 Sukla, S., Biswas, S., Birkmann, A., Lischka, P., Ruebsamen-Schaeff, H., Zimmermann, H., and Field, H.J. (2010) Effects of therapy using a helicase-primase inhibitor (HPI) in mice infected with deliberate mixtures of wild-type HSV-1 and HPI-resistant UL5 mutant. *Antiviral Research*, **87**, 67–73.
- 50 Sukla, S., Biswas, S., Birkmann, A., Lischka, P., Zimmermann, H., and Field, H.J. (2010) Mismatch primer-based PCR reveals that helicase-primase inhibitor resistance mutations pre-exist in herpes simplex virus type 1 clinical isolates and are not induced during incubation with the inhibitor. *Journal of Antimicrobial Chemotherapy*, **65**, 1347–52.

## 7

### Cyclophilin Inhibitors

Grégoire Vuagniaux, Arnaud Hamel, Rafael Crabbé, Hervé C. Porchet,  
and Jean-Maurice Dumont

#### 7.1

##### Introduction

Novel antiviral drugs targeting against host mechanisms rather than against the virus themselves are required to provide better resistance profile and treatment alternatives. Among several host cellular factors involved in viral replication, cyclophilins (Cyps) play a key role [1, 2]. Cyps are members of the immunophilin class of proteins and possess *cis-trans* prolyl isomerase (PPIase) activities [3]. They are assumed to be involved in protein folding and to function as chaperones in intracellular transport. Cyclophilins are known to be the cellular receptor molecules for cyclosporines.

Cyclosporin A (CsA) is a neutral, lipophilic cyclic polypeptide of 11 amino acid residues, originally isolated from the soil fungus *Tolypocladium inflatum* Gams [4, 5]. It has unique immunosuppressive properties and is since decades in first line therapy in the prophylaxis and treatment of transplant rejection. In the cytoplasm, CsA binds to Cyps. The complex CsA–Cyp binds and blocks the function of the enzyme calcineurin. Inhibition of calcineurin activity fails to dephosphorylate the cytoplasmic component of the nuclear factor of activated T cells and its transport to the nucleus, leading to the initiation of interleukin-2 production. The transcription of several other cytokines, including interferon- $\gamma$  (IFN $\gamma$ ) and several other interleukins, is also inhibited by CsA. Thus, CsA acts specifically and reversibly on lymphocytes (in particular, T helper cells) producing selective suppression of cell-mediated immunity [6].

More than 20 years ago, it was proposed that immunosuppression by CsA may have a beneficial effect in human immunodeficiency virus (HIV) disease [7]. A few clinical trials with CsA in patients with AIDS did not allow a definite conclusion regarding the anti-HIV efficacy of CsA [8, 9].

Attempts to identify CsA analogues were made in the late 1980s. Several compounds inhibited the HIV-1-induced cytopathic effect. Surprisingly, nonimmunosuppressive CsA were equal or superior in anti-HIV activity to immunosuppressive analogues. NIM811 was the first representative of this new class [10], followed by Debio 025 a few years later [11]. Cyps were found to play a key role in the anti-HIV



activity of these compounds [12, 13]. In the early 2000s, it was also found that Cyps are important in the replication of the hepatitis C virus (HCV) [14]. CsA was also found to have antiviral activities in other viruses. However, the immunosuppressive activity of CsA may allow virus-infected cells to escape from the immune system, resulting in viral proliferation. Therefore, several compounds, derived from CsA or not, were synthesized in order to dissociate the CsA effects on calcineurin and cyclophilin, aiming for less or no immunosuppressive activity and enhanced cyclophilin inhibition, based on a higher affinity to CypA, leading to a better antiviral activity.

The aim of this chapter is to review nonimmunosuppressive cyclophilin inhibitors with potent antiviral activities, with a focus on compounds that are currently in clinical development.

## 7.2

### Cyclophilin Overview

Cyclophilin A, CypB, CypC, CypD, CypE, Cyp40, and CypNK [15] are the seven major Cyps found in humans. Cyclophilin A, the most abundant of them, represents between 0.1 and 0.4% of total cellular proteins [16]. Cyclophilin A is present in the cytosol of all mammalian tissues, whereas most of the other Cyps are found in the endoplasmic reticulum, mitochondria, or nucleus [15]. Cyclophilin A was discovered in the early 1980s to be a binding protein with high affinity for CsA, and was later found to be identical to peptidyl-prolyl *cis-trans* isomerase (PPIase), a cellular catalyzing enzyme [17, 18]. Other than being the major intracellular receptor for CsA, CypA is necessary for effective HIV-1 and HCV replication [1, 12].

Cyclophilin B that is targeted to the secretory pathway via an endoplasmic reticulum signal sequence is involved in the regulation of inflammatory processes, mainly through interaction with CD147 [19]. Cyclophilin B has also been found to interact with platelets [20]. Like CypA, CypB is a potent chemotactic agent. *In vitro*, HCV replication can be reduced by either RNA interference-mediated reduction in endogenous CypB expression or the induced inhibition of NS5B binding to CypB [21], indicating that CypB might be a functional regulator of the NS5B RNA-dependent RNA polymerase. Nevertheless, results in the literature are not fully consistent, and three recent publications indicate that CypA, and not CypB, is needed for the replication of HCV [22–25]. Cyclophilin C plays a role in the inflammatory and wound healing processes [26], whereas CypD is thought to be involved in mitochondrial permeability transition and the mechanism of cell death [27]. Cyclophilin-40, also present in the cytosol, seems to act as a modulator of protein function [15].

## 7.3

### Cyclophilin Inhibitors Currently in Clinical Development

The structure of CsA bound to cyclophilins and calcineurin has been characterized: two separate domains in the undecapeptide CsA, binding to Cyps and to calcineurin,

can be distinguished and, therefore, chemical modification can change the affinity to calcineurin and/or Cyp.

### 7.3.1

#### Chemical Structure

Modification of amino acids in the calcineurin binding domain of CsA, in particular, substitution of the undecapeptide at position 4, was shown to abolish the formation of the ternary complex with calcineurin, and thus to the loss of immunosuppressive activity [10]. Three nonimmunosuppressive cyclosporine derivatives are currently in clinical development (Table 7.1): NIM811, (Me-Ile-4) cyclosporine, was produced by fermentation of the fungus *Tolyocladium niveum*, followed by extraction and purification. Debio 025 (D-MeAla3-EtVal4) cyclosporine, previously named UNIL025 [11], and SCY635, 4'-hydroxy-MeLeu-4-CsA derivative, are synthetic compounds with CsA as the starting material [28].

### 7.3.2

#### CypA PPIase Inhibition and Lack of Immunosuppressive Activity

In a chymotrypsin-coupled spectrophotometric assay assessing CypA PPIase activity, the derived inhibitor dissociation constant ( $K_i$ ) value of Debio 025 is about 29-fold more potent than CsA, while NIM811 and SCY635 are five to six times more potent (Table 7.1). NIM811 is twice more potent than CsA in inhibiting CypB [29]. It was also shown that NIM811 and Debio 025 are potent inhibitors of mitochondrial permeability transition pore in brain mitochondria, activity mainly related to CpD inhibition [11]. Therefore, these compounds can be considered as pan-Cyp inhibitors rather than selective inhibitor of a specific Cyp.

In an *in vitro* assay in Jurkat cell line containing the  $\beta$ -galactosidase gene under IL-2 promoter control, Debio 025, NIM811, and SCY635 showed strongly reduced immunosuppressive activities (Table 7.1) [10, 30, 31]. This strong decrease in immunosuppressive activity was also conformed in a two-way mixed lymphocyte reaction with human CD4<sup>+</sup> PBMCs. *In vivo*, in a rat keyhole limpet hemocyanin (KLH) model, Debio 025, up to 50 mg/kg po, also showed much less immunosuppressive capacity than CsA [30]. Thus, NIM811 and Debio 025 were demonstrated to have significantly decreased or no immunosuppressive activity compared to that of CsA.

The current hypothesis is that nonimmunosuppressive Cyp inhibitors do not interact directly with the virus, but block viral replication by specifically targeting intracellular Cyps.

## 7.4

### Cyclophilin and HIV

FDA-approved therapies target specific steps of the HIV-1 life cycle: integration, reverse transcription, proteolytic maturation, and fusion. Triple drug therapy is now

**Table 7.1** Anti-immunosuppressive, anti-PPLase of Cyp inhibitors.

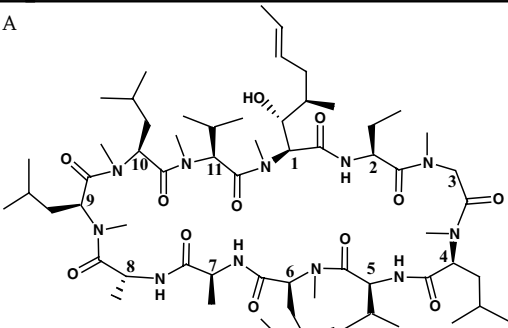
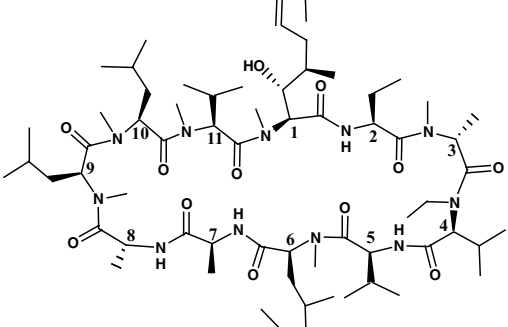
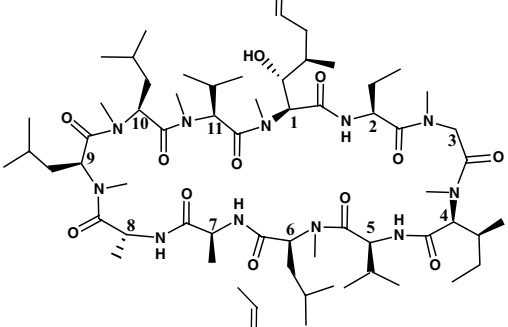
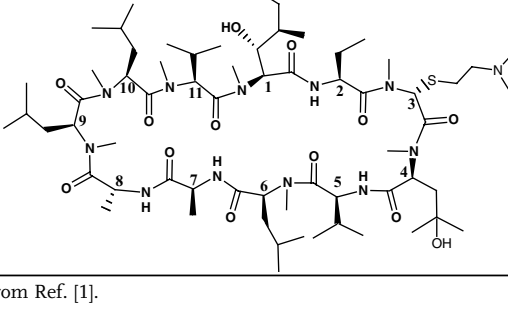
Structure	Immuno-suppressive activity (IL-2 inhibition) ( $\mu\text{g/ml}$ )	CypA PPLase inhibition ( $K_i$ ) (nM)
	0.006	9.79
	21.5	0.34
	>10	2.11
	13	1.8

Data taken from Ref. [1].

the standard treatment (Thomson Pharma® Thomson Reuters). However, despite triple drug therapy, multidrug resistance may still develop mainly because of lack of tolerance and lack of adherence to therapy [32, 55]. Therefore, additional approaches not directly targeting viral enzymes are warranted. One of the potential treatment alternatives is to tackle Cyp, a human host factor involved in HIV-1 replication [33].

#### 7.4.1

#### Cyclophilin Inhibitors against HIV-1

##### 7.4.1.1 *In Vitro* Anti-HIV-1 Activity

The activities of NIM811 and Debio 025 against HIV-1 have been extensively investigated; however, so far, no data with SCY635 have been reported. Compared to CsA, both compounds show increased potential CypA PPIase activity, translating into a higher affinity of binding to CypA [10, 30, 34]. This was correlated with a greater inhibition of HIV-1 replication (see Table 7.2). NIM811 and Debio 025 were respectively 2–3-fold and 5–10-fold more potent than CsA for their inhibition of HIV-1 strain IIIB/LAI replication in MT4 cells and for their inhibition of strains IIIB/LAI and SF2 replication in PBMCs (Table 7.2).

Antiviral activity against other laboratory strains and against clinical isolates of various HIV-1 subtypes from geographically distinct regions in primary T lymphocytes and in PBMCs was also demonstrated [10, 30, 34, 35]. Debio 025 was found active against a large panel of clinical isolates from subclades A–G, O, pediatric isolates, and laboratory-adopted strains NL4-3, JR-CSF, and SF162. It was also active against five isolates with multidrug resistance to reverse transcriptase and protease inhibitors. Debio 025 inhibited the replication of viruses that use CXCR4 or CXCR5 as a coreceptor.

In *in vitro* two-drug combinations studies, a synergetic inhibition was found between NIM811 and AZT [10], while Debio 025 interacted in additive manner with AZT [30].

A slightly synergistic interaction with 3TC was observed. The interactions of Debio 025 with 17 other drugs (nucleoside RT inhibitors, nonnucleoside RT inhibitors,

**Table 7.2** CypA PPIase inhibition and activity against HIV-1 replication.

Compound	$K_i$ (nM) for CypA PPIase inhibition	$IC_{50}$ ( $\mu$ M) for HIV-1		
		IIIB in MT4 cells <sup>a)</sup>	IIIB in PBMCs <sup>b)</sup>	SF2 in PBMCs
CsA	9.79 ± 1.37	>0.83	0.45	0.54
NIM811	2.11 ± 0.32	0.31 ± 0.11	0.47	0.5
Debio 025	0.34 ± 0.12	0.099 ± 0.063	0.064	0.063

a) The CPE was determined by MTT staining; values are means ± standard deviation from four determinations.

b) As determined by a p24 ELISA; values are from one determination.

protease inhibitors, and the fusion inhibitor enfuvirtide) were found to be strictly additive.

#### 7.4.1.2 Resistance Profile

A few viruses from the main group were found to be naturally resistant to Debio 025. Capsid sequence analyses of sensitive versus insensitive viruses revealed that the most relevant amino acid associated with resistance is H87Q/P. Other amino acid changes, like V86A/T/Q/P, I91V/N/L, and/or M96I may also contribute to resistance.

An analysis of 2599 HIV-1 capsid sequences available from the Los Alamos database indicated that 19.74% of the strains contained H87Q. Substitutions in 86, 91, and 96 were also reported in a significant proportion of viruses. Experimentally, 15% of strains (out of 238) were found to be resistant to Debio 025 [30, 34].

#### 7.4.1.3 *In Vivo* Activity

In the SCID/hu/Thy/Liv mouse model, Debio 025, given at 30 and 100 mg/kg/day, significantly inhibited HIV-1 RNA and capsid production of the HIV-1 X4 molecular clone NL4-3 or the R5X4, AZT-resistant clinical isolate JD NL4-3, or JD viruses [36]. The treatment was effective when started 1 day before the infection or 3 days after the inoculation. Debio 025 was inactive *in vivo* against the HIV-1 strain BaL. The BaL-derived capsid sequence contains three mutations (H87Q, A88P, and I91V), which explains the lack of activity of the cyclophilin inhibitor [37].

#### 7.4.1.4 Putative Mechanism of Action of Cyclophilin Inhibitors against HIV-1

HIV-1 poorly replicates human cells following CypA expression knockdown, supporting the hypothesis that CypA plays a key role in HIV-1 replication [33, 38]. Direct and specific CypA–Gag polyprotein interactions are critical for HIV-1 replication [39]. A defined amino acid sequence around G89 and P90 capsid protein p24 was identified as the binding site for CypA [40, 41]. Debio 025 was inactive against mutant viruses that are independent of CypA, suggesting that the compound targets the CypA–capsid interaction [35].

This interaction between CypA and the loop around G89 and P90 of the capsid is important for the efficient replication of HIV-1 in human cells. CypA, linked to the capsid protein, is incorporated into the virions that are produced and is carried over to the target cell in new infections. Virus particles produced in the presence of CsA or NIM811 are less infectious [42–44], underlining the importance of producer cell CypA. However, more recent studies suggest that the target cell CypA plays the most relevant role during early HIV-1 infection [33, 45].

CypA plays a role at a step after penetration of the virion into the cell and before integration of the newly made double-stranded proviral DNA into cellular DNA. CypA may promote uncoating of the incoming viral particle and/or reverse transcription and/or translocation of the preintegration complex of the nucleus. Mechanistic studies with Debio 025 indicate that the newly made cDNA is degraded in the presence of the compound. Addition of Debio 025 could be postponed for 2 h before losing its antiviral activity [35].

If there is a blockade in this sequence of events, the viral replication complex may be destroyed by restriction factors or transported to a compartment of the cell where infection is abortive. The function of CypA may be that of a chaperone that stabilizes or transports the viral replication complex during reverse transcription to the right location before the restriction factors can abort the infection. A review on the human cellular restriction factors that target HIV-1 replication has recently been published [46]. A cyclophilin inhibitor bound to CypA may therefore allow the restriction factor to destroy the virus.

#### 7.4.1.5 Clinical Activity of Debio 025 against HIV-1

So far, only Debio 025 has been investigated in HIV-1 patients, which has been discussed in detail in the following sections.

**Phase I Double-Blind Placebo-Controlled Dose-Escalating Study [47]** Forty-eight asymptomatic HIV-1-infected male and female volunteers, aged 18–60, were included who had HIV-1 RNA copies no less than 5000/ml and CD4 cell count above  $0.25 \times 10^9/l$ . To achieve four treatment groups, patients were randomized into 3 cohorts of 16 subjects (8 of each gender) who received a 10-day course of single oral daily doses of Debio 025 ( $N = 12$ ) or placebo ( $N = 4$ ). A dose of 50 mg of Debio 025 was administered in the first cohort, followed by 400 mg in the second cohort, and 1200 mg in the third cohort. A significant reduction in HIV-1 RNA copies was observed on day 10 after multiple 400 or 1200 mg Debio 025 doses (by 0.3 log in comparison to placebo,  $p \leq 0.011$ ). This decrease was apparent up to 6 days after the last dose. The number of subjects achieving HIV-1 RNA reductions of  $\geq 0.5 \log_{10}$  between day 1 and any postdose assessment day was higher in the Debio 025 groups than in the placebo group, suggesting a possible dose–response relationship: two, four, and five subjects versus one subject in the 50, 400, and 1200 mg, and placebo group, respectively. Three subjects had a decrease of more than 0.5  $\log_{10}$  on day 10. In contrast, placebo subjects and subjects treated with 50 mg Debio 025 experienced a mean increase in HIV-1 RNA copies on day 10 (Figure 7.1). No consistent difference in change in viremia was found between genders.

Intersubject variability in pharmacodynamic parameters was very large (CV% generally  $>100\%$ ) and no clear dose effect could be determined. In addition, no obvious relationship could be established between pharmacokinetics and pharmacodynamics of Debio 025.

**Randomized, Double-Blind, Placebo-Controlled Study in HIV-1/HCV Coinfected or HIV-1 Monoinfected Patients** The initial HIV phase I study was followed by another phase I study (multicenter, double-blind, placebo-controlled), this time in 23 HIV-1/HCV coinfecting or HIV-1 monoinfected patients [2]. Male and female patients between 20 and 65 years of age could take part in the study if they had detectable HIV-1 RNA copies of 5000/ml or more, and HCV RNA copies of 2000/ml or more (the latter applicable only to coinfecting patients), a normal liver or compensated liver disease, and a CD4 cell count above  $0.25 \times 10^9/l$ . Treatment consisted of a randomly assigned 14-day oral course of 1200 mg Debio 025 or placebo twice daily with a final dose on day 15.

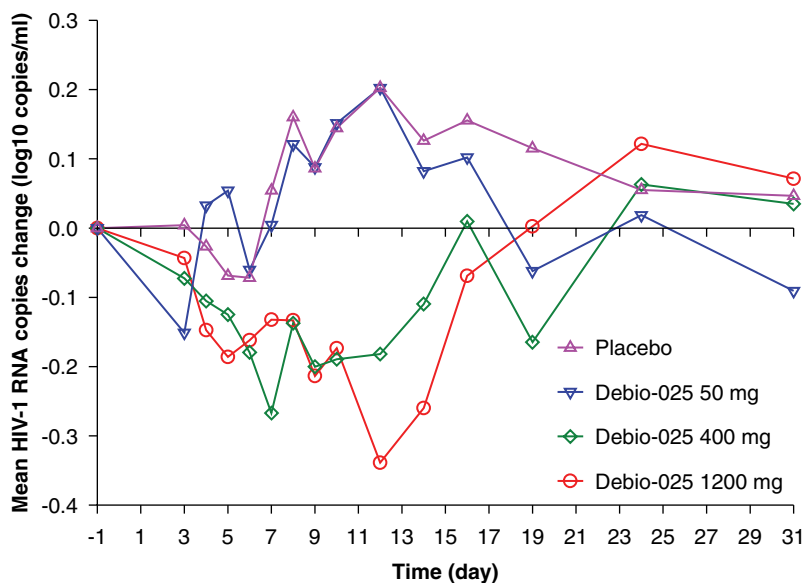

**Figure 7.1** HIV-1 RNA copies/ml mean change from baseline after 10 days of Debio 025 at the daily oral dose of 50, 400, or 1200 mg or placebo.

The maximum reduction of the  $\log_{10}$  number of HIV-1 RNA copies/ml during the study was significantly different compared to baseline for patients in the Debio 025 group ( $n = 19$ ) ( $-1.03$ ; 95% confidence interval (CI):  $-1.28$  to  $-0.78$ ;  $p < 0.0001$ ). However, the difference between treatment groups was not statistically significant ( $-0.47$ ; 95% CI:  $-1.07$  to  $0.13$ ;  $p = 0.1150$ ). The least squares mean of the maximum reduction of the  $\log_{10}$  number of HIV-1 RNA copies/ml was  $-1.03$  (95% CI:  $-1.28$  to  $-0.78$ ) in the Debio 025 group compared to  $-0.56$  (95% CI:  $-1.10$  to  $-0.01$ ) in the placebo ( $n = 4$ ) group (Table 7.4).

Data on HCV and adverse events will be discussed in Section 7.6.1.

Preliminary results in HIV patients showed only limited efficacy, while anti-hepatitis C virus (HCV) activity was far more prominent (see section 7.6.1.1).

#### 7.4.2

##### No Activity against Simian Immunodeficiency Virus

CsA does not inhibit the replication of SIV strains, because these viruses do not depend on CypA for their replication [10, 30]. Both NIM811 and Debio 025 were found to be inactive against these viruses.

#### 7.4.3

##### Activity against HIV-2

CsA was found to be inactive against HIV-2, because a lack of affinity of the HIV-2 capsid protein for CypA and a lack of incorporation of CypA into HIV-2 virions were

demonstrated [13, 40, 42]. Debio 025 was mostly found to be insensitive to inhibition of HIV-2 replication [30, 35]. However, 4 of 33 HIV-2 isolates tested were inhibited by Debio 025. Comparison of the capsid sequence of one sensitive HIV-2 isolate to that of one resistant strain contained the consensus HIV-2 subtype A sequence at positions 85–99, whereas the corresponding sequence of the sensitive HIV-2 strain was identical to the consensus sequence of HIV-1 subtype A. Further studies are needed to determine whether the capsid of Debio 025 HIV-2-sensitive strains binds to CypA and whether these strains represent intermediates between HIV-1 and HIV-2.

## 7.5

### Cyclophilin and Hepatitis C

Hepatitis C is a viral disease caused by the hepatitis C virus, a RNA virus in the family Flaviviridae. This potentially progressive disorder is associated with serious complications such as liver cirrhosis and hepatocellular carcinoma [48]. Global estimates indicate that around 130 million people are affected by HCV infection [49] and that 3–4 million individuals are infected each year [50]. The disease is the leading cause of liver transplantation in developed countries [51]. Based on genetic differences between HCV isolates, the HCV species is classified into six genotypes (1–6) with several subtypes. The preponderance and distribution of HCV genotypes vary globally. Genotype is clinically important in determining potential response to IFN-based therapy and the required duration of such therapy. Genotypes 1 and 4 are less responsive to interferon-based treatment than the other genotypes [52].

Efficacy of antiviral treatment for chronic hepatitis C has improved over the past 15 years. Sustained viral response (SVR) rates reach 50–80% with pegylated interferon (peg-IFN) and ribavirin (RBV) combination therapy, the current standard of care. In patients with genotypes 2 and 3, the SVR rate reaches 75% or more after 24 weeks of treatment, whereas patients with genotype 1 and 4 only achieve a suboptimal success rate of 40–50% [53]. A significant number of patients fail to respond to therapy or relapse, stressing the need for new antiviral treatments [48]. During its life cycle, the HCV offers a number of potential targets for molecular therapy. Current efforts in drug discovery mainly focus on HCV enzymes, NS3-4A serine protease inhibitors, or NS5B RNA-dependent RNA polymerase nucleoside/nonnucleoside polymerase inhibitors. Protease inhibitors are the most advanced of these agents that are all in the preclinical or clinical stage of development. Cyclophilin inhibitors represent a complementary class of anti-HCV agents.

#### 7.5.1

##### Putative Role of Cyclophilin in HCV Replication

In 1988, exploratory work suggested that cyclosporin A at the dose of 20 mg/kg intravenously for 4 weeks in two chimpanzees infected with non-A, non-B type 1 hepatitis virus (NANBHV) decreased ultrastructural alterations in hepatocytes and inhibited proliferation of NANBHV [54]. It was only 15 years later that Watashi *et al.*



reported decreased HCV protein levels and replicon RNA levels in HCV replicon cells after CsA treatment [14]. Development of the HCV subgenomic replicon culture system had made it possible to confirm the potential anti-HCV effect of CsA. The inhibition reported by Watashi *et al.* was achieved at therapeutic levels of CsA and did not result from nonspecific cytotoxic effects; in addition, and this was essential, inhibition was independent of immunosuppressive activity of the drugs. This finding was further confirmed when FK506, which shares the anticalcineurin activity of CsA (determinant for its immunosuppressive activity, see Section 7.5.2) but does not bind to Cyp, was shown to have no inhibitory effect on HCV replication, and, conversely, cyclosporin D (CsD), which lacks immunosuppressive activity but exhibits Cyp binding, induced inhibition of HCV replication in a similar way to CsA [23]. Cyclophilin inhibition was for this reason thought to be the mechanism underlying the anti-HCV activity of CsA.

It was later established that CypB is essential for an efficient replication of the HCV genome and that CsA activity is mediated by disturbing this interaction [21]. A putative model for the role of CypB in HCV replication ensued. In this model, CypB interaction with NS5B enhances RNA binding and promotes RNA replication; CsA blocks the ability of CypB to interact with NS5B, giving rise to weaker RNA binding and the inability to form a functional RNA replication complex [56].

However, data concerning the Cyp subtype (e.g., A, B, or C) involved in HCV inhibition still remain controversial [21–23, 25, 29, 57]. Three recent independent publications suggest that the isomerase activity of CypA, and not CypB, is required for HCV replication *in vitro* [22, 25, 57]. This is in accordance with a recent publication from Tang and coworkers that shows that incorporation of the HCV polymerase into the HCV replication complex seems to depend on its interaction with CypA [60]. In addition, resistance mapping studies suggest that Cyp inhibition may also act on HCV nonstructural protein 5A (NS5A) [61]. This finding is supported by a recent study elegantly showing by NMR spectroscopy that the domain 2 of JFH-1 NS5A is a substrate for the peptidyl-prolyl *cis/trans* isomerase activity of both CypA and CypB [62].

It should be noted that a new insight into the role of Cyps in HCV replication has recently been reported [25, 63]. By selecting for resistance against the Cyp inhibitor Debio 025 in a JFH-1 replicon, mutations were identified close to the cleavage site between NS5A and NS5B that slow down cleavage kinetics at this site and reduce viral replication dependence on CypA. Further amino acid substitutions that accelerate processing at the same cleavage site increase CypA dependence. These results reveal an unexpected correlation between HCV polyprotein processing and HCV replication dependence on CypA.

It has also been reported that the genotype 2a JFH-1 strain replicon is more resistant to CsA than genotype 1 HCV strains, and that the genotype may therefore affect HCV replication sensitivity to a Cyp inhibitor [64, 65]. Nevertheless, Ciesek *et al.* recently made a surprising observation where replication of the JFH1 full-length genome is far more sensitive toward CypA depletion and inhibition than subgenomic replicons [66]. This effect depends on the presence of HCV NS2 protease in the viral polyprotein, suggesting that CypA may also be required for proper folding of NS2 and that Cyp inhibitors may also target NS2 by way of CypA.

In addition to the viral aspects of its effects, CypA may also be required by some host cell factor(s) contributing to virus production. Preliminary results suggest that CypA may be necessary to maintain the integrity of lipid droplets (A. Kaul, C. Berger, and R. Bartenschlager, unpublished observation) [25, 61], which play a key role in HCV assembly.

### 7.5.2

#### Activity of Cyclophilin Inhibitors in HCV

In a comparative *in vitro* study on HCV subgenomic replicon, Debio 025 was the most potent compound compared to CsA ( $IC_{50}$  eight times lower than  $IC_{50}$  of CsA), while NIM811 and SCY635 were respectively five and three times more active than CsA (Table 7.3).

NIM811 exhibits a more potent activity than CsA in the HCV replicon system, particularly at a low concentration (0.5  $\mu\text{g}/\text{ml}$ ) [10]. This characteristic is thought to be related with the drug's Cyp binding affinity, which is about twofold higher than CsA [67]. When combined with IFN $\alpha$ , CsA and NIM811 reduce HCV RNA levels to a greater extent than IFN $\alpha$  alone. The drug's  $IC_{50}$  (50% HCV RNA inhibitory concentration) ranges from 0.35 to 0.66  $\mu\text{M}$  in various HCV genotype 1a and 1b replicon cell lines [68]. A synergistic antiviral activity is observed when NIM811 is combined with HCV polymerase, whereas the effect is additive to synergistic when the drug is combined with HCV protease or polymerase inhibitors. NIM811 addition reduces the emergence of resistance against HCV polymerase and protease inhibitors [61, 69]. The drug is currently under evaluation in HCV patients.

Debio 025 exhibits a CypA binding potency at least three times higher than that of CsA [11] and potent anti-HIV activity [34]. Debio 025 inhibits HCV replication about 10 times more than CsA in subgenomic HCV replicon-containing hepatoma cells and in productively infected cells [70]. The  $IC_{50}$  of Debio 025 ranges from 0.07 to 0.22  $\mu\text{M}$ . Furthermore, Debio 025 shows the unique ability to clear replicons from cultured hepatocytes, suggesting the potential to eradicate HCV from hepatocytes [70, 71]. Debio 025 also displays additive to slightly synergistic activity in replicons in combination with peg-IFN $\alpha$ 2a, ribavirin, and antiviral drugs such as NS3 protease or NS5B (nucleoside and nonnucleoside) polymerase inhibitors [70, 71]. Debio 025 was also able to delay or prevent the development of resistance to HCV protease inhibitors and to nucleoside and nonnucleoside polymerase

**Table 7.3** Anti-HCV activity of Cyp inhibitors.

	Anti-HCV activity ( $EC_{50}$ ) ( $\mu\text{M}$ )
Cyclosporin A	0.3
Debio 025	0.04
NIM811	0.06
SCY635	0.1

HCV replicon, as previously described [70].

inhibitors [71]. There was no cross-resistance with various protease and polymerase inhibitors in drug-resistant replicon cell lines [71]. Moreover, the anti-HCV effect of Debio 025 appears to be synergistic with peg-IFN $\alpha$ 2a in a HCV-infected chimeric mouse model [72].

The recent evaluation in preclinical studies of SCY635, the latest nonimmunosuppressive Cyp inhibitor derived from CsA, showed the drug to exhibit favorable anti-HCV properties. As seen with NIM811 and Debio 025, SCY635 binds to Cyps with a higher affinity than CsA [28, 31]. Hopkins and colleagues demonstrated that the *in vitro* antiviral, pharmacokinetic, and cytotoxic profiles of SCY635 are superior to those of CsA. The antiviral effects on HCV replicon cells of SCY635 combined with IFN $\alpha$  are additive to synergistic [74].

### 7.5.3

#### Resistance Profile

Literature data regarding the *in vitro* development of resistance to cyclosporines are not fully consistent and several amino acid variants have been proposed as resistance-conferring mutations [61, 75–78]. The 521–591-amino acid region of NS5B is thought to be the binding region for CypB; P540A in NS5B affected the interaction between CypB and the RNA-dependent RNA polymerase in nonstructural protein 5B (NS5B) and is thought to decrease the RNA binding activity of NS5B, and subsequently HCV genome replication [21].

Selection and characterization of genotype 1b HCV replicon cells resistant to CsA *in vitro* was first reported by Robida *et al.* [78]. I432V in the NS5B gene was able to produce CsA resistance in the replicon; I432 does not belong to the CypB binding domain, but locates to an allosteric site on the surface of the thumb domain [79]. Tang and colleagues showed that the association of CyPA with the HCV replication machinery was targeted by CsA and that the CsA-resistant interaction between NS5B and CyPA contributed to the CsA-resistant replication of the resistant replicon [22].

Another group detected, in addition to changes in NS5B, amino acid variants in NS5A and pointed out that NS5A variants in its carboxyterminus sequence had the largest effect on CsA susceptibility [76]. More recently, Wiedmann *et al.* showed that resistance to NIM811 was induced by multiple changes in the Con1 replicon [61]. Specifically, D320E in NS5A conferred the largest part of resistance. D320E in NS5A was also observed during *in vitro* resistance selection against CsA [77] and Debio 025 [75]. Finally, two other substitutions in NS5A were identified following resistance selection with Debio 025 in a JFH-1 (genotype 2a) replicon close to the cleavage site between NS5A and NS5B (V464A and V464L) [25].

Importantly, it was found that it was much more difficult to develop resistance against NIM811 [61], Debio 025, and CsA [71] than against protease or polymerase inhibitors; no cross-resistance was observed between the different classes of inhibitors. Overall, these data indicate that Cyp inhibitors may have a unique resistance profile and that combining inhibitors targeting viral and host proteins might be highly beneficial in patients.

## 7.6

### Clinical Results in HCV

#### 7.6.1

##### Debio 025

Debio 025 was initially developed against HIV. However, preliminary results in HIV patients showed only limited efficacy, while activity against hepatitis C virus was far more prominent. As a result, development was shifted to the treatment of HCV.

##### 7.6.1.1 Randomized, Double-Blind, Placebo-Controlled Study in HIV-1/HCV Coinfected or HIV-1 Monoinfected Patients

The HIV results of this study have already been mentioned in Section 7.4.1.5.

Male and female patients between 20 and 65 years of age could take part in the study if they had detectable HIV-1 RNA copies of 5000/ml or more, HCV RNA copies of 2000/ml or more (the latter applicable only to coinfecting patients), a normal liver or compensated liver disease, and a CD4 cell count above  $0.25 \times 10^9/l$ . Treatment consisted of a randomly assigned 14-day oral course of 1200 mg Debio 025 or placebo twice daily with a final dose on day 15 [2].

Of the 19 coinfecting patients, those treated with Debio 025 ( $n = 16$ ) experienced a significantly greater maximum reduction of  $\log_{10}$  HCV RNA copies/ml compared to placebo-treated ( $n = 3$ ) patients (difference  $-2.90$ ; 95% CI:  $-4.76$  to  $-1.04$ ;  $p = 0.0045$ ). The least squares mean of the maximum reduction of  $\log_{10}$  HCV RNA copies/ml for the Debio 025 group was  $-3.63$  (95% CI:  $-4.37$  to  $-2.90$ ) compared to  $-0.73$  (95% CI:  $-2.44$ – $0.97$ ) for the placebo group (Table 7.4).

The difference between treatment groups was significant also for the HCV RNA reduction between day  $-1$  and day 15 ( $-2.87 \log_{10}$  HCV RNA copies/ml; 95% CI:  $-5.00$  to  $-0.73$ ;  $p = 0.0117$ ). Fifteen out of 16 patients (93.8%) in the Debio 025 group experienced a reduction of HCV RNA by at least  $2 \log_{10}$  (Figure 7.2).

The most important response was observed in patients with genotype 3 who achieved a least squares mean maximum reduction of  $\log_{10}$  HCV RNA copies/ml of  $-4.46 \log_{10}$  (95% CI:  $-6.06$  to  $-2.85$ ). In patients with genotypes 1 and 4, the maximum reduction reached  $-3.19 \log_{10}$  HCV RNA copies/ml (95% CI:  $-4.19$  to  $-2.18$ ).

Viral loads decreased below detectable levels in three patients (one of each genotype) at day 8 (one patient) and at day 15 (two patients). No patient developed a breakthrough phenomenon during treatment and relapses occurred only after treatment cessation. A time to relapse of up to 3 weeks was observed in three patients, although time to relapse was overall highly variable.

##### 7.6.1.2 Randomized, Double-Blind, Placebo-Controlled, Escalating Dose Ranging Study of Debio 025 in Combination with Pegasys in Treatment-Naïve Patients with Chronic Hepatitis

The promising HCV data described above encouraged further investigation of this indication and led to a phase II randomized, double-blind, placebo-controlled,

**Table 7.4** Maximum reduction in log<sub>10</sub> HCV and HIV-1 RNA copies/ml.

	Placebo	Debio 025	Difference <sup>a)</sup>
HCV (log <sub>10</sub> RNA copies/ml)			
Patients, <i>n</i>	3	16	19
LS mean	-0.73	-3.63	-2.90
SE	0.80	0.35	0.88
95% CI	-2.44 to 0.97	-4.37 to -2.90	-4.76 to -1.04
<i>p</i> -value	NA <sup>b)</sup>	<0.0001 <sup>c)</sup>	0.0045 <sup>d)</sup>
HIV-1 (log <sub>10</sub> RNA copies/ml)			
Patients, <i>n</i>	4	19	23
LS mean	-0.56	-1.03	-0.47
SE	0.26	0.12	0.29
95% CI	-1.10 to -0.01	-1.28 to -0.78	-1.07 to 0.13
<i>p</i> -value	NA <sup>b)</sup>	<0.0001 <sup>d)</sup>	0.1150 <sup>e)</sup>

a) LS, least squares; CI, confidence interval.

b) Represents difference (Debio 025 – placebo) between adjusted treatment means from ANCOVA.

c) Analysis was not conducted.

d) *p*-Value associated with test of Debio 025 LS mean change equal to zero.

e) *p*-Value associated with test for difference between adjusted treatment means.

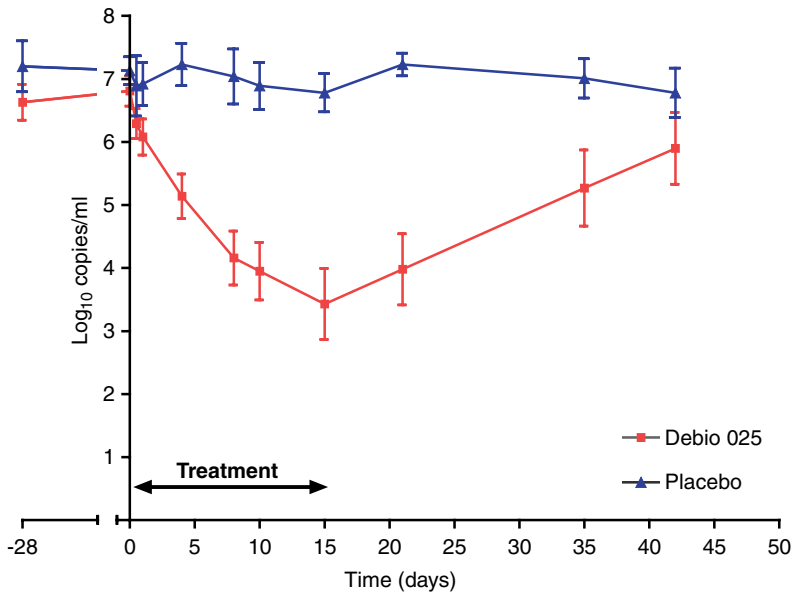

**Figure 7.2** Response to Debio 025 therapy in HIV-1/HCV coinfecting patients. Mean log<sub>10</sub> HCV RNA copies/ml ( $\pm$ SEM) versus time in the Debio 025 group (*n* = 16) and the placebo group (*n* = 3).

escalating dose ranging study comparing several dual regimens combining peginterferon alpha (peg-IFN $\alpha$ 2a) and Debio 025 with peg-IFN $\alpha$ 2a alone and Debio 025 alone in 90 treatment-naïve monoinfected HCV patients with genotype 1, 2, 3, or 4 [80]. Patients of both genders aged 18–70 were included if they presented with detectable plasma HCV RNA levels  $\geq 1000$  IU/ml and a normal or compensated liver function. Patients were randomized into five treatment arms for a total treatment duration of 29 days: (i) 200 Combo (peg-IFN $\alpha$ 2a combined with 200 mg Debio 025), (ii) 600 Combo (peg-IFN $\alpha$ 2a combined with 600 mg Debio 025), (iii) 1000 Combo (peg-IFN $\alpha$ 2a combined with 1000 mg Debio 025), (iv) Peg Mono (peg-IFN $\alpha$ 2a combined with Debio 025 placebo), or (v) 1000 Mono (Debio 025 monotherapy). Debio 025 was given as a loading dose twice daily from day 1 to day 7 and once daily from day 8 to day 29. Peg-IFN $\alpha$ 2a was given as weekly 180  $\mu$ g subcutaneous (s.c.) injections including on day 29 (Figure 7.3).

The most important mean response was observed in the treatment groups combining peg-IFN $\alpha$ 2a and the two highest Debio 025 doses, that is, treatment group 600 Combo and 1000 Combo. In both groups,  $\log_{10}$  HCV RNA mean levels fell rapidly by day 8 from 6.32 and 6.12  $\log_{10}$  IU/ml to 2.89 and 2.06  $\log_{10}$  IU/ml (difference  $-3.43 \pm 1.19$  and  $-4.05 \pm 1.28 \log_{10}$  IU/ml), respectively. HCV RNA levels continued to decline and the mean value after 4 weeks of treatment dropped below the limit of quantification (difference  $-5.07 \pm 1.73$  and  $-5.09 \pm 1.91 \log_{10}$  IU/ml). Mean reduction of HCV RNA levels after 4 weeks in treatment groups 200 Combo, Peg Mono, and 1000 Mono were respectively  $-3.30 \pm 2.18$ ,  $-3.56 \pm 2.37$ ,

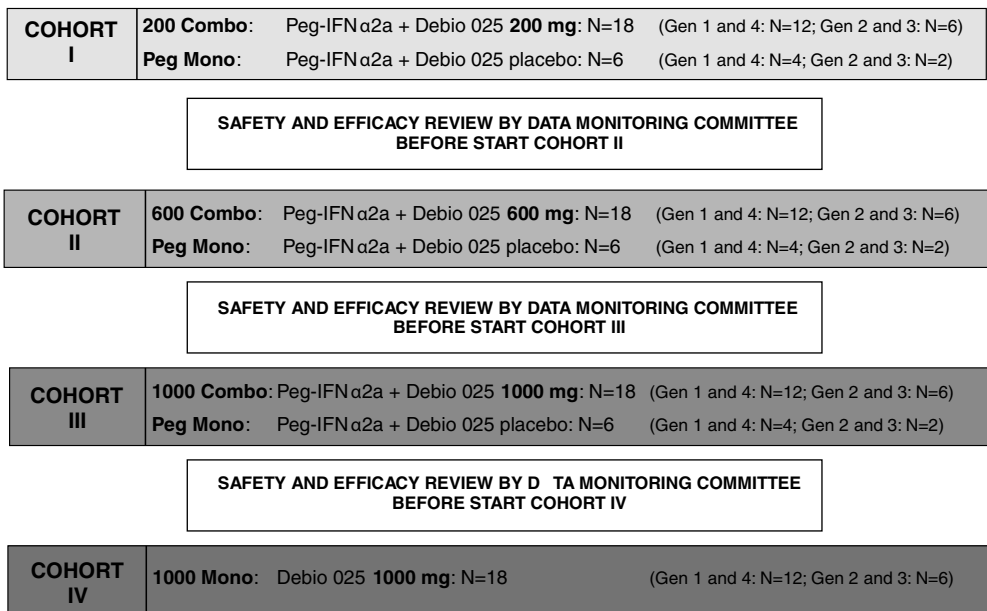

**Figure 7.3** Study design in the treatment-naïve patients with chronic hepatitis. Peg-IFN $\alpha$ 2a, peginterferon alpha-2a; Gen, genotype.

and  $-2.87 \pm 2.28 \log_{10}$  IU/ml. Statistical analysis, using the mixed effect model, showed a significant viral load reduction over time ( $p < 0.001$ ) and significant differences in viral load reduction between treatment groups ( $p < 0.001$ ) and HCV genotype classes ( $p < 0.001$ ). Maximal viral load reduction was also significantly different between treatment groups ( $p = 0.005$ ) and between HCV genotype classes ( $p < 0.001$ ). Among pairwise treatment group comparisons in maximal viral load reduction, 1000 Mono and 1000 Combo were significantly different ( $p < 0.008$ ) using the Holm–Bonferroni adjustment for multiple comparisons. This indicates that the combination of 1000 mg Debio 025 with peg-IFN $\alpha$ 2a is significantly more effective in reducing HCV RNA than 1000 mg Debio 025 in monotherapy.

In the stratum of genotype 1 and 4 patients, response profiles in treatment group 600 Combo and 1000 Combo showed a rapid reduction in HCV RNA levels in the first week with values of  $-3.01 \pm 1.05$  and  $-3.84 \pm 1.47 \log_{10}$  IU/ml, respectively (Table 7.5; Figure 7.4). Afterward, viral load declined steadily and HCV RNA reductions reached  $-4.61 \pm 1.88$  and  $-4.75 \pm 2.19 \log_{10}$  IU/ml at week 4 in group 600 Combo and 1000 Combo, respectively. These viral load reductions were more important than in treatment groups 200 Combo, Peg Mono, and 1000 Mono ( $-2.65 \pm 1.65$ ,  $-2.49 \pm 1.95$ , and  $-2.2 \pm 2.4 \log_{10}$  IU/ml, respectively) at the same time point (Table 7.5; Figure 7.4). The maximum  $\log_{10}$  reduction in HCV RNA copies was significantly larger in treatment groups 600 Combo and in 1000 Combo versus Peg Mono, and in treatment group 1000 Combo versus 1000 Mono (Holm–Bonferroni adjusted  $p < 0.02$ ). In both monotherapy groups (Peg Mono and 1000 Mono), undetectable viral load at study end ( $< 15$  IU/ml) was observed in 3 out of 12 patients. In treatment groups 200 Combo, 600 Combo, and 1000 Combo, the proportion of patients with undetectable viral load at study end reached respectively 2, 4, and 8 out of 12.

Viral load reduction in genotype 2 and 3 patients was more pronounced than in genotype 1 and 4 patients. Peg Mono and 1000 Mono treatments induced HCV RNA reductions of  $-5.69 \pm 1.58$  and  $-4.22 \pm 1.33 \log_{10}$  IU/ml at week 4, respectively; at day 8, levels had dropped by  $-2.67 \pm 1.16$  and  $-3.39 \pm 0.77 \log_{10}$  IU/ml respectively, and at day 22 the large majority of patients had undetectable HCV RNA. In each group, viral load was undetectable in four out of six patients at treatment end (Table 7.5; Figure 7.4). In combination groups 200 Combo, 600 Combo, and 1000 Combo, HCV RNA reductions at week 4 reached  $-4.59 \pm 2.68$ ,  $-5.91 \pm 1.11$ , and  $-5.89 \pm 0.43 \log_{10}$  IU/ml, respectively (Table 7.5; Figure 7.4). The number of patients with undetectable viral load in these groups at treatment end was three, five, and five out of six, respectively. The number of genotype 2 and 4 patients in the 1000 Mono group was very small – two and one, respectively. However, these three patients decreased their HCV RNA by more than  $2 \log_{10}$  IU/ml after the 4-week treatment.

### 7.6.2

#### **Study of Debio 025 in Combination with PEG-IFN $\alpha$ 2 and Ribavirin in Chronic HCV Genotype 1 Nonresponding Patients**

The next step involved chronic HCV genotype 1 patients not responding to standard pegIFN $\alpha$  and ribavirin treatment [81]. To this intent, an open-label, randomized,

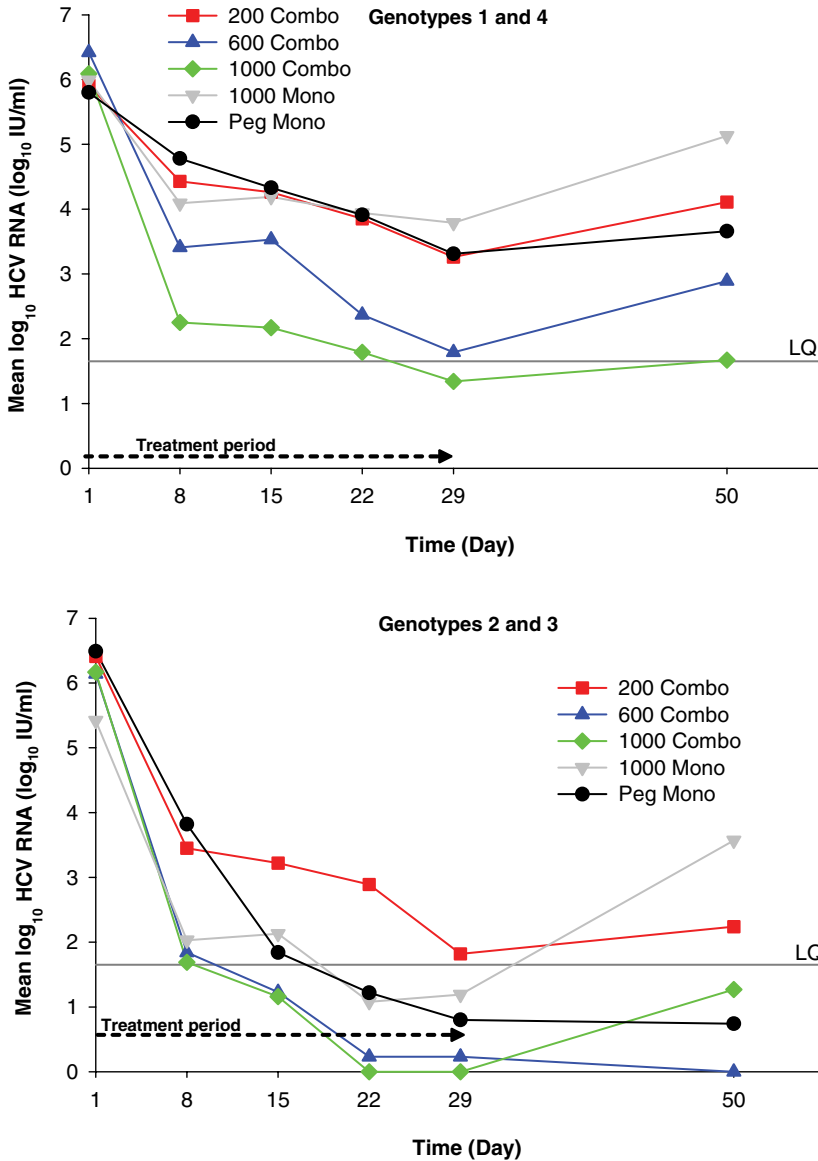

**Figure 7.4** HCV response to Debio 025 and peg-IFN $\alpha$ 2a therapy in treatment-naïve chronic HCV patients per genotype class. Mean  $\log_{10}$  HCV RNA concentrations from baseline versus time. LQ, limit of quantification ( $<\log_{10}$  (45 IU/ml), i.e., 1.65 IU/ml).

parallel group study of the effects on viral kinetics, safety, and pharmacokinetics of different dosing regimens of Debio 025 in combination with peg-IFN $\alpha$ 2a and ribavirin was carried out in 50 such patients. Male or female patients between 18 and 60 years of age diagnosed with chronic HCV genotype 1, nonresponders to



**Table 7.5** Mean ( $\pm$ SD) HCV RNA levels, viral load reduction, and maximum mean viral load reduction per treatment group and genotype class in treatment-naïve chronic HCV patients.

Genotype class	Peg Mono			200 Combo			600 Combo			1000 Combo			1000 Mono		
	1 and 4	2 and 3		1 and 4	2 and 3		1 and 4	2 and 3		1 and 4	2 and 3		1 and 4	2 and 3	
<b>HCV RNA (<math>\log_{10}</math> IU/ml)</b>															
Day 1	5.80 $\pm$ 0.97	6.49 $\pm$ 0.59		5.91 $\pm$ 0.60	6.41 $\pm$ 0.62		6.42 $\pm$ 0.64	6.14 $\pm$ 1.05		6.09 $\pm$ 0.94	6.17 $\pm$ 0.79		5.99 $\pm$ 0.87	5.42 $\pm$ 1.22	
Day 8	4.78 $\pm$ 1.37	3.82 $\pm$ 0.90		4.43 $\pm$ 1.01	3.45 $\pm$ 1.02		3.41 $\pm$ 1.21	1.84 $\pm$ 1.59		2.25 $\pm$ 1.92	1.69		4.09 $\pm$ 2.27	2.03 $\pm$ 1.79	
Day 15	4.33 $\pm$ 1.94	1.84 $\pm$ 1.79		4.26 $\pm$ 1.27	3.22 $\pm$ 1.56		3.53 $\pm$ 1.40	BLQ		2.17 $\pm$ 2.14	BLQ		4.19 $\pm$ 2.54	2.13 $\pm$ 1.67	
Day 22	3.91 $\pm$ 2.02	BLQ		3.85 $\pm$ 1.44	2.89 $\pm$ 1.90		2.37 $\pm$ 1.81	BLQ		1.79	BLD		3.94 $\pm$ 2.51	BLQ	
Day 29	3.31 $\pm$ 2.49	BLQ		3.26 $\pm$ 2.02	1.82		1.79 $\pm$ 1.69	BLQ		BLQ	BLD		3.79 $\pm$ 2.67	BLQ	
Day 50 (posttreatment)	3.66 $\pm$ 2.50	BLQ		4.11 $\pm$ 1.81	2.24		2.89 $\pm$ 2.77	BLD		1.67	BLQ		5.13 $\pm$ 2.10	3.57 $\pm$ 2.78	
<b>Viral load reduction (<math>\log_{10}</math> IU/ml)</b>															
Day 8	1.02 $\pm$ 0.80	2.67 $\pm$ 1.16		1.48 $\pm$ 0.69	2.97 $\pm$ 1.49		3.01 $\pm$ 1.05	4.29 $\pm$ 1.03		3.84 $\pm$ 1.47	4.48 $\pm$ 0.68		1.90 $\pm$ 1.73	3.39 $\pm$ 0.77	
Day 15	1.47 $\pm$ 1.47	4.65 $\pm$ 1.87		1.65 $\pm$ 0.94	3.19 $\pm$ 1.93		2.89 $\pm$ 1.28	4.90 $\pm$ 0.98		3.92 $\pm$ 1.80	4.73 $\pm$ 0.59		1.72 $\pm$ 2.05	3.59 $\pm$ 1.07	
Day 22	1.89 $\pm$ 1.52	5.28 $\pm$ 1.70		2.06 $\pm$ 1.09	3.52 $\pm$ 2.15		4.03 $\pm$ 1.80	5.91 $\pm$ 1.11		4.30 $\pm$ 1.54	5.89 $\pm$ 0.43		2.05 $\pm$ 2.15	4.34 $\pm$ 1.33	
Day 29	2.49 $\pm$ 1.95	5.69 $\pm$ 1.58		2.65 $\pm$ 1.65	4.59 $\pm$ 2.68		4.61 $\pm$ 1.88	5.91 $\pm$ 1.11		4.75 $\pm$ 2.19	5.89 $\pm$ 0.43		2.20 $\pm$ 2.40	4.22 $\pm$ 1.33	
<b>Maximum mean viral load reduction (<math>\log_{10}</math> IU/ml)</b>															
	2.56 $\pm$ 1.95	5.76 $\pm$ 1.47		2.70 $\pm$ 1.56	5.15 $\pm$ 2.46		4.67 $\pm$ 2.06	6.14 $\pm$ 1.05		5.05 $\pm$ 1.84	5.82 $\pm$ 0.42		2.46 $\pm$ 2.14	4.37 $\pm$ 1.26	
		$p = 0.859^a$			$p = 0.019^a$						$p = 0.007^a$				
					$p = 0.007^a$										

BLQ, below limit of quantification ( $<$  $\log$  (45 IU/ml), i.e., 1.65 IU/ml); BLD, below limit of detection ( $<$  $\log$  (1 IU/ml), i.e., 0 IU/ml).  
 a) Holm–Bonferroni adjusted  $p$ -value; genotype class B values were all nonsignificant.

standard treatment for at least 12 weeks, and normal or compensated liver function were included into the study.

The study entailed five 4-week treatment arms with orally administered Debio 025. A first subgroup of 30 patients was equally randomized into treatment arms A (tritherapy with 400 mg Debio 025 daily, 180 µg peg-IFN $\alpha$ 2a s.c. once weekly, and 1000 or 1200 mg ribavirin daily orally), B (monotherapy with 400 mg Debio 025 daily), or C (bitherapy with 400 mg Debio 025 daily and 180 µg peg-IFN $\alpha$ 2a s.c. once weekly). In the second subgroup, the remaining 20 patients were randomized into treatment arms D (tritherapy with 800 mg Debio 025 daily, 180 µg peg-IFN $\alpha$ 2a s.c. once weekly, and 1000 or 1200 mg ribavirin daily orally) or E (tritherapy with 400 mg Debio 025 daily, 180 µg peg-IFN $\alpha$ 2a s.c. once weekly, and 1000 or 1200 mg ribavirin daily orally; in this arm, 400 mg Debio 025 was given as a loading dose twice daily from day 1 to day 7 and once daily from day 8 to day 29). The primary efficacy endpoint was the log<sub>10</sub> HCV RNA change from baseline at day 29 of the three tritherapies (treatments A, D, and E).

Mean baseline log<sub>10</sub> HCV RNA values across all treatment arms were comparable. Mean viral load reduction was most important in treatment arms D (−2.32 log) and E (−2.02 log) and was lowest in treatment arm C (−0.60 log) (Table 7.6; Figure 7.5). Treatment arms D and E both achieved a statistically significant decline in HCV RNA after 29 days of treatment as demonstrated by *p*-values of <0.001; this was not the case for treatment arm A (*p* = 0.163) (Table 7.6). The comparison between treatment arms showed treatment arms D and E to have a statistically significant decline in mean log<sub>10</sub> HCV RNA values versus treatment arm B (*p* < 0.001 for both arms) and treatment arm C (*p* = 0.001 and 0.010, respectively). The same was observed when treatment arms D and E were compared to treatment arm A (*p* = 0.005 and 0.031, respectively) (Table 7.6).

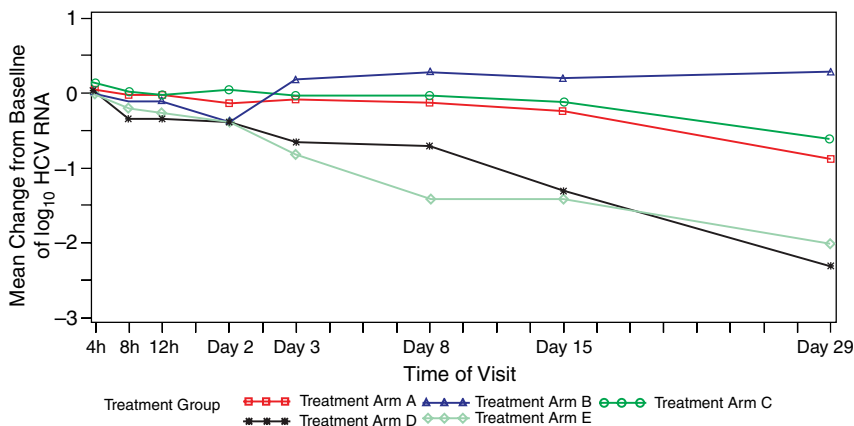

**Figure 7.5** Mean change from baseline in log<sub>10</sub> HCV RNA levels in chronic HCV genotype 1 nonresponding patients.

**Table 7.6** Change from baseline in log<sub>10</sub> HCV RNA values at day 29 of treatment in chronic HCV genotype 1 nonresponding patients.

log <sub>10</sub> HCV RNA	Treatment A (N = 10)	Treatment B (N = 9)	Treatment C (N = 11)	Treatment D (N = 10)	Treatment E (N = 10)
Baseline					
N	10	9	11	10	10
Mean (SD)	6.448 (0.2850)	6.377 (0.1293)	6.434 (0.2949)	6.321 (0.3384)	6.265 (0.4210)
Median	6.436	6.358	6.521	6.366	6.351
Min, Max	5.91, 6.96	6.22, 6.62	6.08, 7.06	5.62, 6.67	5.53, 6.79
Change at day 29 <sup>a)</sup>					
N	10	9	11	10	10
Mean (SD)	-0.881 (1.0099)	0.285 (0.3273)	-0.608 (0.7558)	-2.321 (1.4644)	-2.020 (1.4031)
Median	-0.639	0.248	-0.522	-1.825	-1.746
Min, Max	-3.26, 0.12	-0.16, 0.82	-2.16, 0.24	-5.11, -0.57	-4.91, -0.37
p-Value <sup>b)</sup>					
Versus baseline	0.163	0.179	0.356	<0.001	<0.001
Versus treatment B	0.022	N/A		<0.001	<0.001
Versus treatment C	0.645		N/A	0.001	0.010
Versus treatment A	N/A			0.005	0.031
Versus treatment D				N/A	0.549

HCV, hepatitis C virus; Min, minimum; Max, maximum; N/A, not applicable.

a) Change was computed as log<sub>10</sub> HCV RNA – log<sub>10</sub> HCV RNA at baseline. Baseline was the predose assessment at day 1. If missing, the screening value was reported, if available.

b) p-Values were obtained by fitting a linear mixed model. The model consisted of treatment as a fixed effect, center as a random effect, and race (fixed with two levels: black/nonblack) as a covariate.

### 7.6.3

#### Adverse Events

In HCV trials with Debio 025, the most common reported adverse events were abdominal pain, nausea, fatigue, pyrexia, and headache. Pyrexia was mainly reported when Debio 025 was coadministered with peg-IFN $\alpha$ . Leukopenia, neutropenia, and thrombocytopenia were mainly reported during combination treatment. Debio 025 caused a clear dose-related increase of serum bilirubin due to inhibition of biliary canalicular transporters. This phenomenon was common when daily doses of >1000 mg were administered. This increase was reversible after dose reduction or discontinuation of the drug. Bilirubin was not associated with increases of transaminases, alkaline phosphatases, or  $\gamma$ -GT.

This was already seen with CsA with which mild hyperbilirubinemia and increased serum bile salts were reported, seemingly related to CsA blood levels [82]. In the rat, CsA administration induced a decrease in bile flow and bile acid secretion occurring in the absence of significant biochemical or histologically evident hepatotoxicity [83]. Inhibition of transporters of bile canalicular membranes has been reported with CsA [84, 85].

### 7.6.4

#### NIM811 and SCY635

Only very limited clinical data are available for both compounds.

NIM811 was investigated in a small double-blind, placebo-controlled trial in HCV patients who relapsed after previous treatment with peg-IFN and ribavirin [86]. Twenty patients were randomized 1: 1 to receive oral NIM811 (600 mg twice daily) or matching placebo for 14 days in combination with peg-IFN $\alpha$ 2a (180  $\mu$ g weekly). The patients who received the combination NIM811 and peg-IFN $\alpha$ 2a had a drop of their HCV RNA by 2.78 log<sub>10</sub> IU/ml compared to 0.58 log<sub>10</sub> IU/ml for the control group ( $p < 0.0001$ ).

SCY635 or placebo was administered to 20 HCV positive patients in a randomized way (6: 1) [87]. Patients were sequentially enrolled into three sequential dose cohorts. Total daily doses of 300, 600, and 900 mg SCY635 or matching placebo (divided over three daily administrations) were administered for 15 days. Only the 900 mg dose group showed a consistent decrease in HCV RNA with a median nadir value of 1.82 log<sub>10</sub> below baseline.

## 7.7

### Activity against Other Viruses

Activity of CsA and/or cyclosporine derivatives against several viruses, such as vaccinia virus [88], West Nile virus (WNV), dengue virus, and yellow fever virus [89], human papillomavirus type 16 [90], and mouse CMV [91] has been reported in the literature.

## 7.8

### New Noncyclosporine Cyclophilin Inhibitors

As the biological importance of cyclophilins is gradually revealed, an increasing number of cyclophilin inhibitors have been designed as potential lead compounds against various diseases. Cyclosporines and other cyclic peptides, such as sanglifehrin A, cyclolinopeptide A (CLA), cycloamanides, and antamanides will not be described in this chapter, as these families of compounds have already been extensively discussed in the literature. We will rather focus on the design, structural features, and inhibitory activities of novel molecules with structures derived from natural products.

#### 7.8.1

##### Peptides and Peptidomimetics

Cyclophilins are peptidyl-prolyl isomerases that accelerate the Xaa-Pro isomerization of their substrates; therefore, the design of molecules that mimic the active conformation of their prolyl-containing substrates is particularly interesting. Several X-ray crystal structures of dipeptide or tetrapeptide ligands bound to CypA were resolved and used as templates for the design of several peptidomimetic inhibitors. For example, the phosphinic alanyl-proline mimics, the alkene isosteres of the prolyl amide bond, and the mimics of the type IV  $\beta$ -turn structure were reported to be inhibitors of the CypA PPIase activity with  $IC_{50}$  values ranging from low millimolar to micromolar [92]. By searching selectively, compounds having structural similarities with the *cis*-proline found in a number of peptide cyclophilin ligands, Walkinshaw and coworkers [93] could identify piperidine ligands having dissociation constants between 25 and 320 mM.

The design of peptides or peptidomimetics based on the sequence derived from the HIV-1 capsid domain of the Gag polyprotein also represents an attractive approach to generating potentially potent cyclophilin inhibitors. It was demonstrated that host cyclophilin binds the HIV-1 Gag protein capsid domain, playing therefore a key role in the viral infectivity mechanism [94]. Compounds that bind to cyclophilin with higher affinity than Gag capsid domain may disrupt the Gag-CypA interaction and stop viral function. This strategy was explored by Dugave and coworkers [95], who prepared a series of heptapeptides that were tested as competitors of the CypA PPIase activity in the uncoupled assay developed by Fischer and coworkers [96]. Interestingly, hexapeptides containing either deaminovaline (Dav) in place of the N-terminal valine or substitution of the C-terminal alanine amide with a benzylamide group displayed increased affinities, and the combination of both modifications resulted in the most active compound Dav-His-Ala-Gly-Pro-Ile-NHBn, which has higher affinity to CypA than HIV-1 capsid protein and capsid peptide. Other peptides containing the Gly-Pro sequence have also been published in the literature, such as the nonapeptide selected from a phage display library [97].

Since the cyclophilin active site conserves its conformation when bound to a variety of large and small peptide ligands [98], its structure was docked against virtual libraries using the available X-ray and NMR structures of the protein and several

families of hits could be identified whose structures diverged strongly from the peptide motifs. Surprisingly, none of these contained a proline residue, while most had a hydrophobic moiety that fit into the active site of the protein. Representative examples are presented below.

### 7.8.2

#### CsA Bis-Urea Derivatives

A CsA bis-urea derivative was identified by virtual screening of three chemical databases [99] that were used as a starting point for the design and synthesis of symmetrical 1,3-phenyl bis-ureas, symmetrical 1,3-cyclohexyl bis-ureas, and symmetrical/unsymmetrical 1,3-phenyl bis-amides/amido urea analogues. The finding that aromatic diamines fit inside the narrow hydrophobic pocket of cyclophilin led to the design of achiral polycyclic molecules; all hits identified contained both a hydrophobic core that fit into the active site and at least three sites capable of forming hydrogen bonds with CypA. Variations on the initial hit structures included different substitutions of the aryl portions, changes in the central core, and conversion of urea linkers into amide or thiourea linkers. These compounds were evaluated for their structure–activity relationship using the modified PPIase assay developed by Rich and coworkers [100], and were found to inhibit the PPIase activity of CypA with  $IC_{50}$  values ranging from hundreds of nanomolars to several micromolars.

### 7.8.3

#### Dimedone-Like Molecules

The X-ray structure of human CypA was also used by the group of Walkinshaw [101] as a template for the virtual screening of the Maybridge small molecule library (approximately 50 000 different compounds, stored as 3D structures). A family of dimedone-like molecules was identified as potential inhibitors and several analogues were synthesized and tested in various biochemical assays. The most potent compounds bind CypA with *in vitro*  $K_d$  in the micromolar range, whereas CsA binding was measured at 20 nM.

### 7.8.4

#### Quinoxaline Derivatives

Starting from available X-ray and NMR structures of cyclophilins, the *de novo* design of quinoxaline derivatives was also reported [102, 103]. Some compounds demonstrated high cyclophilin PPIase inhibitory activity, with  $IC_{50}$  values in the hundreds of nanomolar range, the  $IC_{50}$  value of CsA against CypA measured in the same assay being 61.4 nM, which was in agreement with reported results. Using SPR and fluorescence techniques, a quantitative kinetic analysis of the interaction between the most promising compound and CypA was also performed; combined with the molecular docking analysis, the data demonstrated that this compound and CsA bind to CypA in the same binding pocket. *In vivo* assay results showed that this



compound could inhibit mouse spleen cell proliferation induced by concanavalin A, therefore representing a potential lead compound for the design of further immunosuppressive agents. Additional series of quinoxalines have also been designed and tested [58].

### 7.8.5

#### Diarylurea Derivatives

More recently, additional efforts [73] have been made to identify nonpeptidic small-molecule inhibitors of cyclophilin by virtual screening of commercially available libraries. The hits obtained by Guichou *et al.* [73] were scored according to their affinity to the active site of the protein and the most promising candidates were then tested for PPIase inhibition activity using the standard assay reported in the literature [100]. The  $IC_{50}$  values determined for the top five compounds were found to be between 0.3 and 5  $\mu$ M (data not shown). The most promising structures were further evaluated with a second docking program in order to rationalize the structure–activity relationship. Compounds **1** and **2** appeared to bind to the active site in similar ways, with the benzyl group located in the active site of the protein, and the phenyl ring positioned toward the small Abu pocket (Table 7.7; Figure 7.6). Several molecules were then synthesized with the aim of adding fragments that could create

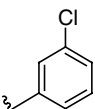
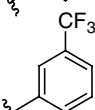
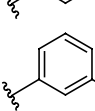
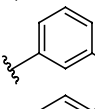
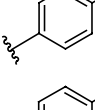
**Table 7.7** Chemical structures of compounds **1–6** and their activities against PPIase.

Compound	R	PPIase isomerase $IC_{50}$ (nM)
1		316
2		303
3		60
4		71
5		14
6		20

PPIase, peptidyl prolyl *cis-trans* isomerase.

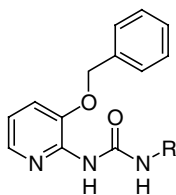

**Figure 7.6** General structure of compounds 1–6.

additional contacts with the hydrophobic region of the Abu pocket. The most potent compounds showed nanomolar inhibitory potency against the PPIase activity. Structure–activity relationship analysis pointed out the importance of the urea moiety that forms three hydrogen bonds with the protein and the phenyl-substituted groups that either displace or replace at least one of the water molecules present in the Abu pocket. The compounds were also tested in a one-round infection assay and on the replication of the pNL4.3 strain of HIV-1 in human peripheral blood mononuclear cells. Compound 1 showed moderate activity, while compound 2 had no effect on HIV-1 infectivity in the model used, presumably due to poor membrane permeability properties.

#### 7.8.6

##### Other Acylurea Derivatives

An integrated approach based on *de novo* drug design, chemical synthesis, and bioassay for quick identification of novel small-molecule cyclophilin inhibitors was also published recently [59]. The authors analyzed the structure of the published cyclophilin inhibitors and built a pharmacophore of the protein–ligand interaction. The analysis demonstrated that most reported inhibitors contain an amide fragment as the key linker between two terminal fragments and that this moiety forms two or three hydrogen bonds with CypA residues Arg55, Gln63, and Asn102 located between the two pockets. Based on their idea that tandem amide (acylurea) could contribute to an increased number of hydrogen bond interactions more effectively than either amide or urea, new ligands were designed targeting inside the cavity of the three CypA residues mentioned above. They were ranked according to their binding affinity, biological availability, shape complementarities, and synthetic feasibility. Structure–activity relationship analyses were conducted by chemical modification of the terminal fragments of compound 9, that is, the 9H-fluorene ring and the 2,6-dihydroxyphenyl moiety, that confirmed the importance of the acylurea moiety for the increased *in vitro* potency of these compounds. The most promising derivatives obtained, compounds 7–8 and 9–18, respectively (Figures 7.7 and 7.8), turned out to be potent CypA inhibitors, with  $IC_{50}$  values ranging from single digit to hundreds of nanomolars (Tables 7.8 and 7.9). However, so far, the potential antiviral activity of these compounds is unknown.

The development of small-molecule inhibitors has gained interest in recent years because their synthesis might be easier than that of the cyclosporine derivatives and



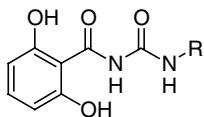

**Figure 7.7** General structure of compounds **7** and **8**.

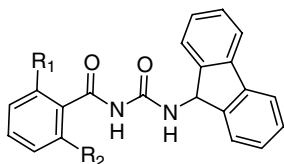

**Figure 7.8** General structure of compounds **9–18**.

**Table 7.8** Chemical structures of compounds **7** and **8** and their activities against PPIase.

Compound	R	IC <sub>50</sub> (nM)
7		370 ± 12
8		163 ± 13
CsA		40.7 ± 3.0

**Table 7.9** Chemical structures of compounds **9–18** and their activities against PPIase.

Compound	R <sub>2</sub>	R <sub>3</sub>	IC <sub>50</sub> (nM)
9	OH	OH	31.6 ± 2.0
10	Cl	H	103 ± 5
11	CN	H	71.2 ± 3
12	F	H	159 ± 7
13	CF <sub>3</sub>	H	364 ± 17
14	F	F	263 ± 24
15	Cl	Cl	2.59 ± 0.20
16	Cl	F	1.52 ± 0.10
17	BnO	H	12.1 ± 0.4
18	NO <sub>2</sub>	H	620 ± 32
CsA	NA	NA	40.7 ± 3.0

they may have different tolerance profile. The compounds reported until now show encouraging results, despite the fact that none of them succeed to reach the potency levels of the structurally more complex peptides and macrolides. It may be pointed out that some *in vitro* results are rather difficult to analyze and should probably be interpreted with caution. Positive controls should have been used in each assay in

order to confirm good reproducibility of each experiment. Another important point to consider is that none of the published molecules show strong and convincing positive *in vitro* and *in vivo* results toward the most important diseases involving cyclophilins, such as HCV. The question of the druggability of a target such as cyclophilin using a small molecule approach should be further discussed. Taking into account that the chemical structures of these small molecules are quite simple and that their drug-like properties are not yet acceptable for further development, these compounds should be considered more as hits than leads or development candidates, and significant efforts will still be necessary to reach the preclinical development phase.

## 7.9

### Conclusion

Nonimmunosuppressive cyclosporine inhibitors show potent *in vitro* activities against HIV-1 and HCV with a unique resistance profile.

Debio 025 is the most advanced cyclophilin inhibitor under clinical development. The drug has shown an important anti-HCV activity against the most prevalent HCV genotypes (1–4), not only in treatment-naïve patients but also in HIV-1/HCV coinfecting and treatment-experienced patients. Debio 025 combined with peg-IFN $\alpha$ 2a also displayed an additive antiviral effect in treatment-naïve patients and was very active in previous nonresponders to interferon-based treatment when ribavirin was added to this combination. Debio 025 is in general well tolerated, with hyperbilirubinemia and mild decreases in thrombocyte levels being its most prominent adverse events. Preliminary clinical results showed only limited efficacy in patients infected with HIV-1. NIM811 and SCY635 are the two other cyclophilin inhibitors derived from CsA currently investigated in HCV clinical studies.

Several attempts have been made to synthesize novel noncyclosporine inhibitors. So far no lead compound with potent cyclophilin inhibition and antiviral activity *in vitro* has been described in the literature. However, because of the current clinical development of the first generation of cyclophilin inhibitors as a novel anti-HCV therapy, this research is currently expanding and new derivatives are expected to be developed in the near future.

### References

- Gallay, P.A. (2009) Cyclophilin inhibitors. *Clinics in Liver Disease*, **13**, 403–417.
- Flisiak, R., Horban, A., Gallay, P., Bobardt, M., Selvarajah, S., Wiercinska-Drapalo, A., Siwak, E., Cielniak, I., Higersberger, J., Kierkus, J., Aeschlimann, C., Grosgrin, P., Nicolas-Métral, V., Dumont, J.M., Porchet, H., Crabbé, R., and Scalfaro, P. (2008) The cyclophilin inhibitor Debio-025 shows potent anti-hepatitis C effect in patients coinfecting with hepatitis C and human immunodeficiency virus. *Hepatology (Baltimore, MD)*, **47**, 817–826.

- 3 Galat, A. (2003) Peptidylprolyl *cis/trans* isomerases (immunophilins): biological diversity – targets – functions. *Current Topics in Medicinal Chemistry*, **3**, 1315–1347.
- 4 Faulds, D., Goa, K.L., and Benfield, P. (1993) Cyclosporin. A review of its pharmacodynamic and pharmacokinetic properties, and therapeutic use in immunoregulatory disorders. *Drugs*, **45**, 953–1040.
- 5 Borel, J.F., Di Padova, F., Mason, J., Quesniaux, V., Ryffel, B., and Wenger, R. (1989) Pharmacology of cyclosporine (sandimmune). *Pharmacological Reviews*, **41**, 239–434.
- 6 Stepkowski, S.M. (2000) Molecular targets for existing and novel immunosuppressive drugs. *Expert Reviews in Molecular Medicine*, **2**, 1–23.
- 7 Andrieu, J.M., Even, P., and Venet, A. (1986) AIDS and related syndromes as a viral-induced autoimmune disease of the immune system: an anti-MHC II disorder. Therapeutic implications. *AIDS Research*, **2**, 163–174.
- 8 Andrieu, J.M., Even, P., Venet, A., Tourani, J.M., Stern, M., Lowenstein, W., Audroin, C., Eme, D., Masson, D., Sors, H., Israel-Biet, D., and Beldjord, K. (1988) Effects of cyclosporin on T-cell subsets in human immunodeficiency virus disease. *Clinical Immunology and Immunopathology*, **47**, 181–198.
- 9 Levy, R., Jais, J.P., Tourani, J.M., Even, P., and Andrieu, J.M. (1995) Long-term follow-up of HIV positive asymptomatic patients having received cyclosporin A. *Advances in Experimental Medicine and Biology*, **374**, 229–234.
- 10 Rosenwirth, B., Billich, A., Datema, R., Donatsch, P., Hammerschmid, F., Harrison, R., Hiestand, P., Jaksche, H., Mayer, P., Peichl, P., Quesniaux, V., Schatz, F., Schuurman, H.-J., Traber, R., Wenger, R., Wolff, B., Zenke, G., and Zurini, M. (1994) Inhibition of human immunodeficiency virus type 1 replication by SDZ NIM 811, a nonimmunosuppressive cyclosporine analog. *Antimicrobial Agents and Chemotherapy*, **38**, 1763–1772.
- 11 Hansson, M.J., Mattiasson, G., Månsson, R., Karlsson, J., Keep, M.F., Waldmeier, P., Ruegg, U.T., Dumont, J.M., Besseghir, K., and Elmer, E. (2004) The nonimmunosuppressive cyclosporin analogs NIM811 and UNIL025 display nanomolar potencies on permeability transition in brain-derived mitochondria. *Journal of Bioenergetics and Biomembranes*, **36**, 407–413.
- 12 Franke, E.K., Yuan, H.E., and Luban, J. (1994) Specific incorporation of cyclophilin A into HIV-1 virions. *Nature*, **372**, 359–362.
- 13 Thali, M., Bukovsky, A., Kondo, E., Rosenwirth, B., Walsh, C.T., Sodroski, J., and Göttlinger, H.G. (1994) Functional association of cyclophilin A with HIV-1 virions. *Nature*, **372**, 363–365.
- 14 Watashi, K., Hijikata, M., Hosaka, M., Yamaji, M., and Shimotohno, K. (2003) Cyclosporin A suppresses replication of hepatitis C virus genome in cultured hepatocytes. *Hepatology (Baltimore, MD)*, **38**, 1282–1288.
- 15 Wang, P. and Heitman, J. (2005) The cyclophilins. *Genome Biology*, **6**, 226.
- 16 Göthel, S.F. and Marahiel, M.A. (1999) Peptidyl-prolyl *cis-trans* isomerases, a superfamily of ubiquitous folding catalysts. *Cellular and Molecular Life Sciences*, **55**, 423–436.
- 17 Fischer, G., Wittmann-Liebold, B., Lang, K., Kiefhaber, T., and Schmid, F.X. (1989) Cyclophilin and peptidyl-prolyl *cis-trans* isomerase are probably identical proteins. *Nature*, **337**, 476–478.
- 18 Heitman, J. and Cullen, B.R. (2005) Cyclophilin B escorts the hepatitis C virus RNA polymerase: a viral Achilles heel? *Molecular Cell*, **19**, 145–146.
- 19 Yurchenko, V., Constant, S., and Bukrinsky, M. (2006) Dealing with the family: CD147 interactions with cyclophilins. *Immunology*, **117**, 301–309.
- 20 Allain, F., Durieux, S., Denys, A., Carpentier, M., and Spik, G. (1999) Cyclophilin B binding to platelets supports calcium-dependent adhesion to collagen. *Blood*, **94**, 976–983.
- 21 Watashi, K., Ishii, N., Hijikata, M., Inoue, D., Murata, T., Miyanari, Y., and Shimotohno, K. (2005) Cyclophilin B is a functional regulator of hepatitis C virus RNA polymerase. *Molecular Cell*, **19**, 111–122.
- 22 Yang, F., Robotham, J.M., Nelson, H.B., Irsigler, A., Kenworthy, R., and Tang, H.

- (2008) Cyclophilin A is an essential cofactor for hepatitis C virus infection and the principal mediator of cyclosporine A resistance *in vitro*. *Journal of Virology*, **82**, 5269–5278.
- 23 Nakagawa, M., Sakamoto, N., Tanabe, Y., Koyama, T., Itsui, Y., Takeda, Y., Chen, C.H., Kakinuma, S., Oooka, S., Maekawa, S., Enomoto, N., and Watanabe, M. (2005) Suppression of hepatitis C virus replication by cyclosporin A is mediated by blockade of cyclophilins. *Gastroenterology*, **129**, 1031–1041.
- 24 Gallay, P.A. (2007) Anti-HCV mechanisms of action of Debio 025. Study Debio 025-0160. Final report, July.
- 25 Kaul, A., Stauffer, S., Berger, C., Pertel, T., Schmitt, J., Kallis, S., Zayas, M., Lohmann, V., Luban, J., and Bartenschlager, R. (2009) Essential role of cyclophilin A for hepatitis C virus replication and virus production and possible link to polyprotein cleavage kinetics. *PLoS Pathogens*, **5**, e1000546.
- 26 Kong, W., Li, S., Longaker, M.T., and Lorenz, H.P. (2007) Cyclophilin C-associated protein is up-regulated during wound healing. *Journal of Cellular Physiology*, **210**, 153–160.
- 27 Halestrap, A. (2005) Biochemistry: a pore way to die. *Nature*, **434**, 578–579.
- 28 Houck, D.R. and Hopkins, S. (2006) Preclinical evaluation of SCY-635, a cyclophilin inhibitor with potent anti-HCV activity. *Hepatology (Baltimore, MD)*, **44**, 534, Abstract No. 934.
- 29 Gaither, L.A., Borawski, J., Anderson, L.J., Balabanis, K.A., Devay, P., Joberty, G., Rau, C., Schirle, M., Bouwmeester, T., Mickanin, C., Zhao, S., Vickers, C., Lee, L., Deng, G., Baryza, J., Fujimoto, R.A., Lin, K., Compton, T., and Wiedmann, B. (2010) Multiple cyclophilins involved in different cellular pathways mediate HCV replication. *Virology*, **397**, 43–55.
- 30 Ptak, R.G., Gallay, P.A., Jochmans, D., Halestrap, A.P., Ruegg, U.T., Pallansch, L.A., Bobardt, M.D., de Béthune, M.P., Neyts, J., De Clercq, E., Dumont, J.M., Scalfaro, P., Besseghir, K., Wenger, R.M., and Rosenwirth, B. (2008) Inhibition of human immunodeficiency virus type 1 replication in human cells by Debio-025, a novel cyclophilin binding agent. *Antimicrobial Agents and Chemotherapy*, **52**, 1302–1317.
- 31 Hopkins, S., Scorneaux, B., Huang, Z., Murray, M.G., Wring, S., Smitley, C., Harris, R., Erdmann, F., Fisher, G., and Ribeill, Y. (2010) SCY-635: a novel non-immunosuppressive analog of cyclosporine that exhibits potent inhibition of hepatitis C virus RNA replication *in vitro*. *Antimicrobial Agents and Chemotherapy*, **54**, 660–672.
- 32 Maggiolo, F. (2009) Efavirenz: a decade of clinical experience in the treatment of HIV. *The Journal of Antimicrobial Chemotherapy*, **64**, 910–928.
- 33 Sokolskaja, E., Sayah, D.M., and Luban, J. (2004) Target cell cyclophilin A modulates human immunodeficiency virus type 1 infectivity. *Journal of Virology*, **78**, 12800–12808.
- 34 Chatterji, U., Bobardt, M.D., Stanfield, R., Ptak, R.G., Pallansch, L.A., Ward, P.A., Jones, M.J., Stoddart, C.A., Scalfaro, P., Dumont, J.M., Besseghir, K., Rosenwirth, B., and Gallay, P.A. (2005) Naturally occurring capsid substitutions render HIV-1 cyclophilin A independent in human cells and TRIM-cyclophilin-resistant in owl monkey cells. *The Journal of Biological Chemistry*, **280**, 40293–40300.
- 35 Daelemans, D., Dumont, J.M., Rosenwirth, B., De Clercq, E., and Pannecouque, C. (2010) Debio-025 inhibits HIV-1 by interfering with an early event in the replication cycle. *Antiviral Research*, **85**, 418–421.
- 36 Bare, J., Dumont, J.-M., Besseghir, K., and Stoddart, C.A. (2004) Potent *in vivo* anti-HIV-1 activity of the nonimmunosuppressive cyclosporin UNIL-025. Keystone Symposium on HIV Pathogenesis, April 2004, Whistler British Columbia, Canada.
- 37 Kootstra, N.A., Munk, C., Tonnu, N., Landau, N.R., and Verma, I.M. (2003) Abrogation of postentry restriction of HIV-1-based lentiviral vector transduction in simian cells. *Proceedings of the National Academy of Sciences of the United States of America*, **100**, 1298–1303.
- 38 Cullen, B.R. and Heitman, J. (1994) Human immunodeficiency virus. Chaperoning a pathogen. *Nature*, **372**, 319–320.
- 39 Luban, J. (2007) Cyclophilin A, TRIM5, and resistance to human

- immunodeficiency virus type 1 infection. *Journal of Virology*, **81**, 1054–1061.
- 40 Bukovsky, A.A., Weimann, A., Accola, M.A., and Göttlinger, H.G. (1997) Transfer of the HIV-1 cyclophilin-binding site to simian immunodeficiency virus from *Macaca mulatta* can confer both cyclosporin sensitivity and cyclosporin dependence. *Proceedings of the National Academy of Sciences of the United States of America*, **94**, 10943–10948.
- 41 Gamble, T.R., Vajdos, F.F., Yoo, S., Worthylake, D.K., Houseweart, M., Sundquist, W.I., and Hill, C.P. (1996) Crystal structure of human cyclophilin A bound to the amino-terminal domain of HIV-1 capsid. *Cell*, **87**, 1285–1294.
- 42 Braaten, D., Franke, E.K., and Luban, J. (1996) Cyclophilin A is required for an early step in the life cycle of human immunodeficiency virus type 1 before the initiation of reverse transcription. *Journal of Virology*, **70**, 3551–3560.
- 43 Steinkasserer, A., Harrison, R., Billich, A., Hammerschmid, F., Werner, G., Wolff, B., Peichl, P., Palfi, G., Schnitzel, W., Mlynar, E., and Rosenwirth, B. (1995) Mode of action of SDZ NIM 811, a nonimmunosuppressive cyclosporin A analog with activity against human immunodeficiency virus type 1 (HIV-1): interference with early and late events in HIV-1 replication. *Journal of Virology*, **69**, 814–824.
- 44 Mlynar, E., Bevec, D., Billich, A., Rosenwirth, B., and Steinkasserer, A. (1997) The non-immunosuppressive cyclosporin A analogue SDZ NIM 811 inhibits cyclophilin A incorporation into virions and virus replication in human immunodeficiency virus type 1-infected primary and growth-arrested T cells. *The Journal of General Virology*, **78**, 825–835.
- 45 Hatziioannou, T., Perez-Caballero, D., Cowan, S., and Bieniasz, P.D. (2005) Cyclophilin interactions with incoming human immunodeficiency virus type 1 capsids with opposing effects on infectivity in human cells. *Journal of Virology*, **79**, 176–183.
- 46 Strebel, K., Luban, J., and Jeang, K.T. (2009) Human cellular restriction factors that target HIV-1 replication. *BMC Medicine*, **7**, 48.
- 47 Steyn, D., Richman, D.D., Aeschlimann, C., Dumont, J.-M., Groscurin, P., Rosenwirth, B., Loveday, C., Porchet, H., Nicolas, V., and Scalfaro, P. (2006) A double blind placebo controlled study in HIV-1-infected subjects on the safety, pharmacokinetics and antiviral effect of cyclophilin A targeting DEBIO-025. 13th Conference on Retroviruses and Opportunistic Infections (CROI), February 5–8, 2006, Denver, Colorado.
- 48 Dienstag, J.L. and McHutchison, J.G. (2006) American Gastroenterological Association technical review on the management of hepatitis C. *Gastroenterology*, **130**, 231–264.
- 49 Alter, M.J. (2007) Epidemiology of hepatitis C virus infection. *World Journal of Gastroenterology*, **13**, 2436–2441.
- 50 Soriano, V., Madejon, A., Vispo, E., Labarga, P., Garcia-Samaniego, J., Martin-Carbonero, L., Sheldon, G., Bottecchia, M., Tuma, P., and Barreiro, P. (2008) Emerging drugs for hepatitis C. *Expert Opin Emerg Drugs*, **13** (1), 1–19.
- 51 Shepard, C.W., Finelli, L., and Alter, M.J. (2005) Global epidemiology of hepatitis C virus infection. *The Lancet Infectious Diseases*, **5**, 558–567.
- 52 Simmonds, P., Bukh, J., Combet, C., Deleage, G., Enomoto, N., Feinstone, S., Halfon, P., Inchauspe, G., Kuiken, C., Maertens, G., Mizokami, M., Murphy, D.G., Okamoto, H., Pawlotsky, J.M., Penin, F., Sablon, E., Shin, I.T., Stuyver, L.J., Thiel, H.J., Viazov, S., Weiner, A.J., and Widell, A. (2005) Consensus proposals for a unified system of nomenclature of hepatitis C virus genotypes. *Hepatology (Baltimore, MD)*, **42**, 962–973.
- 53 Cross, T.J., Antoniadis, C.G., and Harrison, P.M. (2008) Current and future management of chronic hepatitis C infection. *Postgraduate Medical Journal*, **84**, 172–176.
- 54 Teraoka, S., Mishiro, S., Ebihara, K., Sanaka, T., Yamaguchi, Y., Nakajima, I., Kawai, T., Yagisawa, T., Honda, H., Fuchinoue, S., Takahashi, K., Toma, H., Agishi, T., and Ota, K. (1988) Effect of cyclosporine on proliferation of non-A, non-B hepatitis virus. *Transplantation Proceedings*, **20**, 868–876.

- 55 Harrigan, P.R., Hogg, R.S., Dong, W.W., Yip, B., Wynhoven, B., Woodward, J., Brumme, C.J., Brumme, Z.L., Mo, T., Alexander, C.S., and Montaner, J.S. (2005) Predictors of HIV drug-resistance mutations in a large antiretroviral-naive cohort initiating triple antiretroviral therapy. *The Journal of Infectious Diseases*, **191**, 339–347.
- 56 Rice, C.M. and You, S. (2005) Treating hepatitis C: Can you teach old dogs new tricks? *Hepatology (Baltimore, MD)*, **42**, 1455–1458.
- 57 Chatterji, U., Bobardt, M., Selvarajah, S., Yang, F., Tang, H., Sakamoto, N., Vuagniaux, G., Parkinson, T., and Gallay, P. (2009) The isomerase active site of cyclophilin A is critical for HCV replication. *The Journal of Biological Chemistry*, **284**, 16998–17005.
- 58 Wang, F., Chen, J., Liu, X., Shen, X., He, X., Jiang, H., and Bai, D. (2006) Synthesis and peptidyl-prolyl isomerase inhibitory activity of quinoxalines as ligands of cyclophilin A. *Chemical & Pharmaceutical Bulletin*, **54**, 372–376.
- 59 Ni, S., Yuan, Y., Huang, J., Mao, X., Lv, M., Zhu, J., Shen, X., Pei, J., Lai, L., Jiang, H., and Li, J. (2009) Discovering potent small molecule inhibitors of cyclophilin A using *de novo* drug design approach. *Journal of Medicinal Chemistry*, **52**, 5295–5298.
- 60 Liu, Z., Yang, F., Robotham, J.M., and Tang, H. (2009) Critical role of cyclophilin A and its prolyl-peptidyl isomerase activity in the structure and function of the hepatitis C virus replication complex. *Journal of Virology*, **83**, 6554–6565.
- 61 Wiedemann, B., Puyang, X., Poulin, D., Mathy, J.E., Ma, S., Anderson, L.J., Fujimoto, R., Compton, T., and Lin, K. (2008) Characterization of the mechanism of resistance to cyclophilin inhibitors in HCV replicon. 15th International Symposium on Hepatitis C & Related Viruses, October 5–9, 2008, San Antonio, TX, USA.
- 62 Hanouille, X., Badillo, A., Wieruszkeski, J.M., Verdegem, D., Landrieu, I., Bartenschlager, R., Pemin, F., and Lippens, G. (2009) Hepatitis C virus NS5A protein is a substrate for the peptidyl-prolyl *cis/trans* isomerase activity of cyclophilins A and B. *The Journal of Biological Chemistry*, **284**, 13589–13601.
- 63 Bartenschlager, R. and Kaul, A. (2008) Analyses of the antiviral effects of Debio 025 and understanding its mode of action. Study Debio-025-0135. Final report.
- 64 Ishii, N., Watashi, K., Hishiki, T., Goto, K., Inoue, D., Hijikata, M., Wakita, T., Kato, N., and Shimotohno, K. (2006) Diverse effects of cyclosporine on hepatitis C virus strain replication. *Journal of Virology*, **80**, 4510–4520.
- 65 Abe, K., Ikeda, M., Ariumi, Y., Dansako, H., Wakita, T., and Kato, N. (2009) HCV genotype 1b chimeric replicon with NS5B of JFH-1 exhibited resistance to cyclosporine A. *Archives of Virology*, **154**, 1671–1677.
- 66 Ciesek, S., Steinmann, E., Wedemeyer, H., Manns, M.P., Neyts, J., Tautz, N., Madan, V., Bartenschlager, R., von Hahn, T., and Pietschmann, T. (2009) Cyclosporine A inhibits hepatitis C virus nonstructural protein 2 through cyclophilin A. *Hepatology (Baltimore, MA)*, **50**, 1638–1645.
- 67 Goto, K., Watashi, K., Murata, T., Hishiki, T., Hijikata, M., and Shimotohno, K. (2006) Evaluation of the anti-hepatitis C virus effects of cyclophilin inhibitors, cyclosporin A, and NIM811. *Biochemical and Biophysical Research Communications*, **343**, 879–884.
- 68 Ma, S., Boerner, J.E., TiongYip, C., Weidmann, B., Ryder, N.S., Cooreman, M.P., and Lin, K. (2006) NIM811, a cyclophilin inhibitor, exhibits potent *in vitro* activity against hepatitis C virus alone or in combination with alpha interferon. *Antimicrobial Agents and Chemotherapy*, **50**, 2976–2982.
- 69 Lin, K., Boerner, J.E., and Cooreman, M.P. (2006) NIM811, a cyclophilin inhibitor targeting host–viral interaction, significantly enhances the antiviral activity of HCV polymerase inhibitors and reduces the emergence of resistance *in vitro*. First International Workshop on Hepatitis C Resistance and New Compounds, Boston, MA, USA.

- 70 Paeshuyse, J., Kaul, A., De Clercq, E., Rosenwirth, B., Dumont, J.M., Scalfaro, P., Bartenschlager, R., and Neyts, J. (2006) The non-immunosuppressive cyclosporin DEBIO-025 is a potent inhibitor of hepatitis C virus replication *in vitro*. *Hepatology (Baltimore, MD)*, **43**, 761–770.
- 71 Coelmont, L., Kaptein, S., Paeshuyse, J., Vliegen, I., Dumont, J.M., Vuagniaux, G., and Neyts, J. (2009) Debio 025, a cyclophilin binding molecule, is highly efficient in clearing hepatitis C virus (HCV) replicon-containing cells when used alone or in combination with specifically targeted antiviral therapy for HCV (STAT-C) inhibitors. *Antimicrobial Agents and Chemotherapy*, **53**, 967–976.
- 72 Inoue, K., Umehara, T., Ruegg, U.T., Yasui, F., Watanabe, T., Yasuda, H., Dumont, J.M., Scalfaro, P., Yoshida, M., and Kohara, M. (2007) Evaluation of a cyclophilin inhibitor in hepatitis C virus-infected chimeric mice *in vivo*. *Hepatology (Baltimore, MD)*, **45**, 921–928.
- 73 Guichou, J.F., Viaud, J., Mettling, C., Subra, G., Lin, Y.L., and Chavanieu, A. (2006) Structure-based design, synthesis, and biological evaluation of novel inhibitors of human cyclophilin A. *Journal of Medicinal Chemistry*, **49**, 900–910.
- 74 Hopkins, S., Scorneaux, B., Harris, R., Huang, Z., and Murray, M. (2008) The genetic and biochemical basis for resistance to SCY-635. 59th Annual Meeting of the American Association for the Study of Liver Diseases, October 31–November 4, 2008, San Francisco, CA, USA, Poster 1814, p. 1117A.
- 75 Coelmont, L., Gally, P., Bobardt, M., Kaptein, S., Paeshuyse, J., Vliegen, I., Vuagniaux, G., and Neyts, J. (2009) Particular *in vitro* anti-HCV activities and resistance profile of the cyclophilin inhibitor Debio 025. *Journal of Hepatology*, **50**, S36.
- 76 Fernandes, F., Poole, D.S., Hoover, S., Middleton, R., Andrei, A.C., Gerstner, J., and Striker, R. (2007) Sensitivity of hepatitis C virus to cyclosporine A depends on nonstructural proteins NS5A and NS5B. *Hepatology (Baltimore, MD)*, **46**, 1026–1033.
- 77 Goto, K., Watashi, K., Inoue, D., Hijikata, M., and Shimotohno, K. (2009) Identification of cellular and viral factors related to anti-hepatitis C virus activity of cyclophilin inhibitor. *Cancer Science*, **100**, 1943–1950.
- 78 Robida, J.M., Nelson, H.B., Liu, Z., and Tang, H. (2007) Characterization of hepatitis C virus subgenomic replicon resistance to cyclosporine *in vitro*. *Journal of Virology*, **81**, 5829–5840.
- 79 Liu, Z., Robida, J.M., Chinnaswamy, S., Yi, G., Robotham, J.M., Nelson, H.B., Irsigler, A., Kao, C.C., and Tang, H. (2009) Mutations in the hepatitis C virus polymerase that increase RNA binding can confer resistance to cyclosporine A. *Hepatology (Baltimore, MD)*, **50**, 25–33.
- 80 Flisiak, R., Feinman, S.V., Jablkowski, M., Horban, A., Kryczka, W., Pawlowska, M., Heathcote, J.E., Mazzella, G., Vandelli, C., Nicolas-Métral, V., Groscurin, P., Liz, J.S., Scalfaro, P., Porchet, H., and Crabbé, R. (2009) The cyclophilin inhibitor Debio 025 combined with PEG IFN $\alpha$ 2a significantly reduces viral load in treatment-naïve hepatitis C patients. *Hepatology (Baltimore, MD)*, **49**, 1460–1468.
- 81 Nelson, D.R., Ghalib, R.H., Sulkowski, M., Schiff, E., Rustgi, V., Pockros, P.J., Wang, C., Decosterd Kerhuel, G., Groscurin, P., Porchet, H., and Crabbé, R. (2009) Efficacy and safety of the cyclophilin inhibitor Debio 025 in combination with pegylated interferon alpha-2a and ribavirin in previously null-responder genotype 1 HCV patients. *Journal of Hepatology*, **50**, S40.
- 82 Mason, J. (1990) Pharmacology of cyclosporine (sandimmune). VII. Pathophysiology and toxicology of cyclosporine in humans and animals. *Pharmacological Reviews*, **41**, 423–434.
- 83 Stone, B.G., Udani, M., Sanghvi, A., Warty, V., Plocki, K., Bedetti, C.D., and Van Thiel, D.H. (1987) Cyclosporin A-induced cholestasis. The mechanism in a rat model. *Gastroenterology*, **93**, 344–351.
- 84 Horikawa, M., Kato, Y., Tyson, C.A., and Sugiyama, Y. (2003) Potential cholestatic activity of various therapeutic agents assessed by bile canalicular membrane

- vesicles isolated from rats and humans. *The Drug Metabolism and Pharmacokinetics*, **18**, 16–22.
- 85 Stieger, B., Fattinger, K., Madon, J., Kullak-Ublick, G.A., and Meier, P.J. (2000) Drug- and estrogen-induced cholestasis through inhibition of the hepatocellular bile salt export pump (Bsep) of rat liver. *Gastroenterology*, **118**, 422–430.
- 86 Lawitz, E., Rouzier, R., Nguyen, T., Huang, D., Ke, J., and Praetgaard, J. (2009) Safety and antiviral efficacy of 14 days of the cyclophilin inhibitor NIM811 in combination with pegylated interferon  $\alpha$ 2a in relapsed genotype 1 HCV infected patients. *Journal of Hepatology*, **50**, S379.
- 87 Hopkins, S., Heuman, D., Gavis, E., Lalezari, J., Glutzer, E., and DiMassimo, B. (2009) Safety, plasma pharmacokinetics, and anti-viral activity of SCY-635 in adult patients with chronic hepatitis C virus infection. *Journal of Hepatology*, **50**, S36.
- 88 Damaso, C.R. and Moussatché, N. (1998) Inhibition of vaccinia virus replication by cyclosporin A analogues correlates with their affinity for cellular cyclophilins. *The Journal of General Virology*, **79**, 339–346.
- 89 Qing, M., Yang, F., Zhang, B., Zou, G., Robida, J.M., Yuan, Z., Tang, H., and Shi, P.Y. (2009) Cyclosporine inhibits flavivirus replication through blocking the interaction between host cyclophilins and viral NS5 protein. *Antimicrobial Agents and Chemotherapy*, **53**, 3226–3235.
- 90 Bienkowska-Haba, M., Patel, H.D., and Sapp, M. (2009) Target cell cyclophilins facilitate human papillomavirus type 16 infection. *PLoS Pathogens*, **5**, e1000524.
- 91 Kawasaki, H., Mocarski, E.S., Kosugi, I., and Tsutsui, Y. (2007) Cyclosporin inhibits mouse cytomegalovirus infection via a cyclophilin-dependent pathway specifically in neural stem/progenitor cells. *Journal of Virology*, **81**, 9013–9023.
- 92 Wang, X.J. and Etzkorn, F.A. (2006) Peptidyl-prolyl isomerase inhibitors. *Biopolymers*, **84**, 125–146.
- 93 Kontopidis, G., Taylor, P., and Walkinshaw, M.D. (2004) Enzymatic and structural characterization of non-peptide ligand–cyclophilin complexes. *Acta Crystallographica. Section D, Biological Crystallography*, **60**, 479–485.
- 94 Luban, J., Bossolt, K.L., Franke, E.K., Kalpana, G.V., and Goff, S.P. (1993) Human immunodeficiency virus type 1 Gag protein binds to cyclophilins A and B. *Cell*, **73**, 1067–1078.
- 95 Li, Q., Moutiez, M., Charbonnier, J.-B., Vaudry, K., Ménez, A., Quéméneur, E., and Dugave, C. (2000) Design of a Gag pentapeptide analogue that binds human cyclophilin A more efficiently than the entire capsid protein: new insights for the development of novel anti-HIV-1 drugs. *Journal of Medicinal Chemistry*, **43**, 1770–1779.
- 96 Janowski, B., Wöllner, S., Schutkowski, M., and Fischer, G. (1997) A protease-free assay for peptidyl prolyl *cis/trans* isomerases using standard peptide substrates. *Analytical Biochemistry*, **252**, 299–307.
- 97 Piotukh, K., Gu, W., Kofler, M., Labudde, D., Helms, V., and Freund, C. (2005) Cyclophilin A binds to linear peptide motifs containing a consensus that is present in many human proteins. *The Journal of Biological Chemistry*, **280**, 23668–23674.
- 98 Taylor, P., Husi, H., Kontopidis, G., and Walkinshaw, M.D. (1997) Structures of cyclophilin–ligand complexes. *Progress in Biophysics and Molecular Biology*, **67**, 155–181.
- 99 Wu, Y.Q., Belyakov, S., Choi, C., Limburg, D., Thomas, B.E., IV, Vaal, M., Wei, L., Wilkinson, D.E., Holmes, A., Fuller, M., McCormick, J., Connolly, M., Moeller, T., Steiner, J., and Hamilton, G.S. (2003) Synthesis and biological evaluation of non-peptidic cyclophilin ligands. *Journal of Medicinal Chemistry*, **46**, 1112–1115.
- 100 Kofron, J.L., Kuzmic, P., Kishore, V., Colón-Bonilla, E., and Rich, D.H. (1991) Determination of kinetic constants for peptidyl prolyl *cis/trans* isomerases by an improved spectrophotometric assay. *Biochemistry*, **30**, 6127–6134.
- 101 Yang, Y., Moir, E., Kontopidis, G., Taylor, P., Wear, M.A., Malone, K., Dunsmore, C.J., Page, A.P., Turner, N.J., and Walkinshaw, M.D. (2007) Structure-based discovery of a family of synthetic



- cyclophilin inhibitors showing a cyclosporin-A phenotype in *Caenorhabditis elegans*. *Biochemical and Biophysical Research Communications*, **363**, 1013–1019.
- 102** Li, J., Chen, J., Zhang, L., Wang, F., Gui, C., Zhang, L., Qin, Y., Xu, Q., Liu, H., Nan, F., Shen, J., Bai, D., Chen, K., Shen, X., and Jiang, H. (2006) One novel quinoxaline derivative as a potent human cyclophilin A inhibitor shows highly inhibitory activity against mouse spleen cell proliferation. *Bioorganic & Medicinal Chemistry*, **14**, 5527–5534.
- 103** Guo, H.X., Wang, F., Yu, K.Q., Chen, J., Bai, D.L., Chen, K.X., Shen, X., and Jiang, H.L. (2005) Novel cyclophilin D inhibitors derived from quinoxaline exhibit highly inhibitory activity against rat mitochondrial swelling and  $\text{Ca}_2^+$  uptake/release. *Acta Pharmacologica Sinica*, **26**, 1201–1211.

## 8

# Alkoxyalkyl Ester Prodrugs of Antiviral Nucleoside Phosphates and Phosphonates

*James R. Beadle and Karl Y. Hostetler*

### 8.1

#### Introduction

Prodrugs have proven to be an effective method for the oral delivery of antiviral nucleoside and nucleotide analogues. Several approved antiviral prodrugs have already contributed to the rapid advancements seen recently in the treatment of viral infections, and a number of alternative approaches featuring different mechanisms of action have been described, some of which are undergoing preclinical or clinical development [1, 2].

Many prodrug strategies employ modifications of the hydroxyl groups of water-soluble antiviral nucleosides with esters, carbonates, and carbamates to increase the lipophilicity and membrane permeability of the parent nucleosides [3]. For example, the bis(2-methylpropanoate) ester of 2'-deoxy-2'-fluoro-2'-C-methylcytidine R7128 is currently in a clinical trial for hepatitis C virus (HCV) [4]. Modifications of the nucleobase that increase lipophilicity are also potentially useful strategies in designing oral prodrugs [5].

Targeting specific transporters has proven to be an effective strategy for increasing the intestinal permeation of polar or charged molecules [6]. Valacyclovir and valganciclovir (VGCV), the valine ester prodrugs of the poorly absorbed antiviral drugs acyclovir and ganciclovir (GCV), are actively transported by the amino acid transporter hPEPT-1 and are converted to their corresponding parent drugs inside cells [7]. This approach has also been applied to anticancer nucleoside analogues [8, 9].

Bypass of the first nucleoside kinase step has been an important focus of prodrug activity. Cidofovir (CDV) and (S)-HPMPA, which contain a phosphonate residue, bypass the first phosphorylation step and are active against thymidine kinase-deficient herpes simplex virus (HSV) and varicella zoster virus (VZV) mutants [10]. Lipid prodrugs having two phosphates [11, 12] or one phosphate [13, 14] have been shown to bypass the initial kinase step. Other prodrugs that enable kinase bypass include the bis(S-acylthioethyl) "SATE" ester [15] and cyclosaligenyl (cyclosal) [16] approaches that were reviewed recently [17]. The very effective aryloxy phosphoramidate triester technology has been applied to both conventional nucleosides and

nucleoside phosphonates [18–20]. Two phosphoramidate prodrugs are reportedly advancing in clinical trials for treatment of hepatitis C virus [21, 22]. PSI 7851 is a phosphoramidate prodrug of 2'-deoxy-2'-fluoro-2'-C-methyluridine [23] and IDX184 (a mixed phosphoramidate mono-SATE prodrug of 2'-C-methyl guanosine) employs Idenix's proprietary liver-targeting technology [24].

As part of our effort to identify a generally applicable approach to orally active antiviral prodrugs, we chose to disguise various poorly absorbed nucleotide (and pyrophosphate) analogues as lysophospholipids by esterification with alkoxyalkyl and other phospholipid-like groups. The phosphoester linkage was postulated to be stable because of the absence of phospholipase C and related enzymes in pancreatic secretions. Since this linkage is stable and because a high percentage of lysophospholipids are absorbed intact [25, 26], this approach facilitates absorption in the gastrointestinal tract, delivering the intact prodrug to the systemic circulation. In this way, the modified compounds are delivered into cells, where they may then be metabolized by cellular phospholipase C-like enzymes to release their active species. The application of this modification has resulted in the improvement of the oral antiviral activity of several drugs. In addition, the alkoxyalkyl approach has been applied to several antiviral nucleoside phosphonates, resulting in two promising antiviral drugs that have now progressed into clinical development [27].

In this chapter, we describe the development and application of our approach to the design of orally active antiviral compounds. In addition to this chapter, another recent review is available that specifically describes the application of this technology to the acyclic nucleoside phosphonates (ANPs) and includes more detailed discussion on the mechanisms responsible for the increased oral antiviral activity of these compounds [28].

## 8.2

### Enhancing the Oral Activity of Antiviral Compounds: Overview of the Development of Alkoxyalkyl Esterification Approach

Phospholipids are a part of normal dietary intake and specialized absorption pathways for lipids exist [29]. About 2–8 g of phospholipid are ingested per day, which represents 1–10% of total daily fat intake. The most common phospholipid in the diet is phosphatidylcholine. The structure of phosphatidylcholine is shown in Figure 8.1 (left panel) and the arrows indicate the enzymatic cleavage points of phospholipases A<sub>1</sub>, A<sub>2</sub>, C, and D. Our early approach to prodrug design was based on the premise that enhanced uptake and targeting could be achieved through bioreversible derivatization of antiviral nucleosides with phosphatidyl groups, in essence replacing the polar head group of phosphatidylcholine with an antiviral nucleoside.

AZT was the first among the 2',3'-dideoxynucleosides found to be effective in inhibiting the replication of HIV. However, AZT was ineffective in chronically infected cells such as macrophages. To direct much larger amounts of antiretroviral nucleosides to macrophages, we synthesized several phosphatidyl derivatives of AZT (Figure 8.1) and found the prodrugs to be effective inhibitors of HIV replication

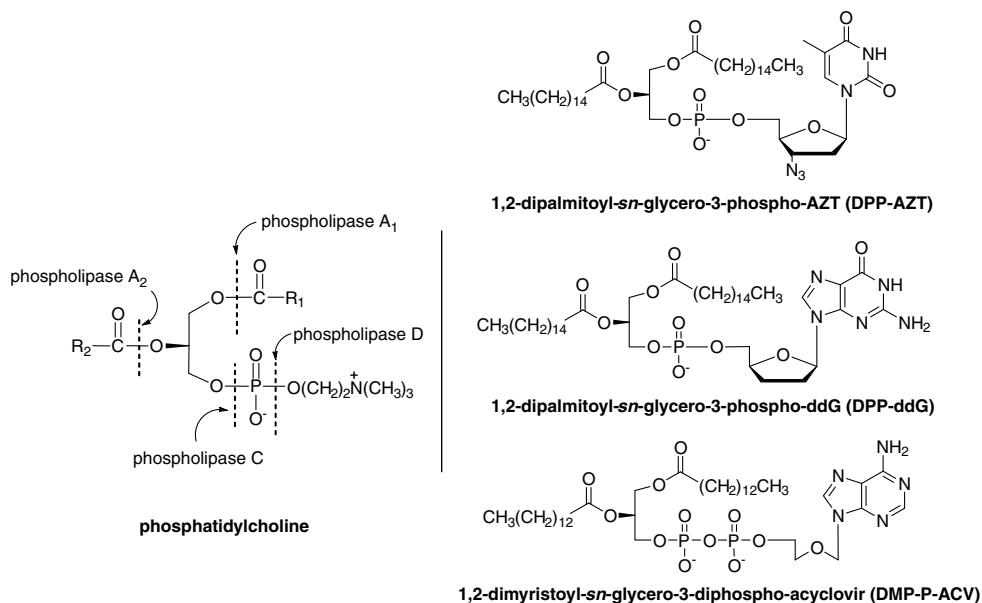

**Figure 8.1** Phosphatidylcholine showing potential cleavage sites (left) and some examples of phosphatidyl analogues of antiviral nucleosides.

*in vitro* [30]. Likewise, 3'-deoxythymidine (3dT) diphosphate dimyristoylglycerol was synthesized and found to be 18–50 times more effective than 3dT *in vitro* [11], acyclovir diphosphate dimyristoylglycerol was found to be effective *in vitro* against three different ACV-resistant thymidine kinase mutants of herpes simplex virus [12], and phosphatidyl-ddC was active against hepatitis B virus (HBV)-infected cells. Finally, intraperitoneal administration of liposomal formulations of phosphatidyl-ddC to mice resulted in a 40-fold increased retention in the liver [31] and, in other animal studies, a related analogue DPP-ddG (Figure 8.1) was targeted to the liver [32].

Together, these data provided strong evidence that lipid prodrugs have great potential for delivery of antivirals into cells. While the studies clearly demonstrated the utility of liver targeting using a phosphatidyl-linked antiviral agent, parenteral administration of the formulation was required and subsequent experiments revealed that DPP-ddG and phosphatidyl analogues of other nucleosides are poorly absorbed after oral administration in mice (K.Y. Hostetler, unpublished data, 1999).

To address these limitations, we made several changes to our original phosphatidyl analogue approach. We based our design on lysophosphatidylcholine (LPC) that is formed in the gut by the action of phospholipase A<sub>2</sub> on phosphatidylcholine. A substantial percentage of LPC is absorbed intact [25, 26].

First, the acyl ester bond at the *sn*-1 position of LPC was replaced with an ether linkage, preventing hydrolysis of the acyl group by lysophospholipase during

absorption. The alkyl ether also increases compound stability. Second, the hydroxyl at the *sn*-2 position of glycerol in LPC was replaced with a hydrogen atom to prevent reacylation by lysophosphatidylcholine acyltransferases present in small intestinal enterocytes and other tissues.

We applied the design strategy illustrated in Figure 8.2 to phosphonoformate and several nucleoside and nucleoside phosphonate analogues, and used various alkylglycerol and alkoxyalkyl groups with chains ranging from 12 to 24 atoms. From these investigations, alkoxyalkyl groups having about 20 atoms emerged as the preferred structure for enhancement of oral bioavailability. In particular, the hexadecyloxypropyl (HDP) and octadecyloxyethyl (ODE) esters have become favored lipids based on our examination of several series of compounds. The synthesis of 3-hexadecyloxy-1-propanol, the key precursor for the preparation of many of the prodrugs, is straightforward and protocols for its preparation have been published [33]. Its structure, along with the structures of several other ether lipids that have been studied, is shown in Figure 8.2. In the following sections, we will summarize some of the data obtained from applying the alkoxyalkyl ester strategy to various antiviral nucleoside phosphates and phosphonates.

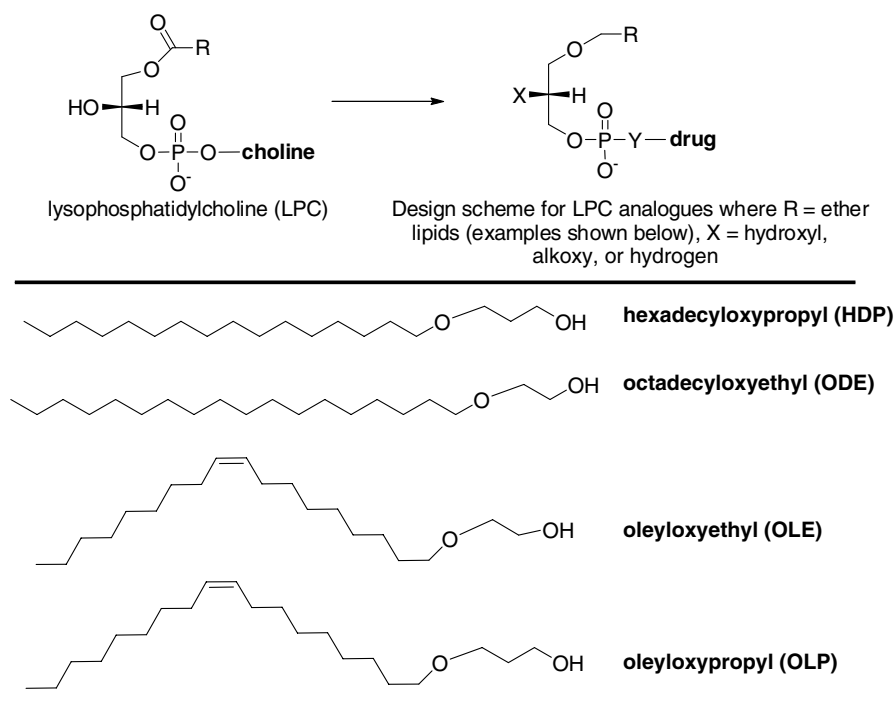

**Figure 8.2** Design scheme for structural mimics of dietary phospholipids that facilitate oral delivery of antiviral drugs.

### 8.3

#### Alkylglycerol and Alkoxyalkyl Prodrugs of Phosphonoformate: Enhanced Antiviral Activity and Synergism with AZT

Phosphonoformic acid (PFA, foscarnet) is an FDA-approved treatment for CMV retinitis in AIDS patients. PFA, an analogue of pyrophosphate, inhibits a variety of viral polymerases, including those of herpes simplex virus, cytomegalovirus (CMV), and the human immunodeficiency virus (HIV-1). Although foscarnet is very active as an inhibitor of viral polymerases, much higher concentrations of the drug are required to inhibit viral replication in virus-infected cells *in vitro* due to poor cellular permeability. The unique antiviral profile of PFA [34], its obvious inability to pass through cell membranes, and its negligible oral bioavailability made it an ideal candidate for our prodrug approach.

We synthesized a wide range of PFA analogues with varying lipophilic groups [35–38]. One of the first analogues we prepared, 1-*O*-octadecyl-*sn*-glycero-3-phosphonoformate (ODG-PFA), was 93-fold more active than PFA in cells infected with the AD169 strain of HCMV and 43-fold more active in cells infected with herpes simplex virus (HSV-1) [35]. Further studies of the mechanisms of increased antiviral activity indicated that [<sup>14</sup>C]-ODG-PFA is taken up more extensively than the free drug by MRC-5 human lung fibroblasts, and intracellular enzymes convert ODG-PFA to PFA [35].

ODG-PFA was also 44-fold more active than PFA in HIV-1-infected cells [39]. As shown in Table 8.1, we also evaluated the antiviral activity against viruses containing mutations conferring resistance to single or multiple nucleoside reverse transcriptase inhibitors (NRTIs). Of the viruses tested, only those encoding K65R demonstrated significant resistance to the prodrugs and unmodified PFA, with fold resistance values ranging from 3.3 to 8.2 ( $EC_{50}$  values from 1.66 to 14.68  $\mu$ M). Viruses resistant to 3TC or ddI/ddC (containing M184V and L74V resistance mutations, respectively) were sensitive to both the PFA prodrugs and unmodified PFA (Table 8.1) [40].

The data from these studies allowed us to draw several important conclusions. First, alkoxyalkyl PFA analogues are potent inhibitors of HCMV, wild-type HIV-1<sub>LAI</sub>, and most NRTI-resistant variants *in vitro*, a result of the much better membrane permeability compared to the parent compound. Second, the PFA analogues are being cleaved intracellularly to yield free PFA since the resistance mutations selected by the PFA prodrugs do not confer cross-resistance to AZT and have similar antagonistic interactions with AZT resistance mutations as those selected by unmodified PFA.

### 8.4

#### Alkoxyalkyl Esters of Nucleoside 5'-Monophosphates

We originally attempted to design phospholipid prodrugs using the concept that phosphatidyl analogues of nucleosides might be well absorbed orally and lead to targeting of the drugs to macrophages (AZT) [30] or to the liver (ddG) [32]. When

**Table 8.1** Susceptibility of NRTI-resistant HIV-1 to PFA prodrugs.

HIV-1 variant	EC <sub>50</sub> (fold resistance relative to wild-type virus)			
	1-O-octadecyl- <i>sn</i> -glycero- -3-PFA	1-O-octadecyl-2- O-methyl- <i>sn</i> - glycero-3-PFA	1-O-octadecyl- 2-O-ethyl- <i>sn</i> - glycero-3-PFA	Phosphonoformate (PFA)
Wild type	1.79	0.50	0.65	17.66
K65R	14.68	1.66	2.91	67.0
L74V	4.45	0.88	1.21	32.7
M184V	1.93	1.51	1.36	33.4

Adapted from Ref. [40].

liposomal preparations of phosphatidyl analogues such as 1,2-dipalmitoylphosphatidyl-2',3'-dideoxyguanosine (DPP-ddG) were made and evaluated by intraperitoneal administration in woodchucks infected with woodchuck hepatitis virus, a significant antiviral effect was observed even if an equimolar dose of ddG had little effect [32]. While this study clearly demonstrated the utility of liver targeting using a phosphatidyl-linked antiviral agent, parenteral administration of the formulation was required and subsequent experiments revealed that DPP-ddG and phosphatidyl analogues of other nucleosides are poorly absorbed after oral administration in mice (K.Y. Hostetler, unpublished data, 1999). To pursue orally active lipid prodrugs, we focused on further evaluation of alkoxyalkyl esters of nucleoside monophosphates, deciding to focus initially on acyclovir.

Although acyclovir triphosphate is an effective inhibitor of HBV polymerase activity, ACV is not highly active in patients infected with HBV, suggesting that the inability of ACV to display anti-HBV activity was due to poor intracellular phosphorylation to the active triphosphate metabolite [41, 42]. We synthesized (Scheme 8.1) and evaluated the hexadecyloxypropyl ester of acyclovir monophosphate (HDP-P-ACV) and found that the lipid prodrug has significantly enhanced activity against hepatitis B virus replication in 2.2.15 cells compared to ACV, and produces much higher intracellular levels of phosphorylated ACV metabolites than observed with free acyclovir [13].

Follow-up oral pharmacokinetic studies using radiolabeled HDP-P-ACV indicated that the prodrug had oral bioavailability of over 90% in mice. Furthermore, analysis of plasma indicated that a substantial proportion of the drug was circulating as the intact prodrug [13]. We then treated mice that had been infected with HSV-1 with oral ACV or HDP-P-ACV. On a molar basis, the lipid prodrug was 2.4 times more active orally in preventing mortality from acute HSV-1 infection in mice [43].

Oral HDP-P-ACV also proved to be effective *in vivo* against woodchuck hepatitis virus, providing a 2 log reduction in viral load, while ACV at the maximal tolerated dose had no significant effect (Figure 8.3) [14]. In the case of acyclovir, the application of the approach was successful in transforming an inactive nucleoside (against HBV) to one with significant HBV activity by the oral route.

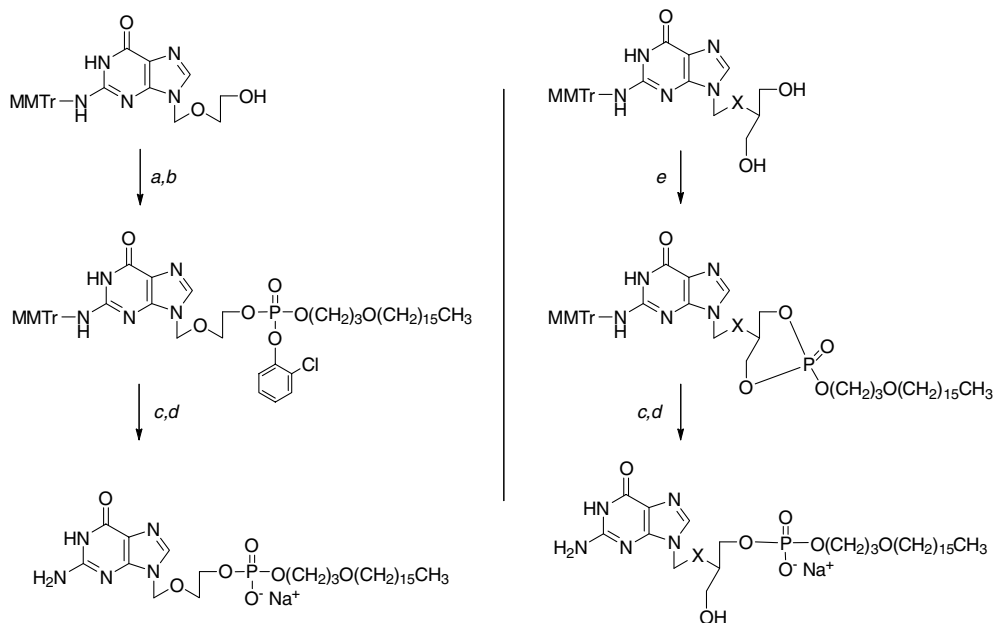

**Reagents:** (a) 2-chlorophenyl dichlorophosphate, 1,2,4-triazole, triethylamine; (b) 3-hexadecyloxy-1-propanol; (c) 80% aqueous acetic acid, 60 °C; (d) 0.4 N NaOH, 50 °C; (e) hexadecyloxypropyl phosphate, dicyclohexylcarbodiimide (2 equiv), pyridine. MMTr, monomethoxytrityl; X, oxygen (ganciclovir) or carbon (penciclovir).

**Scheme 8.1** Two approaches to the synthesis of nucleoside analogues: HDP-P-ACV, HDP-P-GCV, and HDP-P-penciclovir.

Encouraged by these results with acyclovir, we applied a similar strategy to two other antiviral nucleoside analogues, penciclovir and ganciclovir. Penciclovir is known to have poor oral bioavailability and is used clinically as its diacetyl prodrug, famciclovir [1]. To test our alternative approach, we synthesized the HDP ester HDP-P-PCV using the process outlined in Scheme 8.1. The *in vitro* data showed that this prodrug was somewhat less potent than PCV against HSV-1; however, as expected, penciclovir showed little effect on mortality from intranasal HSV-1 infection in mice when given orally. In contrast, oral dosing of HDP-P-PCV (120 mg/kg, twice daily) showed a significant effect, reducing mortality in the infected mice from 87 to 40% [44].

Further studies using ganciclovir included a series of derivatives designed to ascertain the optimal length for the alkoxyalkyl group for nucleoside monophosphates (Table 8.2). A family of derivatives, with a varying alkoxyalkyl ester moiety was prepared [45]. Interestingly, the length of the alkoxy group had a significant effect on the biological activity. Decreasing the length of the alkoxy group below tetradecyloxy resulted in a significant loss of antiviral activity, perhaps because the compounds became too water soluble and did not penetrate the lipid bilayer. This series confirmed that the HDP ester was the most active [45]. HDP-P-GCV was orally active against MCMV and HSV-1 infections in mice, with antiviral activity equivalent to (HSV-1) or greater than oral GCV (MCMV) [44].



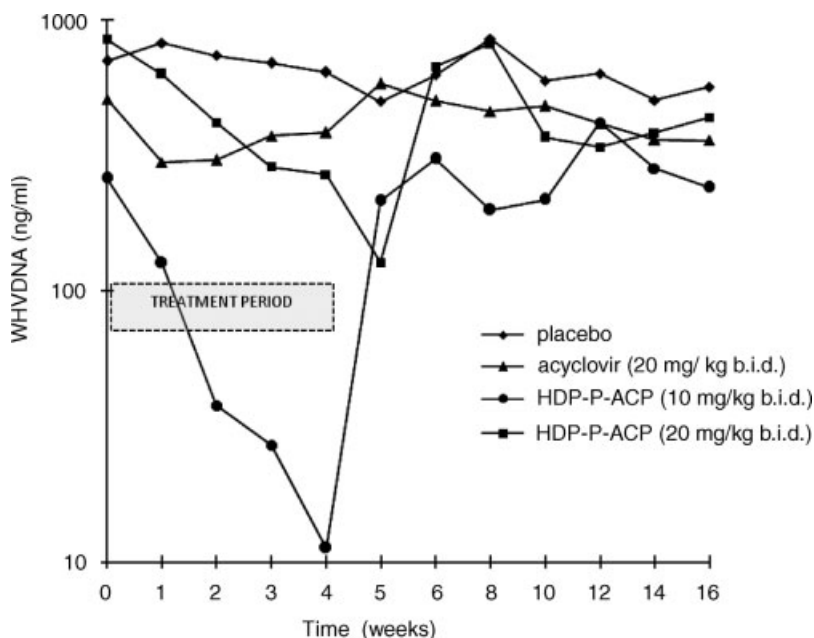

**Figure 8.3** Effect of ACV or HDP-P-ACV on serum WHV levels in WHV-infected woodchucks.

Overall, these studies of alkoxyalkyl nucleoside monophosphates provided more encouraging evidence for our alkoxyalkyl prodrug strategy: the modified compounds displayed good antiviral activity *in vitro* and were orally bioavailable in several animal models. This success next led us to prepare alkoxyalkyl esters of several acyclic nucleoside phosphonates, a class of compounds that were first synthesized and evaluated by Holý and De Clercq [46, 47]. The ANPs can be regarded as close analogues of nucleoside monophosphates, except that they possess a metabolically

**Table 8.2** Effect of ganciclovir derivatives on HSV-1- and HCMV-infected cells.

Atoms in alkoxyalkyl chain	Compound	EC <sub>50</sub> (μM)	
		HSV-1	HCMV
0	Ganciclovir (GCV)	0.02 ± 0.02 (11)	1.2 ± 0.7 (9)
12	Octyloxypropyl-phospho-GCV	5.9 ± 1.7 (3)	39 (2)
14	Decyloxypropyl-phospho-GCV	1.87 ± 0.08 (3)	54 (2)
16	Dodecyloxypropyl-phospho-GCV	0.60 ± 0.35 (3)	5.2 (2)
18	Tetradecyloxypropyl-phospho-GCV	0.04 ± 0.03 (3)	2.6 ± 1.8 (3)
20	Hexadecyloxypropyl-phospho-GCV	0.024 ± 0.027 (11)	0.64 ± 0.23 (11)
22	Octadecyloxypropyl-phospho-GCV	0.013 ± 0.02 (3)	1.9 ± 0.4 (3)
24	Docosyloxypropyl-phospho-GCV	0.34 ± 0.27 (3)	1.3 (2)

Adapted from Ref. [45].

stable phosphorus–carbon bond. Unlike conventional nucleosides, ANPs do not require the often rate-limiting initial phosphorylation step for activation and, as a result, they are fully active against thymidine kinase or UL97 mutant viruses that are resistant to acyclovir or ganciclovir. After conversion to the active metabolite inside cells (diphosphate), the metabolites are generally retained inside cells for prolonged periods of time, which, in turn, leads to more convenient dosing regimens [48].

However, ANPs have poor cellular permeation and oral bioavailability due to the charges on the phosphonic acid at physiologic pH levels. Another drawback involves their tendency to concentrate in the kidney proximal tubule, resulting in nephrotoxicity [48]. The next section describes the application of the alkoxyalkyl ester strategy to ANPs.

## 8.5

### Oral Prodrugs of Acyclic Nucleoside Phosphonates

Our efforts to synthesize and evaluate oral prodrugs of acyclic nucleoside phosphonates [46] began in 1999 when we became involved in the effort to develop orally active antivirals for the prevention or treatment of smallpox (variola virus (VARV)) infection. Historically, smallpox has caused more deaths than any other cause of mortality. The virus was eradicated in the mid-1970s by the World Health Organization (WHO) vaccination campaign [49] and smallpox vaccination was discontinued except for the military and some health care personnel. Because the worldwide population is now vulnerable to bioterrorism using variola virus as a biological weapon, there has been renewed interest in the development of antipoxvirus compounds that could be deployed rapidly in response to a smallpox outbreak [50, 51].

#### 8.5.1

##### Cidofovir

In 2004, cidofovir (Vistide™) was the only drug available for treating smallpox infection. Unfortunately, CDV exhibits a number of disadvantages that would prevent its widespread use in case of an orthopoxvirus epidemic, including poor oral bioavailability and significant nephrotoxicity. Cidofovir-resistant poxviruses have also been isolated [52–54].

##### 8.5.1.1 Activity against Poxviruses *In Vitro*

A series of cidofovir phosphonoesters with alkoxyalkyl, alkyl, and alkylglyceryl moieties of varying length were prepared using the synthetic approach shown in Scheme 8.2. The compounds were screened for antiviral activity in cells infected with HCMV and ganciclovir-resistant isolates [55, 56]. The analogues having the optimal antiviral activity were clearly alkyl or alkoxyalkyl esters having a total of 20 or 21 atoms in the lipid chain. Short chains such as octyl or octyloxypropyl were much less active. Esters having chains of 24 atoms also exhibited reduced antiviral activity. Therefore, from the initial group, hexadecyloxypropyl cidofovir (HDP-CDV) and octadecyloxyethyl cidofovir (ODE-CDV) were selected for more detailed studies in cells infected with poxviruses.

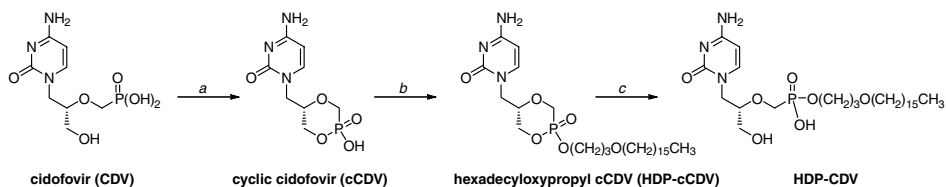

**Reagents:** (a) *N,N*-dicyclohexyl-4-morpholinocarboxamide, *N,N*-dicyclohexylcarbodiimide (DCC), pyridine, 100 °C; (b) 3-(hexadecyloxy)-1-propanol, triphenylphosphine, diisopropyl azodicarboxylate (DIAD), *N,N*-DMF 80 °C; (c) 0.5 M NaOH.

**Scheme 8.2** Synthesis of hexadecyloxypropyl cidofovir (HDP-CDV).

When studied *in vitro*, HDP-CDV and ODE-CDV showed a greatly increased antiviral activity against poxviruses compared to CDV (Table 8.3). Unmodified CDV had EC<sub>50</sub> values ranging from 12 to 46 μM, while HDP-CDV and ODE-CDV had EC<sub>50</sub> values ranging from 0.003 to 0.9 μM [57, 58]. Variola appeared to be even more sensitive to inhibition by HDP-CDV and ODE-CDV, yielding EC<sub>50</sub> values of 0.10 and 0.03 μM, respectively [59].

ST246 is an orally bioavailable drug that, like HDP-CDV, strongly inhibits *in vitro* replication of orthopoxviruses, including monkeypox virus, camelpox virus, cowpox virus (CV), ectromelia (mousepox) virus, and VARV [60]. The two compounds have distinctly different mechanisms of action: HDP-CDV inhibits DNA polymerase, resulting in reduced viral replication, and ST246 inhibits formation and release of enveloped virus [61]. Not surprisingly, combinations of ST246 and HDP-CDV were found to be strongly synergistic against vaccinia virus (VV) and CV *in vitro*, suggesting that combined therapy might offer additional benefit [62].

### 8.5.1.2 Activity against Other Double-Stranded DNA Viruses *In Vitro*

Against herpesviruses, the HDP and ODE esters of CDV showed remarkable activity in the low nanomolar EC<sub>50</sub> range (0.9 nM for HCMV; 8–60 nM for HSV-1, HSV-2, and HHV-8; and 0.02–0.04 μM for EBV) versus unmodified CDV that ranged from 0.38 (HCMV) to 65 μM (EBV) [56]. Increases in antiviral activity of several logs were routinely noted, compared to unmodified CDV (Table 8.4). HDP and ODE esters were generally similar in activity against herpesviruses.

**Table 8.3** Antiviral effects of CDV, HDP-CDV, and ODE-CDV on replication of poxviruses *in vitro*.

Virus	EC <sub>50</sub> (μM)			Reference
	CDV	HDP-CDV	ODE-CDV	
Cowpox, Brighton	44.7	0.9	0.3	[57]
Vaccinia, Copenhagen	46.2	0.8	0.2	
Variola, Bangladesh	27.3	0.10	0.03	[59]
Ectromelia virus	12.0	0.50	0.20	[58]
Rabbitpox virus	39.0	0.50	Not tested	Prichard (personal communication, 2008)

**Table 8.4** Antiviral effects of CDV, HDP-CDV, and ODE-CDV on replication of herpesviruses.

Virus	EC <sub>50</sub> (μM)			Reference
	CDV	HDP-CDV	ODE-CDV	
HCMV	0.38	0.0009	0.0009	[63]
HSV-1	5.5	0.06	0.02	[56]
HSV-2	5.1	0.01	0.008	
HHV-8	2.6	0.02	0.03	
EBV	65.6	0.03	0.10	
VZV	0.5	0.0004	0.0001	
ADV3	2.0	0.01	<0.006	[64]
ADV5	0.5	0.002	<0.008	

Against five strains of adenovirus, the order of activity was ODE-CDV > HDP-CDV ≫ CDV, and increases of activity of 2–3 logs were commonly seen compared to unmodified CDV [64]. HDP-CDV and ODE-CDV also showed potent inhibitory activity against BK virus [65] and orf viruses [66].

### 8.5.1.3 Efficacy of Alkoxyalkyl Esters of ANPs in Animal Models of Disease

Naturally occurring variola virus has been eradicated from the earth. Therefore, closely related orthopoxviruses that replicate in rodents (such as cowpox virus, ectromelia virus, and vaccinia virus, including the rabbitpox strain) are usually used for studies of potential smallpox antivirals. The “Animal Efficacy Rule” is used by the FDA to approve drugs and vaccines when it is not feasible to conduct human efficacy studies, as is the case for a smallpox antiviral drug [67]. We and our collaborators studied HDP-CDV and some related alkoxyalkyl ANPs in several animal models of poxvirus infection. The results of these studies are summarized in Table 8.5. Additional studies in animal models of HCMV, adenovirus, and hepatitis B virus have also been completed and are included in Table 8.5. Overall, the studies showed that HDP-CDV and ODE-CDV are orally bioavailable and are effective in several animal models of orthopoxvirus, CMV, and adenovirus infection. As a result, HDP-CDV (known as CMX001, Chimerix Inc.) is currently undergoing phase I/II human clinical trials.

## 8.5.2

### Alkoxyalkyl Esters of (S)-HPMPA

(S)-HPMPA [(S)-9-(3-hydroxy-2-phosphonomethoxypropyl)-adenine] was the first acyclic nucleoside phosphonate to show potent, broad-spectrum antiviral activity. Described by De Clercq *et al.* in 1986, (S)-HPMPA inhibits replication of many double-stranded DNA viruses [10].

We prepared a series of (S)-HPMPA alkoxyalkyl esters using the process outlined in Scheme 8.3. The synthesis is a stepwise approach in which the alkoxyalkyl ester is incorporated early into the synthesis. For synthesis of HDP-(S)-HPMPA, the key step is preparation of phosphonate synthon, hexadecyloxypropyl *p*-toluenesulfonyloxy-

Table 8.5 Summary of the *in vivo* studies conducted with alkoxyalkyl esters of acyclic nucleoside phosphonates.

Compounds studied	Virus	Animal	Route of administration (dose)	Results	Reference
Orthopoxvirus infections	HDP-CDV, ODE-CDV	Cowpox, vaccinia	Mice (BALB/c)	Oral	Effective in reducing mortality when given orally prior to or 1, 2, or 3 days following intranasal infection [68]
HDP-CDV	Vaccinia-IHD strain	Mice	Oral (25–100 mg/kg)	Up to 100% survival versus 100% mortality in untreated mice [69]	
HDP-CDV, ODE-CDV	Ectromelia	Mice (A/Ncr)	Oral (5 and 10 mg/kg)	Prevented mortality and viral titers in liver and spleen were reduced [58]	
HDP-CDV	Ectromelia	Mice (A/Ncr)	Oral (10 mg/kg first day and then 2.5 mg/kg on day 3)	The dose of HDP-CDV required for 100% survival varied with the infectious dose of ectromelia [70]	
HDP-CDV and ST246 in combination	Cowpox	Mice	Oral (various combinations – started 6 days after infection)	The two drugs were synergistic. Ineffective doses of ST246 and HDP-CDV were effective when used in combination [62]	
HDP-CDV, ODBG-CDV	Ectromelia	Mice	Oral (2 and 8 mg/kg)	Targeting drug to the lung was achieved by using the more lipophilic prodrug ODBG-CDV [71]	

HDP-CDV	Rabbitpox	Rabbits	Oral (1 or 5 mg/kg twice daily)	Animals receiving 5 mg/kg showed little sign of disease	[72]
HDP-CDV	CDV-resistant vaccinia-WR	Mice	Oral (100 or 50 mg/kg)	Single dose provided 80–90% survival	[52]
HDP-(S)-HPMPA, ODE-(S)-HPMPA	Cowpox, vaccinia	Mice (BALB/C)	Oral (10 and 30 mg/kg)	Provided 87–100% protection	[73]
HCMV infection	HCMV	SCID mice implanted human fetal retinal or human fetal thymus/liver	Oral (5 and 10 mg/kg)	HDP-CDV reduced HCMV infection in the implants with 7% positive for HCMV versus 71% positive in untreated implants	[74]
HDP-(S)-HPMPA, ODE-(S)-HPMPA	HCMV	Same as above	Oral (10 mg/kg)	Reduced % of infected implants from 45% (untreated) to 9%	[75]
HDP-CDV, ODE-CDV	Murine CMV Smith strain	Mice	Oral (3–30 mg/kg)	87–100% survival compared to 7–10% survival in untreated animals	[76]
Adenovirus	Adenovirus type 5	Immunosuppressed Syrian hamsters	Oral (2.5 mg/kg)	Provided complete protection if given 6 or 24 h after infection	[77]
Hepatitis B virus	HBV	HBV transgenic mice	Oral (4 mg/kg)	Treatment for 14 days reduced liver HBV DNA levels by roughly 1.5 log units, a response equivalent to that of adefovir dipivoxil	[78]

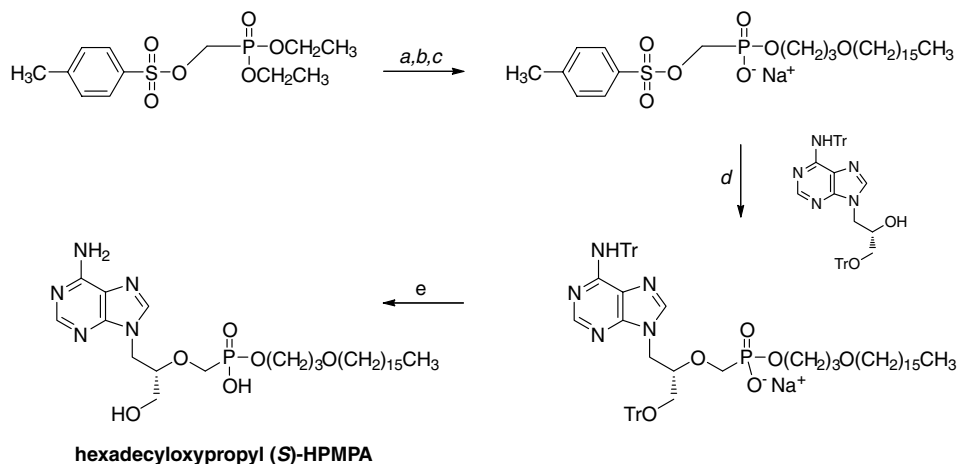

**Reagents:** (a) bromotrimethylsilane,  $\text{CH}_2\text{Cl}_2$ ; (b) oxalyl chloride, cat. *N,N*-DMF,  $\text{CH}_2\text{Cl}_2$ ; (c) 3-(hexadecyloxy)-1-propanol, pyridine, diethyl ether; (d) sodium *t*-butoxide, triethylamine, 50 °C; (e) 80% aq acetic acid, 60 °C. Tr, trityl protecting group.

**Scheme 8.3** Synthesis of hexadecyloxypropyl (S)-HPMPA.

methylphosphonate from commercially available diethyl toluenesulfonyloxymethylphosphonate, and 3-(hexadecyloxy)-1-propanol. Alkylation of the secondary hydroxyl of (S)-9-(3-trityloxy-2-hydroxypropyl)-*N*<sup>6</sup>-trityladenine with synthon, followed by deprotection, provides convenient access to HDP-(S)-HPMPA [33]. Oleyloxyethyl (OLE), octadecyloxyethyl, and several other analogues were also synthesized.

The (S)-HPMPA esters were evaluated *in vitro* in cells infected with vaccinia and cowpox viruses (Table 8.6). The most active compound, oleyloxyethyl (S)-HPMPA, was found to have  $\text{EC}_{50}$  values of 0.003 and 0.007  $\mu\text{M}$  in cells infected with VV and CV, respectively. When compared with the alkoxyalkyl esters of cidofovir, the corresponding alkoxyalkyl esters of (S)-HPMPA were 15–20-fold more active against VV and CV *in vitro* [79]. The potencies of several alkoxyalkyl esters of acyclic nucleoside

**Table 8.6** Antiviral effects of (S)-HPMPA, HDP-(S)-HPMPA, and ODE-(S)-HPMPA on replication of poxviruses.

Virus	$\text{EC}_{50}$ ( $\mu\text{M}$ )			Reference
	(S)-HPMPA	HDP-(S)-HPMPA	ODE-(S)-HPMPA	
Cowpox, Brighton	4.0	0.02	0.02	[79]
Vaccinia, Copenhagen	2.7	0.01	0.01	
Variola, Bangladesh	7.9	<0.05	<0.05	Huggins (personal communication, 2006)
Ectromelia	0.24	0.049	0.032	Buller and Hostetler (unpublished, 2008)

phosphonates against vaccinia virus and cowpox virus were also evaluated in cell monolayers and three-dimensional epithelial raft cultures. ODE- and HDP-(S)-HPMPA were highly active and more potent than the corresponding cidofovir prodrugs [80].

Because of the higher *in vitro* activity of the HPMPA esters versus the corresponding cidofovir esters, both were evaluated in the BALB/c mouse model using lethal doses of vaccinia WR. Oral treatment with either HDP-(S)-HPMPA or ODE-(S)-HPMPA given orally for 5 days provided significant protection (87–100% survival). However, in spite of their greater *in vitro* antiviral activity, the (S)-HPMPA esters did not appear to offer significant benefits over HDP-CDV [73].

Other viral assays confirmed that like HPMPA, the corresponding alkoxyalkyl prodrugs have broad-spectrum activity. In HCMV-infected cells, the antiviral activity of HDP-(S)-HPMPA and ODE-(S)-HPMPA was increased by 270-fold compared to (S)-HPMPA [79]. In adenovirus-infected cells, ODE-(S)-HPMPA, was the most active compound with EC<sub>50</sub> values of 0.04–0.16 μM compared to 0.19–1.1 μM with HDP-(S)-HPMPA [64]. HDP-(S)-HPMPA and ODE-(S)-HPMPA are also active in the low nanomolar range against BK virus [65] and orf viruses [66].

Since (S)-HPMPA was previously shown to have activity against hepatitis B virus *in vitro*, we also assessed the effect of HDP-(S)-HPMPA and ODE-(S)-HPMPA on HBV replication *in vitro*. The HDP- and ODE-esters were 6 and 16 times more potent than unmodified (S)-HPMPA in 2.2.15 cells, respectively (Table 8.7). Notably, HDP-(S)-HPMPA retained full activity against lamivudine-resistant HBV mutants (L180M, M204V), but was cross-resistant to an adefovir-resistant mutant (N236T). In addition, oral treatment of HBV transgenic mice with HDP-(S)-HPMPA or ODE-(S)-HPMPA for 14 days reduced liver HBV DNA levels by roughly 1.5 log units, a response equivalent to that of adefovir dipivoxil [78].

The alkoxyalkyl esters of (S)-HPMPA have shown significant activity against several other viruses, including those where unmodified (S)-HPMPA is inactive. For example, unmodified (S)-HPMPA was essentially inactive against HIV-1, as reported previously. Surprisingly, the alkoxyalkyl esters of (S)-HPMPA were active with EC<sub>50</sub> values in the low nanomolar range (Table 8.8). HDP-(S)-HPMPA and ODE-(S)-HPMPA were also active against HIV variants that are resistant to AZT, lamivudine, nonnucleoside reverse transcriptase inhibitors, and tenofovir [81].

HDP and ODE esters of (S)-HPMPA were also evaluated for their activity against hepatitis C virus in replicon assays using luciferase (1b and 2a replicons) or RNA (1b) quantification. ODE-(S)-HPMPA was the most active compound with EC<sub>50</sub> values in

**Table 8.7** Anti-HBV activities of (S)-HPMPA and alkoxyalkyl prodrugs in 2.2.15 cells.

Compound	HBV EC <sub>50</sub> (μM)	CC <sub>50</sub> (μM)	Selectivity
(S)-HPMPA	1.20	>300	>60
HDP-(S)-HPMPA	0.188	>300	>483
ODE-(S)-HPMPA	0.076	>300	>1422

Adapted from Ref. [78].



**Table 8.8** Antiviral activities of alkoxyalkyl esters of (S)-HPMPA against HIV-1.

Compound	HIV-1 EC <sub>50</sub> (μM)	CC <sub>50</sub> (μM)	Selectivity
(S)-HPMPA	77.5	>100	>1.29
HDP-(S)-HPMPA	0.007	1.0	143
ODE-(S)-HPMPA	0.0004	0.03	75

Adapted from Ref. [81].

0.69–1.31 μM range, while (S)-HPMPA was inactive. The alkoxyalkyl derivatives of HPMPA offer low micromolar potency with reasonable toxicity profiles, and are interesting lead compounds that may lead to ANPs useful against HCV [82].

### 8.5.3

#### Alkoxyalkyl Esters of Tenofovir (HDP-(R)-PMPA)

Tenofovir (9-(R)-[2-(phosphonomethoxy)propyl]adenine, (R)-PMPA), first described by Holý *et al.* in 1993 [83], is an acyclic nucleoside phosphonate with potent efficacy against hepadnaviruses and retroviruses. To achieve oral bioavailability, Gilead Sciences masked the dual negative charges of (R)-PMPA as isopropoxyloxycarbonyloxymethyl esters [84] and the resulting prodrug, tenofovir disoproxil fumarate, is currently marketed for HIV infections as either the single drug (Viread®) or in combination with other antiretrovirals (Truvada® and Atripla™) [46].

To apply our prodrug strategy, we synthesized the tenofovir hexadecyloxypropyl ester (hexadecyloxypropyl 9-(R)-[2-(phosphonomethoxy)propyl]adenine [HDP-(R)-PMPA]) using the synthetic scheme outlined in Scheme 8.4. The potency of HDP-(R)-PMPA against HIV was substantially enhanced compared to unmodified (R)-PMPA, reaching EC<sub>50</sub> of <0.00001 μM versus 0.65 μM for tenofovir. In PBMCs, the EC<sub>50</sub> was 0.012 μM compared to 3.20 μM for tenofovir [85]. HDP-(R)-PMPA was

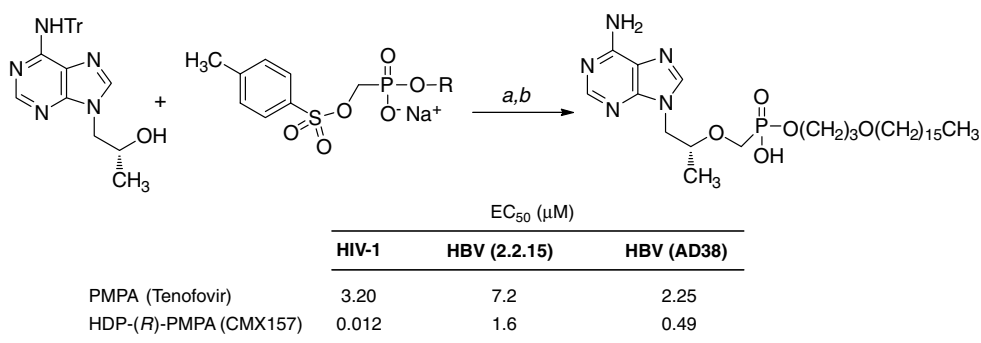

**Reagents:** (a) sodium hydride, *N,N*-DMF, 50 °C; (b) 80% aq CH<sub>3</sub>COOH, 60 °C. Tr, trityl, R, hexadecyloxypropyl.

**Scheme 8.4** Synthesis of hexadecyloxypropyl (R)-PMPA.

also tested against a panel of 30 NRTI-resistant HIV variants and found to be substantially more active (295–472-fold) than tenofovir with low nanomolar EC<sub>50</sub> values [86]. The increased activity may also be attributed, in part, to HDP-(R)-PMPA binding directly to HIV virions and inhibiting viral replication in “untreated” cells. Neither direct binding to HIV nor subsequent inhibition of viral replication was observed with tenofovir [87]. The *in vitro* activity of (R)-PMPA against replicating HBV was also enhanced by the HDP esterification. Evaluated in 2.2.15 cells, the EC<sub>50</sub> of (R)-PMPA was 7.2 μM, while HDP-(R)-PMPA was 4.5-fold more active with EC<sub>50</sub> of 1.6 μM. A 4.6-fold enhancement of potency was also found using the HepAD38 cell line [85].

Studies in rats indicated good oral bioavailability after oral administration of single or multiple doses of 10, 30, or 100 mg/kg HDP-(R)-PMPA [85], and 28-day toxicology studies in rats and monkeys with doses up to 200 mg/kg were well tolerated with the dose-limiting toxicity of the gastrointestinal tract [88].

Chimerix, Inc., the commercial sponsor developing HDP-(R)-PMPA (identified as CMX157), filed an IND application and has begun phase I clinical trials [88].

#### 8.5.4

#### Hexadecyloxypropyl Adefovir and Prodrugs of Other ANPs and Antivirals

The bis(pivaloyloxymethyl) ester oral prodrug of 9-(2-phosphonomethoxyethyl)adenine (PMEA, adefovir dipivoxil, Hepsera<sup>®</sup>) is licensed for treating hepatitis B virus infections [89], but its spectrum of antiviral activity also includes herpesviruses and retroviruses. As illustrated by the results summarized in Table 8.9, HDP esterification of PMEA results in an impressive boost in activity against HIV-1 [90].

In a separate paper, the antiviral effects of HDP-PMEA against several other viruses were reported [91]. From the results summarized in Table 8.9, it is clear that the enhancement of antiviral activity is not confined to one particular type of virus. All viruses assayed showed enhancement of antiviral activity and, in a number of cases, viruses not inhibited by PMEA (HSV-1, HCMV) are inhibited by HDP-PMEA.

**Table 8.9** Antiviral effects of PMEA and HDP-PMEA.

Virus	PMEA EC <sub>50</sub> (μM)	HDP-PMEA EC <sub>50</sub> (μM)	Fold decrease of EC <sub>50</sub>	Reference
HIV-1	1.1	0.000015	>73 000	[90]
HIV-1	6.22	0.072	86	[91]
HIV-2	6.59	0.14	47	
HSV-1	>100	1.08	>92	
HSV-2	73.2	0.54	135	
HCMV (AD169)	>100	0.13	>769	
HCMV (Davis)	>100	<0.058	>1724	
VZV TK + OKA	30.38	<0.058	>523	
VZV TK- 07/1	7.32	<0.058	>126	

Interestingly, it was reported that addition of a second HDP ester to HDP-PMEA resulted in prodrugs with reduced antiviral activity relative to unmodified PMEAs [91].

In fact, in addition to the ANP prodrugs already discussed, many others have been synthesized and evaluated in our laboratory [90, 92]. All types of acyclic nucleoside phosphonates show enhancement of antiviral activity, presumably due to increased cellular penetration of the alkoxyalkyl esterified compounds and increased metabolic conversion to their diphosphates [93].

Interestingly, the alkoxyalkyl prodrug approach may be useful for esterification of groups other than phosphate/phosphonate. Recently, the synthesis and evaluation of three alkoxyalkyl 2-carboxylate ester derivatives related to zanamivir was reported. Zanamivir (Relenza<sup>®</sup>) is an anti-influenza drug administered by inhalation, but an oral prodrug would be more convenient. The analogues of zanamivir modified at the carboxylic moiety with alkoxyalkyl esters showed significant antiviral activities against influenza A and B viruses in cells. Oral administration of the octadecyloxypopyl ester provided protective effects in mice infected with influenza A [94].

## 8.6

### Intraocular Delivery of Antiviral Prodrugs for Treatment or Prevention of Cytomegalovirus Retinitis

Delivery of antiviral drugs to the posterior segments of the eye presents a major challenge. Even drugs with good oral uptake and disposition to systemic tissues are often ineffective due to their inability to cross the blood–retinal barrier and gain access to the infected site. A promising approach to treating back-of-the-eye viral infections involves introducing antiviral drugs with limited aqueous solubility directly into the vitreous chamber by intraocular injection. To address this need, we devised a strategy that uses our lipid esterification approach to prepare sparingly soluble antiviral agents that are slowly released from an intravitreal depot, penetrate the retinal membrane, and release the antiviral inside retinal tissues. Here, we summarize some of the data obtained from our studies aimed at developing sustained release treatments for cytomegalovirus retinitis, an infection common in severely immunocompromised patients that may result in blindness if not treated.

#### 8.6.1

##### 1-O-Octadecyl-*sn*-glycero-3-phosphonoformate (ODG-PFA)

Current drugs approved for CMV include phosphonoformate (PFA, foscarnet), ganciclovir, its oral prodrug valganciclovir, cidofovir, and fomivirsen [34]. Intraocular injections of PFA are effective in treating CMV retinitis, but the repeated injections that are necessary carry a high risk of complications and are not well tolerated due to patient discomfort. For intravitreal treatment of CMV, we chose to evaluate 1-O-octadecyl-*sn*-glycero-3-PFA (ODG-PFA, Figure 8.4), a prodrug that was 93 times more active than PFA in cells infected by the AD169 strain of HCMV ( $EC_{50} = 0.43 \mu\text{M}$ ) and also a potent inhibitor of HSV-1 replication *in vitro* ( $EC_{50} = 1.1 \mu\text{M}$ ) [35].

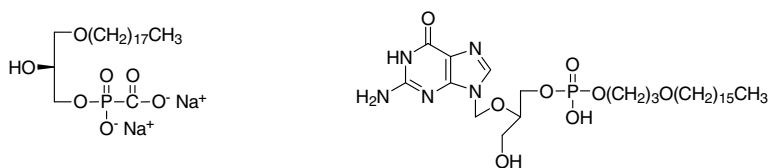
1-O-Octadecyl-*sn*-3-PFA (ODG-PFA)

Hexadecyloxypropyl-phospho-ganciclovir (HDP-P-GCV)

**Figure 8.4** Lipophilic prodrugs of PFA and ganciclovir for slow release intravitreal treatment of CMV retinitis.

ODG-PFA forms micelles in water; however, this formulation resulted in toxicity to the retina when injected into the vitreous. However, when the ODG-PFA was incorporated into liposomes, better toxicological results were obtained [95]. More detailed pharmacokinetic studies confirmed that liposomal ODG-PFA resides up to 4 weeks in the vitreous, where it is not metabolized in the absence of living ocular tissues or cells, and yields significant levels of the drug in the retina [96]. The ability of the drug to provide sustained antiviral effect *in vivo* against HSV-1 infection was evaluated in pretreated rabbit eyes. After 1 and 2 weeks, eyes pretreated with liposomal ODG-PFA were protected from HSV-1 retinitis, but after 4 weeks there was no protective effect, suggesting that sustained delivery was maintained for between 2 and 4 weeks after a single intravitreal injection [97]. Similarly, the closely related carboxymethyl ester analogue was evaluated and gave good results [98].

### 8.6.2

#### Hexadecyloxypropyl Ganciclovir 5'-Monophosphate (HDP-P-GCV)

We had also prepared a series of ganciclovir derivatives described in section 8.4 in order to evaluate alkoxyalkyl esters of ganciclovir monophosphate as intravitreal drugs. Intravitreal GCV therapy is effective against CMV retinitis, but the short intravitreal half-life makes frequent injections necessary to maintain an effective drug level in the retina [99]. Intravitreal GCV implants were developed to provide sustained levels of GCV in the vitreous and were shown to be effective in treatment of HCMV retinitis, but this requires complex, invasive surgical techniques for implantation and extraction [100].

Like the previously studied PFA analogues, HDP-P-GCV (Figure 8.4) was evaluated in rabbit eyes for toxicity and duration of action. HDP-P-GCV could be formulated readily into liposomes and provided long-lasting protection against HSV-1 retinitis of at least 4 weeks, somewhat longer than that observed with the PFA analogue. Liposomal HDP-P-GCV provided good vitreous clarity and demonstrated minimal retinal toxicity except at the highest doses [101].

Surprisingly, even better results were obtained when HDP-P-GCV was administered directly as the crystalline solid. The suspension of HDP-P-GCV was injected into the vitreous through a small gauge needle. Once injected, particles of the drug formed a depot that dissolved slowly, maintaining levels of the freely dissolved drug in the eye. Rabbit eyes pretreated with the highest nontoxic dose of HDP-P-GCV

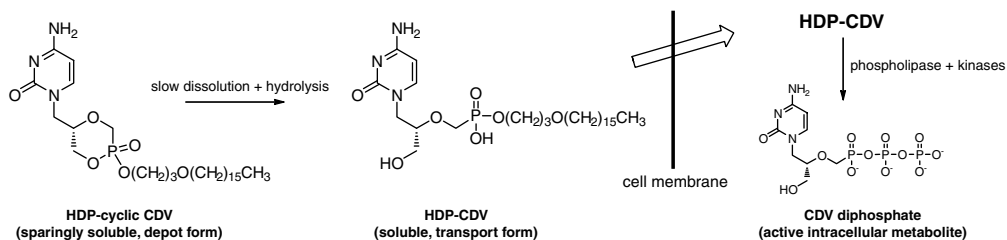

**Figure 8.5** Scheme for sustained delivery of CDV diphosphate starting from an intravitreal depot of hexadecyloxypropyl cyclic cidofovir (HDP-cCDV).

provided 20 weeks of complete retinal protection against HSV-1 infection [102]. The antiviral protection provided by a single intravitreal injection of the crystalline HDP-P-GCV is at least 20 times longer than that provided by a single GCV injection, and at least 4 times longer than that provided by a single injection of liposomal HDP-P-GCV [103].

### 8.6.3

#### Hexadecyloxypropyl Esters of Cyclic Cidofovir and Cyclic (S)-HPMPA

Intravitreal injections of cidofovir are also effective in slowing the progression of CMV retinitis; however, intravitreal CDV may cause a sight-threatening drop in intraocular pressure, and therefore it is presently not used for anti-CMV therapy [104]. The impressive anti-CMV activity of HDP-CDV led us to also evaluate HDP esters of cyclic CDV as intravitreal prodrugs. The cyclic diesters (Figure 8.5) are much less soluble than the corresponding monoesters, such as HDP-CDV, and are only slightly less potent inhibitors of CMV replication *in vitro* [63].

Hexadecyloxypropyl cyclic cidofovir (HDP-cyclic CDV) given by intravitreal injection was nontoxic at doses up to 100  $\mu\text{g}/\text{eye}$  and did not cause decreased intraocular pressure [105]. We hypothesize that slow dissolution of the deposited prodrug after injection, followed by hydrolysis, transforms HDP-cyclic CDV to the more soluble compound HDP-CDV, which may then be taken up by retinal cells where intracellular metabolism leads to efficient loading of the retinal tissue with the active metabolite CDV diphosphate.

We observed that after injection into rabbit eyes, HDP-cyclic-CDV cleared slowly from the vitreous with a half-life of 6.3 days. Control and pretreated rabbits were challenged with intraretinal HSV-1 infection at varying times after pretreatment. A single intravitreal dose of HDP-cyclic-CDV prevented HSV retinitis for up to 68 days. HDP-cyclic-CDV is expected to be even more active against human CMV retinitis because its  $\text{EC}_{50}$  value is 42 nM, lower than the  $\text{EC}_{50}$  for HSV-1 (1100–600 nM) [105].

Hexadecyloxypropyl cyclic (S)-HPMPA (HDP-cyclic-(S)-HPMPA) is also highly active against human CMV with an  $\text{EC}_{50}$  of 20 nM. Intravitreal injection of the highest nontoxic dose of this sparingly soluble compound in the rabbit eye (55  $\mu\text{g}/\text{eye}$ ) did not cause decreased intraocular pressure in the guinea pig eye and had a

residence time in the vitreous of over 4 months. This warrants its further evaluation for the local treatment of CMV retinitis [106].

Overall, these experiments in a rabbit model of HSV retinitis have shown a marked benefit of alkoxyalkyl esters; they could both significantly increase the intravitreal drug half-life leading to greater drug efficacy and reduce the intraocular toxic effects of the drugs used.

## 8.7

### Conclusion

In this chapter, we have described our strategy of utilizing the naturally existing pathways for absorption, distribution, and metabolism of dietary and cellular phospholipids to enhance the oral uptake and efficacy of antiviral compounds. The strategy relies on the disguise of polar antiviral compounds as partially metabolized phospholipids such as lysophosphatidylcholine and has resulted in the improvement in antiviral activity of a variety of antiviral compounds. In particular, the approach appears to be generally applicable to acyclic nucleoside phosphonates and has led to two compounds that are in clinical development. Further applications of this strategy may lead to better antiviral therapies in the future.

### References

- 1 De Clercq, E. and Field, H.J. (2006) Antiviral prodrugs: the development of successful prodrug strategies for antiviral chemotherapy. *British Journal of Pharmacology*, **147**, 1–11.
- 2 Testa, B. (2009) Prodrugs. *Methods and Principles in Medicinal Chemistry*, **40**, 559–570.
- 3 Rautio, J., Kumpulainen, H., Heimbach, T., Oliyai, R., Oh, D., Järvinen, T., and Savolainen, J. (2008) Prodrugs: design and clinical applications. *Nature Reviews. Drug Discovery*, **7**, 255–270.
- 4 Cole, P., Castaner, R., and Bolos, J. (2009) R-7128: RNA-directed RNA polymerase (NS5B) inhibitor treatment of hepatitis C virus infection. *Drugs of the Future*, **34**, 282–290.
- 5 Mackman, R.L. and Cihlar, T. (2004) Prodrug strategies in the design of nucleoside and nucleotide antiviral therapeutics, in *Annual Reports in Medicinal Chemistry*, vol. 39 (ed. A.M. Doherty), Elsevier, pp. 305–321.
- 6 Shin, H.-C., Landowski, C.P., Sun, D., and Amidon, G.L. (2003) Transporters in the GI tract. *Methods and Principles in Medicinal Chemistry*, **18**, 245–287.
- 7 Sugawara, M., Huang, W., Fei, Y.J., Leibach, F.H., Ganapathy, J., and Ganapathy, M.E. (2000) Transport of valganciclovir, a ganciclovir prodrug, via peptide transporters PEPT1 and PEPT2. *Journal of Pharmaceutical Sciences*, **89**, 781–789.
- 8 Sun, J., Dahan, A., and Amidon, G.L. (2010) Enhancing the intestinal absorption of molecules containing the polar guanidino functionality: a double-targeted prodrug approach. *Journal of Medicinal Chemistry*, **53**, 624–632.
- 9 Bender, D., Bao, J., Dantzig, A.H., Diseroad, W.D., Law, K.L., Magnus, N.A., Peterson, J.A., Perkins, E.J., Pu, Y.J., Reutzel-Edens, S.M., Remick, D.M., Starling, J.J., Stephenson, G.A., Vaid, R.K., Zhang, D., and McCarthy, J.R. (2009) Synthesis, crystallization, and biological evaluation of an orally active

- prodrug of gemcitabine. *Journal of Medicinal Chemistry*, **52**, 6958–6961.
- 10 De Clercq, E., Holý, A., Rosenberg, I., Sakuma, T., Balzarini, J., and Maudgal, P.C. (1986) A novel selective broad-spectrum anti-DNA virus agent. *Nature*, **323**, 464–467.
  - 11 Hostetler, K.Y., Richman, D.D., Carson, D.A., Stuhmiller, L.M., van Wijk, G.M., and van den Bosch, H. (1992) Greatly enhanced inhibition of human immunodeficiency virus type 1 replication in CEM and HT4-6C cells by 3'-deoxythymidine diphosphate dimyristoylglycerol, a lipid prodrug of 3'-deoxythymidine. *Antimicrobial Agents and Chemotherapy*, **36**, 2025–2029.
  - 12 Hostetler, K.Y., Parker, S., Sridhar, C.N., Martin, M.J., Li, J.-L., Stuhmiller, L.M., van Wijk, G.M.T., van den Bosch, H., Gardner, M.F., Aldern, K.A., and Richman, D.D. (1993) Acyclovir diphosphate dimyristoylglycerol: a phospholipid prodrug with activity against acyclovir-resistant herpes simplex virus. *Proceedings of the National Academy of Sciences of the United States of America*, **90**, 11835–11839.
  - 13 Hostetler, K.Y., Beadle, J.R., Kini, G.D., Gardner, M.F., Wright, K.N., Wu, T.H., and Korba, B.A. (1997) Enhanced oral absorption and antiviral activity of 1-*O*-octadecyl-*sn*-glycero-3-phospho-acyclovir and related compounds in hepatitis B virus infection, *in vitro*. *Biochemical Pharmacology*, **53**, 1815–1822.
  - 14 Hostetler, K.Y., Beadle, J.R., Hornbuckle, W.E., Bellezza, C.A., Tochkov, I.A., Cote, P.J., Gerin, J.L., Korba, B.E., and Tennant, B.C. (2000) Antiviral activities of oral 1-*O*-hexadecylpropanediol-3-phosphoacyclovir and acyclovir in woodchucks with chronic woodchuck hepatitis virus infection. *Antimicrobial Agents and Chemotherapy*, **44**, 1964–1969.
  - 15 Peyrottes, S., Egron, D., Lefebvre, I., Gosselin, G., and Périgaud, C. (2004) SATE pronucleotide approaches: an overview. *Mini-Reviews in Medicinal Chemistry*, **4**, 395–408.
  - 16 Meier, C. and Balzarini, J. (2006) Application of the cycloSal-prodrug approach for improving the biological potential of phosphorylated biomolecules. *Antiviral Research*, **71**, 282–292.
  - 17 Peterson, L.W. and McKenna, C.E. (2009) Prodrug approaches to improving the oral absorption of antiviral nucleotide analogues. *Expert Opinion on Drug Delivery*, **6**, 405–420.
  - 18 Mehellou, Y., Balzarini, J., and McGuigan, C. (2009) Aryloxy phosphoramidate triesters: a technology for delivering monophosphorylated nucleosides and sugars into cells. *ChemMedChem*, **4**, 1779–1791.
  - 19 Mackman, R.L., Boojamra, C.G., Chen, J., Feng, J., Gao, Y., Laflamme, G., Lee, S., Mabery, E., Markevitch, D., Parrish, J., Perry, J., Petrakovsky, O., Ray, A.S., Shih, I.-H., Sperandio, D., Vela, J., and Cihlar, T. (2008) Synthesis and antiviral activity of 4'-modified carbocyclic nucleoside phosphonates (CNPs). *Collection Symposium Series*, **10**, 191–195.
  - 20 Boojamra, C.G., Parrish, J.P., Sperandio, D., Gao, Y., Petrakovsky, O.V., Lee, S.K., Markevitch, D.Y., Vela, J.E., Laflamme, G., Chen, J.M., Ray, A.S., Barron, A.C., Sparacino, M.L., Desai, M.C., Kim, C.U., Cihlar, T., and Mackman, R.L. (2009) Design, synthesis, and anti-HIV activity of 4'-modified carbocyclic nucleoside phosphonate reverse transcriptase inhibitors. *Bioorganic & Medicinal Chemistry*, **17**, 1739–1746.
  - 21 Brown, N.A. (2009) Progress towards improving antiviral therapy for hepatitis C with hepatitis C virus polymerase inhibitors. Part I: nucleoside analogues. *Expert Opinion on Investigational Drugs*, **18**, 709–725.
  - 22 Furman, P. (2009) Nucleoside analog inhibitors of hepatitis C viral replication: recent advances, challenges and trends. *Future Medicinal Chemistry*, **1**, 1429–1452.
  - 23 Furman, P.A., Wang, P., Niu, C., Bao, D., Symonds, W., Nagarathnam, D., Steuer, H., Rachakonda, S., Ross, B.S., Otto, M.J., and Sofia, M. (2008) PSI-7851: a novel liver-targeting nucleotide prodrug for the treatment of hepatitis C. *Hepatology (Baltimore, MD)*, **48**, 1161A.
  - 24 Cretton-Scott, E., Périgaud, C., Peyrottes, S., Licklider, L., Camire, M., Larsson, M., La Colla, M., Hildebrand, E., Lалlos, L., Bilello, J., McCarville, J., Seifer, M.,

- Liuzzi, M., Pierra, C., Badaroux, E., Gosselin, G., Surleraux, D., and Strandring, D.N. (2008) *In vitro* antiviral activity and pharmacology of IDX184, a novel and potent inhibitor of HCV replication. *Journal of Hepatology*, **48** (Suppl. 2), S220.
- 25 Nilsson, Å. and Borgström, B. (1967) Absorption and metabolism of lecithin and lysolecithin by intestinal slices. *Biochimica et Biophysica Acta*, **137**, 240–254.
- 26 Scow, R.O., Stein, Y., and Stein, O. (1967) Incorporation of dietary lecithin and lysolecithin into lymph chylomicrons in the rat. *The Journal of Biological Chemistry*, **242**, 4919–4924.
- 27 Painter, G., Trost, L.C., Lampert, B.M., Almond, M.R., Buller, R.M., Kern, E.R., Painter, G.P., Robertson, A.T., and O'Mahoney, R. (2008) CMX001: anti-smallpox agent, anti-cytomegalovirus agent. Viral polymerase inhibitor. *Drugs of the Future*, **33**, 655–661.
- 28 Hostetler, K.Y. (2009) Alkoxyalkyl prodrugs of acyclic nucleoside phosphonates enhance oral antiviral activity and reduce toxicity: current state of the art. *Antiviral Research*, **82**, A84–A88.
- 29 Shackelford, D.M., Porter, C.J.H., and Charman, W.N. (2007) Lymphatic absorption of orally administered prodrugs, in *Prodrugs: Challenges and Rewards* (eds V.J. Stella, R.T. Borchardt, M.J. Hageman, R. Oliyai, H. Maag, and J.W. Tilley), Springer, New York, pp. 653–682.
- 30 Hostetler, K.Y., Stuhmiller, L.M., Lenting, H.B., van den Bosch, H., and Richman, D.D. (1990) Synthesis and antiretroviral activity of phospholipid analogs of azidothymidine and other antiviral nucleosides. *The Journal of Biological Chemistry*, **265**, 6112–6117.
- 31 Hostetler, K.Y., Richman, D.D., Sridhar, C.N., Felgner, P.L., Felgner, J., Ricci, J., Gardner, M.F., Selleseth, D.W., and Ellis, M.N. (1994) Phosphatidylazidothymidine and phosphatidyl-ddC: assessment of uptake in mouse lymphoid tissues and antiviral activities in human immunodeficiency virus-infected cells and in Rauscher leukemia virus-infected mice. *Antimicrobial Agents and Chemotherapy*, **38**, 2792–2797.
- 32 Korba, B.A., Xie, H., Wright, K.N., Hornbuckle, W.E., Gerin, J.L., Tennant, B.C., and Hostetler, K.Y. (1996) Liver-targeted antiviral nucleosides: enhanced antiviral activity of phosphatidyl-dideoxyguanosine versus dideoxyguanosine in woodchuck hepatitis virus infection *in vivo*. *Hepatology (Baltimore, MD)*, **23**, 958–963.
- 33 Beadle, J.R. (2007) Synthesis of cidofovir and (S)-HPMPA ether lipid prodrugs. *Current Protocols in Nucleic Acid Chemistry*, Volume 2 (Suppl. 29), 15.15.2.
- 34 Biron, K.K. (2006) Antiviral drugs for cytomegalovirus diseases. *Antiviral Research*, **71**, 154–163.
- 35 Hostetler, K.Y., Kini, G.D., Beadle, J.R., Aldern, K.A., Gardner, M.F., Border, R., Kumar, R., Barshak, L., Sridhar, C.N., Wheeler, C.J., and Richman, D.D. (1996) Lipid prodrugs of phosphonoacids: greatly enhanced antiviral activity of 1-O-octadecyl-*sn*-glycero-3-phosphonoformate in HIV-1, HSV-1 and HCMV-infected cells, *in vitro*. *Antiviral Research*, **31**, 59–67.
- 36 Beadle, J.R., Kini, G.D., Aldern, K.A., Gardner, M.F., Wright, K.N., Richman, D.D., and Hostetler, K.Y. (1998) Alkylthioglycerol prodrugs of foscarnet: synthesis, oral bioavailability and structure–activity studies in human cytomegalovirus-, herpes simplex virus type 1- and human immunodeficiency virus type 1-infected cells. *Antiviral Chemistry & Chemotherapy*, **9**, 33–40.
- 37 Kini, G.D., Beadle, J.R., Xie, H., Aldern, K.A., Richman, D.D., and Hostetler, Y.K. (1997) Alkoxy propane prodrugs of foscarnet: effect of alkyl chain length on *in vitro* antiviral activity in cells infected with HIV-1, HSV-1 and HCMV. *Antiviral Research*, **36**, 43–53.
- 38 Kini, G.D., Hostetler, S.E., Beadle, J.R., and Aldern, K.A. (1997) Synthesis and antiviral activity of 1-O-octadecyl-2-O-alkyl-*sn*-glycero-3-foscarnet conjugates in human cytomegalovirus-infected cells. *Antiviral Research*, **36**, 115–124.
- 39 Hostetler, K.Y., Hammond, J.L., Kini, G.D., Hostetler, S.E., Beadle, J.R., Aldern,



- K.A., Chou, T., Richman, D.D., and Mellors, J.W. (2000) *In vitro* anti-HIV-1 activity of *sn*-2-substituted 1-O-octadecyl-*sn*-glycero-3-phosphonofornate analogues and synergy with zidovudine. *Antiviral Chemistry & Chemotherapy*, **11**, 213–220.
- 40 Hammond, J.L., Koontz, D.L., Bazmi, H.Z., Beadle, J.R., Hostetler, S.E., Kini, G.D., Aldern, K.A., Richman, D.D., Hostetler, K.Y., and Mellors, J.W. (2001) Alkylglycerol prodrugs of phosphonofornate are potent *in vitro* inhibitors of nucleoside-resistant human immunodeficiency virus type 1 and select for resistance mutations that suppress zidovudine resistance. *Antimicrobial Agents and Chemotherapy*, **45**, 1621–1628.
- 41 Hantz, O., Allaudeen, H.S., Ooka, T., De Clercq, E., and Trépo, C. (1984) Inhibition of human and woodchuck hepatitis virus DNA polymerase by the triphosphates of acyclovir, 1-(2'-deoxy-2'-fluoro- $\beta$ -D-arabinofuranosyl)-5-iodocytosine and E-5-(2-bromovinyl)-2'-deoxyuridine. *Antiviral Research*, **4**, 187–199.
- 42 Berk, L., Schalm, S.W., de Man, R.A., Heytink, R.A., Berthelot, P., Brechot, C., Boboc, B., Degos, F., Marcellin, P., Benhamou, J., Hess, G., Rossol, S., zum Büschenfelde, K.M., Chamuleau, R.A.F.M., Jansen, P.L.M., Reesink, H.W., Meyer, B., Beglinger, C., Stalder, G.A., den Ouden-Muller, J.W., and de Jong, M. (1992) Failure of acyclovir to enhance the antiviral effect of  $\alpha$  lymphoblastoid interferon on HBe-seroconversion in chronic hepatitis B: a multi-centre randomized controlled trial. *Journal of Hepatology*, **14** 305–309.
- 43 Beadle, J.R., Kini, G.D., Aldern, K.A., Gardner, M.F., Wright, K.N., Rybak, R.J., Kern, E.R., and Hostetler, K.Y. (2000) Synthesis and antiviral evaluation of 1-O-hexadecylpropanediol-3-P-acyclovir: efficacy against HSV-1 infection in mice. *Nucleosides, Nucleotides & Nucleic Acids*, **19**, 471–479.
- 44 Hostetler, K.Y., Rybak, R.J., Beadle, J.R., Gardner, M.F., Aldern, K.A., Wright, K.N., and Kern, E.R. (2001) *In vitro* and *in vivo* activity of 1-O-hexadecylpropanediol-3-phospho-ganciclovir and 1-O-hexadecylpropanediol-3-phospho-penciclovir in cytomegalovirus and herpes simplex virus infections. *Antiviral Chemistry & Chemotherapy*, **12**, 61–70.
- 45 Strah, S., Beadle, J.R., Aldern, K.A., and Hostetler, K.Y. (1999) Effect of alkoxy chain length on the *in vitro* antiviral activity of ganciclovir monophosphate alkoxypropyl esters. 218th National Meeting of American Chemical Society, August 22–26, 1999, New Orleans, LA, USA, MEDI-288.
- 46 De Clercq, E. (2007) Acyclic nucleoside phosphonates: past, present and future – bridging chemistry to HIV, HBV, HCV, HPV, adeno-, herpes-, and poxvirus infections: the phosphonate bridge. *Biochemical Pharmacology*, **73**, 911–922.
- 47 De Clercq, E. and Holý, A. (2005) Acyclic nucleoside phosphonates: a key class of antiviral drugs. *Nature Reviews. Drug Discovery*, **4**, 928–940.
- 48 Cundy, K. (1999) Clinical pharmacokinetics of the antiviral nucleotide analogues cidofovir and adefovir. *Clinical Pharmacokinetics*, **36**, 127–143.
- 49 Geddes, A.M. (2006) The history of smallpox. *Clinics in Dermatology*, **24**, 152–157.
- 50 Bossi, P., Garin, D., Guihot, A., Gay, F., Crance, J.M., Debord, T., Autran, B., and Bricaire, F. (2006) Bioterrorism: management of major biological agents. *Cellular and Molecular Life Sciences*, **63**, 2196–2212.
- 51 Jahrling, P.B., Fritz, E.A., and Hensley, L.E. (2005) Countermeasures to the bioterrorist threat of smallpox. *Current Molecular Medicine*, **5**, 817–826.
- 52 Kornbluth, R.S., Smee, D.F., Sidwell, R.W., Snarsky, V., Evans, D.H., and Hostetler, K.Y. (2006) Mutations in the E9L polymerase gene of cidofovir-resistant vaccinia virus strain WR are associated with the drug resistance phenotype. *Antimicrobial Agents and Chemotherapy*, **50**, 4038–4043.
- 53 Andrei, G., Gammon, D.B., Fiten, P., De Clercq, E., Opdenakker, G., Snoeck, R., and Evans, D.H. (2006) Cidofovir resistance in vaccinia virus is linked to diminished virulence in mice. *Journal of Virology*, **80**, 9391–9401.
- 54 Smee, D.F., Sidwell, R.W., Kefauver, D., Bray, M., and Huggins, J.W. (2002)

- Characterization of wild-type and cidofovir-resistant strains of camelpox, cowpox, monkeypox, and vaccinia viruses. *Antimicrobial Agents and Chemotherapy*, **46**, 1329–1335.
- 55 Wan, W.B., Beadle, J.R., Hartline, C., Kern, E.R., Ciesla, S.L., Valiaeva, N., and Hostetler, K.Y. (2005) Comparison of the antiviral activities of alkoxyalkyl and alkyl esters of cidofovir against human and murine cytomegalovirus replication *in vitro*. *Antimicrobial Agents and Chemotherapy*, **49**, 656–662.
- 56 Williams-Aziz, S.L., Hartline, C.B., Harden, E.A., Daily, S.L., Prichard, M.N., Kushner, N.L., Beadle, J.R., Wan, W.B., Hostetler, K.Y., and Kern, E.R. (2005) Comparative activities of lipid esters of cidofovir and cyclic cidofovir against replication of herpesviruses *in vitro*. *Antimicrobial Agents and Chemotherapy*, **49**, 3724–3733.
- 57 Kern, E.R., Hartline, C., Harden, E., Keith, K., Rodriguez, N., Beadle, J.R., and Hostetler, K.Y. (2002) Enhanced inhibition of orthopoxvirus replication *in vitro* by alkoxyalkyl esters of cidofovir and cyclic cidofovir. *Antimicrobial Agents and Chemotherapy*, **46**, 991–995.
- 58 Buller, R.M., Owens, G., Schriewer, J., Melman, L., Beadle, J.R., and Hostetler, K.Y. (2004) Efficacy of oral active ether lipid analogs of cidofovir in a lethal mousepox model. *Virology*, **318**, 474–481.
- 59 Huggins, J.W., Baker, R.O., Beadle, J.R., and Hostetler, K.Y. (2002) Orally active ether lipid prodrugs of cidofovir for the treatment of smallpox. *Antiviral Research*, **53**, A66, 104.
- 60 Yang, G., Pevear, D.C., Davies, M.H., Collett, M.S., Bailey, T., Rippen, S., Barone, L., Burns, C., Rhodes, G., Tohan, S., Huggins, J.W., Baker, R.O., Buller, R.L.M., Touchette, E., Waller, K., Schriewer, J., Neyts, J., De Clercq, E., Jones, K., Hruby, D., and Jordan, R. (2005) An orally bioavailable antipoxvirus compound (ST-246) inhibits extracellular virus formation and protects mice from lethal orthopoxvirus challenge. *Journal of Virology*, **79**, 13139–13149.
- 61 Prichard, M.N. and Kern, E.R. (2005) Orthopoxvirus targets for the development of antiviral therapies. *Current Drug Targets: Infectious Disorders*, **5**, 17–28.
- 62 Quenelle, D.C., Prichard, M.N., Keith, K.A., Hruby, D.E., Jordan, R., Painter, G.R., Robertson, A., and Kern, E.R. (2007) Synergistic efficacy of the combination of ST-246 with CMX001 against orthopoxviruses. *Antimicrobial Agents and Chemotherapy*, **51**, 4118–4124.
- 63 Beadle, J.R., Hartline, C., Aldern, K.A., Rodriguez, N., Harden, E., Kern, E.R., and Hostetler, K.Y. (2002) Alkoxyalkyl esters of cidofovir and cyclic cidofovir exhibit multiple-log enhancement of antiviral activity against cytomegalovirus and herpesvirus replication *in vitro*. *Antimicrobial Agents and Chemotherapy*, **46**, 2381–2386.
- 64 Hartline, C.B., Gustin, K.M., Wan, W.B., Ciesla, S.L., Beadle, J.R., Hostetler, K.Y., and Kern, E.R. (2005) Ether lipid-ester prodrugs of acyclic nucleoside phosphonates: activity against adenovirus replication *in vitro*. *The Journal of Infectious Diseases*, **191**, 396–399.
- 65 Randhawa, P., Farasati, N.A., Shapiro, R., and Hostetler, K.Y. (2006) Ether lipid ester derivatives of cidofovir inhibit polyomavirus BK replication *in vitro*. *Antimicrobial Agents and Chemotherapy*, **50**, 1564–1566.
- 66 Dal Pozzo, F., Andrei, G., Lebeau, I., Beadle, J.R., Hostetler, K.Y., De Clercq, E., and Snoeck, R. (2007) *In vitro* evaluation of the anti-orf virus activity of alkoxyalkyl esters of CDV, cCDV and (S)-HPMPA. *Antiviral Research*, **75**, 52–57.
- 67 Painter, G., Buller, M., Kern, E., Huggins, J., Moyer, R., Painter, W., Doucette, M., and Robertson, A. (2006) The challenges of developing an antiviral agent for the treatment of smallpox using the animal efficacy rule. *Future Virology*, **1**, 173–179.
- 68 Quenelle, D.C., Collins, D.J., Wan, W.B., Beadle, J.R., Hostetler, K.Y., and Kern, E.R. (2004) Oral treatment of cowpox and vaccinia virus infections in mice with ether lipid esters of cidofovir. *Antimicrobial Agents and Chemotherapy*, **48**, 404–412.
- 69 Smees, D.F., Wong, M., Bailey, K.W., Beadle, J.R., Hostetler, K.Y., and Sidwell,

- R.W. (2004) Effects of four antiviral substances on lethal vaccinia virus (IHD strain) respiratory infections in mice. *International Journal of Antimicrobial Agents*, **23**, 430–437.
- 70 Parker, S., Touchette, E., Oberle, C., Almond, M., Robertson, A., Trost, L.C., Lampert, B., Painter, G., and Buller, R.M. (2008) Efficacy of therapeutic intervention with an oral ether–lipid analogue of cidofovir (CMX001) in a lethal mousepox model. *Antiviral Research*, **77**, 39–49.
- 71 Hostetler, K.Y., Beadle, J.R., Trahan, J., Aldern, K.A., Owens, G., Schreier, J., Melman, L., and Buller, R.M. (2007) Oral 1-O-octadecyl-2-O-benzyl-sn-glycero-3-cidofovir targets the lung and is effective against a lethal respiratory challenge with ectromelia virus in mice. *Antiviral Research*, **73**, 212–218.
- 72 Adams, M.M., Rice, A.D., and Moyer, R.W. (2007) Rabbitpox virus and vaccinia virus infection of rabbits as a model for human smallpox. *Journal of Virology*, **81**, 11084–11095.
- 73 Quenelle, D.C., Collins, D.J., Herrod, B.P., Keith, K.A., Trahan, J., Beadle, J.R., Hostetler, K.Y., and Kern, E.R. (2007) Effect of oral treatment with hexadecyloxypropyl-[(S)-9-(3-hydroxy-2-phosphonylmethoxypropyl)adenine] [(S)-HPMPA] or octadecyloxyethyl-(S)-HPMPA on cowpox or vaccinia virus infections in mice. *Antimicrobial Agents and Chemotherapy*, **51**, 3940–3947.
- 74 Bidanset, D.J., Beadle, J.R., Wan, W.B., Hostetler, K.Y., and Kern, E.R. (2004) Oral activity of ether lipid ester prodrugs of cidofovir against experimental human cytomegalovirus infection. *The Journal of Infectious Diseases*, **190**, 499–503.
- 75 Quenelle, D.C., Collins, D.J., Pettway, L.R., Hartline, C.B., Beadle, J.R., Wan, W.B., Hostetler, K.Y., and Kern, E.R. (2008) Effect of oral treatment with (S)-HPMPA, HDP-(S)-HPMPA or ODE-(S)-HPMPA on replication of murine cytomegalovirus (MCMV) or human cytomegalovirus (HCMV) in animal models. *Antiviral Research*, **79**, 133–135.
- 76 Kern, E.R., Collins, D.J., Wan, W.B., Beadle, J.R., Hostetler, K.Y., and Quenelle, D.C. (2004) Oral treatment of murine cytomegalovirus infections with ether lipid esters of cidofovir. *Antimicrobial Agents and Chemotherapy*, **48**, 3516–3522.
- 77 Toth, K., Spencer, J.F., Dhar, D., Sagartz, J.E., Buller, R.M.L., Painter, G.R., and Wold, W.S.M. (2008) Hexadecyloxypropyl-cidofovir, CMX001, prevents adenovirus-induced mortality in a permissive, immunosuppressed animal model. *Proceedings of the National Academy of Sciences of the United States of America*, **105**, 7293–7297.
- 78 Morrey, J.D., Korba, B.E., Beadle, J.R., Wyles, D.L., and Hostetler, K.Y. (2009) Alkoxyalkyl esters of 9-(S)-(3-hydroxy-2-phosphonomethoxypropyl) adenine are potent and selective inhibitors of hepatitis B virus (HBV) replication *in vitro* and in HBV transgenic mice *in vivo*. *Antimicrobial Agents and Chemotherapy*, **53**, 2865–2870.
- 79 Beadle, J.R., Wan, W.B., Ciesla, S.L., Keith, K.A., Hartline, C., Kern, E.R., and Hostetler, K.Y. (2006) Synthesis and antiviral evaluation of alkoxyalkyl derivatives of 9-(S)-(3-hydroxy-2-phosphonomethoxypropyl)adenine against cytomegalovirus and orthopoxviruses. *Journal of Medicinal Chemistry*, **49**, 2010–2015.
- 80 Lebeau, I., Andrei, G., Dal Pozzo, F., Beadle, J.R., Hostetler, K.Y., De Clercq, E., van den Oord, J., and Snoeck, R. (2006) Activities of alkoxyalkyl esters of cidofovir (CDV), cyclic CDV, and (S)-9-(3-hydroxy-2-phosphonylmethoxypropyl)adenine against orthopoxviruses in cell monolayers and in organotypic cultures. *Antimicrobial Agents and Chemotherapy*, **50**, 2525–2529.
- 81 Hostetler, K.Y., Aldern, K.A., Wan, W.B., Ciesla, S.L., and Beadle, J.R. (2006) Alkoxyalkyl esters of (S)-9-[3-hydroxy-2-(phosphonomethoxy)propyl]adenine are potent inhibitors of the replication of wild-type and drug-resistant human immunodeficiency virus type 1 *in vitro*. *Antimicrobial Agents and Chemotherapy*, **50**, 2857–2859.
- 82 Wyles, D.L., Kaihara, K.A., Korba, B.E., Schooley, R.T., Beadle, J.R., and Hostetler, K.Y. (2009) The octadecyloxyethyl ester of (S)-9-[3-hydroxy-2-(phosphonomethoxy)propyl]adenine is a potent and selective

- inhibitor of hepatitis C virus replication in genotype 1A, 1B, and 2A replicons. *Antimicrobial Agents and Chemotherapy*, **53**, 2660–2662.
- 83** Balzarini, J., Holý, A., Jindrich, J., Naesens, L., Snoeck, R., Schols, D., and De Clercq, E. (1993) Differential antiherspesvirus and antiretrovirus effects of the (S) and (R) enantiomers of acyclic nucleoside phosphonates: potent and selective *in vitro* and *in vivo* antiretrovirus activities of (R)-9-(2-phosphonomethoxypropyl)-2,6-diaminopurine. *Antimicrobial Agents and Chemotherapy*, **37**, 332–338.
- 84** Kearney, B.P., Flaherty, J.F., and Shah, J. (2004) Tenofovir disoproxil fumarate: clinical pharmacology and pharmacokinetics. *Clinical Pharmacokinetics*, **43**, 595–612.
- 85** Painter, G.R., Almond, M.R., Trost, L.C., Lampert, B.M., Neyts, J., De Clercq, E., Korba, B.E., Aldern, K.A., Beadle, J.R., and Hostetler, K.Y. (2007) Evaluation of hexadecyloxypropyl-9-R-[2-(phosphonomethoxy) propyl]-adenine, CMX157, as a potential treatment for human immunodeficiency virus type 1 and hepatitis B virus infections. *Antimicrobial Agents and Chemotherapy*, **51**, 3505–3509.
- 86** Lanier, E.R., Ptak, R.G., Lampert, B.M., Keilholz, L., Hartman, T., Buckheit, R.W., Mankowski, M.K., Osterling, M.C., Almond, M.R., and Painter, G.R. (2010) Development of hexadecyloxypropyl tenofovir (CMX157) for treatment of wild-type and nucleoside/nucleotide resistant HIV. *Antimicrobial Agents and Chemotherapy*, **54**, 2901–2909.
- 87** Lanier, E.R., Lampert, B.M., Robertson, A., Almond, M.R., and Painter, G.R. (2009) Hexadecyloxypropyl-tenofovir (HDP-TFV, CMX157) associates directly with HIV and subsequently inhibits viral replication in “untreated” cells. Proceedings of the 16th Conference on Retroviruses and Opportunistic Infections, February 8–11, 2009, Montreal, Canada.
- 88** Lanier, E.R., Lampert, B., Trost, L., Almond, M., and Painter, G. (2009) Development of hexadecyloxypropyl tenofovir (CMX157) for HIV: potential for use as a microbicide and therapeutic. *Antiviral Research*, **82**, A43.
- 89** Cihlar, T., Delaney, W.E., and Mackman, R. (2008) Tenofovir and adefovir as antiviral agents, in *Modified Nucleosides: Biochemistry, Biotechnology, and Medicine* (ed. P. Herdewijn), Wiley-VCH Verlag GmbH, pp. 601–622.
- 90** Valiaeva, N., Beadle, J.R., Aldern, K.A., Trahan, J., and Hostetler, K.Y. (2006) Synthesis and antiviral evaluation of alkoxyalkyl esters of acyclic purine and pyrimidine nucleoside phosphonates against HIV-1 *in vitro*. *Antiviral Research*, **72**, 10–19.
- 91** Vrbková, S., Dračinský, M., and Holý, A. (2007) Synthesis of phosphonomethoxyethyl or 1,3-bis (phosphonomethoxy)propan-2-yl lipophilic esters of acyclic nucleoside phosphonates. *Tetrahedron*, **63**, 11391–11398.
- 92** Choo, H., Beadle, J.R., Chong, Y., Trahan, J., and Hostetler, K.Y. (2007) Synthesis of the 5-phosphono-pent-2-en-1-yl nucleosides: a new class of antiviral acyclic nucleoside phosphonates. *Bioorganic & Medicinal Chemistry*, **15**, 1771–1779.
- 93** Aldern, K.A., Ciesla, S.L., Winegarden, K.L., and Hostetler, K.Y. (2003) Increased antiviral activity of 1-O-hexadecyloxypropyl-[2-14C]cidofovir in MRC-5 human lung fibroblasts is explained by unique cellular uptake and metabolism. *Molecular Pharmacology*, **63**, 678–681.
- 94** Liu, Z.Y., Wang, B., Zhao, L.X., Li, Y.H., Shao, H.Y., Yi, H., You, X.F., and Li, Z. (2007) Synthesis and anti-influenza activities of carboxyl alkoxyalkyl esters of 4-guanidino-Neu5Ac2en (zanamivir). *Bioorganic & Medicinal Chemistry Letters*, **17**, 4851–4854.
- 95** Cheng, L., Hostetler, K.Y., Gardner, M.F., Avila, C.P., Jr., Bergeron-Lynn, G., Keefe, K.S., Wiley, C.A., and Freeman, W.R. (1999) Intravitreal toxicology in rabbits of two preparations of 1-O-octadecyl-*sn*-glycerol-3-phosphonoformate, a sustained-delivery anti-CMV drug. *Investigative Ophthalmology & Visual Science*, **40**, 1487–1495.

- 96 Cheng, L.L., Hostetler, K.Y., Gardner, M.F., Avila, C.P., Jr., Bergeron-Lynn, G., Severson, G.M., and Freeman, W.R. (1999) Intravitreal pharmacokinetics in rabbits of the foscarnet lipid prodrug: 1-O-octadecyl-*sn*-glycerol-3-phosphonoformate (ODG-PFA). *Current Eye Research*, **18**, 161–167.
- 97 Cheng, L., Hostetler, K.Y., Chaidhawangul, S., Gardner, M.F., Ozerdem, U., Bergeron-Lynn, G., Mach-Hofacre, B., Mueller, A.J., Severson, G.M., and Freeman, W.R. (1999) Treatment of herpes retinitis in an animal model with a sustained delivery antiviral drug, liposomal 1-O-octadecyl-*sn*-glycerol-3-phosphonoformate. *Retina (Philadelphia, PA)*, **19**, 325–331.
- 98 Cheng, L., Hostetler, K.Y., Gardner, M.F., Avila, C.P., Jr., Bergeron-Lynn, G., Keefe, K.S., Beadle, J.R., Wiley, C.A., and Freeman, W.R. (1999) Intravitreal toxicology and therapeutic efficacy of the carboxymethyl ester of the 1-O-Octadecyl-*sn*-glycerol-3-phosphonoformate (ODG-PFA-O-Me), a novel lipid antiviral prodrug for intraocular drug delivery. *Journal of Ocular Pharmacology and Therapeutics*, **15**, 363–377.
- 99 Montero, M.C., Pastor, M., Buenestado, C., and Lluch, A. (1996) Intravitreal ganciclovir for cytomegalovirus retinitis in patients with AIDS. *The Annals of Pharmacotherapy*, **30**, 717–723.
- 100 Chang, M. and Dunn, J.P. (2005) Ganciclovir implant in the treatment of cytomegalovirus retinitis. *Expert Review of Medical Devices*, **2**, 421–427.
- 101 Cheng, L., Hostetler, K.Y., Chaidhawangul, S., Gardner, M.F., Beadle, J.R., Keefe, K.S., Bergeron-Lynn, G., Severson, G.M., Soules, K.A., Mueller, A.J., and Freeman, W.R. (2000) Intravitreal toxicology and duration of efficacy of a novel antiviral lipid prodrug of ganciclovir in liposome formulation. *Investigative Ophthalmology & Visual Science*, **41**, 1523–1532.
- 102 Cheng, L., Hostetler, K.Y., Chaidhawangul, S., Gardner, M.F., Beadle, J.R., Toyoguchi, M., Bergeron-Lynn, G., and Freeman, W.R. (2002) Treatment or prevention of herpes simplex virus retinitis with intravitreally injectable crystalline 1-O-hexadecylpropanediol-3-phosphoganciclovir. *Investigative Ophthalmology & Visual Science*, **43**, 515–521.
- 103 Cheng, L., Hostetler, K.Y., Toyoguchi, M., Beadle, J.R., Rodanant, N., Gardner, M.F., Aldern, K.A., Bergeron-Lynn, G., and Freeman, W.R. (2003) Ganciclovir release rates in vitreous from different formulations of 1-O-hexadecylpropanediol-3-phosphoganciclovir. *Journal of Ocular Pharmacology and Therapeutics*, **19**, 161–169.
- 104 Garcia, C.R., Torriani, F.J., and Freeman, W.R. (1998) Cidofovir in the treatment of cytomegalovirus (CMV) retinitis. *Ocular Immunology and Inflammation*, **6**, 195–203.
- 105 Cheng, L., Hostetler, K.Y., Lee, J., Koh, H.J., Beadle, J.R., Bessho, K., Toyoguchi, M., Aldern, K., Bovet, J., and Freeman, W.R. (2004) Characterization of a novel intraocular drug-delivery system using crystalline lipid antiviral prodrugs of ganciclovir and cyclic cidofovir. *Investigative Ophthalmology & Visual Science*, **45**, 4138–4144.
- 106 Tammewar, A.M., Cheng, L., Hostetler, K.Y., Falkenstein, I., Beadle, J.R., Barron, E.C., Kozak, I., and Freeman, W.R. (2007) Intraocular properties of an alkoxyalkyl derivative of cyclic 9-(*S*)-(3-hydroxyl-2-phosphonomethoxypropyl) adenine, an intravitreally injectable anti-HCMV drug in rabbit and guinea pig. *Journal of Ocular Pharmacology and Therapeutics*, **23**, 433–444.

## 9

# Maribavir: A Novel Benzimidazole Ribonucleoside for the Prevention and Treatment of Cytomegalovirus Diseases

Karen K. Biron

### 9.1

#### Cytomegalovirus Diseases: Unmet Challenges

Viruses in the Herpesviridae family, such as herpes simplex virus (HSV) and cytomegalovirus (CMV), share the capacity to infect asymptotically, but then persist for life. Clinical disease generally occurs only in the case of immature or compromised immune function, as in the case of developing fetus, leading to congenital disease, or in patients immunosuppressed for transplantation, or as a consequence of advanced HIV disease or chemotherapeutic cancer regimens [1–3]. In organ transplant recipients, CMV infection has been associated with acute and chronic graft rejection and multiple microbial opportunistic infections, and CMV disease is an independent risk factor for graft or even patient survival [4, 5].

In the mid-1980s the nucleoside analogue acyclovir showed extraordinary success in the prophylaxis and treatment of HSV infections [6], prompting extensive studies of similar analogues for control of HSV and other human herpesvirus infections. CMV was emerging at the time as a significant opportunistic infection in the rapidly expanding AIDS population [7], and CMV retinitis provided an impetus for the development and approval of most of the present treatments for CMV disease. However, development of the ideal anti-CMV agent remained elusive. Acyclovir and its prodrug valacyclovir (Valtrex<sup>®</sup>, GlaxoSmithKline) have excellent safety profiles, but lack potency for established CMV disease [8–10]. The related purine analogue ganciclovir (GCV; Cytovene<sup>®</sup>, Roche) provides increased potency, but with undesirable side effects and poor oral bioavailability [10–12]; the latter problem was solved with the approval in 2000 of the amino acid ester prodrug, valgCV (Valcyte<sup>®</sup>, Roche) [13]. The pyrophosphate analogue foscarnet (PFA, AstraZeneca Pharmaceuticals) was approved in 1991 as a second-line treatment of CMV, but is also limited by its IV delivery and toxicities [14]. Cidofovir (CDV; Vistide, Gilead Sciences), a nucleotide analogue approved in 1996, provided a rescue therapy for treatment failures, but both toxicities and its intravenous route of administration are serious limitations [15]. An alkoxyalkyl ester prodrug of CDV, hexadecyloxypropyl-CDV (HDP-CDV), reduces the risk of renal toxicities and has recently entered clinical

evaluation for CMV diseases [16]. However, despite initial success in prophylaxis or treatment of CMV infections in solid organ transplant recipients with these available drugs, viral infections often rebound late posttransplant [17]. Moreover, a troublesome feature of all of these agents is the shared mechanism of action: they all target the viral DNA polymerase. As a consequence, emergence of drug resistance and cross-resistance could compromise the entire class of anti-CMV drugs. Safe, effective, and durable new therapies with a different mechanism of action and resistance profile are desperately needed.

Thus, the news of a new chemical class of CMV inhibitors at the University of Michigan in the late 1980s triggered great interest in the field. Professors Leroy B. Townsend and John C. Drach discovered antiviral activity in a series of benzimidazole compounds that they had originally investigated as part of an anticancer program [18–20]. Two compounds, TCRB and BDCRB (2,5,6-trichloro-1-( $\beta$ -D-ribofuranosyl)benzimidazole and 2-bromo-5,6-dichloro-1-( $\beta$ -D-ribofuranosyl)benzimidazole, respectively), were potent inhibitors of the human and certain animal cytomegaloviruses; no other herpesviruses, or other DNA or RNA viruses tested, were found to be susceptible.

Clearly, the most exciting aspect of this new chemical series was the novel mode of action. BDCRB and TCRB blocked the CMV DNA maturation process and encapsidation catalyzed by the component enzymes of the terminase complex, pUL56 and pUL89 [21–24]. Unfortunately, their clinical development potential was limited by instability of the glycosidic linkage of base and sugar *in vivo* [25].

Through a collaborative partnership with Burroughs Wellcome Company and its discovery research team led by Nobel Laureate Dr. Gertrude Elion, the ensuing productive exploratory structure/activity relationship in the benzimidazole series led to two clinical candidates, each with novel but distinct modes of action and with improvement in safety over the standard CMV therapeutics. In the  $\beta$ -D-ribose analogue series, the pyranoside of BDCRB, known as GW275175X (2-bromo-5,6-dichloro-1-( $\beta$ -D-pyranosyl)benzimidazole), which retained the novel mechanism of the original leads BDCRB and TCRB [26], advanced through a phase I clinical study to sit as backup to a more advanced candidate, maribavir (2-isopropylamino-5,6-dichloro-1-( $\beta$ -D-ribofuranosyl)benzimidazole, 1263W94) (Figure 9.1). The chemistry, pharmacology, and virologic profiles of the series have recently been reviewed [27]. This chapter will focus on maribavir, the advanced candidate that exhibited yet another novel mode of action within the benzimidazole series, and the only benzimidazole riboside that is progressing through clinical development.

## 9.2

### Maribavir: Antiviral Activity

Maribavir resulted from the conformational change of the natural  $\beta$ -D-ribose sugar format in BDCRB to the unnatural  $\beta$ -L-ribose, along with replacement of halogen in position 2 of the base with an isopropylamino moiety [28, 29]. These key alterations provided the desired pharmacokinetic stability while retaining potency against CMV.

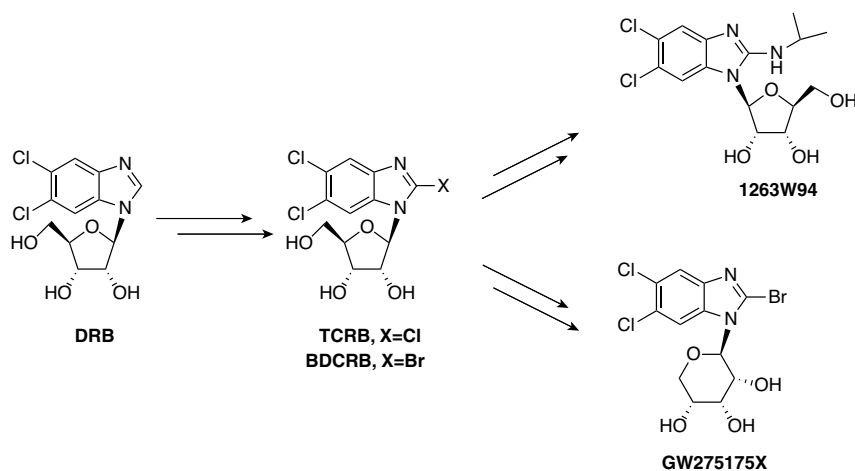

**Figure 9.1** Structures of key halogenated benzimidazole ribosides in the CMV drug discovery program. 1263W94 is the original designation for maribavir.

Maribavir's activity against laboratory and clinical strains of CMV has been measured using standard assays, including cytopathic effect endpoints, plaque reduction, DNA reductions by both hybridization and PCR protocols, yield reduction, ELISA, and immunofluorescence assays, with a broad  $EC_{50}$  range of more than 100 [30–32]. Interestingly, maribavir has shown an unusual variability in laboratory potency according to the physiologic state of the cells, and even cell type, which can be attributed to its unusual mechanism of action [31, 33].

Unexpectedly, the compound was not only active against both clinical and laboratory strains of CMV but it also reduced the *in vitro* replication of another human herpesvirus, the Epstein–Barr virus (EBV), a member of the gamma subclass [31, 34]. Other human or animal herpesviruses were not reported susceptible to maribavir nor was HIV, HBV, HCV, influenza A, or HPV [30, 31]. Unfortunately, maribavir also showed little activity against the animal CMVs that might have provided convenient efficacy models [35].

Unlike the β-D-ribose analogues BDCRB, TCRB, and GW275175X, maribavir did not interfere with the DNA maturational processing machinery of CMV by interacting with the terminase components. Moreover, maribavir did not function as a nucleoside analogue. Maribavir was not anabolized in infected or normal cells *in vitro*, and the various phosphorylated forms were not inhibitory to the CMV or mammalian alpha DNA polymerases [31]. Maribavir showed an even more intriguing alteration in its mechanism of action: this 1-ribose benzimidazole analogue selectively inhibited the kinase activity of the CMV-encoded UL97 protein kinase. Two lines of evidence initially supported this conclusion: genetic mapping of the maribavir-resistant phenotype and direct inhibition by maribavir of the enzymatic activity of pUL97 cloned and expressed *in vitro* [31]. Thus, the strategy of stabilizing the glycosidic linkage of the benzimidazoles *in vivo* by a conformational switch of the



sugar from the  $\beta$ -D-ribose to the  $\beta$ -L-ribose led to a completely unexpected change in the mechanism of action, as well as an extension of the antiviral spectrum to include EBV.

### 9.3

#### Maribavir: Mechanisms of Action and Resistance

Maribavir is active against CMV strains resistant to GCV, CDV, and PFA, consistent with its novel mode of action [31, 36]. The reciprocal is also true: CMV strains resistant to maribavir remain susceptible to all three approved CMV drugs [31, 37]. This may seem counterintuitive since the CMV pUL97 is involved in the mechanisms of action of both GCV and maribavir. However, resistance genetics shows that GCV and maribavir differ in their interactions with pUL97.

The viral kinase pUL97 is principally responsible for the initial monophosphorylation of GCV [38, 39]. GCV-resistant mutations in the kinase gene that were generated *in vitro* by serial passage of CMV strains in drug-containing medium or detected in isolates recovered from clinical samples map to the substrate binding region of the protein, at codons 460, 592, and between 594 and 607 [37]. These GCV-resistant strains retain pUL97 function and remain sensitive to maribavir. Maribavir-resistant mutations similarly generated *in vitro* map in and around the ATP binding domain, at codons 353, 397, 409, and 411 [31, 37, 40], and confer moderate to high levels of resistance to maribavir in culture. Mutations at codon 353 affect the catalytic lysine and can knock out pUL97 function; the other maribavir-resistance mutations in UL97 do neither significantly affect viral growth nor alter GCV susceptibility. In good agreement with findings from the mutational analysis, enzyme inhibition studies have indicated that maribavir is competitive with respect to ATP binding in the pUL97 catalytic region, with  $I_{50}$  values less than 10 nM [41].

Maribavir was clearly the first of a new class of antiviral drugs, and as the first viral protein kinase inhibitor, there was no precedented target validation in the clinic when maribavir advanced in development in the mid-1990s. However, there was confidence that viral-specific protein kinases would be excellent drug targets, on the basis of prevailing understanding of their importance to the virus and their uniqueness compared to host cell counterparts. The CMV pUL97 targeted by maribavir is one of a family of highly conserved protein kinase homologues of the herpesvirus class, all of which share certain structural features with serine-threonine protein kinases of mammalian origin and with some bacterial aminoglycoside phosphotransferase enzymes [42–44]. The CMV pUL97 is a 707 amino acid protein that is transcribed early in infection; it is localized to the nucleus of infected cells and also carried in the tegument of virion particles [45].

Studies of these herpesviral protein kinases *in vitro* over the past two decades have revealed functional homologies in their multiple regulatory roles over both viral and host cell functions. In the case of the HSV and VZV protein kinases, studies have demonstrated their importance for aspects of disease pathogenesis in animal infection models [46, 47]. The evolution of these protein kinases within the herpes-

virus family is evidenced by the fact that maribavir is highly specific for the CMV pUL97. Maribavir has no demonstrable activity against the HSV-1 pUL13 homologue in enzyme assays, a finding consistent with the *in vitro* spectrum of activity of maribavir. The nature of EBV inhibition by maribavir has not been demonstrated to occur through direct enzyme inhibition of the viral-encoded protein kinase homologue BGLF4; however, the phenotype in lytically infected, maribavir-treated cells is consistent with viral protein kinase reduction [34, 48, 49].

The selectivity of maribavir for the CMV protein kinase has been suggested by lack of significant inhibition of a panel of over 70 mammalian protein kinases, including many cell cycle kinases known to be upregulated during herpesviral infections [45, 50]. Of note is the fact that the pharmacological screening panel included casein kinase II, which is inhibited by the prototypic benzimidazole riboside, DRB (5,6-dichloro-1-( $\beta$ -D-ribofuranosyl)benzimidazole) [51]. Maribavir's *in vitro* selectivity profile has been consistent both with the preclinical safety evaluations [52] and with the clinical experience reported to date. By contrast, various kinase inhibitors in the indolocarbazole series and in the quinazoline class, including the anticancer agent gefitinib, have been reported not only to inhibit the CMV pUL97 kinase *in vitro* but also to interfere with the activity of various host cell kinases [53, 54], posing a risk for undesirable adverse effects in clinical use.

The major question remains: will treatment of patients with a selective inhibitor of the CMV pUL97 protein kinase result in the desired therapeutic benefit? The consequences of inhibition of the pUL97 kinase activity on the life cycle of CMV *in vitro* has been the subject of intense study in many laboratories over the past two decades. In the late 1990s, a genetically engineered deletion mutant (RCA97) provided an important tool to identify replication events affected by loss of pUL97 function [55]. The deletion resulted in severely impaired replication, a slight reduction in CMV DNA synthesis in infected cells [55, 56], a weak effect on stable DNA encapsidation (based on one report [56]), altered intracellular distribution of the pp65 tegument protein [57, 58], and a strong reduction in capsid egress from the infected cell nucleus [59].

Viral protein substrates subsequently shown to be phosphorylated, at least in part, by pUL97, included itself [60], and the viral polymerase processivity factor pUL44 [61, 62], which may account for the impaired viral DNA synthesis. A third known viral substrate is the pp65 tegument protein, whose intracellular distribution is altered in the mutant strain RCA97 in conjunction with the failure of DNA-containing capsids to exit the nucleus for tegumentation and envelopment during the virion particle maturation process. The phenotype of the pUL97 deletion virus is recapitulated by treating susceptible CMV strains with maribavir [45].

CMV must manipulate the metabolic state/biochemical environment of the cell in order to support its replication and does so, in part, by the regulatory action that the pUL97 exerts on at least three host cell proteins. Viral gene expression may be enhanced by the pUL97 phosphorylation of the RNA polymerase II carboxy terminal domain in infected cells [63]. Several laboratories have reported that the pUL97 protein kinase homologues from the alpha, beta, and gamma subfamilies of human herpesviruses can all phosphorylate the eukaryotic elongation factor-1 delta [64, 65],

and as such, can mimic the regulatory functions of *cdc2*. Herpesvirus infections are known to modify the cell cycle by stimulating the activity of several cyclin-dependent kinases, and inhibitors of cell kinases such as roscovitine exert antiviral activities in infected cell cultures [66]. According to the studies with the pUL97-deficient or biochemically inhibited virus strains, the viral protein kinase also phosphorylates the lamin proteins A and C, which promotes the disruption of lamins and produces the morphological change in cell nuclear pores required for CMV capsid egress [45, 59, 67]. More recently, the pUL97 was shown to hyperphosphorylate the Rb oncoprotein, which should release the cell cycle from the G0/G1 block and allow events of cell cycle progression [45, 68, 69]. Additional viral and host targets of the pUL97 will likely be identified.

While the pUL97 is clearly the major target of MBV, a second gene has been implicated indirectly in maribavir's action, on the basis of laboratory selection of virus resistant in the UL27 ORF [70–72]. The pUL27 encodes a 608-amino acid polypeptide that carries nuclear localization signals and motifs for protein kinase phosphorylation [70, 71]. It is dispensable for CMV growth in cell culture and has no precedence of functional homologies; its function is still under study. Development of maribavir-resistant mutations has been observed in the laboratory in strains deficient in pUL97, but such mutations were not present at baseline in clinical isolates, suggesting that the mutations may arise as a response to loss of the viral protein kinase activity [72]. The levels of maribavir resistance conferred by UL27 mutations, which include multiple point, stop, and frameshift mutations, are modest and may not preclude efficacy of the drug.

The significance of UL97 mutations in the development of maribavir resistance will become clear with further clinical experience, as will the role of UL27 mutations in treatment response. An important aspect of the use of this drug will be the potential for interactions with other antivirals or antimicrobials that might be used concurrently with maribavir in the transplant setting. Laboratory studies have indicated no negative effect of maribavir on the antiretroviral activity of commonly used HIV reverse transcriptase inhibitors and protease inhibitors, and vice versa [73]. Maribavir does not interact with PFA or CDV in CMV–antiviral combination assays, while there are reports of antagonism [74, 75] for the combination of maribavir with GCV. Other maribavir–antimicrobial combinations have not been studied *in vitro* for interactions affecting their activities.

#### 9.4

##### Preclinical Studies

Preclinical toxicology studies and absorption, distribution, metabolism, and elimination (ADME) studies in rodents and monkeys established a favorable safety and pharmacokinetic profile that supported further clinical development of maribavir [52]. In animal studies, maribavir had excellent oral bioavailability (50% in monkeys; >90% in rats). Doses of 10 mg/kg led to plasma concentrations that were

at least more than 10-fold higher than the mean  $EC_{50}$  reported for 10 CMV clinical isolates [31] and plasma levels were dose proportional up to 180–200 mg/(kg day). Maribavir was able to penetrate the blood–brain barrier in cynomolgus monkeys, with low levels of maribavir detected in brain, cerebrospinal fluid, and vitreous humor.

Drug clearance in the animal species was mediated primarily by biliary secretion with some enterohepatic recirculation. The rate of maribavir clearance was 1.8 l/(kg h) in the rat and 0.8 l/(kg h) in the monkey. The predominant metabolic pathway in both rodents and monkeys was N-dealkylation. Notably, the N-dealkylated derivative, BW4469W94, showed no apparent antiviral activity against CMV *in vitro* [31] and thus would not contribute to efficacy. *In vitro* studies with human liver microsomal extracts identified CYP 3A4 as the major cytochrome P450 isozyme responsible for the metabolism of 1263W94 to its N-dealkylated analogue in humans. In acute oral toxicology studies, the maximum tolerated single dose was 250 mg/kg in mice and 1000 mg/kg in rats. With intravenous dosing, the maximum tolerated single doses were 30 and 74 mg/kg in mice and rats, respectively. In acute toxicology studies, adverse events were minimal; at higher maribavir doses, increased neutrophil and monocyte cell counts and increases in liver weights were noted in female rats.

Chronic toxicology studies consisted of 1 month toxicology studies with oral dosing in rodents and monkeys, 6 month studies with oral dosing in rats and monkeys, and a 12 month study with oral dosing in monkeys [52]. In the 1 month study on monkeys, the no-observable-effect level of oral drug was 180 mg/(kg day) (plasma  $C_{max}$  8 µg/ml). Mild but reversible treatment-related effects seen with chronic exposures included elevations of WBCs, anemias, and liver enzyme functions. At higher doses, both rat and monkey experienced altered stools or diarrhea, which was shown to result from mild to moderate mucosal hyperplasia of the intestinal tract. The mucosal hyperplasia partially resolved within the 1 month recovery period.

*In vitro* cytotoxicity screens indicated that maribavir was not cytotoxic to rapidly dividing cells at antiviral concentrations. Significantly, maribavir was less inhibitory than GCV to the growth of human marrow progenitor cells [52]. Unlike GCV and CDV, maribavir exhibited highly favorable profiles in genetic toxicology studies, including the Ames test, *in vitro* mouse lymphoma assay (below cytotoxic concentrations), and *in vivo* rodent bone marrow micronucleus test. Finally, standard reproductive toxicology studies did not reveal any serious reproductive risks with maribavir.

## 9.5

### Clinical Development of Maribavir: Early Phase I

The clinical development of maribavir began at GlaxoWellcome (later GlaxoSmith Kline) in 1996; the initial indication was to be oral treatment of CMV retinitis disease in individuals infected with HIV-1. Two dose-escalating phase I studies were

performed to evaluate the safety and pharmacokinetic parameters of maribavir and determine an optimal dose for phase II trials [76]. In the first study, 13 healthy male subjects were given single maribavir doses of 50, 100, 200, 400, 800, and 1600 mg, under fasting conditions. The second study enrolled 17 subjects with HIV-1 infection and evaluated single doses of 100, 200, 400, 800, and 1600 mg, also given under fasting conditions. After the final dosing period, 10 subjects in the second study were fed a high-fat breakfast and immediately given a 400 mg dose of maribavir, in order to evaluate the effects of food on the pharmacokinetics of maribavir.

The pharmacokinetic and safety profiles of maribavir were similar in both study populations, and these features have been consistent in subsequent phase I and II studies. Maribavir was rapidly absorbed, with detectable levels in the plasma within 15 min of dosing [76]. Peak concentrations in plasma occurred within 1–3 h under fasting conditions, and plasma concentrations were roughly dose-dependent across the dosing range assessed in the studies. Consumption of a high-fat meal delayed the time of peak concentration by approximately 2 h and resulted in a 30% reduction in  $C_{\max}$  in plasma. Consistent with results from preclinical studies, more than 98% of maribavir in plasma samples was bound to proteins, primarily albumin. Drug elimination occurred rapidly, with a mean plasma half-life of 3–5 h across all doses tested.

These first two phase I studies of maribavir raised no safety concerns. No serious adverse events occurred in the trial with healthy subjects. Two serious adverse events occurred among the HIV-infected subjects, but neither was attributed to maribavir. Taste disturbance and headache were the only two adverse events that were consistently reported more frequently following maribavir dosing compared to placebo, and were dose related. At the 1600 mg dose level, 80% of the healthy subjects and 67% of the HIV-1-infected subjects reported taste disturbance (compared to 17 and 19% in the placebo arms), and 30 and 33% of subjects in the two trials, respectively, reported headache (versus 0 and 13% in the placebo arms). The nature of this “aftertaste” was described as bitter or metallic, and its occurrence was tentatively attributed to the secretion of maribavir or its N-dealkylated metabolite in the salivary glands [31, 76].

The first demonstration of antiviral activity of maribavir in CMV-positive individuals was achieved in 1997, in a 28 day, randomized, placebo-controlled phase I–II dose escalation study in 78 HIV-1-infected male subjects with asymptomatic CMV shedding [77]. Subjects were randomly assigned to placebo or one of the six dosing regimens of maribavir: 100, 200, or 400 mg three times a day and 600, 900, or 1200 mg twice a day. Serial plasma, urine, and semen samples were collected for pharmacokinetic analyses at day 1 and at day 28. CMV was monitored in semen samples by plaque titration and PCR analysis, and in whole-blood samples by PCR, in a subset of subjects on days 1, 4, 7, 14, 21, and 28.

As was seen in the earlier studies, pharmacokinetic parameters showed dose-proportional increases over the dose range tested. Maribavir was well tolerated, even at the higher doses, with the dose-related taste disturbance again the most frequently

reported adverse event (82 versus 19% in placebo recipients), followed by reports of headache, gastrointestinal nausea, and diarrhea. Five patients (four of whom had a history of allergic reactions) discontinued treatment because of grade II rash; all cases resolved within 1–4 days after drug discontinuation. Notably, maribavir showed promising antiviral activity in the group of subjects evaluated for effects on viral load, with an informative dose response typically used to guide subsequent trial design [77].

Despite the small numbers of subjects available for analyses, the antiviral action of maribavir was encouraging. Mean decreases in semen CMV titers were 2.9 (100 mg t.i.d.), 3.7 (200 and 400 mg t.i.d.), and 3.4 (600 mg b.i.d.)  $\log_{10}$  PFU/ml, by the end of treatment on day 28 [77]. Maribavir appeared less efficacious on the basis of PCR monitoring, which is the standard method of treatment monitoring, showing viral genome drops of 1.11  $\log_{10}$  copies/ml (100 mg t.i.d.), 1.27  $\log_{10}$  copies/ml (200 mg t.i.d.), 1.28  $\log_{10}$  copies/ml (400 mg t.i.d.), and 1.25  $\log_{10}$  copies/ml (600 mg b.i.d.). The delayed decrease in viral DNA load detected by PCR over the 28 day dosage window, and the modest reductions achieved in DNA titer compared to actual infectious virus loads, may reflect the unusual mechanism of action of maribavir. Notably, maribavir also reduced the viral load in other tissue compartments, producing decreases in the urine of subjects across all doses, a 4.81  $\log_{10}$  drop in the blood titer in one subject with viremia, and a decrease in saliva titer in another subject who showed measurable salivary shedding before therapy [77].

Ability to cross the blood–brain barrier is one of the important properties that a good CMV drug should possess, particularly if the drug is to have potential either for CMV retinitis or for the neurological manifestations of congenital CMV infections. A small pilot study evaluated vitreal penetration of maribavir in eight men with AIDS and CMV retinitis who were scheduled to receive GCV intravitreal implant surgery. Participants were administered 800 mg t.i.d. or 1200 mg b.i.d. maribavir for 7 days to establish steady state. Maribavir levels in vitreal fluids were then measured and found to exceed *in vitro* anti-CMV  $EC_{50}$  values. Three of the subjects who had detectable virus in blood by PCR at baseline showed reductions of 0.26, 1.1, and 1.9  $\log_{10}$  after 7 days of maribavir oral administration [78].

Just as maribavir was positioned to move into phase III development as an oral treatment for CMV retinitis, events stymied its further development. First, the overall CMV drug market changed. The outstanding success of highly active antiretroviral therapy (HAART) led to a dramatic decrease in CMV-related morbidity and mortality in individuals with HIV-1 infection [44, 79], resulting in a decline in the overall CMV market to a level below the value threshold typically required for large pharmaceutical investment. Consequently, the clinical development of maribavir was jeopardized by two sequential mergers of Burroughs Wellcome into increasingly large pharmaceutical companies. In 2003, maribavir and its backup benzimidazole pyranoside GW275175X were outlicensed to ViroPharma, Inc. (Exton, PA) for the prophylaxis and treatment of CMV diseases [80]. By 2007, maribavir had successfully progressed through phase I and II studies into initial phase III evaluation.

## 9.6

### Clinical Development in a Transplant Population

ViroPharma undertook clinical development of maribavir for prevention of CMV viremia and CMV disease in transplant recipients, with the goal of filing for marketing approval in both the United States and Europe. Their first trial, initiated in July 2004, was a randomized, double-blind, placebo-controlled phase II trial to evaluate maribavir prophylaxis for prevention of CMV infection in allogeneic stem cell transplant recipients [80, 81]. A total of 111 patients were enrolled in the study and were randomly assigned to receive placebo or maribavir at 100 mg b.i.d., 400 mg q.d., or 400 mg b.i.d. These doses would have delivered lower total daily maribavir exposures than the doses (usually t.i.d.) administered earlier in the HIV population study [77]. The dosing period was up to 12 weeks. CMV antigenemia (pp65) and CMV DNA levels (PCR) were monitored weekly to detect viral reactivation, with a threshold trigger for switch to standard-of-care CMV treatment.

Maribavir treatment during the 12 week dosing regimen demonstrated clinical benefit. There was a statistically significant reduction in the numbers of subjects who required preemptive intervention: 57% of placebo recipients versus 15, 30, and 15% of patients given maribavir at 100 mg b.i.d., 400 mg q.d., and 400 mg b.i.d., respectively. The CMV infection rates were similarly reduced in the maribavir groups, as determined by both virologic measures: by antigenemia, infection rates of 15, 19, and 15% in the 100 mg b.i.d., 400 mg q.d., and 400 mg b.i.d. maribavir groups, respectively, compared to 39% in placebo group, and by plasma CMV DNA load, infection rates of 7, 11, and 19% in the three maribavir groups, respectively, compared to 39% in the placebo group. Moreover, there were no cases of CMV disease in the treatment groups, compared to three cases in the placebo group. No unexpected safety concerns arose in this sensitive patient population; the characteristic taste disturbance and nausea were noted, but no incidence of rash attributable to study drug. These results encouraged further clinical evaluation of maribavir.

To support phase III development of maribavir for a transplant population, a series of pharmacokinetic studies were conducted. These included phase I studies in patients with renal impairment and in patients with hepatic impairment, as well as studies investigating drug interactions [82]. The latter studies focused on clarifying the role of P450 enzymes in maribavir metabolism. Results of liver microsome assays [52] had suggested that CYP 3A was principally responsible for the generation of the major metabolite. To analyze the effect of CYP 3A inhibition on maribavir metabolism *in vivo*, the maribavir pharmacokinetic profile after dosing with maribavir alone was compared to the profile after dosing with ketoconazole plus maribavir [83]. An assumption underlying the study rationale was that ketoconazole causes near-complete inhibition of CYP 3A4.

The study was an open-label, random-sequence, two-way crossover study in which 20 healthy subjects were given (under fasting conditions) either a single 400 mg dose of maribavir (treatment 1) or a single 400 mg dose of ketoconazole, followed 1 h later by a single 400 mg dose of maribavir (treatment 2) [83]. A complete 24 h pharma-

cokinetic profile assessment was performed following each treatment. Ketoconazole moderately reduced the clearance of both maribavir and its principal metabolite, suggesting that there are other mechanisms of clearance besides liver isozyme CYP 3A4.

A more rigorous examination of cytochrome P450 activities and maribavir was performed using 16 healthy adults given 400 mg oral maribavir b.i.d. for 10 days and challenged with the “Cooperstown 5 + 1” multiple drug probe cocktail [84]. Maribavir appeared to have no effect on the activity of CYP 1A2, CYP 2C9, CYP 3A, NAT-2, or XO, but lack of bioequivalence was seen for CYP 2C19 and CYP 2D6, suggesting that maribavir decreased or inhibited these two activities.

Another study to assess possible interactions of maribavir with other drugs metabolized through the CYP 3A4 pathway was conducted while the pivotal trials in transplant recipients were underway. A randomized, double-blind, placebo-controlled pharmacokinetic study examined the effect of oral maribavir at 400 mg for 7 days on tacrolimus dosing in 25 stable renal transplant recipients [85]. Coadministration of maribavir increased systemic exposure to tacrolimus, with a 38% increase in tacrolimus mean  $C_{\max}$  and a 57% increase in mean tacrolimus trough concentrations 12 h after dosing [85]. Thus, for drugs such as cyclosporine or tacrolimus known to be metabolized by the CYP 3A4 pathway, therapeutic monitoring would be recommended if the drugs were coadministered with maribavir.

The effect of renal impairment on maribavir pharmacokinetics was examined in an open-label study of adult subjects with normal renal function or with mild, moderate, or severe renal impairment [86]. Study participants were given a single 400 mg dose of maribavir under fasting conditions. Blood samples were collected over a 36 h period for measurement of plasma concentrations of maribavir and its principal metabolite, and a 24 h urine collection was performed. Study results indicated no statistically significant differences between patients with normal renal function and those with impaired renal function [86]. No data have been published concerning maribavir pharmacokinetics in patients with hepatic impairment.

In December 2006, a randomized, placebo-controlled, double-blind phase III study evaluating the prophylactic use of maribavir in stem cell transplant recipients was initiated (study NCT00411645) [87]. The dosing period was up to 12 weeks and the planned enrollment was 613 patients. Several months later, a second phase III study was launched to evaluate the prophylactic use of maribavir versus oral GCV (1000 mg t.i.d.) for prevention of CMV disease in orthotopic liver transplant recipients (study NCT00497796) [87]. The dosing period was 14 weeks and the planned enrollment was 348 patients. In both studies, the maribavir dose selected for evaluation was 100 mg b.i.d., the lowest dose evaluated in the earlier phase II study. The primary outcome measure in both studies was CMV organ disease within 6 months post-transplant. Secondary outcome measures included CMV infection, CMV organ disease, graft versus host disease, and mortality at 100 days, 6 months, and/or 12 months posttransplantation.

However, in February 2009, it was reported that the study in patients undergoing allogeneic stem cell transplant had failed to meet its primary and secondary endpoints, and the study was discontinued [88]. Shortly thereafter, the pivotal study in



liver transplant recipients was also discontinued. To date no results have been published from either trial.

Additional data on maribavir safety and efficacy come from individual transplant patients with resistant or refractory CMV infection who received higher doses of maribavir under an Emergency IND. An open-label case series consisted of six transplant patients (five solid organ transplant, one stem cell transplant) with renal impairment, ranging in age from 15 to 67 years, who were treated for a median duration of 171 days (range: 15–228 days) [89]. CMV DNA levels in blood showed  $>1 \log_{10}$  decrease in all six patients within the first 6 weeks of treatment, with undetectable CMV levels in four patients between days 10 and 41 [89]. However, CMV viremia persisted in two patients after more than 6 months of maribavir treatment; genotypic analysis showed emergence of maribavir resistance in the strains harbored by these two patients that recapitulate mutations selected in the laboratory: at codons 409 and 411 [90].

## 9.7

### Summary and Conclusions

Maribavir is a novel, orally bioavailable antiviral agent of the bezimidazole riboside series with *in vitro* antiviral activity against CMV and EBV, two herpesviruses of significant disease potential. It is the first antiviral to selectively target a viral protein kinase: based on standard safety screen assays it does not inhibit any of the more than 70 mammalian kinases tested to date. Preclinical safety evaluations and multiple phase I–II clinical studies have confirmed safety advantages of maribavir over currently approved CMV therapies, notably a lack of hematological and renal toxicities. The major adverse effect of maribavir treatment is a dose-related taste disturbance, which may affect treatment tolerability but otherwise appears benign.

Antiviral activity has been documented in both HIV-infected subjects (semen viral load reductions) and stem cell transplant recipients (reduced incidence of CMV reactivation). Although two phase III studies for prophylaxis of CMV disease in stem cell transplant and solid organ transplant at the dose of 100 mg b.i.d. failed to meet primary study objectives or were terminated, viral load reductions were achieved in six transplant treatment failures using doses of 400 mg b.i.d. or higher.

Maribavir has shown safety advantages and sufficient therapeutic potential to warrant continued evaluation for both prevention and treatment of CMV diseases with carefully designed clinical studies in the transplant population. On the basis of the superior safety profile, oral bioavailability, and CNS penetration, maribavir should also be evaluated for congenital and neonatal CMV disease indications.

### Acknowledgments

The author acknowledges the crucial discovery of the antiviral activity of the benzimidazole ribonucleosides by Professors Leroy B. Townsend and John C. Drach

of the University of Michigan, and their insightful contributions to the extensive chemical SAR, along with the Burroughs Wellcome medicinal chemistry team, notably Susan Daluge, George Koszalka, and Stan Chamberlain. The dedication and commitment of the original Burroughs Wellcome 1263W94 team brought the candidate from original synthesis in 1994 up through the proof-of-principle clinical trial in 1997, a record achievement. Our team thanks the clinical investigators who continue to support the development of this interesting compound for the patients who would ultimately benefit. Finally, the author gratefully acknowledges the excellent editorial assistance of Barbara Rutledge.

## References

- 1 Mocarski, E.S., Jr., Shenk, T., and Pass, R.F. (2006) Cytomegaloviruses, in *Fields Virology*, 5th edn (eds D.M. Knipe and P.M. Howley), Lippincott Williams and Wilkins, Philadelphia, pp. 2701–2772.
- 2 Eid, A.J. and Razonable, R.R. (2010) New developments in the management of cytomegalovirus infection after solid organ transplantation. *Drugs*, **70**, 965–981.
- 3 Hodge, W.G., Seiff, S.R., and Margolis, T.P. (1998) Ocular opportunistic infection incidences among patients who are HIV positive compared to patients who are HIV negative. *Ophthalmology*, **105**, 895–900.
- 4 Fishman, J.A., Emery, V., Freeman, R., Pascual, M., Rostaing, L., Schlitt, H.J., Sgarabotto, D., Torre-Cisneros, J., and Uknis, M.E. (2007) Cytomegalovirus in transplantation: challenging the status quo. *Clinical Transplantation*, **21**, 149–158.
- 5 Hodson, E.M., Craig, J.C., Strippoli, G.F., and Webster, A.C. (2008) Antiviral medications for preventing cytomegalovirus disease in solid organ transplant recipients. *Cochrane Database of Systematic Reviews*, (2), CD003774, doi: 10.1002/14651858.CD003774.pub3.
- 6 Elion, G.B., Furman, P.A., Fyfe, J.A., de Miranda, P., Beauchamp, L., and Schaeffer, H.J. (1977) Selectivity of action of an antitherpetic agent, 9-(2-hydroxyethoxymethyl) guanine. *Proceedings of the National Academy of Sciences of the United States of America*, **74**, 5716–5720.
- 7 Holbrook, J.T., Jabs, D.A., Weinberg, D.V., Lewis, R.A., Davis, M.D., Friedberg, D. and Studies of Ocular Complications of AIDS (SOCA) Research Group. (2003) Visual loss in patients with cytomegalovirus retinitis and acquired immunodeficiency syndrome before widespread availability of highly active antiretroviral therapy. *Archives of Ophthalmology*, **121**, 99–107.
- 8 GlaxoSmithKline Inc. (2010) Valtrex (valacyclovir caplets) package insert.
- 9 Lowance, D., Neumayer, H.H., Legendre, C.M., Squifflet, J.P., Kovarik, J., Brennan, P.J., Norman, D., Mendez, R., Keating, M.R., Coggon, G.L., Crisp, A., and Lee, I.C. (1999) Valacyclovir for the prevention of cytomegalovirus disease after renal transplantation: international valacyclovir cytomegalovirus prophylaxis transplantation study group. *The New England Journal of Medicine*, **340**, 1462–1470.
- 10 Biron, K.K. (2006) Antiviral drugs for cytomegalovirus diseases. *Antiviral Research*, **71**, 154–163.
- 11 Roche Laboratories Inc. (2009). Cytovene-IV (ganciclovir sodium for intravenous infusion only) and Cytovene (ganciclovir capsules for oral administration only) package insert.
- 12 Hodson, E.M., Jones, C.A., Webster, A.C., Strippoli, G.F., Barclay, P.G., Kable, K., Vimalachandra, D., and Craig, J.C. (2005) Antiviral medications to prevent cytomegalovirus disease and early death in recipients of solid-organ transplants: a systematic review of randomised controlled trials. *Lancet*, **365**, 2105–2115.

- 13 Cvetković, R.S. and Wellington, K. (2005) Valganciclovir: a review of its use in the management of CMV infection and disease in immunocompromised patients. *Drugs*, **65**, 859–878.
- 14 Astra Zeneca Inc. (2000) Foscavir (foscarnet injection) package insert.
- 15 Gilead Sciences Inc. (1996) Vistide (cidofovir injection) package insert.
- 16 Ciesla, S.L., Trahan, J., Wan, W.B., Beadle, J.R., Aldern, K.A., Painter, G.R., and Hostetler, K.Y. (2003) Esterification of cidofovir with alkoxyalkanols increases oral bioavailability and diminishes drug accumulation in kidney. *Antiviral Research*, **59**, 163–171.
- 17 Rowshani, A.T., Bemelman, F.J., van Leeuwen, E.M., van Lier, R.A., and ten Berge, I.J. (2005) Clinical and immunologic aspects of cytomegalovirus infection in solid organ transplant recipients. *Transplantation*, **79**, 381–386.
- 18 Townsend, L.B. and Revankar, G.R. (1970) Benzimidazole nucleosides, nucleotides, and related derivatives. *Chemical Reviews*, **70**, 389–438.
- 19 Zou, R., Drach, J.C., and Townsend, L.B. (1997) Design, synthesis, and antiviral evaluation of 2-chloro-5,6-dihalo-1- $\beta$ -D-ribofuranosylbenzimidazoles as potential agents for human cytomegalovirus infections. *Journal of Medicinal Chemistry*, **40**, 811–818.
- 20 Townsend, L.B., Drach, J.C., Good, S.S., DaLuge, S.M., and Martin, M.C. (1996) Therapeutic nucleosides. US Patent 5,534,535. Issued Sept. 7, 1996.
- 21 Underwood, M.R., Harvey, R.J., Stanat, S.C., Hemphill, M.L., Miller, T., Drach, J.C., Townsend, L.B., and Biron, K.K. (1998) Inhibition of HCMV DNA maturation by a benzimidazole ribonucleoside is mediated through the UL89 gene product. *Journal of Virology*, **72**, 717–725.
- 22 Krosky, P.M., Underwood, M.R., Turk, S.R., Feng, K.W.-H., Jain, R.K., Ptak, R.G., Westerman, A.C., Biron, K.K., Townsend, L.B., and Drach, J.C. (1998) Resistance of human cytomegalovirus to benzimidazole ribonucleosides maps to two open reading frames: UL89 and UL56. *Journal of Virology*, **72**, 4721–4728.
- 23 Bogner, E. (2002) Human cytomegalovirus terminase as a target for antiviral chemotherapy. *Reviews in Medical Virology*, **12**, 115–127.
- 24 Dittmer, A., Drach, J.C., Townsend, L.B., Fischer, A., and Bogner, E. (2005) Interaction of the putative HCMV portal protein pUL104 with the large terminase subunit pUL56 and its inhibition by benzimidazole-D-ribonucleosides. *Journal of Virology*, **79**, 14660–14667.
- 25 Good, S.S., Owens, B.S., Townsend, L.B., and Drach, J.C. (1994) The disposition in rats and monkeys of 2-bromo-5,6-dichloro-1-( $\beta$ -D-ribofuranosyl)-benzimidazole (BDCRB) and its 2,5,6-trichloro congener (TCRB). *Antiviral Research*, **23** (S1), 103.
- 26 Underwood, M.R., Ferris, R.G., Selleseth, D.W., Davis, M.G., Drach, J.C., Townsend, L.B., Biron, K.K., and Boyd, F.L. (2004) Mechanism of action of the ribopyranoside benzimidazole GW275175X against human cytomegalovirus. *Antimicrobial Agents and Chemotherapy*, **48**, 1647–1651.
- 27 Biron, K.K., Guudmundson, K.S., and Drach, J.C. (2010) Benzimidazole ribonucleosides: Novel drug candidates for the prevention and treatment of cytomegalovirus disease, in *Antiviral Drugs: Biology, Chemistry, Clinic* (ed. W.M. Kazmierski), John Wiley & Sons, Inc., Hoboken, NJ, in press.
- 28 Townsend, L.B., Devivar, R.V., Turk, S.R., Nassiri, M.R., and Drach, J.C. (1995) Design, synthesis, and antiviral activity of certain 2,5,6-trihalo-1-( $\beta$ -D-ribofuranosyl) benzimidazoles. *Journal of Medicinal Chemistry*, **38**, 4098–4105.
- 29 Chamberlain, S.D., Daluge, S.M., and Koszalka, G.W. (1999) Antiviral benzimidazole nucleoside analogues and methods for their preparation. US patent 5,998,605. Issued July 12, 1999.
- 30 Williams, S.L., Hartline, C.B., Kushner, N.L., Harden, E.A., Bidanset, D.J., Drach, J.C., Townsend, L.B., Underwood, M.R., Biron, K.K., and Kern, E.R. (2003) *In vitro* activities of benzimidazole D- and L-ribonucleosides against herpesviruses. *Antimicrobial Agents and Chemotherapy*, **47**, 2186–2192.

- 31 Biron, K.K., Harvey, R.J., Chamberlain, S.C., Good, S.S., Smith, A.A., 3rd, Davis, M.G., Talarico, C.L., Miller, W.H., Ferris, R., Dornsife, R.E., Stanat, S.C., Drach, J.C., Townsend, L.B., and Koszalka, G.W. (2002) Potent and selective inhibition of human cytomegalovirus replication by 1263W94, a benzimidazole l-ribose with a unique mode of action. *Antimicrobial Agents and Chemotherapy*, **46**, 2365–2372.
- 32 McSharry, J.J., McDonough, A., Olson, B., Talarico, C., Davis, M., and Biron, K.K. (2001) Inhibition of ganciclovir-susceptible and -resistant human cytomegalovirus clinical isolates by the benzimidazole l-ribose 1263W94. *Clinical and Diagnostic Laboratory Immunology*, **8**, 1279–1281.
- 33 Chou, S., Van Wechel, L.C., and Marousek, G.I. (2006) Effect of cell culture conditions on the anticytomegalovirus activity of maribavir. *Antimicrobial Agents and Chemotherapy*, **50**, 2557–2559.
- 34 Zacny, V.I., Gershburg, E., Davis, M.G., Biron, K.K., and Pagano, J.S. (1999) Inhibition of Epstein-Barr virus replication by a benzimidazole l-ribose: novel antiviral mechanism of 5,6-dichloro-2-(isopropylamino)1-beta-l-ribofuranosyl-1H-benzimidazole. *Journal of Virology*, **73**, 7271–7277.
- 35 Kern, E.R., Hartline, C.B., Rybak, R.J., Drach, J.C., Townsend, L.B., Biron, K.K., and Bidanset, D.J. (2004) Activities of benzimidazole D- and l-ribonucleosides in animal models of cytomegalovirus infections. *Antimicrobial Agents and Chemotherapy*, **48**, 1749–1755.
- 36 Drew, W.L., Minor, R.C., Marousek, G.L., and Chou, S. (2006) Maribavir sensitivity of cytomegalovirus isolates resistant to ganciclovir, cidofovir or foscarnet. *Journal of Clinical Virology*, **37**, 124–127.
- 37 Chou, S. (2008) Cytomegalovirus UL97 mutations in the era of ganciclovir and maribavir. *Reviews in Medical Virology*, **18**, 233–246.
- 38 Biron, K.K., Fyfe, J.A., Stanat, S.C., Leslie, L.K., Sorrell, J.B., Lambe, C.U., and Coen, D.M. (1986) A human cytomegalovirus mutant resistant to the nucleoside analog 9-[(2-hydroxy-1-(hydroxymethyl)ethoxy)methyl]guanine (BW B759U) induces reduced levels of BW B759U triphosphate. *Proceedings of the National Academy of Sciences of the United States of America*, **83**, 8769–8773.
- 39 Sullivan, V., Talarico, C.L., Stanat, S.C., Davis, M., Coen, D.M., and Biron, K.K. (1992) A protein kinase homologue controls phosphorylation of ganciclovir in human cytomegalovirus-infected cells. *Nature*, **359**, 85.
- 40 Chou, S. and Marousek, G.I. (2008) Accelerated evolution of maribavir resistance in a cytomegalovirus exonuclease domain II mutant. *Journal of Virology*, **82**, 246–253.
- 41 Truesdale, A.T., Biron, K.K., Ellis, B.P., Miller, W.H., and Wood, E.R. (2007) Mode of inhibition studies with MBV and the CMV kinase UL97. 32nd International Herpesvirus Workshop, Asheville, N.C. (Abst. 10.27).
- 42 Chee, M.S., Lawrence, G.L., and Barrell, B.G. (1989) Alpha-, beta- and gammaherpesviruses encode a putative phosphotransferase. *The Journal of General Virology*, **70**, 1151–1160.
- 43 Hanks, S.K., Quinn, A.M., and Hunter, T. (1988) The protein kinase family: conserved features and deduced phylogeny of the catalytic domains. *Science*, **241**, 42–52.
- 44 Smith, R.F. and Smith, T.F. (1989) Identification of new protein kinase-related genes in three herpesviruses, herpes simplex virus, varicella-zoster virus, and Epstein-Barr virus. *Journal of Virology*, **63**, 450–455.
- 45 Prichard, M.N. (2009) Function of human cytomegalovirus UL97 kinase in viral infection and its inhibition by maribavir. *Reviews in Medical Virology*, **19**, 215–229.
- 46 Coulter, L.J., Moss, H.W., Lang, J., and McGeoch, D.J. (1993) A mutant of herpes simplex virus type 1 in which the UL13 protein kinase gene is disrupted. *The Journal of General Virology*, **74**, 387–395.
- 47 Moffat, J.F., Zerboni, L., Sommer, M.H., Heineman, T.C., Cohen, J.I., Kaneshima, H., and Arvin, A.M. (1998) The ORF47 and ORF66 putative protein kinases of varicella-zoster virus determine tropism for human T cells and skin in the SCID-hu mouse. *Proceedings of the National*

- Academy of Sciences of the United States of America*, **95**, 11969–11974.
- 48 Gershburg, E. and Pagano, J.S. (2002) Phosphorylation of the Epstein-Barr (EBV) DNA polymerase processivity factor EA-D by the EBV-encoded protein kinase and effects of the L-riboside benzimidazole 1263W94. *Journal of Virology*, **76**, 998–1003.
  - 49 Wang, F.Z., Roy, D., Gershburg, E., Whitehurst, C.B., Dittmer, D.P., and Pagano, J.S. (2009) Maribavir inhibits Epstein-Barr virus transcription in addition to viral DNA replication. *Journal of Virology*, **83**, 12108–12117.
  - 50 Jault, F.M., Jault, J.M., Ruchti, F., Fortunato, E.A., Clark, C., Corbeil, J., Richman, D.D., and Spector, D.H. (1995) Cytomegalovirus infection induces high levels of cyclins, phosphorylated Rb, and p53, leading to cell cycle arrest. *Journal of Virology*, **69**, 6697–6704.
  - 51 Tamm, I. and Sehgal, P.B. (1978) Halobenzimidazole ribosides and RNA synthesis of cells and viruses. *Advances in Virus Research*, **22**, 187–258.
  - 52 Koszalka, G.W., Johnson, N.W., Good, S.S., Boyd, L., Chamberlain, S.C., Townsend, L.B., Drach, J.C., and Biron, K.K. (2002) Preclinical and toxicology studies of 1263W94, a potent and selective inhibitor of human cytomegalovirus replication. *Antimicrobial Agents and Chemotherapy*, **46**, 2373–2380.
  - 53 Zimmermann, A., Wilts, H., Lenhardt, M., Hahn, M., and Mertens, T. (2000) Indolocarbazoles exhibit strong antiviral activity against human cytomegalovirus and are potent inhibitors of the pUL97 protein kinase. *Antiviral Research*, **48**, 49–60.
  - 54 Schleiss, M., Eickhoff, J., Auerochs, S., Leis, M., Abele, S., Choi, Y., Anderson, J., Scott, G., Rawlinson, W., Rechter, S., Michel, D., Ensminger, S., Klebl, B., Stamminger, T., and Marschall, M. (2008) Protein kinase inhibitors of the quinazoline class exert anti-cytomegalovirus activity *in vitro* and *in vivo*. *Antiviral Research*, **79**, 49–61.
  - 55 Prichard, M.N., Gao, N., Jairath, S., Mulamba, G., Krosky, P., Coen, D.M., Parker, B.O., and Pari, G.S. (1999) A recombinant human cytomegalovirus with a large deletion in UL97 has a severe replication deficiency. *Journal of Virology*, **73**, 5663–5670.
  - 56 Wolf, D.G., Courcelle, C.T., Prichard, M.N., and Mocarski, E.S. (2001) Distinct and separate roles for herpesvirus-conserved UL97 kinase in cytomegalovirus DNA synthesis and encapsidation. *Proceedings of the National Academy of Sciences of the United States of America*, **98**, 1895–1900.
  - 57 Kamil, J.P. and Coen, D.M. (2007) Human cytomegalovirus protein kinase UL97 forms a complex with the tegument phosphoprotein pp65. *Journal of Virology*, **81**, 10659–10668.
  - 58 Prichard, M.N., Britt, W.J., Daily, S.L., Hartline, C.B., and Kern, E.R. (2005) Human cytomegalovirus UL97 kinase is required for the normal intranuclear distribution of pp65 and virion morphogenesis. *Journal of Virology*, **79**, 15494–15502.
  - 59 Krosky, P.M., Baek, M.C., and Coen, D.M. (2003) The human cytomegalovirus UL97 protein kinase, an antiviral drug target, is required at the stage of nuclear egress. *Journal of Virology*, **77**, 905–914.
  - 60 Baek, M.C., Krosky, P.M., and Coen, D.M. (2002) Relationship between autophosphorylation and phosphorylation of exogenous substrates by the human cytomegalovirus UL97 protein kinase. *Journal of Virology*, **76**, 11943–11952.
  - 61 Krosky, P.M., Baek, M.C., Jahng, W.J., Barrera, I., Harvey, R.J., Biron, K.K., Coen, D.M., and Sethna, P.B. (2003) The human cytomegalovirus UL44 protein is a substrate for the UL97 protein kinase. *Journal of Virology*, **77**, 7720–7727.
  - 62 Marschall, M., Freitag, M., Suchy, P., Romaker, D., Kupfer, R., Hanke, M., and Stamminger, T. (2003) The protein kinase pUL97 of human cytomegalovirus interacts with and phosphorylates the DNA polymerase processivity factor pUL44. *Virology*, **311**, 60–71.
  - 63 Baek, M.C., Krosky, P.M., Pearson, A., and Coen, D.M. (2004) Phosphorylation of the RNA polymerase II carboxyl-terminal domain in human cytomegalovirus-infected cells and *in vitro* by the viral UL97 protein kinase. *Virology*, **324**, 184–193.

- 64 Kawaguchi, Y., Matsumura, T., Roizman, B., and Hirai, K. (1999) Cellular elongation factor 1delta is modified in cells infected with representative alpha-, beta-, or gammaherpesviruses. *Journal of Virology*, **73**, 4456–4460.
- 65 Kawaguchi, Y. and Kato, K. (2003) Protein kinases conserved in herpesviruses potentially share a function mimicking the cellular protein kinase cdc2. *Reviews in Medical Virology*, **13**, 331–340.
- 66 Schang, L.M., St Vincent, M.R., and Lacasse, J.J. (2006) Five years of progress on cyclin-dependent kinases and other cellular proteins as potential targets for antiviral drugs. *Antiviral Chemistry & Chemotherapy*, **17**, 293–320.
- 67 Marschall, M., Marzi, A., aus dem Siepen, P., Jochmann, R., Kalmer, M., Auerochs, S., Lischka, P., Leis, M., and Stamminger, T. (2005) Cellular p32 recruits cytomegalovirus kinase pUL97 to redistribute the nuclear lamina. *The Journal of Biological Chemistry*, **280**, 33357–33367.
- 68 Hume, A.J., Finkel, J.S., Kamil, J.P., Coen, D.M., Culbertson, M.R., and Kalejta, R.F. (2008) Phosphorylation of retinoblastoma protein by viral protein with cyclin-dependent kinase function. *Science*, **320**, 797–799.
- 69 Prichard, M.N., Sztul, E., Daily, S.L., Perry, A.L., Frederick, S.L., Gill, R.B., Hartline, C.B., Streblov, D.N., Varnum, S.M., Smith, R.D., and Kern, E.R. (2008) Human cytomegalovirus UL97 kinase activity is required for the hyperphosphorylation of retinoblastoma protein and inhibits the formation of nuclear aggresomes. *Journal of Virology*, **82**, 5054–5067.
- 70 Komazin, G., Ptak, R.G., Emmer, B.T., Townsend, L.B., and Drach, J.C. (2003) Resistance of human cytomegalovirus to the benzimidazole l-ribonucleoside maribavir maps to UL27. *Journal of Virology*, **77**, 11499–11506.
- 71 Chou, S., Marousek, G.I., Senters, A.E., Davis, M.G., and Biron, K.K. (2004) Mutations in the human cytomegalovirus UL27 gene that confer resistance to maribavir. *Journal of Virology*, **78**, 7124–7130.
- 72 Chou, S. (2009) Diverse cytomegalovirus UL27 mutations adapt to loss of viral UL97 kinase activity under maribavir. *Antimicrobial Agents and Chemotherapy*, **53**, 81–85.
- 73 Biron, K. (2006) Maribavir: a promising new antiherpes therapeutic agent, in *New Concepts of Antiviral Therapy* (eds E. Bogner and A. Holzenburg), Springer, pp. 309–366.
- 74 Chou, S. and Marousek, G.I. (2006) Maribavir antagonizes the antiviral action of ganciclovir on human cytomegalovirus. *Antimicrobial Agents and Chemotherapy*, **50**, 3470–3472.
- 75 Evers, D.L., Komazin, G., Shin, D., Hwang, D.D., Townsend, L.B., and Drach, J.C. (2002) Interactions among antiviral drugs acting late in the replication cycle of human cytomegalovirus. *Antiviral Res.*, **56** (1), 61–22.
- 76 Wang, L.H., Peck, R.W., Yin, Y., Allanson, J., Wiggs, R., and Wire, M.B. (2003) Phase I safety and pharmacokinetic trials of 1263W94, a novel oral anti-human cytomegalovirus agent, in healthy and human immunodeficiency virus-infected subjects. *Antimicrobial Agents and Chemotherapy*, **47**, 1334–1342.
- 77 Lalezari, J.P., Aberg, J.A., Wang, L.H., Wire, M.B., Miner, R., Snowden, W., Talarico, C.L., Shaw, S., Jacobson, M.A., and Drew, W.L. (2002) Phase I dose escalation trial evaluating the pharmacokinetics, anti-human cytomegalovirus (HCMV) activity, and safety of 1263W94 in human immunodeficiency virus-infected men with asymptomatic HCMV shedding. *Antimicrobial Agents and Chemotherapy*, **46**, 2969–2976.
- 78 Hendrix, C., Kuppermann, B.D., Dunn, J.P., Wang, L.H., Starns, E., Snowden, B.W., Hamzeh, F., and Wire, M.B. (2000) A phase I trial to evaluate the ocular (intravitreal) penetration of 1263W94 after multiple dose, oral administration in AIDS patients with CMV retinitis. Interscience Conference on Antimicrobial Agents and Chemotherapy, Toronto, Ontario.
- 79 Deayton, J.R., Wilson, P., Sabin, C.A., Davey, C.C., Johnson, M.A., Emery, V.C., and Griffiths, P.D. (2000) Changes in the natural history of cytomegalovirus retinitis following the introduction of

- highly active antiretroviral therapy. *AIDS (London, England)*, **14**, 1163–1170.
- 80** ViroPharma Incorporated (2005) Form 10-K for the Fiscal Year Ended December 31, 2004.
- 81** Winston, D.J., Young, J.A., Pullarkat, V., Papanicolaou, G.A., Vij, R., Vance, E., Alangaden, G.J., Chemaly, R.F., Petersen, F., Chao, N., Klein, J., Sprague, K., Villano, S.A., and Boeckh, M. (2008) Maribavir prophylaxis for prevention of cytomegalovirus infection in allogeneic stem cell transplant recipients: a multicenter, randomized, double-blind, placebo-controlled, dose-ranging study. *Blood*, **111**, 5403–5410.
- 82** ViroPharma Incorporated (2008) Form 10-K for the fiscal year ended December 31, 2007.
- 83** Goldwater, D.R., Dougherty, C., Schumacher, M., and Villano, S.A. (2008) Effect of ketoconazole on the pharmacokinetics of maribavir in healthy adults. *Antimicrobial Agents and Chemotherapy*, **52**, 1794–1798.
- 84** Ma, J.D., Nafziger, A.N., Villano, S.A., Gaedigk, A., and Bertino, J.S., Jr. (2006) Maribavir pharmacokinetics and the effects of multiple-dose maribavir on cytochrome P450 (CYP) 1A2, CYP 2C9, CYP 2C19, CYP 2D6, CYP 3A, N-acetyltransferase-2, and xanthine oxidase activities in healthy adults. *Antimicrobial Agents and Chemotherapy*, **50**, 1130–1135.
- 85** Pescovitz, M.D., Bloom, R., Pirsch, J., Johnson, J., Gelone, S., and Villano, S.A. (2009) A randomized, double-blind, pharmacokinetic study of oral maribavir with tacrolimus in stable renal transplant recipients. *American Journal of Transplantation*, **9**, 2324–2330.
- 86** Swan, S.K., Smith, W.B., Marbury, T.C., Schumacher, M., Dougherty, C., Mico, B.A., and Villano, S.A. (2007) Pharmacokinetics of maribavir, a novel oral anticytomegalovirus agent, in subjects with varying degrees of renal impairment. *Journal of Clinical Pharmacology*, **47**, 209–217.
- 87** [www.clinicaltrials.gov](http://www.clinicaltrials.gov) (accessed June 25, 2010).
- 88** ViroPharma Incorporated (2009) Form 10-K for the fiscal year ended December 31, 2008.
- 89** Avery, R., Marty, F., Strasfeld, L., Lee, I., Arrieta, A., Chou, S., and Villano, S. (2009) Oral maribavir (MBV) for treatment of resistant or refractory cytomegalovirus (CMV) infections in transplant recipients. 49th Interscience Conference on Antimicrobial Agents and Chemotherapy, San Francisco, California.
- 90** Strasfeld, L., Lee, I., Tatarowicz, W., Villano, S., and Chou, S. (2010) Virologic characterization of multidrug-resistant cytomegalovirus infection in 2 transplant recipients treated with maribavir. *The Journal of Infectious Diseases*, **202**, 104–108.

## 10

### Anti-HCMV Compounds

*Graciela Andrei and Robert Snoeck*

#### 10.1

##### Introduction

Human cytomegalovirus (HCMV) is a highly species-specific virus, with humans being the only host. HCMV is a ubiquitous opportunistic viral pathogen infecting between 30 and 90% of the world's population, depending on the socioeconomic status and geographical location [1]. Seroprevalence in developed countries is in the range of 30–70%, while in the developing world, most preschool children (more than 90%) are HCMV antibody positive [2]. HCMV is easily transmitted by direct close contact via exposure to body fluids such as saliva, tears, urine, stool, semen, and breast milk. Because breastfeeding, increased exposure to young children, and sexual contact are the main routes of HCMV transmission, most adults are seropositive for HCMV. Furthermore, the virus has been found in every population tested.

Like all herpesviruses, HCMV following primary infection establishes a lifelong latency in the infected hosts. Although the exact site of HCMV latency remains to be elucidated, cells of the myeloid lineage constitute an important reservoir. In healthy individuals, HCMV infections are usually asymptomatic; however, a primary infection or reactivation of latent virus is a major cause of disease and death in immunocompromised patients. Thus, organ transplant recipients, patients undergoing hemodialysis, patients with cancer, individuals receiving immunosuppressive drugs, and HIV-infected patients are at a high risk of developing clinical manifestation of HCMV infection. Prolonged therapy is required to prevent or treat HCMV disease in immunocompromised individuals. In addition, HCMV is the most common congenital infection of the developed world, affecting approximately 1% of all born infants [3].

The primary manifestation of HCMV infection in AIDS patients is HCMV retinitis that usually results as a reactivation from latency when CD4<sup>+</sup> cell counts are severely suppressed (<50 cells/ $\mu$ l). Following the introduction of highly active antiretroviral therapy (HAART), the incidence of HCMV retinitis in AIDS patients has significantly diminished [4, 5]. Considering that the restoration of HCMV-specific immune responses may require up to 3–6 months of HAART, and that some patients do



not have access or do not respond to HAART, HCMV still remains a concern in AIDS patients with low CD4 cell counts (i.e., <50 or <100 cells/ $\mu$ l). In addition, immune recovery does not guarantee protection from recurrent disease since some patients who experience immune recovery may develop CMV retinitis and uveitis causing vision loss in this population [6]. HCMV still remains an important cofactor in the era of HAART since asymptomatic HCMV viremia is a risk factor for disease progression and death in HIV-infected patients receiving HAART [7, 8].

HCMV-associated posttransplant diseases continue to be a real problem in transplant recipients. HCMV infection is the main viral cause of morbidity and mortality among solid organ transplant (SOT) and hematopoietic stem cell transplant (HSCT) recipients not only due to the direct adverse effects resulting from viral replication and viral invasion of different organs but also due to indirect effects, such as dysfunction or rejection of the transplant organ, an increased risk of bacterial or fungal opportunistic infections [9]. HCMV viremia is a major risk factor for organ involvement and progression to HCMV disease [10]. Among SOT patients, those at greatest risk for developing HCMV-associated disease within the first 3 months posttransplant are the serologically negative patients receiving an organ from a serologically positive donor (R -/D +). HCMV-associated disease is initially localized in the transplant organ and can subsequently spread systemically causing pneumonitis, enteritis, hepatitis, and (less frequently) retinitis and CNS involvement.

HCMV infection is the main viral cause of morbidity and mortality after HSCT. HCMV disease observed in this group of patients is due to primary infection or reactivation of latent virus present in the seropositive recipient, pneumonitis and enteritis being the most common manifestations of HCMV disease, with a mortality of 60–80% without treatment and 50% when treated with antiviral therapy and cytomegalovirus hyperimmunoglobulin. HCMV-associated pneumonitis appears to result from a combination of the direct cytopathic effects of viral replication and host-dependent immunopathological mechanisms. Prophylactic administration of ganciclovir (GCV) can prevent HCMV reactivation within the first 3 months posttransplantation. However, recent studies have reported the late-onset HCMV-disease (defined as more than 100 days after transplant) associated with chronic graft versus host disease (GvHD) and long-term administration of GCV [11]. GCV is immunosuppressive and prevents the recovery of HCMV-specific T-cell responses necessary for protective immunity in these patients. The use of prophylactic immunoglobulins in patients at high risk of HCMV disease after HSCT does not diminish the incidence of HCMV infection [12].

Congenital cytomegalovirus is one of the most important clinical manifestations of primary infection with HCMV. Newborn infection occurs as a consequence of intrauterine, intrapartum (perinatal), or postnatal (breast milk) transmission. Approximately, 10% of neonates with congenital HCMV have symptomatic disease associated with severely deleterious effects of the CNS (including microcephaly, intracranial calcifications, and ventriculomegaly). Prognosis for neonates with symptomatic disease is poor, with a high probability of mental retardation, hearing loss, and psychomotor and perceptual handicaps. Even those babies who are

asymptomatic at birth have a risk of hearing loss, and overall it is estimated that congenital HCMV infection accounts for one-third of all cases of hearing loss [3].

## 10.2

### Anti-HCMV Drugs in Clinical Use

#### 10.2.1

##### Classes of Anti-HCMV Drugs

While a limited number of drugs are licensed for the prophylaxis or treatment of HCMV disease in transplant patients, no anti-HCMV drugs are approved for treatment of primary CMV infection during pregnancy that can result in infections with catastrophic consequences for the newborn. Current drugs licensed for the treatment of HCMV infections include ganciclovir, its oral prodrug valganciclovir, foscarnet (FOS), cidofovir (CDV), and fomivirsen (Figure 10.1) [13]. Ganciclovir (GCV), a deoxyguanosine analogue, was the first drug to be approved for the treatment of HCMV infections in 1989 and it has become the first-line treatment for HCMV infections in immunocompromised patients. GCV is selectively phosphorylated in HCMV-infected cells by a viral protein kinase homologue (the product of the UL97 gene, pUL97). Cellular kinases are responsible for the conversion of GCV monophosphate to GCV-diphosphate and GCV-triphosphate, which acts as a potent inhibitor of the HCMV DNA polymerase by competing with dGTP. Incorporation of GCV triphosphate in place of dGTP into the growing DNA chain results in slower chain elongation. Figure 10.2 shows an outline of the mechanism of action of drugs approved for the treatment of CMV disease that target the viral DNA polymerase. GCV can be given intravenously (IV), orally (Cytovene<sup>®</sup>, Roche), or as an ocular implant (Vitraset<sup>®</sup>, Chiron) for the treatment of HCMV retinitis. Because of the low bioavailability of GCV (~6%), valganciclovir (VGCV, Valcyte<sup>®</sup>, Roche), a prodrug of GCV, was developed exhibiting an oral bioavailability of about 60%. VGCV is the L-valyl ester of GCV and following oral administration is metabolized to the active form (GCV) in the intestinal wall and liver. VGCV has now replaced oral GCV and there is still a debate whether prophylaxis therapy or preemptive therapy should be used for asymptomatic high-risk transplant recipients. Both strategies have been shown to be effective to prevent HCMV disease after transplantation, but they also have disadvantages [14]. The limitations of prophylaxis include prolonged drug exposure, higher risk to develop drug resistance, and mainly late-onset HCMV disease [15]. On the other hand, the preemptive therapy requires frequent laboratory monitoring of viral loads, and some patients may develop symptomatic disease before the diagnosis of HCMV. Although acyclovir (ACV) and its oral prodrug valacyclovir (VACV) are not sufficiently potent for the treatment of established CMV disease, VACV has been approved in several countries for prophylaxis of HCMV disease in transplant recipients [13]. The safety and efficacy of VACV for prevention of HCMV has been documented in several studies [16, 17].

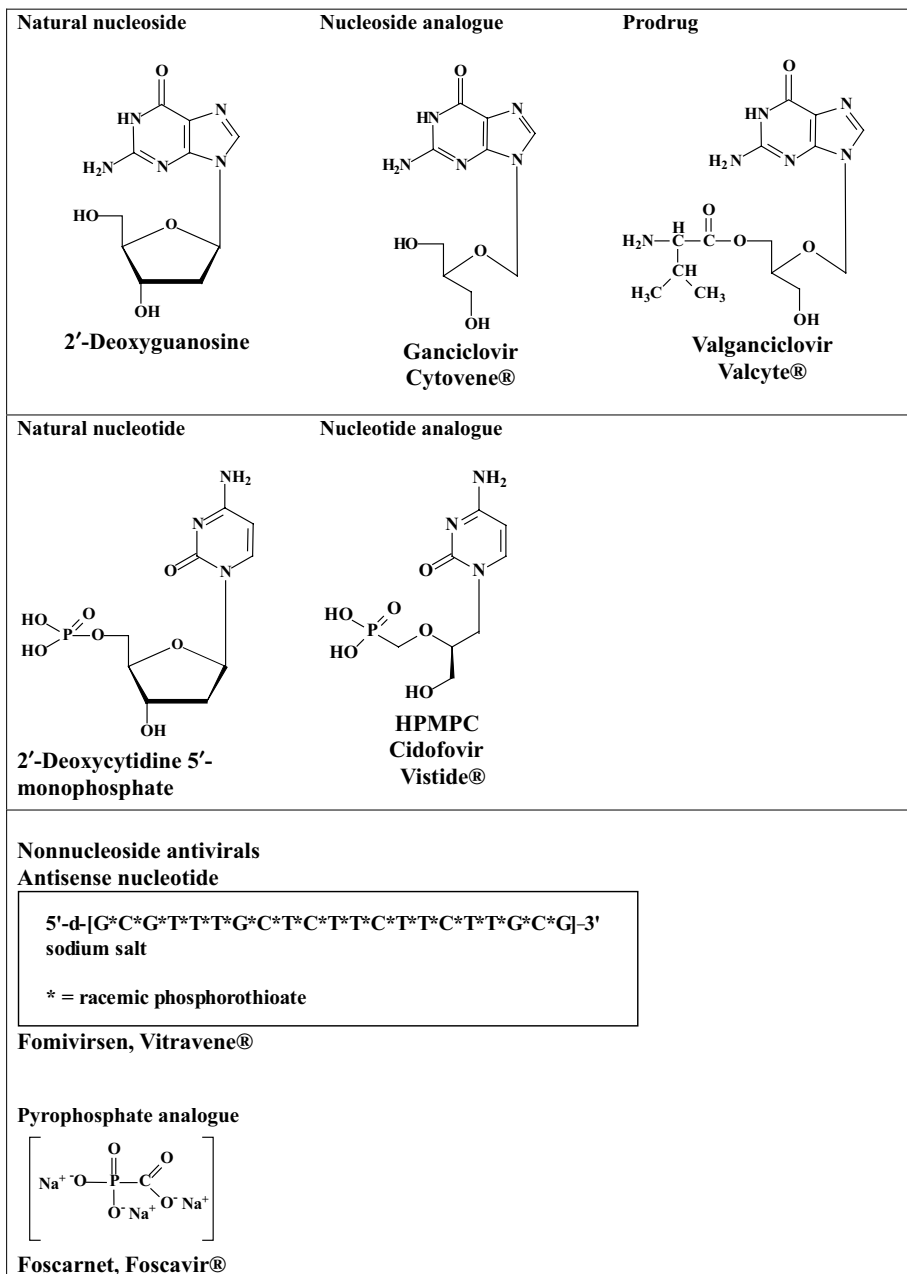

Figure 10.1 Approved anti-HCMV drugs.

Cidofovir (CDV) and foscarnet (POS) are approved for systemic treatment of HCMV infections. In contrast to GCV, these drugs do not require activation by the viral pUL97. CDV (Vistide<sup>®</sup>, Gilead), an acyclic nucleoside phosphonate with broad-spectrum activity against DNA viruses, has been licensed for the intravenous treatment of HCMV retinitis in AIDS patients. Due to the broad activity of CDV against a variety of human DNA viruses, this compound is also used “off label” for the intravenous or topical treatment of various herpes-, polyoma-, and adenovirus infections, poxvirus infections (i.e., molluscum contagiosum and orf virus), and papillomavirus-associated diseases such as genital warts and laryngeal papillomas [18, 19]. Because CDV has a phosphonate group, it bypasses the first phosphorylation step and therefore is independent of activation by the viral pUL97. Cellular kinases convert the drug to the active diphosphoryl form (i.e. CDVpp), which acts as a competitive inhibitor of the viral DNA polymerase, causing premature chain termination during viral DNA synthesis (Figure 10.2). Incorporation of CDVpp into HCMV DNA slows down elongation and results in chain termination when two consecutive CDVpp residues are incorporated in a row [20, 21]. The diphosphorylated forms of acyclic nucleoside phosphonates (ANPs) inhibit viral polymerases more potently than cellular DNA polymerases. The metabolites of the ANPs (i.e., CDV) show an unusually long intracellular half-life; this may account for the long-lasting antiviral activity of the compounds. This prolonged antiviral action may be attributed to the formation of the CDVp-choline adduct, which could serve as an intracellular reservoir for the mono- and diphosphoryl derivatives of HPMP. CDV present two major disadvantages that have restrained its use: (i) low oral bioavailability (<5%) requiring IV administration, usually once a week, (ii) and dose-dependent nephrotoxicity that can be limited by prehydration and coadministration of probenecid.

Foscarnet (Foscavir<sup>®</sup>, FOS, Astra Zeneca) is the trisodium salt of phosphonoformic acid, a pyrophosphate analogue. FOS, which does not require phosphorylation by viral or cellular kinases, inhibits the activity of the viral DNA polymerase by binding to the pyrophosphate binding site and blocking the release of pyrophosphate from the terminal nucleoside triphosphate when added onto the growing DNA chain. FOS can be considered as a second-line therapy and its use is reserved for patients who have failed GCV therapy or who cannot be treated with GCV due to side effects of the drug.

Finally, fomivirsen (Vitravene<sup>®</sup>, Novartis) is a 21-nucleotide (nt) antisense with sequence complementarity to the HCMV immediate early 2 mRNA. Fomivirsen is administered by intraocular injection and was approved in 1998 as a second-line therapy for the local treatment of HCMV retinitis in AIDS patients.

Although available anti-HCMV drugs have proved useful in the management of HCMV disease, their use can be associated with several drawbacks, including toxicity, poor oral bioavailability (except VGCV and VACV), and emergence of drug resistance.

### 10.2.2

#### Toxicity Associated with Approved Anti-HCMV Drugs

Serious side effects associated with prolonged treatment can be seen with the available anti-HCMV drugs. The most common adverse effects linked to GCV

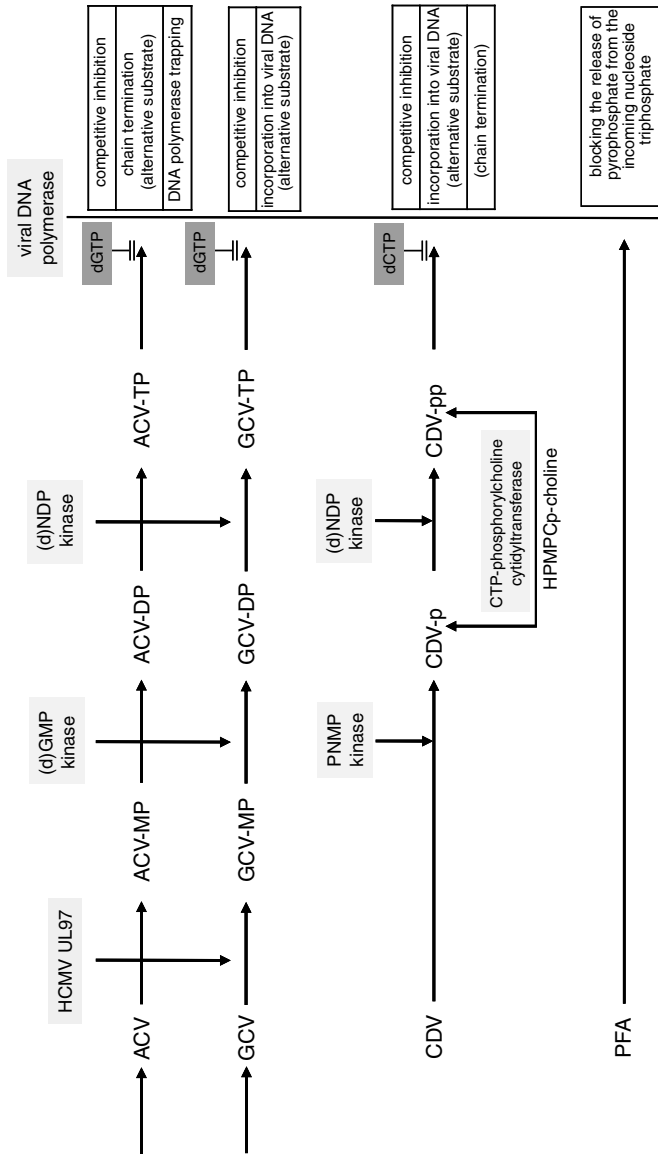

include hematologic abnormalities (mostly neutropenia, anemia, and thrombocytopenia), and probably long-term reproductive toxicity. In the case of CDV, nephrotoxicity is the major limitation of the drug. Concomitant administration of fluid (hydration) and probenecid is required to prevent kidney failure. Mineral and electrolyte abnormalities, as a result of renal impairment, are the main side effects observed in patients treated with FOS. Therefore, adequate hydration and frequent monitoring of serum creatinine levels are necessary in patients receiving FOS. The most frequent adverse effect observed in patients receiving fomivirsen is ocular inflammation (uveitis), which can be treated with topical corticosteroids.

### 10.2.3

#### Resistance to Anti-HCMV Antivirals

Prolonged treatment with anti-HCMV drugs is necessary to prevent or to manage HCMV disease in the immunocompromised population, which may result in the selection of HCMV strains with decreased drug susceptibility [22, 23]. GCV-resistant HCMV strains have been reported in 5–30% of immunocompromised patients treated for more than 2 months with GCV [24–26]. GCV-resistant HCMV infection had been described for years in AIDS patients and was originally thought to be rare in transplant recipients [27]. However, several cases of delayed-onset HCMV disease have been reported to be caused by GCV-resistant HCMV. Almost all described cases of GCV-resistant HCMV among SOT recipients have occurred in HCMV D + /R– patients [28–32]. GCV resistance has also been described in HSCT recipients treated

**Figure 10.2** Intracellular metabolism and mechanism of action of HCMV DNA polymerase inhibitors approved for the treatment of HCMV disease. Acyclic nucleoside analogues such as ACV and GCV need to be selectively phosphorylated intracellularly in three steps, to the triphosphate (TP) active forms. The first phosphorylation step to the monophosphate (MP) forms is carried out by the HCMV UL97 open reading frame that encodes for a phosphonotransferase. Therefore, the first phosphorylation is limited to virus-infected cells. Further phosphorylation to the diphosphate (DP) and triphosphate forms is carried out by cellular enzymes (i.e., dGMP kinase and nucleoside 5'-diphosphate (NDP) kinase). The triphosphate forms then inhibit the viral DNA polymerases acting as competitive inhibitors of dGTP binding and as alternative substrates and finally are incorporated into the growing DNA chain. In the case of ACV, the incorporation of ACV-TP to the viral DNA leads to termination of chain elongation and trapping

of the viral polymerase on the terminated DNA chain when the next deoxynucleoside triphosphate binds. Once inside the cells, the ANP cidofovir (CDV) needs to be activated by cellular enzymes. Pyrimidine nucleoside monophosphate (PNMP) kinase catalyzes the conversion of CDV to CDV-monophosphoryl (CDVp), which is then further phosphorylated to the active form, CDV-diphosphoryl (CDVpp) by NDP kinase. CDVp-choline is considered to serve as an intracellular reservoir for the mono- and diphosphoryl derivatives of CDV. The diphosphoryl derivative of CDV (i.e., CDVpp) interacts with the viral DNA polymerase as either competitive inhibitor (with respect to the natural substrates (i.e., dCTP)) or alternative substrates (thus leading to incorporation of CDVpp into DNA). For CDV, a hydroxyl function in the acyclic side chain allows further chain elongation, but chain termination occurs when two consecutive CDVpp are incorporated into the growing DNA chain.

with GCV and a few cases have been associated with encephalitis [33–35]. Development of drug resistance in the clinic is linked to disease progression, an aggressive clinical course, organ dysfunction, and mortality. In the first trial of VGCV versus oral GCV prophylaxis, no resistance was observed in the VGCV arm [36]; however, later reports showed that GCV-resistant HCMV is not negligible in CMV D + /R– SOT recipients who received VGCV prophylaxis [37, 38]. Also, Marfori *et al.* described the development of GCV-resistant HCMV infection after preemptive therapy with VGCV in HSCT recipients [39]. Other reports have confirmed that GCV-resistant HCMV still occurs in the VGCV era [40, 41].

Resistance to GCV is due to specific alterations in two different viral gene products, namely, pUL97 and the viral DNA polymerase (pUL54). Since the pUL97 is responsible for GCV monophosphorylation in HCMV-infected cells, changes in pUL97 confer resistance only to GCV. Therefore, either CDV or FOS can be used as alternative therapy for the treatment of GCV-resistant HCMV due to mutations in the pUL97. In contrast, mutations in the UL54 gene associated with GCV resistance confer cross-resistance to CDV. Thus, the only alternative in case of GCV resistance due to mutations in the viral DNA polymerase is treatment with FOS. However, cases of multidrug resistance to GCV, CDV, and FOS associated with mutations in the UL54 gene have been reported and no approved drugs are available to manage HCMV diseases linked to multidrug-resistant viruses [42].

### 10.3

#### Need for New Anti-HCMV Drugs

All available anti-HCMV drugs are limited by their toxic side effects, pharmacokinetic drawbacks, and resistance development. Moreover, the approved anti-HCMV drugs, except for fomivirsen, have a common target, the viral DNA polymerase. In addition, no anti-HCMV drug has been licensed for the treatment of congenital HCMV disease, which has an economic burden that exceeds 2 billion dollars annually in the United States of America [3]. VGCV has been used to treat infants with symptomatic congenital HCMV disease, but concerns on hematologic and reproductive toxicities limit the usefulness of the therapy to the most severely affected babies [43, 44]. Therefore, there is an urgent need to develop new orally bioavailable anti-HCMV compounds with a safer profile than the current anti-HCMV agents, a different molecular target from that of the licensed anti-HCMV drugs, or novel inhibitors of the viral DNA polymerase to avoid cross-resistance with the available anti-HCMV agents. Hence, considerable efforts have been made in the last few years to identify novel inhibitors of HCMV.

Combinatorial chemistry, high-throughput screening (HTS) that allows the evaluation of thousands of compounds, and structure-based drug design considering the crystal structure of viral proteins have boosted the research on novel anti-HCMV compounds. Novel classes of antiviral compounds able to target viral entry, viral transcription, viral protein synthesis and processing, viral genome replication, or viral maturation and egress have been identified. Moreover, a new strategy based on

the discovery of specific cellular targets required for viral replication has been developed.

## 10.4

### Novel Viral Targets

#### 10.4.1

##### Viral Entry Inhibitors

Today, prevention of virus entry represents an attractive alternative target for drug development. Herpesviruses use multiple proteins to induce fusion between the viral envelope and the target cell membrane; however, the molecular mechanisms involved in this fusion process are not completely understood yet. In the case of HCMV, fusion appears to involve  $\alpha$ -helical regions of the viral surface glycoproteins gB and gH [45, 46].

##### 10.4.1.1 $\beta$ -Peptides

$\beta$ -Peptides (i.e., oligomers of  $\beta$ -amino acids) (Figure 10.3), designed to mimic the gB heptad repeat, were shown to be able to inhibit viral entry [47]. The  $\beta$ -peptides are attractive unnatural scaffolds for mimicry of specific protein surfaces due to their ability to adopt predictable helical conformations and resist proteolysis. Mechanism of action studies indicated that the inhibitory  $\beta$ -peptides act by disrupting membrane fusion and are specific for HCMV [48], suggesting that  $\beta$ -peptides may be considered as a general platform for development of a new class of antiviral agents.

##### 10.4.1.2 Dendrimers

Dendrimer-base molecules have been recognized as having a large potential therapeutic applications [49, 50]. Dendrimers are highly branched macromolecules synthesized from a variety of polyfunctional cores in order to present multiple functional groups on the surface layer. Their hyperbranched structures enable a given molecular motif to be exposed in a highly multivalent fashion thus offering an efficient means of presenting multiple ligands, or sites of contact, on a single molecule. While the dendrimer core may vary, the surface functional groups in the antiviral dendrimers are represented by carbohydrates, anions, or peptides. Two peptide-derivatized dendrimers, that is, SB105 and its derivative SB105-A10 (Figure 10.3), showed a significant dose-dependent inhibitory effect on the infection of several HCMV strains (including GCV-resistant clinical isolates) [51]. Moreover, it appears that their antiviral activities are specific for herpesviruses since replication of both HCMV and murine cytomegalovirus (MCMV) as well as that of human herpes simplex virus type 1 (HSV-1) and type 2 (HSV-2) was inhibited, while negligible inhibition was observed for other families of viruses. SB105 and SB105-A10 inhibited the first phases of the HCMV replicative cycle. They lacked virucidal activity and they were shown to inhibit virus binding to heparan sulfate proteoglycans (HSPG). In fact,



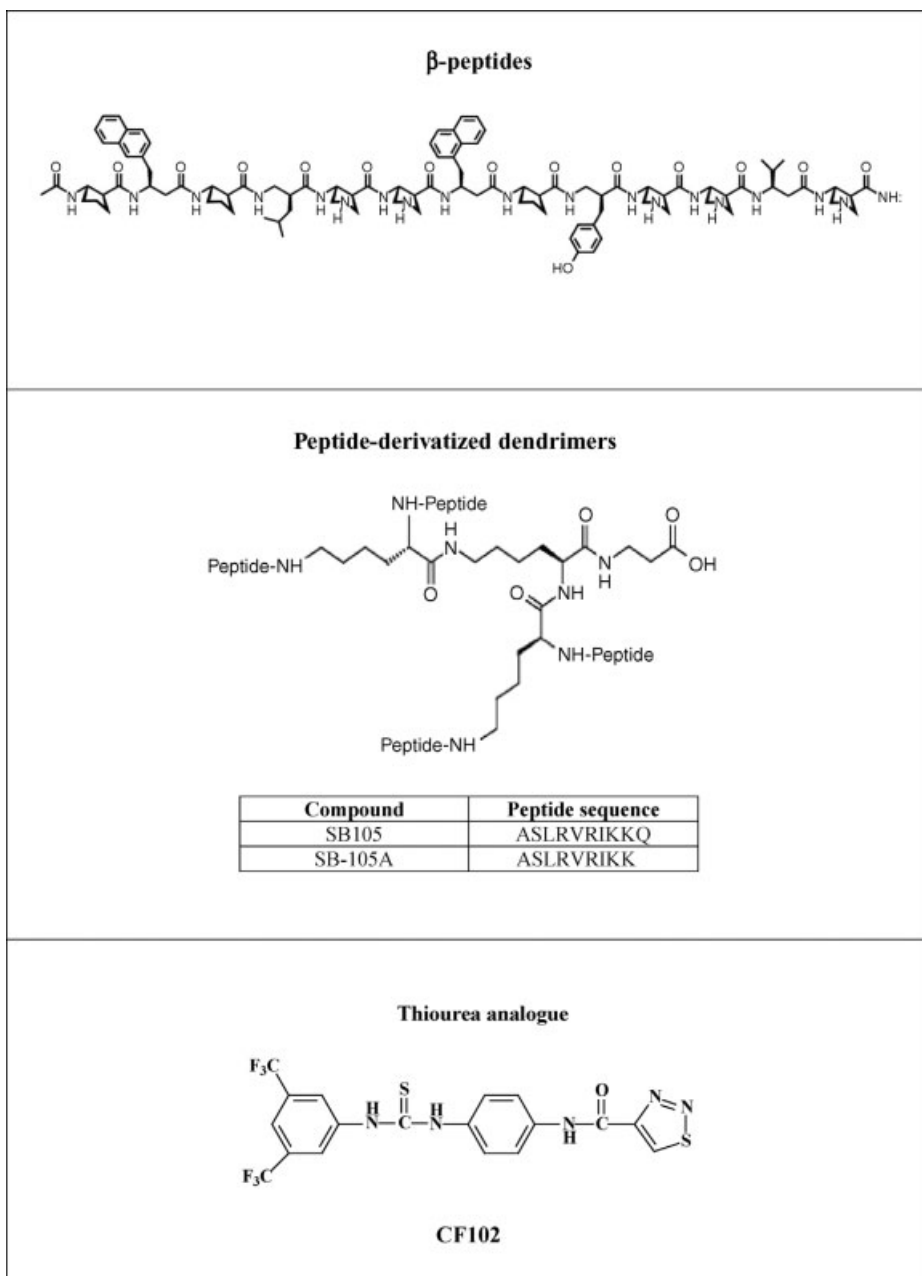

**Figure 10.3** Inhibitors of HCMV entry.

the SB105-A10 was shown to bind to human cells through an interaction with cell surface heparan sulfate and thereby blocked virion attachment to the target cells [52].

#### 10.4.1.3 Amphipathic DNA Polymers

Phosphorothioated oligonucleotides (PS-ONs) have a sequence-independent, broad-spectrum antiviral activity as amphipathic polymers (APs). They exhibit potent *in vitro* antiviral activity against a broad spectrum of herpesviruses, including HSV-1, HSV-2, HCMV, varicella-zoster virus (VZV), Epstein-Barr virus (EBV), and human herpesvirus 6 (HHV-6), and *in vivo* activity in a murine microbiocide model of genital HSV-2 infection [53–56]. Recently, the activity of these agents against MCMV and guinea pig cytomegalovirus (GPCMV) infections *in vitro* and *in vivo* was investigated [57]. *In vitro*, a 40 mer degenerate AP (REP 9) inhibited both MCMV and GPCMV with an IC<sub>50</sub> of 0.045 and 0.16 μM, respectively, and a 40 mer poly C AP (REP 9C) inhibited MCMV with an IC<sub>50</sub> of 0.05 μM. No data on anti-HCMV activity was reported in this study. In a murine model of CMV infection, systemic treatment for 5 days significantly reduced virus replication in spleens and livers of infected mice compared to saline-treated control mice. REP 9 and REP 9C were administered intraperitoneally for 5 consecutive days at 10 mg/kg, starting 2 days prior to MCMV infection. One of the limitations of the study was that the compounds were evaluated only prophylactically. The authors concluded that APs exhibit potent, well-tolerated antiviral activity against CMV infection *in vivo* and represent a new class of broad-spectrum antiherpetic agents.

#### 10.4.1.4 Thiourea Derivatives

CFI02, a novel thiourea small molecule (Figure 10.3), was identified as a result of the screening of a chemical library using a cell-based assay [58]. CFI02 proved to be a selective and potent inhibitor of HCMV without activity against other CMVs, α-herpesviruses, or unrelated viruses. CFI02 acts at a very early step in the HCMV replication cycle and inhibits virion envelope fusion with the plasma membrane. Mutants resistant to CFI02 bear mutations in the virus envelope glycoprotein gB that are sufficient to confer resistance. Furthermore, CFI02 was shown to inhibit cell–cell spread of HCMV.

#### 10.4.1.5 Phosphorothioate-Modified Oligonucleotides

Short synthetic oligodeoxynucleotides (ODNs) containing one or more unmethylated deoxycytidyl-deoxyguanosine (CpG) dinucleotides (CpG ODNs) can mimic bacterial and viral DNA to stimulate Toll-like receptors (TLRs) *in vitro* and *in vivo* and activate host immune responses [59, 60]. TLRs detect highly conserved pathogen-associated molecular patterns during an infection that provides an alarm signal to the innate immune system and stimulates the host to eliminate the pathogen. The efficacy of CpGs ODNs against a wide range of viral pathogens has been attributed to an indirect and secondary effect: induction of cytokines and inflammatory responses triggered through TLR9 activation. However, it has been shown by Lukanini *et al.* [52] that CpG ODNs have a direct anti-HCMV effect in both primary fibroblasts and endothelial cells. MCMV replication was inhibited as well, whereas no inhibition was observed for herpes simplex type 1 (HSV-1), adenovirus, or vesicular stomatitis virus. Inter-

estingly, the mode of inhibition of CpG ODNs was due to interference with viral entry into the cells as the antiviral activity of these ODNs was significantly reduced when they were added after virus adsorption. The B-class prototype CpG ODN 2006 effectively prevented the nuclear localization of pp65 and input viral DNA, suggesting inhibition of viral entry. The anti-HCMV inhibitory effect of these CpG ODNs was shown to be independent of the CpG motifs but related to the phosphorothioate backbone of the ODN.

#### 10.4.2

##### Inhibitors of Viral Genome Replication

Herpesviruses encode for different proteins necessary for viral DNA synthesis, that is, DNA polymerase, DNA polymerase accessory protein, terminase/helicase, and single-stranded DNA binding protein. Because these enzymes are virus specific, they are suitable targets for drug development and indeed significant efforts have been made to discover new drugs that target herpesvirus DNA replication.

##### 10.4.2.1 DNA Polymerase Inhibitors

Due to the success of licensed antiviral agents that target the viral DNA polymerase, the development of antiherpesvirus drugs that target this enzyme (including nucleoside and nonnucleoside inhibitors, and nucleotide analogues) remains still attractive.

##### Nucleoside Analogues

**Lobucavir** Lobucavir (LBV), <sup>®</sup>-9-[4-hydroxy-2-(hydroxymethyl)butyl]guanine (Figure 10.4a) is a cyclobutyl analogue of guanine with activity against most herpesviruses and also against HIV and HBV. LBV is a potent inhibitor of HCMV DNA polymerase *in vitro*. This nucleoside analogue is phosphorylated intracellularly into its triphosphate form in both infected and uninfected cells, the phosphorylated metabolite levels in HCMV-infected cells being only two- to threefold higher compared to uninfected cells [61]. LBV lacks a selective metabolism in virus-infected cells and it can be used as a substrate by host cell polymerases, thus increasing toxicity and safety risks. Despite promising results obtained in early clinical trials against HCMV and HBV, the development of LBV was halted due to safety concerns. An increase in the number of different cancers upon long-term administration of the drug was observed in toxicology studies in rodents.

**S2242** The 2-amino-7-[(1,3-dihydroxy-2-propoxy)methyl]purine (S2242) (Figure 10.4a) is the only known acyclic nucleoside analogue with the side chain substituted at the N<sup>7</sup> position of the purine ring that has antiviral activity. This acyclic purine nucleoside analogue has been reported to possess potent activity not only against several herpesviruses, including HSV, VZV, HCMV, EBV, HHV-6, human herpesvirus 7 (HHV-7), human herpesvirus 8 (HHV-8), but also against poxviruses [62–66]. Of special interest is the potent activity of the compound against HCMV and against TK-deficient mutants of HSV and VZV. S2242 is phosphorylated neither by HSV TK

nor by the HCMV-encoded UL-97 kinase [67]. It is a substrate for deoxycytidine (dCK) kinase and for deoxyguanosine (dGK) kinase and it was shown to be phosphorylated in a time- and concentration-dependent manner to its mono-, di-, and triphosphate forms [68]. S2242 appeared not to be preferentially phosphorylated in HSV-1-, VZV-, or HHV-6-infected cells. However, in HCMV-infected human embryonic lung cells, a 5–25-fold increase in S2242 metabolite formation was observed compared to noninfected cells, suggesting that an HCMV-encoded enzyme causes the specific phosphorylation of S2242. This acyclic nucleoside analogue proved to be more effective than ACV in different mouse models of HSV-1 infection and it was also far more effective than GCV in preventing or delaying murine cytomegalovirus-induced mortality in immunocompetent and SCID mice [69]. The development of this compound was stopped due to safety concerns.

**Methylenecyclopropane Analogues (e.g., Cyclopropavir)** Qiu *et al.* described the synthesis and antiviral activity of the original first generation of methylenecyclopropane analogues of purines and pyrimidines [70–72]. The first generation of methylenecyclopropanes can be regarded as bioisosteric analogues of ACV where the C–O–C moiety was replaced by the methylenecyclopropane moiety. The Z isomers

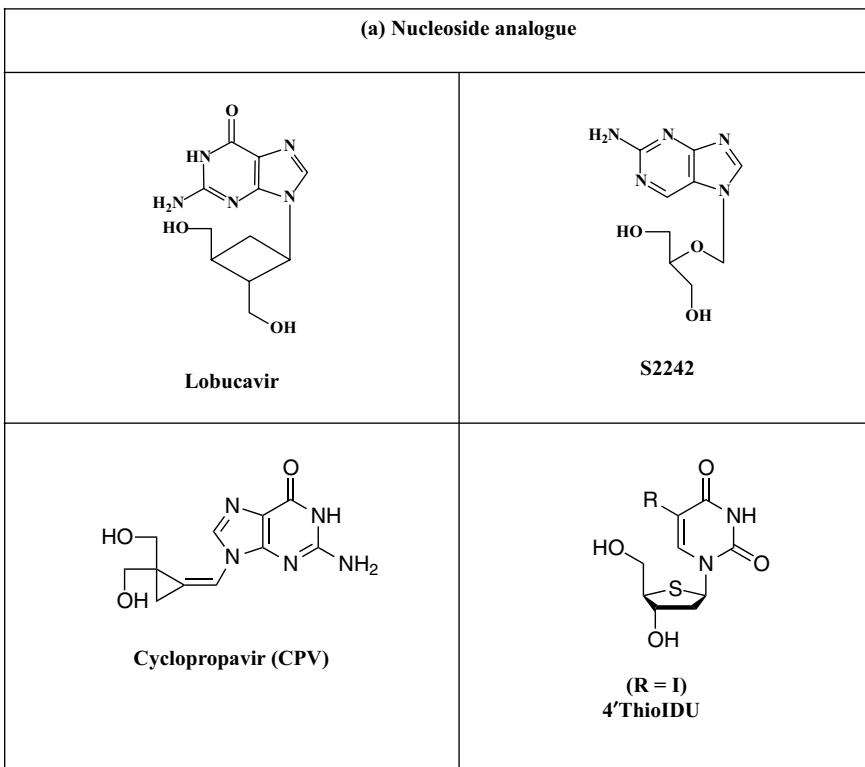

**Figure 10.4** DNA polymerase inhibitors.

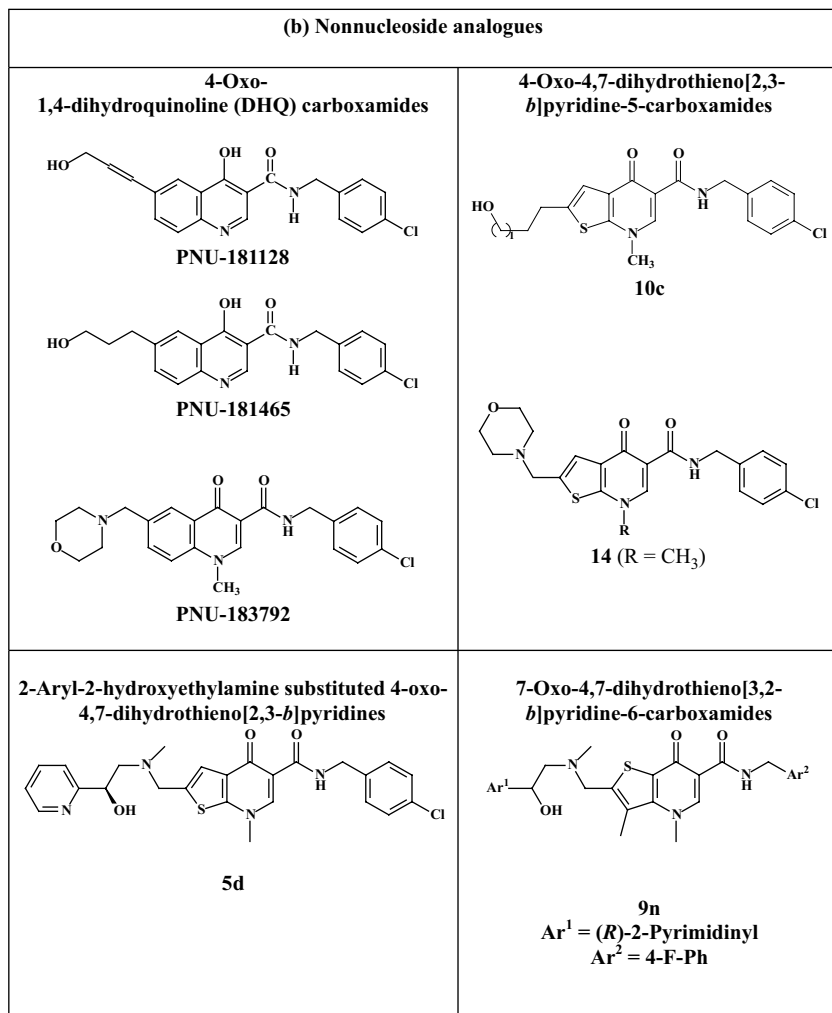

**Figure 10.4** (Continued)

of these analogues proved to be potent inhibitors of some members of the herpesvirus family, including HCMV, MCMV, rat CMV, guinea pig CMV, rhesus monkey CMV, HHV-6, and HHV-8 [73–77]. These methylenecyclopropane analogues were at least as active against HCMV as GCV [78–80]. Importantly, these compounds retained activity against GCV- and PFA-resistant HCMV isolates. Furthermore, some of these compounds significantly reduced mortality and virus replication in animal models of HCMV and MCMV [81].

In an attempt to improve the activity of these molecules and enhance oral bioavailability, a new series of methylenecyclopropane analogues, the 2,2'-bis-hydroxymethyl derivatives, were synthesized [82]. One member of this new series of



Mechanism-of-action studies with HCMV suggested that the methylenecyclopropane analogues are phosphorylated by the pUL97 phosphonotransferase, but it may be a substrate specificity different from that of GCV, and they are potent inhibitors of viral DNA synthesis [85].

The phosphate derivative of CPV was reported to be an effective prodrug of the parent compound, although the pattern of antiviral activity of the cyclic phosphate was different since it also exhibited potent activity against hepatitis B virus [86]. Mhaske *et al.* investigated the *Z*- and *E*-phosphonate analogues derived from CPV and the corresponding cyclic phosphonates [87]. The *Z*-phosphonates were effective inhibitors of replication of wild-type strains of HCMV and MCMV replication, and they also inhibited HCMV with mutations in the UL97 gene. The *E*-isomers were devoid of antiviral activity. Following the example of *L*-valine prodrugs of antiviral nucleoside analogues, the *L*-valine ester of CPV (valcyclopropavir) was synthesized, which was able to inhibit HCMV replication to approximately the same extent as the parent drug CPV [88]. The prodrug valcyclopropavir appeared to offer some improved therapeutic parameters over the parent compound with an oral bioavailability of 95% in mice.

Preclinical pharmacokinetic, toxicokinetic, and toxicologic results for CPV in rats and dogs demonstrated a very acceptable margin of safety for the advancement of CPV into human phase I clinical studies [89]. Microbiotix Inc. has completed an Investigational New Drug (IND) application for CPV enabling preclinical toxicology and safety pharmacology studies.

**5-Substituted 4'Thiopyrimidine Nucleosides** In 1991, Secrist *et al.* described a series of 2'-deoxy-4'thiopyrimidine nucleosides with activity against HCMV [90]. Other related analogues were reported to have good activities against VZV and HSV [91]. One of these analogues, 5-iodo-4'-thio-2'-deoxyuridine (4'-thioIDU) (Figure 10.4) also exhibited activity against HCMV. A UL97 protein kinase null mutant was found to be fully susceptible to 4'-thioIDU, indicating that the compound does not require activation by the UL97 kinase. However, three isolates bearing mutations in the viral DNA polymerase were resistant to the compound, suggesting that 4'thioIDU targets the viral DNA polymerase and that point mutations in this enzyme conferring resistance to GCV or PFA may also confer resistance to 4'-thioIDU [92].

**Nonnucleoside Analogues** By using an *in vitro* HCMV DNA polymerase assay in high-throughput screening, a novel class of nonnucleoside herpesvirus polymerase inhibitors, the naphthalene-carboxamides, were identified. PNU-26370 emerged as the lead compound of this series of nonnucleoside DNA polymerase inhibitors [93, 94]. Structure–activity relationship (SAR) studies demonstrated that a quinoline ring could be substituted for naphthalene, leading to the discovery of the 4-oxo-dihydroquinoline-3-carboxamides (4-oxo-DHQ), represented by PNU-181128, PNU-181465, and PNU-183792 (Figure 10.4b), which proved inhibitory toward HCMV, HSV, and VZV polymerases [95, 96]. The compounds showed high specificity for the viral polymerases compared to human alpha ( $\alpha$ ), gamma ( $\gamma$ ), and delta ( $\delta$ ) polymerases. PNU-183792 displayed a broad-spectrum activity in cell culture against different herpesviruses, including HSV-1, HSV-2, VZV simian varicella virus,

HCMV, murine and rat cytomegaloviruses, EBV, and HHV-8 (Kaposi-associated herpesvirus), the exceptions being HHV-6 and HHV-7 [97]. PNU-183792 was inactive against unrelated DNA or RNA viruses, pointing to the specificity for herpesviruses. Due to the strong correlation between inhibition of viral DNA polymerase activity and antiviral activity of this class of compounds, the mechanism of antiviral action was attributed to the inhibition of the viral polymerase. The 4-oxo-DHQs were found to be competitive inhibitors of nucleoside binding; however, no cross-resistance could be detected with GCV-resistant HCMV or ACV-resistant HSV mutants. The *in vitro* antiviral activity of the 4-oxo-DHQs was comparable or superior to the existing antiherpesvirus drugs, and drug resistance to these compounds correlated with point mutations in the conserved domain III of the HCMV DNA polymerase (V823A + V824L) [98]. The position V823 is conserved in the DNA polymerases of human herpesviruses, except for HHV-6 and HHV-7 that contain an alanine at this position. The mutations associated with resistance to 4-oxo-DHQs did not confer resistance to existing antiherpesvirus nucleoside analogues. On the basis of the crystal structure of the HSV DNA polymerase, Liu *et al.* proposed an HSV DNA polymerase model, suggesting that the 4-oxo-DHQs binds at the polymerase active site interacting noncovalently with the DNA duplex–DNA polymerase complex and not with the enzyme or the DNA duplex alone [99]. PNU-183792 is orally bioavailable and proved active in a model of lethal MCMV infection [100].

Schnute *et al.* identified a novel series of 4-oxo-4,7-dihydrothieno[2,3-*b*]pyridine-5-carboxamides as potential antivirals against human herpesvirus infections, including HCMV, VZV, and HSV. In the 4-oxo-4,7-dihydrothienopyridines (DHTPs), the quinolone ring of the 4-oxo-DHQ was replaced by the thieno[2,3-*b*]pyridine ring [101]. Among these nonnucleoside analogues, compounds **10c** and **14** (Figure 10.4b) demonstrated broad-spectrum inhibition of herpesvirus polymerases HCMV, VZV, and HSV-1 [102], with high specificity for the viral polymerases compared to human  $\alpha$  polymerase. The antiviral activity of **10c** and **14** was comparable or superior to that of the existing antiherpesvirus drugs. Drug resistance to compound **14** was associated with point mutations in the conserved region III of the herpesvirus DNA polymerase, but they did not confer resistance to reference nucleoside analogues. In contrast to the kinetics determined for the 4-oxo-DHQs, DHTPs proved to be competitive inhibitors of dTTP incorporation into the primer template by HCMV DNA polymerase [103].

Further SAR studies led to the discovery of compound **5d** (Figure 10.4b) that demonstrated broad-spectrum inhibition of the herpesvirus polymerases HCMV, HSV-1, EBV, and VZV. This compound was selected for advanced clinical development [104]. Later on, the 7-oxo-4,7-dihydrothieno[3,2-*b*]pyridine-6-carboxamides were synthesized [105], leading to the identification of compound **9n** (Figure 10.4b) that exhibited an antiviral activity equivalent to compound **5d** but had better solubility and markedly improved hERG (human ether-á-go-go-related gene) profile. hERG potassium channel blockage is considered to be a significant cardiovascular risk factor when selecting compounds for advanced development [106].

Despite promising results *in vitro*, these nonnucleoside DNA polymerase inhibitors have not been evaluated for any herpesvirus indication in clinical trials.



## Nucleotide Analogues

**Esters of Acyclic Nucleoside Phosphonates** Because of the limitations associated with the use of cidofovir, that is, poor oral bioavailability and renal toxicity, alkoxyalkyl esters of CDV and of its cyclic form (cCDV) have been synthesized [107, 108]. In these prodrugs, a natural fatty acid (lysophosphatidylcholine) molecule is used as a carrier to facilitate drug absorption in the gastrointestinal tract. Different alkoxyalkyl esters (i.e., hexadecyloxypropyl (HDP) and octadecyloxyethyl (ODE)) of CDV and cCDV proved much more active *in vitro* than the parent compounds against several herpesviruses, including HSV, VZV, CMV, EBV, HHV-6 and HHV-8, and poxviruses. *In vitro*, a 2.5–4 log increase in antiviral activity against HCMV replication was observed. In addition to herpes- and poxviruses, the increased activity of alkoxyalkyl esters of CDV compared to the parent compound CDV was also shown against adenovirus, polyomavirus, and papillomavirus [109–111].

The alkoxyalkyl ester derivatives of CDV showed improved uptake and absorption, and had 88–97% oral bioavailabilities in mice, compared to less than 5% for CDV. Increased cell penetration (10–20-fold) and higher intracellular levels (100-fold) of CDV-DP (the active form of the compound) than those measured following treatment of the cells with CDV were confirmed in studies using radiolabeled compound [112]. *In vivo*, oral administration of the hexadecyloxypropyl-CDV (HDP-CDV) (Figure 10.4c) proved as effective as the parental compound CDV in the treatment of herpes- and poxvirus infections in several mouse models [113–117]. Importantly, diminished accumulation of the drug in the kidney was reported according to studies evaluating tissue distribution of radiolabeled HDP-CDV and other alkoxyalkyl esters of CDV in mice [118, 119]. Thus, these prodrugs are supposed to avoid the dose-limiting toxicity of CDV.

HDP-CDV (CMX001), an oral formulation of CDV, is being developed both for prevention and treatment of smallpox and for various double-stranded DNA virus infections by Chimerix. A phase I clinical study to evaluate the safety and pharmacokinetics of orally administered CMX001 in healthy volunteers showed dose-proportional  $C_{max}$  and AUC with single doses [108, 120]. Plasma concentrations of CMX001 in normal volunteers were as much as 20-fold higher than those observed in animals at comparable doses per kg of body weight. At present, Chimerix is conducting a phase 1 clinical trial of multidose CMX001 in transplant recipients with polyoma BK viruria and a phase 2 clinical trial of CMX001 in immunocompromised patients with HCMV.

A similar prodrug strategy was applied to other ANPs, such as (S)-HPMPA, the enhancement of antiviral potency being similar to that of CDV [121–125]. Thus, the HDP ester of (S)-HPMPA showed 40–270-fold increase in anti-CMV activity *in vitro* compared to the parent compound. The HDP derivatives of PME analogues of diaminopurine (PMEDAP) and of  $N^6$ -cyclopropyldiaminopurine (PME- $N^6$ -cPr-PME-DAP) also showed increased anti-HCMV *in vitro* [108].

**New Generations of Acyclic Nucleoside Phosphonates** The discovery of ANPs represented a breakthrough in the treatment of DNA viruses and retroviruses [126, 127]. According to their activity spectrum, the first generation of ANPs can be classified

into three categories: (i) the “HPMP” derivatives represented by HPMP (CDV), which displays activity against a broad variety of DNA viruses, and (ii) the “PME” derivatives, represented by PMEA (adefovir) with activity against retro-, hepadna-, and herpesviruses, and (iii) the “PMP” derivatives, represented by PMPA (tenofovir) active against retro- and hepadnaviruses. These three compounds have been licensed for the treatment of HCMV retinitis in AIDS patients (cidofovir, Vistide), chronic hepatitis B virus infections (adefovir dipivoxil, Hepsera<sup>®</sup>, the oral prodrug form of adefovir), and HIV infections (tenofovir disoproxil fumarate, Viread<sup>®</sup>, the oral prodrug form of tenofovir). Following the success of this first generation of ANPs, two new generations have been described. The “second-generation” ANPs include the “open ring” or “O-linked” ANP analogues or 6-[2-phosphonomethoxyalkoxy]-2,4-diaminopyrimidines (DAPys), which showed substantial potential for the treatment of a broad range of DNA virus and retrovirus infections [128–131]. HPMP-O-DAPy presented a spectrum of activity similar to that of HPMP except for HCMV that was poorly inhibited. The “third generation” of ANPs encompasses HPMP derivatives with a 5-azacytosine moiety such as HPMP-5-azaC (Figure 10.4c) and its cyclic form (i.e., cHPMP-5-azaC) [132]. These compounds were at least as potent as the parent compounds against several DNA viruses, including HCMV. Furthermore, HPMP and HPMP-5-azaC proved equally potent in pathogenic models of HSV and poxvirus infections in mice. Among several prodrugs of cHPMP-5-azaC synthesized, the hexadecyloxyethyl ester (Figure 10.4c) proved to be about 250-fold more active than the parent compound [133]. Further studies are needed to determine the clinical potential of these compounds to become new drug candidates to treat HCMV infections.

#### 10.4.2.2 Helicase/Primase Inhibitors

**Nitropyrimidines** The helicase/primase complex of HCMV consists of three interacting proteins: the helicase UL105, the primase UL70, and the cofactor protein UL102. So far, only a few inhibitors of HCMV UL70 primase have been reported [134]. A specific HCMV inhibitor, that is, T-0902611 (Figure 10.5) that covalently modifies the primase component of the helicase/primase complex in DNA replication, has

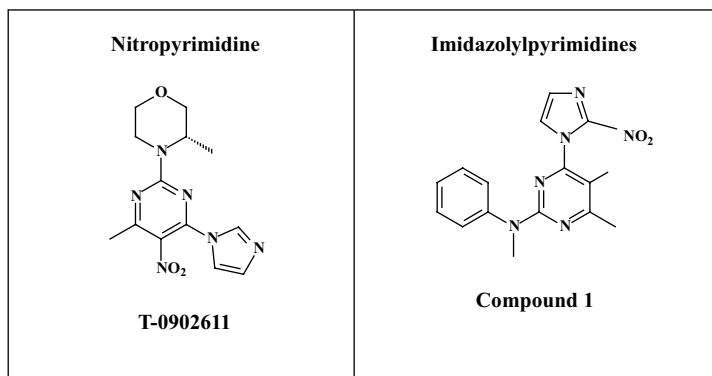

**Figure 10.5** Helicase/primase inhibitors.

been described [135, 136]. This compound had 30-fold better activity against HCMV isolates than GCV in cell culture. T-0902611 entered phase I and II clinical trials in AIDS patients and transplant recipients, but did not progress further and its development has been halted [134].

**Imidazolyl-Pyrimidines** A novel class of imidazolyl-pyrimidines (Figure 10.5) has been shown to be able to selectively and irreversibly bind to HCMV UL70 primase, resulting in the blockage of HCMV replication and infection [137, 138]. Drug-resistant virus cultivated in the presence of the lead compound carried a single point mutation in the viral primase (P571S amino acid change). The thiol group of the cysteine 570 of the UL70 primase was suggested to act as a nucleophile that attacks the imidazolyl-pyrimidines with displacement of the imidazole moiety, resulting in the formation of a covalent link between the target enzyme and the drug and rendering the primase inactive. Detailed SAR studies of this series of CMV inhibitors have been carried out. Orally bioavailable compounds with anti-HCMV activity in both viral yield and viral DNA replication assays have been identified. These compounds show reduced cytotoxicity compared to that of GCV and CDV [139]. As these compounds possess an original mechanism of action, they may have the potential to become a novel therapeutic approach for HCMV infection.

#### 10.4.2.3 Inhibitors of Protein–Protein Interactions

Protein–protein interactions among proteins involved in herpesvirus DNA replication are essential for viral genome replication. Inhibition of these interactions are considered attractive potential drug targets [135]. Similar to other herpesviruses, the HCMV DNA polymerase contains a catalytic subunit (UL54) and an accessory protein (UL44) that is thought to increase the processivity of the enzyme. Peptides from the C-terminus of the UL54 were identified that could efficiently disrupt the physical interaction between UL54 and UL44 and specifically inhibit stimulation of UL54 by UL44 [140]. These findings provided the basis for developing new classes of anti-HCMV inhibitors that act by disrupting the UL54/UL44 interaction. Recently, five compounds (Figure 10.6), from a high-throughput screening using 50 000 small molecules, were identified as selective anti-HCMV agents that disrupt the interaction between UL44 and the C-terminal 22 residues of UL54 [136, 141]. These compounds were able to interfere with the physical interactions of UL54 and UL44 *in vitro* and also inhibited HCMV replication with submicromolar to low micromolar potency, and at concentrations up to 500-fold lower than those at which they exhibited toxicity. These small molecules represent an interesting starting point for the design of new specific anti-HCMV agents. Rational structural modifications of these compounds could be based on the crystal structures of both UL44 alone and UL44 bound to a UL54 C-terminal peptide.

One approach to specifically interfere with protein–protein interactions is the recently developed peptide aptamer technology [142]. Peptide aptamers consist of short random peptide sequences that are displayed on the surface of an inert scaffold protein, resulting in a constrained conformation of the molecules [143]. Due to their ability to specifically bind to and inactivate a given target protein at the intracellular

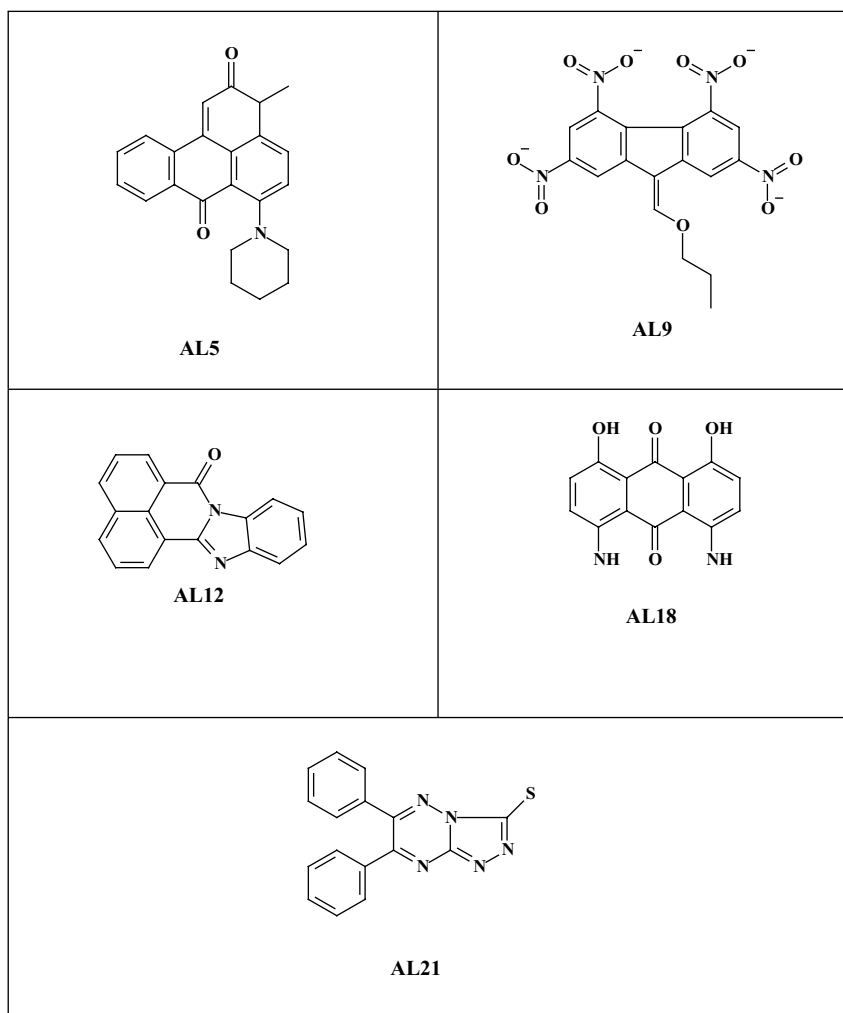

**Figure 10.6** Protein–protein interaction inhibitors.

level, they represent a powerful method to inactivate protein functions *in vitro* and *in vivo* [144]. Kaiser *et al.* [145] demonstrated the ability of selected peptide aptamers directed against the nonconventional nuclear localization signal (NLS) of the essential viral replication factor pUL84 to inhibit HCMV replication. Factor pUL84 was proposed to act as an initiator protein for viral DNA synthesis of HCMV. The pUL89 is able to interact with several viral proteins, including the viral transactivator IE2-p86, the viral DNA polymerase accessory protein pUL44, and the tegument protein pp65 [146]. Also, pUL84 binds with high affinity to  $\alpha$ -importin proteins, thus using the cellular importin- $\alpha/\beta$  pathway for nuclear translocation [147]. Because herpesvirus replication occurs in the nucleus, this interaction is a prerequisite for

pUL84 to initiate viral DNA replication. Since pUL84 uses a nonconventional NLS to bind to importin- $\alpha$  proteins via a domain that differs from the binding pocket for cellular proteins containing classical NLS motifs, inhibition of the nonconventional NLS of pUL84 emerges as a new anti-HCMV target. Indeed, peptide aptamers directed against the nonconventional NLS of pUL84 were able to interfere with the nuclear import of pUL84 and resulted in a decreased viral replication [145].

### 10.4.3

#### Viral Gene Expression Inhibitors

##### 10.4.3.1 Small Interfering RNAs

RNA interference (RNAi) is a natural mechanism of posttranscriptional gene silencing, widely conserved in multicellular organisms. This pathway is thought to be an ancient mechanism for protecting the host and its genome against viruses and transposable genetic elements [148]. The molecular mediators of RNAi are double-stranded RNAs of 21–23 nucleotides in length that induce the sequence-specific degradation of homologous RNAs. RNAi has been used as a means both to experimentally manipulate gene expression and to probe gene function, and it has also been proposed that this biological response might be exploited therapeutically as an antiviral defense mechanism. The small interfering RNA (siRNA) approach has been shown to be effective against a variety of viruses in cell culture [149–151]. Recently, it has been described that synthetic siRNA against essential gene products of HCMV such as UL54 (DNA polymerase) and UL97 (protein kinase) can trigger RNAi in infected cells leading to effective inhibition of viral replication [152, 153]. These results demonstrate the effectiveness of siRNAs against experimental HCMV infection and opens new possibilities for antiviral strategies.

### 10.4.4

#### Inhibitors of Virion Assembly and Egress

The maturation of herpesviruses is a multistep process that has been characterized only partially. The translocation of concatemeric viral DNA into procapsids, its cleavage at packaging sites, and the packaging of the viral DNA into procapsids, are processes carried out by specific virus-encoded enzymes representing specific targets for antiviral therapy. Since mammalian DNA does not undergo comparable maturation steps, compounds targeting viral assembly and egress may be expected to have an excellent selectivity.

##### 10.4.4.1 Inhibitors of DNA Cleavage/Packaging

**Phenylenediamine Sulphonamides (i.e., BAY 38-4766)** Phenylenediamine sulphonamides, a novel class of nonnucleoside inhibitors, were shown to specifically block the cleavage and packaging of HCMV DNA into capsids [154]. BAY 38-4766, 3-hydroxy-2,2-dimethyl-*N*-[4([[5-(dimethylamino)-1-naphthyl]sulfonyl]amino)-phenyl]propanamide (Figure 10.7a), emerged as the lead compound of this new class of anti-HCMV

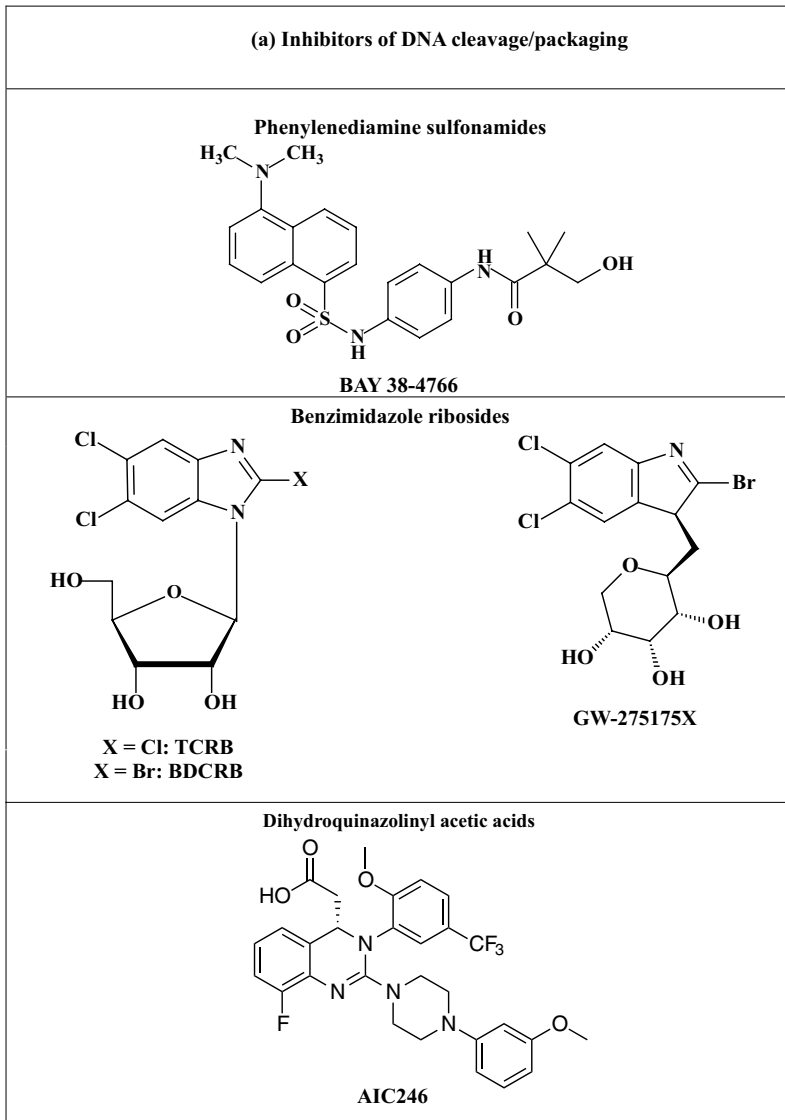

**Figure 10.7** Inhibitors of virion assembly and egress.

agents. This compound and its structural analogues inhibited neither viral DNA synthesis nor viral transcription or translation, but instead they did hinder both concatemer processing and functional cleavage at intergenomic transitions, pointing to interference with viral maturation and packaging of monomeric genome lengths. Mutations conferring resistance to these compounds have been mapped to the

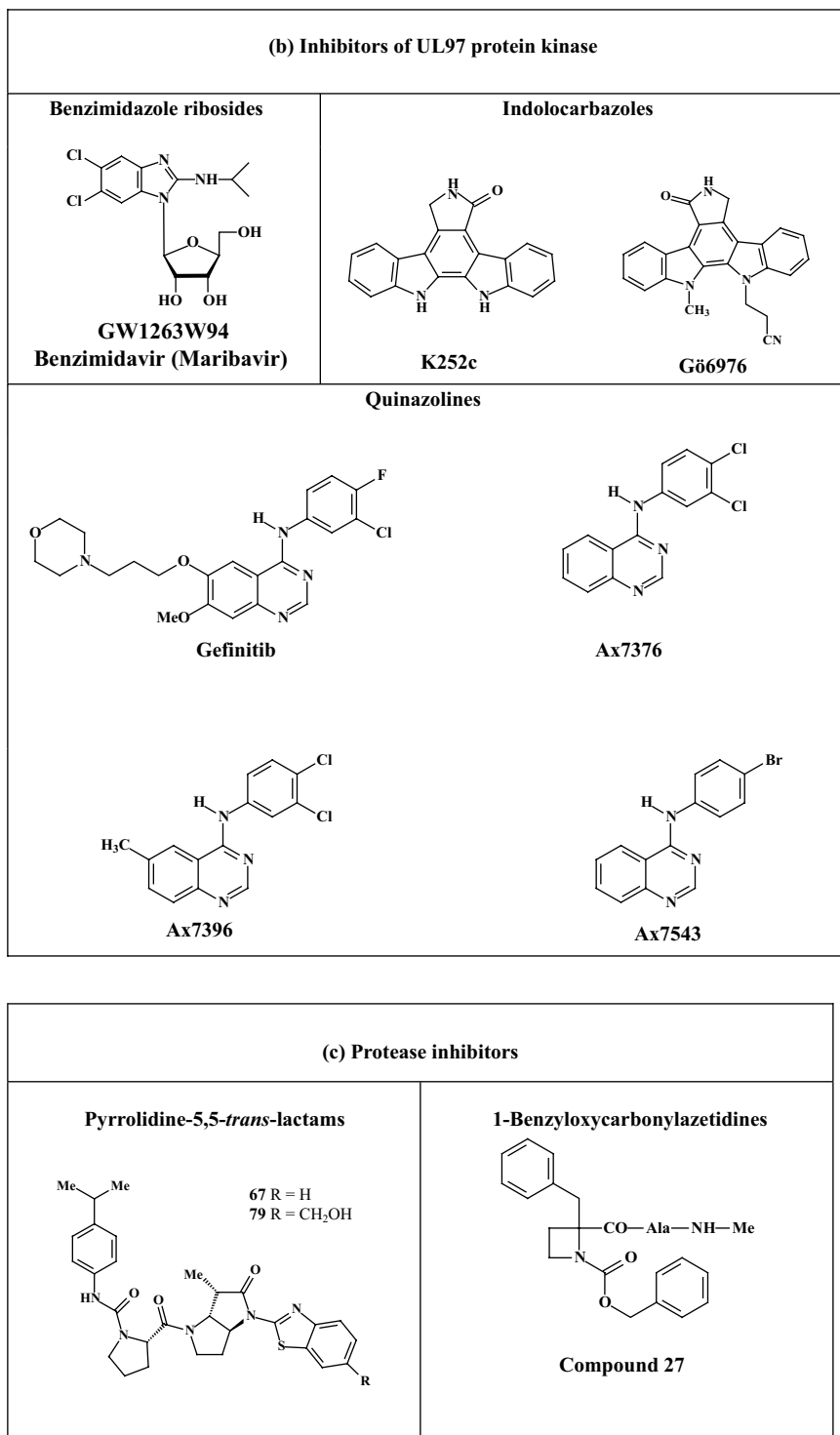

Figure 10.7 (Continued)

HCMV UL56 and UL89 genes whose products function as the HCMV terminase [155]. The HCMV terminase is composed of two subunits, the large one encoding pUL56 and the small pUL89, each of them having a different function: the large subunit mediates sequence-specific DNA binding and ATP hydrolysis and the pUL89 subunit is required for duplex nicking [156].

BAY 38-4766 was shown to inhibit not only HCMV strains, including viral mutants resistant to available anti-HCMV drugs, but also monkey and rodent cytomegaloviruses. In a murine cytomegalovirus pathogenicity model in mice, this compound demonstrated good antiviral activity and excellent tolerability [157, 158]. Furthermore, favorable pharmacokinetic data of BAY 38-4766 and of its main metabolite in mice, rats, and dogs, and excellent safety, tolerability, and pharmacokinetic data after single oral doses in healthy male subjects, were reported. Despite these promising data, clinical development of BAY 38-4766 was not further pursued.

**Benzimidazole Ribosides (i.e., BDCRB, TCRB, and GW273175X)** In 1995, 2-bromo-5,6-dichloro-1- $\beta$ -D-ribofuranosyl benzimidazole (BDCRB) and the 2-chloro analogue thereof (2,5,6-trichloro-1-( $\beta$ -D-ribofuranosyl)benzimidazole, TCRB) (Figure 10.7a) were shown to be potent and selective inhibitors of HCMV replication [159]. The benzimidazole ribosides represent another unique class of compounds that have been shown to prevent the cleavage of high molecular weight viral DNA concatemers to monomeric genomic lengths [160]. Resistance to BDCRB has been mapped to the HCMV UL89 open reading frame (ORF), whose product is involved in the viral DNA concatemer cleavage process [161]. Further investigations on the mode of action of the benzimidazole ribosides revealed that mutations in strains that are resistant to TCRB mapped in the UL89 and UL56 ORF [162], both gene products being responsible for the cleavage of viral high molecular weight DNA before packaging of the unit-length viral DNA into procapsids.

An important role during the process of viral DNA packaging is played by portal proteins. Portal proteins are large macromolecules and are found throughout herpesviruses and double-stranded bacteriophages examined to date. Portal proteins provide not only the channel for entry of the DNA during packaging but also the exit for releasing DNA during infection [163]. The putative HCMV portal protein pUL104 has been shown to directly interact with the large subunit of the viral terminase complex, that is, pUL56, and, interestingly, BDCRB was able to block this interaction [164]. These results indicated that BDCRB blocks the insertion of the DNA into the capsid by preventing a necessary interaction of pUL56 with the portal protein. Further SAR studies allowed the identification of other benzimidazole ribosides such as GW275175X (Figure 10.7a) with improved pharmacokinetic properties and reduced protein binding. GW275175X presented activity against HCMV and not against other herpesviruses. Mode-of-action studies supported inhibition of viral cleavage and packaging, similar to BDCRB. As expected, viruses with the BDCRB- and TCRB-resistant mutations in UL89 were cross-resistant to GW275175X [165]. This compound entered phase I clinical trials and no drug-related or clinically significant changes from baseline were seen in vital signs, ECG, or clinical laboratory values, with all adverse events considered as mild. GW275175X had several advan-



tages (such as better CNS penetration, longer plasma half-life, and reduced protein binding) over the parent BDCRB and maribavir. However, further clinical development of GW275175X was discontinued because of sponsor's decision to proceed with the other benzimidazole riboside maribavir.

**Dihydroquinazolinyl-Acetic Acids (i.e., AIC246)** Dihydroquinazolinyl-acetic acids were identified as novel anti-HCMV compounds by HTS of a compound library. Hit-to-lead optimization activities, including extensive structure–activity relationship studies and pharmacological analysis, led to the discovery of AIC246 (Figure 10.7a) [166]. This compound showed excellent *in vitro* inhibitory activity both against HCMV laboratory strains and clinical isolates ( $IC_{50} \sim 0.005 \mu M$ ) and against GCV-resistant viruses. AIC246 appeared to be well tolerated in different cell types (median selectivity index, 18 000) and its inhibitory effect was shown to be reversible. Drug efficacy was not significantly affected by cell culture variations such as cell type or multiplicity of infection. Mode-of-action analysis revealed that AIC246 targets a process in the viral replication cycle that occurs later than DNA synthesis, and time of addition studies indicated that it might interfere with capsid assembly, DNA processing/packaging, or virus egress. The point of action of AIC246 coincided with that of the compound BAY 38-4766, raising the possibility of a common target. However, since the maturation of herpesviruses is a linked, multistep process that has been characterized only partially, it is conceivable that AIC246 targets other late processes. The isolation and characterization of AIC 246-resistant mutants is in progress in order to identify the exact target for its anti-HCMV activity. AIC246 showed a potent efficacy in a mouse xenograft model. The compound was administered per os starting 4 h after transplantation of HCMV-gelfoam implants for 9 days. AIC246 treatment (at doses of 1, 3, 10, 30, or 100 mg/(kg day)) led to a dose-dependent reduction of the HCMV titer in transplanted cells compared to that of the placebo-treated control group. Phase I trials were initiated and demonstrated that the drug has a favorable pharmacokinetic profile and is safe and generally well tolerated. Consequently, AIC246 is under evaluation in phase II studies as an oral therapeutic for the treatment of HCMV in transplant recipients [166, 167].

#### 10.4.4.2 UL97 Protein Kinase (pUL97) Inhibitors

**Benzimidazole Ribosides (i.e., Maribavir)** SAR studies performed to improve the pharmacokinetics of the benzimidazole ribosides led to the synthesis of maribavir (1-( $\beta$ -L-ribofuranosyl)-2-isopropylamino-5,6-dichlorobenzimidazole, GW1263W94, and benzimidavir) (Figure 10.7b). Maribavir can be considered as the L-counterpart of BDCRB with, additionally, the bromide being replaced by an isopropylamine moiety. Remarkably, maribavir has a very different target from the other benzimidazole ribosides.

Treatment of HCMV-infected cells with maribavir resulted in inhibition of viral DNA synthesis and interference with viral nucleocapsid egress from the nucleus reducing the production of infectious virus [168]. This molecule was found to specifically inhibit the HCMV protein kinase UL97 (pUL97), and indeed drug-

resistant mutations map to the UL97 gene [169, 170]. UL97 mutations that confer resistance to the compound have been identified at codons 353, 397, 409, and 411 [171]. These residues are located upstream of the GCV-resistance mutations (i.e., 460, 520, 590–607), close to the ATP binding and catalytic domains common to all kinases, which is in agreement with maribavir acting as a small ATP-competitive kinase inhibitor. Until now, no UL97 mutations are known to confer resistance to both GCV and MBV.

Direct protein kinase inhibition studies showed that maribavir is able to inhibit pUL97 phosphorylation [172]. Further studies using a UL97 null mutant, which is severely deficient in viral replication, confirmed that maribavir inhibits replication by directly affecting a pUL97-dependent step in viral replication [173]. The HCMV pUL97 has been characterized as a serine/threonine kinase that is autophosphorylated and is capable of phosphorylating GCV. Its biological function is the phosphorylation of its natural viral and cellular protein substrates affecting viral replication at many levels [174]. Following fusion of the virus particle with the cell membrane, the tegument proteins (including pUL97) are released into the host cell. pUL97 is also expressed early in infection and phosphorylates a number of cellular and viral proteins considered to be natural substrates of the kinase. The HCMV polymerase accessory protein, pUL44, was found to be a substrate for the pUL97 kinase, which explains inhibition of viral DNA synthesis by maribavir [175]. The HCMV pp65 tegument protein is also phosphorylated directly by the purified pUL97 enzyme and the two proteins were shown to interact physically. The pp65 was shown to be required for the incorporation of other viral proteins into the virus particle and thus is involved in the protein–protein interaction network leading to normal tegument formation. In this way, the kinase contributes to virion morphogenesis [176].

pUL97 also phosphorylates several cellular proteins: eukaryotic elongation factor 1delta (resulting in enhanced expression of viral genes) [177], the carboxyl terminal domain of the large subunit of RNA polymerase II (leading to activation of protein synthesis) [178], the retinoblastoma tumor suppressor (stimulating cell cycle progression to support viral DNA synthesis) [179], and lamins A and C (facilitating the egress of nuclear capsids from the nucleus) [180]. In the absence of pUL97 kinase activity, viral DNA synthesis is inefficient and structural proteins are sequestered in nuclear aggresomes, reducing the efficiency of virion morphogenesis. As reported by Wolf *et al.*, the pUL97 kinase has an impact on at least two distinct phases of viral replication: DNA synthesis as well as capsid assembly and nuclear egress, indicating that protein phosphorylation mediated by this kinase increases the efficiency of these two phases of virus replication [181].

The pUL97 inhibitory effect of maribavir is predicted to impair the phosphorylation of GCV, and indeed it was recently reported that maribavir antagonizes the antiviral action of GCV [182]. Additional studies with *in vitro*-generated mutants revealed that mutations conferring resistance to maribavir also map to the HCMV UL27 gene [183]. Most resistant strains isolated in the laboratory do not have mutations in UL97, but rather map to the UL27 open reading frame. In contrast to

UL97 mutants that show moderate to high levels of resistance to maribavir, the UL27 mutants display low level of resistance to the drug. The UL27 protein has no reported function, today. Chou has performed studies with mutations that interrupt the expression of UL27 and analyzed the evolution of similar UL27 mutations in genetically UL97-deficient viruses without maribavir exposure. The results indicated that these mutations are due to an adaptation to the loss of pUL97 kinase activity rather than due to the possibility that UL27 acts as an independent antiviral target for maribavir [184].

Maribavir differs from the earlier benzimidazoles not only in the mechanism of action but also in the spectrum of antiviral activity. Maribavir inhibits both HCMV and EBV, but not other herpesviruses, in cell cultures. It was about 10-fold more potent against HCMV than GCV. In addition, as expected, maribavir displayed activity against strains of HCMV that are resistant to current antiviral therapy [185].

In phase I clinical studies, the compound showed promising pharmacokinetics with no evidence of neutropenia or renal toxicity across a wide range of doses. Taste disturbances were recognized as a side effect of maribavir [186]. Phase II studies in HIV-positive patients, who were asymptotically shedding HCMV, demonstrated a dose- and time-dependent reduction of HCMV titers in semen [187]. Phase II studies in HSCT patients demonstrated that prophylaxis with maribavir resulted in strong antiviral activity, as measured by significant reduction in the rate of reactivation of HCMV in HSCT patients that received maribavir for up to 12 weeks [188]. After engraftment, 111 patients were randomized to receive HCMV prophylaxis with maribavir (100 mg b.i.d., 400 mg q.d., or 400 mg b.i.d.). The incidence of HCMV pp65 antigenemia was lower in each of the respective maribavir group (15%,  $p = 0.046$ ; 19%,  $p = 0.116$ ; 15%,  $p = 0.053$ ) compared to placebo (39%). Also, the incidence of HCMV infection based on plasma HCMV DNA was lower in each of the respective maribavir groups (7%,  $p = 0.001$ ; 11%,  $p = 0.007$ ; 19%,  $p = 0.038$ ) compared to placebo (46%). The lowest dose of maribavir (100 mg twice daily) evaluated in this study appeared to be as effective as the higher dose for prevention of HCMV infection and was better tolerated than the 400 mg twice daily dose of maribavir. Adverse events of maribavir were mostly taste disturbance, nausea, and vomiting. No nephrotoxicity or bone marrow toxicity was seen in the maribavir group. No maribavir resistance HCMV isolates were detected in these clinical trials.

However, a recent phase III clinical trial for maribavir used as prophylaxis in allogeneic stem cell or bone marrow transplant recipients did not show a superior activity of maribavir compared to placebo. This was a randomized, double-blind, placebo-controlled, multicenter pivotal phase III study in 681 patients. Following allogeneic stem cell or bone marrow transplantation, eligible patients were randomized to receive maribavir 100 mg b.i.d. or placebo for a maximum duration of 12 weeks, and followed for an additional 12 weeks to reach 6 month post-transplant analysis. All patients were followed for another 24 weeks. The study did not achieve its primary endpoint (incidence of HCMV disease within 6 months post-transplant). The incidence of HCMV disease was 4.4% for maribavir compared to 4.8% for placebo ( $p = 0.79$ ). The first of four key secondary endpoints was the rate of initiation

of anti-HCMV treatment within 6 months, which was 37.9% for maribavir compared to 40.5% for placebo ( $p = 0.49$ ). The other endpoints (i.e., the incidence of graft versus host disease, mortality, and HCMV-free survival) were comparable between the placebo- and the maribavir-treated groups.

Due to the disappointing results in the phase III clinical trial for maribavir in the allogeneic stem cell or bone marrow transplant recipients, ViroPharma discontinued its phase III trial evaluating maribavir prophylaxis in liver transplant recipients. In this study, the patients were randomized, following transplantation, to receive maribavir (100 mg b.i.d.) or oral GCV (1000 t.i.d.) in a 1: 1 allocation ratio for up to 14 weeks. Further development of maribavir by ViroPharma has been halted.

**Indolocarbazoles, that is, Gö6976, K252a, and K252c** Some indolocarbazoles (Gö6976, K252a, and K252c) (Figure 10.7b), selected from a panel of protein kinase inhibitors (PKIs), proved to be highly effective inhibitors of both GCV-sensitive and GCV-resistant HCMV strains, but were found inactive against HSV [189]. These indolocarbazoles exhibited prolonged antiviral activity in the HCMV replication cycle and antagonized the activity of GCV. Mechanism-of-action studies of indolocarbazoles demonstrated that these compounds strongly inhibited both pUL97 autophosphorylation and pUL97-dependent GCV phosphorylation. In a study, Marschall *et al.* [190] showed that the indolocarbazole-mediated inhibition of virus replication is a result of diminished pUL97 protein kinase activity. They provided evidence that indolocarbazoles specifically inhibit UL97 and are active against GCV-resistant mutants carrying mutations in the UL97 gene. Moreover, an HCMV deletion mutant, lacking a functional UL97 gene and showing a severe impairment of replication, was completely insensitive to this class of compounds.

**Quinazolines** A novel group of potent inhibitors targeting pUL97 that belong to the chemical class of quinazolines, that is, Ax7376, Ax7396, and Ax7543 (Figure 10.7b) were described by Herget *et al.* [191]. It is worth mentioning that the drug gefitinib (Iressa, ZD1839), a protein kinase inhibitor approved for antitumor therapy, also belongs to this class. Ax7376, Ax7396, and Ax7396 inhibited HCMV replication in cell culture and were found to be potent inhibitors of the pUL97 kinase activity and block *in vitro* substrate phosphorylation. The quinazoline derivatives showed a high degree of specificity for the HCMV pUL97 kinase, although the cellular epidermal growth factor receptor (EGFR) was also partially inhibited. These selected quinazolines had strong antiviral effects against clinical HCMV strains, including GCV- and CDV-resistant viruses and, interestingly, resistance to the quinazolines was not observed. These data suggest that the mechanism of resistance against these compounds may be different from that against GCV. In the case of GCV resistance, the pUL97 loses its ability to recognize GCV as a substrate, but the enzyme retains its kinase properties. In contrast, in the case of quinazolines and indolocarbazoles (and other protein kinase inhibitors) the resistance appears to be caused by a catalytic inactivation of the pUL97 leading to viruses with a poor replication capacity [192].

#### 10.4.4.3 Viral Protease Inhibitors

In view of the clinical efficacy of anti-HIV protease inhibitors, significant efforts have been performed to explore proteins involved in HCMV maturation as new drug targets. The HCMV protease belongs to the serine protease family of enzymes and is essential for capsid maturation. Due to the high degree of conservation between proteases of various herpesviruses, it is possible to develop compounds active against several herpesviruses. However, the three-dimensional structure of the HCMV protease pointed out various issues that impeded the subsequent discovery of herpesvirus protease inhibitors. Contrary to the HIV protease, the active site of the HCMV protease is situated within a shallow cleft that limits the interaction with an antiviral molecule [193, 194]. The first inhibitors of herpesvirus protease described (i.e., thieno[2,3-*d*]ioxazinone, spirocyclopropyl oxazolones, and benzimidazole sulfoxides) inhibited the enzyme by covalent modification of the active site [195, 196]. Although the interactions of small molecules with the active site of the HCMV protease are limited by the shallow cleft of the active site, these compounds appeared to have some specificity for the viral protease compared to human proteases.

Borthwick *et al.* succeeded in designing potent antivirals against HCMV by targeting the HCMV serine protease [197]. This group cloned and expressed the viral specific  $\delta$ Ala HCMV protease (wild-type enzyme with the internal cleavage site deleted) in *E. coli* and used it to develop an enzyme assay for evaluation of potential inhibitors and determination of its X-ray crystal structure [198]. Synthesis of the chiral pure (*SRS*)- $\alpha$ -methyl pyrrolidine-5,5-*trans*-lactam template together with detailed SAR studies enabled the production of potent and selective inhibitors of HCMV protease. They identified anti-HCMV drug candidates, that is, compounds **67** and **79** (Figure 10.7c), with a potency comparable to that of GCV, good pharmacokinetics in dogs, and good brain and ocular penetration in guinea pigs [199].

A series of 1-benzoyloxycarbonylazetidines, that is, compound **27** (Figure 10.4) with improved antiviral activity, was reported. These compounds were designed starting from the structure of known  $\beta$ -lactam covalent HCMV protease inhibitors and from the knowledge of the residues implicated in the active site of the enzyme [200, 201].

### 10.4.5

#### Additional New Inhibitors of HCMV

##### 10.4.5.1 Agonist for HCMV-Encoded Chemokine Receptors

G-protein-coupled receptors (GPCRs) encoded by viruses represent an unexplored class of potential drug targets. The genome of HCMV encodes four GPCRs, namely, the open reading frames UL33, UL78, US27, and US28. Two of these GPCRs, that is, UL33 and UL78, have counterparts in the genome of rodent cytomegaloviruses, whereas US27 and US28 are specific for HCMV. US28 is able to sequester CC chemokines from the extracellular environment via endocytosis and this is a strategy of the virus to escape immune surveillance by reducing the immune response to sites of HCMV infection. Hulshof *et al.* [202] reported the synthesis and SAR of the first nonpeptidergic inverse agonist for the HCMV-encoded chemokine receptor US28.

Compound 1 {5-(4-(4-chlorophenyl)-4-hydroxypiperidin-1-yl)2,2-diphenylpentanenitrile} emerged as a lead compound, and a 4-phenylpiperidine moiety appeared to be essential for affinity and binding. Further SAR studies on compound 1 resulted in the identification of compound 50 (Figure 10.8a), which proved to be the highest affinity inverse agonist for US28 described so far [203]. These novel inverse agonists

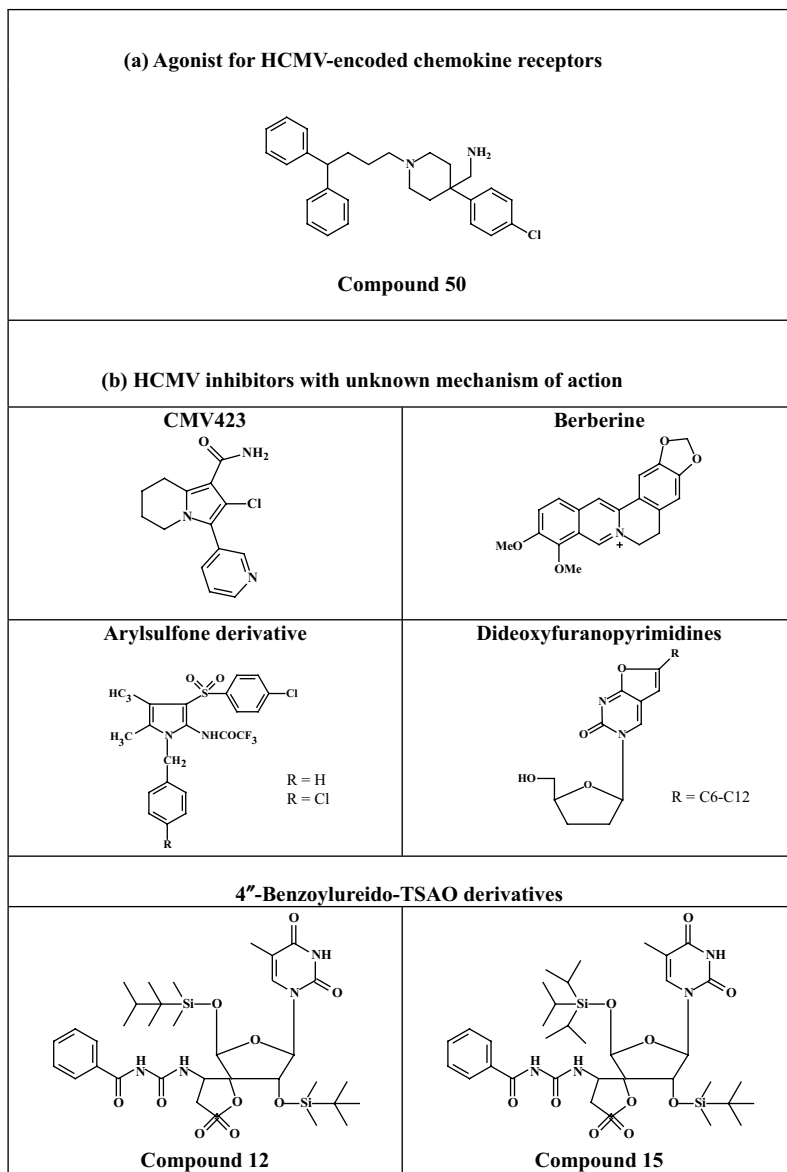

**Figure 10.8** Additional new inhibitors of HCMV.

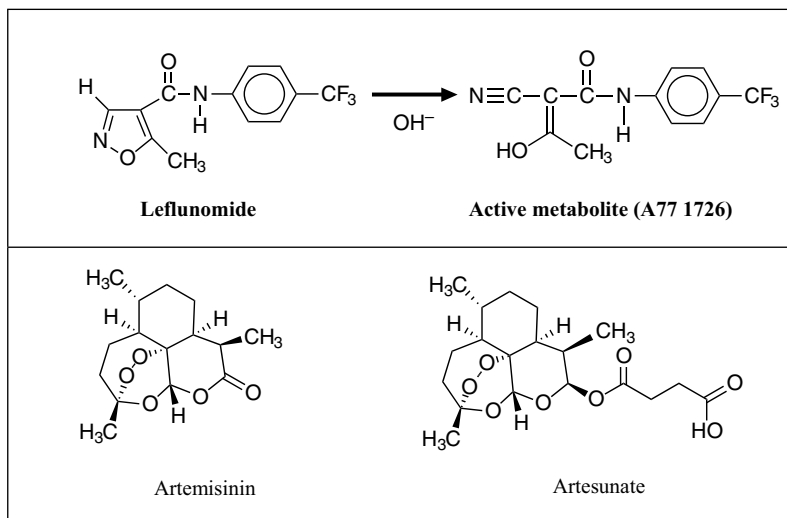

Figure 10.8 (Continued)

represent valuable tools to study the significance of constitutive signaling and the influence of these receptors on viral infection. Furthermore, they can be considered as new targets for designing antiviral drugs.

#### 10.4.6

#### HCMV Inhibitors with a Mechanism of Action not Fully Unraveled

##### 10.4.6.1 CMV423

HCMV inhibitors with a mechanism of action unknown or not completely understood have been reported by different groups. For example, CMV423 (2-chloro-3-pyridin-3-yl-5,6,7,8-tetrahydroindolizine-1-carboxamide) (Figure 10.8b) was shown to inhibit the replication of  $\beta$ -herpesviruses, including HCMV, HHV-6, and HHV-7 [204, 205]. CMV423 was shown to interfere with an early step in the replication cycle of HCMV, presumably the expression or functioning of the immediately early (IE) antigens. Further mechanistic studies revealed that this compound exerts its activity against HHV-6 through inhibition of a cellular process that is critical at early stages of viral replication and that may affect protein tyrosine kinase activity. The development of CMV423 against HCMV was halted due to toxicity concerns.

##### 10.4.6.2 Berberine Chloride, Arylsulfone Derivatives, Lipophilic Alkyl Furano Pyrimidine Dideoxy Nucleosides, and 4''-Benzoyl-Ureido-TSAO Derivatives

Berberine chloride (Figure 10.8b) and structurally related compounds were also described as novel anti-HCMV compounds; they are presumed to interfere with

intracellular events after virus penetration into the host cells and before viral DNA synthesis [206]. Novel arylsulfone derivatives (Figure 10.8b) were described with favorable activity and selectivity against  $\beta$ -herpesviruses and were shown to have a novel mode of action resulting in an indirect inhibition of viral DNA synthesis [207]. McGuigan *et al.* reported the discovery of a new family of inhibitors of HCMV based on lipophilic alkyl furano pyrimidine dideoxy nucleosides (Figure 10.8b) [208]. These compounds may inhibit HCMV replication at an event in the virus replicative cycle preceding DNA synthesis. Recently, two analogues of the 4''-benzoyl-ureido-TSAO derivatives, that is, compounds 12 and 15 (Figure 10.8b), were shown to inhibit both reference HCMV strains and drug-resistant mutants [209]. Mode-of-action studies suggest that these compounds target HCMV replication when viral DNA synthesis occurs, although direct inhibition of HCMV-encoded DNA polymerase could not be observed in cell-free assays. These compounds represent new leads in the discovery of improved therapies for HCMV infections and may be of particular interest in unraveling their precise mechanism of action.

#### 10.4.6.3 Leflunomide

Leflunomide, (*N*-(4-trifluoromethylphenyl)-5-methylisoxazole-4-carboxamide), was approved by the FDA for the treatment of rheumatoid arthritis [210]. Although safety and efficacy of leflunomide in transplant recipients have not yet been established, the drug is designated an orphan drug by the FDA for the prevention of acute and chronic rejection in recipients of solid organs [211]. Following oral administration, leflunomide is rapidly metabolized into its active form (i.e., A77 1726) that is known to inhibit both the activity of protein kinase and the activity of dihydroorotate dehydrogenase (DHODH), a key enzyme in the biosynthesis of pyrimidine nucleotide triphosphates [212, 213]. The anti-HCMV activity of leflunomide was first described by Waldman *et al.* [214] who reported that this agent affected a late stage in virion assembly (i.e., prevention of tegument acquisition by viral nucleocapsids). They found leflunomide equally inhibitory against wild-type and multidrug-resistant HCMV strains. The antiviral activity of A77 1726 against HCMV and HSV-1 *in vitro* could not be attributed to pyrimidine depletion because addition of exogenous uridine, which restores pyrimidine nucleotide triphosphates to normal levels, does not restore the efficacy of leflunomide [214, 215]. However, in a study by Evers *et al.* [216], the biochemical mechanisms responsible for the mode of antiviral action of an immunosuppressant structurally related to A77 1726, that is, FK-778, were found to mirror those responsible for its immunosuppressive properties: inhibition of protein tyrosine phosphorylation and inhibition of cellular *de novo* pyrimidine biosynthesis. Furthermore, the antiviral activity of FK778 was reversed in cell culture by treatment with uridine, consistent with specific inhibition of DHODH.

The concurrent bifunctionality of leflunomide as both immunosuppressive and antiviral in an allogeneic cardiac transplant model of rat cytomegalovirus infection was demonstrated by Chong *et al.* [217]. In this study, leflunomide was found to possess superior antiviral efficacy and less toxicity compared to the related malonitrile amide FK-778. In humans, leflunomide therapy proved to



be useful in the treatment of multidrug-resistance HCMV and among patients unable to afford ganciclovir therapy [218–220]. However, the exact dose and duration of treatment for HCMV infection, for secondary prophylaxis, and in situations of ganciclovir resistance need further studies. According to the studies reported by Avery [221], the following points should be taken into consideration when employing leflunomide: the drug is slow in onset, should have a very long half-life, and may take months for virological clearance; besides, hepatic, hematopoietic, and gastrointestinal side effects may also occur, and measuring their levels is important. Leflunomide has also been shown to possess activity against polyomavirus BK *in vitro* and in some cases of BK infections in humans [222, 223].

#### 10.4.6.4 Artesunate

The antimalaria drug artesunate (an artemisinin-derived monomer) was shown to be an effective inhibitor of human and animal cytomegaloviruses *in vitro* [224, 225]. HCMV with different phenotypes, including low-passage clinical isolates, drug-resistant mutants, laboratory strains, and recombinant clones were inhibited by artesunate [226]. The antiviral efficacy of artesunate was also demonstrated against rat cytomegalovirus *in vivo* [225]. These findings raised the possibility that artesunate could represent a safe therapeutic option for the treatment of HCMV infections. The clinical efficacy of this drug was described in an HSCT recipient with late drug-resistant HCMV infection (artesunate treatment resulted in a 1.7–2.0 log reduction in viral load by day 7 of therapy) [227]. The mechanism of action of artesunate against HCMV is not fully understood, but differs from that of the available anti-HCMV drugs. Its mode of action may be mediated by inhibition of cellular activation pathways, such as those dependent on NF- $\kappa$ B or Sp1, that play an essential role in viral replication [224]. Artesunate is active not only against CMV but also against other members of the Herpesviridae family (e.g., HSV-1 and EBV), hepatitis B virus, hepatitis C virus, and bovine viral diarrhea virus [224]. Recently, Arav-Boger reported that artemisinin-derived dimers have greatly improved cytomegalovirus activity compared to the artemisinin monomers (artemisinin, artesunate, artemether, and artefanilide) [228].

## 10.5

### Cellular Targets

As an alternative approach to traditional antiviral agents that are designed to target specific viral proteins, cellular proteins essential for viral replication may serve as novel targets to specifically inhibit virus replication [229]. Classical antiviral agents are active against a narrow spectrum of viruses and development of resistance has been considered a hallmark of the specificity of these antiviral drugs. On the contrary, antivirals that target cellular proteins indispensable for viral replication are expected to be active against a broader range of viruses because several unrelated viruses may require the same cellular proteins. Also, antivirals targeting

cellular proteins might select drug-resistant virus mutants less rapidly than antivirals that target viral proteins. Furthermore, they should retain their activity against viral mutants resistant to conventional antiviral agents. However, one of the limitations of targeting cellular proteins might be the risk of increased cytotoxicity and undesirable side effects.

### 10.5.1

#### **Inhibitors of Cyclin-Dependent Kinases**

Many viruses such as papillomaviruses, polyomaviruses, adenoviruses, poxviruses, herpesviruses, and HIV require cyclin-dependent kinases (CDKs) for their replication. HCMV has a dramatic stimulatory impact on permissive cells and is also associated with dysregulation of host cell cyclin levels and disruption of cell cycle progression. The upregulation of CDK activity during the infection implies that the virus depends on these enzymes for viral transcription, replication, and/or assembly of virus particles. Roscovitine (a reversible inhibitor of CDK-1, -2, -5, -7, and -9) (Figure 10.9a) and other CDK inhibitors such as olomoucine and flavopiridol (Figure 10.9a) are able to inhibit herpesviruses, other DNA viruses, and retroviruses, underlying the importance of host cell protein kinases in viral replication [230–232]. In the case of HCMV, the addition of roscovitine, a purine derivative that acts by attaching to the ATP binding pocket of CDKs at the beginning of the infection, was shown to significantly disrupt IE gene expression and the progression of the infection [233]. This resulted in a decreased viral DNA synthesis, late (L) antigen expression, and virus production. Sanchez and Spector [234] demonstrated that delaying the addition of the drug up to 6 h postinfection did not affect IE and early (E) gene expression and viral DNA synthesis, but still virus production was reduced. The localization of some HCMV proteins was altered in cells treated with roscovitine, indicating that CDKs are also important for virus maturation [235].

CDK1 was shown to play a critical role in pseudomitosis that occurs during HCMV infection [236]. Pseudomitosis appears to be similar to cellular mitosis, but involves the formation of multiple spindle poles, abnormal condensation, and mislocalization of chromosomal DNA. Broad inhibition of cell cycle-regulated kinases (CDK-1, -2, -5, and -9) with indirubin-3'-monoxime substantially decreased virus yield and synergized with the viral pUL97 inhibitor, maribavir [237]. Furthermore, CDK1 proved to be necessary and sufficient to drive pseudomitosis, whereas a combination of viral and cell cycle-regulated kinases is important during viral replication.

In the past few years, the activity of CDK inhibitors has been assessed *in vivo* [238]. Using mouse models, Yang *et al.* [239] and Reeves *et al.* [240] demonstrated that the CDK inhibitors imatinib and CI-1033 were able to inhibit poxvirus pathogenesis. CDK inhibitors were also able to prevent VZV replication in culture, *ex vivo*, and in SCID-Hu mice [241]. Imatinib also proved efficacious against Kaposi's sarcoma in AIDS patients [242]. Additional clinical studies are needed to determine the potential of CDK inhibitors in the treatment of viral diseases.

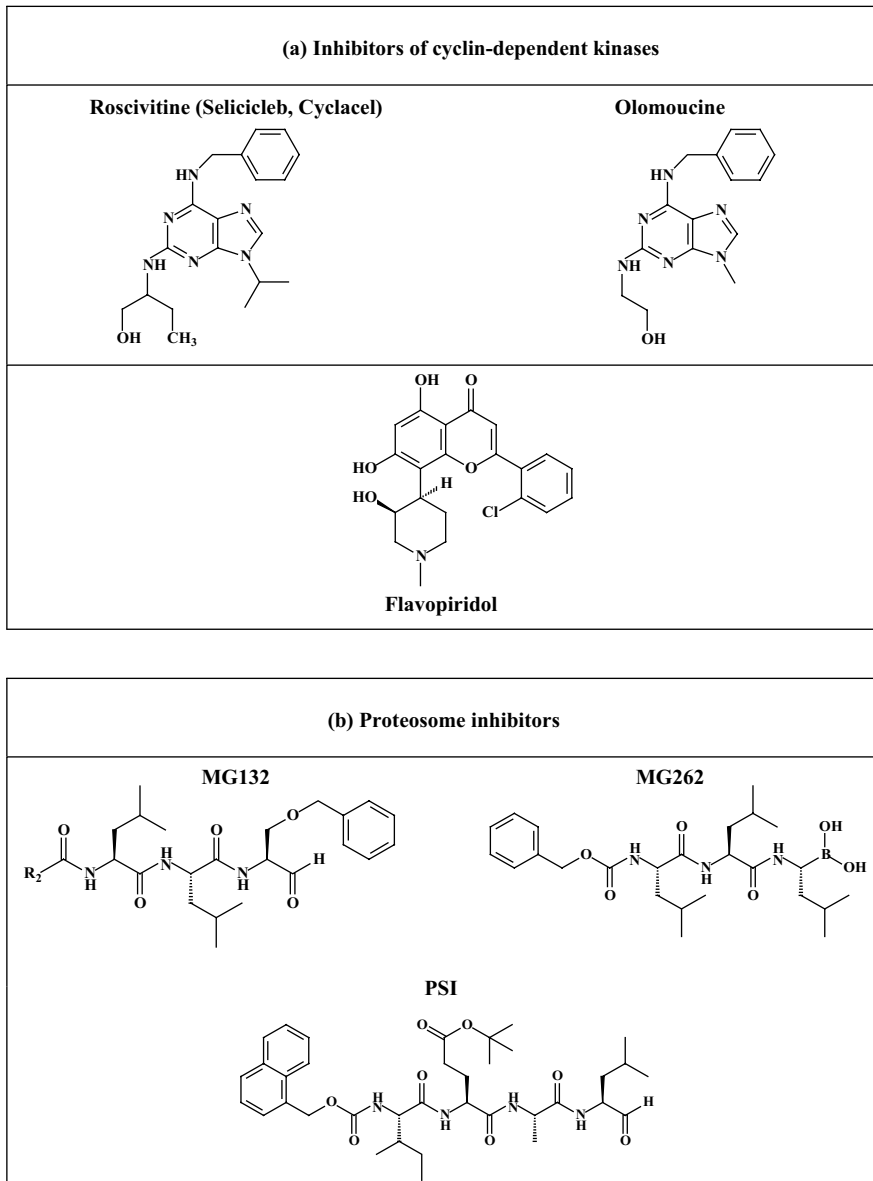

**Figure 10.9** Cellular targets.

### 10.5.2

#### Inhibitors of Cyclooxygenase 2

Virogenomics involves the identification of the global changes in infected host cells and the assessment whether those changes are truly important for virus

replication [243]. This approach can be used to identify host targets encoded in the human genome necessary for survival and replication of viruses. For instance, Shenk's group using DNA microarray experiments demonstrated that several genes regulating prostaglandin metabolism were induced in HCMV-infected cells [244]. One of the upregulated genes was cyclooxygenase-2 (COX-2), which leads to the synthesis of prostaglandin E<sub>2</sub> (PGE<sub>2</sub>), resulting in modulation of cellular gene expression and immune function. In a study, Zhu *et al.* demonstrated that HCMV replication requires the function of COX-2, and specific COX-2 inhibitors led to a more than 100-fold decrease in HCMV yield [245]. Furthermore, addition of PGE<sub>2</sub> restored virus replication, indicating an important role for this factor in HCMV replication. COX-2 inhibitors blocked the accumulation of HCMV immediate early 2 (IE2) mRNA and protein, but had little effect on the levels of immediate early 1 (IE1) protein and mRNA and on viral DNA replication. Thus, the presence of COX-2 inhibitors might block the production of normal levels of this critical viral regulatory protein and normal progression of the virus replication cycle might be blocked beyond the immediate early phase. This study supports the use of microarray analysis for the identification of potential cellular targets that could be explored in antiviral therapy.

### 10.5.3

#### **Proteasome Inhibitors**

Systemic inflammation is the most important mechanism involved in reactivation of HCMV. The eukaryotic transcription factor NF- $\kappa$ B could be identified as the key mediator of IE1-dependent stimulation of HCMV IE1/2 enhancer/promoter activity, which is critical for initiation of viral gene expression. NF- $\kappa$ B plays a crucial role in promoting inflammation and controlling cell proliferation and survival. The enzymatic proteasome complex participates in the regulation of key events in cell cycle and transcription regulation, apoptosis, and the activation of NF- $\kappa$ B. Proteasomes are large multimeric and multicatalytic protease complexes located in the nucleus and cytoplasm of eukaryotic cells that are in charge of the degradation of ubiquitinated proteins [246]. Proteasome inhibitors that block NF- $\kappa$ B function by preventing degradation of the inhibitory proteins I $\kappa$ B $\alpha$  have been widely used both *in vitro* and *in vivo* for cell biology studies and as anticancer drugs [247, 248]. Recently, they have been used as therapeutics in animal models for inflammation-associated diseases. The anti-inflammatory activity of proteasome inhibitors is probably due to their inhibitory activity on NF- $\kappa$ B activation. The proteasome inhibitors such as MG132, PSI, PSII, and PSIII (MG262) (Figure 10.9b) have been shown to block both TNF- $\alpha$ -associated upregulation of the HCMV IE1/2 enhancer/promoter in monocytic cells and HCMV replication in permissive fibroblasts [249]. Inhibition of HCMV replication correlated with a delayed and significantly reduced expression of IE proteins and with inhibition of NF- $\kappa$ B activation and binding. MG132 also reduced the immune modulatory activity of the virus by abrogating virus-induced upregulation of intercellular adhesion molecule 1 (ICAM-1). These findings suggest that therapy with protea-

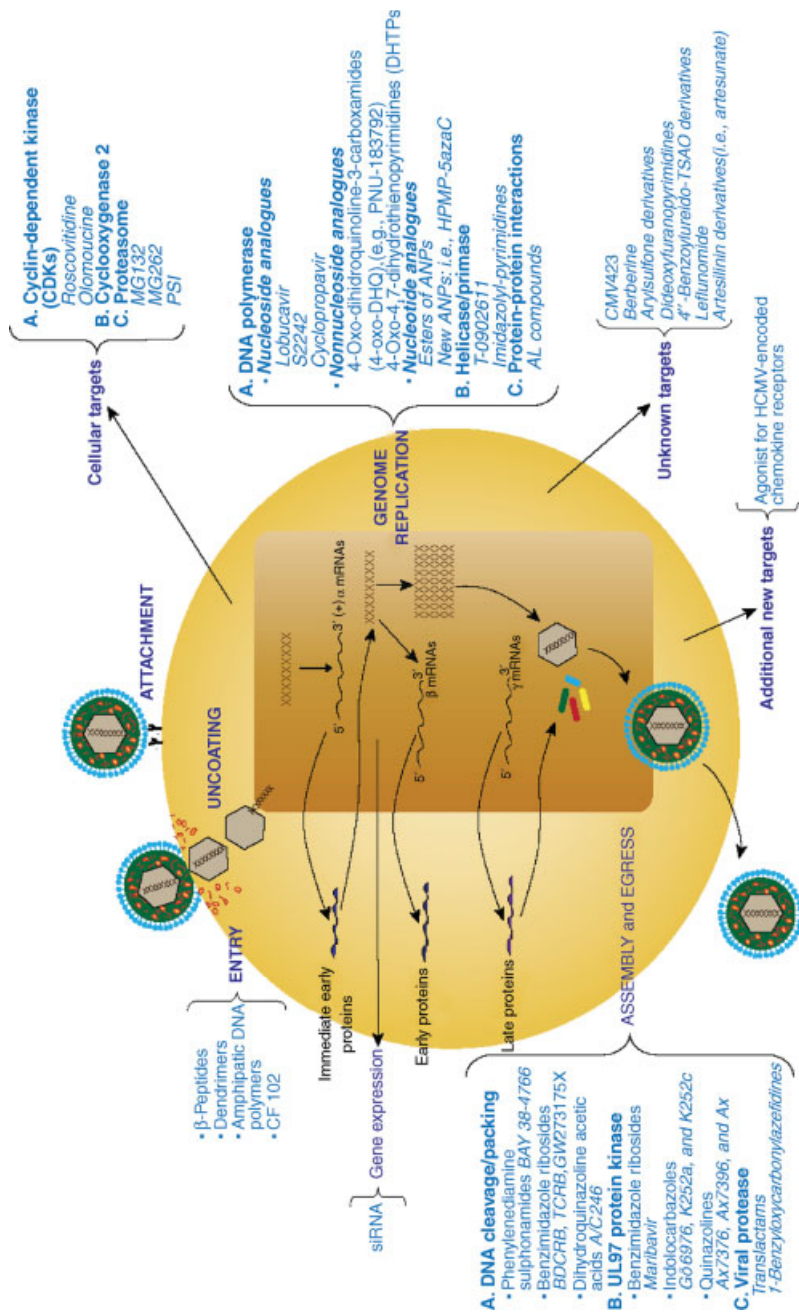

some inhibitors may be an alternative strategy for prevention of HCMV reactivation, replication, and immune modulatory activity. This hypothesis is further supported by recent studies showing that proteasome inhibitors could prevent HSV-1-induced NF- $\kappa$ B activation in the early phase of infection [250].

## 10.6

### Conclusions

Despite a significant progress in the management of HCMV infections in the immunocompromised hosts based on the available diagnostic and therapeutic modalities, HCMV still remains an important cause of morbidity and mortality. Also, HCMV influences many short-term and long-term indirect effects that collectively contribute to patient survival. The major drawbacks of available antiviral agents are the poor oral bioavailability (except for valganciclovir), side effects, and emergence of drug resistance. Therefore, new drugs, preferably oral bioavailable, with a good efficacy and a safe toxicology profile are needed for the treatment of HCMV disease. Novel anti-HCMV drugs are needed not only for the management of viral-associated disease in the immunocompromised host but also for congenital disease in neonates.

Novel classes of anti-HCMV molecules targeting different viral functions such as viral entry, viral genome replication (i.e., DNA polymerase-, helicase/primase-, and protein-protein interaction inhibitors), viral gene expression, virion assembly, and egress (i.e., inhibitors of DNA cleavage/packaging, protein kinase, and protease) (Figure 10.10) have been identified in the past few years by using different approaches. Additional HCMV inhibitors that target cellular proteins essential for viral replication (i.e., inhibitors of cyclin-dependent kinases, proteasome, and cyclooxygenase 2) have also been described. Although there is an urgent medical need for new anti-HCMV drugs, most of the novel agents have so far been stuck in the preclinical or early clinical phase of drug development. The development of maribavir, which was considered one of the most promising anti-HCMV drug, has been halted due to inefficacy in a placebo-controlled pivotal phase III clinical study in allogeneic stem cell transplant recipients.



**Figure 10.10** Novel drug targets and strategies for HCMV infection. Replicative cycle of herpesvirus showing the different steps starting from virus entry and uncoating to assembly of virions and exit from the cell. Also illustrated is transcription and coordinated sequential processing of mRNAs and synthesis of sets of

proteins ( $\alpha$ ,  $\beta$ , and  $\gamma$ ) required for DNA replication and virion structures. The different targets in HCMV infection and the novel drugs are indicated. Modified from a diagram in *Microbiology*, 4th edition, Lippincott Company, editors, B. Davis, R. Dulbecco, H. Eisen, and H. Ginsberg (1990).

## Acknowledgment

The authors are very grateful to Christiane Callebaut for providing editorial assistance.

## References

- 1 Bate, S.L., Dollard, S.C., and Cannon, M.J. (2010) Cytomegalovirus seroprevalence in the United States: the national health and nutrition examination surveys, 1988–2004. *Clinical Infectious Diseases*, **50**, 1439–1447.
- 2 O'Brien, T.P., Thompson, J.M., Black, P.N., Becroft, D.M., Clark, P.M., Robinson, E., Wild, C., and Mitchell, E.A. (2009) Prevalence and determinants of cytomegalovirus infection in pre-school children. *The Journal of Paediatrics and Child Health*, **45**, 291–296.
- 3 Nassetta, L., Kimberlin, D., and Whitley, R. (2009) Treatment of congenital cytomegalovirus infection: implications for future therapeutic strategies. *The Journal of Antimicrobial Chemotherapy*, **63**, 862–867.
- 4 Palella, F.J., Jr., Delaney, K.M., Moorman, A.C., Loveless, M.O., Fuhrer, J., Satten, G.A., Aschman, D.J., and Holmberg, S.D. (1998) Declining morbidity and mortality among patients with advanced human immunodeficiency virus infection. HIV outpatient study investigators. *The New England Journal of Medicine*, **338**, 853–860.
- 5 Forrest, D.M., Seminari, E., Hogg, R.S., Yip, B., Raboud, J., Lawson, L., Phillips, P., Schechter, M.T., O'Shaughnessy, M.V., and Montaner, J.S. (1998) The incidence and spectrum of AIDS-defining illnesses in persons treated with antiretroviral drugs. *Clinical Infectious Diseases*, **27**, 1379–1385.
- 6 Kedhar, S.R. and Jabs, D.A. (2007) Cytomegalovirus retinitis in the era of highly active antiretroviral therapy. *Herpes*, **14**, 66–71.
- 7 Deayton, J.R., Sabin, C.A., Johnson, M.A., Emery, V.C., Wilson, P., and Griffiths, P.D. (2004) Importance of cytomegalovirus viraemia in risk of disease progression and death in HIV-infected patients receiving highly active antiretroviral therapy. *Lancet*, **363**, 2116–2121.
- 8 Griffiths, P.D. (2006) CMV as a cofactor enhancing progression of AIDS. *Journal of Clinical Virology*, **35**, 489–492.
- 9 Gandhi, M.K. and Khanna, R. (2004) Human cytomegalovirus: clinical aspects, immune regulation, and emerging treatments. *The Lancet Infectious Diseases*, **4**, 725–738.
- 10 Cope, A.V., Sweny, P., Sabin, C., Rees, L., Griffiths, P.D., and Emery, V.C. (1997) Quantity of cytomegalovirus viruria is a major risk factor for cytomegalovirus disease after renal transplantation. *Journal of Medical Virology*, **52**, 200–205.
- 11 Tuthill, M., Chen, F., Paston, S., De La, P.H., Rusakiewicz, S., and Madrigal, A. (2009) The prevention and treatment of cytomegalovirus infection in haematopoietic stem cell transplantation. *Cancer Immunology, Immunotherapy*, **58**, 1481–1488.
- 12 Schmidt-Hieber, M., Schwarck, S., Stroux, A., Thiel, E., Ganepola, S., Uharek, L., and Blau, I.W. (2009) Prophylactic i.v. Igs in patients with a high risk for CMV after allo-SCT. *Bone Marrow Transplantation*, **44**, 185–192.
- 13 Biron, K.K. (2006) Antiviral drugs for cytomegalovirus diseases. *Antiviral Research*, **71**, 154–163.
- 14 Boeckh, M. and Ljungman, P. (2009) How we treat cytomegalovirus in hematopoietic cell transplant recipients. *Blood*, **113**, 5711–5719.
- 15 Lautenschlager, I. (2009) CMV infection, diagnosis and antiviral strategies after liver transplantation. *Transplant International*, **22**, 1031–1040.

- 16 Hodson, E.M., Jones, C.A., Webster, A.C., Strippoli, G.F., Barclay, P.G., Kable, K., Vimalachandra, D., and Craig, J.C. (2005) Antiviral medications to prevent cytomegalovirus disease and early death in recipients of solid-organ transplants: a systematic review of randomised controlled trials. *Lancet*, **365**, 2105–2115.
- 17 Lowance, D., Neumayer, H.H., Legendre, C.M., Squifflet, J.P., Kovarik, J., Brennan, P.J., Norman, D., Mendez, R., Keating, M.R., Coggon, G.L., Crisp, A., and Lee, I.C. (1999) Valacyclovir for the prevention of cytomegalovirus disease after renal transplantation. International Valacyclovir Cytomegalovirus Prophylaxis Transplantation Study Group. *The New England Journal of Medicine*, **340**, 1462–1470.
- 18 De Clercq, E. and Holy, A. (2005) Acyclic nucleoside phosphonates: a key class of antiviral drugs. *Nature Reviews. Drug Discovery*, **4**, 928–940.
- 19 Snoeck, R. and De Clercq, E. (2002) Role of cidofovir in the treatment of DNA virus infections, other than CMV infections, in immunocompromised patients. *Current Opinion in Investigational Drugs*, **3**, 1561–1566.
- 20 Xiong, X., Smith, J.L., and Chen, M.S. (1997) Effect of incorporation of cidofovir into DNA by human cytomegalovirus DNA polymerase on DNA elongation. *Antimicrobial Agents and Chemotherapy*, **41**, 594–599.
- 21 Xiong, X., Smith, J.L., Kim, C., Huang, E.S., and Chen, M.S. (1996) Kinetic analysis of the interaction of cidofovir diphosphate with human cytomegalovirus DNA polymerase. *Biochemical Pharmacology*, **51**, 1563–1567.
- 22 Gilbert, C. and Boivin, G. (2005) Human cytomegalovirus resistance to antiviral drugs. *Antimicrobial Agents and Chemotherapy*, **49**, 873–883.
- 23 Chou, S. (1999) Antiviral drug resistance in human cytomegalovirus. *Transplant Infectious Disease*, **1**, 105–114.
- 24 Boivin, G., Gilbert, C., Gaudreau, A., Greenfield, I., Sudlow, R., and Roberts, N.A. (2001) Rate of emergence of cytomegalovirus (CMV) mutations in leukocytes of patients with acquired immunodeficiency syndrome who are receiving valganciclovir as induction and maintenance therapy for CMV retinitis. *The Journal of Infectious Diseases*, **184**, 1598–1602.
- 25 Limaye, A.P., Corey, L., Koelle, D.M., Davis, C.L., and Boeckh, M. (2000) Emergence of ganciclovir-resistant cytomegalovirus disease among recipients of solid-organ transplants. *Lancet*, **356**, 645–649.
- 26 Eckle, T., Lang, P., Prix, L., Jahn, G., Klingebiel, T., Handgretinger, R., Selle, B., Niethammer, D., and Hamprecht, K. (2002) Rapid development of ganciclovir-resistant cytomegalovirus infection in children after allogeneic stem cell transplantation in the early phase of immune cell recovery. *Bone Marrow Transplantation*, **30**, 433–439.
- 27 Avery, R.K. (2008) Update in management of ganciclovir-resistant cytomegalovirus infection. *Current Opinion in Infectious Diseases*, **21**, 433–437.
- 28 Limaye, A.P., Corey, L., Koelle, D.M., Davis, C.L., and Boeckh, M. (2000) Emergence of ganciclovir-resistant cytomegalovirus disease among recipients of solid-organ transplants. *Lancet*, **356**, 645–649.
- 29 Isada, C.M., Yen-Lieberman, B., Lurain, N.S., Schilz, R., Kohn, D., Longworth, D.L., Taeye, A.J., Mossad, S.B., Maurer, J., Flechner, S.M., Mawhorter, S.D., Braun, W., Gordon, S.M., Schmitt, S.K., Goldman, M., Long, J., Haug, M., and Avery, R.K. (2002) Clinical characteristics of 13 solid organ transplant recipients with ganciclovir-resistant cytomegalovirus infection. *Transplant Infectious Disease*, **4**, 189–194.
- 30 Lurain, N.S., Bhorade, S.M., Pursell, K.J., Avery, R.K., Yeldandi, V.V., Isada, C.M., Robert, E.S., Kohn, D.J., Arens, M.Q., Garrity, E.R., Taeye, A.J., Mullen, M.G., Todd, K.M., Bremer, J.W., and Yen-Lieberman, B. (2002) Analysis and characterization of antiviral drug-resistant cytomegalovirus isolates from solid organ transplant recipients. *The Journal of Infectious Diseases*, **186**, 760–768.



- 31 Li, F., Kenyon, K.W., Kirby, K.A., Fishbein, D.P., Boeckh, M., and Limaye, A.P. (2007) Incidence and clinical features of ganciclovir-resistant cytomegalovirus disease in heart transplant recipients. *Clinical Infectious Diseases*, **45**, 439–447.
- 32 Limaye, A.P., Raghu, G., Koelle, D.M., Ferrenberg, J., Huang, M.L., and Boeckh, M. (2002) High incidence of ganciclovir-resistant cytomegalovirus infection among lung transplant recipients receiving preemptive therapy. *The Journal of Infectious Diseases*, **185**, 20–27.
- 33 Arslan, F., Tabak, F., Avsar, E., Midilli, K., Mert, A., Ozaras, R., Soysal, T., Ozturk, R., and Ferhanoglu, B. (2010) Ganciclovir-resistant cytomegalovirus encephalitis in a hematopoietic stem cell transplant recipient. *Journal of Neurovirology*, **16** (2), 174–178.
- 34 Seo, S.K., Regan, A., Cihlar, T., Lin, D.C., Boulad, F., George, D., Prasad, V.K., Kiehn, T.E., and Polsky, B. (2001) Cytomegalovirus ventriculoencephalitis in a bone marrow transplant recipient receiving antiviral maintenance: clinical and molecular evidence of drug resistance. *Clinical Infectious Diseases*, **33**, e105–e108.
- 35 Julin, J.E., van Burik, J.H., Krivit, W., Webb, C., Holman, C.J., Clark, H.B., and Balfour, H.H., Jr. (2002) Ganciclovir-resistant cytomegalovirus encephalitis in a bone marrow transplant recipient. *Transplant Infectious Disease*, **4**, 201–206.
- 36 Boivin, G., Goyette, N., Gilbert, C., Roberts, N., Macey, K., Paya, C., Pescovitz, M.D., Humar, A., Dominguez, E., Washburn, K., Blumberg, E., Alexander, B., Freeman, R., Heaton, N., and Covington, E. (2004) Absence of cytomegalovirus-resistance mutations after valganciclovir prophylaxis, in a prospective multicenter study of solid-organ transplant recipients. *The Journal of Infectious Diseases*, **189**, 1615–1618.
- 37 Avery, R.K. (2008) Update in management of ganciclovir-resistant cytomegalovirus infection. *Current Opinion in Infectious Diseases*, **21**, 433–437.
- 38 Eid, A.J., Arthurs, S.K., Deziel, P.J., Wilhelm, M.P., and Razonable, R.R. (2008) Emergence of drug-resistant cytomegalovirus in the era of valganciclovir prophylaxis: therapeutic implications and outcomes. *Clinical Transplantation*, **22**, 162–170.
- 39 Marfori, J.E., Exner, M.M., Marousek, G.I., Chou, S., and Drew, W.L. (2007) Development of new cytomegalovirus UL97 and DNA polymerase mutations conferring drug resistance after valganciclovir therapy in allogeneic stem cell recipients. *Journal of Clinical Virology*, **38**, 120–125.
- 40 Eid, A.J., Arthurs, S.K., Deziel, P.J., Wilhelm, M.P., and Razonable, R.R. (2008) Emergence of drug-resistant cytomegalovirus in the era of valganciclovir prophylaxis: therapeutic implications and outcomes. *Clinical Transplantation*, **22**, 162–170.
- 41 Bonnafous, P., Naesens, L., Petrella, S., Gautheret-Dejean, A., Boutolleau, D., Sougakoff, W., and Agut, H. (2007) Different mutations in the HHV-6 DNA polymerase gene accounting for resistance to foscarnet. *Antiviral Therapy*, **12**, 877–888.
- 42 Scott, G.M., Weinberg, A., Rawlinson, W.D., and Chou, S. (2007) Multidrug resistance conferred by novel DNA polymerase mutations in human cytomegalovirus isolates. *Antimicrobial Agents and Chemotherapy*, **51**, 89–94.
- 43 Galli, L., Novelli, A., Chiappini, E., Gervaso, P., Cassetta, M.I., Fallani, S., and de Martino, M. (2007) Valganciclovir for congenital CMV infection: a pilot study on plasma concentration in newborns and infants. *The Pediatric Infectious Disease Journal*, **26**, 451–453.
- 44 Meine Jansen, C.F., Toet, M.C., Rademaker, C.M., Ververs, T.F., Gerards, L.J., and van Loon, A.M. (2005) Treatment of symptomatic congenital cytomegalovirus infection with valganciclovir. *Journal of Perinatal Medicine*, **33**, 364–366.
- 45 Kinzler, E.R. and Compton, T. (2005) Characterization of human cytomegalovirus glycoprotein-induced cell–cell fusion. *Journal of Virology*, **79**, 7827–7837.
- 46 Lopper, M. and Compton, T. (2004) Coiled-coil domains in glycoproteins B

- and H are involved in human cytomegalovirus membrane fusion. *Journal of Virology*, **78**, 8333–8341.
- 47 English, E.P., Chumanov, R.S., Gellman, S.H., and Compton, T. (2006) Rational development of beta-peptide inhibitors of human cytomegalovirus entry. *The Journal of Biological Chemistry*, **281**, 2661–2667.
- 48 English, E.P., Chumanov, R.S., Gellman, S.H., and Compton, T. (2006) Rational development of beta-peptide inhibitors of human cytomegalovirus entry. *The Journal of Biological Chemistry*, **281**, 2661–2667.
- 49 Rosa, B.A. and Schengrund, C.L. (2005) Dendrimers and antivirals: a review. *Current Drug Targets: Infectious Disorders*, **5**, 247–254.
- 50 McCarthy, T.D., Karellas, P., Henderson, S.A., Giannis, M., O’Keefe, D.F., Heery, G., Paull, J.R., Matthews, B.R., and Holan, G. (2005) Dendrimers as drugs: discovery and preclinical and clinical development of dendrimer-based microbicides for HIV and STI prevention. *Molecular Pharmaceutics*, **2**, 312–318.
- 51 Lujanini, A., Giuliani, A., Pirri, G., Pizzuto, L., Landolfo, S., and Gribaudo, G. (2010) Peptide-derivatized dendrimers inhibit human cytomegalovirus infection by blocking virus binding to cell surface heparan sulfate. *Antiviral Research*, **85**, 532–540.
- 52 Lujanini, A., Caposio, P., Landolfo, S., and Gribaudo, G. (2008) Phosphorothioate-modified oligodeoxynucleotides inhibit human cytomegalovirus replication by blocking virus entry. *Antimicrobial Agents and Chemotherapy*, **52**, 1111–1120.
- 53 Bernstein, D.I., Goyette, N., Cardin, R., Kern, E.R., Boivin, G., Ireland, J., Juteau, J.M., and Vaillant, A. (2008) Amphipathic DNA polymers exhibit antiherpetic activity *in vitro* and *in vivo*. *Antimicrobial Agents and Chemotherapy*, **52**, 2727–2733.
- 54 Vaillant, A., Juteau, J.M., Lu, H., Liu, S., Lackman-Smith, C., Ptak, R., and Jiang, S. (2006) Phosphorothioate oligonucleotides inhibit human immunodeficiency virus type 1 fusion by blocking gp41 core formation. *Antimicrobial Agents and Chemotherapy*, **50**, 1393–1401.
- 55 Guzman, E.M., Cheshenko, N., Shende, V., Keller, M.J., Goyette, N., Juteau, J.M., Boivin, G., Vaillant, A., and Herold, B.C. (2007) Amphipathic DNA polymers are candidate vaginal microbicides and block herpes simplex virus binding, entry and viral gene expression. *Antiviral Therapy*, **12**, 1147–1156.
- 56 Matsumura, T., Hu, Z., Kato, T., Dreux, M., Zhang, Y.Y., Imamura, M., Hiraga, N., Juteau, J.M., Cosset, F.L., Chayama, K., Vaillant, A., and Liang, T.J. (2009) Amphipathic DNA polymers inhibit hepatitis C virus infection by blocking viral entry. *Gastroenterology*, **137**, 673–681.
- 57 Cardin, R.D., Bravo, F.J., Sewell, A.P., Cummins, J., Flamand, L., Juteau, J.M., Bernstein, D.I., and Vaillant, A. (2009) Amphipathic DNA polymers exhibit antiviral activity against systemic murine cytomegalovirus infection. *Virology Journal*, **6**, 214.
- 58 Jones, T.R., Lee, S.W., Johann, S.V., Razinkov, V., Visalli, R.J., Feld, B., Bloom, J.D., and O’Connell, J. (2004) Specific inhibition of human cytomegalovirus glycoprotein B-mediated fusion by a novel thiourea small molecule. *Journal of Virology*, **78**, 1289–1300.
- 59 Klinman, D.M., Currie, D., Gursel, I., and Verthelyi, D. (2004) Use of CpG oligodeoxynucleotides as immune adjuvants. *Immunological Reviews*, **199**, 201–216.
- 60 Vollmer, J. and Krieg, A.M. (2009) Immunotherapeutic applications of CpG oligodeoxynucleotide TLR9 agonists. *Advanced Drug Delivery Reviews*, **61**, 195–204.
- 61 Tenney, D.J., Yamanaka, G., Voss, S.M., Cianci, C.W., Tuomari, A.V., Sheaffer, A.K., Alam, M., and Colonno, R.J. (1997) Lobucavir is phosphorylated in human cytomegalovirus-infected and -uninfected cells and inhibits the viral DNA polymerase. *Antimicrobial Agents and Chemotherapy*, **41**, 2680–2685.
- 62 Neyts, J. and De Clercq, E. (1997) Antiviral drug susceptibility of human herpesvirus 8. *Antimicrobial Agents and Chemotherapy*, **41**, 2754–2756.

- 63 Meerbach, A., Holy, A., Wutzler, P., De Clercq, E., and Neyts, J. (1998) Inhibitory effects of novel nucleoside and nucleotide analogues on Epstein-Barr virus replication. *Antiviral Chemistry & Chemotherapy*, **9**, 275–282.
- 64 Neyts, J., Andrei, G., Snoeck, R., Jahne, G., Winkler, I., Helsenberg, M., Balzarini, J., and De Clercq, E. (1994) The N-7-substituted acyclic nucleoside analog 2-amino-7-[(1,3-dihydroxy-2-propoxy)methyl]purine is a potent and selective inhibitor of herpesvirus replication. *Antimicrobial Agents and Chemotherapy*, **38**, 2710–2716.
- 65 Zhang, Y., Schols, D., and De Clercq, E. (1999) Selective activity of various antiviral compounds against HHV-7 infection. *Antiviral Research*, **43**, 23–35.
- 66 De Clercq, E., Naesens, L., De Bolle, L., Schols, D., Zhang, Y., and Neyts, J. (2001) Antiviral agents active against human herpesviruses HHV-6, HHV-7 and HHV-8. *Reviews in Medical Virology*, **11**, 381–395.
- 67 Zimmermann, A., Michel, D., Pavic, I., Hampl, W., Luske, A., Neyts, J., De Clercq, E., and Mertens, T. (1997) Phosphorylation of aciclovir, ganciclovir, penciclovir and S2242 by the cytomegalovirus UL97 protein: a quantitative analysis using recombinant vaccinia viruses. *Antiviral Research*, **36**, 35–42.
- 68 Neyts, J., Balzarini, J., Andrei, G., Chaoyong, Z., Snoeck, R., Zimmermann, A., Mertens, T., Karlsson, A., and De Clercq, E. (1998) Intracellular metabolism of the N7-substituted acyclic nucleoside analog 2-amino-7-(1,3-dihydroxy-2-propoxymethyl)purine, a potent inhibitor of herpesvirus replication. *Molecular Pharmacology*, **53**, 157–165.
- 69 Neyts, J., Jahne, G., Andrei, G., Snoeck, R., Winkler, I., and De Clercq, E. (1995) *In vivo* antitherpesvirus activity of N-7-substituted acyclic nucleoside analog 2-amino-7-[(1,3-dihydroxy-2-propoxy)methyl]purine. *Antimicrobial Agents and Chemotherapy*, **39**, 56–60.
- 70 Qiu, Y.L., Ksebaty, M.B., Ptak, R.G., Fan, B.Y., Breitenbach, J.M., Lin, J.S., Cheng, Y.C., Kern, E.R., Drach, J.C., and Zemlicka, J. (1998) (Z)- and (E)-2-((hydroxymethyl)cyclopropylidene)methyladenine and -guanine: new nucleoside analogues with a broad-spectrum antiviral activity. *Journal of Medicinal Chemistry*, **41**, 10–23.
- 71 Qiu, Y.L., Ptak, R.G., Breitenbach, J.M., Lin, J.S., Cheng, Y.C., Drach, J.C., Kern, E.R., and Zemlicka, J. (1999) Synthesis and antiviral activity of phosphoralaninate derivatives of methylenecyclopropane analogues of nucleosides. *Antiviral Research*, **43**, 37–53.
- 72 Qiu, Y.L., Ptak, R.G., Breitenbach, J.M., Lin, J.S., Cheng, Y.C., Kern, E.R., Drach, J.C., and Zemlicka, J. (1998) (Z)- and (E)-2-((hydroxymethyl)cyclopropylidene)methylpurines and pyrimidines as antiviral agents. *Antiviral Chemistry & Chemotherapy*, **9**, 341–352.
- 73 Chen, X., Kern, E.R., Drach, J.C., Gullen, E., Cheng, Y.C., and Zemlicka, J. (2003) Structure–activity relationships of (S, Z)-2-aminopurine methylenecyclopropane analogues of nucleosides: variation of purine-6 substituents and activity against herpesviruses and hepatitis B virus. *Journal of Medicinal Chemistry*, **46**, 1531–1537.
- 74 Kushner, N.L., Williams, S.L., Hartline, C.B., Harden, E.A., Bidanset, D.J., Chen, X., Zemlicka, J., and Kern, E.R. (2003) Efficacy of methylenecyclopropane analogs of nucleosides against herpesvirus replication *in vitro*. *Nucleosides, Nucleotides & Nucleic Acids*, **22**, 2105–2119.
- 75 Rybak, R.J., Zemlicka, J., Qiu, Y.L., Hartline, C.B., and Kern, E.R. (1999) Effective treatment of murine cytomegalovirus infections with methylenecyclopropane analogues of nucleosides. *Antiviral Research*, **43**, 175–188.
- 76 Rybak, R.J., Hartline, C.B., Qiu, Y.L., Zemlicka, J., Harden, E., Marshall, G., Sommadossi, J.P., and Kern, E.R. (2000) *In vitro* activities of methylenecyclopropane analogues of nucleosides and their phosphoralaninate prodrugs against cytomegalovirus and other herpesvirus infections. *Antimicrobial*

- Agents and Chemotherapy*, **44**, 1506–1511.
- 77 Qiu, Y.L., Geiser, F., Kira, T., Gullen, E., Cheng, Y.C., Ptak, R.G., Breitenbach, J.M., Drach, J.C., Hartline, C.B., Kern, E.R., and Zemlicka, J. (2000) Synthesis and enantioselectivity of the antiviral effects of (R,Z)-,(S,Z)-methylenecyclopropane analogues of purine nucleosides and phosphoralaninate prodrugs: influence of heterocyclic base, type of virus and host cells. *Antiviral Chemistry & Chemotherapy*, **11**, 191–202.
- 78 Rybak, R.J., Hartline, C.B., Qiu, Y.L., Zemlicka, J., Harden, E., Marshall, G., Sommadossi, J.P., and Kern, E.R. (2000) *In vitro* activities of methylenecyclopropane analogues of nucleosides and their phosphoralaninate prodrugs against cytomegalovirus and other herpesvirus infections. *Antimicrobial Agents and Chemotherapy*, **44**, 1506–1511.
- 79 Kushner, N.L., Williams, S.L., Hartline, C.B., Harden, E.A., Bidanset, D.J., Chen, X., Zemlicka, J., and Kern, E.R. (2003) Efficacy of methylenecyclopropane analogs of nucleosides against herpesvirus replication in vitro. *Nucleosides, Nucleotides & Nucleic Acids*, **22**, 2105–2119.
- 80 Rybak, R.J., Zemlicka, J., Qiu, Y.L., Hartline, C.B., and Kern, E.R. (1999) Effective treatment of murine cytomegalovirus infections with methylenecyclopropane analogues of nucleosides. *Antiviral Research*, **43**, 175–188.
- 81 Rybak, R.J., Zemlicka, J., Qiu, Y.L., Hartline, C.B., and Kern, E.R. (1999) Effective treatment of murine cytomegalovirus infections with methylenecyclopropane analogues of nucleosides. *Antiviral Research*, **43**, 175–188.
- 82 Zhou, S., Breitenbach, J.M., Borysko, K.Z., Drach, J.C., Kern, E.R., Gullen, E., Cheng, Y.C., and Zemlicka, J. (2004) Synthesis and antiviral activity of (Z)- and (E)-2,2-[bis(hydroxymethyl)cyclopropylidene]methylpurines and -pyrimidines: second-generation methylenecyclopropane analogues of nucleosides. *Journal of Medicinal Chemistry*, **47**, 566–575.
- 83 Kern, E.R., Kushner, N.L., Hartline, C.B., Williams-Aziz, S.L., Harden, E.A., Zhou, S., Zemlicka, J., and Prichard, M.N. (2005) *In vitro* activity and mechanism of action of methylenecyclopropane analogs of nucleosides against herpesvirus replication. *Antimicrobial Agents and Chemotherapy*, **49**, 1039–1045.
- 84 Kern, E.R., Bidanset, D.J., Hartline, C.B., Yan, Z., Zemlicka, J., and Quenelle, D.C. (2004) Oral activity of a methylenecyclopropane analog, cyclopropavir, in animal models for cytomegalovirus infections. *Antimicrobial Agents and Chemotherapy*, **48**, 4745–4753.
- 85 Kern, E.R., Kushner, N.L., Hartline, C.B., Williams-Aziz, S.L., Harden, E.A., Zhou, S., Zemlicka, J., and Prichard, M.N. (2005) *In vitro* activity and mechanism of action of methylenecyclopropane analogs of nucleosides against herpesvirus replication. *Antimicrobial Agents and Chemotherapy*, **49**, 1039–1045.
- 86 Yan, Z., Kern, E.R., Gullen, E., Cheng, Y.C., Drach, J.C., and Zemlicka, J. (2005) Nucleotides and pronucleotides of 2,2-bis(hydroxymethyl)methylenecyclopropane analogues of purine nucleosides: synthesis and antiviral activity. *Journal of Medicinal Chemistry*, **48**, 91–99.
- 87 Mhaske, S.B., Ksebaty, B., Prichard, M.N., Drach, J.C., and Zemlicka, J. (2009) Phosphonate analogues of cyclopropavir phosphates and their E-isomers: synthesis and antiviral activity. *Bioorganic and Medicinal Chemistry*, **17**, 3892–3899.
- 88 Wu, Z., Drach, J.C., Prichard, M.N., Yanachkova, M., Yanachkov, I., Bowlin, T.L., and Zemlicka, J. (2009) L-Valine ester of cyclopropavir: a new antiviral prodrug. *Antiviral Chemistry & Chemotherapy*, **20**, 37–46.
- 89 Bowlin, T., Brooks, J., and Zemlicka, J. (2009) Preclinical pharmacokinetic, toxicokinetic and toxicology results for cyclopropavir, a promising new agent for the treatment of beta- and gamma-herpesviruses. *Antiviral Research*, **82**, A46–A47.
- 90 Secrist, J.A., III, Tiwari, K.N., Riordan, J.M., and Montgomery, J.A. (1991)

- Synthesis and biological activity of 2'-deoxy-4'-thio pyrimidine nucleosides. *Journal of Medicinal Chemistry*, **34**, 2361–2366.
- 91 Rahim, S.G., Trivedi, N., Bogunovic-Batchelor, M.V., Hardy, G.W., Mills, G., Selway, J.W., Snowden, W., Littler, E., Coe, P.L., Basnak, I., Whale, R.F., and Walker, R.T. (1996) Synthesis and anti-herpes virus activity of 2'-deoxy-4'-thiopyrimidine nucleosides. *Journal of Medicinal Chemistry*, **39**, 789–795.
- 92 Prichard, M.N., Quenelle, D.C., Hartline, C.B., Harden, E.A., Jefferson, G., Frederick, S.L., Daily, S.L., Whitley, R.J., Tiwari, K.N., Maddry, J.A., Secrist, J.A., III, and Kern, E.R. (2009) Inhibition of herpesvirus replication by 5-substituted 4'-thiopyrimidine nucleosides. *Antimicrobial Agents and Chemotherapy*, **53**, 5251–5258.
- 93 Vaillancourt, V.A., Cudahy, M.M., Staley, S.A., Brideau, R.J., Conrad, S.J., Knechtel, M.L., Oien, N.L., Wieber, J.L., Yagi, Y., and Wathen, M.W. (2000) Naphthalene carboxamides as inhibitors of human cytomegalovirus DNA polymerase. *Bioorganic & Medicinal Chemistry Letters*, **10**, 2079–2081.
- 94 Tucker, J.A., Clayton, T.L., Chidester, C.G., Schulz, M.W., Harrington, L.E., Conrad, S.J., Yagi, Y., Oien, N.L., Yurek, D., and Kuo, M.S. (2000) Structure–activity relationships of acyloxyamidine cytomegalovirus DNA polymerase inhibitors. *Bioorganic and Medicinal Chemistry*, **8**, 601–615.
- 95 Brideau, R.J., Knechtel, M.L., Huang, A., Vaillancourt, V.A., Vera, E.E., Oien, N.L., Hopkins, T.A., Wieber, J.L., Wilkinson, K.F., Rush, B.D., Schwende, F.J., and Wathen, M.W. (2002) Broad-spectrum antiviral activity of PNU-183792, a 4-oxo-dihydroquinoline, against human and animal herpesviruses. *Antiviral Research*, **54**, 19–28.
- 96 Oien, N.L., Brideau, R.J., Hopkins, T.A., Wieber, J.L., Knechtel, M.L., Shelly, J.A., Anstadt, R.A., Wells, P.A., Poorman, R.A., Huang, A., Vaillancourt, V.A., Clayton, T.L., Tucker, J.A., and Wathen, M.W. (2002) Broad-spectrum antiherpes activities of 4-hydroxyquinoline carboxamides, a novel class of herpesvirus polymerase inhibitors. *Antimicrobial Agents and Chemotherapy*, **46**, 724–730.
- 97 Wathen, M.W. (2002) Non-nucleoside inhibitors of herpesviruses. *Reviews in Medical Virology*, **12**, 167–178.
- 98 Thomsen, D.R., Oien, N.L., Hopkins, T.A., Knechtel, M.L., Brideau, R.J., Wathen, M.W., and Homa, F.L. (2003) Amino acid changes within conserved region III of the herpes simplex virus and human cytomegalovirus DNA polymerases confer resistance to 4-oxo-dihydroquinolines, a novel class of herpesvirus antiviral agents. *Journal of Virology*, **77**, 1868–1876.
- 99 Liu, S., Knafels, J.D., Chang, J.S., Waszak, G.A., Baldwin, E.T., Deibel, M.R., Jr., Thomsen, D.R., Homa, F.L., Wells, P.A., Tory, M.C., Poorman, R.A., Gao, H., Qiu, X., and Seddon, A.P. (2006) Crystal structure of the herpes simplex virus 1 DNA polymerase. *The Journal of Biological Chemistry*, **281**, 18193–18200.
- 100 Brideau, R.J., Knechtel, M.L., Huang, A., Vaillancourt, V.A., Vera, E.E., Oien, N.L., Hopkins, T.A., Wieber, J.L., Wilkinson, K.F., Rush, B.D., Schwende, F.J., and Wathen, M.W. (2002) Broad-spectrum antiviral activity of PNU-183792, a 4-oxo-dihydroquinoline, against human and animal herpesviruses. *Antiviral Research*, **54**, 19–28.
- 101 Schnute, M.E., Cudahy, M.M., Brideau, R.J., Homa, F.L., Hopkins, T.A., Knechtel, M.L., Oien, N.L., Pitts, T.W., Poorman, R.A., Wathen, M.W., and Wieber, J.L. (2005) 4-Oxo-4,7-dihydrothieno[2,3-b]pyridines as non-nucleoside inhibitors of human cytomegalovirus and related herpesvirus polymerases. *Journal of Medicinal Chemistry*, **48**, 5794–5804.
- 102 Schnute, M.E., Cudahy, M.M., Brideau, R.J., Homa, F.L., Hopkins, T.A., Knechtel, M.L., Oien, N.L., Pitts, T.W., Poorman, R.A., Wathen, M.W., and Wieber, J.L. (2005) 4-Oxo-4,7-dihydrothieno[2,3-b]pyridines as non-nucleoside inhibitors of human cytomegalovirus and related herpesvirus polymerases. *Journal of Medicinal Chemistry*, **48**, 5794–5804.

- 103 Schnute, M.E., Cudahy, M.M., Brideau, R.J., Homa, F.L., Hopkins, T.A., Knechtel, M.L., Oien, N.L., Pitts, T.W., Poorman, R.A., Wathen, M.W., and Wieber, J.L. (2005) 4-Oxo-4,7-dihydrothieno[2,3-b]pyridines as non-nucleoside inhibitors of human cytomegalovirus and related herpesvirus polymerases. *Journal of Medicinal Chemistry*, **48**, 5794–5804.
- 104 Schnute, M.E., Anderson, D.J., Brideau, R.J., Ciske, F.L., Collier, S.A., Cudahy, M.M., Eggen, M., Genin, M.J., Hopkins, T.A., Judge, T.M., Kim, E.J., Knechtel, M.L., Nair, S.K., Nieman, J.A., Oien, N.L., Scott, A., Tanis, S.P., Vaillancourt, V.A., Wathen, M.W., and Wieber, J.L. (2007) 2-Aryl-2-hydroxyethylamine substituted 4-oxo-4,7-dihydrothieno[2,3-b]pyridines as broad-spectrum inhibitors of human herpesvirus polymerases. *Bioorganic & Medicinal Chemistry Letters*, **17**, 3349–3353.
- 105 Larsen, S.D., Zhang, Z., Dipaolo, B.A., Manninen, P.R., Rohrer, D.C., Hageman, M.J., Hopkins, T.A., Knechtel, M.L., Oien, N.L., Rush, B.D., Schwende, F.J., Stefanski, K.J., Wieber, J.L., Wilkinson, K.F., Zamora, K.M., Wathen, M.W., and Brideau, R.J. (2007) 7-Oxo-4,7-dihydrothieno[3,2-b]pyridine-6-carboxamides: synthesis and biological activity of a new class of highly potent inhibitors of human cytomegalovirus DNA polymerase. *Bioorganic & Medicinal Chemistry Letters*, **17** (14), 3840–3844.
- 106 Ekins, S., Crumb, W.J., Sarazan, R.D., Wikel, J.H., and Wrighton, S.A. (2002) Three-dimensional quantitative structure–activity relationship for inhibition of human ether-a-go-go-related gene potassium channel. *The Journal of Pharmacology and Experimental Therapeutics*, **301**, 427–434.
- 107 Beadle, J.R., Hartline, C., Aldern, K.A., Rodriguez, N., Harden, E., Kern, E.R., and Hostetler, K.Y. (2002) Alkoxyalkyl esters of cidofovir and cyclic cidofovir exhibit multiple-log enhancement of antiviral activity against cytomegalovirus and herpesvirus replication *in vitro*. *Antimicrobial Agents and Chemotherapy*, **46**, 2381–2386.
- 108 Hostetler, K.Y. (2009) Alkoxyalkyl prodrugs of acyclic nucleoside phosphonates enhance oral antiviral activity and reduce toxicity: current state of the art. *Antiviral Research*, **82**, A84–A88.
- 109 Hostetler, K.Y., Rought, S., Aldern, K.A., Trahan, J., Beadle, J.R., and Corbeil, J. (2006) Enhanced antiproliferative effects of alkoxyalkyl esters of cidofovir in human cervical cancer cells *in vitro*. *Molecular Cancer Therapeutics*, **5**, 156–159.
- 110 Lebeau, I., Andrei, G., Dal Pozzo, F., Beadle, J.R., Hostetler, K.Y., De Clercq, E., van den, O.J., and Snoeck, R. (2006) Activities of alkoxyalkyl esters of cidofovir (CDV), cyclic CDV, and (S)-9-(3-hydroxy-2-phosphonylmethoxypropyl)adenine against orthopoxviruses in cell monolayers and in organotypic cultures. *Antimicrobial Agents and Chemotherapy*, **50**, 2525–2529.
- 111 Hartline, C.B., Harden, E.A., Williams-Aziz, S.L., Kushner, N.L., Brideau, R.J., and Kern, E.R. (2005) Inhibition of herpesvirus replication by a series of 4-oxo-dihydroquinolines with viral polymerase activity. *Antiviral Research*, **65**, 97–105.
- 112 Aldern, K.A., Ciesla, S.L., Winegarden, K.L., and Hostetler, K.Y. (2003) Increased antiviral activity of 1-O-hexadecyloxypropyl-[2-(14)C]cidofovir in MRC-5 human lung fibroblasts is explained by unique cellular uptake and metabolism. *Molecular Pharmacology*, **63**, 678–681.
- 113 Kern, E.R., Collins, D.J., Wan, W.B., Beadle, J.R., Hostetler, K.Y., and Quenelle, D.C. (2004) Oral treatment of murine cytomegalovirus infections with ether lipid esters of cidofovir. *Antimicrobial Agents and Chemotherapy*, **48**, 3516–3522.
- 114 Bidanset, D.J., Beadle, J.R., Wan, W.B., Hostetler, K.Y., and Kern, E.R. (2004) Oral activity of ether lipid ester prodrugs of cidofovir against experimental human cytomegalovirus infection. *The Journal of Infectious Diseases*, **190**, 499–503.
- 115 Wan, W.B., Beadle, J.R., Hartline, C., Kern, E.R., Ciesla, S.L., Valiaeva, N., and Hostetler, K.Y. (2005) Comparison of the

- antiviral activities of alkoxyalkyl and alkyl esters of cidofovir against human and murine cytomegalovirus replication *in vitro*. *Antimicrobial Agents and Chemotherapy*, **49**, 656–662.
- 116** Keith, K.A., Wan, W.B., Ciesla, S.L., Beadle, J.R., Hostetler, K.Y., and Kern, E.R. (2004) Inhibitory activity of alkoxyalkyl and alkyl esters of cidofovir and cyclic cidofovir against orthopoxvirus replication *in vitro*. *Antimicrobial Agents and Chemotherapy*, **48**, 1869–1871.
- 117** Quenelle, D.C., Collins, D.J., Wan, W.B., Beadle, J.R., Hostetler, K.Y., and Kern, E.R. (2004) Oral treatment of cowpox and vaccinia virus infections in mice with ether lipid esters of cidofovir. *Antimicrobial Agents and Chemotherapy*, **48**, 404–412.
- 118** Ciesla, S.L., Trahan, J., Wan, W.B., Beadle, J.R., Aldern, K.A., Painter, G.R., and Hostetler, K.Y. (2003) Esterification of cidofovir with alkoxyalkanols increases oral bioavailability and diminishes drug accumulation in kidney. *Antiviral Research*, **59**, 163–171.
- 119** Kern, E.R., Collins, D.J., Wan, W.B., Beadle, J.R., Hostetler, K.Y., and Quenelle, D.C. (2004) Oral treatment of murine cytomegalovirus infections with ether lipid esters of cidofovir. *Antimicrobial Agents and Chemotherapy*, **48**, 3516–3522.
- 120** Painter, G.R. and Hostetler, K.Y. (2004) Design and development of oral drugs for the prophylaxis and treatment of smallpox infection. *Trends in Biotechnology*, **22**, 423–427.
- 121** Ruiz, J.C., Aldern, K.A., Beadle, J.R., Hartline, C.B., Kern, E.R., and Hostetler, K.Y. (2006) Synthesis and antiviral evaluation of alkoxyalkyl esters of phosphonopropoxymethyl-guanine and phosphonopropoxymethyl-diaminopurine. *Antiviral Chemistry & Chemotherapy*, **17**, 89–95.
- 122** Ruiz, J.C., Beadle, J.R., Aldern, K.A., Keith, K.A., Hartline, C.B., Kern, E.R., and Hostetler, K.Y. (2007) Synthesis and antiviral evaluation of alkoxyalkyl-phosphate conjugates of cidofovir and adefovir. *Antiviral Research*, **75**, 87–90.
- 123** Dal Pozzo, F., Andrei, G., Lebeau, I., Beadle, J.R., Hostetler, K.Y., De Clercq, E., and Snoeck, R. (2007) *In vitro* evaluation of the anti-orf virus activity of alkoxyalkyl esters of CDV, cCDV and (S)-HPMPA. *Antiviral Research*, **75**, 52–57.
- 124** Lebeau, I., Andrei, G., Dal Pozzo, F., Beadle, J.R., Hostetler, K.Y., De Clercq, E., van den, O.J., and Snoeck, R. (2006) Activities of alkoxyalkyl esters of cidofovir (CDV), cyclic CDV, and (S)-9-(3-hydroxy-2-phosphonylmethoxypropyl)adenine against orthopoxviruses in cell monolayers and in organotypic cultures. *Antimicrobial Agents and Chemotherapy*, **50**, 2525–2529.
- 125** Beadle, J.R., Wan, W.B., Ciesla, S.L., Keith, K.A., Hartline, C., Kern, E.R., and Hostetler, K.Y. (2006) Synthesis and antiviral evaluation of alkoxyalkyl derivatives of 9-(S)-(3-hydroxy-2-phosphonomethoxypropyl)adenine against cytomegalovirus and orthopoxviruses. *Journal of Medicinal Chemistry*, **49**, 2010–2015.
- 126** De Clercq, E. (2007) The acyclic nucleoside phosphonates from inception to clinical use: historical perspective. *Antiviral Research*, **75**, 1–13.
- 127** De Clercq, E. and Holy, A. (2005) Acyclic nucleoside phosphonates: a key class of antiviral drugs. *Nature Reviews. Drug Discovery*, **4**, 928–940.
- 128** Balzarini, J., Pannecouque, C., Naesens, L., Andrei, G., Snoeck, R., De Clercq, E., Hockova, D., and Holy, A. (2004) 6-[2-Phosphonomethoxy]alkoxy]-2,4-diaminopyrimidines: a new class of acyclic pyrimidine nucleoside phosphonates with antiviral activity. *Nucleosides, Nucleotides & Nucleic Acids*, **23**, 1321–1327.
- 129** Hockova, D., Holy, A., Masojdkova, M., Andrei, G., Snoeck, R., De Clercq, E., and Balzarini, J. (2003) 5-Substituted-2,4-diamino-6-[2-(phosphonomethoxy)ethoxy]pyrimidines-acyclic nucleoside phosphonate analogues with antiviral activity. *Journal of Medicinal Chemistry*, **46**, 5064–5073.
- 130** Hockova, D., Holy, A., Masojdkova, M., Andrei, G., Snoeck, R., De Clercq, E., and

- Balzarini, J. (2004) Synthesis and antiviral activity of 2,4-diamino-5-cyano-6-[2-(phosphonomethoxy)ethoxy]pyrimidine and related compounds. *Bioorganic and Medicinal Chemistry*, **12**, 3197–3202.
- 131 De Clercq, E., Andrei, G., Balzarini, J., Leysen, P., Naesens, L., Neyts, J., Pannecouque, C., Snoeck, R., Ying, C., Hockova, D., and Holy, A. (2005) Antiviral potential of a new generation of acyclic nucleoside phosphonates, the 6-[2-(phosphonomethoxy)alkoxy]-2,4-diaminopyrimidines. *Nucleosides, Nucleotides & Nucleic Acids*, **24**, 331–341.
- 132 Krecmerova, M., Holy, A., Piskala, A., Masojdkova, M., Andrei, G., Naesens, L., Neyts, J., Balzarini, J., De Clercq, E., and Snoeck, R. (2007) Antiviral activity of triazine analogues of 1-(S)-[3-hydroxy-2-(phosphonomethoxy)propyl]cytosine (cidofovir) and related compounds. *Journal of Medicinal Chemistry*, **50**, 1069–1077.
- 133 Krecmerova, M., Holy, A., Pohl, R., Masojdkova, M., Andrei, G., Naesens, L., Neyts, J., Balzarini, J., De Clercq, E., and Snoeck, R. (2007) Ester prodrugs of cyclic 1-(S)-[3-hydroxy-2-(phosphonomethoxy)propyl]-5-azacytosine: synthesis and antiviral activity. *Journal of Medicinal Chemistry*, **50**, 5765–5772.
- 134 Mercorelli, B., Sinigalia, E., Loregian, A., and Palu, G. (2008) Human cytomegalovirus DNA replication: antiviral targets and drugs. *Reviews in Medical Virology*, **18**, 177–210.
- 135 Coen, D.M. and Schaffer, P.A. (2003) Antitherpesvirus drugs: a promising spectrum of new drugs and drug targets. *Nature Reviews. Drug Discovery*, **2**, 278–288.
- 136 Wathen, M.W. (2002) Non-nucleoside inhibitors of herpesviruses. *Reviews in Medical Virology*, **12**, 167–178.
- 137 Chen, X., Adrian, J., Cushing, T., Dimaio, H., Liang, L., Mayorga, V., Miao, S., Peterson, M.G., Powers, J.P., Spector, F., Stein, C., Wright, M., Xu, D., Ye, Q., and Jaen, J. (2007) SAR studies on a novel series of human cytomegalovirus primase inhibitors. *Bioorganic & Medicinal Chemistry Letters*, **17**, 2188–2192.
- 138 Cushing, T.D., Adrian, J., Chen, X., Dimaio, H., Doughan, B., Flygare, J., Liang, L., Mayorga, V., Miao, S., Mellon, H., Peterson, M.G., Powers, J.P., Spector, F., Stein, C., Wright, M., Xu, D., Ye, Q., and Jaen, J. (2006) Discovery of a novel series of inhibitors of human cytomegalovirus primase. *Bioorganic & Medicinal Chemistry Letters*, **16**, 4879–4883.
- 139 Chen, X., Adrian, J., Cushing, T., Dimaio, H., Liang, L., Mayorga, V., Miao, S., Peterson, M.G., Powers, J.P., Spector, F., Stein, C., Wright, M., Xu, D., Ye, Q., and Jaen, J. (2007) SAR studies on a novel series of human cytomegalovirus primase inhibitors. *Bioorganic & Medicinal Chemistry Letters*, **17**, 2188–2192.
- 140 Loregian, A., Sinigalia, E., Mercorelli, B., Palu, G., and Coen, D.M. (2007) Binding parameters and thermodynamics of the interaction of the human cytomegalovirus DNA polymerase accessory protein, UL44, with DNA: implications for the processivity mechanism. *Nucleic Acids Research*, **35**, 4779–4791.
- 141 Loregian, A. and Coen, D.M. (2006) Selective anti-cytomegalovirus compounds discovered by screening for inhibitors of subunit interactions of the viral polymerase. *Chemistry & Biology*, **13**, 191–200.
- 142 Lopez-Ochoa, L., Nash, T.E., Ramirez-Prado, J., and Hanley-Bowdoin, L. (2009) Isolation of peptide aptamers to target protein function. *Methods in Molecular Biology (Clifton, NJ)*, **535**, 333–360.
- 143 Hoppe-Seyler, F., Crnkovic-Mertens, I., Tomai, E., and Butz, K. (2004) Peptide aptamers: specific inhibitors of protein function. *Current Molecular Medicine*, **4**, 529–538.
- 144 Hoppe-Seyler, F. and Butz, K. (2000) Peptide aptamers: powerful new tools for molecular medicine. *Journal of Molecular Medicine (Berlin, Germany)*, **78**, 426–430.
- 145 Kaiser, N., Lischka, P., Wagenknecht, N., and Stamminger, T. (2009) Inhibition of human cytomegalovirus replication via peptide aptamers directed against the nonconventional nuclear localization



- signal of the essential viral replication factor pUL84. *Journal of Virology*, **83**, 11902–11913.
- 146 Gao, Y., Colletti, K., and Pari, G.S. (2008) Identification of human cytomegalovirus UL84 virus- and cell-encoded binding partners by using proteomics analysis. *Journal of Virology*, **82**, 96–104.
- 147 Lischka, P., Sorg, G., Kann, M., Winkler, M., and Stamminger, T. (2003) A nonconventional nuclear localization signal within the UL84 protein of human cytomegalovirus mediates nuclear import via the importin alpha/beta pathway. *Journal of Virology*, **77**, 3734–3748.
- 148 Hannon, G.J. (2002) RNA interference. *Nature*, **418**, 244–251.
- 149 Leonard, J.N. and Schaffer, D.V. (2006) Antiviral RNAi therapy: emerging approaches for hitting a moving target. *Gene Therapy*, **13**, 532–540.
- 150 Silva, J.M., Hammond, S.M., and Hannon, G.J. (2002) RNA interference: a promising approach to antiviral therapy? *Trends in Molecular Medicine*, **8**, 505–508.
- 151 Dykxhoorn, D.M. and Lieberman, J. (2006) Silencing viral infection. *PLoS Medicine*, **3**, e242.
- 152 Wiebusch, L., Truss, M., and Hagemeyer, C. (2004) Inhibition of human cytomegalovirus replication by small interfering RNAs. *The Journal of General Virology*, **85**, 179–184.
- 153 Shin, M.C., Hong, S.K., Yoon, J.S., Park, S.S., Lee, S.G., Lee, D.G., Min, W.S., Shin, W.S., and Paik, S.Y. (2006) Inhibition of UL54 and UL97 genes of human cytomegalovirus by RNA interference. *Acta Virologica*, **50**, 263–268.
- 154 Reefschaeger, J., Bender, W., Hallenberger, S., Weber, O., Eckenberg, P., Goldmann, S., Haerter, M., Buerger, I., Trappe, J., Herrington, J.A., Haebich, D., and Ruebsamen-Waigmann, H. (2001) Novel non-nucleoside inhibitors of cytomegaloviruses (BAY 38-4766): *in vitro* and *in vivo* antiviral activity and mechanism of action. *The Journal of Antimicrobial Chemotherapy*, **48**, 757–767.
- 155 Buerger, I., Reefschaeger, J., Bender, W., Eckenberg, P., Popp, A., Weber, O., Graeper, S., Klenk, H.D., Ruebsamen-Waigmann, H., and Hallenberger, S. (2001) A novel nonnucleoside inhibitor specifically targets cytomegalovirus DNA maturation via the UL89 and UL56 gene products. *Journal of Virology*, **75**, 9077–9086.
- 156 Bogner, E. (2002) Human cytomegalovirus terminase as a target for antiviral chemotherapy. *Reviews in Medical Virology*, **12**, 115–127.
- 157 Reefschaeger, J., Bender, W., Hallenberger, S., Weber, O., Eckenberg, P., Goldmann, S., Haerter, M., Buerger, I., Trappe, J., Herrington, J.A., Haebich, D., and Ruebsamen-Waigmann, H. (2001) Novel non-nucleoside inhibitors of cytomegaloviruses (BAY 38-4766): *in vitro* and *in vivo* antiviral activity and mechanism of action. *The Journal of Antimicrobial Chemotherapy*, **48**, 757–767.
- 158 McSharry, J.J., McDonough, A., Olson, B., Hallenberger, S., Reefschaeger, J., Bender, W., and Drusano, G.L. (2001) Susceptibilities of human cytomegalovirus clinical isolates to BAY38-4766, BAY43-9695, and ganciclovir. *Antimicrobial Agents and Chemotherapy*, **45**, 2925–2927.
- 159 Townsend, L.B., Devivar, R.V., Turk, S.R., Nassiri, M.R., and Drach, J.C. (1995) Design, synthesis, and antiviral activity of certain 2,5,6-trihalo-1-(beta-D-ribofuranosyl)benzimidazoles. *Journal of Medicinal Chemistry*, **38**, 4098–4105.
- 160 Underwood, M.R., Harvey, R.J., Stanat, S.C., Hemphill, M.L., Miller, T., Drach, J.C., Townsend, L.B., and Biron, K.K. (1998) Inhibition of human cytomegalovirus DNA maturation by a benzimidazole ribonucleoside is mediated through the UL89 gene product. *Journal of Virology*, **72**, 717–725.
- 161 Underwood, M.R., Harvey, R.J., Stanat, S.C., Hemphill, M.L., Miller, T., Drach, J.C., Townsend, L.B., and Biron, K.K. (1998) Inhibition of human cytomegalovirus DNA maturation by a benzimidazole ribonucleoside is mediated through the UL89 gene product. *Journal of Virology*, **72**, 717–725.
- 162 Krosky, P.M., Underwood, M.R., Turk, S.R., Feng, K.W., Jain, R.K., Ptak, R.G., Westerman, A.C., Biron, K.K., Townsend, L.B., and Drach, J.C. (1998) Resistance of

- human cytomegalovirus to benzimidazole ribonucleosides maps to two open reading frames: UL89 and UL56. *Journal of Virology*, **72**, 4721–4728.
- 163 Dittmer, A. and Bogner, E. (2005) Analysis of the quaternary structure of the putative HCMV portal protein PUL104. *Biochemistry*, **44**, 759–765.
- 164 Dittmer, A., Drach, J.C., Townsend, L.B., Fischer, A., and Bogner, E. (2005) Interaction of the putative human cytomegalovirus portal protein pUL104 with the large terminase subunit pUL56 and its inhibition by benzimidazole-*D*-ribonucleosides. *Journal of Virology*, **79**, 14660–14667.
- 165 Underwood, M.R., Ferris, R.G., Selleseth, D.W., Davis, M.G., Drach, J.C., Townsend, L.B., Biron, K.K., and Boyd, F.L. (2004) Mechanism of action of the ribopyranoside benzimidazole GW275175X against human cytomegalovirus. *Antimicrobial Agents and Chemotherapy*, **48**, 1647–1651.
- 166 Lischka, P., Hewlett, G., Wunberg, T., Baumeister, J., Paulsen, D., Goldner, T., Ruebsamen-Schaeff, H., and Zimmermann, H. (2010) *In vitro* and *in vivo* activities of the novel anticytomegalovirus compound AIC246. *Antimicrobial Agents and Chemotherapy*, **54**, 1290–1297.
- 167 Zimmermann, H., Stoelben, S., Kroppeit, D., Lischka, P., Detlef, M., Renders, L., Budde, K., Goldner, T., Arns, W., and Ruebsamen-Schaeff, H. (2010) Overview on clinical trials and resistance breaking activity of the anti-cytomegalovirus compound AIC246. *Antiviral Research*, **86**, A78–A79.
- 168 Krosky, P.M., Baek, M.C., and Coen, D.M. (2003) The human cytomegalovirus UL97 protein kinase, an antiviral drug target, is required at the stage of nuclear egress. *Journal of Virology*, **77**, 905–914.
- 169 Biron, K.K., Harvey, R.J., Chamberlain, S.C., Good, S.S., Smith, A.A., III, Davis, M.G., Talarico, C.L., Miller, W.H., Ferris, R., Dornsife, R.E., Stanat, S.C., Drach, J.C., Townsend, L.B., and Koszalka, G.W. (2002) Potent and selective inhibition of human cytomegalovirus replication by 1263W94, a benzimidazole *L*-riboside with a unique mode of action. *Antimicrobial Agents and Chemotherapy*, **46**, 2365–2372.
- 170 Chou, S., Wechel, L.C., and Marousek, G.I. (2007) Cytomegalovirus UL97 kinase mutations that confer maribavir resistance. *The Journal of Infectious Diseases*, **196**, 91–94.
- 171 Chou, S. (2008) Cytomegalovirus UL97 mutations in the era of ganciclovir and maribavir. *Reviews in Medical Virology*, **18**, 233–246.
- 172 Biron, K.K., Harvey, R.J., Chamberlain, S.C., Good, S.S., Smith, A.A., III, Davis, M.G., Talarico, C.L., Miller, W.H., Ferris, R., Dornsife, R.E., Stanat, S.C., Drach, J.C., Townsend, L.B., and Koszalka, G.W. (2002) Potent and selective inhibition of human cytomegalovirus replication by 1263W94, a benzimidazole *L*-riboside with a unique mode of action. *Antimicrobial Agents and Chemotherapy*, **46**, 2365–2372.
- 173 Krosky, P.M., Baek, M.C., and Coen, D.M. (2003) The human cytomegalovirus UL97 protein kinase, an antiviral drug target, is required at the stage of nuclear egress. *Journal of Virology*, **77**, 905–914.
- 174 Prichard, M.N. (2009) Function of human cytomegalovirus UL97 kinase in viral infection and its inhibition by maribavir. *Reviews in Medical Virology*, **19**, 215–229.
- 175 Krosky, P.M., Baek, M.C., Jahng, W.J., Barrera, I., Harvey, R.J., Biron, K.K., Coen, D.M., and Sethna, P.B. (2003) The human cytomegalovirus UL44 protein is a substrate for the UL97 protein kinase. *Journal of Virology*, **77**, 7720–7727.
- 176 Chevillotte, M., Landwehr, S., Linta, L., Frascaroli, G., Luske, A., Buser, C., Mertens, T., and von Einem, J. (2009) Major tegument protein pp65 of human cytomegalovirus is required for the incorporation of pUL69 and pUL97 into the virus particle and for viral growth in macrophages. *Journal of Virology*, **83**, 2480–2490.
- 177 Kawaguchi, Y., Matsumura, T., Roizman, B., and Hirai, K. (1999) Cellular elongation factor 1delta is modified in cells infected with representative alpha-, beta-, or gammaherpesviruses. *Journal of Virology*, **73**, 4456–4460.

- 178 Baek, M.C., Krosky, P.M., Pearson, A., and Coen, D.M. (2004) Phosphorylation of the RNA polymerase II carboxyl-terminal domain in human cytomegalovirus-infected cells and *in vitro* by the viral UL97 protein kinase. *Virology*, **324**, 184–193.
- 179 Prichard, M.N., Sztul, E., Daily, S.L., Perry, A.L., Frederick, S.L., Gill, R.B., Hartline, C.B., Strelow, D.N., Varnum, S.M., Smith, R.D., and Kern, E.R. (2008) Human cytomegalovirus UL97 kinase activity is required for the hyperphosphorylation of retinoblastoma protein and inhibits the formation of nuclear aggresomes. *Journal of Virology*, **82**, 5054–5067.
- 180 Hamirally, S., Kamil, J.P., Ndassa-Colday, Y.M., Lin, A.J., Jahng, W.J., Baek, M.C., Noton, S., Silva, L.A., Simpson-Holley, M., Knipe, D.M., Golan, D.E., Marto, J.A., and Coen, D.M. (2009) Viral mimicry of Cdc2/cyclin-dependent kinase 1 mediates disruption of nuclear lamina during human cytomegalovirus nuclear egress. *PLoS Pathogens*, **5**, e1000275.
- 181 Wolf, D.G., Courcelle, C.T., Prichard, M.N., and Mocarski, E.S. (2001) Distinct and separate roles for herpesvirus-conserved UL97 kinase in cytomegalovirus DNA synthesis and encapsidation. *Proceedings of the National Academy of Sciences of the United States of America*, **98**, 1895–1900.
- 182 Chou, S. and Marousek, G.I. (2006) Maribavir antagonizes the antiviral action of ganciclovir on human cytomegalovirus. *Antimicrobial Agents and Chemotherapy*, **50**, 3470–3472.
- 183 Komazin, G., Ptak, R.G., Emmer, B.T., Townsend, L.B., and Drach, J.C. (2003) Resistance of human cytomegalovirus to the benzimidazole  $\gamma$ -ribonucleoside maribavir maps to UL27. *Journal of Virology*, **77**, 11499–11506.
- 184 Chou, S. (2009) Diverse cytomegalovirus UL27 mutations adapt to loss of viral UL97 kinase activity under maribavir. *Antimicrobial Agents and Chemotherapy*, **53**, 81–85.
- 185 Drew, W.L., Miner, R.C., Marousek, G.I., and Chou, S. (2006) Maribavir sensitivity of cytomegalovirus isolates resistant to ganciclovir, cidofovir or foscarnet. *Journal of Clinical Virology*, **37**, 124–127.
- 186 Trofe, J., Pote, L., Wade, E., Blumberg, E., and Bloom, R.D. (2008) Maribavir: a novel antiviral agent with activity against cytomegalovirus. *The Annals of Pharmacotherapy*, **42**, 1447–1457.
- 187 Lalezari, J.P., Aberg, J.A., Wang, L.H., Wire, M.B., Miner, R., Snowden, W., Talarico, C.L., Shaw, S., Jacobson, M.A., and Drew, W.L. (2002) Phase I dose escalation trial evaluating the pharmacokinetics, anti-human cytomegalovirus (HCMV) activity, and safety of 1263W94 in human immunodeficiency virus-infected men with asymptomatic HCMV shedding. *Antimicrobial Agents and Chemotherapy*, **46**, 2969–2976.
- 188 Winston, D.J., Young, J.A., Pullarkat, V., Papanicolaou, G.A., Vij, R., Vance, E., Alangaden, G.J., Chemaly, R.F., Petersen, F., Chao, N., Klein, J., Sprague, K., Villano, S.A., and Boeckh, M. (2008) Maribavir prophylaxis for prevention of cytomegalovirus infection in allogeneic stem cell transplant recipients: a multicenter, randomized, double-blind, placebo-controlled, dose-ranging study. *Blood*, **111**, 5403–5410.
- 189 Zimmermann, A., Wilts, H., Lenhardt, M., Hahn, M., and Mertens, T. (2000) Indolocarbazoles exhibit strong antiviral activity against human cytomegalovirus and are potent inhibitors of the pUL97 protein kinase. *Antiviral Research*, **48**, 49–60.
- 190 Marschall, M., Stein-Gerlach, M., Freitag, M., Kupfer, R., van den, B.M., and Stamminger, T. (2002) Direct targeting of human cytomegalovirus protein kinase pUL97 by kinase inhibitors is a novel principle for antiviral therapy. *The Journal of General Virology*, **83**, 1013–1023.
- 191 Herget, T., Freitag, M., Morbitzer, M., Kupfer, R., Stamminger, T., and Marschall, M. (2004) Novel chemical class of pUL97 protein kinase-specific inhibitors with strong anticytomegaloviral activity. *Antimicrobial Agents and Chemotherapy*, **48**, 4154–4162.
- 192 Herget, T., Freitag, M., Morbitzer, M., Kupfer, R., Stamminger, T., and

- Marschall, M. (2004) Novel chemical class of pUL97 protein kinase-specific inhibitors with strong anticytomegaloviral activity. *Antimicrobial Agents and Chemotherapy*, **48**, 4154–4162.
- 193 Qiu, X., Culp, J.S., DiLella, A.G., Hellmig, B., Hoog, S.S., Janson, C.A., Smith, W.W., and Abdel-Meguid, S.S. (1996) Unique fold and active site in cytomegalovirus protease. *Nature*, **383**, 275–279.
- 194 Chen, P., Tsuge, H., Almasy, R.J., Gribskov, C.L., Katoh, S., Vanderpool, D.L., Margosiak, S.A., Pinko, C., Matthews, D.A., and Kan, C.C. (1996) Structure of the human cytomegalovirus protease catalytic domain reveals a novel serine protease fold and catalytic triad. *Cell*, **86**, 835–843.
- 195 Flynn, D.L., Abood, N.A., and Holwerda, B.C. (1997) Recent advances in antiviral research: identification of inhibitors of the herpesvirus proteases. *Current Opinion in Chemical Biology*, **1**, 190–196.
- 196 Wathen, M.W. (2002) Non-nucleoside inhibitors of herpesviruses. *Reviews in Medical Virology*, **12**, 167–178.
- 197 Borthwick, A.D., Davies, D.E., Ertl, P.F., Exall, A.M., Haley, T.M., Hart, G.J., Jackson, D.L., Parry, N.R., Patikis, A., Trivedi, N., Weingarten, G.G., and Woolven, J.M. (2002) Design and synthesis of pyrrolidine-5,5'-trans-lactams (5-oxo-hexahydropyrrolo[3,2-b]pyrroles) as novel mechanism-based inhibitors of human cytomegalovirus protease. 2. Potency and chirality. *Journal of Medicinal Chemistry*, **45**, 1–18.
- 198 Borthwick, A.D., Davies, D.E., Ertl, P.F., Exall, A.M., Haley, T.M., Hart, G.J., Jackson, D.L., Parry, N.R., Patikis, A., Trivedi, N., Weingarten, G.G., and Woolven, J.M. (2003) Design and synthesis of pyrrolidine-5,5'-trans-lactams (5-oxo-hexahydropyrrolo[3,2-b]pyrroles) as novel mechanism-based inhibitors of human cytomegalovirus protease. 4. Antiviral activity and plasma stability. *Journal of Medicinal Chemistry*, **46**, 4428–4449.
- 199 Borthwick, A.D. (2005) Design of trans-lactam HCMV protease inhibitors as potent antivirals. *Medicinal Research Reviews*, **25**, 427–452.
- 200 Gerona-Navarro, G., Perez d, V., Garcia-Lopez, M.T., Andrei, G., Snoeck, R., Balzarini, J., De Clercq, E., and Gonzalez-Muniz, R. (2004) Synthesis and anti-HCMV activity of 1-acyl-beta-lactams and 1-acylazetidines derived from phenylalanine. *Bioorganic & Medicinal Chemistry Letters*, **14**, 2253–2256.
- 201 Gerona-Navarro, G., Perez d, V., Garcia-Lopez, M.T., Andrei, G., Snoeck, R., De Clercq, E., Balzarini, J., and Gonzalez-Muniz, R. (2005) From 1-acyl-beta-lactam human cytomegalovirus protease inhibitors to 1-benzyloxycarbonylazetidines with improved antiviral activity. A straightforward approach to convert covalent to noncovalent inhibitors. *Journal of Medicinal Chemistry*, **48**, 2612–2621.
- 202 Hulshof, J.W., Casarosa, P., Menge, W.M., Kuusisto, L.M., van der, G.H., Smit, M.J., de Esch, I.J., and Leurs, R. (2005) Synthesis and structure–activity relationship of the first nonpeptidic inverse agonists for the human cytomegalovirus encoded chemokine receptor US28. *Journal of Medicinal Chemistry*, **48**, 6461–6471.
- 203 Hulshof, J.W., Vischer, H.F., Verheij, M.H., Fratantoni, S.A., Smit, M.J., de Esch, I.J., and Leurs, R. (2006) Synthesis and pharmacological characterization of novel inverse agonists acting on the viral-encoded chemokine receptor US28. *Bioorganic and Medicinal Chemistry*, **14**, 7213–7230.
- 204 Snoeck, R., Andrei, G., Bodaghi, B., Lagneaux, L., Daelemans, D., De Clercq, E., Neyts, J., Schols, D., Naesens, L., Michelson, S., Bron, D., Otto, M.J., Bousseau, A., Nemecek, C., and Roy, C. (2002) 2-Chloro-3-pyridin-3-yl-5,6,7,8-tetrahydroindolizine-1-carboxamide (CMV423), a new lead compound for the treatment of human cytomegalovirus infections. *Antiviral Research*, **55**, 413–424.
- 205 De Bolle, L., Andrei, G., Snoeck, R., Zhang, Y., Van Lommel, A., Otto, M., Bousseau, A., Roy, C., De Clercq, E., and Naesens, L. (2004) Potent, selective and cell-mediated inhibition of human herpesvirus 6 at an early stage of viral replication by the non-nucleoside

- compound CMV423. *Biochemical Pharmacology*, **67**, 325–336.
- 206 Hayashi, K., Minoda, K., Nagaoka, Y., Hayashi, T., and Uesato, S. (2007) Antiviral activity of berberine and related compounds against human cytomegalovirus. *Bioorganic & Medicinal Chemistry Letters*, **17**, 1562–1564.
- 207 Naesens, L., Stephens, C.E., Andrei, G., Loregian, A., De Bolle, L., Snoeck, R., Sowell, J.W., and De Clercq, E. (2006) Antiviral properties of new arylsulfone derivatives with activity against human betaherpesviruses. *Antiviral Research*, **72**, 60–67.
- 208 McGuigan, C., Pathirana, R.N., Snoeck, R., Andrei, G., De Clercq, E., and Balzarini, J. (2004) Discovery of a new family of inhibitors of human cytomegalovirus (HCMV) based upon lipophilic alkyl furano pyrimidine dideoxy nucleosides: action via a novel non-nucleosidic mechanism. *Journal of Medicinal Chemistry*, **47**, 1847–1851.
- 209 de Castro, S., Peromingo, M.T., Naesens, L., Andrei, G., Snoeck, R., Balzarini, J., Velazquez, S., and Camarasa, M.J. (2008) 4''-Benzoylureido-TSAO derivatives as potent and selective non-nucleoside HCMV inhibitors. Structure–activity relationship and mechanism of antiviral action. *Journal of Medicinal Chemistry*, **51**, 5823–5832.
- 210 Prakash, A. and Jarvis, B. (1999) Leflunomide: a review of its use in active rheumatoid arthritis. *Drugs*, **58**, 1137–1164.
- 211 Williams, J.W., Mital, D., Chong, A., Kottayil, A., Millis, M., Longstreth, J., Huang, W., Brady, L., and Jensik, S. (2002) Experiences with leflunomide in solid organ transplantation. *Transplantation*, **73**, 358–366.
- 212 Elder, R.T., Xu, X., Williams, J.W., Gong, H., Finnegan, A., and Chong, A.S. (1997) The immunosuppressive metabolite of leflunomide, A77 1726, affects murine T cells through two biochemical mechanisms. *Journal of Immunology (Baltimore, MD: 1950)*, **159**, 22–27.
- 213 Xu, X., Williams, J.W., Gong, H., Finnegan, A., and Chong, A.S. (1996) Two activities of the immunosuppressive metabolite of leflunomide, A77 726. Inhibition of pyrimidine nucleotide synthesis and protein tyrosine phosphorylation. *Biochemical Pharmacology*, **52**, 527–534.
- 214 Waldman, W.J., Knight, D.A., Lurain, N.S., Miller, D.M., Sedmak, D.D., Williams, J.W., and Chong, A.S. (1999) Novel mechanism of inhibition of cytomegalovirus by the experimental immunosuppressive agent leflunomide. *Transplantation*, **68**, 814–825.
- 215 Knight, D.A., Hejmanowski, A.Q., Dierksheide, J.E., Williams, J.W., Chong, A.S., and Waldman, W.J. (2001) Inhibition of herpes simplex virus type 1 by the experimental immunosuppressive agent leflunomide. *Transplantation*, **71**, 170–174.
- 216 Evers, D.L., Wang, X., Huong, S.M., Andreoni, K.A., and Huang, E.S. (2005) Inhibition of human cytomegalovirus signaling and replication by the immunosuppressant FK778. *Antiviral Research*, **65**, 1–12.
- 217 Chong, A.S., Zeng, H., Knight, D.A., Shen, J., Meister, G.T., Williams, J.W., and Waldman, W.J. (2006) Concurrent antiviral and immunosuppressive activities of leflunomide *in vivo*. *American Journal of Transplantation*, **6**, 69–75.
- 218 Avery, R.K., Bolwell, B.J., Yen-Lieberman, B., Lurain, N., Waldman, W.J., Longworth, D.L., Taeye, A.J., Mossad, S.B., Kohn, D., Long, J.R., Curtis, J., Kalaycio, M., Pohlman, B., and Williams, J.W. (2004) Use of leflunomide in an allogeneic bone marrow transplant recipient with refractory cytomegalovirus infection. *Bone Marrow Transplantation*, **34**, 1071–1075.
- 219 John, G.T., Manivannan, J., Chandy, S., Peter, S., Fleming, D.H., Chandy, S.J., Balakrishnan, N., Krishnamurthy, K., Kirubakaran, M.G., and Jacob, C.K. (2005) A prospective evaluation of leflunomide therapy for cytomegalovirus disease in renal transplant recipients. *Transplantation Proceedings*, **37**, 4303–4305.
- 220 Sudarsanam, T.D., Sahni, R.D., and John, G.T. (2006) Leflunomide: a possible alternative for gangciclovir sensitive and

- resistant cytomegalovirus infections. *Postgraduate Medical Journal*, **82**, 313–314.
- 221 Avery, R.K. (2008) Update in management of ganciclovir-resistant cytomegalovirus infection. *Current Opinion in Infectious Diseases*, **21**, 433–437.
- 222 Araya, C.E., Garin, E.H., Neiberger, R.E., and Dharnidharka, V.R. (2010) Leflunomide therapy for BK virus allograft nephropathy in pediatric and young adult kidney transplant recipients. *Pediatric Transplantation*, **14**, 145–150.
- 223 Wu, J.K. and Harris, M.T. (2008) Use of leflunomide in the treatment of polyomavirus BK-associated nephropathy. *The Annals of Pharmacotherapy*, **42**, 1679–1685.
- 224 Efferth, T., Romero, M.R., Wolf, D.G., Stamminger, T., Marin, J.J., and Marschall, M. (2008) The antiviral activities of artemisinin and artesunate. *Clinical Infectious Diseases*, **47**, 804–811.
- 225 Kaptein, S.J., Efferth, T., Leis, M., Rechter, S., Auerochs, S., Kalmer, M., Bruggeman, C.A., Vink, C., Stamminger, T., and Marschall, M. (2006) The anti-malaria drug artesunate inhibits replication of cytomegalovirus *in vitro* and *in vivo*. *Antiviral Research*, **69**, 60–69.
- 226 Efferth, T., Marschall, M., Wang, X., Huong, S.M., Hauber, I., Olbrich, A., Kronschnabl, M., Stamminger, T., and Huang, E.S. (2002) Antiviral activity of artesunate towards wild-type, recombinant, and ganciclovir-resistant human cytomegaloviruses. *Journal of Molecular Medicine (Berlin, Germany)*, **80**, 233–242.
- 227 Shapira, M.Y., Resnick, I.B., Chou, S., Neumann, A.U., Lurain, N.S., Stamminger, T., Caplan, O., Saleh, N., Efferth, T., Marschall, M., and Wolf, D.G. (2008) Artesunate as a potent antiviral agent in a patient with late drug-resistant cytomegalovirus infection after hematopoietic stem cell transplantation. *Clinical Infectious Diseases*, **46**, 1455–1457.
- 228 Arav-Boger, R., He, R., Chiou, C.J., Liu, J., Woodard, L., Rosenthal, A., Jones-Brando, L., Forman, M., and Posner, G. (2010) Artemisinin-derived dimers have greatly improved anti-cytomegalovirus activity compared to artemisinin monomers. *PLoS One*, **5**, e10370.
- 229 Schang, L.M. (2002) Cyclin-dependent kinases as cellular targets for antiviral drugs. *The Journal of Antimicrobial Chemotherapy*, **50**, 779–792.
- 230 Schang, L.M., St Vincent, M.R., and Lacasse, J.J. (2006) Five years of progress on cyclin-dependent kinases and other cellular proteins as potential targets for antiviral drugs. *Antiviral Chemistry & Chemotherapy*, **17**, 293–320.
- 231 Guendel, I., Agbottah, E.T., Kehn-Hall, K., and Kashanchi, F. (2010) Inhibition of human immunodeficiency virus type-1 by cdk inhibitors. *AIDS Research and Therapy*, **7**, 7.
- 232 Orba, Y., Sunden, Y., Suzuki, T., Nagashima, K., Kimura, T., Tanaka, S., and Sawa, H. (2008) Pharmacological cdk inhibitor R-Roscovitine suppresses JC virus proliferation. *Virology*, **370**, 173–183.
- 233 Sanchez, V., McElroy, A.K., Yen, J., Tamrakar, S., Clark, C.L., Schwartz, R.A., and Spector, D.H. (2004) Cyclin-dependent kinase activity is required at early times for accurate processing and accumulation of the human cytomegalovirus UL122-123 and UL137 immediate-early transcripts and at later times for virus production. *Journal of Virology*, **78**, 11219–11232.
- 234 Sanchez, V. and Spector, D.H. (2006) Cyclin-dependent kinase activity is required for efficient expression and posttranslational modification of human cytomegalovirus proteins and for production of extracellular particles. *Journal of Virology*, **80**, 5886–5896.
- 235 Sanchez, V. and Spector, D.H. (2006) Cyclin-dependent kinase activity is required for efficient expression and posttranslational modification of human cytomegalovirus proteins and for production of extracellular particles. *Journal of Virology*, **80**, 5886–5896.
- 236 Hertel, L. and Mocarski, E.S. (2004) Global analysis of host cell gene expression late during cytomegalovirus infection reveals extensive dysregulation

- of cell cycle gene expression and induction of pseudomitosis independent of US28 function. *Journal of Virology*, **78**, 11988–12011.
- 237 Hertel, L., Chou, S., and Mocarski, E.S. (2007) Viral and cell cycle-regulated kinases in cytomegalovirus-induced pseudomitosis and replication. *PLoS Pathogens*, **3**, e6.
- 238 Schang, L.M. (2006) First demonstration of the effectiveness of inhibitors of cellular protein kinases in antiviral therapy. *Expert Review of Anti-Infective Therapy*, **4**, 953–956.
- 239 Yang, H., Kim, S.K., Kim, M., Reche, P.A., Morehead, T.J., Damon, I.K., Welsh, R.M., and Reinherz, E.L. (2005) Antiviral chemotherapy facilitates control of poxvirus infections through inhibition of cellular signal transduction. *The Journal of Clinical Investigation*, **115**, 379–387.
- 240 Reeves, P.M., Bommarius, B., Lebeis, S., McNulty, S., Christensen, J., Swimm, A., Chahroudi, A., Chavan, R., Feinberg, M.B., Veach, D., Bornmann, W., Sherman, M., and Kalman, D. (2005) Disabling poxvirus pathogenesis by inhibition of Abl-family tyrosine kinases. *Nature Medicine*, **11**, 731–739.
- 241 Rowe, J., Greenblatt, R.J., Liu, D., and Moffat, J.F. (2010) Compounds that target host cell proteins prevent varicella-zoster virus replication in culture, *ex vivo*, and in SCID-Hu mice. *Antiviral Research*, **86**, 276–285.
- 242 Koon, H.B., Buble, G.J., Pantanowitz, L., Masiello, D., Smith, B., Crosby, K., Proper, J., Weeden, W., Miller, T.E., Chatis, P., Egorin, M.J., Tahan, S.R., and Dezube, B.J. (2005) Imatinib-induced regression of AIDS-related Kaposi's sarcoma. *Journal of Clinical Oncology*, **23**, 982–989.
- 243 DeFilippis, V., Raggo, C., Moses, A., and Fruh, K. (2003) Functional genomics in virology and antiviral drug discovery. *Trends in Biotechnology*, **21**, 452–457.
- 244 Browne, E.P., Wing, B., Coleman, D., and Shenk, T. (2001) Altered cellular mRNA levels in human cytomegalovirus-infected fibroblasts: viral block to the accumulation of antiviral mRNAs. *Journal of Virology*, **75**, 12319–12330.
- 245 Zhu, H., Cong, J.P., Yu, D., Bresnahan, W.A., and Shenk, T.E. (2002) Inhibition of cyclooxygenase 2 blocks human cytomegalovirus replication. *Proceedings of the National Academy of Sciences of the United States of America*, **99**, 3932–3937.
- 246 Coux, O., Tanaka, K., and Goldberg, A.L. (1996) Structure and functions of the 20S and 26S proteasomes. *Annual Review of Biochemistry*, **65**, 801–847.
- 247 Rivett, A.J. and Gardner, R.C. (2000) Proteasome inhibitors: from *in vitro* uses to clinical trials. *Journal of Peptide Science*, **6**, 478–488.
- 248 Goldberg, A.L. and Rock, K. (2002) Not just research tools: proteasome inhibitors offer therapeutic promise. *Nature Medicine*, **8**, 338–340.
- 249 Prosch, S., Priemer, C., Hoflich, C., Liebentaf, C., Babel, N., Kruger, D.H., and Volk, H.D. (2003) Proteasome inhibitors: a novel tool to suppress human cytomegalovirus replication and virus-induced immune modulation. *Antiviral Therapy*, **8**, 555–567.
- 250 La Frazia, S., Amici, C., and Santoro, M.G. (2006) Antiviral activity of proteasome inhibitors in herpes simplex virus-1 infection: role of nuclear factor-kappaB. *Antiviral Therapy*, **11**, 995–1004.

## 11

# Lethal Mutagenesis as an Unconventional Approach to Combat HIV

*Pinar Iyidogan and Karen S. Anderson*

### 11.1

#### Introduction

HIV is the causative agent of the acquired immunodeficiency syndrome (AIDS) that targets human immune system [1]. In 2008, an estimated 33.4 million people lived with HIV and 2 million AIDS-related deaths occurred worldwide [2]. For more than two decades, extensive research has been invested into discovering anti-HIV drugs resulting in 25 FDA approved drugs with different modes of action [3]. Today, these drugs are prescribed as multidrug regimens known as highly active antiretroviral therapy (HAART). A cornerstone of antiviral therapy, especially for treating AIDS, is the use of nucleoside analogues as drugs that inhibit the viral polymerase, HIV-1 reverse transcriptase (RT), by halting DNA replication. These nucleoside analogues lack a 3'-hydroxyl group required for primer extension thereby resulting in chain termination of DNA synthesis.

Although the anti-HIV drugs reduce morbidity and mortality rates in patients, the virus easily develops resistance via rapid mutagenesis, in turn raising problems with prevention and treatment of HIV infection [4, 5]. Most importantly, accumulation of resistance mutations within the newly emerged highly resistant progeny could lead to a dramatic failure in combination drug therapy [6] and compels researchers to develop new therapeutics and novel strategies for eradication of the virus.

In principle, the lack of a proofreading mechanism in RNA viruses and retroviruses initiates substitutions that would easily establish resistance against antiviral drugs [7–9]. Considerable experimental evidence suggests that high mutation rates in virus populations have powered their rapid evolution [10]. However, a promising new strategy, known as lethal mutagenesis, has been explored with the idea that this essential ability could turn against the virus fitness while laying the foundation to eliminate HIV. This approach represents a paradigm shift from nucleoside analogues that are chain terminators of viral DNA replication.

Lethal mutagenesis is specifically designed to elevate the mutation rates of the highly error-prone virus during replication above the error threshold such that the viability diminishes, hence the virus eventually extinguishes [11]. Earlier efforts



using lethal mutagenesis as a therapeutic target have been summarized [12]. This chapter updates this topic and focuses on the lethal mutagenesis as a potential cure or treatment strategy for viral infections. Published data on several mutagenic nucleoside analogues and their clinical applications against various viruses are summarized. We also discuss the advantages and challenges of this novel antiviral strategy while proposing possible improvements via combining innovative nanotechnology and decades-old drugs to tackle HIV or any viral disease.

## 11.2

### Viral Fitness and Intrinsic Mutagenesis in RNA Viruses and Retroviruses

Mutation frequency and the rate of genetic diversification play an important role in the evolution and adaptation of viruses [13]. Since the limited sequence space in a small viral genome is responsible for encoding multiple functions, only one or a few mutations might be sufficient to alter the phenotype of an RNA virus [14]. Evolution studies suggest that mutation rates of RNA viruses vary depending on the sequence diversity at the DNA level and environmental conditions that would accelerate the adaptation by fitness gains [15]. The primary cause for the high mutation rate is both the lack of efficient proofreading activity and the absence of postreplicative repair mechanisms associated with RNA polymerases and reverse transcriptases during the viral genome replication [16, 17]. Furthermore, environmental changes such as intracellular nucleotide concentrations, the presence of mutagens, and so on might affect the overall fidelity of the replication process.

In addition to generating high variations in the viral genome, the high mutation rate of RNA viruses is critical from an evolutionary perspective since the mutation rate reaches to an extreme value, a concept known as error threshold, which could sustain viable and infectious progeny [18, 19]. Beyond this theoretical threshold, intolerable deleterious mutations occur after each replication cycle and the fitness of viral genome would diminish irreversibly until that population undergoes extinction. The loss of viral propagation is referred to as error catastrophe [20]. Even though replicating near the error threshold appears to be extremely risky, RNA viruses turn this evolutionary strategy into a useful tool for adapting beneficial mutations when the environmental conditions change drastically.

RNA viruses tend to have mutation rates in the range of  $10^{-3}$  and  $10^{-5}$  substitutions per nucleotide per replication cycle [21, 22]. Since the size of a viral RNA genome is approximately  $\sim 10^3$ – $10^5$ , one mutation will likely occur after the first round of replication. Thus, as a rule, individual genomes in a virus population will give rise to one or more nucleotide changes that will differ from the consensus sequence of viral population. The formation of such heterogeneous populations is termed as viral quasispecies introduced initially by Eigen and Schuster [23–25]. The concept of quasispecies as a genetic organization has linked the evolutionary trajectory of RNA viruses and viral pathology [26, 27]. More insight into this theory revealed that the constant distribution of altered quasispecies is closely associated with oxidative stress, nutritional imbalances, and cellular modifications and that

enhancement of viral mutagenesis above the error threshold might have a potential application in medicine [28–30].

HIV is a member of the retrovirus family that shares the same inherent evolutionary tactic, and the average mutation rate is approximately  $\sim 5 \times 10^{-5}$  per nucleotide per replication cycle for the whole virus genome, which is also comparable to other retroviruses and about  $10^6$ -fold more than eukaryotic cells [31, 32]. Extensive sequence analyses of several HIV-1 isolates reveal significant genetic variations among different individuals [33–36]. Moreover, some of the clonal analyses indicate simultaneous coexistence of multiple subclasses of variants in HIV-1-infected individuals and a connection between dominant genotype fluctuations and disease progression [37–39]. These findings underscore the widely accepted phenomena that retroviruses and RNA viruses exist as combinations of genetically distinct subtypes and thus various phenotypes, which exhibit different pathophysiological properties [40].

The fidelity of HIV-1 RT plays a major role in determining the rate at which mutations occur during the two distinct polymerization steps: minus-strand DNA synthesis from an RNA template and plus-strand DNA synthesis from a DNA template. Host RNA polymerase II also contributes to the overall mutations in HIV-1 genome by catalyzing the plus-strand RNA synthesis [7]. *In vitro* measurements of RT fidelity indicate that *de novo* mutations are generated in the course of error-prone DNA synthesis while generating base substitutions, frame shifts, genetic rearrangements, and hypermutations [41, 42]. Other *in vitro* studies using presteady-state kinetics have shown that HIV RT exhibits a higher fidelity during RNA-directed DNA synthesis relative to DNA-directed DNA synthesis [43]. The accuracy of HIV RT is substantially low compared to the cellular DNA polymerases due to the absence of  $3' \rightarrow 5'$  exonucleolytic proofreading activity [44, 45]. As a result, it has been assumed that cellular replicative DNA polymerases contribute rarely to the genetic variety of actively replicating retroviruses [46]. While HIV RT primarily produces most of the mutations, RNA polymerase II becomes a secondary error source to a lesser extent during viral replication [47–49]. Other error sources can be listed such as fluctuations in cellular nucleotide pools and incorporation of damaged nucleotides with a consecutive misincorporation across the damaged nucleotide by RT [50–52].

More recently, the cellular enzyme APOBEC3G has been shown to generate G-to-A hypermutations in newly synthesized HIV-1 DNA via deaminating cytosines to uracils in minus-strand DNA during reverse transcription [53–55]. Therefore, APOBEC3G is a critical element of an innate defense mechanism against HIV-1 by causing an instability in the DNA in the presence of uracils and introducing aberrant stop codons in the nascent viral reverse transcripts that will reduce the viral fitness [56–59]. In essence, the host actually induces lethal mutagenesis to defend itself against viral infections.

While the host-encoded enzymes alter the viral coding sequence in addition to the error-prone retroviral replication process, HIV uses genetic recombination to avoid deleterious mutations and to stay fit under selective pressure like antiviral drugs [60]. The frequency of recombination reaches a peak during replication because RT could switch from one copy of the genomic RNA to the second copy while synthesizing viral

DNA [61]. In cell culture assays, each recombination event generates at least two crossovers per genome in the course of one cycle [62–64]. In addition, the number of crossovers increases to an average of 9 and 30 per replication cycle for T lymphocytes and macrophages, respectively [65]. The recombinogenic ability of HIV-1 is an order of magnitude higher compared to other retroviruses such as murine leukemia virus (MLV) and spleen necrosis virus (SNV) [64, 66]. This ability provides an efficient mechanism to redistribute mutations while elevating variation in the viral population. High variation in viral population hinders the antiviral treatment by generating multiple drug-resistant variants after frequent recombination cycles. Lethal mutagenesis could be invaluable in solving this real-world resistance problem through artificially increasing mutations to a point that even the recombination-mediated repair of defective retroviral genomes would no longer function and eventually lead to extinction of the viral population.

### 11.3

#### Fundamentals of Lethal Mutagenesis

An increased mutation rate through error-prone replication approach provides an extraordinary adaptability to retroviruses, but at the same time deleterious effects on the viral fitness take over after reaching a certain threshold. For example, sequencing the protein-coding regions of HIV revealed that all the mutations were nonsynonymous and almost half of these were deleterious due to some premature stop codons [31]. Moreover, the rest of the nonsynonymous mutations yielded amino acid substitutions that would compromise the biological function or protein folding. Consequently, spontaneous mutations are shown to cause defective particles in HIV and other retroviral populations.

Using this inherent infidelity of HIV-1 RT, Loeb, Mullins, Essigmann, and coworkers proposed the idea of introducing mutagenic deoxyribonucleoside analogues into proviral DNA and ribonucleoside analogues into viral RNA to increase the already high viral mutation rate [11, 67]. When the error threshold is approached with a mutagenic agent, small increases in mutation rates give rise to large declines in viability [68]. To show their mutagenic activities (as illustrated in Figure 11.1), these deoxyribonucleoside analogues must be converted into corresponding 5'-triphosphate forms by cellular kinases after entering the cell. Once the triphosphate is formed, RT incorporates the mutagenic analogue into viral DNA during minus-strand DNA synthesis, which would generate mispairs in subsequent plus-strand DNA synthesis [11]. Similarly, analogues incorporated during plus-strand synthesis generate mispairs when copied by host DNA polymerases.

For the case of ribose derivatives (as illustrated in Figure 11.2), cellular RNA polymerase II catalyzes the incorporation of mutagenic ribonucleoside analogues into viral RNA transcripts upon phosphorylation, resulting in mispairing during subsequent RT-catalyzed minus-strand DNA synthesis in newly infected cells [67]. The resulting mismatched nucleotides are unlikely to be excised since DNA repair enzymes are less efficient on RNA–DNA hybrid duplexes [69]. Consequently, many mutations accumulate in the newly synthesized RNA genome per replication cycle

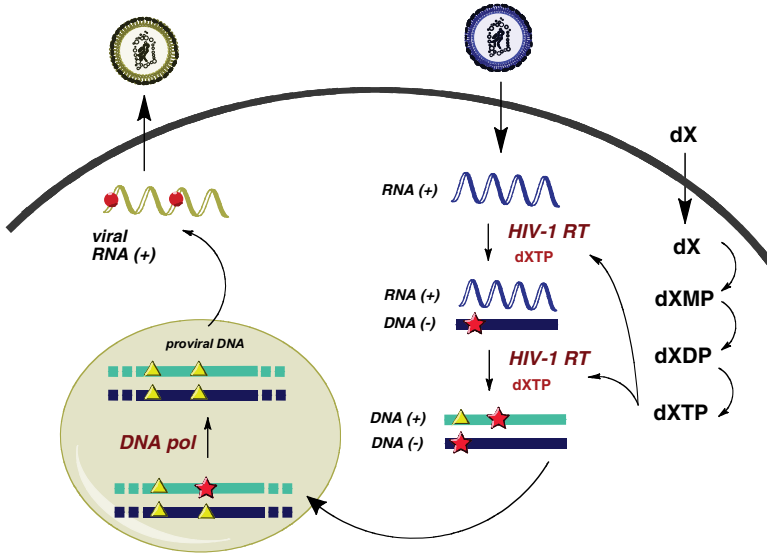

**Figure 11.1** Illustration of deoxyribose nucleosides as lethal mutagens. After the transportation of mutagenic deoxyribonucleosides (dX) into the cytosol, cellular kinases convert these analogues into deoxyribonucleoside 5'-triphosphates (dXTP). HIV-1 RT incorporates the mutagenic

triphosphates (red star, dXTP) into viral DNA and subsequent viral polymerization steps by RT generate mispairs (yellow triangles) in plus-strand DNA synthesis. Host DNA polymerases (DNA pol) also generate mispairs, but a number of the incorporated mutagenic nucleotides are most likely to be repaired by cellular enzymes.

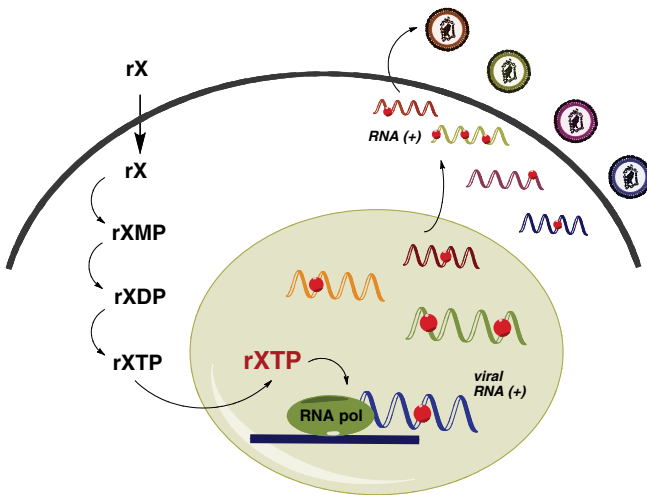

**Figure 11.2** Illustration of ribonucleoside analogues as lethal mutagens. After the transportation of mutagenic ribonucleosides (rX) into the cytosol, cellular kinases convert these analogues into ribonucleoside-5'-

triphosphates (rXTPs). Host RNA polymerase II (RNA pol) incorporates the mutagenic triphosphates (red circles, rXTP) into the nascent viral RNA genome.

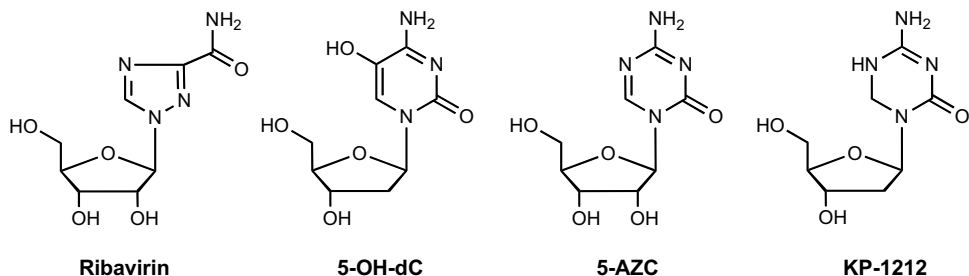

**Figure 11.3** Structures of nucleoside analogues with mutagenic effects.

and the number of mutations for each HIV genome reaches to a point where no functional viral proteins could be produced. This approach could, in principle, be applicable to RNA viruses [14].

Because virus populations tightly regulate the error rate to maintain an optimal level of quasispecies diversity, it has been assumed that a lethal mutagen is unlikely to alter the error frequency in order to completely extinguish the viral population, even prevent disease or diminish virus spread [70]. Since RNA viruses may replicate at a rate of one mutation per genome per replication cycle, highly resistant virus variants might emerge upon introduction of a lethal mutagen. Therefore, it has been suggested that application of a mutagen in combination with conventional viral inhibitors may allow extinction of a virus population under conditions where treatment alone is insufficient and this combination may inhibit the evolution of resistance [71, 72]. Earlier work shows an inverse correlation between the mutation rate and the viral fitness/infectivity using nucleoside analogues such as ribavirin, 5-hydroxy-2'-deoxycytidine, 5-azacytosine, and KP-1212 (Figure 11.3) [11, 73–75]. In the next section, we summarize and discuss in detail, clinically important mutagenic nucleoside analogues.

## 11.4

### Mutagenic Pharmaceuticals as Antiviral Agents

#### 11.4.1

##### Ribavirin

Ribavirin (1- $\beta$ -D-ribofuranosyl-1,2,4-triazole-3-carboxamide, also known as Virazole<sup>®</sup>) is a ribonucleoside derivative that inhibits RNA virus replication [76]. Ribavirin possesses several inhibition mechanisms to show its pharmacological activity against various RNA viruses such as hepatitis C virus (HCV), respiratory syncytial virus (RSV), Lassa virus, and coronavirus [77–83]. In a clinical trial, ribavirin has also been shown to reduce the severity of hemorrhagic fever with renal syndrome and lower the mortality rates among the patients [84]. The suggested mechanisms for the broad-spectrum antiviral activity are inhibition of inosine 5'-monophosphate

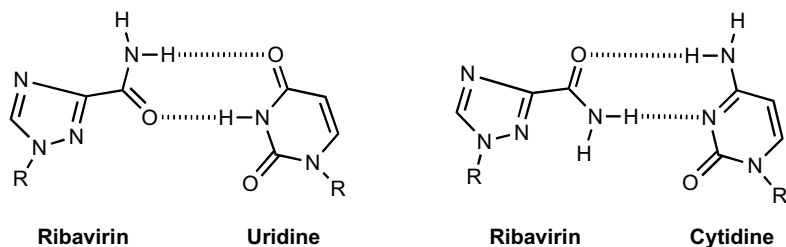

**Figure 11.4** Alternative base pairing of ribavirin.

dehydrogenase (IMPDH) [85], inhibition of the viral RNA polymerase [86–89], immunomodulation [88, 89], or lethal mutagenesis [90]. A recent review elucidates all the proposed mechanisms of action against distinct viruses [91]. Here, we highlight the lethal mutagenesis mode of action for ribavirin.

Ribavirin has a unique hydrogen-bonding pattern due to the rotation of the exocyclic carboxamide on the nucleobase moiety as shown in Figure 11.4. Ribavirin acts as a guanosine analogue and specifically induces the rate of C-to-U and G-to-A transition mutations [92]. Therefore, incorporation of ribavirin into RNA results in base pairing with cytidine or uridine during virus replication. Facilitating the pairing with both pyrimidines increases the mutation rate and suggests that ribavirin possibly acts as a lethal mutagen. However, its inhibition effect on IMPDH can also elevate the mutational rates via depletion of intracellular GTP pools. Ribavirin treatment causes a substantial drop in cellular GTP levels with a simultaneous increase in UTP and CTP pools. Consequently, the unbalanced physiological levels of natural nucleotides result in incorporation of more ribavirin triphosphate (RTP) into viral RNA [93, 94].

Considering this highly debated topic, several reports conclude contradictory results as to whether ribavirin acts as a true lethal mutagen or illustrates its activity via additional effects on cellular physiology and inhibition of various parts of virus life cycle. In a full-length hepatitis C virus replication system, ribavirin was shown to generate errors even in rigid regions of the HCV genome, which confirms the suggestion that it induces lethal mutagenesis *in vivo* [95]. In addition, ribavirin-induced HCV mutagenesis was assessed in the presence of both IMPDH inhibitors and alpha interferon using an HCV subgenomic replicon system [96, 97]. Both studies illustrated that ribavirin has a great contribution to the overall anti-HCV effect by increasing the mutation rate and hence reduces viability. A close relative to HCV, GB virus B (GBV-B), was used as a surrogate model for ribavirin-induced mutagenesis of HCV in tamarin hepatocytes, suggesting that incorporation of ribavirin triphosphate by the viral polymerase at sufficient levels induces error-prone replication [98].

Several other viruses were also studied to investigate the error catastrophe action of ribavirin. To test this hypothesis, Severson *et al.* used Hantaan virus-infected cells and sequenced the viral mRNA segments from ribavirin-treated cells [99]. The

resulting data demonstrated a high mutation frequency during the hantaviral RNA synthesis along with low levels of viral proteins, which would confirm the lethal mutagen theory. Besides the apparent mutagenesis effects on hantaviruses, it was subsequently suggested that ribavirin triphosphate incorporation might reduce the stability of mRNA species as well [100]. Surprisingly, an observation for ribavirin-treated Hantaan virus revealed that beyond the lethal threshold, half the viral cDNA population is identical to the wild type. Nevertheless, the virus is driven to extinction [101]. Ribavirin has also shown to induce error-prone replication in West Nile virus during infection of HeLa cells [102]. After four passages, the infectivity of West Nile virus was reduced dramatically and the virus became prone to extinction. To investigate the mutagenic effects of ribavirin on foot-and-mouth disease virus (FMDV), BHK-21 cells were infected with the virus. The sequencing results suggested that the direct mutagenic action of ribavirin was the sole source for the elevated mutation frequency of FMDV rather than its effect on nucleotide pool imbalances or the selection of already existing mutations originating from the FMDV genomes that were utilized in the study [103].

Results of *in vivo* studies of ribavirin have remained conflicting thus far. While some analyses have found increased rates of molecular evolution in NS5A and NS5B regions of HCV genome after initiation of the ribavirin treatment [104], others have failed to detect such differences [105, 106]. Similarly, comparative studies of patients receiving ribavirin treatment and patients receiving placebo or interferon immunotherapy have shown either a slightly accelerated rate of molecular evolution for the NS5B gene in the former group [107] or no significant changes [108, 109]. The latest study on the *in vivo* mutagenic effect of ribavirin exploited a different methodology to overcome the limitations of negative selection from the previous research [73]. After sequencing the nonsense mutations for the E1-E2 and NS5A regions of HCV genome isolated from 74 infected patients, a threefold increase in mutation rate and a significant shift in mutational spectrum were observed. In conclusion, published literature establishes the ribavirin's lethal mutagenesis effect on viral genomes as a primary antiviral mechanism of action against RNA viruses. Efforts are underway to discover new nucleoside analogues that may serve as lethal mutagens for HCV infections.

#### 11.4.2

##### 5-OH-dC

5-Hydroxy-2'-deoxycytidine (shown in Figure 11.3) is a highly mutagenic 2'-deoxycytidine analogue that has been tested against HIV [11]. 5-OH-dC structure could be present in the form of imino and amino tautomers under physiological conditions that then utilizes this tautomerization ability to base pair with guanosine and adenosine [110]. Loeb and colleagues investigated several mutagenic deoxyribonucleoside analogues at 1 mM or 10-fold lower concentration of which reduced human CEM cell growth by more than 30% [11]. The virion production for HIV was assessed by measuring the viral p24 production in culture supernatants over the course of serial passages of HIV-infected cells and each one carried out in triplicate.

5-OH-dC was selected from the initial screen for further analysis. After performing 16 sequential passages of HIV in the presence of 1 mM 5-OH-dC, an irreversible loss of viral infectivity was observed and by the passage 17 no detectable levels of p24 were present. In comparison, no loss in viral titer was detected in the absence of the mutagenic analogue. In order to confirm the observed infectivity loss, frozen aliquots from the 14th passage were used to infect fresh cells, which led to a similar loss of p24 protein with 5-OH-dC, whereas no infectivity loss was observed in the untreated control cultures passaged in parallel. Verification of the nucleotide changes was conducted by sequencing a part of the HIV RT gene isolated from the passage prior to annihilation. The frequency of the imino tautomer of 5-OH-dC regulates the switched base pairing and thus explains the preferred adenosine over guanosine pairing. Consequently, a sixfold increase in G-to-A transition was calculated out of 15 060 sequenced nucleotides derived from the analogue-treated cells.

Based on the experimental data, 5-OH-dC initiates lethal mutagenesis in HIV-1 infected cells via increasing the G-to-A mutation frequency throughout the genome to a level that is sufficient to kill the virus. Moreover, 5-OH-dC was found to be nontoxic to the host genome. Accordingly, incorporation of 5-OH-dC was as low as one molecule per  $1 \times 10^5$  nucleotides in cellular DNA and also no mitochondrial toxicity was detected after culturing CEM lymphoblasts in the presence of 2 mM 5-OH-dC for 8 days [111].

#### 11.4.3

##### **5-AZC**

5-Azacytidine, also known as Vidaza<sup>®</sup> (shown in Figure 11.3), is a ribonucleoside analogue, which is clinically used to treat myelodysplastic syndrome [112, 113]. 5-AZC has been shown to inhibit HIV-1 replication in human CEM cells [114]. According to the proposed mechanism of action for 5-AZC, the anti-HIV activity was primarily directed by incorporation of the cytidine analogue into HIV-1 RNA during the genomic RNA transcription and followed by the subsequent increase in viral mutation frequency. In addition, HIV RT could also incorporate the 2'-deoxyribonucleoside form of the drug into viral DNA upon reduction by cellular ribonucleotide reductase (RNR). In an attempt to test the hypothesis explained above, HIV producing cells and target cells were used for the late and early stages of viral replication, respectively [74]. A single-cycle assay was utilized with the use of two reporter genes as follows: HAS gene for infectivity and GFP gene for the mutational analysis. Sequencing GFP genes isolated from target cells indicated a substantial enrichment in G-to-C transversions for the early phase of replication. As a result, 5-AZC stimulated a 2.3-fold increase in the HIV-1 mutation frequency compared to the untreated cells containing virus. However, the late phase of replication was affected to a lesser extent with a 1.5-fold mutational increase composed of C-to-G and G-to-C transversions. This observation was consistent with the previous mutation analysis of spleen necrosis virus induced by 5-AZC [115]. The overall mutation frequency was moderate yet enough to decrease the viability of virus as expected. The calculated  $IC_{50}$



values of 5-AZC for the early-phase and late-phase replication were 57 and 112  $\mu\text{M}$ , respectively. The toxicity of 5-AZC was also analyzed and no significant adverse effects on the host cell were detected at the inhibitory concentrations. The reason for the nontoxic effects of this type of analogues is the probable detection by the host DNA machinery and ensuing elimination from genomic DNA in case of incorporation.

## 11.5

### KP-1212: From Bench to Clinic

KP-1212 (5-aza-5,6-dihydro-2'-deoxycytidine, Figures 11.3, 11.5– and 11.6) is a novel mutagenic deoxycytidine analogue that induces acceleration of HIV error rate during viral replication by RT. Before KP-1212 was studied as an anti-HIV agent, a previous study had shown that a clinically investigated antitumor drug, DHAC (5-aza-5,6-dihydrocytidine), was metabolized to the 2'-deoxy derivative, KP-1212, in human leukemia cell lines by ribonucleotide reductase [116]. DHAC was tested in phase II clinical trials for the treatment of malignant mesothelioma and melanoma with no reported antiviral activity [117, 118].

KP-1212 possesses ambiguous base pairing ability, which promotes an elevated number of random mutations in viral genome *in vivo*. The uniqueness of drug structure originates from the tautomerization of nucleobase moiety between the amino and imino forms as shown in Figure 11.6, which could result in pairing with both guanine and adenine. Therefore, the viability of viral quasispecies is pressed beyond a fit threshold and this approach is termed as viral decay acceleration (VDA) by Koronis Pharmaceuticals (Redmond, WA, USA) [119]. Koronis introduced KP-1461 ( $N^4$ -heptyloxycarbonyl-5,6-dihydro-5-aza-2'-deoxycytidine, Figure 11.5), an oral prodrug form of KP-1212, to phase I and phase II clinical trials for the treatment of HIV. After administering KP-1461, liver enzymes convert the prodrug to KP-1212 that is sequentially phosphorylated into its triphosphate form. HIV-1 RT efficiently

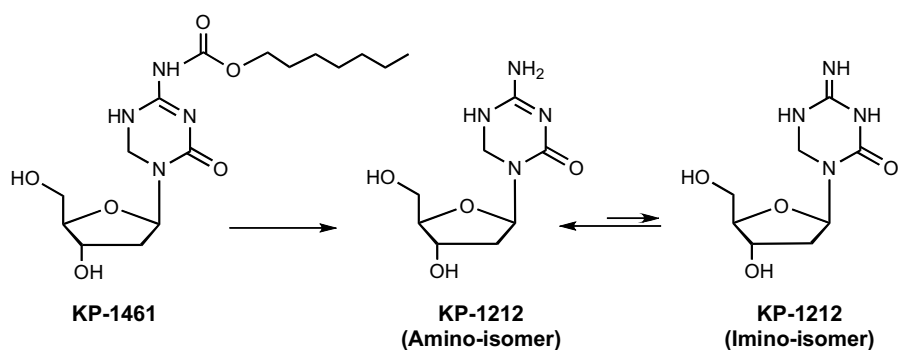

**Figure 11.5** Structures of KP-1461 prodrug and both tautomers of KP-1212.

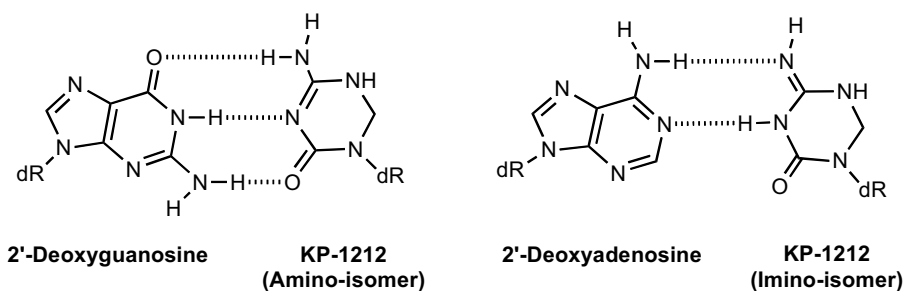

**Figure 11.6** Ambiguous base pairing of KP-1212.

incorporates the nucleotide analogue into viral DNA instead of natural substrate (dCTP). *In vitro* kinetic analysis showed only a 19- and 12-fold less incorporation efficiency of KP-1212-TP versus dCTP for DNA and RNA templates, respectively [120]. As a result, KP-1212 became a promising anti-HIV agent because of its high efficacy. Furthermore, initial serial passage experiments of KP-1212 reported an increase in the mutation rate of HIV-1 NL4-3 strain, which then led to viral annihilation by passage 13 at the concentration of 10  $\mu\text{M}$  [75]. HIV RT and ENV genes were sequenced to analyze the viral mutation profile of 10  $\mu\text{M}$  drug-treated MT-2 cells. The sequencing data revealed predominantly G-to-A and A-to-G transition mutations and to a lesser extent C-to-T and T-to-C transitions with no significant increase in transversions. These transitions are consistent with the coexistence of both tautomers as explained above.

Many of the nucleoside analogues developed to date retain mitochondrial toxicity; thus, the long-term administration of FDA approved antiretroviral drugs [121–125] remains a concern. Therefore, potential mitochondrial toxicity of KP-1212 was assessed utilizing both *in vitro* and *in vivo* experiments. The detailed kinetic analysis using the triphosphate form of KP-1212 demonstrated that human mitochondrial DNA polymerase (Pol  $\gamma$ ) could incorporate KP-1212 into the DNA template and HIV-1 RT, which makes it potentially toxic to mitochondria [120]. According to this study,  $K_i$  values of KP-1212-TP for HIV-1 RT and Pol  $\gamma$  were 95 and 28  $\mu\text{M}$ , respectively, and the discrimination ratio between dCTP and KP-1212-TP was 27 for Pol  $\gamma$  and 78 for RT enzyme. Due to the weaker binding interactions of KP-1212-TP compared to its natural substrate, the incorporation efficiency of KP-1212-MP with HIV-1 RT and Pol  $\gamma$  is 11-fold and 26-fold lower than dCMP, respectively. Although the incorporation of KP-1212 could lead to mitochondrial toxicity, KP-1212-MP can be excised efficiently by the exonuclease activity of Pol  $\gamma$ . In fact, the rate of removal of the drug is similar to that of the natural nucleotide [120]. Toxic effects on mitochondria was also tested utilizing a lactate assay in human CEM cells along with a test of mitochondrial DNA (mtDNA) synthesis after KP-1212 treatment [75]. Only a 6% decrease in mtDNA synthesis was detected with 320  $\mu\text{M}$  KP-1212, and insignificant lactic acid quantities were yielded utilizing doses up to 1 mM. The high therapeutic index ( $IC_{50}/EC_{50}$ ) of  $\sim 1 \times 10^5$  in human lymphoid cell culture along with nontoxic effects on mitochondria made KP-1212 a good candidate for clinical analysis.

Indeed, KP-1461 has successfully completed phase Ia and phase Ib human clinical trials. Evaluation of these trials showed that KP-1461 is tolerated well by healthy and HIV-infected subjects with no toxicity concerns. In the phase Ib study, HIV positive subjects demonstrated a statistically significant drop in viral load. After the encouraging results of phase I study, KP-1461 entered an open label phase IIa clinical trial including 24 treatment-experienced patients. In this trial, salvage HIV patients received 1600 mg of KP-1461 as a monotherapy twice per day for 124 days. An analysis of the clinical data confirmed that KP-1461 caused a statistically significant increase in viral mutations compared to a cohort of untreated HIV-infected subjects ( $p = 0.0022$ ). Very recently, Mullins *et al.* performed a detailed characterization of the mutation profile of viral genome obtained from KP-1461-treated patients who completed the phase IIa trial [126]. The sequenced viral genes originating from treated subjects revealed more A-to-G and G-to-A transition mutations in comparison to control group since the drug can base pair with both A and G [126]. An additional phase II study is planned by the end of 2010 to further evaluate KP-1461. It has been suggested that in addition to the lethal mutational leverage, KP-1461 could be coadministered with other inhibitors since the drug will weaken the already poor viral fitness even more. Concerted efforts on KP-1461 or other mutagenic analogues could significantly improve the treatment of viral diseases.

## 11.6

### Challenges and Advantages of Lethal Mutagenesis Compared to Conventional Strategies

In order to fully exploit lethal mutagenesis strategy potential challenges and limitations must be considered. Many of the limitations are comparable to the conventional antiretroviral therapy. For example, an ideal antiviral nucleoside analogue should possess good bioavailability properties, enhanced phosphorylation upon cellular uptake leading to a rapid accumulation at the target site and high selectivity and efficacy for viral targets rather than cellular enzymes. Both mutagenic and conventional nucleoside analogues are inactive until they are phosphorylated into their active triphosphate metabolites by cellular kinases. Enzymatic conversion of these analogues should be efficient enough to compete with high levels of endogenous nucleotides for incorporation into the HIV-1 genome. The intracellular concentrations of all four natural ribonucleotide triphosphates (rNTPs) are suggested to range from submillimolar to low millimolar, whereas deoxyribonucleoside triphosphates (dNTPs) are considered to be in the range of tens of micromolar or lower [127]. Therefore, mutagenic nucleosides that are derived from 2'-deoxyribonucleosides (dN) might be more effective than the ribose derivatives since the competition with natural dNTPs would be at minimal concentrations. It might be reasoned that smaller amounts of a deoxyribonucleoside analogue could be administered due to the low levels of required intracellular active metabolite, which would suffice for antiretroviral activity and minimize the adverse effects of the drug in mammalian cells.

Similar to conventional chain-terminating nucleoside analogues, the ultimate goal of the antiviral nucleoside analogue development is to retain the antiviral activity while reducing the off-target effects on the host cell. Although the mutagenic deoxyribonucleoside analogues are being incorporated only by RT, host DNA polymerases (pol  $\alpha$ ,  $\beta$ ,  $\gamma$ ,  $\delta$ ,  $\epsilon$ ) might also utilize them. The same potential complication also stands for ribonucleoside analogues because the host RNA polymerase II is targeted for the analogue incorporation into viral RNA and a fraction of the analogue may end up in host cell mRNA. However, the consequences of this event might be minimal since the mRNAs are denatured rapidly and do not become part of the cellular genome. In addition, some ribonucleotides are reduced to the corresponding deoxy derivatives at the 2'-position of the ribose ring by ribonucleotide reductase [128]. Due to the broad substrate specificity of ribonucleotide reductase, designing ribonucleoside analogues that are resistant to conversion is difficult. As described above for dNTP derivatives, a newly formed analogue possibly could cause genomic mutation after being incorporated into cellular DNA via host DNA polymerases. More importantly, even if these analogues are incorporated into cellular DNA, they can be removed by several repair mechanisms such as base excision, nucleotide excision, homologous recombination repair, mismatch repair, and specialized bypass polymerase removal [129, 130]. On the other hand, mitochondrial transcription machinery could still be impacted by the incorporation of the analogues via mitochondrial DNA polymerase  $\gamma$  [131, 132]. In conclusion, host cell toxicity could be avoided by replication machinery including enhanced proofreading activity that is absent in viral polymerases. There is still relatively scant information concerning the structure and function relationships in these polymerases that could define the details of substrate specificities [133]. This topic has been recently reviewed [134, 135]. Exploration of these properties is warranted to design and synthesize new nucleoside analogue structures retaining viral specific modifications.

Another critical challenge for mutagenic nucleosides is the development of drug resistance in combination with viral latency. All mutations in HIV-1 variants causing resistance against current inhibitors have been extensively characterized and studied [136–138]. Patients failing HAART frequently harbor viruses resistant to one or more drugs in the regimen. Different methods are used to predict and understand the mutation mechanism [139]. In addition, detection of resistant viruses prior to initiation of treatment is often an independent predictor of therapy failure. Thus, the development of drug resistance is generally associated with a poor clinical outcome.

Utilization of mutagenic nucleoside analogues in clinical treatment is unlikely to generate new resistance mutations or introduce more mutations into the multidrug resistant variants. Since a high error rate is generally essential for virus viability and pathogenesis in the host, the sole mechanism for resistance against a lethal mutagen might be increased fidelity of viral polymerase. Enhanced replication fidelity would restrict quasispecies diversity and lead to less fit viral progeny that is unable to evolve under selective pressure. There have been several reports of increased robustness in various viral and subviral pathogens after exposure to a mutagen [140, 141]. Experimental results and *in silico* analyses suggest that under the pressure of high mutation rates, the survivability of slow-replicating organisms can be higher than

fast-replicating counterparts if they evolve toward mutational robustness to avoid the deleterious mutations. Not surprisingly, two independent studies observed a single ribavirin-resistant mutation (G64S) in poliovirus (PV) polymerase that would enhance the fidelity threefold [142, 143]. However, there are some other exceptions where no selection of robustness in cell culture assays is reported [144]. Recently, a ribavirin-resistant FMDV polymerase variant that carries M296I substitution indicates an alternative mechanism for resistance to lethal mutagens beyond a universal increase in polymerase fidelity [145]. Biochemical analysis of the mutant polymerase revealed a 2.5-fold decrease in fidelity and no loss in quasispecies diversity compared to the wild-type polymerase while specifically discriminating against ribavirin incorporation [146]. Thus, FMDV can obtain ribavirin resistance by decreasing the efficiency of incorporation, although this results in a trade-off of fidelity for normal nucleotide incorporation, specifically a higher frequency of GMP misincorporation. Multiple mechanisms could rise to confer resistance to lethal mutagens, and this further underscores the importance of a tightly controlled mutation rate in virus populations.

Viruses in reservoirs are composed of a wide range of genetic variants that could provide new mutants to the circulating quasispecies and substantially contribute to the rapid emergence of resistance against both antiviral therapeutics and lethal mutagens in the case of HIV-1. Several types of long-lived HIV-1-infected cells such as resting CD4<sup>+</sup> lymphocytes and macrophages are potential reservoirs located in lymph nodes and the central nervous system (CNS) [147–152]. In particular, integrated proviruses carrying the wild-type or drug-resistant genotypes can be preserved in reservoirs for months or years. Therefore, HIV-1 genomes present in a reservoir would make an extensive collection of viral variants that can be significantly distinct from the dominant genotype in the plasma. Generally, it might be anticipated that HIV-RT inhibitors and blood–brain barrier (BBB) that may prevent the accessibility of certain antiretroviral drugs to CNS may augment this advantageous genetic condition [153–155]. As a consequence, reemergence of viruses from reservoirs can perturb the circulating quasispecies when the selective pressure compromises the current plasma HIV-1 population [156–158]. The viral latency of HIV-1 may be less likely to diminish the efficiency of lethal mutagens compared to more conventional nucleoside analogues.

## 11.7

### Concluding Remarks and Future Perspectives

Although the concept of lethal mutagenesis has been extensively investigated *in vitro*, several critical questions concerning the mode of action are still awaiting answers. Especially potential off-site targets of lethal mutagens and the resulting decline in viral titers should be addressed and evaluated experimentally. Specifically, ribavirin establishes a good example for multisite drug targeting effects as explained in the previous section. While acute cytotoxic effects may not be observed, this is unlikely to represent or predict potential problems with chronic cellular toxicity due to the effects after long-term administration of lethal mutagens on host cell nucleic acid biosyn-

thesis and metabolism. Theoretically, the effect of mutation rates on the survival of a population has generally been described within the paradigm of Muller's ratchet [159, 160]. The concept of Muller's ratchet applies to finite, asexual populations. It states that if back mutations cannot occur, eventually any finite asexual population will accumulate deleterious mutations and the mutation-free wild-type genotype would be lost. While this model provided some useful insight into the phenomenon of lethal mutagenesis, several other theories have been proposed in recent years to explain the feedback relationship between the mutation rate and the fitness of an organism [161, 162]. Authors suggested a model assuming that the loss of protein stability would lead to the loss of essential functions within the organism and therefore to a lethal phenotype. Finally, these models are important to predict the possible mutational outcomes and interpret the action mechanism before a mutagenic nucleoside analogue will be used experimentally.

Because the available drugs are not potent enough to completely eradicate HIV within the AIDS patient, or even maintain long-term suppression of virus replication and drug resistance development, additional drugs and novel therapeutic approaches should be developed. One common strategy that has been successfully used to improve the bioavailability of some anti-HIV drugs is the design of prodrugs with optimized pharmacokinetic properties. However, they are unable to eradicate HIV infection because they suffer from poor specificity for the infected cell types or the physiological sites that sequester HIV. Besides prodrug design, targeting specifically HIV-infected tissues with drug delivery approaches could eradicate HIV virus. Microspheres, liposomes, and nanoparticle-based delivery systems have been developed for delivering drugs to macrophages and T cells. Polyethylene glycol (PEG)-based nanocarriers can be easily modified to incorporate various antiviral drugs/prodrugs and targeting moieties [163]. Improved therapy can be achieved using these drug delivery systems to incorporate the mutagenic nucleotides to enhance distribution to sanctuary sites in the body, for example, to the lymphatics, where the majority of the viral replication and infection occur. Targeted drug delivery to macrophages and T cells would not only improve the efficacy of mutagenic drugs but would also potentially limit the development of toxicities/adverse effects often associated with the presence of drugs in noninfected cells. Another potential auxiliary benefit of targeted drug delivery is the reduction of HIV resistance by increasing uptake into HIV infected cells.

In summary, the true challenge of lethal mutagenesis lies in accumulating better knowledge of how to use these mutagenic drugs within the tenets of HIV therapy. Future studies should be directed at determining the mechanistic details of mutational strategy for *in vivo* analysis of HIV-1 and the risks of the drug-induced mutagenesis in relation to virus mutation rate and virus evolution for immune escape, drug resistance, and disease progression.

### Acknowledgments

The authors thank NIH GM49551 for support and Drs. J.I. Mullins, J.P. Laurent, and L.A. Loeb for sharing their submitted manuscript.

## References

- 1 Weiss, R.A. (1993) How does HIV cause AIDS? *Science*, **260**, 1273–1279.
- 2 HIV/AIDS, J.U.N.P.o. AIDS epidemic update – December 2009. [23 January 2010] Available online: [http://data.unaids.org/pub/Report/2009/2009\\_epidemic\\_update\\_en.pdf](http://data.unaids.org/pub/Report/2009/2009_epidemic_update_en.pdf).
- 3 Antiretroviral drugs used in the treatment of HIV infection. [23 January 2010] Available online: <http://www.fda.gov/ForConsumers/ByAudience/ForPatientAdvocates/ucm076940.htm>.
- 4 Valenti, W.M. (2001) HAART is cost-effective and improves outcomes. *Aids for Reading*, **11**, 260–262.
- 5 Martinez-Picado, J., DePasquale, M.P., Kartsonis, N., Hanna, G.J., Wong, J., Finzi, D., Rosenberg, E., Gunthard, H.F., Sutton, L., Savara, A., Petropoulos, C.J., Hellmann, N., Walker, B.D., Richman, D.D., Siliciano, R., and D'Aquila, R.T. (2000) Antiretroviral resistance during successful therapy of HIV type 1 infection. *Proceedings of the National Academy of Sciences of the United States of America*, **97**, 10948–10953.
- 6 Little, S.J., Holte, S., Routy, J.P., Daar, E.S., Markowitz, M., Collier, A.C., Koup, R.A., Mellors, J.W., Connick, E., Conway, B., Kilby, M., Wang, L., Whitcomb, J.M., Hellmann, N.S., and Richman, D.D. (2002) Antiretroviral-drug resistance among patients recently infected with HIV. *The New England Journal of Medicine*, **347**, 385–394.
- 7 Steinhauer, D.A., Domingo, E., and Holland, J.J. (1992) Lack of evidence for proofreading mechanisms associated with an RNA virus polymerase. *Gene*, **122**, 281–288.
- 8 Castro, C., Arnold, J.J., and Cameron, C.E. (2005) Incorporation fidelity of the viral RNA-dependent RNA polymerase: a kinetic, thermodynamic and structural perspective. *Virus Research*, **107**, 141–149.
- 9 Svarovskaia, E.S., Cheslock, S.R., Zhang, W.H., Hu, W.S., and Pathak, V.K. (2003) Retroviral mutation rates and reverse transcriptase fidelity. *Frontiers in Bioscience: A Journal and Virtual Library*, **8**, d117–d134.
- 10 Steinhauer, D.A. and Holland, J.J. (1987) Rapid evolution of RNA viruses. *Annual Review of Microbiology*, **41**, 409–433.
- 11 Loeb, L.A., Essigmann, J.M., Kazazi, F., Zhang, J., Rose, K.D., and Mullins, J.I. (1999) Lethal mutagenesis of HIV with mutagenic nucleoside analogs. *Proceedings of the National Academy of Sciences of the United States of America*, **96**, 1492–1497.
- 12 Graci, J.D. and Cameron, C.E. (2008) Therapeutically targeting RNA viruses via lethal mutagenesis. *Future Virology*, **3**, 553–566.
- 13 Domingo, E. (1992) Genetic variation and quasi-species. *Current Opinion in Genetics & Development*, **2**, 61–63.
- 14 Holmes, E.C. (2003) Error thresholds and the constraints to RNA virus evolution. *Trends in Microbiology*, **11**, 543–546.
- 15 Domingo, E. and Holland, J.J. (1997) RNA virus mutations and fitness for survival. *Annual Review of Microbiology*, **51**, 151–178.
- 16 Domingo, E., Escarmís, C., Sevilla, N., Moya, A., Elena, S.F., Quer, J., Novella, I.S., and Holland, J.J. (1996) Basic concepts in RNA virus evolution. *The FASEB Journal*, **10**, 859–864.
- 17 Friedberg, E.C., Walker, G.C., Siede, W., Wood, R.D., and Schultz, R. (eds) (2006) *DNA Repair and Mutagenesis*, 2nd edn, American Society for Microbiology, Washington DC.
- 18 Eigen, M. (1971) Selforganization of matter and the evolution of biological macromolecules. *Die Naturwissenschaften*, **58**, 465–523.
- 19 Holland, J.J., Domingo, E., de la Torre, J.C., and Steinhauer, D.A. (1990) Mutation frequencies at defined single codon sites in vesicular stomatitis virus and poliovirus can be increased only slightly by chemical mutagenesis. *Journal of Virology*, **64**, 3960–3962.
- 20 Eigen, M. (2002) Error catastrophe and antiviral strategy. *Proceedings of the National Academy of Sciences of the United States of America*, **99**, 13374–13376.

- 21 Drake, J.W. and Holland, J.J. (1999) Mutation rates among RNA viruses. *Proceedings of the National Academy of Sciences of the United States of America*, **96**, 13910–13913.
- 22 Domingo, E., Parrish, C. and Holland, J.J. (eds) (2008) *Origin and Evolution of Viruses*, 2nd edn, Elsevier, Oxford.
- 23 Eigen, M. and Schuster, P. (1977) The hypercycle. A principle of natural self-organization. Part A: emergence of the hypercycle. *Die Naturwissenschaften*, **64**, 541–565.
- 24 Eigen, M. (1993) Viral quasispecies. *Scientific American*, **269**, 42–49.
- 25 Eigen, M. (1996) On the nature of virus quasispecies. *Trends in Microbiology*, **4**, 216–218.
- 26 Eigen, M. and Schuster, P. (eds) (1979) *The Hypercycle: A Principle of Natural Self-Organization*, Springer, Berlin.
- 27 Holland, J.J., De La Torre, J.C., and Steinhauer, D.A. (1992) RNA virus populations as quasispecies. *Current Topics in Microbiology and Immunology*, **176**, 1–20.
- 28 Domingo, E. (1997) Rapid evolution of viral RNA genomes. *The Journal of Nutrition*, **127** (Suppl.), 958S–961S.
- 29 Domingo, E. (2003) Quasispecies and the development of new antiviral strategies. *Progress in Drug Research*, **60**, 133–158.
- 30 Biebricher, C.K. and Eigen, M. (2006) What is a quasispecies? *Current Topics in Microbiology and Immunology*, **299**, 1–31.
- 31 Gao, F., Chen, Y., Levy, D.N., Conway, J.A., Kepler, T.B., and Hui, H. (2004) Unselected mutations in the human immunodeficiency virus type 1 genome are mostly nonsynonymous and often deleterious. *Journal of Virology*, **78**, 2426–2433.
- 32 Drake, J.W. (1999) The distribution of rates of spontaneous mutation over viruses, prokaryotes, and eukaryotes. *Annals of the New York Academy of Sciences*, **870**, 100–107.
- 33 Coffin, J.M. (1986) Genetic variation in AIDS viruses. *Cell*, **46**, 1–4.
- 34 Coffin, J.M. (1995) HIV population dynamics *in vivo*: implications for genetic variation, pathogenesis, and therapy. *Science*, **267**, 483–489.
- 35 Desai, S.M., Kalyanaraman, V.S., Casey, J.M., Srinivasan, A., Andersen, P.R., and Devare, S.G. (1986) Molecular cloning and primary nucleotide sequence analysis of a distinct human immunodeficiency virus isolate reveal significant divergence in its genomic sequences. *Proceedings of the National Academy of Sciences of the United States of America*, **83**, 8380–8384.
- 36 Hahn, B.H., Shaw, G.M., Taylor, M.E., Redfield, R.R., Markham, P.D., Salahuddin, S.Z., Wong-Staal, F., Gallo, R.C., Parks, E.S., and Parks, W.P. (1986) Genetic variation in HTLV-III/LAV over time in patients with AIDS or at risk for AIDS. *Science*, **232**, 1548–1553.
- 37 Goodenow, M., Huet, T., Saurin, W., Kwok, S., Sninsky, J., and Wain-Hobson, S. (1989) HIV-1 isolates are rapidly evolving quasispecies: evidence for viral mixtures and preferred nucleotide substitutions. *Journal of Acquired Immune Deficiency Syndromes*, **2**, 344–352.
- 38 Shankarappa, R., Margolick, J.B., Gange, S.J., Rodrigo, A.G., Upchurch, D., Farzadegan, H., Gupta, P., Rinaldo, C.R., Learn, G.H., He, X., Huang, X.L., and Mullins, J.I. (1999) Consistent viral evolutionary changes associated with the progression of human immunodeficiency virus type 1 infection. *Journal of Virology*, **73**, 10489–10502.
- 39 Liu, S.L., Mittler, J.E., Nickle, D.C., Mulvania, T.M., Shriner, D., Rodrigo, A.G., Kosloff, B., He, X., Corey, L., and Mullins, J.I. (2002) Selection for human immunodeficiency virus type 1 recombinants in a patient with rapid progression to AIDS. *Journal of Virology*, **76**, 10674–10684.
- 40 Temin, H.M. (1989) Is HIV unique or merely different? *Journal of Acquired Immune Deficiency Syndromes*, **2**, 1–9.
- 41 Preston, B.D. and Dougherty, J.P. (1996) Mechanisms of retroviral mutation. *Trends in Microbiology*, **4**, 16–21.
- 42 Menéndez-Arias, L. (2002) Molecular basis of fidelity of DNA synthesis and nucleotide specificity of retroviral reverse transcriptases. *Progress in Nucleic Acid Research and Molecular Biology*, **71**, 91–147.
- 43 Kerr, S.G. and Anderson, K.S. (1997) RNA dependent DNA replication fidelity of



- HIV-1 reverse transcriptase: evidence of discrimination between DNA and RNA substrates. *Biochemistry*, **36**, 14056–14063.
- 44 Roberts, J.D., Bebenek, K., and Kunkel, T.A. (1988) The accuracy of reverse transcriptase from HIV-1. *Science*, **242**, 1171–1173.
- 45 Jonckheere, H., Anné, J., and De Clercq, E. (2000) The HIV-1 reverse transcription (RT) process as target for RT inhibitors. *Medicinal Research Reviews*, **20**, 129–154.
- 46 Alberts, B., Bray, D., Hopkin, K., Johnson, A., Lewis, J., Raff, M., Roberts, K., and Walter, P. (2009) *Essential Cell Biology*, 3rd edn, Garland Science.
- 47 Kim, T., Mudry, R.A., Jr., Rexrode, C.A., 2nd, and Pathak, V.K. (1996) Retroviral mutation rates and A-to-G hypermutations during different stages of retroviral replication. *Journal of Virology*, **70**, 7594–7602.
- 48 O'Neil, P.K., Sun, G., Yu, H., Ron, Y., Dougherty, J.P., and Preston, B.D. (2002) Mutational analysis of HIV-1 long terminal repeats to explore the relative contribution of reverse transcriptase and RNA polymerase II to viral mutagenesis. *The Journal of Biological Chemistry*, **277**, 38053–38061.
- 49 Zhang, J. (2004) Host RNA polymerase II makes minimal contributions to retroviral frame-shift mutations. *The Journal of General Virology*, **85**, 2389–2395.
- 50 Julias, J.G. and Pathak, V.K. (1998) Deoxyribonucleoside triphosphate pool imbalances *in vivo* are associated with an increased retroviral mutation rate. *Journal of Virology*, **72**, 7941–7949.
- 51 Hizi, A., Kamath-Loeb, A.S., Rose, K.D., and Loeb, L.A. (1997) Mutagenesis by human immunodeficiency virus reverse transcriptase: incorporation of O<sup>6</sup>-methyldeoxyguanosine triphosphate. *Mutation Research*, **374**, 41–50.
- 52 Furge, L.L. and Guengerich, F.P. (1997) Analysis of nucleotide insertion and extension at 8-oxo-7, 8-dihydroguanine by replicative T7 polymerase exo- and human immunodeficiency virus-1 reverse transcriptase using steady-state and pre-steady-state kinetics. *Biochemistry*, **36**, 6475–6487.
- 53 Goff, S.P. (2003) Death by deamination: a novel host restriction system for HIV-1. *Cell*, **114**, 281–283.
- 54 KewalRamani, V.N. and Coffin, J.M. (2003) Virology. Weapons of mutational destruction. *Science*, **301**, 923–925.
- 55 Bhagwat, A.S. (2004) DNA-cytosine deaminases: from antibody maturation to antiviral defense. *DNA Repair*, **3**, 85–89.
- 56 Harris, R.S., Bishop, K.N., Sheehy, A.M., Craig, H.M., Petersen-Mahrt, S.K., Watt, I.N., Neuberger, M.S., and Malim, M.H. (2003) DNA deamination mediates innate immunity to retroviral infection. *Cell*, **113**, 803–809.
- 57 Lecossier, D., Bouchonnet, F., Clavel, F., and Hance, A.J. (2003) Hypermutation of HIV-1 DNA in the absence of the Vif protein. *Science*, **300**, 1112.
- 58 Mangeat, B., Turelli, P., Caron, G., Friedli, M., Perrin, L., and Trono, D. (2003) Broad antiretroviral defence by human APOBEC3G through lethal editing of nascent reverse transcripts. *Nature*, **424**, 99–103.
- 59 Zhang, H., Yang, B., Pomerantz, R.J., Zhang, C., Arunachalam, S.C., and Gao, L. (2003) The cytidine deaminase CEM15 induces hypermutation in newly synthesized HIV-1 DNA. *Nature*, **424**, 94–98.
- 60 Zhuang, J., Jetzt, A.E., Sun, G., Yu, H., Klarmann, G., Ron, Y., Preston, B.D., and Dougherty, J.P. (2002) Human immunodeficiency virus type 1 recombination: rate, fidelity, and putative hot spots. *Journal of Virology*, **76**, 11273–11282.
- 61 Hu, W.S., Rhodes, T., Dang, Q., and Pathak, V. (2003) Retroviral recombination: review of genetic analyses. *Frontiers in Bioscience: A Journal and Virtual Library*, **8**, d143–d155.
- 62 Jetzt, A.E., Yu, H., Klarmann, G.J., Ron, Y., Preston, B.D., and Dougherty, J.P. (2000) High rate of recombination throughout the human immunodeficiency virus type 1 genome. *Journal of Virology*, **74**, 1234–1240.
- 63 Jung, A., Maier, R., Vartanian, J.P., Bocharov, G., Jung, V., Fischer, U., Meese, E., Wain-Hobson, S., and Meyerhans, A. (2002) Recombination: multiply infected

- spleen cells in HIV patients. *Nature*, **418**, 144.
- 64 Onafuwa, A., An, W., Robson, N.D., and Telesnitsky, A. (2003) Human immunodeficiency virus type 1 genetic recombination is more frequent than that of Moloney murine leukemia virus despite similar template switching rates. *Journal of Virology*, **77**, 4577–4587.
- 65 Levy, D.N., Aldrovandi, G.M., Kutsch, O., and Shaw, G.M. (2004) Dynamics of HIV-1 recombination in its natural target cells. *Proceedings of the National Academy of Sciences of the United States of America*, **101**, 4204–4209.
- 66 Rhodes, T., Wargo, H., and Hu, W.S. (2003) High rates of human immunodeficiency virus type 1 recombination: near-random segregation of markers one kilobase apart in one round of viral replication. *Journal of Virology*, **77**, 11193–11200.
- 67 Loeb, L.A. and Mullins, J.I. (2000) Lethal mutagenesis of HIV by mutagenic ribonucleoside analogs. *AIDS Research and Human Retroviruses*, **16**, 1–3.
- 68 Grande-Pérez, A., Lázaro, E., Lowenstein, P., Domingo, E., and Manrubia, S.C. (2005) Suppression of viral infectivity through lethal defection. *Proceedings of the National Academy of Sciences of the United States of America*, **102**, 4448–4452.
- 69 Kamath-Loeb, A.S., Hizi, A., Tabone, J., Solomon, M.S., and Loeb, L.A. (1997) Inefficient repair of RNA×DNA hybrids. *European Journal of Biochemistry*, **250**, 492–501.
- 70 Bull, J.J., Sanjuan, R., and Wilke, C.O. (2007) Theory of lethal mutagenesis for viruses. *Journal of Virology*, **81**, 2930–2939.
- 71 Pariente, N., Sierra, S., Lowenstein, P.R., and Domingo, E. (2001) Efficient virus extinction by combinations of a mutagen and antiviral inhibitors. *Journal of Virology*, **75**, 9723–9730.
- 72 Domingo, E., Mas, A., Yuste, E., Pariente, N., Sierra, S., Gutiérrez-Riva, M., and Menéndez-Arias, L. (2001) Virus population dynamics, fitness variations and the control of viral disease: an update. *Progress in Drug Research*, **57**, 77–115.
- 73 Cuevas, J.M., González-Candelas, F., Moya, A., and Sanjuán, R. (2009) Effect of ribavirin on the mutation rate and spectrum of hepatitis C virus *in vivo*. *Journal of Virology*, **83**, 5760–5764.
- 74 Dapp, M.J., Clouser, C.L., Patterson, S., and Mansky, L.M. (2009) 5-Azacytidine can induce lethal mutagenesis in human immunodeficiency virus type 1. *Journal of Virology*, **83**, 11950–11958.
- 75 Harris, K.S., Brabant, W., Styrchak, S., Gall, A., and Daifuku, R. (2005) KP-1212/1461, a nucleoside designed for the treatment of HIV by viral mutagenesis. *Antiviral Research*, **67**, 1–9.
- 76 De Clercq, E. (1993) Antiviral agents: characteristic activity spectrum depending on the molecular target with which they interact. *Advances in Virus Research*, **42**, 1–55.
- 77 Pawlotsky, J.M., Dahari, H., Neumann, A.U., Hezode, C., Germanidis, G., Lonjon, I., Castera, L., and Dhumeaux, D. (2004) Antiviral action of ribavirin in chronic hepatitis C. *Gastroenterology*, **126**, 703–714.
- 78 Pawlotsky, J.M. (2004) Treating hepatitis C in “difficult-to-treat” patients. *The New England Journal of Medicine*, **351**, 422–423.
- 79 Lau, J.Y., Tam, R.C., Liang, T.J., and Hong, Z. (2002) Mechanism of action of ribavirin in the combination treatment of chronic HCV infection. *Hepatology (Baltimore, MD)*, **35**, 1002–1009.
- 80 Krilov, L.R. (2001) Respiratory syncytial virus: update on infection, treatment, and prevention. *Current Infectious Disease Reports*, **3**, 242–246.
- 81 Günther, S., Asper, M., Röser, C., Luna, L.K., Drosten, C., Becker-Ziaja, B., Borowski, P., Chen, H.M., and Hosmane, R.S. (2004) Application of real-time PCR for testing antiviral compounds against Lassa virus, SARS coronavirus and Ebola virus *in vitro*. *Antiviral Research*, **63**, 209–215.
- 82 Khan, S.H., Goba, A., Chu, M., Roth, C., Healing, T., Marx, A., Fair, J., Guttieri, M.C., Ferro, P., Imes, T., Monagin, C., Garry, R.F., Bausch, D.G., and Mano River Union Lassa Fever Network (2008) New opportunities for field research on the pathogenesis and treatment of Lassa fever. *Antiviral Research*, **78**, 103–115.
- 83 Saijo, M., Morikawa, S., Fukushi, S., Mizutani, T., Hasegawa, H., Nagata, N., Iwata, N., and Kurane, I. (2005) Inhibitory

- effect of mizoribine and ribavirin on the replication of severe acute respiratory syndrome (SARS)-associated coronavirus. *Antiviral Research*, **66**, 159–163.
- 84 Huggins, J.W., Hsiang, C.M., Cosgriff, T.M., Guang, M.Y., Smith, J.I., Wu, Z.O., LeDuc, J.W., Meegan, J.M., and Wang, Q.N. (1991) Prospective, double-blind, concurrent, placebo-controlled clinical trial of intravenous ribavirin therapy of hemorrhagic fever with renal syndrome. *The Journal of Infectious Diseases*, **164**, 1119–1127.
- 85 Streeter, D.G., Witkowski, J.T., Khare, G.P., Sidwell, R.W., Bauer, R.J., Robins, R.K., and Simon, L.N. (1973) Mechanism of action of 1- $\beta$ -D-ribofuranosyl-1,2,4-triazole-3-carboxamide (Virazole), a new broad-spectrum antiviral agent. *Proceedings of the National Academy of Sciences of the United States of America*, **70**, 1174–1178.
- 86 Fernandez-Larsson, R. and Patterson, J.L. (1990) Ribavirin is an inhibitor of human immunodeficiency virus reverse transcriptase. *Molecular Pharmacology*, **38**, 766–770.
- 87 Maag, D., Castro, C., Hong, Z., and Cameron, C.E. (2001) Hepatitis C virus RNA-dependent RNA polymerase (NS5B) as a mediator of the antiviral activity of ribavirin. *The Journal of Biological Chemistry*, **276**, 46094–46098.
- 88 Hultgren, C., Milich, D.R., Weiland, O., and Sällberg, M. (1998) The antiviral compound ribavirin modulates the T helper (Th) 1/Th2 subset balance in hepatitis B and C virus-specific immune responses. *The Journal of General Virology*, **79**, 2381–2391.
- 89 Tam, R.C., Pai, B., Bard, J., Lim, C., Averett, D.R., Phan, U.T., and Milovanovic, T. (1999) Ribavirin polarizes human T cell responses towards a Type 1 cytokine profile. *Journal of Hepatology*, **30**, 376–382.
- 90 Crotty, S., Cameron, C., and Andino, R. (2002) Ribavirin's antiviral mechanism of action: lethal mutagenesis? *Journal of Molecular Medicine (Berlin, Germany)*, **80**, 86–95.
- 91 Graci, J.D. and Cameron, C.E. (2006) Mechanisms of action of ribavirin against distinct viruses. *Reviews in Medical Virology*, **16**, 37–48.
- 92 Vo, N.V., Young, K.C., and Lai, M.M. (2003) Mutagenic and inhibitory effects of ribavirin on hepatitis C virus RNA polymerase. *Biochemistry*, **42**, 10462–10471.
- 93 Müller, W.E., Maidhof, A., Taschner, H., and Zahn, R.K. (1977) Virazole (1-beta-D-ribofuranosyl-1,2,4-triazole-3-carboxamide: a cytostatic agent. *Biochemical Pharmacology*, **26**, 1071–1075.
- 94 Zimmerman, T.P. and Deeprase, R.D. (1978) Metabolism of 5-amino-1-beta-D-ribofuranosylimidazole-4-carboxamide and related five-membered heterocycles to 5'-triphosphates in human blood and L5178Y cells. *Biochemical Pharmacology*, **27**, 709–716.
- 95 Contreras, A.M., Hiasa, Y., He, W., Terella, A., Schmidt, E.V., and Chung, R.T. (2002) Viral RNA mutations are region specific and increased by ribavirin in a full-length hepatitis C virus replication system. *Journal of Virology*, **76**, 8505–8517.
- 96 Zhou, S., Liu, R., Baroudy, B.M., Malcolm, B.A., and Reyes, G.R. (2003) The effect of ribavirin and IMPDH inhibitors on hepatitis C virus subgenomic replicon RNA. *Virology*, **310**, 333–342.
- 97 Lanford, R.E., Guerra, B., Lee, H., Averett, D.R., Pfeiffer, B., Chavez, D., Notvall, L., and Bigger, C. (2003) Antiviral effect and virus–host interactions in response to alpha interferon, gamma interferon, poly(i)-poly(c), tumor necrosis factor alpha, and ribavirin in hepatitis C virus subgenomic replicons. *Journal of Virology*, **77**, 1092–1104.
- 98 Lanford, R.E., Chavez, D., Guerra, B., Lau, J.Y., Hong, Z., Brasky, K.M., and Beames, B. (2001) Ribavirin induces error-prone replication of GB virus B in primary tamarin hepatocytes. *Journal of Virology*, **75**, 8074–8081.
- 99 Severson, W.E., Schmaljohn, C.S., Javadian, A., and Jonsson, C.B. (2003) Ribavirin causes error catastrophe during Hantaan virus replication. *Journal of Virology*, **77**, 481–488.
- 100 Jonsson, C.B., Milligan, B.G., and Arterburn, J.B. (2005) Potential importance of error catastrophe to the

- development of antiviral strategies for hantaviruses. *Virus Research*, **107**, 195–205.
- 101 Chung, D.H., Sun, Y., Parker, W.B., Arterburn, J.B., Bartolucci, A., and Jonsson, C.B. (2007) Ribavirin reveals a lethal threshold of allowable mutation frequency for Hantaan virus. *Journal of Virology*, **81**, 11722–11729.
- 102 Day, C.W., Smee, D.F., Julander, J.G., Yamshchikov, V.F., Sidwell, R.W., and Morrey, J.D. (2005) Error-prone replication of West Nile virus caused by ribavirin. *Antiviral Research*, **67**, 38–45.
- 103 Airaksinen, A., Pariente, N., Menéndez-Arias, L., and Domingo, E. (2003) Curing of foot-and-mouth disease virus from persistently infected cells by ribavirin involves enhanced mutagenesis. *Virology*, **311**, 339–349.
- 104 Asahina, Y., Izumi, N., Enomoto, N., Uchihara, M., Kurosaki, M., Onuki, Y., Nishimura, Y., Ueda, K., Tsuchiya, K., Nakanishi, H., Kitamura, T., and Miyake, S. (2005) Mutagenic effects of ribavirin and response to interferon/ribavirin combination therapy in chronic hepatitis C. *Journal of Hepatology*, **43**, 623–629.
- 105 Schinkel, J., de Jong, M.D., Bruning, B., van Hoek, B., Spaan, W.J., and Kroes, A.C. (2003) The potentiating effect of ribavirin on interferon in the treatment of hepatitis C: lack of evidence for ribavirin-induced viral mutagenesis. *Antiviral Therapy*, **8**, 535–540.
- 106 Chevaliez, S., Brillet, R., Lázaro, E., Hézode, C., and Pawlotsky, J.M. (2007) Analysis of ribavirin mutagenicity in human hepatitis C virus infection. *Journal of Virology*, **81**, 7732–7741.
- 107 Young, K.C., Lindsay, K.L., Lee, K.J., Liu, W.C., He, J.W., Milstein, S.L., and Lai, M.M. (2003) Identification of a ribavirin-resistant NS5B mutation of hepatitis C virus during ribavirin monotherapy. *Hepatology (Baltimore, MD)*, **38**, 869–878.
- 108 Lutchman, G., Danehower, S., Song, B.C., Liang, T.J., Hoofnagle, J.H., Thomson, M., and Ghany, M.G. (2007) Mutation rate of the hepatitis C virus NS5B in patients undergoing treatment with ribavirin monotherapy. *Gastroenterology*, **132**, 1757–1766.
- 109 Querenghi, F., Yu, Q., Billaud, G., Maertens, G., Trépo, C., and Zoulim, F. (2001) Evolution of hepatitis C virus genome in chronically infected patients receiving ribavirin monotherapy. *Journal of Viral Hepatitis*, **8**, 120–131.
- 110 Suen, W., Spiro, T.G., Sowers, L.C., and Fresco, J.R. (1999) Identification by UV resonance Raman spectroscopy of an imino tautomer of 5-hydroxy-2'-deoxycytidine, a powerful base analog transition mutagen with a much higher unfavored tautomer frequency than that of the natural residue 2'-deoxycytidine. *Proceedings of the National Academy of Sciences of the United States of America*, **96**, 4500–4505.
- 111 Anderson, J.P., Daifuku, R., and Loeb, L.A. (2004) Viral error catastrophe by mutagenic nucleosides. *Annual Review of Microbiology*, **58**, 183–205.
- 112 Issa, J.P. and Kantarjian, H. (2005) Azacitidine. *Nature Reviews. Drug Discovery (Suppl)*, S6–S7.
- 113 Yoo, C.B. and Jones, P.A. (2006) Epigenetic therapy of cancer: past, present and future. *Nature Reviews. Drug Discovery*, **5**, 37–50.
- 114 Bouchard, J., Walker, M.C., Leclerc, J.M., Lapointe, N., Beaulieu, R., and Thibodeau, L. (1990) 5-Azacytidine and 5-azadeoxycytidine inhibit human immunodeficiency virus type 1 replication *in vitro*. *Antimicrobial Agents and Chemotherapy*, **34**, 206–209.
- 115 Pathak, V.K. and Temin, H.M. (1992) 5-Azacytidine and RNA secondary structure increase the retrovirus mutation rate. *Journal of Virology*, **66**, 3093–3100.
- 116 Kees, U.R. and Avramis, V.I. (1995) Biochemical pharmacology and DNA methylation studies of arabinosyl 5-azacytidine and 5,6-dihydro-5-azacytidine in two human leukemia cell lines PER-145 and PER-163. *Anti-Cancer Drugs*, **6**, 303–310.
- 117 Samuels, B.L., Herndon, J.E., 2nd, Harmon, D.C., Carey, R., Aisner, J., Corson, J.M., Suzuki, Y., Green, M.R., and Vogelzang, N.J. (1998) Dihydro-5-azacytidine and cisplatin in the treatment of malignant mesothelioma: a phase II study by the Cancer and Leukemia Group B. *Cancer*, **82** 1578–1584.

- 118 Creagan, E.T., Schaid, D.J., Hartmann, L.C., and Loprinzi, C.L. (1993) A phase II study of 5,6-dihydro-5-azacytidine hydrochloride in disseminated malignant melanoma. *American Journal of Clinical Oncology*, **16**, 243–244.
- 119 Koronis (2010) Viral Decay Acceleration™ (VDA). (Cited). Available at <http://www.koronispharma.com/viraldecayacceleration.html>.
- 120 Murakami, E., Basavapathruni, A., Bradley, W.D., and Anderson, K.S. (2005) Mechanism of action of a novel viral mutagenic covert nucleotide: molecular interactions with HIV-1 reverse transcriptase and host cell DNA polymerases. *Antiviral Research*, **67**, 10–17.
- 121 Johnson, A.A., Ray, A.S., Hanes, J., Suo, Z., Colacino, J.M., Anderson, K.S., and Johnson, K.A. (2001) Toxicity of antiviral nucleoside analogs and the human mitochondrial DNA polymerase. *The Journal of Biological Chemistry*, **276**, 40847–40857.
- 122 Feng, J.Y., Johnson, A.A., Johnson, K.A., and Anderson, K.S. (2001) Insights into the molecular mechanism of mitochondrial toxicity by AIDS drugs. *The Journal of Biological Chemistry*, **276**, 23832–23837.
- 123 Lim, S.E. and Copeland, W.C. (2001) Differential incorporation and removal of antiviral deoxynucleotides by human DNA polymerase gamma. *The Journal of Biological Chemistry*, **276**, 23616–23623.
- 124 Birkus, G., Hitchcock, M.J., and Cihlar, T. (2002) Assessment of mitochondrial toxicity in human cells treated with tenofovir: comparison with other nucleoside reverse transcriptase inhibitors. *Antimicrobial Agents and Chemotherapy*, **46**, 716–723.
- 125 Venhoff, N., Setzer, B., Melkaoui, K., and Walker, U.A. (2007) Mitochondrial toxicity of tenofovir, emtricitabine and abacavir alone and in combination with additional nucleoside reverse transcriptase inhibitors. *Antiviral Therapy*, **12**, 1075–1085.
- 126 Mullins, J. *et al.* (2011) Mutations based on viral decay acceleration in the HIV-1 genomes of clinical populations treated with the mutagenic nucleoside KP1461. PLoS ONE, in press.
- 127 Traut, T.W. (1994) Physiological concentrations of purines and pyrimidines. *Molecular and Cellular Biochemistry*, **140**, 1–22.
- 128 Nordlund, P. and Reichard, P. (2006) Ribonucleotide reductases. *Annual Review of Biochemistry*, **75**, 681–706.
- 129 McGowan, C.H. (2003) Running into problems: how cells cope with replicating damaged DNA. *Mutation Research*, **532**, 75–84.
- 130 López-Camarillo, C., Lopez-Casamichana, M., Weber, C., Guillen, N., Orozco, E., and Marchat, L.A. (2009) DNA repair mechanisms in eukaryotes: special focus in *Entamoeba histolytica* and related protozoan parasites. *Infection, Genetics and Evolution*, **9**, 1051–1056.
- 131 Gerschenson, M. and Brinkman, K. (2004) Mitochondrial dysfunction in AIDS and its treatment. *Mitochondrion*, **4**, 763–777.
- 132 Lund, K.C., Peterson, L.L., and Wallace, K.B. (2007) Absence of a universal mechanism of mitochondrial toxicity by nucleoside analogs. *Antimicrobial Agents and Chemotherapy*, **51**, 2531–2539.
- 133 Berdis, A.J. (2008) DNA polymerases as therapeutic targets. *Biochemistry*, **47**, 8253–8260.
- 134 Anderson, K.S. (2010) A transient kinetic approach to investigate nucleoside inhibitors of mitochondrial DNA polymerase  $\gamma$ , **51** (4), 392–398 *Methods (San Diego, Calif.)*.
- 135 Bailey, C.M. and Anderson, K.S. (2010) A mechanistic view of human mitochondrial DNA polymerase gamma: providing insight into drug toxicity and mitochondrial disease. *Biochimica et Biophysica Acta*, **1804**, 1213–1222.
- 136 Clark, S.A., Calef, C., and Mellors, J.W. (2007) Mutations in retroviral genes associated with drug resistance, in *HIV Sequence Compendium 2006/2007* (eds T. Leitner, B. Foley, B. Hahn, P. Marx, F. McCutchan, J. Mellors, S. Wolinsky, and B. Korber), Theoretical Biology and Biophysics Group, Los Alamos, National Laboratory, Los Alamos, pp. 58–158.
- 137 Johnson, V.A., Brun-Vezinet, F., Clotet, B., Gunthard, H.F., Kuritzkes, D.R., Pillay, D., Schapiro, J.M., and Richman, D.D. (2009) Update of the drug resistance

- mutations in HIV-1: December 2009. *Top HIV Medicine*, **17**, 138–145.
- 138 HIV drug resistance mutations by drug class (2009). Available at [http://hivdb.stanford.edu/pages/download/resistanceMutations\\_handout.pdf](http://hivdb.stanford.edu/pages/download/resistanceMutations_handout.pdf).
- 139 Zhang, J., Hou, T., Wang, W., and Liu, J.S. (2010) Detecting and understanding combinatorial mutation patterns responsible for HIV drug resistance. *Proceedings of the National Academy of Sciences of the United States of America*, **107**, 1321–1326.
- 140 Codoñer, F.M., Darós, J.A., Solé, R.V., and Elena, S.F. (2006) The fittest versus the flattest: experimental confirmation of the quasispecies effect with subviral pathogens. *PLoS Pathogens*, **2**, e136.
- 141 Sanjuán, R., Cuevas, J.M., Furió, V., Holmes, E.C., and Moya, A. (2007) Selection for robustness in mutagenized RNA viruses. *PLoS Genetics*, **3**, e93.
- 142 Pfeiffer, J.K. and Kirkegaard, K. (2003) A single mutation in poliovirus RNA-dependent RNA polymerase confers resistance to mutagenic nucleotide analogs via increased fidelity. *Proceedings of the National Academy of Sciences of the United States of America*, **100**, 7289–7294.
- 143 Arnold, J.J., Vignuzzi, M., Stone, J.K., Andino, R., and Cameron, C.E. (2005) Remote site control of an active site fidelity checkpoint in a viral RNA-dependent RNA polymerase. *The Journal of Biological Chemistry*, **280**, 25706–25716.
- 144 Domingo, E., Grande-Perez, A., and Martin, V. (2008) Future prospects for the treatment of rapidly evolving viral pathogens: insights from evolutionary biology. *Expert Opinion on Biological Therapy*, **8**, 1455–1460.
- 145 Sierra, M., Airaksinen, A., González-López, C., Agudo, R., Arias, A., and Domingo, E. (2007) Foot-and-mouth disease virus mutant with decreased sensitivity to ribavirin: implications for error catastrophe. *Journal of Virology*, **81**, 2012–2024.
- 146 Arias, A., Arnold, J.J., Sierra, M., Smidansky, E.D., Domingo, E., and Cameron, C.E. (2008) Determinants of RNA-dependent RNA polymerase (in) fidelity revealed by kinetic analysis of the polymerase encoded by a foot-and-mouth disease virus mutant with reduced sensitivity to ribavirin. *Journal of Virology*, **82**, 12346–12355.
- 147 Pantaleo, G., Graziosi, C., Butini, L., Pizzo, P.A., Schnittman, S.M., Kotler, D.P., and Fauci, A.S. (1991) Lymphoid organs function as major reservoirs for human immunodeficiency virus. *Proceedings of the National Academy of Sciences of the United States of America*, **88**, 9838–9842.
- 148 Finzi, D., Hermankova, M., Pierson, T., Carruth, L.M., Buck, C., Chaisson, R.E., Quinn, T.C., Chadwick, K., Margolick, J., Brookmeyer, R., Gallant, J., Markowitz, M., Ho, D.D., Richman, D.D., and Siliciano, R.F. (1997) Identification of a reservoir for HIV-1 in patients on highly active antiretroviral therapy. *Science*, **278**, 1295–1300.
- 149 Pierson, T., McArthur, J., and Siliciano, R.F. (2000) Reservoirs for HIV-1: mechanisms for viral persistence in the presence of antiviral immune responses and antiretroviral therapy. *Annual Review of Immunology*, **18**, 665–708.
- 150 Blankson, J.N., Persaud, D., and Siliciano, R.F. (2002) The challenge of viral reservoirs in HIV-1 infection. *Annual Review of Medicine*, **53**, 557–593.
- 151 Kulkosky, J. and Bray, S. (2006) HAART-persistent HIV-1 latent reservoirs: their origin, mechanisms of stability and potential strategies for eradication. *Current HIV Research*, **4**, 199–208.
- 152 Koelsch, K.K., Liu, L., Haubrich, R., May, S., Havlir, D., Günthard, H.F., Ignacio, C.C., Campos-Soto, P., Little, S.J., Shafer, R., Robbins, G.K., D'Aquila, R.T., Kawano, Y., Young, K., Dao, P., Spina, C.A., Richman, D.D., and Wong, J.K. (2008) Dynamics of total, linear nonintegrated, and integrated HIV-1 DNA *in vivo* and *in vitro*. *The Journal of Infectious Diseases*, **197**, 411–419.
- 153 Goff, S.P. (2001) Intracellular trafficking of retroviral genomes during the early phase of infection: viral exploitation of cellular pathways. *The Journal of Gene Medicine*, **3**, 517–528.
- 154 Devereux, H.L., Burke, A., Lee, C.A., and Johnson, M.A. (2002) *In vivo* HIV-1 compartmentalisation: drug resistance-

- associated mutation distribution. *Journal of Medical Virology*, **66**, 8–12.
- 155 Shehu-Xhilaga, M., Tachedjian, G., Crowe, S.M., and Kedzierska, K. (2005) Antiretroviral compounds: mechanisms underlying failure of HAART to eradicate HIV-1. *Current Medicinal Chemistry*, **12**, 1705–1719.
- 156 Imamichi, H., Crandall, K.A., Natarajan, V., Jiang, M.K., Dewar, R.L., Berg, S., Gaddam, A., Bosche, M., Metcalf, J.A., Davey, Jr., R.T., and Lane, H.C. (2001) Human immunodeficiency virus type 1 quasi species that rebound after discontinuation of highly active antiretroviral therapy are similar to the viral quasi species present before initiation of therapy. *The Journal of Infectious Diseases*, **183**, 36–50.
- 157 Deeks, S.G., Grant, R.M., Wrin, T., Paxinos, E.E., Liegler, T., Hoh, R., Martin, J.N., and Petropoulos, C.J. (2003) Persistence of drug-resistant HIV-1 after a structured treatment interruption and its impact on treatment response. *AIDS (London, England)*, **17**, 361–370.
- 158 Boucher, S., Recordon-Pinson, P., Neau, D., Ragnaud, J.M., Titier, K., Faure, M., Fleury, H., and Masquelier, B. (2005) Clonal analysis of HIV-1 variants in proviral DNA during treatment interruption in patients with multiple therapy failures. *Journal of Clinical Virology*, **34**, 288–294.
- 159 Muller, H.J. (1964) The relation of recombination to mutational advance. *Mutation Research*, **106**, 2–9.
- 160 Haigh, J. (1978) The accumulation of deleterious genes in a population: Muller's ratchet. *Theoretical Population Biology*, **14**, 251–267.
- 161 Zeldovich, K.B., Chen, P., and Shakhnovich, E.I. (2007) Protein stability imposes limits on organism complexity and speed of molecular evolution. *Proceedings of the National Academy of Sciences of the United States of America*, **104**, 16152–16157.
- 162 Chen, P. and Shakhnovich, E.I. (2009) Lethal mutagenesis in viruses and bacteria. *Genetics*, **183**, 639–650.
- 163 Palombo, M.S., Singh, Y., and Sinko, P.J. (2009) Prodrug and conjugate drug delivery strategies for improving HIV/AIDS therapy. *Journal of Drug Delivery Science and Technology*, **19**, 3–14.

## 12

### Recent Progress in the Development of HCV Protease Inhibitors

*Nagraj Mani, Bhisetti G. Rao, Tara L. Kieffer, and Ann D. Kwong*

#### 12.1

##### Introduction

The natural history and clinical features of chronic hepatitis C, a disease affecting approximately 170 million people worldwide, are extensively reviewed in a recent publication [1]. Most patients are persistently infected and although HCV has a high replication rate [2], the initial effect on the hepatocytes it infects is relatively benign without the gross cytopathic effect observed with lytic virus infections (such as herpesviruses) or significant inflammation. Decades may pass before the patient presents with variable degrees of liver damage, including fibrosis, that may progress to cirrhosis, liver failure, portal hypertension, and hepatocellular carcinoma.

#### 12.2

##### HCV Therapy

The current standard of care (SOC) for patients infected with genotype 1 HCV is 48 weeks of Peg-IFN/RBV [3]. A “cure” is defined as a sustained viral response (SVR) where the plasma HCV RNA remains below the limit of detection at 24 weeks after the end of treatment. The success rate for achieving an SVR using Peg-IFN/RBV for genotype 1 patients, the most prevalent genotype in the United States, Europe, and Japan, is 42–46% [4]. The high failure rate (~60%) of current SOC combined with the long treatment duration can be difficult for patients to tolerate due to side effects such as IFN-induced bone marrow depression, flu-like symptoms, neuropsychiatric disorders, autoimmune symptoms, and RBV-induced hemolytic anemia (reviewed in Ref. [5]).

Recent reviews of the development of new HCV therapeutics [6–9] and HCV serine protease inhibitors in particular [10–14] attest to the tremendous explosion of knowledge and research work in this area. Because this is a rapidly changing field, this chapter is not intended to be comprehensive and will only focus on some of the most advanced HCV protease inhibitors currently in clinical development.



## 12.2.1

**The Role of HCV Protease**

As schematically illustrated in Figure 12.1a, the HCV genome is translated into a single viral polypeptide chain of ~3000 amino acids in length that is proteolytically processed by host and viral proteases into structural (C, E1, E2, and p7) and nonstructural (NS2, NS3, NS4A, NS4B, NS5A, and NS5B) proteins (reviewed in Ref. [15]). As summarized in Figure 12.1b, the NS3-4A protease is responsible for the cleavage of the viral polyprotein between NS3–NS4A, NS4A–NS4B, NS4B–NS5A, and NS5A–NS5B, to release components of the HCV replicase, and has been shown to be essential for viral replication. Thus, HCV protease inhibitors act upstream of viral replication complex formation as they block the release of individual NS proteins from the polyprotein (Figure 12.1c).

NS3 is a 631-amino acid bifunctional protein with a serine protease domain in the N-terminal 181-amino acid portion and an NTPase/helicase domain in the C-terminal portion (Figure 12.2a). NS3 protein associates tightly and noncovalently

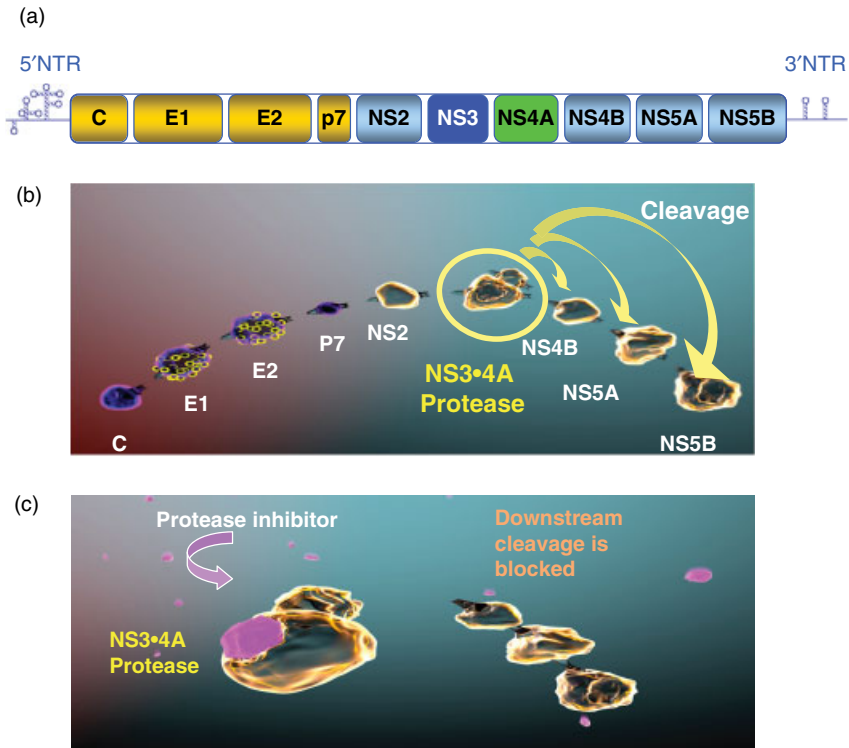

**Figure 12.1** HCV genome organization, NS3 protease function, and effect of protease inhibitors. (a) Organization of the HCV genome. (b) NS3-4A cleavage of the HCV polyprotein is required for replicase assembly. (c) HCV protease inhibitors inhibit viral replication by preventing replicase assembly.

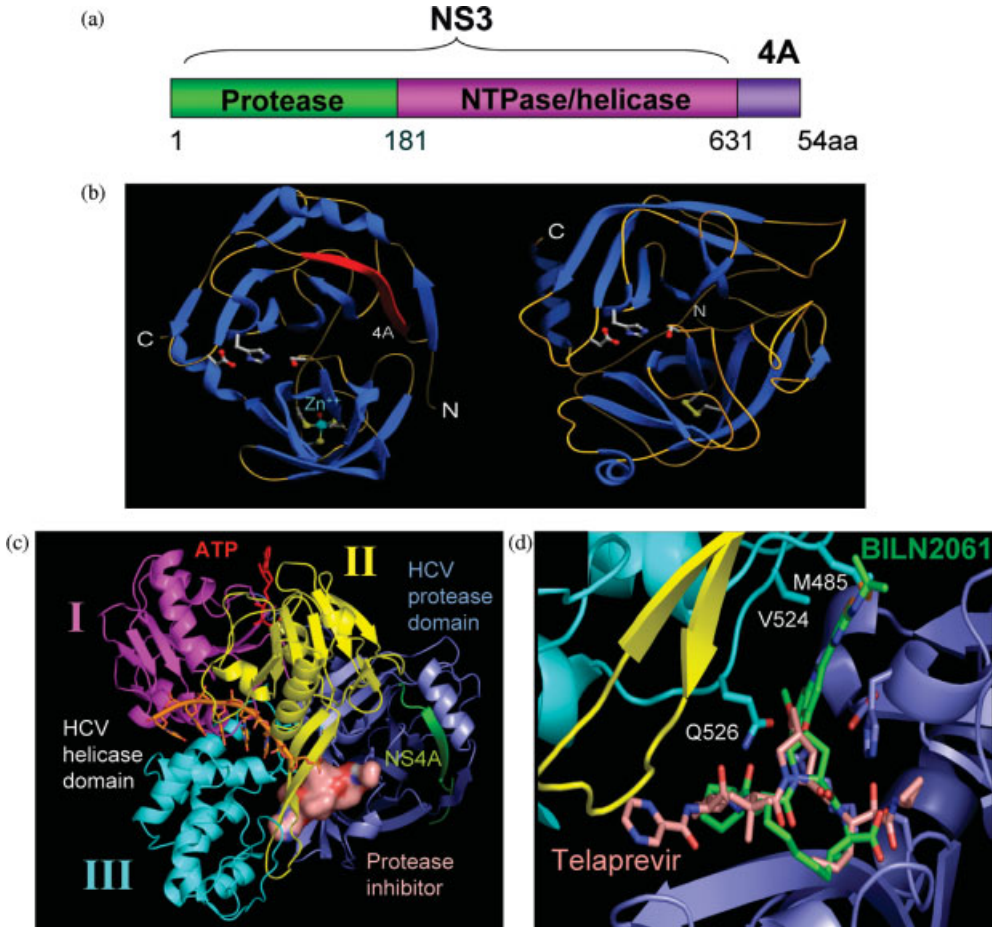

**Figure 12.2** HCV helicase domain interaction with the HCV protease substrate binding site. (a) Domain organization of the bifunctional NS3-4A protease/helicase complex. (b) Comparison of NS3-4A protease domain (left) to chymotrypsin (right). (c) HCV 4A-NS3 fusion docked with protease inhibitor, ATP, and oligonucleotide. (d) HCV 4A-NS3 fusion docked with protease inhibitors (close-up view). The NS4A co-factor is shown in red.

with NS4A, a 54-amino acid cofactor, to form the native HCV protease NS3-4A complex (Figure 12.2b) [16–22]. NS4A is buried deeply into the core of NS3 and assists in reorganizing the active site of the enzyme, increasing the catalytic efficiency of the native NS3 protein [22–24]. The NS3-4A protease adopts a chymotrypsin-like fold with two  $\beta$ -barrels with the catalytic triad (S139-H57-D81) located at the cleft between the two  $\beta$ -barrels. In addition, the structure features a tetrahedrally coordinated zinc ion distal to the active site. The crystal structure of the full-length NS3 has stimulated the hypothesis that the side of the helicase domain facing the protease active site forms part of the HCV protease substrate binding pocket and that some helicase domain residues could interact with protease inhibitors [25]. The three-

dimensional models of inhibitors docked into this full-length NS3 structure place the large P2 substituents of certain protease inhibitors within the interacting distance of three residues of domain III of the helicase (Figure 12.2c and d). In particular, the side chains of M485, V524, and Q526 of the helicase domain are found at the interface of the protease substrate/inhibitor binding site. A few publications have noted differences in the SAR of inhibitors when comparing data obtained with truncated NS3 protease versus full-length NS3 [26, 27]. However, a recent study [28] showed that simultaneous mutation of these three amino acid residues did not significantly affect enzymatic activity or binding of several classes of inhibitors. These findings are consistent with our initial hypothesis that the protease domain with the NS4A peptide is a good model for the protease activity of native NS3–NS4A protein.

### 12.2.2

#### **HCV Protease Inhibitor Design**

The structures of all inhibitors are constrained by the biology and physicochemical properties of the target they are designed to inhibit. The HCV protease substrate binding site is extremely shallow, elongated, and hydrophobic with no deep pockets to facilitate inhibitor binding [22]. Affinity for natural substrate peptides spanning the S6–S4' subsites of the enzyme drops significantly when the P4' group is removed, but not the P3' and P2' [29]. Similarly, loss of P6 and P5 acidic residues results in a large decrease in binding affinity with additional loss when the P3 and P4 hydrophobic residues are truncated.

The design of HCV protease inhibitors has been driven by two nonexclusive approaches: (i) medicinal chemistry-driven evolution of peptidomimetic inhibitors from the natural substrate and (ii) iterative optimization of inhibitors using structural information gained from their cocomplexes with the HCV protease. The diversity of peptidomimetic approaches pursued to optimize HCV protease inhibitors is illustrated by, but not limited to, the following examples [30–40]. These approaches were adopted in large part due to the fact that no viable starting points or “hits” were obtained using traditional high-throughput screening of large chemical libraries against the HCV protease enzyme.

### 12.2.3

#### **Similarities and Differences in HCV Protease Inhibitors**

Current HCV protease inhibitors can be broadly divided into two classes: (1) covalent (linear) and (2) noncovalent (linear or macrocyclic) peptidomimetic inhibitors (Table 12.1 and Figure 12.3). Covalent linear HCV protease inhibitors, exemplified by telaprevir and boceprevir (Figure 12.3b), inhibit HCV protease activity via formation of a reversible covalent interaction with serine-139 [37, 41, 42]. Attack of the electrophilic carbonyl of the ketoamide warhead by the catalytic serine results in the formation of a tetrahedral mimic of the transition state for peptide bond cleavage. This intermediate is further stabilized through additional ionic interactions with the active site.

Table 12.1 Linear and macrocyclic HCV protease inhibitors.

Inhibitor/ company	Clinical trial stage	Chemical structure	MW	clogP	PSA	Enzyme $K_i$ (nM) <sup>a</sup>		Replicon EC <sub>50</sub> (nM)		Source for enzyme/ replicon data
						GT 1a	GT 1b	GT 1a	GT 1b	
Covalent, linear										
Telaprevir (VX-950) Vertex	3		679	2.6	180	7	—	—	354	37
Boceprevir (SCH 503034) Schering- Plough/Merck	3		519	1.8	151	—	14	—	200	42
Narlaparevir (SCH 900518) Schering- Plough/Merck	2 <sup>b</sup>		707	3.5	171	0.7	7	—	20	90

(continued)

Table 12.1 (Continued)

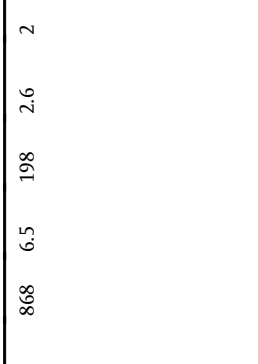
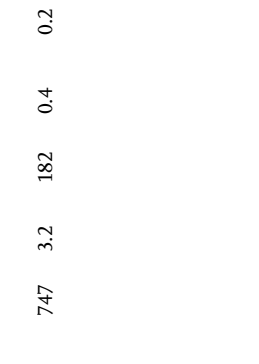
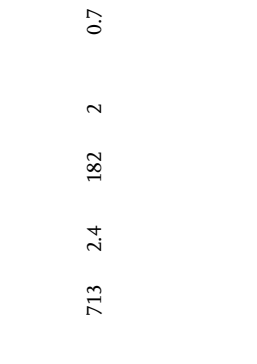
	Inhibitor/ company	Clinical trial stage	Chemical structure	MW	clogP	PSA	Enzyme $K_i$ (nM) <sup>a)</sup>		Replicon EC <sub>50</sub> (nM)		Source for enzyme/ replicon data
							GT 1a	GT 1b	GT 1a	GT 1b	
Noncovalent, linear	BI 201335 Boehringer- Ingelheim	2		868	6.5	198	2.6	2	6.5	3.1	44
	BMS-650032 Bristol-Myers Squibb	2		747	3.2	182	0.4	0.2	4.0	1.0	47
	BMS-605339 Bristol-Myers Squibb	1		713	2.4	182	2	0.7	8.0	3.0	46

Noncovalent, macrocyclic

ITMN-191 (RG7227)/ Danoprevir Roche/ InterMune

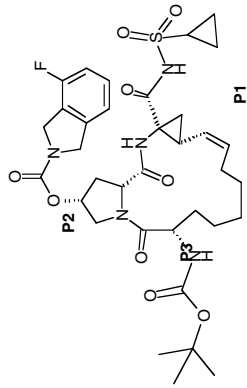

731 2.6 181 — 0.062 — 1.8 51,52

TMC435350 Medivir/Tibotec/ Johnson & Johnson

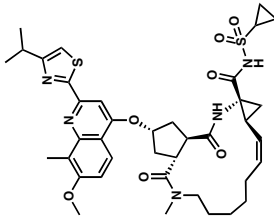

749 4.5 157 0.5 0.4 28.4 8.0 54

MK-7009 (Vani-previr) Merck

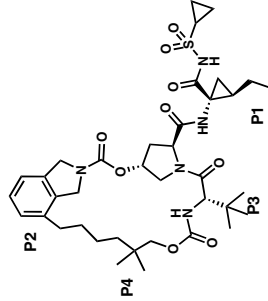

757 4.1 181 0.07 0.06 4.5 5.0 56,57

(continued)

Table 12.1 (Continued)

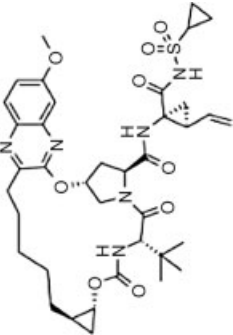
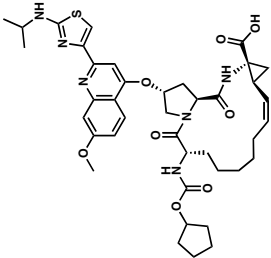
Inhibitor/ company	Clinical trial stage	Chemical structure	MW	clogP	PSA	Enzyme $K_i$ (nM) <sup>a)</sup>		Replicon EC <sub>50</sub> (nM)		Source for enzyme/ replicon data
						GT 1a	GT 1b	GT 1a	GT 1b	
MK-5172 Merck	1		768	3.7	195	—	<0.02	—	—	58
BILN 2061 (Gileuprevir) Boehringer- Ingelheim	1 <sup>c)</sup>		774	5.3	181	0.3	0.66	4.0	3.0	49

a) For telaprevir, boceprevir, narlaprevir, and danoprevir, this represents  $K_i^*$  for a multistep inhibition mechanism.

b) Development on hold.

c) Development stopped.

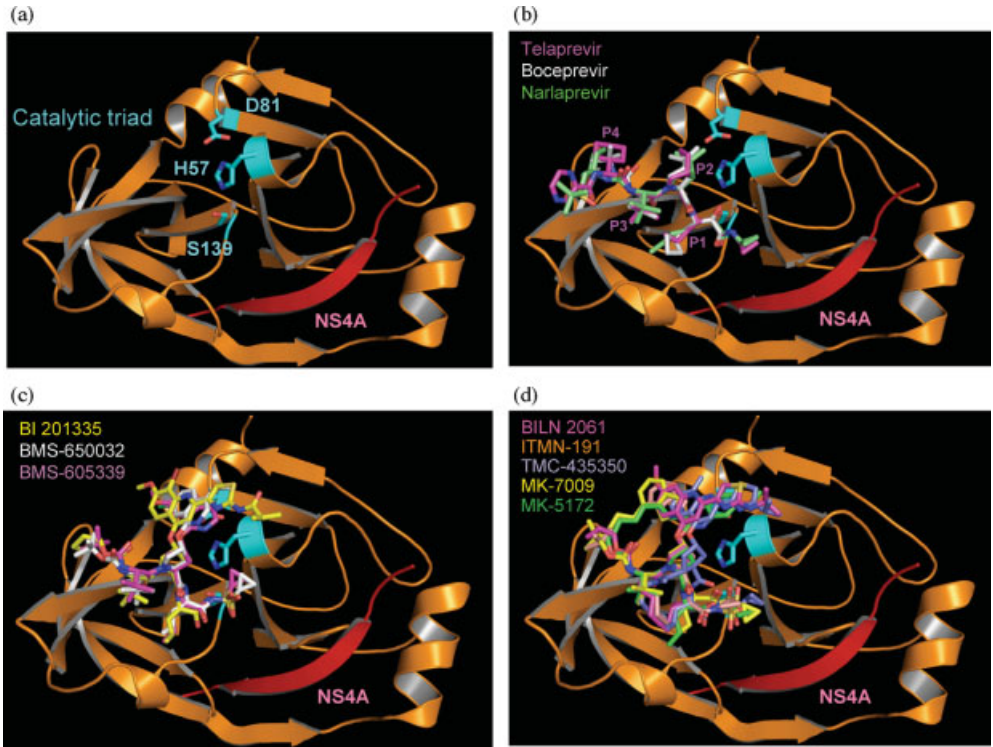

**Figure 12.3** HCV protease domain with modeled covalent linear, noncovalent linear, and noncovalent macrocyclic protease inhibitors bound to the HCV protease domain.

(a) HCV protease domain. (b) Covalent, linear protease inhibitors. (c) Noncovalent, linear protease inhibitors. (d) Noncovalent, macrocyclic, protease inhibitors.

In contrast, noncovalent linear protease inhibitors represented by BI 201335 [43–45], BMS-605339, and BMS-650032 (Table 12.1 and Figure 12.3c) [46, 47] do not function as electrophilic traps and do not form a covalent interaction with the catalytic serine. In addition, these noncovalent inhibitors have larger P2 substituents compared to the covalent linear inhibitors. In these aspects, BI 201335, BMS-605339, and BMS-650032 resemble the noncovalent macrocyclic inhibitors described below.

As described by Tsantrizos *et al.* [48], analysis of the X-ray structure of a linear inhibitor cocomplexed with the HCV protease domain revealed that the P1 and P3 side chains were in proximity of each other and could potentially be linked into a macrocycle. Such cyclized structures rigidify the bound conformation of the inhibitor and hence reduce the entropic cost of binding (Figure 12.3d). Macrocyclic peptidomimetics have been synthesized with hydrocarbon bridges of various lengths linking P1 to P3 as exemplified by BILN 2061 [49, 50], ITMN-191 [51, 52], and TMC435350 [53, 54] or linking P2 to P4 as exemplified by MK-7009 [55–57] and MK-5172 [58]. These inhibitors make noncovalent interactions as they include a



carboxylic acid or an acyl sulfonamide as the warhead; however, it is possible to design macrocyclic inhibitors containing electrophilic warheads. Interestingly, although BILN 2061 and ITMN-191 bind noncovalently, they both exhibit a two-step binding mechanism with a slow dissociation enzyme–inhibitor complex with a relatively long half-life [52, 59].

In general, all high-affinity HCV protease inhibitors tend to have high molecular weight (MW), polar surface area (PSA), and  $\text{clog}P$  (log octanol/water partition coefficient) (Table 12.1) and violate Lipinski's "rule of five" [60] for molecules with drug-like properties. While the main area of difference between these protease inhibitors is in their binding modes and kinetics of the enzyme–inhibitor interaction, their enzymatic mechanism of action remains the same. All protease inhibitors act as competitive inhibitors of the natural substrates.

#### 12.2.4

#### **Antiviral Potency and the Emergence of Resistance**

Unlike interferon-based therapy, DAA drugs have the potential to select for the emergence of clinical resistance [14, 61–63]. In order to be effective and result in a SVR, an HCV therapeutic regimen containing a DAA drug must be able to shut down the replication of both wild-type (WT) virus and preexisting resistant variants to reach a state of sustained elimination of HCV.

### 12.3

#### **Mechanism of Resistance and Cross-Resistance to NS3 Protease Inhibitors**

Viruses have the potential to generate resistance to DAA such as protease inhibitors. It has been estimated that  $\sim 10^{12}$  HCV virions are produced every day in an HCV-infected patient [2]. The high replication rate, coupled with low replicative fidelity, of its RNA-dependent RNA polymerase attributable to a lack of proofreading ability results in a high mutation rate. It has been estimated that point mutations will arise at each position of the HCV genome every day [64]. As a result, quasispecies or preexisting minor variant viral populations allow rapid emergence of resistance in HCV patients treated with DAA therapies. Amino acid changes that confer decreased sensitivity to HCV protease inhibitors are located in or near the substrate binding pocket (Figure 12.4a) and are summarized in the table in Figure 12.4b [46, 47, 58, 65–84].

Variants that confer resistance to protease inhibitors have been shown to remain fully susceptible to interferon and ribavirin [85, 86], and also to inhibitors with different mechanisms of action [72, 74].

#### 12.3.1

#### **Pattern of Resistance to Covalent Linear Protease Inhibitors**

Telaprevir was the first protease inhibitor where the selection of resistant variants during exposure to short-term monotherapy in clinical trials was described [77, 87].

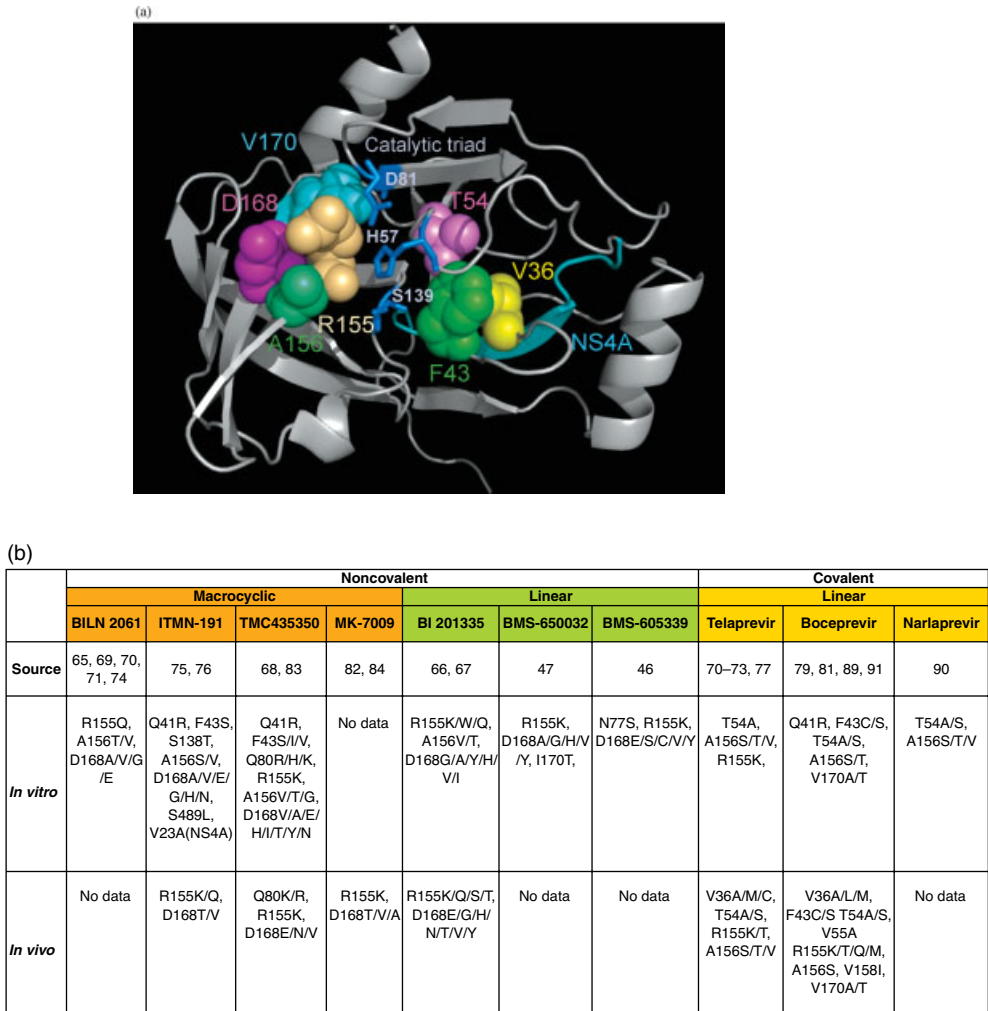

**Figure 12.4** HCV protease variants with decreased sensitivity to inhibitors.

These variants exhibit substitutions at four amino acid positions of the NS3 protease: V36, T54, R155, and A156 located in the protease active site (Figure 12.4a and b) in the vicinity of the telaprevir binding site (Figure 12.3b). Analyses of the rate of replication of these variants in a clinical study and phenotypic analyses of the degree of resistance to telaprevir and impact on replicative fitness in a HCV replicon system revealed an inverse relationship between the degree of resistance and the replicative fitness of a variant [77]. Boceprevir and narlaprevir belong to the same class of linear peptidomimetic inhibitors as telaprevir. NS3 variants with decreased sensitivity to boceprevir in clinical trials have been reported to involve amino acid substitutions at positions

V36, F43, T54, V55, R155, A156, V158, and V170 (Figure 12.4b) [79, 81, 88, 89]. Resistance selection studies with nardaprevir in an HCV replicon system identified amino acid substitutions at positions T54 (T54A/S) and A156 (A156S/T/V) that share a cross-resistance profile with boceprevir [76, 90]. These results are consistent with the overlap in binding modes of telaprevir, boceprevir, and nardaprevir to the NS3 protease active site as observed in X-ray crystal structures and/or predicted from application of molecular modeling approaches (Figure 12.3b).

### 12.3.2

#### Pattern of Resistance to Noncovalent Protease Inhibitors

While the noncovalent (linear or macrocyclic) class of NS3 protease inhibitors distinguish themselves from the covalent linear peptidomimetic compounds by differences in their structure and the mechanism by which they inhibit protease activity, X-ray crystallographic data and molecular modeling-based predictions indicate that there exists a significant molecular overlap between the covalent and noncovalent class of inhibitors (Table 12.1 and Figure 12.3). Therefore, some cross-resistance between these two distinct classes could be expected, although the degree of impact of certain amino acid substitutions on the potency of compounds can be variable. The most striking difference is that the noncovalent linear or macrocyclic inhibitors that have larger P2 substitutions select variants with changes at NS3 positions R155 and D168 in clinical studies with ITMN-191, TMC435350, MK-7009, and BI 201335 (Figure 12.4b). Interestingly, MK-5172 (Table 12.1), a second-generation noncovalent macrocyclic protease inhibitor related to MK-7009, shows improved *in vitro* activity against NS3 enzyme variants [58].

### 12.3.3

#### Cross-Resistance between Linear and Macrocyclic HCV Protease Inhibitors

In general, phenotypic analyses show that single variants at HCV NS3 protease residues V36 and T54 confer no resistance to the macrocyclic protease inhibitors, although they confer a low level of resistance (<25-fold change in susceptibility) to the linear peptidomimetic inhibitors (telaprevir and boceprevir) [68, 79]. Single variants with certain substitutions at residue 155 (R155K/T) show cross-resistance to both the linear (telaprevir and boceprevir) and the macrocyclic protease inhibitors (BILN 2061, ITMN-191, TMC435350, and MK-7009). In contrast, substitutions at position 168 (D168A/V) convey a relatively higher level of resistance to the macrocyclic class of inhibitors (e.g., BILN 2061 and ITMN-191), but confer no resistance to telaprevir and boceprevir. Amino acid substitutions A156T/V impart significant resistance to both telaprevir [71] and boceprevir [68, 79, 80, 91]. In the case of macrocyclics, a substantial fold increase in the IC<sub>50</sub> values of BILN 2061 over WT IC<sub>50</sub> values could be observed for A156T/V variants, whereas ITMN-191, TMC435350, and MK-7009 appear to be less affected.

## 12.4

### Antiviral Potency and Clinical Efficacy of HCV Protease Inhibitors

HCV protease inhibitors represent the first wave of potent specifically targeted antiviral therapy for HCV (STAT-C) that have the potential to significantly increase the cure rate and shorten treatment duration for the majority of patients infected with HCV. Multiple recent reviews of clinical trials with HCV protease inhibitors reflect the high interest in the HCV-treating community for the development programs of DAA drugs in general [7–9, 63] and NS3 protease inhibitors in particular [92] as they are farthest in development. This interest is likely due to the potential paradigm shift that may occur due to the improvement in efficacy and potential shorter treatment durations of DAA drug combined with Peg-IFN and RBV that may be possible compared to Peg-IFN or RBV alone that has been seen in clinical trials. A number of HCV protease inhibitors are currently in development, with boceprevir and telaprevir being the farthest in development and completing phase 3 clinical trials. The excitement over the paradigm shift to more potent combinations with direct acting antiviral drugs is tempered by a growing awareness of the implications of resistance for treatment success and failure as reflected in recent review articles [7, 14, 61, 62, 93, 94].

#### 12.4.1

##### Telaprevir

Results of three phase 2 clinical trials have been published for telaprevir in combination with Peg-IFN $\alpha$ 2a/RBV in genotype 1 treatment-naïve patients (PROVE1 and PROVE2) and in patients who previously failed a prior course of Peg-IFN/RBV therapy (PROVE3). In the PROVE1 [95] and PROVE2 [96] studies, various durations of Peg-IFN/RBV (PR) treatment were tested to determine the optimal duration of treatment. Patients received 12 weeks of telaprevir (T12) in combination with 12, 24, or 48 weeks of Peg-IFN $\alpha$ 2a/RBV (T12/PR12, T12/PR24, or T12/PR48). In these trials, SVR rates were significantly improved in treatment-naïve subjects with a telaprevir-based regimen compared to current Peg-IFN $\alpha$ 2a/RBV therapy alone. Specifically, in the T12/PR24 group, SVR rates were 61% (PROVE1;  $p=0.02$ ) and 69% (PROVE2;  $p=0.004$ ) compared to 41% (PROVE1) and 46% (PROVE2) in the PR48 control group. In the 48 week regimen tested in PROVE1, SVR rate was 67% ( $p=0.002$ ) compared to 41% in the control group. Results from these studies showed that subjects who received telaprevir had higher rates of undetectable HCV RNA at week 4, higher SVR rates, and very low relapse rates in comparison to Peg-IFN $\alpha$ 2a/RBV alone. Similar results were seen in two phase 3 trials (ADVANCE and ILLUMINATE).

In the 12 week regimen, SVR rates were 35% (PROVE1; exploratory and not compared to the control group) and 60% (PROVE2;  $p=0.12$ ) compared to 46% in the PR48 week control group; however, higher relapse rates suggested that longer durations may potentially reduce relapse in some patients. Viral breakthrough rates

during telaprevir, Peg-IFN, and RBV treatment were low (~5%), indicating that this combination therapy suppressed the emergence of resistant variants in most patients. In addition, one arm in the PROVE2 trial tested telaprevir with Peg-IFN alone (no RBV) and showed that regimens without RBV resulted in higher viral breakthrough and lower SVR rates, indicating that RBV contributes significantly to antiviral activity in combination therapy.

In the PROVE3 study, SVR rates were significantly improved with a telaprevir-based regimen compared to current Peg-IFN $\alpha$ 2a/RBV therapy alone in subjects who previously failed Peg-IFN/RBV treatment [97]. Treatment with 12 weeks of telaprevir in combination with 24 weeks of Peg-IFN $\alpha$ 2a/RBV (T12/PR24) and 24 weeks of telaprevir in combination with 48 weeks of Peg-IFN $\alpha$ 2a/RBV (T24/PR48) were compared to standard therapy (PR48). SVR rates were 51% in the T12/PR24 group ( $p < 0.001$ ) and 53% in the T24/PR48 group ( $p < 0.001$ ), which was significantly higher compared to 14% in the control PR48 group. This trial also tested telaprevir with Peg-IFN $\alpha$ 2a alone (no RBV) and, similar to the PROVE2 trial, showed that regimens without RBV resulted in higher viral breakthrough and lower SVR rates, indicating again a significant contribution of RBV to antiviral activity. Response rates were greatest among prior relapsers, but were also significantly higher for prior nonresponders (subjects who never had undetectable HCV RNA during prior treatment). The SVR rates in prior non-responders were 39% in the T12PR24 group, 38% in the T24PR48 group, and 11% in the T24P24 group, and in prior relapsers were 69% in the T12PR24 group, 76% in the T24PR48 group, and 42% in the T24P24 group. In the PR48 control group, SVR rates were 9% for prior non-responders and 20% for prior relapsers. Results from this study suggested that 12 weeks of telaprevir in combination with 48 weeks of Peg-IFN $\alpha$ 2a/RBV may be an optimal regimen for most patients who had previously failed a Peg-IFN/RBV regimen. Similar results were observed in a phase 3 trial (REALIZE).

#### 12.4.2

##### **Boceprevir**

Recent results from a phase 2 clinical trial have been published describing results of boceprevir in combination with Peg-IFN $\alpha$ 2b/RBV in genotype 1 treatment-naïve patients (SPRINT-1) [98]. This trial tested two treatment durations of boceprevir, Peg-IFN $\alpha$ 2b, and RBV of 28 (BPR28) and 48 (BPR48) weeks, and tested a 4 week pretreatment with Peg-IFN $\alpha$ 2b/RBV prior to initiating treatment with boceprevir (PR4/BPR24 and PR4/BPR44). All treatment groups with boceprevir had significantly higher SVR rates compared to the control group (PR48), with the highest response rates observed with 48 weeks of treatment, with 75% ( $p < 0.0001$ ) in the PR4/BPR44 and 67% ( $p < 0.0001$ ) in the BPR48 groups; and 56% ( $p = 0.005$ ) in the PR4/BPR24 and 54% ( $p = 0.013$ ) in the BPR28 groups compared to 38% in the PR48 control group. On comparing the regimens with or without a pretreatment with Peg-IFN/RBV, somewhat higher SVR rates were seen with the pretreatment, while relapse rates did not differ significantly. In addition, this trial also tested boceprevir with Peg-IFN $\alpha$ 2b and a low dose of RBV (400–1000 mg) for 48 weeks, and similar to

what was observed in the telaprevir clinical trials, regimens without or with less RBV resulted in higher viral breakthrough and relapse rates, again indicating that RBV contributes significantly to antiviral activity. These results were recently confirmed in a phase 3 study (SPRINT-2). A phase 3 trial of boceprevir in patients who previously failed a prior course of Peg-IFN/RBV therapy is ongoing (RESPOND-2).

#### 12.4.3

#### **Safety Profile of Protease Inhibitors**

Another important consideration for DAA compounds, which are being developed for use in combination with Peg-IFN and ribavirin, is the safety profile of the new combination therapy regimens. In two phase 2 studies of treatment-naïve subjects with telaprevir, Peg-IFN $\alpha$ 2a, and RBV, the types of adverse events were similar to those seen in the Peg-IFN $\alpha$ 2a/ribavirin control groups, with higher rates of rash (including 7% discontinuation for severe rash) and anemia in the telaprevir groups [95, 96]. In one of the two studies, a higher incidence (increase of about 10%) of gastrointestinal events (nausea, diarrhea) compared to the SOC control arm was observed [95]. In the phase 2 study of treatment-naïve subjects with boceprevir, Peg-IFN $\alpha$ 2b, and RBV, the most common adverse events included fatigue, nausea, headache, dysgeusia, and anemia, with 44–48% of subjects receiving erythropoietin for anemia [98].

### 12.5

#### **Future Directions**

Short-term goals for future therapies include increasing the SVR rate, decreasing treatment duration, reducing side effects, minimizing breakthroughs due to resistance while developing treatment strategies for patients in whom resistance may have developed, and treating patients who have not achieved SVR with Peg-IFN and RBV. In addition, studies in patients with historically low response rates to Peg-IFN and RBV, such as African-Americans, patients with advanced cirrhosis, liver transplant patients, HIV–HCV coinfecting patients, and patients with kidney failure, need to be conducted. A longer-term goal for the treatment of chronic HCV is the removal of interferon from the treatment regimen in order to achieve improved treatment tolerability and accessibility to more HCV-infected patients. It is hoped that the potential future introduction of combinations of DAA agents having additive/synergistic potency and without cross-resistance could help achieve this goal. In addition, lessons learned from the HIV field suggest that the first-generation protease inhibitors could eventually be replaced by the second- and third-generation inhibitors having improved potency to reduce pill burden and to address resistant variants. These novel combinations of DAA drugs would need to be developed with an eye toward combinability and minimizing significant drug–drug interactions that could limit their utility in the clinic.

### List of Abbreviations

BPR boceprevir + Peg-IFNalpha2b + RBV  
 $\log P$   $\log P_{\text{oct/water}}$  is the calculated log octanol/water partition coefficient that is a predictor of the hydrophobic (lipophilic) properties of a compound  
 DAA direct acting antiviral  
 GT 1a HCV genotype 1 subtype a  
 GT 1b HCV genotype 1 subtype b  
 HCV hepatitis C virus  
 HIV human immunodeficiency virus  
 IFN interferon  
 MW molecular weight  
 NS3 nonstructural protein 3  
 NS3-4A nonstructural protein 3-4A  
 NS4A nonstructural protein 4A  
 NTP nucleotide triphosphate  
 Peg-IFN pegylated interferon- $\alpha$   
 PR Peg-IFN $\alpha$ 2a and RBV  
 PSA polar surface area  
 q8h every 8 h  
 q12h every 12 h  
 RBV ribavirin  
 RNA ribonucleic acid  
 SAR structure–activity relationships (relationship between the structure of inhibitor/ligand and its effect on the activity of the protein)  
 SOC standard of care (Peg-IFN $\alpha$  and RBV)  
 STAT-C specifically targeted antiviral therapy for HCV  
 SVR sustained viral response (undetectable HCV RNA at end of treatment visit and at 24 weeks after the last actual dose of treatment without any confirmed detectable HCV RNA in between)  
 T/PR telaprevir + Peg-IFN $\alpha$ 2a + RBV  
 WT wild-type

### Acknowledgments

The authors would like to sincerely thank Mark Namchuk, Rene Rijnbrand, Anne-Laure Grillot, Doug Bartels, Shahin Gharakhanian, Kelly Bierly, Kristin Stephan, Robert Kauffman, Hilary Winters, and Valerie Philippon for reviewing this chapter and for helpful discussions.

### References

- 1 Modi, A.A. and Liang, T.J. (2008) Hepatitis C: a clinical review. *Oral Diseases*, **14** (1), 10–14.
- 2 Neumann, A.U., Lam, N.P., Dahari, H., Gretch, D.R., Wiley, T.E., Layden, T.J. *et al.* (1998) Hepatitis C viral dynamics *in vivo*

- and the antiviral efficacy of interferon-alpha therapy. *Science*, **282** (5386), 103–107.
- 3 McHutchison, J.G., Lawitz, E.J., Shiffman, M.L., Muir, A.J., Galler, G.W., McCone, J. *et al.* (2009) Peginterferon alfa-2b or alfa-2a with ribavirin for treatment of hepatitis C infection. *The New England Journal of Medicine*, **361** (6), 580–593.
  - 4 Manns, M.P., Foster, G.R., Rockstroh, J.K., Zeuzem, S., Zoulim, F., and Houghton, M. (2007) The way forward in HCV treatment: finding the right path. *Nature Reviews. Drug Discovery*, **6** (12), 991–1000.
  - 5 Manns, M., Wedemeyer, H., and Cornberg, M. (2006) Treating viral hepatitis C: efficacy, side effects and complications. *Gut*, **55**, 1350–1359.
  - 6 Shimakami, T., Lanford, R.E., and Lemon, S.M. (2009) Hepatitis C: recent successes and continuing challenges in the development of improved treatment modalities. *Current Opinion in Pharmacology*, **9** (5), 537–544.
  - 7 Thompson, A., Patel, K., Tillman, H., and McHutchison, J.G. (2009) Directly acting antivirals for the treatment of patients with hepatitis C infection: a clinical development update addressing key future challenges. *Journal of Hepatology*, **50** (1), 184–194.
  - 8 Pockros, P. (2010) New direct-acting antivirals in development for hepatitis C virus infection. *Therapeutic Advances in Gastroenterology*, **1**, 191–202.
  - 9 Michaels, A.J. and Nelson, D.R. (2010) New therapies in the management of hepatitis C virus. *Current Opinion in Gastroenterology*, **26** (3), 196–201.
  - 10 De Francesco, R. and Carfi, A. (2007) Advances in the development of new therapeutic agents targeting the NS3-4A serine protease or the NSSB RNA-dependent RNA polymerase of the hepatitis C virus. *Advanced Drug Delivery Reviews*, **59** (12), 1242–1262.
  - 11 Lopez-Labrador, F.X. (2008) Hepatitis C virus NS3/4A protease inhibitors. *Recent Patents on Anti-Infective Drug Discovery*, **3** (3), 157–167.
  - 12 Asselah, T., Benhamou, Y., and Marcellin, P. (2009) Protease and polymerase inhibitors for the treatment of hepatitis C. *Liver International*, **29** (Suppl. 1), 57–67.
  - 13 Reiser, M. and Timm, J. (2009) Serine protease inhibitors as anti-hepatitis C virus agents. *Expert Review of Anti-Infective Therapy*, **7** (5), 537–547.
  - 14 Kronenberger, B. and Zeuzem, S. (2009) Treatment of chronic hepatitis C: anticipated impact of resistance in patients treated with protease inhibitors. *Current Gastroenterology Reports*, **11** (1), 15–21.
  - 15 Lindenbach, B.D. and Rice, C.M. (2001) Flaviviridae: the viruses and their replication, in *Fields Virology*, 4th edn (eds D.M. Knipe, P.M. Howley, and D.E. Griffin), Lippincott Williams & Wilkins, Philadelphia, pp. 991–1041.
  - 16 Failla, C., Tomei, L., and De Francesco, R. (1994) Both NS3 and NS4A are required for proteolytic processing of hepatitis C virus nonstructural proteins. *Journal of Virology*, **68** (6), 3753–3760.
  - 17 Tanji, Y., Hijikata, M., Satoh, S., Kaneko, T., and Shimotohno, K. (1995) Hepatitis C virus-encoded nonstructural protein NS4A has versatile functions in viral protein processing. *Journal of Virology*, **69** (3), 1575–1581.
  - 18 Lin, C. and Rice, C.M. (1995) The hepatitis C virus NS3 serine proteinase and NS4A cofactor: establishment of a cell-free trans-processing assay. *Proceedings of the National Academy of Sciences of the United States of America*, **92** (17), 7622–7626.
  - 19 Lin, C., Thomson, J.A., and Rice, C.M. (1995) A central region in the hepatitis C virus NS4A protein allows formation of an active NS3–NS4A serine proteinase complex *in vivo* and *in vitro*. *Journal of Virology*, **69**, 4373–4380.
  - 20 Bartenschlager, R., Lohmann, V., Wilkinson, T., and Koch, J.O. (1995) Complex formation between the NS3 serine-type proteinase of the hepatitis C virus and NS4A and its importance for polyprotein maturation. *Journal of Virology*, **69**, 7519–7528.
  - 21 Failla, C., Tomei, L., and De Francesco, R. (1995) An amino-terminal domain of the hepatitis C virus NS3 protease is essential for interaction with NS4A. *Journal of Virology*, **69** (3), 1769–1777.
  - 22 Kim, J.L., Morgenstern, K.A., Lin, C., Fox, T., Dwyer, M.D., Landro, J.A. *et al.* (1996)



- Crystal structure of the hepatitis C virus NS3 protease domain complexed with a synthetic NS4A cofactor peptide. *Cell*, **87**, 343–355.
- 23 Love, R.A., Parge, H.E., Wickersham, J.A., Hostomsky, Z., Habuka, N., Moomaw, E.W. *et al.* (1996) The crystal structure of hepatitis C virus NS3 proteinase reveals a trypsin-like fold and a structural zinc binding site. *Cell*, **87**, 331–342.
- 24 Sali, D.L., Ingram, R., Wendel, M., Gupta, D., McNemar, C., Tsarboboulos, A. *et al.* (1998) Serine protease of hepatitis C virus expressed in insect cells as the NS3/4A complex. *Biochemistry*, **37** (10), 3392–3401.
- 25 Yao, N., Reichert, P., Taremi, S.S., Prosser, W.W., and Weber, P.C. (1999) Molecular views of the viral polyprotein processing revealed by the crystal structure of the hepatitis C virus bifunctional protease–helicase. *Structure (London, England: 1993)*, **7**, 1353–1363.
- 26 Johansson, A., Hubatsch, I., Akerblom, E., Lindeberg, G., Winiwarter, S., Danielson, U.H. *et al.* (2001) Inhibition of hepatitis C virus NS3 protease activity by product-based peptides is dependent on helicase domain. *Bioorganic & Medicinal Chemistry Letters*, **11** (2), 203–206.
- 27 Johansson, A., Poliakov, A., Akerblom, E., Wiklund, K., Lindeberg, G., Winiwarter, S. *et al.* (2003) Acyl sulfonamides as potent protease inhibitors of the hepatitis C virus full-length NS3 (protease–helicase/NTPase): a comparative study of different C-terminals. *Bioorganic & Medicinal Chemistry*, **11** (12), 2551–2568.
- 28 Thibeault, D., Massariol, M.J., Zhao, S., Welchner, E., Goudreau, N., Gingras, R. *et al.* (2009) Use of the fused NS4A peptide–NS3 protease domain to study the importance of the helicase domain for protease inhibitor binding to hepatitis C virus NS3–NS4A. *Biochemistry*, **48** (4), 744–753.
- 29 Landro, J.A., Raybuck, S.A., Luong, Y.P., O'Malley, E.T., Harbeson, S.L., Morgenstern, K.A. *et al.* (1997) Mechanistic role of an NS4A peptide cofactor with the truncated NS3 protease of hepatitis C virus: elucidation of the NS4A stimulatory effect via kinetic analysis and inhibitor mapping. *Biochemistry*, **36** (31), 9340–9348.
- 30 LaPlante, S.R., Cameron, D.R., Aubry, N., Lefebvre, S., Kukolj, G., Maurice, R. *et al.* (1999) Solution structure of substrate-based ligands when bound to hepatitis C virus NS3 protease domain. *The Journal of Biological Chemistry*, **274** (26), 18618–18624.
- 31 Cicero, D.O., Barbato, G., Koch, U., Ingallinella, P., Bianchi, E., Nardi, M.C. *et al.* (1999) Structural characterization of the interactions of optimized product inhibitors with the N-terminal proteinase domain of the hepatitis C virus (HCV) NS3 protein by NMR and modelling studies. *Journal of Molecular Biology*, **289** (2), 385–396.
- 32 Glunz, P.W., Douty, B.D., and Decicco, C.P. (2003) Design and synthesis of bicyclic pyrimidinone-based HCV NS3 protease inhibitors. *Bioorganic & Medicinal Chemistry Letters*, **13** (5), 785–788.
- 33 Andrews, D.M., Chaignot, H.M., Coomber, B.A., Dowle, M.D., Hind, S.L., Johnson, M.R., Jones, P.S., Mills, G., Patikis, A., Pateman, T.J., Robinson, J.E., Slater, M.J., and Trivedi, N. (2003) The design of potent non-peptidic inhibitors of hepatitis C protease. *European Journal of Medicinal Chemistry*, **38**, 339–343.
- 34 Tsantrizos, Y.S. (2004) The design of a potent inhibitor of the hepatitis C virus NS3 protease: BILN 2061 – from the NMR tube to the clinic. *Biopolymers*, **76** (4), 309–323.
- 35 Llinas-Brunet, M., Bailey, M.D., Bolger, G., Brochu, C., Faucher, A.M., Ferland, J.M. *et al.* (2004) Structure–activity study on a novel series of macrocyclic inhibitors of the hepatitis C virus NS3 protease leading to the discovery of BILN 2061. *Journal of Medicinal Chemistry*, **47** (7), 1605–1608.
- 36 Goudreau, N. and Llinas-Brunet, M. (2005) The therapeutic potential of NS3 protease inhibitors in HCV infection. *Expert Opinion on Investigational Drugs*, **14** (9), 1129–1144.
- 37 Perni, R.B., Almquist, S.J., Byrn, R.A., Chandorkar, G., Chaturvedi, P.R., Courtney, L.F. *et al.* (2006) Preclinical profile of VX-950, a potent, selective, and orally bioavailable inhibitor of hepatitis C virus NS3-4A serine protease. *Antimicrobial Agents and Chemotherapy*, **50** (3), 899–909.

- 38 Venkatraman, S. and Njoroge, F.G. (2007) Macrocytic inhibitors of HCV NS3-4A protease: design and structure activity relationship. *Current Topics in Medicinal Chemistry*, **7** (13), 1290–1301.
- 39 Vendeville, S., Nilsson, M., de Kock, H., Lin, T.I., Antonov, D., Classon, B. *et al.* (2008) Discovery of novel, potent and bioavailable proline-urea based macrocytic HCV NS3/4A protease inhibitors. *Bioorganic & Medicinal Chemistry Letters*, **18** (23), 6189–6193.
- 40 Njoroge, F.G., Chen, K.X., Shih, N.Y., and Piwinski, J.J. (2008) Challenges in modern drug discovery: a case study of boceprevir, an HCV protease inhibitor for the treatment of hepatitis C virus infection. *Accounts of Chemical Research*, **41** (1), 50–59.
- 41 Leung, D., Abbenante, G., and Fairlie, D.P. (2000) Protease inhibitors: current status and future prospects. *Journal of Medicinal Chemistry*, **43** (3), 305–341.
- 42 Malcolm, B.A., Liu, R., Lahser, F., Agrawal, S., Belanger, B., Butkiewicz, N. *et al.* (2006) SCH 503034, a mechanism-based inhibitor of hepatitis C virus NS3 protease, suppresses polyprotein maturation and enhances the antiviral activity of alpha interferon in replicon cells. *Antimicrobial Agents and Chemotherapy*, **50** (3), 1013–1020.
- 43 Lemke, C., Zhao, S., Goudreau, N., Hucke, O., Thibeault, D., Llinas-Brunet, M. *et al.* (2009) Bound structure and biochemical mechanism of action of non-covalent HCV NS3/4A protease inhibitor BI 201335. The 23rd International Conference on Antiviral Research (ICAR), April 25–28, 2009, San Francisco, CA, USA, p. A20.
- 44 White, P.W., Llinas-Brunet, M., Amad, Ma, Bethell, R., Bolger, G., Cordingley, M. *et al.* (2010) Preclinical characterization of non-covalent HCV NS3/4A protease inhibitor BI 201335. 45th Annual Meeting of European Association for the Study of the Liver (EASL), April 14–18, 2010, Vienna, Austria.
- 45 Llinas-Brunet, M., Bailey, M.D., Goudreau, N., Bhardwaj, P.K., Bordeleau, J., Bos, M. *et al.* (2010) Discovery of a potent and selective noncovalent linear inhibitor of the Hepatitis C Virus NS3 protease (BI 201335). *Journal of Medicinal Chemistry*, **53** (17), 6466–6476.
- 46 McPhee, F., Good, A., Campbell, A.D., Sheaffer, A., Want, A., Knige, J. *et al.* (2009) The discovery and early development of the HCV NS3 protease inhibitor BMS-605339. HepDart, December 6–10, 2009, Kohala Coast, IHL Press, Division of Informed Horizons, LLC, Hawaii, p. 51.
- 47 McPhee, F. (2010) Identification and preclinical profile of the novel HCV NS3 protease inhibitor BMS-650032. 45th Annual Meeting of European Association for the Study of the Liver (EASL), April 14–18, 2010, Vienna, Austria.
- 48 Tsantrizos, Y.S., Bolger, G., Bonneau, P., Cameron, D.R., Goudreau, N., Kukolj, G., LaPlante, S.R., Llinas-Brunet, M., Nar, H., and Lamarre, D. (2003) Macrocytic inhibitors of the NS3 protease as potential therapeutic agents of hepatitis C virus infection. *Angewandte Chemie*, **42**, 1355–1360.
- 49 Lamarre, D., Anderson, P.C., Bailey, M., Beaulieu, P., Bolger, G., Bonneau, P. *et al.* (2003) An NS3 protease inhibitor with antiviral effects in humans infected with hepatitis C virus. *Nature*, **426** (6963), 186–189.
- 50 Faucher, A.M., Bailey, M.D., Beaulieu, P.L., Brochu, C., Duceppe, J.S., Ferland, J.M. *et al.* (2004) Synthesis of BILN 2061, an HCV NS3 protease inhibitor with proven antiviral effect in humans. *Organic Letters*, **6** (17), 2901–2904.
- 51 Seiwert, S.D., Andrews, S.W., Jiang, Y., Serebryany, V., Tan, H., Kossen, K. *et al.* (2008) Preclinical characteristics of the hepatitis C virus NS3/4A protease inhibitor ITMN-191 (R7227). *Antimicrobial Agents and Chemotherapy*, **52** (12), 4432–4441.
- 52 Rajagopalan, R., Misialek, S., Stevens, S.K., Myszk, D.G., Brandhuber, B.J., Ballard, J.A. *et al.* (2009) Inhibition and binding kinetics of the hepatitis C virus NS3 protease inhibitor ITMN-191 reveals tight binding and slow dissociative behavior. *Biochemistry*, **48** (11), 2559–2568.
- 53 Raboisson, P., de Kock, H., Rosenquist, A., Nilsson, M., Salvador-Oden, L., Lin, T.I. *et al.* (2008) Structure–activity relationship study on a novel series of cyclopentane-containing macrocytic inhibitors of the

- hepatitis C virus NS3/4A protease leading to the discovery of TMC435350. *Bioorganic & Medicinal Chemistry Letters*, **18** (17), 4853–4858.
- 54 Lin, T.I., Lenz, O., Fanning, G., Verbinnen, T., Delouvroy, F., Scholliers, A. *et al.* (2009) *In vitro* activity and preclinical profile of TMC435350, a potent hepatitis C virus protease inhibitor. *Antimicrobial Agents and Chemotherapy*, **53** (4), 1377–1385.
- 55 Liverton, N.J., Holloway, M.K., McCauley, J.A., Rudd, M.T., Butcher, J.W., Carroll, S.S. *et al.* (2008) Molecular modeling based approach to potent P2–P4 macrocyclic inhibitors of hepatitis C NS3/4A protease. *Journal of the American Chemical Society*, **130** (14), 4607–4609.
- 56 Liverton, N.J., Carroll, S.S., Dimuzio, J., Fandozzi, C., Graham, D.J., Hazuda, D. *et al.* (2010) MK-7009, a potent and selective inhibitor of hepatitis C virus NS3/4A protease. *Antimicrobial Agents and Chemotherapy*, **54** (1), 305–311.
- 57 McCauley, J.A., McIntyre, C.J., Rudd, M.T., Nguyen, K.T., Romano, J.J., Butcher, J.W. *et al.* (2010) Discovery of vaniprevir (MK-7009), a macrocyclic hepatitis C virus NS3/4a protease inhibitor. *Journal of Medicinal Chemistry*, **53** (6), 2443–2463.
- 58 Liverton, N. (2010) MK-5172: a novel HCV NS3/4A protease inhibitor with potent activity against known resistance mutants. 45th Annual Meeting of the European Society for the Study of the Liver (EASL), April 14–18, 2010, Vienna, Austria.
- 59 Flores, M.V., Strawbridge, J., Ciaramella, G., and Corbau, R. (2009) HCV-NS3 inhibitors: determination of their kinetic parameters and mechanism. *Biochimica et Biophysica Acta*, **1794** (10), 1441–1448.
- 60 Lipinski, C.A., Lombardo, F., Dominy, B.W., and Feeney, P.J. (1997) Experimental and computational approaches to estimate solubility and permeability in drug discovery and development settings. *Advanced Drug Delivery Reviews*, **23** (1–3), 3–25.
- 61 Kieffer, T.L., Kwong, A.D., and Picchio, G.R. (2010) Viral resistance to specifically targeted antiviral therapies for hepatitis C (STAT-Cs). *The Journal of Antimicrobial Chemotherapy*, **65** (2), 202–212.
- 62 Sarrazin, C. and Zeuzem, S. (2010) Resistance to direct antiviral agents in patients with hepatitis C virus infection. *Gastroenterology*, **138** (2), 447–462.
- 63 Cooper, C. (2010) Viral response to specifically targeted antiviral therapy for hepatitis C and the implications for treatment success. *Canadian Journal of Gastroenterology*, **24** (6), 385–390.
- 64 Rong, L., Dahari, H., Ribeiro, R.M., and Perelson, A.S. (2010) Rapid emergence of protease inhibitor resistance in hepatitis C virus. *Science Translational Medicine*, **2** (30), 30ra2.
- 65 Imhof, I. and Simmonds, P. (2010) Development of an intergenotypic hepatitis C virus (HCV) cell culture method to assess antiviral susceptibilities and resistance development of HCV NS3 protease genes from HCV genotypes 1 to 6. *Journal of Virology*, **84** (9), 4597–4610.
- 66 Kukulj, G., Benhamou, Y., Mann, M., bourliere, M., Pol, S., Schuchmann, M. *et al.* (2009) BI 201335, a potent HCV NS3 protease inhibitor, in treatment-naïve and -experienced chronic HCV genotype-1 infection: genotypic and phenotypic analysis of the NS3 protease domain. 45th Annual Meeting of the European Society for the Study of the Liver (EASL), April 23–26, 2009, Copenhagen, Denmark.
- 67 Kukulj, G., Bousquet, C., Dansereau, N., Lagace, L., Llinas-Brunet, M., Massariol, M.-J. *et al.* (2010) Characterization of resistant mutants selected *in vitro* by the HCV NS3/4A protease inhibitor BI 201335. 45th Annual Meeting of the European Society for the Study of the Liver (EASL), April 23–26, 2010, Copenhagen, Denmark.
- 68 Lenz, O., Verbinnen, T., Lin, T.I., Vijgen, L., Cummings, M.D., Lindberg, J. *et al.* (2010) *In vitro* resistance profile of the hepatitis C virus NS3/4A protease inhibitor TMC435. *Antimicrobial Agents and Chemotherapy*, **54** (5), 1878–1887.
- 69 Lu, L., Pilot-Matias, T.J., Stewart, K.D., Randolph, J.T., Pithawalla, R., He, W. *et al.* (2004) Mutations conferring resistance to a potent hepatitis C virus serine protease inhibitor *in vitro*. *Antimicrobial Agents and Chemotherapy*, **48** (6), 2260–2266.
- 70 Lin, C., Lin, K., Luong, Y.P., Rao, B.G., Wei, Y.Y., Brennan, D.L. *et al.* (2004) *In vitro* resistance studies of hepatitis C virus serine protease inhibitors, VX-950 and

- BILN 2061: structural analysis indicates different resistance mechanisms. *The Journal of Biological Chemistry*, **279** (17), 17508–17514.
- 71 Lin, C., Gates, C.A., Rao, B.G., Brennan, D.L., Fulghum, J.R., Luong, Y.P. *et al.* (2005) *In vitro* studies of cross-resistance mutations against two hepatitis C virus serine protease inhibitors, VX-950 and BILN 2061. *The Journal of Biological Chemistry*, **280** (44), 36784–36791.
- 72 McCown, M.F., Rajyaguru, S., Le Pogam, S., Ali, S., Jiang, W.R., Kang, H. *et al.* (2008) The hepatitis C virus replicon presents a higher barrier to resistance to nucleoside analogs than to nonnucleoside polymerase or protease inhibitors. *Antimicrobial Agents and Chemotherapy*, **52** (5), 1604–1612.
- 73 Barbotte, L., Ahmed-Belkacem, A., Chevaliez, S., Soulier, A., Hezode, C., Wajcman, H. *et al.* (2010) Characterization of V36C, a novel amino acid substitution conferring hepatitis C virus (HCV) resistance to telaprevir, a potent peptidomimetic inhibitor of HCV protease. *Antimicrobial Agents and Chemotherapy*, **54** (6), 2681–2683.
- 74 Mo, H., Lu, L., Pilot-Matias, T., Pithawalla, R., Mondal, R., Masse, S. *et al.* (2005) Mutations conferring resistance to a hepatitis C virus (HCV) RNA-dependent RNA polymerase inhibitor alone or in combination with an HCV serine protease inhibitor *in vitro*. *Antimicrobial Agents and Chemotherapy*, **49** (10), 4305–4314.
- 75 Seiwert, S. (2006) Sequence variation of NS3 and NS4A in hepatitis C virus (HCV) replicons following exposure to ITMN-191 concentrations likely to encompass those achieved in human liver following clinical dosing. First International Workshop on Hepatitis C Resistance & New Compounds, October 25–26, 2006, Boston, MA, USA.
- 76 Sarrazin, C., Hong, J., Lim, S.R., Qin, X., Moy, C., Susser, S. *et al.* (2009) Incidence of virologic escape observed during ITMN-191 (R7227) monotherapy is genotype dependent, associated with a specific NS3 substitution, and suppressed upon combination with peginterferon alpha-2a/ribavirin. 45th Annual Meeting of the European Association for the Study of Liver Diseases, April 14–18, 2010, Vienna, Austria.
- 77 Sarrazin, C., Kieffer, T.L., Bartels, D., Hanzelka, B., Muh, U., Welker, M. *et al.* (2007) Dynamic hepatitis C virus genotypic and phenotypic changes in patients treated with the protease inhibitor telaprevir. *Gastroenterology*, **132** (5), 1767–1777.
- 78 Sarrazin, C., Rouzier, R., Wagner, F., Forestier, N., Larrey, D., Gupta, S.K. *et al.* (2007) SCH 503034, a novel hepatitis C virus protease inhibitor, plus pegylated interferon alpha-2b for genotype 1 nonresponders. *Gastroenterology*, **132** (4), 1270–1278.
- 79 Susser, S., Welsch, C., Wang, Y., Zettler, M., Domingues, F.S., Karey, U. *et al.* (2009) Characterization of resistance to the protease inhibitor boceprevir in hepatitis C virus-infected patients. *Hepatology (Baltimore, MD)*, **50** (6), 1709–1718.
- 80 Tong, X., Bogen, S., Chase, R., Girijavallabhan, V., Guo, Z., Njoroge, F.G. *et al.* (2008) Characterization of resistance mutations against HCV ketoamide protease inhibitors. *Antiviral Research*, **77** (3), 177–185.
- 81 Ralston, R. (2007) Development of resistance to boceprevir: observations from clinical trials. First International Workshop on Hepatitis C Resistance & New Compounds, October 31–November 1, 2007, Boston, MA.
- 82 Manns, M., Gane, E., Rodriguez-Torres, M., Stoehr, A., Yeh, C., Wiedmann, R. *et al.* (2009) MK-7009 significantly improves rapid viral response (RVR) in combination with pegylated interferon alfa-2a and ribavirin in patients with chronic hepatitis C (CHC) genotype 1 infection. 44th Annual Meeting of European Association for the Study of the Liver (EASL), April 22–26, 2009, Copenhagen, Denmark.
- 83 Manns, M., Reesink, H., Moreno, C., Berg, T., Benhamou, Y., Horsmans, Y. *et al.* (2009) Opera-1 trial (study TMC435-C201): interim analysis of safety and antiviral activity of TMC435 in treatment-naive genotype-1 HCV patients. 44th Annual Meeting of European Association for the Study of the Liver (EASL), April 22–26, 2009, Copenhagen, Denmark.

- 84 Barnard, R., Adeniji-Adele, A., Himmelberger, A., Wiedmann, R., Hwang, P., Quirk, E. *et al.* (2009) Longitudinal clonal resistance analysis of treatment-naïve patients with chronic hepatitis C (CHC) genotype 1 infection treated with MK-7009, a novel NS3/4a protease inhibitor, in combination with pegylated interferon alfa-2a and ribavirin for 28 day. HepDART, December 6–10, 2009, Kohala Coast, Hawaii, USA.
- 85 Zhou, Y., Bartels, D.J., Hanzelka, B.L., Muh, U., Wei, Y., Chu, H.M. *et al.* (2008) Phenotypic characterization of resistant Val36 variants of hepatitis C virus NS3-4A serine protease. *Antimicrobial Agents and Chemotherapy*, **52** (1), 110–120.
- 86 Zhou, Y., Bartels, D., Muh, U., Hanzelka, B., Kieffer, T., Kwong, A. *et al.* (2006) Phenotypic characterization of telaprevir (VX-950) protease variants in a HCV replicon system. 13th International Symposium on Hepatitis C Virus and Related Viruses, August 27–31, 2006, Cairns, Australia.
- 87 Kieffer, T.L., Sarrazin, C., Miller, J.S., Welker, M.W., Forestier, N., Reesink, H.W. *et al.* (2007) Telaprevir and pegylated interferon-alpha-2a inhibit wild-type and resistant genotype 1 hepatitis C virus replication in patients. *Hepatology (Baltimore, MD)*, **46** (3), 631–639.
- 88 Curry, S., Qiu, P., and Tong, X. (2008) Analysis of HCV resistance mutations during combination therapy with protease inhibitor boceprevir and PEG-IFN alpha-2b using TaqMan mismatch amplification mutation assay. *Journal of Virological Methods*, **153** (2), 156–162.
- 89 Qiu, P., Sanfiorenzo, V., Curry, S., Guo, Z., Liu, S., Skelton, A. *et al.* (2009) Identification of HCV protease inhibitor resistance mutations by selection pressure-based method. *Nucleic Acids Research*, **37** (10), e74.
- 90 Tong, X., Arasappan, A., Bennett, F., Chase, R., Feld, B., Guo, Z. *et al.* (2010) Preclinical characterization of the antiviral activity of SCH 900518 (marlaprevir), a novel mechanism-based inhibitor of hepatitis C virus NS3 protease. *Antimicrobial Agents and Chemotherapy*, **54** (6), 2365–2370.
- 91 Tong, X., Chase, R., Skelton, A., Chen, T., Wright-Minogue, J., and Malcolm, B.A. (2006) Identification and analysis of fitness of resistance mutations against the HCV protease inhibitor SCH 503034. *Antiviral Research*, **70** (2), 28–38.
- 92 Kronenberger, B. and Zeuzem, S. (2009) Current and future treatment options for HCV. *Annals of Hepatology*, **8** (2), 103–112.
- 93 Thompson, A.J. and McHutchison, J.G. (2009) Antiviral resistance and specifically targeted therapy for HCV (STAT-C). *Journal of Viral Hepatitis*, **16** (6), 377–387.
- 94 Pawlotsky, J.-M. (2009) Therapeutic implications of hepatitis C virus resistance to antiviral drugs. *Therapeutic Advances in Gastroenterology*, **2**, 205–219.
- 95 McHutchison, J.G., Everson, G.T., Gordon, S.C., Jacobson, I.M., Sulkowski, M., Kauffman, R. *et al.* (2009) Telaprevir with peginterferon and ribavirin for chronic HCV genotype 1 infection. *The New England Journal of Medicine*, **360** (18), 1827–1838.
- 96 Hezode, C., Forestier, N., Dusheiko, G., Ferenci, P., Pol, S., Goeser, T. *et al.* (2009) Telaprevir and peginterferon with or without ribavirin for chronic HCV infection. *The New England Journal of Medicine*, **360** (18), 1839–1850.
- 97 McHutchison, J.G., Manns, M.P., Muir, A.J., Terrault, N.A., Jacobson, I.M., Afdhal, N.H. *et al.* (2010) Telaprevir for previously treated chronic HCV infection. *The New England Journal of Medicine*, **362** (14), 1292–1303.
- 98 Kwo, P.Y., Lawitz, E.J., McCone, J., Schiff, E.R., Vierling, J.M., Pound, D. *et al.* (2010) Efficacy of boceprevir, an NS3 protease inhibitor, in combination with peginterferon alfa-2b and ribavirin in treatment-naïve patients with genotype 1 hepatitis C infection (SPRINT-1): an open-label, randomised, multicentre phase 2 trial. *The Lancet*, **376** (9742), 705–716.

## 13

### Antiviral RNAi: How to Silence Viruses

Karin J. von Eije and Ben Berkhout

#### 13.1

##### The Discovery of RNA Interference

RNAi is a cellular mechanism that can be induced by siRNAs to mediate the sequence-specific gene knockdown by cleavage or translational repression of the targeted mRNA. The initial phenomenon that led to the discovery of RNAi was made by Jorgensen and colleagues in petunia flowers that turned partially or completely white after the introduction of a pigment-producing gene that was supposed to deepen the purple color [1]. Around the same time, van der Krol *et al.* reported similar observations in petunias [2]. Soon thereafter, similar phenomena were described in the fungi *Neurospora crassa* by Romano and Macino, where this posttranscriptional gene silencing (PTGS) is also known as “quelling” [3]. Fire *et al.* described the RNAi phenomenon in mechanistic terms in the nematode *Caenorhabditis elegans*. Efficient sequence-specific gene silencing was observed upon introduction of double-stranded RNA (dsRNA) [4]. Injection of dsRNA corresponding to different genes resulted in a specific null mutant phenotype in *Drosophila* [5, 6]. Subsequently, RNAi was also described in *Trypanosoma brucei* [7], zebrafish [8], and mice [9]. Introduction of base paired 21-nucleotide dsRNA into mammalian cell lines also triggered sequence-specific gene silencing [10]. This discovery triggered the development of RNAi-based therapies against a wide variety of diseases, including cancer, neurological, autoimmune, and infectious diseases [11–17].

#### 13.2

##### Therapeutic Application of the RNAi Mechanism

The importance of RNAi in future drug development was underlined when the Nobel Prize in Medicine or Physiology was awarded in 2006 to Andrew Fire and Craig Mello for the description of the RNAi mechanism [4]. RNAi also holds promise as a powerful strategy for intracellular therapy against pathogenic viruses. To properly evaluate the RNAi therapeutic approaches and the risks involved in redirecting the

cellular RNAi machinery, it is essential to understand the RNAi mechanism in molecular detail and its natural function. Therefore, we will first describe the microRNA (miRNA) pathway in more detail. It is estimated that human cells express more than 500 miRNAs (<http://microrna.sanger.ac.uk>). These miRNAs are important in cell regulation and development [18–22] and they regulate gene expression in humans by translational repression of specific mRNAs or by mRNA cleavage and subsequent degradation [23]. Figure 13.1 depicts the natural miRNA pathway. Polymerase (Pol) II or occasionally Pol III produces the primary transcript, pri-miRNA, that encodes the miRNA [24]. Some miRNAs are clustered and transcribed as a single polycistronic transcript. The pri-miRNA is processed into the pre-miRNA with 5'-monophosphate and 3'-hydroxyl 2-nucleotide (nt) overhang [25] by the

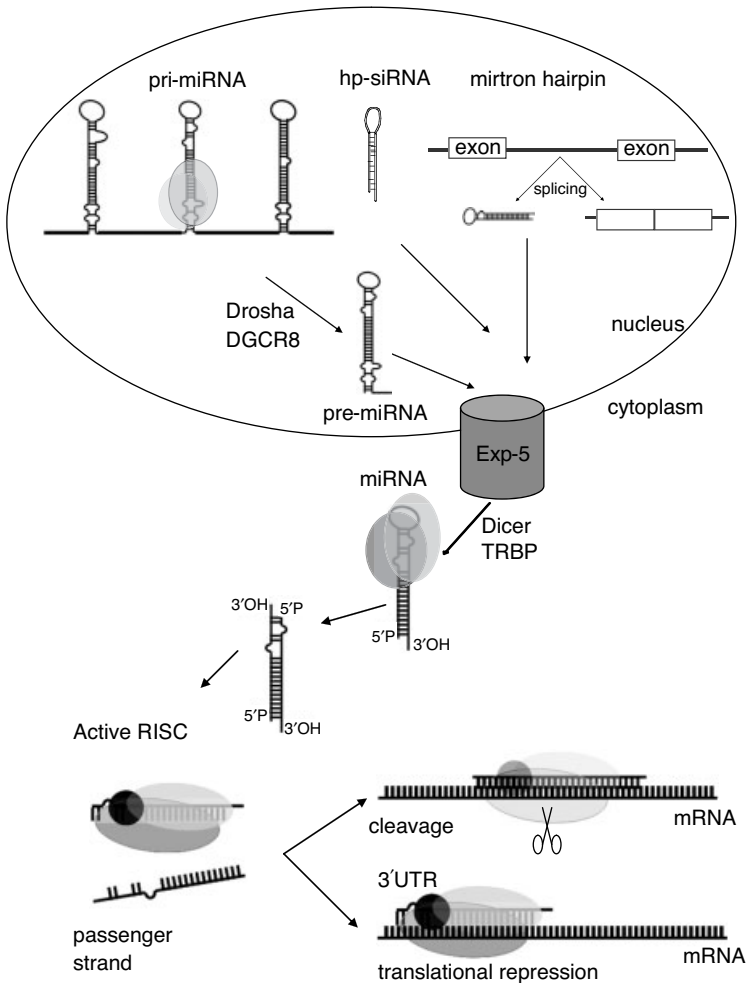

**Figure 13.1** The miRNA pathway. See the text for details.

microprocessor complex that contains the RNase III-like enzyme Drosha and the dsRNA binding protein DGCR8/Pasha [26–30]. A small number of miRNAs do not require processing by Drosha. Some miRNAs are expressed as shRNA with a 5'-single-stranded tail; these molecules are termed hairpin (hp) siRNAs [31]. Other miRNAs are encoded within introns (mirtrons) and processed into pre-miRNAs by the splicing machinery [32, 33]. The pre-miRNA is formed in the nucleus and exported to the cytoplasm by Exportin-5 (Exp-5) [34–36]. The RNase III-like endonuclease Dicer subsequently cleaves the base paired stem approximately 22 bp away from its base, generating a 2-nt overhang at the 3'-end [37]. Dicer is associated with the TAR RNA binding protein (TRBP), which is required to recruit Argonaute-2 (Ago2) [38]. The Ago2–RNA complex forms the minimal core of the RNA-induced silencing complex (RISC) [39, 40]. RISC unwinds the miRNA and loads one RNA strand (guide strand) in the complex, the other strand (passenger strand) is degraded [41]. The RNA strand with its 5'-end at the side of the duplex with the lowest thermodynamic stability gets preferentially incorporated into RISC [42, 43]. In mammals, posttranscriptional silencing is mainly elicited by translational repression of the targeted mRNA [23]. An important determinant is the level of base pairing complementarity between the miRNA and the mRNA target, leading to mRNA cleavage (perfect complementarity) or translational repression (near-perfect complementarity) [44–48]. RISC typically forms complexes when the “seed” region of the miRNA (5'-end) anneal to multiple target sequences in the 3'-untranslated region (3'-UTR) of the mRNA. The number of 3'-UTR targets and their distance determine the silencing efficiency [49]. Most mammalian miRNAs anneal through imperfect base pairing complementarity with the mRNA to cause translational repression, but at least one case of perfect complementarity and mRNA cleavage is known in humans [50]. Endonucleolytic cleavage of the targeted mRNA occurs opposite to nucleotide position 10–11 of the miRNA and the cleaved mRNA is subsequently degraded. In contrast to natural miRNAs, siRNAs with full base pairing complementarity can direct mRNA cleavage, even with only a single target site that can be located anywhere within the mRNA. Such artificial dsRNA can be produced by several methods. Synthetic mature siRNAs can be transfected into cells [10], but shRNAs [51, 52] and artificial miRNAs can be expressed intracellularly from a transgene construct [53]. The natural miRNA pathway can be instructed with the man-made inhibitors for therapeutic downregulation of a specific mRNA. This therapeutic approach can be used for diseases caused by overexpression of a specific mRNA or to specifically target the RNA genomes and mRNAs of invading microbes.

### 13.3

#### Mammalian Viruses and the RNAi Mechanism

RNAi plays a significant role in the antiviral defense of plants and in *Drosophila melanogaster* [54, 55]. Whether RNAi has natural antiviral activity in mammals is still under investigation. In contrast to plants, mammals have an innate immune system, which includes the interferon pathway, and an adaptive immune system, which



includes antibodies and cytotoxic T cells, to react on invading viruses. Like the RNAi mechanism, the interferon pathway is also triggered by dsRNA. However, the interferon pathway is not present in embryonic stem cells and oocytes, which therefore may be more dependent on alternative antiviral mechanisms such as RNAi. That small RNAs play an important role in these cell types is underlined by the identification of endogenous siRNAs that map to transposable elements, including retrotransposons, in the mouse genome. This finding suggests that mammals repress retrotransposons by the RNAi mechanism, similar to what has previously been observed for *C. elegans* and plants. The presence of suppressors of the RNAi pathway in several mammalian viruses also suggests that RNAi plays an antiviral role. Examples include the E3L of vaccinia virus, viral protein 35 (VP35) of Ebola virus, and the nonstructural NS proteins of La Crosse virus (LACV) [56–59]. Research also suggests that viruses use the endogenous RNAi mechanism in mammalian cells. For example, viral miRNAs are encoded by DNA viruses, such as the polyoma viruses SV40 and SA12 and several members of the herpesvirus family. Possible roles of these miRNAs may be regulation of cellular or viral gene expression. Phenocopying of a cellular miRNA has been reported for Kaposi's sarcoma-associated herpesvirus, where miR-K12-11 shares a seed region with the cellular miRNA-155. Even cellular miRNAs can support viral replication, such as miR-122 that is abundantly expressed in liver cells where it supports replication of hepatitis C virus (HCV). For more details, several reviews on this virus–cell interplay are available [60–62].

#### 13.4

##### Basic Design of an RNAi Therapy against Viruses

In principle, all viruses can be targeted with RNAi. RNA viruses will have a genomic RNA and the DNA viruses encode essential mRNAs that can be targeted. Reason for developing an antiviral RNAi therapy may be the unavailability of any therapy, viral escape or severe side effects of the current therapy, or absence of an effective vaccine. Subsequently, it is important to define the optimal viral target sequences that yield potent inhibition by the RNAi effectors. The target should ideally be present in all/most viral strains, and targeting of such conserved sequences will hopefully also prevent viral escape because no sequence variation may be allowed. Another challenge is to select the most suitable delivery method to target the infected organs.

#### 13.5

##### Selecting Optimal Targets

An overview of several viruses that have already been targeted with RNAi is provided in Table 13.1. Depending on the type of virus, single-stranded viral RNA is present at different steps of the viral life cycle. Viral RNA may be shielded from cleavage by

**Table 13.1** Viruses targeted by RNAi.

Virus family	Genome	Virus	Reference
<b>RNA viruses</b>			
Picornaviridae	(+) ssRNA	Echovirus 30	[111]
Coronaviridae	(+) ssRNA	SARS-associated CoV	[112–117]
Flaviviridae	(+) ssRNA	Hepatitis C virus	[12, 77, 118, 119]
Flaviviridae	(+) ssRNA	West Nile virus	[120–123]
Picornaviridae	(+) ssRNA	Coxsackievirus B3	[124–126]
Picornaviridae	(+) ssRNA	Foot-and-mouth disease virus	[127–132]
Picornaviridae	(+) ssRNA	Hepatitis A virus	[78, 133]
Picornaviridae	(+) ssRNA	Human rhinovirus 16	[134]
Flaviviridae	(+) ssRNA	Yellow fever virus	[135]
Flaviviridae	(+) ssRNA	Japanese encephalitis virus	[122, 136]
Picornaviridae	(+) ssRNA	Poliovirus	[76]
Hepeviridae	(+) ssRNA	Hepatitis E virus	[137]
Picornaviridae	(+) ssRNA	Human rhinovirus-16	[134]
Paramyxoviridae	(–) ssRNA	Respiratory syncytial virus	[138]
Rhabdoviridae	(–) ssRNA	Rabies virus	[139]
Orthomyxoviridae	segmented; (–) ssRNA	Influenza A virus	[140–144]
Paramyxoviridae	(–) ssRNA	Henipavirus	[145]
Reoviridae	Segmented; dsRNA	Rotavirus	[146, 147]
Filoviridae	(–) ssRNA	Marburgvirus	[148]
<b>Reverse-transcribing RNA and DNA viruses</b>			
Retroviridae	ssRNA	HIV-1	[13, 17, 66, 73, 74, 80, 81, 84, 149–154]
Hepadnaviridae	Circular; partially dsDNA	Hepatitis B virus	[11, 155–159]
<b>DNA viruses</b>			
Herpesviridae	dsDNA	Herpes simplex virus-1	[160]
Herpesviridae	dsDNA	Herpes simplex virus-2	[70]
Herpesviridae	dsDNA	Human cytomegalovirus	[161]
Herpesviridae	dsDNA	Epstein–Barr virus	[162]
Herpesviridae	dsDNA	Human herpesvirus 6B	[163]
Papillomaviridae	Circular; dsDNA	Human papillomavirus 18	[164–166]
Polyomaviridae	Circular; dsDNA	JC polyomavirus	[167]

RISC because of nuclear localization, replication in membranous inclusions, or the association with nucleocapsid proteins. Most viral genomic RNAs may be protected by protein or membrane structures, but the mRNAs may still be sensitive to the RNAi machinery. For HIV-1, only the *de novo* viral transcripts are targeted; the incoming RNA genome of the infecting virus particle is not targeted by RNAi because it is protected in a virion core structure [63, 64]. There are several ways of identifying

optimal target sites for RNAi attack. First, selection of the target sites in mRNAs that encode early viral proteins (e.g., the early spliced HIV-1 mRNAs encoding Tat, Rev, and Nef proteins). By an early blocking of viral gene expression, the formation of late structural proteins and virion assembly will be severely affected. Second, for viruses that encode multiple overlapping mRNAs, the selection of regions that are present in all or several mRNAs could be a good strategy (e.g., HIV-1 genome regions that are present in all spliced RNA forms and the unspliced RNA [65]). Third, targeting of “open” regions of the viral RNA genome is beneficial because highly structured regions are inaccessible to RISC [66, 67]. Fourth, the selection of targets with a sequence that is highly conserved among viral strains is important. In addition, the targeting of highly conserved regions may prevent the rapid generation of escape mutants. Viruses can also be inhibited by silencing of the right cellular targets. An advantage of targeting cellular mRNAs encoding host cell proteins that are important for viral replication is the reduced chance of viral escape. High-throughput RNAi gene knockdown screens recently described many candidate host factors that are essential for HIV-1 replication [68–70]. These studies surprisingly did not show a remarkable overlap of the identified cofactors. Identified cofactors should first be validated in other assays to exclude false positives. Such studies will hopefully increase the number of antivirals for the design of a combinatorial RNAi attack. An other important concern when developing therapeutic RNAi is to ensure sequence specificity of the inhibition. The inclusion of appropriate controls remains critical. Several studies on the inhibition of infections and inflammation used a control siRNA that targets the GFP mRNA. Results were in favor of a therapeutic effect, but it later turned out that the GFP siRNA is particular in that it is of low immunogenicity compared to most other shRNAs that trigger the TLR7/8 interferon pathway [71]. Thus, the therapeutic effect was not elicited by specific downregulation of the targeted mRNA. Also an siRNA designed to block age-related macular degeneration in the eye exhibited a therapeutic effect, but this was not likely to be elicited by the RNAi mechanism since the siRNA cannot penetrate cells. Instead, the clinical effect was obtained through TLR-3 signaling [72]. Both examples illustrate the importance of selecting the correct controls to ensure that one is looking at sequence-specific RNAi effects. For HIV-1 therapies that target the viral genome, exclusive specificity can in fact be demonstrated by the selection of escape virus variants, which usually have acquired a specific mutation in the target sequence [17, 73, 74].

## 13.6

### Prevention of Viral Escape

Despite that RNAi is regarded as a promising strategy to combat a broad variety of viruses, escape from siRNA treatment has been described for several viruses, including poliovirus [75, 76], hepatitis C virus [77], hepatitis A virus [78] coxsackievirus B3 [79], and HIV-1 [66, 80–86]. These studies suggest that single-point mutations can diminish or even abolish the RNAi effect. Thus, escape-prone viruses

require a combinatorial RNAi therapeutic approach [87]. This can be a combination of siRNAs against the virus [74], siRNAs against host cofactors, or a combination of both. Effective combinatorial RNAi strategies that show prolonged inhibition and/or the prevention of viral escape have been described for several viruses, including HIV-1 [74, 84], coxsackievirus B3 [88], SARS-CoV [89], and HCV [90]. One could also combine RNAi molecules with other RNA effector molecules such as decoys and ribozymes [91]. Another elegant solution to avoid viral escape is the use of second-generation shRNAs that specifically target viral escape variants [92]. However, the feasibility of this approach depends on the type of virus, for example, the relatively high number of viral escape routes reported for HIV-1 may compound this approach [73]. The method may be ideal for pathogens such as hepatitis B virus (HBV) that have a highly constrained genome organization with overlapping genes and consequently less escape routes.

### 13.7

#### Multiplexing siRNAs

After the selection of the optimal combination of siRNAs, the next step is to choose the expression method to multiplex several RNAi inhibitors as a single therapeutic. Viruses that cause an acute infection may be treated with siRNA, and a mixture of different siRNAs may suffice. Chronic viral infections will likely require the delivery of RNAi-inducing gene cassettes. Several of these strategies are depicted in Figure 13.2. Simultaneous expression of multiple shRNAs can be achieved from separate Pol III promoters or a combination of Pol II and III promoters [74]. Alternatively, multiplexed siRNAs expressed from a single RNA transcript have also been developed, such as extended-shRNAs (e-shRNAs) that will be processed into two or three predetermined siRNAs [93]. Another strategy uses long hairpin RNAs (lhrRNAs) that should encode many siRNAs [94–96]. The disadvantage of the latter approach is that it is unclear upfront whether the produced siRNAs will be active inhibitors, and poor results have been reported [92, 97]. Pol II-expressed polycistronic miRNA clusters have also been developed [98, 99].

### 13.8

#### Delivery Issues

It is important to know the exact location of viral replication and the cells or organs that should be targeted. For example, respiratory syncytial virus (RSV) and influenza A virus cause acute infections in the lungs and thus transient inhalation of an siRNA agent might be sufficient. Naked siRNAs are prone to degradation; therefore, methods of siRNA modification to enhance stability and cell uptake have been developed, which were reviewed by others [100]. Delivery of the RNAi therapy can be performed *in vivo* by methods such as inhalation or intravenous injection. *Ex vivo* delivery may be more appropriate for a gene therapy against HIV-1, for example,

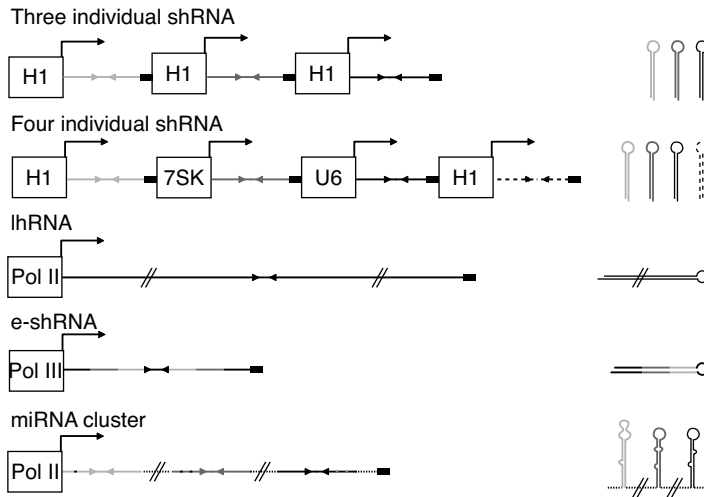

**Figure 13.2** Strategies for multiplexing siRNAs. Simultaneous expression of multiple shRNAs can be achieved by several strategies. From top to bottom the following strategies are depicted: expression from separate Pol III

promoters, a combination of Pol II and III promoters, long hairpin RNA (lhrRNA), extended shRNAs (e-shRNAs), Pol II-expressed polycistronic miRNA clusters. On the right, the formed transcripts are schematically depicted.

using a lentiviral vector with RNAi cargo that is stably delivered into isolated hematopoietic stem cells that are subsequently returned to the patient.

### 13.9 Potential Risks of an RNAi Therapy

Instruction of the cellular miRNA pathway with new siRNA specificity is associated with certain risks. One potential problem is direct competition of the artificial siRNAs with the endogenous siRNAs and/or saturation of the miRNA pathway. Since the miRNA pathway is important in the control of cellular gene expression, this can have unwanted side effects such as cell death, disturbances in cell differentiation programs, or even cancer. Saturation of the miRNA pathway can lead to cell death when extremely high doses of shRNAs are expressed from an adeno-associated virus (AAV) vector in mice [101]. While the therapeutic delivery method has to provide a therapeutic dose, it should obviously not reach the toxicity threshold. Multiplexing of siRNAs increases the risk of saturation effects. It is important to achieve equimolarity of the multiple siRNAs to achieve equal pressure on each target, otherwise viral escape may occur at the point of the weakest inhibition [97]. Toxicity of shRNAs has been demonstrated [98, 99], which may be solved by insertion of the siRNA into a natural miRNA backbone [102]. Alternatively, one could use vectors that allow conditional siRNA expression, which is either tissue-specific or pathogen-

induced expression. Tissue-specific miRNA expression has been described for the liver, which could be helpful when treating hepatotropic viruses such as HCV [103]. Virus-inducible constructs include the expression of anti-HIV-1 shRNAs under control of the viral Tat protein [85]. Selective shRNA expression in virus-susceptible or preferentially virus-infected cells would be an elegant way to restrict putative toxicity effects. Another option is the use of drug-inducible gene expression systems, such as the doxycycline-dependent Tet system [104, 105], but this may also complicate clinical applications. Another potential risk of using the RNAi pathway for antiviral therapy is the targeting of unrelated mRNAs. This is particularly true for miRNA-like inhibitors that require only a seed sequence complementarity with the mRNA of 7–8 bp [106]. Such “off-target” effects, in principle, can be elicited by the passenger and the guide strand [107]. Another problem relates to induction of an immune response by siRNAs and shRNAs, which can be avoided by optimal design of the si/shRNA molecule [108].

### 13.10

#### Example of an Acute Infection: RSV

RSV causes respiratory tract infections and is the major cause of lower respiratory tract infection and hospital visits during infancy and childhood [109]. RSV is seasonal and the majority of the infection occurs in winter months in the temperate climates and during the rainy season in tropical climates. RSV is a negative-stranded RNA virus that belongs to the Paramyxoviridae family and the Paramyxovirus subfamily Pneumovirinae. The only treatment option is to provide oxygen and there is currently no vaccine available. RSV was the first human pathogenic virus against which RNAi-mediated inhibition was demonstrated to be effective. RSV replication was inhibited *in vitro* by synthetic siRNAs against the viral polymerase subunit P and the fusion protein F. As the infection of RSV is restricted to the respiratory tissues, the logical route for the application of siRNAs is via the nasal/respiratory route. In 2006, in the United States, Alnylam Pharmaceuticals launched a phase I clinical trial of an inhaled formulation of ALN-RSV01 – the siRNA drug – to combat RSV infection, and a phase II study is ongoing.

### 13.11

#### Example of a Chronic Infection: HIV-1

An estimated 33 million people are infected with HIV-1 (<http://www.unaids.org>). All efforts to develop a protective vaccine against HIV-1 have been unsuccessful. Since the introduction of highly active antiretroviral therapy (HAART), the quality of life and life expectancy of treated individuals in the Western World has improved dramatically. However, strict drug regimens and drug side effects decrease the quality of life for most patients, and low therapy adherence can result in the emergence of drug-resistant viruses and exhaustion of the current antiviral drug

armamentarium. In all, this pleads for the development of new therapies that are preferably less dependent on patient compliance, with a durable impact and minimal side effects. HIV-1 belongs to the lentivirus genus, a subfamily of Retroviridae. All retroviruses encode a diploid positive-stranded RNA genome that is reverse transcribed into dsDNA that integrates into the host cell genome. The main focus of an RNAi-based gene therapy against AIDS would be the durable protection of HIV-susceptible cells of the immune system, which are the CD4-positive T cells, monocytes, macrophages, and dendritic cells [114]. This “intracellular immunization” will prevent the depletion of these immune cells during disease progression. Hematopoietic stem cells (HSC) form an excellent target for an RNAi therapy because they seed the different lineages of immune cells in the blood, including all HIV-susceptible cells. Maintenance of the immune system will prevent opportunistic infections and progression toward AIDS. For such a gene therapy, we and others have proposed to use a lentiviral vector that is in fact based on HIV-1 itself. The pathogenic genes were replaced by regulatory and therapeutic sequences. The lentiviral vector infects the target cell and deposits the transgene, but cannot replicate. The benefits of a lentiviral vector compared to other delivery methods is that it can transduce dividing and nondividing cell types and that it stably transduces cells because the vector is integrated into the genome [110]. Figure 13.3 depicts this *ex vivo* gene therapy procedure, including the lentiviral vector production scheme. Preferential survival of the shRNA-expressing immune cells over untreated cells under HIV-1 pressure would result in an increase in the percentage of protected immune cells. Thus, the treatment should result in a partial or complete reconstitution of the immune system, preventing HIV-1 infection to progress toward AIDS. In an ideal setting, the treatment of a patient with a single gene therapy should achieve a durable effect. An anti-HIV lentiviral gene therapy with HSC was initiated at the City of Hope by the team of John Rossi. This therapy contains a single RNAi effector molecule (shRNA) that was combined with an anti-CCR5 ribozyme and an antiviral decoy RNA.

### 13.12

#### Future Perspective

We provided an overview of the current status of the development of an RNAi-based gene therapy against viruses, focusing on the possibilities, limitations, and concerns. The major advantage of this therapeutic approach is that it can act in a truly sequence-specific manner, as demonstrated by the selection of escape virus variants with a mutation in the target sequence. Combinatorial RNAi approaches are able to prevent viral escape that may occur when targeting chronic viral infections. Nevertheless, aspecific off-target effects should be vigorously screened for in preclinical test systems. Delivery remains a serious hurdle, but much progress has been reported for certain applications. Overall, an RNAi-based therapy seems to be a promising candidate for the treatment of acute and chronic infections with pathogenic viruses.

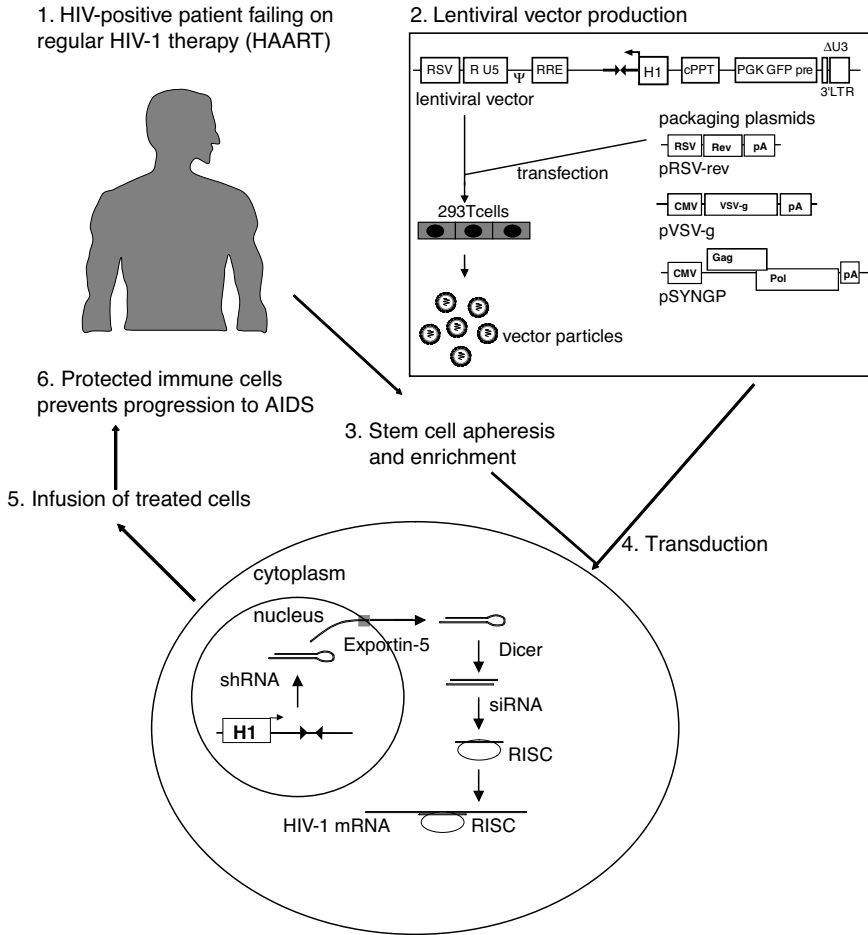

**Figure 13.3** RNAi gene therapy for HIV-1. The HIV-1-infected patient that fails on regular antiretroviral therapy (1) could be offered a durable RNAi-based gene therapy with a lentiviral vector. The lentiviral vector is produced in 293T cells (2) transfected with the lentiviral vector (e.g., JS1) and a standard set of packaging plasmids (pRSV-Rev, pVSV-g, and pSYNGP). The lentiviral vector will produce viral genomes and the packaging plasmids will produce the proteins required to assemble new viral particles. pVSV-g produces the vesicular stomatitis virus glycoprotein that is used for virus pseudotyping. Virus particles are collected

after 2 or 3 days. The patient will undergo an apheresis for the collection of hematopoietic stem cells after pretreatment with granulocyte colony stimulatory factor (G-CSF) that mobilizes these cells from the bone marrow into the periphery (3). The hematopoietic stem cells will be purified and transduced with the therapeutic lentiviral construct (4). This “intracellular immunization” with the antiviral shRNA will protect these cells against productive HIV-1 infection. Transduced cells will be infused back into the patient (5) and the HIV-resistant immune cells will hopefully prevent disease progression toward AIDS (6).



## Acknowledgments

RNAi research in the Berkhout lab is sponsored by ZonMw grants (VICI and Translational gene therapy program).

## References

- Napoli, C., Lemieux, C., and Jorgensen, R. (1990) Introduction of a chimeric chalcone synthase gene into petunia results in reversible co-suppression of homologous genes in trans. *The Plant Cell*, **2**, 279–289.
- van der Krol, A., Mur, L., Beld, M., Mol, J., and Stuitje, A. (1990) Flavonoid genes in petunia: addition of a limited number of gene copies may lead to a suppression of gene expression. *The Plant Cell*, **2**, 291–299.
- Romano, N. and Macino, G. (1992) Quelling: transient inactivation of gene expression in *Neurospora crassa* by transformation with homologous sequences. *Molecular Microbiology*, **6**, 3343–3353.
- Fire, A., Xu, S., Montgomery, M.K., Kostas, S.A., Driver, S.E., and Mello, C.C. (1998) Potent and specific genetic interference by double-stranded RNA in *Caenorhabditis elegans*. *Nature*, **391**, 806–811.
- Misquitta, L. and Paterson, B.M. (1999) Targeted disruption of gene function in *Drosophila* by RNA interference (RNA-i): a role for *nautilus* in embryonic somatic muscle formation. *Proceedings of the National Academy of Sciences of the United States of America*, **96**, 1451–1456.
- Kennerdell, J.R. and Carthew, R.W. (1998) Use of dsRNA-mediated genetic interference to demonstrate that frizzled and frizzled 2 act in the wingless pathway. *Cell*, **95**, 1017–1026.
- Ngo, H., Tschudi, C., Gull, K., and Ullu, E. (1998) Double-stranded RNA induces mRNA degradation in *Trypanosoma brucei*. *Proceedings of the National Academy of Sciences of the United States of America*, **95**, 14687–14692.
- Wargelius, A., Ellingsen, S., and Fjose, A. (1999) Double-stranded RNA induces specific developmental defects in zebrafish embryos. *Biochemical and Biophysical Research Communications*, **263**, 156–161.
- Wianny, F. and Zernicka-Goetz, M. (2000) Specific interference with gene function by double-stranded RNA in early mouse development. *Nature Cell Biology*, **2**, 70–75.
- Elbashir, S.M., Harborth, J., Lendeckel, W., Yalcin, A., Weber, K., and Tuschl, T. (2001) Duplexes of 21-nucleotide RNAs mediate RNA interference in cultured mammalian cells. *Nature*, **411**, 494–498.
- McCaffrey, A.P., Nakai, H., Pandey, K., Huang, Z., Salazar, F.H., Xu, H., Wieland, S.F., Marion, P.L., and Kay, M.A. (2003) Inhibition of hepatitis B virus in mice by RNA interference. *Nature Biotechnology*, **21**, 639–644.
- Kapadia, S.B., Brideau-Andersen, A., and Chisari, F.V. (2003) Interference of hepatitis C virus RNA replication by short interfering RNAs. *Proceedings of the National Academy of Sciences of the United States of America*, **100**, 2014–2018.
- Banerjee, A., Li, M.J., Bauer, G., Remling, L., Lee, N.S., Rossi, J., and Akkina, R. (2003) Inhibition of HIV-1 by lentiviral vector-transduced siRNAs in T lymphocytes differentiated in SCID-hu mice and CD34<sup>+</sup> progenitor cell-derived macrophages. *Molecular Therapy: The Journal of the American Society of Gene Therapy*, **8**, 62–71.
- Ding, H., Schwarz, D.S., Keene, A., Affar, B., Fenton, L., Xia, X., Shi, Y., Zamore, P., and Xu, Z. (2003) Selective silencing by RNAi of a dominant allele that causes amyotrophic lateral sclerosis. *Aging Cell*, **2**, 209–217.
- Takeshita, F. and Ochiya, T. (2006) Therapeutic potential of RNA interference against cancer. *Cancer Science*, **97**, 689–696.

- 16 Davidson, B.L. and Paulson, H.L. (2004) Molecular medicine for the brain: silencing of disease genes with RNA interference. *The Lancet Neurology*, **3**, 145–149.
- 17 ter Brake, O., Legrand, N., von Eije, K., Centlivre, M., Spits, H., Weijer, K., Blom, B., and Berkhout, B. (2009) Evaluation of safety and efficacy of RNAi against HIV-1 in the human immune system mouse model. *Gene Therapy*, **16**, 148–153.
- 18 Ambros, V. (2001) microRNAs: tiny regulators with great potential. *Cell*, **107**, 823–826.
- 19 Baehrecke, E.H. (2003) miRNAs: micro managers of programmed cell death. *Current Biology*, **13**, R473–R475.
- 20 Carrington, J.C. and Ambros, V. (2003) Role of microRNAs in plant and animal development. *Science*, **301**, 336–338.
- 21 McManus, M.T. (2004) Small RNAs and immunity. *Immunity*, **21**, 747–756.
- 22 Bartel, D.P. (2004) MicroRNAs: genomics, biogenesis, mechanism, and function. *Cell*, **116**, 281–297.
- 23 Ambros, V. (2004) The functions of animal microRNAs. *Nature*, **431**, 350–355.
- 24 Lee, Y., Jeon, K., Lee, J.T., Kim, S., and Kim, V.N. (2002) MicroRNA maturation: stepwise processing and subcellular localization. *The EMBO Journal*, **21**, 4663–4670.
- 25 Bernstein, E., Caudy, A.A., Hammond, S.M., and Hannon, G.J. (2001) Role for a bidentate ribonuclease in the initiation step of RNA interference. *Nature*, **409**, 363–366.
- 26 Denli, A.M., Tops, B.B., Plasterk, R.H., Ketting, R.F., and Hannon, G.J. (2004) Processing of primary microRNAs by the microprocessor complex. *Nature*, **432**, 231–235.
- 27 Gregory, R.I., Yan, K.P., Amuthan, G., Chendrimada, T., Doratotaj, B., Cooch, N., and Shiekhattar, R. (2004) The microprocessor complex mediates the genesis of microRNAs. *Nature*, **432**, 235–240.
- 28 Han, J., Lee, Y., Yeom, K.H., Kim, Y.K., Jin, H., and Kim, V.N. (2004) The Drosha-DGCR8 complex in primary microRNA processing. *Genes and Development*, **18**, 3016–3027.
- 29 Landthaler, M., Yalcin, A., and Tuschl, T. (2004) The human DiGeorge syndrome critical region gene 8 and its *D. Melanogaster* homolog are required for miRNA biogenesis. *Current Biology*, **14**, 2162–2167.
- 30 Lee, Y., Ahn, C., Han, J., Choi, H., Kim, J., Yim, J., Lee, J., Provost, P., Radmark, O., and Kim, V. (2003) The nuclear RNase III Drosha initiates microRNA processing. *Nature*, **425**, 415–419.
- 31 Babiarz, J.E., Ruby, J.G., Wang, Y., Bartel, D.P., and Blelloch, R. (2008) Mouse ES cells express endogenous shRNAs, siRNAs, and other microprocessor-independent, Dicer-dependent small RNAs. *Genes and Development*, **22**, 2773–2785.
- 32 Ruby, J.G., Jan, C.H., and Bartel, D.P. (2007) Intronic microRNA precursors that bypass Drosha processing. *Nature*, **448**, 83–86.
- 33 Chan, S.P. and Slack, F.J. (2007) And now introducing mammalian mirtrons. *Developmental Cell*, **13**, 605–607.
- 34 Bohnsack, M.T., Czaplinski, K., and Gorlich, D. (2004) Exportin 5 is a RanGTP-dependent dsRNA-binding protein that mediates nuclear export of pre-miRNAs. *RNA (New York, NY)*, **10**, 185–191.
- 35 Lund, E., Güttinger, S., Calado, A., Dahlberg, J.E., and Kutay, U. (2004) Nuclear export of microRNA precursors. *Science*, **303**, 95–98.
- 36 Yi, R., Qin, Y., Macara, I.G., and Cullen, B.R. (2003) Exportin-5 mediates the nuclear export of pre-microRNAs and short hairpin RNAs. *Genes and Development*, **17**, 3011–3016.
- 37 Zhang, H., Kolb, F.A., Jaskiewicz, L., Westhof, E., and Filipowicz, W. (2004) Single processing center models for human dicer and bacterial RNase III. *Cell*, **118**, 57–68.
- 38 Chendrimada, T.P., Gregory, R.I., Kumaraswamy, E., Normann, J., Cooch, N., Nishikura, K., and Shiekhattar, R. (2005) TRBP recruits the dicer complex to Ago2 for microRNA processing and gene silencing. *Nature*, **436**, 740–744.
- 39 Gregory, R.I., Chendrimada, T.P., Cooch, N., and Shiekhattar, R. (2005) Human RISC couples microRNA biogenesis and

- posttranscriptional gene silencing. *Cell*, **123**, 631–640.
- 40 Maniataki, E. and Mourelatos, Z. (2005) A human, ATP-independent, RISC assembly machine fueled by pre-miRNA. *Genes and Development*, **19**, 2979–2990.
  - 41 Hammond, S.M., Boettcher, S., Caudy, A.A., Kobayashi, R., and Hannon, G.J. (2001) Argonaute2, a link between genetic and biochemical analyses of RNAi. *Science*, **293**, 1146–1150.
  - 42 Tomari, Y., Matranga, C., Haley, B., Martinez, N., and Zamore, P.D. (2004) A protein sensor for siRNA asymmetry. *Science*, **306**, 1377–1380.
  - 43 Tomari, Y. and Zamore, P.D. (2005) Perspective: machines for RNAi. *Genes and Development*, **19**, 517–529.
  - 44 Brennecke, J., Hipfner, D.R., Stark, A., Russell, R.B., and Cohen, S.M. (2003) Bantam encodes a developmentally regulated microRNA that controls cell proliferation and regulates the proapoptotic gene *hid* in *Drosophila*. *Cell*, **113**, 25–36.
  - 45 Doench, J.G. and Sharp, P.A. (2004) Specificity of microRNA target selection in translational repression. *Genes and Development*, **18**, 504–511.
  - 46 Lewis, B.P., Shih, I.H., Jones-Rhoades, M.W., Bartel, D.P., and Burge, C.B. (2003) Prediction of mammalian microRNA targets. *Cell*, **115**, 787–798.
  - 47 Kiriakidou, M., Nelson, P.T., Kouranov, A., Fitziev, P., Bouyioukos, C., Mourelatos, Z., and Hatzigeorgiou, A. (2004) A combined computational–experimental approach predicts human microRNA targets. *Genes and Development*, **18**, 1165–1178.
  - 48 Lai, E.C. (2002) Micro RNAs are complementary to 3' UTR sequence motifs that mediate negative post-transcriptional regulation. *Nature Genetics*, **30**, 363–364.
  - 49 Saetrom, P., Heale, B.S., Snøve, O., Jr., Aagaard, L., Alluin, J., and Rossi, J.J. (2007) Distance constraints between microRNA target sites dictate efficacy and cooperativity. *Nucleic Acids Research*, **35**, 2333–2342.
  - 50 Yekta, S., Shih, I.H., and Bartel, D.P. (2004) MicroRNA-directed cleavage of HOXB8 mRNA. *Science*, **304**, 594–596.
  - 51 Brummelkamp, T.R., Bernards, R., and Agami, R. (2002) A system for stable expression of short interfering RNAs in mammalian cells. *Science*, **296**, 550–553.
  - 52 Paddison, P.J., Caudy, A.A., Bernstein, E., Hannon, G.J., and Conklin, D.S. (2002) Short hairpin RNAs (shRNAs) induce sequence-specific silencing in mammalian cells. *Genes and Development*, **16**, 948–958.
  - 53 Zeng, Y., Wagner, E.J., and Cullen, B.R. (2002) Both natural and designed micro RNAs can inhibit the expression of cognate mRNAs when expressed in human cells. *Molecular Cell*, **9**, 1327–1333.
  - 54 Ding, S.W. and Voinnet, O. (2007) Antiviral immunity directed by small RNAs. *Cell*, **130**, 413–426.
  - 55 van Rij, R.P., Saleh, M.C., Berry, B., Foo, C., Houk, A., Antoniewski, C., and Andino, R. (2006) The RNA silencing endonuclease Argonaute 2 mediates specific antiviral immunity in *Drosophila melanogaster*. *Genes and Development*, **20**, 2985–2995.
  - 56 Haasnoot, J., de Vries, W., Geutjes, E.J., Prins, M., de Haan, P., and Berkhout, B. (2007) The Ebola virus VP35 protein is a suppressor of RNA silencing. *PLoS Pathogens*, **3**, e86.
  - 57 Li, W.X., Li, H., Lu, R., Li, F., Dus, M., Atkinson, P., Brydon, E.W., Johnson, K.L., Garcia-Sastre, A., Ball, L.A., Palese, P., and Ding, S.W. (2004) Interferon antagonist proteins of influenza and vaccinia viruses are suppressors of RNA silencing. *Proceedings of the National Academy of Sciences of the United States of America*, **101**, 1350–1355.
  - 58 Lichner, Z., Silhavy, D., and Burgyan, J. (2003) Double-stranded RNA-binding proteins could suppress RNA interference-mediated antiviral defences. *The Journal of General Virology*, **84**, 975–980.
  - 59 Soldan, S.S., Plassmeyer, M.L., Matukonis, M.K., and González-Scarano, F. (2005) La Crosse virus nonstructural protein NSs counteracts the effects of short interfering RNA. *Journal of Virology*, **79**, 234–244.
  - 60 Grassmann, R. and Jeang, K.T. (2008) The roles of microRNAs in mammalian virus

- infection. *Biochimica et Biophysica Acta*, **1779**, 706–711.
- 61 Umbach, J.L. and Cullen, B.R. (2009) The role of RNAi and microRNAs in animal virus replication and antiviral immunity. *Genes and Development*, **23**, 1151–1164.
- 62 van Rij, R.P. (2008) Virus meets RNAi symposium on antiviral applications of RNA interference. *EMBO Reports*, **9**, 725–729.
- 63 Surabhi, R.M. and Gaynor, R.B. (2002) RNA interference directed against viral and cellular targets inhibits human immunodeficiency virus type 1 replication. *Journal of Virology*, **76**, 12963–12973.
- 64 Westerhout, E.M., ter Brake, O., and Berkhout, B. (2006) The virion-associated incoming HIV-1 RNA genome is not targeted by RNA interference. *Retrovirology*, **3**, 57–65.
- 65 Muesing, M.A., Smith, D.H., Cabradilla, C.D., Benton, C.V., Lasky, L.A., and Capon, D.J. (1985) Nucleic acid structure and expression of the human AIDS/lymphadenopathy retrovirus. *Nature*, **313**, 450–458.
- 66 Westerhout, E.M., Ooms, M., Vink, M., Das, A.T., and Berkhout, B. (2005) HIV-1 can escape from RNA interference by evolving an alternative structure in its RNA genome. *Nucleic Acids Research*, **33**, 796–804.
- 67 Westerhout, E.M. and Berkhout, B. (2007) A systematic analysis of the effect of target RNA structure on RNA interference. *Nucleic Acids Research*, **35**, 4322–4330.
- 68 Brass, A.L., Dykxhoorn, D.M., Benita, Y., Yan, N., Engelman, A., Xavier, R.J., Lieberman, J., and Elledge, S.J. (2008) Identification of host proteins required for HIV infection through a functional genomic screen. *Science*, **319**, 921–926.
- 69 König, R., Zhou, Y., Elleder, D., Diamond, T.L., Bonamy, G.M., Irelan, J.T., Chiang, C.Y., Tu, B.P., De Jesus, P.D., Lilley, C.E., Seidel, S., Opaluch, A.M., Caldwell, J.S., Weitzman, M.D., Kuhlen, K.L., Bandyopadhyay, S., Ideker, T., Orth, A.P., Miraglia, L.J., Bushman, F.D., Young, J.A., and Chanda, S. (2008) Global analysis of host-pathogen interactions that regulate early-stage HIV-1 replication. *Cell*, **135** 49–60.
- 70 Palliser, D., Chowdhury, D., Wang, Q.Y., Lee, S.J., Bronson, R.T., Knipe, D.M., and Lieberman, J. (2006) An siRNA-based microbicide protects mice from lethal herpes simplex virus 2 infection. *Nature*, **439** (7072), 89–94.
- 71 Robbins, M., Judge, A., Ambegia, E., Choi, C., Yaworski, E., Palmer, L., McClintock, K., and MacLachlan, I. (2008) Misinterpreting the therapeutic effects of small interfering RNA caused by immune stimulation. *Human Gene Therapy*, **19**, 991–999.
- 72 Kleinman, M.E., Yamada, K., Takeda, A., Chandrasekaran, V., Nozaki, M., Baffi, J.Z., Albuquerque, R.J., Yamasaki, S., Itaya, M., Pan, Y., Appukkuttan, B., Gibbs, D., Yang, Z., Karikó, K., Ambati, B.K., Wilgus, T.A., DiPietro, L.A., Sakurai, E., Zhang, K., Smith, J.R., Taylor, E.W., and Ambati, J. (2008) Sequence- and target-independent angiogenesis suppression by siRNA via TLR3. *Nature*, **452** 591–597.
- 73 von Eije, K., ter Brake, O., and Berkhout, B. (2008) Human immunodeficiency virus type 1 escape is restricted when conserved genome sequences are targeted by RNA interference. *Journal of Virology*, **82**, 2895–2903.
- 74 ter Brake, O., 't Hooft, K., Liu, Y., Centlivre, M., von Eije, K., and Berkhout, B. (2008) Lentiviral vector design for multiple shRNA expression and durable HIV-1 inhibition. *Molecular Therapy: The Journal of the American Society of Gene Therapy*, **16**, 557–564.
- 75 Gitlin, L., Karelsky, S., and Andino, R. (2002) Short interfering RNA confers intracellular antiviral immunity in human cells. *Nature*, **418**, 430–434.
- 76 Gitlin, L., Stone, J.K., and Andino, R. (2005) Poliovirus escape from RNA interference: short interfering RNA-target recognition and implications for therapeutic approaches. *Journal of Virology*, **79**, 1027–1035.
- 77 Wilson, J.A. and Richardson, C.D. (2005) Hepatitis C virus replicons escape RNA interference induced by a short

- interfering RNA directed against the NS5b coding region. *Journal of Virology*, **79**, 7050–7058.
- 78 Kusov, Y., Kanda, T., Palmenberg, A., Sgro, J.Y., and Gauss-Müller, V. (2006) Silencing of hepatitis A virus infection by small interfering RNAs. *Journal of Virology*, **80**, 5599–5610.
- 79 Merl, S. and Wessely, R. (2007) Anti-coxsackieviral efficacy of RNA interference is highly dependent on genomic target selection and emergence of escape mutants. *Oligonucleotides*, **17**, 44–53.
- 80 Boden, D., Pusch, O., Lee, F., Tucker, L., and Ramratnam, B. (2003) Human immunodeficiency virus type 1 escape from RNA interference. *Journal of Virology*, **77**, 11531–11535.
- 81 Das, A.T., Brummelkamp, T.R., Westerhout, E.M., Vink, M., Madiredjo, M., Bernards, R., and Berkhout, B. (2004) Human immunodeficiency virus type 1 escapes from RNA interference-mediated inhibition. *Journal of Virology*, **78**, 2601–2605.
- 82 Nishitsuji, H., Kohara, M., Kannagi, M., and Masuda, T. (2006) Effective suppression of human immunodeficiency virus type 1 through a combination of short- or long-hairpin RNAs targeting essential sequences for retroviral integration. *Journal of Virology*, **80**, 7658–7666.
- 83 Sabariego, R., Giménez-Barcons, M., Tàpia, N., Clotet, B., and Martínez, M.A. (2006) Sequence homology required by human immunodeficiency virus type 1 to escape from short interfering RNAs. *Journal of Virology*, **80**, 571–577.
- 84 ter Brake, O., Konstantinova, P., Ceylan, M., and Berkhout, B. (2006) Silencing of HIV-1 with RNA interference: a multiple shRNA approach. *Molecular Therapy: The Journal of the American Society of Gene Therapy*, **14**, 883–892.
- 85 ter Brake, H.J., Li, H.T., Bahner, I., Li, M.J., Kohn, D., and Rossi, J.J. (2006) Novel Pol II fusion promoter directs human immunodeficiency virus type 1-inducible coexpression of a short hairpin RNA and protein. *Journal of Virology*, **80**, 1863–1873.
- 86 Haasnoot, J., Westerhout, E.M., and Berkhout, B. (2007) RNA interference against viruses: strike and counterstrike. *Nature Biotechnology*, **25**, 1435–1443.
- 87 Grimm, D. and Kay, M.A. (2007) Combinatorial RNAi: a winning strategy for the race against evolving targets? *Molecular Therapy: The Journal of the American Society of Gene Therapy*, **15**, 878–888.
- 88 Corallini, A., Sampaoli, R., Possati, L., Merlin, M., Bagnarelli, P., Piola, C., Fabris, M., Menegatti, M.A., Talevi, S., Gibellini, D., Rocchetti, R., Caputo, A., and Barbanti-Brodano, G. (2002) Inhibition of HIV-1 Tat activity correlates with down-regulation of bcl-2 and results in reduction of angiogenesis and oncogenicity. *Virology*, **299**, 1–7.
- 89 He, M.L., Zheng, B.J., Chen, Y., Wong, K.L., Huang, J.D., Lin, M.C., Peng, Y., Yuen, K.Y., Sung, J.J., and Kung, H.F. (2006) Kinetics and synergistic effects of siRNAs targeting structural and replicase genes of SARS-associated coronavirus. *FEBS Letters*, **580**, 2414–2420.
- 90 Henry, S.D., Scholte, B., van der Wegen, P., Tilanus, H.W., Metselaar, H.J., and van der Laan, L. (2006) Simultaneous targeting of HCV replication and viral binding with a single lentiviral vector containing multiple RNA interference expression cassettes. *Molecular Therapy: The Journal of the American Society of Gene Therapy*, **14**, 485–493.
- 91 Li, M.J., Kim, J., Li, S., Zaia, J., Yee, J.K., Anderson, J., Akkina, R., and Rossi, J.J. (2005) Long-term inhibition of HIV-1 infection in primary hematopoietic cells by lentiviral vector delivery of a triple combination of anti-HIV shRNA, anti-CCR5 ribozyme, and a nucleolar-localizing TAR decoy. *Molecular Therapy: The Journal of the American Society of Gene Therapy*, **12**, 900–909.
- 92 ter Brake, O. and Berkhout, B. (2005) A novel approach for inhibition of HIV-1 by RNA interference: counteracting viral escape with a second generation of siRNAs. *Journal of RNAi and Gene Silencing*, **1**, 56–65.
- 93 Liu, Y.P., Haasnoot, J., and Berkhout, B. (2007) Design of extended short hairpin RNAs for HIV-1 inhibition. *Nucleic Acids Research*, **35**, 5683–5693.

- 94 Barichievy, S., Saayman, S., von Eije, K.J., Morris, K.V., Arbutnot, P., and Weinberg, M. (2007) The inhibitory efficacy of RNA POL III-expressed long hairpin RNAs targeted to untranslated regions of the HIV-1 5' long terminal repeat. *Oligonucleotides*, **17**, 419–431.
- 95 Sano, M., Li, H., Nakanishi, M., and Rossi, J.J. (2008) Expression of long anti-HIV-1 hairpin RNAs for the generation of multiple siRNAs: advantages and limitations. *Molecular Therapy: The Journal of the American Society of Gene Therapy*, **16**, 170–177.
- 96 Konstantinova, P., de Vries, W., Haasnoot, J., ter Brake, O., de Haan, P., and Berkhout, B. (2006) Inhibition of human immunodeficiency virus type 1 by RNA interference using long-hairpin RNA. *Gene Therapy*, **13**, 1403–1413.
- 97 Liu, Y.P., von Eije, K.J., Schopman, N.C., Westerink, J., ter Brake, O., Haasnoot, J., and Berkhout, B. (2009) Combinatorial RNAi against HIV-1 using extended short hairpin RNAs. *Molecular Therapy: The Journal of the American Society of Gene Therapy*, **17**, 1712–1723.
- 98 Liu, Y.P., Haasnoot, J., ter Brake, O., Berkhout, B., and Konstantinova, P. (2008) Inhibition of HIV-1 by multiple siRNAs expressed from a single microRNA polycistron. *Nucleic Acids Research*, **36**, 2811–2824.
- 99 Aagaard, L.A., Zhang, J., von Eije, K.J., Li, H., Saetrom, P., Amarzguioui, M., and Rossi, J. (2008) Engineering and optimization of the miR-106b cluster for ectopic expression of multiplexed anti-HIV RNAs. *Gene Therapy*, **15**, 1536–1549.
- 100 Deleavey, G.F., Watts, J.K., and Damha, M.J. (2009) Chemical modification of siRNA. *Current Protocols in Nucleic Acid Chemistry*, **39**, 16.3.1–16.3.22.
- 101 Grimm, D., Streetz, K.L., Jopling, C.L., Storm, T.A., Pandey, K., Davis, C.R., Marion, P., Salazar, K., and Kay, M.A. (2006) Fatality in mice due to oversaturation of cellular microRNA/short hairpin RNA pathways. *Nature*, **441**, 537–541.
- 102 McBride, J.L., Boudreau, R.L., Harper, S.Q., Staber, P.D., Montey, A.M., Martins, I., Gilmore, B.L., Burstein, H., Peluso, R.W., Polisky, B., Carter, B.J., and Davidson, B.L. (2008) Artificial miRNAs mitigate shRNA-mediated toxicity in the brain: implications for the therapeutic development of RNAi. *Proceedings of the National Academy of Sciences of the United States of America*, **105**, 5868–5873.
- 103 Snyder, L.L., Esser, J.M., Pachuk, C.J., and Steel, L.F. (2008) Vector design for liver-specific expression of multiple interfering RNAs that target hepatitis B virus transcripts. *Antiviral Research*, **80**, 36–44.
- 104 Wiznerowicz, M. and Trono, D. (2003) Conditional suppression of cellular genes: lentivirus vector-mediated drug-inducible RNA interference. *Journal of Virology*, **77**, 8957–8961.
- 105 Zhou, X., Symons, J., Hoppes, R., Krueger, C., Berens, C., Hillen, W., Berkhout, B., and Das, A.T. (2007) Improved single-chain transactivators of the Tet-On gene expression system. *BMC Biotechnology*, **7**, 6.
- 106 Brennecke, J., Stark, A., Russell, R.B., and Cohen, S.M. (2005) Principles of microRNA-target recognition. *PLoS Biology*, **3**, e85.
- 107 Jackson, A.L., Bartz, S.R., Schelter, J., Kobayashi, S.V., Burchard, J., Mao, M., Li, B., Cavet, G., and Linsley, P.S. (2003) Expression profiling reveals off-target gene regulation by RNAi. *Nature Biotechnology*, **21**, 635–637.
- 108 Marques, J.T. and Williams, B.R. (2005) Activation of the mammalian immune system by siRNAs. *Nature Biotechnology*, **23**, 1399–1405.
- 109 Bourgeois, F.T., Valim, C., McAdam, A.J., and Mandl, K.D. (2009) Relative impact of influenza and respiratory syncytial virus in young children. *Pediatrics*, **124**, e1072–e1080.
- 110 Naldini, L., Blömer, U., Gallay, P., Ory, D., Mulligan, R., Gage, F.H., Verma, I.M., and Trono, D. (1996) *In vivo* gene delivery and stable transduction of nondividing cells by a lentiviral vector. *Science*, **272**, 263–267.
- 111 Rothe, D., Werk, D., Niedrig, S., Horbelt, D., Grunert, H.P., Zeichhardt, H., Erdmann, V.A., and Kurreck, J. (2009) Antiviral activity of highly potent siRNAs against echovirus 30 and its receptor.

- Journal of Virological Methods*, **157**, 211–218.
- 112 He, M.L., Zheng, B., Peng, Y., Peiris, J.S., Poon, L.L., Yuen, K.Y., Lin, M.C., Kung, H.F., and Guan, Y. (2003) Inhibition of SARS-associated coronavirus infection and replication by RNA interference. *The Journal of the American Medical Association*, **290**, 2665–2666.
- 113 Zhang, Y., Li, T., Fu, L., Yu, C., Li, Y., Xu, X., Wang, Y., Ning, H., Zhang, S., Chen, W., Babiuk, L.A., and Chang, Z. (2004) Silencing SARS-CoV spike protein expression in cultured cells by RNA interference. *FEBS Letters*, **560**, 141–146.
- 114 Zhao, P., Qin, Z.L., Ke, J.S., Lu, Y., Liu, M., Pan, W., Zhao, L.J., Cao, J., and Qi, Z.T. (2005) Small interfering RNA inhibits SARS-CoV nucleocapsid gene expression in cultured cells and mouse muscles. *FEBS Letters*, **579**, 2404–2410.
- 115 Li, T., Zhang, Y., Fu, L., Yu, C., Li, X., Li, Y., Zhang, X., Rong, Z., Wang, Y., Ning, H., Liang, R., Chen, W., Babiuk, L.A., and Chang, Z. (2005) siRNA targeting the leader sequence of SARS-CoV inhibits virus replication. *Gene Therapy*, **12**, 751–761.
- 116 Wu, C.J., Huang, H.W., Liu, C.Y., Hong, C.F., and Chan, Y.L. (2005) Inhibition of SARS-CoV replication by siRNA. *Antiviral Research*, **65**, 45–48.
- 117 Åkerström, S., Mirazimi, A., and Tan, Y.J. (2007) Inhibition of SARS-CoV replication cycle by small interference RNAs silencing specific SARS proteins, 7a/7b, 3a/3b and S. *Antiviral Research*, **73**, 219–227.
- 118 Wilson, J.A., Jayasena, S., Khvorova, A., Sabatino, S., Rodrigue-Gervais, I.G., Arya, S., Sarangi, F., Harris-Brandts, M., Beaulieu, S., and Richardson, C.D. (2003) RNA interference blocks gene expression and RNA synthesis from hepatitis C replicons propagated in human liver cells. *Proceedings of the National Academy of Sciences of the United States of America*, **100**, 2783–2788.
- 119 Krönke, J., Kittler, R., Buchholz, F., Windisch, M.P., Pietschmann, T., Bartenschlager, R., and Frese, M. (2004) Alternative approaches for efficient inhibition of hepatitis C virus RNA replication by small interfering RNAs. *Journal of Virology*, **78**, 3436–3446.
- 120 Brackney, D.E., Beane, J.E., and Ebel, G.D. (2009) RNAi targeting of West Nile virus in mosquito midguts promotes virus diversification. *PLoS Pathogens*, **5**, e1000502.
- 121 Geiss, B.J., Pierson, T.C., and Diamond, M.S. (2005) Actively replicating West Nile virus is resistant to cytoplasmic delivery of siRNA. *Virology Journal*, **2**, 53.
- 122 Kumar, P., Lee, S.K., Shankar, P., and Manjunath, N. (2006) A single siRNA suppresses fatal encephalitis induced by two different flaviviruses. *PLoS Medicine*, **3**, e96.
- 123 Anthony, K.G., Bai, F., Krishnan, M.N., Fikrig, E., and Koski, R.A. (2009) Effective siRNA targeting of the 3' untranslated region of the West Nile virus genome. *Antiviral Research*, **82**, 166–168.
- 124 Schubert, S., Grunert, H.P., Zeichhardt, H., Werk, D., Erdmann, V.A., and Kurreck, J. (2005) Maintaining inhibition: siRNA double expression vectors against coxsackieviral RNAs. *Journal of Molecular Biology*, **346**, 457–465.
- 125 Schubert, S., Rothe, D., Werk, D., Grunert, H.P., Zeichhardt, H., Erdmann, V.A., and Kurreck, J. (2007) Strand-specific silencing of a picornavirus by RNA interference: evidence for the superiority of plus-strand specific siRNAs. *Antiviral Research*, **73**, 197–205.
- 126 Werk, D., Pinkert, S., Heim, A., Zeichhardt, H., Grunert, H.P., Poller, W., Erdmann, V.A., Fechner, H., and Kurreck, J. (2009) Combination of soluble coxsackievirus-adenovirus receptor and anti-coxsackievirus siRNAs exerts synergistic antiviral activity against coxsackievirus B3. *Antiviral Research*, **83**, 298–306.
- 127 Chen, W., Yan, W., Du, Q., Fei, L., Liu, M., Ni, Z., Sheng, Z., and Zheng, Z. (2004) RNA interference targeting VP1 inhibits foot-and-mouth disease virus replication in BHK-21 cells and suckling mice. *Journal of Virology*, **78**, 6900–6907.
- 128 Kahana, R., Kuznetsova, L., Rogel, A., Shemesh, M., Hai, D., Yadin, H., and Stram, Y. (2004) Inhibition of foot-and-mouth disease virus replication by small

- interfering RNA. *The Journal of General Virology*, **85**, 3213–3217.
- 129 Lu, W.W., Hsu, Y.Y., Yang, J.Y., and Kung, S.H. (2004) Selective inhibition of enterovirus 71 replication by short hairpin RNAs. *Biochemical and Biophysical Research Communications*, **325**, 494–499.
- 130 Wu, Z., Yang, F., Zhao, R., Zhao, L., Guo, D., and Jin, Q. (2009) Identification of small interfering RNAs which inhibit the replication of several enterovirus 71 strains in China. *Journal of Virological Methods*, **159**, 233–238.
- 131 Tan, E.L., Tan, T.M., Tak, V., Chow, K., and Poh, C.L. (2007) Inhibition of enterovirus 71 in virus-infected mice by RNA interference. *Molecular Therapy: The Journal of the American Society of Gene Therapy*, **15**, 1931–1938.
- 132 Lv, K., Guo, Y., Zhang, Y., Wang, K., Li, K., Zhu, Y., and Sun, S. (2005) Transient inhibition of foot-and-mouth disease virus replication by siRNAs silencing VP1 protein coding region. *Research in Veterinary Science*, **86**, 443–452.
- 133 Kanda, T., Zhang, B., Kusov, Y., Yokosuka, O., and Gauss-Müller, V. (2005) Suppression of hepatitis A virus genome translation and replication by siRNAs targeting the internal ribosomal entry site. *Biochemical and Biophysical Research Communications*, **330**, 1217–1223.
- 134 Phipps, K.M., Martinez, A., Lu, J., Heinz, B.A., and Zhao, G. (2004) Small interfering RNA molecules as potential anti-human rhinovirus agents: *in vitro* potency, specificity, and mechanism. *Antiviral Research*, **61**, 49–55.
- 135 Pacca, C.C., Severino, A.A., Mondini, A., Rahal, P., D'ávila, S.G., Cordeiro, J.A., Nogueira, M.C., Bronzoni, R.V., and Nogueira, M.L. (2009) RNA interference inhibits yellow fever virus replication *in vitro* and *in vivo*. *Virus Genes*, **38**, 224–231.
- 136 Murakami, M., Ota, T., Nukuzuma, S., and Takegami, T. (2005) Inhibitory effect of RNAi on Japanese encephalitis virus replication *in vitro* and *in vivo*. *Microbiology and Immunology*, **49**, 1047–1056.
- 137 Huang, F., Hua, X., Yang, S., Yuan, C., and Zhang, W. (2009) Effective inhibition of hepatitis E virus replication in A549 cells and piglets by RNA interference (RNAi) targeting RNA-dependent RNA polymerase. *Antiviral Research*, **83**, 274–281.
- 138 DeVincenzo, J., Cehelsky, J.E., Alvarez, R., Elbashir, S., Harborth, J., Toudjarska, I., Nechev, L., Murugaiah, V., Van Vliet, A., Vaishnav, A.K., and Meyers, R. (2008) Evaluation of the safety, tolerability and pharmacokinetics of ALN-RSV01, a novel RNAi antiviral therapeutic directed against respiratory syncytial virus (RSV). *Antiviral Research*, **77**, 225–231.
- 139 Israsena, N., Supavonwong, P., Ratanasetyuth, N., Khawplod, P., and Hemachudha, T. (2009) Inhibition of rabies virus replication by multiple artificial microRNAs. *Antiviral Research*, **84**, 76–83.
- 140 Ge, Q., McManus, M.T., Nguyen, T., Shen, C.H., Sharp, P.A., Eisen, H.N., and Chen, J. (2003) RNA interference of influenza virus production by directly targeting mRNA for degradation and indirectly inhibiting all viral RNA transcription. *Proceedings of the National Academy of Sciences of the United States of America*, **100**, 2718–2723.
- 141 Ge, Q., Filip, L., Bai, A., Nguyen, T., Eisen, H.N., and Chen, J. (2004) Inhibition of influenza virus production in virus-infected mice by RNA interference. *Proceedings of the National Academy of Sciences of the United States of America*, **101**, 8676–8681.
- 142 Tompkins, S.M., Lo, C.Y., Tumpey, T.M., and Epstein, S.L. (2004) Protection against lethal influenza virus challenge by RNA interference *in vivo*. *Proceedings of the National Academy of Sciences of the United States of America*, **101**, 8682–8686.
- 143 Sui, H.Y., Zhao, G.Y., Huang, J.D., Jin, D.Y., Yuen, K.Y., and Zheng, B.J. (2009) Small interfering RNA targeting m2 gene induces effective and long term inhibition of influenza A virus replication. *PLoS One*, **4**, e5671.
- 144 Zhou, H., Jin, M., Yu, Z., Xu, X., Peng, Y., Wu, H., Liu, J., Liu, H., Cao, S., and Chen, H. (2007) Effective small interfering RNAs targeting matrix and nucleocapsid protein gene inhibit influenza A virus



- replication in cells and mice. *Antiviral Research*, **76**, 186–193.
- 145 Mungall, B.A., Schopman, N.C., Lambeth, L.S., and Doran, T.J. (2008) Inhibition of henipavirus infection by RNA interference. *Antiviral Research*, **80**, 324–331.
- 146 Dector, M.A., Romero, P., Lopez, S., and Arias, C.F. (2002) Rotavirus gene silencing by small interfering RNAs. *EMBO Reports*, **3**, 1175–1180.
- 147 Arias, C.F., Dector, M.A., Segovia, L., Lopez, T., Camacho, M., Isa, P., Espinosa, R., and Lopez, S. (2004) RNA silencing of rotavirus gene expression. *Virus Research*, **102**, 43–51.
- 148 Fowler, T., Bamberg, S., Moller, P., Klenk, H.D., Meyer, T.F., Becker, S., and Rudel, T. (2005) Inhibition of Marburg virus protein expression and viral release by RNA interference. *The Journal of General Virology*, **86**, 1181–1188.
- 149 Martinez, M.A., Clotet, B., and Esté, J.A. (2002) RNA interference of HIV replication. *Trends in Immunology*, **23**, 559–561.
- 150 Lee, N.S., Dohjima, T., Bauer, G., Li, H., Li, M.J., Ehsani, A., Salvaterra, P., and Rossi, J. (2002) Expression of small interfering RNAs targeted against HIV-1 rev transcripts in human cells. *Nature Biotechnology*, **20**, 500–505.
- 151 Li, M.J., Bauer, G., Michienzi, A., Yee, J.K., Lee, N.S., Kim, J., Li, S., Castanotto, D., Zaia, J., and Rossi, J.J. (2003) Inhibition of HIV-1 infection by lentiviral vectors expressing POL III-promoted anti-HIV RNAs. *Molecular Therapy: The Journal of the American Society of Gene Therapy*, **8**, 196–206.
- 152 Westerhout, E.M., Vink, M., Haasnoot, P.C., Das, A.T., and Berkhout, B. (2006) A conditionally replicating HIV-based vector that stably expresses an antiviral shRNA against HIV-1 replication. *Molecular Therapy: The Journal of the American Society of Gene Therapy*, **14**, 268–275.
- 153 von Eije, K., ter Brake, O., and Berkhout, B. (2009) Stringent testing identifies highly potent and escape-proof anti-HIV short hairpin RNAs. *The Journal of Gene Medicine*, **11**, 459–467.
- 154 Unwalla, H.J., Li, M.J., Kim, J.D., Li, H.T., Ehsani, A., Alluin, J., and Rossi, J.J. (2004) Negative feedback inhibition of HIV-1 by TAT-inducible expression of siRNA. *Nature Biotechnology*, **22**, 1573–1578.
- 155 Jia, F., Zhang, Y.Z., and Liu, C.M. (2007) Stable inhibition of hepatitis B virus expression and replication in HepG2.2.15 cells by RNA interference based on retrovirus delivery. *Journal of Biotechnology*, **128**, 32–40.
- 156 Ying, R.S., Zhu, C., Fan, X.G., Li, N., Tian, X.F., Liu, H.B., and Zhang, B.X. (2007) Hepatitis B virus is inhibited by RNA interference in cell culture and in mice. *Antiviral Research*, **73**, 24–30.
- 157 Zhao, Z.F., Yang, H., Han, D.W., Zhao, L.F., Zhang, G.Y., Zhang, Y., and Liu, M.S. (2006) Inhibition of hepatitis B virus expression and replication by RNA interference in HepG2.2.15. *World Journal of Gastroenterology*, **12**, 6046–6049.
- 158 Moore, M.D., McGarvey, M.J., Russell, R.A., Cullen, B.R., and McClure, M.O. (2005) Stable inhibition of hepatitis B virus proteins by small interfering RNA expressed from viral vectors. *The Journal of Gene Medicine*, **7**, 918–925.
- 159 Giladi, H., Ketzinel-Gilad, M., Rivkin, L., Felig, Y., Nussbaum, O., and Galun, E. (2003) Small interfering RNA inhibits hepatitis B virus replication in mice. *Molecular Therapy: The Journal of the American Society of Gene Therapy*, **8**, 769–776.
- 160 Bhuyan, P.K., Kariko, K., Capodici, J., Lubinski, J., Hook, L.M., Friedman, H.M., and Weissman, D. (2004) Short interfering RNA-mediated inhibition of herpes simplex virus type 1 gene expression and function during infection of human keratinocytes. *Journal of Virology*, **78**, 10276–10 281.
- 161 Wiebusch, L., Truss, M., and Hagemeyer, C. (2004) Inhibition of human cytomegalovirus replication by small interfering RNAs. *The Journal of General Virology*, **85**, 179–184.
- 162 Chang, Y., Chang, S.S., Lee, H.H., Doong, S.L., Takada, K., and Tsai, C.H. (2004) Inhibition of the Epstein–Barr virus lytic cycle by Zta-targeted RNA interference.

- The Journal of General Virology*, **85**, 1371–1379.
- 163** Yoon, J.S., Kim, S.H., Shin, M.C., Hong, S.K., Jung, Y.T., Khang, I.G., Shin, W.S., Kim, C.C., and Paik, S.Y. (2004) Inhibition of herpesvirus-6B RNA replication by short interference RNAs. *Journal of Biochemistry and Molecular Biology*, **37**, 383–385.
- 164** Butz, K., Ristriani, T., Hengstermann, A., Denk, C., Scheffner, M., and Hoppe-Seyler, F. (2003) siRNA targeting of the viral E6 oncogene efficiently kills human papillomavirus-positive cancer cells. *Oncogene*, **22**, 5938–5945.
- 165** Chen, X.Z., Zhu, K.J., Xu, Y., Tang, X.Y., Cai, X.Z., Zhang, X., and Cheng, H. (2010) RNA interference silences the human papillomavirus 6b/11 early gene E7 *in vitro* and *in vivo*. *Clinical and Experimental Dermatology*, **35**, 509–515.
- 166** Putral, L.N., Bywater, M.J., Gu, W., Saunders, N.A., Gabrielli, B.G., Leggatt, G.R., and McMillan, N.A. (2005) RNA interference against human papillomavirus oncogenes in cervical cancer cells results in increased sensitivity to cisplatin. *Molecular Pharmacology*, **68**, 1311–1319.
- 167** Orba, Y., Sawa, H., Iwata, H., Tanaka, S., and Nagashima, K. (2004) Inhibition of virus production in JC virus-infected cells by postinfection RNA interference. *Journal of Virology*, **72**, 7270–7273.



## 14

### Neuraminidase Inhibitors as Anti-Influenza Agents

*Willard Lew, Michael Z. Wang, Xiaowu Chen, James F. Rooney, and Choung Kim*

#### 14.1

##### Introduction

Influenza is a highly contagious and acute respiratory illness that continues to threaten public health with yearly epidemics causing significant morbidity and mortality. Every year, the global burden of influenza epidemics is believed to be around 3.5 million cases of severe illness and an estimated 300 000–500 000 deaths. In the past century, humans experienced several worldwide epidemics or pandemics. The worst pandemic, the so-called “Spanish influenza,” struck in 1918 and killed more than 20 million people worldwide. This disaster was followed by epidemics of Asian flu in 1957, Hong Kong flu in 1968, and Russian flu in 1977. The avian influenza outbreak in 1997 killed 6 people among 18 infected Hong Kong residents. The following highly pathogenic avian flu H5N1 virus outbreak in 2003 alarmed public health organizations worldwide due to its high fatality rate. More than 385 cases of infection with the H5N1 virus and as many as 243 deaths were reported by June 2008. The most recent swine flu H1N1 virus outbreak in spring 2009 has already spread worldwide during the first few months since the first case was reported [1]. The World Health Organization (WHO) declared it pandemic influenza in June 2009. As of August 2009, there have been more than 170 000 confirmed cases of swine flu infection among over 170 countries with more than 1400 deaths [2].

Influenza virus is a member of the orthomyxoviridae family, containing segmented single-stranded RNA molecules of negative sense associated with proteins responsible for RNA replication and transcription [3]. Influenza viruses are divided into three serologically distinct types, A, B, and C, on the basis of the antigenic differences between their nucleoprotein and matrix protein antigens. Influenza A and B viruses cause respiratory diseases in humans and both are highly contagious pathogens for human populations. Influenza C virus causes sporadic upper respiratory tract illness and is rarely associated with severe respiratory disease. Influenza A viruses are further classified into subtypes on the basis of the antigenic properties of the envelope-associated surface glycoprotein molecules, namely, the hemagglutinin (HA) and the neuraminidase (NA) [3]. So far, there have been 16 hemagglutinin subtypes (H1–H16)

and 9 neuraminidase subtypes (N1–N9) identified for type A influenza viruses, but only a limited number of subtypes (H1N1, H2N2, and H3N2) have been circulated in humans. Influenza B viruses carry one form of hemagglutinin and one form of neuraminidase, although the amino acid sequences in one B strain can differ slightly from another. In addition, influenza A and B differ in their infectivity in various hosts. Influenza B viruses infect only man and cause regional epidemics rather than pandemics. Influenza A viruses, in contrast, infect many species, such as pigs, horses, seals, whales, and birds as well as man, although not all influenza A strains are capable of infecting all species. In fact, influenza A viruses have been responsible for causing all pandemics in this century and the previous century.

Hemagglutinin is a trimeric glycoprotein consisting of three identical subunits that are anchored to the viral membrane and is responsible for the attachment of the virus to cells by targeting host cell-surface glycoconjugates containing *N*-acetylneuraminic acid as the terminal carbohydrate residues [3]. Subsequently, hemagglutinin contributes to the internalization of the virus through fusion of the viral envelope with the host cell endosomes during the initial stage of infection.

Neuraminidase, a sialidase, is a tetrameric glycoprotein consisting of four identical subunits [3]. Each NA monomer is composed of a single polypeptide chain and is anchored in the virus membrane with the N-terminus embedded in the transmembrane portion. Neuraminidase catalyzes the cleavage of terminal  $\alpha$ -(2,3 or 2,6)-ketosidically linked *N*-acetylneuraminic acid from a wide range of glycoconjugates, including glycolipids and glycoproteins from upper respiratory tract mucins, facilitating movement of the virus, and from the surface glycoproteins of the newly synthesized virion progeny and the infected host cell surface. The latter action facilitates the release of progeny viruses that would otherwise clump at the infected cell surface through sialic acid–hemagglutinin interactions and be cleared by the host immune system.

Attempts to control influenza disease through immunization have been hampered by rapid mutations occurring naturally within the RNA genome of influenza virus. Influenza vaccines in use are a combination of inactivated influenza viruses containing hemagglutinin and neuraminidase from various strains. They are reasonably effective against the strain used to make the vaccine and are cost-effective. However, it would be difficult to precisely predict the circulating influenza virus pathogens in any upcoming season, and more importantly to detect and identify newly emerging influenza virus subtypes with severe pathogenicity within sufficient time to enable vaccine production and distribution ahead of the virus spread.

Thus, there has been a long-standing interest in the development of effective and safe antiviral agents with which to treat infected individuals. Both of the two surface glycoproteins, hemagglutinin and neuraminidase, appear to be essential in the lifecycle of the virus and as such both are considered attractive targets for the development of anti-influenza drugs.

At present, there are two classes of anti-influenza drugs available for the treatment of influenza, the adamantanamine-based M2 ion channel protein inhibitors, rimantadine 1 and amantadine 2, and the neuraminidase inhibitors zanamivir 3 and oseltamivir 4 (Figure 14.1).

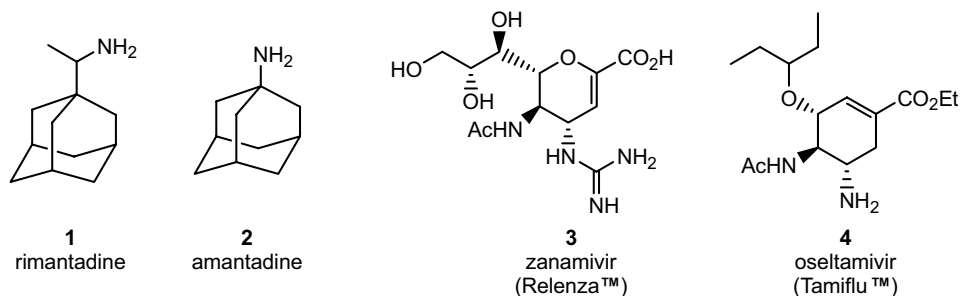

**Figure 14.1** Structures of anti-influenza drugs rimantadine, amantadine, zanamivir, and oseltamivir.

The M2 ion channel protein is involved either in initiating the infection or in assembling influenza A, but is absent in influenza B virus genome. These compounds have been useful in the treatment of influenza A infection but are not effective against influenza virus B strains. Although these drugs have been found to be effective against influenza A virus infection, both have been reported not only to have significant side effects but also rapidly lead to the emergence of drug-resistant influenza A virus strains. Many recently circulating influenza A viruses have been found resistant to the adamantanes. As a consequence, these adamantane-based drugs have limited value as clinically useful therapeutics [4, 5]. The second and most recently developed class of influenza A and B antiviral drugs are the neuraminidase inhibitors, which bind to the NA surface glycoprotein of newly formed virus particles and prevent their efficient release from the host cell. At present, two neuraminidase inhibitors, inhalation-administered zanamivir (Relenza™) and orally administered oseltamivir phosphate (Tamiflu™), have been approved for treatment and prevention of influenza infection in both adults and children [6–8]. Oseltamivir is the most commonly prescribed drug and is used worldwide for the treatment and prevention of influenza. Resistance to the neuraminidase inhibitors has also been described and can also limit the use against selected virus strains.

This chapter highlights the discovery of the anti-influenza neuraminidase inhibitors zanamivir and oseltamivir. In addition, some selected neuraminidase inhibitors in clinical development are also mentioned.

## 14.2

### Influenza Neuraminidase as a Drug Target

Neuraminidase is present in all influenza types and shares high sequence homology. Due to the essential role neuraminidase plays in the viral life cycle and high conservation of its active site, it is an ideal target for drugs with broad-spectrum anti-influenza activity. Neuraminidase has been studied as a potential target for

anti-influenza agents since the 1930s and has been subject to intensive academic, government, and industrial efforts over the past few decades culminating in the 1999 approval of zanamivir and oseltamivir. Determination of high-resolution crystal structures of neuraminidase/inhibitor complexes, along with the application of molecular modeling, has been instrumental in accelerating the drug discovery process. The discovery of small-molecule neuraminidase inhibitors has, in our view, proven to be one of the most successful approaches of structure-based drug discovery.

### 14.3

#### Neuraminidase Active Site and Inhibitor Binding

Despite nearly three decades of intensive research on neuraminidase (from the early 1960s to the late 1980s) and the discovery of a lead compound with low  $\mu\text{M}$  potency, DANA (2-deoxy-2,3-dehydro-*N*-acetylneuraminic acid, Neu5Ac2en) **5** in the late 1960s, very little progress was made. Even though low-resolution crystal structures of neuraminidase were obtained in the early 1980s [9], it did not dramatically speed up progress in the discovery of small-molecule inhibitors. Striking and rapid progress was made only after high-resolution complex structures of neuraminidase and sialic acid (and related analogues) became available in the late 1980s [10].

The high-resolution crystal structures revealed a highly conserved active site with well-formed deep, highly polar binding pocket containing five negatively charged Asp/Glu residues, five positively charged Arg residues, and one polar Asn residue. The highly polar nature of neuraminidase active site is not surprising since the enzyme needs to recognize and interact with the polar terminally linked sialic acid from the host cells. Inhibitors are anchored into the neuraminidase active site through two key moieties present in all potent inhibitor scaffolds (Figure 14.2).

A negatively charged carboxylic acid (occasionally phosphonic acid) moiety, shared by all potent inhibitors, makes strong charge–charge interactions with three Arg residues that form one side of the active site. Opposite of the acid, a common *N*-acetyl moiety of inhibitors makes both polar and hydrophobic interactions with Arg 152, Trp 178, and Leu 222. The rest of the active site can then be divided into three subsites: Pocket 1 consists of highly polar residues that interact with a glycerol moiety in substrate and early inhibitors; this pocket is most intriguing because it is also capable of making classic hydrophobic interactions through a simple conformational change of Glu 276 residue. Pocket 2 is small and typical of a hydrophobic binding site and is not utilized by substrate and early inhibitors. Pocket 3 is again rather polar due to the presence of Glu 119, Asp 151, and Glu 227. These residues interact with the 4-OH of substrate and early inhibitors, either directly or through two tightly bound water molecules, and this subsite is an ideal location to introduce a basic moiety to take advantage of the cluster of negatively charged neuraminidase residues in this subsite.

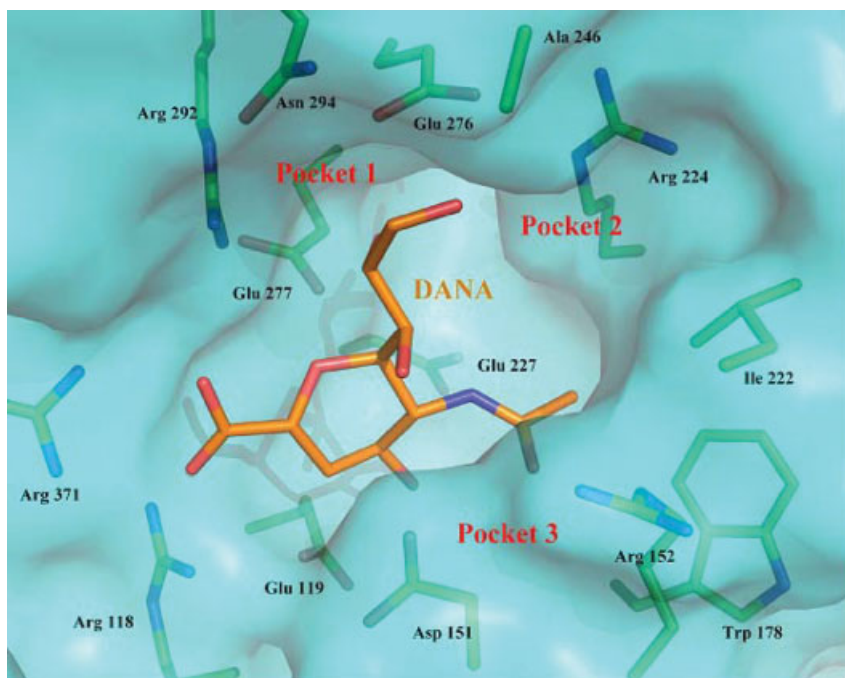

**Figure 14.2** Complex crystal structure of NA/5. Neuraminidase active site is shown as cyan surface and key residues as stick; carbons are colored green; inhibitor carbon is colored brown; oxygen is colored red; nitrogen blue for the rest of atoms.

## 14.4

### Small-Molecule Inhibitors of Influenza Neuraminidase

#### 14.4.1

##### Zanamivir (Relenza) and Related Compounds

Zanamivir was the first in the class of small-molecule anti-influenza drugs discovered utilizing a rational structure-based drug design approach. Using available X-ray crystal structures of influenza neuraminidase bound with sialic acid [11], in conjunction with computational methods, researchers designed and synthesized potent inhibitors based on compound 5. Detailed analysis using GRID program suggested that the cluster of negatively charged pocket 3 residues could be further explored through charge–charge interactions by introducing a more basic moiety to replace the 4-hydroxyl group of compound 5. Pocket 3 is not only polar but can also accommodate a group larger than hydroxyl. To this end, the 4-hydroxyl was replaced with an amino group, compound 6, which resulted in a significant increase in potency. This was then followed by the replacement of the amino group with a positively charged guanidinium group, compound 3, which further improved



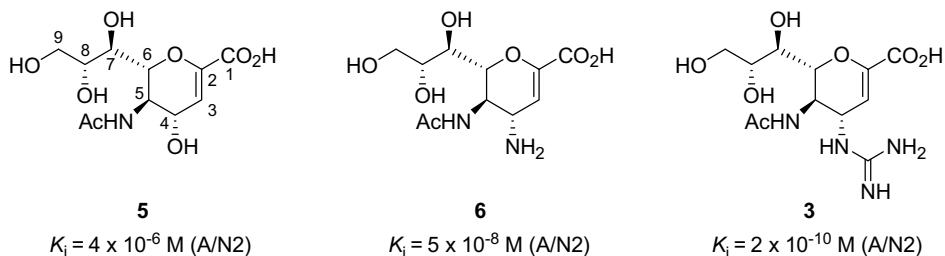

**Figure 14.3** Activity of DANA, Neu5Ac2en, and zanamivir.

potency by replacing two tightly bound water molecules and making a buried charge–charge interaction (Figure 14.3).

The X-ray crystal structures of neuraminidase bound with either compound **6** or **3** revealed that the amino group of **6** or the guanidinium group of **3** forms a salt bridge with Glu 119. In addition, the guanidinium group also generated multiple interactions with Glu 119, Asp 151, and Glu 227. Compound **3**, later to become known as zanamivir, exhibited potent antiviral activity against a variety of influenza A and B strains in cell culture and demonstrated *in vivo* efficacy in influenza-infected animal models via intranasal administration. Zanamivir was ultimately licensed to GlaxoWellcome (now GlaxoSmithKline) and is marketed as Relenza for the treatment of influenza. Due to the highly polar nature of the molecule, Relenza has poor oral bioavailability and is administered via inhalation. It is interesting to point out that it only took a few years to discover zanamivir after obtaining complex crystal structures, which contrasts dramatically with the little progress made during previous decades of research and is a prime example of how structure and modeling can accelerate drug discovery.

Expanding on their work on zanamivir, GlaxoWellcome scientists examined a series of C-6 carboxamide analogues [12] in which the polar glycerol side chain of zanamivir is replaced with secondary and tertiary amides (Figure 14.4) to optimize hydrophobic enzyme interactions and improve the overall lipophilicity of the molecule. Initial work in this area examined alkyl amides with either a terminal

Compound	R <sub>1</sub>	R <sub>2</sub>	Flu A IC <sub>50</sub> (μM)	Flu B IC <sub>50</sub> (μM)
<b>7</b>	CH <sub>2</sub> CH <sub>2</sub> NH <sub>2</sub>	H	390.00	-
<b>8</b>	CH <sub>2</sub> CH <sub>2</sub> OH	H	420.00	-
<b>9</b>	CH <sub>2</sub> CH <sub>2</sub> CH <sub>3</sub>	H	19.00	50.00
<b>10</b>	CH <sub>3</sub>	CH <sub>3</sub>	2.40	61.00
<b>11</b>	CH <sub>2</sub> CH <sub>2</sub> CH <sub>3</sub>	CH <sub>3</sub>	0.18	23.00

**Figure 14.4** Activity of C-6 carboxamide analogues.

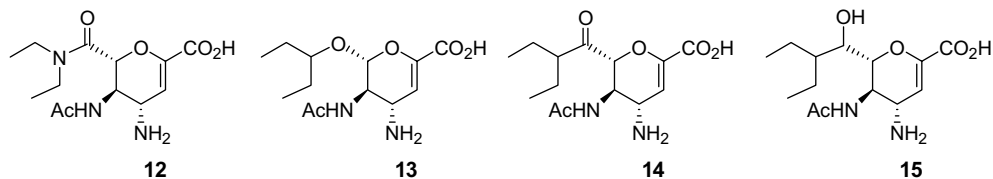

Compound	Flu A IC <sub>50</sub> (μM)	Flu B IC <sub>50</sub> (μM)
<b>12</b>	0.003	0.360
<b>13</b>	0.770	42.000
<b>14</b>	0.002	0.470
<b>15</b>	0.039	7.400

**Figure 14.5** Activity of C-6 carboxamide, ether, ketone, and hydroxy analogues.

amino or hydroxy group on the alkyl group (**7** and **8**) in order to preserve the hydrogen-bonding interactions with Glu 276.

Introduction of simple alkyl groups (**9** and **10**) reduced inhibitory activity in both enzyme and plaque reduction assays. In contrast, tertiary amides exhibited increased potency compared to the secondary amides (**10** versus **9**). Interestingly, while various tertiary amides exhibited good potency against influenza A, the compounds exhibited significantly less potency against influenza B. Differences in potency against influenza A and B for the carboxamide series was explained by the fact that the lipophilic amide group induces a conformational change in the binding pocket of both influenza A and B neuraminidase. Analysis of X-ray crystal structures of the carboxamides bound with either influenza A or B neuraminidase revealed that for influenza B neuraminidase, the induced conformational change results in a distortion of the protein backbone that is energetically disfavored. In another study, the conformational effects of the C-6 carboxamides were examined by looking at the ether, ketone, and alcohol derivatives, **13–15** [13]. The three analogues were comparable to the C-6 carboxamide in that they all exhibited selectivity toward influenza A neuraminidase (Figure 14.5).

In another variant of zanamivir, replacement of the glycerol side-chain with a heterocycle was examined as a way to exploit hydrophobic contacts in the S4 and S5 binding subsites, compounds **16a–d** and **17** (Figure 14.6) [14]. On the basis of

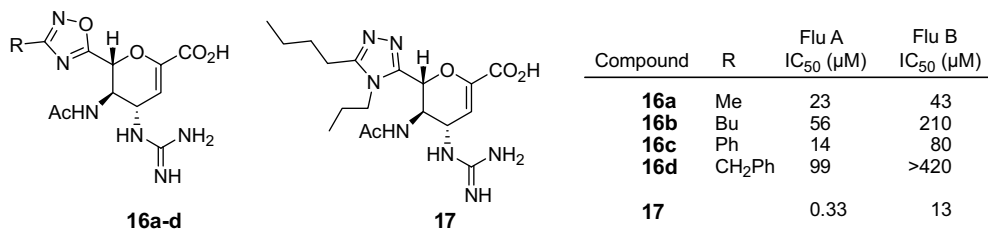

**Figure 14.6** Activity of heterocyclic analogues.

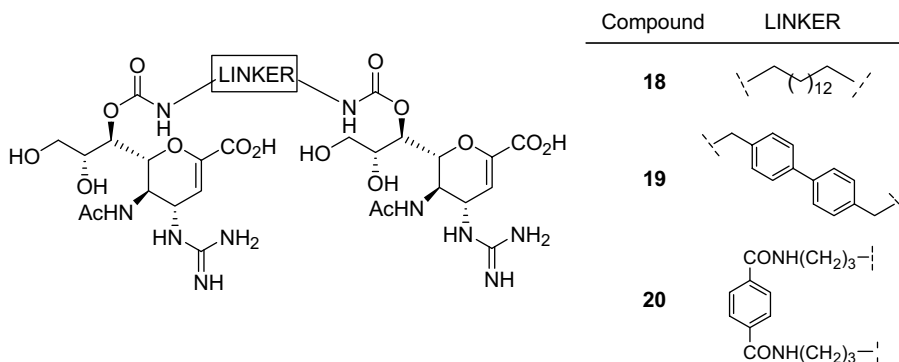

**Figure 14.7** Dimeric analogues of zanamivir.

inhibitory activity and molecular modeling studies, the authors inferred that the heterocyclic side chains induced the same active site reorganization as seen with the C-6 amide series of inhibitors. It was also inferred that the differences in the activity of the oxadiazole and triazole derivatives are analogous to the differences in the activity of secondary and tertiary amides at C-6.

Finally, GlaxoSmithKline researchers have also reported a series of dimeric zanamivir conjugates as part of a follow-up effort aimed at developing second-generation therapies targeting influenza by utilizing a multivalency approach [15]. The dimeric compounds are linked together via the C-7 position of zanamivir, for example, compounds **18**, **19**, and **20** (Figure 14.7). Analogues within this series were shown both to possess good to excellent potency against a variety of influenza A and B strains in plaque reduction assays and to exhibit a prolonged antiviral effect *in vivo*.

#### 14.4.2

#### Laninamivir (CS-8958): A Long-Acting Neuraminidase Inhibitor

As demonstrated by previous work on zanamivir, the two hydroxyl groups corresponding to the C-8 and C-9 diol on the glycerol side chain engage Glu 276 in the enzyme active site. However, the hydroxyl group at C-7 was found not to be important for enzyme binding. The idea that the C-7 hydroxyl could be dispensed with led to the idea that the C-7 position could possibly be used to introduce lipophilic functionality that would in turn improve the pharmacokinetic properties of zanamivir-like molecules. Work in this area has led to the design and synthesis of several modified glycerol side-chain analogues of zanamivir. Most notable of these are the class of long-acting inhaled neuraminidase inhibitors (Figure 14.8) [16]. The main goal of the program was to develop a new series of inhaled neuraminidase inhibitors that would have a greater duration of activity than that of zanamivir and, in turn, would have the advantage of less frequent dosing (zanamivir is administered twice daily via inhalation). One of the lead compounds from this class of compounds, **21** (R-125489), is being developed by Daiichi Sankyo/Biota Holdings as its octanoyl ester prodrug, **22** (CS-8958, laninamivir). Laninamivir has shown to be effective against both the

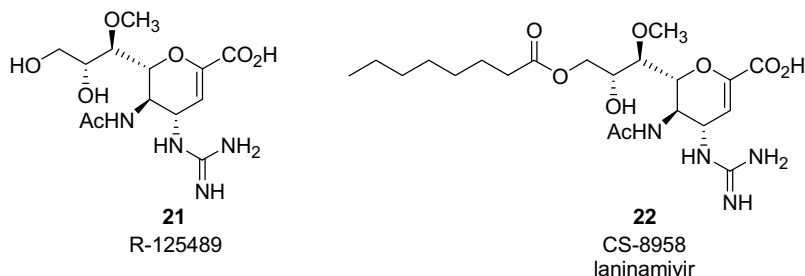

**Figure 14.8** Structures of R-125489 and CS-8958 (laninamivir).

H1N1 swine flu and the H5N1 avian flu [17]. Laninamivir was recently approved in September 2010 in Japan for the treatment of influenza and is marketed as Inavir® (laninamivir octanoate).

#### 14.4.3

#### Osetamivir (Tamiflu)

The discovery of osetamivir began with the goal of developing an orally active small-molecule neuraminidase inhibitor. At the early stages of the program, a cyclohexene ring was evaluated as a possible carbocyclic scaffold replacement for the dihydropyran ring of Neu5Ac2en (Figure 14.9). The cyclohexene ring was expected to be chemically and enzymatically stable, to be well suited for chemical modifications, and, more importantly, to be a suitable bioisostere of the proposed flat oxonium cation in the transition-state of sialic acid cleavage by neuraminidase [18]. An oxygen atom was selected to replace the C-7 hydroxy methylene unit of the glycerol side chain and would provide a convenient synthetic handle for analogue synthesis. Early

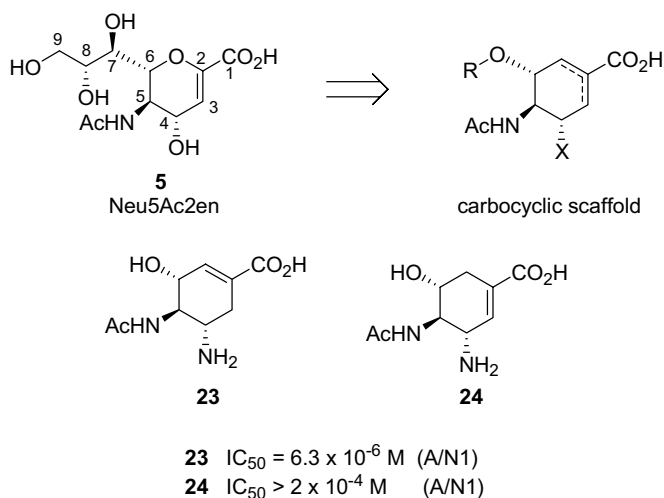
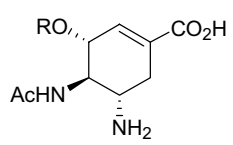

**Figure 14.9** Carbocyclic scaffold-based inhibitors.

investigations showed that the position of the double bond, in the context of the simple cyclohexene analogues, was critical for NA activity (**23** versus **24**). On the basis of these initial results, positional isomer **23** was selected for further investigation.

At the start of the program, it was decided that the key binding elements found in Neu5Ac2en and zanamivir would be retained. Namely, the C-2 carboxylate, C-4 amine, and C-5 acetamide would be held constant on the cyclohexene ring and the primary focus would be to identify a suitable lipophilic replacement of the corresponding polar C-6 glycerol side chain. To this end, a systematic exploration of various alkyl groups of the C-3 hydroxyl group (cyclohexene ring numbering system) clearly demonstrated that the nature of the alkyl side chain, with regard to its size, branching, and stereochemistry, has a dramatic influence on neuraminidase inhibitory activity [18, 19]. A representative set of compounds is shown in Figure 14.10.

A more than 20-fold increase in inhibitory activity of the simple *n*-propyl analogue **28** compared to that of the methyl analogue **25** implicated a significant hydrophobic interaction of the *n*-propyl group in the glycerol portion of the NA active site. Further

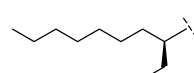
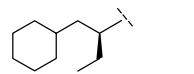
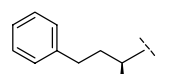
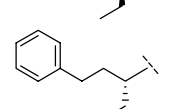

Compound	R	Flu A IC <sub>50</sub> (nM)	Flu B IC <sub>50</sub> (nM)
<b>25</b>	CH <sub>3</sub>	3700	ND <sup>c</sup>
<b>26</b>	CH <sub>3</sub> CH <sub>2</sub>	2000	185
<b>27</b>	CH <sub>3</sub> (CH <sub>2</sub> ) <sub>2</sub>	180	15
<b>28</b>	CH <sub>3</sub> (CH <sub>2</sub> ) <sub>3</sub>	300	215
<b>29</b>	CH <sub>3</sub> (CH <sub>2</sub> ) <sub>5</sub>	150	1450
<b>30</b>	(CH <sub>3</sub> CH <sub>2</sub> ) <sub>2</sub> CH	1	3
<b>31</b>	CH <sub>3</sub> CH <sub>2</sub> (CH <sub>3</sub> )CH* ( <i>R</i> )	10	7
<b>32</b>	CH <sub>3</sub> CH <sub>2</sub> (CH <sub>3</sub> )CH* ( <i>S</i> )	9	2
<b>33</b>		1	4
<b>34</b>		16	6500
<b>35</b>		0.3	70
<b>36</b>		12	35

**Figure 14.10** Activity of representative carbocyclic analogues.

extension of the alkyl chain beyond *n*-propyl did not improve the influenza A inhibitory activity, but there was a detrimental effect on influenza B inhibitory activity. Building up of the *n*-propyl group adjacent to the ether oxygen resulted in a significant increase in potency, as demonstrated by the 3-pentyl analogue **30** (GS4071).

The X-ray crystal structure of GS4071 bound to neuraminidase revealed that the binding mode for this series of carbocyclic inhibitors is similar to that of 4-amino-Neu5Ac2en **6** [18, 19]. Namely, the corresponding C-1 carboxylate, C-4 acetamide, and C-5 amino groups of GS4071 and **6** interact with the same active-site amino acid residues upon binding to the NA active site. More importantly, the X-ray crystal structure of GS4071 revealed that the 3-pentyl side chain binds in an extended conformation and forms hydrophobic interactions previously not observed in the sialic acid/neuraminidase complex. The branched 3-pentyl moiety interacts with both pocket 1 and pocket 2, compared to that of the zanamivir-bound form, and the only significant difference in the GS4071 bound neuraminidase structure was the conformation of Glu 276 (Figure 14.11).

In the presence of GS4071, Glu 276 adopts a different conformation and forms a salt bridge with Arg 224; such a simple conformational change has two significant consequences. First, pocket 1 now is much larger and open, allowing one end of the 3-pentyl moiety to bind in this pocket. Second, and much more significant, pocket 1

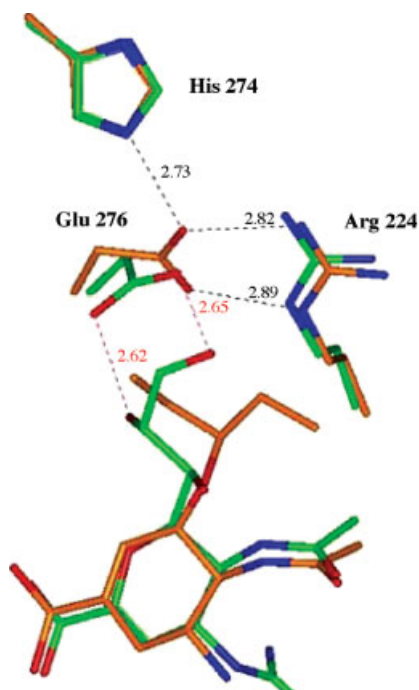
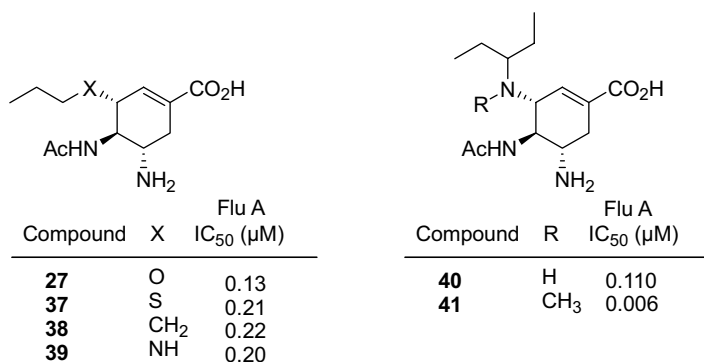

**Figure 14.11** Comparison of complex crystal structures of GS4071/NA (carbon in brown) versus zanamivir/NA (carbon in green).

undergoes total transformation from a highly polar, charged pocket to a conventional hydrophobic pocket (see discussion below). Further gain in potency is through the binding of the other end of the 3-pentyl moiety to hydrophobic pocket 2, which was not occupied by zanamivir. The increase in potency due to interaction with pockets 1 and 2 is sufficient so that it is not necessary to incorporate the guanidinium group that was critical to the potency of zanamivir. As a result, GS4071 was more balanced in potency and overall molecular properties (molecular weight, lipophilicity, solubility, etc.).

Pocket 1 turns out to be a very intriguing binding site. It is composed of Glu 276, Glu 277, Arg 292, Asn 294, and Ala 246. Except for Ala 246, the other residues are highly polar, which is necessary since the glycerol group of the substrate and zanamivir binds in this pocket; classic electrostatic potential calculation also confirms the polar nature of this pocket. However, as demonstrated by GS4071 binding to pocket 1, this pocket is capable of behaving as a typical hydrophobic binding site. Close examination led to the observation that the charged/polar side chains of Arg, Glu, and Asn all share a common feature and a novel hypothesis that polar side chains are capable of forming hydrophobic interactions. The guanidinium, carboxylate, and amide moiety all contain a central sp<sup>2</sup> carbon that makes these moieties planar, and the excess charge is distributed across the whole plane. Unlike point charges, these charges are highly directional and are focused along the edge of the plane. The face of the plane is much less polar. Analysis of multiple high-resolution crystal structures of neuraminidase with inhibitors placing various alkyl moieties in pocket 1 reveal that all these polar side chains indeed use their planar face to form pocket 1, the polar edges are all directed away from the inhibitor's alkyl moiety.

Further variations of the C-3 side chain included replacement of the ether oxygen linkage with either a carbon, sulfur, or nitrogen atom to examine their effects on inhibitory potency, compounds **37**, **38**, and **39** (Figure 14.12) [20, 21]. For the most part good potency was retained among related analogues. However, even though the most direct analogues of GS4071, aza analogues **40** and **41**, exhibited very good potency in the enzymatic assay, their level of activity was reduced compared to the oxygen-linked parent compound.



**Figure 14.12** C-3 side-chain ether heteroatom replacements.

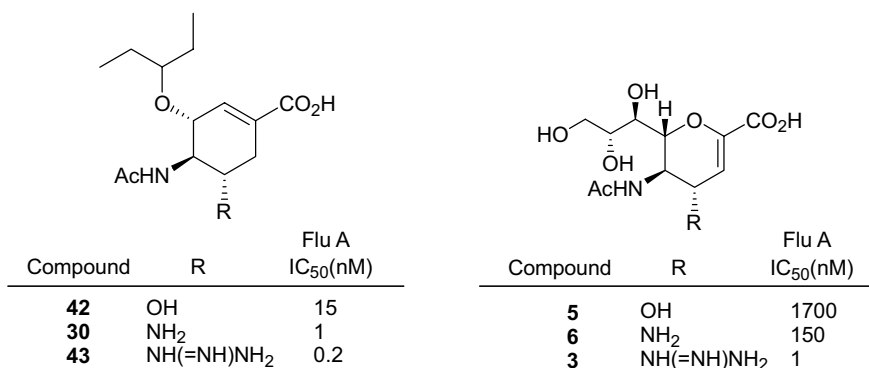
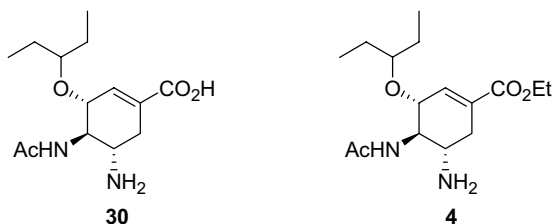

**Figure 14.13** Activity of hydroxy, amino, and guanidino analogues.

The corresponding guanidinium analogue of GS4071, compound **43**, was also evaluated and, surprisingly, it exhibited only a modest improvement in inhibitory activity relative to the amino analogue [19, 22]. Interestingly, the carbocyclic analogues appear to be more than 100-fold active than the corresponding dihydropyran analogues in the series when R = OH (**42** versus **5**) or NH<sub>2</sub> (**30** versus **6**) (Figure 14.13). This result provides evidence that the 3-pentyl group in the carbocyclic series contributes a considerable amount of binding energy via its additional hydrophobic interactions.

Although GS4071 was designed with the goal of developing an orally active influenza neuraminidase inhibitor, preliminary pharmacokinetic experiments demonstrated that the oral bioavailability of GS4071 was poor. In order to address poor oral bioavailability, a prodrug strategy was employed. The corresponding ethyl ester prodrug of GS4071 (Figure 14.14), compound **4** (GS4104, oseltamivir), was synthesized and gratifyingly the oral bioavailability of GS4071 in rats following oral administration was found to be more than fivefold higher compared to that of the parent compound [23].

In addition, good oral bioavailability of GS4071 following oral administration of GS4104 was observed in mice (~30%), dogs (~70%), and humans (~80%). GS4071/GS4104 was licensed to Roche for development as an oral anti-influenza agent in 1996 and was granted approval by the FDA in 1999. GS4104 (oseltamivir) is marketed



**Figure 14.14** GS4071 and ethyl ester prodrug GS4104 (oseltamivir).



by Roche under the trade name of Tamiflu as an orally administered treatment for influenza infection.

A comprehensive review describing the original, as well as alternative synthetic routes, of both zanamivir and oseltamivir has recently been published [24].

## 14.5

### Mechanism of Resistance

Drug resistance is a very important issue for antiviral treatment due to rapid viral replication cycles that make it possible for the virus to generate new mutations. Therefore, it is essential to gain an understanding of the structural basis of resistance.

Oseltamivir relies on hydrophobic interactions in pocket 1; hence, mutations that change the nature of pocket 1 could affect the activity of oseltamivir. This is the case with the H274Y mutation [25]. His 274 is a second-layer residue that is buried in the neuraminidase active site, so it does not interact with any bound inhibitor directly. However, when it is mutated to a bulkier Tyr, it causes a steric clash with the Glu 276–Arg 222 salt bridge that forces the Glu 276 back into pocket 1 and transforms pocket 1 back to a polar binding site that is unfavorable for the alkyl side chain of oseltamivir to interact with. On the other hand, zanamivir introduces additional charge interactions that may lead to mutations that reduce the polarity of the neuraminidase active site that in turn could cause resistance. Indeed, this is the case with Glu 119 mutations [26].

## 14.6

### Influenza Neuraminidase Inhibitors Based on Other Scaffolds

The wealth of available structural data and published structure–activity relationships of neuraminidase inhibitors has resulted in the design and discovery of other novel small-molecule inhibitors. Strategies have been described to further modify zanamivir- and oseltamivir-based inhibitors with the goal of obtaining new inhibitors with improved biological activity and physicochemical properties, compounds 44–51 (Figure 14.15) [27]. Inhibitors based on an aromatic template have also been reported, for example, compounds 52–55 (Figure 14.16) [28]. Despite encouraging early *in vitro* activity and the generation of structural data, none of the compounds demonstrated activity sufficient to warrant advancement.

#### 14.6.1

##### Peramivir (BCX-1812, RWJ-270201)

Researchers at Biocryst Pharmaceuticals utilized a structure-based approach to discover a new class of cyclopentane-based inhibitors. Examination and comparison of the protein crystal structure of the furan compound (56) (Figure 14.17) bound to neuraminidase with that of the DANA/neuraminidase crystal structure revealed that

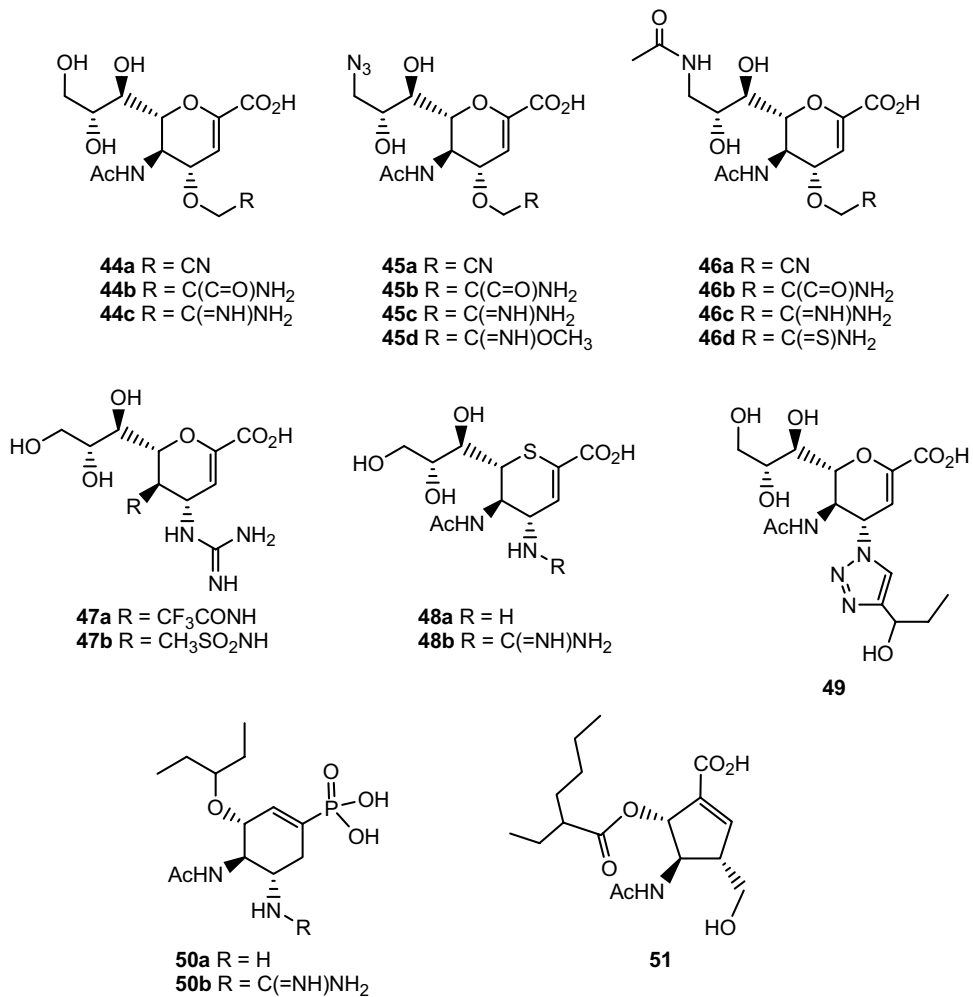

Figure 14.15 Analogues of zanamivir- and oseltamivir-based inhibitors.

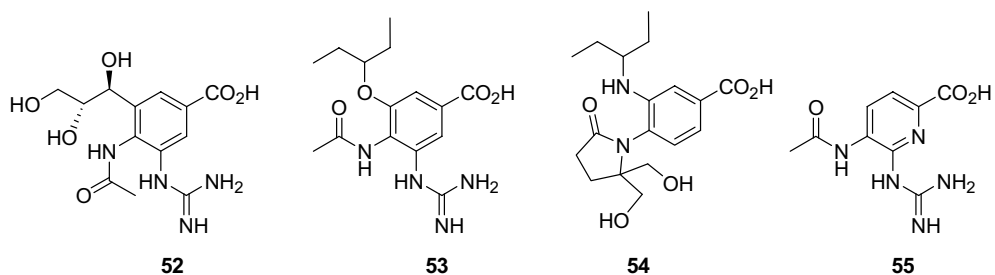
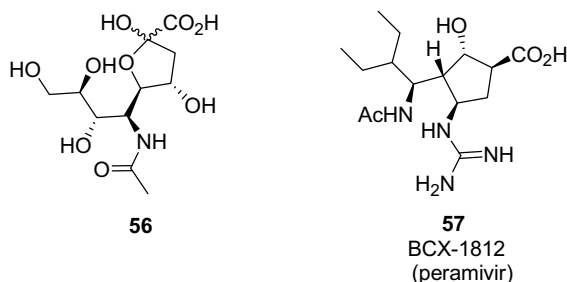

Figure 14.16 Structure of aromatic neuraminidase inhibitors.



**Figure 14.17** Structure of 56 and BCX-1812 (peramivir).

the carboxylic acid, glycerol side chain, *N*-acetyl group, and C-4 hydroxyl group of **56** occupy the same relative positions in the active site and make similar binding interactions with the enzyme to the corresponding functional groups of DANA. On the basis of this comparison, it was concluded that a cyclopentane ring would be a suitable scaffold for novel neuraminidase inhibitors. The decision was made early on to not put any constraints on the stereochemistry around the cyclopentane ring during synthesis that resulted in mixtures of racemates. The strategy adopted was to rely extensively on protein crystallography with neuraminidase crystals to screen and identify the active isomers from mixtures containing isomeric compounds. This approach proved to be successful and a series of novel and potent cyclopentane-based neuraminidase inhibitors were discovered, as exemplified by BCX-1812 (peramivir, RWJ-270201) **57** (Figure 14.17) [29]. BCX-1812 exhibited potent inhibitory activity against influenza A and B neuraminidase with potency in the nanomolar range and successfully completed animal studies and phase I and phase II clinical trials as an orally administered agent. However, in phase III trials, peramivir did not demonstrate a statistically significant efficacy endpoint, which was presumed to be due to low bioavailability of the compound. At present, Biocryst is evaluating peramivir with its partner Shionogi in phase III clinical trials via intravenous administration. In October 2009, the US FDA issued an Emergency Use Authorization for peramivir to allow the use of the drug in intravenous form for hospitalized patients with 2009 H1N1 influenza only in cases where other methods of treatment are ineffective or unavailable. In January 2010, Shionogi received marketing and manufacturing approval for intravenous peramivir to treat patients with influenza in Japan under the commercial name Rapiacta. Shionogi received approval for single-dose administration of 300 mg i.v. peramivir in the cases of adult uncomplicated seasonal influenza infection, as well as single- and multiple dose administration of 600 mg i.v. peramivir for patients at a high risk of complications associated with influenza.

#### 14.6.2

##### ABT-675

A directed screening campaign at Abbott Laboratories identified a pyrrolidine scaffold, compound **58** (Figure 14.18), as a lead compound exhibiting  $\mu\text{M}$  activity



sooner the treatment initiated, the greater the benefit in reduction of duration of illness [38]. This benefit has been observed in both adult and pediatric patient populations. For uncomplicated influenza in otherwise healthy patients, it is recommended that treatment be initiated within 48 h of the onset of clinical symptoms, which is the peak period of virus replication. In immunocompromised and in hospitalized patients, the duration of viral shedding may be prolonged, and treatment with neuraminidase inhibitors may be beneficial even if initiated more than 48 h after symptoms onset [39, 40]. Data from several cohort studies have suggested a survival benefit for hospitalized patients with influenza treated with oseltamivir [33, 39, 41]. Observational studies of the highly pathogenic avian influenza strain H5N1, which has caused a pandemic in birds and can occasionally infect humans with a high mortality rate, have also suggested a substantial reduction in mortality associated with oseltamivir treatment [40]. Higher doses or longer durations of therapy have sometimes been recommended for the highly pathogenic strains of influenza virus (e.g., H5N1) or for the treatment of immunocompromised patients, in whom viral shedding can be prolonged [33, 42].

Oseltamivir and zanamivir have also proven efficacious in the prevention of influenza virus infection [33]. In controlled studies in otherwise healthy adults and separate studies in children, administration of oseltamivir or zanamivir for up to 6 weeks on a daily basis during the influenza season has been shown to reduce the chances of developing laboratory confirmed influenza disease by 70–90% [43–45]. When given for 10 days following exposure to an infected individual (postexposure prophylaxis), oseltamivir or zanamivir can reduce the chances of developing influenza infections by 68–89% [46–51]. By treating infected patients and providing prophylaxis to exposed individuals, neuraminidase inhibitors have proven very useful in controlling influenza outbreaks in closed settings such as nursing homes, long-term care facilities, prisons, and summer camps [33, 52].

Resistance to influenza neuraminidase inhibitors has been reported in clinical settings, and resistance mutations have been characterized for both oseltamivir and zanamivir [31, 32]. Development of resistance following treatment has occurred in less than 2% of otherwise healthy adults with seasonal influenza treated with oseltamivir or zanamivir, while resistance has been reported in 9% of pediatric patients and 2% of patients with influenza B virus treated with oseltamivir, and can also occur at higher incidence in immunocompromised patients [32, 33, 53–58]. Sustained transmission of emerging treatment-resistant virus is not common. During the 2007–2008 influenza season in Europe, a naturally occurring H1N1 variant that carried the H275Y mutation in the viral neuraminidase gene and was resistant to oseltamivir became the dominant circulating strain for that season. The strain was sensitive to treatment with zanamivir [59, 60]. In April 2009, a novel H1N1 pandemic strain emerged in North America and has continued to circulate globally. Till April 7, 2010, resistance to oseltamivir has been observed infrequently (285 resistant isolates out of more than 23 000 samples tested), and the strain is also sensitive to zanamivir, although resistant to the adamantanes [61, 62]. Recommendations for the use of antivirals to treat influenza vary by geography and season, and

combinations of antiviral agents (e.g., oseltamivir plus rimantadine or amantadine) have sometimes been recommended when influenza viruses with differing resistance profiles are cocirculating in the community [33, 63].

## 14.8

### Concluding Remarks

The design of the small-molecule influenza neuraminidase inhibitors described in this chapter illustrates the elegant and successful use of structure-based drug design. A side-by-side comparison of the high-resolution crystal structures of GG167 (zanamivir), GS4071 (parent form of oseltamivir), and BCX-1812 (peramivir) clearly illustrates how structurally distinct molecules can bind and make the same key interactions in the neuraminidase active site (Figure 14.19). The first licensed neuraminidase inhibitor, zanamivir (Relenza), was rationally designed on the basis of X-ray crystal structure of N-2 type neuraminidase. Replacement of the 4-hydroxyl group of DANA with a guanidinium group resulted in a substantial increase in binding affinity to the enzyme active site. The highly polar nature of zanamivir precludes its use as an oral agent and it must be delivered by inhalation. Subsequently, oseltamivir (Tamiflu) was designed around a cyclohexene scaffold to have an orally administered drug. Oseltamivir, with a lipophilic 3-pentyl side chain, can be administered orally as its carboxylate prodrug.

Over the past few years, zanamivir and oseltamivir have been used extensively worldwide to treat influenza infection and both drugs have proven successful in reducing the severity of influenza and influenza-associated complications. So far, the neuraminidase inhibitors, as a class, are associated with fewer antiviral resistance problems compared to M2 inhibitors, amantadine and rimantadine. However, due to the prevailing H1N1 pandemic threat and potential emergence of resistance to neuraminidase inhibitors, the development of new anti-influenza drugs must be a high priority. Peramivir was recently issued an Emergency Use Authorization by the US FDA in October 2009 that allows the use of the drug in intravenous form for hospitalized patients with 2009 H1N1 influenza when other methods of treatment

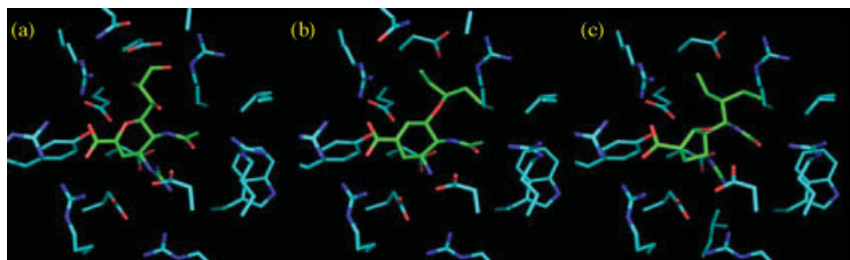

**Figure 14.19** X-ray crystal structures of neuraminidase (carbon colored cyan) complexed with (a) GG167 (zanamivir), (b) GS4071 (parent form of oseltamivir), and (c) BCX-1812 (peramivir) (inhibitor carbons colored green).

are unavailable or ineffective. Shionogi received marketing and manufacturing approval for intravenous peramivir to treat patients with influenza in Japan under the commercial name Rapiacta in January 2010. In addition, intravenous zanamivir is subject of a compassionate use program and a phase III study of hospital patients using IV zanamivir was recently initiated by GlaxoSmithKline in January 2011. An intravenous formulation of oseltamivir (Tamiflu IV) was granted an Emergency Investigational New Drug (EIND) in the United States and a compassionate use program in Europe. An alternative drug such as the influenza RNA polymerase inhibitor, favipiravir, is an important addition as a potential agent against the virulence of H5N1 viruses in humans [64]. Analogous to HIV treatment, combination therapy of two different influenza targets will reduce the potential of resistance development. Attempts to design and develop further new anti-influenza drugs should be intensified.

## References

- 1 Neumann, G., Noda, T., and Kawaoka, Y. (2009) Emergence and pandemic potential of swine-origin H1N1 influenza virus. *Nature*, **459**, 931–939.
- 2 [www.who.int/csr/disease/swineflu](http://www.who.int/csr/disease/swineflu) (accessed on September 10, 2009).
- 3 Murphy, B.R. and Webster, R.G. (1990) Orthomyxoviruses, in *Virology*, 2nd edn (eds B.N. Fields and D.M. Knipe), Raven Press Ltd, New York, pp. 1091–1152.
- 4 Hayden, F.G. and Hay, A.J. (1992) Emergence and transmission of influenza A viruses resistant to amantadine and rimantadine. *Current Topics in Microbiology and Immunology*, **176**, 119–130.
- 5 Douglas, R.G., Jr. (1990) Prophylaxis and treatment of influenza. *The New England Journal of Medicine*, **322**, 443–450.
- 6 Oxford, J.S. and Lambkin, R. (1998) Targeting influenza virus neuraminidase: a new strategy for antiviral therapy. *Drug Discovery Today*, **3**, 448–456.
- 7 Mendel, D.B. and Roberts, N.A. (1998) *In-vitro* and *in-vivo* efficacy of influenza neuraminidase inhibitors. *Current Opinion in Infectious Disease*, **11**, 727–732.
- 8 Jackson, H.C., Roberts, N., Wang, Z.M., and Belshe, R. (2000) Management of influenza: use of new antivirals and resistance in perspective. *Clinical Drug Investigation*, **20**, 447–454.
- 9 Varghese, J.N., Laver, W.G., and Colman, P.M. (1983) Structure of the influenza virus glycoprotein antigen neuraminidase at 2.9 Å resolution. *Nature*, **303**, 35–40.
- 10 (a) Varghese, J.N., McKimm-Breschkin, J.L., Caldwell, J.B., Kortt, A.A., and Colman, P.M. (1992) The structure of the complex between influenza virus neuraminidase and sialic acid, the viral receptor. *Proteins*, **14**, 327–332; (b) Burmeister, W.P., Ruigrok, R.W. and Cusack, S. (1992) The 2.2 Å resolution crystal structure of influenza B neuraminidase and its complex with sialic acid. *The EMBO Journal*, **11**, 49–56.
- 11 (a) von Itzstein, M., Wu, W.Y., Kok, G.B., Pegg, M.S., Dyason, J.C., Jin, B., Van Phan, T., Smythe, M.L., White, H.F., Oliver, S.W., Colman, P.M., Varghese, J.N., Ryan, D.M., Woods, J.M., Bethell, R.C., Hotham, V.J., Cameron, J.M., and Penn, C.R. (1993) Rational design of potent sialidase-based inhibitors of influenza virus replication. *Nature*, **363**, 418–423; (b) von Itzstein, M., Dyason, J.C., Oliver, S.W., White, H.F., Wu, W.Y., Kok, G.B., and Pegg, M.S. (1996) A study of the active site of influenza virus sialidase: an approach to the rational design of novel anti-influenza drugs. *Journal of Medicinal Chemistry*, **39**, 388–391; (c) von Itzstein, L.M., Wu, W.Y., Phan Tho, V., Danylec, B., and Jin, B. (1991) Preparation of

- derivatives and analogs of 2-deoxy-2,3-didehydro-N-acetylneuraminic acid as antiviral agents, Biota Scientific Management Pty. Ltd. Australia WO 9116320;(d) von Itzstein, M., Wu, W.Y., and Jin, B. (1994) The synthesis of 2,3-didehydro-2,4-dideoxy-4-guanidinyln-acetylneuraminic acid: a potent influenza virus sialidase inhibitor. *Carbohydrate Research*, **259**, 301–305.
- 12 (a) Sollis, S.L., Smith, P.W., Howes, P.D., Cherry, P.C., and Bethell F.R.C. (1996) Novel inhibitors of influenza sialidase related to GG167. Synthesis of 4-amino and guanidino-4H-pyran-2-carboxylic acid-6-propylamides: selective inhibitors of influenza A virus sialidase. *Bioorganic & Medicinal Chemistry Letters*, **6**, 1805–1808; (b) Smith, P.W., Sollis, S.L., Howes, P.D., Cherry, P.C., Starkey, I.D., Cobley, K.N., Weston, H., Scicinski, J., Merritt, A., Whittington, A., Wyatt, P., Taylor, N., Green, D., Bethell, R., Madar, S., Fenton, R.J., Morley, P.J., Pateman, T., and Beresford, A. (1998) Dihydropyranocarboxamides related to zanamivir: a new series of inhibitors of influenza virus sialidases. 1. Discovery, synthesis, biological activity, and structure–activity relationships of 4-guanidino- and 4-amino-4H-pyran-6-carboxamides. *Journal of Medicinal Chemistry*, **41**, 787–797.
- 13 Smith, P.W., Robinson, J.E., Evans, D.N., Sollis, S.L., Howes, P.D., Trivedi, N., and Bethell, R.C. (1999) Sialidase inhibitors related to zanamivir: synthesis and biological evaluation of 4H-pyran-6-ether and ketone. *Bioorganic & Medicinal Chemistry Letters*, **9**, 601–604.
- 14 Smith, P.W. and Whittington, A.R. (1997) Novel inhibitors of influenza sialidases related to zanamivir. Heterocyclic replacements of the glycerol sidechain. *Bioorganic & Medicinal Chemistry Letters*, **7**, 2239–2242.
- 15 (a) Macdonald, S.J., Cameron, R., Demaine, D.A., Fenton, R.J., Foster, G., Gower, D., Hamblin, J.N., Hamilton, S., Hart, G.J., Hill, A.P., Inglis, G.G., Jin, B., Jones, H.T., McConnell, D.B., McKimm-Breschkin, J., Mills, G., Nguyen, V., Owens, I.J., Parry, N., Shanahan, S.E., Smith, D., Watson, K.G., Wu, W.Y., and Tucker, S.P. (2005) Dimeric zanamivir conjugates with various linking groups are potent, long-lasting inhibitors of influenza neuraminidase including H5N1 avian influenza. *Journal of Medicinal Chemistry*, **48**, 2964–2971; (b) Macdonald, S.J., Watson, K.G., Cameron, R., Chalmers, D.K., Demaine, D.A., Fenton, R.J., Gower, D., Hamblin, J.N., Hamilton, S., Hart, G.J., Inglis, G.G., Jin, B., Jones, H.T., McConnell, D.B., Mason, A.M., Nguyen, V., Owens, I.J., Parry, N., Reece, P.A., Shanahan, S.E., Smith, D., Wu, W.Y. and Tucker, S.P. (2004) Potent and long-acting dimeric inhibitors of influenza virus neuraminidase are effective at a once-weekly dosing regimen. *Antimicrobial Agents and Chemotherapy*, **48**, 4542–4549.
- 16 Honda, T., Masuda, T., Yoshida, S., Arai, M., Kaneko, S., and Yamashita, M. (2002) Synthesis and anti-influenza virus activity of 7-O-alkylated derivatives related to zanamivir. *Bioorganic & Medicinal Chemistry Letters*, **12**, 1925–1928.
- 17 Yamashita, M., Tomozawa, T., Kakuta, M., Tokumitsu, A., Nasu, H., and Kubo, S. (2009) CS-8958, a prodrug of the new neuraminidase inhibitor R-125489, shows long-acting anti-influenza virus activity. *Antimicrobial Agents and Chemotherapy*, **53**, 186–192.
- 18 Kim, C.U., Lew, W., Williams, M.A., Zhang, L., Liu, H., Swaminathan, S., Bischofberger, N., Chen, M.S., Tai, C.Y., Mendel, D.B., Tai, C.Y., Laver, W.G., and Stevens, R.C. (1997) Influenza neuraminidase inhibitors possessing a novel hydrophobic interaction in the enzyme active site: design, synthesis, and structural analysis of carbocyclic sialic acid analogs with potent anti-influenza activity. *Journal of the American Chemical Society*, **119**, 681–690.
- 19 Kim, C.U., Lew, W., Williams, M.A., Wu, H., Zhang, L., Chen, X., Escarpe, P.A., Mendel, D.B., Laver, W.G., and Stevens, R.C. (1998) Structure–activity relationship studies of novel carbocyclic influenza neuraminidase inhibitors. *Journal of Medicinal Chemistry*, **41**, 2451–2460.
- 20 Lew, W., Williams, M.A., Mendel, D.B., Escarpe, P.A., and Kim, C.U. (1997) C3-Thia and C3-carba isosteres of a carbocyclic influenza neuraminidase



- inhibitor, (3R,4R, 5R)-4-acetamido-5-amino-3-propoxy-1-cyclohexene-1-carboxylic acid. *Bioorganic & Medicinal Chemistry Letters*, **7**, 1843–1846.
- 21 Lew, W., Chen, X., and Kim, C.U. (2000) Discovery and development of GS4104 (oseltamivir): an orally active influenza neuraminidase inhibitor. *Current Medicinal Chemistry*, **7**, 663–672.
- 22 Williams, M.A., Lew, W., Mendel, D.B., Tai, C.Y., Escarpe, P.A., Laver, W.G., Stevens, R.C., and Kim, C.U. (1997) Structure–activity relationships of carbocyclic influenza neuraminidase inhibitors. *Bioorganic & Medicinal Chemistry Letters*, **7**, 1837–1842.
- 23 (a) Li, W., Escarpe, P.A., Eisenberg, E.J., Cundy, K.C., Sweet, C., Jakeman, K.J., Merson, J., Lew, W., Williams, M.A., Zhang, L., Kim, C.U., Bischofberger, N., Chen, M.S., and Mendel, D.B. (1998) Identification of GS4104 as an orally bioavailable prodrug of the influenza virus neuraminidase inhibitor GS4071. *Antimicrobial Agents and Chemotherapy*, **42**, 647–653; (b) Eisenberg, E.J., Bidgood, A. and Cundy, K.C. (1997) Penetration of GS4071, a novel influenza neuraminidase inhibitor, into rat bronchoalveolar lining fluid following oral administration of the prodrug GS4104. *Antimicrobial Agents and Chemotherapy*, **41**, 1949–1952.
- 24 Magano, J. (2009) Synthetic approaches to the neuraminidase inhibitors zanamivir (Relenza) and oseltamivir phosphate (Tamiflu) for the treatment of influenza. *Chemical Reviews*, **109**, 4398–4438.
- 25 Moscona, A. (2005) Oseltamivir resistance: disabling our influenza defenses. *The New England Journal of Medicine*, **353**, 2633–2636.
- 26 Blick, T.J., Tiong, T., Sahasrabudhe, A., Varghese, J.N., Colman, P.M., Hart, G.J., Bethell, R.C., and McKimm-Breschkin, J.L. (1995) Generation and characterization of an influenza virus neuraminidase variant with decreased sensitivity to the neuraminidase-specific inhibitor 4-guanidino-Neu5Ac2en. *Virology*, **214**, 475–484.
- 27 (a) Ikeda, K., Sano, K., Ito, M., Saito, M., Hidari, K., Suzuki, T., Suzuki, Y., and Tanaka, K. (2001) Synthesis of 2-deoxy-2,3-didehydro-*N*-acetylneuraminic acid analogues modified at the C-4 and C-9 positions and their behaviour towards sialidase from influenza virus and pig liver membrane. *Carbohydrate Research*, **330**, 31–41; (b) Ikeda, K., Kimura, F., Sano, K., Suzuki, Y. and Achiwa, K. (1998) Chemoenzymatic synthesis of an *N*-acetylneuraminic acid analogue having a carbamoylmethyl group at C-4 as an inhibitor of sialidase from influenza virus. *Carbohydrate Research*, **312**, 183–189; (c) Li, J., Zheng, M., Tang, W., He, P.L., Zhu, W., Li, T., Zuo, J.P., Liu, H. and Jiang, H. (2006) Syntheses of triazole-modified zanamivir analogues via click chemistry and anti-AIV activities. *Bioorganic & Medicinal Chemistry Letters*, **16**, 5009–5013; (d) Smith, P.W., Starkey, I.D., Howes, P.D., Sollis, S.L., Keeling, S.P., Cherry, P.C., von Itzstein, M., Wu, W.Y., and Jin, B. (1996) Synthesis and influenza virus sialidase inhibitory activity of analogs of 4-guanidino-Neu5Ac2en (GG167) with modified 5-substituents. *European Journal of Medicinal Chemistry*, **31**, 143–150; (e) Kok, G.B., Campbell, M., Mackey, B., and von Itzstein, M. (1996) Synthesis and biological evaluation of sulfur isosteres of the potent influenza virus sialidase inhibitors 4-amino-4-deoxy- and 4-deoxy-4-guanidino-Neu5Ac2en. *Journal of the Chemical Society, Perkin Transactions 1*, 2811–2815; (f) Shie, J.-J., Fang, J.-M., Wang, S.-Y., Tsai, K.-C., Cheng, Y.-S.E., Yang, A.-S., Hsiao, S.-C., Su, C.-Y. and Wong, C.-H. (2007) Synthesis of Tamiflu and its phosphonate congeners possessing potent anti-influenza activity. *Journal of the American Chemical Society*, **129**, 11892–11893; (g) Piao, F. and Hong, J.H. (2008) Design and synthesis of a cyclopentene scaffold mimicking oseltamivir as a novel neuraminidase inhibitor. *The Bulletin of Korean Chemical Society*, **29**, 2221–2226.
- 28 (a) Jedrzejewski, M.J., Singh, S., Brouillette, W.J., Laver, W.G., Air, G.M., and Luo, M. (1995) Structures of aromatic inhibitors of influenza virus neuraminidase. *Biochemistry*, **34**, 3144–3151; (b) Singh, S., Jedrzejewski, M.J., Air, G.M., Luo, M., Laver, W.G., and Brouillette, W.J. (1995) Structure-based inhibitors of influenza virus sialidase: a benzoic acid lead with

- novel interaction. *Journal of Medicinal Chemistry*, **38**, 3217–3225; (c) Chand, P., Babu, Y.S., Bantia, S., Chu, N., Cole, L.B., Kotian, P.L., Laver, W.G., Montgomery, J.A., Pathak, V.P., Petty, S.L., Shrout, D.P., Walsh, D.A., and Walsh, G.M. (1997) Design and synthesis of benzoic acid derivatives as influenza neuraminidase inhibitors using structure-based drug design. *Journal of Medicinal Chemistry*, **40**, 4030–4052; (d) Sudbeck, E.A., Jedrzejewski, M.J., Singh, S., Brouillette, W.J., Air, G.M., Laver, W.G., Babu, Y.S., Bantia, S., Chand, P., Chu, N., Montgomery, J.A., Walsh, D.A., and Luo, M. (1997) Guanidinobenzoic acid inhibitors of influenza virus neuraminidase. *Journal of Molecular Biology*, **267**, 584–594; (e) Howes, P.D., Cleasby, A., Evans, D.N., Fielden, H., Smith, P.W., Sollis, S.L., Taylor, N., and Wonacott, A.J. (1999) 4-Acetylamino-3-(imidazol-1-yl)-benzoic acids as novel inhibitors of influenza sialidase. *European Journal of Medicinal Chemistry*, **34**, 225–234; (f) Brouillette, W.J., Atigadda, V.R., Duarte, F., Luo, M., Air, G.M., Babu, Y.S., and Bantia, S. (1999) Design of benzoic acid inhibitors of influenza neuraminidase containing a cyclic substitution for the N-acetyl grouping. (Erratum to document cited in CA131:266560). *Bioorganic & Medicinal Chemistry Letters*, **9**, 3259; (g) Finley, J.B., Atigadda, V.R., Duarte, F., Zhao, J.J., Brouillette, W.J., Air, G.M., and Luo, M. (1999) Novel aromatic inhibitors of influenza virus neuraminidase make selective interactions with conserved residues and water molecules in the active site. *Journal of Molecular Biology*, **293**, 1107–1119; (h) Atigadda, V.R., Brouillette, W.J., Duarte, F., Ali, S.M., Babu, Y.S., Bantia, S., Chand, P., Chu, N., Montgomery, J.A., Walsh, D.A., Sudbeck, E.A., Finley, J., Luo, M., Air, G.M., and Laver, G.W. (1999) Potent inhibition of influenza sialidase by a benzoic acid containing a 2 pyrrolidinone substituent. *Journal of Medicinal Chemistry*, **42**, 2332–2343; (i) Williams, M., Bischofberger, N., Swaminathan, S., and Kim, C.U. (1995) Synthesis and influenza neuraminidase inhibitory activity of aromatic analogs of sialic acid. *Bioorganic & Medicinal Chemistry Letters*, **5**, 2251–2254; (j) Chand, P., Kotian, P.L., Morris, P.E., Bantia, S., Walsh, D.A., and Babu, Y.S. (2005) Synthesis and inhibitory activity of benzoic acid and pyridine derivatives on influenza neuraminidase. *Bioorganic and Medicinal Chemistry*, **13**, 2665–2678; (k) Brouillette, W.J., Atigadda, V.R., Luo, M., Air, G.M., Babu, Y.S., and Bantia, S. (1999) Design of benzoic acid inhibitors of influenza neuraminidase containing a cyclic substitution for the N-acetyl grouping. *Bioorganic & Medicinal Chemistry Letters*, **9**, 1901–1906.
- 29 (a) Babu, Y.S., Chand, P., Bantia, S., Kotian, P., Dehghani, A., El-Kattan, Y., Lin, T.H., Hutchison, T.L., Elliott, A.J., Parker, C.D., Ananth, S.L., Horn, L.L., Laver, G.W., and Montgomery, J.A. (2000) BCX-1812 (RWJ-270201): discovery of a novel, highly potent, orally active, and selective influenza neuraminidase inhibitor through structure-based drug design. *Journal of Medicinal Chemistry*, **43**, 3482–3486; (b) Chand, P., Kotian, P.L., Dehghani, A., El-Kattan, Y., Lin, T.H., Hutchison, T.L., Babu, Y.S., Bantia, S., Elliott, A.J., and Montgomery, J.A. (2001) Systematic structure-based design and stereoselective synthesis of novel multisubstituted cyclopentane derivatives with potent antiinfluenza activity. *Journal of Medicinal Chemistry*, **44**, 4379–4392; (c) Sidwell, R.W. and Smee, D.F. (2002) Peramivir (BCX-1812, RWJ-270201): potential new therapy for influenza. *Expert Opinion on Investigational Drugs*, **11**, 859–869; (d) Bantia, S., Arnold, C.S., Parker, C.D., Upshaw, R. and Chand, P. (2006) Anti-influenza virus activity of peramivir in mice with single intramuscular injection. *Antiviral Research*, **69**, 39–45; (e) Bantia, S., Parker, C.D., Ananth, S.L., Horn, L.L., Andries, K., Chand, P., Kotian, P.L., Dehghani, A., El-Kattan, Y., Lin, T., Hutchison, T.L., Montgomery, J.A., Kellogg, D.L., and Babu, Y.S. (2001) Comparison of the anti-influenza virus activity of RWJ-270201 with those of oseltamivir and zanamivir. *Antimicrobial Agents and Chemotherapy*, **45**, 1162–1167; (f) Sidwell, R.W., Smee, D.F., Huffman, J.H., Barnard, D.L., Bailey, K.W., Morrey, J.D., and Babu, Y.S. (2001)

- In vivo* influenza virus-inhibitory effects of the cyclopentane neuraminidase inhibitor RJW-270201. *Antimicrobial Agents and Chemotherapy*, **45**, 743–748; (h) Chand, P., Babu, Y.S., Bantia, S., Rowland, S., Dehghani, A., Kotian, P.L., Hutchison, T.L., Ali, S., Brouillette, W., El-Kattan, Y., and Lin, T.H. (2004) Syntheses and neuraminidase inhibitory activity of multisubstituted cyclopentane amide derivatives. *Journal of Medicinal Chemistry*, **47**, 1919–1929.
- 30 (a) Stoll, V., Stewart, K.D., Maring, C.J., Muchmore, S., Giranda, V., Gu, Y.G., Wang, G., Chen, Y., Sun, M., Zhao, C., Kennedy, A.L., Madigan, D.L., Xu, Y., Saldivar, A., Kati, W., Laver, G., Sowin, T., Sham, H.L., Greer, J., and Kempf, D. (2003) Influenza neuraminidase inhibitors: structure-based design of a novel inhibitor series. *Biochemistry*, **42**, 718–727; (b) Kati, W.M., Montgomery, D., Carrick, R., Gubareva, L., Maring, C., McDaniel, K., Steffy, K., Molla, A., Hayden, F., Kempf, D., and Kohlbrenner, W. (2002) *In vitro* characterization of A-315675, a highly potent inhibitor of A and B strain influenza virus neuraminidases and influenza virus replication. *Antimicrobial Agents and Chemotherapy*, **46**, 1014–1021; (c) Wang, G.T., Chen, Y., Wang, S., Gentles, R., Sowin, T., Kati, W., Muchmore, S., Giranda, V., Stewart, K., Sham, H., Kempf, D., and Laver, W.G. (2001) Design, synthesis, and structural analysis of influenza neuraminidase inhibitors containing pyrrolidine cores. *Journal of Medicinal Chemistry*, **44**, 1192–1201; (d) Kati, W.M., Montgomery, D., Maring, C., Stoll, V.S., Giranda, V., Chen, X., Laver, W.G., Kohlbrenner, W., and Norbeck, D.W. (2001) Novel  $\alpha$ - and  $\beta$ -amino acid inhibitors of influenza virus neuraminidase. *Antimicrobial Agents and Chemotherapy*, **45**, 2563–2570.
- 31 Genentech (2009) Package Insert for Tamiflu (oseltamivir), USA. Genentech, South San Francisco, CA, 2009. Available at <http://www.gene.com/gene/products/information/tamiflu/pdf/pi.pdf> (accessed December 17, 2009).
- 32 GlaxoSmithKline Package insert for Relenza (zanamivir), USA. GlaxoSmithKline, Research Triangle Park, NC, 2009. Available at [http://us.gsk.com/products/assets/us\\_relenza.pdf](http://us.gsk.com/products/assets/us_relenza.pdf) (accessed December 17, 2009).
- 33 Harper, S.A., Bradley, J.S., Englund, J.A., File, T.M., Gravenstein, S., Hayden, F.G., McGeer, A.J., Neuzil, K.M., Pavia, A.T., Tapper, M.L., Uyeki, T.M., and Zimmerman, R.K. (2009) Seasonal influenza in adults and children – diagnosis, treatment, chemoprophylaxis, and institutional outbreak management: Clinical Practice Guidelines of the Infectious Diseases Society of America. *Clinical Infectious Diseases*, **48**, 1003–1032.
- 34 Treanor, J.J., Hayden, F.G., Vrooman, P.S., Barbarash, R., Bettis, R., Riff, D., Singh, S., Kinnersley, N., Ward, P., Mills, R.G., and for the US Oral Neuraminidase Study Group (2000) Efficacy and safety of the oral neuraminidase inhibitor oseltamivir in treating acute influenza: a randomized controlled trial. *The Journal of the American Medical Association*, **283**, 1016–1024.
- 35 Hayden, F.G., Osterhaus, A.D.M.E., Treanor, J.J., Fleming, D.M., Aoki, F.Y., Nicholson, K.G., Bohnen, A.M., Hirst, H.M., Keene, O., Wightman, K., and for The GG167 Influenza Study Group (1997) Efficacy and safety of the neuraminidase inhibitor zanamivir in the treatment of influenza virus infections. *The New England Journal of Medicine*, **337**, 874–880.
- 36 Whitley, R.J., Hayden, F.G., Reisinger, K.S., Young, N., Dutkowski, R., Ipe, D., Mills, R.G., and Ward, P. (2001) Oral oseltamivir treatment of influenza in children. *The Pediatric Infectious Disease Journal*, **20**, 127–133.
- 37 Hedrick, J.A., Barzilay, A., Behre, U., Henderson, F.W., Hammond, J., Reilly, L., and Keene, O. (2000) Zanamivir for treatment of symptomatic influenza A and B infection in children five to twelve years of age: a randomized controlled trial. *The Pediatric Infectious Disease Journal*, **19**, 410–417.
- 38 Aoki, F.Y., Macleod, M.D., Paggiaro, P., Carewicz, O., El Sawy, A., Wat, C.,

- Griffiths, M., Waalberg, E., Ward, P., and on behalf of the IMPACT Study Group† (2003) Early administration of oral oseltamivir increases the benefits of influenza treatment. *The Journal of Antimicrobial Chemotherapy*, **51**, 123–129.
- 39 McGeer, A., Green, K.A., Plevneshi, A., Shigayeva, A., Siddiqi, N., Raboud, J., Low, D.E., and for the Toronto Invasive Bacterial Diseases Network (2007) Antiviral therapy and outcomes of influenza requiring hospitalization in Ontario, Canada. *Clinical Infectious Diseases*, **45**, 1568–1575.
- 40 Abdel-Ghafar, A.N., Chotpitayasunondh, T., Gao, Z., Hayden, F.G., Hien, N.D., de Jong, M.D., Naghdaliyev, A., Peiris, M., Shindo, N., Soeroso, S., and Uyeki, T.M. (2008) Update on avian influenza A (H5N1) virus infection in humans. *The New England Journal of Medicine*, **358**, 261–273.
- 41 Bowles, S.K., Lee, W., Simor, A.E., Vearncombe, M., Loeb, M., Tamblyn, S., Fearon, M., Li, Y., McGeer, A., and The Oseltamivir Compassionate Use Program Group (2002) Use of oseltamivir during influenza outbreaks in Ontario nursing homes, 1999–2000. *Journal of the American Geriatrics Society*, **50**, 608–616.
- 42 World Health Organization. WHO Guidelines for Pharmacological Management of Pandemic Influenza A (H1N1) 2009 and Other Influenza Viruses. Revised February 2010. Available at [http://www.who.int/csr/resources/publications/swineflu/h1n1\\_use\\_antivirals\\_20090820/en/index.html](http://www.who.int/csr/resources/publications/swineflu/h1n1_use_antivirals_20090820/en/index.html). Accessed 26 April, 2010.
- 43 Khazeni, N., Bravata, D.M., Holty, J.E.C., Uyeki, T.M., Stave, C.D., and Gould, M.K. (2009) Systemic review: safety and efficacy of extended-duration antiviral chemoprophylaxis against pandemic and seasonal influenza. *Annals of Internal Medicine*, **151**, 464–473.
- 44 Jefferson, T., Demicheli, V., Rivetti, D., Jones, M., Di Pietrantonj, C., and Rivetti, A. (2006) Antivirals for influenza in healthy adults: systematic review. *The Lancet*, **367**, 303–313.
- 45 Hayden, F.G., Atmar, R.L., Schilling, M., Johnson, C., Poretz, D., Paar, D., Huson, L., Ward, P., Mills, R.G., and the Oseltamivir Study Group (1999) Use of the selective oral neuraminidase inhibitor oseltamivir to prevent influenza. *The New England Journal of Medicine*, **341**, 1336–1343.
- 46 Hayden, F.G. and Pavia, A.T. (2006) Antiviral management of seasonal and pandemic influenza. *The Journal of Infectious Diseases*, **194** (Suppl. 2), S119–S126.
- 47 Cooper, N.J., Sutton, A.J., Abrams, K.R., Wailoo, A., Turner, D.A., and Nicholson, K.G. (2003) Effectiveness of neuraminidase inhibitors in treatment and prevention of influenza A and B: systemic review and meta-analysis of randomized controlled trials. *BMJ (Clinical Research Ed.)*, **326**, 1235–1242.
- 48 Hayden, F.G., Gubareva, L.V., Monto, A.S., Klein, T.C., Elliott, M.J., Hammond, J.M., Sharp, S.J., Ossi, M.J. and for the Zanamivir Family Study Group (2000) Inhaled zanamivir for the prevention of influenza in families. *The New England Journal of Medicine*, **343**, 1282–1289.
- 49 Monto, A.S., Pichichero, M.E., Blanckenberg, S.J., Ruuskanen, O., Cooper, C., Fleming, D.M., and Kerr, C. (2002) Zanamivir prophylaxis: an effective strategy for the prevention of influenza types A and B within households. *The Journal of Infectious Diseases*, **186**, 1582–1588.
- 50 Hayden, F.G., Belshe, R., Villanueva, C., Lanno, R., Hughes, C., Small, I., Dutkowski, R., Ward, P., and Carr, J. (2004) Management of influenza in households: a prospective, randomized comparison of oseltamivir treatment with or without postexposure prophylaxis. *The Journal of Infectious Diseases*, **189**, 440–449.
- 51 Welliver, R., Monto, A.S., Carewicz, O., Schatterman, E., Hassman, M., Hedrick, J., Jackson, H.C., Huson, L., Ward, P., Oxford, J.S. and for the Oseltamivir Post Exposure Prophylaxis Investigator Group (2001) Effectiveness of oseltamivir in preventing influenza in household contacts: a randomized controlled trial. *The Journal of the American Medical Association*, **285**, 748–754.
- 52 Hota, S. and McGeer, A. (2007) Antivirals and the control of influenza outbreaks. *Clinical Infectious Diseases*, **45**, 1362–1368.

- 53 Monto, A.S., McKimm-Breschkin, J.L., Macken, C., Hampson, A.W., Hay, A., Klimov, A., Tashiro, M., Webster, R.G., Aymard, M., Hayden, F.G., and Zambon, M. (2006) Detection of influenza viruses resistant to neuraminidase inhibitors in global surveillance during the first 3 years of their use. *Antimicrobial Agents and Chemotherapy*, **50**, 2395–2402.
- 54 Neuraminidase Inhibitor Susceptibility Network (2007) Monitoring of neuraminidase inhibitor resistance among clinical influenza virus isolates in Japan during the 2003–2006 influenza seasons. *Weekly Epidemiological Record*, **82**, 149–150.
- 55 Hurt, A.C., Holien, J.K., Parker, M., Kelso, A., and Barr, I.G. (2009) Zanamavir-resistant influenza viruses with a novel neuraminidase mutation. *Journal of Virology*, **83**, 10366–10373.
- 56 Kiso, M., Mitamura, K., Sakai-Tagawa, Y., Shiraishi, K., Kawakami, C., Kimura, K., Hayden, F.G., Sugaya, N., and Ka, Y. (2004) Resistant influenza A viruses in children treated with oseltamivir: descriptive study. *The Lancet*, **364**, 759–765.
- 57 Stephenson, I., Democratis, J., Lackenby, A., McNally, T., Smith, J., Pareek, M., Ellis, J., Bermingham, A., Nicholson, K., and Zambon, M. (2009) Neuraminidase inhibitor resistance after oseltamivir treatment of acute influenza A and B in children. *Clinical Infectious Diseases*, **48**, 389–396.
- 58 Hauge, S.H., Dudman, S., Borgen, K., Lackenby, A., and Hungnes, O. (2009) Oseltamivir-resistant influenza viruses A (H1N1), Norway, 2007–08. *Emerging Infectious Diseases*, **15**, 155–162.
- 59 Moscona, A. (2009) Global transmission of oseltamivir-resistant influenza. *The New England Journal of Medicine*, **360**, 953–956.
- 60 World Health Organization (2009) Oseltamivir-resistant pandemic (H1N1) 2009 influenza virus, October 2009. *Weekly Epidemiological Record*, **84**, 453–459.
- 61 World Health Organization (2010) Update on oseltamivir-resistant pandemic A (H1N1) 2009 influenza virus: January 2010. *Weekly Epidemiological Record*, **85**, 37–40.
- 62 World Health Organization (2010) Weekly update on oseltamivir resistance to pandemic influenza A (H1N1) 2009 viruses; April 14, 2010. Available at <http://www.who.int/csr/disease/swineflu/oseltamivirresistant20100416.pdf>. Accessed 16 April, 2010).
- 63 The United States Centers for Disease Control and Prevention. Updated interim recommendations for use of antiviral medications in the treatment and prevention of influenza for the 2009/2010 season. Available at <http://www.cdc.gov/H1N1flu/recommendations.htm>. Accessed 17 Dec. 17, 2009).
- 64 Furuta, Y., Takahashi, K., Shiraki, K., Sakamoto, K., Smee, D.F., Barnard, D.L., Gowen, B.B., Julander, J.G., and Morrey, J.D. (2009) T-705 (favipiravir) and related compounds: novel broad-spectrum inhibitors of RNA viral infections. *Antiviral Research*, **82**, 95–102.

## 15

# From TIBO to Rilpivirine: The Chronicle of the Discovery of the Ideal Nucleoside Reverse Transcriptase Inhibitor

Erik De Clercq

### 15.1

#### Introduction

On November 5, 1986, at a personal meeting I had in Beerse with the late Dr. Paul (P.A.J. Janssen, deceased November 11, 2003), we decided to start a collaborative project between the Janssen Research Foundation (Janssen Pharmaceutica) and the Rega Institute for Medical Research (K.U. Leuven), with an ultimate goal to find a “cure” for AIDS. Accordingly, we joined the chemical expertise built up at Janssen with the biological expertise on anti-HIV evaluation developed at the Rega Institute. At Janssen, this project was led by Koen Andries and Paul Janssen; at Rega, the project was led by Rudi Pauwels and myself in the laboratory facilities made available through Prof. Jan Desmyter. Later, in 2007 [1], Jan Heeres and Paul J. Lewi, two of Dr. Paul’s most faithful coworkers, wrote, “Dr. Paul Janssen had a dream . . . that medicinal chemistry could relieve the suffering of mankind.” Sometimes success came quickly, as in the case of analgesics, neuroleptics, anthelmintics, antimycotics, and gastrointestinal compounds. In this fight against HIV, however, progress was laborious, costly, and time-consuming, but, in the end, the effort proved to be worthwhile [1].

Of key importance in the detection of selective anti-HIV activity, in the absence of cytotoxicity, was the evaluation system set up by Rudi Pauwels in our laboratory using MT4 cells (originally obtained from Naoki Yamamoto (Tokyo, Japan) and provided by Luc Montagnier (Paris, France)), which were infected with the HTLV-III/LAV(III<sub>B</sub>) strain (obtained from Robert C. Gallo (Bethesda, MD)). The original method, as described by Pauwels *et al.* [2], was based on a rapid and automated tetrazolium-based colorimetric assay, and is still the most widely used assay for the detection of anti-HIV compounds. The paper itself has been cited more than 1000 times and the protocol used has proven its value when revisited 20 years after the original description [3].

## 15.2

## The TIBO Derivatives

On February 1, 1990, we announced in *Nature* [4] the discovery of a new class of potent and selective inhibitors of HIV-1 replication, the so-called TIBO derivatives. They were based on the tetrahydro-*imidazo*[4,5,1-*jk*][1,4]-*benzodiazepin*-2 (1*H*)-one or thione (TIBO) skeleton, and as described in 1990, they were the most specific and potent inhibitors of HIV replication ever reported [4]. The strategy used was to find new anti-HIV compounds with acceptable pharmacology starting from a selection of 600 molecules, all prototypes of different chemical series, which were without effect in standard pharmacological assays [4]. The original prototypes selected were the TIBOs R82150 (Figure 15.1) [4] and R82913 (7-chloro-TIBO) (Figure 15.1) [4]. As a clinical drug candidate, the 8-chloro-TIBO R86183 (Figure 15.1) was selected. Despite the multitude of TIBO derivatives that were synthesized and found active against HIV-1 [5, 6], the TIBO lead was eventually abandoned for clinical development for a number of reasons, the most important being the laborious chemical synthesis of the TIBO scaffold (10 steps).

Yet, the TIBO derivatives allowed to uncover a new noncatalytic (allosteric) binding at the HIV-1 reverse transcriptase (RT) (Figure 15.2) [7, 8] that could be targeted by specific HIV-1 inhibitors, and this binding site, originally called “TIBO” binding site, appeared to be the binding site for all the specific HIV-1 RT inhibitors that would be described either concomitantly with the TIBO derivatives, that is, 1-(2-hydroxyethoxymethyl)-6-(phenylthio)thymine (HEPT), or shortly thereafter [dipyridodiazepinones (i.e., nevirapine), pyridinones, bis (heteroaryl)piperazines (i.e., delavirdine), benzoxazinones (i.e., efavirenz), thiocarboxanilides, quinoxalines, thiazolobenzimidazoles, loviride, trovirdine, capravirine] and which are now commonly referred to as the nonnucleoside RT inhibitors (NNRTIs) [9–14].

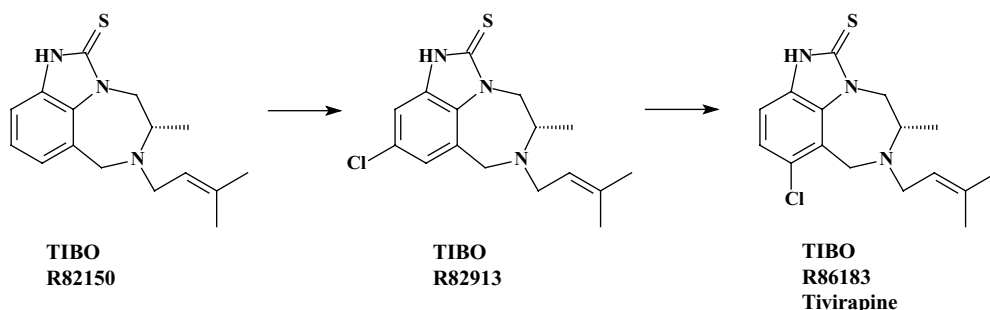

**Figure 15.1** TIBO derivatives R82150, R82913, and R86183.

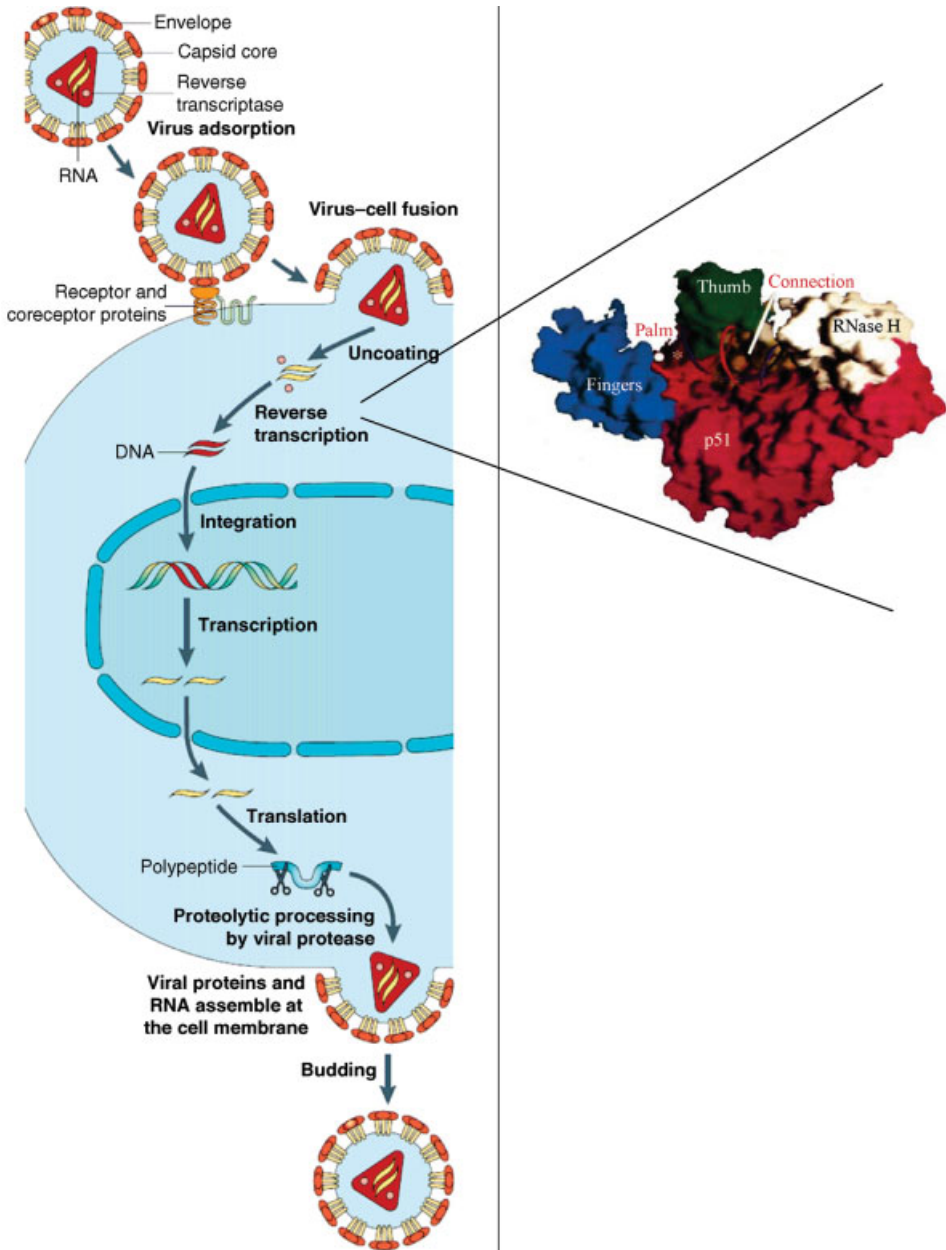

**Figure 15.2** Role of the reverse transcriptase (RT) [8] in the replication cycle of HIV (originally termed HTLV-III/LAV) [7] and the binding site of the NNRTIs (originally called “TIBO” binding site). The catalytic site of the RT (*insert*) is

indicated by a dot (site of interaction for the NRTIs and NNRTIs). The allosteric site for the binding of the NNRTIs is indicated by the asterisk.



### 15.3 From Loviride to Rilpivirine

Independent of the TIBO “lead,” but also resulting from, what I would call, a rational evaluation of the Janssen Library of compounds, we described in 1993 the potent and highly selective anti-HIV-1 activity of the  $\alpha$ -anilinophenylacetamide derivatives (prototype: loviride (R89439)) [15]. These compounds, like the TIBO derivatives, also appeared to be targeted at HIV-1 reverse transcriptase and inhibited HIV-1 replication *in vitro* at nanomolar concentrations 10 000–100 000-fold lower than their cytotoxic concentration. In addition, R89439 (Figure 15.3) had good oral bioavailability and favorable pharmacokinetics and could be easily synthesized on a large scale at reasonable costs. It should be recognized, however, that R89439 has a chiral

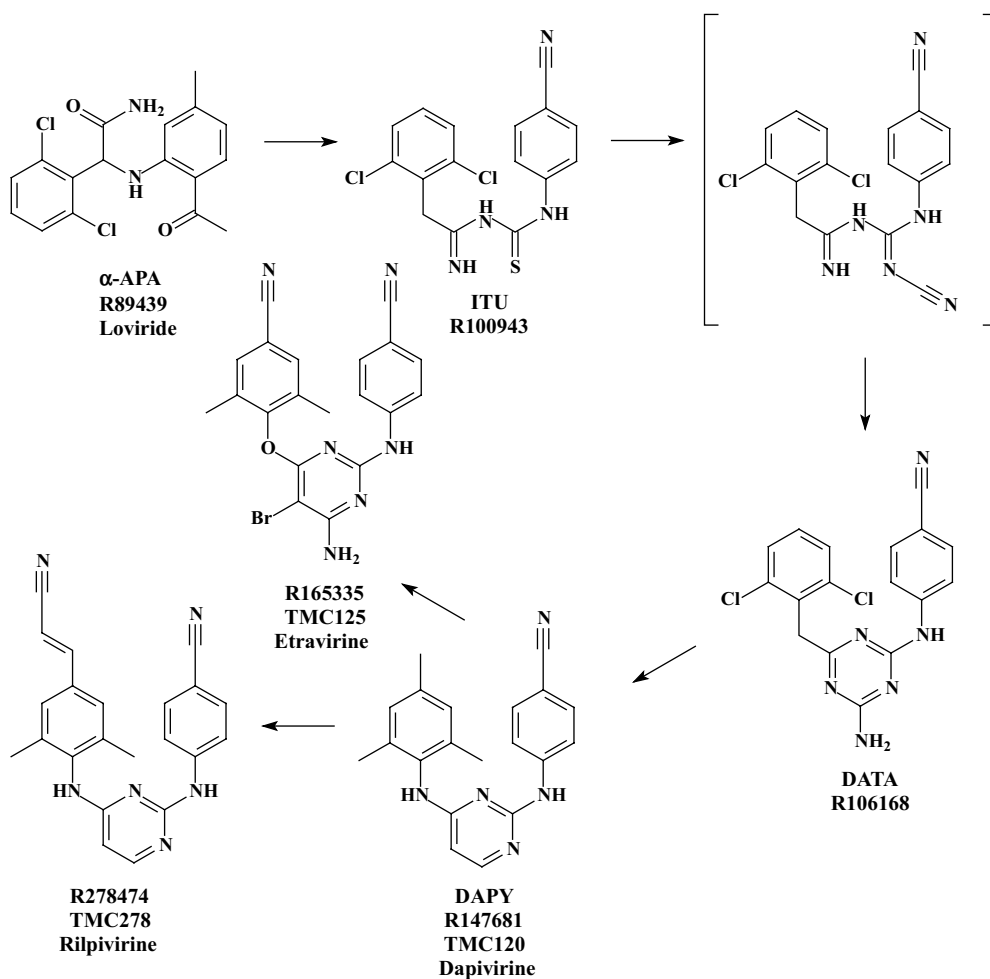

**Figure 15.3** From  $\alpha$ -APA, via ITU, DATA, and DAPY, to etravirine and rilpivirine.

center, and thus occurs as a racemic mixture of two isomeric forms. Officially, the development of loviride was discontinued when it became apparent that it was not going to offer any significant advantage over the NNRTI therapies that had been approved in the mean time. Thus, a new class of compounds was generated, that of the ITU (imidoylthiourea) analogues [16] (Figure 15.3).

In an attempt to synthesize the corresponding imino-*N*-cyanoguanidine derivatives of ITU analogues, an unexpected ring closure occurred (Figure 15.3), producing R106168, the first compound of the DATA (diaryltriazine) class of NNRTIs [17]. Replacement of the central aminotriazine ring of DATA with a pyrimidine ring led to the class of DAPY (diarylpyrimidine) NNRTIs, with TMC120 (R147681) as the prototype [18] (Figure 15.3). TMC120 is being pursued for its microbicidal potential (as a topical (i.e., vaginal) microbicide for the prevention of HIV infections).

Further chemical modifications of the DAPY analogues led to TMC125 (R165335) (Figure 15.3), which has been announced as a novel next-generation NNRTI active against NNRTI-resistant HIV-1 strains [19] and which since January 18, 2008 has been officially approved for the treatment of HIV-1 infections. Starting from TMC120 (Figure 15.3), rilpivirine (R278474, TMC278) was also derived (Figure 15.3). In the paper authored by the late Paul Janssen as the first author [20], which appeared more than 1 year after his death, it was stated that R278474 meets the criteria of an ideal anti-HIV drug: “Such a compound should be highly active against wild-type and mutant HIV without allowing breakthrough; the compound should have high oral bioavailability and long elimination half-life, allowing once-daily oral treatment at low doses; it should have minimal adverse effects and be easy to synthesize and formulate” [20]. These bold predictions, made more than 5 years ago, have been largely borne out.

## 15.4

### Rilpivirine: How Does It Act?

Akin to other NNRTIs, including TIBO R86183, rilpivirine (Figure 15.4) [21] may be expected to assume a butterfly-like shape and bind to the NNRTI binding site in a very similar way as many other NNRTIs [22]. Conformational flexibility (“wiggling” and “jiggling”) has been considered as critical for the NNRTIs such as rilpivirine to retain activity against rapidly mutating viruses [23]. The interaction of rilpivirine with HIV-1 RT has been resolved at 1.8 Å resolution [24, 25]. Strategic flexibility of the compound with its target site may explain its potency against resistance mutations [24, 25]. How TMC278 may interact with the NNRTI binding pocket is shown in Figure 15.5. Similar flexibility as for rilpivirine has also been noted with other NNRTIs such as the 1-(2,6-difluorobenzyl)-2-(2,6-difluorophenyl)benzimidazoles (BPBIs) [26, 27].

New NNRTIs such as rilpivirine have enabled crystal engineering of HIV-1 reverse transcriptase with X-ray diffraction to a resolution of 1.8 Å [28]. Cluster analysis of these crystal structures has helped delineating the conformational landscape of the NNRTI binding pocket within the HIV-1 reverse transcriptase [29]. The amphiphilic behavior of rilpivirine at low pH and its intrinsic flexibility may facilitate drug

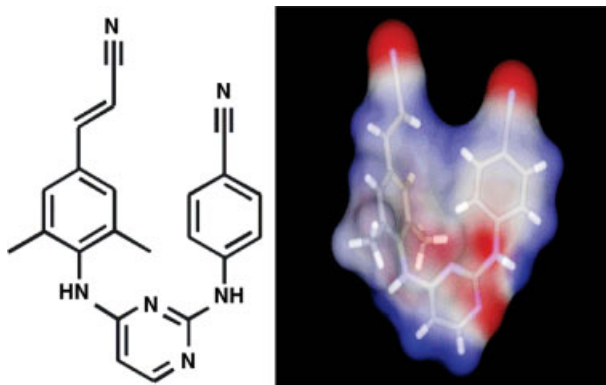

**Figure 15.4** Chemical structures and three-dimensional model of TMC278 or 4-[[4-[(*E*)-2-cyanoethenyl]-2,6-dimethylphenyl]amino]-2-pyrimidinyl]amino]benzonitrile. Red represents

CN groups or the nitrogen of both the pyrimidine and the aniline (highest density of charge in the structure), and blue represents the aromatic group (no charge) [21].

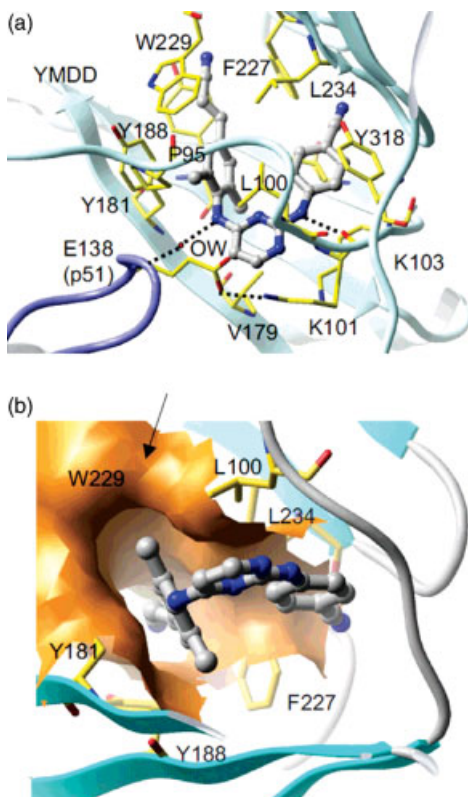

**Figure 15.5** Binding mode of TMC278 to HIV-1 RT. (a) Interactions of TMC278 (gray) with NNRTI binding pocket residues (in yellow). (b) The molecular surface (orange) defines the hydrophobic tunnel that accommodates the cyanovinyl group of TMC278 [25].

aggregation to spherical nanoparticles (100–120 nm in diameter) (at low pH) and favor the oral bioavailability [30].

Further SAR (structure–activity relationship) studies have indicated that in rilpivirine (TMC278) (Figure 15.4), the methyl groups could be efficiently replaced by other functionalities (i.e., methoxy or chlorine groups) without any loss of activity [31]. Formulation studies have been carried out with TMC278: these studies have pointed to the stability of the compound [32], its compatibility, in tablet form, with other anti-HIV agents such as lamivudine and zidovudine [33], and its suitability for development as a long-acting injectable formulation with nanoparticles (200 nm) (resulting after subcutaneous injection of 5 mg/kg in stable plasma levels (constant at 25 ng/ml for 20 days, in dogs)) [34].

## 15.5

### Clinical Proof of Concept

In antiretroviral-naïve HIV-1-infected patients, rilpivirine at doses ranging from 25 ng to 150 mg once daily for 7 days was originally shown to cause a median change from baseline in plasma viral load of  $-1.20 \log_{10}$  copies/ml on day 8 for the combined TMC278 groups [35]. In HIV-1-infected patients who had previously failed antiretroviral therapy, treatment once daily for 7 days with TMC278 at doses of 25, 50, or 150 mg achieved on day 8 changes in plasma viral load of  $-0.87$ ,  $-0.95$ , and  $-0.66 \log_{10}$  copies/ml, respectively [36]. Thus, once-daily TMC278 showed significant antiviral activity against HIV-1 in treatment-experienced patients with NNRTI failure and/or resistance, and was generally considered safe and well tolerated [36].

Data from Pozniak, cited by van Roey *et al.* [37], stemming from a 48-week phase II clinical trial indicated noninferiority of rilpivirine to efavirenz even at the lowest dose of 25 mg. From a safety perspective, rilpivirine was found to have less central nervous system side effects and a better lipid profile than efavirenz. This phase II clinical trial was then extended to 96 weeks, and it was found that once-daily rilpivirine at all doses (25, 75, or 150 mg) had potent and sustained efficacy comparable to efavirenz in treatment-naïve patients over 96 weeks [38]. Rilpivirine was well tolerated with lower incidences of neurological and psychiatric adverse events, rash, and lower lipid elevations than with efavirenz [38].

## 15.6

### Pharmacokinetics and Drug–Drug Interactions

The dose of 25 mg rilpivirine once daily has now been taken forward to phase III clinical trials [39]. Rilpivirine should have a mean terminal half-life between 34 and 55 h [40]. Rilpivirine is a substrate and inducer of CYP3A, and, therefore, it may be expected to engage in drug–drug interactions. However, clinically relevant effects on CYP3A are not considered likely at a daily dose of 25 mg [41]. At 150 mg once daily, while rilpivirine has been shown to increase tenofovir exposure (300 mg once

daily) [42], tenofovir has been shown to have no effect on rilpivirine pharmacokinetics in healthy volunteers [42]. A recent study examined the potential interaction between rilpivirine (75 mg once daily) and sildenafil (50 mg single dose); it showed that neither drug had a significant effect on the other and could be coadministered without dose adjustment [43]. Other drug–drug interaction studies with rilpivirine are ongoing [39].

## 15.7

### Potency and Resilience to NNRTI Resistance

Compared to its direct competitors nevirapine, efavirenz, and etravirine (delavirdine being no longer used), rilpivirine (TMC278) is clearly the most potent (Figure 15.6) [21]. Sensitivity to TMC278 was not affected by the presence of most single NNRTI resistance-associated mutations (RAMs), including those at RT positions 100, 103, 106, 138, 179, 188, 190, 221, 230, and 236. Sensitivity to TMC278 was observed in 62% of efavirenz-resistant and/or nevirapine-resistant HIV-1 recombinant clinical isolates. While a high level of resistance to efavirenz and nevirapine often occurred with strains containing one NNRTI RAM, most of these strains retained sensitivity to both rilpivirine and etravirine.

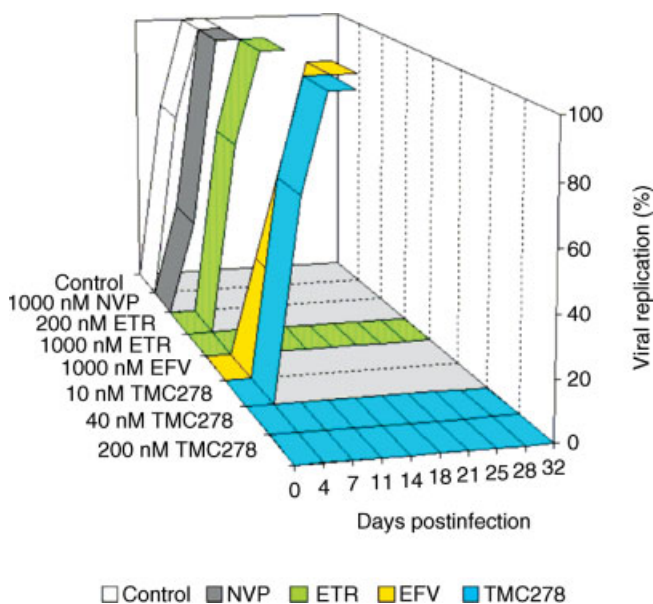

**Figure 15.6** Selection of viruses resistant to TMC278 (rilpivirine), etravirine (ETR), nevirapine (NVP), or efavirenz (EFV) from wild-type HIV-1(III<sub>B</sub>). Time to breakthrough of resistant virus was determined in cell culture,

over a 32-day period, under selective pressure of various concentrations of TMC278, ETR, NVP, or EFV or in the absence of NNRTIs (control) [21].

Resistance to TMC278 is uncommon in NNRTI treatment-experienced patients, as evident from an analysis of over more than 100 000 HIV-1 recombinant clinical isolates received for routine clinical testing [44]: in these analyses, a prevalence of 2.04, 1.05, and 0.63% was found for K101P, Y181I, and Y181V, respectively; that is, three mutations that were associated with resistance to TMC278. Although there might be potential differences in the resistance profiles of rilpivirine and etravirine, rilpivirine clearly has a high genetic barrier to resistance development [21], very much alike etravirine [45].

## 15.8

### Conclusion

Rilpivirine largely fulfills the requirements of an “ideal” anti-HIV drug, as proposed by Paul Janssen and his colleagues in their groundbreaking paper in 2005 [20]. Rilpivirine has been repeatedly appraised in various recent review articles [46–49]. The compound is now in phase III clinical trials for the treatment of therapy-naïve HIV-1-infected subjects at a 25 mg daily dose. At this dosage level, it could be readily combined with tenofovir disoproxil fumarate (300 mg) and emtricitabine (200 mg) in once-daily fixed-dose combination pill that should be half the weight (and volume) of the currently used triple-drug combination pill (Atripla®) containing 600 mg efavirenz.

### Acknowledgment

I thank Mrs. Christiane Callebaut for her proficient editorial assistance.

### References

- 1 Heeres, J. and Lewi, P.J. (2007) The medicinal chemistry of the DATA and DAPY series of HIV-1 non-nucleoside reverse transcriptase inhibitors (NNRTIs). *Advances in Antiviral Drug Design*, **5**, 213–242.
- 2 Pauwels, R., Balzarini, J., Baba, M., Snoeck, R., Schols, D., Herdewijn, P., Desmyter, J., and De Clercq, E. (1988) Rapid and automated tetrazolium-based colorimetric assay for the detection of anti-HIV compounds. *Journal of Virological Methods*, **20**, 309–321.
- 3 Pannecouque, C., Daelemans, D., and De Clercq, E. (2008) Tetrazolium-based colorimetric assay for the detection of HIV replication inhibitors: revisited 20 years later. *Nature Protocols*, **3**, 427–434.
- 4 Pauwels, R., Andries, K., Desmyter, J., Schols, D., Kukla, M.J., Breslin, H.J., Raeymaeckers, A., Van Gelder, J., Woestenborghs, R., Heykants, J., Schellekens, K., Janssen, M.A.C., De Clercq, E., and Janssen, P.A.J. (1990) Potent and selective inhibition of HIV-1 replication *in vitro* by a novel series of TIBO derivatives. *Nature*, **343**, 470–474.
- 5 Kukla, M.J., Breslin, H.J., Pauwels, R., Fedde, C.L., Miranda, M., Scott, M.K., Sherrill, R.G., Raeymaekers, A., Van Gelder, J., Andries, K., Janssen, M.A.C., De Clercq, E., and Janssen, P.A.J. (1991)

- Synthesis and anti-HIV-1 activity of 4,5,6,7-tetrahydro-5-methylimidazo[4,5,1-jk][1,4]benzodiazepin-2(1H)-one (TIBO) derivatives. *Journal of Medicinal Chemistry*, **34**, 746–751.
- 6 Kukla, M.J., Breslin, H.J., Diamond, C.J., Grous, P.P., Ho, C.Y., Miranda, M., Rodgers, J.D., Sherrill, R.G., De Clercq, E., Pauwels, R., Andries, K., Moens, L.J., Janssen, M.A.C., and Janssen, P.A.J. (1991) Synthesis and anti-HIV-1 activity of 4,5,6,7-tetrahydro-5-methyl-imidazo [4,5,1-jk][1,4]benzodiazepin-2(1H)-one (TIBO) derivatives. *Journal of Medicinal Chemistry*, **34**, 3187–3197.
  - 7 De Clercq, E. (2002) Strategies in the design of antiviral drugs. *Nature Reviews. Drug Discovery*, **1**, 13–25.
  - 8 Tantillo, C., Ding, J., Jacobo-Molina, A., Nanni, R.G., Boyer, P.L., Hughes, S.H., Pauwels, R., Andries, K., Janssen, P.A., and Arnold, E. (1994) Locations of anti-AIDS drug binding sites and resistance mutations in the three-dimensional structure of HIV-1 reverse transcriptase. Implications for mechanisms of drug inhibition and resistance. *Journal of Molecular Biology*, **243**, 369–387.
  - 9 Debyser, Z., Pauwels, R., Andries, K., Desmyter, J., Kukla, M., Janssen, P.A., and De Clercq, E. (1991) An antiviral target on reverse transcriptase of human immunodeficiency virus type 1 revealed by tetrahydroimidazo-[4,5,1-jk][1,4]benzodiazepin-2 (1H)-one and -thione derivatives. *Proceedings of the National Academy of Sciences of the United States of America*, **88**, 1451–1455.
  - 10 De Clercq, E. (1993) HIV-1-specific RT inhibitors: highly selective inhibitors of human immunodeficiency virus type 1 that are specifically targeted at the viral reverse transcriptase. *Medicinal Research Reviews*, **13**, 229–258.
  - 11 De Clercq, E. (1996) What can be expected from non-nucleoside reverse transcriptase inhibitors (NNRTIs) in the treatment of human immunodeficiency virus type 1 (HIV-1) infections? *Reviews in Medical Virology*, **6**, 97–117.
  - 12 De Clercq, E. (1998) The role of non-nucleoside reverse transcriptase inhibitors (NNRTIs) in the therapy of HIV-1 infection. *Antiviral Research*, **38**, 153–179.
  - 13 De Clercq, E. (2004) Non-nucleoside reverse transcriptase inhibitors (NNRTIs): past, present, and future. *Chemistry & Biodiversity*, **1**, 44–64.
  - 14 De Clercq, E. (2008) The discovery of antiviral agents: ten different compounds, ten different stories. *Medicinal Research Reviews*, **28**, 929–953.
  - 15 Pauwels, R., Andries, K., Debyser, Z., Van Daele, P., Schols, D., Stoffels, P., De Vreese, K., Woestenborghs, R., Vandamme, A.-M., Janssen, C.G.M., Anné, J., Cauwenbergh, G., Desmyter, J., Heykants, J., Janssen, M.A.C., De Clercq, E., and Janssen, P.A.J. (1993) Potent and highly selective human immunodeficiency virus type 1 (HIV-1) inhibition by a series of  $\alpha$ -anilinophenylacetamide derivatives targeted at HIV-1 reverse transcriptase. *Proceedings of the National Academy of Sciences of the United States of America*, **90**, 1711–1715.
  - 16 Ludovici, D.W., Kukla, M.J., Grous, P.G., Krishnan, S., Andries, K., de Béthune, M.-P., Azijn, H., Pauwels, R., De Clercq, E., Arnold, E., and Janssen, P.A.J. (2001) Evolution of anti-HIV drug candidates. Part 1: from  $\alpha$ -anilinophenylacetamide ( $\alpha$ -APA) to imidothiourea (ITU). *Bioorganic & Medicinal Chemistry Letters*, **11**, 2225–2228.
  - 17 Ludovici, D.W., Kavash, R.W., Kukla, M.J., Ho, C.Y., Ye, H., De Corte, B.L., Andries, K., de Béthune, M.P., Azijn, H., Pauwels, R., Moereels, H.E., Heeres, J., Koymans, L.M., de Jonge, M.R., Van Aken, K.J., Daeyaert, F.F., Lewi, P.J., Das, K., Arnold, E., and Janssen, P.A. (2001) Evolution of anti-HIV drug candidates. Part 2: diarylthiazine (DATA) analogues. *Bioorganic & Medicinal Chemistry Letters*, **11**, 2229–2234.
  - 18 Ludovici, D.W., De Corte, B.L., Kukla, M.J., Ye, H., Ho, C.Y., Lichtenstein, M.A., Kavash, R.W., Andries, K., de Béthune, M.P., Azijn, H., Pauwels, R., Lewi, P.J., Heeres, J., Koymans, L.M., de Jonge, M.R., Van Aken, K.J., Daeyaert, F.F., Das, K., Arnold, E., and Janssen, P.A. (2001) Evolution of anti-HIV drug candidates. Part 3: diarylpyrimidine (DAPY)

- analogues. *Bioorganic & Medicinal Chemistry Letters*, **11**, 2235–2239.
- 19 Andries, K., Azijn, H., Thielemans, T., Ludovici, D., Kukla, M., Heeres, J., Janssen, P., De Corte, B., Vingerhoets, J., Pauwels, R., and de Béthune, M.P. (2004) TMC125, a novel next-generation nonnucleoside reverse transcriptase inhibitor active against nonnucleoside reverse transcriptase inhibitor-resistant human immunodeficiency virus type 1. *Antimicrobial Agents and Chemotherapy*, **48**, 4680–4686.
  - 20 Janssen, P.A., Lewi, P.J., Arnold, E., Daeyaert, F., de Jonge, M., Heeres, J., Koymans, L., Vinkers, M., Guillemont, J., Pasquier, E., Kukla, M., Ludovici, D., Andries, K., de Béthune, M.P., Pauwels, R., Das, K., Clark, A.D., Jr., Frenkel, Y.V., Hughes, S.H., Medaer, B., De Knaep, F., Bohets, H., De Clerck, F., Lampo, A., Williams, P., and Stoffels, P. (2005) In search of a novel anti-HIV drug: multidisciplinary coordination in the discovery of 4-[[4-[[4-[(1E)-2-cyanoethenyl]-2,6-dimethylphenyl]amino]-2-pyrimidinyl]amino]-benzotrile (R278474, rilpivirine). *Journal of Medicinal Chemistry*, **48**, 1901–1909.
  - 21 Azijn, H., Tirry, I., Vingerhoets, J., de Béthune, M.P., Kraus, G., Boven, K., Jochmans, D., Van Craenenbroeck, E., Picchio, G., and Rimsky, L.T. (2010) TMC278, a next-generation NNRTI, active against wild-type and NNRTI-resistant HIV-1. *Antimicrobial Agents and Chemotherapy*, **54**, 718–727.
  - 22 Ding, J., Das, K., Moereels, H., Koymans, L., Andries, K., Janssen, P.A., Hughes, S.H., and Arnold, E. (1995) Structure of HIV-1 RT/TIBO R 86183 complex reveals similarity in the binding of diverse nonnucleoside inhibitors. *Nature Structural Biology*, **2**, 407–415.
  - 23 Das, K., Lewi, P.J., Hughes, S.H., and Arnold, E. (2005) Crystallography and the design of anti-AIDS drugs: conformational flexibility and positional adaptability are important in the design of non-nucleoside HIV-1 reverse transcriptase inhibitors. *Progress in Biophysics & Molecular Biology*, **88**, 209–231.
  - 24 Fang, C., Bauman, J.D., Das, K., Remorino, A., Arnold, E., and Hochstrasser, R.M. (2008) Two-dimensional infrared spectra reveal relaxation of the nonnucleoside inhibitor TMC278 complexed with HIV-1 reverse transcriptase. *Proceedings of the National Academy of Sciences of the United States of America*, **105**, 1472–1477.
  - 25 Das, K., Bauman, J.D., Clark, A.D., Jr., Frenkel, Y.V., Lewi, P.J., Shatkin, A.J., Hughes, S.H., and Arnold, E. (2008) High-resolution structures of HIV-1 reverse transcriptase/TMC278 complexes: strategic flexibility explains potency against resistance mutations. *Proceedings of the National Academy of Sciences of the United States of America*, **105**, 1466–1471.
  - 26 Roth, T., Morningstar, M.L., Boyer, P.L., Hughes, S.H., Buckheit, R.W., Jr., and Michejda, C.J. (1997) Synthesis and biological activity of novel nonnucleoside inhibitors of HIV-1 reverse transcriptase. 2-Aryl-substituted benzimidazoles. *Journal of Medicinal Chemistry*, **40**, 4199–4207.
  - 27 Morningstar, M.L., Roth, T., Farnsworth, D.W., Smith, M.K., Watson, K., Buckheit, R.W., Jr., Das, K., Zhang, W., Arnold, E., Julias, J.G., Hughes, S.H., and Michejda, C.J. (2007) Synthesis, biological activity, and crystal structure of potent nonnucleoside inhibitors of HIV-1 reverse transcriptase that retain activity against mutant forms of the enzyme. *Journal of Medicinal Chemistry*, **50**, 4003–4015.
  - 28 Bauman, J.D., Das, K., Ho, W.C., Baweja, M., Himmel, D.M., Clark, A.D., Jr., Oren, D.A., Boyer, P.L., Hughes, S.H., Shatkin, A.J., and Arnold, E. (2008) Crystal engineering of HIV-1 reverse transcriptase for structure-based drug design. *Nucleic Acids Research*, **36**, 5083–5092.
  - 29 Paris, K.A., Haq, O., Felts, A.K., Das, K., Arnold, E., and Levy, R.M. (2009) Conformational landscape of the human immunodeficiency virus type 1 reverse transcriptase non-nucleoside inhibitor binding pocket: lessons for inhibitor design from a cluster analysis of many crystal structures. *Journal of Medicinal Chemistry*, **52**, 6413–6420.



- 30 Frenkel, YV., Gallicchio, E., Das, K., Levy, RM., and Arnold, E. (2009) Molecular dynamics study of non-nucleoside reverse transcriptase inhibitor 4-[[4-[(E)-2-cyanoethenyl]-2,6-dimethylphenyl]amino]-2-pyrimidinyl]amino]benzotrile (TMC278/rilpivirine) aggregates: correlation between amphiphilic properties of the drug and oral bioavailability. *Journal of Medicinal Chemistry*, **52**, 5896–5905.
- 31 Mordant, C., Schmitt, B., Pasquier, E., Demestre, C., Queguiner, L., Masungi, C., Peeters, A., Smeulders, L., Bettens, E., Hertogs, K., Heeres, J., Lewi, P., and Guillemont, J. (2007) Synthesis of novel diarylpyrimidine analogues of TMC278 and their antiviral activity against HIV-1 wild-type and mutant strains. *European Journal of Medicinal Chemistry*, **42**, 567–579.
- 32 Van Gyseghem, E., Pendela, M., Baert, L., Rosier, J., Van't Klooster, G., De Man, H., Bouche, M.P., Schueller, L., Van Remoortere, P., Wigerinck, P., Adams, E., Hoogmartens, J., and Van den Mooter, G. (2008) Powder for reconstitution of the anti-HIV-1 drug TMC278: formulation development, stability and animal studies. *The European Journal of Pharmaceutics and Biopharmaceutics*, **70**, 853–860.
- 33 Pendela, M., Van Gyseghem, E., Van den Mooter, G., Baert, L., Rosier, J., Hoogmartens, J., and Adams, E. (2009) Development of a liquid chromatographic assay for an anti-HIV tablet containing lamivudine, zidovudine and TMC278.HCL. *Journal of Pharmaceutical and Biomedical Analysis*, **49**, 508–512.
- 34 Baert, L., van't Klooster, G., Dries, W., François, M., Wouters, A., Basstanie, E., Itebeke, K., Stappers, F., Stevens, P., Schueller, L., Van Remoortere, P., Kraus, G., Wigerinck, P., and Rosier, J. (2009) Development of a long-acting injectable formulation with nanoparticles of rilpivirine (TMC278) for HIV treatment. *European Journal of Pharmaceutics and Biopharmaceutics*, **72**, 502–508.
- 35 Goebel, F., Yakovlev, A., Pozniak, A.L., Vinogradova, E., Boogaerts, G., Hoetelmans, R., de Béthune, M.P., Peeters, M., and Woodfall, B. (2006) Short-term antiviral activity of TMC278 – a novel NNRTI – in treatment-naive HIV-1-infected subjects. *AIDS (London, England)*, **20**, 1721–1726.
- 36 Arastéh, K., Rieger, A., Yeni, P., Pozniak, A., Boogaerts, G., van Heeswijk, R., de Béthune, M.P., Peeters, M., and Woodfall, B. (2009) Short-term randomized proof-of-principle trial of TMC278 in patients with HIV type-1 who have previously failed antiretroviral therapy. *Antiviral Therapy*, **14**, 713–722.
- 37 van Roey, J., von Schoen-Angerer, T., Ford, N., and Calmy, A. (2008) How developing world concerns need to be part of drug development plans: a case study of four emerging antiretrovirals. *Drug Discovery Today*, **13**, 601–605.
- 38 Pozniak, A.L., Morales-Ramirez, J., Katabira, E., Steyn, D., Lupo, S.H., Santoscoy, M., Grinsztejn, B., Ruxrungtham, K., Rimsky, L.T., Vanveggel, S., Boven, K. and TMC278-C204 Study Group (2010) Efficacy and safety of TMC278 in antiretroviral-naive HIV-1 patients: week 96 results of a phase IIb randomized trial. *AIDS (London, England)*, **24**, 55–65.
- 39 Dickinson, L., Khoo, S., and Back, D. (2010) Pharmacokinetics and drug–drug interactions of antiretrovirals: an update. *Antiviral Research*, **85**, 176–189.
- 40 de Béthune, M.P., Andries, K., Azijn, H., Guillemont, J., Heeres, J., Vingerhoets, J., Lewi, P., Lee, E., Timmerman, P., and Williams, P. (2005) TMC278, a new potent NNRTI, with an increased barrier to resistance and favourable pharmacokinetic profile. 12th Conference on Retroviruses and Opportunistic Infections (CROI), Boston, MA, USA, Abstract 556.
- 41 Crauwels, H.M., van Heeswijk, R.P.G., Stevens, T., Stevens, M., Buelens, A., Boven, K., and Hoetelmans, R.M.W. (2009) The effect of TMC278, a next generation NNRTI, on CYP3A activity *in vivo*. 10th International Workshop on Clinical Pharmacology of HIV Therapy, Amsterdam, The Netherlands, Abstract P28.
- 42 Hoetelmans, R., Kestens, D., Stevens, M., Peeters, M., Williams, P., Bastiaanse, L., Buffels, R., and Woodfall, B. (2005) Pharmacokinetic interaction between the

- novel non-nucleoside reverse transcriptase inhibitor (NNRTI) TMC278 and tenofovir disoproxil fumarate (TDF) in healthy volunteers. 3rd International AIDS Society Conference on HIV Pathogenesis and Treatment, Rio de Janeiro, Brazil, Abstract WePe3.3C15.
- 43 Crauwels, H.M., van Heeswijk, R.P.G., Stevens, M., Buelens, A., Boven, K., and Hoetelmans, R. (2009) TMC278, a next-generation NNRTI, does not alter the pharmacokinetics of sildenafil. 10th International Workshop on Clinical Pharmacology of HIV Therapy, Amsterdam, The Netherlands, Abstract P22.
- 44 Tambuyzer, L., Azijn, H., Rimsky, L.T., Vingerhoets, J., Lecocq, P., Kraus, G., Picchio, G., and de Béthune, M.P. (2009) Compilation and prevalence of mutations associated with resistance to non-nucleoside reverse transcriptase inhibitors. *Antiviral Therapy*, **14**, 103–109.
- 45 Vingerhoets, J., Azijn, H., Fransen, E., De Baere, I., Smeulders, L., Jochmans, D., Andries, K., Pauwels, R., and de Béthune, M.P. (2005) TMC125 displays a high genetic barrier to the development of resistance: evidence from *in vitro* selection experiments. *Journal of Virology*, **79**, 12773–12782.
- 46 Sweeney, Z.K. and Klumpp, K. (2008) Improving non-nucleoside reverse transcriptase inhibitors for first-line treatment of HIV infection: the development pipeline and recent clinical data. *Current Opinion in Drug Discovery & Development*, **11**, 458–470.
- 47 Ripamonti, D. and Maggiolo, F. (2008) Rilpivirine, a non-nucleoside reverse transcriptase inhibitor for the treatment of HIV infection. *Current Opinion in Investigational Drugs*, **9**, 899–912.
- 48 Fulco, P.P. and McNicholl, I.R. (2009) Etravirine and rilpivirine: nonnucleoside reverse transcriptase inhibitors with activity against human immunodeficiency virus type 1 strains resistant to previous nonnucleoside agents. *Pharmacotherapy*, **29**, 281–294.
- 49 Garvey, L. and Winston, A. (2009) Rilpivirine: a novel non-nucleoside reverse transcriptase inhibitor. *Expert Opinion on Investigational Drugs*, **18**, 1035–1041.

## Dedication

I am gratified to dedicate this paper (chapter 15) and, in fact, the whole book, to Dr. Paul A. J. Janssen, who has remained the personification of low drug strategies, whether antiviral, anti-HIV, or other, should contribute to human health and welfare.



## Index

### a

- ABT-667, chemical structure 367
- ABT-675 366–367
- inhibitor potency and oral bioavailability 367
- acquired immunodeficiency syndrome (AIDS)
- HIV as causative agent 51–52
  - manageable chronic disease 73
  - RNAi gene therapy 338–339
- acute respiratory syncytial virus infection 337
- ACV *see* acyclovir
- acyclic nucleoside phosphonates (ANPs) 231
- antiviral activity spectrum 96
  - antiviral drugs 95
  - human cytomegalovirus DNA polymerase inhibitor 244
  - main classes 95–99
- acyclic nucleoside phosphonates, oral prodrugs 189–198
- acyclovir (ACV) 229
- mechanism of action 232
- adamantanamine-based M2 ion channel protein inhibitors, influenza treatment 352–353
- adefovir *see also* acyclic nucleoside phosphonates
- acyclic nucleoside phosphonates 95–97
  - hepatitis B virus and HIV 11, 97–99
- adefovir derivative, as prodrug of nucleoside phosphonates 197–198
- adefovir dipivoxil, clinical application of nucleoside phosphonate 112–113
- adenovirus
- acyclic nucleoside phosphonates 95–96, 191, 193, 195
  - antiviral drugs 13
- AIDS *see* acquired immunodeficiency syndrome
- alkoxyalkyl ester of nucleoside 5'-monophosphates, prodrugs 185–189
- alkoxyalkyl ester prodrugs
- of nucleoside phosphates 185–189
  - of nucleoside phosphonates 181–185
  - of phosphonoformate 185
- alkoxyalkyl esters
- of (*S*)-HPMPA 191–196
  - of tenofovir (HDP-(*R*)-PMPA) 196–197
- alkylglycerol prodrugs, of phosphonoformate 185
- alphaherpesviruses *see* herpes simplex virus; varicella zoster virus
- amantadine, influenza treatment 352–353
- ambiguous base pairing, 5-aza-5,6-dihydro-2'-deoxycytidine 292–293
- 2-amino-7-[(1,3-dihydroxy-2-propoxy)methyl]purine (S2242), human cytomegalovirus DNA polymerase inhibitor 238–239
- amphipathic DNA polymers, human cytomegalovirus entry inhibitor 237
- amprenavir
- brand name and manufacturer 5
  - chemical structure 76
  - comparison to darunavir 85–86
  - discovery 3, 77–78
  - HIV protease inhibitor 80
  - *in vitro* resistance selection experiment 83–85
- amprenavir monophosphate (fosamprenavir), amprenavir replacement 78
- ANPs *see* acyclic nucleoside phosphonates
- antagonists
- CCR5 38–40
  - CXCR4 40–41
- anti-cytomegalovirus agents *see also* anti-human cytomegalovirus compounds
- maribavir 209–221

- overview 209–210
  - anti-HIV drugs
    - lethal mutagenesis 283–284
    - resistance 283, 295–296
  - anti-HIV evaluation 377
  - anti-human cytomegalovirus
    - compounds 227–265
    - novel viral targets 235–260
  - anti-human cytomegalovirus drugs
    - classes 229–231
    - clinical use 229–234
    - need for new drugs 234–235
    - prophylaxis and treatment 229
    - resistance 233–234
    - toxicity 231–233
  - anti-influenza agents, neuraminidase inhibitors 351–370
  - anti-influenza drugs 352
  - antiretroviral therapy, HIV 29, 52
    - see also* highly active antiretroviral therapy
  - antisense nucleotide, formivirsen 230
  - antiviral activities
    - benzimidazoles 1
    - darunavir 81, 85–86
    - iododeoxyuridine 1
    - ribavirin 2 (*see also* ribavirin)
    - thiosemicarbazones 1
  - antiviral activity spectrum, of acyclic nucleoside phosphonates 96
  - antiviral compounds, oral activity 182–184
  - antiviral drug discoveries, milestones 3
  - antiviral drug era, overview and key events 1–4
  - antiviral drugs
    - against DNA viruses 13
    - against hepatitis B virus 12
    - against herpesviruses 4–8
    - against retroviruses (HIV) 8–12
    - alternatives 19
    - brand names 5–6
    - first 1 (*see also* iododeoxyuridine)
    - for hepatitis C virus 15–17
    - for influenza A virus infections 14–15
    - for poxviruses 17–18
    - manufacturers 5–6
    - milestones of discoveries 3
    - resistance to (*see* drug-resistant mutations)
  - antiviral RNAi, virus silencing 329–339
  - artemisinin 258
  - artesunate, human cytomegalovirus inhibitors 258, 260
  - 2-aryl-2-hydroxyethylamine substituted
    - 4-oxo-4,7-dihydrothieno[2,3-b]pyridines, human cytomegalovirus DNA polymerase inhibitor 240
  - arylsulfone derivatives, human cytomegalovirus inhibitors 257–259
  - 5-azacytidine (5AZC)
    - mechanism of action 291
    - mutagenic HIV pharmaceutical 291–292
  - 5-aza-5,6-dihydro-2'-deoxycytidine (KP-1212)
    - development 292–294
    - mechanism of action 292
    - mitochondrial toxicity 293
  - AZT *see also* zidovudine
    - brand name and manufacturer 5
    - chemical structure 9
    - enhancement of prodrugs 185
- b**
- BAY 38-4766 *see* phenylenediamine sulphonamides
  - BCX-1812 *see* peramivir
  - BDCRB *see* 2-bromo-5,6-dichloro-1-(β-D-ribofuranosyl)benzimidazole
  - benzimidavir, benzimidazole ribosides *see* maribavir
  - benzimidazole compounds, anti-cytomegalovirus activity 210
  - benzimidazole ribonucleoside, maribavir 209–221
  - benzimidazole ribosides, human cytomegalovirus replication inhibitors 250–252
  - benzimidazoles, antiviral activity 1
  - 4'-benzoyl-ureido-TSAO derivatives, human cytomegalovirus inhibitors 258–259
  - 1-benzylloxycarbonylazetidines 250
  - berberine chloride, human cytomegalovirus inhibitors 257–259
  - bioavailability, oral 107–111
  - bioisosteres
    - cyclic nucleoside phosphonates 99–101
    - nucleoside phosphonates 92
  - biological weapon, smallpox (variola virus) 17, 189
  - boceprevir 320–321
    - binding to NS3 protease variants 316–318
  - brand names, antiviral drugs 5–6
  - (2-bromo-5,6-dichloro-1-(β-D-pyranosyl)benzimidazole) (GW275175X), cytomegalovirus inhibitor 210

- 2-bromo-5,6-dichloro-1- $\beta$ -D-ribofuranosyl  
benzimidazole (BDCRB), human  
cytomegalovirus replication  
inhibitors 210, 252
- C**
- caliciviridae, targeted by RNAi 333
- carbocyclic nucleoside phosphonates, cyclic  
nucleoside phosphonates 105
- CCR5 antagonists
- HIV entry 38–40
  - resistance to 39–40
- CDK *see* cyclin-dependent kinase
- CDV *see* cidofovir
- chain terminators *see also* delayed chain  
terminators
- blocking of viral replication 94
  - 2-C-methylsubstituted ribonucleosides  
4, 15
  - 2',3'-dideoxynucleoside analogues 9
  - entecavir 12
  - obligatory and delayed 94
  - RNA 105
- chemokine receptors agonist, human  
cytomegalovirus-encoded receptors  
256–258
- chemotherapy era, antiviral 1
- 2-chloro-3-pyridin-3-yl-5,6,7,8-  
tetrahydroindolizine-1-carboxamide  
(CMV423), human cytomegalovirus  
inhibitors 258
- 8-chloro-TIBO (R86183) 378
- cHPMP-5-azaC *see* cyclo-1-(3-hydroxy-2-  
phosphonylmethoxypropyl)-5-aza-  
cytosine (cHPMP-5-azaC)
- chronic hepatitis C 307
- cidofovir (CDV) 229–230
- alkoxyalkyl ester derivatives 244
  - anti-cytomegalovirus agent 209
  - broad-spectrum activity 231
  - clinical application of nucleoside  
phosphonate 112
  - Epstein–Barr virus 190
  - human cytomegalovirus retinitis 231
  - mechanism of action 231–232
  - molluscivirus 112
  - other double-stranded DNA viruses  
190–191
  - papillomavirus 112
  - poxviruses 189–190
  - toxicity 233
- ciluprevir, hepatitis C virus 4
- clinical applications, nucleoside  
phosphonates 111–115
- clinical development
- cyclophilin inhibitors 148, 149
  - darunavir 86–87
- clinical results in hepatitis C virus,  
cyclophilins 159–167
- 2-C-methylsubstituted ribonucleosides, chain  
terminators 4, 15
- CMV *see* cytomegalovirus
- CMV423 *see* 2-chloro-3-pyridin-3-yl-5,6,7,8-  
tetrahydroindolizine-1-carboxamide
- CNPs *see* cyclic nucleoside phosphonates
- combination drug strategy, prevention of drug  
resistance 19–20
- congenital cytomegalovirus *see* human  
cytomegalovirus
- congenital human cytomegalovirus  
infection 228–229
- coreceptors, virus tropism and infectivity  
33
- coronaviridae, targeted by RNAi 333
- covalent linear hepatitis C virus protease  
inhibitors
- chemical structures 311
  - enzyme-inhibitor interaction kinetics 311
  - log octanol/water partition coefficient 311
  - mechanism of action 310
  - molecular weights 311
  - pattern of resistance 316–318
  - polar surface area 311
- covalent linear protease inhibitors,  
resistance 316–318
- cowpox
- acyclic nucleoside phosphonates 190–194
  - antiviral drugs 17–18
- COX-2 *see* cyclooxygenase-2
- CS-8958 *see* laninamivir
- CsA *see* cyclosporin A
- CXCR4 antagonists, HIV entry 40–41
- cyclic nucleoside phosphonates (CNPs)
- antiviral drugs 99
  - examples of targeting viral RNA  
polymerases 104–107
  - main classes 100–104
  - oral prodrugs 189–198
- cyclin-dependent kinase (CDK) 261
- cyclin-dependent kinases inhibitors, human  
cytomegalovirus 261–262
- cyclo-1-(3-hydroxy-2-  
phosphonylmethoxypropyl)-5-aza-cytosine  
(cHPMP-5-azaC), human cytomegalovirus  
DNA polymerase inhibitor 241, 245
- cyclooxygenase-2 (COX-2) 263
- cyclooxygenase-2 inhibitors, human  
cytomegalovirus 262–263

- cyclopentane and cyclopentene core
    - phosphonates, cyclic nucleoside phosphonates 103–104
  - cyclophilin inhibitors
    - against HIV-1 151–152
    - currently in clinical development 148, 149
    - generation 168–169
    - new noncyclosporine species 168
  - cyclophilins *see also* cyclosporin A
    - activity against other viruses 167
    - clinical results in hepatitis C virus 159–167
    - hepatitis C virus 155–159
    - HIV treatment 149–155
    - overview 148
  - cyclopropavir, human cytomegalovirus DNA polymerase inhibitor 239–242
  - cyclosporin A, immunosuppression 147
  - cyps *see* cyclophilins
  - cytomegalovirus (CMV) *see also* human cytomegalovirus
    - 2-bromo-5,6-dichloro-1-( $\beta$ -D-ribofuranosyl) benzimidazole (BDCRB) 210
    - chemical classes of inhibitors 210–211
    - diseases 210, 215–220
    - drugs 209–210
    - inhibition of DNA maturation process and encapsidation 210
    - inhibition of DNA polymerase 210
    - inhibition of protein kinase pUL97 211
    - (2,5,6-trichloro-1-( $\beta$ -D-ribofuranosyl) benzimidazole (TCRB) 210
    - unmet challenges 209–210
  - cytomegalovirus retinitis *see also* human cytomegalovirus retinitis
    - AIDS patients 227
    - intraocular delivery 198–201
    - maribavir treatment 214
    - under highly active antiretroviral therapy (HAART) 217
  - Cytovene® *see* ganciclovir
- d**
- DAA drugs *see* direct acting antiviral drugs
  - DANA *see* 2-deoxy-2,3-didehydro-N-acetylneuraminic acid
  - dapivirine (R147681, TMC120) 380
  - DAPY *see* diarylpyrimidine
  - darunavir
    - antiviral activities 81, 85–86
    - brand name and manufacturer 5
    - chemical structure 10, 76
    - clinical development 86–87
    - enfuvirtide 41
    - hydroxyethylene scaffold 11
    - ribbon structure of HIV-1 protease 79
    - synthesis scheme 84
  - DATA *see* diarylthiazine
  - delayed chain terminators *see also* chain terminators
    - blocking of viral replication 94
  - dendrimers, human cytomegalovirus entry inhibitor 235–237
  - dengue virus, antiviral drugs 19
  - 2-deoxy-2,3-didehydro-N-acetylneuraminic acid (DANA)
    - carbocyclic analogues 360–361
    - carbocyclic scaffold 359
    - inhibitor activity 356
  - deoxycytidine analogues
    - 5-aza-5,6-dihydro-2'-deoxycytidine 292
    - 5-Hydroxy-2'-deoxycytidine 290–291
  - deoxyguanosine analogue, ganciclovir 229
  - deoxyribose nucleosides, lethal mutagens 287
  - diarylpyrimidine (DAPY)
    - analogues 381
    - chemical structure 380
  - diarylthiazine (DATA)
    - analogues 381
    - chemical structure 380
  - 5,6-dichloro-1- $\beta$ -D-ribofuranosyl benzimidazole (DRB), influenza virus multiplication 1
  - dideoxyfuranopyrimidines, human cytomegalovirus inhibitors 257–259
  - 2',3'-dideoxynucleoside analogues, chain terminators 9
  - dihydroquinazoliny-acetic acids, human cytomegalovirus replication inhibitors 252
  - diketo acids, HIV integrase inhibitors 4, 12
  - direct acting antiviral (DAA) drugs 319
  - DNA binding inhibitors, HIV 59–60
  - DNA binding molecules, HIV 60
  - DNA cleavage inhibition, human cytomegalovirus 248–252
  - DNA packaging inhibition, human cytomegalovirus 248–252
  - DNA polymerase inhibitors
    - aciclovir 232
    - cidovir 231
    - ganciclovir 229
    - human cytomegalovirus 238–244
    - human cytomegalovirus diseases 232
    - nucleoside analogues 238–242

- nucleotide analogues 244–245
- DNA viruses *see also* adenovirus; Epstein–Barr virus; human herpesvirus type 6; mollusciviruses; papillomavirus; parapoxviruses; polyomavirus; poxviridae
- antiviral drugs 13
- cidofovir 231
- inhibition with nucleoside phosphonates 91
- miRNAs 332
- DRB *see* 5,6-dichloro-1- $\beta$ - ribofuranosyl benzimidazole
- drug design
  - hepatitis C virus protease 310
  - oseltamivir 359–364
  - peramivir 366
  - structure-based (*see* structure-based drug design)
- drug development *see* antiviral drugs
- drug-resistant mutations
  - helicase-primase inhibitors 142
  - hepatitis C virus 158
  - herpes simplex virus 95, 135–141
  - HIV 19, 29, 41, 52, 77, 80, 151, 152
- drugs *see* antiviral drugs

**e**

- EBV *see* Epstein–Barr virus
- elvitegravir
  - chemical structure 10
  - discovery 3
  - HIV integrase inhibitor 4, 12, 55–57, 64
  - integrase strand transfer inhibitor 57
- endocytosis, HIV 33
- enfuvirtide
  - brand name and manufacturer 5
  - chemical structure 35
  - discovery 3
  - HIV treatment 11
  - inhibitors of HIV fusion 41–42
  - interaction with other drugs 152
  - protease inhibitors 41
- entecavir, chain terminators 12
- enterovirus, targeted by RNAi 333
- entry inhibition, human cytomegalovirus 235–238
- Epstein–Barr virus (EBV)
  - acyclic nucleoside phosphonates 191
  - adefovir 97
  - antiviral drugs 13
  - cidofovir 190
- error-prone replication, lethal mutagenesis 286–288

- esterification, of alkoxyalkyl compounds 182–184
- etravirine (R165335, TMC125), development 380
- eye infection 198–201
  - herpes simplex virus 1–2

**f**

- filoviridae, targeted by RNAi 333
- flaviviridae, targeted by RNAi 333
- flaviviruses *see also* hepatitis C virus
  - dengue virus 19
  - west nile virus 15
  - yellow fever 15
- flavopiridol, cyclin-dependent kinases inhibitor 262
- 1-(3-fluoro-2-phosphonylmethoxypropyl) (FPMP) analogues, acyclic nucleoside phosphonates 97–98
- FMDV *see* foot-and-mouth disease virus
- fomivirsen
  - chemical structure 230
  - human cytomegalovirus infection 229
  - mechanism of action 231
- foot-and-mouth disease virus (FMDV), ribavirin 290
- fosamprenavir, amprenavir monophosphate 78
- foscarnet (FOS)
  - chemical structure 230
  - human cytomegalovirus infection 229
  - mechanism of action 231
  - toxicity 233
- foscarnet (PFA), anti-cytomegalovirus agent 209
- Foscavir<sup>®</sup> *see* foscarnet
- FPMP *see* 1-(3-fluoro-2-phosphonylmethoxypropyl)

**g**

- ganciclovir (GCV)
  - anti-cytomegalovirus agent 209
  - chemical structure 230
  - human cytomegalovirus infection 229
  - mechanism of action 229, 232
  - resistance 232–233
  - toxicity 231, 233
- gefinitib 250
- gene expression inhibitors, human cytomegalovirus 248
- gene knockdown, RNA interference 329
- gene silencing, RNA interference 329
- generic names, antiviral drugs 5–6



- genome replication inhibitors, human
    - cytomegalovirus 238–248
  - glycoproteins, HIV *see* HIV-1 glycoproteins
  - gp41, HIV-1 glycoprotein 31–32
  - gp120
    - HIV-1 glycoprotein 30–31
    - inhibition of CD4 interaction 36
  - GPCRs *see* G-protein-coupled receptors
  - G-protein-coupled receptors (GPCRs), human
    - cytomegalovirus 256
  - graft *versus* host disease (GvHD), human
    - cytomegalovirus 228
  - GRID, neuraminidase inhibitor 355–358
  - GS4071
    - C-3 side-chain analogues 362
    - hydroxy, amino, and guanidino analogues 363
    - inhibitor-active site interactions 361–362
    - oral bioavailability 363
  - GS4104 *see also* oseltamivir
    - chemical structure 363
  - G-to-A hypermutations, HIV-1 285
  - guanosine analogues, ribavirin 289
  - GvHD *see* graft *versus* host disease
  - GW1263W94, benzimidazole ribosides *see* maribavir
  - GW275175X *see* (2-bromo-5,6-dichloro-1-( $\beta$ -D-pyranosyl)benzimidazole)
    - proposed mechanism of action 134–135
    - replication of herpes simplex virus 130–131
    - resistance of herpesviruses 135–136, 139–143
    - resistance of herpesviruses (overview) 137
    - varicella zoster virus 130–134
  - hemagglutinin (HA), influenza A viruses 351–352
  - hematopoietic stem cell transplant (HSCT), human cytomegalovirus infection 228
  - hepadnaviridae, targeted by RNAi 333
  - hepatitis B virus (HBV)
    - acyclic nucleoside phosphonates 196
    - antiviral drugs 4, 6, 12, 15–17, 19–20, 109, 186
    - clinical results of cyclophilin inhibitors 159–167
    - coinfection 153
    - cyclophilin inhibitors 155–158, 173
    - esters of (S)-9-(3-hydroxy-2-phosphonomethoxypropyl)-adenine 195
    - genotype 1 162–166
    - genotype 2 156–162
    - genotypes 1-4 173
    - inhibition by nucleoside phosphonates 91, 115
    - inhibition of polymerase 104–107
    - nucleoside phosphonates 2, 92, 95, 97–99, 103, 107–109, 112–115, 193, 196–197
    - nucleosides as antiviral drugs 181–182
    - phosphatidyl-ddC 183
    - protease inhibitors 3
    - replication 148
    - replication inhibition 4
    - tenofovir disoproxil fumarate 11
  - hepatitis C virus (HCV)
    - NS3-4A protease 308
    - ribavirin 288–289
    - therapy 307–316
  - hepatitis C virus genome
    - organization 308
    - translation and polypeptide processing 308
  - hepatitis C virus genotype 1
    - standard of care 307
    - sustained viral response 307
  - hepatitis C virus protease
    - catalytic triad 315
    - covalent linear, noncovalent linear, and noncovalent macrocyclic inhibitors bound to 315
    - point mutations 316–318
    - role of 308–310
  - hepatitis C virus protease inhibitors
    - proposed mechanism of action 134–135
    - replication of herpes simplex virus 130–131
    - resistance of herpesviruses 135–136, 139–143
    - resistance of herpesviruses (overview) 137
    - varicella zoster virus 130–134
- h**
- HA *see* hemagglutinin
  - HAART *see* highly active antiretroviral therapy
  - Hantaan virus, ribavirin 290
  - HBB, poliovirus and other enteroviruses *see* 2-(1-hydroxybenzyl)benzimidazole
  - HBV *see* hepatitis B virus
  - HCV *see* hepatitis C virus
  - HDP-CDV *see* hexadecyloxypropyl-Cidofovir
  - HDP-cidofovir nucleotide analogue prodrug, human cytomegalovirus 241
  - helicase inhibitors, human
    - cytomegalovirus 245–246
  - helicase-primase complex
    - predicted structure 141
    - structure 130
  - helicase-primase inhibitors (HPIs)
    - cell culture and *in vivo* 133
    - cross-resistance 136–139
    - drug-resistant mutations 142
    - frequency of mutation of herpesviruses 139–140
    - helicase-primase complex 141
    - inhibition of herpesvirus DNA 131–132, 134

- antiviral potency 316, 319–321
- classes 310
- clinical efficacy 319–321
- combination therapy 321
- design 310
- development 307–321
- emergence of resistance 316
- enzymatic mechanism of action 316
- future directions 321
- resistance 316–318
- roles 308
- similarities and differences 310–316
- threedimensional binding models 309–310
- hepatitis C virus protease variants 317
- N<sup>4</sup>-heptyloxycarbonyl-5,6-dihydro-5-aza-2'-deoxycytidine (KP-1461), HIV treatment 292–294
- hepsera *see* adefovir dipivoxil
- herpes simplex virus (HSV)
  - alphaherpesviruses 129
  - antiviral drugs 4–8
  - inhibitors (*see* helicase-primase inhibitors)
  - iododeoxyuridine 1
  - latent infection 134
  - resistance 135–142
- herpes simplex virus infection, prophylaxis and treatment 209
- herpesviridae
  - cytomegalovirus 209
  - herpes simplex virus 209
  - protein kinase inhibition 212
  - targeted by RNAi 333
- herpesvirus *see also* Epstein–Barr virus; herpes simplex virus; human herpesvirus type 6; varicella zoster virus
  - antiviral drugs 4–8
  - maturation 248, 256
  - replicative cycle 264
  - resistance 135–142
- 2-(hexadecyloxy)ethyl ester of cHPMP-5-azaC, human cytomegalovirus 241
- hexadecyloxypropyl adefovir, as prodrug of nucleoside phosphonates 197–198
- hexadecyloxypropyl-cidofovir (HDP-CDV)
  - anti-cytomegalovirus agent 209
  - human cytomegalovirus DNA polymerase inhibitor 244
- HHV-5 *see* human herpesvirus 5
- HHV-6 *see* human herpesvirus type 6
- highly active antiretroviral therapy (HAART)
  - combination of drugs 29
  - cytomegalovirus retinitis disease 217
  - HIV-1 integrase 55–57
  - human cytomegalovirus retinitis 227–228
  - protease inhibitors 52, 75, 87
  - treatment of HIV 52
- HIV
  - antiretroviral therapy 52 (*see also* highly active antiretroviral therapy)
  - antiviral drugs 8–12
  - integrase (*see* HIV-1 integrase)
  - lethal mutagenesis 283–297
  - mutagenic 5-Hydroxy-2'-deoxycytidine 290–291
  - mutation rates 285
  - nonsynonymous mutations 286
  - replication cycle 51–52
- HIV-1
  - allosteric site for binding NNRTIs 379
  - cytomegalovirus retinitis disease treatment 214–217
  - G-to-A hypermutations 285
  - lethal mutagenesis 286–288
  - mutagenic 5-Azacytidine 291–292
  - mutagenic 5-Hydroxy-2'-deoxycytidine 291
  - mutagenic deoxyribonucleosides 286–287
  - mutagenic ribonucleosides 286–288
  - mutation rates 285–286
  - RNAi gene therapy 338–339
- HIV DNA binding, inhibition 59–60
- HIV entry
  - inhibition 34–42
  - mechanism 32–33
- HIV fusion, inhibitors 41–42
- HIV-1 glycoproteins
  - structure of gp120 30–31
  - structure of transmembrane gp41 31–32
- HIV IN *see* HIV-1 integrase
- HIV inhibition
  - cyclophilin 151–155
  - DNA binding 59–60
  - integrase (*see* HIV integrase inhibitors)
  - multimerization 60–62
- HIV integrase
  - catalysis 53
  - inhibition (*see* HIV integrase inhibitors)
- HIV-1 integrase (HIV IN)
  - as a target for HAART 55–57
  - cofactor interactions 62–64
  - enzymatic mechanism of the integration reaction 53
  - mechanism of integration 53–54
  - strand transfer reaction 12
  - structural organization 54–55
- HIV integrase inhibitors
  - diketo acid group 4, 12
  - elvitegravir (*see* elvitegravir)
  - first (*see* raltegravir)

- integrase binding 57–59
- integrase cofactor interactions 62–64
- integration step 53–59
- raltegravir 41 (*see also* raltegravir)
- strand transfer 55–57
- HIV integration reaction, enzymatic
  - mechanism 53–59 *see also* HIV integrase inhibitors
- HIV multimerization, inhibition 60–62
- HIV-1 replication, inhibitor 378
- HIV-1 reverse transcriptase
  - fidelity 285
  - mutation rate increasing 286–287
  - role in the replication cycle 379
  - TIBO binding site 378
- HIV protease, as target for AIDS 73–74
- HIV treatment, *N*<sup>4</sup>-heptyloxycarbonyl-5,6-dihydro-5-aza-2'-deoxycytidine 292–294
- HIV treatment drug classes
  - chemokine receptor antagonist 73
  - entry and fusion inhibitor (*see* HIV entry)
  - integrase inhibitors (*see* HIV integrase inhibitors)
  - nonnucleoside reverse transcriptase inhibitors (*see* reverse transcriptase)
  - nucleoside/nucleotide reverse transcriptase inhibitors (*see* nucleoside phosphonates)
  - overview 29, 73
  - protease inhibitors (*see* protease inhibitors)
- host kinases, nucleoside phosphonates 92–94
- host mechanisms, as target for antiviral drugs 147
- HPIs *see* helicase-primase inhibitors
- HPMP *see* (*S*)-1-(3-hydroxy-2-phosphonylmethoxypropyl)
- HPMP-5-azaC *see* (*S*)-1-(3-hydroxy-2-phosphonylmethoxypropyl)-5-aza-cytosine
- HPMPA *see* (*S*)-9-(3-hydroxy-2-phosphonomethoxypropyl)-adenine
- HPMPC *see* (*S*)-1-(3-hydroxy-2-phosphonylmethoxypropyl)cytosine
- HSCT *see* hematopoietic stem cell transplant
- HSV *see* herpes simplex virus
- HTLV-III/LAV 377 *see also* HIV-1
- human cytomegalovirus (HCMV) *see also* cytomegalovirus
  - antiviral drugs 229–234
  - cellular targets inhibitors 260–265
  - chemokine receptors agonist 256–258
  - cyclin-dependent kinases inhibitors 261–262
  - cyclooxygenase 2 inhibitors 262–263
  - diseases 227–229
  - DNA polymerase 246
  - DNA polymerase inhibitors 238–245
  - DNA replication 247–248
  - gene expression inhibitors 248
  - infection prophylaxis after transplantation 228–229
  - infections (*see* specific infections)
  - inhibitors of viral genome replication 238–248
  - inhibitors of virion assembly and egress 248–256
  - inhibitors with a mechanism of action not fully unraveled 258–260
  - manifestation of infection 227–228
  - new inhibitors 256–258
  - novel drug targets and strategies 264
  - novel viral targets 235–260
  - protease inhibitors 250, 256
  - proteasome inhibitors 263–265
  - protein kinase pUL97 229–230, 253
  - replication inhibition 238–248
  - viral entry inhibitors 235–238
  - viral genome replication inhibitors 238–248
  - virion assembly and egress 248–256
- human cytomegalovirus retinitis 227–228
  - see also* cytomegalovirus retinitis
  - cidofovir 231
  - fomivirsen 231
- human herpesvirus 5 (HHV-5) *see* cytomegalovirus; human cytomegalovirus
- human herpesvirus type 6 (HHV-6)
  - acyclic nucleoside analogue 238–240
  - antiviral drugs 13
  - human cytomegalovirus inhibitors 258
  - nonnucleoside Analogues 243
  - nucleotide Analogues 244
  - phosphorothioated oligonucleotides 237
- human immunodeficiency virus *see* HIV; retroviruses
- 2-(1-hydroxybenzyl)benzimidazole (HBB) 1
- 5-hydroxy-2'-deoxycytidine (5-OH-dC), mutagenic HIV pharmaceutical 290–291
- hydroxyethylene scaffold, protease inhibitors 11
- (*S*)-9-(3-hydroxy-2-phosphonomethoxypropyl)-adenine (HPMPA), acyclic nucleoside phosphonates 95
- (*S*)-1-(3-hydroxy-2-phosphonylmethoxypropyl) (HPMP), acyclic nucleoside phosphonates 95
- (*S*)-1-(3-hydroxy-2-phosphonylmethoxypropyl)-5-aza-cytosine

(HPMP-5-azaC), human cytomegalovirus DNA polymerase inhibitor 241, 245  
 (S)-1-(3-hydroxy-2-phosphonylmethoxypropyl) cytosine (HPMPC) *see also* cidofovir  
 – human cytomegalovirus DNA polymerase inhibitor 245  
 hypermutations, G-to-A 285

**i**

IDU *see* iododeoxyuridine  
 imidazolylpyrimidines, human  
 cytomegalovirus helicase/primase complex inhibitor 245–246  
 imidoylthiourea (ITU)  
 – analogues 381  
 – chemical structure 380  
 immunocompromised patients,  
 cytomegalovirus diseases 227  
 immunosuppression, cyclosporin A 147  
 IMPDH *see* inosine 5'-monophosphate dehydrogenase  
 INBI *see* integrase binding inhibitors  
 indolocarbazoles, human cytomegalovirus protein kinase inhibitors 250, 255  
 influenza, pandemics 351  
 influenza A infection 14–15  
 influenza neuraminidase, as a drug target 353–354  
 influenza neuraminidase inhibitors,  
 resistance 368–369  
 influenza strain H1N1, neuraminidase inhibitors treatment 368–370  
 influenza strain H5N1, oseltamivir treatment 368  
 influenza vaccines 352  
 influenza virus  
 – antiviral drugs 14–15  
 – parainfluenza 106  
 – research interest 143  
 – types and subtypes 351–352  
 – zanamivir 198  
 influenza virus multiplication, 5,6-dichloro-1- $\beta$ -D-ribofuranosyl benzimidazole 1  
 inhaled neuraminidase inhibitors 358–359  
 inosine 5'-monophosphate dehydrogenase (IMPDH), inhibition 288–289  
 INSTI *see* integrase strand transfer inhibitors  
 integrase binding inhibitors, HIV 57–59  
 integrase cofactor interactions, HIV 62–64  
 integrase inhibitors, HIV *see* HIV integrase inhibitors  
 integrase strand transfer inhibitors (INSTI), HIV 55–57 *see also* HIV-1 Integrase; HIV integrase inhibitors

interferon cytokines, cyclophilins 155, 161, 173  
 intracellular metabolic pathways, nucleoside phosphonates 93  
 intraocular delivery, of antiviral prodrugs 198–201  
 intrinsic mutagenesis  
 – retroviruses 284–286  
 – RNA viruses 284–286  
 iododeoxyuridine (IDU)  
 – alphaherpesviruses 129  
 – discovery 3  
 – first antiviral drug 1  
 – herpes simplex virus 1–2  
 (2-isopropylamino-5,6-dichloro-1( $\beta$ -D-ribofuranosyl)benzimidazole (1263W94) *see also* maribavir  
 – cytomegalovirus inhibitor 210  
 ITU *see* imidoylthiourea

**k**

KP-1212 *see* 5-aza-5,6-dihydro-2'-deoxycytidine  
 KP-1461 *see* N<sup>4</sup>-heptyloxycarbonyl-5,6-dihydro-5-aza-2'-deoxycytidine

**l**

laninamivir (CS-8958) 358–359  
 latency, of infection 134, 227  
 LBV *see* lobucavir  
 leflunomide *see also* N-(4-trifluoromethylphenyl)-5-methylisoxazole-4-carboxamide  
 – human cytomegalovirus inhibitors 259–260  
 lethal mutagenesis  
 – challenges and advantages 294–296  
 – fundamentals 286–288  
 – future perspectives 296–297  
 – HIV 283–297  
 – vs. conventional strategies (HIV) 294–296  
 lethal mutagens  
 – deoxyribose nucleosides 287  
 – ribavirin 288–290  
 – ribonucleoside analogues 287  
 linear and macrocyclic HCV protease inhibitors, cross-resistance 318  
 lobucavir (LBV)  
 – human cytomegalovirus DNA polymerase inhibitor 238  
 – structure 239  
 lopinavir  
 – brand name and manufacturer 5  
 – chemical structure 76  
 – combination with ritonavir 77–78

- comparison to darunavir 86
- discovery 3
- HIV protease inhibitor 80
- loviride (R89439) 380–381

**m**

- mammalian viruses, RNAi mechanism 331–332
- maraviroc, HIV treatment 38
- maribavir *see also* benzimidazole ribosides
  - antiviral activity 210–212
  - blood-brain barrier crossing 217
  - clearance in animal species 215
  - clinical development 215–217
  - clinical phase I and II studies in treatment of cytomegalovirus retinitis disease 214–217
  - clinical phase II study in prophylaxis of cytomegalovirus disease in transplant recipients 218
  - clinical phase III study with stem cell transplant recipients 218
  - clinical studies phases I-III 254–255
  - cytotoxicity in animal species 215
  - failure of study with allogeneic stem cell transplant recipients 220
  - interactions with tacrolimus 219
  - mechanism of action 212–214, 252–253
  - metabolism 214, 218–219
  - oral bioavailability in animal studies 214
  - pivotal study in liver transplant recipients 218–220
  - preclinical studies 214–215
  - prevention and treatment of cytomegalovirus diseases 209–221
  - prophylaxis of cytomegalovirus diseases 218–221
  - renal transplant recipients 219
  - resistance 212–214, 220
  - role of P450 enzymes 218–219
  - selectivity 213
  - structure 210–211
  - toxicology in animal studies 214
  - transplant population 218–220
  - treatment of cytomegalovirus diseases 215–217
  - UL97 protein kinase (pUL97) inhibitor 252–255
  - viral protein kinase inhibition 212–213
- maribavir pharmacokinetics
  - cytomegalovirus retinitis disease 216
  - effect of hepatic impairment 218–219
  - effect of renal impairment 219
- mechanistic classes of HIV treatment drugs

- chemokine receptor antagonist 73
- entry and fusion inhibitor (*see* HIV entry)
- integrase inhibitors (*see* HIV integrase inhibitors)
- nonnucleoside reverse transcriptase inhibitors (*see* reverse transcriptase)
- nucleoside/nucleotide reverse transcriptase inhibitors (*see* nucleoside phosphonates)
- overview 29, 73
- protease inhibitors (*see* protease inhibitors)
- metabolic pathways, nucleoside phosphonates 93
- microRNA (miRNA), pathway 330–331
- mollusciviruses
  - anti human cytomegalovirus 231
  - antiviral drugs 13
  - cidofovir 112
- monkeypox
  - acyclic nucleoside phosphonates 99, 190
  - antiviral drugs 17–18
- Muller's ratchet 297
- multimerization inhibitors, HIV 60–62
- mutagenesis, lethal 286–288 *see also* lethal mutagenesis
- mutagenic deoxyribonucleosides, HIV-1 286–287
- mutagenic pharmaceuticals
  - 5-azacytidine 291–292
  - 5-Hydroxy-2'-deoxycytidine 290–291
  - antiviral agents 288–292
  - ribavirin 288–290
- mutagenic ribonucleosides, HIV-1 incorporation 286–288
- mutation rates
  - HIV 285–286
  - RNA viruses 284
- mutations
  - nonsynonymous 286
  - viruses (*see* drug-resistant mutations)

**n**

- NA *see* neuraminidase
- narlaprevir, binding to NS3 protease variants 316–318
- Neu5Ac2en (DANA) *see* 2-deoxy-2,3-didehydro-N-acetylneuraminic acid
- neuraminidase (NA) *see also* influenza neuraminidase
  - active site 354–355
  - aromatic inhibitors 364–365
  - crystal structure 354–355
  - cyclopentane-based inhibitors 364
  - influenza A viruses 351–352
  - inhibitor binding 354–355

- oseltamivir-based inhibitors 364–365
- small-molecule inhibitors 355–364
- zanamivir-based inhibitors 364–365
- neuraminidase active site, crystal structure 354–355
- neuraminidase inhibitors 369
  - ABT-675 366–367
  - anti-influenza agents 351–370
  - based on other scaffolds 364–367
  - clinical use 367–369
  - influenza 352–353
  - inhaled (*see* inhaled neuraminidase inhibitors)
  - laninamivir 358–359
  - oseltamivir 359–364
  - peramivir 364–366
  - resistance 364
  - zanamivir 355–358
- nitropyrimidines, human cytomegalovirus helicase/primase complex inhibitor 245–246
- NNRTIs *see* nonnucleoside reverse transcriptase inhibitors
- noncovalent linear hepatitis C virus protease inhibitors
  - chemical structures 312
  - enzyme-inhibitor interaction kinetics 312
  - log octanol/water partition coefficient 312
  - molecular weights 312
  - pattern of resistance 318
  - polar surface area 312
- noncovalent macrocyclic hepatitis C virus protease inhibitors
  - chemical structures 313–314
  - enzyme-inhibitor interaction kinetics 313–314
  - log octanol/water partition coefficient 313–314
  - molecular weights 313–314
  - pattern of resistance and cross-resistance 318
  - polar surface area 313–314
- noncovalent protease inhibitors, resistance 318
- noncyclosporine cyclophilin inhibitors, antiviral drugs 168–173
- nonnucleoside analogues, human cytomegalovirus DNA polymerase inhibitor 240, 242–243
- nonnucleoside antivirals 230
- nonnucleoside inhibitors, phenylenediamine sulphonamides 248–251
- nonnucleoside reverse transcriptase inhibitors (NNRTIs), HIV-1 377–379
- NS3 protease 309–310
- NS3 protease inhibitors, resistance and cross-resistance 316–318
- NS3 protease variants, sensitivity to inhibitors 316–318
- NS3-4A protease/helicase complex, threedimensional model 309–310
- NS3-4A protease, hepatitis C virus 308–310
- nucleoside 5'-monophosphates, prodrugs 185–189
- nucleoside analogues
  - anti-cytomegalovirus drugs 209
  - anti-HIV drug resistance 295–296
  - antiviral activity 295
  - ganciclovir 230
  - human cytomegalovirus DNA polymerase inhibitor 238–243
  - incorporation into HIV-1 genome 294
  - mutagenic effects 288
- nucleoside phosphonates
  - antiviral drugs (*see* acyclic nucleoside phosphonates; cyclic nucleoside phosphonates)
  - clinical applications 111–115
  - examples 92
  - metabolic pathways 93
  - oral bioavailability 107–111
  - prodrugs 107–111 (*see also* alkoxyalkyl ester prodrugs)
  - strategy for antiviral drugs 92–95
- nucleotide analogues
  - cidovir 230
  - human cytomegalovirus DNA polymerase inhibitor 241, 244–245
- o**
- 5-OH-dC *see* 5-hydroxy-2'-deoxycytidine
- oligodeoxyribonucleotides (ODNs), phosphorothioate-modified 237
- olomoucine, cyclin-dependent kinases inhibitor 262
- orf viruses
  - acyclic nucleoside phosphonates 191, 195
  - anti human cytomegalovirus 231
  - antiviral drugs 13
- orthomyxoviridae, targeted by RNAi 333
- orthomyxoviruses *see* influenza virus
- orthopoxviruses *see also* smallpox
  - studies of smallpox antivirals 191
- oseltamivir
  - avian influenza strain H5N1 368
  - chemical structure 353
  - clinical use 367–368

- influenza treatment and prevention 352–353
  - inhibitor design 359–364
  - resistance 364, 368–369
  - oseltamivir (GS4104) 359–364
  - mechanism of resistance 364
  - 4-oxo-1,4-dihydroquinoline (DHQ)
    - carboxamides, human cytomegalovirus DNA polymerase inhibitor 240, 242
  - 4-oxo-4,7-dihydrothieno[2,3-b]pyridine-5-carboxamides, human cytomegalovirus DNA polymerase inhibitor 240, 243
  - 7-oxo-4,7-dihydrothieno[3,2-b]pyridine-6-carboxamides, human cytomegalovirus DNA polymerase inhibitor 240, 243
- P**
- papillomavirus
    - acyclic nucleoside phosphonates 95–97
    - antiviral drugs 13
    - cidofovir 112
    - cyclosporin A and derivatives 167
    - phosphonoamidates 110
  - papovaviridae, targeted by RNAi 333
  - parainfluenza, cyclic nucleoside phosphonates 106
  - paramyxoviridae, targeted by RNAi 333
  - parapoxviruses *see also* orf viruses
    - antiviral drugs 13
  - peptide aptamer technology 246–247
  - β-peptides 236
  - human cytomegalovirus entry inhibitor 235
  - peptides, generation of cyclophilin inhibitors 168–169
  - peptidyl-prolyl isomerase, cyclophilins 168
  - peramivir (BCX-1812, RWJ-270201) 364–366
    - inhibitor design 366
  - peramivir, chemical structure 366
  - PFA *see* phosphonoformic acid
  - pharmacophores
    - antiviral drugs 7–8, 19
    - cyclophilin inhibitors 171
    - hepatitis C virus 15
    - in antiretrovirus agents (overview) 9
    - model 57
    - optimization and design of inhibitors 56–60
  - phenylenediamine sulphonamides (BAY 38-4766), human cytomegalovirus replication inhibitors 248–251
  - phosphonates, antiviral drugs *see* acyclic nucleoside phosphonates; cyclic nucleoside phosphonates; nucleoside phosphonates
  - phosphonoamidates, as prodrugs of nucleoside phosphonates 107–111
  - phosphonoesters, as prodrugs of nucleoside phosphonates 107–109
  - phosphonoformic acid (PFA) 185 *see also* foscarnet
  - 9-(2-phosphonylmethoxyethyl)adenine (PMEA), acyclic nucleoside phosphonates 95–97
  - 9-(2-phosphonylmethoxypropyl) (PMP) analogues, acyclic nucleoside phosphonates 97–98
  - phosphorothioate-modified oligonucleotides, human cytomegalovirus entry inhibitor 237–238
  - picornaviridae, targeted by RNAi 333
  - PIs *see* protease inhibitors
  - plaque reduction assays 132–133
    - helicase-primase inhibitors 132–133, 141
  - PMEA *see* 9-(2-phosphonylmethoxyethyl)adenine
  - PMP *see* 9-(2-phosphonylmethoxypropyl)
  - point mutations, resistance to protease inhibitors 316–318
  - poliovirus, infection 1
  - polyanions, as inhibitors of HIV attachment 34–36
  - polymerase, hepatitis C virus 104–107
  - polyomavirus
    - acyclic nucleoside phosphonates 96
    - antiviral drugs 13
  - portal proteins 252
  - postattachment inhibitors, HIV entry 37
  - posttranscriptional gene silencing (PTGS) 329
    - mammals 331
  - poxviridae *see also* poxviruses; vaccinia virus; variola virus
    - antiviral drugs 13
  - poxviruses *see also* variola virus
    - acyclic nucleoside phosphonates 194
    - antiviral drugs 17–18
    - antiviral effects of cidofovir derivatives 190
    - cidofovir derivatives 189–190
  - primase inhibitors, human cytomegalovirus 245–246
  - pro-140, HIV treatment 39
  - prodrugs
    - of nucleoside phosphates (*see* alkoxyalkyl (ester) prodrugs)

- of nucleoside phosphonates (*see* alkoxyalkyl (ester) prodrugs)
  - of phosphonofornate (*see* alkoxyalkyl (ester) prodrugs)
  - oral 189–198
  - protease
    - HIV 73–74
    - viral target for HIV therapy 29–30
  - protease inhibitors (PIs)
    - amprenavir (*see* amprenavir)
    - darunavir (*see* darunavir)
    - early developments 74–78
    - first 2, 75 (*see also* saquinavir)
    - hepatitis C virus 3
    - highly active antiretroviral therapy 52, 75, 87
    - HIV 73–74
    - human cytomegalovirus 250, 256
    - hydroxyethylene scaffold 11
    - lopinavir (*see* lopinavir)
    - medical need for next generation 78–85
    - ritonavir (*see* ritonavir)
    - safety profile 321
    - saquinavir (*see* saquinavir)
    - tipranavir (*see* tipranavir)
  - proteasome inhibitors, human
    - cytomegalovirus 262–265
  - protein kinase family, herpesviridae 212
  - protein kinase inhibitor, maribavir 212
  - protein-protein interactions inhibition, human
    - cytomegalovirus 246–248
  - prusoff, iododeoxyuridine 1
  - PTGS *see* posttranscriptional gene silencing
  - pUL84, human cytomegalovirus replication factor 247–248
  - pUL97
    - cytomegalovirus protein kinase 211
    - human cytomegalovirus protein kinase 253
  - purine cyclic nucleoside phosphonates, chemical structures 102
  - pyrimidine cyclic nucleoside phosphonates, chemical structures 100
  - pyrophosphate analogue, foscarnet 230
  - pyrrolidine-5,5-trans-lactams 250
- q**
- quinazolines, human cytomegalovirus protein kinase inhibitors 250, 255
  - quinoxaline derivatives, design starting from cyclophilins structures 169–170
- r**
- R89439 *see* lorigide
  - R147681 *see* dapivirine
  - R165335 *see* etravirine
  - R278474 *see* rilpivirine
  - R-125489 358–359
  - raltegravir
    - brand name and manufacturer 6
    - chemical structure 10
    - discovery 3
    - first HIV integrase inhibitor 4, 12, 72
    - HIV integrase inhibitor 41, 55–57, 64
    - integrase strand transfer inhibitor 57
  - RBV *see* ribavirin
  - Relenza® *see* zanamivir
  - reoviridae, targeted by RNAi 333
  - replicative cycle, herpesviruses 264
  - respiratory syncytial virus (RSV), RNAi therapy 337
  - retroviridae, targeted by RNAi 333
  - retroviruses *see also* HIV
    - acyclic nucleoside phosphonates 96–99, 196–197
    - antiviral drugs 8–12
    - inhibition with nucleoside phosphonates 91
    - intrinsic mutagenesis 284–286
    - viral fitness 284–286
  - reverse transcriptase (RT)
    - HIV-1 378
    - viral target for HIV therapy 29–30
  - rhabdoviridae, targeted by RNAi 333
  - ribavirin (RBV)
    - antiviral activity 2
    - brand name and manufacturer 6
    - chemical structure 7, 106
    - chronic HCV genotype 1 162–165
    - discovery 3
    - hepatitis C 155–157, 173
    - hepatitis C and cyclophilin 15
    - influenza A 14
    - mechanism of action 8, 289
    - mutagenic pharmaceutical 288–290
    - RNA virus 104
  - 1- $\beta$ -D-ribofuranosyl-1,2,4-triazole-3-carboxamide *see* ribavirin
  - 1-( $\beta$ -L-ribofuranosyl)-2-isopropylamino-5,6-dichlorobenzimidazole (GW1263W94) *see* maribavir
  - ribonucleoside analogues
    - 5-Azacytidine 291–292
    - 5-Hydroxy-2'-deoxycytidine 290–291
    - lethal mutagens 287
    - ribavirin 288–290
  - rilpivirine 377–385
    - clinical proof of concept 383–384
    - combination therapy 385



- development 380
  - drug-drug interactions 383–384
  - mechanism of action 381–383
  - pharmacokinetics 383–384
  - potency 384–385
  - resilience to NNRTI resistance 384–385
  - resistance 385
  - rilpivirine (R278474, TMC278) 380–381
    - structure-activity relationship 381–383
  - rimantadine, influenza treatment 352–353
  - RISC *see* RNA-induced silencing complex
  - ritonavir
    - body absorption 75
    - brand name and manufacturer 5
    - chemical structure 76
    - combination with elvitegravir 56
    - combination with lopinavir 77–78
    - comparison to darunavir 86
    - discovery 3
    - HIV protease inhibitor 80
  - RNAi *see also* RNA interference
    - antiviral activity 331–332
    - selecting optimal targets 332–334
  - RNAi gene knockdown, high-throughput screens 334
  - RNAi gene therapy
    - chronic infection 337–338
    - future perspective 338–339
    - HIV-1 infection 337–338
  - RNAi mechanism
    - mammalian viruses 331–332
    - therapeutic application 329–331
  - RNA-induced silencing complex (RISC) 331
  - RNA interference (RNAi) 248
    - see also* RNAi
    - discovery 329
  - RNAi strategies, prevention of viral escape 334–335
  - RNAi therapy
    - basic design 332
    - potential risks 336–337
  - RNA viruses
    - hepatitis C virus 92, 155
    - intrinsic mutagenesis 284–286
    - mutagenic nucleoside analogues 288
    - mutation rates 284
    - replication inhibitor 288–289
    - viral fitness 284–286
  - roscovitine, cyclin-dependent kinases inhibitor 262
  - RSV *see* respiratory syncytial virus
  - RT *see* reverse transcriptase
  - RWJ-270201 *see* peramivir
- S**
- S2242 *see* 2-amino-7-[(1,3-dihydroxy-2-propoxy)methyl]purine
  - saquinavir
    - brand name and manufacturer 5
    - chemical structure 10, 76
    - discovery 3
    - first HIV protease inhibitor 2
    - HIV protease inhibitor 80, 82
    - HIV treatment 75, 80
    - hydroxyethylene scaffold 11
  - SAR *see* structure-activity relationship
  - second-generation HIV integrase inhibitors
    - see* HIV integrase inhibitors
  - Selzentry® *see* maraviroc
  - sequence-specific gene silencing 329
  - sialic acid analogues, neuraminidase inhibitor 355–358
  - sialidase, neuraminidase 352
  - siRNAs
    - delivery issues 335–336
    - multiplexing 335–336
  - siRNA treatment, escape for several viruses 334
  - small interfering RNAs, human cytomegalovirus 248
  - small-molecule inhibitors, HIV entry 36–37
  - smallpox *see also* biological weapon; poxviruses; variola virus
    - orthopoxviruses 191
    - vaccine 1, 17, 189
  - SOC *see* standard of care
  - solid organ transplant (SOT), human cytomegalovirus infection 228
  - spontaneous mutations, HIV 286
  - standard of care (SOC), hepatitis C virus genotype 1 307
  - strand transfer inhibitors *see* integrase strand transfer inhibitors
  - strand transfer reaction, HIV integrase 12
  - structure-activity relationship (SAR) 242
    - acyclic nucleoside phosphonates 95–98
    - cyclic nucleoside phosphonates 100–104
  - rilpivirine//HIV-1 reverse transcriptase 381–383
  - structure-based drug design
    - hepatitis C virus protease inhibitors 234–238
    - influenza neuraminidase inhibitors 369
    - zanamivir 355–358
  - surface protein, viral 30
  - sustained viral response (SVR), hepatitis C virus therapy 307
  - SVR *see* sustained viral response

**t**

- Tamiflu<sup>®</sup> *see* oseltamivir  
 TCRB *see* (2,5,6-trichloro-1-( $\beta$ -D-ribofuranosyl) benzimidazole  
 TDF *see* tenofovir disoproxil fumarate  
 telaprevir  
 – binding to NS3 protease variants 316–318  
 – phase 2 clinical trials 319–320  
 tenofovir  
 – acyclic nucleoside phosphonates 97–98  
 – alkoxyalkyl esters 196–197  
 tenofovir disoproxil fumarate (TDF) *see also*  
 acyclic nucleoside phosphonates  
 – clinical application of nucleoside phosphonate 113–115  
 – hepatitis B virus and HIV 11, 92, 97–99, 196  
 tetrahydrofuran core phosphonates  
 – cyclic nucleoside phosphonates 100–103  
 – purine cyclic nucleoside phosphonates 102  
 – pyrimidine cyclic nucleoside phosphonates 100  
 tetrahydro-imidazo[4,5,1-*jk*][1,4]-benzodiazepin-2(1H)-one (TIBO) 378  
 4'-thiopyrimidine nucleosides 242  
 – human cytomegalovirus infection 242  
 thiourea derivatives, entry inhibitor 236–237  
 thymidine analogue, iododeoxyuridine 1  
 TIBO *see also* tetrahydro-imidazo[4,5,1-*jk*][1,4]-benzodiazepin-2(1H)-one  
 – chronicle of the discovery 377–385  
 – derivatives 378–379  
 TIBO R82150 378  
 TIBO R82913 378  
 TIBO R86183 378  
 tipranavir  
 – brand name and manufacturer 5  
 – chemical structure 76  
 – development 78–79  
 – discovery 3  
 – enfuvirtide 41  
 – HIV protease inhibitor 80  
 – no hydroxyethylene scaffold 11  
 tivirapine, chemical structure 378  
 TMC120 *see* dapivirine  
 TMC125 *see* etravirine  
 TMC278 *see* rilpivirine  
 transmembrane glycoprotein, HIV *see* HIV-1 glycoproteins  
 transplant recipients  
 – cytomegalovirus disease prophylaxis 218–220  
 – human cytomegalovirus infection and diseases 228

- (2,5,6-trichloro-1-( $\beta$ -D-ribofuranosyl) benzimidazole (TCRB), cytomegalovirus inhibitor 210, 251  
 N-(4-trifluoromethylphenyl)-5-methylisoxazole-4-carboxamide, human cytomegalovirus inhibitors 259

**u**

- UL97 protein kinase (pUL97) inhibitors, human cytomegalovirus 250, 252–255  
 UL54-UL44 interaction, human cytomegalovirus 246

**v**

- vaccines  
 – poliovirus 1  
 – smallpox 1, 17, 189  
 vaccinia virus  
 – acyclic nucleoside phosphonates 191–194  
 – antiviral drugs 17–18  
 – antiviral effects of cidofovir derivatives 190  
 – cyclosporin A and derivatives 167  
 – nucleoside phosphates and phosphonates 190  
 – thiosemicarbazones 1  
 valacyclovir (VACV), human cytomegalovirus 229  
 Valcyte<sup>®</sup> *see* valganciclovir  
 valganciclovir (VGCV), human cytomegalovirus disease prophylaxis 229–230  
 varicella zoster virus (VZV)  
 – alphaherpesviruses 129  
 – antiviral drugs 4–8, 104, 146, 191, 197  
 – helicase-primase inhibitors 130–134  
 – mutation 136, 181  
 variola virus (VARV) *see also* poxviruses; smallpox  
 – acyclic nucleoside phosphonates 189–190  
 – antiviral drugs 17–18  
 VDA *see* viral decay acceleration  
 VGCV *see* valganciclovir  
 vicriviroc, HIV treatment 39  
 Vidaza<sup>®</sup> *see* 5-azacytidine  
 viral decay acceleration (VDA) 292  
 viral fitness  
 – retroviruses 284–286  
 – RNA viruses 284–286  
 viral surface protein, HIV entry 30  
 viral targets, earlier HIV therapy 29–30  
 Virazole<sup>®</sup> *see* ribavirin  
 viread *see* tenofovir disoproxil fumarate

- virion assembly and egress inhibition, human cytomegalovirus 248–256
  - virus attachment, inhibitors 34–37
  - virus-cell fusion, HIV entry 33
  - virus entry, HIV *see* HIV entry
  - virus silencing, antiviral RNAi 329–339
  - virus tropism and infectivity, coreceptors 33
  - viruses
    - enteroviruses 1
    - hepatitis B (*see* hepatitis B virus)
    - hepatitis C (*see* hepatitis C virus)
    - herpes 4–8
    - herpes simplex 1
    - influenza 1
    - polio 1
    - smallpox 1
    - varicella zoster 4–8
  - Vistide® *see* cidofovir
  - Vitravene® *see* formivirsen
  - VZV *see* varicella zoster virus
- w**
- 1263W94 *see* (2-isopropylamino-5,6-dichloro-1(β-D-ribofuranosyl)benzimidazole (1263W94)
  - west nile virus
    - nucleosides 15
    - ribavirin 290
- x**
- X-ray crystallography
    - GS4071/neuraminidase complex 361, 369
    - hepatitis C virus protease inhibitors 315, 318
    - human cytomegalovirus protease inhibitors 256
    - neuraminidase inhibitor 355–358
    - peramivir/neuraminidase complex 369
    - pyrrolidine- and cyclopentane-based neuraminidase inhibitors 367
    - zanamivir/neuraminidase complex 361, 369
  - X-ray diffraction
    - NNRTI binding pocket within the HIV-1 reverse transcriptase 381
    - rilpivirine/HIV-1 reverse transcriptase complex 381
- y**
- yellow fever, nucleosides 15
- z**
- zanamivir
    - C-6 carboxamide analogues 356–357
    - C-6 carboxamide, ether, ketone, and hydroxy analogues 357
    - chemical structure 353
    - clinical use 367–368
    - derivatives 198
    - dimeric analogues 358
    - glycerol side-chain analogues 358–359
    - heterocyclic analogues 357–358
    - influenza treatment and prevention 352–353
    - inhibitor activity 356
    - inhibitor design 355–358
    - neuraminidase inhibitor 355–358
    - resistance 368–369
  - zidovudine *see also* AZT
    - brand name and manufacturer 5