

# *Fundamentals* of Remote Sensing

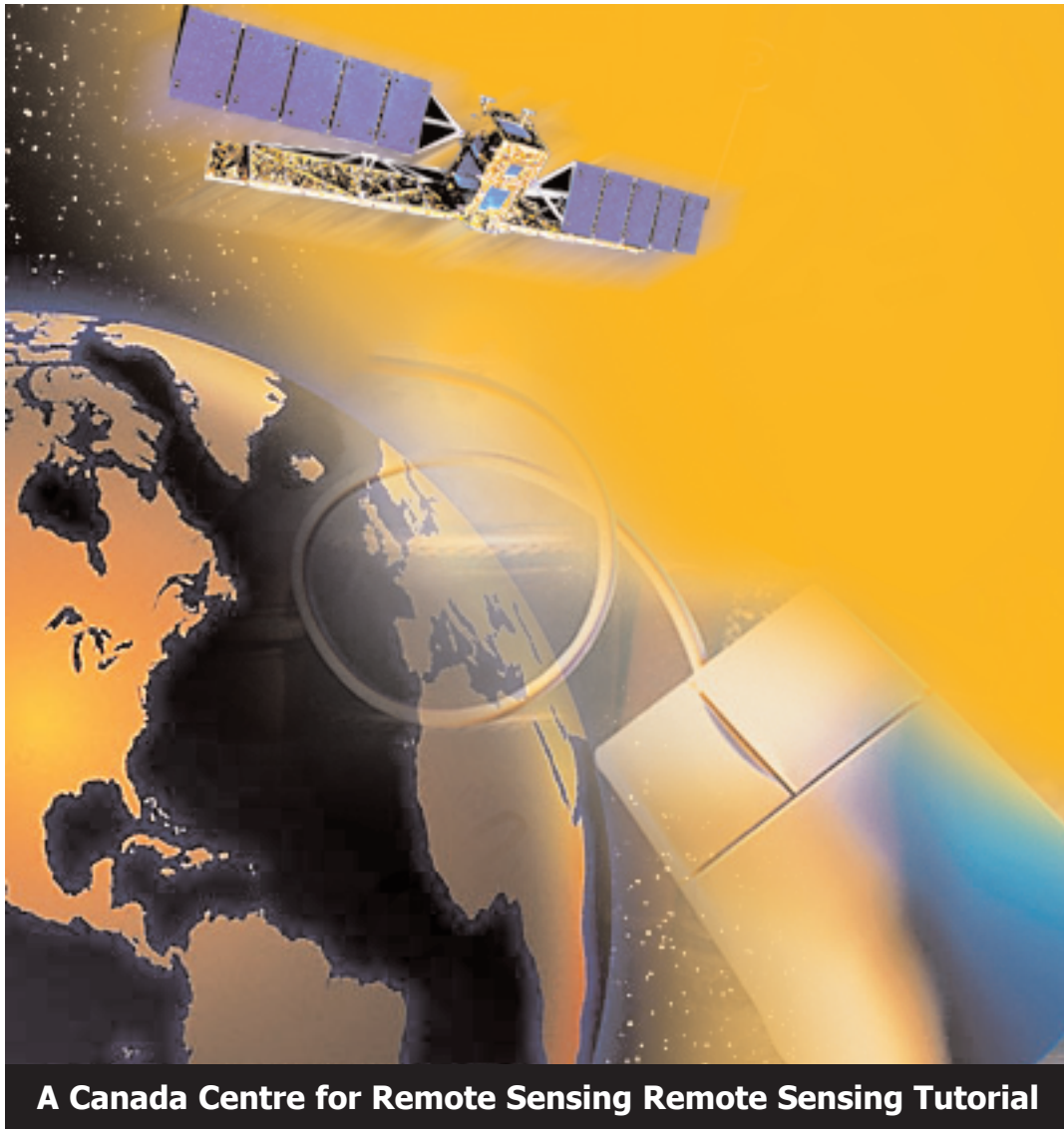

**A Canada Centre for Remote Sensing Remote Sensing Tutorial**



Natural Resources  
Canada

Ressources naturelles  
Canada

Canada 

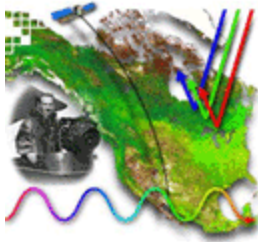

## Table of Contents

---

### 1. Introduction

1.1 What is Remote Sensing?	5
1.2 Electromagnetic Radiation	7
1.3 Electromagnetic Spectrum	9
1.4 Interactions with the Atmosphere	12
1.5 Radiation - Target	16
1.6 Passive vs. Active Sensing	19
1.7 Characteristics of Images	20
1.8 Endnotes	22
Did You Know	23
Whiz Quiz and Answers	27

### 2. Sensors

2.1 On the Ground, In the Air, In Space	34
2.2 Satellite Characteristics	36
2.3 Pixel Size, and Scale	39
2.4 Spectral Resolution	41
2.5 Radiometric Resolution	43
2.6 Temporal Resolution	44
2.7 Cameras and Aerial Photography	45
2.8 Multispectral Scanning	48
2.9 Thermal Imaging	50
2.10 Geometric Distortion	52
2.11 Weather Satellites	54
2.12 Land Observation Satellites	60
2.13 Marine Observation Satellites	67
2.14 Other Sensors	70
2.15 Data Reception	72
2.16 Endnotes	74
Did You Know	75
Whiz Quiz and Answers	83

**3. Microwaves**

3.1 Introduction	92
3.2 Radar Basic	96
3.3 Viewing Geometry & Spatial Resolution	99
3.4 Image distortion	102
3.5 Target interaction	106
3.6 Image Properties	110
3.7 Advanced Applications	114
3.8 Polarimetry	117
3.9 Airborne vs Spaceborne	123
3.10 Airborne & Spaceborne Systems	125
3.11 Endnotes	129
Did You Know	131
Whiz Quiz and Answers	135

**4. Image Analysis**

4.1 Introduction	141
4.2 Visual interpretation	144
4.3 Digital processing	147
4.4 Preprocessing	149
4.5 Enhancement	154
4.6 Transformations	158
4.7 Classification	161
4.8 Integration	164
4.9 Endnotes	166
Did You Know	167
Whiz Quiz and Answers	170

**5. Applications**

5.1 Introduction	174
5.2 Agriculture	177
■ Crop Type Mapping	
■ Crop Monitoring	
5.3 Forestry	184
■ Clear cut Mapping	
■ Species identification	
■ Burn Mapping	

5.4 Geology	196
■ Structural Mapping	
■ Geologic Units	
5.5 Hydrology	203
■ Flood Delineation	
■ Soil Moisture	
5.6 Sea Ice	209
■ Type and Concentration	
■ Ice Motion	
5.7 Land Cover	215
■ Rural/Urban change	
■ Biomass Mapping	
5.8 Mapping	222
■ Planimetry	
■ DEMs	
■ Topo Mapping	
5.9 Oceans & Coastal	232
■ Ocean Features	
■ Ocean Colour	
■ Oil Spill Detection	
5.10 Endnotes	240
Did You Know	241
Whiz Quiz	250
<b>Credits</b>	<b>254</b>
<b>Permissions</b>	<b>256</b>
<b>Download</b>	<b>257</b>
<b>Notes for Teachers</b>	<b>258</b>

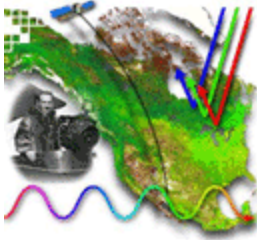

# 1. Introduction to Fundamentals

## 1.1 What is Remote Sensing?

So, what exactly is **remote sensing**? For the purposes of this tutorial, we will use the following definition:

"Remote sensing is the science (and to some extent, art) of acquiring information about the Earth's surface without actually being in contact with it. This is done by sensing and recording reflected or emitted energy and processing, analyzing, and applying that information."

In much of remote sensing, **the process** involves an interaction between incident radiation and the targets of interest. This is exemplified by the use of imaging systems where the following seven elements are involved. Note, however that remote sensing also involves the sensing of emitted energy and the use of non-imaging sensors.

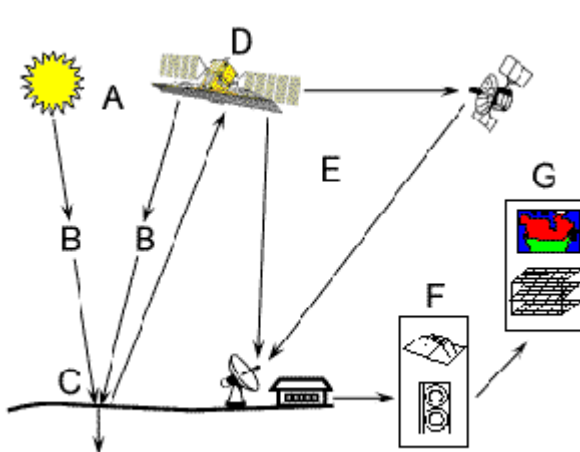

© CCRS / CCT

**1. Energy Source or Illumination (A)** - the first requirement for remote sensing is to have an energy source which illuminates or provides electromagnetic energy to the target of interest.

**2. Radiation and the Atmosphere (B)** - as the energy travels from its source to the target, it will come in contact with and interact with the atmosphere it passes through. This interaction may take place a second time as the energy travels from the target to the sensor.

**3. Interaction with the Target (C)** - once the energy makes its way to the target through the atmosphere, it interacts with the target depending on the properties of both the target and the radiation.

**4. Recording of Energy by the Sensor (D)** - after the energy has been scattered by, or emitted from the target, we require a sensor (remote - not in contact with the target) to collect and record the electromagnetic radiation.

**5. Transmission, Reception, and Processing (E)** - the energy recorded by the sensor has to be transmitted, often in electronic form, to a receiving and processing station where the data are processed into an image (hardcopy and/or digital).

**6. Interpretation and Analysis (F)** - the processed image is interpreted, visually and/or digitally or electronically, to extract information about the target which was illuminated.

**7. Application (G)** - the final element of the remote sensing process is achieved when we apply the information we have been able to extract from the imagery about the target in order to better understand it, reveal some new information, or assist in solving a particular problem.

These seven elements comprise the remote sensing process from beginning to end. We will be covering all of these in sequential order throughout the five chapters of this tutorial, building upon the information learned as we go. Enjoy the journey!

## 1.2 Electromagnetic Radiation

As was noted in the previous section, the first requirement for remote sensing is to have an **energy source to illuminate the target** (unless the sensed energy is being emitted by the target). This energy is in the form of electromagnetic radiation.

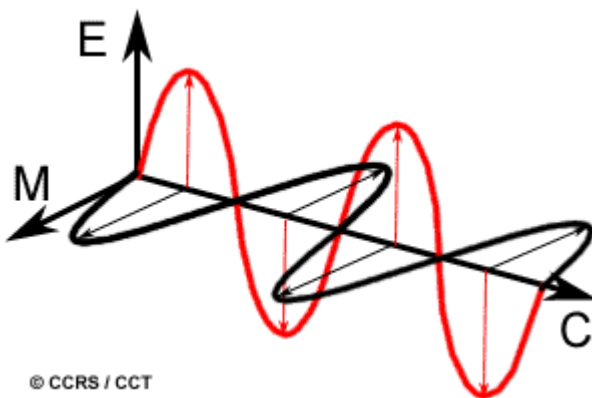
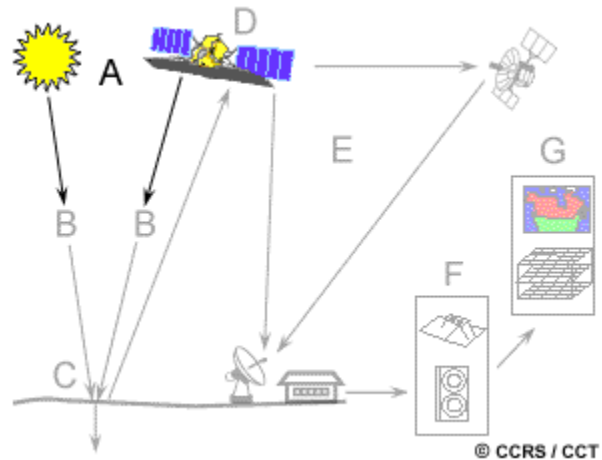

All electromagnetic radiation has fundamental properties and behaves in predictable ways according to the basics of wave theory.

**Electromagnetic radiation** consists of an electrical field (E) which varies in magnitude in a direction perpendicular to the direction in which the radiation is traveling, and a magnetic field (M) oriented at right angles to the electrical field. Both these fields travel at the speed of light (c).

Two characteristics of electromagnetic radiation are particularly important for understanding remote sensing. These are the **wavelength and frequency**.

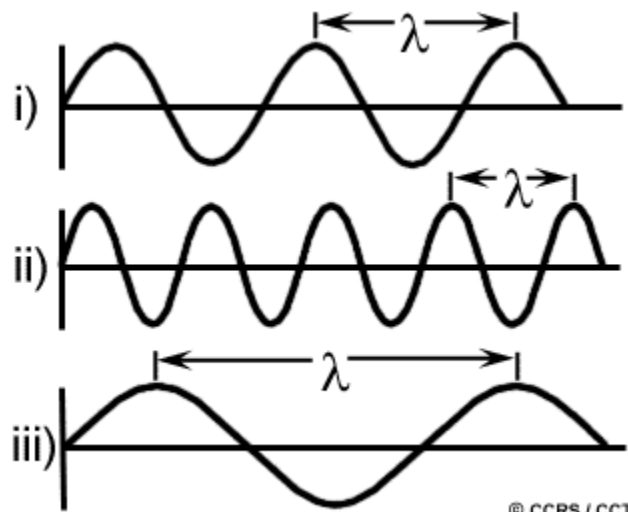

The wavelength is the length of one wave cycle, which can be measured as the distance between successive wave crests. Wavelength is usually represented by the Greek letter lambda ( $\lambda$ ). Wavelength is measured in metres (m) or some factor of metres such as **nanometres** (nm,  $10^{-9}$  metres), **micrometres** ( $\mu\text{m}$ ,  $10^{-6}$  metres) ( $\mu\text{m}$ ,  $10^{-6}$  metres) or centimetres (cm,  $10^{-2}$  metres). Frequency refers to the number of cycles of a wave passing a fixed point per unit of time. Frequency is normally measured in **hertz** (Hz), equivalent to one cycle per second, and various multiples of hertz.

Wavelength and frequency are related by the following formula:

$$c = \lambda \nu$$

where:

$\lambda$  = wavelength (m)

$\nu$  = frequency (cycles per second, Hz)

$c$  = speed of light ( $3 \times 10^8$  m/s)

Therefore, the two are inversely related to each other. The shorter the wavelength, the higher the frequency. The longer the wavelength, the lower the frequency. Understanding the characteristics of electromagnetic radiation in terms of their wavelength and frequency is crucial to understanding the information to be extracted from remote sensing data. Next we will be examining the way in which we categorize electromagnetic radiation for just that purpose.



## 1.3 The Electromagnetic Spectrum

The **electromagnetic spectrum** ranges from the shorter wavelengths (including gamma and x-rays) to the longer wavelengths (including microwaves and broadcast radio waves). There are several regions of the electromagnetic spectrum which are useful for remote sensing.

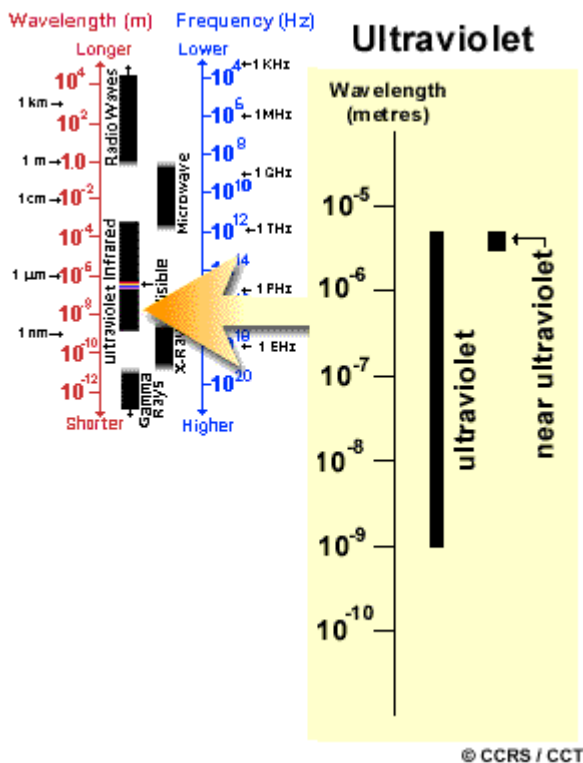
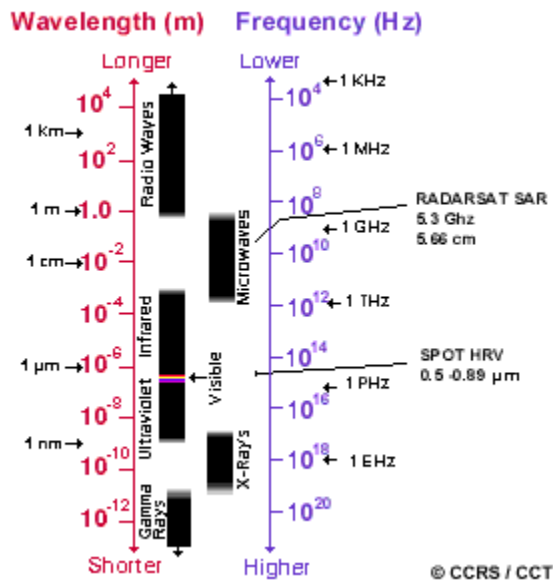

For most purposes, the **ultraviolet or UV** portion of the spectrum has the shortest wavelengths which are practical for remote sensing. This radiation is just beyond the violet portion of the visible wavelengths, hence its name. Some Earth surface materials, primarily rocks and minerals, fluoresce or emit visible light when illuminated by UV radiation.

The light which our eyes - our "remote sensors" - can detect is part of the **visible spectrum**. It is important to recognize how small the visible portion is relative to the rest of the spectrum. There is a lot of radiation around us which is "invisible" to our eyes, but can be detected by other remote sensing instruments and used to our advantage. The visible wavelengths cover a range from approximately 0.4 to 0.7  $\mu\text{m}$ . The longest visible wavelength is red and the shortest is violet. Common wavelengths of what we perceive as particular colours from the visible portion of the spectrum are listed below. It is important to note that this is the only portion of the spectrum we can associate with the concept of **colours**.

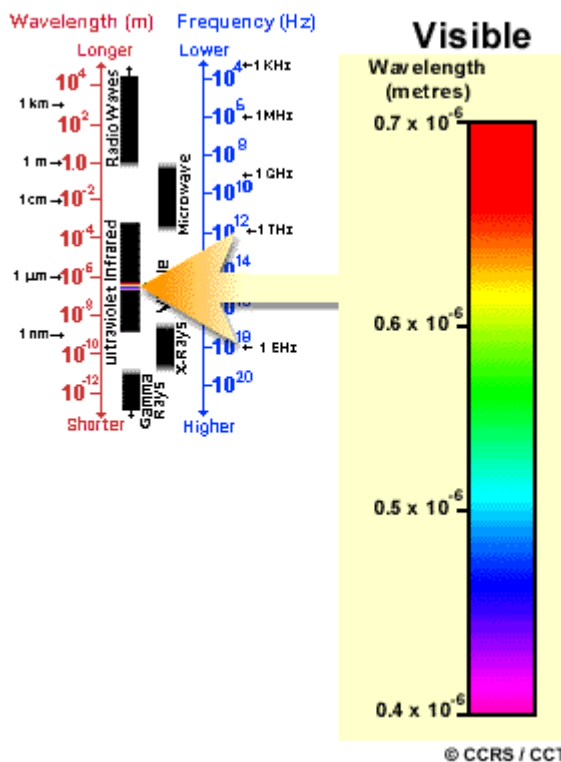

- **Violet:** 0.4 - 0.446  $\mu\text{m}$
- **Blue:** 0.446 - 0.500  $\mu\text{m}$
- **Green:** 0.500 - 0.578  $\mu\text{m}$
- **Yellow:** 0.578 - 0.592  $\mu\text{m}$
- **Orange:** 0.592 - 0.620  $\mu\text{m}$
- **Red:** 0.620 - 0.7  $\mu\text{m}$

**Blue, green, and red** are the **primary colours** or wavelengths of the visible spectrum. They are defined as such because no single primary colour can be created from the other two, but all other colours can be formed by combining blue, green, and red in various proportions. Although we see sunlight as a uniform or homogeneous colour, it is actually composed of various wavelengths of radiation in primarily the ultraviolet, visible and infrared portions of the spectrum. The visible portion of this radiation can be shown in its

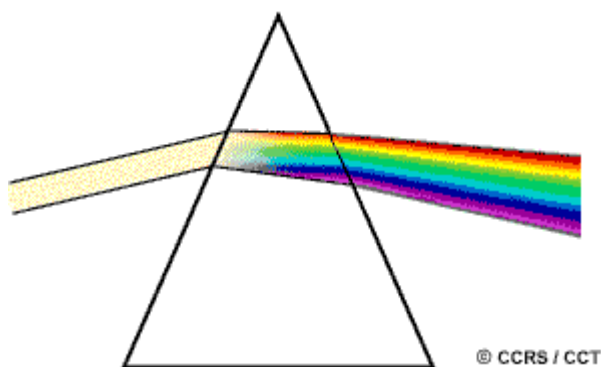

component colours when sunlight is passed through a **prism**, which bends the light in differing amounts according to wavelength.

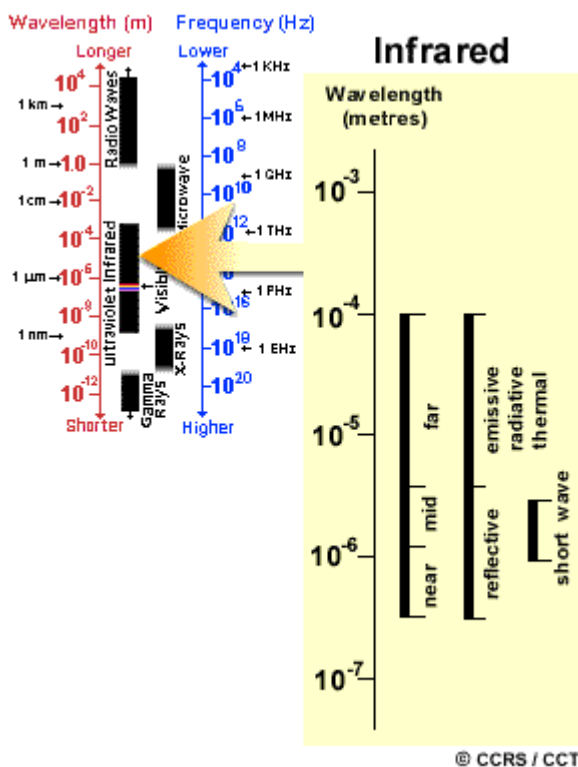

The next portion of the spectrum of interest is the infrared (IR) region which covers the wavelength range from approximately 0.7  $\mu\text{m}$  to 100  $\mu\text{m}$  - more than 100 times as wide as the visible portion! The infrared region can be divided into two categories based on their radiation properties - the **reflected IR**, and the emitted or **thermal IR**. Radiation in the reflected IR region is used for remote sensing purposes in ways very similar to radiation in the visible portion. The reflected IR covers wavelengths from approximately 0.7  $\mu\text{m}$  to 3.0  $\mu\text{m}$ . The thermal IR region is quite different than the visible and reflected IR portions, as this energy is essentially the radiation that is emitted from the Earth's surface in the form of heat. The thermal IR covers wavelengths from approximately 3.0  $\mu\text{m}$  to 100  $\mu\text{m}$ .

The portion of the spectrum of more recent interest to remote sensing is the **microwave region** from about 1 mm to 1 m. This covers the longest wavelengths used for remote sensing. The shorter wavelengths have properties similar to the thermal infrared region while the longer wavelengths approach the wavelengths used for radio broadcasts. Because of the special nature of this region and its importance to remote sensing in Canada, an entire chapter (Chapter 3) of the tutorial is dedicated to microwave sensing.

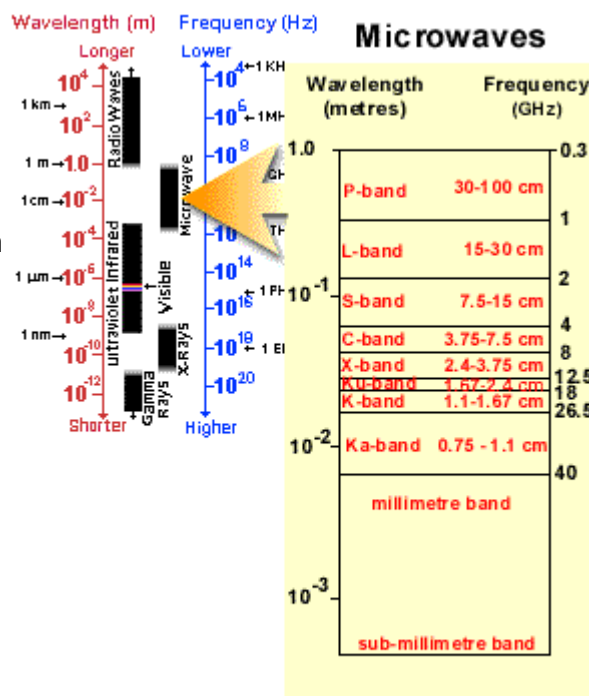

## 1.4 Interactions with the Atmosphere

Before radiation used for remote sensing reaches the Earth's surface it has to travel through some distance of the Earth's atmosphere. Particles and gases in the atmosphere can affect the incoming light and radiation. These effects are caused by the mechanisms of **scattering** and **absorption**.

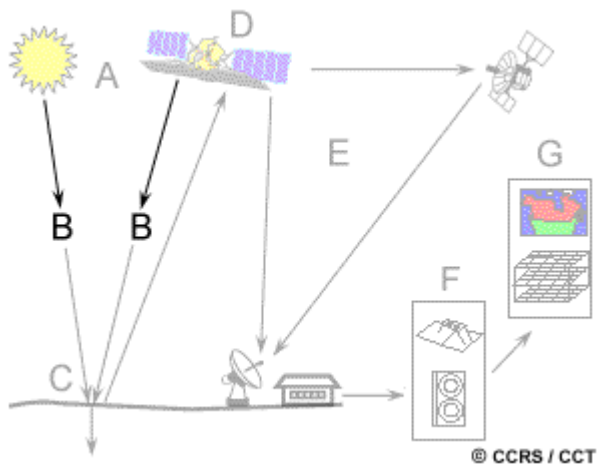

**Scattering** occurs when particles or large gas molecules present in the atmosphere interact with and cause the electromagnetic radiation to be redirected from its original path. How much scattering takes place depends on several factors including the wavelength of the radiation, the abundance of particles or gases, and the distance the radiation travels through the atmosphere. There are three (3) types of scattering which take place.

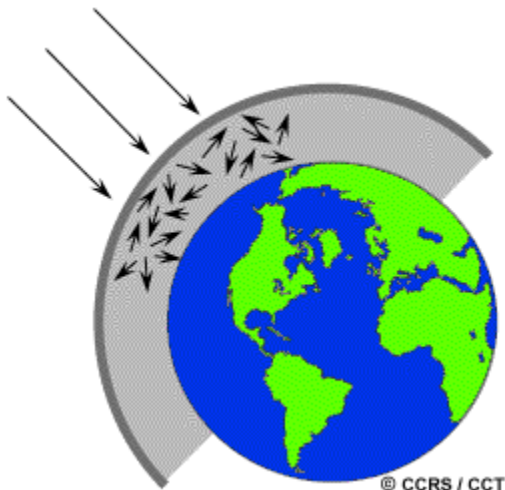

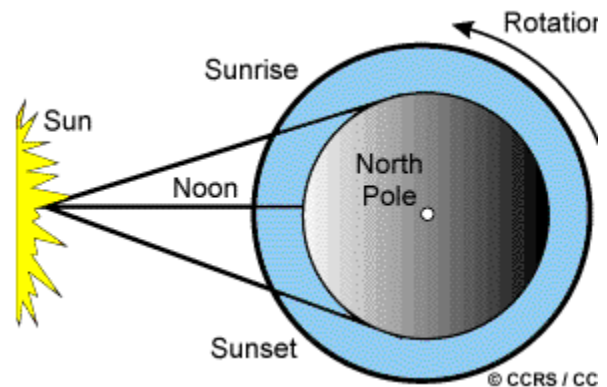

**Rayleigh scattering** occurs when particles are very small compared to the wavelength of the radiation. These could be particles such as small specks of dust or nitrogen and oxygen molecules. Rayleigh scattering causes shorter wavelengths of energy to be scattered much more than longer wavelengths. Rayleigh scattering is the dominant scattering mechanism in the upper atmosphere. The fact that the sky appears "blue" during the day is because of this phenomenon. As sunlight passes through the atmosphere, the shorter wavelengths (i.e. blue) of the visible spectrum are scattered more than the other (longer) visible wavelengths. At **sunrise and sunset** the light has to travel farther through the atmosphere than at midday and the scattering of the shorter wavelengths is more complete; this leaves a greater proportion of the longer wavelengths to penetrate the atmosphere.

**Mie scattering** occurs when the particles are just about the same size as the wavelength of the radiation. Dust, pollen, smoke and water vapour are common causes of Mie scattering which tends to affect longer wavelengths than those affected by Rayleigh scattering. Mie scattering occurs mostly in the lower portions of the atmosphere where larger particles are more abundant, and dominates when cloud conditions are overcast.



The final scattering mechanism of importance is called **nonselective scattering**. This occurs when the particles are much larger than the wavelength of the radiation. Water droplets and large dust particles can cause this type of scattering. Nonselective scattering gets its name from the fact that all wavelengths are scattered about equally. This type of scattering causes fog and clouds to appear white to our eyes because blue, green, and red light are all scattered in approximately equal quantities (blue+green+red light = white light).

**Absorption** is the other main mechanism at work when electromagnetic radiation interacts with the atmosphere. In contrast to scattering, this phenomenon causes molecules in the atmosphere to absorb energy at various wavelengths. Ozone, carbon dioxide, and water vapour are the three main atmospheric constituents which absorb radiation.

**Ozone** serves to absorb the harmful (to most living things) ultraviolet radiation from the sun. Without this protective layer in the atmosphere our skin would burn when exposed to sunlight.

You may have heard **carbon dioxide** referred to as a greenhouse gas. This is because it tends to absorb radiation strongly in the far infrared portion of the spectrum - that area associated with thermal heating - which serves to trap this heat inside the atmosphere. Water vapour in the atmosphere absorbs much of the incoming longwave infrared and shortwave microwave radiation (between  $22\mu\text{m}$  and  $1\text{m}$ ). The presence of water vapour in the lower atmosphere varies greatly from location to location and at different times of the year. For example, the air mass above a desert would have very little water vapour to absorb energy, while the tropics would have high concentrations of water vapour (i.e. high humidity).

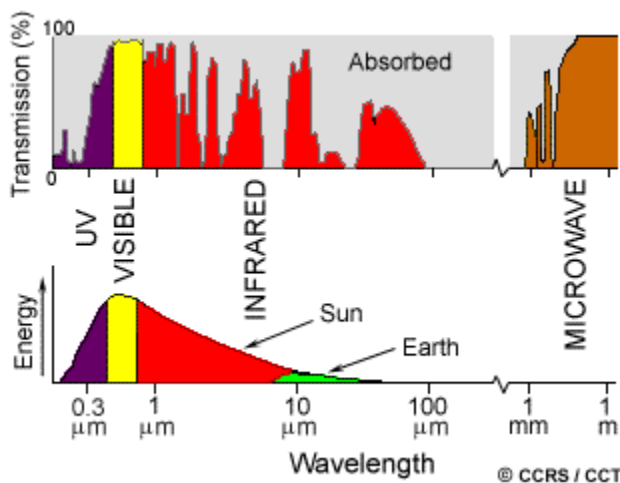
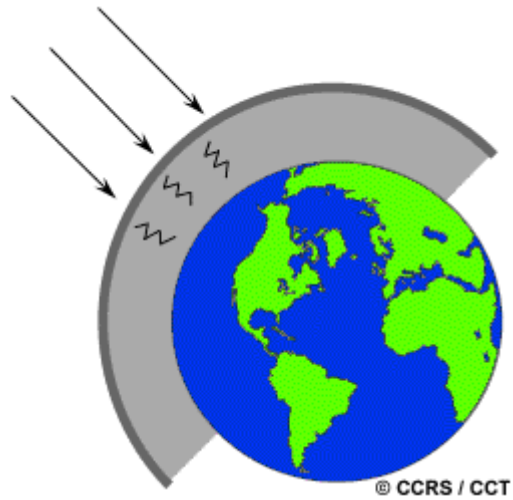

Because these gases absorb electromagnetic energy in very specific regions of the spectrum, they influence where (in the spectrum) we can "look" for remote sensing purposes. Those areas of the spectrum which are not severely influenced by atmospheric absorption and thus, are useful to remote sensors, are called **atmospheric windows**. By comparing the characteristics of the two most common energy/radiation sources (the sun and the earth) with the

atmospheric windows available to us, we can define those wavelengths that we can use **most effectively** for remote sensing. The visible portion of the spectrum, to which our eyes are most sensitive, corresponds to both an atmospheric window and the peak energy level of the sun. Note also that heat energy emitted by the Earth corresponds to a window around  $10\mu\text{m}$  in the thermal IR portion of the spectrum, while the large window at wavelengths beyond  $1\text{mm}$  is associated with the

microwave region.

Now that we understand how electromagnetic energy makes its journey from its source to the surface (and it is a difficult journey, as you can see) we will next examine what happens to that radiation when it does arrive at the Earth's surface.

### 1.5 Radiation - Target Interactions

Radiation that is not absorbed or scattered in the atmosphere can reach and interact with the Earth's surface. There are three (3) forms of interaction that can take place when energy strikes, or is **incident (I)** upon the surface. These are: **absorption (A)**; **transmission (T)**; and **reflection (R)**. The total incident energy will interact with the surface in one or more of these three ways. The proportions of each will depend on the wavelength of the energy and the material and condition of the feature.

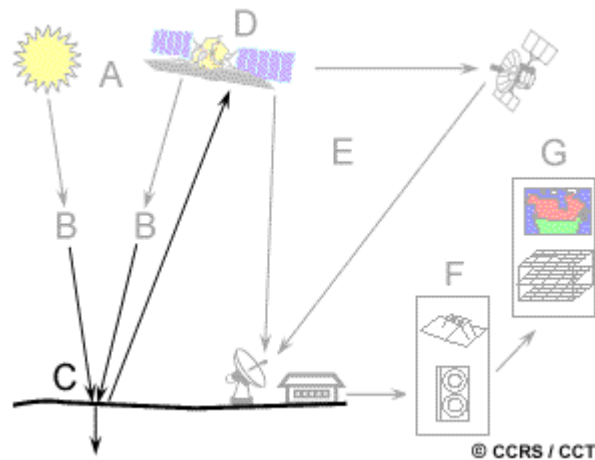

Absorption (A) occurs when radiation (energy) is absorbed into the target while transmission (T) occurs when radiation passes through a target. Reflection (R) occurs when radiation "bounces" off the target and is redirected. In remote sensing, we are most interested in measuring the radiation reflected from targets. We refer to two types of reflection, which represent the two extreme ends of the way in which energy is reflected from a target: **specular reflection** and **diffuse reflection**.

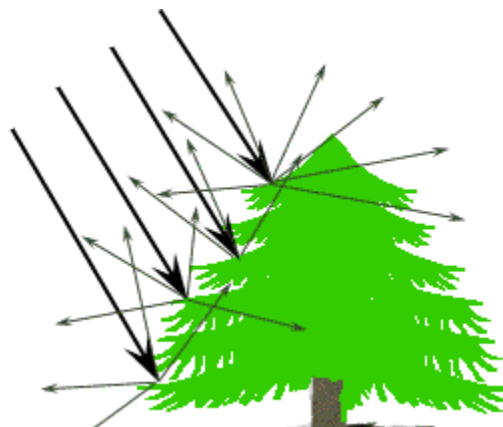
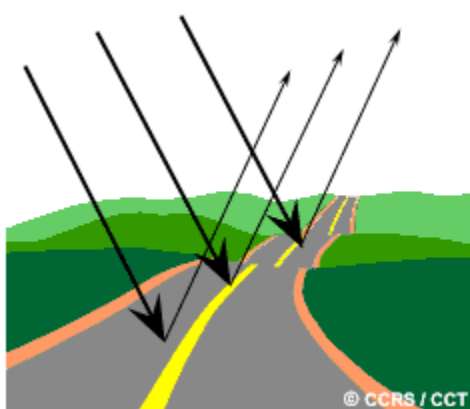



When a surface is smooth we get **specular** or mirror-like reflection where all (or almost all) of the energy is directed away from the surface in a single direction. **Diffuse** reflection occurs when the surface is rough and the energy is reflected almost uniformly in all directions. Most earth surface features lie somewhere between perfectly specular or perfectly diffuse reflectors. Whether a particular target reflects specularly or diffusely, or somewhere in between, depends on the surface roughness of the feature in comparison to the wavelength of the incoming radiation. If the wavelengths are much smaller than the surface variations or the particle sizes that make up the surface, diffuse reflection will dominate. For example, fine-grained sand would appear fairly smooth to long wavelength microwaves but would appear quite rough to the visible wavelengths.

Let's take a look at a couple of examples of targets at the Earth's surface and how energy at the visible and infrared wavelengths interacts with them.

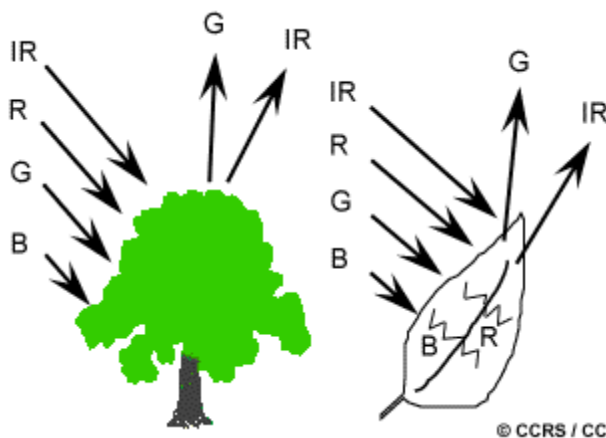

**Leaves:** A chemical compound in leaves called chlorophyll strongly absorbs radiation in the red and blue wavelengths but reflects green wavelengths. Leaves appear "greenest" to us in the summer, when chlorophyll content is at its maximum. In autumn, there is less chlorophyll in the leaves, so there is less absorption and proportionately more reflection of the red wavelengths, making the leaves appear red or yellow (yellow is a combination of red and green wavelengths). The

internal structure of healthy leaves act as excellent diffuse reflectors of near-infrared wavelengths. If our eyes were sensitive to near-infrared, trees would appear extremely bright to us at these wavelengths. In fact, measuring and monitoring the near-IR reflectance is one way that scientists can determine how healthy (or unhealthy) vegetation may be.

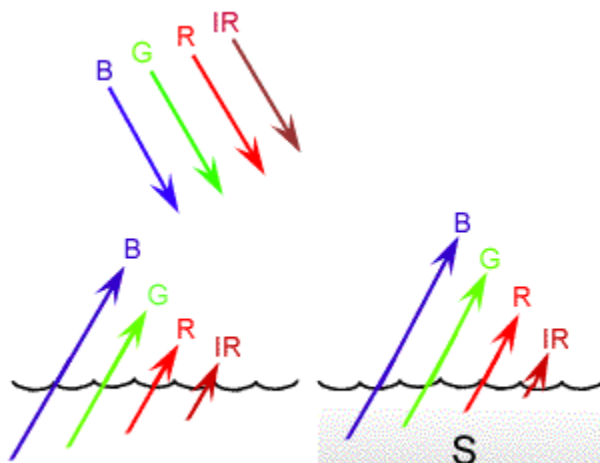

**Water:** Longer wavelength visible and near infrared radiation is absorbed more by water than shorter visible wavelengths. Thus water typically looks blue or blue-green due to stronger reflectance at these shorter wavelengths, and darker if viewed at red or near infrared wavelengths. If there is suspended sediment present in the upper layers of the water body, then this will allow better reflectivity and a brighter appearance of the water. The apparent colour of the water will show a slight shift to longer

wavelengths. Suspended sediment (S) can be easily confused with shallow (but clear) water, since these two phenomena appear very similar. Chlorophyll in algae absorbs more of the blue wavelengths and reflects the green, making the water appear more green in colour when algae is present. The topography of the water surface (rough, smooth, floating materials, etc.) can also lead to complications for water-related interpretation due to potential problems of specular reflection and other influences on colour and brightness.

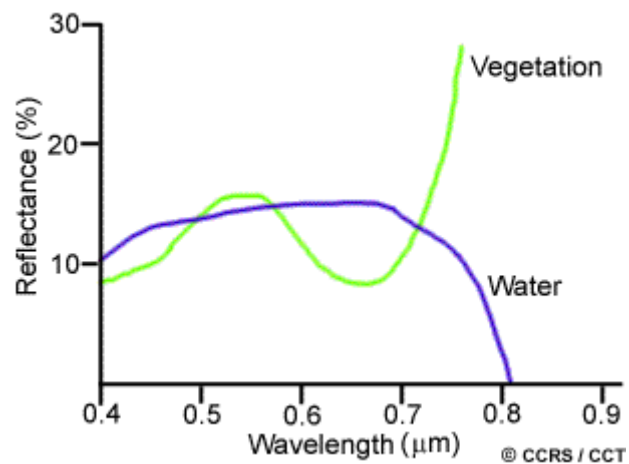

We can see from these examples that, depending on the complex make-up of the target that is being looked at, and the wavelengths of radiation involved, we can observe very different responses to the mechanisms of absorption, transmission, and reflection. By measuring the energy that is reflected (or emitted) by targets on the Earth's surface over a variety of different wavelengths, we can build up a **spectral response** for that object. By comparing the response patterns of different features we may be able to distinguish between them, where we might not be able to, if we only compared them at one wavelength. For example, water and vegetation may reflect somewhat similarly in the visible wavelengths but are almost always separable in the infrared. Spectral response can be quite variable, even for the same target type, and can also vary with time (e.g. "green-ness" of leaves) and location. Knowing where to "look" spectrally and understanding the factors which influence the spectral response of the features of interest are critical to correctly interpreting the interaction of electromagnetic radiation with the surface.

## 1.6 Passive vs. Active Sensing

So far, throughout this chapter, we have made various references to the sun as a source of energy or radiation. The sun provides a very convenient source of energy for remote sensing. The sun's energy is either **reflected**, as it is for visible wavelengths, or absorbed and then **re-emitted**, as it is for thermal infrared wavelengths. Remote sensing systems which measure energy that is naturally available are called **passive sensors**. Passive sensors can only be used to detect energy when the naturally occurring energy is available. For all reflected energy, this can only take place during the time when the sun is illuminating the Earth. There is no reflected energy available from the sun at night. Energy that is naturally emitted (such as thermal infrared) can be detected day or night, as long as the amount of energy is large enough to be recorded.

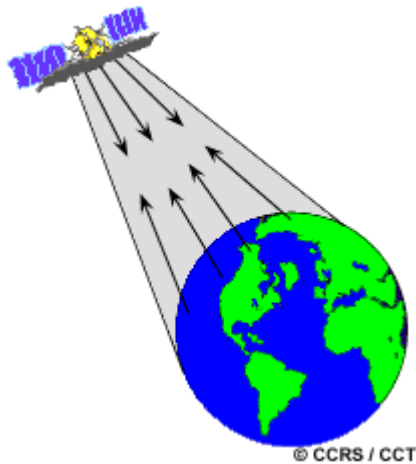
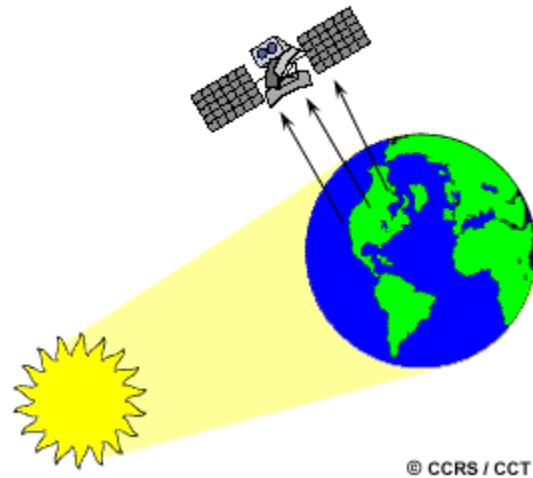

aperture radar (SAR).

**Active sensors**, on the other hand, provide their own energy source for illumination. The sensor emits radiation which is directed toward the target to be investigated. The radiation reflected from that target is detected and measured by the sensor. Advantages for active sensors include the ability to obtain measurements anytime, regardless of the time of day or season. Active sensors can be used for examining wavelengths that are not sufficiently provided by the sun, such as microwaves, or to better control the way a target is illuminated. However, active systems require the generation of a fairly large amount of energy to adequately illuminate targets. Some examples of active sensors are a laser fluorosensor and a synthetic

## 1.7 Characteristics of Images

Before we go on to the next chapter, which looks in more detail at sensors and their characteristics, we need to define and understand a few fundamental terms and concepts associated with remote sensing images.



Electromagnetic energy may be detected either photographically or electronically. The photographic process uses chemical reactions on the surface of light-sensitive film to detect and record energy variations. It is important to distinguish between the terms **images** and **photographs** in remote sensing. An image refers to any pictorial representation, regardless of what wavelengths or remote sensing device has been used to detect and record the electromagnetic energy. A **photograph** refers

specifically to images that have been detected as well as recorded on photographic film. The black and white photo to the left, of part of the city of Ottawa, Canada was taken in the visible part of the spectrum. Photos are normally recorded over the wavelength range from  $0.3 \mu\text{m}$  to  $0.9 \mu\text{m}$  - the visible and reflected infrared. Based on these definitions, we can say that all photographs are images, but not all images are photographs. Therefore, unless we are talking specifically about an image recorded photographically, we use the term image.

© CCRS / CCT

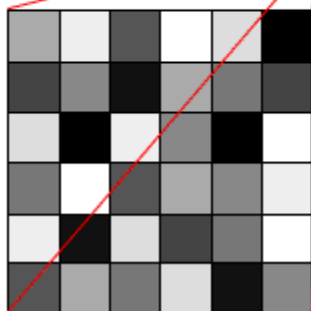

170	238	85	255	221	0
68	136	17	170	119	68
221	0	238	136	0	255
119	255	85	170	136	238
238	17	221	68	119	255
85	170	119	221	17	136

A photograph could also be represented and displayed in a **digital** format by subdividing the image into small equal-sized and shaped areas, called picture elements or **pixels**, and representing the brightness of each area with a numeric value or **digital number**. Indeed, that is exactly what has been done to the photo to the left. In fact, using the definitions we have just discussed, this is actually a **digital image** of the

original photograph! The photograph was scanned and subdivided into pixels with each pixel assigned a digital number representing its relative brightness. The computer displays each digital value as different brightness levels. Sensors that

record electromagnetic energy, electronically record the energy as an array of numbers in digital format right from the start. These two different ways of representing and displaying remote sensing data, either pictorially or digitally, are interchangeable as they convey the same information (although some detail may be lost when converting back and forth).

In previous sections we described the visible portion of the spectrum and the concept of colours. We see colour because our eyes detect the entire visible range of wavelengths and our brains process the information into separate colours. Can you imagine what the world would look like if we could only see very narrow ranges of wavelengths or colours? That is how many sensors work. The information from a narrow wavelength range is gathered and stored in a **channel**, also sometimes referred to as a **band**. We can combine and display channels of information digitally using the three primary colours (blue, green, and red). The data from each channel is represented as one of the primary colours and, depending on the relative brightness (i.e. the digital value) of each pixel in each channel, the primary colours combine in different proportions to represent different colours.

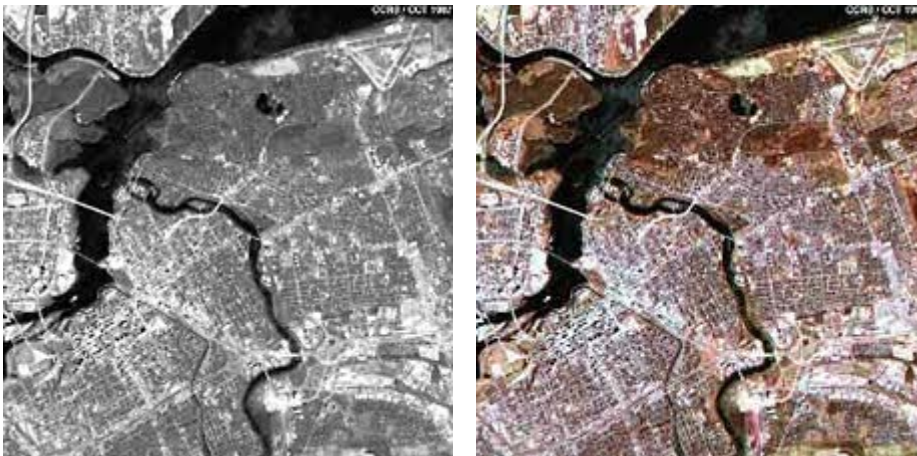

When we use this method to display a single channel or range of wavelengths, we are actually displaying that channel through all three primary colours. Because the brightness level of each pixel is the same for each primary colour, they combine to form a **black and white image**, showing various shades of gray from black to white. When we display more than one channel each as a different primary colour, then the brightness levels may be different for each channel/primary colour combination and they will combine to form a **colour image**.

## 1.8 Endnotes

You have just completed **Chapter 1 - Fundamentals of Remote Sensing**. You can continue to Chapter 2 - Satellites and Sensors or first browse the [CCRS Web site](#)<sup>1</sup> for other articles related to remote sensing fundamentals.

For instance, you may want to look at some [conventional](#)<sup>2</sup> or [unconventional definitions](#)<sup>3</sup> of "remote sensing" developed by experts and other rif-raf from around the world.

We have an explanation and calculation on just how much [you need to worry about the effect of radiation](#)<sup>4</sup> from Canada's first remote sensing satellite: RADARSAT.

The knowledge of how radiation interacts with the atmospheric is used by scientists in the Environmental Monitoring Section of CCRS to develop various ["radiation products"](#)<sup>5</sup>. Check them out!

Learn more on how various targets like [water](#)<sup>6</sup>, [rocks](#)<sup>7</sup>, [ice](#)<sup>8</sup>, [man-made features](#)<sup>9</sup>, and [oil slicks](#)<sup>10</sup> interact with microwave energy.

Our [Remote Sensing Glossary](#)<sup>11</sup> can help fill out your knowledge of remote sensing fundamentals. Try searching for specific terms of interest or review the terms in the "phenomena" category.

---

<sup>1</sup><http://www.ccrs.nrcan.gc.ca/>

<sup>2</sup>[http://www.ccrs.nrcan.gc.ca/ccrs/learn/terms/definition/convdef\\_e.html](http://www.ccrs.nrcan.gc.ca/ccrs/learn/terms/definition/convdef_e.html)

<sup>3</sup>[http://www.ccrs.nrcan.gc.ca/ccrs/learn/terms/definition/unconvdef\\_e.html](http://www.ccrs.nrcan.gc.ca/ccrs/learn/terms/definition/unconvdef_e.html)

<sup>4</sup>[http://www.ccrs.nrcan.gc.ca/ccrs/learn/fun/radiation/radiation\\_e.html](http://www.ccrs.nrcan.gc.ca/ccrs/learn/fun/radiation/radiation_e.html)

<sup>5</sup>[http://www.ccrs.nrcan.gc.ca/ccrs/rd/apps/landcov/rad/emrad\\_e.html](http://www.ccrs.nrcan.gc.ca/ccrs/rd/apps/landcov/rad/emrad_e.html)

<sup>6</sup>[http://www.ccrs.nrcan.gc.ca/ccrs/data/satsens/radarsat/images/man/rman01\\_e.html](http://www.ccrs.nrcan.gc.ca/ccrs/data/satsens/radarsat/images/man/rman01_e.html)

<sup>7</sup>[http://www.ccrs.nrcan.gc.ca/ccrs/data/satsens/radarsat/images/nwt/rnwt01\\_e.html](http://www.ccrs.nrcan.gc.ca/ccrs/data/satsens/radarsat/images/nwt/rnwt01_e.html)

<sup>8</sup>[http://www.ccrs.nrcan.gc.ca/ccrs/data/satsens/radarsat/images/pei/rpei01\\_e.html](http://www.ccrs.nrcan.gc.ca/ccrs/data/satsens/radarsat/images/pei/rpei01_e.html)

<sup>9</sup>[http://www.ccrs.nrcan.gc.ca/ccrs/rd/ana/cnfdbrig/confed\\_e.html](http://www.ccrs.nrcan.gc.ca/ccrs/rd/ana/cnfdbrig/confed_e.html)

<sup>10</sup>[http://www.ccrs.nrcan.gc.ca/ccrs/data/satsens/radarsat/images/uk/ruk01\\_e.html](http://www.ccrs.nrcan.gc.ca/ccrs/data/satsens/radarsat/images/uk/ruk01_e.html)

<sup>11</sup>[http://www.ccrs.nrcan.gc.ca/ccrs/learn/terms/glossary/glossary\\_e.html](http://www.ccrs.nrcan.gc.ca/ccrs/learn/terms/glossary/glossary_e.html)

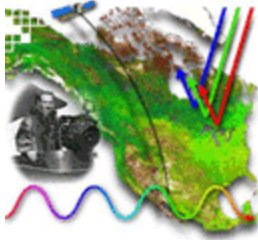

## 1. Did You Know

---

### 1.1 Did You Know?



Of our five senses (sight, hearing, taste, smell, touch), three may be considered forms of "remote sensing", where the source of information is at some distance. The other two rely on direct contact with the source of information - which are they?

## 1.2 Did You Know?

"I've Gone Batty!"

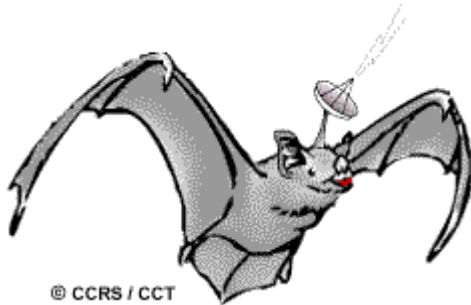

...that remote sensing, in its broadest definition, includes ultrasounds, satellite weather maps, speed radar, graduation photos, and sonar - both for ships and for bats!. Hospitals use imaging technology, including CAT scans, magnetic resonance imaging (3-D imaging of soft tissue), and x-rays for examining our bodies. These are all examples of non-intrusive remote sensing methods.

...you can use an oscilloscope, a special electronic device which displays waves similar to the electromagnetic radiation waves you have seen here, to look at the wavelength and frequency patterns of your voice. High-pitched sounds have short wavelengths and high frequencies. Low sounds are the opposite. Scientists say that the Earth itself vibrates at a very low frequency, making a sound far below the human hearing range.

...that the concept of wavelength and frequency is an important principle behind something called the Doppler Shift, which explains how sound and light waves are perceived to be compressed or expanded if the object producing them is moving relative to the sensor. As a train or race car advances towards us, our ears tend to hear progressively lower sounds or frequencies (shorter wavelengths) until it reaches us, the original frequency of the object when it is broadside, then even lower frequencies as it moves further away. This same principle (applied to light) is used by astronomers to see how quickly stars are moving away from us (the Red shift).

## 1.3 Did You Know?

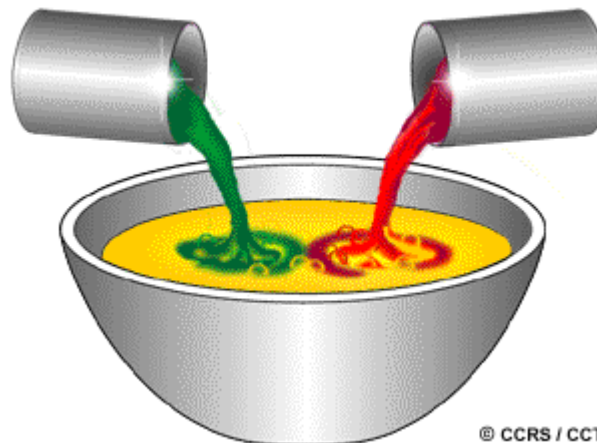

**Hue** and **saturation** are independent characteristics of colour. Hue refers to the wavelength of light, which we commonly call "colour", while saturation indicates how pure the colour is, or how much white is mixed in with it. For instance, "pink" can be considered a less saturated version of "red".



## 1.4 Did You Know?

"...sorry, no pot of gold at the end of this rainbow..."

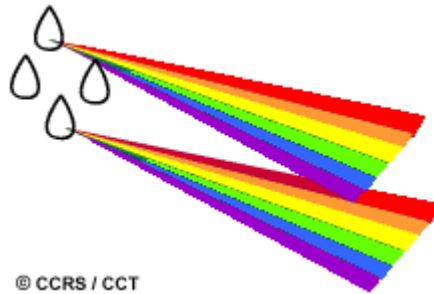

...water droplets act as tiny, individual prisms. When sunlight passes through them, the constituent wavelengths are bent in varying amounts according to wavelength. Individual colours in the sunlight are made visible and a rainbow is the result, with shorter wavelengths (violet, blue) in the inner part of the arc, and longer wavelengths (orange, red) along the outer arc.

...if scattering of radiation in the atmosphere did not take place, then shadows would appear as jet black instead of being various degrees of darkness. Scattering causes the atmosphere to have its own brightness (from the light scattered by particles in the path of sunlight) which helps to illuminate the objects in the shadows.

## 1.5 Did You Know?

"...now, here's something to 'reflect' on..."



... the colours we perceive are a combination of these radiation interactions (absorption, transmission, reflection), and represent the wavelengths being reflected. If all visible wavelengths are reflected from an object, it will appear white, while an object absorbing all visible wavelengths will appear colourless, or black.

## 1.6 Did You Know?

"...say 'Cheese!'..."

...a camera provides an excellent example of both passive and active sensors. During a bright sunny day, enough sunlight is illuminating the targets and then reflecting toward the camera lens, that the camera simply records the radiation provided (passive mode). On a cloudy day or inside a room, there is often not enough sunlight for the camera to record the targets adequately. Instead, it uses its own energy source - a flash - to illuminate the targets and record the radiation reflected from them (active mode).

... radar used by police to measure the speed of traveling vehicles is a use of active remote sensing. The radar device is pointed at a vehicle, pulses of radiation are emitted, and the reflection of that radiation from the vehicle is detected and timed. The speed of the vehicle is determined by calculating time delays between the repeated emissions and reception of the pulses. This can be calculated very accurately because the speed of the radiation is moving much, much faster than most vehicles...unless you're driving at the speed of light!



## 1.7 Did You Know?

Photographic film has the clear advantage of recording extremely fine spatial detail, since individual silver halide molecules can record light sensitivity differently than their neighbouring molecules. But when it comes to spectral and radiometric qualities, digital sensors outperform film, by being able to use extremely fine spectral bands (for spectral 'fingerprinting' of targets), and recording up to many thousands of levels of brightness.

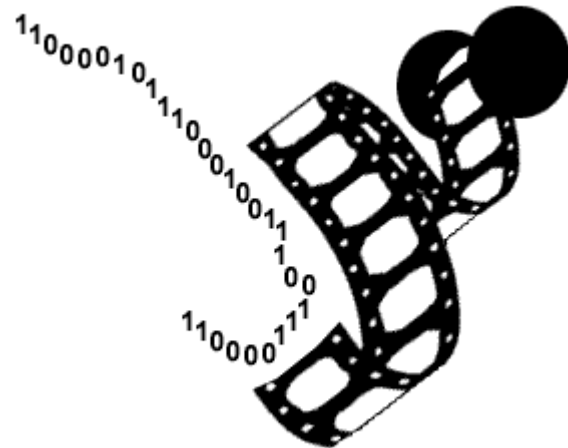

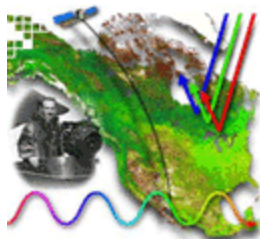

## 1. Whiz Quiz and Answers

---

### 1.1 Whiz Quiz

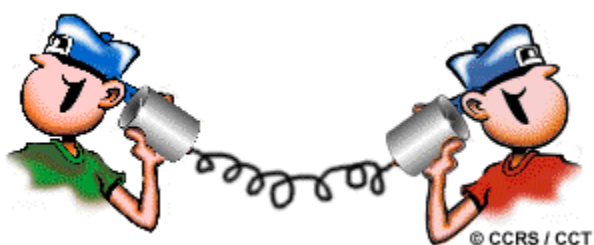

Can "remote sensing" employ anything other than electromagnetic radiation?

### 1.1 Whiz Quiz - Answer

While the term 'remote sensing' typically assumes the use of electromagnetic radiation, the more general definition of 'acquiring information at a distance', does not preclude other forms of energy. The use of sound is an obvious alternative; thus you can claim that your telephone conversation is indeed 'remote sensing'.

## 1.2 Whiz Quiz

The first requirement for remote sensing is an energy source which can illuminate a target. What is the obvious source of electromagnetic energy that you can think of? What "remote sensing device" do you personally use to detect this energy?



Assume the speed of light to be  $3 \times 10^8$  m/s. If the frequency of an electromagnetic wave is 500,000 GHz (GHz = gigahertz =  $10^9$  m/s), what is the wavelength of that radiation? Express your answer in micrometres ( $\mu\text{m}$ ).

## 1.2 Whiz Quiz - Answers

**Answer 1:** The most obvious source of electromagnetic energy and radiation is the sun. The sun provides the initial energy source for much of the remote sensing of the Earth surface. The remote sensing device that we humans use to detect radiation from the sun is our eyes. Yes, they can be considered remote sensors - and very good ones - as they detect the visible light from the sun, which allows us to see. There are other types of light which are invisible to us...but more about that later.

**Answer 2:** Using the equation for the relationship between wavelength and frequency, let's calculate the wavelength of radiation of a frequency of 500,000 GHz.



$$\begin{aligned}
 c &= \lambda \nu \\
 3 \times 10^8 &= \lambda (500,000 \times 10^9) \\
 3 \times 10^8 &= \lambda (5 \times 10^{14}) \\
 3 \times 10^8 / 5 \times 10^{14} &= \lambda \\
 6 \times 10^{-7} \text{ metres} &= \lambda
 \end{aligned}$$

### 1.3 Whiz Quiz

The infrared portion of the electromagnetic spectrum has two parts: the reflective and the emissive. Can you take photographs in these wavelength ranges?

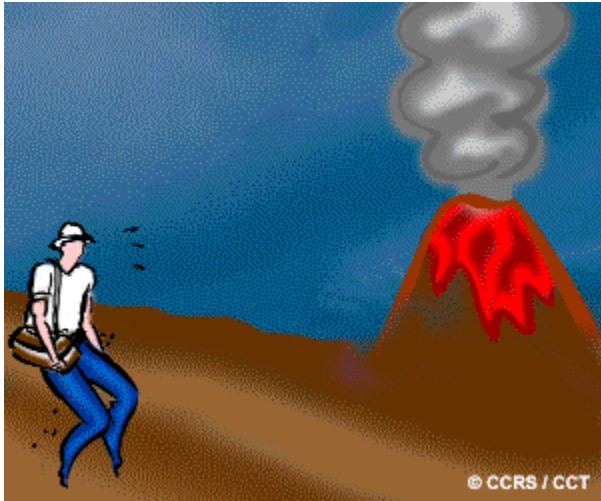

### 1.3 Whiz Quiz - Answer

Yes and no. There are photographic films in black and white as well as colour emulsions, which are sensitive to the reflective portion of the infrared band and these are used for scientific and artistic purposes too. But no photographic films exist to directly record emissive infrared (heat). If they did, then they would have to be cooled (and kept very cold during use), which would be very impractical. However there are a number of electronic devices which detect and record thermal infrared images.

## 1.4 Whiz Quiz



© CCRS / CCT

1. Most remote sensing systems avoid detecting and recording wavelengths in the ultraviolet and blue portions of the spectrum. Explain why this would be the case.

is ...

2. What do you think would be some of the best atmospheric conditions for remote sensing in the visible portion of the spectrum?

## 1.4 Whiz Quiz - Answer



© CCRS / CCT

1. Detecting and recording the ultraviolet and blue wavelengths of radiation is difficult because of scattering and absorption in the atmosphere. Ozone gas in the upper atmosphere absorbs most of the ultraviolet radiation of wavelengths shorter than about 0.25  $\mu\text{m}$ . This is actually a positive thing for us and most other living things, because of the harmful nature of ultraviolet radiation below these wavelengths. Rayleigh scattering, which affects the shorter wavelengths more severely than longer wavelengths, causes the remaining UV radiation and the shorter visible wavelengths (i.e. blue) to be scattered much more than longer wavelengths, so that very little of this energy is able to reach and interact with the Earth's surface. In fact, blue light is scattered about 4 times as much as red light, while UV light is scattered 16 times as much as red light!

2. Around noon on a sunny, dry day with no clouds and no pollution would be very good for remote sensing in the visible wavelengths. At noon the sun would be at its most directly overhead point, which would reduce the distance the radiation has to travel and therefore the effects of scattering, to a minimum. Cloud-free conditions would ensure that there will be uniform illumination and that there will be no shadows from clouds. Dry, pollutant-free conditions would minimize the scattering and absorption that would take place due to water droplets and other particles in the atmosphere.



### 1.5 Whiz Quiz



On a clear night with the crescent or half moon showing, it is possible to see the outline and perhaps very slight detail of the dark portion of the moon. Where is the light coming from, that illuminates the dark side of the moon?

### 1.5 Whiz Quiz - Answer

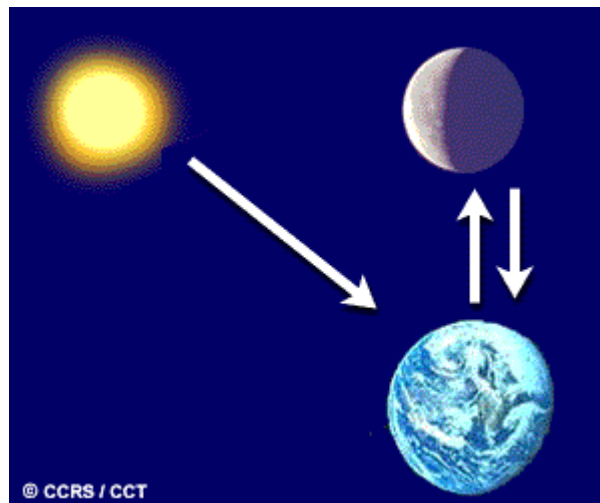

The light originates from the sun (of course), hits the earth, bounces up to the (dark side of the) moon and then comes back to the earth and into your eye. A long way around - isn't it?

## 1.6 Whiz Quiz

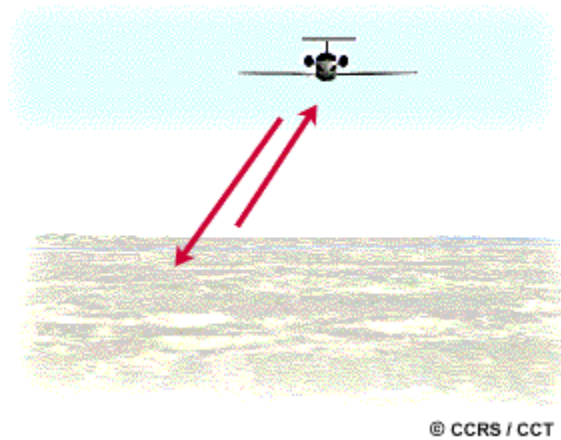

Is there a passive equivalent to the radar sensor?

### 1.6 Whiz Quiz - Answer

Indeed. The passive microwave radiometer, for instance, does not carry an illumination source, relying instead on detecting naturally emitted microwave energy. Such an instrument can be used for detecting, identifying and measuring marine oil slicks, for instance.



## 1.7 Whiz Quiz

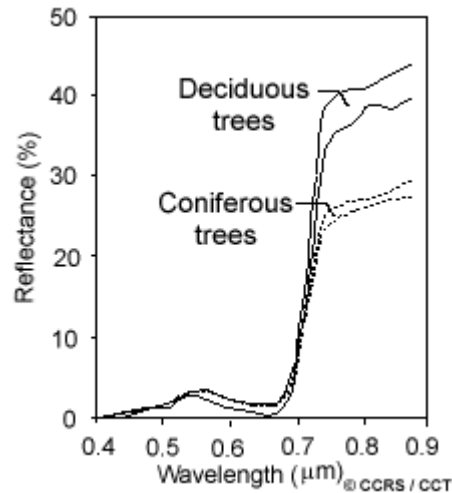

1. If you wanted to map the deciduous (e.g. maple, birch) and the coniferous (e.g. pine, fir, spruce) trees in a forest in summer using remote sensing data, what would be the best way to go about this and why? Use the reflectance curves illustrating the spectral response patterns of these two categories to help explain your answer.

2. What would be the advantage of displaying various wavelength ranges, or channels, in combination as colour images as opposed to examining each of the images individually?

## 1.7 Whiz Quiz - Answer

1. Because both types of trees will appear as similar shades of green to the naked eye, imagery (or photography) using the visible portion of the spectrum may not be useful. Trying to distinguish the different types from aerial photographs based on tree crown shape or size might also be difficult, particularly when the tree types are intermixed. Looking at the reflectance curves for the two types, it is clear that they would be difficult to distinguish using any of the visible wavelengths. However, in the near-infrared, although both types reflect a significant portion of the incident radiation, they are clearly separable. Thus, a remote sensing system, such as black and white infrared film, which detects the infrared reflectance around 0.8 mm wavelength would be ideal for this purpose.

2. By combining different channels of imagery representing different wavelengths, we may be able to identify combinations of reflectance between the different channels which highlight features that we would not otherwise be able to see, if we examine only one channel at a time. Additionally, these combinations may manifest themselves as subtle variations in colour (which our eyes are more sensitive to), rather than variations in gray tone, as would be seen when examining only one image at a time.



## 2. Satellites and Sensors

### 2.1 On the Ground, In the Air, In Space

In Chapter 1 we learned some of the fundamental concepts required to understand the process that encompasses remote sensing. We covered in some detail the first three components of this process: the energy source, interaction of energy with the atmosphere, and interaction of energy with the surface. We touched briefly on the fourth component - **recording of energy by the sensor** - when we discussed passive vs. active sensors and characteristics of images. In this chapter, we will take a closer look at this component of the remote sensing process by examining in greater detail, the characteristics of remote sensing platforms and sensors and the data they collect. We will also touch briefly on how those data are processed once they have been recorded by the sensor.

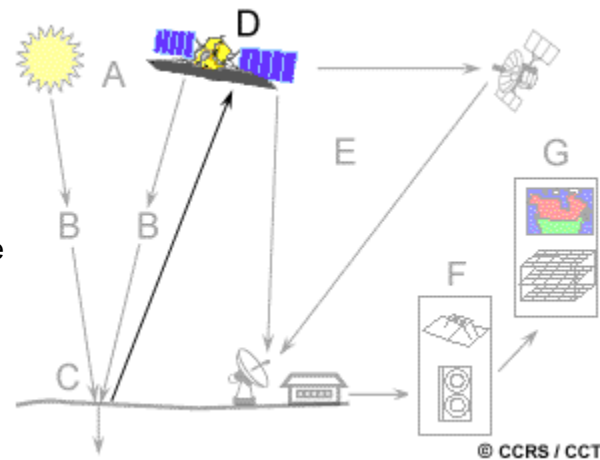

In order for a sensor to collect and record energy reflected or emitted from a target or surface, it must reside on a stable **platform** removed from the target or surface being observed. Platforms for remote sensors may be situated on the ground, on an aircraft or balloon (or some other platform within the Earth's atmosphere), or on a spacecraft or satellite outside of the Earth's atmosphere.

**Ground-based sensors** are often used to record detailed information about the surface which is compared with information collected from aircraft or satellite sensors. In some cases,

this can be used to better characterize the target which is being imaged by these other sensors, making it possible to better understand the information in the imagery.



Sensors may be placed on a ladder, scaffolding, tall building, cherry-picker, crane, etc. Aerial platforms are primarily stable wing **aircraft**, although helicopters are occasionally used. Aircraft are often used to collect very detailed images and facilitate the collection of data over virtually any portion of the Earth's surface at any time.

In space, remote sensing is sometimes conducted from the **space shuttle** or, more commonly, from satellites. **Satellites** are objects which revolve around another object - in this case, the Earth. For example, the moon is a natural satellite, whereas man-made satellites include those platforms launched for remote sensing, communication, and telemetry (location and navigation) purposes. Because of their orbits, satellites permit repetitive coverage of the Earth's surface on a continuing basis. Cost is often a significant factor in choosing among the various platform options.



## 2.2 Satellite Characteristics: Orbits and Swaths

We learned in the previous section that remote sensing instruments can be placed on a variety of platforms to view and image targets. Although ground-based and aircraft platforms may be used, satellites provide a great deal of the remote sensing imagery commonly used today. Satellites have several unique characteristics which make them particularly useful for remote sensing of the Earth's surface.

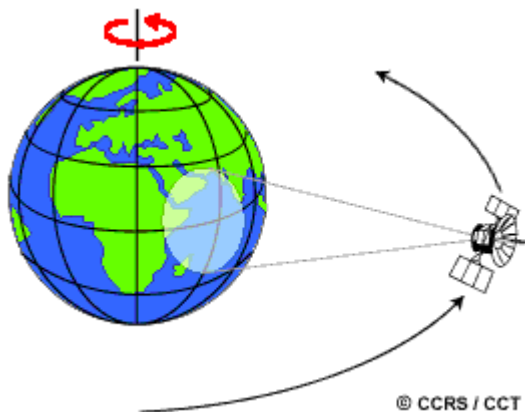

The path followed by a satellite is referred to as its **orbit**. Satellite orbits are matched to the capability and objective of the sensor(s) they carry. Orbit selection can vary in terms of altitude (their height above the Earth's surface) and their orientation and rotation relative to the Earth. Satellites at very high altitudes, which view the same portion of the Earth's surface at all times have **geostationary orbits**. These geostationary satellites, at altitudes of approximately 36,000 kilometres, revolve at speeds which match the rotation of the Earth so they seem stationary, relative to the Earth's

surface. This allows the satellites to observe and collect information continuously over specific areas. Weather and communications satellites commonly have these types of orbits. Due to their high altitude, some geostationary weather satellites can monitor weather and cloud patterns covering an entire hemisphere of the Earth.

Many remote sensing platforms are designed to follow an orbit (basically north-south) which, in conjunction with the Earth's rotation (west-east), allows them to cover most of the Earth's surface over a certain period of time. These are **near-polar orbits**, so named for the inclination of the orbit relative to a line running between the North and South poles. Many of these satellite orbits are also **sun-synchronous** such that they cover each area of the world at a constant local time of day called **local sun time**. At any given latitude, the position of the sun in the sky as the satellite passes overhead will be the same within the same season. This ensures consistent illumination conditions when acquiring images in a specific season over successive years, or over a particular area over a series of days. This is an important factor for monitoring changes between images or for mosaicking adjacent images together, as they do not have to be corrected for different illumination conditions.

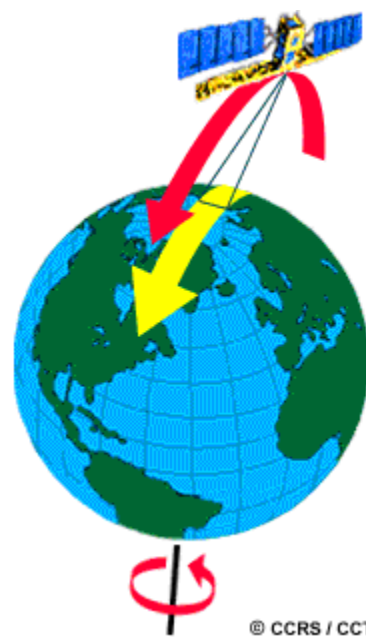

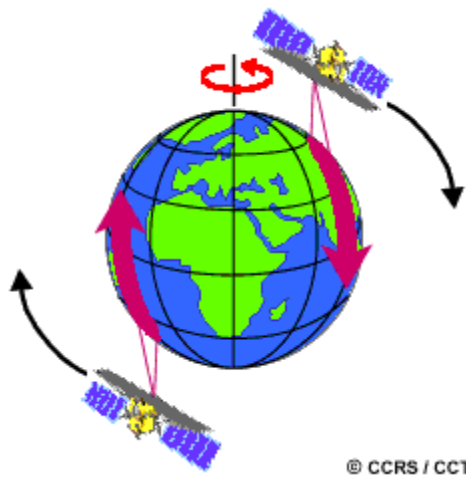

Most of the remote sensing satellite platforms today are in near-polar orbits, which means that the satellite travels northwards on one side of the Earth and then toward the southern pole on the second half of its orbit. These are called **ascending and descending passes**, respectively. If the orbit is also sun-synchronous, the ascending pass is most likely on the shadowed side of the Earth while the descending pass is on the sunlit side. Sensors recording reflected solar energy only image the surface on a descending pass, when solar illumination is available. Active sensors which provide their own illumination or passive sensors that record emitted (e.g. thermal) radiation can also image the surface on ascending

passes.

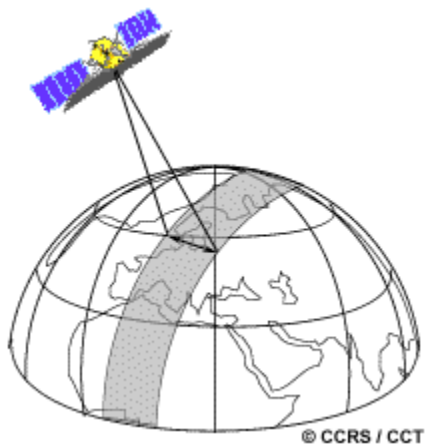

As a satellite revolves around the Earth, the sensor "sees" a certain portion of the Earth's surface. The area imaged on the surface, is referred to as the **swath**. Imaging swaths for spaceborne sensors generally vary between tens and hundreds of kilometres wide. As the satellite orbits the Earth from pole to pole, its east-west position wouldn't change if the Earth didn't rotate. However, as seen from the Earth, it seems that the satellite is shifting westward because the Earth is rotating (from west to east) beneath it. This apparent movement allows the satellite swath to cover a **new area with each consecutive pass**. The satellite's orbit and the rotation of the Earth work together to allow complete coverage of

the Earth's surface, after it has completed one complete cycle of orbits.

If we start with any randomly selected pass in a satellite's orbit, an orbit cycle will be completed when the satellite retraces its path, passing over the same point on the Earth's surface directly below the satellite (called the **nadir** point) for a second time. The exact length of time of the orbital cycle will vary with each satellite. The interval of time required for the satellite to complete its orbit cycle is not the same as the "**revisit period**". Using steerable sensors, an

satellite-borne instrument can view an area (off-nadir) before and after the orbit passes over a target, thus making the 'revisit' time less than the orbit cycle time. The revisit period is an important consideration for a number of monitoring applications, especially when frequent imaging is required (for example, to monitor the spread of an oil spill, or the extent of flooding). In near-polar orbits, areas at high latitudes will be imaged more frequently than the equatorial zone due to the increasing **overlap in adjacent swaths** as the orbit paths come closer together near the poles.

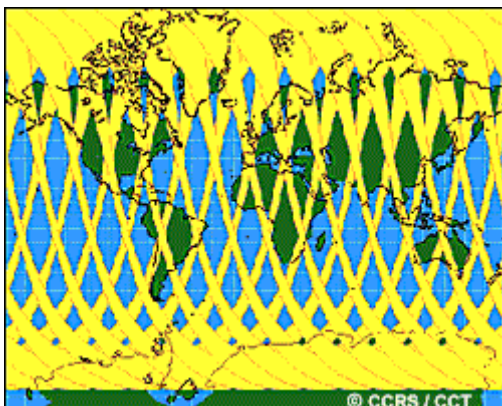
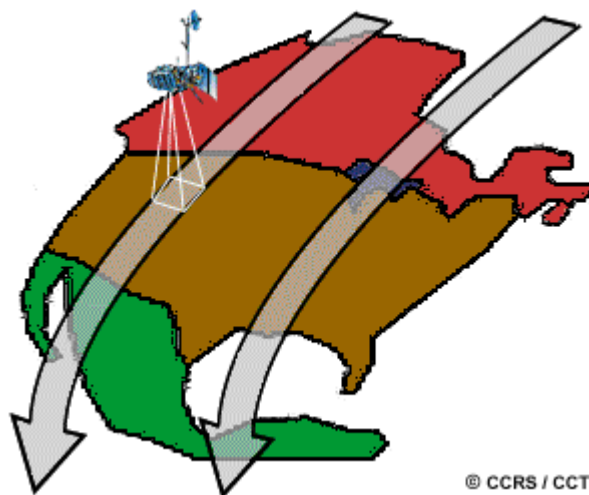

## 2.3 Spatial Resolution, Pixel Size, and Scale

For some remote sensing instruments, the distance between the target being imaged and the platform, plays a large role in determining the detail of information obtained and the total area imaged by the sensor. Sensors onboard platforms far away from their targets, typically view a larger area, but cannot provide great detail. Compare what an astronaut onboard the space shuttle sees of the Earth to what you can see from an airplane. The astronaut might see your whole province or country in one glance, but couldn't distinguish individual houses. Flying over a city or town, you would be able to see individual buildings and cars, but you would be viewing a much smaller area than the astronaut. There is a similar difference between satellite images and airphotos.

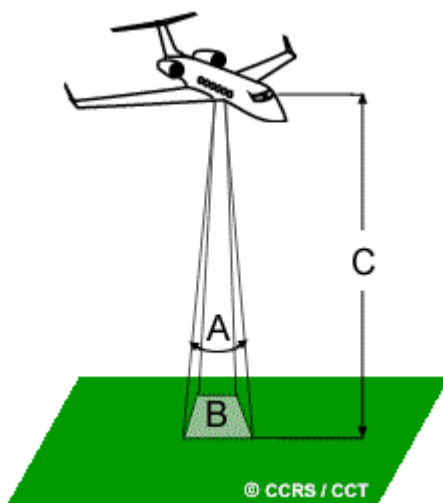

The detail discernible in an image is dependent on the **spatial resolution** of the sensor and refers to the size of the smallest possible feature that can be detected. Spatial resolution of passive sensors (we will look at the special case of active microwave sensors later) depends primarily on their **Instantaneous Field of View (IFOV)**. The IFOV is the angular cone of visibility of the sensor (A) and determines the area on the Earth's surface which is "seen" from a given altitude at one particular moment in time (B). The size of the area viewed is determined by multiplying the IFOV by the distance from the ground to the sensor (C). This area on the ground is called the **resolution cell** and determines a sensor's maximum spatial resolution. For a homogeneous feature to be

detected, its size generally has to be equal to or larger than the resolution cell. If the feature is smaller than this, it may not be detectable as the average brightness of all features in that resolution cell will be recorded. However, smaller features may sometimes be detectable if their reflectance dominates within a particular resolution cell allowing sub-pixel or resolution cell detection.

As we mentioned in Chapter 1, most remote sensing images are composed of a matrix of picture elements, or **pixels**, which are the smallest units of an image. Image pixels are normally square and represent a certain area on an image. It is important to distinguish between pixel size and spatial resolution - they are not interchangeable. If a sensor has a spatial resolution of 20 metres and an image from that sensor is displayed at full resolution, each pixel represents an area of 20m x 20m on the ground. In this case the pixel size and resolution are the same. However, it is possible to display an image with a pixel size different than the resolution. Many posters of satellite images of the Earth have their pixels averaged to represent larger areas, although the original spatial resolution of the sensor that collected the imagery remains the same.



Images where only large features are visible are said to have **coarse or low resolution**. In **fine or high resolution** images, small objects can be detected. Military sensors for example, are designed to view as much detail as possible, and therefore have very fine resolution. Commercial satellites provide imagery with resolutions varying from a few metres to several kilometres. Generally speaking, the finer the resolution, the less total ground area can be seen.

The ratio of distance on an image or map, to actual ground distance is referred to as scale. If you had a map with a scale of 1:100,000, an object of 1cm length on the map would actually be an object 100,000cm (1km) long on the ground. Maps or images with small "map-to-ground ratios" are referred to as small scale (e.g. 1:100,000), and those with larger ratios (e.g. 1:5,000) are called large scale.



## 2.4 Spectral Resolution

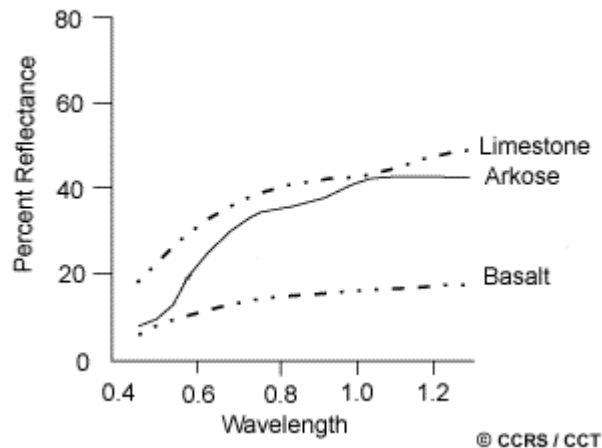

In Chapter 1, we learned about **spectral response** and **spectral emissivity curves** which characterize the reflectance and/or emittance of a feature or target over a variety of wavelengths. Different classes of features and details in an image can often be distinguished by comparing their responses over distinct wavelength ranges. Broad classes, such as water and vegetation, can usually be separated using very broad wavelength ranges - the visible and near infrared - as we learned in section 1.5. Other more specific classes, such as **different rock types**, may not be easily distinguishable using either of these broad wavelength ranges and would require comparison at much finer wavelength ranges to separate them. Thus, we would require a sensor with higher **spectral resolution**. Spectral resolution describes the ability of a sensor to define fine wavelength intervals. The finer the spectral resolution, the narrower the wavelength range for a particular channel or band.

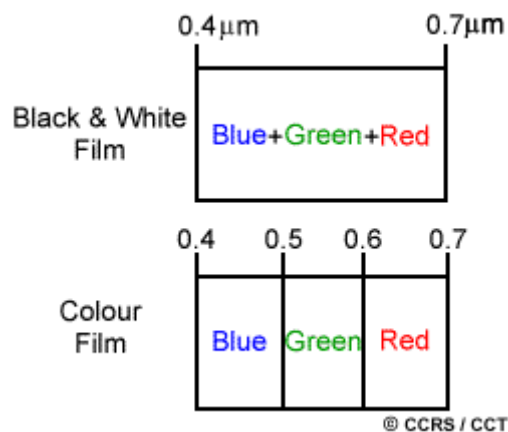

Black and white film records wavelengths extending over much, or all of the visible portion of the electromagnetic spectrum. Its **spectral resolution** is fairly coarse, as the various wavelengths of the visible spectrum are not individually distinguished and the overall

reflectance in the entire visible portion is recorded. Colour film is also sensitive to the reflected energy over the visible portion of the spectrum, but has higher spectral resolution, as it is individually sensitive to the reflected energy at the blue, green, and red wavelengths of the spectrum. Thus, it can represent features of various colours based on their reflectance in each of these distinct wavelength ranges.

Many remote sensing systems record energy over several separate wavelength ranges at various spectral resolutions. These are referred to as **multi-spectral sensors** and will be described in some detail in following sections. Advanced multi-spectral sensors called **hyperspectral** sensors, detect hundreds of very narrow spectral bands throughout the visible, near-infrared, and mid-infrared portions of the electromagnetic spectrum. Their very high spectral resolution facilitates fine discrimination between different targets based on their spectral response in each of the narrow bands.

## 2.5 Radiometric Resolution

While the arrangement of pixels describes the spatial structure of an image, the radiometric characteristics describe the actual information content in an image. Every time an image is acquired on film or by a sensor, its sensitivity to the magnitude of the electromagnetic energy determines the **radiometric resolution**. The radiometric resolution of an imaging system describes its ability to discriminate very slight differences in energy. The finer the radiometric resolution of a sensor, the more sensitive it is to detecting small differences in reflected or emitted energy.



Imagery data are represented by positive digital numbers which vary from 0 to (one less than) a selected power of 2. This range corresponds to the number of bits used for coding numbers in binary format. Each bit records an exponent of power 2 (e.g. 1 bit =  $2^1 = 2$ ). The maximum number of brightness levels available depends on the number of bits used in representing the energy recorded. Thus, if a sensor used 8 bits to record the data, there would be  $2^8 = 256$  digital values available, ranging from 0 to 255. However, if only 4 bits were used, then only  $2^4 = 16$  values ranging from 0 to 15 would be available. Thus, the radiometric resolution would be much less. Image data are generally displayed in a range of grey tones, with black representing a digital number of 0 and white representing the maximum value (for example, 255 in 8-bit data). By **comparing a 2-bit image with an 8-bit image**, we can see that there is a large difference in the level of detail discernible depending on their radiometric resolutions.

## 2.6 Temporal Resolution

In addition to spatial, spectral, and radiometric resolution, the concept of **temporal resolution** is also important to consider in a remote sensing system. We alluded to this idea in section 2.2 when we discussed the concept of revisit period, which refers to the length of time it takes for a satellite to complete one entire orbit cycle. The revisit period of a satellite sensor is usually several days. Therefore the absolute temporal resolution of a remote sensing system to image the exact same area at the same viewing angle a second time is equal to this period. However, because of some degree of overlap in the imaging swaths of adjacent orbits for most satellites and the increase in this overlap with increasing latitude, some areas of the Earth tend to be re-imaged more frequently. Also, some satellite systems are able to **point their sensors to image the same area** between different satellite passes separated by periods from one to five days. Thus, the actual temporal resolution of a sensor depends on a variety of factors, including the satellite/sensor capabilities, the swath overlap, and latitude.

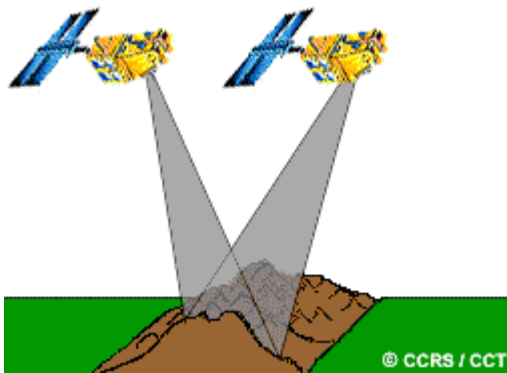

The ability to collect imagery of the same area of the Earth's surface at different periods of time is one of the most important elements for applying remote sensing data. Spectral characteristics of features may change over time and these changes can be detected by collecting and comparing **multi-temporal** imagery. For example, during the growing season, most species of vegetation are in a continual state of change and our ability to monitor those subtle changes using remote sensing is dependent on when and how frequently we collect imagery. By imaging on a continuing basis at different times we are able to monitor the changes that take place on the Earth's surface, whether they are naturally occurring (such as changes in natural vegetation cover or flooding) or induced by humans (such as urban development or deforestation). The time factor in imaging is important when:

- persistent clouds offer limited clear views of the Earth's surface (often in the tropics)
- short-lived phenomena (floods, oil slicks, etc.) need to be imaged
- multi-temporal comparisons are required (e.g. the spread of a forest disease from one year to the next)
- the changing appearance of a feature over time can be used to distinguish it from near-similar features (wheat / maize)

## 2.7 Cameras and Aerial Photography

Cameras and their use for aerial photography are the simplest and oldest of sensors used for remote sensing of the Earth's surface. Cameras are **framing systems** which acquire a near-instantaneous "snapshot" of an **area (A)**, of the surface. Camera systems are passive optical sensors that use a **lens (B)** (or system of lenses collectively referred to as the optics) to form an image at the focal plane (C), the plane at which an image is sharply defined.

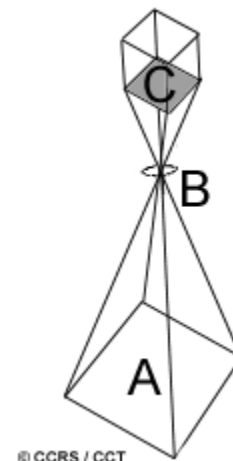

Photographic films are sensitive to light from 0.3  $\mu\text{m}$  to 0.9  $\mu\text{m}$  in wavelength covering the ultraviolet (UV), visible, and near-infrared (NIR). **Panchromatic** films are sensitive to the UV and the visible portions of the spectrum. Panchromatic film produces black and white images and is the most common type of film used for aerial photography. UV photography also uses panchromatic film, but a filter is used with the camera to absorb and block the visible energy from reaching the film. As a result, only the UV reflectance from targets is recorded. UV photography is not widely used, because of the atmospheric scattering and absorption that occurs in this region of the spectrum. Black and white infrared photography uses film sensitive to the entire 0.3 to 0.9  $\mu\text{m}$  wavelength range and is useful for detecting differences in vegetation cover, due to its sensitivity to IR reflectance.



Colour and false colour (or colour infrared, CIR) photography involves the use of a three layer film with each layer sensitive to different ranges of light. For a **normal colour photograph**, the layers are sensitive to blue, green, and red light - the same as our eyes. These photos appear to us the same way that our eyes see the environment, as the colours resemble those which would appear to us as "normal" (i.e. trees appear green, etc.). In colour infrared (CIR) photography, the three emulsion layers are sensitive to green, red, and the photographic portion of near-infrared radiation, which are processed to appear as blue, green, and red,

respectively. In a **false colour photograph**, targets with high near-infrared reflectance appear red, those with a high red reflectance appear green, and those with a high green reflectance appear blue, thus giving us a "false" presentation of the targets relative to the colour we normally perceive them to be.

Cameras can be used on a variety of platforms including ground-based stages, helicopters, aircraft, and spacecraft. Very detailed photographs taken from aircraft are useful for many applications where identification of detail or small targets is required. The ground coverage of a photo depends on several factors, including the focal length of the lens, the platform altitude, and the format and size of the film. The focal length effectively controls the **angular field of view** of the lens (similar to the concept of instantaneous field of view discussed in section 2.3) and determines the area "seen" by the camera. Typical focal lengths used are 90mm, 210mm, and most commonly, 152mm. The longer the focal length, the smaller the area covered on the ground, but with greater detail (i.e. larger scale). The area covered also depends on the altitude of the platform. At high altitudes, a camera will "see" a larger area on the ground than at lower altitudes, but with reduced detail (i.e. smaller scale). Aerial photos can provide fine detail down to spatial resolutions of less than 50 cm. A photo's exact spatial resolution varies as a complex function of many factors which vary with each acquisition of data.



Most aerial photographs are classified as either **oblique** or **vertical**, depending on the orientation of the camera relative to the ground during acquisition. **Oblique aerial photographs** are taken with the camera pointed to the side of the aircraft. High oblique photographs usually include the horizon while low oblique photographs do not. Oblique photographs can be useful for covering very large areas in a single image and for depicting terrain relief and scale. However, they are not widely used for mapping as distortions in scale from the foreground to the background preclude easy measurements of distance, area, and elevation.

**Vertical photographs** taken with a single-lens frame camera is the most common use of aerial photography for remote sensing and mapping purposes. These cameras are specifically built for capturing a rapid sequence of photographs while limiting geometric distortion. They are often linked with navigation systems onboard the aircraft platform, to allow for accurate geographic coordinates to be instantly assigned to each photograph. Most camera systems also include mechanisms which compensate for the effect of the aircraft motion relative to the ground, in order to limit distortion as much as possible.

When obtaining vertical aerial photographs, the aircraft normally flies in a series of lines, each called a **flight line**. Photos are taken in rapid succession looking straight down at the ground, often with a 50-60 percent overlap (A) between successive photos. The overlap ensures total coverage along a flight line and also facilitates **stereoscopic viewing**. Successive photo pairs display the overlap region from different perspectives and can be viewed through a device called a **stereoscope** to see a three-dimensional view of the area, called a **stereo model**. Many applications of aerial photography use stereoscopic coverage and stereo viewing.

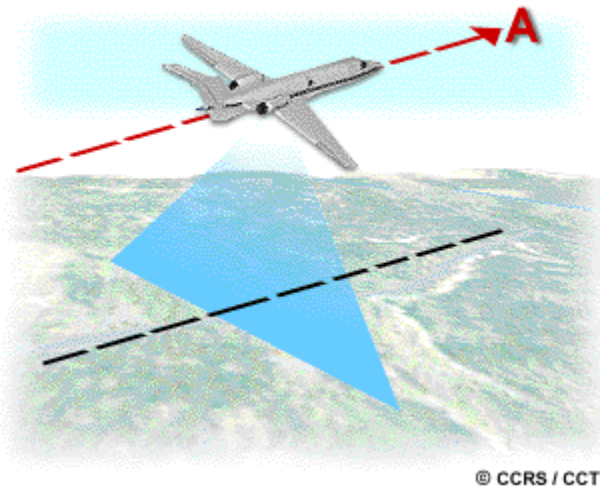

Aerial photographs are most useful when fine spatial detail is more critical than spectral information, as their spectral resolution is generally coarse when compared to data captured with electronic sensing devices. The geometry of vertical photographs is well understood and it is possible to make very accurate measurements from them, for a variety of different applications (geology, forestry, mapping, etc.). The science of making measurements from photographs is called **photogrammetry** and has been performed extensively since the very beginnings of aerial photography. Photos are most often interpreted manually by a human analyst (often viewed stereoscopically). They can also be scanned to create a digital image and then analyzed in a digital computer environment. In Chapter 4, we will discuss in greater detail, various methods (manually and by computer) for interpreting different types of remote sensing images.

**Multiband photography** uses multi-lens systems with different film-filter combinations to acquire photos simultaneously in a number of different spectral ranges. The advantage of these types of cameras is their ability to record reflected energy separately in discrete wavelength ranges, thus providing potentially better separation and identification of various features. However, simultaneous analysis of these multiple photographs can be problematic. **Digital cameras**, which record electromagnetic radiation electronically, differ significantly from their counterparts which use film. Instead of using film, digital cameras use a gridded array of silicon coated CCDs (charge-coupled devices) that individually respond to electromagnetic radiation. Energy reaching the surface of the CCDs causes the generation of an electronic charge which is proportional in magnitude to the "brightness" of the ground area. A digital number for each spectral band is assigned to each pixel based on the magnitude of the electronic charge. The digital format of the output image is amenable to digital analysis and archiving in a computer environment, as well as output as a hardcopy product similar to regular photos. Digital cameras also provide quicker turn-around for acquisition and retrieval of data and allow greater control of the spectral resolution. Although parameters vary, digital imaging systems are capable of collecting data with a spatial resolution of 0.3m, and with a spectral resolution of 0.012 mm to 0.3 mm. The size of the pixel arrays varies between systems, but typically ranges between 512 x 512 to 2048 x 2048.

## 2.8 Multispectral Scanning

Many electronic (as opposed to photographic) remote sensors acquire data using **scanning systems**, which employ a sensor with a narrow field of view (i.e. IFOV) that sweeps over the terrain to build up and produce a two-dimensional image of the surface. Scanning systems can be used on both aircraft and satellite platforms and have essentially the same operating principles. A scanning system used to collect data over a variety of different wavelength ranges is called a **multispectral scanner (MSS)**, and is the most commonly used scanning system. There are two main modes or methods of scanning employed to acquire multispectral image data - **across-track scanning**, and **along-track scanning**.

**Across-track scanners** scan the Earth in a series of lines. The lines are oriented perpendicular to the direction of motion of the sensor platform (i.e. across the swath). Each line is scanned from one side of the sensor to the other, using a **rotating mirror (A)**. As the platform moves forward over the Earth, successive scans build up a two-dimensional image of the Earth's surface. The incoming reflected or emitted radiation is separated into several spectral components that are detected independently. The UV, visible, near-infrared, and thermal radiation are dispersed into their constituent wavelengths. A bank of internal **detectors (B)**, each sensitive to a specific range of wavelengths, detects and measures the energy for each spectral band and then, as an electrical signal, they are converted to digital data and recorded for subsequent computer processing.

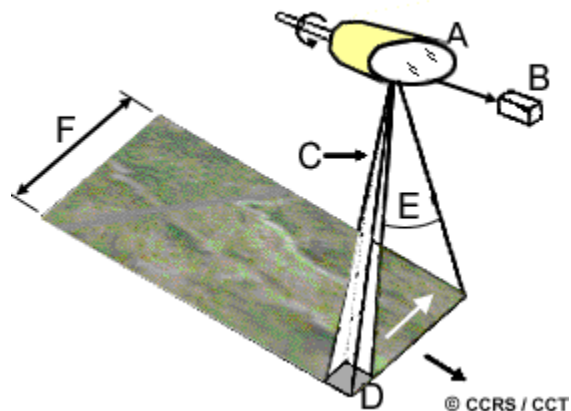

The **IFOV (C)** of the sensor and the altitude of the platform determine the **ground resolution cell viewed (D)**, and thus the spatial resolution. The **angular field of view (E)** is the sweep of the mirror, measured in degrees, used to record a scan line, and determines the width of the imaged **swath (F)**. Airborne scanners typically sweep large angles (between 90° and 120°), while satellites, because of their higher altitude need only to sweep fairly small angles (10-20°) to cover a broad region. Because the distance from the sensor to the target increases towards the edges of the swath, the ground resolution cells also become larger and introduce geometric distortions to the images. Also, the length of time the IFOV "sees" a ground resolution cell as the rotating mirror scans (called the **dwelt time**), is generally quite short and influences the design of the spatial, spectral, and radiometric resolution of the sensor.



**Along-track scanners** also use the forward motion of the platform to record successive scan lines and build up a two-dimensional image, perpendicular to the flight direction. However, instead of a scanning mirror, they use a linear array of detectors (A) located at the focal plane of the image (B) formed by lens systems (C), which are "pushed" along in the flight track direction (i.e. along track). These systems are also referred to as **pushbroom scanners**, as the motion of the detector array is analogous to the bristles of a broom being pushed along a floor. Each individual detector measures the energy for a single ground resolution cell (D) and thus the size and IFOV of the detectors determines the spatial resolution of the system. A separate linear array is required to measure each spectral band or channel. For each scan line, the energy detected by each detector of each linear array is sampled electronically and digitally recorded.

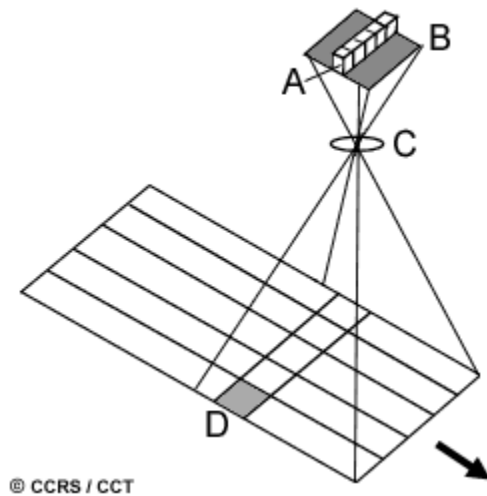

Along-track scanners with linear arrays have several advantages over across-track mirror scanners. The array of detectors combined with the pushbroom motion allows each detector to "see" and measure the energy from each ground resolution cell for a longer period of time (dwell time). This allows more energy to be detected and improves the radiometric resolution. The increased dwell time also facilitates smaller IFOVs and narrower bandwidths for each detector. Thus, finer spatial and spectral resolution can be achieved without impacting radiometric resolution. Because detectors are usually solid-state microelectronic devices, they are generally smaller, lighter, require less power, and are more reliable and last longer because they have no moving parts. On the other hand, cross-calibrating thousands of detectors to achieve uniform sensitivity across the array is necessary and complicated.

Regardless of whether the scanning system used is either of these two types, it has several advantages over photographic systems. The spectral range of photographic systems is restricted to the visible and near-infrared regions while MSS systems can extend this range into the thermal infrared. They are also capable of much higher spectral resolution than photographic systems. Multi-band or multispectral photographic systems use separate lens systems to acquire each spectral band. This may cause problems in ensuring that the different bands are comparable both spatially and radiometrically and with registration of the multiple images. MSS systems acquire all spectral bands simultaneously through the same optical system to alleviate these problems. Photographic systems record the energy detected by means of a photochemical process which is difficult to measure and to make consistent. Because MSS data are recorded electronically, it is easier to determine the specific amount of energy measured, and they can record over a greater range of values in a digital format. Photographic systems require a continuous supply of film and processing on the ground after the photos have been taken. The digital recording in MSS systems facilitates transmission of data to receiving stations on the ground and immediate processing of data in a computer environment.

## 2.9 Thermal Imaging

Many multispectral (MSS) systems sense radiation in the thermal infrared as well as the visible and reflected infrared portions of the spectrum. However, remote sensing of energy emitted from the Earth's surface in the thermal infrared ( $3\ \mu\text{m}$  to  $15\ \mu\text{m}$ ) is different than the sensing of reflected energy. **Thermal sensors** use photo detectors sensitive to the direct contact of photons on their surface, to detect emitted thermal radiation. The detectors are cooled to temperatures close to absolute zero in order to limit their own thermal emissions. Thermal sensors essentially measure the surface temperature and thermal properties of targets.

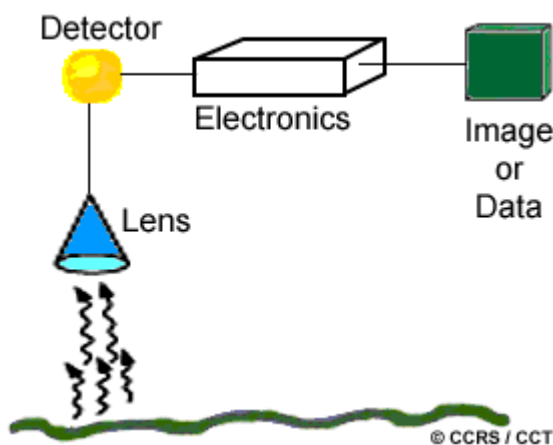

**Thermal imagers** are typically across-track scanners (like those described in the previous section) that detect emitted radiation in only the thermal portion of the spectrum. Thermal sensors employ one or more internal temperature references for comparison with the detected radiation, so they can be related to absolute radiant temperature. The data are generally recorded on film and/or magnetic tape and the temperature resolution of current sensors can reach  $0.1\ ^\circ\text{C}$ . For analysis, an image of relative radiant temperatures

(a **thermogram**) is depicted in grey levels, with warmer temperatures shown in light tones, and cooler temperatures in dark tones. Imagery which portrays relative temperature differences in their relative spatial locations are sufficient for most applications. Absolute temperature measurements may be calculated but require accurate calibration and measurement of the temperature references and detailed knowledge of the thermal properties of the target, geometric distortions, and radiometric effects.

Because of the relatively long wavelength of thermal radiation (compared to visible radiation), atmospheric scattering is minimal. However, absorption by atmospheric gases normally

restricts thermal sensing to two specific regions - 3 to 5  $\mu\text{m}$  and 8 to 14  $\mu\text{m}$ . Because energy decreases as the wavelength increases, thermal sensors generally have large IFOVs to ensure that enough energy reaches the detector in order to make a reliable measurement. Therefore the spatial resolution of thermal sensors is usually fairly coarse, relative to the spatial resolution possible in the visible and reflected infrared. Thermal imagery can be acquired during the day or night (because the radiation is emitted not reflected) and is used for a variety of applications such as military reconnaissance, disaster management (forest fire mapping), and heat loss monitoring.

## 2.10 Geometric Distortion in Imagery

Any remote sensing image, regardless of whether it is acquired by a multispectral scanner on board a satellite, a photographic system in an aircraft, or any other platform/sensor combination, will have various geometric distortions. This problem is inherent in remote sensing, as we attempt to accurately represent the three-dimensional surface of the Earth as a two-dimensional image. All remote sensing images are subject to some form of geometric distortions, depending on the manner in which the data are acquired. These errors may be due to a variety of factors, including one or more of the following, to name only a few:

- the perspective of the sensor optics,
- the motion of the scanning system,
- the motion and (in)stability of the platform,
- the platform altitude, attitude, and velocity,
- the terrain relief, and
- the curvature and rotation of the Earth.

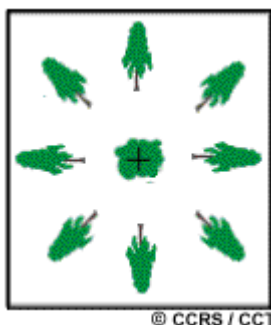

Framing systems, such as cameras used for aerial photography, provide an instantaneous "snapshot" view of the Earth from directly overhead. The primary geometric distortion in vertical aerial photographs is due to **relief displacement**. Objects directly below the centre of the camera lens (i.e. at the **nadir**) will have only their tops visible, while all other objects will appear to lean away from the centre of the photo such that their tops and sides are visible. If the objects are tall or are far away from the centre of the photo, the distortion and positional error will be larger.

The geometry of along-track scanner imagery is similar to that of an aerial photograph for each scan line as each detector essentially takes a "snapshot" of each ground resolution cell. Geometric variations between lines are caused by random variations in platform altitude and attitude along the direction of flight.

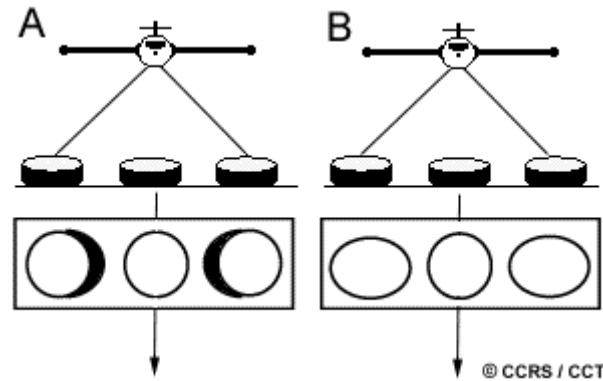

Images from across-track scanning systems exhibit two main types of **geometric distortion**. They too exhibit relief displacement (A), similar to aerial photographs, but in only one direction parallel to the direction of scan. There is no displacement directly below the sensor, at nadir. As the sensor scans across the swath, the top and side of objects are imaged and appear to lean away from the nadir point in each scan line. Again, the displacement increases, moving towards the edges of the swath. Another distortion (B) occurs due to the rotation of the scanning optics. As the sensor scans across each line, the distance from the sensor to the ground increases further away from the centre of the swath. Although the scanning mirror rotates at a constant speed, the IFOV of the sensor moves faster (relative to the ground) and scans a larger area as it moves closer to the edges. This effect results in the compression of image features at points away from the nadir and is called **tangential scale distortion**. All images are susceptible to geometric distortions caused by variations in platform stability including changes in their speed, altitude, and attitude (angular orientation with respect to the ground) during data acquisition. These effects are most pronounced when using aircraft platforms and are alleviated to a large degree with the use of satellite platforms, as their orbits are relatively stable, particularly in relation to their distance from the Earth. However, the eastward rotation of the Earth, during a satellite orbit causes the sweep of scanning systems to cover an area slightly to the west of each previous scan. The resultant imagery is thus skewed across the image. This is known as **skew distortion** and is common in imagery obtained from satellite multispectral scanners.

The sources of geometric distortion and positional error vary with each specific situation, but are inherent in remote sensing imagery. In most instances, we may be able to remove, or at least reduce these errors but they must be taken into account in each instance before attempting to make measurements or extract further information.

Now that we have learned about some of the general characteristics of platforms and sensors, in the next sections we will look at some specific sensors (primarily satellite systems) operating in the visible and infrared portions of the spectrum.

## 2.11 Weather Satellites/Sensors



Weather monitoring and forecasting was one of the first civilian (as opposed to military) applications of satellite remote sensing, dating back to the first true weather satellite, TIROS-1 (Television and Infrared Observation Satellite - 1), launched in 1960 by the United States. Several other weather satellites were launched over the next five years, in near-polar orbits, providing repetitive coverage of global weather patterns. In 1966, NASA (the U.S. National Aeronautics and Space Administration) launched the geostationary Applications Technology Satellite (ATS-1) which provided **hemispheric images** of the Earth's surface and cloud cover every half hour.

For the first time, the development and movement of weather systems could be routinely monitored. Today, several countries operate weather, or meteorological satellites to monitor weather conditions around the globe. Generally speaking, these satellites use sensors which have fairly coarse spatial resolution (when compared to systems for observing land) and provide large areal coverage.

Their temporal resolutions are generally quite high, providing frequent observations of the Earth's surface, atmospheric moisture, and cloud cover, which allows for near-continuous monitoring of global weather conditions, and hence - forecasting. Here we review a few of the representative satellites/sensors used for meteorological applications.

### GOES



The GOES (Geostationary Operational Environmental Satellite) System is the follow-up to the ATS series. They were designed by NASA for the National Oceanic and Atmospheric Administration (NOAA) to provide the United States National Weather Service with frequent, small-scale imaging of the Earth's surface and cloud cover. The GOES series of satellites have been used extensively by meteorologists for weather monitoring and forecasting for over 20 years. These satellites are part of a global network of meteorological

satellites spaced at approximately 70° longitude intervals around the Earth in order to provide near-global coverage. Two GOES satellites, placed in **geostationary orbits** 36000 km above the equator, each view approximately one-third of the Earth. One is situated at 75°W longitude and monitors North and South America and most of the Atlantic Ocean. The other is situated at 135°W longitude and monitors North America and the Pacific Ocean basin. Together they

cover from 20°W to 165°E longitude. This GOES image covers a portion of the southeastern United States, and the adjacent ocean areas where many severe storms originate and develop. This image shows Hurricane Fran approaching the southeastern United States and the Bahamas in September of 1996.

Two generations of GOES satellites have been launched, each measuring emitted and reflected radiation from which atmospheric temperature, winds, moisture, and cloud cover can be derived. The first generation of satellites consisted of GOES-1 (launched 1975) through GOES-7 (launched 1992). Due to their design, these satellites were capable of viewing the Earth only a small percentage of the time (approximately five per cent). The second generation of satellites began with GOES-8 (launched 1994) and has numerous technological improvements over the first series. They provide near-continuous observation of the Earth allowing more frequent imaging (as often as every 15 minutes). This increase in temporal resolution coupled with improvements in the spatial and radiometric resolution of the sensors provides timelier information and improved data quality for forecasting meteorological conditions.

GOES-8 and the other second generation GOES satellites have separate **imaging** and **sounding** instruments. The **imager** has five channels sensing visible and infrared reflected and emitted solar radiation. The infrared capability allows for day and night imaging. Sensor pointing and scan selection capability enable imaging of an entire hemisphere, or small-scale imaging of selected areas. The latter allows meteorologists to monitor specific weather trouble spots to assist in improved short-term forecasting. The imager data are 10-bit radiometric resolution, and can be transmitted directly to local user terminals on the Earth's surface. The accompanying table describes the individual bands, their spatial resolution, and their meteorological applications.

### GOES Bands

Band	Wavelength Range (> $\mu\text{m}$ )	Spatial Resolution	Application
1	0.52 - 0.72 (visible)	1 km	cloud, pollution, and haze detection; severe storm identification
2	3.78 - 4.03 (shortwave IR)	4 km	identification of fog at night; discriminating water clouds and snow or ice clouds during daytime; detecting fires and volcanoes; night time determination of sea surface temperatures
3	6.47 - 7.02 (upper level water vapour)	4 km	estimating regions of mid-level moisture content and advection; tracking mid-level atmospheric motion
4	10.2 - 11.2 (longwave IR)	4 km	identifying cloud-drift winds, severe storms, and heavy rainfall
5	11.5 - 12.5 (IR window sensitive to water vapour)	4 km	identification of low-level moisture; determination of sea surface temperature; detection of airborne dust and volcanic ash

The 19 channel **sounder** measures emitted radiation in 18 thermal infrared bands and reflected radiation in one visible band. These data have a spatial resolution of 8 km and 13-bit radiometric resolution. Sounder data are used for surface and cloud-top temperatures, multi-level moisture profiling in the atmosphere, and ozone distribution analysis.

### NOAA AVHRR

NOAA is also responsible for another series of satellites which are useful for meteorological, as well as other, applications. These satellites, in **sun-synchronous, near-polar orbits** (830-870 km above the Earth), are part of the Advanced TIROS series (originally dating back to 1960) and provide complementary information to the geostationary meteorological satellites (such as GOES). Two satellites, each providing global coverage, work together to ensure that data for any region of the Earth is no more than six hours old. One satellite crosses the equator in the early morning from north-to-south while the other crosses in the afternoon.

The primary sensor on board the NOAA satellites, used for both meteorology and small-scale Earth observation and reconnaissance, is the **Advanced Very High Resolution Radiometer (AVHRR)**. The AVHRR sensor detects radiation in the visible, near and mid infrared, and thermal infrared portions of the electromagnetic spectrum, over a swath width of 3000 km. The accompanying table, outlines the AVHRR bands, their wavelengths and spatial resolution (at swath nadir), and general applications of each.



### NOAA AVHRR Bands

Band	Wavelength Range ( $\mu\text{m}$ )	Spatial Resolution	Application
1	0.58 - 0.68 (red)	1.1 km	cloud, snow, and ice monitoring
2	0.725 - 1.1 (near IR)	1.1 km	water, vegetation, and agriculture surveys
3	3.55 - 3.93 (mid IR)	1.1 km	sea surface temperature, volcanoes, and forest fire activity
4	10.3 - 11.3 (thermal IR)	1.1 km	sea surface temperature, soil moisture
5	11.5 - 12.5 (thermal IR)	1.1 km	sea surface temperature, soil moisture

AVHRR data can be acquired and formatted in four operational modes, differing in resolution and method of transmission. Data can be transmitted directly to the ground and viewed as data are collected, or recorded on board the satellite for later transmission and processing. The accompanying table describes the various data formats and their characteristics.

### AVHRR Data Formats

Format	Spatial Resolution	Transmission and Processing
APT (Automatic Picture Transmission)	4 km	low-resolution direct transmission and display
HRPT (High Resolution Picture Transmission)	1.1 km	full-resolution direct transmission and display
GAC (Global Area Coverage)	4 km	low-resolution coverage from recorded data
LAC (Local Area Coverage)	1.1 km	selected full-resolution local area data from recorded data

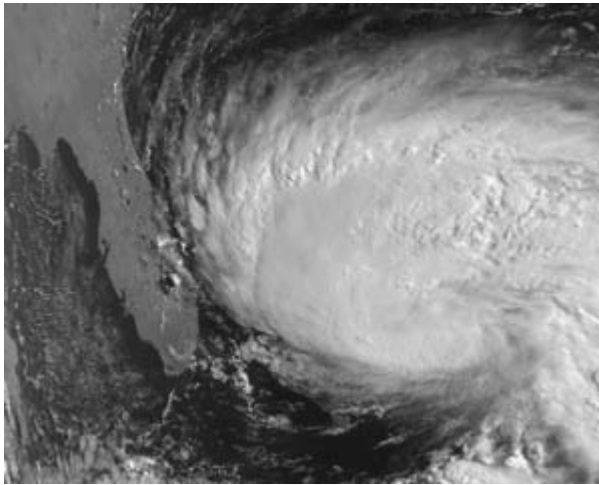

Although AVHRR data are widely used for **weather system** forecasting and analysis, the sensor is also well-suited to observation and monitoring of land features. AVHRR has much coarser spatial resolution than other typical land observations sensors (discussed in the next section), but is used extensively for monitoring regional, small-scale phenomena, including mapping of **sea surface temperature**, and natural vegetation and crop conditions. **Mosaics** covering large areas can be created from several AVHRR data sets allowing small scale analysis and mapping of broad vegetation cover. In

Canada, AVHRR data received at the Prince Albert Receiving Station Saskatchewan, are used as part of a crop information system, monitoring the health of grain crops in the Prairies throughout the growing season.

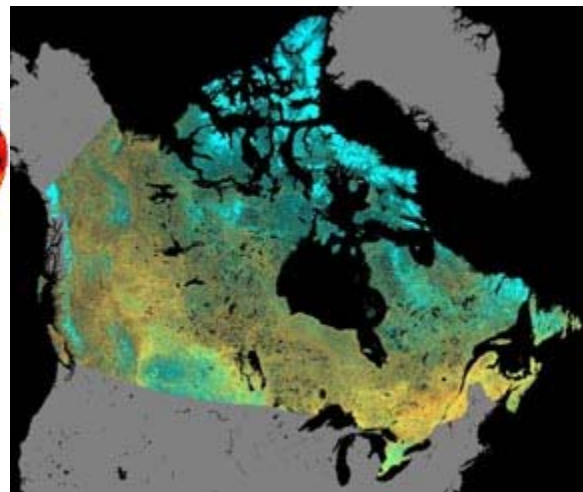
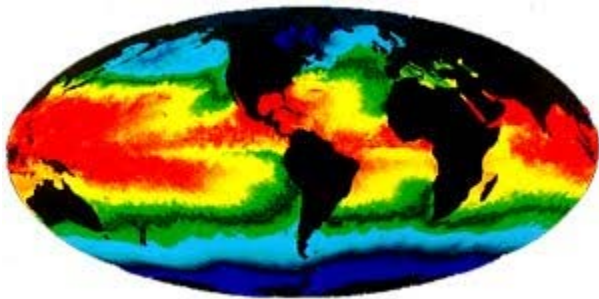

### Other Weather Satellites

The United States operates the **DMSP** (Defense Meteorological Satellite Program) series of satellites which are also used for weather monitoring. These are near-polar orbiting satellites whose Operational Linescan System (OLS) sensor provides twice daily coverage with a swath width of 3000 km at a spatial resolution of 2.7 km. It has two fairly broad wavelength bands: a visible and near infrared band (0.4 to 1.1  $\mu\text{m}$ ) and a thermal infrared band (10.0 to 13.4  $\mu\text{m}$ ). An interesting feature of the sensor is its ability to acquire visible band night time imagery under very low illumination conditions. With this sensor, it is possible to collect striking images of the Earth showing (typically) the night time lights of large urban centres.

There are several other meteorological satellites in orbit, launched and operated by other countries, or groups of countries. These include Japan, with the **GMS** satellite series, and the consortium of European communities, with the **Meteosat** satellites. Both are geostationary satellites situated above the equator over Japan and Europe, respectively. Both provide half-hourly imaging of the Earth similar to GOES. **GMS** has two bands: 0.5 to 0.75  $\mu\text{m}$  (1.25 km resolution), and 10.5 to 12.5  $\mu\text{m}$  (5 km resolution). **Meteosat** has three bands: visible band (0.4 to 1.1  $\mu\text{m}$ ; 2.5 km resolution), mid-IR (5.7 to 7.1  $\mu\text{m}$ ; 5 km resolution), and thermal IR (10.5 to 12.5  $\mu\text{m}$ ; 5 km resolution).

## 2.12 Land Observation Satellites/Sensors

### Landsat

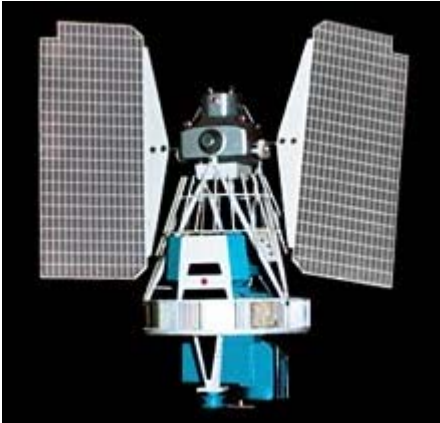

Although many of the weather satellite systems (such as those described in the previous section) are also used for monitoring the Earth's surface, they are not optimized for detailed mapping of the land surface. Driven by the exciting views from, and great success of the early meteorological satellites in the 1960's, as well as from images taken during manned spacecraft missions, the first satellite designed specifically to monitor the Earth's surface, Landsat-1, was launched by NASA in 1972. Initially referred to as ERTS-1, (Earth Resources Technology Satellite), **Landsat** was designed as an experiment to test the feasibility of collecting multi-spectral Earth observation data from an unmanned satellite platform. Since that time, this highly successful program has collected an abundance of data from around the world from several Landsat satellites. Originally managed by NASA, responsibility for the Landsat program was transferred to NOAA in 1983. In 1985, the program became commercialized, providing data to civilian and applications users.

Landsat's success is due to several factors, including: a combination of sensors with spectral bands tailored to Earth observation; functional spatial resolution; and good areal coverage (swath width and revisit period). The long lifespan of the program has provided a voluminous archive of Earth resource data facilitating long term monitoring and historical records and research. All Landsat satellites are placed in near-polar, sun-synchronous orbits. The first three satellites (Landsats 1-3) are at altitudes around 900 km and have revisit periods of 18 days while the later satellites are at around 700 km and have revisit periods of 16 days. All Landsat satellites have equator crossing times in the morning to optimize illumination conditions.

A number of sensors have been on board the Landsat series of satellites, including the **Return Beam Vidicon (RBV)** camera systems, the **MultiSpectral Scanner (MSS)** systems, and the **Thematic Mapper (TM)**. The most popular instrument in the early days of Landsat was the MultiSpectral Scanner (MSS) and later the Thematic Mapper (TM). Each of these sensors collected data over a swath width of 185 km, with a full scene being defined as 185 km x 185 km.

The MSS senses the electromagnetic radiation from the Earth's surface in four spectral bands. Each band has a spatial resolution of approximately 60 x 80 metres and a radiometric resolution of 6 bits, or 64 digital numbers. Sensing is accomplished with a line scanning device using an oscillating mirror. Six scan lines are collected simultaneously with each west-to-east sweep of the scanning mirror. The accompanying table outlines the spectral wavelength ranges for the MSS.

**MSS Bands**

Channel		Wavelength Range ( $\mu\text{m}$ )
Landsat 1,2,3	Landsat 4,5	
MSS 4	MSS 1	0.5 - 0.6 (green)
MSS 5	MSS 2	0.6 - 0.7 (red)
MSS 6	MSS 3	0.7 - 0.8 (near infrared)
MSS 7	MSS 4	0.8 - 1.1 (near infrared)

Routine collection of MSS data ceased in 1992, as the use of TM data, starting on Landsat 4, superseded the MSS. The **TM** sensor provides several improvements over the MSS sensor including: higher spatial and radiometric resolution; finer spectral bands; seven as opposed to four spectral bands; and an increase in the number of detectors per band (16 for the non-thermal channels versus six for MSS). Sixteen scan lines are captured simultaneously for each non-thermal spectral band (four for thermal band), using an oscillating mirror which scans during both the forward (west-to-east) and reverse (east-to-west) sweeps of the scanning mirror. This difference from the MSS increases the **dwel time** (see section 2.8) and improves the geometric and radiometric integrity of the data. Spatial resolution of TM is 30 m for all but the thermal infrared band which is 120 m. All channels are recorded over a range of 256 digital numbers (8 bits). The accompanying table outlines the spectral resolution of the individual TM bands and some useful applications of each.

**TM Bands**

Channel	Wavelength Range ( $\mu\text{m}$ )	Application
TM 1	0.45 - 0.52 (blue)	soil/vegetation discrimination; bathymetry/coastal mapping; cultural/urban feature identification
TM 2	0.52 - 0.60 (green)	green vegetation mapping (measures reflectance peak); cultural/urban feature identification
TM 3	0.63 - 0.69 (red)	vegetated vs. non-vegetated and plant species discrimination (plant chlorophyll absorption); cultural/urban feature identification
TM 4	0.76 - 0.90 (near IR)	identification of plant/vegetation types, health, and biomass content; water body delineation; soil moisture
TM 5	1.55 - 1.75 (short wave IR)	sensitive to moisture in soil and vegetation; discriminating snow and cloud-covered areas
TM 6	10.4 - 12.5 (thermal IR)	vegetation stress and soil moisture discrimination related to thermal radiation; thermal mapping (urban, water)
TM 7	2.08 - 2.35 (short wave IR)	discrimination of mineral and rock types; sensitive to vegetation moisture content

Data from both the TM and MSS sensors are used for a wide variety of applications, including resource management, mapping, environmental monitoring, and change detection (e.g. **monitoring forest clearcutting**). The archives of Canadian imagery include over 350,000 scenes of MSS and over 200,000 scenes of TM, managed by the licensed distributor in Canada: RSI Inc. Many more scenes are held by foreign facilities around the world.

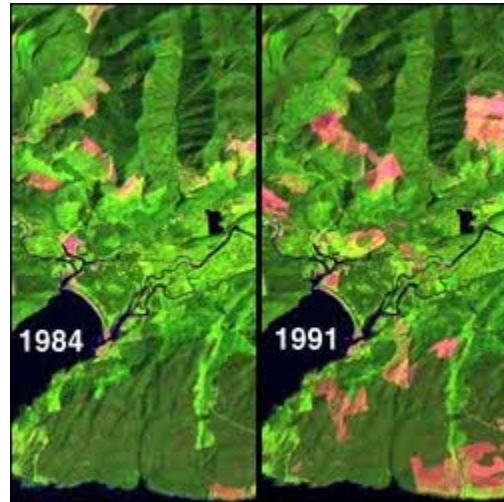

## SPOT

**SPOT** (Système Pour l'Observation de la Terre) is a series of Earth observation imaging satellites designed and launched by CNES (Centre National d'Études Spatiales) of France, with support from Sweden and Belgium. SPOT-1 was launched in 1986, with successors following every three or four years. All satellites are in sun-synchronous, near-polar orbits at altitudes around 830 km above the Earth, which results in orbit repetition every 26 days. They have equator crossing times around 10:30 AM local solar time. SPOT was designed to be a commercial provider of Earth observation data, and was the first satellite to use along-track, or pushbroom scanning technology.

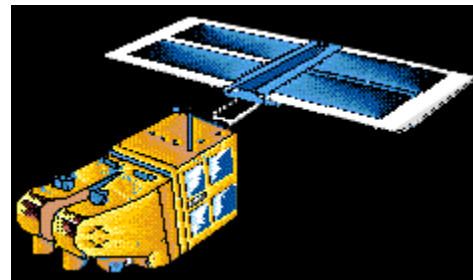

The SPOT satellites each have twin **high resolution visible (HRV)** imaging systems, which can be operated independently and simultaneously. Each HRV is capable of sensing either in a high spatial resolution single-channel **panchromatic (PLA)** mode, or a coarser spatial resolution three-channel **multispectral (MLA)** mode. Each along-track scanning HRV sensor consists of four linear arrays of detectors: one 6000 element array for the panchromatic mode recording at a spatial resolution of 10 m, and one 3000 element array for each of the three multispectral bands, recording at 20 m spatial resolution. The swath width for both modes is 60 km at nadir. The accompanying table illustrates the spectral characteristics of the two different modes.

**HRV Mode Spectral Ranges**

Mode/Band	Wavelength Range (µm)
Panchromatic (PLA)	0.51 - 0.73 (blue-green-red)
Multispectral (MLA)	
Band 1	0.50 - 0.59 (green)
Band 2	0.61 - 0.68 (red)
Band 3	0.79 - 0.89 (near infrared)

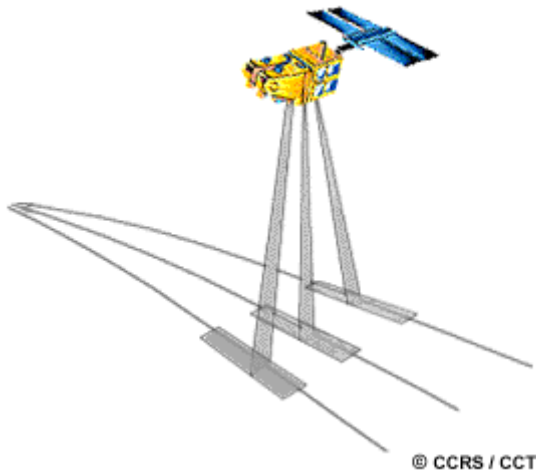

The viewing angle of the sensors can be adjusted to look to either side of the satellite's vertical (nadir) track, allowing **off-nadir viewing** which increases the satellite's revisit capability. This ability to point the sensors up to 27° from nadir, allows SPOT to view within a 950 km swath and to revisit any location several times per week. As the sensors point away from nadir, the swath varies from 60 to 80 km in width. This not only improves the ability to monitor specific locations and increases the chances of obtaining cloud free scenes, but the off-nadir viewing also provides the

capability of acquiring imagery for stereoscopic coverage. By recording the same area from two different angles, the imagery can be viewed and analyzed as a three dimensional model, a technique of tremendous value for terrain interpretation, mapping, and visual terrain simulations.

This oblique viewing capability increases the revisit frequency of equatorial regions to three days (seven times during the 26 day orbital cycle). Areas at a latitude of 45° can be imaged more frequently (11 times in 26 days) due to the convergence of orbit paths towards the poles. By pointing both HRV sensors to cover **adjacent ground swaths** at nadir, a swath of 117 km (3 km overlap between the two swaths) can be imaged. In this mode of operation, either panchromatic or multispectral data can be collected, but not both simultaneously.

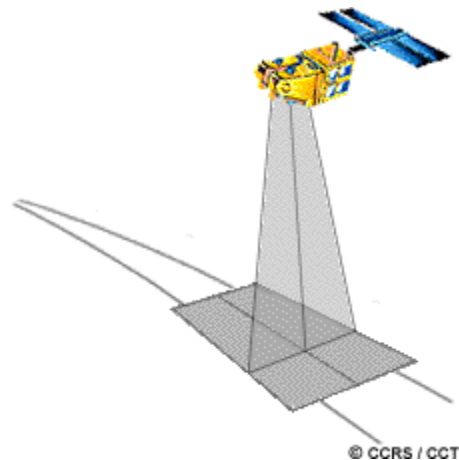

SPOT has a number of benefits over other spaceborne optical sensors. Its fine spatial resolution and pointable sensors are the primary reasons for its popularity. The three-band multispectral data are well suited to displaying as false-colour images and the panchromatic band can also be used to "sharpen" the spatial detail in the multispectral data. SPOT allows applications requiring fine spatial detail (such as **urban mapping**) to be addressed while retaining the cost and timeliness advantage of satellite data. The potential applications of SPOT data are numerous. Applications requiring frequent monitoring (agriculture, forestry) are well served by the SPOT sensors. The acquisition of stereoscopic imagery from SPOT has played an important role in mapping applications and in the derivation of topographic information (Digital Elevation Models - DEMs) from satellite data.



## IRS

The Indian Remote Sensing (IRS) satellite series, combines features from both the Landsat MSS/TM sensors and the SPOT HRV sensor. The third satellite in the series, IRS-1C, launched in December, 1995 has three sensors: a single-channel panchromatic (PAN) high resolution camera, a medium resolution four-channel Linear Imaging Self-scanning Sensor (LISS-III), and a coarse resolution two-channel Wide Field Sensor (WiFS). The accompanying table outlines the specific characteristics of each sensor.



### IRS Sensors

Sensor	Wavelength Range (µm)	Spatial Resolution	Swath Width	Revisit Period (at equator)
<b>PAN</b>	0.5 - 0.75	5.8 m	70 km	24 days
<b>LISS-II</b>				
Green	0.52 - 0.59	23 m	142 km	24 days
Red	0.62 - 0.68	23 m	142 km	24 days
Near IR	0.77 - 0.86	23 m	142 km	24 days
Shortwave IR	1.55 - 1.70	70 m	148 km	24 days
<b>WiFS</b>				
Red	0.62 - 0.68	188 m	774 km	5 days
Near IR	0.77 - 0.86	188 m	774 km	5 days

In addition to its high spatial resolution, the panchromatic sensor can be steered up to 26° across-track, enabling stereoscopic imaging and increased revisit capabilities (as few as five days), similar to SPOT. This high resolution data is useful for urban planning and mapping applications. The four LISS-III multispectral bands are similar to Landsat's TM bands 1 to 4 and are excellent for vegetation discrimination, land-cover mapping, and natural resource planning. The WiFS sensor is similar to NOAA AVHRR bands and the spatial resolution and coverage is useful for regional scale vegetation monitoring.

### MEIS-II and CASI

Although this tutorial concentrates on satellite-borne sensors, it is worth mentioning a couple of Canadian airborne sensors which have been used for various remote sensing applications, as these systems (and others like them) have influenced the design and development of satellite systems. The first is the MEIS-II (**Multispectral Electro-optical Imaging Scanner**) sensor developed for the Canada Centre for Remote Sensing. Although no longer active, MEIS was the first operational use of pushbroom, or along-track scanning technology in an airborne platform. The sensor collected 8-bit data (256 digital numbers) in eight spectral bands ranging from 0.39 to 1.1 µm, using linear arrays of 1728 detectors per band. The specific wavelength ranges were selectable, allowing different band combinations to be used for different applications. Stereo imaging from a single flight line was also possible, with channels aimed ahead of and behind nadir, supplementing the other nadir facing sensors. Both the stereo mapping and the selectable band capabilities were useful in research and development which was applied to development of other satellite (and airborne) sensor systems.

CASI, the **Compact Airborne Spectrographic Imager**, is a leader in airborne imaging, being the first commercial imaging spectrometer. This hyperspectral sensor detects a vast array of narrow spectral bands in the visible and infrared wavelengths, using along-track scanning. The spectral range covered by the 288 channels is between 0.4 and 0.9  $\mu\text{m}$ . Each band covers a wavelength range of 0.018  $\mu\text{m}$ . While spatial resolution depends on the altitude of the aircraft, the spectral bands measured and the bandwidths used are all programmable to meet the user's specifications and requirements. Hyperspectral sensors such as this can be important sources of diagnostic information about specific targets' absorption and reflection characteristics, in effect providing a spectral 'fingerprint'. Experimentation with CASI and other airborne imaging spectrometers has helped guide the development of hyperspectral sensor systems for advanced satellite systems.

## 2.13 Marine Observation Satellites/Sensors

The Earth's oceans cover more than two-thirds of the Earth's surface and play an important role in the global climate system. They also contain an abundance of living organisms and natural resources which are susceptible to pollution and other man-induced hazards. The meteorological and land observations satellites/sensors we discussed in the previous two sections can be used for monitoring the oceans of the planet, but there are other satellite/sensor systems which have been designed specifically for this purpose.

The Nimbus-7 satellite, launched in 1978, carried the first sensor, the **Coastal Zone Colour Scanner (CZCS)**, specifically intended for monitoring the Earth's oceans and water bodies. The primary objective of this sensor was to observe ocean colour and temperature, particularly in coastal zones, with sufficient spatial and spectral resolution to detect pollutants in the upper levels of the ocean and to determine the nature of materials suspended in the water column. The Nimbus satellite was placed in a sun-synchronous, near-polar orbit at an altitude of 955 km. Equator crossing times were local noon for ascending passes and local midnight for descending passes. The repeat cycle of the satellite allowed for global coverage every six days, or every 83 orbits. The CZCS sensor consisted of six spectral bands in the visible, near-IR, and thermal portions of the spectrum each collecting data at a spatial resolution of 825 m at nadir over a 1566 km swath width. The accompanying table outlines the spectral ranges of each band and the primary parameter measured by each.

**CZCS Spectral Bands**

Channel	Wavelength Range ( $\mu\text{m}$ )	Primary Measured Parameter
1	0.43 - 0.45	Chlorophyll absorption
2	0.51 - 0.53	Chlorophyll absorption
3	0.54 - 0.56	Gelbstoffe (yellow substance)
4	0.66 - 0.68	Chlorophyll concentration
5	0.70 - 0.80	Surface vegetation
6	10.5 - 12.50	Surface temperature

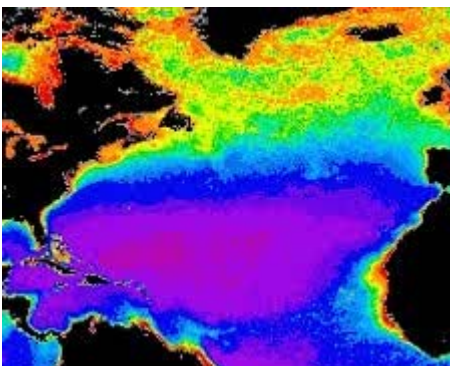

As can be seen from the table, the first four bands of the CZCS sensor are very narrow. They were optimized to allow detailed discrimination of differences in water reflectance due to **phytoplankton concentrations** and other suspended particulates in the water. In addition to detecting surface vegetation on the water, band 5 was used to discriminate water from land prior to processing the other bands of information. The CZCS sensor ceased operation in 1986.

## MOS

The first Marine Observation Satellite (MOS-1) was launched by Japan in February, 1987 and was followed by its successor, MOS-1b, in February of 1990. These satellites carry three different sensors: a four-channel Multispectral Electronic Self-Scanning Radiometer (MESSR), a four-channel Visible and Thermal Infrared Radiometer (VTIR), and a two-channel Microwave Scanning Radiometer (MSR), in the microwave portion of the spectrum. The characteristics of the two sensors in the visible/infrared are described in the accompanying table.

### MOS Visible/Infrared Instruments

Sensor	Wavelength Ranges ( $\mu\text{m}$ )	Spatial Resolution	Swath Width
MESSR	0.51 - 0.59	50 m	100 km
	0.61 - 0.69	50 m	100 km
	0.72 - 0.80	50 m	100 km
	0.80 - 1.10	50 m	100 km
VTIR	0.50 - 0.70	900 m	1500 km
	6.0 - 7.0	2700 m	1500 km
	10.5 - 11.5	2700 m	1500 km
	11.5 - 12.5	2700 m	1500 km

The MESSR bands are quite similar in spectral range to the Landsat MSS sensor and are thus useful for land applications in addition to observations of marine environments. The MOS systems orbit at altitudes around 900 km and have revisit periods of 17 days.

## SeaWiFS

The SeaWiFS (Sea-viewing Wide-Field-of View Sensor) on board the SeaStar spacecraft is an advanced sensor designed for ocean monitoring. It consists of eight spectral bands of very narrow wavelength ranges (see accompanying table) tailored for very specific detection and monitoring of various ocean phenomena including: ocean primary production and phytoplankton processes, ocean influences on climate processes (heat storage and aerosol formation), and monitoring of the cycles of carbon, sulfur, and nitrogen. The orbit altitude is 705 km with a local equatorial crossing time of 12 PM. Two combinations of spatial resolution and swath width are available for each band: a higher resolution mode of 1.1 km (at nadir) over a swath of 2800 km, and a lower resolution mode of 4.5 km (at nadir) over a swath of 1500 km.

**SeaWiFS Spectral Bands**

<b>Channel</b>	<b>Wavelength Ranges (<math>\mu\text{m}</math>)</b>
1	0.402 - 0.422
2	0.433 - 0.453
3	0.480 - 0.500
4	0.500 - 0.520
5	0.545 - 0.565
6	0.660 - 0.680
7	0.745 - 0.785
8	0.845 - 0.885

These ocean-observing satellite systems are important for global and regional scale monitoring of ocean pollution and health, and assist scientists in understanding the influence and impact of the oceans on the global climate system.

## 2.14 Other Sensors



The three previous sections provide a representative overview of specific systems available for remote sensing in the (predominantly) optical portions of the electromagnetic spectrum. However, there are many **other types of less common sensors** which are used for remote sensing purposes. We briefly touch on a few of these other types of sensors. The information is not considered comprehensive but serves as an introduction to alternative imagery sources and imaging concepts.

### Video

Although coarser in spatial resolution than traditional photography or digital imaging, video cameras provide a useful means of acquiring timely and inexpensive data and vocally annotated imagery. Applications with these requirements include natural disaster management, (fires, flooding), crop and disease assessment, environmental hazard control, and police surveillance. Cameras used for video recording measure radiation in the visible, near infrared, and sometimes mid-infrared portions of the EM spectrum. The image data are recorded onto cassette, and can be viewed immediately.

### FLIR

Forward Looking InfraRed (FLIR) systems operate in a similar manner to across-track thermal imaging sensors, but provide an oblique rather than nadir perspective of the Earth's surface. Typically positioned on aircraft or helicopters, and imaging the area ahead of the platform, FLIR systems provide relatively high spatial resolution imaging that can be used for military applications, search and rescue operations, law enforcement, and forest fire monitoring.

### Laser fluorosensor

Some targets fluoresce, or emit energy, upon receiving incident energy. This is not a simple reflection of the incident radiation, but rather an absorption of the initial energy, excitation of the molecular components of the target materials, and emission of longer wavelength radiation which is then measured by the sensor. Laser fluorosensors illuminate the target with a specific wavelength of radiation and are capable of detecting multiple wavelengths of fluoresced radiation. This technology has been proven for ocean applications, such as chlorophyll mapping, and pollutant detection, particularly for naturally occurring and accidental oil slicks.

### Lidar

Lidar is an acronym for LIght Detection And Ranging, an active imaging technology very similar to RADAR (see next paragraph). Pulses of laser light are emitted from the sensor and

energy reflected from a target is detected. The time required for the energy to reach the target and return to the sensor determines the distance between the two. Lidar is used effectively for measuring heights of features, such as forest canopy height relative to the ground surface, and water depth relative to the water surface (laser profilometer). Lidar is also used in atmospheric studies to examine the particle content of various layers of the Earth's atmosphere and acquire air density readings and monitor air currents.

## **RADAR**

RADAR stands for RAdio Detection And Ranging. RADAR systems are active sensors which provide their own source of electromagnetic energy. Active radar sensors, whether airborne or spaceborne, emit microwave radiation in a series of pulses from an antenna, looking obliquely at the surface perpendicular to the direction of motion. When the energy reaches the target, some of the energy is reflected back towards the sensor. This backscattered microwave radiation is detected, measured, and timed. The time required for the energy to travel to the target and return back to the sensor determines the distance or range to the target. By recording the range and magnitude of the energy reflected from all targets as the system passes by, a two-dimensional image of the surface can be produced. Because RADAR provides its own energy source, images can be acquired day or night. Also, microwave energy is able to penetrate through clouds and most rain, making it an all-weather sensor. Because of the unique characteristics and applications of microwave remote sensing, Chapter 3 covers this topic in detail, concentrating on RADAR remote sensing.

## 2.15 Data Reception, Transmission, and Processing

Data obtained during airborne remote sensing missions can be retrieved once the aircraft lands. It can then be processed and delivered to the end user. However, data acquired from satellite platforms need to be electronically transmitted to Earth, since the satellite continues to stay in orbit during its operational lifetime. The technologies designed to accomplish this can also be used by an aerial platform if the data are urgently needed on the surface.

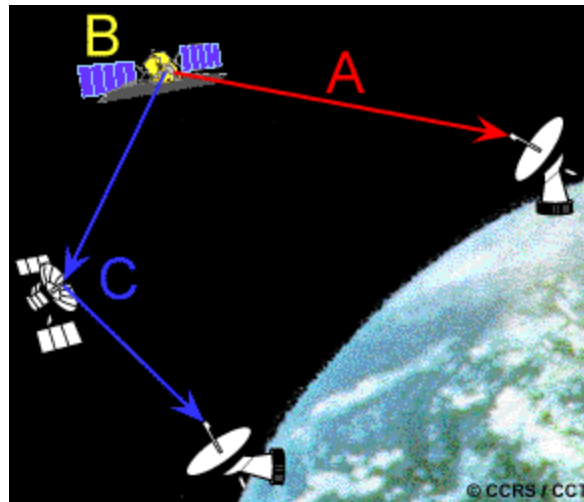

There are three main options for **transmitting data** acquired by satellites to the surface. The data can be directly transmitted to Earth if a Ground Receiving Station (GRS) is in the line of sight of the satellite (A). If this is not the case, the data can be recorded on board the satellite (B) for transmission to a GRS at a later time. Data can also be relayed to the GRS through the Tracking and Data Relay Satellite System (TDRSS) (C), which consists of a series of communications satellites in geosynchronous orbit. The data are transmitted from one satellite to another until they reach the appropriate GRS.

In Canada, CCRS operates two **ground receiving stations** - one at Cantley, Québec (GSS), just outside of Ottawa, and another one at Prince Albert, Saskatchewan (PASS). The combined coverage circles for these Canadian ground stations enable the potential for reception of real-time or recorded data from satellites passing over almost any part of Canada's land mass, and much of the continental United States as well. Other ground stations have been set up around the world to capture data from a variety of satellites.



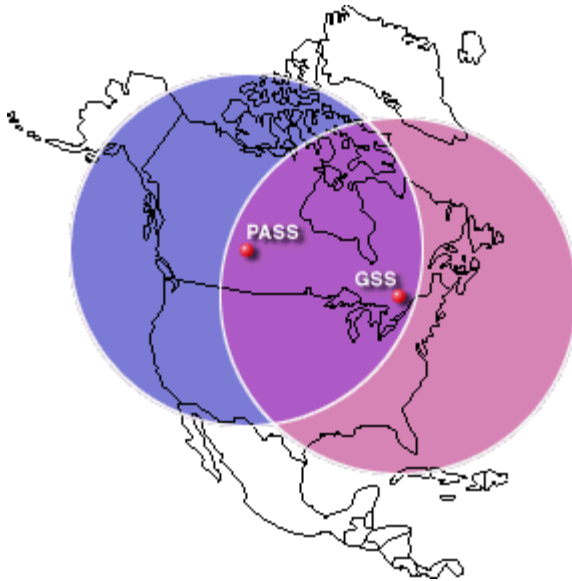

The data are received at the GRS in a raw digital format. They may then, if required, be processed to correct systematic, geometric and atmospheric distortions to the imagery, and be translated into a standardized format. The data are written to some form of storage medium such as tape, disk or CD. The data are typically archived at most receiving and processing stations, and full libraries of data are managed by government agencies as well as commercial companies responsible for each sensor's archives.

For many sensors it is possible to provide customers with **quick-turnaround** imagery when they need data as quickly as possible after it is collected. Near real-time processing systems are used to produce low resolution imagery in hard copy or soft copy (digital) format within hours of data acquisition. Such imagery can then be faxed or transmitted digitally to end users. One application of this type of fast data processing is to provide imagery to ships sailing in the Arctic, as it allows them to assess current ice conditions quickly in order to make navigation decisions about the easiest/safest routes through the ice. Real-time processing of imagery in airborne systems has been used, for example, to pass thermal infrared imagery to forest fire fighters right at the scene.

Low resolution quick-look imagery is used to preview archived imagery prior to purchase. The spatial and radiometric quality of these types of data products is degraded, but they are useful for ensuring that the overall quality, coverage and cloud cover of the data is appropriate.

## 2.16 Endnotes

You have just completed **Chapter 2 - Satellites and Sensors**. You can continue to Chapter 3 - Microwave Sensing or first browse the CCRS Web site for other articles related to platforms and sensors.

For instance, the [Remote Sensing Glossary](#)<sup>1</sup> has platform and sensor categories that contain more information about various platforms and sensors and their use around the world. The glossary also has optical and radar categories of terms, to allow you to focus on these aspects of remote sensing technology.

Our receiving stations at [Prince Albert](#)<sup>2</sup>, Saskatchewan and [Gatineau](#)<sup>3</sup>, Quebec receive data from a number of satellites. See which satellites are received and what data reception [coverage](#)<sup>4</sup> and [services](#)<sup>5</sup> they provide.

If you are curious about detecting targets which are smaller than a pixel, see a [detailed discussion](#)<sup>6</sup> in one of our "Images of Canada".

Until 1997, CCRS owned and operated a [Convair 580](#)<sup>7</sup> aircraft which carried a number of research instruments including a [Synthetic Aperture Radar](#)<sup>8</sup> (SAR) sensor. There are a number of images from this instrument on our Web site, one of which is of the [Confederation Bridge](#)<sup>9</sup> between PEI and New Brunswick taken while it was under construction.

---

<sup>1</sup>[http://www.ccrs.nrcan.gc.ca/ccrs/learn/terms/glossary/glossary\\_e.html](http://www.ccrs.nrcan.gc.ca/ccrs/learn/terms/glossary/glossary_e.html)

<sup>2</sup>[http://www.ccrs.nrcan.gc.ca/ccrs/data/stations/pass\\_e.html](http://www.ccrs.nrcan.gc.ca/ccrs/data/stations/pass_e.html)

<sup>3</sup>[http://www.ccrs.nrcan.gc.ca/ccrs/data/stations/gss\\_e.html](http://www.ccrs.nrcan.gc.ca/ccrs/data/stations/gss_e.html)

<sup>4</sup>[http://www.ccrs.nrcan.gc.ca/ccrs/data/stations/cc\\_e.html](http://www.ccrs.nrcan.gc.ca/ccrs/data/stations/cc_e.html)

<sup>5</sup>[http://www.ccrs.nrcan.gc.ca/ccrs/data/stations/grss\\_e.html](http://www.ccrs.nrcan.gc.ca/ccrs/data/stations/grss_e.html)

<sup>6</sup>[http://www.ccrs.nrcan.gc.ca/ccrs/learn/tour/16/16ns\\_e.html](http://www.ccrs.nrcan.gc.ca/ccrs/learn/tour/16/16ns_e.html)

<sup>7</sup>[http://www.ccrs.nrcan.gc.ca/ccrs/data/satsens/airborne/sarbro/sbc580\\_e.html](http://www.ccrs.nrcan.gc.ca/ccrs/data/satsens/airborne/sarbro/sbc580_e.html)

<sup>8</sup>[http://www.ccrs.nrcan.gc.ca/ccrs/data/satsens/airborne/sarbro/sbmain\\_e.html](http://www.ccrs.nrcan.gc.ca/ccrs/data/satsens/airborne/sarbro/sbmain_e.html)

<sup>9</sup>[http://www.ccrs.nrcan.gc.ca/ccrs/rd/apps/marine/pei\\_link/bridge\\_e.html](http://www.ccrs.nrcan.gc.ca/ccrs/rd/apps/marine/pei_link/bridge_e.html)



## 2. Did You Know?

---

### 2.1 Did You Know?



© CCRS / CCT

- High wing aircraft are preferable to low wing aircraft for hand-held aerial photography.
- The 'drop hatch' in aircraft such as the DeHavilland "Beaver" and "Otter" are convenient to use for vertical aerial photography without performing aircraft structural modifications.
- Oblique aerial photography can preferably be done through an open window rather than through window glass/plastic.
- Photography through the aircraft door opening (having removed the door prior to flight) is also frequently done.
- Tethered balloons provide an inexpensive photography platform for long-term monitoring of a specific site.

## 2.2 Did You Know?

**"...the forecast calls for scattered clouds with the possibility of rain..."**

...most of the images you see on television weather forecasts are from geostationary satellites. This is because they provide broad coverage of the weather and cloud patterns on continental scales. Meteorologists (weather forecasters) use these images to help them determine in which direction the weather patterns are likely to go. The high repeat coverage capability of satellites with geostationary orbits allows them to collect several images daily to allow these patterns to be closely monitored.



...satellites occasionally require their orbits to be corrected. Because of atmospheric drag and other forces that occur when a satellite is in orbit, they may deviate from their initial orbital path. In order to maintain the planned orbit, a control center on the ground will issue commands to the satellite to place it back in the proper orbit. Most satellites and their sensors have a finite life-span ranging from a few to several years. Either the sensor will cease to function adequately or the satellite will suffer severe orbit decay such that the system is no longer useable.

## 2.3 Did You Know?

If the IFOV for all pixels of a scanner stays constant (which is often the case), then the ground area represented by pixels at the nadir will have a larger scale than those pixels which are off-nadir. This means that spatial resolution will vary from the image centre to the swath edge.

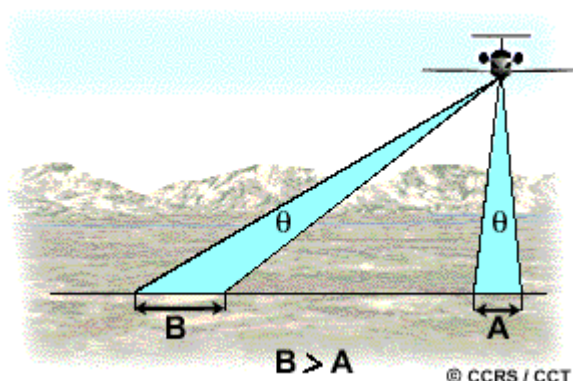

## 2.5 Did You Know?

"...you just can't have it all!"

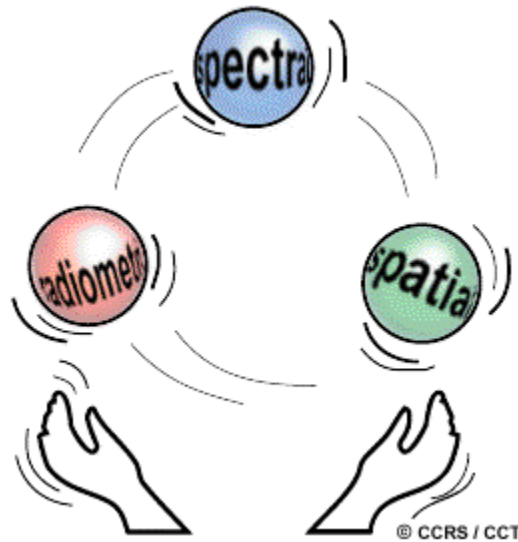

...that there are trade-offs between spatial, spectral, and radiometric resolution which must be taken into consideration when engineers design a sensor. For high spatial resolution, the sensor has to have a small IFOV (Instantaneous Field of View). However, this reduces the amount of energy that can be detected as the area of the ground resolution cell within the IFOV becomes smaller. This leads to reduced radiometric resolution - the ability to detect fine energy differences. To increase the amount of energy detected (and thus, the radiometric resolution) without reducing spatial resolution, we would have to broaden the wavelength range detected for a particular channel or band. Unfortunately, this would reduce the spectral resolution of the sensor. Conversely, coarser spatial resolution would allow improved radiometric and/or spectral resolution. Thus, these three types of resolution must be balanced against the desired capabilities and objectives of the sensor.

## 2.7 Did You Know?

"...let's take a look at the **BIG PICTURE**..."



...that the U.S. Space Shuttles have been used to take photographs from space. The astronauts onboard the shuttle have taken many photographs using hand-held cameras, similar to the type you would use for taking family photos. They have also used much larger and more sophisticated cameras mounted in the shuttle's cargo bay, called Large Format Cameras (LFCs). LFCs have long focal lengths (305 mm) and take high quality photographs covering several hundreds of kilometres in both dimensions. The exact dimensions depend (of course) on the height of the shuttle above the Earth. Photos from these passive sensors need to be taken when the Earth's surface is being illuminated by the sun and are subject to cloud cover and other attenuation from the atmosphere. The shuttle has also been used several times to image many regions of the Earth using a special active microwave sensor called a RADAR. The RADAR sensor can collect detailed imagery during the night or day, as it provides its own energy source, and is able to penetrate and "see" through cloud cover due to the long wavelength of the electromagnetic radiation. We will learn more about RADAR in Chapter 3.

... although taking photographs in the UV portion of the spectrum is problematic due to atmospheric scattering and absorption, it can be very useful where other types of photography are not. An interesting example in wildlife research and management has used UV photography for detecting and counting harp seals on snow and ice. Adult harp seals have dark coats while their young have white coats. In normal panchromatic imagery, the dark coats of the adult seals are readily visible against the snow and ice background but the white coats of the young seals are not. However, the coats of both the adult and infant seals are strong absorbers of UV energy. Thus, both adult and young appear very dark in a UV image and can be easily detected. This allows simple and reliable monitoring of seal population changes over very large areas.

## 2.8 Did You Know?

"...backfield in motion..."

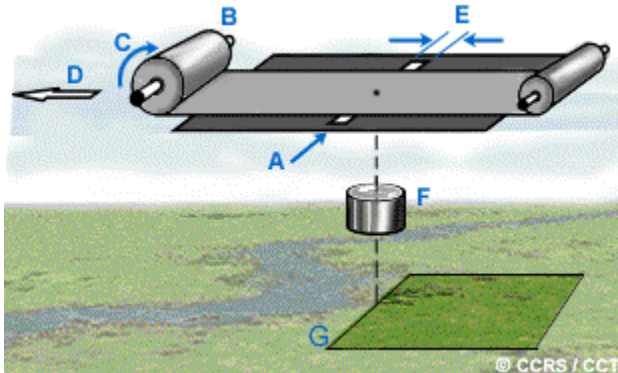

There is a photographic parallel to the push-broom scanner. It is based on the "slit camera". This camera does not have a shutter per se, but a slit (A) running in the across-track direction, which exposes film (B) which is being moved continuously (C) past the slit. The speed of motion of the film has to be proportional to the ground speed (D) of the aircraft. Thus the film speed has to be adjusted for the flying circumstances of the moment. The slit width (E) in the along-track direction is also adjustable so as to control exposure time. There are no individual photo 'frames' produced, but a continuous strip of imagery. Stereo slit photography is also possible, using a twin-lens system aimed slightly apart from parallel and each exposing one half of the film width.

## 2.10 Did You Know?

"...scanning for warm-bodied life forms, captain... "

...that, just as in aerial photography, some thermal scanner systems view the surface **obliquely**. Forward-Looking Infrared (**FLIR**) systems point ahead of the aircraft and scan across the scene. FLIR systems produce images very similar in appearance to oblique aerial photographs and are used for applications ranging from forest fire detection to law enforcement.

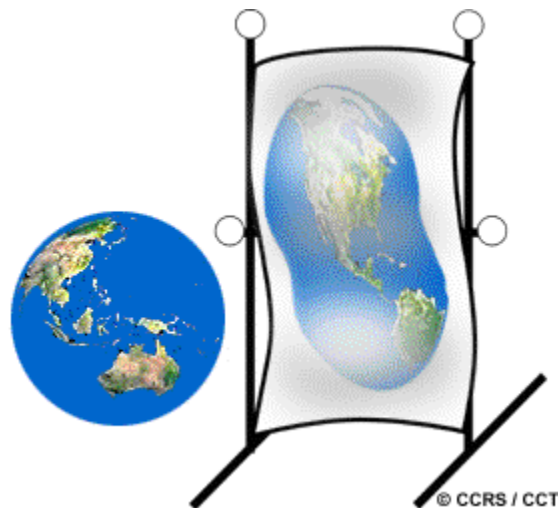

...many **systematic**, or predictable, geometric distortions can be accounted for in real-time (i.e. during image acquisition). As an example, skew distortion in across-track scanner imagery due to the Earth's rotation can be accurately modeled and easily corrected. Other random variations causing distortion cannot be as easily modeled and require **geometric correction** in a digital environment after the data have been collected. We will discuss this topic in more detail in Chapter 4.



## 2.12 Did You Know?

"...Land, Ho, matey!..."

...the ERTS (Earth Resources Technology Satellite) program was renamed to Landsat just prior to the launch of the second satellite in the series. The Landsat title was used to distinguish the program from another satellite program in the planning stages, called Seasat, intended primarily for oceanographic applications. The first (and only) Seasat satellite was successfully launched in 1978, but unfortunately was only operational for 99 days. Even though the satellite was short-lived and the Seasat program was discontinued, it collected some of the first RADAR images from space which helped heighten the interest in satellite RADAR remote sensing. Today, several RADAR satellites are operational or planned. We will learn more about RADAR and these satellites in the next chapter.



...originally the MSS sensor numbering scheme (bands 4, 5, 6, and 7) came from their numerical sequence after the three bands of the RBV (Return Beam Vidicon) sensors. However, due to technical malfunctions with the RBV sensor and the fact that it was dropped from the satellite sensor payload with the launch of Landsat-4, the MSS bands were renumbered from 1 to 4. For the TM sensor, if we look at the wavelength ranges for each of the bands, we see that TM6 and TM7 are out of order in terms of increasing wavelength. This was because the TM7 channel was added as an afterthought late in the original system design process.

## 2.15 Did You Know?

"...I'm receiving you loud and clear..."

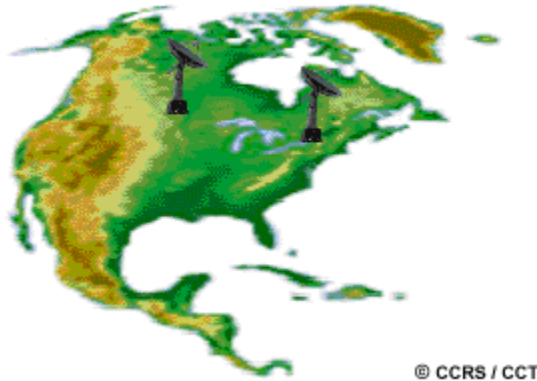

... Canada's ground receiving stations have been in operation since 1972 in Prince Albert, Saskatchewan and 1985 in Gatineau, Quebec. These two stations receive and process image data from several different satellites (NOAA, Landsat, RADARSAT, J-ERS, MOS, SPOT, and ERS) from five different countries or group of countries (USA, Canada, Japan, France, and Europe).



## 2. Whiz Quiz and Answers

---

### 2.2 Whiz Quiz

What advantages do sensors carried on board satellites have over those carried on aircraft?  
Are there any disadvantages that you can think of?

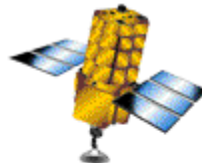

© CCRS / CCT

As a satellite in a near-polar sun-synchronous orbit revolves around the Earth, the satellite crosses the equator at approximately the same local sun time every day. Because of the orbital velocity, all other points on the globe are passed either slightly before or after this time. For a sensor in the visible portion of the spectrum, what would be the advantages and disadvantages of crossing times (local sun time) a) in the early morning, b) around noon, and c) in the mid afternoon?

## 2.2 Whiz Quiz - Answers

**Answer 1:** Sensors on board satellites generally can "see" a much larger area of the Earth's surface than would be possible from a sensor onboard an aircraft. Also, because they are continually orbiting the Earth, it is relatively easy to collect imagery on a systematic and repetitive basis in order to monitor changes over time. The geometry of orbiting satellites with respect to the Earth can be calculated quite accurately and facilitates correction of remote sensing images to their proper geographic orientation and position. However, aircraft sensors can collect data at any time and over any portion of the Earth's surface (as long as conditions allow it) while satellite sensors are restricted to collecting data over only those areas and during specific times dictated by their particular orbits. It is also much more difficult to fix a sensor in space if a problem or malfunction develops!



© CCRS / CCT

**Answer 2:** An early morning crossing time would have the sun at a very low angle in the sky and would be good for emphasizing topographic effects but would result in a lot of shadow in areas of high relief. A crossing time around noon would have the sun at its highest point in the sky and would provide the maximum and most uniform illumination conditions. This would be useful for surfaces of low reflectance but might cause saturation of the sensor over high reflectance surfaces, such as ice. Also, under such illumination, 'specular reflection' from smooth surfaces may be a problem for interpreters. In the mid afternoon, the illumination conditions would be more moderate. However, a phenomenon called solar heating (due to the sun heating the surface), which causes difficulties for recording reflected energy, will be near maximum at this time of day. In order to minimize between these effects, most satellites which image in the visible, reflected, and emitted infrared regions use crossing times around mid-morning as a compromise.

### 2.3 Whiz Quiz

1. Look at the detail apparent in each of these two images. Which of the two images is of a smaller scale? What clues did you use to determine this? Would the imaging platform for the smaller scale image most likely have been a satellite or an aircraft?



2. If you wanted to monitor the general health of all vegetation cover over the Canadian Prairie provinces for several months, what type of platform and sensor characteristics (spatial, spectral, and temporal resolution) would be best for this and why?

### 2.3 Whiz Quiz - Answers

**Answer 1:** The image on the left is from a satellite while the image on the right is a photograph taken from an aircraft. The area covered in the image on the right is also covered in the image on the left, but this may be difficult to determine because the scales of the two images are much different. We are able to identify relatively small features (i.e. individual buildings) in the image on the right that are not discernible in the image on the left. Only general features such as street patterns, waterways, and bridges can be identified in the left-hand image. Because features appear larger in the image on the right and a particular measurement (eg. 1 cm) on the image represents a smaller true distance on the ground, this image is at a larger scale. It is an aerial photograph of the Parliament Buildings in Ottawa, Canada. The left-hand image is a satellite image of the city of Ottawa.



**Answer 2:** A satellite sensor with large area coverage and fairly coarse spatial resolution would be excellent for monitoring the general state of vegetation health over Alberta, Saskatchewan, and Manitoba. The large east-to-west expanse would be best covered by a sensor with a wide swath and broad coverage. This would also imply that the spatial resolution of the sensor would be fairly coarse. However, fine detail would not really be necessary for monitoring a broad class including all vegetation cover. With broad area coverage the revisit period would be shorter, increasing the opportunity for repeat coverage necessary for monitoring change. The frequent coverage would also allow for areas covered by clouds on one date, to be filled in by data collected from another date, reasonably close in time. The sensor would not necessarily require high spectral resolution, but would at a minimum, require channels in the visible and near-infrared regions of the spectrum. Vegetation generally has a low reflectance in the visible and a high reflectance in the near-infrared. The contrast in reflectance between these two regions assists in identifying vegetation cover. The magnitude of the reflected infrared energy is also an indication of vegetation health. A sensor on board the U.S. NOAA (National Oceanographic and Atmospheric Administration) series of satellites with exactly these types of characteristics is actually used for this type of monitoring over the entire surface of the Earth!

## 2.4 Whiz Quiz

1. Hyperspectral scanners (mentioned in Chapter 2.4) are special multispectral sensors which detect and record radiation in several (perhaps hundreds) of very narrow spectral bands. What would be some of the advantages of these types of sensors? What would be some of the disadvantages?

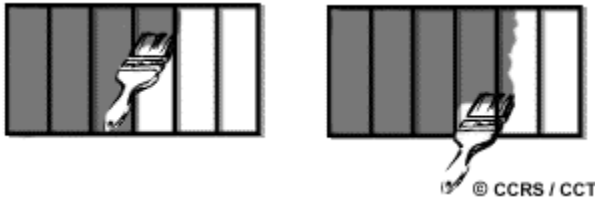

2. If the spectral range of the 288 channels of the CASI (Compact Airborne Spectrographic Imager) is exactly  $0.40 \mu\text{m}$  to  $0.90 \mu\text{m}$  and each band covers a wavelength of  $1.8 \text{ nm}$  (nanometres,  $10^{-9} \text{ m}$ ), will there be any overlap between the bands?

## 2.4 Whiz Quiz - Answers

**Answer 1:** Hyperspectral scanners have very high spectral resolution because of their narrow bandwidths. By measuring radiation over several small wavelength ranges, we are able to effectively build up a continuous spectrum of the radiation detected for each pixel in an image. This allows for fine differentiation between targets based on detailed reflectance and absorption responses which are not detectable using the broad wavelength ranges of conventional multispectral scanners. However, with this increased sensitivity comes significant increases in the volume of data collected. This makes both storage and manipulation of the data, even in a computer environment, much more difficult. Analyzing multiple images at one time or combining them, becomes cumbersome, and trying to identify and explain what each unique response represents in the "real world" is often difficult.

**Answer 2:** The total wavelength range available will be  $0.90 - 0.40 \mu\text{m} = 0.50 \text{ mm}$ . If there are 288 channels of  $1.8 \text{ nm}$  each, let's calculate the total wavelength range they would span if they did not overlap.

$$1.8 \text{ nm} = 1.8 \times 10^{-9} \text{ m}$$

$$1.8 \times 10^{-9} \text{ m} \times 288 = 0.0000005184 \text{ m}$$

$$0.0000005184 \text{ m} = 0.5184 \mu\text{m}$$

Since  $0.5184$  is greater than  $0.50$ , the answer is YES, there will have to be some overlap between some or all of the 288 bands to fit into this  $0.50 \mu\text{m}$  range.

## 2.5 Whiz Quiz



Suppose you have a digital image which has a radiometric resolution of 6 bits. What is the maximum value of the digital number which could be represented in that image?

## 2.5 Whiz Quiz - Answers



The number of digital values possible in an image is equal to the number two (2 - for binary codings in a computer) raised to the exponent of the number of bits in the image (i.e.  $2^{\# \text{ of bits}}$ ). The number of values in a 6-bit image would be equal to  $2^6 = 2 \times 2 \times 2 \times 2 \times 2 \times 2 = 64$ . Since the range of values displayed in a digital image normally starts at zero (0), in order to have 64 values, the maximum value possible would be 63.



## 2.9 Whiz Quiz



How would thermal imagery be useful in an urban environment?

## 2.9 Whiz Quiz - Answers



Detecting and monitoring heat loss from buildings in urban areas is an excellent application of thermal remote sensing. Heating costs, particularly in northern countries such as Canada, can be very expensive. Thermal imaging in both residential and commercial areas allows us to identify specific buildings, or parts of buildings, where heat is escaping. If the amount of heat is significant, these areas can be targeted for repair and re-insulation to reduce costs and conserve energy.

## 2.10 Whiz Quiz

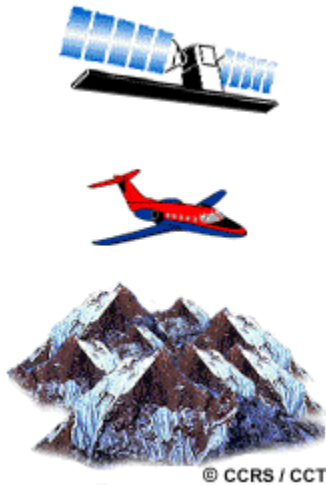

If you wanted to map a mountainous region, limiting geometric distortions as much as possible, would you choose a satellite-based or aircraft-based scanning system? Explain why in terms of imaging geometry.

## 2.10 Whiz Quiz Answers

Although an aircraft scanning system may provide adequate geometric accuracy in most instances, a satellite scanner would probably be preferable in a mountainous region. Because of the large variations in relief, geometric distortions as a result of relief displacement would be amplified at aircraft altitudes much more than from satellite altitudes. Also, given the same lighting conditions, shadowing would be a greater problem using aircraft imagery because of the shallower viewing angles and would eliminate the possibility for practical mapping in these areas.

## 2.12 Whiz Quiz



Explain why data from the Landsat TM sensor might be considered more useful than data from the original MSS sensor. Hint: Think about their spatial, spectral, and radiometric resolutions.

## 2.12 Whiz Quiz - Answers

There are several reasons why TM data may be considered more useful than MSS data. Although the areal coverage of a TM scene is virtually the same as a MSS scene, TM offers higher spatial, spectral, and radiometric resolution. The spatial resolution is 30 m compared to 80 m (except for the TM thermal channels, which are 120 m to 240 m). Thus, the level of spatial detail detectable in TM data is better. TM has more spectral channels which are narrower and better placed in the spectrum for certain applications, particularly vegetation discrimination. In addition, the increase from 6 bits to 8 bits for data recording represents a four-fold increase in the radiometric resolution of the data.

(Remember, 6 bits =  $2^6 = 64$ , and 8 bits =  $2^8 = 256$  - therefore,  $256/64 = 4$ ). However, this does not mean that TM data are "better" than MSS data. Indeed, MSS data are still used to this day and provide an excellent data source for many applications. If the desired information cannot be extracted from MSS data, then perhaps the higher spatial, spectral, and radiometric resolution of TM data may be more useful.



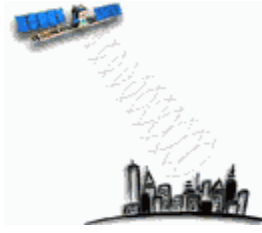

## 3. Microwave Remote Sensing

### 3.1 Introduction

Microwave sensing encompasses both active and passive forms of remote sensing. As described in Chapter 2, the microwave portion of the spectrum covers the range from approximately 1cm to 1m in wavelength. Because of their long wavelengths, compared to the visible and infrared, microwaves have special properties that are important for remote sensing. **Longer wavelength microwave radiation can penetrate through cloud cover, haze, dust, and all but the heaviest rainfall** as the longer wavelengths are not susceptible to atmospheric scattering which affects shorter optical wavelengths. This property allows detection of microwave energy under almost all weather and environmental conditions so that data can be collected at any time.

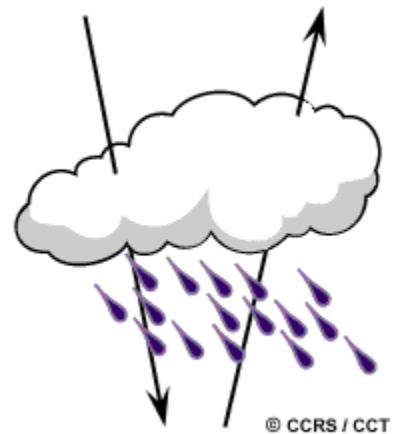

Passive microwave sensing is similar in concept to thermal remote sensing. All objects emit microwave energy of some magnitude, but the amounts are generally very small. A passive microwave sensor detects the naturally emitted microwave energy within its field of view. This emitted energy is related to the temperature and moisture properties of the emitting object or surface. Passive microwave sensors are typically radiometers or scanners and operate in much the same manner as systems discussed previously except that an antenna is used to detect and record the microwave energy.

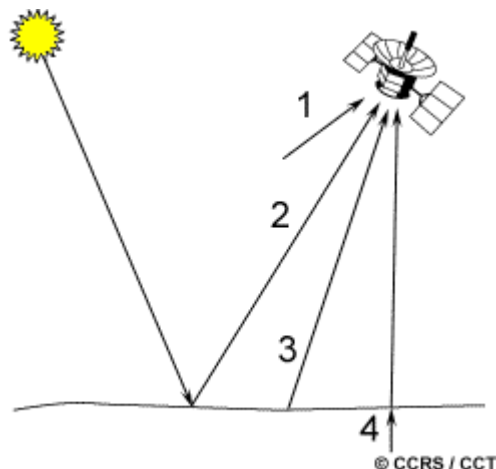

The microwave energy recorded by a passive sensor can be emitted by the atmosphere (1), reflected from the surface (2), emitted from the surface (3), or transmitted from the subsurface (4). Because the wavelengths are so long, the energy available is quite small compared to optical wavelengths. Thus, the fields of view must be large to detect enough energy to record a signal. Most passive microwave sensors are therefore characterized by low spatial resolution.

Applications of passive microwave remote sensing include meteorology, hydrology, and oceanography. By looking "at", or "through" the atmosphere, depending on the wavelength, meteorologists can use passive microwaves to measure atmospheric profiles and to determine water and ozone content in the atmosphere. Hydrologists use passive microwaves to measure soil moisture since microwave emission is influenced by moisture content. Oceanographic applications include mapping sea ice, currents, and surface winds as well as detection of pollutants, such as oil slicks.

Active microwave sensors provide their own source of microwave radiation to illuminate the target. Active microwave sensors are generally divided into two distinct categories: **imaging and non-imaging**. The most common form of imaging active microwave sensors is RADAR. **RADAR** is an acronym for **R**ADIO **D**ETECTION **A**ND **R**ANGING, which essentially characterizes the function and operation of a radar sensor. The sensor transmits a microwave (radio) signal towards the target and detects the backscattered portion of the signal.

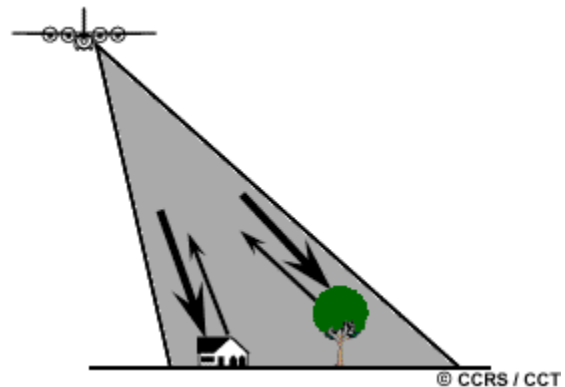

The strength of the backscattered signal is measured to discriminate between different targets and the time delay between the transmitted and reflected signals determines the distance (or **range**) to the target.

Non-imaging microwave sensors include **altimeters** and **scatterometers**. In most cases these are profiling devices which take measurements in one linear dimension, as opposed to the two-dimensional representation of imaging sensors. Radar altimeters transmit short microwave pulses and measure the round trip time delay to targets to determine their distance from the sensor. Generally altimeters look straight down at nadir below the platform and thus measure height or elevation (if the altitude of the platform is accurately known). Radar altimetry is used on aircraft for altitude determination and on aircraft and satellites for topographic mapping and sea surface height estimation. Scatterometers are also generally non-imaging sensors and are used to make precise quantitative measurements of the amount of energy backscattered from targets. The amount of energy backscattered is dependent on the surface properties (roughness) and the angle at which the microwave energy strikes the target. Scatterometry measurements over ocean surfaces can be used to estimate wind speeds based on the sea surface roughness. Ground-based scatterometers are used extensively to accurately measure the backscatter from various targets in order to

characterize different materials and surface types. This is analogous to the concept of spectral reflectance curves in the optical spectrum.

For the remainder of this chapter we focus solely on **imaging radars**. As with passive microwave sensing, a major advantage of radar is the capability of the radiation to penetrate through cloud cover and most weather conditions. Because radar is an active sensor, it can also be used to image the surface at any time, day or night. These are the two primary advantages of radar: **all-weather and day or night** imaging. It is also important to understand that, because of the fundamentally different way in which an active radar operates compared to the passive sensors we described in Chapter 2, a radar image is quite different from and has special properties unlike images acquired in the visible and infrared portions of the spectrum. Because of these differences, radar and optical data can be complementary to one another as they offer different perspectives of the Earth's surface providing different information content. We will examine some of these fundamental properties and differences in more detail in the following sections.

Before we delve into the peculiarities of radar, let's first look briefly at the origins and history of imaging radar, with particular emphasis on the Canadian experience in radar remote sensing. The first demonstration of the transmission of radio microwaves and reflection from various objects was achieved by Hertz in 1886. Shortly after the turn of the century, the first rudimentary radar was developed for ship detection. In the 1920s and 1930s, experimental ground-based pulsed radars were developed for detecting objects at a distance. The first imaging radars used during World War II had rotating sweep displays which were used for detection and positioning of aircrafts and ships. After World War II, side-looking airborne radar (SLAR) was developed for military terrain reconnaissance and surveillance where a strip of the ground parallel to and offset to the side of the aircraft was imaged during flight. In the 1950s, advances in SLAR and the development of higher resolution synthetic aperture radar (SAR) were developed for military purposes. In the 1960s these radars were declassified and began to be used for civilian mapping applications. Since this time the development of several airborne and spaceborne radar systems for mapping and monitoring applications use has flourished.

Canada initially became involved in radar remote sensing in the mid-1970s. It was recognized that radar may be particularly well-suited for surveillance of our vast northern expanse, which is often cloud-covered and shrouded in darkness during the Arctic winter, as well as for monitoring and mapping our natural resources. Canada's SURSAT (Surveillance Satellite) project from 1977 to 1979 led to our participation in the (U.S.) SEASAT radar satellite, the first operational civilian radar satellite. The Convair-580 airborne radar program, carried out by the Canada Centre for Remote Sensing following the SURSAT program, in conjunction with radar research programs of other agencies such as NASA and the European Space Agency (ESA), led to the conclusion that spaceborne remote sensing was feasible. In 1987, the Radar Data Development Program (RDDP), was initiated by the Canadian government with the objective of "operationalizing the use of radar data by Canadians". Over the 1980s and early 1990s, several research and commercial airborne radar systems have collected vast amounts of

imagery throughout the world demonstrating the utility of radar data for a variety of applications. With the launch of ESA's ERS-1 in 1991, spaceborne radar research intensified, and was followed by the major launches of Japan's J-ERS satellite in 1992, ERS-2 in 1995, and Canada's advanced RADARSAT satellite, also in 1995.

### 3.2 Radar Basics

As noted in the previous section, a **radar** is essentially a ranging or distance measuring device. It consists fundamentally of a transmitter, a receiver, an antenna, and an electronics system to process and record the data. The transmitter generates successive short bursts (or **pulses** of microwave (A) at regular intervals which are focused by the antenna into a beam (B). The radar beam illuminates the surface obliquely at a right angle to the motion of the platform. The antenna receives a portion of the transmitted energy reflected (or **backscattered**) from various objects within the illuminated beam (C). By measuring the time delay between the transmission of a pulse and the reception of the backscattered "echo" from different targets, their distance from the radar and thus their location can be determined. As the sensor platform moves forward, recording and processing of the backscattered signals builds up a two-dimensional image of the surface.

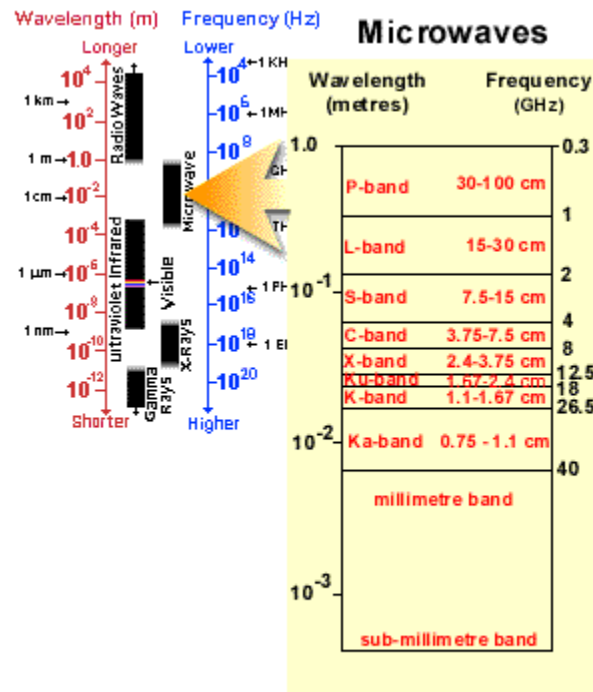
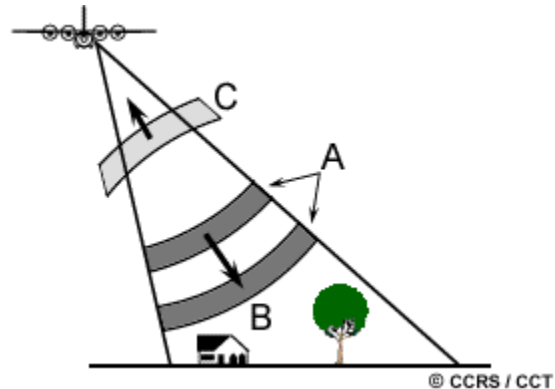

While we have characterized electromagnetic radiation in the visible and infrared portions of the spectrum primarily by wavelength, microwave portions of the spectrum are often referenced according to both wavelength and frequency. The **microwave region of the spectrum** is quite large, relative to the visible and infrared, and there are several wavelength ranges or bands commonly used which given code letters during World War II, and remain to this day.

- Ka, K, and Ku bands: very short wavelengths used in early airborne radar systems but uncommon today.
- X-band: used extensively on airborne systems for military reconnaissance and terrain mapping.
- C-band: common on many airborne research systems (CCRS Convair-580 and NASA AirSAR) and spaceborne systems (including
- ERS-1 and 2 and RADARSAT).



- S-band: used on board the Russian ALMAZ satellite.
- L-band: used onboard American SEASAT and Japanese JERS-1 satellites and NASA airborne system.
- P-band: longest radar wavelengths, used on NASA experimental airborne research system.

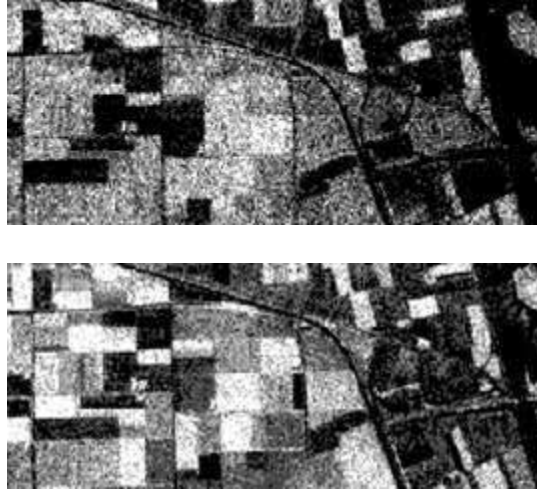

Two radar images of the same agricultural fields

Here are two radar images of the same agricultural fields, each image having been collected using a different radar band. The one on the top was acquired by a C-band radar and the one below was acquired by an L-band radar. You can clearly see that there are significant differences between the way the various fields and crops appear in each of the two images. This is due to the different ways in which the radar energy interacts with the fields and crops depending on the radar wavelength. We will learn more about this in later sections.

When discussing microwave energy, the **polarization** of the radiation is also important. Polarization refers to the orientation of the electric field (recall the definition of electromagnetic radiation from Chapter 1). Most radars are designed to transmit microwave radiation either horizontally polarized (H) or vertically polarized (V). Similarly, the antenna receives either the horizontally or vertically polarized backscattered energy, and some radars can receive both. These two polarization states are designated by the letters H for horizontal, and V, for vertical. Thus, there can be four combinations of both transmit and receive polarizations as follows:

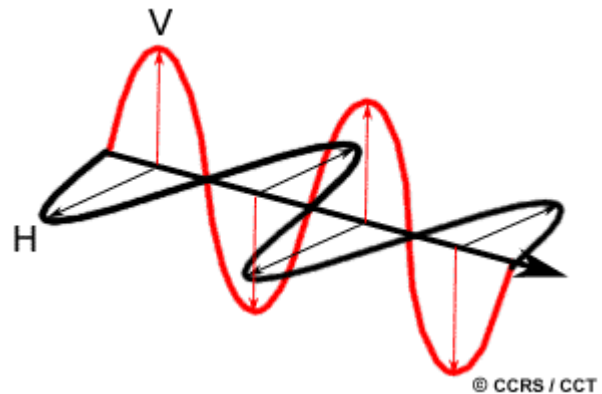

- HH - for horizontal transmit and horizontal receive,
- VV - for vertical transmit and vertical receive,
- HV - for horizontal transmit and vertical receive, and
- VH - for vertical transmit and horizontal receive.

The first two polarization combinations are referred to as like-polarized because the transmit and receive polarizations are the same. The last two combinations are referred to as cross-polarized because the transmit and receive polarizations are opposite of one another. These **C-band images** of agricultural fields demonstrate the variations in radar response due to changes in polarization. The bottom two images are like-polarized (HH and VV, respectively), and the upper right image is cross-polarized (HV). The upper left image is the result of displaying each of the three different polarizations together, one through each of the primary colours (red, green, and blue). Similar to variations in wavelength, depending on the transmit and receive polarizations, the radiation will interact with and be

backscattered differently from the surface. Both wavelength and polarization affect how a radar "sees" the surface. Therefore, radar imagery collected using different polarization and wavelength combinations may provide different and complementary information about the targets on the surface.

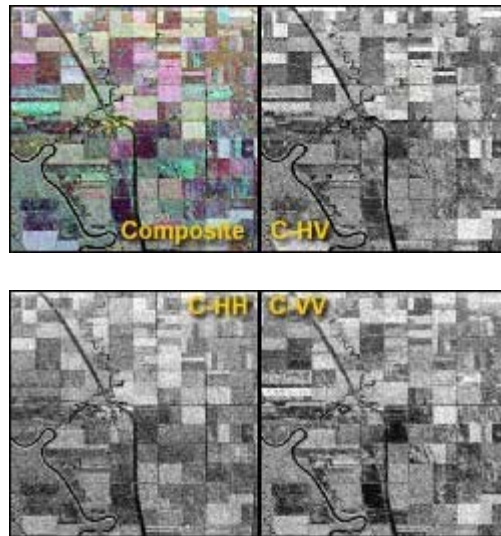

C-band images

### 3.3 Viewing Geometry and Spatial Resolution

The imaging geometry of a radar system is different from the framing and scanning systems commonly employed for optical remote sensing described in Chapter 2. Similar to optical systems, the platform travels forward in the **flight direction (A)** with the **nadir (B)** directly beneath the platform. The microwave beam is transmitted obliquely at right angles to the direction of flight illuminating a **swath (C)** which is offset from nadir. **Range (D)** refers to the across-track dimension perpendicular to the flight direction, while **azimuth (E)** refers to the along-track dimension parallel to the flight direction. This side-looking viewing geometry is typical of imaging radar systems (airborne or spaceborne).

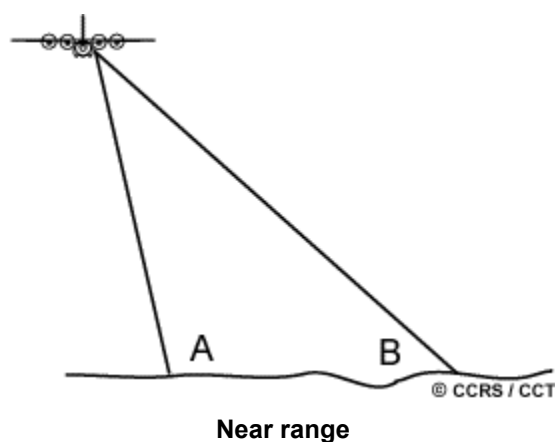
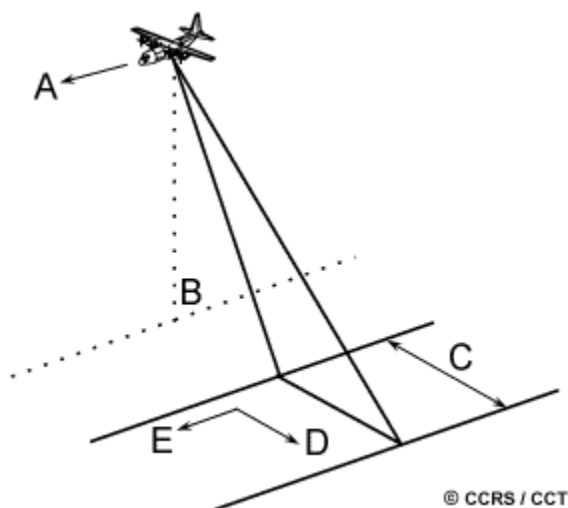

The portion of the image swath closest to the nadir track of the radar platform is called the **near range (A)** while the portion of the swath farthest from the nadir is called the **far range (B)**.

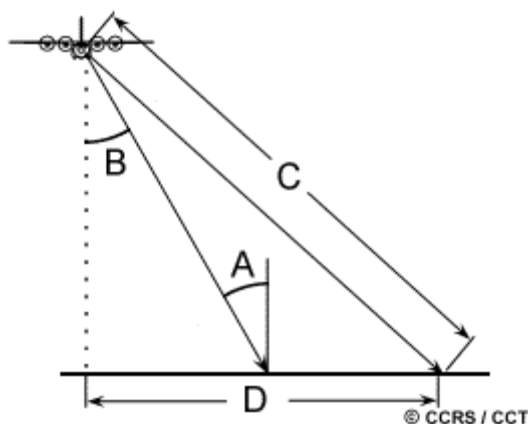

Incidence angle

The incidence angle is the angle between the **radar beam and ground surface (A)** which increases, moving across the swath from near to far range. The **look angle (B)** is the angle at which the radar "looks" at the surface. In the near range, the viewing geometry may be referred to as being steep, relative to the far range, where the viewing geometry is shallow. At all ranges the radar antenna measures the radial line of sight distance between the radar and each target on the surface. This is the **slant range distance (C)**. The **ground range distance (D)** is the true horizontal distance along the ground corresponding to each point measured in slant range.

Unlike optical systems, a radar's spatial resolution is a function of the specific properties of the microwave radiation and geometrical effects. If a Real Aperture Radar (RAR) is used for image formation (as in Side-Looking Airborne Radar) a single transmit pulse and the backscattered signal are used to form the image. In this case, the resolution is dependent on the effective length of the pulse in the slant range direction and on the width of the illumination in the azimuth direction.

The **range or across-track resolution** is dependent on the length of the pulse ( $P$ ). Two distinct targets on the surface will be resolved in the range dimension if their separation is greater than half the pulse length. For example, targets 1 and 2 will not be separable while targets 3 and 4 will. Slant range resolution remains constant, independent of range. However, when projected into ground range coordinates, the resolution in ground range will be dependent of the incidence angle. Thus, for fixed slant range resolution, the ground range resolution will decrease with increasing range.

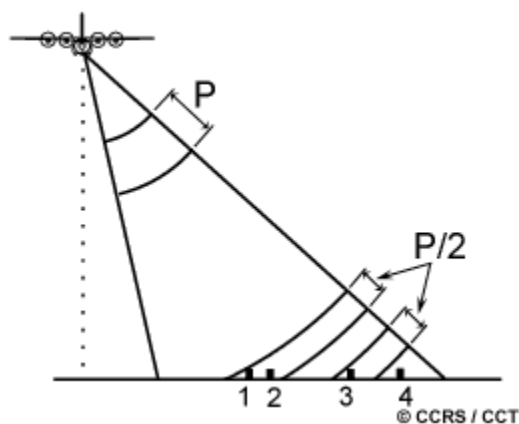

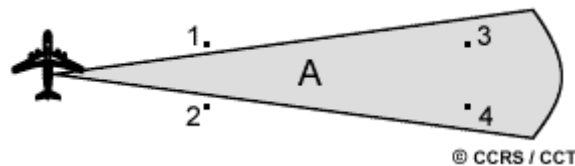

The **azimuth or along-track resolution** is determined by the angular width of the radiated microwave beam and the slant range distance. This **beamwidth (A)** is a measure of the width of the illumination pattern. As the radar illumination propagates to increasing distance from the sensor, the azimuth resolution increases (becomes coarser). In this illustration, targets 1 and 2 in the near range would be separable, but targets 3 and 4 at further range would not. The radar beamwidth is inversely proportional to the antenna length (also referred to as the aperture) which means that a longer antenna (or aperture) will produce a narrower beam and finer resolution.

Finer range resolution can be achieved by using a shorter pulse length, which can be done within certain engineering design restrictions. Finer azimuth resolution can be achieved by increasing the antenna length. However, the actual length of the antenna is limited by what can be carried on an airborne or spaceborne platform. For airborne radars, antennas are usually limited to one to two metres; for satellites they can be 10 to 15 metres in length. To overcome this size limitation, the forward motion of the platform and special recording and processing of the backscattered echoes are used to simulate a very long antenna and thus **increase azimuth resolution**.

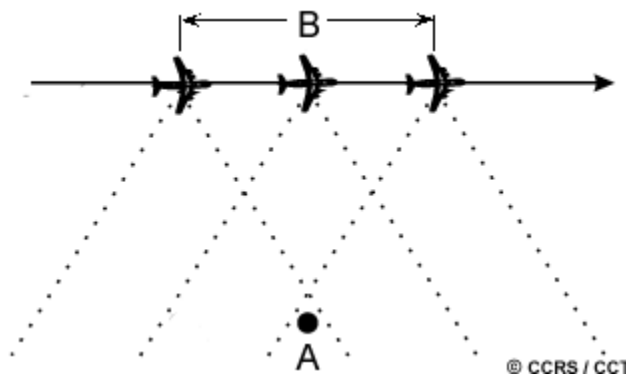

This figure illustrates how this is achieved. As a **target (A)** first enters the radar beam (1), the backscattered echoes from each transmitted pulse begin to be recorded. As the platform continues to move forward, all echoes from the target for each pulse are recorded during the entire time that the target is within the beam. The point at which the target leaves the view of the radar beam (2) some time later, determines the length of the simulated or **synthesized antenna (B)**. Targets at far range, where the beam is widest will be illuminated for a longer period of time than objects at near range. The expanding beamwidth, combined with the increased time a target is within the beam as ground range increases, balance each other, such that the resolution remains constant across the entire swath. This method of achieving uniform, fine azimuth resolution across the entire imaging swath is called **synthetic aperture radar**, or **SAR**. Most airborne and spaceborne radars employ this type of radar.

### 3.4 Radar Image Distortions

As with all remote sensing systems, the viewing geometry of a radar results in certain geometric distortions on the resultant imagery. However, there are key differences for radar imagery which are due to the side-looking viewing geometry, and the fact that the radar is fundamentally a distance measuring device (i.e. measuring range). **Slant-range scale distortion** occurs because the radar is measuring the distance to features in slant-range rather than the true horizontal distance along the ground. This results in a varying image scale, moving from near to far range. Although targets A1 and B1 are the same size on the ground, their apparent dimensions in slant range (A2 and B2) are different. This causes targets in the near range to appear compressed relative to the far range. Using trigonometry, ground-range distance can be calculated from the slant-range distance and platform altitude to convert to the proper ground-range format.

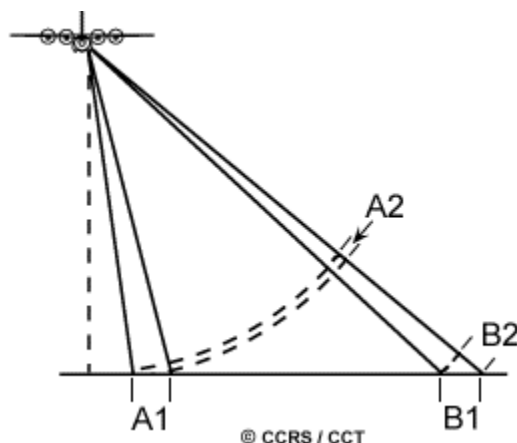

**This conversion comparison** shows a radar image in slant-range display (top) where the fields and the road in the near range on the left side of the image are compressed, and the same image converted to ground-range display (bottom) with the features in their proper geometric shape.

Similar to the distortions encountered when using cameras and scanners, radar images are also subject to geometric distortions due to **relief displacement**. As with scanner imagery, this displacement is one-dimensional and occurs perpendicular to the flight path. However, the displacement is reversed with targets being displaced towards, instead of away from the sensor. Radar **foreshortening** and **layover** are two consequences which result from relief displacement.

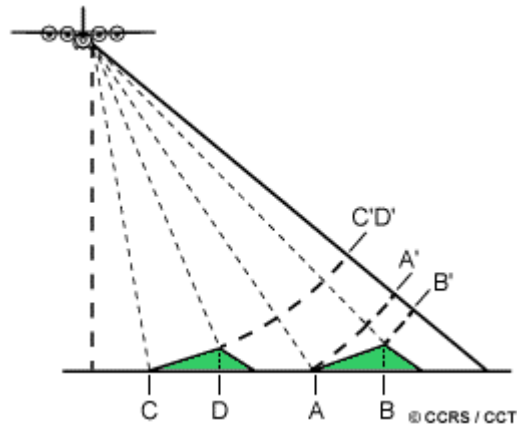

When the radar beam reaches the base of a tall feature tilted towards the radar (e.g. a mountain) before it reaches the top **foreshortening** will occur. Again, because the radar measures distance in slant-range, the slope (A to B) will appear compressed and the length of the slope will be represented incorrectly (A' to B'). Depending on the angle of the hillside or mountain slope in relation to the incidence angle of the radar beam, the severity of foreshortening will vary. Maximum foreshortening occurs when the radar beam is perpendicular to the slope such that the slope, the base, and the top are imaged simultaneously (C to D). The length of the slope will be reduced to an effective length of zero in slant range (C'D'). The figure below shows a radar image of **steep mountainous terrain** with severe foreshortening effects. The foreshortened slopes appear as bright features on the image.

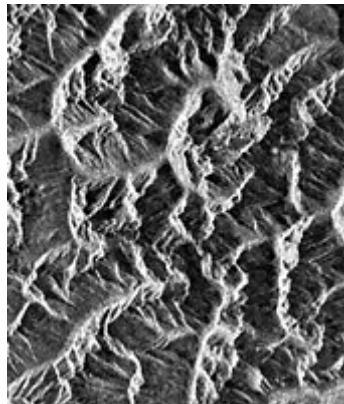

**Layover** occurs when the radar beam reaches the top of a tall feature (B) before it reaches the base (A). The return signal from the top of the feature will be received before the signal from the bottom. As a result, the top of the feature is displaced towards the radar from its true position on the ground, and "lays over" the base of the feature (B' to A'). **Layover effects** on a radar image look very similar to effects due to foreshortening. As with foreshortening, layover is most severe for small incidence angles, at the near range of a swath, and in mountainous terrain.

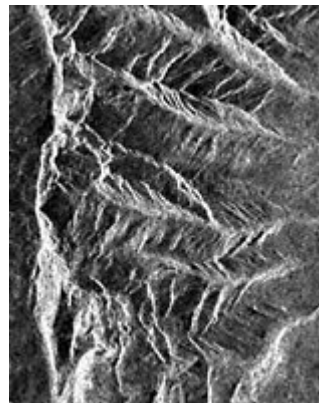
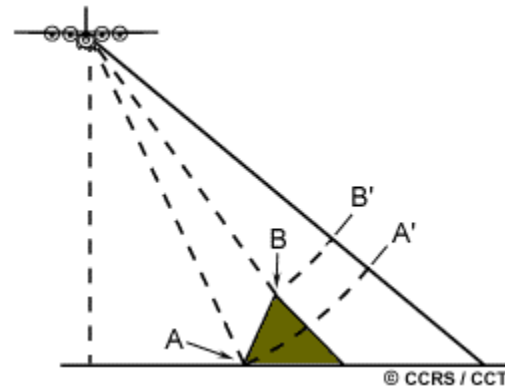

Both foreshortening and layover result in **radar shadow**. Radar shadow occurs when the radar beam is not able to illuminate the ground surface. Shadows occur in the down range dimension (i.e. towards the far range), behind vertical features or slopes with steep sides. Since the radar beam does not illuminate the surface, shadowed regions will appear dark on an image as no energy is available to be backscattered. As incidence angle increases from near to far range, so will shadow effects as the radar beam looks more and more obliquely at the surface. This image illustrates **radar shadow effects** on the right side of the hillsides which are being illuminated from the left.



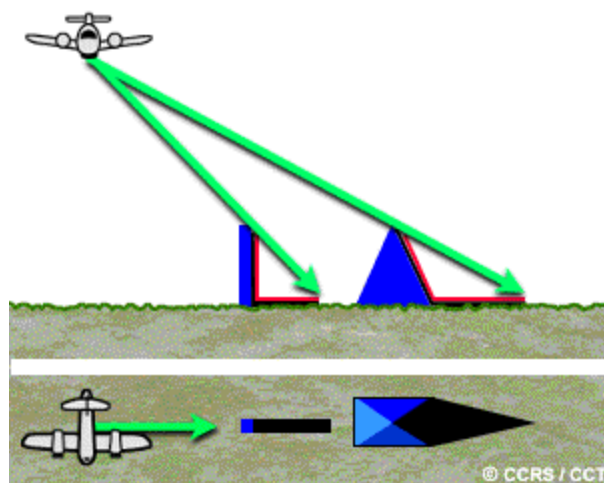

**Red surfaces are completely in shadow. Black areas in image are shadowed and contain no information.**



**Radar shadow effects**

### 3.5 Target Interaction and Image Appearance

The brightness of features in a radar image is dependent on the portion of the transmitted energy that is returned back to the radar from targets on the surface. The magnitude or intensity of this backscattered energy is dependent on how the radar energy interacts with the surface, which is a function of several variables or parameters. These parameters include the particular characteristics of the radar system (frequency, polarization, viewing geometry, etc.) as well as the characteristics of the surface (landcover type, topography, relief, etc.). Because many of these characteristics are interrelated, it is impossible to separate out each of their individual contributions to the appearance of features in a radar image. Changes in the various parameters may have an impact on and affect the response of other parameters, which together will affect the amount of backscatter. Thus, the brightness of features in an image is usually a combination of several of these variables. However, for the purposes of our discussion, we can group these characteristics into three areas which fundamentally control radar energy/target interactions. They are:

- Surface roughness of the target
- Radar viewing and surface geometry relationship
- Moisture content and electrical properties of the target

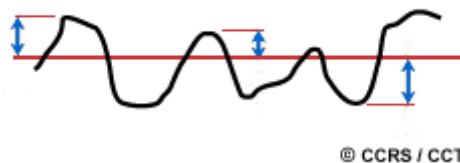

The surface roughness of a feature controls how the microwave energy interacts with that surface or target and is generally the dominant factor in determining the tones seen on a radar image. **Surface roughness** refers to the average height variations in the surface cover from a plane surface, and is measured on the order of centimetres. Whether a surface appears rough or smooth to a radar depends on the wavelength and incidence angle.

Simply put, a surface is considered "smooth" if the height variations are much smaller than the radar wavelength. When the surface height variations begin to approach the size of the wavelength, then the surface will appear "rough". Thus, a given surface will appear rougher as the wavelength becomes shorter and smoother as the wavelength becomes longer. A **smooth surface (A)** causes **specular** reflection of the incident energy (generally away from the sensor) and thus only a small amount of energy is returned to the radar. This results in smooth surfaces appearing as

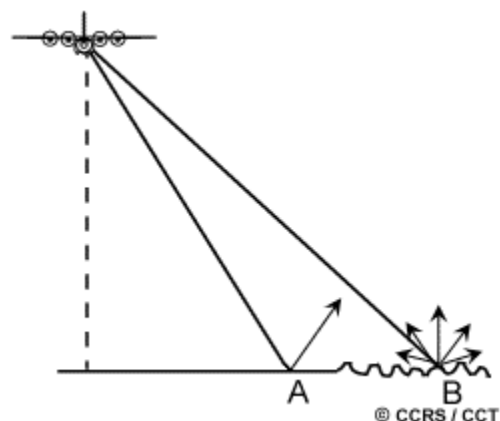

darker toned areas on an image. A **rough surface (B)** will scatter the energy approximately equally in all directions (i.e. **diffusely**) and a significant portion of the energy will be backscattered to the radar. Thus, rough surfaces will appear lighter in tone on an image. Incidence angle, in combination with wavelength, also plays a role in the apparent roughness of a surface. For a given surface and wavelength, the surface will appear smoother as the incidence angle increases. Thus, as we move farther across the swath, from near to far range, less energy would be returned to the sensor and the image would become increasingly darker in tone.

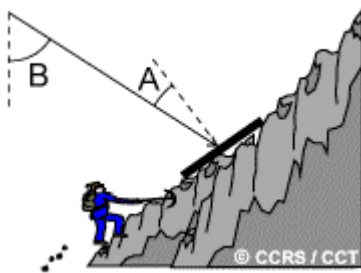

We have already discussed incidence or look angle in relation to viewing geometry and how changes in this angle affect the signal returned to the radar. However, in relation to surface geometry, and its effect on target interaction and image appearance, the local incidence angle is a more appropriate and relevant concept. The local incidence angle is the angle between the radar beam and a line perpendicular to the slope at the point of incidence (A). Thus, local incidence angle takes into account the local slope of the terrain in relation to the radar beam. With flat terrain, the local incidence angle is the same as the look angle (B) of the radar. For terrain with any type of relief, this is not the case. Generally, slopes facing towards the radar will have small local incidence angles, causing relatively strong backscattering to the sensor, which results in a bright-toned appearance in an image.

As the concept of **local incidence angle** demonstrates, the relationship between viewing geometry and the geometry of the surface features plays an important role in how the radar energy interacts with targets and their corresponding brightness on an image. Variations in viewing geometry will accentuate and enhance topography and relief in different ways, such that varying degrees of foreshortening, layover, and shadow (section 3.4) may occur depending on surface slope, orientation, and shape.

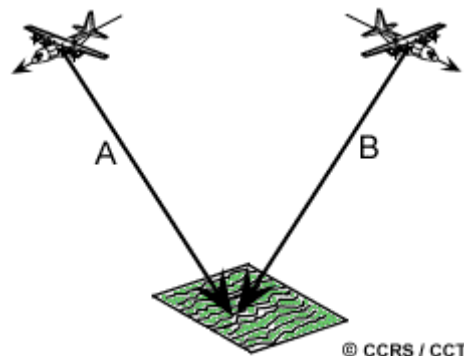

The **look direction or aspect angle** of the radar describes the orientation of the transmitted radar beam relative to the direction or alignment of linear features on the surface. The look direction can significantly influence the appearance of features on a radar image, particularly when ground features are organized in a linear structure (such as agricultural crops or

mountain ranges). If the look direction is close to perpendicular to the orientation of the feature (A), then a large portion of the incident energy will be reflected back to the sensor and the feature will appear as a brighter tone. If the look direction is more oblique in relation to the feature orientation (B), then less energy will be returned to the radar and the feature will appear darker in tone. Look direction is important for enhancing the contrast between features in an image. It is particularly important to have the proper look direction in mountainous regions in order to minimize effects such as layover and shadowing. By acquiring imagery from different look directions, it may be possible to enhance identification of features with different orientations relative to the radar.

Features which have two (or more) surfaces (usually smooth) at right angles to one another, may cause **corner reflection** to occur if the 'corner' faces the general direction of the radar antenna. The orientation of the surfaces at right angles causes most of the radar energy to be reflected directly back to the antenna due to the double bounce (or more) reflection. Corner reflectors with complex angular shapes are common in urban environments (e.g. buildings and streets, bridges, other man-made structures). Naturally occurring corner reflectors may include severely folded rock and cliff faces or upright vegetation standing in water. In all cases, corner reflectors show up as very bright targets in an image, such as the buildings and other man-made structures in this **radar image of a city**.

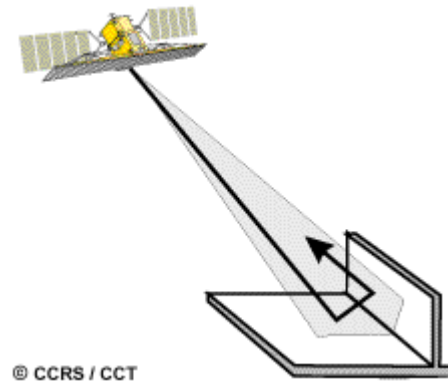

The presence (or absence) of moisture affects the electrical properties of an object or medium. Changes in the electrical properties influence the absorption, transmission, and reflection of microwave energy. Thus, the moisture content will influence how targets and surfaces reflect energy from a radar and how they will appear on an image. Generally, reflectivity (and image brightness) increases with increased moisture content. For example, surfaces such as soil and vegetation cover will appear brighter when they are wet than when they are dry.

When a target is moist or wet, scattering from the topmost portion (surface scattering) is the dominant process taking place. The type of reflection (ranging from specular to diffuse) and the magnitude will depend on how rough the material appears to the radar. If the target is very dry and the surface appears smooth to the radar, the radar energy may be able to penetrate below the surface, whether that surface is discontinuous (e.g. forest canopy with leaves and branches), or a homogeneous surface (e.g. soil, sand, or ice). For a given surface, longer wavelengths are able to penetrate further than shorter wavelengths.

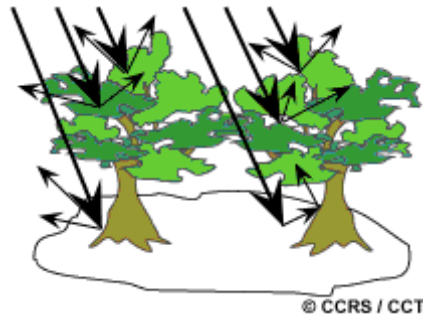

If the radar energy does manage to penetrate through the topmost surface, then volume scattering may occur. **Volume scattering** is the scattering of radar energy within a volume or medium, and usually consists of multiple bounces and reflections from different components within the volume. For example, in a forest, scattering may come from the leaf canopy at the tops of the trees, the leaves and branches further below, and the tree trunks and soil at the ground level. Volume scattering may serve to decrease or increase image brightness, depending on how much of the energy is scattered out of the volume and back to the radar.

### 3.6 Radar Image Properties



All radar images appear with some degree of what we call radar speckle. **Speckle** appears as a grainy "salt and pepper" texture in an image. This is caused by random constructive and destructive interference from the multiple scattering returns that will occur within each resolution cell. As an example, an homogeneous target, such as a large grass-covered field, without the effects of speckle would generally result in light-toned pixel values on an image (A). However, reflections from the individual blades of grass within each resolution cell results in some image pixels being brighter and some being darker than the average tone (B), such that the field appears speckled.

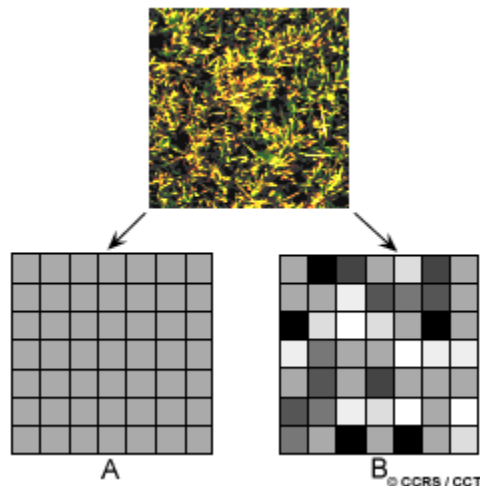

Speckle is essentially a form of noise which degrades the quality of an image and may make interpretation (visual or digital) more difficult. Thus, it is generally desirable to reduce speckle prior to interpretation and analysis. **Speckle reduction** can be achieved in two ways:

- multi-look processing, or
- spatial filtering.

Multi-look processing refers to the division of the radar beam (A) into several (in this example, five) narrower sub-beams (1 to 5). Each sub-beam provides an independent "look" at the illuminated scene, as the name suggests. Each of these "looks" will also be subject to speckle, but by summing and averaging them together to form the final output image, the amount of speckle will be reduced.

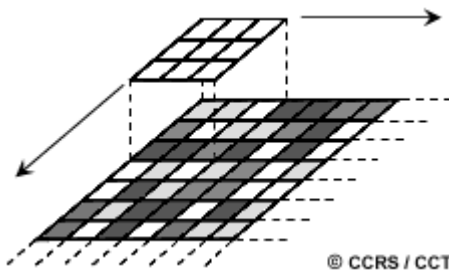
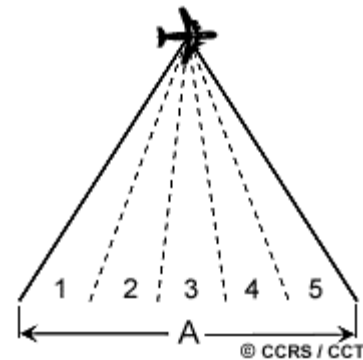

While multi-look processing is usually done during data acquisition, speckle reduction by spatial filtering is performed on the output image in a digital (i.e. computer) image analysis environment. Speckle reduction filtering consists of moving a small window of a few pixels in dimension (e.g. 3x3 or 5x5) over each pixel in the image, applying a mathematical calculation using the pixel values under that window (e.g. calculating the average), and replacing the central pixel with the new value. The window is moved along in both the row and column dimensions one pixel at a time, until the entire image has been covered. By calculating the average of a small window around each pixel, a smoothing effect is achieved and the visual appearance of the speckle is reduced.

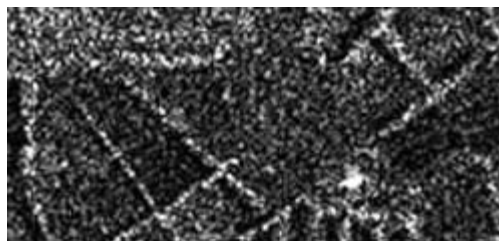

**Speckle reduction using an averaging filter**

This graphic shows a radar image before (top) and after (bottom) speckle reduction using an averaging filter. The median (or middle) value of all the pixels underneath the moving window is also often used to reduce speckle. Other more complex filtering calculations can be performed to reduce speckle while minimizing the amount of smoothing taking place.

Both multi-look processing and spatial filtering reduce speckle at the expense of resolution, since they both essentially smooth the image. Therefore, the amount of speckle reduction desired must be balanced with the particular application the image is being used for, and the amount of detail required. If fine detail and high resolution is required then little or no multi-look/spatial filtering should be done. If broad-scale interpretation and mapping is the application, then speckle reduction techniques may be more appropriate and acceptable.

Another property peculiar to radar images is slant-range distortion, which was discussed in some detail in section 3.4. Features in the near-range are compressed relative to features in the far range due to the slant-range scale variability. For most applications, it is desirable to have the radar image presented in a format which corrects for this distortion, to enable true distance measurements between features. This requires the slant-range image to be converted to 'ground range' display. This can be done by the radar processor prior to creating an image or after data acquisition by applying a transformation to the slant range image. In most cases, this conversion will only be an estimate of the geometry of the ground features due to the complications introduced by variations in terrain relief and topography.

A radar antenna transmits more power in the mid-range portion of the illuminated swath than at the near and far ranges. This effect is known as **antenna pattern** and results in stronger returns from the center portion of the swath than at the edges. Combined with this antenna pattern effect is the fact that the energy returned to the radar decreases dramatically as the range distance increases. Thus, for a given surface, the strength of the returned signal becomes smaller and smaller moving farther across the swath. These effects combine to produce an image which varies in intensity (tone) in the range direction across the image. A process known as **antenna pattern correction** may be applied to produce a uniform average brightness across the imaged swath, to better facilitate visual interpretation.



The range of brightness levels a remote sensing system can differentiate is related to radiometric resolution (section 2.5) and is referred to as the **dynamic range**. While optical sensors, such as those carried by satellites such as Landsat and SPOT, typically produce 256 intensity levels, radar systems can differentiate intensity levels up to around 100,000 levels! Since the human eye can only discriminate about 40 intensity levels at one time, this is too much information for visual interpretation. Even a typical computer would have difficulty dealing with this range of information. Therefore, most radars record and process the original



data as 16 bits (65,536 levels of intensity), which are then further scaled down to 8 bits (256 levels) for visual interpretation and/or digital computer analysis.

**Calibration** is a process which ensures that the radar system and the signals that it measures are as consistent and as accurate as possible. Prior to analysis, most radar images will require **relative calibration**. Relative calibration corrects for known variations in radar antenna and systems response and ensures that uniform, repeatable measurements can be made over time. This allows relative comparisons between the response of features within a single image, and between separate images to be made with confidence. However, if we wish to make accurate **quantitative** measurements representing the actual energy or power returned from various features or targets for comparative purposes, then **absolute calibration** is necessary.

Absolute calibration, a much more involved process than relative calibration, attempts to relate the magnitude of the recorded signal strength to the actual amount of energy backscattered from each resolution cell. To achieve this, detailed measurements of the radar system properties are required as well as quantitative measurements of the scattering properties of specific targets. The latter are often obtained using ground-based scatterometers, as described in section 3.1. Also, devices called **transponders** may be placed on the ground prior to data acquisition to calibrate an image. These devices receive the incoming radar signal, amplify it, and transmit a return signal of known strength back to the radar. By knowing the actual strength of this return signal in the image, the responses from other features can be referenced to it.

### 3.7 Advanced Radar Applications

In addition to standard acquisition and use of radar data, there are three specific applications worth mentioning.



The first is **stereo radar** which is similar in concept to stereo mapping using aerial photography (described in section 2.7). Stereo radar image pairs are acquired covering the same area, but with different look/incidence angles (A), or opposite look directions (B). Unlike aerial photos where the displacement is radially outward from the nadir point directly below the camera, radar images show displacement only in the range direction. Stereo pairs taken from opposite look directions (i.e. one looking north and the other south) may show significant contrast and may be difficult to interpret visually or digitally. In mountainous terrain, this will be even more pronounced as shadowing on opposite sides of features will eliminate the stereo effect. Same side stereo imaging (A) has been used operationally for years to assist in interpretation for forestry and geology and also to generate topographic maps. The estimation of distance measurements and terrain height for topographic mapping from stereo radar data is called **radargrammetry**, and is analogous to photogrammetry carried out for similar purposes with aerial photographs.

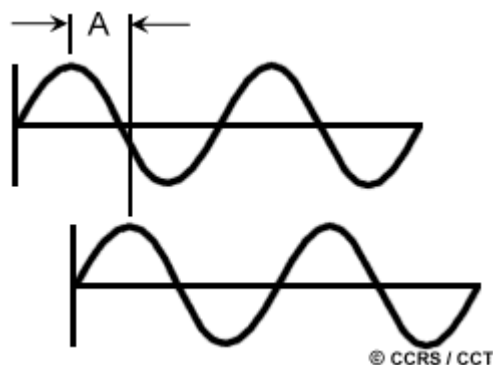

Radargrammetry is one method of estimating terrain height using radar. Another, more advanced method is called **interferometry**. Interferometry relies on being able to measure a property of electromagnetic waves called **phase**. Suppose we have **two waves** with the exact

same wavelength and frequency traveling along in space, but the starting point of one is offset slightly from the other. The offset between matching points on these two waves (A) is called the **phase difference**. **Interferometric systems** use two antennas, separated in the range dimension by a small distance, both recording the returns from each resolution cell. The two antennas can be on the same platform (as with some airborne SARs), or the data can be acquired from two different passes with the same sensor, such as has been done with both airborne and satellite radars. By measuring

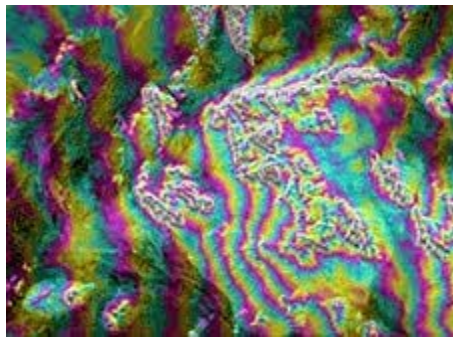

the exact phase difference between the two returns (A), the path length difference can be calculated to an accuracy that is on the order of the wavelength (i.e. centimetres). Knowing the position of the antennas with respect to the Earth's surface, the position of the resolution cell, including its elevation, can be determined. The phase difference between adjacent resolution cells, is illustrated in this **interferogram**, where colours

represents the variations in height. The information contained in an interferogram can be used to derive topographic information and produce **three-dimensional imagery** of terrain height.

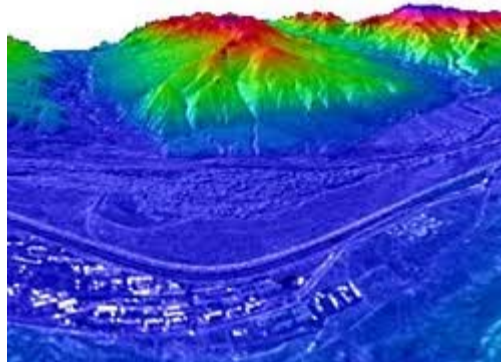
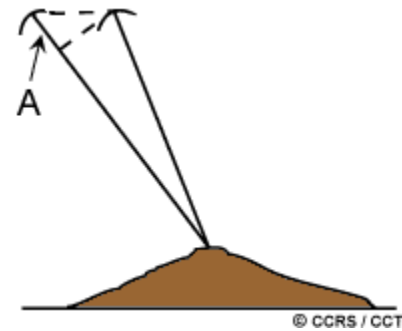

The concept of radar **polarimetry** was already alluded to in our discussion of radar fundamentals in section 3.2. As its name implies, polarimetry involves discriminating between the **polarizations** that a radar system is able to transmit and receive. Most radars transmit microwave radiation in either horizontal (H) or vertical (V) polarization, and similarly, receive the backscattered signal at only one of these polarizations. **Multi-polarization** radars are able to transmit either H or V polarization and receive both the like- and cross-polarized returns (e.g. HH and HV or VV and VH, where the first letter stands for the polarization transmitted and the second letter the polarization received). **Polarimetric radars** are able to transmit and receive both horizontal and vertical polarizations. Thus, they are able to receive and process all four combinations of these polarizations: HH, HV, VH, and VV. Each of these "polarization channels" have varying sensitivities to different surface characteristics and properties. Thus,

the availability of multi-polarization data helps to improve the identification of, and the discrimination between features. In addition to recording the magnitude (i.e. the strength) of the returned signal for each polarization, most polarimetric radars are also able to record the **phase** information of the returned signals. This can be used to further characterize the polarimetric "signature" of different surface features.

## 3.8 Radar Polarimetry

### Introduction to Polarization

When discussing microwave energy propagation and scattering, the polarization of the radiation is an important property. For a plane electromagnetic (EM) wave, polarization refers to the locus of the electric field vector in the plane perpendicular to the direction of propagation. While the length of the vector represents the **amplitude** of the wave, and the rotation rate of the vector represents the **frequency** of the wave, polarization refers to the **orientation** and **shape** of the pattern traced by the tip of the vector.

The waveform of the electric field strength (voltage) of an EM wave can be predictable (the wave is polarized) or random (the wave is unpolarized), or a combination of both. In the latter case, the degree of polarization describes the ratio of polarized power to total power of the wave. An example of a fully polarized wave would be a **monochromatic** sine wave, with a single, constant frequency and stable amplitude.

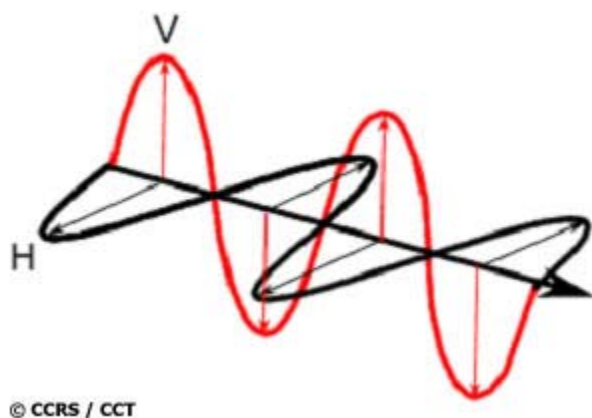

Examples of horizontal (black) and vertical (red) polarizations of a plane electromagnetic wave

Many radars are designed to transmit microwave radiation that is either horizontally polarized (H) or vertically polarized (V). A transmitted wave of either polarization can generate a backscattered wave with a variety of polarizations. It is the analysis of these transmit and receive polarization combinations that constitutes the science of radar polarimetry.

Any polarization on either transmission or reception can be synthesized by using H and V components with a well-defined relationship between them. For this reason, systems that transmit and receive both of these linear polarizations are commonly used. With these radars, there can be four combinations of transmit and receive polarizations:

- HH - for horizontal transmit and horizontal receive
- VV - for vertical transmit and vertical receive

- HV - for horizontal transmit and vertical receive, and
- VH - for vertical transmit and horizontal receive.

The first two polarization combinations are referred to as "like-polarized" because the transmit and receive polarizations **are the same**. The last two combinations are referred to as "cross-polarized" because the transmit and receive polarizations **are orthogonal** to one another.

Radar systems can have one, two or all four of these transmit/receive polarization combinations. Examples include the following types of radar systems:

<b>single polarized</b>	- HH or VV (or possibly HV or VH)
<b>dual polarized</b>	- HH and HV, VV and VH, or HH and VV
<b>alternating polarization</b>	- HH and HV, alternating with VV and VH
<b>polarimetric</b>	- HH, VV, HV, and VH

Note that "quadrature polarization" and "fully polarimetric" can be used as synonyms for "polarimetric". The **relative phase** between channels is measured in a polarimetric radar, and is a very important component of the measurement. In the other radar types, relative phase may or may not be measured. The alternating polarization mode has been introduced on ENVISAT - relative phase is measured but the important HH-VV phase is not meaningful because of the time lapse between the measurements.

These C-band images of agricultural fields demonstrate the dependence of the radar response on polarization. The top two images are like-polarized (HH on left, VV on right), and the lower left image is cross-polarized (HV). The lower right image is the result of displaying these three images as a colour composite (in this case, HH - red, VV - green, and HV - blue).

Both wavelength and polarization affect how a radar system "sees" the elements in the scene. Therefore, radar imagery collected using different polarization and wavelength combinations may provide different and complementary information. Furthermore, when three polarizations are combined in a colour composite, the information is presented in a way that an image interpreter can infer more information of the surface characteristics.

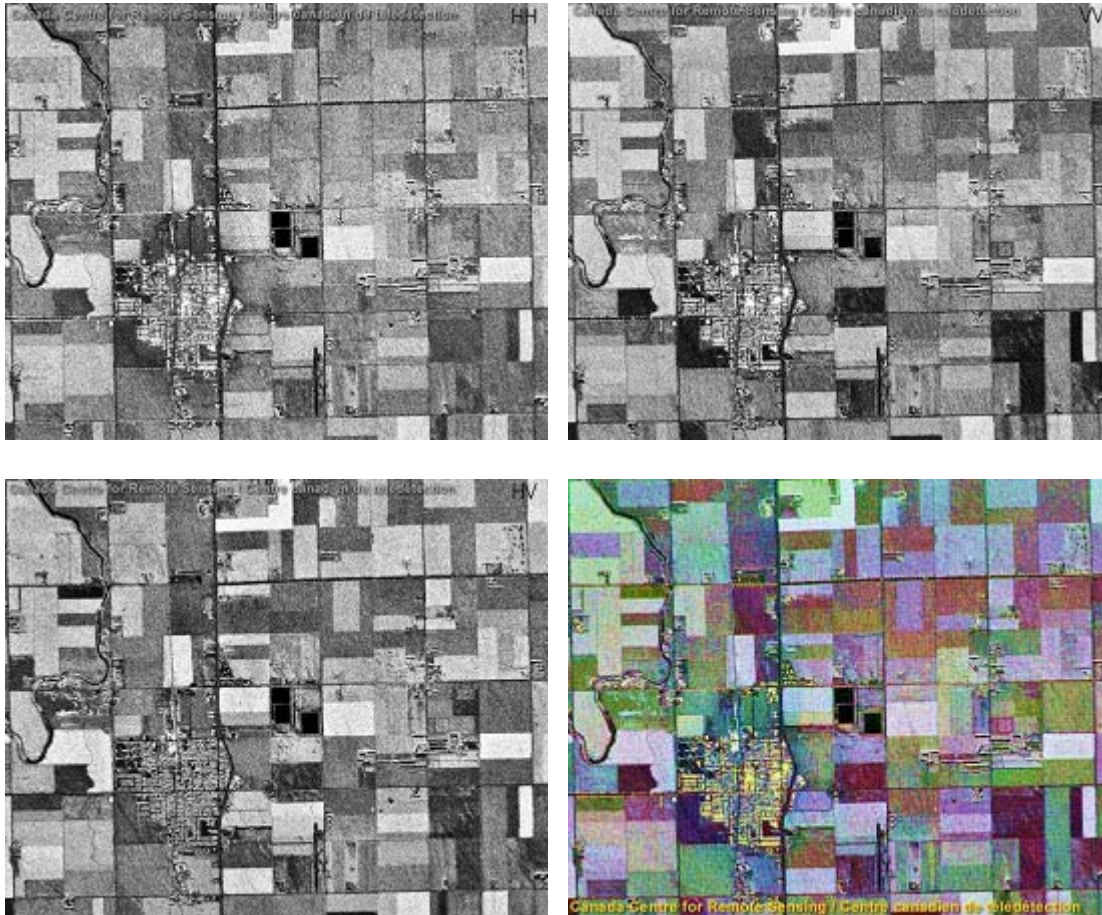

**Illustration of how different polarizations (HH, VV, HV & colour composite) bring out different features in an agricultural scene**

### **Polarimetric Information**

The primary description of how a radar target or surface feature scatters EM energy is given by the scattering matrix. From the scattering matrix, other forms of polarimetric information can be derived, such as synthesized images and polarization signatures.

### **Polarization Synthesis**

A polarimetric radar can be used to determine the target response or scattering matrix using two orthogonal polarizations, typically linear H and linear V on each of transmit and receive. If a scattering matrix is known, the response of the target to **any combination** of incident and received polarizations can be computed. This is referred to as **polarization synthesis**, and illustrates the power and flexibility of a fully polarimetric radar.

Through polarization synthesis, an image can be created to improve the detectability of

selected features. An example is the detection of ships in ocean images. To find the best transmit-receive polarization combination to use, the polarization signature of a typical ship and that of the ocean is calculated for a number of polarizations. Then the ratio of the ship to ocean backscatter is computed for each polarization. The transmit-receive polarization combination that maximises the ratio of backscatter strength is then used to improve the detectability of ships. This procedure is called "polarimetric contrast enhancement" or the use of a "polarimetric matched filter".

### Polarization Signatures

Because the incident and scattered waves can take on so many different polarizations, and the scattering matrix consists of four complex numbers, it is helpful to simplify the interpretation of the scattering behaviour using three-dimensional plots. The "polarization signature" of the target provides a convenient way of visualising a target's scattering properties. The signatures are also called "polarization response plots".

An incident electromagnetic wave can be selected to have an electric field with ellipticity between  $-45^\circ$  and  $+45^\circ$ , and an orientation between  $0$  and  $180^\circ$ . These variables are used as the x- and y-axes of a 3-D plot portraying the polarization signature. For each of these possible incident polarizations, the strength of the backscatter can be computed for the **same** polarization on transmit and receive (the co-polarized signature) and for **orthogonal** polarizations on transmit and receive (the cross-polarized signature). The strength is displayed on the z-axis of the signatures.

**Co-polarized signature**

**Cross-polarized signature**

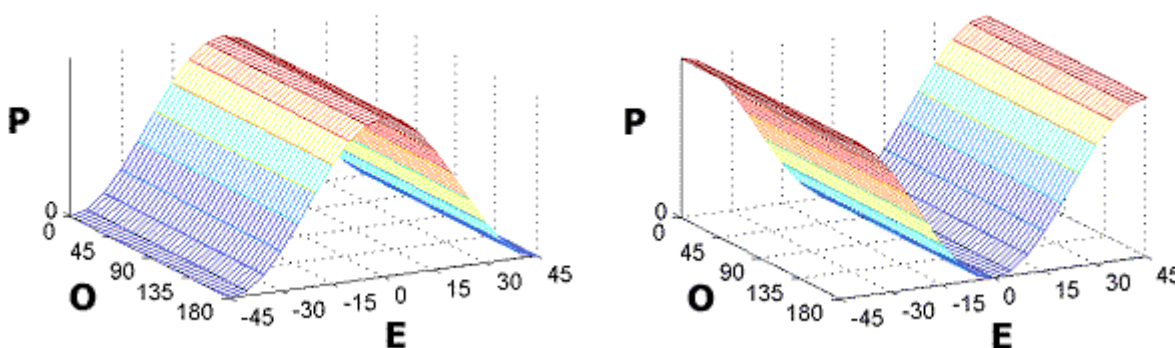

**Polarization signatures of a large conducting sphere.**  
**P = Power, O = Orientation (degrees), E = Ellipticity (degrees)**

This figure shows the polarization signatures of the most simple of all targets - a large conducting sphere or a trihedral corner reflector. The wave is backscattered with the same polarization, except for a change of sign of the ellipticity (or in the case of linear polarization, a



change of the phase angle between  $E_h$  and  $E_v$  of  $180^\circ$ ). The sign changes once for every reflection - the sphere represents a single reflection, and the trihedral gives three reflections, so each behaves as an "odd-bounce" reflector.

For more complicated targets, the polarization signature takes on different shapes. Two interesting signatures come from a dihedral corner reflector and Bragg scattering from the sea surface. In the case of the dihedral reflector, the co-pol signature has a double peak, characteristic of "even-bounce" reflectors. In the case of Bragg scattering, the response is similar to the single-bounce sphere, except that the backscatter of the vertical polarization is higher than that of the horizontal polarization.

### **Data Calibration**

One critical requirement of polarimetric radar systems is the need for calibration. This is because much of the information lies in the ratios of amplitudes and the differences in phase angle between the four transmit-receive polarization combinations. If the calibration is not sufficiently accurate, the scattering mechanisms will be misinterpreted and the advantages of using polarization will not be realised.

Calibration is achieved by a combination of radar system design and data analysis. Imagine the response to a trihedral corner reflector. Its ideal response is only obtained if the four channels of the radar system all have the same gain, system-dependent phase differences between channels are absent, and there is no energy leakage from one channel to another.

In terms of the radar system design, the channel gains and phases should be as carefully matched as possible. In the case of the phase balance, this means that the signal path lengths should be effectively the same in all channels. Calibration signals are often built into the design to help verify these channel balances.

In terms of data analysis, channel balances, cross-talk and noise effects can be measured and corrected by analysing the received data. In addition to analysing the response of internal calibration signals, the signals from known targets such as corner reflectors, active transponders, and uniform clutter can be used to calibrate some of the parameters.

### **Polarimetric Applications**

Synthetic Aperture Radar polarimetry has been limited to a number of experimental airborne SAR systems and the SIR-C (shuttle) mission. With these data, researchers have studied a number of applications, and have shown that the interpretation of a number of features in a scene is facilitated when the radar is operated in polarimetric mode. The launch of RADARSAT-2 will make polarimetric data available on an operational basis, and uses of such data will become more routine and more sophisticated.

Some applications in which polarimetric SAR has already proved useful include:

- Agriculture: for crop type identification, crop condition monitoring, soil moisture measurement, and soil tillage and crop residue identification;
- Forestry: for clearcuts and linear features mapping, biomass estimation, species identification and fire scar mapping;
- Geology: for geological mapping;
- Hydrology: for monitoring wetlands and snow cover;
- Oceanography: for sea ice identification, coastal windfield measurement, and wave slope measurement;
- Shipping: for ship detection and classification;
- Coastal Zone: for shoreline detection, substrate mapping, slick detection and general vegetation mapping.

### 3.9 Airborne versus Spaceborne Radars

Like other remote sensing systems, an imaging radar sensor may be carried on either an airborne or spaceborne platform. Depending on the use of the prospective imagery, there are trade-offs between the two types of platforms. Regardless of the platform used, a significant advantage of using a Synthetic Aperture Radar (SAR) is that the spatial resolution is independent of platform altitude. Thus, fine resolution can be achieved from both airborne and spaceborne platforms.

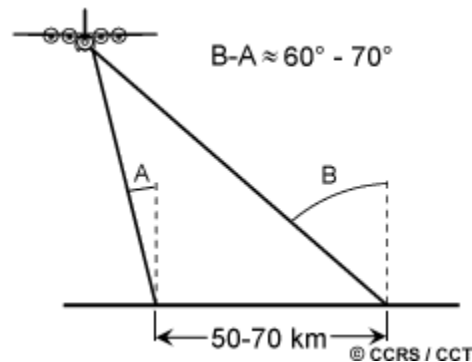

Although spatial resolution is independent of altitude, viewing geometry and swath coverage can be greatly affected by altitude variations. At aircraft operating altitudes, an airborne radar must image over a wide range of incidence angles, perhaps as much as 60 or 70 degrees, in order to achieve relatively wide swaths (let's say 50 to 70 km). As we have learned in the preceding sections, incidence angle (or look angle) has a significant effect on the backscatter from surface features and on their appearance on an image. Image characteristics such as foreshortening, layover, and shadowing will be subject to wide variations, across a large incidence angle range. Spaceborne radars are able to avoid some of these imaging geometry problems since they operate at altitudes up to one hundred times higher than airborne radars. At altitudes of several hundred kilometres, spaceborne radars can image comparable swath widths, but over a much narrower range of incidence angles, typically ranging from five to 15 degrees. This provides for more uniform illumination and reduces undesirable imaging variations across the swath due to viewing geometry.

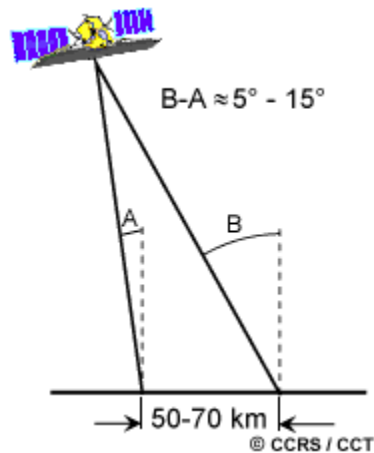

Although airborne radar systems may be more susceptible to imaging geometry problems, they are flexible in their capability to collect data from different look angles and look directions. By optimizing the geometry for the particular terrain being imaged, or by acquiring imagery from more than one look direction, some of these effects may be reduced. Additionally, an airborne radar is able to collect data anywhere and at any time (as long as weather and flying conditions are acceptable!). A spaceborne radar does not have this degree of flexibility, as its viewing geometry and data acquisition schedule is controlled by the pattern of its orbit. However, satellite radars do have the advantage of being able to collect imagery more quickly over a larger area than an airborne radar, and provide consistent viewing geometry. The frequency of coverage may not be as often as that possible with an airborne platform, but depending on the orbit parameters, the viewing geometry flexibility, and the geographic area of interest, a spaceborne radar may have a revisit period as short as one day.

As with any aircraft, an airborne radar will be susceptible to variations in velocity and other motions of the aircraft as well as to environmental (weather) conditions. In order to avoid image artifacts or geometric positioning errors due to random variations in the motion of the aircraft, the radar system must use sophisticated navigation/positioning equipment and advanced image processing to compensate for these variations. Generally, this will be able to correct for all but the most severe variations in motion, such as significant air turbulence. Spaceborne radars are not affected by motion of this type. Indeed, the geometry of their orbits is usually very stable and their positions can be accurately calculated. However, geometric correction of imagery from spaceborne platforms must take into account other factors, such as the rotation and curvature of the Earth, to achieve proper geometric positioning of features on the surface.

### 3.10 Airborne and Spaceborne Radar Systems

In order to more clearly illustrate the differences between airborne and spaceborne radars, we will briefly outline a few of the representative systems of each type, starting with airborne systems.



The **Convair-580 C/X SAR** system developed and operated by the Canada Centre for Remote Sensing was a workhorse for experimental research into advanced SAR applications in Canada and around the world, particularly in preparation for satellite-borne SARs. The system was transferred to Environment Canada in 1996 for use in oil spill research and other environmental applications. This system operates at two radar bands, C- (5.66 cm) and X- (3.24 cm). Cross-polarization data can be recorded simultaneously for both the C- and X-band channels, and the C-band system can be operated as a fully polarimetric radar. Imagery can be acquired at three different imaging geometries (nadir, narrow and wide swath modes) over a wide range of incidence angles (five degrees to almost 90 degrees). In addition to being a fully calibratable system for quantitative measurements, the system has a second antenna mounted on the aircraft fuselage to allow the C-band system to be operated as an interferometric radar.



The **Sea Ice and Terrain Assessment (STAR)** systems operated by Intera Technologies Limited of Calgary, Alberta, Canada, (later Intermap Technologies ) were among the first SAR systems used commercially around the world. Both STAR-1 and STAR-2 operate at X-band (3.2 cm) with HH polarization in two different resolution modes. The swath coverage varies from 19 to 50 km, and the resolution from 5 to 18 m. They were primarily designed for monitoring sea ice (one of the key applications for radar, in Canada) and for terrain

analysis. Radar's all-weather, day or night imaging capabilities are well-suited to monitoring ice in Canada's northern and coastal waters. STAR-1 was also the first SAR system to use on-board data processing and to offer real-time downlinking of data to surface stations.

The United States National Aeronautics and Space Administration (NASA) has been at the forefront of multi-frequency, multi-polarization synthetic aperture radar research for many years. The Jet Propulsion Laboratory (JPL) in California has operated various advanced systems on contract for NASA. The **AirSAR**



system is a C-, L-, and P-band advanced polarimetric SAR which can collect data for each of these bands at all possible combinations of horizontal and vertical transmit and receive polarizations (i.e. HH, HV, VH, and VV). Data from the AirSAR system can be fully calibrated to allow extraction of quantitative measurements of radar backscatter. Spatial resolution of the AirSAR system is on the order of 12 metres in both range and azimuth. Incidence angle ranges from zero degrees at nadir to about 70 degrees at the far range. This capability to collect multi-frequency, multi-polarization data over such a diverse range of incidence angles allows a wide variety of specialized research experiments to be carried out.



With the advances and success of airborne imaging radar, satellite radars were the next logical step to complement the optical satellite sensors in operation. **SEASAT**, launched in 1978, was the first civilian remote sensing satellite to carry a spaceborne SAR sensor. The SAR operated at L-band (23.5 cm) with HH polarization. The viewing geometry was fixed between nine and 15 degrees with a swath width of 100 km and a spatial resolution of 25 metres. This steep viewing geometry was designed primarily for observations of ocean and sea ice, but a great deal of imagery was also collected over land areas. However, the small incidence angles amplified foreshortening and layover effects over terrain with high relief, limiting its utility in these areas. Although the satellite was only operational for three months, it demonstrated the wealth of information (and the large volumes of data!) possible from a spaceborne radar.

With the success of the short-lived SEASAT mission, and impetus provided from positive results with several airborne SARs, the European Space Agency (ESA) launched ERS-1 in July of 1991. **ERS-1** carried on-board a radar altimeter, an infrared radiometer and microwave sounder, and a C-band (5.66 cm), active microwave instrument. This is a flexible instrument which can be operated as a scatterometer to measure reflectivity of the ocean surface, as well as ocean surface wind speed and direction. It can also operate as a synthetic aperture radar, collecting imagery over a 100 km swath over an incidence angle range of 20 to 26 degrees, at a resolution of approximately 30 metres. Polarization is

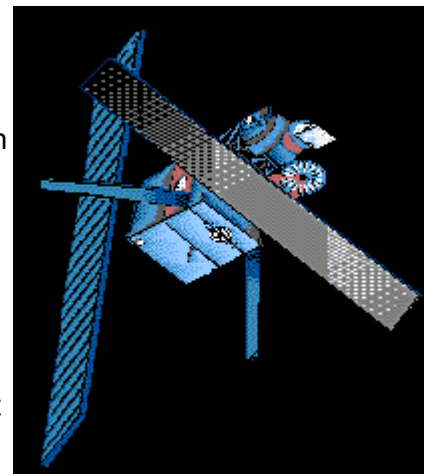

vertical transmit and vertical receive (VV) which, combined with the fairly steep viewing angles, make ERS-1 particularly sensitive to surface roughness. The revisit period (or repeat cycle) of ERS-1 can be varied by adjusting the orbit, and has ranged from three to 168 days, depending on the mode of operation. Generally, the repeat cycle is about 35 days. A second satellite, ERS-2, was launched in April of 1995 and carries the same active microwave sensor as ERS-1. Designed primarily for ocean monitoring applications and research, ERS-1 provided the worldwide remote sensing community with the first wide-spread access to spaceborne SAR data. Imagery from both satellites has been used in a wide range of applications, over both ocean and land environments. Like SEASAT, the steep viewing angles limit their utility for some land applications due to geometry effects.

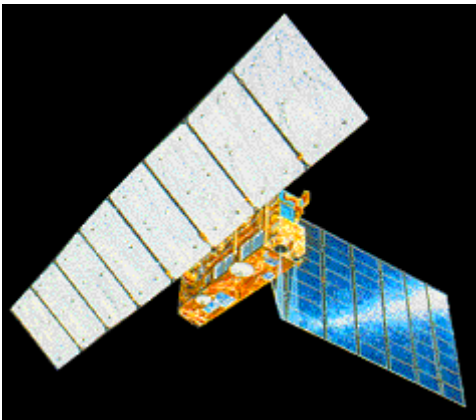

The National Space Development Agency of Japan (NASDA), launched the **JERS-1** satellite in February of 1992. In addition to carrying two optical sensors, JERS-1 has an L-band (23.5 cm) SAR operating at HH polarization. The swath width is approximately 75 km and spatial resolution is approximately 18 metres in both range and azimuth. The imaging geometry of JERS-1 is slightly shallower than either SEASAT or the ERS satellites, with the incidence angle at the middle of the swath being 35 degrees. Thus, JERS-1 images are slightly less susceptible to geometry and terrain effects.

The longer L-band wavelength of JERS-1 allows some penetration of the radar energy through vegetation and other surface types.

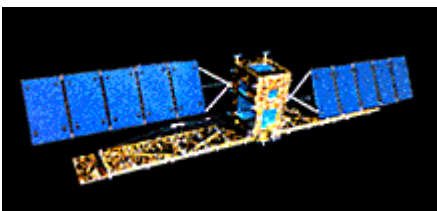

Spaceborne SAR remote sensing took a giant leap forward with the launch of Canada's **RADARSAT** satellite on Nov. 4, 1995. The RADARSAT project, led by the Canadian Space Agency (CSA), was built on the development of remote sensing technologies and applications work carried out by the Canada Centre for Remote Sensing (CCRS)

since the 1970s. RADARSAT carries an advanced C-band (5.6 cm), HH-polarized SAR with a steerable radar beam allowing **various imaging options** over a 500 km range. Imaging swaths can be varied from 35 to 500 km in width, with resolutions from 10 to 100 metres. Viewing geometry is also flexible, with incidence angles ranging from less than 20 degrees to more than 50 degrees. Although the satellite's orbit repeat cycle is 24 days, the flexibility of the steerable radar beam gives RADARSAT the ability to image regions much more frequently and to address specific geographic requests for data acquisition. RADARSAT's orbit is optimized for frequent coverage of mid-latitude to polar regions, and is able to provide daily images of the entire Arctic region as well as view any part of Canada within three days. Even at equatorial latitudes, complete coverage can be obtained within six days using the widest swath of 500 km.

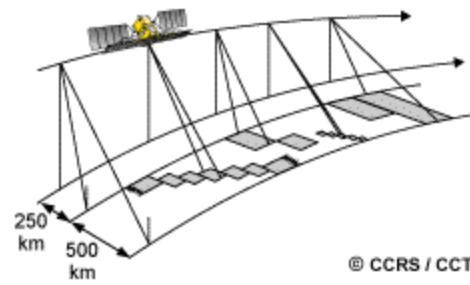

**Imaging options over a 500 km range**



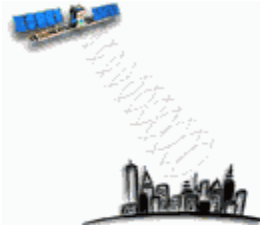

## 3. Endnotes

### 3.11 Endnotes

You have just completed Chapter 3 - Microwave Sensing. You can continue to Chapter 4 - Image Interpretation and Analysis or first browse the CCRS Web site for other articles related to microwave remote sensing.

You can get more information about remote sensing radars by checking out an the [overview](#)<sup>1</sup> or the more detailed [technical specifications](#)<sup>2</sup> of Canada's own microwave satellite: RADARSAT. You can even see [photos](#)<sup>3</sup> of the satellite being built, watch a [video of the launch and see the very first image!](#)<sup>4</sup> As well, learn how microwave remote sensing is used for various applications such as [agriculture](#)<sup>5</sup>, [forestry](#)<sup>6</sup>, and [geology](#)<sup>7</sup>, and see [international applications](#)<sup>8</sup> of RADARSAT imagery.

Learn about a new way of [reducing speckle](#)<sup>9</sup> in a radar image that was developed by scientists at CCRS in co-operation with scientists in France. As well, learn how a digital elevation model can be used to [correct topographic distortions](#)<sup>10</sup> in radar images or how a radar image is calibrated using [precision transponders](#)<sup>11</sup> and see the mysterious movement of the [transponder](#)<sup>12</sup> when shown in an image!

A [training manual](#)<sup>13</sup> has been prepared on how radar data can be used to obtain stereo images. [Interferometry](#)<sup>14</sup> is another fascinating technique studied extensively at CCRS. It has been tried with both airborne and satellite data and applied to detecting [changes in the land](#)<sup>15</sup>, [glacier movement](#)<sup>16</sup> and [ocean studies](#)<sup>17</sup>.

Our Remote Sensing Glossary has extensive terminology and explanations of microwave-related concepts which can be accessed through [individual term searches](#)<sup>18</sup> or by selecting the [radar](#)" category.

<sup>1</sup>[http://www.ccrs.nrcan.gc.ca/ccrs/data/satsens/radarsat/specs/rsatoview\\_e.html](http://www.ccrs.nrcan.gc.ca/ccrs/data/satsens/radarsat/specs/rsatoview_e.html)

<sup>2</sup>[http://www.ccrs.nrcan.gc.ca/ccrs/data/satsens/radarsat/specs/radspec\\_e.html](http://www.ccrs.nrcan.gc.ca/ccrs/data/satsens/radarsat/specs/radspec_e.html)

<sup>3</sup>[http://www.ccrs.nrcan.gc.ca/ccrs/data/satsens/radarsat/photos/radpix\\_e.html](http://www.ccrs.nrcan.gc.ca/ccrs/data/satsens/radarsat/photos/radpix_e.html)

<sup>4</sup>[http://www.ccrs.nrcan.gc.ca/ccrs/data/satsens/radarsat/photos/radpix\\_e.html](http://www.ccrs.nrcan.gc.ca/ccrs/data/satsens/radarsat/photos/radpix_e.html)

<sup>5</sup>[http://www.ccrs.nrcan.gc.ca/ccrs/data/satsens/airborne/sarbro/sbagri\\_e.html](http://www.ccrs.nrcan.gc.ca/ccrs/data/satsens/airborne/sarbro/sbagri_e.html)

<sup>6</sup>[http://www.ccrs.nrcan.gc.ca/ccrs/data/satsens/airborne/sarbro/sbfort\\_e.html](http://www.ccrs.nrcan.gc.ca/ccrs/data/satsens/airborne/sarbro/sbfort_e.html)

- <sup>7</sup>[http://www.ccrs.nrcan.gc.ca/ccrs/data/satsens/airborne/sarbro/sbgeol\\_e.html](http://www.ccrs.nrcan.gc.ca/ccrs/data/satsens/airborne/sarbro/sbgeol_e.html)
- <sup>8</sup>[http://www.ccrs.nrcan.gc.ca/ccrs/data/satsens/airborne/sarbro/sbgbsar\\_e.html](http://www.ccrs.nrcan.gc.ca/ccrs/data/satsens/airborne/sarbro/sbgbsar_e.html)
- <sup>9</sup>[http://www.ccrs.nrcan.gc.ca/ccrs/com/rsnewsltr/2303/2303ap1\\_e.html](http://www.ccrs.nrcan.gc.ca/ccrs/com/rsnewsltr/2303/2303ap1_e.html)
- <sup>10</sup>[http://www.ccrs.nrcan.gc.ca/ccrs/com/rsnewsltr/2401/2401ap3\\_e.html](http://www.ccrs.nrcan.gc.ca/ccrs/com/rsnewsltr/2401/2401ap3_e.html)
- <sup>11</sup>[http://www.ccrs.nrcan.gc.ca/ccrs/data/satsens/radarsat/trans/transpo\\_e.html](http://www.ccrs.nrcan.gc.ca/ccrs/data/satsens/radarsat/trans/transpo_e.html)
- <sup>12</sup>[http://www.ccrs.nrcan.gc.ca/ccrs/rd/ana/transpond/rpt\\_e.html](http://www.ccrs.nrcan.gc.ca/ccrs/rd/ana/transpond/rpt_e.html)
- <sup>13</sup>[http://www.ccrs.nrcan.gc.ca/ccrs/learn/tutorials/stereosc/chap1/chapter1\\_1\\_e.html](http://www.ccrs.nrcan.gc.ca/ccrs/learn/tutorials/stereosc/chap1/chapter1_1_e.html)
- <sup>14</sup>[http://www.ccrs.nrcan.gc.ca/ccrs/data/satsens/airborne/sarbro/sbinter\\_e.html](http://www.ccrs.nrcan.gc.ca/ccrs/data/satsens/airborne/sarbro/sbinter_e.html)
- <sup>15</sup>[http://www.ccrs.nrcan.gc.ca/ccrs/com/rsnewsltr/2301/2301rn2\\_e.html](http://www.ccrs.nrcan.gc.ca/ccrs/com/rsnewsltr/2301/2301rn2_e.html)
- <sup>16</sup>[http://www.ccrs.nrcan.gc.ca/ccrs/data/satsens/radarsat/images/ant/rant01\\_e.html](http://www.ccrs.nrcan.gc.ca/ccrs/data/satsens/radarsat/images/ant/rant01_e.html)
- <sup>17</sup>[http://www.ccrs.nrcan.gc.ca/ccrs/rd/ana/split/insar\\_e.html](http://www.ccrs.nrcan.gc.ca/ccrs/rd/ana/split/insar_e.html)
- <sup>18</sup>[http://www.ccrs.nrcan.gc.ca/ccrs/learn/terms/glossary/glossary\\_e.html](http://www.ccrs.nrcan.gc.ca/ccrs/learn/terms/glossary/glossary_e.html)



## 3. Did You Know?

---

### 3.1 Did You Know?

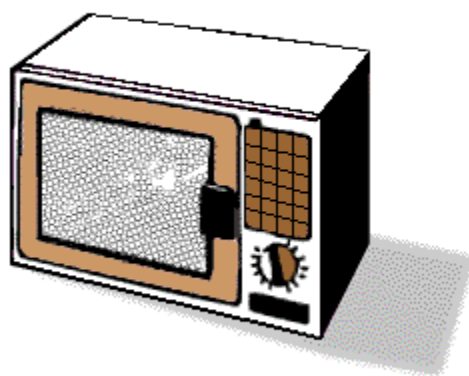

© CCRS / CCT

'S' band magnetrons are typically used for microwave oven power sources. They operate in the range of 2-4 GHz. The corresponding wavelengths are 15 cm to 7.5 cm. The screening mesh used on microwave oven doors is sufficiently fine (much smaller than 7.5 cm) that it behaves as a continuous, thin, metal sheet, preventing the escape of the radar energy, yet allowing good visibility of the interior (using visible wavelengths, which are much shorter yet).

### 3.2 Did You Know?

"...Just what do those numbers mean?!"



Typical output products (e.g. RADARSAT imagery) have used 8-bit or 16-bit data formats (digital numbers) for data storage. In order to obtain the original physically meaningful backscatter values ( $\sigma^0$  sigma nought,  $\beta^0$  beta nought) of calibrated radar products, it is necessary to reverse the final steps in the SAR processing chain. For RADARSAT imagery, this must include the squaring of the digital values and the application of a lookup table (which can have range dependent values). Thus, as you can see, the relationships among the digital numbers in the imagery are not that simple!

### 3.4 Did You Know?

"...look to the left, look to the right, stand up, sit down..."

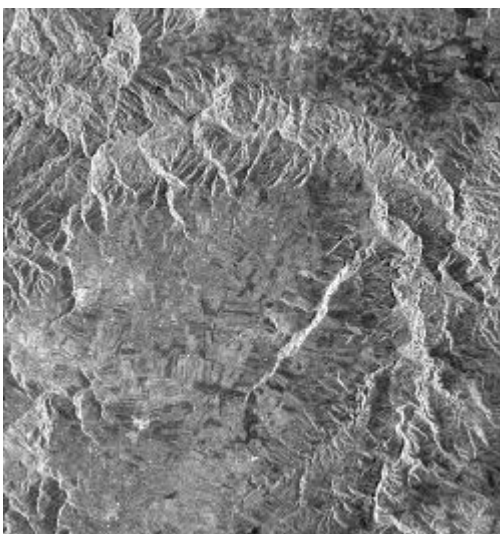

...although a radar's side-looking geometry can result in several image effects such as foreshortening, layover, and shadow, this geometry is exactly what makes radar so useful for terrain analysis. These effects, if not too severe, actually enhance the visual appearance of relief and terrain structure, making radar imagery excellent for applications such as topographic mapping and identifying geologic structure.

### 3.5 Did You Know?

"...rivers in the Sahara desert?...you're crazy!..."

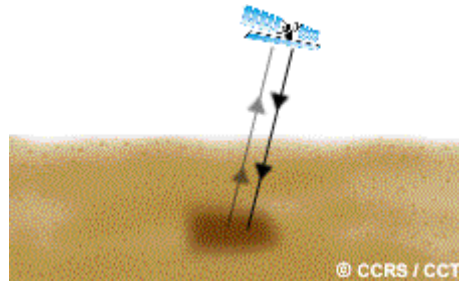

... that an L-band radar (23.5 cm wavelength) imaging from the orbiting space shuttle was able to discover ancient river channels beneath the Sahara Desert in Northern Africa. Because of the long wavelength and the extreme dryness of the sand, the radar was able to penetrate several metres below the desert surface to reveal the old river beds during ancient times when this area was not so dry.

### 3.7 Did You Know?

"...we've picked up an unidentified moving object on the radar, sir..."

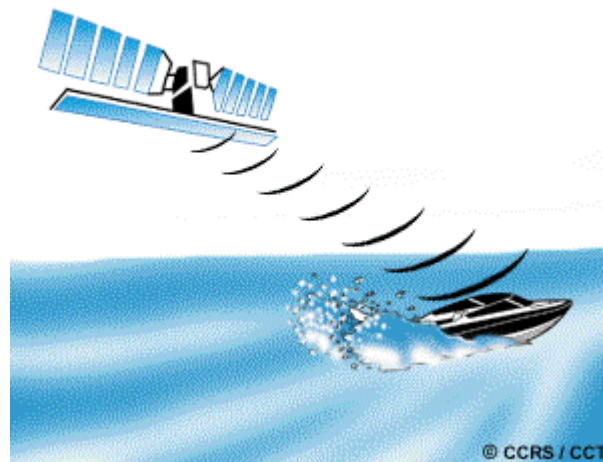

... besides being able to determine terrain height using interferometry, it is also possible to measure the velocity of targets moving towards or away from the radar sensor, using only one pass over the target. This is done by recording the returns from two antennas mounted on the platform, separated by a short distance in the along-track or flight direction. The phase differences between the returns at each antenna are used to derive the speed of motion of targets in the illuminated scene. Potential applications include determination of sea-ice drift, ocean currents, and ocean wave parameters.

### 3.8 Did You Know?

That many other polarizations can be transmitted (or received) if a radar system can transmit or receive the H and V channels simultaneously. For example, if a radar system transmits an H and a V signal simultaneously, and the V signal is 90° out of phase with respect to the H signal, the resulting transmitted wave will have circular polarization.

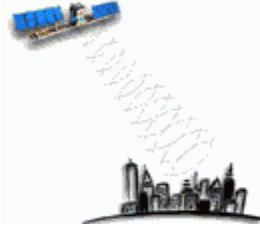

## 3. Whiz Quiz and Answers

### 3.2 Whiz Quiz

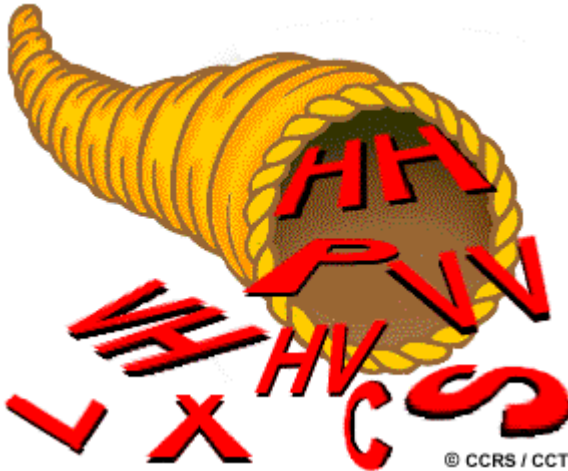

How could we use radar images of different wavelengths and/or polarizations to extract more information about a particular scene? Think back to Chapter 1, the general characteristics of remote sensing images, and Chapter 2, interpretation of data from optical sensors.

Explain how data from a non-imaging scatterometer could be used to extract more accurate information from an imaging radar.

### 3.2 Answers

1. Much the same as with optical sensors that have different bands or channels of data, multi-wavelength and multi-frequency radar images can provide complementary information. Radar data collected at different wavelengths is analogous to the different bands of data in optical remote sensing. Similarly, the various polarizations may also be considered as different bands of information. Depending on the wavelength and polarization of the radar energy, it will interact differently with features on the surface. As with multi-band optical data, we can combine these different "channels" of data together to produce colour images which may highlight subtle variations in features as a function of wavelength or polarization.

2. A scatterometer is used to precisely measure the intensity of backscatter reflected from an object or surface. By accurately characterizing (i.e. measuring) the intensity of energy reflected from a variety of objects or surface types, these measurements can be used to generate typical **backscatter signatures**, similar to the concept of spectral signatures with optical data. These measurements can be used as references for calibrating imagery from an imaging radar sensor so that more accurate comparisons can be made of the response between different features.

### 3.3 Whiz Quiz



Explain why the use of a synthetic aperture radar (SAR) is the only practical option for radar remote sensing from space.

### 3.3 Answer

The high altitudes of spaceborne platforms (i.e. hundreds of kilometres) preclude the use of real aperture radar (RAR) because the azimuth resolution, which is a function of the range distance, would be too coarse to be useful. In a spaceborne RAR, the only way to achieve fine resolution would be to have a very, very narrow beam which would require an extremely long physical antenna. However, an antenna of several kilometres in length is physically impossible to build, let alone fly on a spacecraft. Therefore, we need to use synthetic aperture radar to synthesize a long antenna to achieve fine azimuth resolution.



### 3.5 Whiz Quiz



If an agricultural area, with crops such as wheat and corn, became flooded, what do you think these areas might look like on a radar image? Explain the reasons for your answers based on your knowledge of how radar energy interacts with a target.

### 3.5 Answer

Generally, image brightness increases with increased moisture content. However, in the case of flooding, the surface is completely saturated and results in standing water. Areas where the water has risen above the height of the crops will likely appear dark in tone, as the water acts as a specular reflector bouncing the energy away from the radar sensor. Flooded areas would generally be distinguishable by a darker tone from the surrounding agricultural crops which are not flooded and would scatter more diffusely. However, if the wheat and corn stalks are not completely submersed, then these areas may actually appear brighter on the image. In this situation, specular reflections off the water which then bounce and hit the wheat and corn stalks may act like corner reflectors and return most of the incoming energy back to the radar. This would result in these areas appearing quite bright on the image. Thus, the degree of flooding and how much the crops are submersed will impact the appearance of the image.

### 3.6 Whiz Quiz

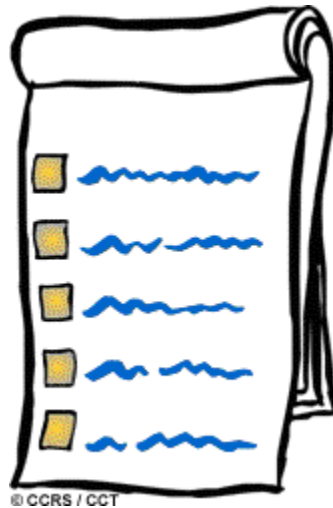

Outline the basic steps you might want to perform on a radar image before carrying out any visual interpretation.

### 3.6 Answer

Before visually interpreting and analyzing a radar image, there are several procedures which would be useful to perform, including:

- Converting the slant-range image to the ground-range plane display. This will remove the effects of slant-range scale distortion so that features appear in their proper relative size across the entire swath and distances on the ground are represented correctly.
- Correcting for antenna pattern. This will provide a uniform average brightness of image tone making visual interpretation and comparison of feature responses at different ranges easier.
- Reducing the effects of speckle to some degree. Unless there is a need for detailed analysis of very small features (i.e. less than a few pixels in size), speckle reduction will reduce the "grainy" appearance of the image and make general image interpretation simpler.
- Scaling of the dynamic range in the image to a maximum of 8-bits (256 grey levels). Because of the limitations of most desktop computer systems, as well as of the human eye in discriminating brightness levels, any more grey levels would not be useful.

### 3.8 Whiz Quiz



Can sound waves be polarized?

### 3.8 Answer

Polarization is a phenomenon which is characteristic of those waves that vibrate in a direction perpendicular to their direction of propagation. While electromagnetic waves vibrate up/down, side to side and in intermediate directions, sound waves vibrate in the same direction as their direction of travel, so cannot be polarized.



### 3.10 Whiz Quiz

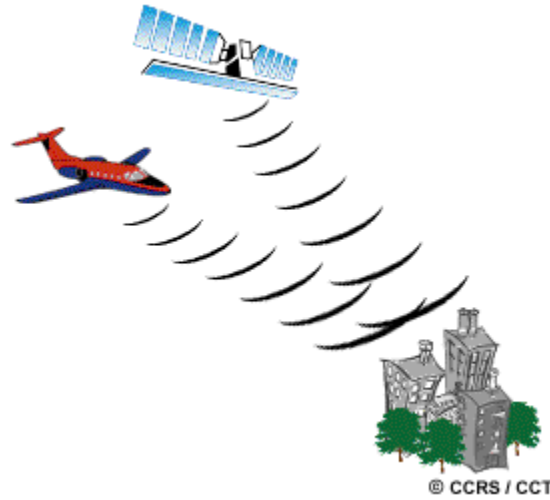

A particular object or feature may not have the same appearance (i.e. backscatter response) on all radar images, particularly airborne versus spaceborne radars. List some of the factors which might account for this.

### 3.10 Answer

The backscatter response, and thus the appearance of an object or feature on a radar image, is dependent on several things.

- Different radar wavelengths or frequencies will result in variations due to their differing sensitivities to surface roughness, which controls the amount of energy backscattered.
- Using different polarizations will also affect how the energy interacts with a target and the subsequent energy that is reflected back to the radar.
- Variations in viewing geometry, including look/incidence angle, the look direction and orientation of features to the radar, and the local incidence angle at which the radar energy strikes the surface, play a major role in the amount of energy reflected. Generally, these differences can be quite significant between airborne and spaceborne platforms.
- Changes in the moisture content of an object or feature will also change the amount of backscatter.

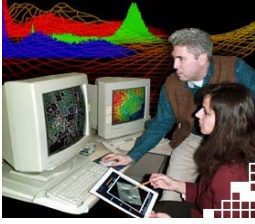

## 4. Image Analysis

### 4.1 Introduction

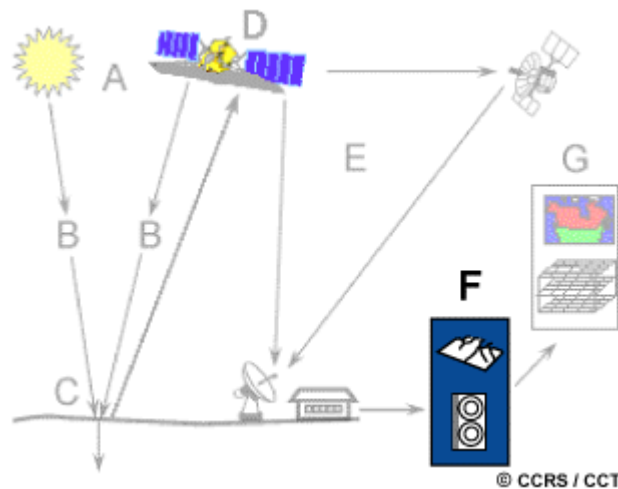

In order to take advantage of and make good use of remote sensing data, we must be able to extract meaningful information from the imagery. This brings us to the topic of discussion in this chapter - **interpretation and analysis** - the sixth element of the remote sensing process which we defined in Chapter 1. Interpretation and analysis of remote sensing imagery involves the identification and/or measurement of various targets in an image in order to extract useful information about them. Targets in remote sensing images may be any feature or object which can be observed in an image, and have the following characteristics:

- Targets may be a point, line, or area feature. This means that they can have any form, from a bus in a parking lot or plane on a runway, to a bridge or roadway, to a large expanse of water or a field.
- The target must be distinguishable; it must contrast with other features around it in the image.



Much interpretation and identification of targets in remote sensing imagery is performed manually or visually, i.e. by a human interpreter. In many cases this is done using imagery displayed in a pictorial or photograph-type format, independent of what type of sensor was used to collect the data and how the data were collected. In this case we refer to the data as being in **analog** format. As we discussed in Chapter 1, remote sensing images can also be represented in a computer as arrays of pixels, with each pixel corresponding to a digital number, representing the brightness level of that pixel in the image. In this case, the data are in a **digital** format. Visual interpretation may also be performed by examining digital imagery displayed on a computer screen. Both analogue and digital imagery can be displayed as black and white (also called monochrome) images, or as colour images (refer back to Chapter 1, Section 1.7) by combining different channels or bands representing different wavelengths.



When remote sensing data are available in digital format, **digital processing and analysis** may be performed using a computer. Digital processing may be used to enhance data as a prelude to visual interpretation. Digital processing and analysis may also be carried out to automatically identify targets and extract information completely without manual intervention by a human interpreter. However, rarely is digital processing and analysis carried out as a complete replacement for manual interpretation. Often, it is done to supplement and assist the human analyst.

Manual interpretation and analysis dates back to the early beginnings of remote sensing for

air photo interpretation. Digital processing and analysis is more recent with the advent of digital recording of remote sensing data and the development of computers. Both manual and digital techniques for interpretation of remote sensing data have their respective advantages and disadvantages. Generally, manual interpretation requires little, if any, specialized equipment, while digital analysis requires specialized, and often expensive, equipment. Manual interpretation is often limited to analyzing only a single channel of data or a single image at a time due to the difficulty in performing visual interpretation with multiple images. The computer environment is more amenable to handling complex images of several or many channels or from several dates. In this sense, digital analysis is useful for simultaneous analysis of many spectral bands and can process large data sets much faster than a human interpreter. Manual interpretation is a subjective process, meaning that the results will vary with different interpreters. Digital analysis is based on the manipulation of digital numbers in a computer and is thus more objective, generally resulting in more consistent results. However, determining the validity and accuracy of the results from digital processing can be difficult.

It is important to reiterate that visual and digital analyses of remote sensing imagery are not mutually exclusive. Both methods have their merits. In most cases, a mix of both methods is usually employed when analyzing imagery. In fact, the ultimate decision of the utility and relevance of the information extracted at the end of the analysis process, still must be made by humans.

## 4.2 Elements of Visual Interpretation

As we noted in the previous section, analysis of remote sensing imagery involves the identification of various targets in an image, and those targets may be environmental or artificial features which consist of points, lines, or areas. Targets may be defined in terms of the way they reflect or emit radiation. This radiation is measured and recorded by a sensor, and ultimately is depicted as an image product such as an air photo or a satellite image.

What makes interpretation of imagery more difficult than the everyday visual interpretation of our surroundings? For one, we lose our sense of depth when viewing a two-dimensional image, unless we can view it **stereoscopically** so as to simulate the third dimension of height. Indeed, interpretation benefits greatly in many applications when images are viewed in stereo, as visualization (and therefore, recognition) of targets is enhanced dramatically. Viewing objects from directly above also provides a very different perspective than what we are familiar with. Combining an unfamiliar perspective with a very different scale and lack of recognizable detail can make even the most familiar object unrecognizable in an image. Finally, we are used to seeing only the visible wavelengths, and the imaging of wavelengths outside of this window is more difficult for us to comprehend.

Recognizing targets is the key to interpretation and information extraction. Observing the differences between targets and their backgrounds involves comparing different targets based on any, or all, of the visual elements of **tone, shape, size, pattern, texture, shadow, and association**. Visual interpretation using these elements is often a part of our daily lives, whether we are conscious of it or not. Examining satellite images on the weather report, or following high speed chases by views from a helicopter are all familiar examples of visual image interpretation. Identifying targets in remotely sensed images based on these visual elements allows us to further interpret and analyze. The nature of each of these interpretation elements is described below, along with an image example of each.



**Tone** refers to the relative brightness or colour of objects in an image. Generally, tone is the fundamental element for distinguishing between different targets or features. Variations in



tone also allows the elements of shape, texture, and pattern of objects to be distinguished.



**Shape** refers to the general form, structure, or outline of individual objects. Shape can be a very distinctive clue for interpretation. Straight edge shapes typically represent urban or agricultural (field) targets, while natural features, such as forest edges, are generally more irregular in shape, except where man has created a road or clear cuts. Farm or crop land irrigated by rotating sprinkler systems would appear as circular shapes.



**Size** of objects in an image is a function of scale. It is important to assess the size of a target relative to other objects in a scene, as well as the absolute size, to aid in the interpretation of that target. A quick approximation of target size can direct interpretation to an appropriate result more quickly. For example, if an interpreter had to distinguish zones of land use, and had identified an area with a number of buildings in it, large buildings such as factories or warehouses would suggest commercial property, whereas small buildings would indicate residential use.

**Pattern** refers to the spatial arrangement of visibly discernible objects. Typically an orderly repetition of similar tones and textures will produce a distinctive and ultimately recognizable pattern. Orchards with evenly spaced trees, and urban streets with regularly spaced houses are good examples of pattern.



**Texture** refers to the arrangement and frequency of tonal variation in particular areas of an image. Rough textures would consist of a mottled tone where the grey levels change abruptly in a small area, whereas smooth textures would have very little tonal variation. Smooth textures are most often the result of uniform, even surfaces, such as fields, asphalt, or grasslands. A target with a rough surface and irregular structure, such as a forest canopy, results in a rough textured appearance. Texture is one of the most important elements for distinguishing features in radar imagery.

**Shadow** is also helpful in interpretation as it may provide an idea of the profile and relative height of a target or targets which may make identification easier. However, shadows can also reduce or eliminate interpretation in their area of influence, since targets within shadows are much less (or not at all) discernible from their surroundings. Shadow is also useful for enhancing or identifying topography and landforms, particularly in radar imagery.



**Association** takes into account the relationship between other recognizable objects or features in proximity to the target of interest. The identification of features that one would expect to associate with other features may provide information to facilitate identification. In the example given above, commercial properties may be associated with proximity to major transportation routes, whereas residential areas would be associated with schools, playgrounds, and sports fields. In our example, a lake is associated with boats, a marina, and adjacent recreational land.

## 4.3 Digital Image Processing

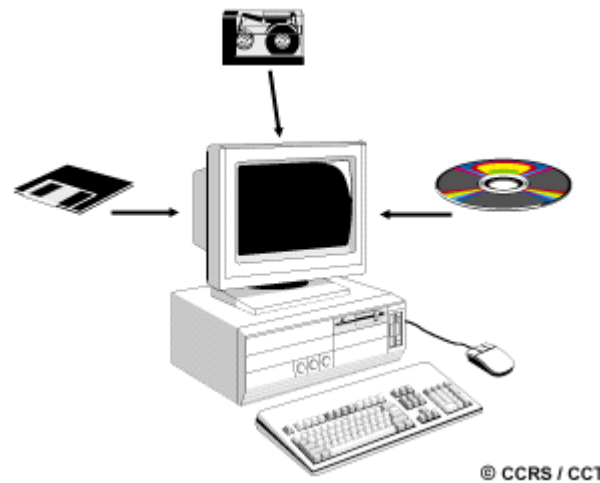

In today's world of advanced technology where most remote sensing data are recorded in digital format, virtually all image interpretation and analysis involves some element of digital processing. Digital image processing may involve numerous procedures including formatting and correcting of the data, digital enhancement to facilitate better visual interpretation, or even automated classification of targets and features entirely by computer. In order to process remote sensing imagery digitally, the data must be recorded and available in a digital form suitable for storage on a computer tape or disk. Obviously, the other requirement for digital image processing is a computer system, sometimes referred to as an **image analysis system**, with the appropriate hardware and software to process the data. Several commercially available software systems have been developed specifically for remote sensing image processing and analysis.

For discussion purposes, most of the common image processing functions available in image analysis systems can be categorized into the following four categories:

- Preprocessing
- Image Enhancement
- Image Transformation
- Image Classification and Analysis

**Preprocessing** functions involve those operations that are normally required prior to the main data analysis and extraction of information, and are generally grouped as **radiometric or geometric corrections**. Radiometric corrections include correcting the data for sensor irregularities and unwanted sensor or atmospheric noise, and converting the data so they accurately represent the reflected or emitted radiation measured by the sensor. Geometric corrections include correcting for geometric distortions due to sensor-Earth geometry variations, and conversion of the data to real world coordinates (e.g. latitude and longitude) on the Earth's surface.

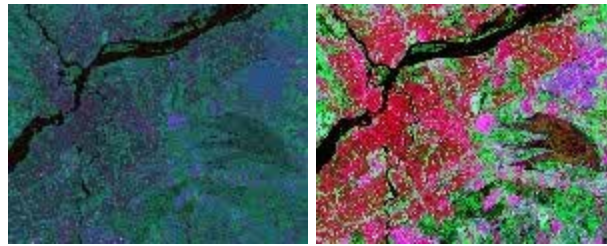

The objective of the second group of image processing functions grouped under the term of **image enhancement**, is solely to **improve the appearance of the imagery** to assist in visual interpretation and analysis. Examples of enhancement functions include contrast stretching to increase the tonal distinction between various features in a scene, and **spatial filtering** to enhance (or suppress) specific spatial patterns in an image.

**Image transformations** are operations similar in concept to those for image enhancement. However, unlike image enhancement operations which are normally applied only to a single channel of data at a time, image transformations usually involve combined processing of data from multiple spectral bands. Arithmetic operations (i.e. subtraction, addition, multiplication, division) are performed to combine and transform the original bands into "new" images which better display or highlight certain features in the scene. We will look at some of these operations including various methods of **spectral or band** ratioing, and a procedure called **principal components analysis** which is used to more efficiently represent the information in multichannel imagery.

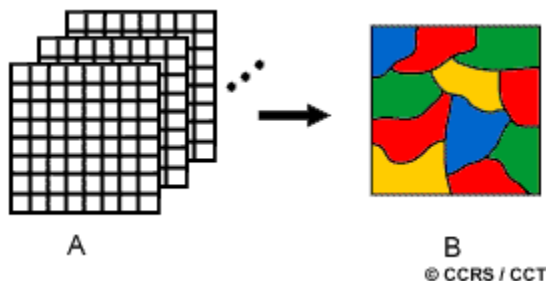

**Image classification and analysis** operations are used to digitally identify and classify pixels in the data. **Classification** is usually performed on multi-channel data sets (A) and this process assigns each pixel in an image to a particular class or theme (B) based on statistical characteristics of the pixel brightness values. There are a variety of approaches taken to perform digital classification. We will briefly describe the two generic approaches which are used most often, namely **supervised** and **unsupervised** classification.

In the following sections we will describe each of these four categories of digital image processing functions in more detail.

## 4.4 Pre-processing

Pre-processing operations, sometimes referred to as image restoration and rectification, are intended to correct for sensor- and platform-specific radiometric and geometric distortions of data. Radiometric corrections may be necessary due to variations in scene illumination and viewing geometry, atmospheric conditions, and sensor noise and response. Each of these will vary depending on the specific sensor and platform used to acquire the data and the conditions during data acquisition. Also, it may be desirable to convert and/or calibrate the data to known (absolute) radiation or reflectance units to facilitate comparison between data.



Variations in illumination and viewing geometry between images (for optical sensors) can be corrected by modeling the geometric relationship and distance between the area of the Earth's surface imaged, the sun, and the sensor. This is often required so as to be able to more readily compare images collected by different sensors at different dates or times, or to **mosaic multiple images from a single sensor** while maintaining uniform illumination conditions from scene to scene.

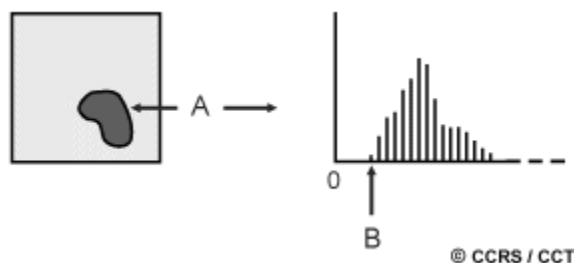

As we learned in Chapter 1, scattering of radiation occurs as it passes through and interacts with the atmosphere. This scattering may reduce, or attenuate, some of the energy illuminating the surface. In addition, the atmosphere will further attenuate the signal propagating from the target to the sensor. Various methods of atmospheric correction can be

applied ranging from detailed modeling of the atmospheric conditions during data acquisition, to simple calculations based solely on the image data. An example of the latter method is to **examine the observed brightness values** (digital numbers), in an area of shadow or for a very dark object (such as a large clear lake - A) and determine the minimum value (B). The correction is applied by subtracting the minimum observed value, determined for each specific band, from all pixel values in each respective band. Since scattering is wavelength dependent (Chapter 1), the minimum values will vary from band to band. This method is based on the assumption that the reflectance from these features, if the atmosphere is clear, should be very small, if not zero. If we observe values much greater than zero, then they are considered to have resulted from atmospheric scattering.

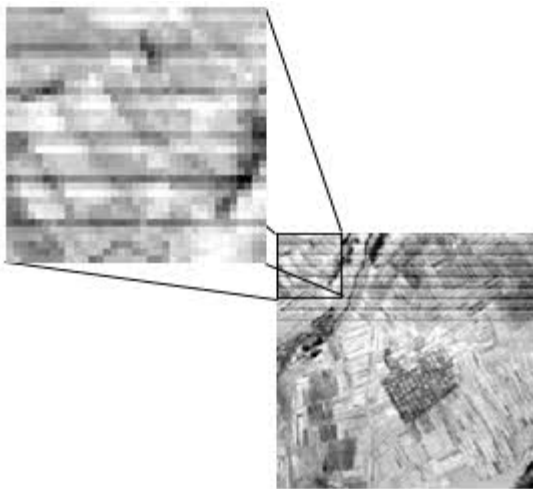

Noise in an image may be due to irregularities or errors that occur in the sensor response and/or data recording and transmission. Common forms of noise include systematic **striping** or banding and **dropped lines**. Both of these effects should be corrected before further enhancement or classification is performed. Striping was common in early Landsat MSS data due to variations and drift in the response over time of the six MSS detectors. The "drift" was different for each of the six detectors, causing the same

brightness to be represented differently by each detector. The overall appearance was thus a 'striped' effect. The corrective process made a relative correction among the six sensors to bring their apparent values in line with each other. Dropped lines occur when there are systems errors which result in missing or defective data along a scan line. Dropped lines are normally 'corrected' by replacing the line with the pixel values in the line above or below, or with the average of the two.

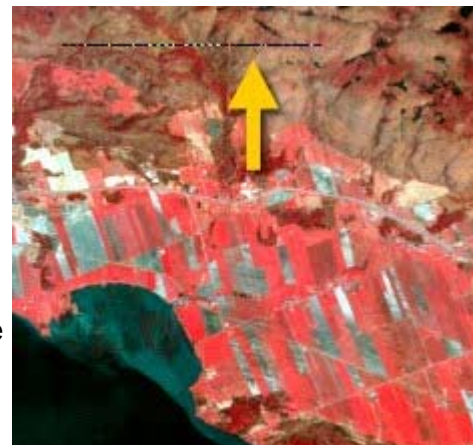

For many quantitative applications of remote sensing data, it is necessary to convert the digital numbers to measurements in units which represent the actual reflectance or emittance from the surface. This is done based on detailed knowledge of the sensor response and the way in which the analog signal (i.e. the reflected or emitted radiation) is converted to a digital number, called **analog-to-digital** (A-to-D) conversion. By solving this relationship in the reverse direction, the absolute radiance can be calculated for each pixel, so that comparisons can be accurately made over time and between different sensors.

In section 2.10 in Chapter 2, we learned that all remote sensing imagery are inherently subject

to geometric distortions. These distortions may be due to several factors, including: the perspective of the sensor optics; the motion of the scanning system; the motion of the platform; the platform altitude, attitude, and velocity; the terrain relief; and, the curvature and rotation of the Earth. Geometric corrections are intended to compensate for these distortions so that the geometric representation of the imagery will be as close as possible to the real world. Many of these variations are **systematic**, or **predictable** in nature and can be accounted for by accurate modeling of the sensor and platform motion and the geometric relationship of the platform with the Earth. Other **unsystematic**, or **random**, errors cannot be modeled and corrected in this way. Therefore, **geometric registration** of the imagery to a known ground coordinate system must be performed.

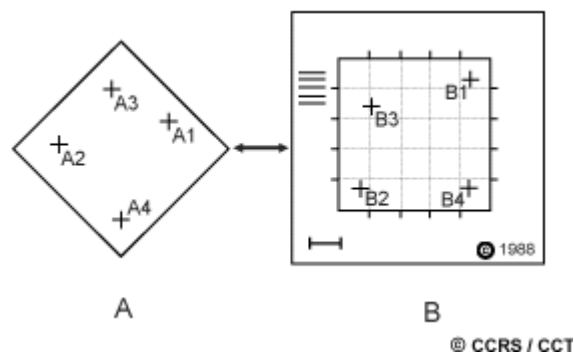

The **geometric registration process** involves identifying the image coordinates (i.e. row, column) of several clearly discernible points, called **ground control points** (or **GCPs**), in the distorted image (A - A1 to A4), and matching them to their true positions in ground coordinates (e.g. latitude, longitude). The true ground coordinates are typically measured from a map (B - B1 to B4), either in paper or digital format. This is **image-to-map registration**. Once several well-distributed GCP pairs have been identified, the coordinate information is processed by the computer to determine the proper transformation equations to apply to the original (row and column) image coordinates to map them into their new ground coordinates. Geometric registration may also be performed by registering one (or more) images to another image, instead of to geographic coordinates. This is called image-to-image registration and is often done prior to performing various image transformation procedures, which will be discussed in section 4.6, or for multitemporal image comparison.

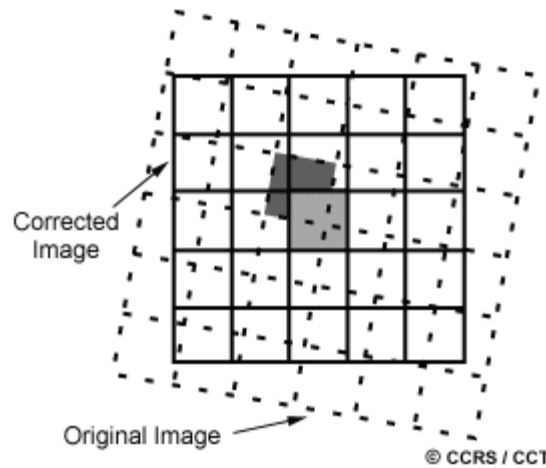

In order to actually geometrically correct the original distorted image, a procedure called **resampling** is used to determine the digital values to place in the new pixel locations of the corrected output image. The resampling process calculates the new pixel values from the original digital pixel values in the uncorrected image. There are three common methods for resampling: **nearest neighbour**, **bilinear interpolation**, and **cubic convolution**. **Nearest neighbour** resampling uses the digital value from the pixel in the original image which is nearest to the new pixel location in the corrected image. This is the simplest method and does not alter the original values, but may result in some pixel values being duplicated while others are lost. This method also tends to result in a disjointed or blocky image appearance.

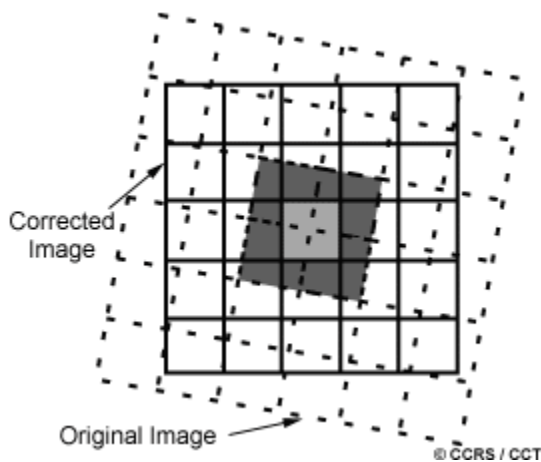

**Bilinear interpolation** resampling takes a weighted average of four pixels in the original image nearest to the new pixel location. The averaging process alters the original pixel values and creates entirely new digital values in the output image. This may be undesirable if further processing and analysis, such as classification based on spectral response, is to be done. If this is the case, resampling may best be done after the classification process. **Cubic convolution** resampling goes even further to calculate a distance weighted average of a block of sixteen pixels from the original image which surround the

new output pixel location. As with bilinear interpolation, this method results in completely new pixel values. However, these two methods both produce images which have a much sharper appearance and avoid the blocky appearance of the nearest neighbour method.



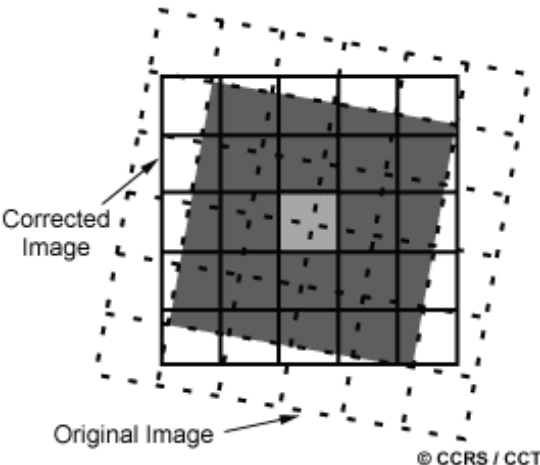

## 4.5 Image Enhancement

Enhancements are used to make it easier for visual interpretation and understanding of imagery. The advantage of digital imagery is that it allows us to manipulate the digital pixel values in an image. Although radiometric corrections for illumination, atmospheric influences, and sensor characteristics may be done prior to distribution of data to the user, the image may still not be optimized for visual interpretation. Remote sensing devices, particularly those operated from satellite platforms, must be designed to cope with levels of target/background energy which are typical of all conditions likely to be encountered in routine use. With large variations in spectral response from a diverse range of targets (e.g. forest, deserts, snowfields, water, etc.) no generic radiometric correction could optimally account for and display the optimum brightness range and contrast for all targets. Thus, for each application and each image, a custom adjustment of the range and distribution of brightness values is usually necessary.

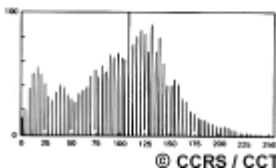
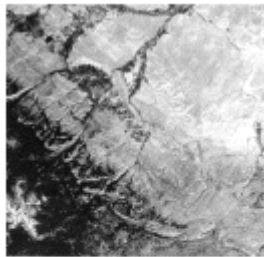

In raw imagery, the useful data often populates only a small portion of the available range of digital values (commonly 8 bits or 256 levels). Contrast enhancement involves changing the original values so that more of the available range is used, thereby increasing the contrast between targets and their backgrounds. The key to understanding contrast enhancements is to understand the concept of an **image histogram**. A histogram is a graphical representation of the brightness values that comprise an image. The brightness values (i.e. 0-255) are displayed along the x-axis of the graph. The frequency of occurrence of each of these values in the image is shown on the y-axis.

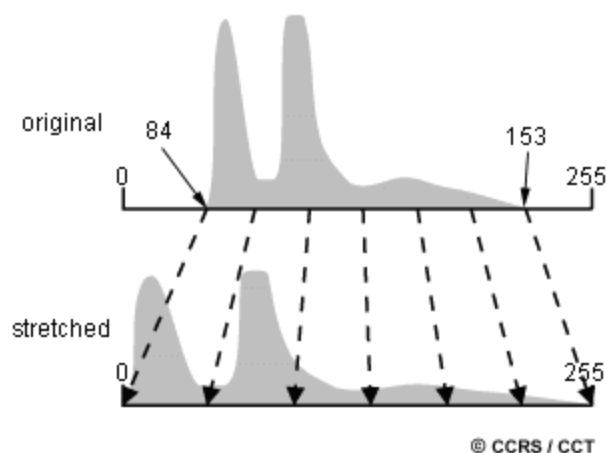

By manipulating the range of digital values in an image, graphically represented by its histogram, we can apply various enhancements to the data. There are many different techniques and methods of enhancing contrast and detail in an image; we will cover only a

few common ones here. The simplest type of enhancement is a **linear contrast stretch**. This involves identifying lower and upper bounds from the histogram (usually the minimum and maximum brightness values in the image) and applying a transformation to stretch this range to fill the full range. In our example, the minimum value (occupied by actual data) in the histogram is 84 and the maximum value is 153. These 70 levels occupy less than one-third of the full 256 levels available. A linear stretch uniformly expands this small range to cover the full range of values from 0 to 255. This enhances the contrast in the image with light toned areas appearing lighter and dark areas appearing darker, making visual interpretation much easier. This graphic illustrates the increase in contrast in an image before (left) and after (right) a linear contrast stretch.

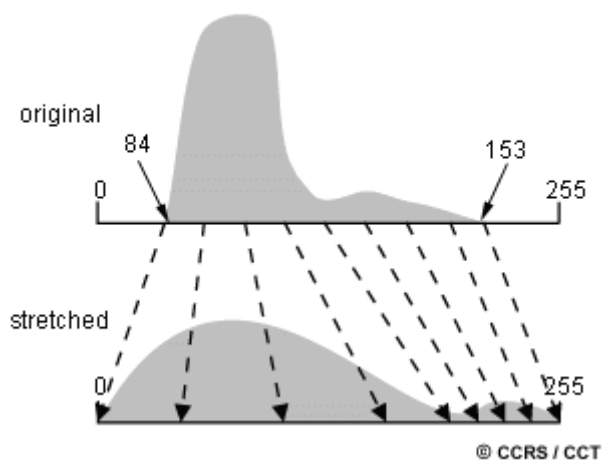

A uniform distribution of the input range of values across the full range may not always be an appropriate enhancement, particularly if the input range is not uniformly distributed. In this case, a **histogram-equalized stretch** may be better. This stretch assigns more display values (range) to the frequently occurring portions of the histogram. In this way, the detail in these areas will be better enhanced relative to those areas of the original histogram where values occur less frequently. In other cases, it may be desirable to enhance the contrast in only a specific portion of the histogram.

For example, suppose we have an image of the mouth of a river, and the water portions of the image occupy the digital values from 40 to 76 out of the entire image histogram. If we wished to enhance the detail in the water, perhaps to see variations in sediment load, we could stretch only that small portion of the histogram represented by the water (40 to 76) to the full grey level range (0 to 255). All pixels below or above these values would be assigned to 0 and 255, respectively, and the detail in these areas would be lost. However, the detail in the water would be greatly enhanced.

**Spatial filtering**

encompasses another set of digital processing functions which are used to enhance the appearance of an

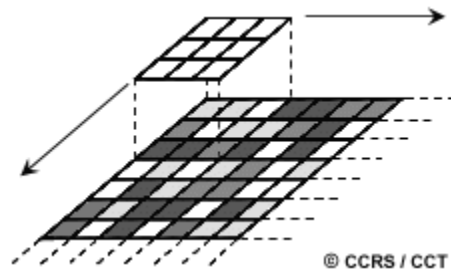
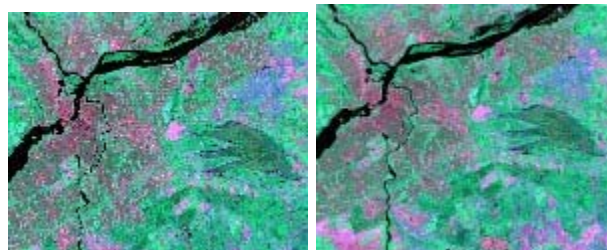
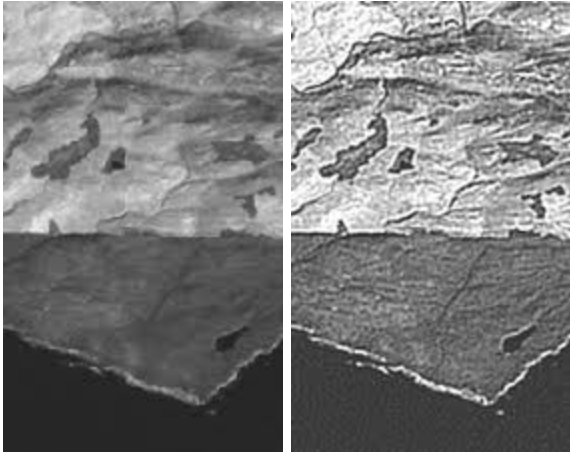

image. Spatial filters are designed to highlight or suppress specific features in an image based on their **spatial frequency**. Spatial frequency is related to the concept of image texture, which we discussed in section 4.2. It refers to the frequency of the variations in tone that appear in an image. "Rough" textured areas of an image, where the changes in tone are abrupt over a small area, have high spatial frequencies, while "smooth" areas with little variation in tone over several pixels, have low spatial frequencies. A common **filtering procedure** involves moving a 'window' of a few pixels in dimension (e.g. 3x3, 5x5, etc.) over each pixel in the image, applying a mathematical calculation using the pixel values under that window, and replacing the central pixel with the new value. The window is moved along in both the row and column dimensions one pixel at a time and the calculation is repeated until the entire image has been filtered and a "new" image has been generated. By varying the calculation performed and the weightings of the individual pixels in the filter window, filters can be designed to enhance or suppress different types of features.



A **low-pass filter** is designed to emphasize larger, homogeneous areas of similar tone and reduce the smaller detail in an image. Thus, low-pass filters generally serve to smooth the appearance of an image. Average and median filters, often used for radar imagery (and described in Chapter 3), are examples of low-pass filters. **High-pass filters** do the opposite and serve to sharpen the appearance of fine detail in an image. One implementation of a high-pass filter first applies a low-pass filter to an image and then subtracts the result from the original, leaving behind only the high spatial frequency information. **Directional, or edge detection filters** are designed to highlight linear features, such as roads or field boundaries. These filters can also be designed to enhance features which are oriented in specific directions. These filters are useful in applications such as geology, for the detection of linear geologic structures.



## 4.6 Image Transformations

Image transformations typically involve the manipulation of multiple bands of data, whether from a single multispectral image or from two or more images of the same area acquired at different times (i.e. multitemporal image data). Either way, image transformations generate "new" images from two or more sources which highlight particular features or properties of interest, better than the original input images.

Basic image transformations apply simple arithmetic operations to the image data. **Image subtraction** is often used to identify changes that have occurred between images collected on different dates. Typically, two images which have been geometrically registered (see section 4.4), are used with the pixel (brightness) values in one image (1) being subtracted from the pixel values in the other (2).

Scaling the resultant image (3) by adding a constant (127 in this case) to the output values will result in a suitable 'difference' image. In such an image, areas where there has been little or no change (A) between the original images, will have resultant brightness values around 127 (mid-grey tones), while those areas where significant change has occurred (B) will have values higher or lower than 127 - brighter or darker depending on the 'direction' of change in reflectance between the two images. This type of image transform can be useful for mapping changes in urban development around cities and for identifying areas where deforestation is occurring, as in this example.

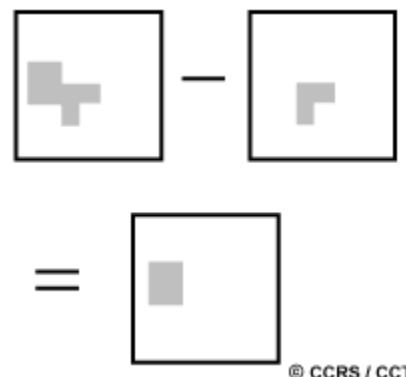
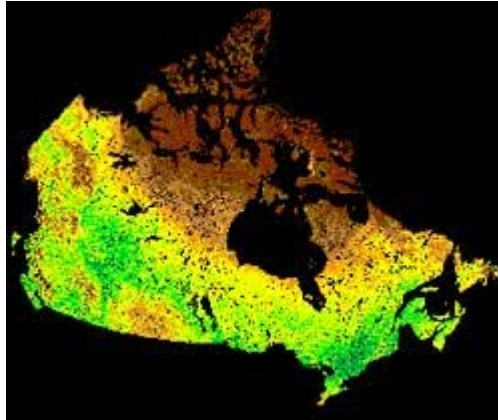
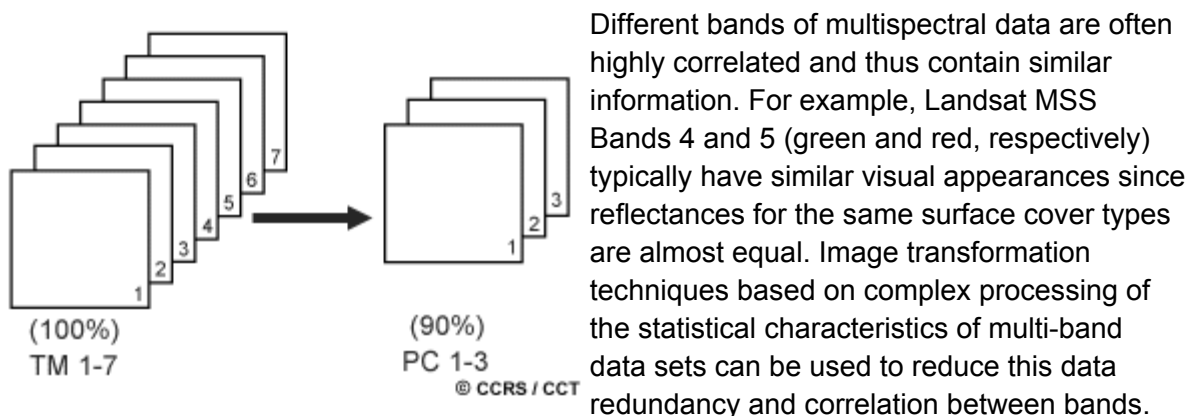

Image division or **spectral ratioing** is one of the most common transforms applied to image data. Image ratioing serves to highlight subtle variations in the spectral responses of various surface covers. By ratioing the data from two different spectral bands, the resultant image enhances variations in the slopes of the spectral reflectance curves between the two different spectral ranges that may otherwise be masked by the pixel brightness variations in each of the bands. The following example illustrates the concept of spectral ratioing. Healthy vegetation reflects strongly in the near-infrared portion of the spectrum while absorbing strongly in the visible red. Other surface types, such as soil and water, show near equal reflectances in both the near-infrared and red portions. Thus, a ratio image of Landsat MSS Band 7 (Near-Infrared - 0.8 to 1.1 mm) divided by Band 5 (Red - 0.6 to 0.7 mm) would result in ratios much greater than 1.0 for vegetation, and ratios around 1.0 for soil and water. Thus the discrimination of vegetation from other surface cover types is significantly enhanced. Also, we may be better able to identify areas of unhealthy or stressed vegetation, which show low near-infrared reflectance, as the ratios would be lower than for healthy green vegetation.



Another benefit of spectral ratioing is that, because we are looking at relative values (i.e. ratios) instead of absolute brightness values, variations in scene illumination as a result of topographic effects are reduced. Thus, although the absolute reflectances for forest covered slopes may vary depending on their orientation relative to the sun's illumination, the ratio of their reflectances between the two bands should always be very similar. More complex ratios involving the sums of and differences between spectral bands for various sensors, have been developed for monitoring vegetation conditions. One widely used image transform is the **Normalized Difference Vegetation Index (NDVI)** which has been used to monitor vegetation conditions on continental and global scales using the Advanced Very High Resolution Radiometer (AVHRR) sensor onboard the NOAA series of satellites (see Chapter 2, section 2.11).



One such transform is called **principal components analysis**. The objective of this transformation is to reduce the dimensionality (i.e. the number of bands) in the data, and compress as much of the information in the original bands into fewer bands. The "new" bands that result from this statistical procedure are called components. This process attempts to maximize (statistically) the amount of information (or variance) from the original data into the least number of new components. As an example of the use of principal components analysis, a seven band Thematic Mapper (TM) data set may be transformed such that the first three principal components contain over 90 percent of the information in the original seven bands. Interpretation and analysis of these three bands of data, combining them either visually or

digitally, is simpler and more efficient than trying to use all of the original seven bands. Principal components analysis, and other complex transforms, can be used either as an enhancement technique to improve visual interpretation or to reduce the number of bands to be used as input to digital classification procedures, discussed in the next section.



## 4.7 Image Classification and Analysis

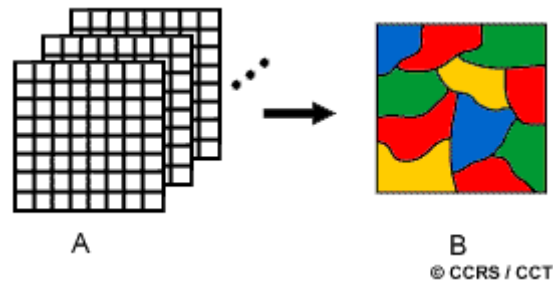

A human analyst attempting to classify features in an image uses the elements of visual interpretation (discussed in section 4.2) to identify homogeneous groups of pixels which represent various features or land cover classes of interest. **Digital image classification** uses the spectral information represented by the digital numbers in one or more spectral bands, and attempts to classify each individual pixel based on this spectral information. This type of classification is termed **spectral pattern recognition**. In either case, the objective is to assign all pixels in the image to particular classes or themes (e.g. water, coniferous forest, deciduous forest, corn, wheat, etc.). The resulting classified image is comprised of a mosaic of pixels, each of which belong to a particular theme, and is essentially a thematic "map" of the original image.

When talking about classes, we need to distinguish between **information classes and spectral classes**. Information classes are those categories of interest that the analyst is actually trying to identify in the imagery, such as different kinds of crops, different forest types or tree species, different geologic units or rock types, etc. Spectral classes are groups of pixels that are uniform (or near-similar) with respect to their brightness values in the different spectral channels of the data. The objective is to match the spectral classes in the data to the information classes of interest. Rarely is there a simple one-to-one match between these two types of classes. Rather, unique spectral classes may appear which do not necessarily correspond to any information class of particular use or interest to the analyst. Alternatively, a broad information class (e.g. forest) may contain a number of spectral **sub-classes** with unique spectral variations. Using the forest example, spectral sub-classes may be due to variations in age, species, and density, or perhaps as a result of shadowing or variations in scene illumination. It is the analyst's job to decide on the utility of the different spectral classes and their correspondence to useful information classes.

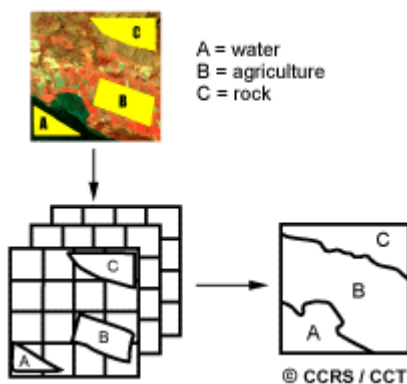

Common classification procedures can be broken down into two broad subdivisions based on the method used: **supervised classification** and **unsupervised classification**. In a **supervised classification**, the analyst identifies in the imagery homogeneous representative samples of the different surface cover types (information classes) of interest. These samples are referred to as **training areas**. The selection of appropriate training areas is based on the analyst's familiarity with the geographical area and their knowledge of the actual surface cover types present in the image. Thus, the analyst is "supervising" the categorization of a set of specific classes. The numerical information in all spectral bands for the pixels comprising these areas are used to "train" the computer to recognize spectrally similar areas for each class. The computer uses a special program or algorithm (of which there are several variations), to determine the numerical "signatures" for each training class. Once the computer has determined the signatures for each class, each pixel in the image is compared to these signatures and labeled as the class it most closely "resembles" digitally. Thus, in a supervised classification we are first identifying the information classes which are then used to determine the spectral classes which represent them.

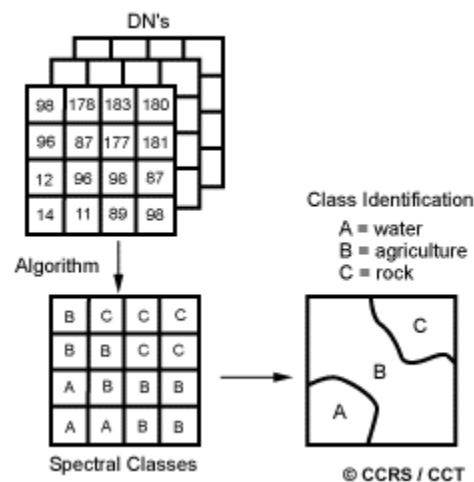

**Unsupervised classification** in essence reverses the supervised classification process. Spectral classes are grouped first, based solely on the numerical information in the data, and are then matched by the analyst to information classes (if possible). Programs, called **clustering algorithms**, are used to determine the natural (statistical) groupings or structures in the data. Usually, the analyst specifies how many groups or clusters are to be looked for in the data. In addition to specifying the desired number of classes, the analyst may also specify parameters related to the separation distance among the clusters and the variation within each cluster. The final result of this iterative clustering process may result in some clusters

that the analyst will want to subsequently combine, or clusters that should be broken down further - each of these requiring a further application of the clustering algorithm. Thus, unsupervised classification is not completely without human intervention. However, it does not start with a pre-determined set of classes as in a supervised classification.

## 4.8 Data Integration and Analysis

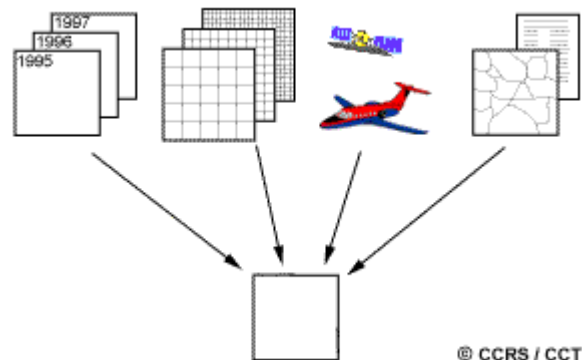

In the early days of analog remote sensing when the only remote sensing data source was aerial photography, the capability for integration of data from different sources was limited. Today, with most data available in digital format from a wide array of sensors, data integration is a common method used for interpretation and analysis. **Data integration** fundamentally involves the combining or merging of data from multiple sources in an effort to extract better and/or more information. This may include data that are multitemporal, multiresolution, multisensor, or multi-data type in nature.



Multitemporal data integration has already been alluded to in section 4.6 when we discussed image subtraction. Imagery collected at different times is integrated to identify areas of change. Multitemporal change detection can be achieved through simple methods such as these, or by other more complex approaches such as multiple classification comparisons or classifications using integrated multitemporal data sets. Multiresolution data merging is useful for a variety of applications. The merging of data of a higher spatial resolution with data of lower resolution can significantly sharpen the spatial detail

in an image and enhance the discrimination of features. **SPOT data** are well suited to this approach as the 10 metre panchromatic data can be easily merged with the 20 metre multispectral data. Additionally, the multispectral data serve to retain good spectral resolution while the panchromatic data provide the improved spatial resolution.

Data from different sensors may also be merged, bringing in the concept of multisensor data fusion. An excellent example of this technique is the combination of **multispectral optical data with radar imagery**. These two diverse spectral representations of the surface can provide complementary information. The optical data provide detailed spectral information useful for discriminating between surface cover types, while the radar imagery highlights the structural detail in the image.

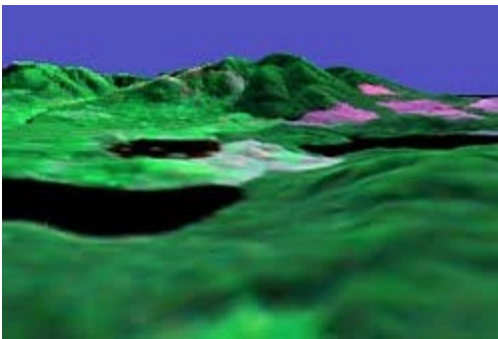
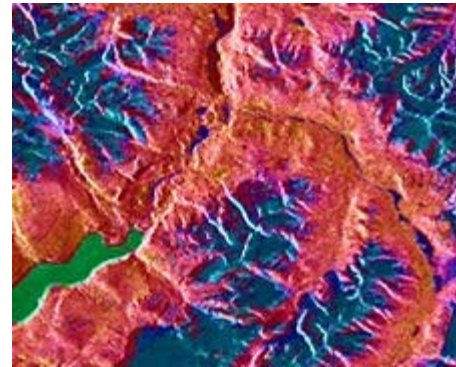

Applications of multisensor data integration generally require that the data be geometrically registered, either to each other or to a common geographic coordinate system or map base. This also allows other **ancillary** (supplementary) data sources to be integrated with the remote sensing data. For example, elevation data in digital form, called **Digital Elevation or Digital Terrain Models (DEMs/DTMs)**, may be combined with remote sensing data for a variety of purposes. DEMs/DTMs

may be useful in image classification, as effects due to terrain and slope variability can be corrected, potentially increasing the accuracy of the resultant classification. DEMs/DTMs are also useful for generating **three-dimensional perspective views** by draping remote sensing imagery over the elevation data, enhancing visualization of the area imaged.

Combining data of different types and from different sources, such as we have described above, is the pinnacle of data integration and analysis. In a digital environment where all the data sources are geometrically registered to a common geographic base, the potential for information extraction is extremely wide. This is the concept for analysis within a digital **Geographical Information System (GIS)** database. Any data source which can be referenced spatially can be used in this type of environment. A DEM/DTM is just one example of this kind of data. Other examples could include digital maps of soil type, land cover classes, forest species, road networks, and many others, depending on the application. The results from a classification of a remote sensing data set in map format, could also be used in a GIS as another data source to update existing map data. In essence, by analyzing diverse data sets together, it is possible to extract better and more accurate information in a synergistic manner than by using a single data source alone. There are a myriad of potential applications and analyses possible for many applications. In the next and final chapter, we will look at examples of various applications of remote sensing data, many involving the integration of data from different sources.

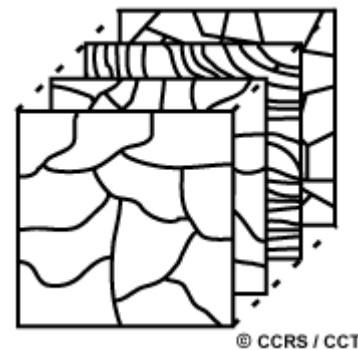

© CCRS / CCT



## 4. Endnotes

---

### 4.9 Endnotes

You have just completed **Chapter 4 - Image Interpretation and Analysis**. You can continue to Chapter 5 - Applications or first browse the CCRS Web site for other articles related to Image Interpretation and Analysis.

By browsing the "[Images of Canada](#)"<sup>1</sup>, you can learn in detail about the visual elements of interpretation and test yourself with a variety of remote sensing questions and answers.

We have a downloadable [tutorial](#)<sup>2</sup> and exercise on the topic of digital images and digital analysis techniques that makes a good start into this field.

See how the Intensity, Hue and Saturation (IHS) transformation, as applied to 3-D images are used to help [visualize terrain relief](#)<sup>3</sup>. As well, an IHS transformation can also be used to exploit the synergy of two different image data sets; in the case shown here, to study the [hydrogeology](#)<sup>4</sup> of an area. [Image fusion](#)<sup>5</sup> of data from different sensors is well demonstrated in an image of Canada's Capital - Ottawa.

Image compression is important for storage and transmission of large images. One compression technique developed at CCRS uses [multiscale methods](#)<sup>6</sup> to compress images and reduce file size.

There are many other image manipulation / interpretation techniques demonstrated on the CCRS Web site. You may also want to check our Remote Sensing Glossary for terms in the "[techniques](#)"<sup>7</sup> category.

---

<sup>1</sup>[http://www.ccrs.nrcan.gc.ca/ccrs/learn/tour/tour\\_e.html](http://www.ccrs.nrcan.gc.ca/ccrs/learn/tour/tour_e.html)

<sup>2</sup>[http://www.ccrs.nrcan.gc.ca/ccrs/learn/tutorials/digitech/digitech\\_e.html](http://www.ccrs.nrcan.gc.ca/ccrs/learn/tutorials/digitech/digitech_e.html)

<sup>3</sup>[http://www.ccrs.nrcan.gc.ca/ccrs/rd/ana/chromo/chromo\\_e.html](http://www.ccrs.nrcan.gc.ca/ccrs/rd/ana/chromo/chromo_e.html)

<sup>4</sup>[http://www.ccrs.nrcan.gc.ca/ccrs/data/satsens/radarsat/images/jor/rjor04\\_e.html](http://www.ccrs.nrcan.gc.ca/ccrs/data/satsens/radarsat/images/jor/rjor04_e.html)

<sup>5</sup>[http://www.ccrs.nrcan.gc.ca/ccrs/learn/tour/06/06ont\\_e.html](http://www.ccrs.nrcan.gc.ca/ccrs/learn/tour/06/06ont_e.html)

<sup>6</sup>[http://www.ccrs.nrcan.gc.ca/ccrs/com/rsnewsltr/2302/2302ap1\\_e.html](http://www.ccrs.nrcan.gc.ca/ccrs/com/rsnewsltr/2302/2302ap1_e.html)

<sup>7</sup>[http://dweb.ccrs.nrcan.gc.ca/ccrs/db/glossary/glossary\\_e.cfm](http://dweb.ccrs.nrcan.gc.ca/ccrs/db/glossary/glossary_e.cfm)

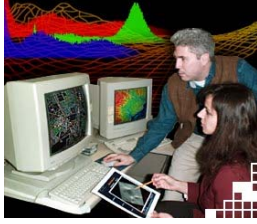

## 4. Did You Know?

---

### 4.2 Did You Know?

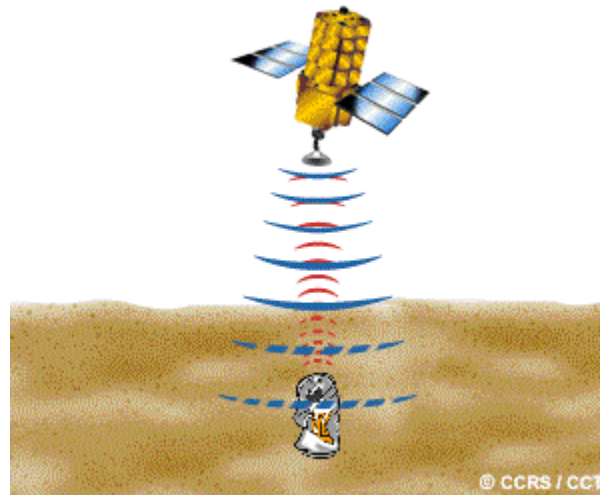

**"...What will they think of next ?!..."**

Remote sensing (image interpretation) has been used for archeological investigations. Sometimes the 'impression' that a buried artifact, such as an ancient fort foundation, leaves on the surface, can be detected and identified. That surface impression is typically very subtle, so it helps to know the general area to be searched and the nature of the feature being sought. It is also useful if the surface has not been disturbed much by human activities.

### 4.3 Did You Know?

"...our standard operating procedure is..."

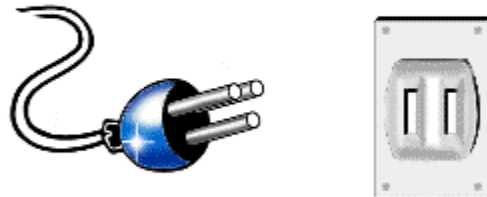

© CCRS / CCT

... the remote sensing industry and those associated with it have attempted to standardize the way digital remote sensing data are formatted in order to make the exchange of data easier and to standardize the way data can be read into different image analysis systems. The Committee on Earth Observing Satellites (CEOS) have specified this format which is widely used around the world for recording and exchanging data.

### 4.5 Did You Know?

An image 'enhancement' is basically anything that makes it easier or better to visually interpret an image. In some cases, like 'low-pass filtering', the enhanced image can actually look worse than the original, but such an enhancement was likely performed to help the interpreter see low spatial frequency features among the usual high frequency clutter found in an image. Also, an enhancement is performed for a specific application. This enhancement may be inappropriate for another purpose, which would demand a different type of enhancement.

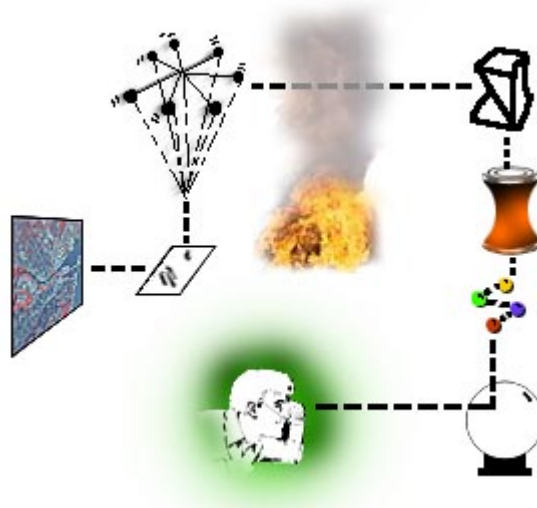



## 4.7 Did You Know?

"...this image has such lovely texture, don't you think?..."



...texture was identified as one of the key elements of visual interpretation (section 4.2), particularly for radar image interpretation. Digital texture classifiers are also available and can be an alternative (or assistance) to spectral classifiers. They typically perform a "moving window" type of calculation, similar to those for spatial filtering, to estimate the "texture" based on the variability of the pixel values under the window. Various textural measures can be calculated to attempt to discriminate between and characterize the textural properties of different features.



## 4. Whiz Quiz and Answers

### 4.2 Whiz Quiz



Take a look at the aerial photograph above. Identify the following features in the image and explain how you were able to do so based on the elements of visual interpretation described in this section.

- race track
- river
- roads
- bridges
- residential area
- dam

### 4.2 Answers

- The race track in the lower left of the image is quite easy to identify because of its characteristic shape.
- The river is also easy to identify due to its contrasting tone with the surrounding land and also due to its shape.
- The roads in the image are visible due to their shape (straight in many cases) and their generally bright tone contrasting against the other darker features.
- Bridges are identifiable based on their shape, tone, and association with the river - they cross it!
- Residential areas on the left hand side of the image and the upper right can be identified by the pattern that they make in conjunction with the roads. Individual houses and other buildings can also be identified as dark and light tones.
- The dam in the river at the top center of the image can be identified based on its contrasting tone with the dark river, its shape, and its association with the river - where else would a dam be!

### 4.3 Whiz Quiz

One 8-bit pixel takes up one single byte of computer disk space. One kilobyte (Kb) is 1024 bytes. One megabyte (Mb) is 1024 kilobytes. How many megabytes of computer disk space would be required to store an 8-bit Landsat Thematic Mapper (TM) image (7 bands), which is 6000 pixels by 6000 lines in dimension?

The answer is ...



### 4.3 Answers



If we have seven bands of TM data, each 6000 pixels by 6000 lines, and each pixel takes up one byte of disk space, we have:

$$7 \times 6000 \times 6000 = 252,000,000 \text{ bytes of data}$$

To convert this to kilobytes we need to divide by 1024, and to convert that answer to megabytes we need to divide by 1024 again!

$$252,000,000 (1024 \times 1024) = 240.33 \text{ megabytes}$$

So, we would need over 240 megabytes of disk space just to hold one full TM image, let alone analyze the imagery and create any new image variations! Needless to say, it takes a lot of storage space and powerful computers to analyze the data from today's remote sensing systems.

#### 4.4 Whiz Quiz



What would be the advantage of geometrically correcting an image to geographic coordinates prior to further analysis and interpretation?

#### 4.4 Answers



The advantage of geometrically correcting an image prior to further analysis and interpretation is that it would then allow proper measurements of distances and areas to be made from features in the image. This may be particularly useful in different applications where true measurements are necessary, such as in urban mapping applications. Also, the geographic locations of features could be determined. Once an image is geometrically registered to a known geographic base, it can be combined with other mapped data in a digital environment for further analysis. This is the concept of data integration which is discussed in section 4.8.

### 4.7 Whiz Quiz

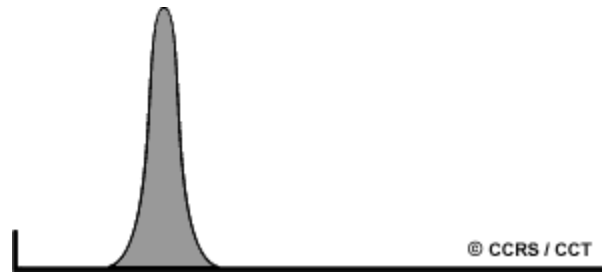

You want to perform a classification on a satellite image, but when examining its histogram, you notice that the range of useful data is very narrow. Prior to attempting classification, would you enhance the image with a linear contrast stretch?

### 4.7 Answer

An 'enhancement' of an image is done exclusively for visually appreciating and analyzing its contents. An enhancement would not add anything useful, as far as the classification algorithm is concerned. Another way of looking at this is: if two pixels have brightness values just one digital unit different, then it would be very difficult to notice this subtle difference by eye. But for the computer, the difference is just as 'obvious' as if it was 100 times greater.

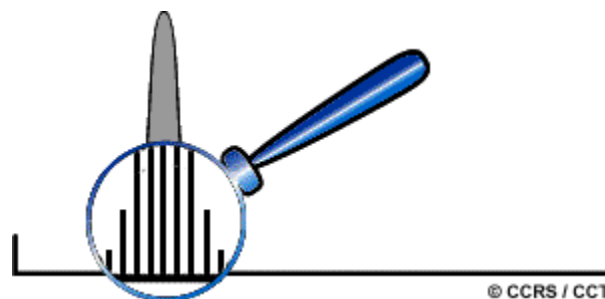

An enhanced version of the image may help in selecting 'training' sites (by eye), but you would still perform the classification on the unenhanced version.



## 5. Applications

---

### 5.1 Introduction

As we learned in the section on sensors, each one was designed with a specific purpose. With optical sensors, the design focuses on the spectral bands to be collected. With radar imaging, the incidence angle and microwave band used plays an important role in defining which applications the sensor is best suited for.

Each application itself has specific demands, for spectral resolution, spatial resolution, and temporal resolution.



To review, spectral resolution refers to the width or range of each spectral band being recorded. As an example, panchromatic imagery (sensing a broad range of all visible wavelengths) will not be as sensitive to vegetation stress as a narrow band in the red wavelengths, where chlorophyll strongly absorbs electromagnetic energy.

Spatial resolution refers to the discernible detail in the image. Detailed mapping of wetlands requires far finer spatial resolution than does the regional mapping of physiographic areas.

Temporal resolution refers to the time interval between images. There are applications requiring data repeatedly and often, such as oil spill, forest fire, and sea ice motion monitoring. Some applications only require seasonal imaging (crop identification, forest insect infestation, and wetland monitoring), and some need imaging only once (geology structural mapping). Obviously, the most time-critical applications also demand fast turnaround for image processing and delivery - getting useful imagery quickly into the user's hands.

In a case where repeated imaging is required, the revisit frequency of a sensor is important (how long before it can image the same spot on the Earth again) and the reliability of successful data acquisition. Optical sensors have limitations in cloudy environments, where the targets may be obscured from view. In some areas of the world, particularly the tropics, this is virtually a permanent condition. Polar areas also suffer from inadequate solar illumination, for months at a time. Radar provides reliable data, because the sensor provides its own illumination, and has long wavelengths to penetrate cloud, smoke, and fog, ensuring that the target won't be obscured by weather conditions, or poorly illuminated.

Often it takes more than a single sensor to adequately address all of the requirements for a given application. The combined use of multiple sources of information is called integration. Additional data that can aid in the analysis or interpretation of the data is termed "ancillary" data.

The applications of remote sensing described in this chapter are representative, but not exhaustive. We do not touch, for instance, on the wide area of research and practical application in weather and climate analysis, but focus on applications tied to the surface of the Earth. The reader should also note that there are a number of other applications that are practiced but are very specialized in nature, and not covered here (e.g. terrain trafficability analysis, archeological investigations, route and utility corridor planning, etc.).

### **Multiple sources of information**

Each band of information collected from a sensor contains important and unique data. We know that different wavelengths of incident energy are affected differently by each target - they are absorbed, reflected or transmitted in different proportions. The appearance of targets can easily change over time, sometimes within seconds. In many applications, using information from several different sources ensures that target identification or information extraction is as accurate as possible. The following describe ways of obtaining far more information about a target or area, than with one band from a sensor.

### **Multispectral**

The use of multiple bands of spectral information attempts to exploit different and independent "views" of the targets so as to make their identification as confident as possible. Studies have been conducted to determine the optimum spectral bands for analyzing specific targets, such as insect damaged trees.

### **Multisensor**

Different sensors often provide complementary information, and when integrated together, can facilitate interpretation and classification of imagery. Examples include combining high resolution panchromatic imagery with coarse resolution multispectral imagery, or merging actively and passively sensed data. A specific example is the integration of SAR imagery with multispectral imagery. SAR data adds the expression of surficial topography and relief to an otherwise flat image. The multispectral image contributes meaningful colour information about the composition or cover of the land surface. This type of image is often used in geology,

where lithology or mineral composition is represented by the spectral component, and the structure is represented by the radar component.

### **Multitemporal**

Information from multiple images taken over a period of time is referred to as multitemporal information. Multitemporal may refer to images taken days, weeks, or even years apart. Monitoring land cover change or growth in urban areas requires images from different time periods. Calibrated data, with careful controls on the quantitative aspect of the spectral or backscatter response, is required for proper monitoring activities. With uncalibrated data, a classification of the older image is compared to a classification from the recent image, and changes in the class boundaries are delineated. Another valuable multitemporal tool is the observation of vegetation phenology (how the vegetation changes throughout the growing season), which requires data at frequent intervals throughout the growing season.

"Multitemporal information" is acquired from the interpretation of images taken over the same area, but at different times. The time difference between the images is chosen so as to be able to monitor some dynamic event. Some catastrophic events (landslides, floods, fires, etc.) would need a time difference counted in days, while much slower-paced events (glacier melt, forest regrowth, etc.) would require years. This type of application also requires consistency in illumination conditions (solar angle or radar imaging geometry) to provide consistent and comparable classification results.

The ultimate in critical (and quantitative) multitemporal analysis depends on calibrated data. Only by relating the brightnesses seen in the image to physical units, can the images be precisely compared, and thus the nature and magnitude of the observed changes be determined.



## 5.2 Agriculture



Agriculture plays a dominant role in economies of both developed and undeveloped countries. Whether agriculture represents a substantial trading industry for an economically strong country or simply sustenance for a hungry, overpopulated one, it plays a significant role in almost every nation. The production of food is important to everyone and producing food in a cost-effective manner is the goal of every farmer, large-scale farm manager and regional agricultural agency. A farmer needs to be informed to be efficient, and that includes having the knowledge and information products to forge a viable strategy for farming operations. These tools will help him understand the health of his crop, extent of infestation or stress damage, or potential yield and soil conditions. Commodity brokers are also very interested in how well farms are producing, as yield (both quantity and quality) estimates for all products control price and worldwide trading.



**Satellite and airborne images** are used as mapping tools to classify crops, examine their health and viability, and monitor farming practices. Agricultural applications of remote sensing include the following:

- crop type classification
- crop condition assessment
- crop yield estimation
- mapping of soil characteristics
- mapping of soil management practices
- compliance monitoring (farming practices)

## 5.2.1 Crop Type Mapping

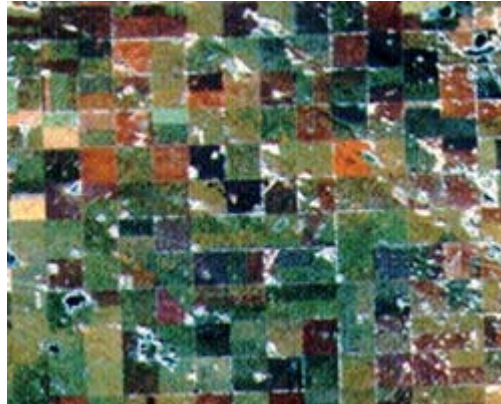

### Background

Identifying and mapping crops is important for a number of reasons. Maps of crop type are created by national and multinational agricultural agencies, insurance agencies, and regional agricultural boards to prepare an inventory of what was grown in certain areas and when. This serves the purpose of forecasting grain supplies (yield prediction), collecting crop production statistics, facilitating crop rotation records, mapping soil productivity, identification of factors influencing crop stress, assessment of crop damage due to storms and drought, and monitoring farming activity.

Key activities include identifying the crop types and delineating their extent (often measured in acres). Traditional methods of obtaining this information are census and ground surveying. In order to standardize measurements however, particularly for multinational agencies and consortiums, remote sensing can provide common data collection and information extraction strategies.

### Why remote sensing?

Remote sensing offers an efficient and reliable means of collecting the information required, in order to map crop type and acreage. Besides providing a synoptic view, remote sensing can provide structure information about the health of the vegetation. The spectral reflection of a field will vary with respect to changes in the phenology (growth), stage type, and crop health, and thus can be measured and monitored by multispectral sensors. Radar is sensitive to the structure, alignment, and moisture content of the crop, and thus can provide complementary information to the optical data. Combining the information from these two types of sensors increases the information available for distinguishing each target class and its respective signature, and thus there is a better chance of performing a more accurate classification.

Interpretations from remotely sensed data can be input to a geographic information system (GIS) and crop rotation systems, and combined with ancillary data, to provide information of ownership, management practices etc.

### Data requirements

Crop identification and mapping benefit from the use of multitemporal imagery to facilitate classification by taking into account changes in reflectance as a function of plant phenology (stage of growth). This in turn requires calibrated sensors, and frequent repeat imaging throughout the growing season. For example, crops like canola may be easier to identify when they are flowering, because of both the spectral reflectance change, and the timing of the

flowering.

Multisensor data are also valuable for increasing classification accuracies by contributing more information than a sole sensor could provide. VIR sensing contributes information relating to the chlorophyll content of the plants and the canopy structure, while radar provides information relating to plant structure and moisture. In areas of persistent cloud cover or haze, radar is an excellent tool for observing and distinguishing crop type due to its active sensing capabilities and long wavelengths, capable of penetrating through atmospheric water vapour.

**Canada vs. International**

Although the principles of identifying crop type are the same, the scale of observation in Europe and Southeast Asia is considerably smaller than in North America, primarily due to smaller field parcel sizes. Cloud cover in Europe and tropical countries also usually limits the feasibility of using high-resolution optical sensors. In these cases high-resolution radar would have a strong contribution.

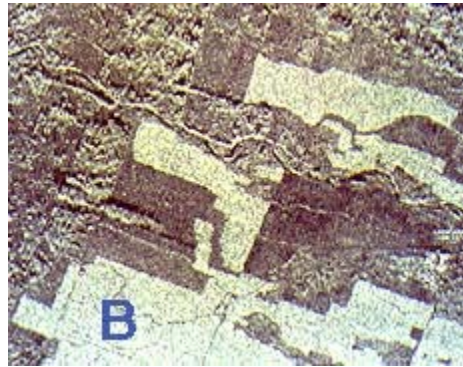

The sizable leaves of tropical agricultural crops (cocoa, banana, and oil palm) have distinct radar signatures. Banana leaves in particular are characterized by bright backscatter (represented by "B" in image). Monitoring stages of rice growth is a key application in tropical areas, particularly Asian countries. Radar is very sensitive to surface roughness, and the development of rice paddies provides a dramatic change in brightness from the low returns from smooth water surfaces in flooded paddies , to the high return of the emergent rice crop.



**Case study (example)**

The countries involved in the European Communities (EC) are using remote sensing to help fulfil the requirements and mandate of the EC Agricultural Policy, which is common to all

members. The requirements are to delineate, identify, and measure the extent of important crops throughout Europe, and to provide an early forecast of production early in the season. Standardized procedures for collecting this data are based on remote sensing technology, developed and defined through the MARS project (Monitoring Agriculture by Remote Sensing).

The project uses many types of remotely sensed data, from low resolution NOAA-AVHRR, to high-resolution radar, and numerous sources of ancillary data. These data are used to classify crop type over a regional scale to conduct regional inventories, assess vegetation condition, estimate potential yield, and finally to predict similar statistics for other areas and compare results. Multisource data such as VIR and radar were introduced into the project for increasing classification accuracies. Radar provides very different information than the VIR sensors, particularly vegetation structure, which proves valuable when attempting to differentiate between crop type.

One of the key applications within this project is the operational use of high resolution optical and radar data to confirm conditions claimed by a farmer when he requests aid or compensation. The use of remote sensing identifies potential areas of non-compliance or suspicious circumstances, which can then be investigated by other, more direct methods.

As part of the Integrated Administration and Control System (IACS), remote sensing data supports the development and management of databases, which include cadastral information, declared land use, and parcel measurement. This information is considered when applications are received for area subsidies.

This is an example of a truly successfully operational crop identification and monitoring application of remote sensing.

## 5.2.2 Crop Monitoring & Damage Assessment

### Background

Assessment of the health of a crop, as well as early detection of crop infestations, is critical in ensuring good agricultural productivity. Stress associated with, for example, moisture deficiencies, insects, fungal and weed infestations, must be detected early enough to provide an opportunity for the farmer to mitigate. This process requires that remote sensing imagery be provided on a frequent basis (at a minimum, weekly) and be delivered to the farmer quickly, usually within 2 days.

Also, crops do not generally grow evenly across the field and consequently crop yield can vary greatly from one spot in the field to another. These growth differences may be a result of soil nutrient deficiencies or other forms of stress. Remote sensing allows the farmer to identify areas within a field which are experiencing difficulties, so that he can apply, for instance, the correct type and amount of fertilizer, pesticide or herbicide. Using this approach, the farmer not only improves the productivity from his land, but also reduces his farm input costs and minimizes environmental impacts.

There are many people involved in the trading, pricing, and selling of crops that never actually set foot in a field. They need information regarding crop health worldwide to set prices and to negotiate trade agreements. Many of these people rely on products such as a crop assessment index to compare growth rates and productivity between years and to see how well each country's agricultural industry is producing. This type of information can also help target locations of future problems, for instance the famine in Ethiopia in the late 1980's, caused by a significant drought which destroyed many crops. Identifying such areas facilitates in planning and directing humanitarian aid and relief efforts.

### Why remote sensing?



Remote sensing has a number of attributes that lend themselves to monitoring the health of crops. One advantage of optical (VIR) sensing is that it can see beyond the visible wavelengths into the infrared, where wavelengths are highly sensitive to crop vigour as well as crop stress and crop damage. Remote sensing imagery also gives the required spatial overview of the land. Recent advances in communication and technology allow a farmer to observe images of his fields and make timely decisions about managing the crops. Remote sensing can aid in identifying crops affected by conditions that are too dry or wet, affected by insect, weed or fungal infestations or **weather related damage**. Images can be obtained throughout

the growing season to not only detect problems, but also to monitor the success of the treatment. In the example image given here, a tornado has destroyed/damaged crops southwest of Winnipeg, Manitoba.



Healthy vegetation contains large quantities of chlorophyll, the substance that gives most vegetation its distinctive green colour. In referring to healthy crops, reflectance in the blue and red parts of the spectrum is low since chlorophyll absorbs this energy. In contrast, reflectance in the green and near-infrared spectral regions is high. Stressed or damaged crops experience a decrease in chlorophyll content and changes to the internal leaf structure. The reduction in chlorophyll content results in a decrease in reflectance in the green region and internal leaf damage results in a decrease in near-infrared reflectance. These reductions in green and infrared reflectance provide

early detection of crop stress. Examining the ratio of reflected infrared to red wavelengths is an excellent measure of vegetation health. This is the premise behind some vegetation indices, such as the normalized differential vegetation index (NDVI) (Chapter 4). Healthy plants have a high NDVI value because of their high reflectance of infrared light, and relatively low reflectance of red light. Phenology and vigour are the main factors in affecting NDVI. An excellent example is the difference between irrigated crops and non-irrigated land. The irrigated crops appear bright green in a **real-colour simulated image**. The darker areas are dry rangeland with minimal vegetation. In a CIR (**colour infrared simulated**) image, where infrared reflectance is displayed in red, the healthy vegetation appears bright red, while the rangeland remains quite low in reflectance.



Examining variations in crop growth within one field is possible. Areas of consistently healthy and vigorous crop would appear uniformly bright. Stressed vegetation would appear dark amongst the brighter, healthier crop areas. If the data is georeferenced, and if the farmer has a GPS (global position satellite) unit, he can find the exact area of the problem very quickly, by matching the coordinates of his location to that on the image.

### Data requirements

Detecting damage and monitoring crop health requires high-resolution imagery and multispectral imaging capabilities. One of the most critical factors in making imagery useful to farmers is a quick turnaround time from data acquisition to distribution of crop information. Receiving an image that reflects crop conditions of two weeks earlier does not help real time management nor damage mitigation. Images are also required at specific times during the growing season, and on a frequent basis.

Remote sensing doesn't replace the field work performed by farmers to monitor their fields, but it does direct them to the areas in need of immediate attention.

### Canada vs. International

Efficient agricultural practices are a global concern, and other countries share many of the same requirements as Canada in terms of monitoring crop health by means of remote sensing. In many cases however, the scale of interest is smaller - smaller fields in Europe and Asia dictate higher resolution systems and smaller areal coverage. Canada, the USA, and

Russia, amongst others, have more expansive areas devoted to agriculture, and have developed, or are in the process of developing crop information systems (see below). In this situation, regional coverage and lower resolution data (say: 1km) can be used. The lower resolution facilitates computer efficiency by minimizing storage space, processing efforts and memory requirements.

As an example of an international crop monitoring application, date palms are the prospective subject of an investigation to determine if remote sensing methods can detect damage from the red palm weevil in the Middle East. In the Arabian Peninsula, dates are extremely popular and date crops are one of the region's most important agricultural products. Infestation by the weevil could quickly devastate the palm crops and swallow a commodity worth hundreds of millions of dollars. Remote sensing techniques will be used to examine the health of the date crops through spectral analysis of the vegetation. Infested areas appear yellow to the naked eye, and will show a smaller near infrared reflectance and a higher red reflectance on the remotely sensed image data than the healthy crop areas. Authorities are hoping to identify areas of infestation and provide measures to eradicate the weevil and save the remaining healthy crops.

#### Case study (example)

Canadian Crop Information System: A composite crop index map is created each week, derived from composited NOAA-AVHRR data. Based on the NDVI, the index shows the health of crops in the prairie regions of Manitoba through to Alberta. These indices are produced weekly, and can be compared with indices of past years to compare crop growth and health.

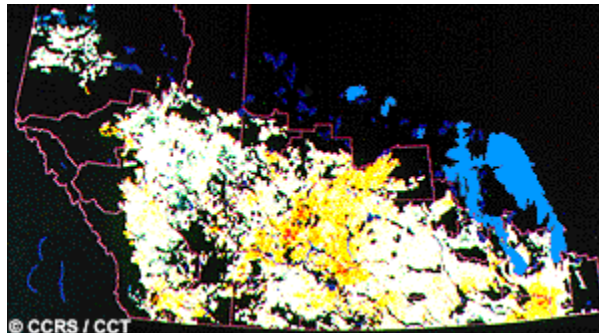

In 1988, severe drought conditions were prevalent across the prairies. Using NDVI values from NOAA AVHRR data, a **drought area analysis** determined the status of drought effects on crops across the affected area. Red and yellow areas indicate those crops in a weakened and stressed state, while green indicates healthy crop conditions. Note that most of the healthy crops are those in the cooler locations, such as in the northern Alberta (Peace River) and the higher elevations (western Alberta). Non-cropland areas (dry rangeland and forested land) are indicated in black, within the analysis region.

### 5.3 Forestry



Forests are a valuable resource providing food, shelter, wildlife habitat, fuel, and daily supplies such as medicinal ingredients and paper. Forests play an important role in balancing the Earth's CO<sub>2</sub> supply and exchange, acting as a key link between the atmosphere, geosphere, and hydrosphere. Tropical rainforests, in particular, house an immense **diversity of species**, more capable of adapting to, and therefore surviving, changing environmental conditions than monoculture forests. This diversity also provides habitat for numerous animal species and is an important source of

medicinal ingredients. The main issues concerning forest management are depletion due to natural causes (fires and infestations) or human activity (clear-cutting, burning, land conversion), and monitoring of health and growth for effective commercial exploitation and conservation.

Humans generally consider the products of forests useful, rather than the forests themselves, and so extracting **wood** is a widespread and historical practice, virtually global in scale. Depletion of forest resources has long term effects on climate, soil conservation, biodiversity, and hydrological regimes, and thus is a vital concern of environmental monitoring activities. Commercial forestry is an important industry throughout the world. Forests are cropped and re-harvested, and the new areas continually sought for providing a new source of lumber. With increasing pressure to conserve native and virgin forest areas, and unsustainable forestry practices limiting the remaining areas of potential cutting, the companies involved in extracting wood supplies need to be more efficient, economical, and aware of sustainable forestry practices. Ensuring that there is a healthy regeneration of trees where forests are extracted will ensure a future for the commercial forestry firms, as well as adequate wood supplies to meet the demands of a growing population.



Non-commercial sources of forest depletion include removal for agriculture (pasture and crops), urban development, droughts, desert encroachment, loss of ground water, insect damage, fire and other natural phenomena (disease, typhoons). In some areas of the world, particularly in the tropics, (rain) forests, are covering what might be considered the most valuable commodity - viable agricultural land. Forests are burned or **clear-cut** to facilitate access to, and use of, the land. This practice often occurs when the perceived need for long term sustainability is overwhelmed by short-term

sustenance goals. Not only are the depletion of species-rich forests a problem, affecting the local and regional hydrological regime, the smoke caused by the burning trees pollutes the



atmosphere, adding more CO<sub>2</sub>, and furthering the greenhouse effect.

Of course, monitoring the health of forests is crucial for sustainability and conservation issues. Depletion of key species such as mangrove in environmentally sensitive coastline areas, removal of key support or shade trees from a potential crop tree, or disappearance of a large biota acting as a CO<sub>2</sub> reservoir all affect humans and society in a negative way, and more effort is being made to monitor and enforce regulations and plans to protect these areas.

International and domestic forestry applications where remote sensing can be utilized include sustainable development, biodiversity, land title and tenure (cadastre), monitoring deforestation, reforestation monitoring and managing, commercial logging operations, shoreline and watershed protection, biophysical monitoring (wildlife habitat assessment), and other environmental concerns.

General forest cover information is valuable to developing countries with limited previous knowledge of their forestry resources. General cover type mapping, shoreline and watershed mapping and monitoring for protection, monitoring of cutting practices and regeneration, and forest fire/burn mapping are global needs which are currently being addressed by Canadian and foreign agencies and companies employing remote sensing technology as part of their information solutions in foreign markets.

Forestry applications of remote sensing include the following:

### **1) reconnaissance mapping:**

Objectives to be met by national forest/environment agencies include forest cover updating, depletion monitoring, and measuring biophysical properties of forest stands.

- forest cover type discrimination
- agroforestry mapping

### **2) Commercial forestry:**

Of importance to commercial forestry companies and to resource management agencies are inventory and mapping applications: collecting harvest information, updating of inventory information for timber supply, broad forest type, vegetation density, and biomass measurements.

- clear cut mapping / regeneration assessment
- burn delineation
- infrastructure mapping / operations support
- forest inventory
- biomass estimation
- species inventory

### **3) Environmental monitoring**

Conservation authorities are concerned with monitoring the quantity, health, and diversity of the Earth's forests.

- deforestation (rainforest, mangrove colonies)
- species inventory
- watershed protection (riparian strips)
- coastal protection (mangrove forests)

- forest health and vigour

Canadian requirements for forestry application information differ considerably from international needs, due in part to contrasts in tree size, species diversity (monoculture vs. species rich forest), and agroforestry practices. The level of accuracy and resolution of data required to address respective forestry issues differs accordingly. Canadian agencies have extensive a priori knowledge of their forestry resources and present inventory and mapping needs are often capably addressed by available data sources.

For Canadian applications requirements, high accuracy (for accurate information content), multispectral information, fine resolution, and data continuity are the most important. There are requirements for large volumes of data, and reliable observations for seasonal coverage. There is a need to balance spatial resolution with the required accuracy and costs of the data. Resolution capabilities of 10 m to 30 m are deemed adequate for forest cover mapping, identifying and monitoring clearcuts, burn and fire mapping, collecting forest harvest information, and identifying general forest damage. Spatial coverage of 100 - 10000 km<sup>2</sup> is appropriate for district to provincial scale forest cover and clear cut mapping, whereas 1-100 km<sup>2</sup> coverage is the most appropriate for site specific vegetation density and volume studies.

Tropical forest managers will be most concerned with having a reliable data source, capable of imaging during critical time periods, and therefore unhindered by atmospheric conditions.

### 5.3.1 Clear Cut Mapping & Deforestation



#### Background

Deforestation is a global problem, with many implications. In industrialized Europe, pollution (acid rain, soot and chemicals from factory smoke plumes) has damaged a large percentage of forested land. In the former Czechoslovakia, one half of the forests are destroyed or damaged from pollutants. Similar effects are felt in Germany, Poland, and even the Scandinavian countries. In tropical countries, valuable rainforest is being destroyed in an effort to clear potentially valuable agricultural and pasture land. This has resulted in huge losses of tropical rainforest throughout Latin America (Central America, southern Mexico, Haiti), South America (Brazil), Africa and Asia. In both Haiti and Madagascar in particular, the results have been devastating. The loss of forests increases soil erosion, river siltation, and deposition, affecting navigation, fisheries, wildlife habitat, and drinking water supplies, as well as farming productivity and self-sufficiency.

Sensitive estuarine environments are protected by mangrove forest, which is cut or lost to urban growth, aquaculture, or damaged by pollutants or siltation. Monitoring the health of this forest is a step towards protecting the coastlines from erosion and degradation, and nearby inland areas from flooding.

The loss of forests also affects the genetic diversity of species on Earth, which controls our intrinsic ability to adapt to changing conditions and environment. Rainforests account for approximately one half of the plant and animal species on Earth, and destroying large sections will only serve to reduce the gene and species pool.

The rate and extent of deforestation, as well as monitoring regeneration, are the key parameters measured by remote sensing methods.

#### Why remote sensing?

Remote sensing brings together a multitude of tools to better analyze the scope and scale of the deforestation problem. Multitemporal data provides for change detection analyses. Images of earlier years are compared to recent scenes, to tangibly measure the differences in the sizes and extents of the clearcuts or loss of forest. Data from a variety of sources are used to provide complementary information. Radar, merged with optical data, can be used to efficiently monitor the status of existing clearcuts or emergence of new ones, and even assess regeneration condition. In countries where cutting is controlled and regulated, remote sensing serves as a monitoring tool to ensure companies are following cut guidelines and specifications.

High resolution data provide a detailed view of forest depletion, while radar can provide a view that may otherwise be obscured by clouds. All remote sensing devices, however, provide a view of often remote and inaccessible areas, where illegal cutting or damage could continue unnoticed for long periods of time if aerial surveillance wasn't possible.

### Data requirements

Global monitoring initiatives, such as rain forest depletion studies, depend on large area coverage and data continuity, so it is important to use a sensor that will have successive generations launched and operational. Clear cut mapping and monitoring also require regional scale images and moderate or high resolution data depending on whether cuts are to be simply detected or delineated. As for many multi-temporal applications, a higher resolution image can be used to define the baseline, and coarser resolution images can be used to monitor changes to that baseline.

### Canada vs. International

Optical sensors are still preferred for clear cut mapping and monitoring in Canada because forest vegetation, cuts, and regenerating vegetation have distinguishable spectral signatures, and optical sensors can collect sufficient cloud-free data.

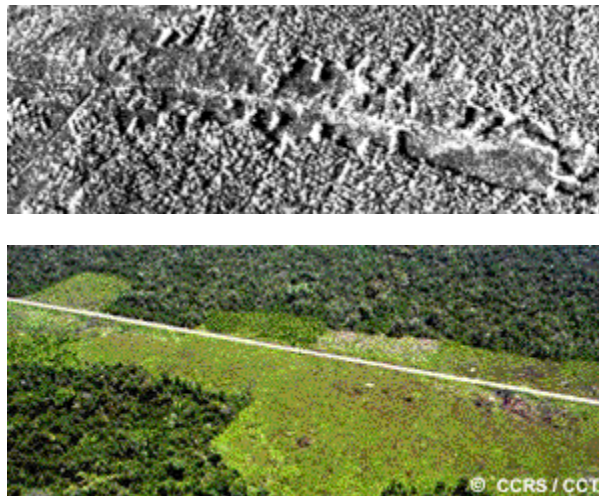

Comparison of photo (bottom) and SAR image (top) of forest cuts along road.

Radar is more useful for applications in the humid tropics because its all weather imaging capability is valuable for monitoring all types of depletion, including clear cuts, in areas prone to cloudy conditions. Cuts can be defined on **radar images** because clear cuts produce less backscatter than the forest canopy, and forest edges are enhanced by shadow and bright backscatter. However, regenerating cuts are typically difficult to detect, as advanced regeneration and mature forest canopy are not separable. Mangrove forests generally occur in tropical coastal areas, which are prone to cloudy conditions, therefore a reliable monitoring tool is required to successively measure the rate of forest depletion. Radar has been proven to differentiate mangrove from other land covers, and some bands have long wavelengths capable of penetrating cloud and rain. The only limitation is in differentiating different mangrove species.

**Case study (example)**

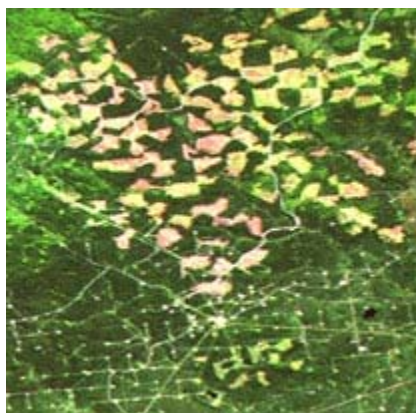

In Alberta, much of the province's forestland has been sold to offshore investors who are interested in selling pulp and paper products. Around the area of Whitecourt, clear cutting of conifer forest has been occurring for decades. In recent years however, the increasing demand for wood products has accelerated the cutting of the forests, resulting in a dissected and checkered landscape. Besides cutting for wood supply, forest depletion is also occurring due to cuts for seismic lines for oil and gas exploration and extraction. Both **optical** and **radar** sensors have been used to monitor the clear cuts and regeneration.

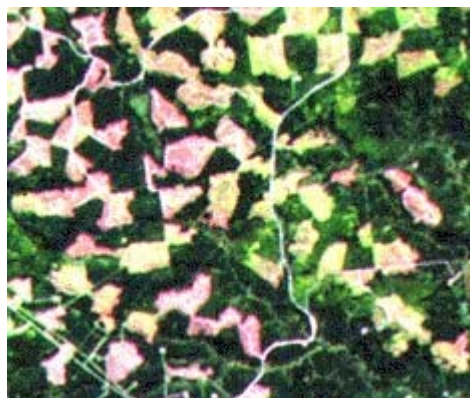

Optical and Radar scenes of forest clear cutting.

## 5.3.2 Species Identification & Typing

### Background

Forest cover typing and species identification are critical to both forest conservation managers and forestry companies interested in their supply inventory. Forest cover typing can consist of reconnaissance mapping over a large area, while species inventories are highly detailed measurements of stand contents and characteristics (tree type, height, density).

### Why remote sensing?

Remote sensing provides a means of quickly identifying and delineating various forest types, a task that would be difficult and time consuming using traditional ground surveys. Data is available at various scales and resolutions to satisfy local or regional demands. Large scale species identification can be performed with multispectral, hyperspectral, or airphoto data, while small scale cover type delineation can be performed by radar or multispectral data interpretation. Both imagery and the extracted information can be incorporated into a GIS to further analyze or present with ancillary data, such as slopes, ownership boundaries, or roads.

Hyperspectral imagery can provide a very high spatial resolution while capturing extremely fine radiometric resolution data. This type of detailed spectral information can be used to generate signatures of vegetation species and certain stresses (e.g. infestations) on trees. Hyperspectral data offers a unique view of the forest cover, available only through remote sensing technology.

### Data requirements

Requirements depend on the scale of study to be conducted. For regional reconnaissance mapping, moderate area coverage, with a sensor sensitive to differences in forest cover (canopy texture, leaf density, spectral reflection) is needed. Multitemporal datasets also contribute phenology information that may aid in interpretation by incorporating the seasonal changes of different species.

For detailed species identification associated with forest stand analysis, very high resolution, multispectral data is required. Being able to view the images in stereo helps in the delineation and assessment of density, tree height, and species. In general, monitoring biophysical properties of forests requires multispectral information and finely calibrated data.

### Canada vs. International

Current sources of data used operationally for forest cover typing and species identification applications within Canada are aerial photography, orthophotography, Landsat TM, and SPOT data. Landsat data are the most appropriate for executing reconnaissance level forest surveys, while aerial photography and digital orthophoto are the preferred data source for extracting stand and local inventory information. Airphotos are the most appropriate operational data source for stand level measurements including species typing. SAR sensors such as RADARSAT are useful where persistent cloud cover limits the usefulness of optical sensors.

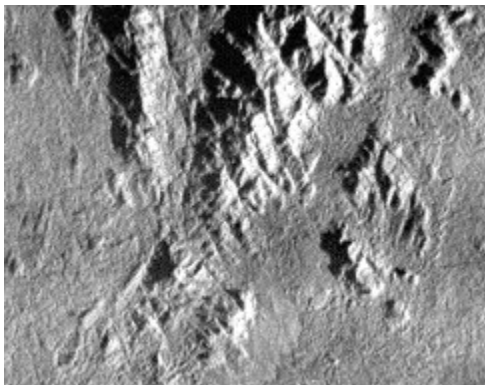

In humid tropical areas, forest resource assessments and measurements are difficult to obtain because of cloudy conditions hindering conventional remote sensing efforts, and difficult terrain impeding ground surveys. In this situation, reliability of data acquisition is more crucial than resolution or frequency of imaging. An active sensor may be the only feasible source of data, and its reliability will facilitate regular monitoring. Radar will serve this purpose, and an airborne sensor is sufficient for high resolution requirements such as cover typing. This type of data can be used for a baseline map, while coarser resolution data can provide updates to any changes in the baseline.

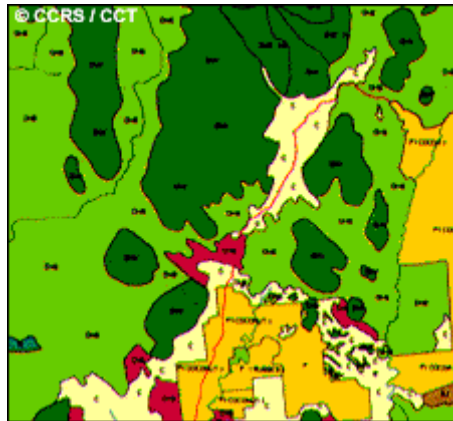

#### Case study (example)

Inventory Branch, Ministry of Forests, Province of British Columbia, Canada

This is an example of the operational requirements and procedure for a provincial department involved in a number of forestry applications using remote sensing technology.

The Inventory Branch is responsible for maintaining a database of Crown Land information concerning historical, stand, and sustainable forest management information which is used for determining timber volumes and annual allowable cuts. The inventory itself is performed every ten years with 1:15,000 scale aerial photography, and updated with satellite imagery every two years.

The Inventory branch requires geocoded, terrain corrected data. For most studies, the branch currently buys precision geocoded data, and for large scale mapping projects, they will cut costs by obtaining systematic versus precision geocoded data. Further processing is done in-house on workstations. Some location data are now being provided by the private sector, conducting field traverses with GPS (global positioning system) data.

Present planimetric accuracy requirements are 20 m, but will be more demanding in the near future. Airphotos and orthophotos meet requirements and are good for interpretation but are limited by expense. Data continuity is important, as monitoring will be an ongoing operation. TM data for updating maps is reasonable in cost and information content for interim monitoring.

Much of the updating in the Ministry of Forests is done with TM data, either brought digitally into a MicroStation workstation to perform heads-up digitizing, or in transparency form with the image overlain onto existing maps using a projection device. The Ministry of Forests is presently investigating the potential of a number of data sources with various levels of processing applied, and integration possibilities to assess accuracy versus cost relationships.

The Ministry of Forests in B.C. employs an expert system SHERI (System of Hierarchical Expert Systems for Resource Inventories) to provide a link between remotely sensed data, GIS and growth and yield modelling. The end to end information flow is complete with the generation of final products including forest cover maps incorporating planimetric and administrative boundary information.

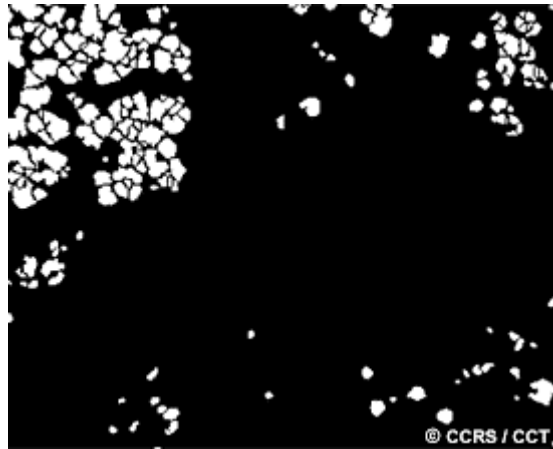
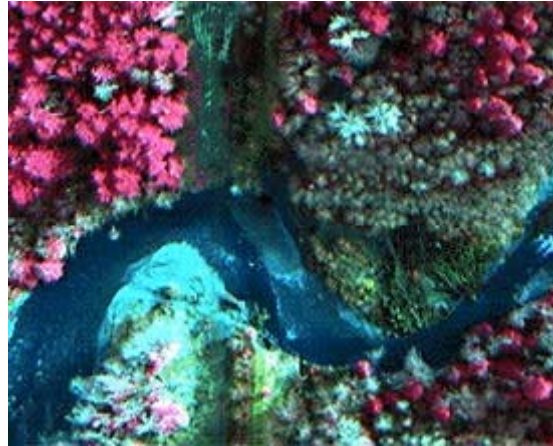
**Case study (example)**

Hyperspectral image and recent stem count from hyperspectral imagery

Forest companies use hyperspectral imagery to obtain stem counts , stand attributes, and for mapping of land cover in the forest region of interest. These images depict a false colour hyperspectral image of a Douglas fir forest on Vancouver Island at a resolution of 60 cm. The imagery was acquired in the fall of 1995 by the CASI (Compact Airborne Imaging Spectrometer). Attributes obtained from the imagery (a subset is shown) include:



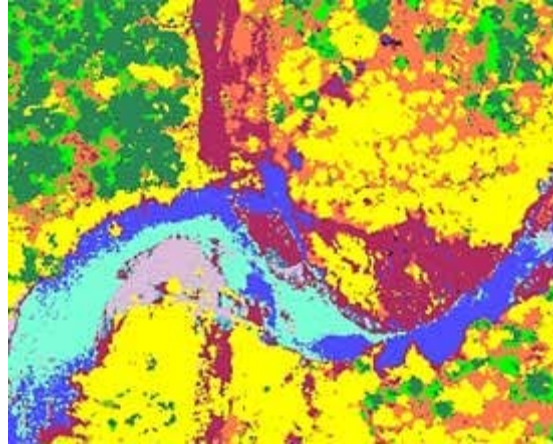

- Stand Area (hectares) 9.0
- Total number of trees 520
- Tree density (stems/ha) 58
- Crown closure (%) 12.46
- Average tree crown area (sq m) 21.47

The corresponding land cover map contains the following classes:

- **Dark green:** conifers
- **Green:** lower branches
- **Light purple:** gravel
- **Yellow:** deciduous
- **Orange:** dry ground cover
- **Red:** wet ground cover
- **Blue (light):** water
- **Blue (dark):** deep or clear water

All imagery courtesy of MacMillan Bloedel and ITRES Research Limited.

### 5.3.3 Burn Mapping

#### Background

Fire is part of the natural reproductive cycle of many forests revitalizing growth by opening seeds and releasing nutrients from the soil. However, fires can also spread quickly and threaten settlements and wildlife, eliminate timber supplies, and temporarily damage conservation areas. Information is needed to help control the extent of fire, and to assess how well the forest is recovering following a burn.

#### Why remote sensing?

Remote sensing can be used to detect and monitor forest fires and the regrowth following a fire. As a surveillance tool, routine sensing facilitates observing remote and inaccessible areas, alerting monitoring agencies to the presence and extent of a fire. NOAA AVHRR thermal data and GOES meteorological data can be used to delineate active fires and remaining "hot-spots" when optical sensors are hindered by smoke, haze, and /or darkness. Comparing burned areas to active fire areas provides information as to the rate and direction of movement of the fire. Remote sensing data can also facilitate route planning for both access to, and escape from, a fire, and supports logistics planning for fire fighting and identifying areas not successfully recovering following a burn.

Years following a fire, updates on the health and regenerative status of an area can be obtained by a single image, and multitemporal scenes can illustrate the progression of vegetation from pioneer species back to a full forest cover.

#### Data requirements

While thermal data is best for detecting and mapping ongoing fires, multispectral (optical and near-infrared) data are preferred for observing stages of growth and phenology in a previous burn area. The relative ages and area extent of burned areas can be defined and delineated, and health of the successive vegetation assessed and monitored. Moderate spatial coverage, high to moderate resolution, and a low turnaround time are required for burn mapping. On the other hand, fire detection and monitoring requires a large spatial coverage, moderate resolution and a very quick turnaround to facilitate response.

#### Canadian vs. International

Requirements for burn mapping are the same, except where cloud cover precludes the use of optical images. In this case, radar can be used to monitor previous burn areas, and is effective from the second year following a burn, onwards.

### Case study (example) Northwest Territory Burn

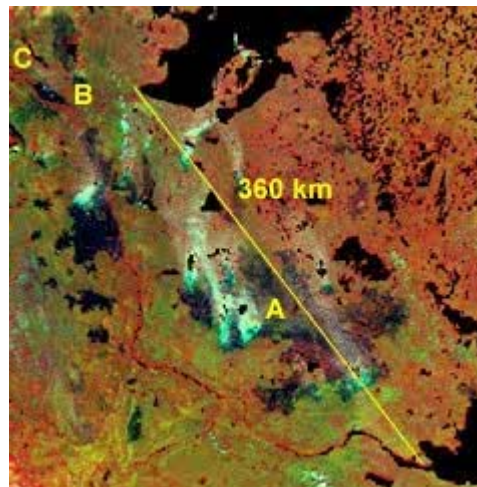

Burned and burning forest near Norman Wells, NWT

In the western Northwest Territories along the Mackenzie River, boreal forest covers much of the landscape. Natives rely on the forests for hunting and trapping grounds, and the sensitive northern soil and permafrost are protected from erosion by the forest cover. In the early 1990's a huge fire devastated the region immediately east of the Mackenzie and threatened the town of Fort Norman, a native town south of Norman Wells.

The extent of the burned area, and the areas still burning, can be identified on this NOAA scene, as dark regions (A). The lake in the upper right is Great Bear Lake, and the lake to the lower right is Great Slave Lake. The distance represented by the yellow line is approximately 580 km. The course of the Mackenzie River can be seen to the left of these lakes. Fort Norman (B) is located at the junction of the Mackenzie River and Great Bear River, leading out of Great Bear Lake. At that location, the fire is on both sides of the river. Norman Wells (C) is known as an oil producing area, and storage silos, oil rigs, homes, and the only commercial airport in that part of the country were threatened. Fires in this region are difficult to access because of the lack of roads into the region. Winter roads provide only seasonal access to vehicles in this part of Canada. The small population base also makes it difficult to control, let alone fight, a fire of this magnitude.

Haze and smoke reflect a large amount of energy at shorter wavelengths and appear as blue on this image.

## 5.4 Geology



Geology involves the study of landforms, structures, and the subsurface, to understand physical processes creating and modifying the earth's crust. It is most commonly understood as the exploration and exploitation of mineral and hydrocarbon resources, generally to improve the conditions and standard of living in society. Petroleum provides gas and oil for vehicle transportation, aggregate and limestone quarrying (sand and gravel) provides ingredients for concrete for paving and construction, potash mines contribute to fertilizer, coal to energy production, precious metals and gems for jewelry, diamonds for drill bits, and copper, zinc and assorted minerals for a variety of uses. Geology also includes the study of potential hazards such as volcanoes, landslides, and earth quakes, and is thus a critical factor for geotechnical studies relating to construction and engineering. Geological studies are not limited to Earth - remote sensing has been used to examine the composition and structure of other planets and moons.

Remote sensing is used as a tool to extract information about the land surface structure, composition or subsurface, but is often combined with other data sources providing complementary measurements. Multispectral data can provide information on lithology or rock composition based on spectral reflectance. Radar provides an expression of surface topography and roughness, and thus is extremely valuable, especially when integrated with another data source to provide detailed relief.

Remote sensing is not limited to direct geology applications - it is also used to support logistics, such as route planning for access into a mining area, reclamation monitoring, and generating basemaps upon which geological data can be referenced or superimposed.

Geological applications of remote sensing include the following:

- surficial deposit / bedrock mapping
- lithological mapping
- structural mapping
- sand and gravel (aggregate) exploration/ exploitation
- mineral exploration
- hydrocarbon exploration
- environmental geology
- geobotany
- baseline infrastructure

- sedimentation mapping and monitoring
- event mapping and monitoring
- geo-hazard mapping
- planetary mapping

### 5.4.1 Structural Mapping & Terrain Analysis



Syncline structures (in Pennsylvania) on SAR imagery

#### Background

Structural geology plays an important role in mineral and hydrocarbon exploration, and potential hazard identification and monitoring.

Structural mapping is the identification and characterization of structural expression. Structures include faults, folds, synclines and anticlines and lineaments. Understanding structures is the key to interpreting crustal movements that have shaped the present terrain. Structures can indicate potential locations of oil and gas reserves by characterizing both the underlying subsurface geometry of rock units and the amount of crustal deformation and stress experienced in a certain locale. Detailed examination of structure can be obtained by geophysical techniques such as seismic surveying.

Structures are also examined for clues to crustal movement and potential hazards, such as earthquakes, landslides, and volcanic activity. Identification of fault lines can facilitate land use planning by limiting construction over potentially dangerous zones of seismic activity.

#### Why remote sensing?

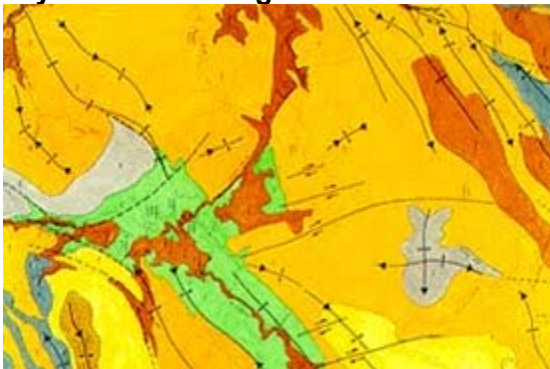

A synoptic view of regional scale is a much different perspective than point ground observations when trying to **map structural elements**. Remote sensing offers this perspective and allows a geologist to examine other reference ancillary data simultaneously and synergistically, such as geo-magnetic information.

Certain remote sensing devices offer unique information regarding structures, such as in the relief expression offered by radar sensors.

Comparing surface expression to other geological information may also allow patterns of association to be recognized. For instance, a rock unit may be characterized by a particular radar texture which may also correlate with a high magnetic intensity or geochemical anomaly. Remote sensing is most useful in combination, or in synergy, with complementary datasets.

A benefit of side looking radar is that the illumination conditions can be controlled, and the most

appropriate geometry used for type of terrain being examined. Uniform illumination conditions provided by the sun, especially at equatorial latitudes, are usually not conducive to highlighting relief features. An extra benefit of airborne SAR sensors is that acquisition missions can be customized to orient the flightline parallel to the target orientation, to maximize the illumination and shadow effect.

### Data requirements

In areas where vegetation cover is dense, it is very difficult to detect structural features. A heavy canopy will visually blanket the underlying formation, limiting the use of optical sensors for this application. Radar however, is sensitive enough to topographic variation that it is able to discern the structural expression reflected or mirrored in the tree top canopy, and therefore the structure may be clearly defined on the radar imagery.

Structural analyses are conducted on regional scales, to provide a comprehensive look at the extent of faults, lineaments and other structural features. Geologic features are typically large (kilometre scale) and applications therefore require small-scale imagery to cover the extent of the element of interest. Aerial photos can be used in temperate areas where large-scale imagery is required, particularly to map potential geohazards (e.g. landslides).



Structural mapping applications generally are not time sensitive (other than for project deadlines!) and so a fast turnaround is not required. Unless a time series analysis of crustal deformation is being conducted, frequency of imaging is not a critical issue either. The key factor for remotely sensed data are that they provide some information on the spatial distribution and surficial relief of the structural elements. Radar is well suited to these requirements with its side-looking

configuration. Imaging with shallow incidence angles enhances surficial relief and structure.

**Shadows** can be used to help define the structure height and shape, and thus increasing the shadow effect, while shallow incidence angles may benefit structural analysis.

### Canadian vs. International requirements

Requirements for remote sensing parameters of structural features are fairly constant throughout the world. Those areas of persistent cloud cover will benefit from radar imaging, while areas at very high or low latitudes can benefit from low sun angles to highlight subtle relief for optical imaging.

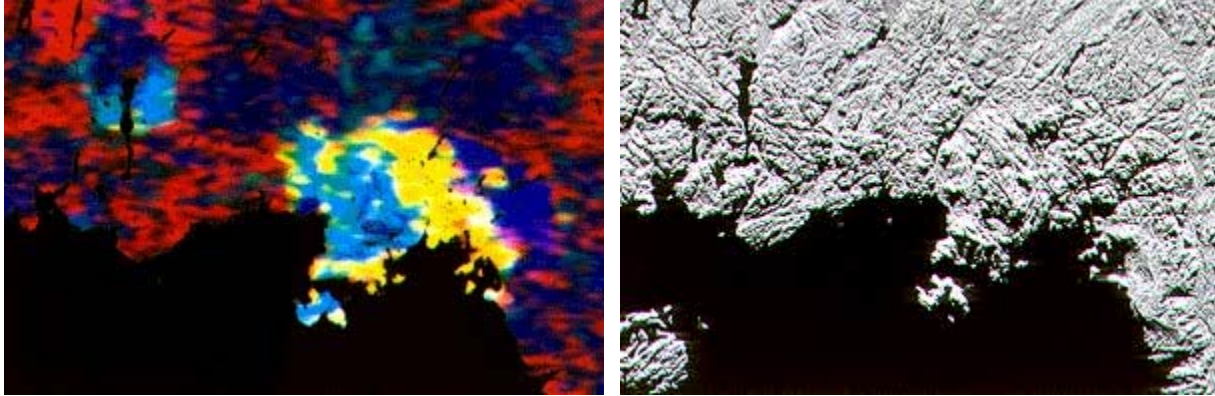
**Case study (example): Port Coldwell, Ontario: A case for SAR integration**

The structural information provided by radar complements other spatial datasets. When integrated together, SAR and spatial geological datasets provide a valuable source of geological information. In this example, radioactivity information of the area of Port Coldwell, Ontario, was provided by an **airborne gamma-ray spectrometry survey**, which collected potassium, thorium, and uranium readings. This data is informative, but it is difficult to put the information into perspective without the layout and recognizable characteristics of the landscape. **Airborne SAR image data** was also acquired of the same region. The SAR image is quite interesting in terms of micro-topography and structure, but does not provide any other geo-technical information about the terrain. These two datasets were integrated, using an IHS approach (intensity-hue- saturation to replace the conventional red-green-blue colour display). The airborne gamma-ray spectrometry data are coded as the hue and saturation information, while the SAR terrain information is coded as the intensity information. The resulting **integrated image** is an excellent display of structural, relief, and natural radioactivity information, allowing a geologist to have a comprehensive view of the data with only one image.

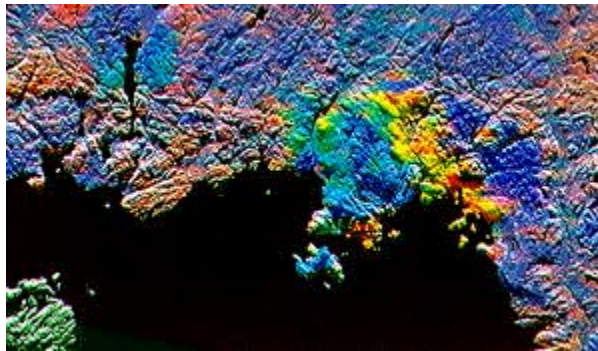

Integrated image (natural radioactivity and SAR) of Port Coldwell



## 5.4.2 Geologic Unit Mapping

### Background

Mapping geologic units consists primarily of identifying physiographic units and determining the rock lithology or coarse stratigraphy of exposed units. These units or formations are generally described by their age, lithology and thickness. Remote sensing can be used to describe lithology by the colour, weathering and erosion characteristics (whether the rock is resistant or recessive), drainage patterns, and thickness of bedding.

Unit mapping is useful in oil and mineral exploration, since these resources are often associated with specific lithologies. Structures below the ground, which may be conducive to trapping oil or hosting specific minerals, often manifest themselves on the Earth's surface. By delineating the structures and identifying the associated lithologies, geologists can identify locations that would most feasibly contain these resources, and target them for exploration. Bedrock mapping is critical to engineering, construction, and mining operations, and can play a role in land use and urban planning. Understanding the distribution and spatial relationships of the units also facilitates interpretation of the geologic history of the Earth's surface.

In terms of remote sensing, these "lithostratigraphic" units can be delineated by their spectral reflectance signatures, by the structure of the bedding planes, and by surface morphology.

### Why remote sensing?

Remote sensing gives the overview required to 1) construct regional unit maps, useful for small scale analyses, and planning field traverses to sample and verify various units for detailed mapping; and 2) understand the spatial distribution and surface relationships between the units. VIR remote sensing provides the multispectral information relating to the composition of the unit, while radar can contribute textural information. Multiple data sources can also be integrated to provide a comprehensive view of the lithostratigraphy.

Stereo imagery can also facilitate delineation and identification of units by providing a three dimensional view of the local relief. Some rocks are resistant to erosion, whereas others erode easily. Identification elements such as weathering manifestations may be apparent on high or medium resolution imagery and airphotos.

Images or airphotos can be taken into the field and used as basemaps for field analysis.

### Data requirements

Two different scales of mapping require slightly different imaging sources and parameters.

1. For site specific analysis, airphotos provide a high resolution product that can provide information on differential weathering, tone, and microdrainage. Photos may be easily viewed in stereo to assess relief characteristics.
2. Regional overviews require large coverage area and moderate resolution. An excellent data source for regional applications is a synergistic combination of radar and optical images to highlight terrain and textural information.

In either case, frequency of imaging is not an issue since in many cases the geological features of interest remain relatively static. Immediate turnaround is also not critical.

### Canada vs. International

Requirements for this application do not differ significantly around the world. One of the

biggest problems faced by both temperate and tropical countries is that dense forest covers much of the landscape. In these areas, geologists can use remote sensing to infer underlying lithology by the condition of vegetation growing above it. This concept is called "geobotany". The underlying principle is that the mineral and sedimentary constituents of the bedrock may control or influence the condition of vegetation growing above.

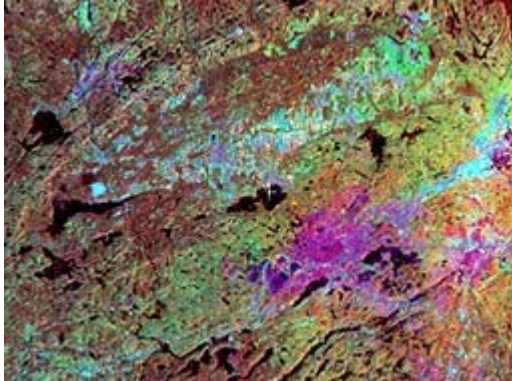

In reality, the topography, structure, surficial materials, and vegetation combine to facilitate geologic unit interpretation and mapping. Optimal use of **remote sensing data** therefore, is one that integrates different sources of image data, such as optical and radar, at a scale appropriate to the study.

#### Image example

Even once **geological unit maps** are created, they can still be presented more informatively by encompassing the textural information provided by SAR data. A basic geological unit map can be made more informative by adding textural and structural information. In this example of the Sudbury, Ontario region, an integration transform was used to merge the map data (bedrock and structural geology information, 1992) with the SAR image data. The **resulting image** can be used on a local or regional scale to detect structural trends within and between units. The areas common to each image are outlined in black.

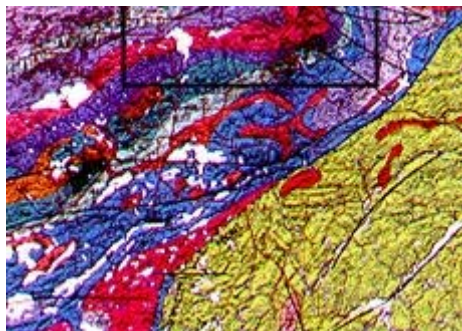

Geological map and SAR data integrated

## 5.5 Hydrology



Hydrology is the study of water on the Earth's surface, whether flowing above ground, frozen in ice or snow, or retained by soil. Hydrology is inherently related to many other applications of remote sensing, particularly forestry, agriculture and land cover, since water is a vital component in each of these disciplines. Most hydrological processes are dynamic, not only between years, but also within and between seasons, and therefore require frequent observations. Remote sensing offers a synoptic view of the spatial distribution and dynamics of hydrological phenomena, often unattainable by traditional ground surveys. Radar has brought a new dimension to hydrological studies with its active sensing capabilities, allowing the time window of image acquisition to include inclement weather conditions or seasonal or diurnal darkness.

Examples of hydrological applications include:

- wetlands mapping and monitoring,
- soil moisture estimation,
- snow pack monitoring / delineation of extent,
- measuring snow thickness,
- determining snow-water equivalent,
- river and lake ice monitoring,
- flood mapping and monitoring,
- glacier dynamics monitoring (surges, ablation)
- river /delta change detection
- drainage basin mapping and watershed modelling
- irrigation canal leakage detection
- irrigation scheduling

## 5.5.1 Flood Delineation & Mapping



### Background

A natural phenomenon in the hydrological cycle is flooding. Flooding is necessary to replenish soil fertility by periodically adding nutrients and fine grained sediment; however, it can also cause loss of life, temporary destruction of animal habitat and permanent damage to urban and rural infrastructure. Inland floods can result from disruption to natural or man-made dams, catastrophic melting of ice and snow (jökulhlaups in Iceland), rain, river ice jams and / or excessive runoff in the spring.

### Why remote sensing?

Remote sensing techniques are used to measure and monitor the areal extent of the flooded areas , to efficiently target rescue efforts and to provide quantifiable estimates of the amount of land and infrastructure affected. Incorporating remotely sensed data into a GIS allows for quick calculations and assessments of water levels, damage, and areas facing potential flood danger. Users of this type of data include flood forecast agencies, hydropower companies, conservation authorities, city planning and emergency response departments, and insurance companies (for flood compensation). The identification and mapping of floodplains, abandoned river channels, and meanders are important for planning and transportation routing.

### Data requirements

Many of these users of remotely sensed data need the information during a crisis and therefore require "near-real time turnaround". Turnaround time is less demanding for those involved in hydrologic modelling, calibration/validation studies, damage assessment and the planning of flood mitigation. Flooding conditions are relatively short term and generally occur during inclement weather, so optical sensors, although typically having high information content for this purpose, can not penetrate through the cloud cover to view the flooded region below. For these reasons, active SAR sensors are particularly valuable for flood monitoring. RADARSAT in particular offers a high turnaround interval, from when the data is acquired by the sensor, to when the image is delivered to the user on the ground. The land / water

interface is quite easily discriminated with SAR data, allowing the flood extent to be delineated and mapped. The SAR data is most useful when integrated with a pre-flood image, to highlight the flood-affected areas, and then presented in a GIS with cadastral and road network information.

### **Canada vs. International**

Requirements for this application are similar the world over. Flooding can affect many areas of the world, whether coastal or inland, and many of the conditions for imaging are the same. Radar provides excellent water/land discrimination and is reliable for imaging despite most atmospheric limitations.

### **Case study (example):**

RADARSAT MAPS THE MANITOBA SEA:

THE FLOODS OF 1997

In 1997, the worst Canadian flood of the 20th century inundated prairie fields and towns in the states of Minnesota, North Dakota, and the Canadian province of Manitoba. By May 5th, 25,000 residents of Manitoba had been evacuated from their homes, with 10,000 more on alert. The watershed of the Red River, flowing north from the United States into Canada, received unusually high winter snowfalls and heavy precipitation in April. These factors, combined with the northward flow into colder ground areas and very flat terrain beyond the immediate floodplain, caused record flooding conditions, with tremendous damage to homes and property, in addition to wildlife and livestock casualties. For weeks emergency response teams, area residents, and the media monitored the extent of the flood, with some input from remote sensing techniques. It is impossible to imagine the scale of flooding from a ground perspective, and even video and photographs from aircraft are unable to show the full extent. Spectacular satellite images however, have shown the river expand from a 200 m wide ribbon, to a body of water measuring more than 40 km across. Towns protected by sand-bag dikes, were dry islands in the midst of what was described as the "Red Sea". Many other towns weren't as fortunate, and home and business owners were financially devastated by their losses.

Insurance agents faced their own flood of claims for property, businesses, and crops ruined or damaged by the Red River flood. To quickly assess who is eligible for compensation, the insurance companies can rely on remotely sensed data to delineate the flood extent, and GIS databases to immediately identify whose land was directly affected. City and town planners could also use the images to study potential locations for future dike reinforcement and construction, as well as residential planning.

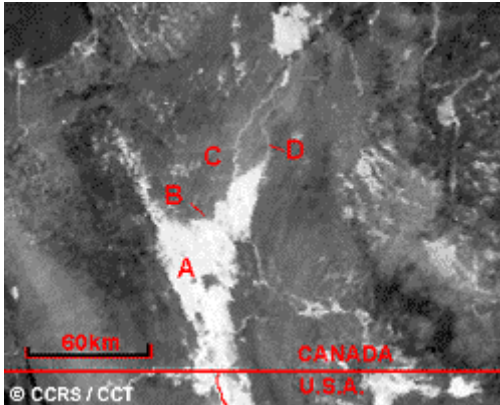

Both NOAA-AVHRR and RADARSAT images captured the scale and extent of the flood. The AVHRR sensors onboard the NOAA satellites provided **small-scale views** of the entire flood area from Lakes Manitoba and Winnipeg south to the North Dakota - South Dakota border. Some of the best images are those taken at night in the thermal infrared wavelengths, where the cooler land appears dark and the warmer water (A) appears white. Manmade dikes, such as the Brunkild Dike (B), were quickly built to prevent the flow of water into southern

Winnipeg. Dikes are apparent on the image as very regular straight boundaries between the land and floodwater. Although the city of Winnipeg (C) is not clearly defined, the Winnipeg floodway (D) immediately to the east, paralleling the Red River at the northeast end of the flood waters, is visible since it is full of water. The floodway was designed to divert excess water flow from the Red River outside of the city limits. In this case, the volume of water was simply too great for the floodway to carry it all, and much of the flow backed up and spread across the prairie.

**RADARSAT** provided some excellent views of the flood, because of its ability to image in darkness or cloudy weather conditions, and its sensitivity to the land/water differences. In this image, the flood water (A) completely surrounds the town of Morris (B), visible as a bright patch within the dark flood water. The flooded areas appear dark on radar imagery because very little of the incident microwave energy directed toward the smooth water surface returns back to the sensor. The town however, has many angular (corner) reflectors primarily in the form of buildings, which cause the incident energy to "bounce" back to the sensor.

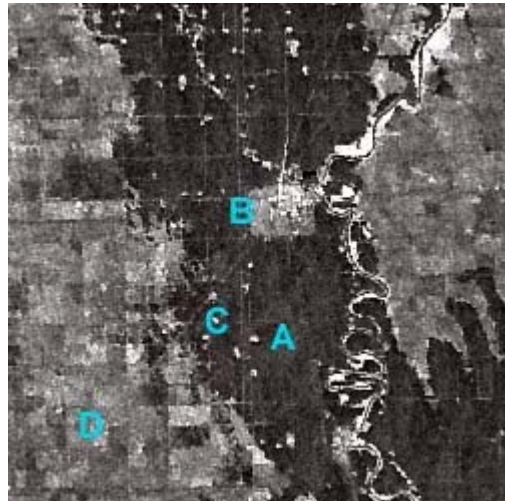

Transportation routes can still be observed. A railroad, on its raised bed, can be seen amidst the water just above (C), trending southwest - northeast. Farmland relatively unaffected by the flood (D) is quite variable in its backscatter response. This is due to differences in each field's soil moisture and surface roughness.

## 5.5.2 Soil Moisture

### Background

Soil moisture is an important measure in determining crop yield potential in Canada and in drought-affected parts of the world (Africa) and for watershed modelling. The moisture content generally refers to the water contained in the upper 1-2m of soil, which can potentially evaporate into the atmosphere. Early detection of dry conditions which could lead to crop damage, or are indicative of potential drought, is important for amelioration efforts and forecasting potential crop yields, which in turn can serve to warn farmers, prepare humanitarian aid to affected areas, or give international commodities traders a competitive advantage. Soil moisture conditions may also serve as a warning for subsequent flooding if the soil has become too saturated to hold any further runoff or precipitation. Soil moisture content is an important parameter in watershed modelling that ultimately provides information on hydroelectric and irrigation capacity. In areas of active deforestation, soil moisture estimates help predict amounts of run-off, evaporation rates, and soil erosion.

Why remote sensing? Remote sensing offers a means of measuring soil moisture across a wide area instead of at discrete point locations that are inherent with ground measurements. RADAR is effective for obtaining qualitative imagery and quantitative measurements, because radar backscatter response is affected by soil moisture, in addition to topography, surface roughness and amount and type of vegetative cover. Keeping the latter elements static, multitemporal radar images can show the change in soil moisture over time. The radar is actually sensitive to the soil's dielectric constant, a property that changes in response to the amount of water in the soil.

Users of soil moisture information from remotely sensed data include agricultural marketing and administrative boards, commodity brokers, large scale farming managers, conservation authorities, and hydroelectric power producers.

### Data requirements

Obviously, a sensor must be sensitive to moisture conditions, and radar satisfies this requirement better than optical sensors. Frequent and regular (repeated) imaging is required during the growing season to follow the change in moisture conditions, and a quick turnaround is required for a farmer to respond to unsuitable conditions (excessive moisture or dryness) in a timely manner. Using high resolution images, a farmer can target irrigation efforts more accurately. Regional coverage allows an overview of soil and growing conditions of interest to agricultural agencies and authorities.

### Canada vs. International

Data requirements to address this application are similar around the world, except that higher resolution data may be necessary in areas such as Europe and Southeast Asia, where field and land parcel sizes are substantially smaller than in North America.

### Case Study (example)

#### Rainfall distribution , Melfort, Saskatchewan, Canada

As with most Canadian prairie provinces, the topography of Saskatchewan is quite flat. The region is dominated by black and brown chernozemic soil characterized by a thick dark organic horizon, ideal for growing cereal crops such as wheat. More recently, canola has been introduced as an alternative to cereal crops.



Shown here is a radar image acquired July 7, 1992 by the European Space Agency (ESA) ERS-1 satellite. This synoptic image of an area near Melfort, Saskatchewan details the effects of a localized precipitation event on the microwave backscatter recorded by the sensor. Areas where precipitation has recently occurred can be seen as a bright tone (bottom half) and those areas unaffected by the event generally appear darker (upper half). This is a result of the complex dielectric constant which is a measure of the electrical properties of surface materials. The dielectric property of a material influences its ability to absorb microwave energy, and therefore critically affects the scattering of microwave energy.

The magnitude of the radar backscatter is proportional to the dielectric constant of the surface. For dry, naturally occurring materials, this is in the range of 3 - 8 , and may reach values as high as 80 for wet surfaces. Therefore the amount of moisture in the surface material directly affects the amount of backscattering. For example, the lower the dielectric constant, the more incident energy is absorbed, the darker the object will be on the image.



## 5.6 Sea Ice



For people living in northern environments, ice is a common phenomenon that affects our local activities. Most of us however, don't consider its larger regional or global implications. Ice covers a substantial part of the Earth's surface and is a major factor in commercial shipping and fishing industries, Coast Guard and construction operations, and global climate change studies. Polar sea ice seasonally covers an even larger area, roughly equal in size to the North American continent, 25 million km<sup>2</sup>.

Its extensive distribution means that sea ice plays a large role in the albedo of the earth. Albedo is a term referring to the measure of reflectivity of the Earth's surface. Ice and snow are highly reflective and changes in their distribution would affect how much solar energy is absorbed by the earth. Under warming conditions, the ice would melt, and less incoming energy would be reflected, thereby potentially increasing the warming trend. The opposite may also be true - an increase of ice due to cooler conditions would reflect even more of the incoming solar energy, potentially propagating even colder conditions. Of course these potential changes in sea ice distribution are of concern to scientists studying global climate change, as are sea ice interactions with the ocean and atmosphere.

During winter in the northern hemisphere, ice creates a substantial barrier to both lake and ocean going vessels trying to reach ports or navigating along coastlines. Ice floes, pack ice and icebergs create potential hazards to navigation, while landfast ice hinders access to the shore. Ice breakers are often used to create routes for ships to follow from the open water to their ports. In Canada, two important locations for this type of operation are the Gulf of St. Lawrence /Great Lakes and the Canadian Arctic. The Gulf is the main route for international cargo vessels headed for Montreal and Québec, and is affected by ice through the winter and spring. Canada's Arctic is home to mineral and hydrocarbon reserves that require shipping for construction equipment, supplies, and transport of resources to refineries and populated markets. In addition, the main method of re-supply for northern communities is by sea. In both areas, information regarding ice conditions, type, concentration and movement are required.

To address these demands, ice analysis charts, daily ice hazard bulletins, seasonal forecasts, and tactical support for observation are provided. In Canada, the Canadian Ice Service is responsible for acquiring and distributing this information and appropriate products. They also maintain an ice information archive which contains useful data for environmental impact assessments, risk assessment, short-term and seasonal route planning for ships, efficient resource transportation and infrastructure development.

Remote sensing data can be used to identify and map different ice types, locate leads (large navigable cracks in the ice), and monitor ice movement. With current technology, this information can be passed to the client in a very short timeframe from acquisition. Users of this type of information include the Coast Guard, port authorities, commercial shipping and fishing industries, ship builders, resource managers (oil and gas / mining), infrastructure construction companies and environmental consultants, marine insurance agents, scientists, and commercial tour operators.

Examples of sea ice information and applications include:

- ice concentration
- ice type / age /motion
- iceberg detection and tracking
- surface topography
- tactical identification of leads: navigation: safe shipping routes/rescue
- ice condition (state of decay)
- historical ice and iceberg conditions and dynamics for planning purposes
- wildlife habitat
- pollution monitoring
- meteorological / global change research

## 5.6.1 Ice type and concentration

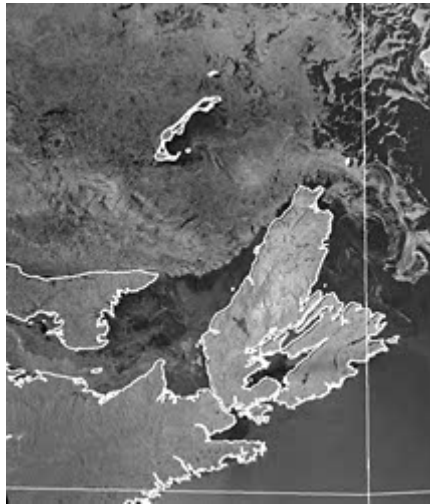

### Background

Ships navigating through high latitude seas (both northern and southern) are often faced with obstacles of pack ice and moving ice floes. Ice breakers are designed to facilitate travel in these areas, but they require knowledge about the most efficient and effective route through the ice. It is important to know the extent of the ice, what type of ice it is, and the concentration and distribution of each type. This information is also valuable for offshore exploration and construction activities, as well as coastal development planning.

### Ice isn't simply ice!

Sea ice isn't a uniform, homogeneous unit. What appears to be a single cover of ice can vary in roughness, strength, salinity, and thickness. Pack ice and ice floes consist of assemblages of different ice types patchworked together, intersected by dynamic leads or cracks. Ice is usually defined by its age - either as new, first-year or multi-year ice. New ice is smooth and relatively thin (5-30 cm) and provides the least resistance to ice breakers. First year ice is older and thicker than new ice (30-200cm) and can pose a significant hazard to all vessels, including icebreakers. When deformed into rubble fields and ridges, first year ice types can become impassable. Ice that survives into a second and later years, generally becomes thicker (>2m) and declines in salinity, increasing the internal strength. This ice is a dangerous hazard to ships and off-shore structures. Ice charts are maps of different ice types and concentration of ice, which are distributed to those working in marine environments where ice affects their operations.

### Why remote sensing?

Observing ice conditions is best from a ground perspective, but this doesn't allow for determining the extent or distribution of the ice. Remote sensing from airborne or spaceborne sensors provides this very valuable view. The areas of ice can be easily mapped from an image, and when georeferenced, provide a useful information source. Remote sensing technology is capable of providing enough information for an analyst to identify ice type (and thus infer ice thickness), and from this data, ice charts can be created and distributed to those who require the information.

Active radar is an excellent sensor to observe ice conditions because the microwave energy and imaging geometry combines to provide measures of both surface and internal characteristics. Backscatter is influenced by dielectric properties of the ice (in turn dependent

on salinity and temperature), surface factors (roughness, snow cover) and internal geometry / microstructure. Surface texture is the main contributor to the radar backscatter and it is this characteristic which is used to infer ice age and thickness. New ice tends to have a low return and therefore dark appearance on the imagery due to the specular reflection of incident energy off the smooth surface. First year ice can have a wide variety of brightness depending on the degree of roughness caused by ridging and rubbing. Multi-year ice has a bright return due to diffuse scattering from its low salinity, and porous structure.

Coarse resolution optical sensors such as NOAA's AVHRR provide an excellent overview of pack ice extent if atmospheric conditions are optimal (resolution = 1km).

Passive microwave sensing also has a role in sea ice applications. Objects (including people!) emit small amounts of microwave radiation, which can be detected by sensors. Sea ice and water emit substantially different amounts of radiation, so it is relatively easy to delineate the interface between the two. The SSM/I onboard the shuttle collected data in this manner. The main drawback of passive microwave sensors is their poor spatial resolution (approx. 25km) which is too coarse for tactical ice navigation.

### **Data requirements**

Ocean ice occurs in extreme latitudes - the high Arctic and Antarctica. But ice also covers prime sea and lake shipping routes in northern countries, particularly Canada, Russia, Japan and northern European and Scandinavian countries. High latitude areas experience low solar illumination conditions in the winter when the ice is at a maximum. This has traditionally hindered remote sensing effectiveness, until the operationalization of radar sensors. The all weather / day - night, capabilities of SAR systems, makes radar remote sensing the most useful for ice type and concentration mapping.

To provide sufficient information for navigation purposes, the data must be captured frequently and must be processed and ready for use within a very short time frame. High resolution data covering 1-50 km is useful for immediate ship navigation, whereas coarse resolution (1-50km), large area coverage (100 - 2000km<sup>2</sup>) images are more useful for regional strategic route planning. For navigation purposes, the value of this information has a limited time window. However, for playing a role in increasing our knowledge about climate dynamics and ice as an indicator of global climate change, the data has long term value.

RADARSAT has orbital parameters and a radar sensor designed to address the demands of the ice applications community. The Arctic area is covered once a day by RADARSAT and systems are in place to efficiently download the data direct from the ground processing station right to the vessel requiring the information, in a time frame of four hours. Airborne radar sensors are also useful for targeting specific areas and providing high resolution imagery unavailable from commercial spaceborne systems. Airborne radar is more expensive but has the benefit of directly targetting the area of interest, which may be important for time critical information, such as tactical navigation in dynamic ice. Winter is the preferred season for acquiring radar scenes for ice typing. Melting and wet conditions reduce the contrast between ice types which makes information extraction more difficult.

Future remote sensing devices are planned to provide comprehensive measurements of sea ice extent.

## 5.6.2 Ice motion

### Background

Ice moves quickly and sometimes unpredictably in response to ocean currents and wind. Ice floes can move like tectonic plates, sometimes breaking apart like a rift valley or colliding in a style similar to the Indian and Asian plates, creating a smaller version of the Himalayan Mountains - a series of ridges and blocky ice rubble. Vessels can be trapped or damaged by the pressure resulting from these moving ice floes. Even offshore structures can be damaged by the strength and momentum of moving ice. For these reasons it is important to understand the ice dynamics in areas of construction or in the vicinity of a shipping/fishing route.

### Why remote sensing?

Remote sensing gives a tangible measure of direction and rate of ice movement through mapping and change detection techniques. Ice floes actually have individual morphological characteristics (shape, structures) that allow them to be distinguished from one another. The floes can be mapped and their movement monitored to facilitate in planning optimum shipping routes, to predict the effect of ice movement on standing structures (bridges, platforms). Users of this type of information include the shipping, fishing, and tourism industries, as well as engineers involved in offshore platform and bridge design and maintenance.

### Data requirements

Monitoring of ice movement requires frequent and reliable imaging. The revisit interval must be frequent enough to follow identifiable features before tracking becomes difficult due to excessive movement or change in appearance. Active microwave sensing (radar) provides a reliable source of imaging under all weather and illumination conditions. RADARSAT provides this type of sensor and is a spaceborne platform, which is advantageous for routine imaging operations. The orbital path ensures that Arctic areas are covered daily which meets the requirement for frequent imaging.

The resolution and imaging frequency requirements for ice motion tracking vary with the size of floes and the ice dynamics in a region. In areas of large slow moving floes (e.g. Beaufort Sea), 1km resolution data over 10 day intervals is adequate. In dynamic marginal ice zones (e.g. Gulf of St. Lawrence), 100m resolution data over 12-24 hr intervals is required.

### Case study (example)

The significance of the force and potential effect of ice movement was brought to light recently with the design and construction of the Confederation Bridge, a 13km link from Prince Edward Island, in Canada's Maritimes, across Northumberland Strait to New Brunswick on Canada's mainland. Crossing a strait that endures ice floes moving in response to winds, currents and tides through a narrow arm of the Gulf of St. Lawrence, the bridge will have to withstand tremendous forces from moving ice impacting its supports.

"More effort was spent related to the ice engineering aspect of this bridge than probably on any other [similar] structure that has ever been built" Dr. Gus Cammaert

Ice floes in Northumberland Strait are dynamic due to oceanic and atmospheric forces, yet constricted in their movement. The result is compression collisions creating large rubble ice masses that extend vertically above and below the water level up to 20 m (each direction). These ice masses have the potential of critically damaging any structure impeding its movement back and forth in the strait. The design and engineering of the bridge had to take

into account both the thickness and actual constant movement of the ice. Ice information archived at the Canadian Ice Service contributed to the understanding of the ice dynamics in the strait, and its tensile properties, critical for setting engineering parameters.

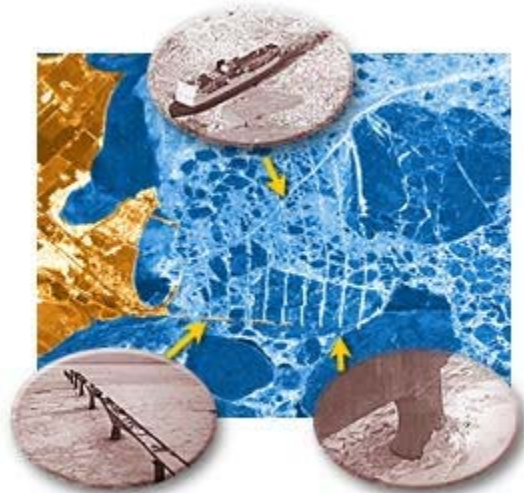

During construction, a radar image of the bridge site was obtained to observe the impact of the bridge supports on the flow of ice around the site. Due to the design of the supports, which are cone-shaped at the waterline to help bend and break the ice, the ice cracked and flowed around the supports. This is one image where ice movement can be inferred from a single image and does not require multi-temporal scenes. In the image, the ice can be seen flowing **from bottom to the top** with the wakes of rubble created by the bridge supports clearly visible.

Remote sensing will be used to monitor the effect of the bridge on the ice movement and ensure that ice build up isn't occurring beyond expectations. As exemplified in the image, the bridge will have an impact on the ice dynamics, by breaking up large floes into smaller pieces which may accumulate on the shore in piles. This effect will be monitored, as will any subsequent effects on microclimate, which might affect the agriculture or fishing industries of PEI.

**Bridge web site:**

Reference: Thurston, H., 1997. Strait Across, Canadian Geographic, Vol. 117, No.2, March-April 1997.

For more information on ice applications:

Canadian Ice Service, Environment Canada:

<http://ice-glaces.ec.gc.ca/App/WsvPageDsp.cfm?ID=1&Lang=eng>

## 5.7 Land Cover & Land Use



Although the terms land cover and land use are often used interchangeably, their actual meanings are quite distinct. Land cover refers to the surface cover on the ground, whether vegetation, urban infrastructure, water, bare soil or other. Identifying, delineating and mapping land cover is important for global monitoring studies, resource management, and planning activities. Identification of land cover establishes the baseline from which monitoring activities (change detection) can be performed, and provides the ground cover information for baseline thematic maps.

Land use refers to the purpose the land serves, for example, recreation, wildlife habitat, or agriculture. Land use applications involve both baseline mapping and subsequent monitoring, since timely information is required to know what current quantity of land is in what type of use and to identify the land use changes from year to year. This knowledge will help develop strategies to balance conservation, conflicting uses, and developmental pressures. Issues driving land use studies include the removal or disturbance of productive land, urban encroachment, and depletion of forests.

It is important to distinguish this difference between land cover and land use, and the information that can be ascertained from each. The properties measured with remote sensing techniques relate to land cover, from which land use can be inferred, particularly with ancillary data or a priori knowledge.

Land cover / use studies are multidisciplinary in nature, and thus the participants involved in such work are numerous and varied, ranging from international wildlife and conservation foundations, to government researchers, and forestry companies. Regional (in Canada, provincial) government agencies have an operational need for land cover inventory and land use monitoring, as it is within their mandate to manage the natural resources of their respective regions. In addition to facilitating sustainable management of the land, land cover and use information may be used for planning, monitoring, and evaluation of development, industrial activity, or reclamation. Detection of long term changes in land cover may reveal a response to a shift in local or regional climatic conditions, the basis of terrestrial global monitoring.

Ongoing negotiations of aboriginal land claims have generated a need for more stringent

knowledge of land information in those areas, ranging from cartographic to thematic information.

Resource managers involved in parks, oil, timber, and mining companies, are concerned with both land use and land cover, as are local resource inventory or natural resource agencies. Changes in land cover will be examined by environmental monitoring researchers, conservation authorities, and departments of municipal affairs, with interests varying from tax assessment to reconnaissance vegetation mapping. Governments are also concerned with the general protection of national resources, and become involved in publicly sensitive activities involving land use conflicts.

Land use applications of remote sensing include the following:

- natural resource management
- wildlife habitat protection
- baseline mapping for GIS input
- urban expansion / encroachment
- routing and logistics planning for seismic / exploration / resource extraction activities
- damage delineation (tornadoes, flooding, volcanic, seismic, fire)
- legal boundaries for tax and property evaluation
- target detection - identification of landing strips, roads, clearings, bridges, land/water interface



## 5.7.1 Land Use Change (Rural / Urban)

### Background

As the Earth's population increases and national economies continue to move away from agriculture based systems, cities will grow and spread. The urban sprawl often infringes upon viable agricultural or productive forest land, neither of which can resist or deflect the overwhelming momentum of urbanization. City growth is an indicator of industrialization (development) and generally has a negative impact on the environmental health of a region.

The change in land use from rural to urban is monitored to estimate populations, predict and plan direction of urban sprawl for developers, and monitor adjacent environmentally sensitive areas or hazards. Temporary refugee settlements and tent cities can be monitored and population amounts and densities estimated.

Analyzing agricultural vs. urban land use is important for ensuring that development does not encroach on valuable agricultural land, and to likewise ensure that agriculture is occurring on the most appropriate land and will not degrade due to improper adjacent development or infrastructure.

### Why remote sensing?

With multi-temporal analyses, remote sensing gives a unique perspective of how cities evolve. The key element for mapping rural to urban land use change is the ability to discriminate between rural uses (farming, pasture forests) and urban use (residential, commercial, recreational). Remote sensing methods can be employed to classify types of land use in a practical, economical and repetitive fashion, over large areas.

### Data requirements

Requirements for rural / urban change detection and mapping applications are 1) high resolution to obtain detailed information, and 2) multispectral optical data to make fine distinction among various land use classes.

Sensors operating in the visible and infrared portion of the spectrum are the most useful data sources for land use analysis. While many urban features can be detected on radar and other imagery (usually because of high reflectivity), VIR data at high resolution permits fine distinction among more subtle land cover/use classes. This would permit a confident identification of the urban fringe and the transition to rural land usage. Optical imagery acquired during winter months is also useful for roughly delineating urban areas vs. non-urban. Cities appear in dramatic contrast to smooth textured snow covered fields.



Radar sensors also have some use for all urban/rural delineation applications, due to the ability of the imaging geometry to enhance anthropogenic features, such as buildings, in the manner of corner reflectors. The optimum geometric arrangement between the sensor and urban area is an orientation of linear features parallel to the sensor movement, perpendicular to the incoming incident EM energy.

Generally, this type of application does not require a high turnaround rate, or a frequent acquisition schedule.

### Canada vs. International



Throughout the world, requirements for rural/urban delineation will differ according to the prevalent atmospheric conditions. Areas with frequently cloudy skies may require the penetrating ability of radar, while areas with clear conditions can use airphoto, optical satellite or radar data. While the land use practices for both rural and urban areas will be significantly different in various parts of the world, the requirement for remote sensing techniques to be applied (other than the cloud-cover issue) will be primarily the need for fine spatial detail.

### Case study (example)

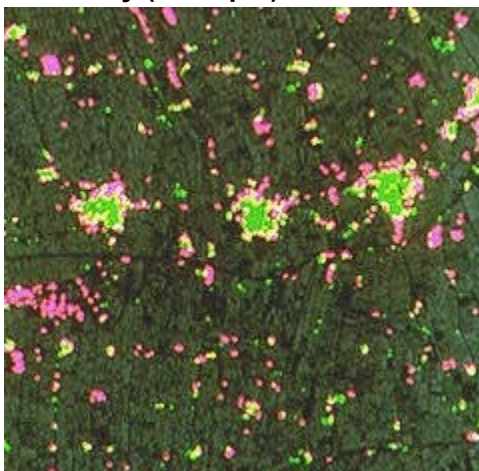

This image of land cover change provides multitemporal information in the form of urban growth mapping. The colours represent urban land cover for two different years. The green delineates those areas of urban cover in 1973, and the pink, urban areas for 1985. This image dramatically shows the change in expansion of existing urban areas, and the clearing of new land for settlements over a 12 year period. This type of information would be used for upgrading government services, planning for increased transportation routes, etc.

## 5.7.2 Land Cover / Biomass Mapping

### Background

Land cover mapping serves as a basic inventory of land resources for all levels of government, environmental agencies, and private industry throughout the world. Whether regional or local in scope, remote sensing offers a means of acquiring and presenting land cover data in a timely manner. Land cover includes everything from crop type, ice and snow, to major biomes including tundra, boreal or rainforest, and barren land.

Regional land cover mapping is performed by almost anyone who is interested in obtaining an inventory of land resources, to be used as a baseline map for future monitoring and land management. Programs are conducted around the world to observe regional crop conditions as well as investigating climatic change on a regional level through biome monitoring. Biomass mapping provides quantifiable estimates of vegetation cover, and biophysical information such as leaf area index (LAI), net primary productivity (NPP) and total biomass accumulations (TBA) measurements - important parameters for measuring the health of our forests, for example.

### Why remote sensing?



There is nothing as practical and cost efficient for obtaining a timely regional overview of land cover than remote sensing techniques. Remote sensing data are capable of capturing changes in plant phenology (growth) throughout the growing season, whether relating to changes in chlorophyll content (detectable with VIR) or structural changes (via radar). For regional mapping, continuous spatial coverage over large areas is required. It would be difficult to detect regional trends with point source data. Remote sensing fulfills this requirement, as well as providing **multispectral**, **multisource**, and multitemporal information for an accurate

classification of land cover. The multisource example image shows the benefit of increased information content when two data sources are integrated. On the left is TM data, and on the right it has been merged with airborne SAR.

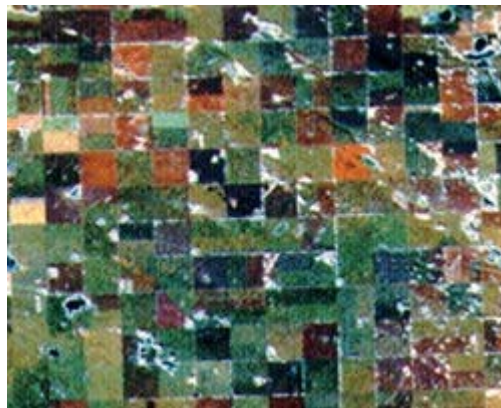

**Data requirements**

For continental and global scale vegetation studies, moderate resolution data (1km) is appropriate, since it requires less storage space and processing effort, a significant consideration when dealing with very large area projects. Of course the requirements depend entirely on the scope of the application. Wetland mapping for instance, demands a critical acquisition period and a high resolution requirement.

Coverage demand will be very large for regional types of surveying. One way to adequately cover a large area and retain high resolution, is to create mosaics of the area from a number of scenes.

Land cover information may be time sensitive. The identification of crops, for instance canola, may require imaging on specific days of flowering, and therefore, reliable imaging is appropriate. Multi-temporal data are preferred for capturing changes in phenology throughout the growing season. This information may be used in the classification process to more accurately discriminate vegetation types based on their growing characteristics.



While optical data are best for land cover mapping, radar imagery is a good replacement in very cloudy areas.

**Case study (example)**

NBIOME: Classification of Canada's Land Cover

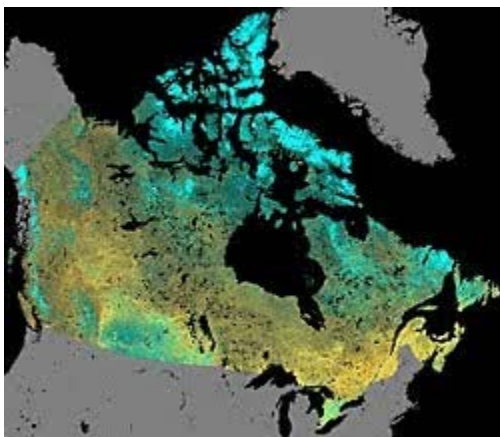

A major initiative of the Canada Centre for Remote Sensing is the development of an objective, reproducible classification of Canada's landcover. This classification methodology is used to produce a baseline map of the major biomes and land cover in Canada, which can then be compared against subsequent classifications to observe changes in cover. These changes may relate to regional climatic or anthropogenic changes affecting the landscape.

The classification is based on NOAA-AVHRR LAC (Local Area Coverage) (1km) data. The coarse resolution is required to ensure efficient processing

and storage of the data, when dealing with such a large coverage area. Before the classification procedure, cloud -cover reduced composites of the Canadian landmass, each spanning 10 day periods are created. In the composite, the value for each pixel used is the

one most cloud free of the ten days. This is determined by the highest normalized difference vegetation index (NDVI) value, since low NDVI is indicative of cloud cover (low infrared reflectance, high visible reflectance). The data also underwent a procedure to minimize atmospheric, bidirectional, and contamination effects.

The composites consist of four channels, mean reflectance of AVHRR channels 1 and 2, NDVI and area under the (temporal NDVI) curve. 16 composites (in 1993) were included in a customized land cover classification procedure (named: classification by progressive generalization), which is neither a supervised nor unsupervised methodology, but incorporates aspects of both. The classification approach is based on finding dominant spectral clusters and conducting progressive merging methodology. Eventually the clusters are labelled with the appropriate land cover classes. The benefit is that the classification is more objective than a supervised approach, while not controlling the parameters of clustering, which could alter the results.

The result of this work is an objective, reproducible classification of Canada's land cover.

## 5.8 Mapping

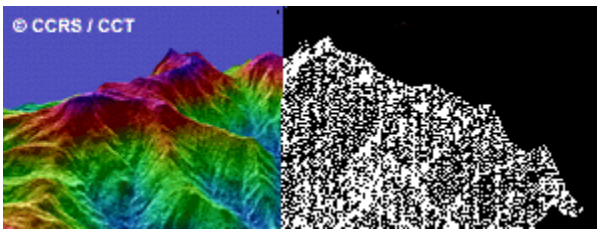

Mapping constitutes an integral component of the process of managing land resources, and mapped information is the common product of analysis of remotely sensed data. Natural features and manufactured infrastructures, such as transportation networks, urban areas, and administrative boundaries can be presented spatially with respect to referenced co-ordinate systems, which may then be combined with thematic information. Baseline, thematic, and topographic maps are essential for planning, evaluating, and monitoring, for military or civilian reconnaissance, or land use management, particularly if digitally integrated into a geographic information system as an information base. Integrating elevation information is crucial to many applications and is often the key to the potential success of present day mapping programs.

Canada has been, and continues to be a world leader in mapping technology. Canada's immense land area with a rich resource potential, coupled with a small population base has necessitated the development of thorough and efficient mechanisms of investigating and recording land information. Traditionally, this information was obtained through surveying and photogrammetric techniques, which have been costly and time consuming, particularly for periodic revision of outdated information. Recent advances in computer technology (speed, data handling and storage capability) and a growing demand for digital databases and computer based mapping production capabilities have encouraged the use of remotely sensed information as a data source for cartographic applications.

There is a growing demand for the utilization of remote sensing data in map production, since the following benefits may be provided: stereo coverage, frequent revisits, timely delivery, wide area coverage, low labour intensity, virtually global coverage, and storage in digital format to facilitate subsequent updating and compatibility with current GIS technology.

End users of base maps and mapping products include resource companies (forestry, mining, oil), support and service industries (engineering), utility and infrastructure development agencies (pipelines, telecommunications, transportation, power), government mapping agencies, and the military. This diversification from traditionally military users to commercial applications has resulted in a greater demand for a wider range of mapping products, with emphasis placed upon the benefits of improved information content and scale, and accuracy versus data costs.

Canadian companies offering mapping services are likely to be looking abroad, as the greatest commercial potential exists within the international community. Developing countries

are currently initiating mapping programs to cover large unsurveyed areas to increase their topographic and planimetric knowledge base. The derived information will be used to support territorial sovereignty issues, assess and monitor resource potential and exploitation, and encourage economic opportunity. Radar data will be relied on in tropical areas for remote sensing mapping solutions.

Mapping applications of remote sensing include the following:

1. planimetry
2. digital elevation models (DEM's)
3. baseline thematic mapping / topographic mapping

## 5.8.1 Planimetry

### Background

Planimetry consists of the identification and geolocation of basic land cover (e.g. forest, marsh), drainage, and anthropogenic features (e.g. urban infrastructure, transportation networks) in the x, y plane. Planimetric information is generally required for large-scale applications - urban mapping, facilities management, military reconnaissance, and general landscape information.

### Why remote sensing?

Land surveying techniques accompanied by the use of a GPS can be used to meet high accuracy requirements, but limitations include cost effectiveness, and difficulties in attempting to map large, or remote areas. Remote sensing provides a means of identifying and presenting planimetric data in convenient media and efficient manner. Imagery is available in varying scales to meet the requirements of many different users. Defence applications typify the scope of planimetry applications - extracting transportation route information, building and facilities locations, urban infrastructure, and general land cover.

### Data requirements

Very high resolution is usually a requirement for accurate planimetric mapping. Concerns of the mapping community with regard to use of satellite data are spatial accuracy and the level of detail of extractable information content. The concern for information content focusses not only on interpretability of features, but on the ability to determine the correct spatial location of a feature. An example of the latter would be the difficulty associated with defining the centre of a river or precise location of a powerline or pipeline right-of-way in vector format, when interpreting from a relatively coarse raster base. Spatial resolution is a critical element in this case.

The turnaround time of one or two weeks will generally meet the requirements for this type of mapping, although defence requirements may be more stringent.

### Canada vs. International

For general Canadian applications, the ability to provide planimetric information is best addressed by current VIR sensors, and for large scale mapping- aerial photography. The importance of adequate resolution and information content outweigh the need for near real time products. Presently, TM and SPOT data provide optimal information for extracting planimetric information for regional applications. Air photos, and particularly orthophotos when available, are preferred for smaller, well defined areas.



Tawausar radar image



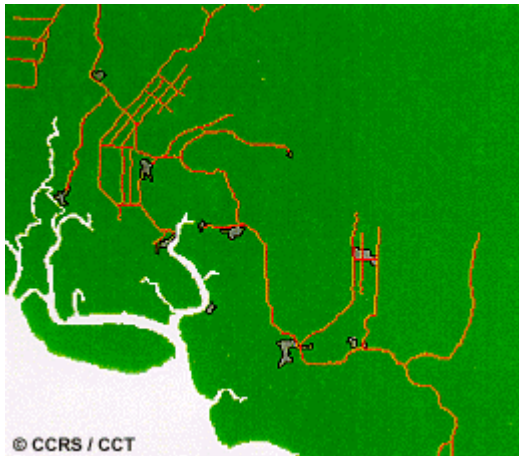

For cloud covered areas, **radar** is the obvious choice for providing **planimetric data**. The detectability of linear features improves when they are oriented perpendicular to the radar look direction. This can be controlled with airborne sensors, by planning the flightlines appropriately. Another issue is that a balance between resolution and speckle has to be reached. Although single look data provides the finest resolution, speckle can be a hindrance to interpretation, and invites multilook processing.

## 5.8.2 Digital Elevation Models

### Background

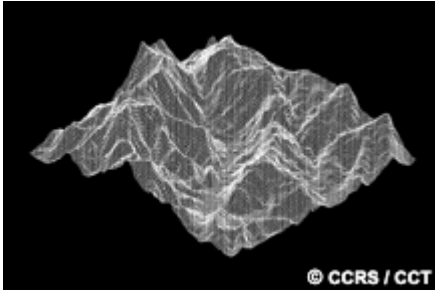

The availability of digital elevation models (DEMs) is critical for performing geometric and radiometric corrections for terrain on remotely sensed imagery, and allows the generation of contour lines and terrain models, thus providing another source of information for analysis.

Present mapping programs are rarely implemented with only planimetric considerations. The demand for digital elevation models is growing with increasing use of GIS and with increasing evidence of improvement in information extracted using elevation data (for example, in discriminating wetlands, flood mapping, and forest management). The incorporation of elevation and terrain data is crucial to many applications, particularly if radar data is being used, to compensate for foreshortening and layover effects, and slope induced radiometric effects. Elevation data is used in the production of popular topographic maps.

Elevation data, integrated with imagery is also used for generating perspective views, useful for tourism, route planning, to optimize views for developments, to lessen visibility of forest clearcuts from major transportation routes, and even golf course planning and development. Elevation models are integrated into the programming of cruise missiles, to guide them over the terrain.

Resource management, telecommunications planning, and military mapping are some of the applications associated with DEMs.

### Why remote sensing?

There are a number of ways to generate elevation models. One is to create point data sets by collecting elevation data from altimeter or Global Positioning System (GPS) data, and then interpolating between the points. This is extremely time and effort consuming. Traditional surveying is also very time consuming and limits the timeliness of regional scale mapping.

Generating DEMs from remotely sensed data can be cost effective and efficient. A variety of sensors and methodologies to generate such models are available and proven for mapping applications. Two primary methods of generating elevation data are 1. Stereogrammetry techniques using airphotos (photogrammetry), VIR imagery, or radar data (radargrammetry), and 2. Radar interferometry.



Stereogrammetry involves the extraction of elevation information from stereo overlapping images, typically airphotos, SPOT imagery, or radar. To give an example, stereo pairs of airborne SAR data are used to find point elevations, using the concept of parallax. Contours (lines of equal elevation) can be traced along the images by operators constantly viewing the images in stereo.

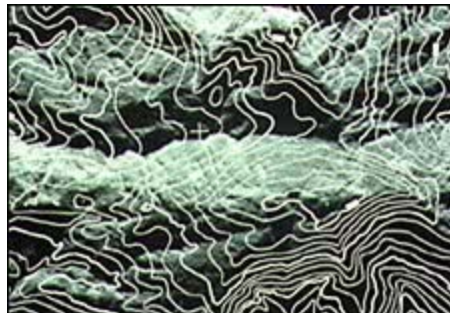

The potential of radar interferometric techniques to measure terrain height, and to detect and measure minute changes in elevation and horizontal base, is becoming quickly recognized.

Interferometry involves the gathering of precise elevation data using successive passes (or dual antenna reception) of spaceborne or airborne SAR. Subsequent images from nearly the same track are acquired and instead of examining the amplitude images, the phase information of the returned signals is compared. The phase images are coregistered, and the differences in phase value for each pixel is measured, and displayed as an interferogram. A computation of phase "unwrapping" or phase integration, and geometric rectification are performed to determine altitude values. High accuracies have been achieved in demonstrations using both airborne (in the order of a few centimetres) and spaceborne data (in the order of 10m).

Primary applications of interferometry include high quality DEM generation, monitoring of surface deformations (measurement of land subsidence due to natural processes, gas removal, or groundwater extraction; volcanic inflation prior to eruption; relative earth movements caused by earthquakes), and hazard assessment and monitoring of natural landscape features and fabricated structures, such as dams. This type of data would be useful for insurance companies who could better measure damage due to natural disasters, and for hydrology-specialty companies and researchers interested in routine monitoring of ice jams

for bridge safety, and changes in mass balance of glaciers or volcano growth prior to an eruption.

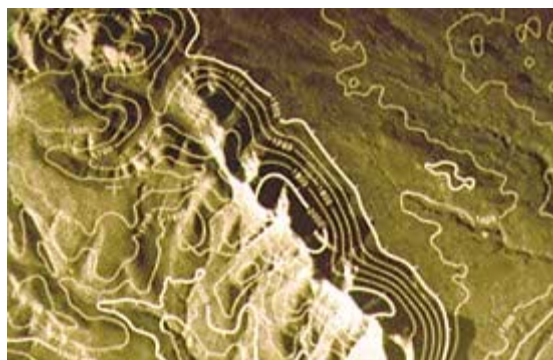

From elevation models, contour lines can be generated for topographic maps, slope and aspect models can be created for integration into (land cover) thematic classification datasets or used as a sole data source, or the model itself can be used to orthorectify remote sensing imagery and generate perspective views.

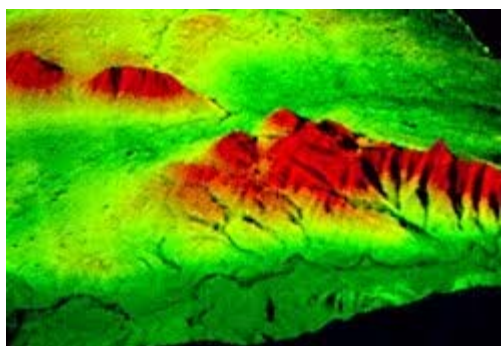

### **Data requirements**

The basic data requirement for both stereogrammetric and interferometric techniques is that the target site has been imaged two times, with the sensor imaging positions separated to give two different viewing angles.

In virtually all DEM and topographic map generation applications, cartographic accuracy is the important limiting factor. Turnaround time is not critical and repeat frequency is dependent on whether the application involves change detection, and what the temporal scope of the study is.

**Canada vs. International**

Aerial photography is the primary data source for DEM generation in Canada for national topographic mapping. For other applications of DEMs, there are additional satellite sources such as SPOT, with its pointable sensors and 10m panchromatic spatial resolution, producing adequate height information at scales smaller than 1:50,000.

The height accuracy requirement for 1:50,000 mapping in Canada is between 5 and 20 m. In developing countries it is typically 20 m. The original elevation information used in the Canadian National Topographic Series Maps was provided from photogrammetric techniques.

In foreign markets, airborne radar mapping is most suited for approximately 1:50,000 scale topographic mapping. Spaceborne radar systems will be able to provide data for the generation of coarser DEMs through radargrammetry, in areas of cloud cover and with less stringent accuracy requirements. Stereo data in most modes of operation will be available because of the flexible incidence angles, allowing most areas to be captured during subsequent passes. Interferometry from airborne and spaceborne systems should meet many mapping requirements.

## 5.8.3 Topographic & Baseline Thematic Mapping

### Background

There is a growing demand for digital databases of topographic and thematic information to facilitate data integration and efficient updating of other spatially oriented data. Topographic maps consist of elevation contours and planimetric detail of varied scale, and serve as general base information for civilian and military use.

Baseline thematic mapping (BTM) is a digital integration of satellite imagery, land use, land cover, and topographic data to produce an "image map" with contour lines and vector planimetry information. This new concept of thematic mapping was developed to take advantage of improvements in digital processing and integration of spatial information, increased compatibility of multisource data sets, the wide use of geographic information systems to synthesize information and execute analyses customized for the user, and increased ability to present the data in cartographic form.

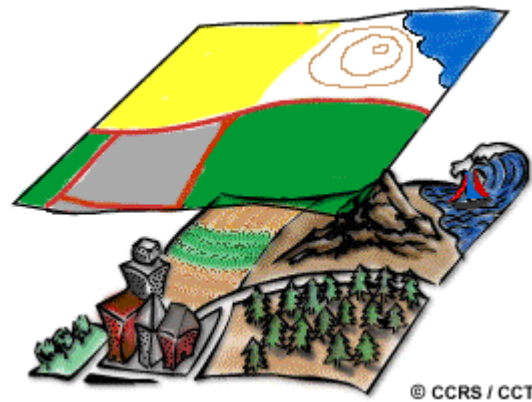

The data for baseline thematic maps are compiled from topographic, land cover, and infrastructure databases. Appropriate thematic information is superimposed on a base map, providing specific information for specific end users, such as resource managers. Various combinations of thematic information may be displayed to optimize the map information for application specific purposes, whether for land use allocation, utility site selection and route planning, watershed management, or natural resource management and operations.

### Why remote sensing?

As a base map, imagery provides ancillary information to the extracted planimetric or thematic detail. Sensitivity to surface expression makes radar a useful tool for creating base maps and providing reconnaissance abilities for hydrocarbon and mineralogical companies involved in exploration activities. This is particularly true in remote northern regions, where vegetation cover does not mask the microtopography and generally, information may be sparse. Multispectral imagery is excellent for providing ancillary land cover information, such as forest cover. Supplementing the optical data with the topographic relief and textural nuance inherent in radar imagery can create an extremely useful image composite product for interpretation.

### Data requirements

The prime data requirement is for high information content and a balance between resolution and data handling ability. There is a moderate turnaround requirement for this application; processed data should be available less than a year after imagery acquisition.

**Canada vs. International**

VIR imagery is excellent as a base map for planimetry detail on a varied landscape, providing information on forest, agriculture cover and gross geomorphology of the land. SAR is also good for providing surficial topographic expression.

**Case study (example) BTM's in BC  
(Baseline Thematic Mapping in British Columbia)**

Baseline thematic mapping involves the compilation of varied data sources, ranging from satellite imagery to detailed forest stand information to planimetric data from the 1:250,000 National Topographic database. Base map sheets overlain by various combinations of thematic data are produced with an aim toward resource management applications. British Columbia's Ministry of Environment, Lands, and Parks routinely produces BTMs. The most recent Landsat TM data available is used as a source for classifications of ground cover and interpretation of land use. DEMs are also integrated into the satellite data to provide 3 dimensional perspective views. Although B.C. is quite advanced in this application, other Canadian provinces have contemplated or are doing similar work, as are private consultants in conjunction with forestry companies.

Baseline thematic mapping incorporates not only interpretations of ground cover data and land use, but topographic information such as elevation contours and planimetry to provide an optimal tool for resource management. This information may be portrayed in traditional map format, or as an image-map, which is an excellent means of presenting spatial data to resource managers and many other users.

## 5.9 Oceans & Coastal Monitoring

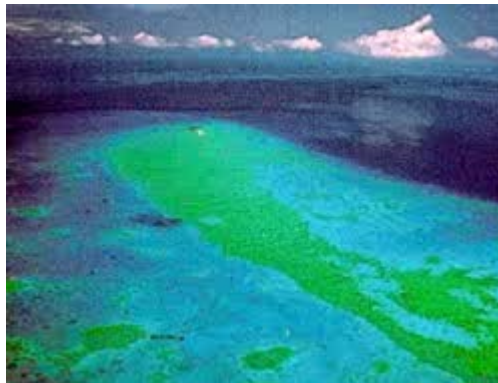

The oceans not only provide valuable food and biophysical resources, they also serve as transportation routes, are crucially important in weather system formation and CO<sup>2</sup> storage, and are an important link in the earth's hydrological balance. Understanding ocean dynamics is important for fish stock assessment, ship routing, predicting global circulation consequences of phenomena such as El Nino, forecasting and monitoring storms so as to reduce the impact of disaster on marine navigation, off-shore exploration, and coastal settlements. Studies of ocean dynamics include wind and wave retrieval (direction, speed, height) , mesoscale feature identification, bathymetry, water temperature, and ocean productivity.

Coastlines are environmentally sensitive interfaces between the ocean and land and respond to changes brought about by economic development and changing land-use patterns. Often coastlines are also biologically diverse inter-tidal zones, and can also be highly urbanized . With over 60% of the world's population living close to the ocean, the coastal zone is a region subject to increasing stress from human activity. Government agencies concerned with the impact of human activities in this region need new data sources with which to monitor such diverse changes as coastal erosion, loss of natural habitat, urbanization, effluents and offshore pollution. Many of the dynamics of the open ocean and changes in the coastal region can be mapped and monitored using remote sensing techniques.

Ocean applications of remote sensing include the following:

- Ocean pattern identification:
  - currents, regional circulation patterns, shears
  - frontal zones, internal waves, gravity waves, eddies, upwelling zones, shallow water bathymetry ,
- Storm forecasting
  - wind and wave retrieval
- Fish stock and marine mammal assessment
  - water temperature monitoring
  - water quality
  - ocean productivity, phytoplankton concentration and drift



- aquaculture inventory and monitoring
- Oil spill
  - mapping and predicting oilspill extent and drift
  - strategic support for oil spill emergency response decisions
  - identification of natural oil seepage areas for exploration
- Shipping
  - navigation routing
  - traffic density studies
  - operational fisheries surveillance
  - near-shore bathymetry mapping
- Intertidal zone
  - tidal and storm effects
  - delineation of the land /water interface
  - mapping shoreline features / beach dynamics
  - coastal vegetation mapping
  - human activity / impact

## 5.9.1 Ocean Features

### Background

Ocean feature analysis includes determining current strength and direction, amplitude and direction of surface winds, measuring sea surface temperatures, and exploring the dynamic relationship and influences between ocean and atmosphere. Knowledge of currents, wind speed, tides, storm surges and surface wave height can facilitate ship routing. Sea floor modelling supports waste disposal and resource extraction planning activities.

Ocean circulation patterns can be determined by the examination of mesoscale features such as eddies, and surface gravity waves. This knowledge is used in global climate modelling, pollution monitoring, navigation and forecasting for offshore operations.

### Why remote sensing?

Remote sensing offers a number of different methods for acquiring information on the open ocean and coastal region. Scatterometers collect wind speed and direction information, altimeters measure wave height, and identify wind speed. Synthetic aperture radar (SAR) is sensitive to spatially varying surface roughness patterns caused by the interaction of the upper ocean with the atmosphere at the marine boundary layer, and scanning radiometers and microwave sounders collect sea surface temperature data. Buoy-collected information can be combined with remote sensing data to produce image maps displaying such things as hurricane structure with annotated wind direction and strength, and wave height. This information can be useful for offshore engineering activities, operational fisheries surveillance and storm forecast operations.

### Data requirements

For general sea-state information (waves, currents, winds), the data are usually time sensitive, meaning that the information is only valuable if it is received while the conditions exist. For forecasting and ship routing, real time data handling / turnaround facilities are necessary, requiring two way data links for efficient dissemination between the forecast centre and data user.

Certain wind speed conditions are necessary in order for the SAR to receive signal information from the ocean surface. At very low wind speeds (2-3m/s) the SAR is not sensitive enough to detect the ocean 'clutter' and at very high winds speeds (greater than 14 m/s) the ocean clutter masks whatever surface features may be present. The principal scattering mechanism for ocean surface imaging is Bragg scattering, whereby the short waves on the ocean surface create spatially varying surface patterns. The backscatter intensity is a function of the incidence angle and radar wavelength, as well as the sea state conditions at the time of imaging. The surface waves that lead to Bragg scattering are roughly equivalent to the wavelength used by RADARSAT. (5.3 cm) These short waves are generally formed in response to the wind stress at the upper ocean layer. Modulation in the short (surface) waves may be caused by long gravity waves, variable wind speed, and surface currents associated with upper ocean processes such as eddies, fronts and internal waves. These variations

result in spatially variable surface roughness patterns which are detectable on SAR imagery.

#### Case study (example)

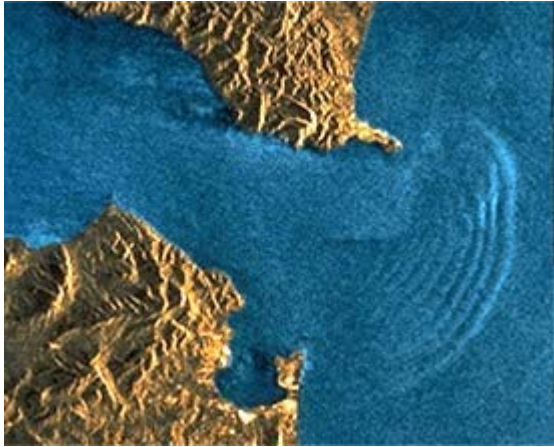

Internal waves form at the interfaces between layers of different water density, which are associated with velocity shears (i.e., where the water above and below the interface is either moving in opposite directions or in the same direction at different speeds). Oscillations can occur if the water is displaced vertically resulting in internal waves. Internal waves in general occur on a variety of scales and are widespread phenomena in the oceans. The most important are those associated with tidal oscillations along continental margins. The internal waves are large

enough to be detected by satellite imagery. In this image, the internal waves, are manifested on the ocean surface as a repeating curvilinear patterns of dark and light banding, a few kilometres east of the Strait of Gibraltar, where the Atlantic Ocean and Mediterranean Sea meet. Significant amounts of water move into the Mediterranean from the Atlantic during high tide and/or storm surges.

## 5.9.2 Ocean Colour & Phytoplankton Concentration

### Background

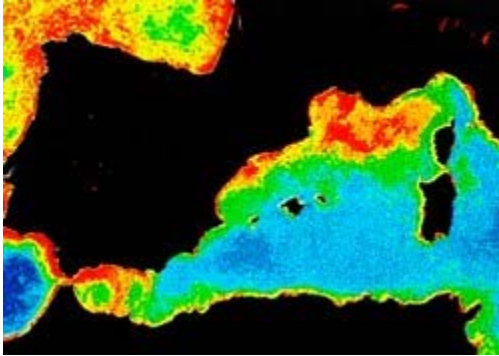

Ocean colour analysis refers to a method of indicating the "health" of the ocean, by measuring oceanic biological activity by optical means . Phytoplankton, are significant building blocks in the world's food chain and grow with the assistance of sunlight and the pigment chlorophyll. Chlorophyll, which absorbs red light (resulting in the ocean's blue-green colour) is considered a good indicator of the health of the ocean and its level of productivity. The ability to map the spatial and temporal patterns

of ocean colour over regional and global scales has provided important insights into the fundamental properties and processes in the marine biosphere.

Mapping and understanding changes in ocean colour can assist in the management of fish stocks and other aquatic life, help define harvest quotas, monitor the water quality and allow for the identification of human and natural water pollution such as oil or algal blooms, which are dangerous to fish farms and other shell fish industries.

In general, ocean productivity appears highest in coastal areas due to their proximity to nutrient upwelling and circulation conditions that favour nutrient accumulation.

### Why remote sensing?

Remotely sensed data can provide the necessary spatial perspective to collect information about the ocean surface on a regional scale. Optical data can detect such targets as suspended sediments, dissolved organic matter, and discern between algal blooms and oilslicks. SAR data can provide additional information on current, wave and mesoscale features so as to observe trends over time when optical data are not available due to periods of cloud cover. Many commercial fishing and aquaculture operators use this information to predict catch sizes and locate potential feeding areas.

Remote sensing provides a near-surface view of the ocean, but is limited in the amount of information it can derive from the water column. However, many applications of ocean colour are in their infancy and with the recent and upcoming missions of advanced sensors, the development and scope of applications will improve substantially.

### Data requirements

Multispectral data are required for ocean colour measurements, and wide spatial coverage provides the best synoptic view of distribution and spatial variability of phytoplankton, water temperature and suspended matter concentration. Hyperspectral data, (collected in many and narrow ranges of the visible and infrared wavelengths), allows for greater precision in characterizing target spectral signatures. Monthly and seasonal imaging provides necessary

data for modelling. For fish harvesting activities and for fish farm operators, information is required on a daily or weekly basis.

We are entering a new era of ocean colour data. The Coastal Zone Colour Scanner (CZCS) on-board the US Nimbus 7 satellite collected colour data from 1978 until 1986. In 1996 after a decade of limited data availability, the Germans launched the Modular Opto-electronic Sensor (MOS) and the Japanese followed with the Ocean Colour Thermal Sensor (OCTS). New sensors include SeaWiFs, launched in 1997 (NASA), MERIS (ESA) scheduled for launch in 1999, MODIS (NASA) in 2000, GLI (Japan) in 1999, and OCI (Taiwan) in 1998. These advanced sensors will collect data on primary productivity, chlorophyll variability and sea surface temperature using advanced algorithms. Their spectral channels are designed to optimize target reflectance and support quantitative measurements of specific biophysical properties. Most offer regional perspectives with relatively coarse (500-1200m) resolution and wide fields of view.

### **Case study (example)**

#### **El Nino and the Plankton Disappearance**

Understanding the dynamics of ocean circulation can play a key role in predicting global weather patterns, which can directly impact agriculture and fishing industries around the world. Detecting the arrival of the El Nino Current off the coast of Peru is an example of how remote sensing can be used to improve our understanding of, and build prediction models for global climate patterns.

El Nino is a warm water current that appears off the coast of South America approximately every seven years. Nutrients in the ocean are associated with cold water upwelling, so the arrival of a warm water current such as El Nino, which displaces the cold current further offshore, causes changes in the migration of the fish population. In 1988, El Nino caused a loss in anchovy stocks near Peru, then moved north, altering the regional climatic patterns and creating an unstable weather system. The resulting storms forced the jet stream further north, which in turn blocked the southward flow of continental precipitation from Canada over the central United States. Central and eastern American States suffered drought, reducing crop production, increasing crop prices, and raising commodity prices on the international markets.

## 5.9.3 Oil Spill Detection

### Background

Oil spills can destroy marine life as well as damage habitat for land animals and humans. The majority of marine oilspills result from ships emptying their bilge tanks before or after entering port. Large area oilspills result from tanker ruptures or collisions with reefs, rocky shoals, or other ships. These spills are usually spectacular in the extent of their environmental damage and generate wide spread media coverage. Routine surveillance of shipping routes and coastal areas is necessary to enforce maritime pollution laws and identify offenders.

Following a spill, the shipping operator or oil company involved is responsible for setting up emergency evaluation and response teams, and employing remediating measures to minimize the extent of a spill. If they do not have the resources, the government regulatory agencies responsible for disaster mitigation become involved and oversee the activity. In all spills, the government agencies play a key role in ensuring the environmental protection laws are being met. To limit the areas affected by the spill and facilitate containment and cleanup efforts, a number of factors have to be identified.

1. Spill location
2. Size and extent of the spill
3. Direction and magnitude of oil movement
4. Wind, current and wave information for predicting future oil movement

### Why remote sensing?

Remote sensing offers the advantage of being able to observe events in remote and often inaccessible areas. For example, oil spills from ruptured pipelines, may go unchecked for a period of time because of uncertainty of the exact location of the spill, and limited knowledge of the extent of the spill. Remote sensing can be used to both detect and monitor spills.

For ocean spills, remote sensing data can provide information on the rate and direction of oil movement through multi-temporal imaging, and input to drift prediction modelling and may facilitate in targeting clean-up and control efforts. Remote sensing devices used include the use of infrared video and photography from airborne platforms, thermal infrared imaging, airborne laser fluorosensors, airborne and space-borne optical sensors, as well as airborne and spaceborne SAR. SAR sensors have an advantage over optical sensors in that they can provide data under poor weather conditions and during darkness. Users of remotely sensed data for oil spill applications include the Coast Guard, national environmental protection agencies and departments, oil companies, shipping industry, insurance industry, fishing industry, national departments of fisheries and oceans, and departments of defence.

### Data requirements

The key operational data requirements are fast turnaround time and frequent imaging of the site to monitor the dynamics of the spill. For spill identification, high resolution sensors are generally required, although wide area coverage is very important for initial monitoring and detection. Airborne sensors have the advantage of frequent site specific coverage on

demand, however, they can be costly. Spills often occur in inclement weather, which can hinder airborne surveillance.

Laser fluorosensors are the best sensors for oil spill detection, and have the capability of identifying oil on shores, ice and snow, and determining what type of oil has been spilled. However, they require relatively cloud free conditions to detect the oilspill. SAR sensors can image oilspills through the localized suppression of Bragg scale waves. Oilspills are visible on a radar image as circular or curvilinear features with a darker tone than the surrounding ocean. The detection of an oilspill is strongly dependent upon the wind speed. At wind speeds greater than 10 m/s, the slick will be broken up and dispersed, making it difficult to detect. Another factor that can play a role in the successful detection of an oilspill is the difficulty in distinguishing between a natural surfactant and an oilspill. Multi-temporal data and ancillary information can help to discriminate between these two phenomena.

#### **Case study (example)**

A supertanker, the Sea Empress, was grounded near the town of Milford Haven, Wales on February 15, 1996. After hitting rocks, the outer hull was breached and approximately 70,000 tonnes of light grade crude oil was dispersed southward under storm conditions.

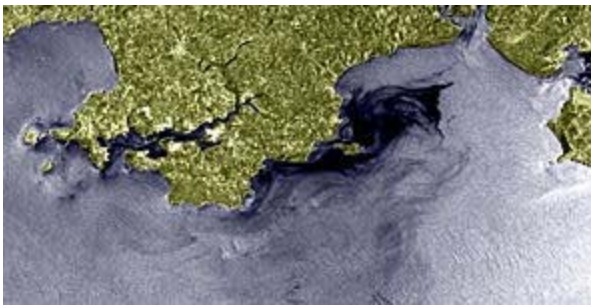

In this RADARSAT image taken a week after the spill, the extent of the oil is visible. The dark areas off the coast represent the areas where oil is present and areas of lighter tone directly south are areas where dispersant was sprayed on the oil to encourage emulsification. Oil, which floats on the top of water, suppresses the ocean's capillary waves, creating a surface smoother than the

surrounding water. This smoother surface appears dark in the radar image. As the oil starts to emulsify and clean-up efforts begin to take effect, the capillary waves are not as effectively damped and the oil appears lighter. Size, location and dispersal of the oil spill can be determined using this type of imagery.



## 5. Endnotes

---

### 5.10 Endnotes



You have just completed **Chapter 5 - Applications**. As a follow-on, you may want to browse the **CCRS Web site** where you will find articles dealing with applications of remote sensing in the fields of agriculture, geology, environmental monitoring, hydrology, ice, oceans, forestry. As a starting point, try our '[Images of Canada](#)'<sup>1</sup>, the RADARSAT '[Applications In Action](#)'<sup>2</sup>, and the articles in our [Technology and R&D Section](#)<sup>3</sup>.

Additionally, you may want to browse the terminology in our [glossary](#)<sup>4</sup>, or review some of the [technical papers](#)<sup>5</sup> written by CCRS staff.

---

<sup>1</sup>[http://www.ccrs.nrcan.gc.ca/ccrs/learn/tour/tour\\_e.html](http://www.ccrs.nrcan.gc.ca/ccrs/learn/tour/tour_e.html)

<sup>2</sup>[http://www.ccrs.nrcan.gc.ca/ccrs/data/satsens/radarsat/images/imgact\\_e.html](http://www.ccrs.nrcan.gc.ca/ccrs/data/satsens/radarsat/images/imgact_e.html)

<sup>3</sup>[http://www.ccrs.nrcan.gc.ca/ccrs/rd/rd\\_e.html](http://www.ccrs.nrcan.gc.ca/ccrs/rd/rd_e.html)

<sup>4</sup>[http://www.ccrs.nrcan.gc.ca/ccrs/learn/terms/glossary/glossary\\_e.html](http://www.ccrs.nrcan.gc.ca/ccrs/learn/terms/glossary/glossary_e.html)

<sup>5</sup>[http://www.ccrs.nrcan.gc.ca/ccrs/rd/sci\\_pub/biblio\\_e.html](http://www.ccrs.nrcan.gc.ca/ccrs/rd/sci_pub/biblio_e.html)





## 5. Did You Know?

---

### 5.2 Did You Know?

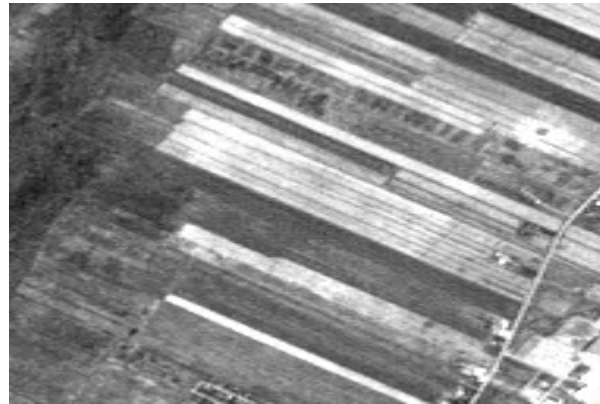

**Fields in Quebec**

Did you know that remote sensing of agricultural areas could give us clues about our heritage? In Québec, farmer's field shapes are very different than in Saskatchewan. In Québec, long thin strips of land extend from riverbanks, following French settlers' tradition. These types of fields are also visible in Nova Scotia, where the Acadians farmed, in New Brunswick, and in parts of Ontario. In the prairies, the fields are square and strictly follow the township and range plan.



**Fields in Saskatchewan**

### 5.3 Did You Know?



**The forest around Mt. St. Helens after the eruption**

Natural disasters can also wipe out huge areas of forest. Burns can destroy several thousand of hectares, landslides can displace trees down a slope, and excessive flooding can damage trees. Volcanoes however, have the greatest potential for destroying forests in the shortest amount of time. In 1980, Mt. St. Helens in northwestern United States violently erupted. The volcanic blast, reaching 320 km/hour, levelled over 600km<sup>2</sup> of forest.

#### 5.3.2 Did You Know?

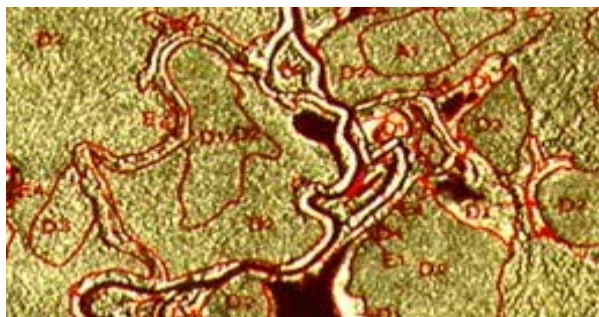

**Forest interpretation from SAR data**

Interpreting forest cover type with radar data is very similar to interpreting multispectral images. The same interpretation elements are used (tone, texture, shape, pattern, size, association), but texture plays a dominant role in the discrimination of different forest types. Viewing the images in stereo helps to differentiate relative tree heights, as well as define rivers that have specific vegetation along their banks.

## 5.5 Did You Know?

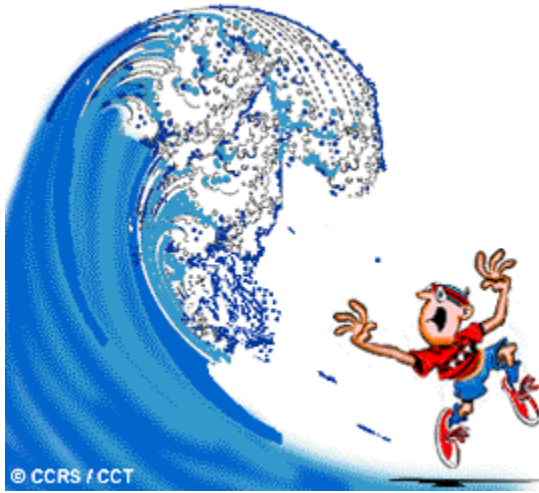

Catastrophic flooding can happen almost anywhere. In Iceland, huge floods that carry boulders the size of houses occur relatively frequently. These floods are called jökulhlaups, roughly meaning "glacial flood". Iceland is situated upon the mid-Atlantic rift, an area of frequent volcanic activity. The island itself is a product of this activity, and continues to grow in size with each volcanic event. Covering much of the island, and some of the volcanic craters, is an 8300 km<sup>2</sup> ice cap. During sub-glacial eruptions, glacial ice is melted, and temporarily dammed by either the crater or the ice itself. Eventually the pressure of the water is released in a catastrophic flood. A flood in 1996 discharged a 3km<sup>3</sup> volume of water, lasting 2 ½ days. The glaciers and landscape are abruptly and extensively modified by this strong force, which erodes channels, moves and deposits huge blocks of ice and rock, and deposits kilometre scale alluvial fans.

Scientists can use radar imagery to create topographic models of the glaciers and extensive outwash plains to use as baseline maps for multitemporal change detection and mapping studies. Radar is preferred because persistently cloudy conditions limit the use of optical data. With new monitoring methods, including the analysis of glacial dynamics related to volcanic activity, scientists are better able to predict the timing of these extreme jökulhlaups.

### 5.5.1 Did You Know?

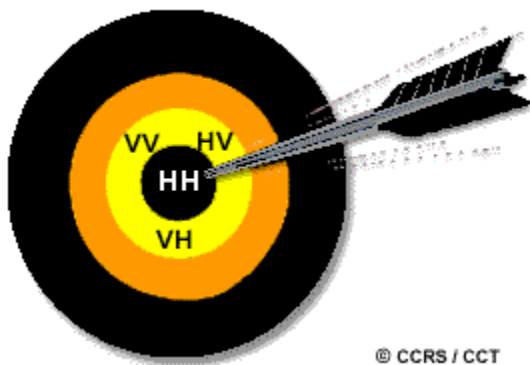

It is worth your while to pay attention to the polarization characteristics of the radar imagery that you are collecting. If your target is to map flooded versus dry land, then HH (horizontal transmit, horizontal receive) is a much better choice than (say) VV (vertical transmit, vertical receive) polarization. The HH imagery will produce a noticeably stronger contrast between these two types of surfaces, allowing greater accuracy in the mapped result.

### 5.5.2 Did You Know?

$$10^{-12} \text{ m} = 0.000000000001 \text{ m}$$

Another part of the electromagnetic spectrum that has been used for soil moisture measurement is the gamma ray wavelength range. Recording the natural emission of gamma rays from the earth, aircraft carrying gamma ray spectrometers are used to detect the attenuation or alteration by soil moisture, of the intensity of the emanation. The gamma ray wavelength is extremely short - about 10-12 metres in length (!) and the intensity of this natural radiation at the earth's surface is very weak. As a result satellite altitudes are not practical for this form of remote sensing. Even the aircraft used for this purpose must fly as close to the ground as possible.

## 5.6 Did You Know?



**"...GPS = Good Protection Sidekick..."**

Accidents like the sinking of the Titanic are virtually eliminated now, with iceberg reconnaissance (provided by the International Ice Patrol) and GPS navigation onboard ships. And even if a ship did collide with an iceberg, search and rescue operations using remote sensing and GPS navigation could save many lives in such an incident.

### 5.6.1 Did You Know?

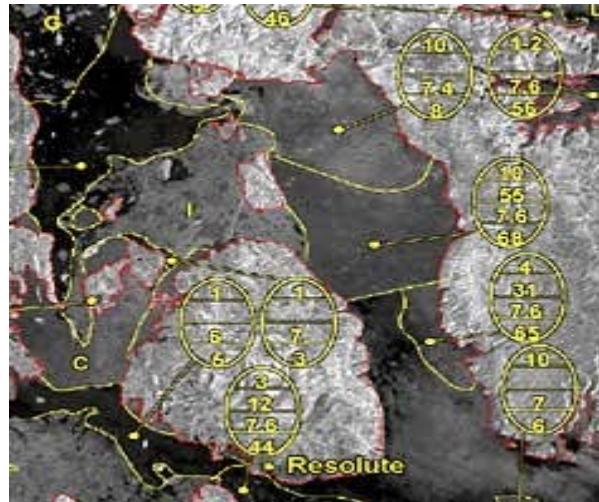

"...I like my eggs on ice..."

#### Creating an Ice Chart

The Canadian Ice Service of Environment Canada (CISEC) creates charts for ice type that are distributed to their clients on a near-real time basis. These charts are essentially ice maps with Egg Codes superimposed, which explain the development stage (thickness), size, and concentration of ice at both regional and site specific scales. The codes used to represent the ice information are displayed in an oval symbol, resembling an egg, hence the term Egg Code. Egg codes are used not only for sea ice, but also lake ice. Also they conform to the WMO (World Meteorological Organization) standards.

Once you understand the meaning of the various codes, the interpretation of the ice charts is relatively easy.

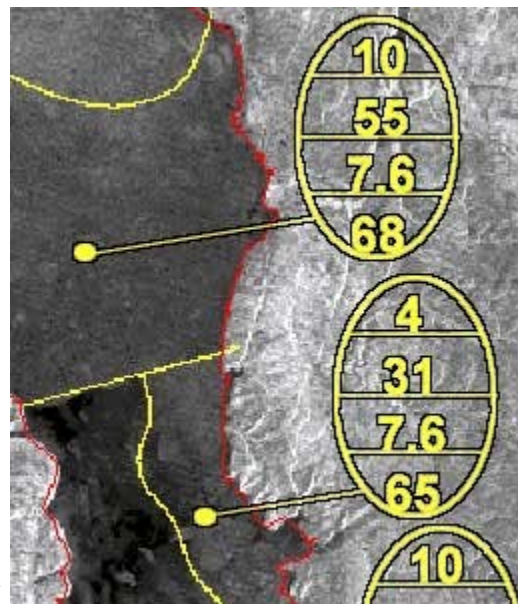

For more detailed information about the coding procedure and terminology, go to the [Canadian Ice Service homepage](#).<sup>1</sup>

**Case study (example)****RADARSAT Expedites Expedition to the Magnetic North Pole!**

In March of 1996, teams of Arctic adventurers set out on an expedition to reach the magnetic North Pole, located on the west coast of Ellef Ringnes Island, in Canada's high Arctic. Travelling across sea ice by ski, the teams required a route on smooth first year ice in order to haul their gear and conserve energy. Ice blocks, rubble and irregular relief made deformed and multi-year ice virtually impassable. One team relied on remote sensing - image maps created from RADARSAT data - to plan their route.

The ScanSAR image covered the entire extent of the route, from Resolute Bay on Cornwallis Island to the pole (78°6'N, 104°3'W). The resolution of 100m provided information about the ice cover and type, and mapped coastlines were added following geometric processing, to provide a geographic reference. The team was also equipped with GPS and communication technologies.

On the image map, passable ice appears uniformly dark, due to the specular reflection of incident radiation from the radar on the smooth surface. Rubbly, rough ice that often contained enough relief to make skiing impossible appears bright, due to the reflection of the radar energy back to the sensor.

The team using RADARSAT image maps was the only one to complete their journey to the magnetic North Pole. The other teams were hindered by rough ice and could not efficiently plan their route without the synoptic view provided by remote sensing. RADARSAT, with its sensitivity to ice type, far northern coverage, and reliable imaging was the most suitable sensor for this type of application. Its success bodes well for future exploration endeavors!

Reference: Lasserre, M., 1996. RADARSAT Image Maps Make Arctic Expedition a Success, Remote Sensing in Canada, Vol. 24, No. 1, June, 1996. Natural Resources Canada.

Expedition Web Site: <http://www.jeaneudes.qc.ca/><sup>2</sup>

---

<sup>1</sup><http://www.msc-smc.ec.gc.ca>

<sup>2</sup><http://www.jeaneudes.qc.ca/>

## 5.7 Did You Know?

"...let me make this perfectly clear..."

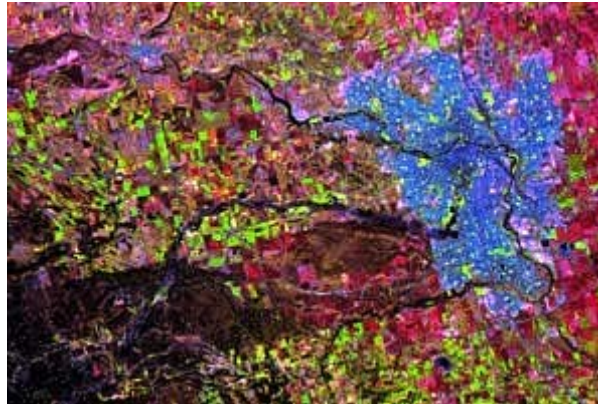

**Calgary (Landsat-TM)**

This is a TM scene of Calgary, Canada, where the 1988 Winter Olympics were held. Calgary appears quite blue; the agricultural fields to the east are red, while grazing land to the west is green. Abutting the southwest corner of the city, is a long rectangular section of land stretching towards the west that is darker and more monotone than the other areas around it. This is the area of the Sarcee Reserve (T'suu T'ina) which has been held by native people, and protected from urbanization and residential construction. Of all the land on the image, this land is the closest to the original state of the Calgary region before agriculture and settlements reworked the landscape. It looks like an oasis amidst suburbia and farmland.

### 5.8.2 Did You Know?

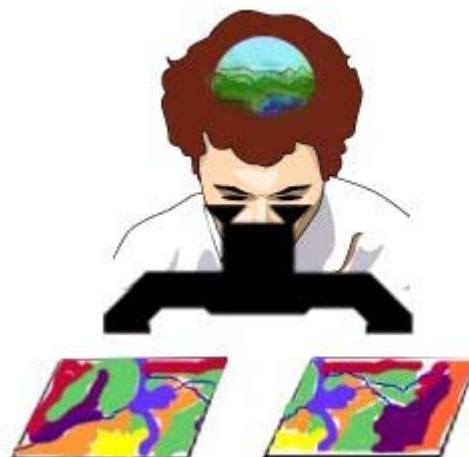

When you look at a stereo pair of images you perceive a virtual 3D model of the terrain or object that was imaged. Through this 3D virtual terrain model (VTM?), it is possible to extract cartographic information without using a DEM!



### 5.8.3 Did You Know?



A 'close' relative of 3D terrain mapping is 'close range photogrammetry'. Using very similar techniques but at very close range, this method is used for 'mapping' an object like a building, sculpture or a human face in three dimensions in order to have a precise record of its shape.

### 5.9.3 Did You Know?

A typical laser fluorosensor operates by emitting radiation at a particular wavelength that will be easily absorbed by the intended target, for instance: oil. The energy thus absorbed by the target is given off by emitting another wavelength of radiation, which is then detected by a sensor (spectrometer) linked to the laser. With aromatic hydrocarbons, this form of fluorescence allows a 'fingerprinting' of the oil, measuring both the spectra of the radiation given off, as well as the decay rate of the fluorescence. Thus oils can be differentiated from other fluorescing targets and even identified into basic oil types (light, heavy, etc.).





## 5. Whiz Quiz and Answers

---

### 5.2 Whiz Quiz

#### Crop Circles Seen from Space!



Every spring seems to bring a resurgence of the mysterious crop circles seen in farmers' fields around the world, often attributed to the work of aliens. Finally, these crop circles have been observed by a remote sensing device! Landsat TM captured this view while over southern Alberta. Look at the green circles on the image - how could they have been caused, other than by alien activity?

### 5.2 Whiz Quiz Answer

The "crop circles" are in fact, healthy crops irrigated using a pivot irrigation system - not the result of alien tricks. In the dry southern prairies, farmers rely on pivot irrigation systems to keep the crops watered and healthy. You can see that in the corners of the fields where the water fails to reach, the vegetation is missing or has suffered. The brownish grey areas in this image are primarily rangeland, while the crops appear green. Crops can be successfully grown if a regular irrigation routine is followed, but this puts a heavy demand on water resources in a typically dry area.

### 5.3 Whiz Quiz



Why are lines being cut out of this forested area in northern Alberta?

### 5.3 Whiz Quiz Answer

In northern Alberta, forests are being cut for pulp and paper mills, but they are also being cut for another reason. Exploration and infrastructure for gas wells requires that forests be cut for seismic lines, pipeline routing, access to sites, and pumping stations.

## 5.7 Whiz Quiz



### More alien circles?

These are even stranger circles than the ones we first encountered. The outer circles are tens of kilometers across. What could have created this shape, and other than being a landing target for UFOs, what possible land use could it serve?

## 5.7 Answer

You had a good guess if you thought these circles were created by an ancient civilization, like the Aztecs, or it represents a giant teepee ring. But it's not correct. Try again.

The circles are part of a military base in southern Alberta. The land is used for practice maneuvers and is "protected" from the ranging and farming on nearby dry grassland. The circles identify radial distances from 'ground zero', where various real and simulated explosions were conducted by the military.

### 5.9.1 Whiz Quiz

What on earth is this 'feature' and how is it that RADARSAT can 'see' it?

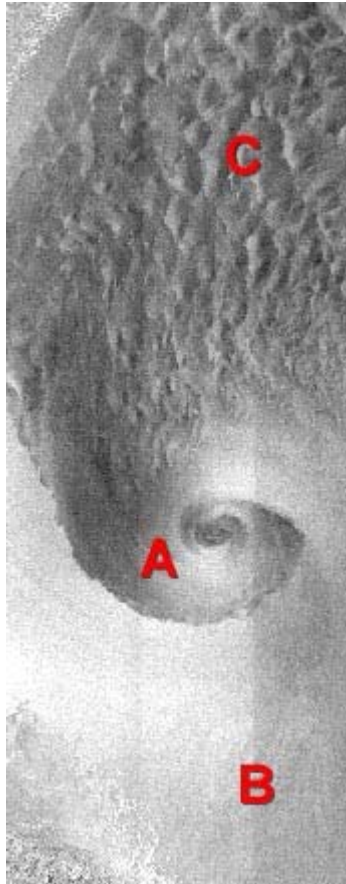

### 5.9.1 Answer

Imaged over the Labrador Sea, this RADARSAT image shows a number of 'imprints' made on the ocean surface by unusual atmospheric conditions. Though the radar beams themselves are not affected by the atmosphere, they have recorded the ocean topographic effects from atmospheric phenomena such as a large low pressure cell (**A**), atmospheric gravity waves (**B**) and a region of multiple rising/falling air currents (**C**). In each case, where the falling air mass dampens ocean waves, the radar backscatter is lessened, while the rising air mass induces surface wind, which in turn increases ocean waves and therefore, radar backscatter. Higher backscatter is shown in the imagery as brighter areas.

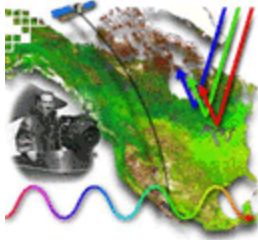

## Credits

---

### Acknowledgements

We would like to recognize the contributions made by several organizations and individuals to this tutorial:

The bulk of the tutorial was prepared by [Intermap Technologies Ltd.](#) of Calgary and Ottawa, under contract to CCRS and funded through the User Education and Training Initiative (UETI).

[RADARSAT International Inc.](#) and the [Canadian Space Agency](#) provided permission to use much of the satellite imagery herein.

Several CCRS scientists assisted in reviewing the contents of the tutorial.

The CCRS [Multimedia Applications Team](#) produced the various versions, contributing the coding, design, editing, graphics and quality control of the tutorial.

---

### References

The following publications were used in the preparation of this tutorial:

- Campbell, J.B. (1987) **Introduction to Remote Sensing**. The Guilford Press, New York.
- Lillesand, T.M. and Kiefer, R.W. (1994) **Remote Sensing and Image Interpretation**. John Wiley and Sons Inc., New York.
- Jensen, John R. (1986) **Introductory Digital Image Processing**. Prentice-Hall, New Jersey.
- Russ, John C. (1995) **The Image Processing Handbook**. 2nd edition. CRC Press, Boca Raton.
- Dougherty, Edward R. and Charles R. Giardina (1987) **Matrix Structured Image**

- Processing.** Prentice-Hall, New Jersey.
- **Computer Eye: Handbook of Image Processing.** Spatial Data Systems Inc., California.
  - Jain, Anil K. (1989) **Fundamentals of Digital Image Processing.** Prentice-Hall, New Jersey.
  - Wahl, Freidrich M. (1987) **Digital Image Signal Processing.** Artech House, Boston.
  - Yu, Francis T.S. and Suganda Jutamulia (1992) **Optical Signal Processing, Computing, and Neural Networks.** John Wiley & Sons, New York.
  - Canada Centre for Remote Sensing/Natural Resources Canada (1997). **GlobeSAR2 Radar Image Processing and Information Extraction Workbook Version 1.2.** Ottawa, Ontario, Canada.
  - Barton, D. & S. Leonov (eds.) (1997) **Radar technology encyclopedia**, 511 p., Artec House, Norwood, MA, USA, ISBN 0-89006-893-3
  - Oliver, C. & S. Quegan (1998) **Understanding synthetic aperture radar images**, 479 p., Artech House, Norwood, MA, USA, ISBN 089006850X.
  - Werle D. (1988 and 1992) **Radar Remote Sensing - A Training Manual**, 193p, 75 35mm slides, Dendron Resource Surveys Ltd, Ottawa, Ontario, Canada, ISBN 0-9693733-0-9
-



## Permission for Use

---

This tutorial may be copied in any form and used for **non-commercial purposes** provided that: the content of any copy is **not altered** and, it is clearly indicated that the Canada Centre for Remote Sensing is the originator of this material.



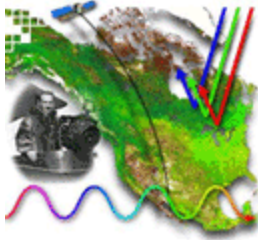

## Download Formats

---

**Is this tutorial available in other formats? Can I use multiple copies off-line?**

If you want to use a hard copy version of this tutorial, then download the [PDF version](#) and print it in colour. It can be printed on either 8½" x 11" or A4 paper

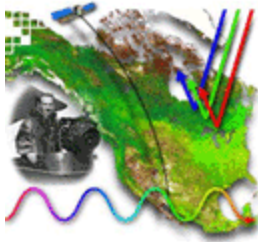

## Notes for Teachers and Students

---

### **What is the target audience for this tutorial?**

This tutorial on remote sensing technology and applications is designed primarily for **late high school or early university students**. Some previous exposure to science, mathematics and environmental studies is a definite advantage.

### **What are the features of the tutorial? How does it relate to the rest of the CCRS Web site?**

The tutorial is structured as a course, with each section building on the concepts introduced in the previous sections and chapters. The numerous images and graphics, as well as interesting facts, help explain and illustrate difficult concepts. Each chapter also includes several questions and quizzes to test the reader's understanding of the subject matter. These quizzes may serve as excellent reviews of each chapter. Informative and sometimes humorous facts in the "Did You Know?" pages are designed to complement the associated section with anecdotes and examples of how remote sensing is used throughout the world.

Covering the material in the tutorial prepares the reader for visiting and appreciating the rest of the CCRS Web site, wherein technical and research articles on most remote sensing topics can be found. An extensive glossary of remote sensing terminology and other educational modules are also available and may be of interest to the student or teacher.

### **Is this tutorial available in other formats? Can I use multiple copies off-line?**

We now have a copy of the "Fundamentals of Remote Sensing Tutorial" in HTML format that may be downloaded via FTP. It has been compressed and formatted into a [zip version](#) and is about 5.2MB in size. It can be downloaded and then copied onto several machines for classroom (non-commercial) usage without an Internet connection. Please read the included "readme.txt" file to learn about the constraints and limitations of using such a copy.

If you want to use a hard copy version of this tutorial, then download the [PDF version](#) and print it in colour. It can be printed on either 8½" x 11" or A4 paper