

Pediatric and child health Nursing
For 3rd year bachelor of science in Comprehensive
nursing students

BY: Getaneh Mulualem (BSc, MSc) and

Kendalem Asmare (BSc, MSc)

Department of pediatrics and child health nursing

School of nursing

College of medicine and health sciences

University of Gondar

Pediatric nursing course syllabus

2

- **Program:** BSc in Comprehensive Nursing
- **Module name:** child health and pediatrics nursing
- Nurs-M 3141
- **Course title:** Pediatric Nursing
- **Course code:** NURS 2092
- **Degree Program:** BSc in comprehensive Nursing
- Credit hours: 4/ 7 ECTS
- For 3rd year comprehensive Nursing students
- Course instructors: Kendalem A. and Getaneh M.

Course description:

3

- This course is designed for BSc nursing students to acquire necessary knowledge, skill and attitude through full description of growth and development, children with protein energy malnutrition, preventive measures (immunization, ORT, and health education) and various neonatal and child hood disease conditions using nursing process and IMNCl protocols.

Course Objectives:

4

- After completing this course, the students will be able to assess, assist, demonstrate and monitor the growth and development of newborns, infants and children, promote normal growth and development, determine and treat or refer and report deviation from normal growth and development.

Contents

5

- Unit I- Introduction to pediatric nursing- 4hrs
- Unit II- Child growth and development-12hrs
- Unit III- Care of Newborn-8hrs
- UNIT-IV: Management of common childhood disease-8hrs
- Unit V- Management of systemic child hood disorders-12hrs
- Unit VI. Management of handicapped children-4hrs
- Unit VII. Expanded program of immunization-8hrs
- UNIT VIII- Pediatric HIV/AIDS-8hrs
- UNIT IX- IMNCI-12hrs

Teaching methods

6

- Illustrated Lecture
- Reading Assignment
- Group discussion
- Case study

Teaching aids

7

- LCD projector
- Text books
- National Pediatrics HIV/AIDS guidelines
- IMNCI chart booklets

Assessments

8

- Continuous assessment =50%
- Final exam=50%

Unit one: Introduction

9

- What is nursing?
- What is paediatrics nursing?
- Why paediatrics is given as a subject it self?

4/24/2020

Objectives

10

At the end of this session the students will be able to:

- √ Define pediatric nursing
- √ Describe the modern concepts of pediatric nursing care
- √ Explain the basics of pediatric health assessment
- √ Differentiate normal and abnormal V/S values
- √ Identify common pediatric nursing procedures

4/24/2020

Definition of nursing

11

ANA

- "responses to actual or potential health problems"

WHO

- Nursing encompasses autonomous and collaborative care of individuals of all ages, families, groups and communities, sick or well and in all settings.
- It includes the promotion of health, the prevention of illness, and the care of ill, disabled and dying people.

Pediatrics

12

- **Pedia** means child
- **latrike** means treatment
- **Ics** means branch of sciences
- **Pediatrics** is a branch of medical science the deals with the care of children from conception to adolescence in health and illness.
- Mainly concerned with preventive, promotive, curative and rehabilitative care of children.

Background

13

- Relatively new medical specialty (1800)
- Anciently
- Epidemics were common
- Many children were died in infancy/childhood
- The children were cared by families or neighbors
- Children were not considered as important
- There were no special concern for children in hospital care
- Mortality rate were 50% to 100%

After world war I

14

- Aseptic techniques were introduced
- Babies were placed in cubicles
- They were isolated
- Infant mortality was continued
- 1970 1980
- Hospital regulations changed slowly
- Nurses used play as therapeutic tools
- Children visited playrooms, isolation practice were relaxed

Pediatrics nursing

15

- ❖ Pediatric nursing is specialty of nursing concerning the care of children during wellness and illness.
- ❖ It encompasses neonates, infants, toddlers, children, and their families to promote health throughout development and growth.
- ❖ It is the art and science of giving nursing care to children from birth through adolescent with emphasis on the physical growth, mental, emotional and psycho-social development

- ❖ Pediatric nursing covers routine immunizations and "well child" check-up appointments, as well as any illnesses or minor injuries that occur.
- ❖ It involves in giving assistance, care and support to the growing and developing to achieve their individual potential for functioning with fullest capacity.

Goals of pediatrics nursing care

17

- To provide skillful intelligent need based comprehensive care for children
- To interpret the basic needs of children to their parents and families to guide them in child care.
- To promote growth and development
- To prevent disease and alleviate suffering

Quality of pediatrics nurses

18

- Love for children
- Patient and pleasant
- Good interpersonal relationship
- Friendly and diligent
- Skill, scientific knowledge and experience.

Principle of pediatrics nursing

19

- Family centered care
- Case management
- Atraumatic care
- Prevent or minimize child separation from family
- Promote sense of control
- Prevent or minimize bodily injury and pain

Philosophy of pediatrics nursing

20

- Children need accessible, continuous, comprehensive, coordinated, family centred and compassionate care that focuses on their changing physical and emotional needs
- This is achieved through provision of care by focusing on the family, providing atraumatic care and using evidence based practice

- **Why should pediatric nursing be an independent specialty?**

(think-pair-share)

Why pediatrics ... ?

22

1. The health problems of children differ from those adults in many ways
2. Children's response to an illness is influenced by age
3. Managements of childhood illness are significantly different from an adult
4. Children need special care since they are among the most vulnerable groups

4/24/2020

Modern concepts of child care

23

- Previously the emphasis was on the care of the ill child as an individual
- Current emphasis:
 - √ Prevention of illnesses and accidents
 - √ Holistic nursing care
 - √ Interdisciplinary approach

4/24/2020

Overview of Pediatric Health Assessment

24

Contents of Pediatric History

1. Personal details
2. C/C
3. HPI
4. Past medical History

...pediatric history

25

5. Family history

6. Immunization history

7. Nutritional history

8. Developmental history

9. Review of systems

4/24/2020

Case study for group work

26

- A 7 months child with fever
- Comes from rural area
- Lives in a single room
- Currently stops feeding per mouth

4/24/2020

Discussion questions

27

- Is this history complete?
- If you say no, suggest any point that you think important

N.B.

- 6-8 students per group
- 5 minutes for discussion
- A total of 5 minutes for reflections.

4/24/2020

Pediatric Physical Examination

28

- The aim is the same as adults but the approach is different
- Both the techniques and interpretations vary according to the age of the patient
- Examination of infants under the age of 6 months is much easier than the older ones

4/24/2020

Physical ...

29

- **Be opportunistic in examining a child!**
- **Starts with general appearance**

4/24/2020

V/S, PR, BP, & RR (Normal values)

Age	Heart rate, Beats/min	BP, mmHg	Respiratory rate, breath/minute
Premature	120-170	55-75/35-45	40-70
0-3 months	100-150	65-85/45-55	35-55
3-6 months	90-120	70-90/50-65	30-45
6-12 months	80-120	80-100/55-65	25-40
1-3 years	70-110	90-105/55-70	20-30
3-6 years	65-110	95-110/60-75	20-25
6-12 years	60-95	100-120/60-75	14-22

4/24/2020

V/S: Temperature

31

- Normal body temperature: 36.5°C to 37.5°C (97.7-99.5°F)
- Hyperthermia: >37.5°C
- Hypothermia: <36.5°C
- ✓ Mild hypothermia: 36-36.4°C
- ✓ Moderate hypothermia: 32-35.9°C
- ✓ Severe hypothermia: <32°C

4/24/2020

The nursing process

32

1. Assessment
2. Nursing diagnosis
3. Planning
4. Intervention
5. Evaluation

4/24/2020

Common pediatric nursing procedures

33

- Medication administration
- NG-tube insertion and feeding
- Oxygen administration
- Resuscitations
- Catheterizations
- Administering enema
- Tracheostomy care

4/24/2020

...pediatric procedures

34

- Blood transfusion
- Specimen collection
- Iv cannulation , etc ...

4/24/2020

Assignment-1

35

- Read and take short note about common pediatric nursing procedures by considering the following points when appropriate.
- √ Indications
- √ Contraindications
- √ precautions
- √ Steps with its rationale
- √ Differences from the adult

4/24/2020

Summary

36

1. What is nursing?
2. why pediatrics nursing?
2. Do you have any questions that you are still thinking about related to these topics?
3. What things will you remember long after this class is over?

4/24/2020

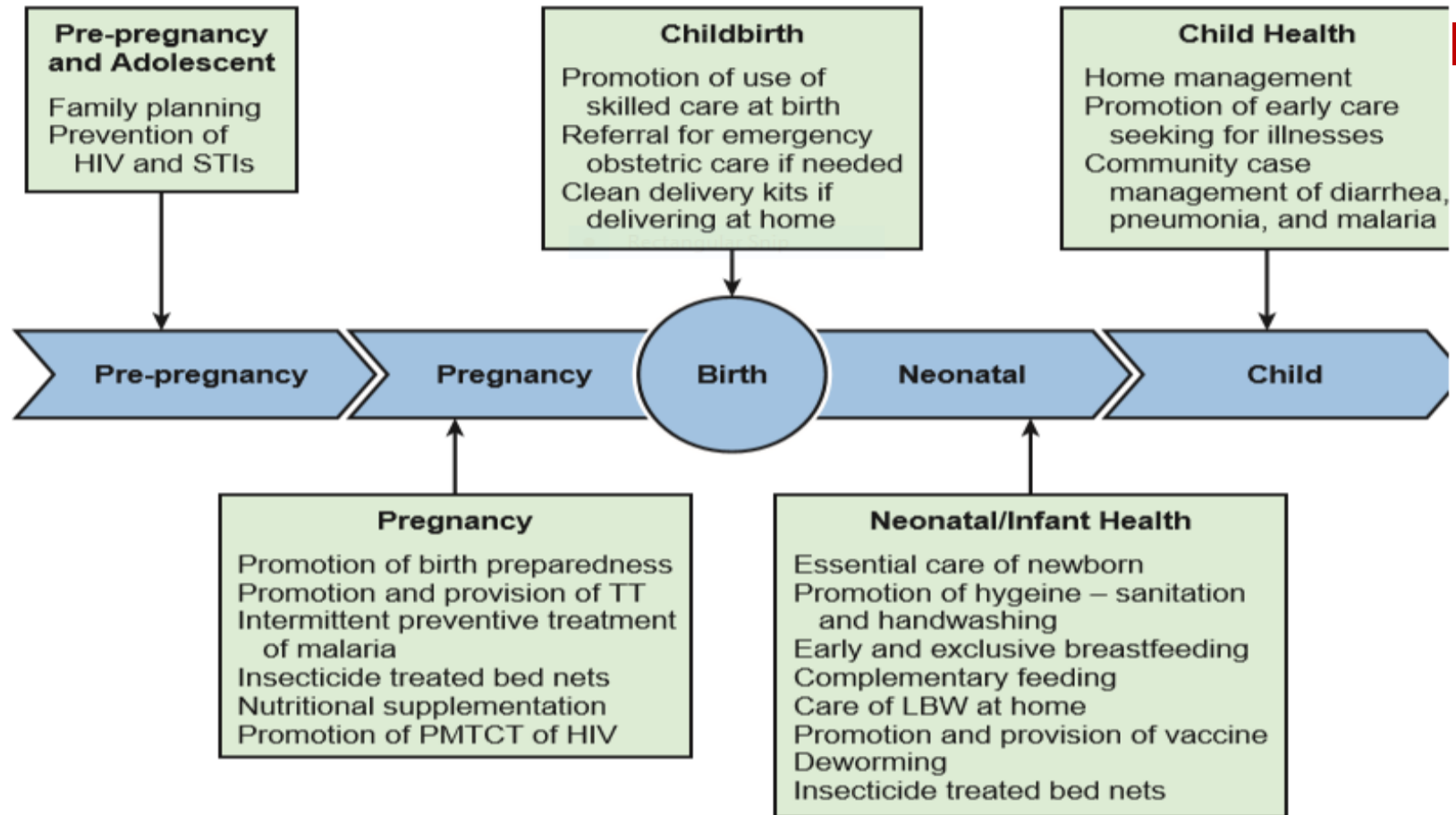



Thank you

UNIT II: GROWTH AND DEVELOPMENT



Growth and development



Unit two-CHILD GROWTH AND DEVELOPMENT

43

- What is growth?
- What is development?
- Are they similar? Can we use interchangeably?

4/24/2020

Session objectives

44

At the end of this session the students will be able to

- ✓ Define growth and development
- ✓ Explain Principles of Growth & Development
- ✓ Explain common theories of development
- ✓ Mention developmental milestones
- ✓ Discuss factors affecting growth and development
- ✓ Describe nutritional requirements of children
- ✓ State the feeding recommendation of children based on their age

4/24/2020

GROWTH AND DEVELOPMENT

GROWTH

Growth refers to an increase in physical size of the whole body or any of its parts.

It is simply a quantitative change in the child's body.

DEVELOPMENT

- Development refers to a progressive increase in skill and capacity of function.
- It is a qualitative change in the child's functioning.

Growth

- It is the process of **physical maturation** resulting an increase in size of the body and various organs. It occurs by **multiplication** of **cells** and an increase in intracellular substance. It is **quantitative** changes of the body.

Development

- It is the process of functional and **physiological maturation** of the individual. It is progressive increase in **skill** and **capacity** to function. It is related to maturation and **myelination** of the **nervous system**. It includes psychological, emotional and social changes. It is **qualitative** aspects.

Types of growth and development



Types of growth:

- Physical growth (Ht, Wt, head & chest circumference)
- Physiological growth (vital signs ...)

Types of development:

- Motor development
- Cognitive development
- Emotional development
- Social development

IMPORTANCE OF GROWTH AND DEVELOPMENT

- Knowing what to expect of a particular child at any given age.
- Gaining better understanding of the reasons behind illnesses.
- Helping in formulating the plan of care.
- Helping in parents' education in order to achieve optimal growth & development at each stage.

Principle of Growth and Development

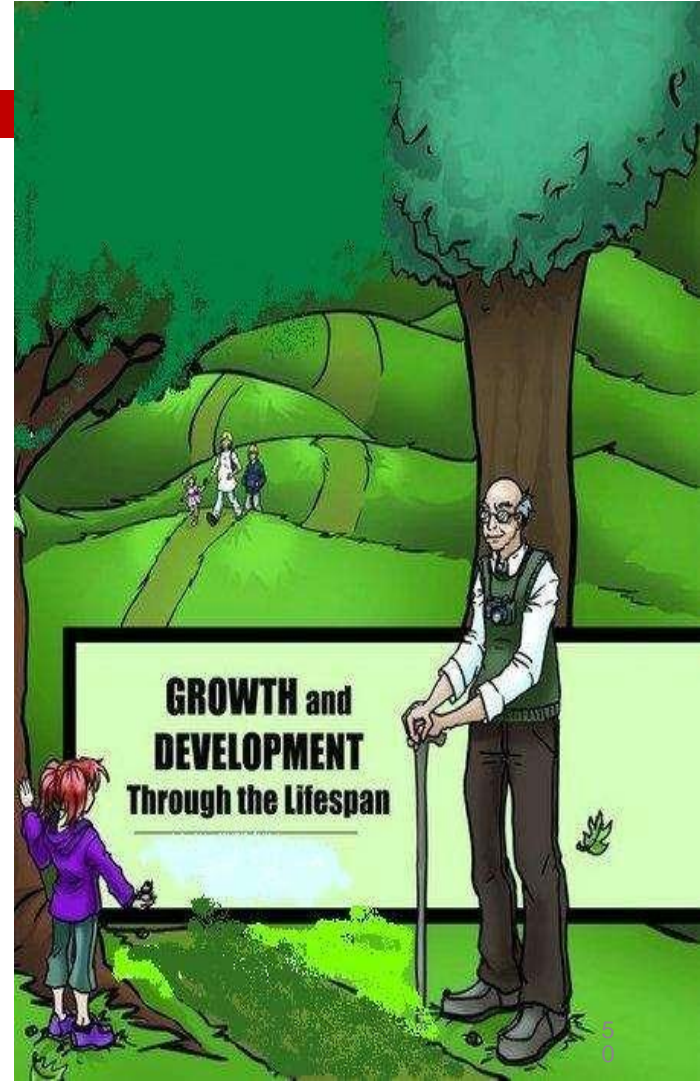

PRINCIPLES OF GROWTH & DEVELOPMENT

- Continuous process
- Predictable Sequence
- Don't progress at the same rate (↑ periods of GR in early childhood and adolescents & ↓ periods of GR in middle childhood)
- Not all body parts grow in the same rate at the same time.
- Each child grows in his/her own unique way.
- Each stage of Growth & Development is affected by the preceding types of development.

- Cephalocaudal direction
- Proximodistal direction
- General to Specific

Cephalocaudal direction

- The process of **cephalocaudal** direction from **head** down to **tail**. This means that improvement in structure and function come first in the head region, then in the trunk, and last in the leg region.

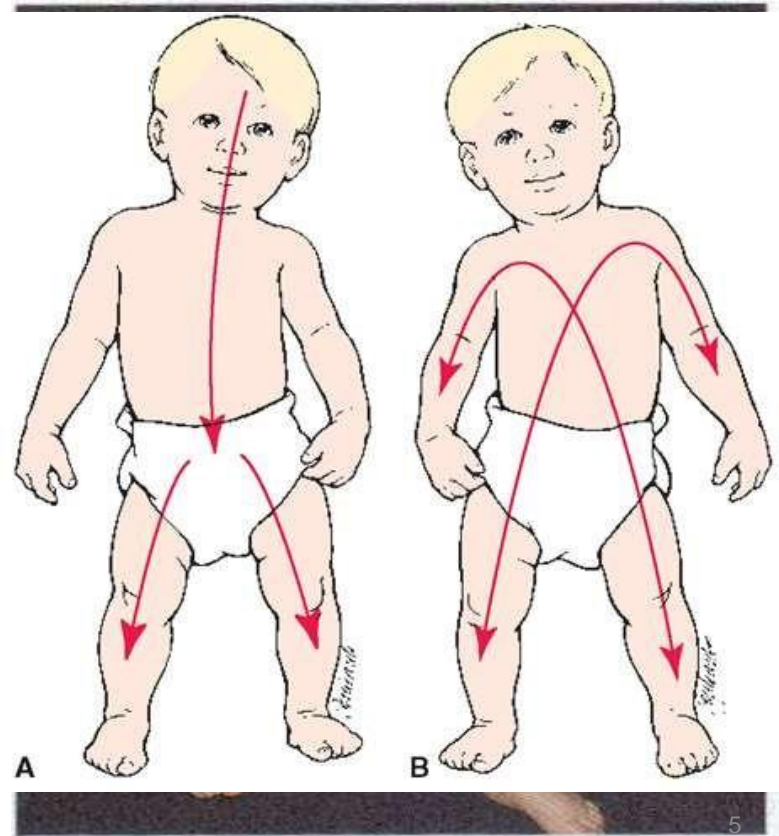

Proximodistal direction

The process in proximodistal from center or midline to periphery direction. development proceeds from near to far - outward from central axis of the body toward the extremities

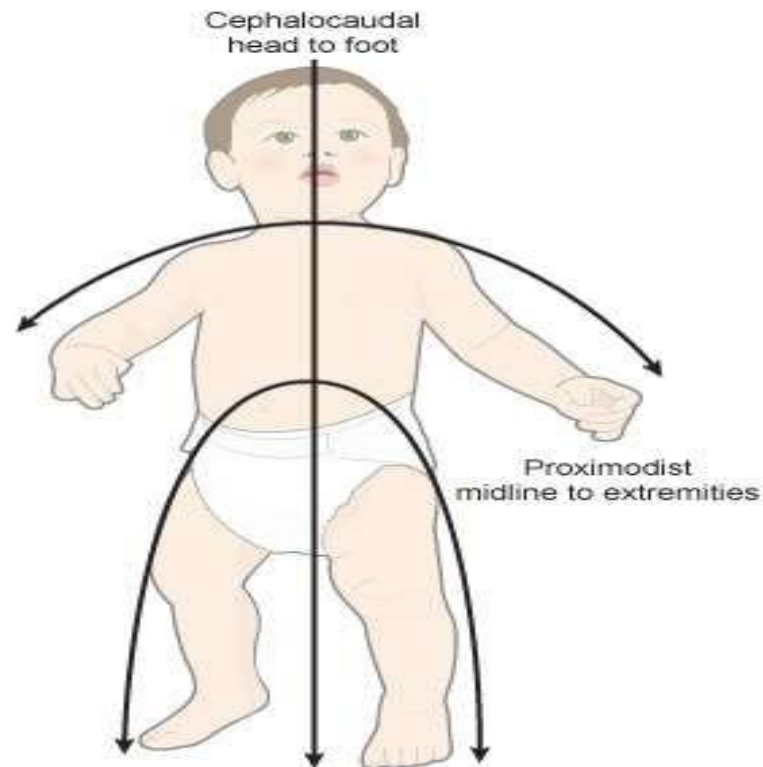

General to Specific

- Children use their cognitive and language skills to reason and solve problems.
- Children at first are able hold the big things by using both arms, In the next part able to hold things in a single hand, then only able to pick small objects like peas, cereals etc.
- Children when able to hold pencil, first starts draw circles then squares then only letters after that the words.

- Development proceeds from general to specific responses



Factor influencing

Growth and Development



- Growth and development depend upon multiple factors or determinates.
- They influence directly or indirectly by promoting or hindering the process.

- Genetic factors
- Prenatal factors
- Postnatal factors

Genetic factors

- Genetic predisposition is the importance factors which influence the growth and development of children.
- Sex
- Race and Nationality

Prenatal factors

- Intrauterine environment is an important predominant factor of growth and development. Various conditions influence the fetal growth in utero.

Cont...

- Maternal malnutrition
- Maternal infection
- Maternal substance abuse
- Maternal illness
- Hormones
- Miscellaneous

Postnatal factors

- Growth potential
- Nutrition
- Childhood illness
- Physical environment
- Psychological environment
- Cultural influence
- Socio economic status
- Climate and season
- Play and exercise
- Birth order of the child
- Intelligence
- Hormonal influence

GROWTH AND DEVELOPMENTAL AGE PERIODS

- Infancy
 - Neonate
 - Birth to 1 month
 - Infancy
 - 1 month to 1 year

- Early Childhood
 - Toddler
 - 1-3 years
 - Preschool
 - 3-6 years

- Middle Childhood
 - School age
 - 6 to 12 years
- Late Childhood
 - Adolescent
 - 13 years to approximately 18 years

Growth and Development Monitoring

Assessment of growth



- Assessment of physical growth can be done by anthropometric measurement and the study of velocity of physical growth.
- Measurement of different growth parameters is the importance nursing responsibility in child care.

Measurements of physical growth (anthropometric measurements)

69

1. Weight

□ Normal birth weight: 2.5-4.0kg,

- ✓ loss of 5-10% in the 1st week
- ✓ Regained at the age of 10th and 14th day
- ✓ Increases 25gm/day in the 1st 3 months and 15 gm/day in the remainder of the 1st year
- ✓ Doubles at 5-6 months, triples at 1 year and quadruples at 2 years of age

4/24/2020

... anthropometric measurements

70

2. Height/length

- At birth=50cm
- At 6 months=65cm
- At 1 year=75cm
- At 2 years=85cm
- At 4 years=100cm, then increases about 5-6cm/year

4/24/2020



... anthropometric measurements

72

3. Head circumference

- At birth=35cm
- At 1 year=45cm
- At 2 years=48cm
- At 5 years=50cm

4/24/2020



Fontanelle Closure

- At birth, anterior and posterior fontanelle are usually present. **Posterior fontanelle** closes early few weeks(**6-8week**) of age.
- The **anterior fontanelle** normally closes by **12-18 months** of age. Early closure of fontanelle indicates **craniosostenosis** due to premature closure of skull sutures.



... anthropometric measurements

76

4. Chest circumference

- At birth 2cm less than head circumference
- At 1 year = head circumference, then it grows relatively faster than the head

5. MUAC

- The average MUAC at **birth** is **11 to 12 cm**,
- At **one** year of age it is **12 to 16 cm**,
- At **1 to 5** years it is **16 to 17 cm**,
- At **12 years** it is **17 to 18 cm**
- At **15 years** it is **20 to 21cm**.

4/24/2020



Organ System Maturation

- The newborn and infant's organ systems undergo significant changes as the infant grows.

Brain Growth

79

- The nervous system continues to mature throughout infancy
- Increase in head circumference is indicative of brain growth.
- By 6 months of age the infant's brain weighs half that of the adult brain.
- At age 12 months, the brain has grown considerably , weighing $2\frac{1}{2}$ times what it did at birth.
- Usually , the anterior fontanel remains open until 12 to 18 months of age to accommodate this rapid brain growth.
- Myelination of the spinal cord and nerves continues over the first 2 years.

Respiratory System

80

- The respiratory system continues to mature over the first year of life.
- The respiratory rate slows from an average of 30 to 60 breaths in the newborn to about 20 to 30 in the 12-month-old.
- In comparison with the adult, in the infant:
 - The nasal passages are narrower.
 - The trachea and chest wall are more compliant.
 - The bronchi and bronchioles are shorter and narrower.
 - The larynx is more funnel shaped.
 - The tongue is larger.
 - There are significantly fewer alveoli.
- These anatomic differences place the infant at higher risk for respiratory compromise.

Cardiovascular System

81

- The heart doubles in size over the first year of life.
- As the cardiovascular system matures, the average pulse rate decreases from 120 to 140 in the newborn to about 100 in the 1-year-old.
- Blood pressure steadily increases over the first 12 months of life, from an average of 60/40 in the newborn to 100/50 in the 12-month-old.
- The peripheral capillaries are closer to the surface of the skin
- Over the first year of life, thermoregulation (the body's ability to stabilize body temperature) becomes more effective

Gastrointestinal System

82

Teeth

- On average, the first primary teeth begin to erupt between the ages of 6 and 8 months.
- The primary teeth (also termed deciduous teeth) are lost later in childhood and will be replaced by the permanent teeth.
- The gums around the emerging tooth often swell.
- The lower central incisors are usually the first to appear, followed by the upper central incisors.

Dentition

83

Deciduous teeth	Eruption (in months)	Shedding (in years)
Central incisor	6-7	6-7
Lateral incisor	7-8	7-8
First molar	10-16	10-12
Canine	16-20	9-11
Second molar	20-30	12-13

4/24/2020

Dentition ...

84

Permanent teeth	Eruption (in years)
Central incisor	6-7
First molar	6-7
Lateral incisor	7-8
Canine	9-11
First premolar	10-12
Second premolar	11-13
Second molar	12-13
Third molar	17-22

4/24/2020

Digestion

- ✓ The newborn's digestive system is not developed fully .
- ✓ Ptyalin is present only in small amounts in the saliva.
- ✓ Gastric digestion occurs as a result of the presence of hydrochloric acid and rennin.
- ✓ The small intestine is about 270 cm long and grows to the adult length over the first few years of life.
- ✓ Trypsin is available in sufficient quantities for protein digestion after birth.
- ✓ Amylase (needed for complex carbohydrate digestion) and lipase (essential for appropriate fat digestion) are both deficient in the infant and do not reach adult levels until about 5 months of age.

- ❖ The liver is also immature at birth.
- ❖ The ability to conjugate bilirubin and secrete bile is present after about 2 weeks of age.
- ❖ Conjugation of medications may remain immature over the first year of life.
- ❖ Other functions of the liver, including gluconeogenesis, vitamin storage, and protein metabolism, remain immature during the first year of life.

Stools

- The consistency and frequency of stools change over the first year of life.
- The newborn's first stools (meconium) are the result of digestion of amniotic fluid swallowed in utero.
- They are dark green to black and sticky.
- In the first few days of life the stools become yellowish or tan.
- Newborns may have as many as 8 to 10 stools per day or as few as one stool every day or two.
- After the newborn period, the number of stools may decrease, and some infants do not have a bowel movement for several days.
- Iron supplements may cause the stool to appear black or very dark green

Genitourinary System

- In the infant, ECF=35% of body weight and ICF= 40%, compared with the adult quantities of 20% and 40%, respectively.
- Thus, the infant is more susceptible to dehydration.
- The renal structures are immature and the glomerular filtration rate, tubular secretion, and reabsorption as well as renal perfusion are all reduced compared with the adult.
- The glomeruli reach full maturity by 2 years of age.

Integumentary System

89

- ❑ At birth, the infant may be covered with vernix
- ❑ Fine downy hair (lanugo) covers the body of many newborns.
- ❑ Often this hair is lost over time and is not replaced.
- ❑ Darker-skinned races tend to have more lanugo present at birth than those with light skin.
- ❑ Acrocyanosis (blueness of the hands and feet) is normal in the newborn; it decreases over the first few days of life.
- ❑ Newborns often experience mottling of the skin (a pink-and-white marbled appearance) because of their immature circulatory system.

Hematopoietic System

- Significant changes in the hematopoietic system occur over the first year of life.
- At birth, fetal hemoglobin (HgbF) is present in large amounts.
- After birth the production of fetal hemoglobin nearly ceases, and adult hemoglobin (HgbA) is produced in steadily increasing amounts throughout the first 6 months.
- Since HgbF has a shorter lifespan than HgbA, infants may experience physiologic anemia at age 2 to 3 months.
- As the high hemoglobin concentration of the newborn decreases over the first 2 to 3 months, iron is reclaimed and stored.

Immunologic System

91

- Newborns receive large amounts of IgG through the placenta from their mothers.
- Infants then synthesize their own IgG, reaching approximately 60% of adult levels at age 12 months.
- IgM is produced in significant amounts after birth, reaching adult levels by 9 months of age.
- IgA, IgD, and IgE production increases very gradually , maturing in early childhood.

Assessment of Development



- Normal development is a complex process & has a multitude of facets. However, it is convenient to understand & assess development under the following domains.

Cont...

- Gross motor development
- Fine motor skill development**
- Personal & social development**
- Language**
- Vision & hearing.**

Gross motor development

- Motor development progress in an orderly sequence to ultimate attainment of locomotion & more complex motor tasks thereafter. In an infant it is assessed & observed as follows:-

Key gross motor development milestones

Age	Milestone
3m	Neck holding
5m	Rolls over
6m	Sits with own support
8m	Sitting without support
9m	Standing holding on (with support)
12m	Creep well, stand without support
15m	Walks alone creeps upstairs
18m	Runs
2 yr	Walks up and down stairs
3 yr	Rides tricycle,
4yr	Hops on one foot, alternate feet going downstairs.

Fine motor skill development

- Fine motor development upon neural tract maturation. Fine motor development promotes adaptive activities with fine **sensorimotor adjustments** and include **eye coordination, hand eye coordination, hand to mouth coordination, hand skill as finger thumb apposition, grasping, dressing** ect.

Key fine motor development milestone

Age	Milestone
4m	reaching out for the objects with both hands
6m	Reaching out for the objects with one hand
9m	Immature pincer graps
12m	Pincer graps mature
15m	Imitates scribbling, tower of 2 blocks
18m	Scribbles, tower of 3 blocks
2yr	Tower of 6 blocks, vertical and circular stroke
3 yr	Tower of 9 blocks, copies circle
4yr	Copies cross, bridge with blocks
5yr	Copies triangle, gate with blocks

Personal & social development



- Personal and social development includes personal reactions to his own social and cultural situations with neuromotor maturity and environment stimulation. It is related to interpersonal and social skill as social smile, recognition of mother, use of toys.

Key social and adaptive milestones

Age	Milestone
2m	Social smile
3m	Recognizes mother
6m	Recognizes strangers, stranger anxiety
9m	Waves “bye bye”
12m	Comes when called, plays simple ball game
15m	Jargon
18m	Copies parents in tasks
2yr	Asks for food, drink, toilet
3yr	Shares toys, knows full name and gender
4yr	Plays cooperatively in a group, goes to toilet alone.
5yr	Helps in household tasks, dressing and undressing

Language development

Age	Milestone
1m	Alerts to sound
3m	Coos (musical vowel sounds)
4m	Laugh loud
6m	Monosyllables (ba, da, pa) sound
9m	Bisyllables (mama, baba, dada) sound
12m	1-2 words with meaning
18 m	8 -10 words vocabulary
2yr	2-3 word sentences, uses pronouns “I”, “Me”, “you”
3 yr	Ask question
4yr	Says songs or poem, tell stories
5yr	Asks meaning of words

Assessment of Development

- *Healthy development, in all forms, particularly social/emotional, communication, and behavior, should be monitored by parents and physicians through screenings at each well visit.*

Summary

102

- Growth
- Development
- Principles of growth and development
- Factors affecting growth and development
- Assessment of growth and development

Thank you

Developmental theory

- ❑ **Freud theory**
(Psycho-sexual development).
- ❑ **Erikson theory**
(psycho-social development).
- ❑ **Piaget theory**
(cognitive development).

Psychoanalytic theories

- **Freud's psychosexual theory**
- ✓ Personality has three structures: the id, the ego, and the superego
- ✓ **Id** consists of instincts-an individual's reservoir of psychic energy
- ✓ The primary source of psychic energy is sexual
- ✓ Id is totally unconscious; it has no contact with reality

Freud's ...

- **Ego**-deals with the demands of reality
 - ✓ It is the executive branch of personality because it uses reasoning to make decisions
- Id and ego have no morality
- **Superego** – the moral branch of personality

Topographical Model

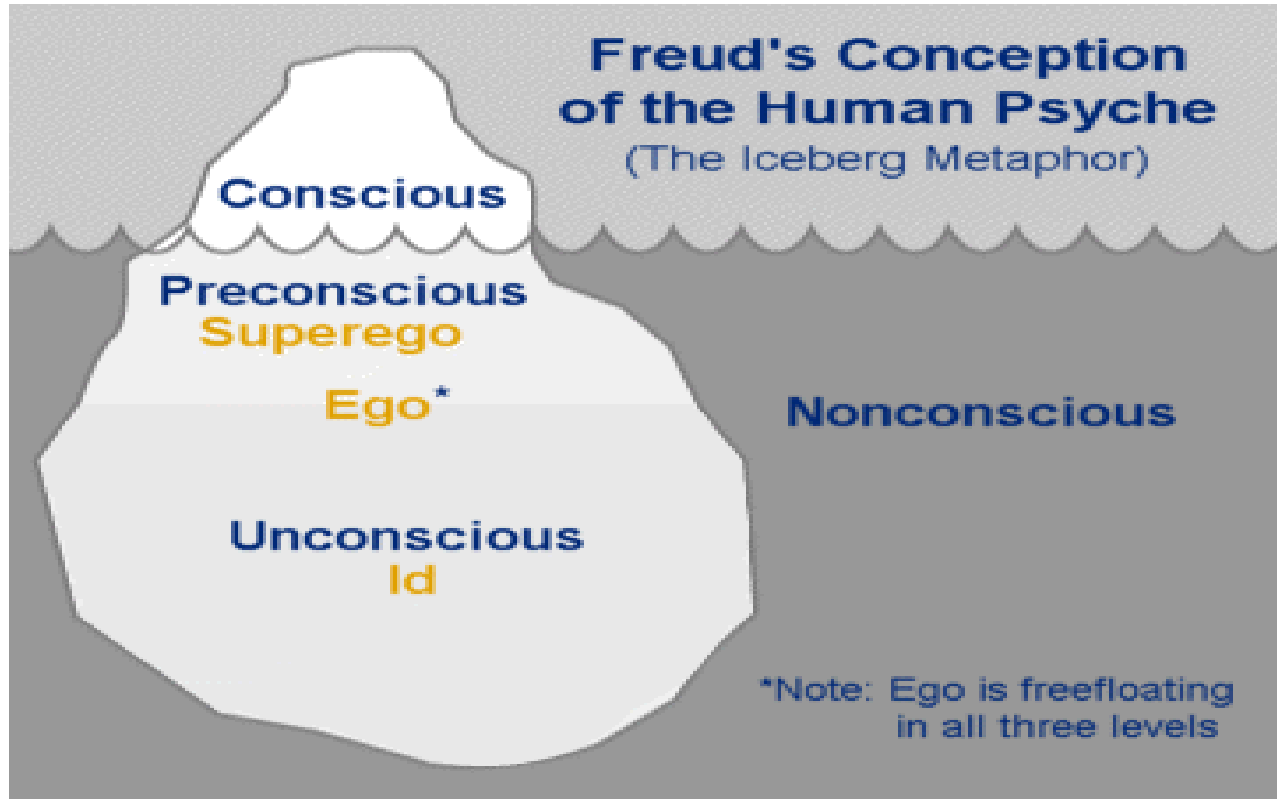

4/24/2020

Freud's ...

108

- 5 stages of development
 1. **Oral stage** (birth to 1 ½ years)
 2. **Anal stage** (1 ½ to 3 years)
 3. **Phallic stage** (3 to 6 years)
- Oedipus complex / Electra Complex
- 4. **Latency stage** (6 years to puberty)
- 5. **Genital stage** (puberty onward)

4/24/2020

Erikson's psychosocial theory

109

- Erikson said we develop in psychosocial stages, rather than in psychosexual stages
- For Freud, the primary motivation for human behaviour was sexual in nature, for Erikson it was social and reflected a desire to affiliate with other people
- Erikson emphasized developmental change throughout the human life span, whereas Freud argued that our basic personality is shaped in the first five years of life.

4/24/2020

Erikson's ...

110

- Eight stages of development
- Each stage consists of **a unique developmental task** that confronts individuals with a **crisis** that must be resolved
- The crisis is not a catastrophe but a turning point of **increased vulnerability** and **enhanced potential**
- The more successfully an individual resolves the crisis, the healthier development will be

4/24/2020

Erikson...

111

The Eight stages of development

1. Trust Vs mistrust (infancy)

- A sense of trust requires a feeling of physical comfort and a minimal amount of fear about the future
- Trust in infancy sets the stage for a lifelong expectation that the world will be a good and pleasant place to live

4/24/2020

Erikson...

112

2. Autonomy Vs shame and doubt (1 to 3 years)

- After gaining thrust in their care givers, infants begin to discover that their behaviour is their own
- They start to assert their sense of independence, or autonomy
- They realize their will
- If infants are restrained too much or punished harshly, they are likely to develop a sense of shame and doubt.

4/24/2020

Erikson...

113

3. Initiative Vs guilt (3 to 5 years)

- As preschool children encounter a widening social world, they are challenged more than when they were infants
- Active, purposeful behaviour is needed to cope with these challenges
- Children are asked to assume responsibility for their bodies, their behaviour, their toys, and their pets
- Uncomfortable guilt feelings may arise, though, if the child is irresponsible and is made to feel too anxious
- Most guilt is quickly compensated for by a sense of accomplishment.

4/24/2020

Erikson...

114

- #### 4. Industry Vs inferiority (6 years to puberty, elementary school years)
- Children's initiative brings them in contact with a wealth of new experiences
 - They direct their energy toward mastering knowledge and intellectual skills
 - The danger in the elementary school years is that the child can develop a sense of inferiority –feeling incompetent and unproductive
 - Teachers have a special responsibility –**mildly but firmly coerce** into the adventure of finding out that one can learn to accomplish things which one would never have thought by oneself

4/24/2020

Erikson...

115

5. Identity Vs identity confusion (10 to 20 years)

- Individuals are faced with finding out who they are, what they are about, and where they are going in life
- Adolescents are confronted with many new roles and adult statuses – vocational and romantic, for example
- Parents need to allow adolescents to explore many different roles and different paths within a particular role
- If an identity is pushed on the adolescent by the parent, if the adolescent does not adequately explore many roles, and if a positive future path is not defined, then identity confusion reigns

4/24/2020

Erikson...

116

6. Intimacy Vs isolation (20s, 30s, early adulthood)

- Individuals face the developmental task of forming intimate relationships with others
- Erikson describes intimacy as finding oneself yet losing oneself in another
- If the young adult forms healthy friendship with another individual, intimacy will be achieved; if not, isolation will result

4/24/2020

Erikson...

117

7. Generativity Vs stagnation (40s, 50s, middle adulthood)

- A chief concern is to assist the younger generation in developing and leading useful lives – **generativity**.
- The feeling of having done nothing to help the next generation is **stagnation**.

4/24/2020

Erikson...

118

8. Integrity Vs despair (60s onward, late adulthood)

- A person reflects on the past and either pieces together a positive review or concludes that life has not been spent well
- Through many routes, the older person may have developed a positive outlook in most or all of the previous stages of development. If so, the person will fill a sense of satisfaction – **integrity**.
- If the older adult resolved many of the earlier stages negatively – **despair**

4/24/2020

Cognitive Development Theory

Children "construct" their understanding of the world through their active involvement and interactions

Two processes are essential for development:

- **Assimilation**

Learning to understand events or objects, based on existing structure.

- **Accommodation**

Expanding understanding, based on new information

Assimilation + accommodation lead to equilibrium

Piaget

Children pass through specific stages as they develop their Cognitive Development skills:

- **Sensorimotor – birth - 2 years** – infants develop their intellect
- **Preoperational – 2-7 years** – children begin to think symbolically and imaginatively
- **Concrete operational – 7-12 years** – children learn to think logically
- **Formal operational – 12 years** – adulthood – adults develop critical thinking skills

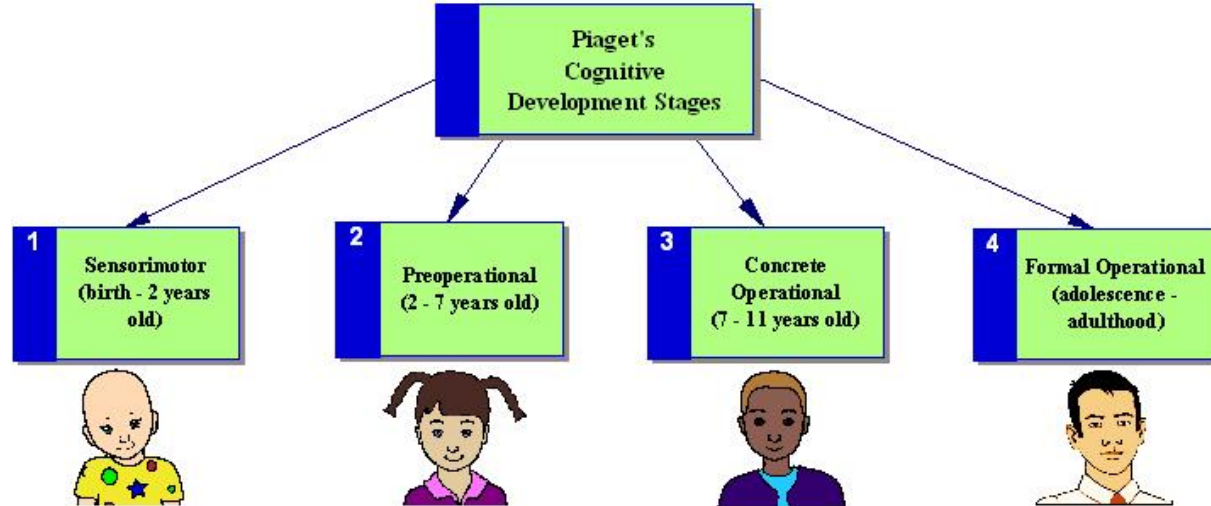



KOHLBERG THEORY

KOHLBERG'S THEORY

TODDLER	PRE CONVENTIONAL
PRE SCHOOL	CONVENTIONAL
SCHOOL	CONVENTIONAL
AGE	POST
ADOLESCENCE	CONVENTIONAL

Nutritional requirements of children

LIFE STAGE GROUP	TOTAL WATER^[†] (L/day)	CARBOHYDRATE (g/day)	TOTAL FIBER (g/day)	FAT (g/day)	PROTEIN (g/day)
INFANTS					
0–6 mo	0.7 ^[*]	60 ^[*]	ND	31 ^[*]	9.1 ^[*]
7–12 mo	0.8 ^[*]	95 ^[*]	ND	30 ^[*]	11.0
CHILDREN					
1–3 yr	1.3	130	19 ^[*]	ND	13
4–8 yr	1.7 ^[*]	130	25 ^[*]	ND	19
MALES					
9–13 yr	2.4 ^[*]	130	31 ^[*]	ND	34
14–18 yr	3.3 ^[*]	130	38 ^[*]	ND	52
19–30 yr	3.7 ^[*]	130	38 ^[*]	ND	56

4/24/2020

* Adequate intake, the bold ones are recommended ones

Nutritional requirements ...

LIFE STAGE GROUP	TOTAL WATER (L/day)	CARBOHYDRATE (g/day)	TOTAL FIBER (g/day)	FAT (g/day)	PROTEIN (g/day)
FEMALES					
9–13 yr	2.1 ^[*]	130	26 ^[*]	ND	34
14–18 yr	2.3 ^[*]	130	26 ^[*]	ND ^[*]	46
19–30 yr	2.7 ^[*]	130	25 ^[*]	ND	46
PREGNANCY					
14–18 yr	3.0 ^[*]	175	28 ^[*]	ND	71
19–30 yr	3.0 ^[*]	175	28 ^[*]	ND	71
LACTATION					
14–18 yr	3.8 ^[*]	210	29 ^[*]	ND	71
19–30 yr	3.8 ^[*]	210	29 ^[*]	ND	71

4/24/2020

ND=not determined







Nutritional requirements ...

125

Child's weight	Caloric need
<10kg	100kcal/kg/day
10-20kg	50kcal/kg/day
>20kg	20kcal/kg/day

4/24/2020

FEEDING RECOMMENDATIONS DURING SICKNESS AND HEALTH

<p>Up to 6 Months of Age</p>  <ul style="list-style-type: none"> • Breastfeed as often as the child wants, day and night, at least 8 times in 24 hours. • Do not give other foods or fluids. 	<p>6 Months up to 12 Months</p>  <ul style="list-style-type: none"> • Breastfeed as often as the child wants. • Give adequate servings of: <ul style="list-style-type: none"> _____ _____ _____ _____ - 3 times per day if breastfed plus snacks - 5 times per day if not breastfed. 	<p>12 Months up to 2 Years</p>  <ul style="list-style-type: none"> • Breastfeed as often as the child wants. • Give adequate servings of: <ul style="list-style-type: none"> _____ _____ _____ _____ or family foods 3 or 4 times per day plus snacks. 	<p>2 Years and Older</p>  <ul style="list-style-type: none"> • Give family foods at 3 meals each day. Also, twice daily, give nutritious food between meals, such as: <ul style="list-style-type: none"> _____ _____ _____ _____ 
--	---	---	---

4/24/2020

Developmental delay

127

Is a significant delay in attaining specific developmental milestones.

Types of developmental delay

- ▣ Global developmental delay
- ▣ Specific developmental delay
- ▣ Intellectual disabilities

Why emphasize early detection of Development Delay

- 1- start early intervention and treatment.
- 2- supply the parent an explanation for their inquiries about difficulties with their children as feeding, handling, sleeping, and temperament.
- 3- to look for associated findings for managing

Global Developmental Delay

GDD

Significant delay* in two or more of the following five developmental skills:

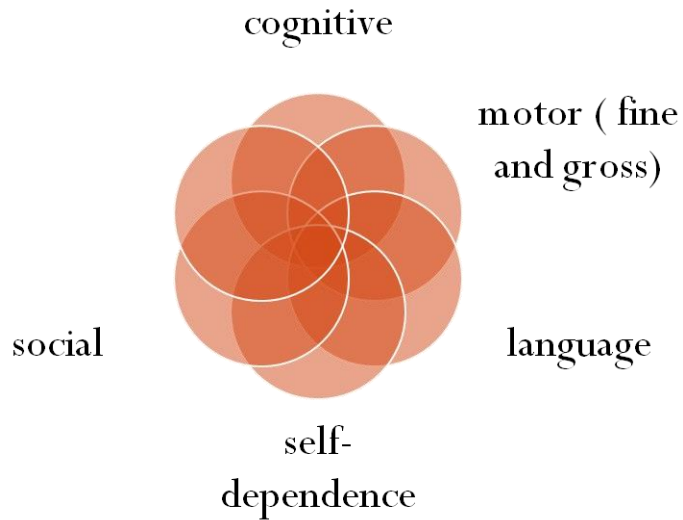

Developmental milestones 5's

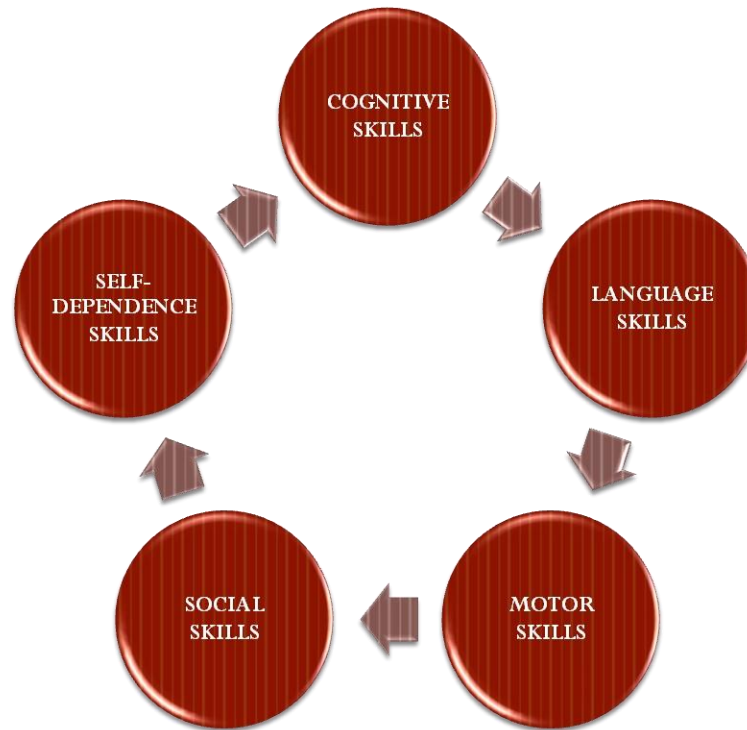

*Who should be screened for
development delay ?*

**All young children especially those
with risk factor All young**

Question

9 months baby only coo, can't sit, with sissoring and increased deep tendon reflexes, social smile. What is ur diagnosis?

early spastic CP with global developmental delay

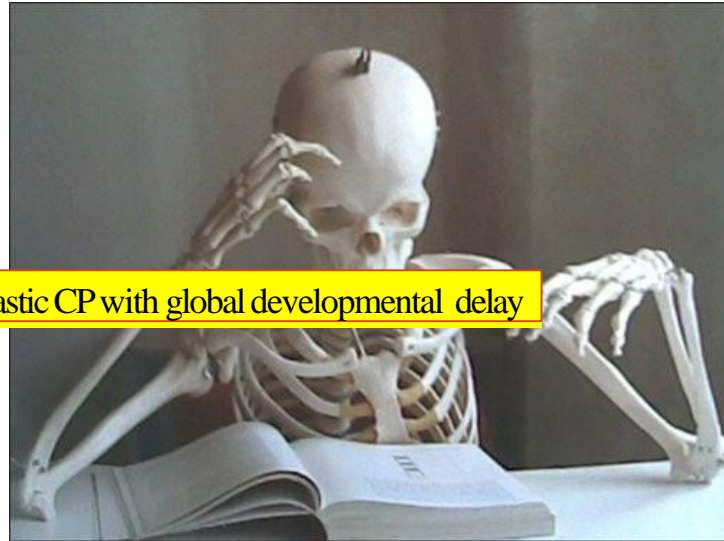

Question

- 9 months baby with ability to hold things between thumb and index , say dada and papa , able to crawl. Parents are anxious , what is ur opinion?

Assure the parent. He is a normal child as regard his developmental milestones achievement

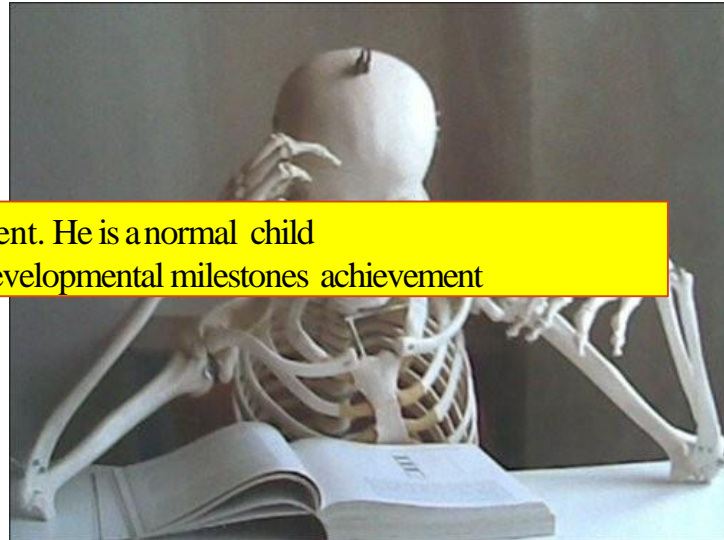

TREATMENT

*Early intervention
Rehabilitation
Treatment of
associated factors.*



Management

rehabilitation



Thank



YOU

UNIT III: NEONATAL CARE

Presentation Outline

139

- Definition of terms
- Essential newborn care
- Classification of newborns
- Neonatal assessment
- Common neonatal problems & their management

Session objective

140

At the end of this session students should be able to:

- Define newborn and neonate
- Discuss the physiological changes during neonatal period
- Explain the steps of essential newborn care
- Classify newborns based on different criteria
- Differentiate the normal physical findings from abnormal presentations
- Discuss common neonatal problems and their managements

Definition of terms

141

- **Newborn**: the age range from birth to seven days
- **Neonate**: the age range from birth to twenty eight days
- **Neonatology**: The branch of medicine that deals with newborn infants, especially the ill or premature newborn infants

Introduction

142

- ❑ The neonatal period is a highly vulnerable time for an infant, who is completing many of the physiologic adjustments required for extrauterine existence.
- ❑ The high neonatal morbidity and mortality rates show to the fragility of life during this period

Introduction ...

- **Neonatal mortality** : the probability of dying within the first month of life
- **Postneonatal mortality**: the probability of dying after the first month of life but before the first birthday
- **Infant mortality**: the probability of dying before the first birthday
- **Child mortality**: the probability of dying between the first and the fifth birthdays
- **Under-five mortality**: the probability of dying between birth and the fifth birthday

Introduction

Fig. 2 Trends in Early Childhood Mortality, EDHS 2016

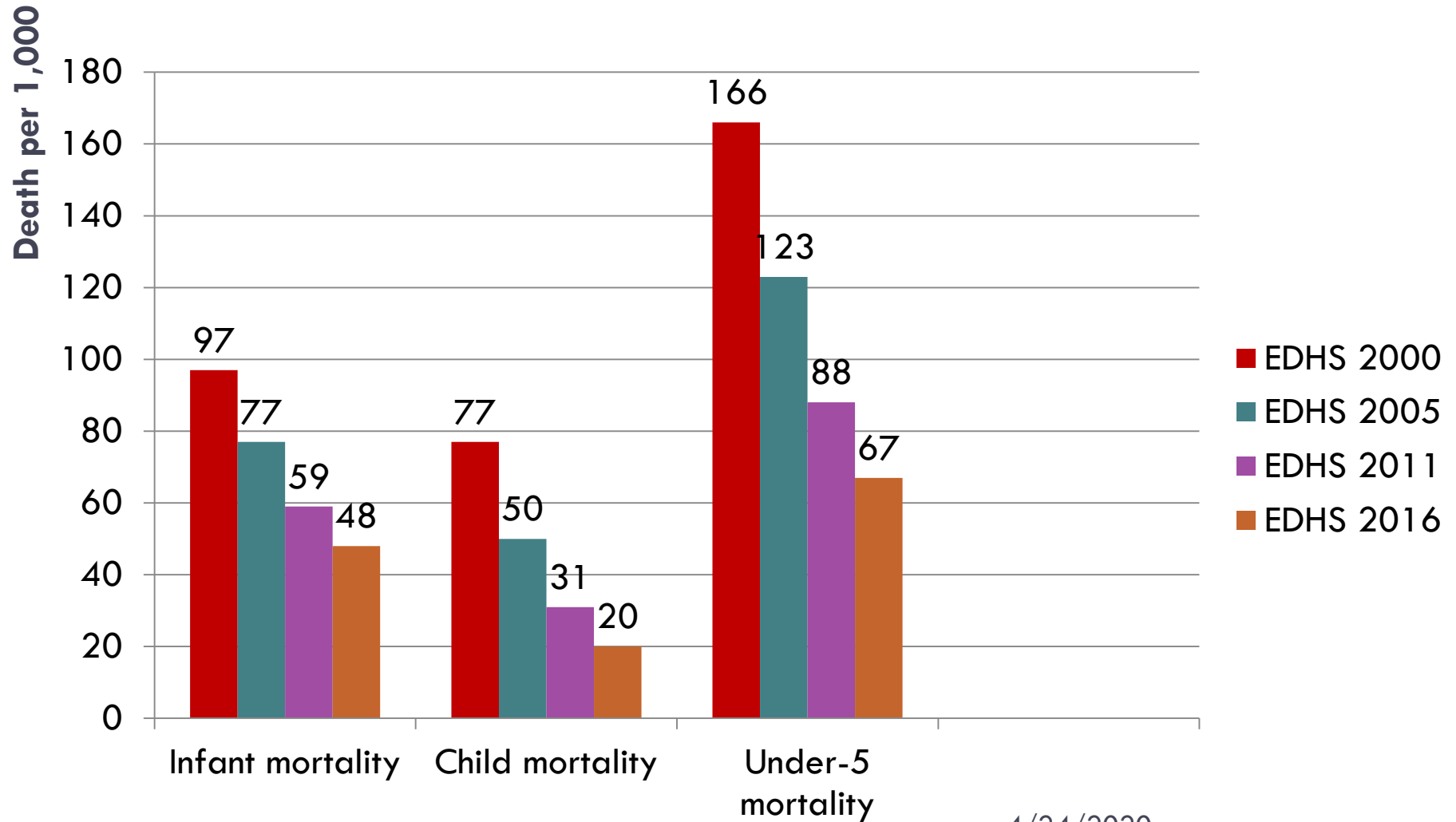

Neonatal physiology

145

- The neonatal period contains the most dramatic and rapid physiological changes seen in humans.
- They vary from the immediate changes to the slower progression .
- These adaptations support life during the development from intrauterine physiology to adult physiology



Neonatal Resuscitation

Indication for resuscitation

148

Abnormal transition



- Gasping, ineffective or no breathing
- Poor muscle tone
- Central cyanosis (blue)
- **All need assisted ventilation!**

Normal transition

149

- **No meconium**
- **Breathing/crying**
- **Good muscle tone**
- **Term**



4/24/2020

Basic Steps in Resuscitation

150

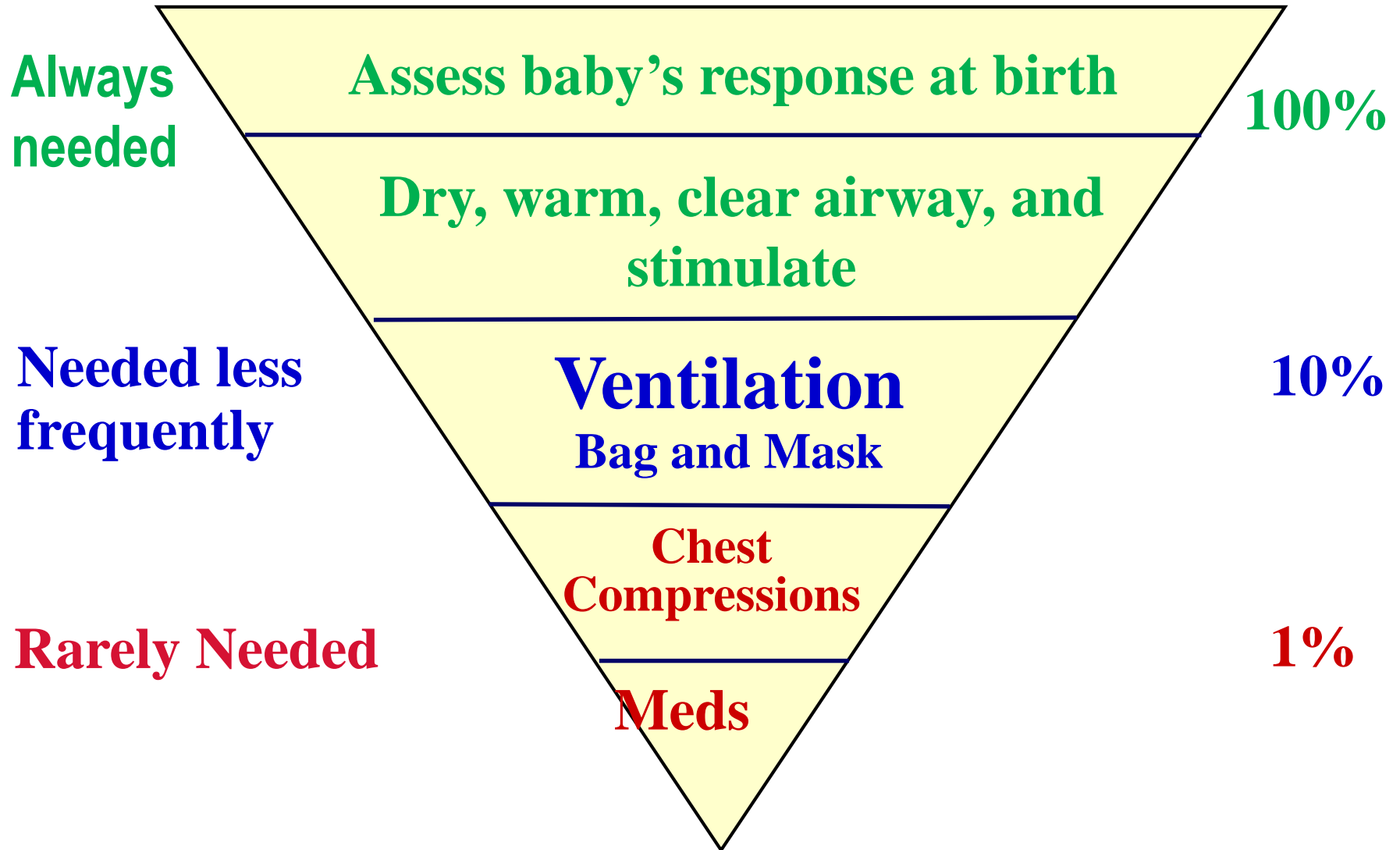

Evaluate These Newborns



- ▶ Dry the infant immediately with a clean cloth.
- ▶ Keep warm by skin-to-skin contact and covered.

Look for

- Breathing or crying
- Good muscle tone or vigorous movements

Yes

Routine care
(see section 3.1)

No

- ▶ Stimulate by rubbing the back 2 to 3 times.
- ▶ Suction only if had meconium stained liquor or the mouth or nose is full of secretions.

Breathing

Routine care and closely observe breathing

Not breathing, or gasping

- ▶ **CALL FOR HELP.**
- ▶ Transfer to newborn resuscitation area.
- ▶ Position the head/neck slightly extended.
- ▶ Start positive pressure ventilation with mask and self-inflating bag within 1 min of birth.^a
- ▶ Make sure the chest is moving adequately.

Breathing well

Observe closely if continues to breathe well

After 30–60 s

Check the heart rate (HR) with a stethoscope.

If HR < 60/min

- ▶ Chest compressions until HR ≥ 100 /min (see figure on p. 48)
- ▶ Give higher oxygen concentration.
- If HR remains at < 60/min, consider:
 - ▶ Other ventilatory support.
 - ▶ IV adrenaline.
 - ▶ Refer where possible
- If **no** HR for > 10 min or remains < 60/min for 20 min, discontinue

If HR ≥ 60 /min

- | | |
|---|---|
| <ul style="list-style-type: none"> ■ HR 60–100/min: ▶ Take ventilation corrective steps. ▶ Continue to ventilate at 40 breaths per min. ▶ Consider higher oxygen concentration. ▶ Suction, if necessary. ▶ Reassess every 1–2 min. | <ul style="list-style-type: none"> ■ HR > 100/min: ▶ Continue to ventilate at 40 breaths per min. ▶ Every 1–2 min stop to see if breathing spontaneously. ▶ Stop ventilating when respiratory rate is > 30 breaths per min. ▶ Give post resuscitation care. |
|---|---|

If HR > 100/min

A

B

C

Signs of Improvement

153

- 1. Increasing Heart Rate (>100)**
- 2. Improving color**
- 3. Spontaneous breathing or crying**
- 4. Improving muscle tone**

Prevention of Asphyxia

154

Primary prevention:

- Improvement of maternal health (Nutritionally, prenatal recognition of at-risk pregnancies, & skilled attendance at birth.

Secondary prevention:

- Provide effective resuscitation.

Tertiary:

- Management & treatment of neonatal post asphyxiated complications

WHAT ARE THE STEPS OF ESSENTIAL NEWBORN CARE?



Essential new born care

156

- ➔ **Step 1:** Dry baby's body with dry and warm towel. Wipe eye, as you dry stimulate breathing. Wrap with another dry towel and cover the head while the mother's abdomen
- ➔ **Step 2:** Assess the breathing(birth asphyxia)
- ➔ **Step 3:** Clamp/tie the cord two finger from abdomen and another clamp/tie two fingers from the 1st one. Cut the cord between the 1st and 2nd clamp/tie.
- ➔ **Step 4:** Place the baby in skin to skin contact with the mother

Essential newborn care

157

- ➡ **Step 5:** Initiate breastfeeding immediately with 1 hour of life
- ➡ **Step 6:** Apply tetracycline eye ointment once on both eyes
- ➡ **Step 7:** Apply chlorhexidine and instruct the mother for next use
- ➡ **Step 8:** Give Vitamin ,1mg IM on anterior mid lateral thigh
- ➡ **Step 9:** Weigh baby& classify

APGAR Score

Sign	Score 0	Score 1	Score 2
Activity	Flaccid	Some flexion	Well flexed
Pulse	Absent	<100 per minute	>100 per minute
Grimace	No response	Grimace	Cough or sneeze
Appearance	Pale/Blue	Blue extremities	Completely pink
Respiration	Absent	Weak	Good cry

Three levels of score:

- Low APGAR score 0-3
- Moderate APGAR score 4-6
- Normal APGAR score 7-10

Note: A newborn with an APGAR score of less than 7 needs special attention.

Examination of newborn

159

The main objective of routine examination is:

- To ensure and assess that the lungs have expanded and that air passages are not obstructed
- To make an early diagnosis of life threatening , congenital mal formations and birth injuries
- To assess the gestational age to classify as term or preterm and as appropriate or not appropriate for gestational age based on the birth weight.
- To assess whether the baby has any sign of infection or metabolic diseases.

How do you classify newborn?

Classification of newborns

161

I. According to the gestational age

1. Term	The GA range is >37 weeks up to 42 weeks
2. Preterm	The GA range is <37 weeks
3. Very preterm	The GA range is <32 weeks
3. Post-term	The GA range is >42 weeks

Classification ...

162

I. According to the birth weight

1. Big baby	\geq 4000gm
2. Normal birth weight	2500-3999gm
3. LBW (Low birth weight)	1500-2499gm
4. VLBW (Very low birth weight)	1000-1499gm
5. ELBW (Extremely low birth wt)	501-999gm

Classification ...

163

I. According to gestational age and birth weight

1. AGA	When the birth weight is “Appropriate for GA”
2. SGA	When the birth weight is “Small for GA”
3. LGA	When the birth weight is “Large for GA”

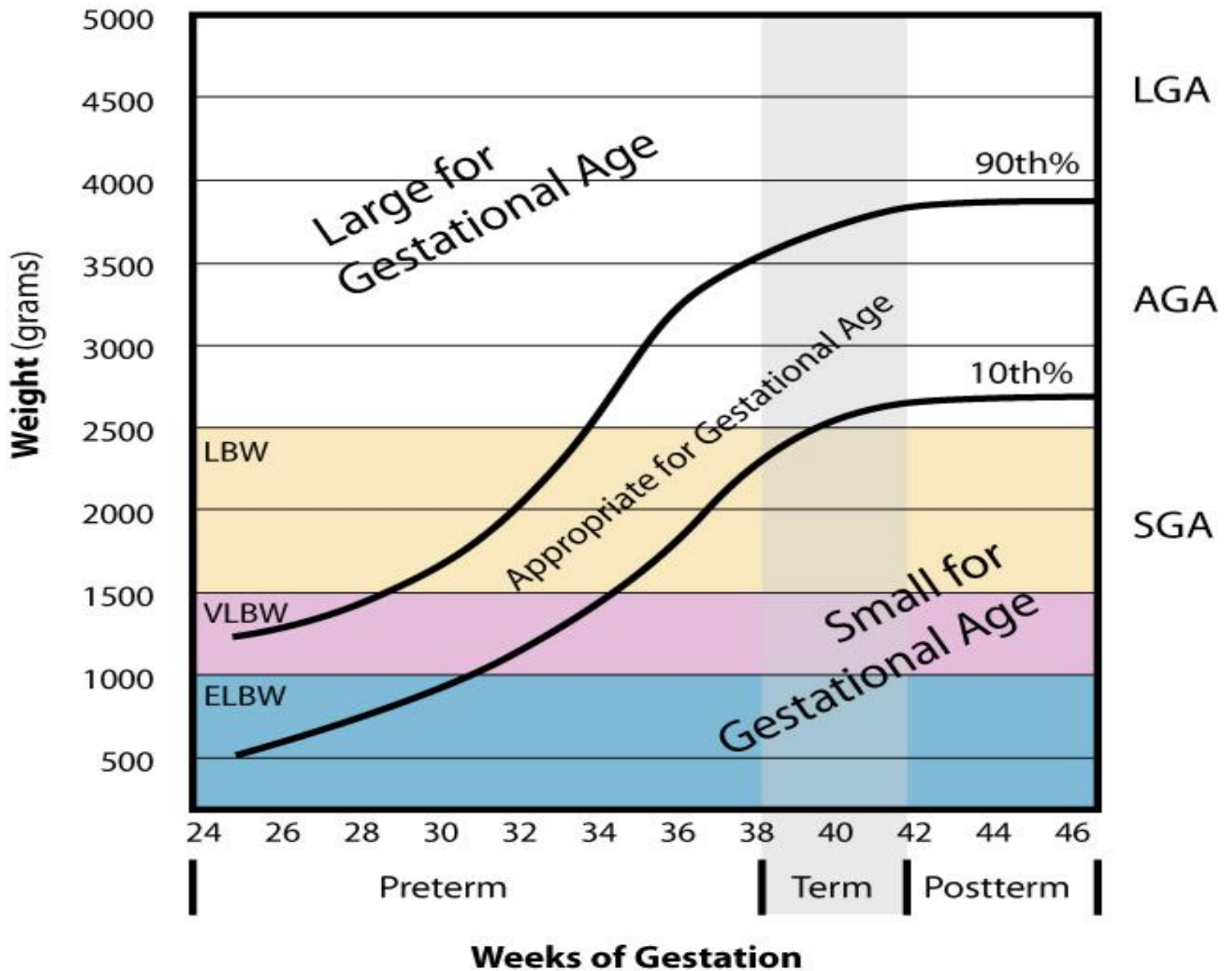

Neonatal history and physical examination

Neonatal assessment

166

□ Neonatal history

□ Identification:

- Similar with older children except **age** (write in *hours* if <72 hours old)

□ Chief complaints:

- Similar with older children except you may *pass* it during examinations for routine check-up (neonate without problem)

- **History of present illness (2 parts):**
 - ▣ **Maternal history:**
 - Age, occupation, marital status, socio-economic status
 - *Previous obstetric history*: gravidity, parity, number of children alive, if child death (age & diagnosis if known), history of abortion (gestational age and when), history of still birth
 - *Past medical history*: anemia, diabetes mellitus, hypertension, heart disease, tuberculosis, weight gain (<15 or >30 pounds) or malnutrition, bleeding d/o, STIs...

- **Present obstetric history:** antenatal care, blood group and VDRL status, RH, HIV status, immunization status (especially TT), gestational age by date (LMP), illness during pregnancy, radiation exposure, drug intake, bleeding, polyhydramnios, oligohydramnios
- **Delivery history:** onset of labor (spontaneous or induced), duration of labor, time of rupture of membrane in relation to labor (PROM >24 hours); date, time, place and mode of delivery
- **Postpartum events**

- Newborn history:
 - **Immediately after birth:** Crying immediately or not any color change (cyanosis), Apgar score if known, sex and weight.
 - **Later:** sucking effectively, drooling of saliva, breathing pattern, passage of urine and stool, overall activity, bleeding from any site
 - ▣ **Care given:** vaccinations (specify), vitamin K, any procedures done like umbilical catheterization, blood transfusion, NG tube insertion, IV administration of fluids or drugs.
 - ▣ **NOTE:** *If the neonate has any chief complaints the history should be elaborated like that of the other children.*

Physical assessment

170

- ❑ **Expected findings**
- ❑ Anterior fontanel diamond shaped 2-3 to 3-4 cms
- ❑ Posterior fontanel triangular 0.5 to 1 cm
- ❑ Fontanel soft, firm and flat
- ❑ Sutures palpable with small separation between each
- ❑ **Abnormal findings**
- ❑ Fontanel that are bulging or depressed
- ❑ Hydrocephalus
- ❑ Macrocephaly
- ❑ Cephalhematoma
- ❑ Closed sutures

Physical assessment ...

171

❖ **Eyes:**

❑ **Expected findings**

- ❑ Slate gray or blue eye color
- ❑ No tears
- ❑ Fixation at times – with ability to follow objects to midline
- ❑ Red reflex
- ❑ Blink reflex
- ❑ Distinct eyebrows
- ❑ Cornea bright and shiny
- ❑ Pupils equal and reactive to light

Eyes ...

172

- ❑ **Abnormal findings**
- ❑ Discharges
- ❑ Chemical conjunctivitis
- ❑ Opaque lenses
- ❑ Absence of red reflex
- ❑ “Doll’s eyes” beyond 10 days of age
- ❑ Reflexes absent
- ❑ Sub-conjunctival hemorrhage

Ears

173

- ❑ **Expected findings**

- ❑ Pinna top on horizontal line with outer canthus of eye
- ❑ Loud noise elicits Startle Reflex
- ❑ Flexible pinna with cartilage present

- ❑ **Abnormal findings**

- ❑ Ear placement low
- ❑ Preauricular sinus
- ❑ Clefts present
- ❑ Malformations
- ❑ Cartilage absent

Nose

174

- ❑ **Expected findings**
- ❑ Nostrils present bilaterally
- ❑ Obligate nose breathers
- ❑ No nasal discharge
- ❑ **Abnormal findings**
- ❑ Choanal atresia and discharge
- ❑ Malformation
- ❑ Nasal flaring beyond first few moments after birth

Mouth and throat

175

- ❑ **Expected findings**
- ❑ Mucosa moist
- ❑ Palate high arched
- ❑ Uvula midline
- ❑ Minimal or absent salivation
- ❑ Tongue moves freely and does not protrude
- ❑ Well developed fat pads bilateral cheeks
- ❑ Sucking reflex
- ❑ Rooting reflex
- ❑ Gag reflex

Mouth and throat ...

176

- ❑ **Abnormal findings**
- ❑ Cleft lip or cleft palate
- ❑ Circumoral pallor
- ❑ Lip movement asymmetrical
- ❑ Reflexes absent or incomplete
- ❑ Protruding tongue
- ❑ Candida albicans
- ❑ Diminished tongue movement
- ❑ Precocious teeth

Neck

❑ **Expected findings**

- ❑ Short and thick
- ❑ Turns easily side to side
- ❑ Clavicles intact
- ❑ Tonic neck reflex present
- ❑ Some head control

❑ **Abnormal findings**

- ❑ Torticollis- stiff neck drawing head to one side
- ❑ Resistance to flexion
- ❑ Webbing of neck
- ❑ Large fat pad on back of neck
- ❑ Palpable crepitus movement with palpation of clavicle

Respiratory system

178

- ~~Major signs of respiratory distress:~~
- Asymmetry of chest
- Apnea >15 to 20 seconds associated with bradycardia and cyanosis
- Diminished breath sound
- Gasping
- Grunting
- Nasal flaring

Signs of respiratory distress ...

179

- Retractions
- Deep sighing
- Tachypnea-respirations >60
- Persistent irregular breathing
- Excessive mucus
- Persistent fine crackles
- Stridor

Chest

180

- ❑ **Expected findings**
- ❑ Evident xiphoid process
- ❑ Equal antero-posterior and lateral diameters
- ❑ Bilateral synchronous chest movement
- ❑ Symmetrical nipples

Chest ...

181

- ❑ **Abnormal findings**
- ❑ Asymmetrical chest movements
- ❑ Sternum depressed
- ❑ Marked retractions
- ❑ Absent breast tissue
- ❑ Flattened chest
- ❑ Nipples widely spaced
- ❑ Bowel sounds auscultated

Circulatory system

182

□ Important to consider:

- Fetal shunts are closing shortly after birth, to make transition to extra-uterine life
- Ductus Arteriosus is the most likely to remain open (PDA)
- Heat regulation is unstable at birth. Report temperature $<36.5^{\circ}\text{C}$ or $>37.5^{\circ}\text{C}$. Be careful to provide adequate warmth

Circulatory ...

183

- Pulse rates may be irregular and rapid, particularly with crying
- Normal heart rate will be between 120 - 160 beats/minute. Heart rate range to 100 when sleeping to 180 when crying. Report pulse rates >160 or <100
- Color pink with Acrocyanosis
- Check for heart murmur/femoral pulses

Circulatory ...

184

- ❑ **Signs of infection:**
- ❑ Pallor, cyanosis
- ❑ Mottling, cold, clammy skin
- ❑ Tachycardia
- ❑ Even a subnormal temperature may be indicative of infection

Gastro-intestinal system

185

- ❑ **General considerations:**
- ❑ Important to note the first bowel elimination – ‘Meconium’
- ❑ If the baby is term, should be within 24 hours
- ❑ If the newborn is preterm, it can exceed 72 hours
- ❑ Small stomach capacity (1-2 ounces)
- ❑ Sleepy state for several hours after birth

GIT ...

186

- May lose weight in the first few days. this should not be more than 9-10% of birth weight for term newborns or 15-20% for preterm
- ‘Regurgitation’ is normal as cardiac sphincter is not fully developed
- Mouth is assessed for:
- Intact palate
- “Rice teeth” – very soft, not a part of primary teeth

Abdomen

187

- ❑ **Expected findings**
- ❑ Dome-shaped abdomen
- ❑ Abdominal respirations
- ❑ Soft to palpation
- ❑ Well formed abdominal cord
- ❑ Three vessels in cord, one vein and two arteries
- ❑ Cord dry at base

Abdomen expected ...

188

- Liver palpable 2-3 cms below right costal margin
- Bilaterally equal femoral pulses
- Bowel sounds auscultated within 2 hours of birth
- Voiding within 24 hours of birth
- Meconium within 24-48 hours of birth
- Small umbilical hernia

Abdomen ...

189

- ❑ **Abnormal findings**
- ❑ Bowel sounds absent
- ❑ Peristaltic waves visible
- ❑ Abdominal distension
- ❑ Palpable masses
- ❑ Scaphoid-shaped abdomen
- ❑ Omphalocele (a hernia of the navel)
- ❑ Base of cord with redness or drainage
- ❑ Cord with two vessels

Genitourinary system

190

- ❑ **Female genitalia – Expected findings:**
- ❑ Edematous labia and clitoris
- ❑ Labia majora are larger and surrounding labia minora
- ❑ Vernix between labia
- ❑ Hymeneal tag
- ❑ Pseudo menstruation
- ❑ Increased pigmentation
- ❑ Ecchymoses and edema after breech birth
- ❑ Red brick “pink-stained urine due to uric acid crystals

Female genitalia ...

191

- ❑ **Abnormal findings**
- ❑ Labia fused
- ❑ Fecal discharge from vaginal opening
- ❑ Imperforate hymen
- ❑ Ambiguous genitalia
- ❑ Widely separated labia

Genitourinary system ...

192

- ❑ **Male genitalia – Expected findings**
- ❑ Urinary meatus at tip of glans penis
- ❑ Palpable testes in scrotum
- ❑ Large, edematous, pendulous scrotum, with rugae
- ❑ **Abnormal findings**
- ❑ Non palpable testes
- ❑ Hypospadias
- ❑ Scrotum smooth
- ❑ Ambiguous genitalia

Neurological

193

- ❑ **Normal newborn reflexes should be noted**
- ❑ Sucking/swallowing
- ❑ Rooting
- ❑ Moro/startle
- ❑ Grasp (palmar and plantar)
- ❑ Tonic neck reflex/ “fencing”
- ❑ Dancing/walking
- ❑ Sneezing

Neurological ...

194

- ❑ **Sleep patterns :**
- ❑ 16-20 hours/day
- ❑ Awakens only for feedings
- ❑ **Signs of possible infection the CNS**
- ❑ Lethargy or irritability
- ❑ Jitteriness or hypo-reflexia, hypotonic
- ❑ Tremors or seizures
- ❑ Full, bulging fontanel

Neuromuscular ...

195

❑ **Neuromuscular system – Expected findings**

- ❑ Maintains position of flexion
- ❑ When prone, returns head side to side
- ❑ Holds head and back in horizontal plane when held prone
- ❑ Ability to hold head momentarily erect

❑ **Abnormal findings**

- ❑ Hypotonia
- ❑ Quivering/shivering
- ❑ Limp extremities or straightening of extremities
- ❑ Clonic jerking
- ❑ Paralysis

Musculoskeletal system

196

- ❑ **Important to consider:**
- ❑ Bones are soft, mostly cartilage
- ❑ Skeleton is flexible – change positions
- ❑ Legs may appear to be bowed
- ❑ Eyes may appear crossed also due to muscle coordination not fully developed

Extremities

197

- ❑ **Expected findings**
- ❑ Maintains posture of flexion
- ❑ Equal and bilateral movement and tone
- ❑ Full range of motion all joints
- ❑ Ten fingers and ten toes
- ❑ Legs appear flat
- ❑ Palmar creases present
- ❑ Sole creases present
- ❑ Grasp reflex present

Extremities ...

198

- ❑ **Abnormal findings**
- ❑ Unequal tone
- ❑ Asymmetrical movement of extremities
- ❑ Polydactyly
- ❑ Syndactyly
- ❑ Unequal leg length
- ❑ Asymmetrical skin creases posterior thigh
- ❑ Dislocation of hip
- ❑ Persistent cyanosis of nail beds

Integumentary system

199

- ❑ **Expected findings**
- ❑ Skin reddish in color, smooth and puffy at birth
- ❑ At 24-36 hours of age, skin flaky, dry and pink in color
- ❑ Edema around eyes, feet, and genitals
- ❑ Vernix caseosa
- ❑ Lanugos

Integumentary ... expected

200

- Turgor good with quick recoil
- Hair silky and soft with individual stands
- Nipples present and in expected location
- Cord with one vein and two arteries
- Cord clamp tight and cord drying
- Nails to end of fingers and often extend slightly beyond

Neonatal reflexes

Assessing neonatal reflexes

202

- Neonatal reflexes are inborn reflexes which are present at birth and occur in a predictable fashion.
- A normally developing newborn should respond to certain stimuli with these reflexes, which eventually become inhibited as the child matures

Assessing neonatal reflexes

203

- A weak, absent or asymmetrical response is considered as abnormal
- Some reflexes (such as the pupillary, blink and gag reflexes) persist throughout life; others (including the doll's eye, sucking, grasp, Babinski, moro, and galant reflexes) normally disappear a few weeks or months after birth

Neonatal reflexes

204

Reflex	Testing method	Normal responses
Babinski	Stroke one side of the neonate's sole upward from the heel and across the ball of the foot	Neonate hyperextends the toes; dorsiflexes the great toe and fans the toes outward
Blink (corneal)	Momentarily shine and bring the light directly into the neonate's eyes	Neonate blinks
Crawl	Place the neonate prone on a flat surface	Neonate attempts to crawl forward using the arms and the legs
Crossed extension	Position the neonate supine; extend one leg and stimulate the sole with a light pin prick or finger flick	Neonate swiftly flexes and extends the opposite leg as though trying to push the stimulus away from the other foot

Neonatal reflexes ...

205

Reflex	Testing method	Normal responses
Doll's eye	With neonate supine, slowly turn the neonates head to either side	Neonate's eyes remain stationary
Galant	Using a fingernail, gently stroke one side of the neonate's spinal column from the head to the buttocks	Neonate's trunk curves toward the stimulated side
Grasp	Palmar: place a finger in the neonate's palm Plantar: place a finger against the base of the neonate's toe	Neonate grasps the finger Neonate's toes curl downward and grasp the finger
Pupillary (light)	Darken the room and shine a pen light directly into the neonate's eye for several seconds	Pupils constrict equally bilaterally

Neonatal reflexes ...

206

Reflex	Testing method	Normal responses
Moro	Suddenly but gently drop the neonate's head backward (relative to the trunk)	Neonate extends and abducts all extremities bilaterally and symmetrically forms a "C" shape with the thumb and forefinger; and adducts, then flexes, the extremities
Rooting	Touch a finger to the neonate's cheek or the corner of mouth. (the mother's nipple also should trigger this reflex)	Neonate turns the head toward the stimulus, opens the mouth and searches for the stimulus

Neonatal reflexes ...

207

Reflex	Testing method	Normal responses
Startle	Make a loud noise near the neonate	Neonate cries and abducts and flexes all extremities
Stepping (automatic walking)	Hold the neonate in an upright position and touch one foot lightly to a flat surface (such as the bed)	Neonate makes walking motions with both feet
Sucking	Place a finger in the neonate's mouth (the mother's nipple also should trigger this reflex)	Neonate sucks on the finger (or nipple) and rhythmically; sucking is coordinated with swallowing





Common neonatal problems

210

- Neonatal sepsis
- Hypothermia
- Jaundice
- Birth asphyxia
- Hypoglycaemia
- Low birth weight

Thermal protection of the newborn

211

- **Thermal protection** is the **series of measures** taken **at birth and during the first days of life** to ensure that the newborn baby does not become either too cold (hypothermia) or too hot (hyperthermia) and maintains a normal body temperature.

Thermal protection ...

212

- Newborn babies cool down or heat up much quicker than adults because they **cannot regulate body temperature** as desired
- In general, newborns **need a warmer environment** than adults
- A naked newborn exposed to a room temperature of 23°C suffers the same heat loss as a naked adult does at 0°C

Thermal protection ...

213

- The natural course is that before birth, the baby is warm and well insulated in the natural uterine environment
- The fetal temperature is slightly higher than the maternal temperature
- From this comfortable environment a baby comes out naked and wet in the labor room environment

Thermal protection ...

214

- The neonate has a large surface area for small body mass, and its heat loss is relatively greater
- The smaller the infant the greater the loss particularly if the baby is kept naked for clinical observation and interventions
- At birth, the skin and core temperatures of the baby fall by 0.1 and 0.3°C/minute respectively. This is equivalent to loss of 200 Kcal per kilogram body weight per minute

Mechanism of heat loss

215

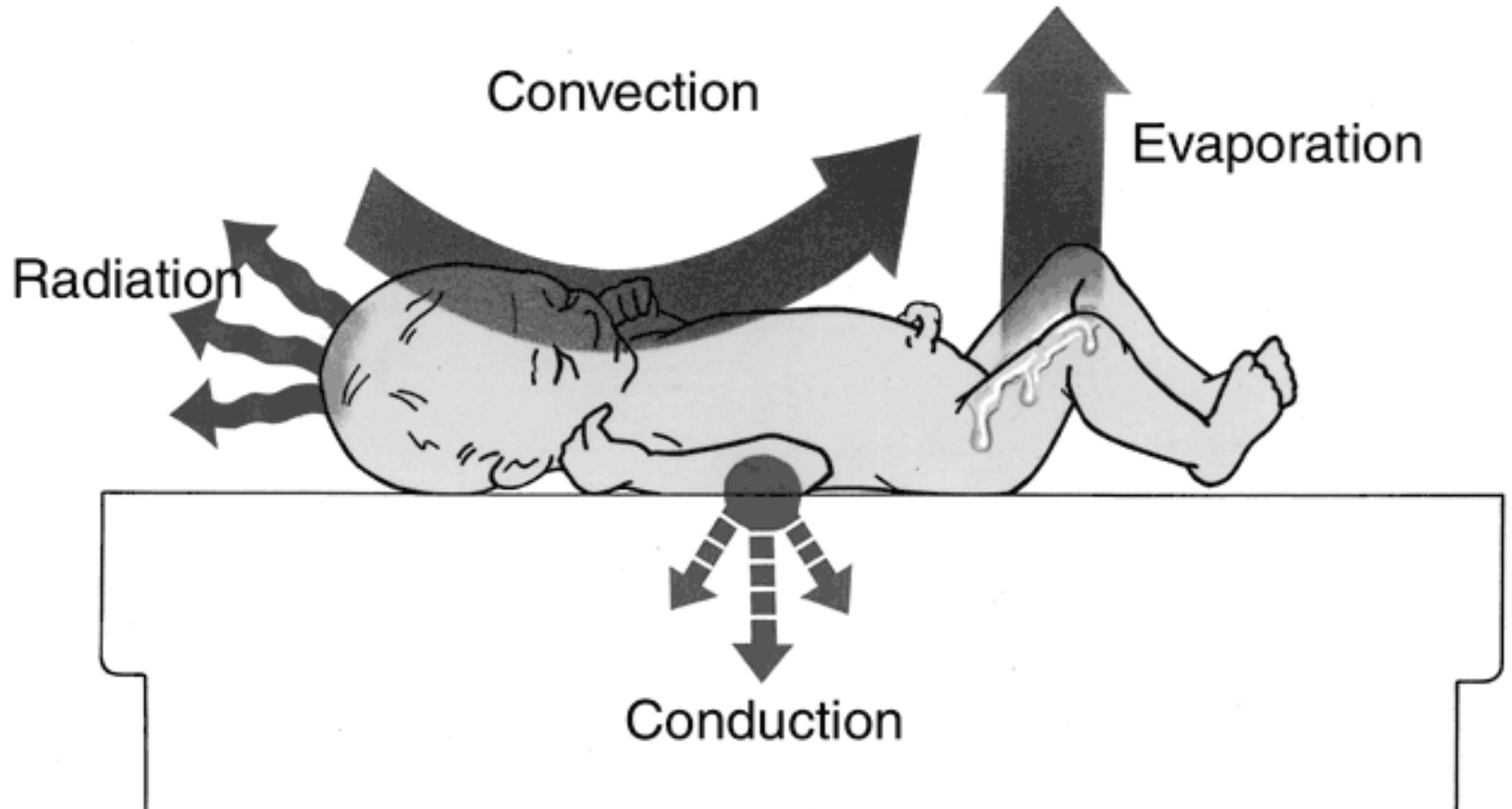

4/24/2020

Mechanism of heat loss

216

1. Convection:

- Heat is lost from the skin to moving air
- Convective heat loss depends on the temperature difference between the skin and the air, the area of surface exposed and the speed of movement of the air
- The cooler the air and the stronger the wind velocity is the greater the convective heat loss from a baby's skin

Mechanism of ...

217

2. Conduction:

- If a body is in contact with another solid body of different temperature, heat flows between the two
- Conductive heat loss is small in the newborn baby, since it is unusual for an infant to be laid on a cold surface

Mechanism of ...

218

3. Radiation:

- It is the transfer of heat between objects of higher temperature to the next solid object of lower temperature, which is opaque to the frequency of electromagnetic photons involved
- It is the transfer of heat from the baby to a colder object in his or her environment
- It is just like heat loss from the baby to the wall, window, floor, etc

Mechanism of ...

219

- This is a major source of heat loss in a newborn baby immediately after birth and while giving bath
- A baby loses as much heat when water is evaporated from his skin, same as evaporation from boiling water
- Large surface area of contact, greater wind velocity and most important thinner stratum corneum of the baby are associated with higher evaporative heat loss

Mechanism of heat production

220

1. Muscular activity:

- During exposure to cold, baby feels uncomfortable, cries and makes some movements of limbs, but the effort is not sustained
- Shivering does occur but it is minimal
- It appears only when the environmental temperature falls below 25°C
- Thus, muscular activity is not a significant source of heat production in newborns

... heat production

221

2. Metabolic thermogenesis

- Non-shivering thermogenesis as a result of **metabolism of the brown fat is the most important source of heat production** in the newborn baby
- The fetal brown fat is produced mostly during the 3rd trimester of pregnancy and is located at the nape, the neck, intra-scapular region, axilla, and groin and around kidneys and adrenals

... heat production

222

- ❑ **Brown fat**
- ❑ Is characterized by a rounded nucleus, granular cytoplasm with a large number of mitochondria and fat vacuoles
- ❑ The quantity of brown fat is directly related to the birth weight & gestational age of the baby
- ❑ In term baby, it accounts for 4% of the total body fat

... heat production

223

- ❑ **The role of CNS in metabolic thermogenesis**
- ❑ Cold skin → afferent neurons → heat regulating center in the anterior hypothalamic area → neurogenic efferent pathway → brown fat trigger the local release of noradrenalin → so that triglycerides are oxidized to glycerol & fatty acids
- ❑ The blood level of glycerol rises but fatty acids are locally consumed for the generation of heat

... heat production

224

- About 30% of non esterified fatty acid is oxidized to generate heat
- 60% of the fatty acid is re-esterified and 10% are released in the circulation
- The areas of brown fat become warm and heat is distributed to various parts of the body through blood stream
- The baby needs extra oxygen and glucose for this metabolic effort to keep itself warm

... heat production

225

- ❑ **Effective metabolic thermogenesis demands:**
- ❑ Integrity of CNS pathways
- ❑ Adequacy of brown fat
- ❑ Availability of glucose & oxygen
- ❑ Normal birth weight & term gestational age

Optimal thermal environment

226

- Heat loss can be minimized by keeping infants in neutral-thermal environment
- **Thermo-neutral environment:** the narrow range of environmental temperature at which a given baby can maintain normal body temperature with minimal fuel (and possibly minimum oxygen consumption)
- A fall in the environmental temperature by 2°C below the neutral range can trigger infant's metabolic machinery to generate 25% of additional heat

Thermo-neutral environment

227

Age	Weight in gram			
	<1,200	1,200- 1,500	1,501- 2,500	>2,500
1 st day	35.0 \pm 0.5	34.3 \pm 0.5	33.4 \pm 1.0	33.0 \pm 1.0
2 nd day	34.5 \pm 0.5	33.7 \pm 0.5	32.7 \pm 1.0	32.2 \pm 1.0
3 rd day	34.0 \pm 0.5	33.5 \pm 0.5	33.0 \pm 1.0	32.0 \pm 1.0
4 th day	33.5 \pm 0.5	32.8 \pm 0.5	32.2 \pm 1.0	31.5 \pm 1.0

Manual of neonatal basic life support, 2nd edition

4/24/2020

Thermo-neutral ...

228

- The environmental temperature at which the metabolic response becomes necessary is called **critical temperature**
- Hypothermia is caused more by **lack of knowledge** rather than lack of equipment
- Hypothermia can be prevented by strictly following **the warm chain system**

Warm chain system

229

- It is a system of keeping a baby in a thermo-neutral environment, immediately after delivery, in the delivery room, postpartum ward, during transportation and while nursing the baby at home

Warm chain system ...

230

□ **Components**

1. Immediate drying
2. Warm resuscitation
3. Skin-to-skin contact with the mother
4. Immediate initiation of breast-feeding
5. Bathing & weighting postponed
6. Appropriate clothing & bedding
7. Warm transportation

Hypothermia

231

- **Hypothermia** in a newborn baby is defined as skin temperature of $<36.5^{\circ}\text{C}$ or core temperature of $<35.5^{\circ}\text{C}$
- **Classification**
 1. Mild hypothermia (cold stress): $36-36.4^{\circ}\text{C}$
 2. Moderate hypothermia: $32-35.9^{\circ}\text{C}$
 3. Severe hypothermia (neonatal cold injury): less than 32°C

Causes of hypothermia

232

- ❑ **External factors**
- ❑ Cold environment
- ❑ Wet or naked baby
- ❑ Cold linen
- ❑ During transportation
- ❑ Bath too early or in a room that is cold or with wind
- ❑ Blood sampling, IV infusion & surgery

Causes ...

233

□ Internal factors

- **Poor ability to conserve heat:** relatively large surface area, poor insulation, paucity of fat, inability to reduce the effective surface area by assuming flexed posture & poor muscle tone
- **Poor metabolic heat production:**
 - Deficiency of brown fat
 - Problems in CNS pathway
 - Hypoxia
 - Hypoglycemia

Core S/S of hypothermia

234

1. Peripheral vasoconstriction

- Acrocyanosis
- Cold extremities
- Decreased peripheral perfusion

2. CNS depression

- Lethargy
- Poor feeding
- Apnoea & bradycardia

... S/S of hypothermia

235

3. Increased metabolism

- Hypoglycemia
- Hypoxia
- Metabolic acidosis

4. Increased pulmonary arterial pressure

- Tachypnea
- Respiratory distress

Management of hypothermia

236

- ❑ **Warm the baby:**
- ❑ Warming using the Kangaroo Mother Care system (KMC)
- ❑ Warming in an open care using a radiant heater
- ❑ Warming in an incubator
- ❑ **Treat hypoglycemia & hypoxia**
- ❑ **Other symptomatic treatments**



4/24/2020

Jaundice

Neonatal jaundice

238

- ❖ Define neonatal jaundice
- ❖ Differentiate between physiological and pathological jaundice
- ❖ List cause of neonatal jaundice
- ❖ Describe risk factor for bilirubin encephalopathy
- ❖ Describe complication of neonatal jaundice
- ❖ Explain management of unconjugated hyperbilirubinemia

Neonatal jaundice

239

- ***It*** is a yellowish discoloration of the skin and or sclera due to **bilirubin deposition**.
- In newborns, jaundice appears when total bilirubin (TB) is more than 7 mg /dl and almost 97 % healthy full term babies have biochemical hyperbilirubinemia.
- Neonatal jaundice can be classified as either **physiologic or pathologic**.

Healthy baby



Baby with severe jaundice



Neonatal jaundice

Jaundice can be **physiological** or **pathological**

241

□ **Pathological jaundice:**

- ✓ jaundice started on the first day of life
- ✓ Jaundice lasting longer than 14 days in term, 21 days in preterm infants
- ✓ Jaundice with fever
- ✓ Deep jaundice: palms & soles of the baby are deep yellow
- **Physiological:** skin & eyes yellow but none of the above

Clinical jaundice

242

- ❑ **Appearing b/n 24-72 hours due to the following factors.**
- ❑ Prematurity
- ❑ Birth asphyxia
- ❑ Hypothermia
- ❑ Hypoglycemia
- ❑ Cephalohematoma

- ❑ **Appearing after 72 hours & with in 2 weeks of life**
- ❑ Sepsicemia
- ❑ Serious bacterial infection
- ❑ Haemolytic disease due to blood group incompatibility or G6PD
- ❑ Congenital syphilis or other intrauterine infection
- ❑ Liver disease such as hepatitis or biliary atresia
- ❑ Hypothyroidism
- ✓ Prematurity

Comparison b/n physiological from Pathological Jaundice

<i>No</i>	<i>Features</i>	<i>Physiologic Jaundice</i>	<i>Pathological Jaundice</i>
1	Clinical onset of jaundice (after birth)	>24 hrs	<24 hrs
2	Jaundice still clinically visible (day after birth)	Term < 8 days Preterm < 14 days	Term \geq 8 days Preterm > 14 days
3	Peak TSB	Term < 12 mg/dl Preterm < 15 mg/dl	Term > 12 mg/dl Preterm > 15 mg/dl
4	Rise in TSB	< 5mg/dl/24 hrs	> 5mg/dl/24 hrs
5	Conjugated serum bilirubin level	<2mg/dl	>2mg/dl or 15 % of TB

Causes

245

- ***Isoimmunization:*** RH incompatibility, ABO incompatibility, Other blood group incompatibility
- ***Infection:*** Bacterial, viral, protozoal
- ***Sequestered blood:*** Subgaleal hemorrhage, cephalhematoma, ecchymosis, hemangioma

- ***Erythrocyte biochemical defect:*** G6PD deficiency, Hexokinase deficiency
- ***Structural abnormalities of erythrocytes:*** Hereditary spherocytosis, elliptocytosis
- ***Disorder of hepatic uptake:*** Gilbert syndrome
- ***Disorder of conjugation:*** Crigler-Najjar syndrome (absence of UGT activity)
- ***Hypothyroidism:*** Disorder of enterohepatic circulation

Manifestations

247

- A newborn presents with yellowish discoloration of sclera, skin, mucus membranes
- Depending on **severity and time of presentation** a newborn may present with signs of bilirubin encephalopathy.

The following risk factors aggravate bilirubin encephalopathy

248

- Prematurity
- Metabolic acidosis,
- Hypoglycemia,
- Sepsis,
- Temperature instability,
- Significant lethargy
- Low serum albumin

Complications of hyperbilirubinemia

249

Acute bilirubin encephalopathy

It is an **early bilirubin toxicity**, which is transient and reversible.

If it is not recognized or untreated, it may progress to permanent neurologic impairment-**Kernicterus**

Be aware

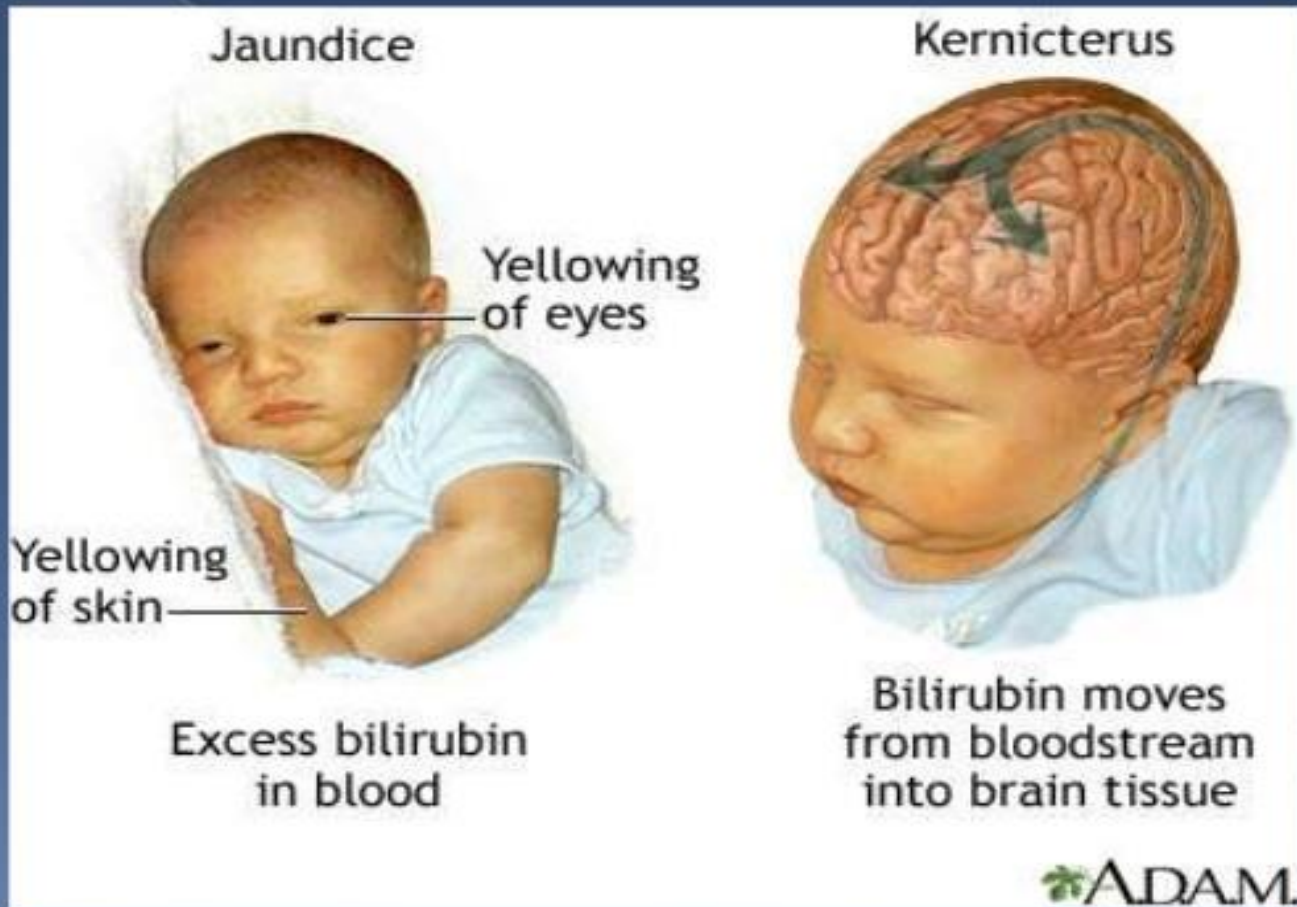

Con.....d

251

- **Acute bilirubin encephalopathy has three phases**
 - ✓ **Phase -1** (1st – 2 Days Of Age):
 - Poor motor reflex, high pitched cry, Decreased tone, lethargy, poor feeding
 - ✓ **Phase- 2** (middle of 1st week age):
 - Hypertonia, seizure and depressed sensorium, fever, opisthotonos posturing, paralysis of upward gazing.
 - ✓ **Phase -3** (after 1 week of age):
 - Hypertonia decreases, Hearing and visual abnormality, poor feeding, and seizure may also occur

Investigations

252

- Total bilirubin
- Direct and indirect bilirubin
- Maternal blood group and RH type
- Neonatal blood group and RH type
- Direct/indirect Coombs test
- Hemoglobin (Hgb) or hematocrit (HCT)
- Peripheral RBC morphology

APPROACH

253

- TSB= $>7\text{Mg/dl}$
- A complete history and examination is warranted to identify the cause and to differentiate the type.

Clinical assessment

254

- Progressed in cephalo-caudal direction
- Face=5-7mg/dl
- Level of chest= 10 mg/dl
- Lower abdomen/thigh= 12 mg/dl
- Sole/palm stained yellow= \geq 15mg/dl

Management

255

The main goal of treatment is to avoid acute and chronic bilirubin encephalopathy by reducing serum bilirubin level.

Principles of treatment include:

- *Phototherapy*
- *Exchange transfusion*
- *Other medical management*

Neonatal sepsis

256

- **Sepsis:** any systemic bacterial infection in the first month of life documented by a positive culture

Classification

257

I. According to the time of onset:

1. **Early onset neonatal sepsis (EONS):** from birth to 7 days
2. **Late onset neonatal sepsis (LONS):** 7-30 days

II. According to culture result:

1. **Proved or confirmed sepsis:** clinical findings with positive culture
2. **Suspected or probable sepsis:** sign & symptom of sepsis but negative culture

Classification ...

258

III. According to the severity of sepsis (staging)

1. Systemic inflammatory response syndrome (SIRS)

□ Characteristics

- ✓ Temperature $\geq 37.5^{\circ}\text{C}$ or $\leq 36.5^{\circ}\text{C}$
- ✓ AHB ≥ 160 beats/minute
- ✓ RR ≥ 60 /minute
- ✓ WBC $\geq 20 \times 10^3$
- ✓ Increased ESR

2. Sepsis: SIRS + positive culture

Classification ...

259

3. Grave sepsis or septicemia:

Sepsis + serious S/S of sepsis like:

- Metabolic disorder (acidosis, persistent hypoglycemia, etc
- Fluid & electrolyte imbalance
- Neurological impairment
- Poor perfusion
- Bleeding disorder (anemia, thrombocytopenia, pancytopenia, DIC, etc

Classification ...

260

4. **Septic shock:** grave sepsis (septicemia) + hypotension or shock associated with organ dysfunction (could respond to proper therapy)
5. **Overwhelming sepsis:** septic shock + multiple organ failure which does not respond to any therapy

Early Onset Neonatal Sepsis (EONS)

261

- EONS is caused by organisms prevalent in the maternal genital tract or in the labor room and maternity operation theatre
- In developing countries most cases are due to E coli, Klebsiella, group D and other Entrobacter species

EONS-risk factors

262

- **Postnatal age:** usually <120 hours (5 days)
- **Gestational age:** more in premature neonates but does not exclude term neonates
- **Birth weight:** more common in LBW, VLBW, ELBW but does not exclude normal weights or overweights
- **Prenatal maternal history:** fever, vaginosis, UTI, etc
- **Perinatal conditions:** lots of manipulation, prolonged labor, etc

... risk factors

263

- **Low APGAR score, fetal distress, passage of meconium; does not exclude normal APGAR neonate**
- **Time of rupture of membrane:>18 hours**
- **Chorioamnionitis**

EONS-sign & symptoms

264

- Hypothermia or hyperthermia
- Hypoglycemia
- Failure to suck
- Respiratory distress, apnoea, cyanotic episodes
- Unexplained jaundice
- Umbilical flare, skin rashes
- Seizure, and in severe cases bleeding disorders

Investigations

265

- Ward routine: blood group, RH factor, blood glucose, Hct, Hgb
- CBC with differentials (specially absolute neutrophil count)
- Blood culture
- Chest X-ray
- Prothrombin time (PT) , Partial Thromboplastin Time (PTT)
- Electrolytes & blood gas
- BUN, creatinine
- LFT

Management

266

1. General management:

- ❑ General neonatal care
- ❑ Maintain fluid & electrolyte accordingly (if there is RDS & meningitis, do not exceed $>60\text{ml/kg}$)
- ❑ No electrolytes for the first 24 hours of life except calcium
- ❑ Maintain Hct $\geq 45\%$
- ❑ Preferably NPO for the first 24 hours

Management ...

267

2. Antibiotics

□ Indications

- Any neonate with risk factors & clinical features of sepsis
- **Initially:** 1st line antibiotics (GBS, E. Coli, Listeria)
 - Ampicillin 100 to 200mg/kg/dose every 12 hours
 - Gentamycin 3 to 7.5mg/kg/d in two divided doses

Antibiotics ...

268

- **After 24 hours:** review clinical progress & microbiology results
 - a. If cultures negative, consider stopping therapy
 - b. Continue therapy if cultures positive or sepsis very likely
 - c. Add **Metronidazole** if suspicion of anaerobic infection (e.g. Intra-abdominal sepsis, NEC)
 - d. Consider **Vancomycin** for Coagulase negative Staphylococcal sepsis, especially if neonate is very sick or there is central line infection
 - e. change to **Cefotaxime** if there is neonatal meningitis

Antibiotics ...

269

Infection type	Duration (days) of therapy
Pneumonia	5-7
Septicemia	7-10
UTI	7-10
Meningitis	14-21 (depending on organism isolated)
Skin conditions	5-14
Conjunctivitis	5-7
Oral thrush	7-10

Consecutive follow up

270

- Control temperature
- Control fluid and electrolyte balance
- Monitor input & output, weight, glycaemia
- Control Hct
- Record daily progress of S/S
- Oral feeding
- In 3-5 days, if there is no improvement, consider 2nd line antibiotics

Late Onset Neonatal Sepsis (LONS)

271

□ **Types**

1. Community acquired infections
2. Hospital acquired infections

□ **Causes**

- GBS, gram negatives like E. Coli & Klebsiella, Streptococcus pneumonia, Neisseria meningitides, Listeria, Staph. aureus, Candida albicans, etc

Common presenting clinical diseases

272

- Acute gastro enteritis (AGE)
- Pneumonia
- Skin infection
- Omphalitis
- Mastitis with or without abscess
- Meningitis
- UTI
- NEC

Investigations

273

- CBC
- Blood culture
- CSF analysis
- ESR
- According to the clinical presentation: gram stain of different specimen (urine, stool, CSF, pus or other fluid)
- According to onset or clinical stage: blood gas analysis, BUN and creatinine, LFT with Bilirubin, and electrolytes
- Radiologic studies if necessary (US, CT scan etc)

Investigation

274

- ❑ **Contraindications of LP:**
- ❑ EONS
- ❑ Respiratory distress
- ❑ Local skin lesions
- ❑ Signs of increased intracranial pressure

Management

275

- General management and follow up are the same as EONS
- Specific management depends on:
 - ✓ Culture & sensitivity result
 - ✓ Condition of the neonate
- All suspected cases of meningitis should be treated with high dose of proper antibiotics
- If there are skin infections, start cloxacillin immediately
- If the neonate looks critical, treat with 2nd line antibiotics

Management ...

276

- ❑ **Evaluate and monitor:**
- ❑ Blood glucose
- ❑ Weight
- ❑ Air way
- ❑ Hct
- ❑ Fluid & electrolyte
- ❑ Body temperature
- ❑ General care
- ❑ Feeding

TORCH Group of infections

□ The word **TORCH** is acronym for:

T – Toxoplasmosis

O – Others

R – Rubella

C – Cytomegalovirus

H – Herpes

□ ‘Others’ include: hepatitis B infection & HIV infection

Reading assignment

1. Neonatal tetanus
 2. Ophthalmia neonatrum
- ❑ Give emphasis for the following points:
 - ✓ Risk factors
 - ✓ Time duration
 - ✓ Key clinical presentations or syndrome statement
 - ✓ Mechanism of disease
 - ✓ Management: both medical & nursing

References

- ANJIAH, B. 2009. *Clinical paediatrics*, Hyderabad, New Delhi, PARAS Medical publisher.
- ETHIOPIAN CENTRAL STATISTICAL AGENCY, 2011. Ethiopia Demographic and Health Survey. Addis Ababa.
- FEDERAL DEMOCRATIC REPUBLIC OF ETHIOPIA MINISTRY OF HEALTH 2011. Training course in management of severe acute malnutrition. Addis Ababa.
- GESSESSE, M. 2010. *Protocol of common newborn problems*. , Yekatit 12 Hospital.
- GOWRISHANKAR, N., LAKSHMI, S., RAVIKUMAR, T. & VIJAYAKUMAR, M. 2006. *Management update for common pediatric problems*, New Delhi, JAYPEE brothers
- KASSAYE, A. 2008. *Manual of neonatal basic life support*.
- SANTROCK, J. W. 2007. *Child development* New Delhi, Tata McGraw-Hill.
- TEMA, T. & HAILU, C. 2006. *Paediatric and child health nursing for health science students: upgraded lecture note*. Jimma University.
- UNITED NATIONS 2008. The Millennium Development Goals Report. New York.

280

UNIT IV: Common childhood diseases

4/24/2020

281

RESPIRATORY SYSTEM DISORDERS

4/24/2020

LEARNING OBJECTIVES

282

At the end of this topic the student will be able to:

- Discuss the respiratory pathophysiology and regulation
- Analyze child presenting with an airway or severe breathing problem
- Manage the selective childhood respiratory disorders

INTRODUCTION

283

- Children are not small adults, their lungs are not miniature versions of adult lungs.
- The lungs undergo enormous growth and development during the first few years of life, and
- marked changes also occur in the mechanical properties

Respiratory Pathophysiology and Regulation

284

- The age- and growth-dependent changes:
 - **physiology and anatomy**
 - **respiratory control mechanism**
 - **airway dynamics and**
 - **lung parenchymal characteristics** have a profound influence on the pathophysiologic manifestations of the disease process.

Why are kids different?

285

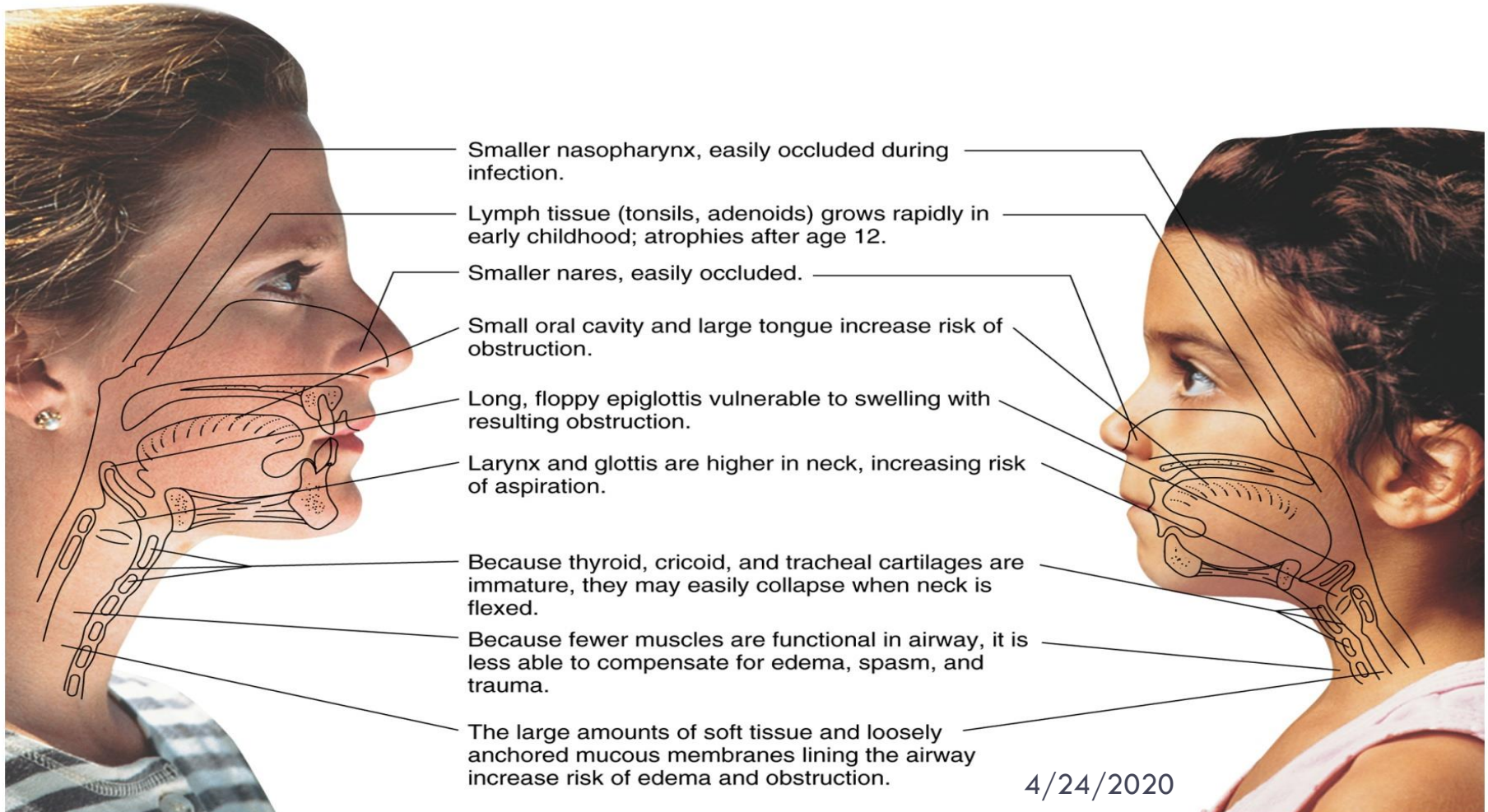

4/24/2020

Child presenting with an airway or severe breathing problem

286

History

- Onset of symptoms: slowly developing or sudden onset
- Previous similar episodes
- Upper respiratory tract infection
- Cough -duration in days & type of cough
- History of choking
- Voice change
- Presence of fever
- Present since birth, or acquired
- Immunization history
- Family history of asthma

Examination

- Cough - quality of cough
- Cyanosis
- Chest indrawing
- Respiratory rate count
- Grunting
- Stridor, abnormal breath sounds
- Nasal flaring
- Swelling of the neck
- Crepitations
- Wheezing – Generalized or Focal
- Reduced air entry – Generalized or focal

4/24/2020

Investigations

287

- CBC, ESR
- Pulse oximetry
- Chest X-ray
- Sputum for AFB
- Tuberculin Skin Test

DDx of child presenting with cough or difficult breathing

288

- Pneumonia
- Malaria
- Severe anaemia
- Cardiac failure
- Tuberculosis
- Pertussis
- Foreign body
- Effusion/empyema
- Pneumothorax
- Pneumocystis
Pneumonia (PCP)

Typical causes of distress

289

- Upper airway
 - ▣ Croup
 - ▣ Retropharyngeal abscess
 - ▣ Epiglottitis
 - ▣ Foreign body aspiration
- Lower airway
 - ▣ Reactive airway disease / asthma
 - ▣ Bronchiolitis
 - ▣ Pneumonia
 - ▣ Pneumothorax

Signs & symptoms of distress

290

- Nasal flaring
- Hypoventilation, apnea
- Stridor
- Grunting
- Wheezing
- Pallor, ashen color
- ↑ WOB
- Tachypnea
- Cyanosis
- Head nodding
- Tripod positioning
- Retractions
- ↓ Level of consciousness
- ↓ Air movement
- Acidosis
- Hypercapnea

4/24/2020

ACUTE PHARYNGO-TONSILLITIS

291

- Inflammatory syndrome of the oropharynx primarily caused by infection.
- Frequent upper airway infections in children and teenagers.

ETIOLOGY

- usually viral, most often caused by the common cold viruses (adenovirus, rhinovirus, influenza, coronavirus, and respiratory syncytial virus), but occasionally by Epstein-Barr virus, herpes simplex virus, cytomegalovirus, or HIV.

ETIOLOGY cont...

292

- In about 30% of patients, the cause is **bacterial**. Group A β -hemolytic streptococcus (GABHS) is most common but Staph. aureus, Strepto. pneumoniae, Mycoplasma pneumoniae, and Chlamydia pneumoniae are sometimes involved.
- GABHS occurs most commonly between ages 5 and 15 and is uncommon before age 3.
- Rarely-pertussis, Fusobacterium, diphtheria, syphilis, and gonorrhea.

Clinical Feature

293

- Pain with swallowing is the hallmark and is often referred to the ears.
- Very young children who are not able to complain of sore throat often refuse to eat.
- High fever, malaise, headache, and GI upset are common, as are halitosis and a muffled voice.
- The tonsils are swollen and red and often have purulent exudates.
- Tender cervical lymphadenopathy may be present.

Clinical Feature cont...

294

- Adenopathy
- Palatal petechiae, and exudates are somewhat more common with GABHS than with viral tonsillopharyngitis, but there is much overlap.
- GABHS usually resolves within 7 days.
- Untreated GABHS may lead to serious complications

CHRONIC INFECTION

295

- The tonsils and adenoid can be chronically infected by multiple microbes
- Children with chronic **or cryptic** tonsillitis
 - frequently present with **halitosis**
 - chronic sore throats
 - foreign body sensation
 - or a history of expelling foul-tasting and smelling cheesy lumps.
 - Examination may reveal tonsils of almost any size and, frequently, they contain copious debris within the crypts.

Complications of GA β HS

296

Suppurative

- Peritonsillar abscess
- Retropharyngeal abscess
- Otitis media
- Sinusitis

Non-suppurative

- Acute rheumatic fever
- Acute glomerulonephritis

MANAGEMENT

297

- Most untreated episodes of streptococcal pharyngotonsillitis resolve uneventfully in a few days, but early antibiotic therapy hastens clinical recovery by 12–24 hr.
- The primary benefit of treatment is the prevention of acute rheumatic fever, which is almost completely successful if antibiotic treatment is instituted within 9 days of illness

MANAGEMENT cont...

298

- A variety of antimicrobial agents are effective.
- GABHS remains universally **susceptible to penicillin**, which has a narrow spectrum and few adverse effects.
- **Benzathin Penicillin** 600,000 IU IM stat for children <27 kgs of weight and 1.2 million IU IM stat for children >27kgs of weight

OR

- **Amoxicillin** 20- 40mg/Kg/d po in three divided doses for 10 days
- For patients allergic to penicillin , **Erythromycin** 40 mg/kg/d in four divided doses for 10 days
- Follow up in two days if no improvement

4/24/2020

MANAGEMENT cont...

299

- ❑ Children with cryptic tonsillitis may be able to express tonsillolith or debris manually with either a cotton-tipped applicator or a water jet.
- ❑ Thanks to antibiotic treatment, fewer children are being submitted to tonsillectomy surgery because of recurrent or chronic pharyngotonsillitis.
- ❑ In resistant cases of cryptic tonsillitis, **tonsillectomy** may be curative.
- ❑ **Indications for surgery remain uncertain**

ACUTE INFLAMMATORY UPPER AIRWAY OBSTRUCTION

300

- **Croup**
- **Epiglottitis**
- **Laryngitis**
- **Bacterial Tracheitis**

GENERAL CONSIDERATIONS

301

- Resistance is determined chiefly by the radius or size of the airway through which the air is flowing
- Minor reductions in cross-sectional area due to mucosal edema or other inflammatory processes cause an exponential increase in airway resistance and a significant increase in the work of breathing.

CONSIDERATION

302

- The cricoid cartilage encircles the airway just below the vocal cords and defines the narrowest portion of the upper airway in children younger than 10 yr of age.
- Inflammation involving the vocal cords and structures inferior to the cords is called laryngitis, laryngotracheitis, or laryngotracheobronchitis
- Croup typically affects the larynx, trachea, and bronchi

CROUP (LaryngoTracheoBronchitis)

303

- The term croup refers to a heterogeneous group of mainly acute and infectious processes that are characterized by a bark like or brassy cough and may be associated with hoarseness, inspiratory stridor, and respiratory distress resulting from upper airway obstruction.
- Usually have sudden onset
- The term is given mainly for *viral origin*

Etiology

304

□ Viral

- Parainfluenza viruses (75% of cases).
- influenza A and B, Measels, adenovirus & RSV

□ Bacterial

- Mycoplasma Pneumonea

□ Allergy

- Spasmodic croup

Pathophysiology

305

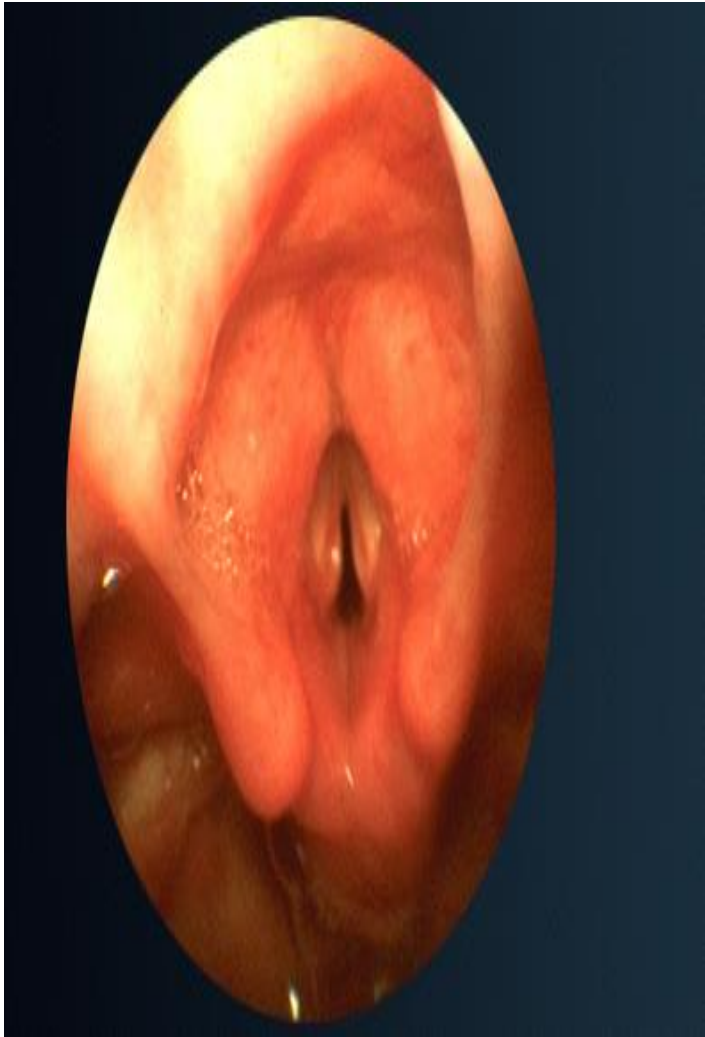

Subglottic narrowing due to inflammation

↓
Cricoid ring allows fixed area for obstruction
(1mm swelling causes 65% obstruction in infant)

↓
Atelectasis/mucus plugging

↓
Ventilation/perfusion mismatch

↓
Negative intrapleural pressure

↓
Pulmonary edema

Hypoxia

4/24/2020

Clinical manifestation

306

Prior to obstruction

- upper respiratory tract infection with rhinorrhea
- pharyngitis
- mild cough
- low grade fever

After obstruction

- barking cough
- hoarseness
- inspiratory stridor
- fever
- coryza
- inflamed pharynx
- Tachypnea

CM cont...

307

□ **sever**

- nasal flaring
- suprasternal, infrasternal and intercostal retraction
- continuous stridor
- hypoxia, decreased oxygen saturation (<95%)

□ **The diagnosis of croup is clinical**

- History and physical examination

The modified Westley clinical scoring system for croup

308

- **Inspiratory stridor:**
 - Not present - 0
 - When agitated/active - 1
 - ▣ At rest - 2 points.
- **Intercostal recession:**
 - ▣ Mild - 1 point.
 - ▣ Moderate - 2 points.
 - ▣ Severe - 3 points.
- **Air entry:**
 - ▣ Normal - 0
 - ▣ Mildly decreased - 1
 - ▣ Severely decreased - 2 points
- **Cyanosis:**
 - ▣ None - 0 .
 - ▣ With agitation/activity - 4 points.
 - ▣ At rest - 5 points.
- **Level of consciousness:**
 - ▣ Normal - 0 point.
 - ▣ Altered - 5 points

**<4 = mild croup,
4-6 = moderate croup
>6 =severe croup**

Management

309

- Nubilised epinephrine
 - 0.5mg/kg 1:1 000 dilution inhaled over 15-20 minute PRN
- Corticosteroids
 - dexamethasone used a *single dose of 0.15- 0.6 mg/kg*
IM/IV/Oral stat
- Antibiotic
 - Incase of bacterial croup

Management cont...

310

- ❑ In child with severe croup who is deteriorating, consider **Intubation and tracheotomy**
 - If there are signs of incipient airway obstruction, such as severe indrawing of the lower chest wall and restlessness, intubate the child immediately.
 - If this is not possible, transfer the child urgently to a hospital where **intubation or emergency tracheotomy** can be done.
 - If this is not possible, monitor the child closely and ensure that facilities for an **emergency tracheotomy** are immediately available, as airway obstruction can occur suddenly.

Supportive care

311

- Don't disturb the child
- If the child has fever ($\geq 39^{\circ} \text{C}$ or $\geq 102.2^{\circ} \text{F}$) which appears to be causing distress, give paracetamol.
- Encourage breastfeeding and oral fluids.
- Children on croup tent should be on iv fluid till they are out of it
- Encourage the child to eat as soon as food can be taken.

MONITORING

- The child's condition, especially respiratory status, should be assessed by nurses every 3 hours
- The child should occupy a bed close to the nursing station, so that any sign of incipient airway obstruction can be detected as soon as it develops.

4/24/2020

CHILDHOOD ASTHMA

312



4/24/2020

BRAINSTORMING

313

What do you mean?

- Atopy**
- Allergen**
- Hypersensitivity**

INTRODUCTION

314

A chronic inflammatory disease of the airways with the following clinical features:

- Episodic and/or chronic symptoms of airway obstruction
- Bronchial hyper responsiveness to triggers
- Evidence of at least partial reversibility of the airway obstruction
- Alternative diagnoses are excluded
- Most common childhood chronic disease

ETIOLOGY cont...

315

Usually has not been determined, contemporary research implicates a combination of :

- Environmental exposures
- Inherent biological and
- Genetic vulnerabilities

Etiology and Pathogenesis

316

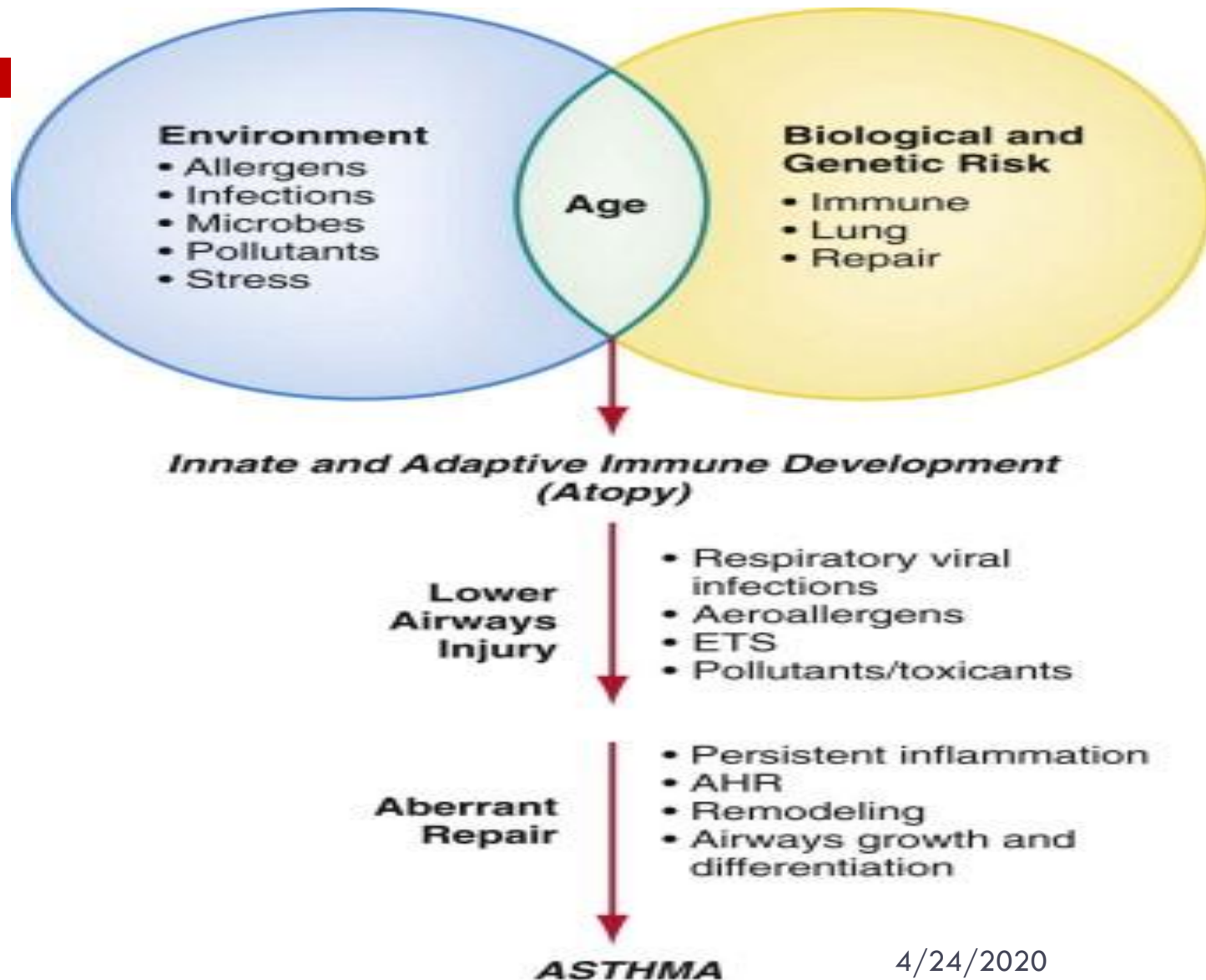

4/24/2020

Types of Childhood Asthma

317

Main types of childhood asthma:

- **Recurrent wheezing** in early childhood
- **Chronic asthma** associated with allergy that persists into later childhood and often adulthood.
- **Triad asthma** associated with hyperplastic sinusitis/nasal polyposis and hypersensitivity to aspirin and non-steroidal anti-inflammatory medications (ibuprofen), rarely has its onset in childhood.
- ❖ The most common persistent form of childhood asthma is that associated with allergy

Clinical manifestation

318

Wheezing is the most characteristic sign of asthma.

Wheezing with upper respiratory infections is very common in small children, but:

- Many of these children will not develop asthma.
- Asthma medications may benefit patients who wheeze whether or not they have asthma.

All that wheezes is not asthma

C/M cont'd

319

❖ cough and shortness of breath.

Consider asthma in children with:

- Recurrent episodes of cough with or without wheezing
- Nocturnal awakening because of cough
- Cough that is associated with exercise/play
- Cough without wheeze is often not asthma

Cough may be the only symptom present in patients with asthma.

C/M cont'd

320

- ❑ Symptoms may include "chest congestion," prolonged cough, exercise intolerance, dyspnea, and recurrent bronchitis or pneumonia.
- ❑ As the obstruction becomes more severe, wheezes become more high-pitched and breath sounds diminished
- ❑ Flaring of nostrils
- ❑ intercostal and suprasternal retractions
- ❑ Flushed, moist skin may be noted, and mucous membranes may be dry
- ❑ Cyanosis

Asthma Predictive Index

321

≥4 wheezing episodes in the past year
(at least one must be diagnosed)

PLUS

OR

One major criterion

- Parent with asthma
- Atopic dermatitis/eczema
- Aero-allergen sensitivity

• Two minor criteria

- Food sensitivity
- Peripheral eosinophilia (≥4%)
- Wheezing not related to infection

Modified from: Castro-Rodriguez JA, Holberg CJ, Wright AL, et al. A clinical index to define risk of asthma in young children with recurrent wheezing. *Am J Respir Crit Care Med.* 2000;162(4 Pt 1):1403–1406

Classification of Asthma Severity

322

CLASSIFICATION	STEP	DAYS WITH SYMPTOMS	NIGHTS WITH SYMPTOMS
Severe persistent	4	Continual	Frequent
Moderate persistent	3	Daily	>1/wk
Mild persistent	2	>2/wk, but <1 time/day	>2/mo
Mild intermittent	1	≤2/wk	<2/mo

Four Components of Optimal Asthma Management

323

1. Regular assessment and monitoring
2. Control of factors contributing to asthma severity
3. Asthma pharmacotherapy
4. patient education

Stepwise approach Rx. for Chronic Treatment of Asthma

324

TYPE	SYMPTOMS (DAY/NIGHT)	FEV ₁	Medications
Severe persistent	Continual Frequent	≤ 60%	High-dose inhaled corticosteroids + long-acting inhaled β ₂ -agonists. Possible PO steroids. PRN short-acting bronchodilator.
Moderate persistent	Daily > 1 night/week	60–80%	Low- to medium-dose inhaled corticosteroids + long-acting inhaled β ₂ -agonists. PRN short-acting bronchodilator.
Mild persistent	> 2/week but < 1/day > 2 nights/month	≥ 80%	Low-dose inhaled corticosteroids. PRN short-acting bronchodilator.
Mild intermittent	≤ 2 days/week ≤ 2 nights/month	≥ 80%	No daily medications. PRN short-acting bronchodilator.

4/24/2020

Management

325

- Classify severity: assign patient to most severe step in which any feature occurs (PEF is % of personal best; FEV₁ is % predicted).
- Gain control as quickly as possible (consider a short course of systemic corticosteroids); then step down to the least medication necessary to maintain control.
- The stepwise approach is intended to assist, not replace, the clinical decision making required to meet individual patient needs.
- Provide education on self-management and controlling environmental factors that make asthma worse (e.g., allergens and irritants).
- Refer to an asthma specialist if there are difficulties controlling asthma or if step 4 care is required.
- Referral may be considered if step 3 care is required.

Management of Asthma Exacerbations

326

- For patients with moderate to severe exacerbations that do not adequately improve within 1–2 hr of intensive treatment, overnight observation and/or admission to the hospital is likely to be needed.
- Supply Frequently or continuously administered inhaled bronchodilator,
- Systemic corticosteroid therapy are the conventional interventions for **status asthmaticus**
- Supplemental oxygen and with increasing SABA administration
- SABAs can be delivered frequently (every 20 min to 1 hr) or continuously (at 5–15 mg/hr).

COMPLICATIONS

327

- Hypoxemia and acidosis and can include generalized seizures
- Pneumomediastinum or pneumothorax can be a complication in **status asthmaticus**.
- Childhood asthma independent of any corticosteroid therapy has been shown to be associated with **delayed maturation and slowing of prepubertal growth velocity**.

PREVENTION

328

- Investigations into the environmental and lifestyle factor
- Avoidance of environmental tobacco smoke (beginning prenatally)
- prolonged breastfeeding (>6 mo)
- An active lifestyle, and a healthy diet—might reduce the likelihood of asthma development.

PNEUMONIA

329

- **Pneumonia** is an inflammatory process of the lung **parenchyma** (the functional tissue of lungs) that is commonly caused by infectious agents.

EPIDEMIOLOGY

- Childhood pneumonia is the leading single cause of mortality in children aged less than 5 years.
- In 2007, 9.2 million children died before age five globally.
- Africa and Asia together accounted for 92 percent of these deaths.
- Sub-Saharan Africa had an average under-five mortality rate of 172 deaths per 1,000 live births

EPIDEMIOLOGY

330

- Therefore, the African Region has the **highest** burden of global child mortality due to pneumonia.
- Although Africa comprises about 20% of the world's population of children aged less than 5 years, it has about 50% of worldwide deaths from pneumonia in under-5 age group.
- Two-thirds of all these deaths are concentrated in just 10 countries including Ethiopia.

Etiology

Community acquired	Hospital acquired
Streptococcus pneumoniae 31 (15-49)%	Staphylococcus aureus
Chlamydomphila pneumoniae 12 (0-32) %	Pseudomonas aeruginosa
Viruses 11 (0 –35) %	Escherichia coli
Haemophilus influenzae 9 (4 –22) %	Klebsiella pneumoniae
Aspiration 8 (6 –10) %	Enterobacter spec.
Legionella pneumophila 6 (0 –23) %	Haemophilus influenzae
Staphylococcus aureus 5 (0- 22) %	Streptococcus pneumoniae
Mycoplasma pneumoniae 5 (0 –13) %	Acinetobacter spp.
Gram neg. rods 4 (0 –18)%	Stenotrophomonas spec.
Unclear 45 (25-66) %	

Classification of pneumonia

332

Pneumonia can be classified based on the:

1. The cause
2. Area involved
3. Setting acquired
4. Clinical presentation
5. Severity of illness

Classification cont'd...

333

1. According to causes

- **Bacterial:** the most common cause of pneumonia
- **Viral** pneumonia
- **Fungal** pneumonia
- **Chemical** pneumonia: ingestion of kerosene or inhalation of irritating substance
- **Inhalation** pneumonia (aspiration pneumonia)

4/24/2020

Classification cont'd...

334

2. According to areas involved

- **Lobar pneumonia**; if one or more lobe is involved
- **Broncho-pneumonia**; the pneumonic process has originated in one or more bronchi and extends to the surrounding lung tissue.

3. According to the setting:

- Community acquired pneumonia
- Hospital acquired pneumonia
- Healthcare associated pneumonia=> a prospective cohort study done in Italy PICU showed that mechanical ventilation can lead to ventilator-associated pneumonia which in turn longer PICU stay, elongate hospital stay & increase mortality rate.

Classification cont'd...

335

4. According to clinical features

- Typical pneumonia
- Atypical pneumonia

5. According to the severity of illness (used in IMNCI)

- No pneumonia or cough or cold
- Pneumonia
- Severe pneumonia

Mode of transmission

336

Pneumonia can be acquired from:

- **Naso-oral florae:** bacteria and viruses living in the nose, sinuses, or mouth may spread to lungs.
- **Droplets infection:** directly breathe in some of these germs into our lungs .
- **Aspiration:** breathe in (inhale) food, liquids, vomit, or fluids from the mouth into your lungs

RISK FACTORS

337

Risk factors related to the **host** and the **environment** that affect incidence of childhood clinical pneumonia in the community in developing countries are:

- **Definite risk factors**
- ✓ Malnutrition (weight-for-age z-score < -2)
- ✓ Low birth weight (≤ 2500 g)
- ✓ Non-exclusive breastfeeding (during the first 6 months of life)
- ✓ Lack of measles immunization (within the first 12 months of life)
- ✓ Indoor air pollution
- ✓ Crowding
- ✓ Immuno-suppressed patients (HIV patients)

Risk factors...

338

- **Likely risk factors**
- ✓ Parental smoking
- ✓ Zinc deficiency
- ✓ Mother's experience as a caregiver
- ✓ Concomitant diseases (e.g. diarrhea, heart disease, asthma, liver disease, DM...)
- ✓ Difficult swallowing (due to stroke, or other neurological conditions)
- ✓ Impaired consciousness
- ✓ Chronic lung disease (**COPD**, bronchostasis)

Risk factors...

339

- **Possible risk factors**
- ✓ Mother's education
- ✓ Day-care attendance
- ✓ Rainfall (humidity)
- ✓ High altitude (cold air)
- ✓ Recent cold, laryngitis or flu
- ✓ Vitamin A deficiency
- ✓ Birth order
- ✓ Outdoor air pollution
- ✓ Frequent suction

Pathophysiology

340

- The streptococci reach the alveoli and lead to inflammation and pouring of an **exudates** into the air spaces.
- WBCs migrate to alveoli, the alveoli become more thick due to its filling consolidation, involved areas by inflammation are not adequately ventilated, due to secretion and edema.
- This will lead to partial occlusion of alveoli and bronchi causing a decrease in alveolar oxygen content.
- Venous blood that goes to affected areas without being oxygenated and returns to the heart.
- This will lead to arterial hypoxemia and even death due to interference with ventilation.

CLINICAL MANIFESTATIONS

341

- Fast breathing
- Nasal flaring
- Grunting
- Lower chest wall indrawing
- Abnormal vocal resonance (decreased over a pleural effusion, increased over lobar consolidation)
- Central cyanosis
- signs of pneumonia on auscultation (decreased breath sounds, bronchial breath sounds, crackles, pleural rub).

Differential diagnoses

342

- Asthma
- Atelectasis
- Bronchiolitis
- Bronchitis
- Chronic obstructive Pulmonary diseases
- Foreign body aspiration
- Lung abscess
- Tuberculosis

Diagnostic modalities

343

- ❑ **History taking**
- ❑ **Physical examination**
- ❑ **Chest x-ray**
- ❑ **Blood test**
- ❑ **Sputum culture**
- ❑ **Lung ultrasound**

Management

344

It depends the severity of the disease . In case of severe pneumonia

- Admit the child to hospital.
- Antibiotic therapy
 - Give ampicillin (50 mg/kg IV/IM every 6 hours) and gentamicin (7.5 mg/kg IM once a day) for 5 days; then,
 - If child responds well, complete treatment at home or in hospital with oral amoxicillin (15 mg/kg three times a day) plus IM gentamicin once daily for a further 5 days.
 - Alternatively, give chloramphenicol (25 mg/kg IM or IV every 6 hours) until the child has improved.

Then continue orally 4 times a day for a total course of 10 days. Or use ceftriaxone (80 mg/kg IM or IV once daily) for the same duration

OXYGEN THERAPY

345

- Give oxygen to all children with very severe pneumonia
- Where pulse oximetry is available, use this to guide oxygen therapy (give to children with oxygen saturation less than 90%,
- Where there is sufficient oxygen available Continue with oxygen until the signs of hypoxia (such as severe lower chest wall in drawing or breathing rate of ≥ 70 /minute) are no longer present.

SUPPORTIVE CARE

346

- If the child has fever ($\geq 39^{\circ}\text{C}$ or $\geq 102.2^{\circ}\text{F}$) which appears to be causing distress, give Paracetamol.
- If wheeze is present, give a rapid-acting bronchodilator (nebulized salbutamol, salbutamol by metered dose inhaler with a spacer device or subcutaneous epinephrine)
- Remove by gentle suction any thick secretions in the throat, which the child cannot clear.
- Ensure that the child receives daily maintenance fluids appropriate for the child's age but avoid overhydration
- Encourage breastfeeding and oral fluids.

MONITORING

347

- The child should be checked by nurses at least every 3 hours and by a doctor at least twice a day.
- In the absence of complications, within two days there should be signs of improvement (breathing not so fast, less indrawing of the lower chest wall, less fever, and improved ability to eat and drink).

Complications or other diagnoses to be considered

348

- If the child has not improved after two days, or if the child's condition has worsened, look for complications or other diagnoses. If possible, obtain a chest X- ray.

STAPHYLOCOCCAL PNEUMONIA.

- This is suggested if there is rapid clinical deterioration despite treatment, by a pneumatocele or pneumothorax with effusion on chest X-ray, numerous Gram-positive cocci in a smear of sputum, or heavy growth of *S. aureus* in cultured sputum or empyema fluid.
- The presence of septic skin pustules supports the diagnosis.

STAPHYLOCOCCAL PNEUMONIA

349

- Treat with cloxacillin (50 mg/kg IM or IV every 6 hours) and gentamicin (7.5 mg/kg IM or IV once a day).
- When the child improves, continue gentamycin IM daily for a total of 10 days and cloxacillin orally 4 times a day for a total course of 3 weeks.
- Note that cloxacillin can be substituted by another antistaphylococcal antibiotic such as flucloxacillin, etc.

Pleural effusion and empyema

350

- This is suggested by persistent fever, and physical and chest X-ray signs of pleural effusion.
- When empyema is present, fever persists despite antibiotic therapy and the pleural fluid is cloudy or frankly purulent.
- On examination, the chest is dull to percussion and breath sounds are reduced or absent over the affected area.
- A pleural rub may be heard at an early stage before the effusion is fully developed.
- If fever and other signs of illness continue, despite adequate chest drainage and antimicrobial therapy, assess for possible tuberculosis

Tuberculosis

351

- A child with persistent fever for more than 3 weeks and signs of pneumonia should be evaluated for tuberculosis.
- Positive contact history with chronic cougher
- Poor growth / wasting or weight loss

- If another cause of the fever cannot be found, tuberculosis should be considered and treatment for tuberculosis, following national guidelines, may be initiated and response to anti-Tb treatment evaluated

4/24/2020

THANK YOU

352



4/24/2020

MALNUTRITION

4/24/2020

Outline

355

- Overview
- Kwashiorkor
- Marasmus
- Stunting
- Vitamin A deficiency
- Vitamin D deficiency
- Management of Severe Acute Malnutrition (SAM)
- Childhood obesity

Session objectives

356

- **At the end of this session the students will be able to:**
 - ✓ Discuss kwashiorkor
 - ✓ Discuss marasmus
 - ✓ Differentiate the clinical presentations of kwashiorkor from marasmus
 - ✓ Explain stunting
 - ✓ Describe common micronutrient deficiencies
 - ✓ Discuss the management of severe acute malnutrition
 - ✓ Explain childhood obesity

Overview of malnutrition

357

- ❑ **Malnutrition includes:**
- ❑ Macronutrient deficiency
- ❑ Micronutrient deficiency
- ❑ Over nutrition-obesity
- ❑ **Can be classified as:**
- ❑ Acute-wasting
- ❑ Chronic-stunting

Kwashiorkor

358

- A nutritional disorder due to deficiency of protein and calories, **particularly proteins**, characterized by mental apathy, wasting, growth retardation, and **oedema**.

Etiology

359

- Lack of knowledge about diet
- Poverty
- Natural calamities like drought, earthquakes, etc
- Repeated infections like diarrhoea, measles, etc
- Taboos
- Religious customs (people of certain religions avoid non-vegetarian diet which has high-quality proteins)

Kwashiorkor ...

360

- **Incidence is more in:**
 - Low birth weight
 - Broken families
 - In children with whose parents are unemployed
 - Large families

Clinical features of kwashiorkor

361

Parameter	Features
Growth	Short statured
Mental faculties	Irritable, lack of interest in surroundings, apathetic, dull, lethargic, resents meddling
Hair	Lack of luster, easily pluckable, sparse , loss of natural curls, brownish discoloration, flag sign (Signa de Bandera)
Anterior fontanel	Delayed closure
Face	Moon face, a full well-rounded somewhat pendulous and blubbery cheeks
Eyes	Conjunctival pallor, signs of vitamin-A deficiency

Clinical features ...

362

Parameter	Features
Oral cavity	Angular stomatitis: iron deficiency anemia, B-complex deficiency; oral thrush
Tongue	Oedema of tongue, scarlet and raw tongue (bright red), magenta tongue (purplish red), atrophy of papillae, geographic tongue (the tongue has irregularly distributed patchy areas of denudation and atrophy of epithelium)
Teeth	Caries, delayed dentition, enamel hypoplasia, enamel erosion
Gums	Spongy, bleeding gums, pyorrhoea alveolaris, recession of gums

Clinical features ...

363

Parameter	Features
Cheeks	Baggy cheeks of Trowel
Neck	Neck appears to be long due to wasting of muscles and sub-cutaneous fat
Chest	All the ribs and spinal processes are prominently seen due to wasting of muscles and sub-cutaneous fat
Abdomen	Abdomen is distended due to intestinal atony, hepatomegally, rarely ascites

Clinical features ...

364

Parameter	Features
Skin	Hypopigmented and hyperpigmented patches (crazy pavement dermatosis), flaky pavement dermatosis (peeling of skin), xerosis: generalized dryness with branny desquamation, petechiae, pellagrous dermatosis
Extremities	are thin due to wasting, pedal oedema, koilonychias
CNS	Patient is dull, lethargic, apathetic, hypotonia due to nutritional myelopathy

Clinical features ...

365

Parameter	Features
CVS	Intensity of heart sounds is decreased due to decrease of cardiac output
Respiratory system	Features of secondary infection
GIT	Hepatomegaly
Salivary glands	Parotid gland is enlarged. It is firm, non-tender

Differential diagnosis

366

- Nephrotic syndrome
- Cirrhosis of liver
- Congestive heart failure

Investigations

367

- ❑ **Blood**
- ❑ CBC
- ❑ Serum electrolytes, plasma protein estimation
- ❑ Blood culture & sensitivity for evaluation of septicaemia
- ❑ **Urine**
- ❑ Albumin, sugar, deposits, urine culture & sensitivity
- ❑ **Stool**
- ❑ Ova of parasite, culture & sensitivity if there is diarrhoea
- ❑ **Chest X-ray:** to r/o TB & other infections
- ❑ **Mantoux test**

Complications

368

- Hypothermia
- Hypoglycaemia
- Infections
- Electrolyte disturbances
- Dehydration
- Anemia

Management

369

- See management of SAM

Prevention

370

- Health and nutrition education
- Early identification and treatment of the diseases
- Exclusive breast feeding up to six months
- Complementary feeding at the age of six months
- Family planning
- Safe and adequate water supply
- Immunization

Marasmus

371

- A nutritional disorder due to deficiency of protein and calories, **particularly calories**, characterized by:
 - Growth failure
 - Gross wasting
 - Absence of oedema

Etiology

372

1. Primary causes

- Lactation failure – the commonest cause

Lactation failure → introduction of dilute & dirty
formula → infections (diarrhoea) → starvation
therapy due to diarrhoea → marasmus

Etiology

373

2. Secondary causes

- a. **Birth weight:** common in premature & LBW
- b. **Cardiovascular diseases** like VSD, ASD, and PDA due to:
 - ❑ Recurrent respiratory infections
 - ❑ Feeding and growth failure
 - ❑ Cough & breathlessness
 - ❑ Hypermetabolic state due to high heart rate, fever, increase in respiratory rate
 - ❑ Decreased assimilation due to congestion of liver and intestines

Secondary causes ...

374

c. Respiratory causes: TB, etc

d. Gastrointestinal causes

- Congenital hypertrophic pyloric stenosis- vomiting
- Congenital megacolon- diarrhoea
- Cleft lip & palate – inadequate intake of feeds, mainly breast feeds

e. Infections

- ▣ Repeated diarrhoea
- ▣ Severe infections like congenital syphilis
- ▣ Malabsorption syndrome

Etiology ...

375

3. CNS causes

- Hydrocephalus and CNS infections like tuberculosis meningitis, pyogenic meningitis can cause marasmus due to decreased intake & chronic vomiting

Clinical features

376

Parameter	Features
Mental faculties	<p>If there is no infection:</p> <ul style="list-style-type: none">• Patient is alert, playful, lively look• The cry is vigorous• Appetite is vigorous <p>If there is an infection:</p> <ul style="list-style-type: none">• The child is less active, apathetic, cries in a low tone, refusal to food
Head	<ul style="list-style-type: none">• Hair is normal, delayed closure of anterior fontanel may be present

Clinical features ...

377

Parameter	Features
Face	<ul style="list-style-type: none">•Eyes: no signs of vitamin A deficiency•Mild to moderate anemia may be present•Sunken cheeks are present due to loss of buccal fat of fat•Child appears as a wizened little old man or monkey face
Oral cavity	<ul style="list-style-type: none">•Oral thrush may be present•Stomatitis and angular stomatitis may be present
Chest	All the ribs and spinal processes are prominently seen due to wasting of subcutaneous fat & muscles

Clinical features ...

378

Parameter	Features
Abdomen	<ul style="list-style-type: none">•Abdomen is distended due intestinal atony•No hepatomegaly
Skin	<ul style="list-style-type: none">•Thin•No skin changes
Extremities	Thin due to wasting of muscles & sub-cutaneous fat. There is no oedema
CVS	Size of heart decreased. Decreased intensity of heart sounds due to low cardiac output
Respiratory system	Features of secondary infection may be present

Investigations

379

- CBC
- Urine and stool culture
- Chest X-ray
- Mantoux test

Complications

380

1. Immediate complications

- Hypoglycaemia
- Hypothermia
- Septicaemia
- Electrolyte imbalance

2. Late complications

- Intellectual sub-normality
- Growth retardation

Management

381

- See the management of SAM

Vitamin A deficiency

382

- More common between 6 months to 3 years of age
- 50 to 80% of severe protein malnutrition patients are associated with vitamin A deficiency

Functions of vitamin A

383

- Functioning of retina
- Growth and differentiation of epithelial tissue
- Growth of bone
- Reproduction and embryonic development
- Enhances immune function, reduces the incidence of infectious diseases and may protect against the development of malignancy

Etiology of vitamin A deficiency

384

- ❑ At birth, the liver has a low vitamin A content that can be augmented by colostrum and breast milk
- ❑ Loss of vitamin A is present by cooking, canning and freezing of food stuffs, oxidizing agents etc
- ❑ Vitamin A deficiency is seen in fat malabsorption or chronic intestinal disorders
- ❑ Low intake of vitamin A
- ❑ Increased excretion of vitamin A present in cancer, urinary tract disease and chronic diseases
- ❑ Low protein intake can cause decrease of vitamin A concentration

Clinical features

385

Parameter	Features
Eyes	<ul style="list-style-type: none">• Night blindness is the earliest manifestation• Bitot spots: dry, silvery-gray plaques may appear on the bulbar conjunctivae• Conjunctival xerosis: drying of conjunctiva• Corneal xerosis: drying of cornea• Xerophthalmia: cornification of the epithelium of the conjunctiva and disappearance of the mucus cells• Keratomalacia: desiccation, ulceration and xerosis of the cornea & conjunctiva

Clinical features ...

386

Parameter	Features
Respiratory tract	Increased risk of respiratory tract infections
Skin	Keratinization & drying of the epidermis occurred and papular eruptions involving the pilosebaceous follicles may be found especially on the extremities
Genitourinary system	Epithelium is damaged. The patient can develop pyuria & hematuria
GI system	Reduction of goblet cells; diarrhoea

Clinical features ...

387

Parameter	Features
CNS	<ul style="list-style-type: none">•Mental retardation can occur•Increased ICP with wide separation of cranial bones may occur•Hydrocephalus with or without paralysis of the cranial nerves may occur
Bone	Associated with faulty modelling of bone, with production of thick, cancellous bone instead of thinner more compact bone
Miscellaneous	<ul style="list-style-type: none">•Taste and smell are impaired•Hearing may be impaired•It can interfere with erythropoiesis
	4/24/2020

Management strategies

388

1. Breast feeding
2. Food diversification
3. Vitamin A supplementation
4. Food fortification

Rickets (Nutritional)

389

- Bone consists of a protein matrix called *osteoid* and a mineral phase, principally composed of calcium and phosphate, mostly in the form of hydroxyapatite.
- **Rickets**, a disease of growing bone, occurs in children only before fusion of the epiphyses, and is **due to unmineralized matrix at the growth plates.**

Rickets ...

390

- Because growth plate cartilage and osteoid continue to expand, but mineralization is inadequate, the growth plate thickens.
- There is also an increase in the circumference of the growth plate and the metaphysis.
- This increases bone width at the location of the growth plates, causing some of the classic clinical manifestations, such as **widening of the wrists and ankles**

Etiology of rickets in general

391

- ❑ There are many causes of rickets including
- ❑ **Vitamin D disorders,**
- ❑ Calcium deficiency,
- ❑ Phosphorous deficiency, and
- ❑ Distal renal tubular acidosis

Vitamin D disorders

392

- **Nutritional vitamin D deficiency**
- Congenital vitamin D deficiency
- Secondary vitamin D deficiency
- Malabsorption
- Increased degradation
- Decreased liver 25-hydroxylase
- Vitamin D–dependent rickets type 1
- Vitamin D–dependent rickets type 2
- Chronic renal failure

Metabolism of vitamin D

393

- **Vitamin D is available in two forms:**
 1. Vitamin D₂ Calciferol is an irradiated ergosterol
 2. Vitamin D₃ is available synthetically. It is present in skin as 7-dehydrocholesterol. It will be converted to cholecalciferol on irradiation of skin by ultraviolet rays in the range of 296-310 nm.

Etiology of Nutritional vitamin D deficiency

394

❑ **Decreased intake**

- ❑ Lack of vitamin D in the diet
- ❑ Lack of exposure to UV irradiation
- ❑ Black children are susceptible to rickets owing to pigmentation of their skin or inadequate penetration of sunlight

❑ **GIT causes**

- ❑ Decreased absorption in the following conditions
 - a. Coeliac disease, steatorrhoea, pancreatitis, or cystic fibrosis
 - b. Glucocorticoids may antagonise vitamin D in calcium transport

Etiology ...

395

❑ Liver

- ❑ Neonatal hepatitis, and liver cell failure may decrease absorption of vitamin D
- ❑ Anticonvulsants like phenobarbitone and phenytoin may convert 25(OH)D₃ in to more polar vitamin D₃ by P450 enzyme, which is an inactive form
- ❑ **Kidney:** chronic renal failure, tubular acidosis, etc

Incidence

396

- The incidence is more during the period of rapid growth, particularly between 4 months to 2 years of age
- Equal in both sexes, but it is more in male children due to rapid growth

Clinical Manifestations

- Most manifestations of rickets are due to skeletal changes.
- **Craniotabes**, a softening of the cranial bones, can be detected by applying pressure at the occiput or over the parietal bones. The sensation is similar to the feel of pressing into a Ping-Pong ball and then releasing.
- Craniotabes may also be secondary to osteogenesis imperfecta, hydrocephalus, and syphilis.
- It is a normal finding in many newborns, especially near the suture lines, but it typically disappears within a few months of birth.

Clinical ...

398

- Widening of the costochondral junctions results in a **rachitic rosary**; this feels like the beads of a rosary as the examiner's fingers move along the costochondral junctions from rib to rib.
- **Growth plate widening** is also responsible for the enlargement at the wrists and ankles.
- The horizontal depression along the lower anterior chest known as **Harrison groove** occurs due to pulling of the softened ribs by the diaphragm during inspiration.

Clinical ...

399

- Softening of the ribs also impairs air movement and predisposes patients to **atelectasis**.
- The **risk of pneumonia** appears to be elevated in children with rickets; in Ethiopia, there may be a 13-fold higher incidence of rickets among children with pneumonia.

Summary of clinical features

400

❑ **GENERAL**

- ❑ Failure to thrive
- ❑ Listlessness
- ❑ Protruding abdomen
- ❑ Muscle weakness (especially proximal)

❑ Fractures

❑ **HEAD**

- ❑ Craniotabes
- ❑ Frontal bossing
- ❑ Delayed fontanelle closure
- ❑ Delayed dentition; caries

Summary of ...

401

- **CHEST**

- Rachitic rosary

- Harrison groove

- Respiratory infections and atelectasis

- **BACK**

- Scoliosis

- Kyphosis

- Lordosis

Summary of ...

402

- **EXTREMITIES**
- Enlargement of wrists and ankles
- Valgus or varus deformities
- Windswept deformity (combination of valgus deformity of 1 leg with varus deformity of the other leg)
- Anterior bowing of the tibia and femur
- Leg pain



Deformities in rickets showing curvature of the limbs, potbelly, and Harrison groove

4/24/2020



Wrist x-rays in a normal child (A) and a child with rickets (B). The child with rickets has metaphyseal fraying and cupping of the distal radius and ulna.

4/24/2020



Rachitic rosary in a young infant. ^{4/24/2020}

Differential diagnoses

406

- ❑ **Craniotabes**
- ❑ Hydrocephalus
- ❑ osteogenesis imperfecta
- ❑ **Costochondrial junction enlargement**
- ❑ Scurvy
- ❑ Chondrodystrophy
- ❑ Congenital epiphyseal dysplasia
- ❑ Cytomegalic inclusion disease
- ❑ Syphilis
- ❑ Copper deficiency
- ❑ Vitamin D resistant rickets

Treatment

407

- Children with nutritional vitamin D deficiency should receive vitamin D and adequate nutritional intake of calcium and phosphorus.
- Vitamin D intake of 400 IU/day, typically given as a multivitamin.
- It is important to ensure that children receive adequate dietary calcium and phosphorus; this is usually provided by milk, formula, and other dairy products.

Complications

408

- Bronchitis
- Bronchopneumonia
- Pulmonary atelectasis
- Anemia

Prevention

409

- Exposure to sunlight
- Oral administration of vitamin D
- Daily requirement of vitamin D is 10 microgram or 400IU/day
- Milk fortified with vitamin D can be given
- Vitamin D should also be given to pregnant & lactating mother

Management of Acute Malnutrition

410

Overview

- ❑ Community-Based Management of Acute Malnutrition (CMAM), consists of four main components:
 1. Community outreach/mobilization:
 2. Inpatient Treatment/ care:
 3. Outpatient Treatment Program (OTP):
 4. Targeted supplementary feeding program (TSF):

Principle of care

411

- ❑ **Recognize signs of severe acute malnutrition**
- ❑ Visible severe wasting for infants under 6 months
- ❑ To look for severe wasting, remove the child's clothes. **Look at the front view of the child:**
 - Is the outline of the child's ribs easily seen?
 - Does the skin of the upper arms look loose?
 - Does the skin of the thighs look loose?

Recognize signs of ...

412

- **Look at the back view of the child:**
 - Are the ribs and shoulder bones easily seen?
 - Is flesh missing from the buttocks?
- When wasting is extreme, there are folds of skin on the buttocks and thighs. It looks as if the child is wearing “**baggy pants**”.
- Because a wasted child has lost fat and muscle, this child will weigh less than other children of the same height/length and will have a **low weight-for-height/Length**



Visible severe wasting

4/24/2020

Recognize signs of ...

414

- ❑ **Oedema**
- ❑ To check for oedema, grasp both feet so that they rest in your hand with your thumbs on top of the feet. **Press your thumbs gently for three seconds** or count 101,102,103.
- ❑ The child has oedema if a pit (dent) remains in both feet when you lift your thumbs



Child with pitting oedema

Grading of edema

416

Grades of bilateral pitting edema	Definition
Absent	Absent
Grade +	Mild: both feet/ankles
Grade ++	Moderate: both feet, plus lower legs, hands or lower arms
Grade +++	Severe: generalized bilateral pitting edema, including both feet, arms and face

Dermatosis

417

- In severe malnutrition, it is more common in children who have oedema than in wasted children.
- A child with dermatosis may have patches of skin that is abnormally light or dark in color, shedding of skin in scales or sheets, and ulceration of the skin of the perineum, groin, limbs, behind the ears, and in the armpits.
- There may be weeping lesions. There may be severe rash in the nappy area. Any break in the skin can let dangerous bacteria get into the body. When the skin is raw and weeping, this risk is very high.

Extent of dermatosis

418

- + **mild**: discoloration or a few rough patches of skin
- + + **moderate**: multiple patches on arms and/or legs
- + + + **severe**: flaking skin, raw skin, fissures (openings in the skin)

Eye signs

419

- ❑ **Bitot's spots** – superficial foamy white spots on the conjunctiva (white part of the eye). These are associated with vitamin A deficiency.
- ❑ **Pus and inflammation (redness)** are signs of eye infection.
- ❑ **Corneal clouding** is seen as an opaque appearance of the cornea (the transparent layer that covers the pupil and iris). It is a sign of vitamin A deficiency.
- ❑ **Corneal ulceration** is a break in the surface of the cornea. It is a severe sign of vitamin A deficiency. If not treated, the lens of the eye may push out and cause blindness. Corneal ulceration is urgent and requires immediate treatment with vitamin A and atropine (to relax the eye).

Weigh and measure the child

- Carefully measure the child's length or height once on the first day. For children less than 85 cm in length, or children too weak to stand, measure the child's length while supine (lying down).
- For children 85 cm or more, measure standing height. Note: Length is usually greater than standing height by 0.5 cm.
- If the child is 85 cm or more but cannot be measured standing, subtract 0.5 cm from the supine length.

Measuring length

421

- Position the child lying on his back on the measuring board, supporting the head and placing it against the headboard.
- Position the crown of the head against the headboard, compressing the hair
- Hold the head with two hands and tilt upwards until the eyes look straight up, and the line of sight is perpendicular to the measuring board.

Measuring length ...

422

- ❑ **The other person should stand alongside the measuring board and:**
 - ❑ Support the child's trunk as the child is positioned on the board.
 - ❑ Place one hand on the shins or knees and press gently but firmly.
 - ❑ Straighten the knees as much as possible without harming the child.
 - ❑ With the other hand, place the foot piece firmly against the feet.
 - ❑ The soles of the feet should be flat on the foot piece, toes pointing up. If the child bends the toes and prevents the foot piece touching the soles, scratch the soles slightly and slide in the foot piece when the child straightens the toes.
 - ❑ Measure length to the last completed 0.1 cm and record immediately on the Multi-chart.

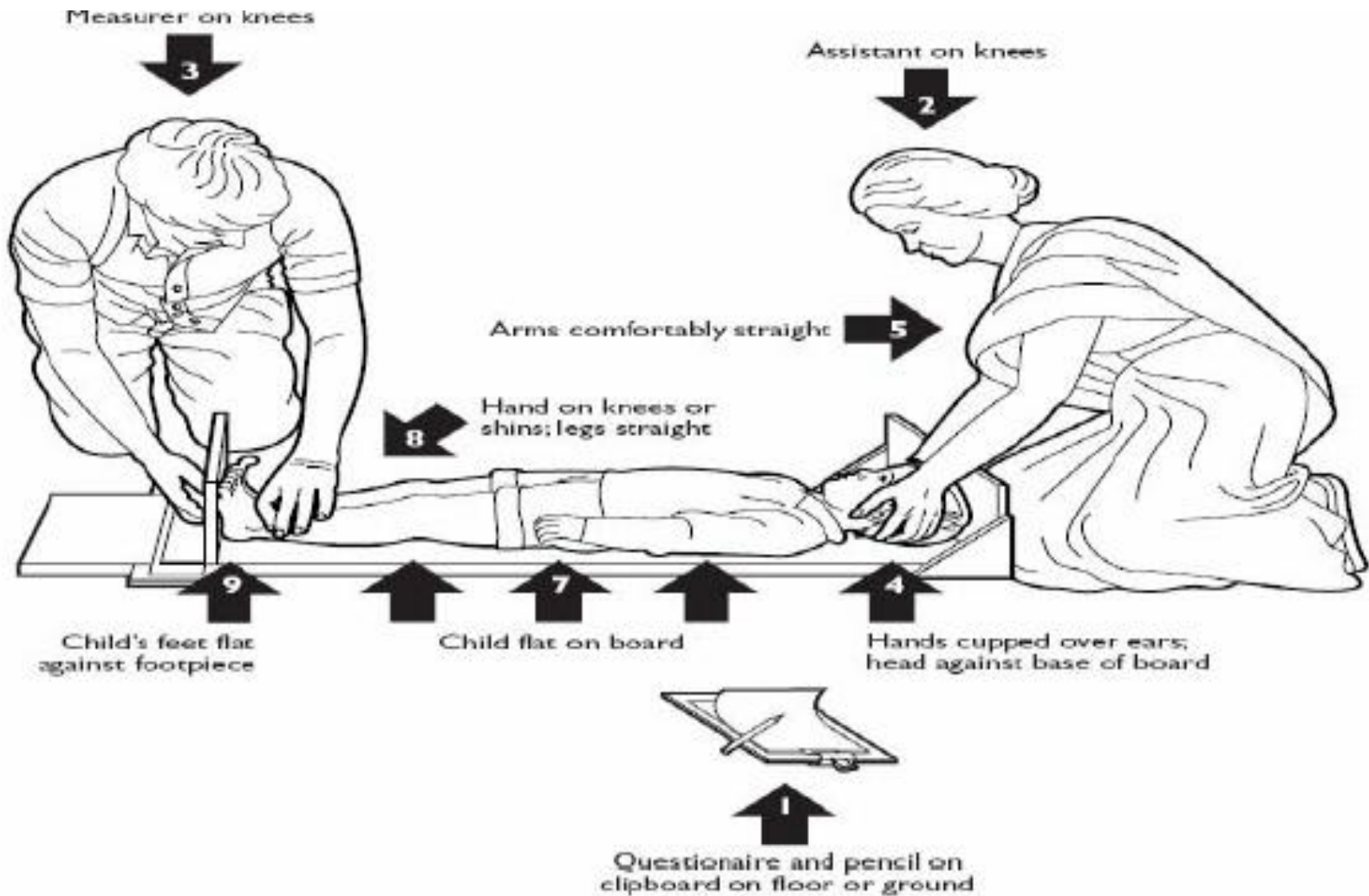

Illus.3, child being measured lying down

Measuring height

424

- Remove the child's socks and shoes for accurate measurement. Also remove hair ornaments and undo braids if they interfere with measurement.
- **Work with a partner. One person should kneel or crouch near the child's feet and:**
- Help the child stand with back of the head, shoulder blades, buttocks, calves and heels touching the vertical board.
- Hold the child's knees and ankles to keep the legs straight and feet flat. Prevent children from standing on their toes.
- Young children may have difficulty standing to full height. If necessary, gently push on the tummy to help the child stand to full height.

Measuring height ...

425

- Position the head so that the child is looking straight ahead (line of sight is parallel to the base of the board).
- Place thumb and forefinger over the child's chin to help keep the head in an upright position
- With the other hand, pull down the head board to rest firmly on top of the head and compress hair.
- Measure the height to the last completed 0.1 cm and record it immediately on the *Multi* chart.

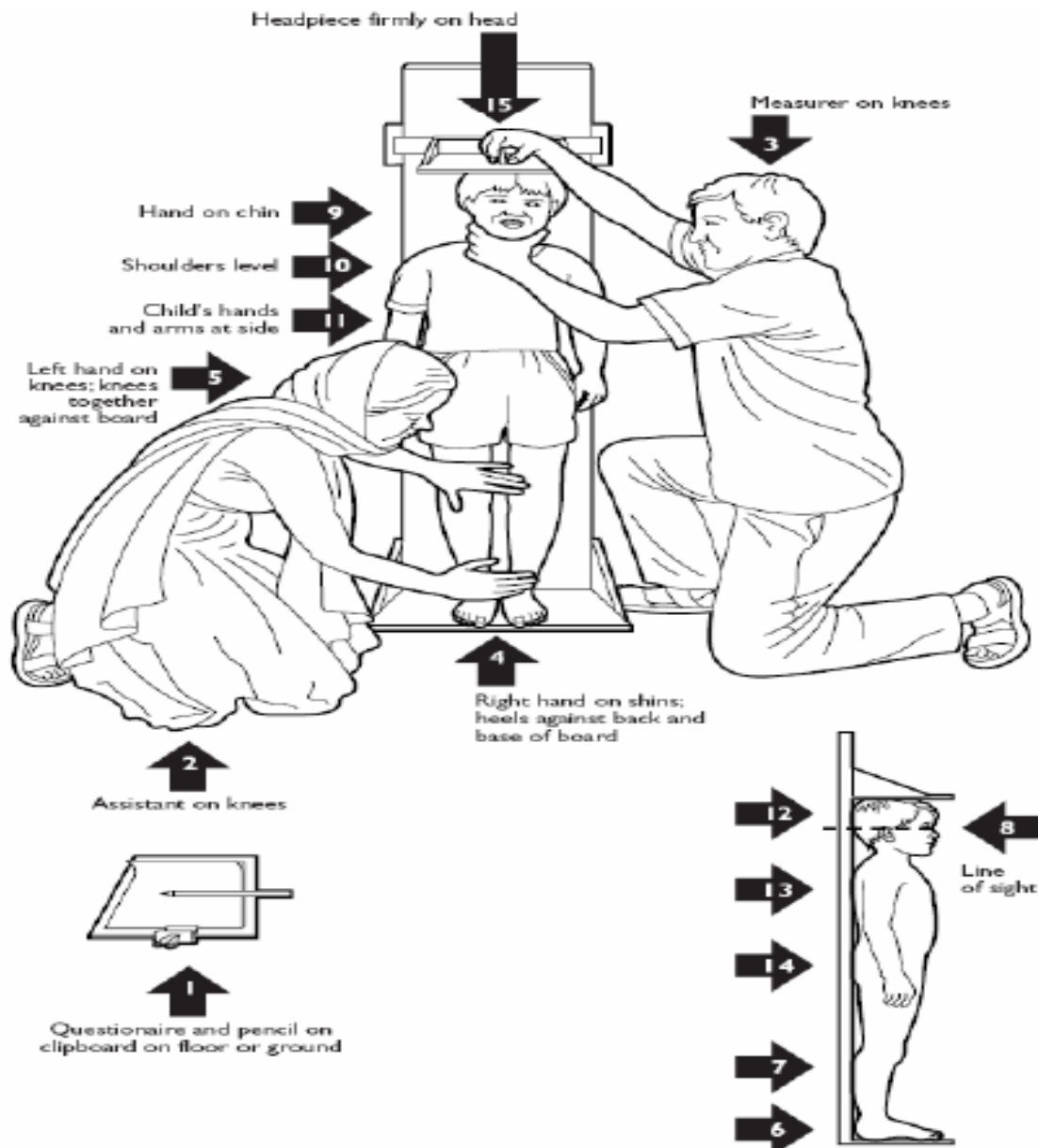

Measuring height

4/24/2020

Weigh the child

427

- Weigh the child as soon as possible after he arrives.
- If the child is admitted, weigh the child once daily, preferably at about the same time each day.
- The weighing time should be about one hour before or after a feed.

To weigh the child ...

428

- ❑ Remove the child's clothes, but keep the child warm with a blanket or cloth while carrying to the scale.
- ❑ Put a cloth in the scale pan to prevent chilling the child.
- ❑ Adjust the scale to zero with the cloth in the pan. (If using a scale with a sling or pants or basin, adjust the scale to zero with that in place.)
- ❑ Place the naked child gently in the pan (or in the sling or pants).
- ❑ Wait for the child to settle and the weight to stabilize.
- ❑ Measure weight to the nearest 100gm or as precisely as possible. Record immediately on multi-chart.
- ❑ Wrap the child immediately to re-warm.

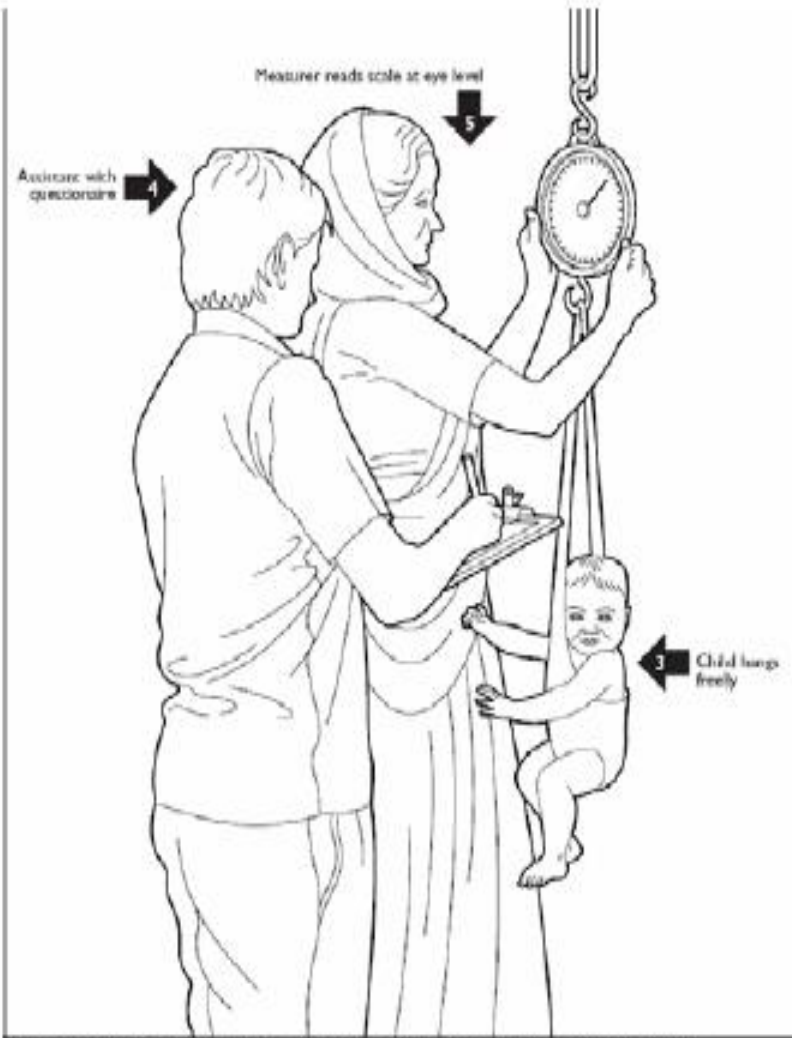

Source: How to Weigh and Measure Children: Assessing the Nutritional Status of Young Children, UN 1986.



Standardize scales

430

- Standardize scales daily or whenever they are moved:
- Set the scale to zero.
- Weigh one object of known weight and record the measured weight. (A container filled with stone or IV fluids etc. if the weight is accurately known.)
- Repeat the weighing of these objects and record the weights again.
- If there is a difference of 0.01 kg or more between duplicate weighing, or if a measured weight differs by 0.01 kg or more from the known standard, check the scales and adjust or replace them if necessary.

Measure mid-upper arm circumference.

431

- MUAC is measured on the upper left arm.
- To locate the correct point for measurement, the child's elbow is flexed to 90° C, with the palm facing upwards.
- A measuring tape is used to find the midpoint between the end of the shoulder (**acromion**) and the tip of the elbow (**olecranon**); this point should be marked.
- The arm is then allowed to hang freely, palm towards the thigh, and the measuring tape is placed snugly around the arm at the midpoint mark.
- The tape should not be pulled too tight or too loose.

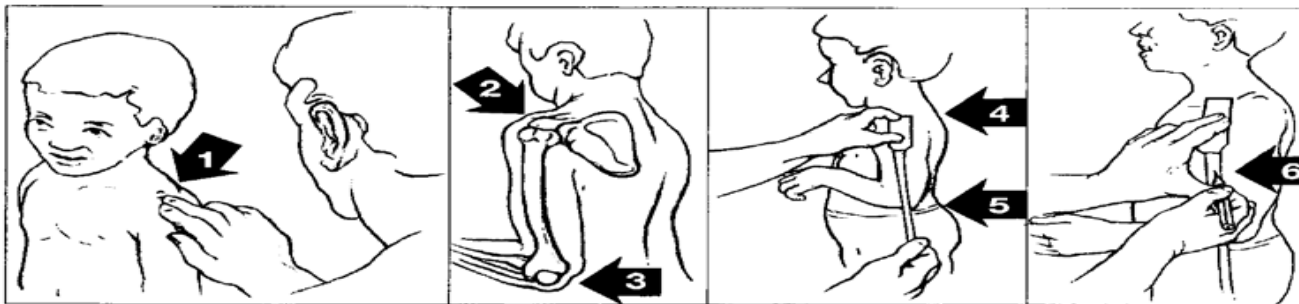

1 Locate tip of shoulder

2 Tip of shoulder
3 Tip of elbow4 Place tape at tip of
shoulder
5 Pull tape past tip of
bent elbow

6 Mark midpoint

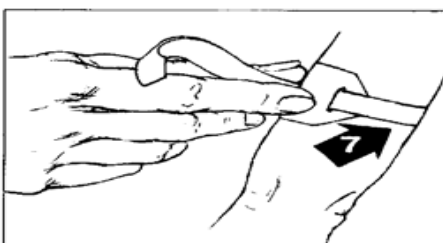

7 Correct tape tension



8 Tape too tight

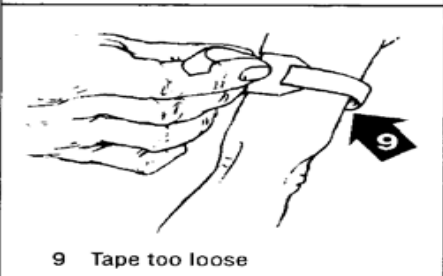

9 Tape too loose

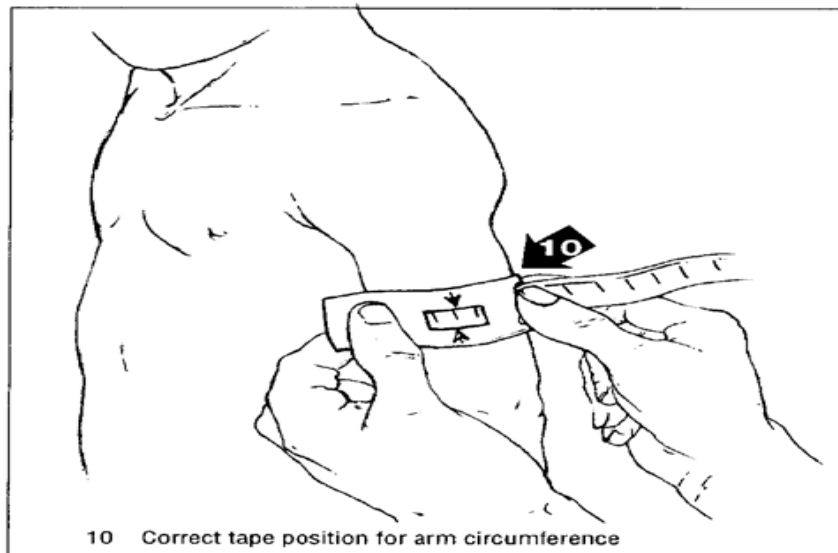
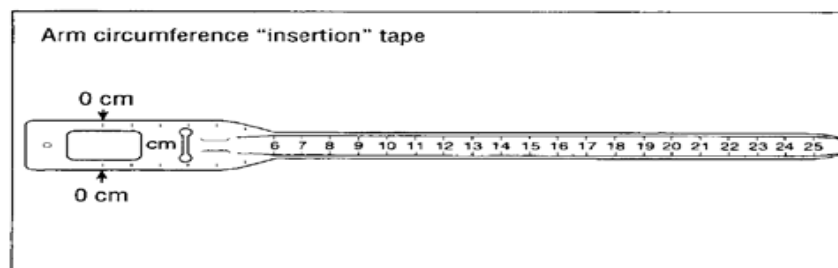

10 Correct tape position for arm circumference

WHO 98051

MUAC measurement

4/24/2020

Identifying a child with severe acute malnutrition

433

- **Determine Percent-of-median based on child's weight and length/height**
- **What is Percent-of-median?**
- It is a way of comparing a measurement, in this case a child's weight-for-length, to an "average" (median).
- The median used in the national protocol and in this course are NCHS reference values for weight-for-height and weight-for-length.
- It is a ratio of a child's weight to the median weight of a child of the same height in the reference, expressed as percentage.
- As a concrete example if the median (or average) weight in the reference tables for a particular height was 10 kg and a child weighed 8 kg, she/he was 80% weight-for-height.

Percent of median ...

434

- It is important to consider a child's weight-for-height rather than simply weight-for-age. The latter is affected by stunting.
- **Stunting may cause low weight-for-age** when a child is adequate weight-for-height.
- **Feeding can correct wasting but cannot easily correct stunting.**
- There is a new WHO child growth standards/ reference that uses **z-score** classification system, which is comparable across ages and heights, and among different indicators.

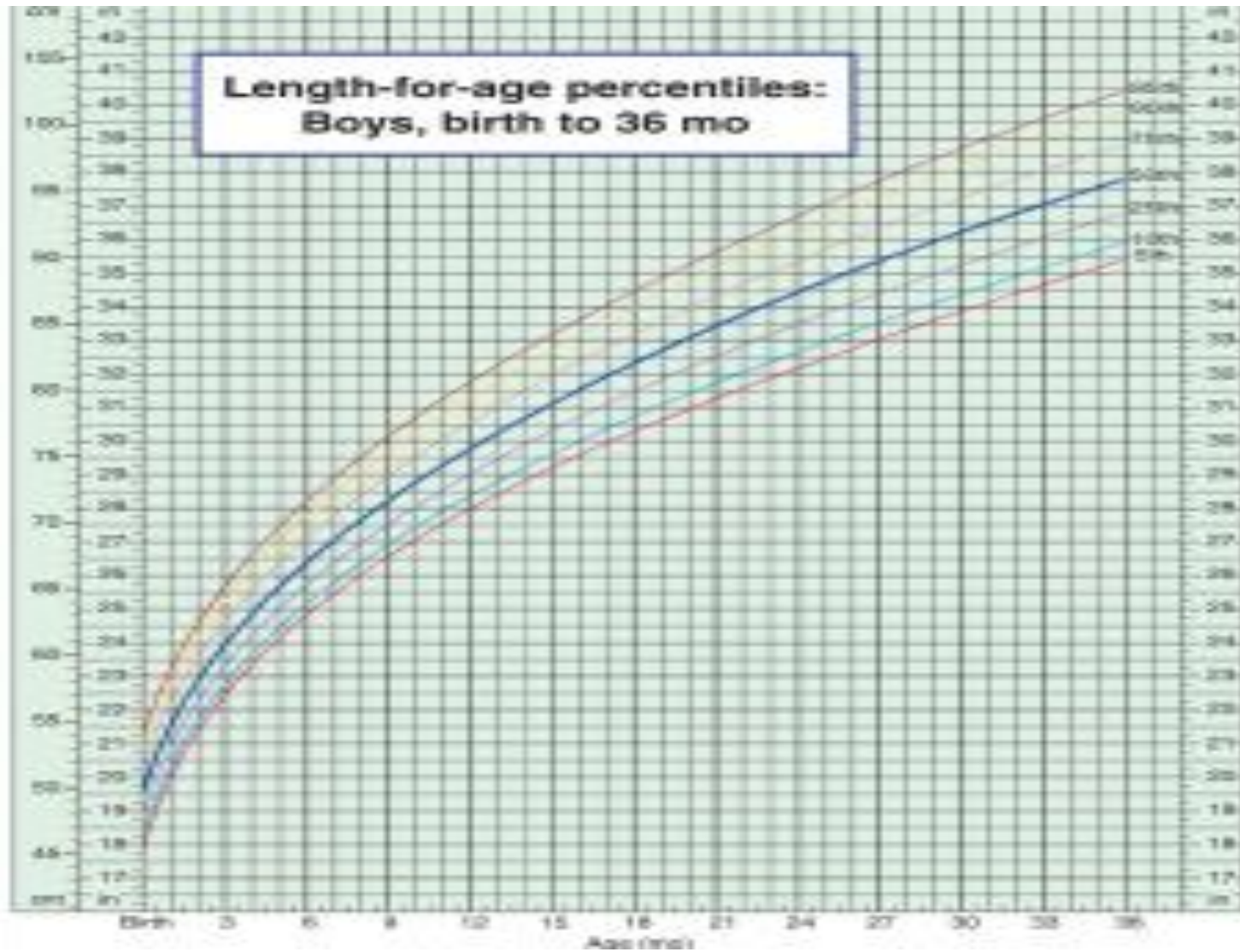

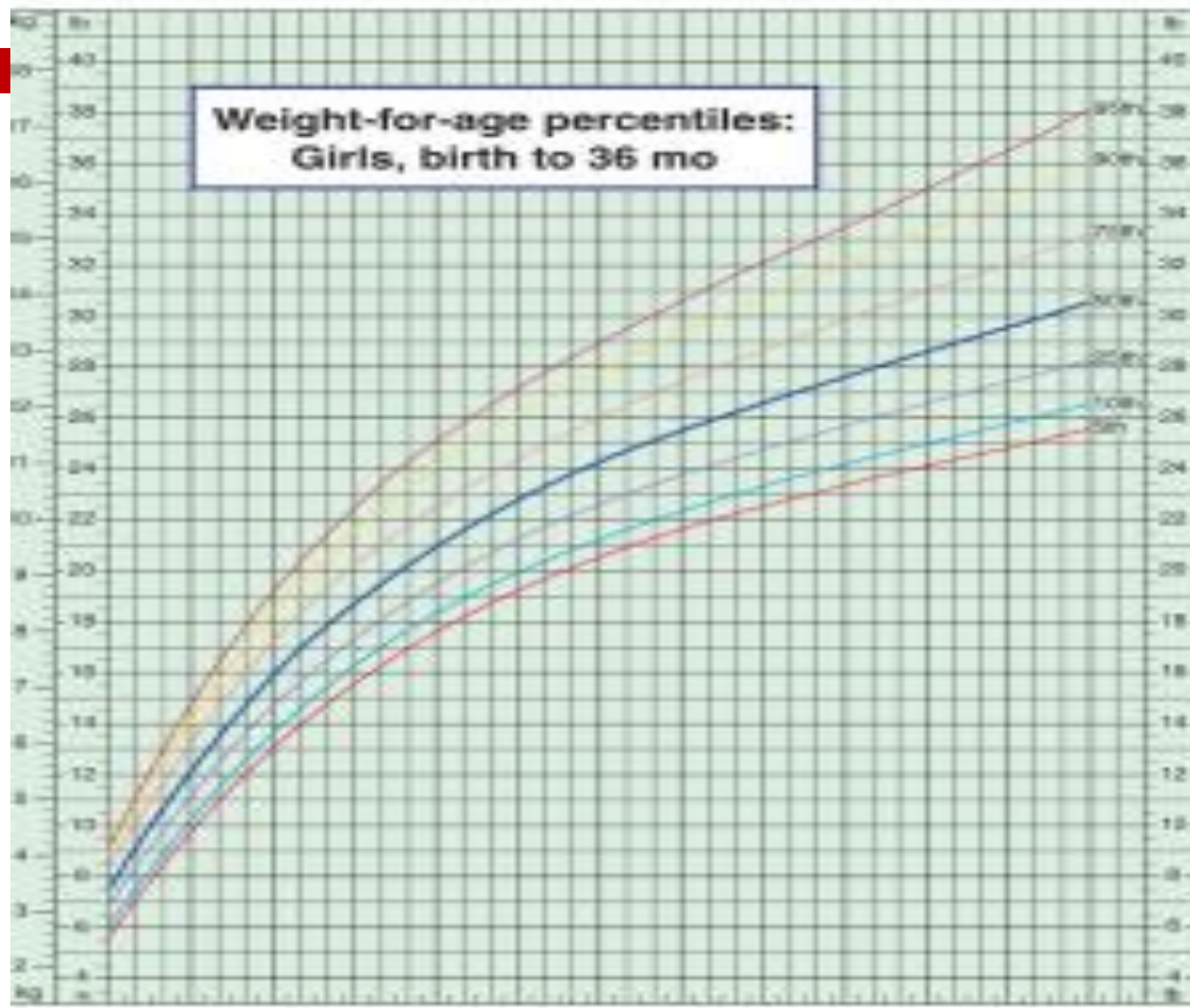

How to calculate the weight/height percentage?

- **Example:** For a child of 80.5 cm and weighing 8.7 kg, Weight-for-Height Reference table give a median weight for a child of this height of 10.9 kg:
- $\text{Weight-for-height} = (8.7/10.9) \times 100 = 80\%$

How to use the Weight-for-Height Reference table

438

- To use the reference table in the chart booklet or on your Weight-for-Height Reference Card:
- First, find the child's length or height in the first column of the table.
- Then look in the right columns in the same row to find the weight that correspond to the weight of the child.
- Look at the top of the column to see what the child's percentage of median or degree of acute malnutrition.

... reference table

439

- The child's weight may be between two percentage of median. If so, indicate that the weight is between these percentage of median by writing less than ($<$)
- For example, if the weight is between 70 and 75%, write down as child's percentage of median is between 70 and 75%.

Recommended criteria for SAM and Admission to TFP

440

1. Infants less than six months or less than 3 Kg:

- Weight –for- Length (WFL) less than 70% or $< -3Z$ score
- OR**
- Presence of pitting Oedema of both feet
- OR**
- Visible Severe Wasting if it is difficult to determine WFL

2. Children 6 months to 5 years:

- Weight –for- Length (WFL) / WFH less than 70 % or $< -3Z$ score
- OR**
- Presence of pitting Oedema of both feet
- OR**
- MUAC < 11 cm for child length greater than 65 cm

Medical Complications

- If a child is 6 months to 5 years and has SAM according to the above criteria, check for the following serious medical complications that will determine the choice of treatment modalities (In-patient (TFU) or Out-patient (OTP)):
 - a. Unable to breast feed or drink
 - b. Vomiting everything
 - c. Very Weak, Lethargic or unconscious
 - d. Convulsions
 - e. Pneumonia/severe pneumonia:
 - Chest in-drawing
 - Fast breathing:
 - For child 6 month to 12 months: 50 breaths per minute and above
 - For a child 12 months up to 5 years: 40 breaths per minute and above

Medical complications ...

442

- f. Hypothermia: axillary temp $< 35^{\circ}\text{C}$ or rectal $< 35.5^{\circ}\text{C}$
- g. Fever $> 39^{\circ}\text{C}$
- h. Shock
- i. Dehydration
- j. Hypoglycemia
- k. Severe anemia: Hgb < 4 gm/dl
- l. Extensive skin lesions/infection (+++ dermatosis)
- m. Dysentery
- n. Jaundice
- o. Bleeding Tendencies

Criteria for in-patient care

443

- ☐ Infants below six months of age with SAM

OR

- ☐ Children 6 months to 5 years with SAM who have any one of the medical complications or failed appetite test

OR

- ☐ Children with SAM and referred from OTP for in-patient care

OR

- ☐ When OTP is not available in your working area or where the care taker lives or if the care taker's choice is inpatient care, all SAM children need to be admitted for inpatient care even if they do not fulfill the In-patient admission criteria.
- ☐ A child who fulfills any of **the first three criteria** is classified as severe complicated acute malnutrition

Infants under 6 Months		
Assess	Classify	Action
<ul style="list-style-type: none"> WFL < 70% of median or < -3Z score, OR Visible severe wasting, OR Edema of both feet 	Complicated Severe Acute Malnutrition	Admit for in-patient management
<ul style="list-style-type: none"> WFL \geq 70% to < 80% of median, or WFL \geq -3Z to < -2Z score, AND No edema of both feet 	Moderate Acute Malnutrition	Counsel on child feeding/ care
<ul style="list-style-type: none"> WFL > 80% of median or > -2Z score, AND No edema of both feet 	No Acute Malnutrition	Congratulate her and Counsel the mother on child feeding/ care

Assessment and classification of acute malnutrition

4/24/2020

Children age 6 Months to 5 years		
Assess	Classify	Action to take
<ul style="list-style-type: none"> • WFL/H $< 70\%$ of median or $< -3Z$ score OR MUAC $< 11\text{cm}$ <li style="text-align: center;">OR • Edema of both feet <li style="text-align: center;">PLUS • Any one of the following medical complications <ul style="list-style-type: none"> ○ Unable to breast feed/drink or feed ○ vomiting everything ○ Convulsions ○ Very Weak, Lethargic or unconscious ○ Pneumonia/severe pneumonia ○ Hypothermic: axillary temp $< 35^{\circ}\text{C}$ or rectal $< 35.5^{\circ}\text{C}$ ○ Fever $> 39^{\circ}\text{C}$ ○ Shock ○ Severe dehydration ○ Hypoglycaemia ○ Severe anemia: Hgb $< 4\text{ gm/dl}$ ○ Dermatitis +++ ○ Dysentery ○ Persistent diarrhoea ○ Jaundice ○ Bleeding Tendencies <li style="text-align: center;">OR • Failed Appetite test <li style="text-align: center;">OR • +++ Edema <li style="text-align: center;">OR • WFL/H $< 70\%$ with edema 	Complicated Severe Acute Malnutrition	Admit for In-patient management
<ul style="list-style-type: none"> • WFL/H $< 70\%$ of median or $< -3Z$ score OR MUAC $< 11\text{cm}$ <li style="text-align: center;">OR • Edema of both feet (+, ++) <li style="text-align: center;">AND • No medical complication AND pass appetite test 	Uncomplicated Severe Acute Malnutrition	Manage in OTP using the OTP Module or protocol or manage as in-patient if OTP service is not available
<ul style="list-style-type: none"> • WFL/H $\geq 70\%$ to $< 80\%$ or $\geq -3Z$ to $< -2Z$ score OR MUAC: 11cm to $< 12\text{cm}$ <li style="text-align: center;">AND • No edema of both feet 	Moderate Acute Malnutrition	Refer to supplementary feeding program if available, Counsel on child feeding/care
<ul style="list-style-type: none"> • If WFL/H $\geq 80\%$ or $\geq -2Z$ score OR MUAC $\geq 12\text{ cm}$ <li style="text-align: center;">AND • No edema of both feet 	No acute malnutrition	Congratulate her and Counsel the mother

Therapeutic Treatment Multi-Chart

Registration No... *464/01*..... Centre: **TFU**.....

Sheet No..... *1*..... Care hosp- ward/hosp- SNU/TFC

Father's Name: *Abebe*. Day care/Day-care-non-res

First Name: *Saron*. Age (d/m/y) *18 mos*.....

Address..... Birth date _____/_____/_____

Distance to House..... Sex F ...

Major Problems

1. **SAM**

2.....

3.....

Admission Date 14 / 2 / 01

Time 10:00 am/pm

Readmission Y/N

From.....

Old Reg Nos.....

Breastfeeding..... Y/N

Complementary feeding..Y/N

Discharge Date ____/____/____

Cured Defaulter Cause

Dead Time.....am/p

Med m

Transfer To.....

Nut referral To.....

Non responder To.....

Follow up by

Anthropometric Chart	Date	1	2	3	4	5	6	7	8	9	10	11	12	13	14	15	16	17	18	19	20	21	
	Height (cm)	72																					
	Weight (Kg)	6.2																					
	Wt for Ht (%)	69																					
	MUAC (cm)																						
	Oedema (0 to +++)	0																					

Physiology of severe malnutrition

447

- ❑ **Reductive adaptation**
- ❑ The systems of the body begin to “shut down” with severe malnutrition.
- ❑ The systems slow down and do less in order to allow survival on limited calories. This slowing down is known as **reductive adaptation**.
- ❑ As the child is treated, the body's systems must gradually “learn” to function fully again.
- ❑ Rapid changes (such as rapid feeding or fluids) would overwhelm the systems, so **feeding must be slowly and cautiously increased**

How does reductive adaptation affect care of the child?

448

- ❑ **Presume and treat infection**
- ❑ Nearly all children with severe malnutrition have bacterial infections.
- ❑ However, as a result of reductive adaptation, the usual signs of infection may not be apparent, because the body does not use its limited energy to respond in the usual ways, such as inflammation or fever.

Reductive adaptation ...

449

- ❑ **Do not give iron early in treatment**
- ❑ Due to reductive adaptation, the severely malnourished child makes less hemoglobin than usual.
- ❑ Iron that is not used for making hemoglobin is put into storage. Thus, there is “extra” iron stored in the body, even though the child may appear anemic.
- ❑ Giving iron early in treatment will not cure anemia, as the child already has a supply of stored iron.

Early iron ...

450

- Giving iron early in treatment can also lead to “free iron” in the body. Free iron can cause problems in three ways:
 1. Free iron is highly reactive and promotes the formation of free radicals, which may engage in uncontrolled chemical reactions with damaging effects.
 2. Free iron promotes bacterial growth and can make some infections worse.
 3. The body tries to protect itself from free iron by converting it to ferritin. This conversion requires energy and amino acids and diverts these from other critical activities.
- Later, as the child recovers and begins to build new tissue and form more red blood cells, the iron in storage will be used and supplements will be needed.

Provide potassium and restrict sodium

451

- Normally the body uses a lot of energy maintaining the appropriate balance of potassium inside the cells and sodium outside the cells.
- This balance is critical to maintaining the correct distribution of water inside the cells, around the cells and in the blood.
- In reductive adaptation, the “pump” that usually controls the balance of potassium and sodium runs slower.
- As a result, the level of sodium in the cells rises and the potassium leaks out of the cells and is lost (for example, in urine or stools).
- Fluid may then accumulate outside of the cells (as in oedema) instead of being properly distributed through the body.

Provide potassium ...

452

- All severely malnourished children should be given potassium to make up for what is lost.
- They should also be given magnesium, which is essential for potassium to enter into the cells and be retained
- The commercially prepared F-75 and F-100 have enough potassium and magnesium and there is no need to supplement.
- However, if you use the F-75 and F-100 recipe that are prepared by the health facility/ locally, Combined Mineral Vitamin mixes (CMV) should be given to supplement potassium, Magnesium, and other important minerals and vitamins.

Provide potassium ...

453

- Malnourished children already have excess sodium in their cells, so sodium intake should be restricted.
- If a child has diarrhea, a special rehydration solution called ReSoMal should be used instead of regular WHO ORS.
- ReSoMal has less sodium and more potassium than regular WHO ORS.

Quiz

454

1. When a child is severely malnourished, why is it important to begin feeding slowly and cautiously?
2. Why should all severely malnourished children be given antibiotics?
3. Why is it dangerous to give iron early in treatment?
4. Why the regular WHO ORS is not recommended for malnourished children?

Phases of in-patient care

455

- ❑ **Phase 1 (Stabilization phase):** children with complicated SAM are initially admitted to an inpatient facility for stabilization.
- ❑ These children are admitted to phase 1 room. During this phase:
 - ❑ Life-threatening medical complications are treated
 - ❑ Routine drugs are given to correct specific deficiencies
 - ❑ Feeding with F-75 milk (low caloric and sodium) is begun
 - ❑ The children in Phase 1 should be together in a separate room or section of the ward and not mixed with other patients

Phases of ...

456

- ❑ **Transition phase:** Once the child appetite recovers and the main medical complications are under control and oedema start to reduce, a transition phase is started where F-100 or RUTF (Ready-to- Use Therapeutic Food) is introduced.
- ❑ This phase is important for slow transition as the introduction of large amounts of RUTF or F100 could lead to imbalance of body fluids and severe medical complications. In this phase:
 - ❑ Routine drugs are continued
 - ❑ Feeding with RUTF or F100 is started

Phases of ...

457

- ❑ **Phase 2 (Rehabilitation Phase):** Children that progress through phase 1 and transition phase enter phase 2 (rehabilitation phase) when they have good appetite and no major medical complication.
- ❑ During phase 2:
- ❑ Routine drugs, deworming tablets and iron, are started
- ❑ Feeding with RUTF or F100 is increased in amount
- ❑ Child starts gaining weight
- ❑ Whenever possible, phase 2 is implemented as OTP with RUTF. Otherwise, it can be implemented in in-patient centers with RUTF or F100.

Process for successful management of children with SAM in In-patient care

458

1. Treat/prevent **hypothermia** and **hypoglycemia** (which are often related) by feeding, keeping warm, and treating infection.
2. Treat/prevent dehydration using Rehydration Solution for Malnutrition (ReSoMal).
3. Correct electrolyte imbalance (by giving feeds and ReSoMal).
4. Presume and treat infection with antibiotics.
5. Correct micronutrient deficiencies (by giving feeds and extra vitamins like vitamin A and folic acid as needed).

Process ...

459

6. Start cautious feeding with F-75 to stabilize the child (usually 2-7 days).
7. Rebuild wasted tissues through higher protein/calorie feeds (F-100 or RUTF).
8. Provide stimulation, play, and loving care.
9. Prepare parents to continue proper feeding and stimulation after discharge.

Important things NOT to do and why

460

- ❑ **Do not give diuretics to treat oedema.**
- ❑ The oedema is partly due to potassium and magnesium deficiencies that may take about 2 weeks to correct.
- ❑ The oedema will go away with proper feeding including a mineral mix containing potassium and magnesium.
- ❑ Giving a diuretic will worsen the child's electrolyte imbalance and may cause death

Not to do ...

461

- ❑ **Do not give iron during phase 1 and transition phase.**
- ❑ Add iron only when the child is in phase 2 (usually during week 2).
- ❑ As described earlier, giving iron early in treatment can have toxic effects and interfere with the body's ability to resist infection.

Not to do ...

462

- ❑ **Do not give high protein formula (over 1.5 g protein per kg body weight daily).**
- ❑ Too much protein in the first days of treatment may be dangerous because the severely malnourished child is unable to deal with the extra metabolic stress involved
- ❑ Too much protein could overload the liver, heart, and kidneys and may cause death.

Not to do ...

463

- ❑ **Do not give IV fluids routinely**
- ❑ IV fluids can easily cause fluid overload and heart failure in a severely malnourished child. Only give IV fluids to children with signs of shock.

Discharge Criteria

464

- The national protocol recommends that children with SAM should be discharged **as cured** from therapeutic feeding Program (TFP) if the child attains the following criteria:
 - **Age 6 months to 5 years:**
 - A weight-for-length or height $\geq 85\%$ on more than one occasion (two days for in-patients, two weeks for out-patients)

And

- No oedema for 10 days (in-patient) or 14 days (out-patient); or
- A target weight gain reached (see target weight table) if the child is admitted with MUAC.

Discharge ...

465

- ❑ **Age less than 6 months or less than 3 kg being breast fed:**
- ❑ If he/she is gaining weight on breast milk alone after the Supplemented Suckling technique has been used,
- ❑ **Age less than 6 months with no prospect of being breast-fed:**
- ❑ When they reach 85% weight for length and switched to infant formula or other animal milk.

Discharge ...

466

- It usually requires about 2 – 6 weeks for a child to achieve the target weight if the principles of care for SAM are followed.
- If a child leaves the TFP before achieving 85 % weight-for height/length, he/she is likely to get worse and have to return, or h/she may die at home.
- Transfer from in-patient care to OTP is **not considered as discharged cure**

MANAGEMENT OF MEDICAL COMPLICATIONS

467

❑ ***Manage Hypoglycemia***

- ❑ Hypoglycemia is a low level of glucose in the blood.
- ❑ In severely malnourished children, the level considered low is less than <54 mg/dl (< 3 mmol/litre).
- ❑ The hypoglycemic child is usually hypothermic (low temperature) as well.
- ❑ Other signs of hypoglycemia include lethargy, limpness, and loss of consciousness.

Hypoglycaemia ...

468

- Another sign of hypoglycemia is eye-lid retraction due to overactive sympathetic nervous system, thus a child sleep with eyes slightly open.
- Sweating and pallor may not occur in malnourished children with hypoglycemia.
- Often the only sign before death is drowsiness.
- The short-term cause of hypoglycemia is lack of food.
- Severely malnourished children are more at risk of hypoglycemia than other children and need to be fed more frequently, including during the night.

Hypoglycaemia ...

469

- Malnourished children may arrive at the hospital hypoglycemic if they have been vomiting, if they have been too sick to eat, or if they have had a long journey without food.
- Children may develop hypoglycemia in the hospital if they are kept waiting for admission, or if they are not fed regularly. Hypoglycemia and hypothermia are also signs that the child has a serious infection.
- Hypoglycemia is extremely dangerous. The child may die if not given glucose (and then food) quickly, or if there is a long time between feeds.
- **Check blood glucose**

Treat Hypoglycemia

470

- If blood glucose is low or hypoglycemia is suspected, immediately give the child a 50 ml bolus of 10% glucose or 10% sucrose orally or by NG tube.
- 50 ml is a very small amount, but it can make a big difference to the child.
- Glucose is preferable because the body can use it more easily; sucrose must be broken down by the body before it can be used.
- **However, give whichever is available most quickly.**
- If only 50% glucose solution is available, dilute one part to four parts sterile or boiled water to make a 10% solution.

Treat Hypoglycemia ...

471

- **If the child can drink, give the 50 ml bolus orally. If the child is alert but not drinking, give the 50 ml by NG tube.**
- **If the child is lethargic, unconscious, or convulsing, give 5 ml/kg body weight of sterile 10% glucose by IV, followed by 50 ml of 10% glucose or sucrose by NG tube.**
- *** If the IV dose cannot be given immediately, give dose first through NG tube.**

Treat Hypoglycemia ...

472

- Start feeding F-75 half an hour after giving glucose and give it every half-hour during the first 2 hours.
- For a hypoglycemic child, the amount to give every half-hour is $\frac{1}{4}$ of the 3-hourly amount shown on your F-75 Reference Card.
- Take another blood sample **after 2 hours** and check the child's blood glucose again.
- If blood glucose is now 54 mg/dl (3mmol/l) or higher, change to 3-hourly feeds (8 feeds per day) of F-75.
- If still low, make sure antibiotics and F-75 have been given.
- Keep giving F-75 every half-hour **and Treat with second-line antibiotics**

Manage Hypothermia

473

- ❑ **Hypothermia**
- ❑ Hypothermia is low body temperature.
- ❑ A severely malnourished child is hypothermic if the **rectal temperature is below 35.5 0C or if the auxiliary temperature is below 35 0C.**
- ❑ Severely malnourished children are at greater risk of hypothermia than other children and need to be kept warm.
- ❑ The hypothermic child has not had enough calories to warm the body.
- ❑ If the child is hypothermic, he is probably also hypoglycemic.
- ❑ Both hypothermia and hypoglycemia are signs that the child has a **serious systemic infection.**

Manage Hypothermia ...

474

- ❑ **Take temperature**
- ❑ Rectal temperatures are preferred because they more accurately reflect core body temperature.
- ❑ If axillary temperatures are taken, convert them to rectal by adding 0.5 C.
- ❑ If possible, use a low-reading thermometer. If no low-reading thermometer is available, use a normal thermometer.
- ❑ With a normal thermometer, assume that the child has hypothermia if the mercury does not move.

Manage Hypothermia ...

475

- ❑ **Maintain temperature (prevent hypothermia)**
- ❑ Cover the child, including his head
- ❑ Stop draughts in the room. Move the child away from windows
- ❑ Maintain room temperature of 28 and 32 0C
- ❑ Keep the child covered at night
- ❑ Warm your hands before touching the child
- ❑ Avoid leaving the child uncovered while being examined, weighed, etc.
- ❑ Promptly change wet clothes or bedding
- ❑ Dry the child thoroughly after bathing.

Manage Hypothermia ...

476

- ❑ **Actively re-warm the hypothermic child**
- ❑ In addition to keeping the child covered and keeping the room warm, use one of the following re-warming techniques if the child is hypothermic:
 1. Have the mother hold the child with his skin next to her skin when possible (kangaroo technique), and cover both of them. Keep the child's head covered. Give warm Fluid to mother.

10

477



kangaroo technique

4/24/2020

Manage Hypothermia ...

478

2. Use a heater or incandescent lamp with caution. Use indirect heat (not too close).
 - Monitor rectal temperature every 30 minutes to make sure the child does not get too hot. Stop rewarming when the child's temperature becomes normal.
 - Do NOT use hot water bottles due to danger of burning fragile skin.
 - All hypothermic children should be treated for hypoglycemia and for infection as well.

Oral feeding technique

479



4/24/2020

Recognize readiness for transition phase

480

- ❑ **Look for the following signs of readiness to progress from Phase 1 to transition phase:**
- ❑ Return of appetite (easily finishes the F-75 feeds)
and
- ❑ Reduced oedema or minimal oedema (++) or less
and
- ❑ No IV line, No NGT

Criteria to move back from transition phase to phase 1

481

- ❑ Move the child back to Phase 1:
- ❑ If the patient gains weight more rapidly than 10g/kg/d (this indicates excess fluid retention)
- ❑ If there is increasing oedema
- ❑ If a child who does not have oedema develops oedema
- ❑ If there is a rapid increase in the size of the liver
- ❑ If any other signs of fluid overload develop.
- ❑

Move the child back to Phase 1 ...

482

- If tense abdominal distension develops
- If the patient gets significant re-feeding diarrhea so that there is weight loss.
- If patient develops medical complication
- If NG-tube is needed
- •If patient takes less than 75% of the feeds in Transition Phase even after interchange between RUTF and F100

Criteria to move from transition phase to phase 2

- ❑ Transition takes 2-3 days. After transition, the child is in the phase 2 ("rehabilitation" phase).
- ❑ A child is ready for phase 2:
 - ❑ If he/she has good appetite. This means taking at least 90% of the RUTF or F100 prescribed for Transition Phase.
 - ❑ Oedematous patients should remain in Transition Phase until there is a definite and steady reduction in oedema (now at + level):
 - ❑ For those who are going to remain as inpatients they should normally remain in transition phase until they have lost their oedema entirely.
 - ❑ For those who are going to continue as OTP they can go when their appetite is good and they have reduced their oedema to ++ or +.

Criteria to move back from phase 2 to phase 1

484

- ❑ **A child who has any one of the following should be returned to Phase 1:**
- ❑ Develops any signs of a complication
- ❑ Increase/development of oedema
- ❑ Development of re-feeding diarrhea sufficient to lead to weight loss.
- ❑ Weight loss for 2 consecutive weighing
- ❑ Static weight for 3 consecutive weighing
- ❑ Fulfilling any of the criteria of “failure to respond to treatment”

Supplementary suckling technique for children <6 months

485



4/24/2020

IV. Summary table of systematic treatment of patients

	Direct admission to in-patient (Phase 1)	Direct admission to out-patient (Phase 2)
Vitamin A	<ul style="list-style-type: none"> - 1 dose at admission (conditional) - 1 dose on discharge - do not give when transferred to OTP management - it will be given in OTP 	<ul style="list-style-type: none"> - 1 dose on the 4th week (4th visit)
Folic Acid	<ul style="list-style-type: none"> - 1 dose at admission if signs of anaemia 	<ul style="list-style-type: none"> - 1 dose at admission if signs of anaemia
Amoxicillin	<ul style="list-style-type: none"> - Every day in Phase 1 + 4 more days in Transition 	<ul style="list-style-type: none"> - 1 dose at admission + give treatment for 7 days at home
Malaria	<ul style="list-style-type: none"> - According to national protocol 	<ul style="list-style-type: none"> - According to national protocol
Measles (from 9 months old)	<ul style="list-style-type: none"> - 1 vaccine at admission if no card - 1 vaccine at discharge 	<ul style="list-style-type: none"> - 1 vaccine on the 4th week (4th visit)
Iron	<ul style="list-style-type: none"> - Add to F100 in Phase 2 	<ul style="list-style-type: none"> - No - iron is already in all RUTF
Deworming	<ul style="list-style-type: none"> - 1 dose at the start of Phase 2 	<ul style="list-style-type: none"> - 1 dose on the 2nd week (2nd visit)

Age > = 6 months

4/24/2020

Childhood obesity

487

- **Obesity:** an excess amount of fat all over the body
- The normal fat content of the body in males is 12% and in females is 20%.
- Obesity can be considered if the fat content in males and females exceeds 20% and 30% respectively
- Triceps skin fold thickness is the best single method for defining this problem

Etiology

488

1. Exogenous causes

- a. Excess intake
- b. Diminished activity
- c. Genetic factors

2. Endocrine disorders

3. Inherited disorders associated with obesity

Classification

489

- ❑ **International Obesity Task Force by using BMI:**
 - ❑ Normal: 18.5-25
 - ❑ Grade I: 25-30
 - ❑ Grade II: 30-40
 - ❑ Grade III: >40

Classification ...

490

□ By using skin fold thickness:

	Mild (mm)	Moderate (mm)	Severe (mm)	Very severe (mm)
Preschool child	12	14	16	>16
School child (7- 10 years)	14-16	16-18	18-20	>20
11-15 years	16-18	18-20	20-22	>22

Types of obesity

491

1. **Generalized obesity:** excess fat deposition is uniform throughout the body. It is characterized by the presence of double chin
2. **Android obesity:** excess fat is deposited over the chest
3. **Gynoid obesity:** excess fat is deposited over the region of the hips and thighs
4. **Superior or central type of obesity:** excess fat is deposited over face, neck and upper part of the trunk, and the arms are thin

Complications of obesity

492

Parameter	Effects
Psychological	Peer discrimination, isolation
Growth	Advanced bone age, early menarche
CNS	Pseudotumour cerebri
Respiratory	Sleep apnoea, infection
CVS	hypertension, cardiac hypertrophy, IHD, sudden death
Orthopedic	Slipped capital femoral epiphysis
Metabolic	DM, hypertriglyceridaemia, hypercholesterolaemia, gout, cholelithiasis, pancreatitis
Malignancy	Endometrial, breast, prostate, colon

Management

493

- **Behaviour modification**
- **Exercise:** walking 3 miles/hour will expend 300 calories leading to a weight loss of around 3kg/3months
- **Education:**
- **Diet:**
- **Surgery:** the last resort if the obesity is greater than 200% of IBW with complications of obesity
- **Drugs** that suppress appetite
- **Symptomatic** management

Prognosis

494

- Obesity in children is due to increase in the number of fat cells and in adults it is due to increase in size
- Once fat cells are increased and fixed, it is very difficult to treat

Thank you

UNIT V: Systemic disorders



CARDIO VASCULAR DISEASE (CVS)

498

LEARNING OBJECTIVES: At the end of this topic the students will be able to:

- Explain the physiological change of CVS in newborn
- Describe congenital heart disease
- Discuss common CHD
- Explain the common acquired heart diseases
- Discuss the mechanism, c/m and management of heart failure

PHYSIOLOGY OVERVIEW

Right-to-left shunting at atrial level (PFO) and at arterial level (ductus arteriosus)

High pulmonary vascular resistance

Little pulmonary blood flow

Ventricles work in parallel

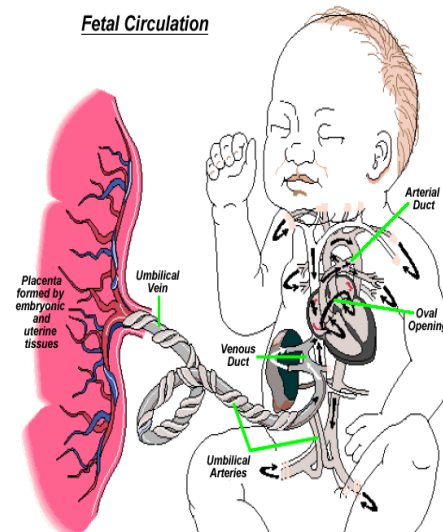

A. CONGENITAL HEART DISEASE (CHD)

- ❑ Globally, CHD affects over one million live births annually and is the leading cause of infant mortality attributable to birth defects.
- ❑ Critical congenital heart disease (CCHD) refers to lesions of the cardiovascular system, present at birth, which if left undiagnosed it will result in infant morbidity and mortality.
- ❑ Gross structural abnormality of the heart or great vessels that is actually or potentially of functional significance

CAUSE

- ❖ **Mostly unknown**
- ❖ **Multifactorial: Genetic-environmental interaction**
 - Genetic/chromosomal
 - Environmental: CMV, maternal hypoxia, hyperthermia, DM (10 ´ risk), drugs: like, phenytoin and other anticonvulsants, alcohol, thalidomide

ANATOMIC CLASSIFICATION

RIGHT TO LEFT SHUNT

- ❑ TOF
- ❑ TGA(transpositions of great artery)
- ❑ Tricuspid Atresia

LEFT TO RIGHT SHUNT

- ❑ ASD
- ❑ VSD
- ❑ PDA

STENOTIC

- ❑ AVS
- ❑ PVS
- ❑ Aortic coarctation

MIXING

- ❑ Total Anomalous Pulmonary Venous Return
- ❑ Hypoplastic left heart syndrome

VSD

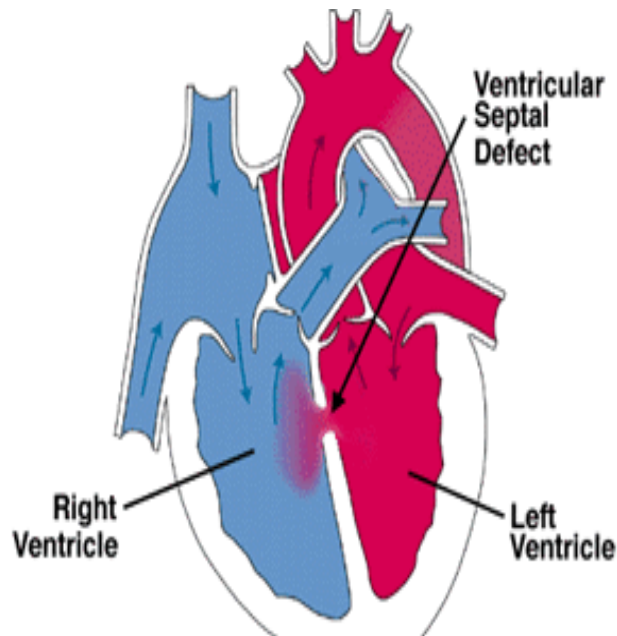

- Most common congenital lesion
- Large VSD's may be silent and become symptomatic in first few weeks as pulmonary resistance ↓
- SOB and diaphoresis w feeds
- Poor weight gain
- Systolic murmur
- CXR demonstrates CHF

Tetralogy of Fallot (TOF or "Tet")

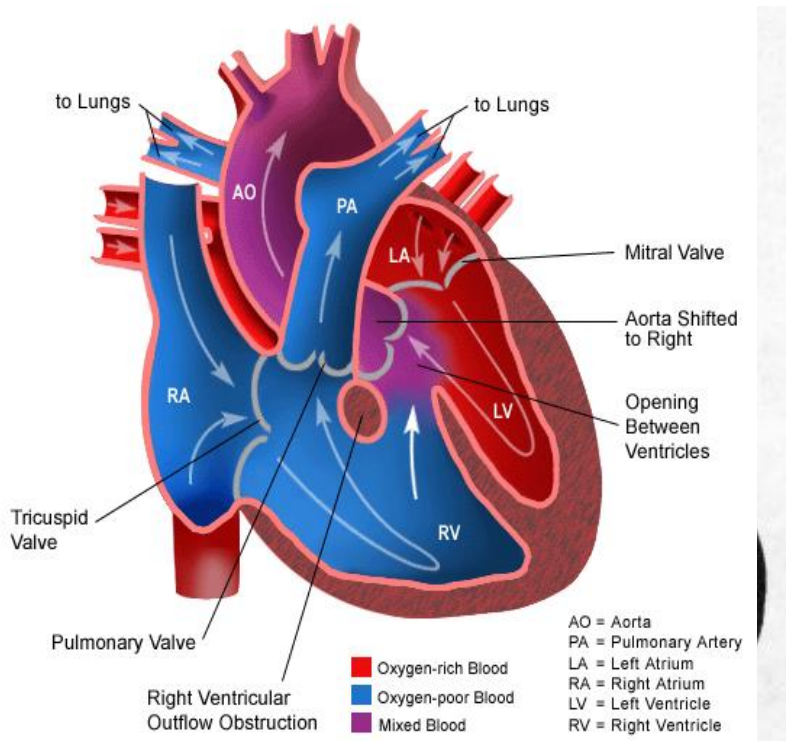

-
- RVH
- VSD
- overriding aorta
- CXR reveals boot shaped heart with decreased pulmonary blood flow

Children with Tetralogy of Fallot exhibit bluish skin during episodes of crying or feeding.



“Tet spell”

 ADAM.

TOF

Hypoxemic spells, also called cyanotic or Tet spells, are one of the hallmarks of severe ToF and are characterized by:

- ❖ Sudden onset of cyanosis or deepening of cyanosis
- ❖ Sudden **dyspnea**
- ❖ Alterations in consciousness, in a spectrum from irritability to syncope
- ❖ Decrease or disappearance of the systolic murmur.
- ❖ These episodes most commonly start at age 4–6 months

Evaluation for suspected congenital heart disease

- At birth, Nada's criteria are used to evaluate a newborn and the presence of one Major or two Minor Criteria indicates Presence of Congenital Heart Disease.

Nada's Major Criteria

- Systolic murmur with thrill
- Any diastolic murmur
- Cyanosis (central)
- Congestive cardiac failure

Evaluation cont'd

508

Nada's Minor Criteria

- Systolic murmur without thrill
- Abnormal P2 (accentuated P2)
- Abnormal BP (hypo / hypertension)
- Abnormal CXR
- Abnormal ECG
- If the Nada's criteria are positive then, send the baby where he can be definitely diagnose with echocardiography and evaluated further.
- All babies suspected to have CHD should be managed with cautions in IV fluid administration to avoid congestion.

Clinical evaluation

□ History

- ▣ feeding difficulties
- ▣ tachypnea
- ▣ diaphoresis
- ▣ syncope
- ▣ cyanotic episodes
- ▣ failure to thrive

□ Physical Examination

- ▣ color: pink, blue, gray
- ▣ vitals: tachypnea, tachycardia, BP
- ▣ symptoms suggestive of infection
- ▣ palpation and auscultation of precordium
- ▣ chest auscultation
- ▣ survey for organomegaly
- ▣ pulses in all extremities

Major components of Evaluation

510

1. Presence or absence of cyanosis, which can be determined by **physical examination** aided by pulse oximetry.
 - Heart sounds - the presence and character of any murmurs.
2. **Chest radiograph**- Less informative but helps to see the heart size and shows evidence of increased, normal, or decreased pulmonary vascular markings
3. **Electrocardiogram** – To look for the rate, rhythm and chamber hypertrophy and axis. can be used to determine whether right, left, or biventricular hypertrophy exists.
4. **Echocardiography**
 - ▣ It's a definitive diagnostic method to evaluate the heart

Time of onset of congestive heart failure

511

Age	Lesions
Birth - 72 hrs	Pulmonary, Mitral, and Aortic atresia or critical stenosis
4 days - 01 week	Hypoplastic Lt and Rt heart, Transposition of great arteries
1wk - 4wks	VSD and PDA in premature infant and the lesions mentioned above
4 – 6 wks	Endocardic cushion defect (ECD)
6wk – 6 mo	Large VSD, large PDA

MANAGEMENT

512

- ❑ Strict cardio respiratory support and monitoring
- ❑ Supportive oxygen therapy
- ❑ Restrict fluid intake to one half to two third of daily maintenance.
- ❑ Treat or correct precipitating factors
- ❑ Treat metabolic derangements (hypoglycemia, hypothermia)
- ❑ After stabilization of the patient refer to a higher center for proper diagnosis and management.

B. ACQUIRED HEART DISEASE

513

Infective endocarditis

- ✓ Infective (bacterial) endocarditis (IE) is an infection of either the heart's **inner lining (endocardium)** or the heart **valves(AHA)**.
- ✓ Infective endocarditis is a serious and sometimes fatal illness .

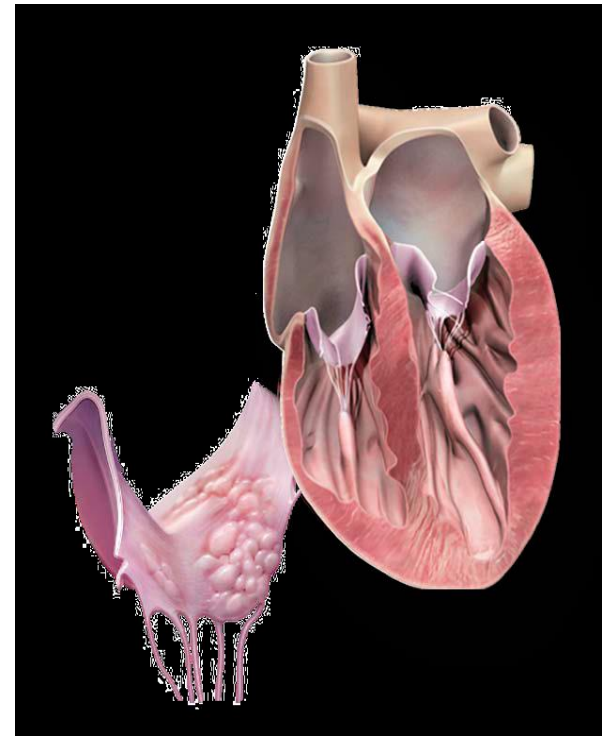

4/24/2020



Etiology

- endocarditis caused by **viruses, fungi, and other microbiologic agents.**

 - **The common causes include :**
 1. *Streptococcus viridans* (20%) (Day, Gauvreau, Shulman, & Newburger, 2009)
 2. *Staphylococcus aureus*(57%)
 3. *Enterococcus*
- (Math et al., 2011; Moges et al., 2015; Slipczuk et al., 2013)



Clinical Manifestations

- **None specific manifestation includes**
 - Splenomegaly and petechiae
 - Cutaneous manifestations
 - **Conjunctival and mucosal petechiae**
 - Splinter hemorrhage
 - Clubbing
 - **embolism** : CNS, spleen ,lung, retinal vessels, coronary artery, and large artery.
 - CHF
- **General : Wight loss ,anorexia, Fever**



Clinical Manifestations

**More specific
signs of infective
endocarditis**

- Osler nodes
- Janeway lesions
- Roth spot
- **Osler nodes** (*tender, pea-sized intradermal nodules in the pads of the fingers and toes*)



Diagnosis

- ❖ **The Diagnosis of endocarditis is based on**
 1. history and physical examination
 2. **blood cultures and other selected laboratory results**
 3. an electrocardiogram (ECG)
 4. a chest radiograph
 5. **and an echocardiogram.**



Blood cultures

- **Gold standard D(x) is blood culture**
(Nelson Text book of Pediatrics 20th Ed)
- A minimum of 3 blood culture is needed
- Blood cultures should be obtained prior to antibiotic therapy.
- obtained after careful preparation of the phlebotomy site.
- Obtain 10-20mL in adults and 0.5-5mL in children



Dukes criteria to diagnosis endocarditis

Major Criteria

1. **positive blood cultures** :- (2 separate cultures for a **usual** pathogen, 2 or more for less-typical pathogens), and
2. **evidence of endocarditis on echocardiography**
(intracardiac mass on a valve or other site, regurgitant flow near prosthesis, abscess, partial dehiscence of prosthetic valves, or new valve regurgitant flow).



Minor Criteria

1. predisposing conditions,
2. fever $\geq 38^{\circ}\text{C}$
3. embolic-vascular signs,
4. immune complex phenomena (glomerulonephritis, arthritis, rheumatoid factor, Osler nodes, Roth spots),
5. a single, positive blood culture or
6. serologic evidence of infection,
7. and echocardiographic signs not meeting the major criteria.



I. Definite IE

- ✚ **Pathologic or Clinical criteria can be used**
- ✚ **Clinical criteria**
 1. Two major criteria, *or*
 2. One major and three minor criteria, *or*
 3. Five minor criteria

2. Possible IE

- major criterion and 1 minor criterion **OR** 3 minor criteria .

3. Rejected IE

1. **Firm** alternative diagnosis for manifestations of endocarditis, *or*
2. Sustained resolution of manifestations of endocarditis, with antibiotic therapy for **4 days or less**, *or*
3. No pathological evidence of infective endocarditis at surgery or autopsy, after antibiotic therapy for 4 days or less

Differential diagnosis

- ✦ **The following diseases have to be considered:**
 1. Recurrence of rheumatic fever
 2. Malaria
 3. Tuberculosis



Medical management

- ✦ Initial empiric antibiotic should be effective for both **Gram-positive and Gram negative organism** combine cloxacillin (100 mg /kg per 24 hours), ampicillin (300 mg/kg per 24 hr, IV) and gentamicine (3 to 4 mg / kg per 24 hours IV).
- ✦ Therapy should continue for 4 to 6 weeks (**except gentamicin for 2 weeks**)

Surgical management

✚ Early surgical intervention is very important for complicated Endocarditis

✚ Common surgical indication

- a mycotic aneurysm,
- rupture of an aortic sinus,
- intraseptal abscess causing complete heart block,
- or dehiscence of an intracardiac patch requires an **emergency operation.**

Nursing Management

1. Watch for signs and symptoms of embolization such as **hematuria, pleuritic chest pain, left upper quadrant pain, and paresis.**
2. Monitor the patient's renal status including **blood urea nitrogen levels, creatinine clearance levels and urine output..**
3. Check for changes in cardiac rhythm or conduction.
4. Evaluate **arterial blood gas** values as needed to ensure adequate oxygenation.
5. Observe for signs of **infiltration or inflammation at the venipuncture** site.

Nursing Management

527

6. Stress the importance of taking the medication
7. **Tell patient to watch closely for fever, anorexia, and other signs of relapse.**
8. **Teach the patient** how to recognize symptoms of endocarditis, and tell him to notify the Health care immediately if such symptoms occur.
9. Stress the importance of dental hygiene to prevent caries and possible recurrent endocarditis.



PREVENTION

1. treatment of infection in **high risk children.**
2. proper general dental care and oral hygiene and antimicrobial prophylaxis.
3. **Oral amoxicillin 2g can be given 1 hour before dental procedures and surgery of the upper respiratory tract.**
4. **Intramuscular or IV ampicillin plus gentamicin** is recommended before surgery of the genitourinary and gastrointestinal system.

RHEUMATIC HEART DISEASE (RHD)

529

Rheumatic fever (ARF) :- is an inflammatory disease affecting the heart , joint & subcutaneous tissue.

- ARF remains an important preventable cause of cardiac disease
- **Usually follow 2-6 wks after hemolytic streptococcal respiratory infection.**
- A family history of rheumatic fever and lower socioeconomic status are additional factors.

Jones Criteria for Diagnosis of Rheumatic Fever

Major manifestation

- Carditis
- Polyarthritits
- Chorea
- Subcutaneous nodules
- Erythema marginatum
-

-N.B Two major or one major and two minor manifestations (plus supporting evidence of streptococcal infection) are needed

Minor manifestation

- Fever
- Arthralgia
- ↑ ESR
- ↑ WBC
- Anemia
- ECG abnormal
- *Clinical* Previous rheumatic fever or rheumatic heart disease

MANAGEMENT

- All patients with acute rheumatic fever should be placed on **bed rest and monitored closely for evidence of carditis.**
- They can be allowed to ambulate as soon as the signs of acute inflammation have subsided..
- ❖ **ANTIBIOTIC THERAPY**
- The patient should receive 10 days of orally administered penicillin or erythromycin, or a single intramuscular injection of benzathine penicillin to eradicate GAS from the upper respiratory tract.
- After this initial course of antibiotic therapy, the patient should be started on long-term antibiotic prophylaxis.

❖ **Anti-Inflammatory Therapy.**

- ❑ Aspirin is 100 mg/kg/day in 4 divided doses PO for 3–5 days, followed by 75 mg/kg/day in 4 divided doses PO for 4 wk.
- ❑ Prednisone is 2 mg/kg/day in 4 divided doses for 2–3 wk followed by a tapering of the dose that reduces the dose by 5 mg/24 hr every 2–3 days
- ❑ **In the case of Sydenham Chorea** Sedatives may be helpful early in the course of chorea;
- ❑ phenobarbital (16–32 mg every 6–8 hr PO) is the drug of choice.
- ❑ If phenobarbital is ineffective, then haloperidol (0.01–0.03 mg/kg/24 hr divided bid PO) or chlorpromazine (0.5 mg/kg every 4–6 hr PO) should be initiated

RHEUMATIC HEART DISEASE (RHD)

533

- **RHD is damage of the heart, particularly the valves by one or more attacks of RF.**
- **Pattern of valvular disease**
- Mitral stenosis
- Aortic insufficiency
- Tricuspid valve disease
- Pulmonary valve disease

HEART FAILURE

- HF is defined as the heart fail to pump sufficient amount of blood to supply blood to either systemic or pulmonary circulation at an appropriate rate of flow, or to receive venous return at an appropriate filling pressure

PATHOPHYSIOLOGY

535

Four Basic Mechanisms

1. Increased Blood Volume (Excessive Preload)

Etiology

- ✚ Mitral Regurgitation
- ✚ Aortic Regurgitation
- ✚ Volume Overload
- ✚ **Left to Right** Shunts
- ✚ Chronic Kidney Disease

Pathophysiology cont'd

2. Increased Resistant to Blood Flow (Excessive Afterload)

Etiology

- ✚ Aortic Stenosis
- ✚ Aortic Coarctation
- ✚ Hypertension

Pathophysiology cont'd

3. Decreased contractility

Etiology

- ❖ Ischemic Cardiomyopathy like, Myocardial Infarction, Myocardial Ischemia
- ❖ Myocarditis
- ❖ Toxins eg. Anthracycline, Alcohol, Cocaine

Pathophysiology cont'd

538

4. Decreased Filling

Etiology

- ✚ Mitral Stenosis
- ✚ Constriction
- ✚ Hypertrophic
- ✚ Cardiomyopathy

Clinical Features

539

- Fast breathing or interruption of feeding with diaphoresis
- Tachycardia (heart rate >160 /minute in a child under 12 months old; >120 /minute in a child aged 12 months to 5 years).
- laboured respirations with intercostal and subcostal retractions
- Nasal flaring
- Feeding difficulties
- Failure to thrive
- weak cry

- ❑ Effort intolerance
- ❑ oedema of the feet, hands or face, or raised JVP
- ❑ Basal crackles on chest exam
- ❑ Gallop rhythm on auscultation with or without murmurs.
- ❑ Enlarged, tender liver
- ❑ If the diagnosis is in doubt, a chest X-ray can be taken and will show an enlarged heart

ROSS HEART FAILURE CLASSIFICATION FOR CHILDREN for dx purpose.

Class I

- Asymptomatic

Class II

- Mild tachypnea or diaphoresis with feeding in infants
- Dyspnea on exertion in older children

Class III

- Marked tachypnea or diaphoresis with feeding in infants
- Marked dyspnea on exertion
- Prolonged feeding times with growth failure

Class IV

- Symptoms such as tachypnea, retractions, grunting, or diaphoresis at rest

Diagnosis Modalities

- ✚ History taking
- ✚ Physical examination
- ✓ Vital sign
- ✓ Growth appearance
- ✓ General appearance
- ✓ cardio vascular exam
- ✓ pericardial exam

Cont...

- ✚ Laboratory investigations
 - ✓ chest x-ray
 - ✓ electrocardiogram
 - ✓ urine test
 - ✓ blood test
 - ✓ echocardiogram

MANAGEMENT

- The underlying cause must be removed or alleviated if possible.
- Medical treatment is indicated to prepare the patient for surgery and in the immediate postoperative period.
- If the lesion is not reversible, heart failure management usually allows the child to return to normal activities

General measure

- ❑ **Strict bed rest** is rarely necessary except in extreme cases, but it is important that the child be allowed to rest during the day as needed and sleep adequately at night.
- ❑ **DIET**
- ❑ **Infants with heart failure may fail to thrive because of increased metabolic requirements and decreased caloric intake.**
- ❑ **Increasing daily calories is an important aspect of their management.**
- ❑ **In some circumstances, nasogastric feedings may be helpful .**
- ❑ **In many children with cardiac enlargement, gastroesophageal reflux is a major problem.**

Pharmacological Mgt

DIURETICS

- Most often used in conjunction with digitalis therapy in patients with severe congestive heart failure.
- Give furosemide (frusemide): a dose of 1 mg/kg should cause increased urine flow within 2 hours.
- If the initial dose is not effective, give 2 mg/kg and repeat in 12 hours, if necessary. Thereafter, a single daily dose of 1–2 mg/kg orally is usually sufficient.
- Supplemental potassium: when digoxin and furosemide are given, or if frusemide is given for more than 5 days, give oral potassium (3–5mmol/kg/day).

Pharmacological Mgt

- **Digitalis**
- **Digoxin is the digitalis glycoside used most often in pediatric patients.**
 - ↑ the force of myocardial
Contraction ⇒ ↑Co
 - Diuretic effect (↓ edema)
- **Afterload-Reducing Agents and ACE Inhibitors**
(e.g catopril)
- **β-Blockers (e.g Metoprolol)**

Management

cont'd

- **Oxygen:** Give oxygen if the child has a respiratory rate of ≥ 70 /min, shows signs of respiratory distress, or has central cyanosis

SUPPORTIVE CARE

- Avoid the use of IV fluids, where possible.
- Support the child in a semi-seated position with head and shoulders elevated and lower limbs dependent.
- Relieve any fever with paracetamol to reduce the cardiac workload.
- Avoid unnecessary movement and transportation

Prognosis

The outcome for patients experiencing HF depends largely on its cause.

- When noncardiac disorders are responsible, the improvement in HF is related to successful treatment of the systemic disease.
- For many cardiac malformations (preloading and afterloading conditions), surgical correction can be curative

Assignment- (Non-graded)

Read and take short note about.

□ **Systemic Hypertension**

Definition

Etiology

Clinical manifestation

Diagnosis criteria

Management

GENITOURINARY SYSTEM DISORDER



Objectives

At the end of this chapter you will be able to

- Mention the common manifestations of GUT problems.
- Diagnosis common GUT disorders
- Manage common GUT disorders

Anatomy and physiology

- Consists of kidney ureters, bladder, urethra

Functions

- Regulating blood volume and pressure
- Regulating plasma concentrations of sodium, potassium, chloride and other ions
- Stabilising blood pH
- Conserving nutrients
- Detoxifying poisons (with the liver)

URINARY TRACT INFECTION

- Urinary tract infections (UTI) is common in the pediatric age group.
- Upper urinary tract infections (i.e, acute pyelonephritis) may lead to renal scarring, hypertension, and end-stage renal diseases.
- Difficult on clinical grounds to distinguish cystitis from pyelonephritis, particularly in young children (those younger than 2 years)

Types of UTI

- Urethritis – infection of the urethra
- Cystitis – an infection in the bladder that has moved up from the urethra
- Pyelonephritis – a urinary infection of the kidney as a result of an infection in the urinary tract

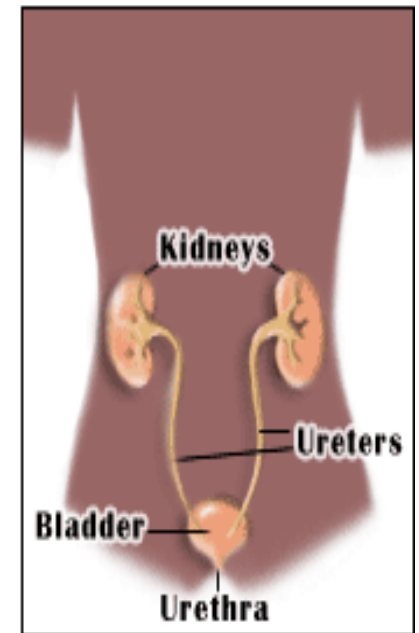

ETIOLOGY

- Bacterial infections are the most common.
- E coli is the most common causing 75-90% of UTI episodes.
- Other bacteria include:
 - ▣ Klebsiella species
 - ▣ Proteus species
 - ▣ Enterococcus species
 - ▣ Staphylococcus saprophyticus
- Adenovirus (rare)
- Fungal in immune compromised patients

PATHOPHYSIOLOGY

- Generally begins in the bladder due to ascending infection from perineal contaminants, usually bowel flora such as **Escherichia coli**.
- In neonates, infection of the urinary tract is assumed to be due to hematogenous rather than ascending infection.
- Bacteremia may then appear as potential sequelae.
- Bacterial invasion of the bladder with overt UTI is more likely to occur if urinary stasis or low flow conditions exist.
- This is triggered by infrequent or incomplete voiding, reflux, or other urinary tract abnormalities.

CLINICAL PRESENTATION

- In young children, UTI often presents with non-specific signs

In young children (<2 yrs)

- Fever, vomiting, poor feeding, abdominal tenderness, irritability, failure to thrive.

Older Children

- Fever, urinary symptoms (dysuria, urgency, frequency, incontinence, macroscopic haematuria), and abdominal pain
- The constellation of fever, chills, and flank pain is suggestive of **pyelonephritis** in older children

Laboratory Investigations

- Urinalysis: Clean catch or suprapubic aspirate
 - ▣ WCC, RCC, Nitrites (E Coli): Sensitivity of 80%.
 - ▣ Urine Microscopy
- Urine Culture
- Blood Culture
- Lumbar Puncture in a febrile child < 3 months

MANAGEMENT

The goals of Treatment

- Elimination of infection and prevention of urosepsis
- Prevention of recurrence and long-term complications
- Relief of acute symptoms

MANAGEMENT

Treat the child as an outpatient, but **Hospitalization is necessary:**

- when there is high fever and systemic upset (such as vomiting everything or inability to drink or breastfeed)
- Patients who are toxemic or septic
- Patients with signs of urinary obstruction or significant underlying disease
- Patients unable to tolerate adequate PO fluids or medications
- Infants younger than 3 months with febrile UTI (presumed pyelonephritis)
- All infants younger than 1 month with suspected UTI even if not febrile

MANAGEMENT

- Start antibiotics after urinalysis and culture are obtained.
- A 10-day course of antibiotics is recommended, even for uncomplicated infection.
- For cystitis, oral antibiotic therapy is adequate, but if pyelonephritis is suspected, a combination of parenteral antibiotics is recommended.
- Recent evidence indicates that oral antibiotics are adequate therapy for febrile UTI in young infants and children; short-term (fever) and long-term (renal scarring) outcomes are comparable to parenteral therapy.

MANAGEMENT

- Oral cotrimoxazole (4 mg trimethoprim/20 mg sulfamethoxazole per kg every 12 hours) for 5 days. Alternatives include ampicillin, amoxicillin and cefalexin.
- If there is a poor response to the first-line antibiotic or the child's condition deteriorates, give gentamicin (7.5 mg/kg IM once daily) plus ampicillin (50 mg/kg IM/IV every 6 hours) or a parenteral cephalosporin.
- Consider complications such as pyelonephritis (tenderness in the costo-vertebral angle and high fever) or septicaemia.

Supportive care

- The child should be encouraged to drink or breastfeed regularly in order to maintain a good fluid intake, which will assist in clearing the infection and prevent dehydration.

Follow-up

- Investigate all episodes of UTI in >1-year-old males and in all children with more than one episode of UTI in order to identify the underlying cause.
- This may require referral to a larger hospital with facilities for appropriate X-ray or ultrasound investigations.

Complications

- **DEHYDRATION** is the most common complication of UTI in the pediatric population. IV fluid replacement is necessary in more severe cases.
- Treat febrile UTI as pyelonephritis, and consider parenteral antibiotics and admission for these patients.
- Untreated UTI may progress to renal involvement with systemic infection (e.g. urosepsis).
- Long-term complications include renal parenchyma scarring, hypertension, decreased renal function, and, in severe cases, renal failure.



ACUTE POSTSTREPTOCOCCAL GLOMERULONEPHRITIS

(APSGN)

INTRODUCTION

- PSGN is caused by prior infection with specific nephritogenic strains of group A beta-hemolytic streptococcus.
- The clinical presentation of PSGN varies from asymptomatic, microscopic hematuria to the full-blown acute nephritic syndrome, characterized by red to brown urine, proteinuria, edema, hypertension, and acute kidney injury.

- ❑ Most common in children aged 5–12 yr
- ❑ Uncommon before the age of 3 yr.
- ❑ Although PSGN continues to be the most common cause of acute nephritis globally, it primarily occurs in developing countries.
- ❑ Of the estimated 470,000 new annual cases of PSGN worldwide, 97 percent occur in developing countries, with an annual incidence that ranges from 9.5 to 28.5 per 100,000 individuals.

- 
- Age: (2-12 years , 5% < 2 yrs)
 - Sex: (M:F → 2:1)
 - Socioeconomic background
 - Genetic predisposition (HLA-DR1 & DRW₄)
(HLA –DRW₄₈ & DRW8 less susceptible)

- 
- ▣ Abrupt onset of hematuria (100%)
 - Proteinuria (80%)
 - Edema (90%)
 - HTN (60-80%)
 - Mild to moderate renal insufficiency (25-40%)
 - Latent period → (1-2 wks, throat infection , 3-6 wks skin infection)
 - Subclinical to clinically overt dx → 4-5:1

- 
- Urinalysis
 - Serology
 - Culture
 - Because PSGN presents weeks after an antecedent GAS infection, only about 25 percent of patients will have either a positive throat or skin culture.
 - In patients with impetigo, there is an increased likelihood of obtaining a positive skin culture

- 
- PSGN is usually diagnosed based upon clinical findings of acute nephritis and demonstration of a recent group A beta-hemolytic streptococcal (GAS) infection.
 - The clinical findings of acute nephritis include hematuria with or without red blood cell casts, variable degrees of proteinuria, edema, and hypertension.
 - Documentation of a recent GAS infection includes either a positive throat or skin culture or serologic tests (eg, ASO or streptozyme

MANAGEMENT

- Management is directed at treating the acute effects of renal insufficiency and hypertension.
- Although a 10-day course of systemic antibiotic therapy with penicillin is recommended to limit the spread of the nephritogenic organisms, antibiotic therapy does not affect the natural history of glomerulonephritis.
- Sodium restriction, diuresis usually with intravenous Lasix, and pharmacotherapy with calcium channel antagonists, vasodilators, or angiotensin-converting enzyme inhibitors are standard therapies used to treat hypertension.



NEPHROTIC SYNDROME

NEPHROTIC SYNDROME (NS)

- It is primarily a pediatric disorder
- 15 times more common in children than adults.
- The incidence is 2-3/100,000 children per year; and the majority of affected children will have steroid-sensitive minimal change disease.
- NS defined by the clinical triad of
 - Oedema
 - Nephrotic range proteinuria and
 - Hypoalbuminaemia
 - Typically accompanied by
 - Dyslipidaemia with elevated plasma cholesterol and triglycerides.

Etiology

- Nephrotic syndrome may occur as a result of any form of glomerular disease and may be associated with a variety of extra renal conditions.
- Approximately 90% of children with this condition have some form of the idiopathic nephrotic syndrome.
- In the remaining 10%, the syndrome is secondary to some form of glomerulonephritis.

NEPHROTIC SYNDROME IN CHILDREN

1. PRIMARY / IDIOPATHIC (INS)

Accounts for approximately 90% of nephrosis in childhood.

It occurs in three morphologic patterns:

- minimal change disease (85%),
- focal segmental glomerulosclerosis (10%)
- mesangial proliferative (5%).

Nephrotic Syndrome in Children

2. SECONDARY

▣ Systemic Illness

- IDDM, obesity

▣ Infections

- Hep B, C; HIV, malaria, syphilis, schistosomiasis

▣ Allergy

- Bee stings, milk, pork

▣ Exposures

- NSAID's, Penicillamine, gold, ampicillin, heavy metals

▣ Lymphomas

PATHOPHYSIOLOGY

- The primary disorder is an increase in glomerular permeability to proteins, most likely as a result of the loss of the glomerular basement membrane sialo proteins, which leads to a loss of the normal negative charge.
- Massive proteinuria results and leads to a decline in serum proteins, especially albumin.
- Plasma oncotic pressure is diminished, **resulting in a shift of fluid from the vascular to the interstitial compartment and a contraction in plasma volume.**
- Renal blood flow and GFR are not usually diminished, and in some instances GFR may be above normal.

- Edema formation is enhanced by a reduction in effective blood volume and by an increase in tubular sodium chloride reabsorption secondary to activation of the renin-angiotensin-aldosterone system.
- Most serum lipids (including cholesterol and triglycerides) and levels of lipoprotein are elevated because hypoproteinemia stimulates hepatic lipoprotein synthesis, while lipid metabolism is diminished

Clinical Manifestations

- It usually presents with pitting edema, initially noted in periorbital area and in the lower extremities. The edema becomes generalized with time.
- Some children present with hypotension secondary to significant shift of fluid from intravascular to third space and they may rarer develop renal failure
- Abdominal pain
- Diarrhea (intestinal edema) or respiratory

DIAGNOSIS

- Urinalysis reveals proteinuria (+3 or +4 on dipstick).
- Serum albumin level is generally $< 2.5\text{g} / 24\text{hr}$.
- The serum cholesterol and triglyceride levels are generally high

MANAGEMENT

❖ **Diet**

- ❑ Normal protein intake
- ❑ Salt restriction during relapses

❖ **Antibiotics**

- ❑ Oral penicillin should be given during both initial illness and relapses.

- ❖ **Diuretics** Careful use of frusemide only in the absence of hypovolaemia, if fluid restriction (e.g. 70% maintenance) and salt restriction alone not effective in controlling oedema formation.

Steroid therapy for first presentation:

STEROID THERAPY

- This is the mainstay of treatment and should be commenced once the diagnosis is established
- Prednisone or Prednisolone - start at 60mg/m²/day (max 80mg) in a single daily dose to complete a total of 42 days.
- Then switch to alternate day therapy at 40mg/ m²/day (max 60mg) for further 42 days.
- Then wean steroid dose gradually over 8-10 weeks and stop.
- Total treatment duration of first presentation for at least 20 weeks.

Parent information

- ▣ Parents need a clear explanation of the diagnosis of NS, its implications for the future and the importance of compliance with medication.
- ▣ Side effects of medications must also be clearly explained.
- ▣ Families should be provided with written information

Complications of Nephrotic Syndrome

- Spontaneous bacterial peritonitis
- Bacteremia
- Steroid-related toxicity
- Immunosuppression-related toxicity
- Acute renal failure
- **Thrombosis**

Acute kidney injuries

587



- ✓ It is a Rapid deterioration of renal function resulting retention of nitrogenous wastes and inability of kidney to regulate fluid and electrolyte homeostasis. **Nelson 20 ed**

Table 535-1 Pediatric-Modified Rife (pRIFLE) Criteria		
CRITERIA	ESTIMATED CCL	URINE OUTPUT
Risk	eCCL decrease by 25%	<0.5 mL/kg/hr for 8 hr
Injury	eCCL decrease by 50%	<0.5 mL/kg/hr for 16 hr
Failure	eCCL decrease by 75% or eCCL <35 mL/min/1.73 m ²	<0.3 mL/kg/hr for 24 hr or anuric for 12 hr
Loss	Persistent failure >4 wk	
End-stage	End-stage renal disease (persistent failure >3 mo)	

CCL, creatinine clearance; eCCL, estimated creatinine clearance; pRIFLE, pediatric risk, injury, failure, loss, and end-stage renal disease.

ETHIOLOGY

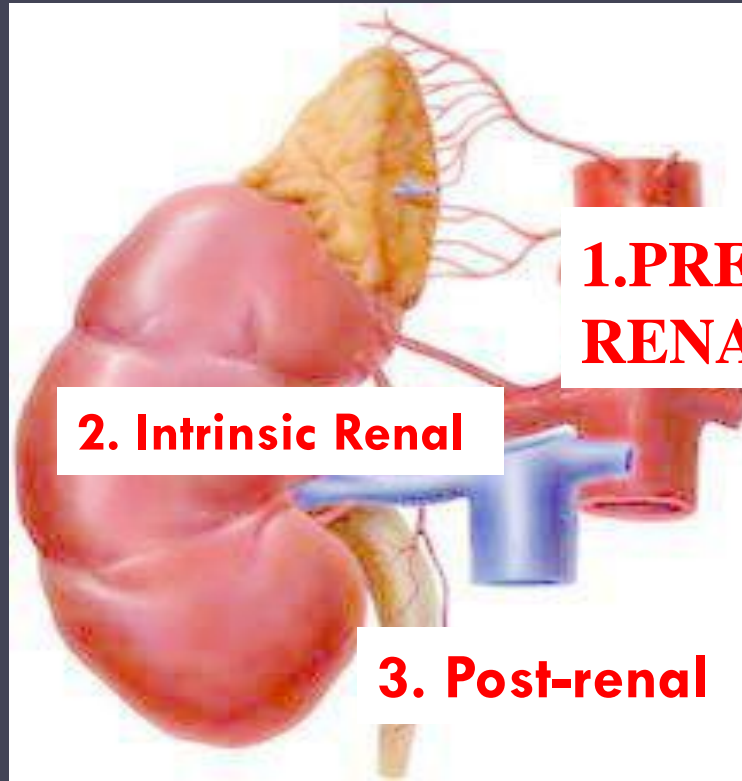

Pre-renal

589

- ✿ **vomiting, diarrhea, poor fluid intake,**
- ✿ **fever, use of diuretics**
- ✿ **hemorrhage**
- ✿ **cardiac failure**
- ✿ **liver dysfunction, or**
- ✿ **septic shock**

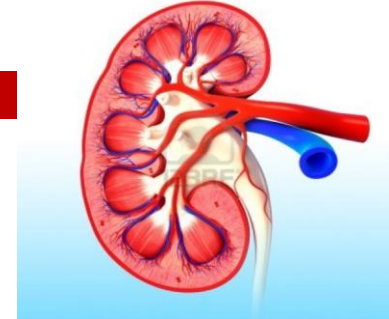

Intrinsic renal

590

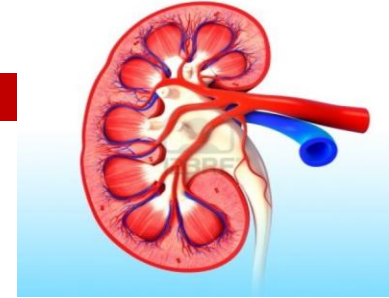

I. **Renal Major vessel obstruction**

-renal vein thrombosis , renal arterial obstruction, hemolytic uremic syndrome , HSP , polyarteritis and other vasculitis.

II. **Glomerular**

- Acute glomerulonephritis (post streptococcal , other infections).

III. **Acute tubulointerstitial nephritis**

IV. **Acute tubular necrosis**

- Prolongation of pre-renal insult , intravascular hemolysis , sepsis , nephrotoxic agents , multiorgan failure , snakebite etc.

Cited by Up to date 21.2

Post renal

591

- ✓ Posterior urethral valves
- ✓ Ureteropelvic junction obstruction
- ✓ Ureterovesicular junction obstruction
- ✓ Ureterocele
- ✓ Tumor
- ✓ Urolithiasis
- ✓ Hemorrhagic cystitis
- ✓ Neurogenic bladder

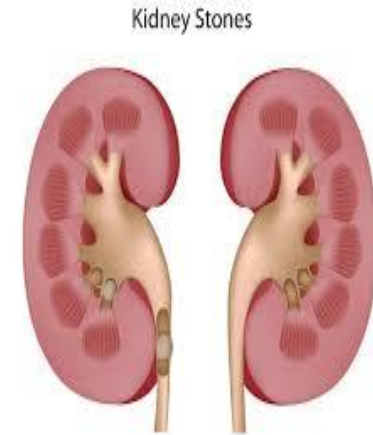

Cited by Up to date 21.2

Clinical presentation

592

Pre renal

There may be history of **volume loss** from vomiting, diarrhea, or blood loss and may present with dehydration , hypotension , tachycardia , pallor , and **decreased urine output ...**

Renal

593

- ✓ Hematuria, edema, and hypertension indicates a **glomerular etiology for AKI**.
- ✓ **Dysentery**, petechiae and pallor- **HUS**
- ✓ **Presence of rash**, arthritis might suggest **SLE**
- ✓ History of **prolong hypotension** or with exposure to **nephrotoxic medication** most likely have ATN.
- ✓ Allergic interstitial nephritis should be suspected with **fevers, rash, arthralgia, and exposure to certain medications**

Nelson Textbook of
PEDIATRICS

Post renal

594

- History of interrupted urinary stream and **palpable bladder** or kidney suggest obstructive uropathy.
- Abdominal colic **hematuria** and **dysuria** suggest urinary tract calculi.

Diagnosis

595

History and

Physical examination: - Obtaining a thorough physical examination is extremely important when collecting evidence about **the etiology of AKI**.

Skin :- Palpable purpura - Systemic vasculitis

Maculo papular rash - Allergic interstitial nephritis

Eye :- **Evidence of uveitis** may indicate interstitial nephritis and necrotizing vasculitis.

Ear :- Hearing loss - Alport disease and amino glycoside toxicity

Mucosal or cartilaginous ulcerations – Wegener granulomatosis.

Pulmonary system :- Respiratory rate , pattern

On Auscultation of lungs creptation

Cont..d

Cardiovascular examination may reveal the following:

- Murmurs - Endocarditis
- Pericardial friction rub - Uremic pericarditis
- Increased jugulovenous distention, S₃ - Heart failure

Abdomen

- Abdominal or costovertebral angle tenderness - Nephrolithiasis, papillary necrosis, renal artery thrombosis, renal vein thrombosis
- distended bladder – Urinary obstruction

Laboratory investigation

- ✓ Blood urea and S. creatinine level
- ✓ Serum electrolyte and C3 level
- **Urinary indices** may be useful in differentiating prerenal AKI from intrinsic AKI.
- **Ultrasound** - evaluates renal size, able to detect masses, obstruction, stones
- **Renal biopsy** - Patient in whom the etiology **is not identified**

Clin J Am Soc Nephrol. 2014 Feb 7

Complication of AKI

598

Metabolic

- Hyponatremia
- Hyperkalemia
- Hypocalcemia, hyperphosphatemia
- Hyperuricemia

Pediatrics lecture note

Con..d

Metabolic acidosis

Cardiovascular

- ❖ Pulmonary edema
- ❖ CHF
- ❖ Hypertension
- ❖ Arrhythmias
- ❖ Pericarditis

Neurologic :- Coma and Seizures

Hematologic :-Anemia and Coagulopathies & bleeding diathesis E.T.C

Pediatrics lecture note

TREATMENT

600

Medical Management

- In infants and children with urinary tract obstruction, such as in a newborn with **suspected posterior ureteral valves**, a bladder catheter should be placed immediately to ensure adequate drainage of the **urinary tract**.
- however, precautions to **prevent iatrogenic** infection should be

Maintain fluid

601

- Determination of the volume status is of critical importance **when initially evaluating** a patient with AKI.
- If there is **no evidence of volume overload** or cardiac failure, intravascular volume should be expanded by intravenous administration of **isotonic saline, 20 mL/kg over 30 min.**

Cont...d

602

- Determination of the **central venous pressure** may be helpful if adequacy of the blood volume is difficult to determine.
- **After volume resuscitation**, hypovolemic patients generally void within **2 hr**; failure to do so suggests intrinsic or postrenal AKI.
- **Hypotension caused by sepsis** requires vigorous fluid resuscitation followed by a continuous infusion of nor - epinephrine.

Nelson 20 ed

Chronic kidney disease

Patient has CKD if either of the following criteria are present:

1. Kidney damage for ≥ 3 mo, as defined by **structural or functional abnormalities** of the kidney, *with or without decreased GFR*, manifested by 1 or more of the following features:
 - Abnormalities in the **composition of the blood or urine**
 - Abnormalities in **imaging tests**
 - Abnormalities on kidney biopsy
2. GFR < 60 mL/min/1.73 m² for ≥ 3 mo, **with or without** the other signs of kidney damage described above

STANDARDIZED TERMINOLOGY FOR STAGES OF CHRONIC KIDNEY DISEASE (K/DOQI(2002))

STAGE	DESCRIPTION	GFR (mL/min/1.73 m ²)
1	Kidney damage with normal or increased GFR	>90
2	Kidney damage with mild decrease in GFR	60-89
3	Moderate decrease in GFR	30-59
4	Severe decrease in GFR	5-29
5	Kidney failure	<15 or on dialysis

GFR, glomerular filtration rate.

Etiology

- Result of **congenital, acquired, inherited, or metabolic** renal disease.
- **in children <5 yr old is**
 - most commonly a result of **congenital abnormalities** such as **renal hypoplasia, dysplasia, or obstructive uropathy**
- **After 5 yr of age**
acquired diseases (various forms of glomerulonephritis including lupus nephritis) and **inherited disorders** (Alport syndrome) predominate.

Clinical Manifestations

606

- The clinical presentation of CKD is **varied** and depends on the underlying renal disease
 - ▣ Children and adolescents with CKD can present with
 - ▣ **edema,**
 - ▣ **hypertension,**
 - ▣ **hematuria, and**
 - ▣ **proteinuria**

- *Infants and children with congenital disorders such as*
 - ▣ *renal dysplasia and obstructive uropathy can present in the neonatal period with failure to thrive, polyuria dehydration, urinary tract infection, or overt renal insufficiency*

Diagnosis

608

On P/E:-Pallor and **a sallow appearance.**

- ❑ *short stature and the bony abnormalities of renal osteodystrophy* (length/height-for age <3rd percentile).
- ❑ Children with CKD due to chronic glomerulonephritis (edema, hypertension and fluid overload)

Laboratory Findings(Elevated BUN and serum creatinine, hyperkalemia, **hyponatremia**, hypernatremia Acidosis, **hypocalcemia**, hyperphosphatemia, and an elevation in uric acid, **hypoalbuminemia**, hematuria and proteinuria.

Management

609

GENERAL PRINCIPLES

- ▣ *Treat reversible kidney dysfunction*
- ▣ **Prevent or slow** the progression of kidney disease
- ▣ Treat the **complications** of CKD
- ▣ Identify and adequately prepare the child/family in whom **renal replacement therapy** will be required



COMMON GASTRO-INTESTINAL DISORDER

LEARNING OBJECTIVES

By the end of this topic the student will be able to:

- Mention the common manifestation of GID
- Recognize the evaluation of abdominal pain and vomiting
- Discuss the common problems of GI obstruction in children
- Discuss appendicitis in childhood

Anatomy and physiology of the GIS

Anatomy and Physiology

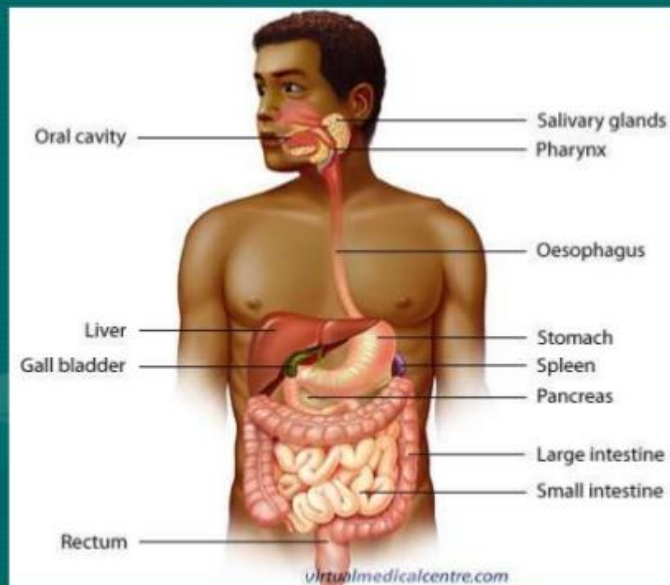

Anatomy and physiology

- It consists of the mouth/oral cavity, esophagus, stomach, intestine, rectum and anus and other accessory glands like liver, gallbladder, pancreas and salivary
- **Functions**
- The main function of GIS is Ingestion digestions and absorptions of foods and eliminations of food
ruminants

Common Manifestations of GID in the Child

- ❑ ABDOMINAL PAIN
- ❑ VOMITING AND REGURGITATION
- ❑ DIARRHEA
- ❑ CONSTIPATION
- ❑ ABDOMINAL DISTENTION AND ABDOMINAL MASSES

FUNCTIONAL GASTROINTESTINAL DISORDERS WITH ABDOMINAL PAIN

- Abdominal pain in a child is one of the **most common presentations** with both **trivial** and **life threatening etiologies**, ranging from functional pain to acute appendicitis.
- Diagnosing abdominal pain in children is also a challenging task.
- The majority of pediatric abdominal complaints are relatively benign
- But it is important to pick up on the cardinal signs that might suggest a more serious underlying disease.

- The majority of children with recurrent or chronic abdominal pain have a **functional** gastrointestinal disorder.
- **Functional disorders** are defined as conditions in which symptoms are present in **the absence** of any readily identifiable **structural or biochemical abnormality**.

Diagnostic criteria

Functional disorders associated with abdominal pain in children appear to fit mainly into three groups.

- 1) Functional dyspepsia refers to pain or discomfort which is centered in the upper abdomen. The pain may be associated with nausea and feelings of early satiety.
- 2) In irritable bowel syndrome (IBS), abdominal pain is associated with defecation or change in bowel habit.
- 3) The third and probably most common group of children does not fit the criteria for IBS or functional dyspepsia and is diagnosed with **functional abdominal pain or functional abdominal pain syndrome**

Common Causes of

Abdominal Pain

NEWBORN	INFANT (<2 YEARS)
Intestinal obstruction (ie. volvulus, pyloric stenosis), GE Reflux, Hernia, Peritonitis (i.e. GI perforation), Trauma (i.e. during birth)	Constipation , Toxin ingestion, Acute gastroenteritis , Trauma, Hernia, volvulus, intussusception, Colic, Respiratory illness
CHILDREN (2 – 18 YEARS)	ADOLESCENTS (12 – 18 YEARS)
Acute gastroenteritis, UTI / Pyelonephritis, Constipation, Toxin ingestion, food poisoning, Intestinal obstruction Trauma, Testicular torsion, Respiratory illness, pneumonia, Appendicitis, pancreatitis,cholecystitis	Trauma ,Toxin ingestion, food poisoning Dysmenorrhea , Pregnancy (i.e. ectopic) Pelvic inflammatory disease, Testicular torsion, Ovarian torsion/cysts, Gastroenteritis, Constipation

PRESENTATION AND EMERGENT CONSIDERATIONS

- ❑ Acute pain lasts several hours to days
- ❑ While chronic pain can last from days to weeks to months.

RED FLAG SIGNS INCLUDE:

- ❑ Bilious vomiting
- ❑ Bloody stool or emesis
- ❑ Night time waking with abdominal pain
- ❑ Hemodynamic instability
- ❑ Weight loss

Evaluation of the Child with Vomiting

- Vomiting is a complex, coordinated reflex mechanism that may occur in response to a variety of stimuli and results in forceful expulsion of gastric contents.
- The differential diagnosis is not limited to the gastrointestinal tract and includes conditions that are pediatric emergencies.
- Assessment of the child with recurrent vomiting starts with a complete history, physical examination, and description of the vomits .

Evaluation cont'd

- Emesis of gastric contents is characteristic of gastroesophageal (GE) reflux, gastric outlet obstruction, central nervous system masses or infection etc
- The infant or child with bilious emesis , abdominal distention should be suspected of **intestinal obstruction**
- Viral and bacterial gastroenteritis are associated with diarrhea and **may produce ileus with bilious vomiting.**

- The hallmark of gastric obstruction is **non bilious vomiting**.
- The **most common** cause of non-bilious vomiting is infantile hypertrophic pyloric stenosis.
- The differential diagnosis also includes gastroesophageal reflux, peptic ulcer disease,, eosinophilic gastroenteritis, and various other metabolic and motility abnormalities.

THE RED FLAGS OF AN ACUTELY PRESENTING CHILD WITH VOMITING

- Any child who has vomiting blood or bile or severe abdominal pain or abdominal signs needs immediate investigation in a hospital emergency room setting.
- ❖ **OTHER RED FLAGS INCLUDE:**
 - projectile vomiting
 - abdominal distension, tenderness
 - high fever
 - persistent tachycardia or hypotension
 - neck stiffness and/or photophobia.

GASTRO-OESOPHAGEAL REFLUX DISEASE (GERD)

- ❑ **GER** is defined as the effortless retrograde movement of gastric contents upward into the esophagus or oropharynx with or without regurgitation and vomiting.
- Most episodes of GER in healthy individuals last <3 minutes, occur in the postprandial period, and cause few or no symptoms.
- ❑ In contrast, **GERD** is present when the reflux of gastric contents causes troublesome symptoms and / or complications.

- GE reflux is common in **young infants** and usually resolves spontaneously by the age of walking.
- Infants, in particular, are predisposed to GER because they **have a short intra-abdominal esophagus and an immature LES.**
- Postprandial regurgitation, which ranges from **effortless to forceful**, is the most common symptom in infants with GE reflux.

CATEGORIES OF GER IN CHILDREN

1. **Physiologic reflux** referring to infrequent regurgitation/emesis without any abnormalities on diagnostic studies.
2. **Functional reflux** may be defined as silent or asymptomatic reflux and can be confirmed by intraesophageal pH monitoring.
3. **Pathologic reflux** is a more severe form of functional GER. It can interfere with normal growth processes and cause complications of the gastrointestinal or respiratory tract.
4. **Secondary reflux** is related to a secondary disorder such as neurologic deficits or anatomic abnormalities of the esophagus.

CLINICAL MANIFESTATIONS

➔ Symptoms associated with GERD are quite vast

- However, within infants regurgitation is

the classic symptom.

- As the child becomes older, particularly within the second to third years of life, substernal or epigastric pain becomes the predominant presenting complaint of GERD.

Other symptoms associated with GERD vary and include:

- **Symptoms due to regurgitation** such as emesis and weight loss
- **Symptoms due to esophagitis** such as chest pain, irritability, feeding aversion, choking, gagging, anemia, hematemesis, and esophageal obstruction due to stricture
- **Respiratory symptoms** including pneumonia, wheezing, bronchospasm , apnea, cyanotic episodes, stridor, cough, hiccups, and hoarseness;
- **Neurobehavioral symptoms** including seizure-like events,

EVALUATION



- Barium radiography (Upper GI) allows for evaluation of whether anatomy is normal and is typically chosen in children with vomiting and dysphagia
- Endoscopy is also indicated in children whom the clinician suspects erosive esophagitis

Management



- Treatment of GERD has classically been divided into the following three discrete phases:
 - 1) Lifestyle modification/Conservative therapy
 - 2) Pharmacologic treatment
 - 3) Antireflux surgery

Management

❖ **Conservative Therapies**

- ❑ Towel on caregiver's shoulder
- ❑ Thickened feedings
- ❑ Enhances nutrition Smaller, more frequent feedings
- ❑ Some benefit Positional therapy-upright in seat, elevate head of crib or bed Prone positioning with head up.

Mgt cont'd

- **Pharmacologic treatment** : involves the use of cytoprotective agents including H2 receptor blockers, or proton-pump inhibitors (PPI).
- **Surgical intervention** is reserved for patients who fail aggressive medical therapy and continue to have life-threatening complications of reflux.

Hypertrophic Pyloric Stenosis

633

- Is an acquired condition caused by hypertrophy and spasm of the pyloric muscle, resulting in gastric outlet obstruction.
- Pyloric stenosis is associated with other congenital defects, including trachea-esophageal fistula and hypoplasia or agenesis of the inferior labial frenulum.

ETIOLOGY

- The cause of pyloric stenosis is unknown, but many factors have been implicated.
- Pyloric stenosis has been associated with eosinophilic gastroenteritis, trisomy 18.
- Abnormal muscle innervation, elevated serum levels of prostaglandins
- A deficiency in inhibitory neuronal signals, mediated by nitric oxide, may contribute to the pathogenesis of pyloric stenosis

Clinical manifestation

- Non-bilious vomiting is the initial symptom of pyloric stenosis.
- The vomiting may or may not be projectile initially but is usually progressive, occurring immediately after a feeding.
- Emesis may follow each feeding, or it may be intermittent. After vomiting, the infant is hungry and wants to feed again.
- Jaundice

- The stomach becomes massively enlarged with retained food and secretions, and gastric **peristaltic waves** are often visible in the left upper quadrant
- As the illness progresses the child becomes progressively thinner and more dehydrated.
- **Greater awareness of pyloric stenosis has led to earlier identification of patients with fewer instances of chronic malnutrition and severe dehydration.**

Pyloric Stenosis

- The classic presentation of IHPS is the three- to six-week-old baby who develops immediate postprandial, non-bilious, often projectile vomiting and demands to be re-fed soon afterwards (a "hungry vomiter").

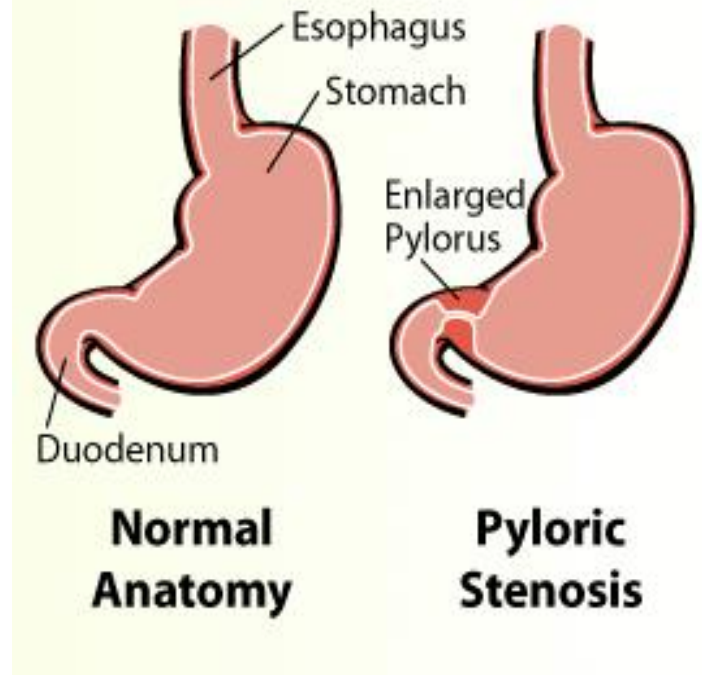

Diagnosis

- ❖ Criteria for diagnosis include pyloric thickness >4 mm or an overall pyloric length >14 mm
- ❖ Ultrasound examination confirms the diagnosis in the majority of cases and allows an earlier diagnosis in infants with suspected disease.

TREATMENT

- Definitive management is **surgical corrections**
- Correcting the fluid volumes
- Correcting the electrolytes
- Feeding

Intussusceptions, and Closed-Loop

ILEUS

- Ileus is the failure of intestinal peristalsis without evidence of mechanical obstruction.
- Ileus can be caused by:
 - Systemic infections/Diseases
 - Metabolic abnormalities,
 - Anti-motility drugs

C/M

- Increasing abdominal distention, emesis, and initially minimal pain.
- Pain increases with increasing distention.
- Bowel sounds are minimal or absent,

Treatment of ileus

- Nasogastric decompression.
- Ileus after abdominal surgical procedures usually results in return of normal intestinal motility in 24–72 hr.
- **Prokinetic agents such as metoclopramide can stimulate the return of normal bowel motility and be of assistance to children with prolonged ileus.**

Adhesions

- Adhesions are fibrous bands of tissue that are a common cause of **postoperative small bowel obstruction after abdominal surgery**.
- The risk not well studied .
- **Diagnosis and C/M**
 - ▣ Abdominal pain,
 - ▣ constipation,
 - ▣ emesis, and
 - ▣ A history of intra-peritoneal surgery.
- Nausea and vomiting quickly follow the development of pain.

Adhesions

Treatment

- Patients with suspected obstruction should have
 - **Nasogastric decompression,**
 - **Intravenous fluid resuscitation, and**
 - **Broad-spectrum antibiotics in anticipation of surgery.**

INTUSSUSCEPTIONS

- Intussusception is the "telescoping" of a segment of proximal bowel (the intussusceptum) into downstream bowel (the intussuscipiens)
- It is the most common cause of intestinal obstruction between 3 mo and 6 yr of age.
- A few intussusceptions reduce spontaneously, but if left untreated, most will lead to intestinal infarction, perforation, peritonitis, and death.

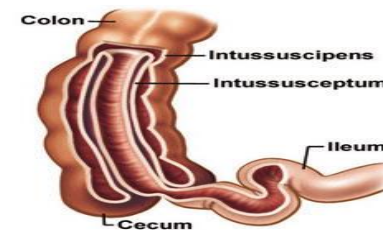

- The proximal segment of bowel telescopes into the distal segment, dragging the associated mesentery with it. 

Leads to the development of venous and lymphatic congestion with resulting intestinal edema, which can ultimately lead to ischemia, perforation and peritonitis.

CLINICAL MANIFESTATIONS

- ❑ Severe, crampy, progressive abdominal pain.
- ❑ Inconsolable crying, Guarding and knees drawing up
- ❑ Bloody stool
- ❑ Feedings are refused.
- ❑ **Bilious vomiting**
- ❑ **lethargy or altered consciousness.**

MANAGEMENT

- **Reduction of an acute intussusception is an emergency procedure and performed immediately after diagnosis in preparation for possible surgery**
- Therapy must begin with placement of an IV catheter and a nasogastric tube.
- Child must have adequate **fluid resuscitation** to correct the often severe dehydration caused by vomiting and third space losses.

Closed-Loop Obstructions

- Intestinal obstruction can be caused by defects in the mesentery (“internal hernias”) through which loops of small bowel may pass and become trapped.
- **Symptoms**
- bilious vomiting, abdominal distention, and abdominal pain. Peritoneal signs suggest ischemic bowel
- **Supportive management includes intravenous fluids, antibiotics, and nasogastric decompression.**
- Prompt surgical intervention is needed

APPENDICITIS

- Appendicitis is the most common surgical emergency in childhood.

POSITIONS OF APPENDIX

Right lower quadrant of the abdomen.

CLINICAL MANIFESTATIONS

- ❑ Visceral pain, localized to the periumbilical region.
- ❑ The pain localizes to the right lower quadrant.
- ❑ Nausea and vomiting
- ❑ Anorexia
- ❑ Diarrhea and urinary symptoms are also common,
- ❑ low-grade fever unless perforation has occurred

- If the appendix is retrocecal in location, appendicitis predictably evolves more slowly and patients are likely to relate 4–5 days of illness preceding evaluation
- Voluntary guarding is present initially, progressing to rigidity, then to rebound tenderness with rupture and peritonitis
- Rebound tenderness and referred rebound tenderness (Rovsing sign) are also consistent findings in acute appendicitis but not always present.
- Rectal examination when a pelvic appendix or abscess is suspected, or in adolescent females when ovarian pathology is suspected

- Treatment of appendicitis is surgical.
- Simple appendectomy is curative if performed before perforation.
- With perforation, a course of postoperative IV antibiotics is required.
- Broad-spectrum coverage is necessary to cover the mixed bowel flora.

Read and take short note

- **Volvulus**
- **RECTAL PROLAPSE**
- **Acute Gastro Enteritis**
- **ANORECTAL MALFORMATIONS**



Thank you

Nervous system disorders

Objectives



At the end of this session you will be able to:

- Assess, diagnose and manage common nervous system problems in children

Anatomy and physiology

Organs

CNS:

- Brain
- Spinal Cord

PNS:

- Nerves

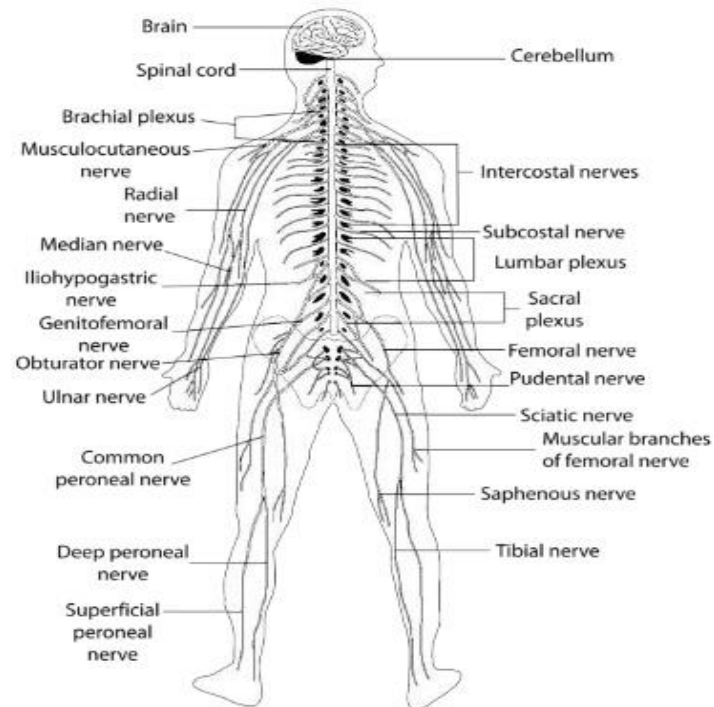

Functions

- Control and coordinates all parts of the body
- Receives stimuli from body's interior and from the external environment through the system.
- Determines the body's responses to these impulse-messages-through the motor system.
- Contains the human higher functions e.g. memory and reasoning.

Assessment of NS

- Level of consciousness
 - ▣ Alert, disoriented, drowsy, stupors, comatose
 - ▣ The examiner observes for eye opening, verbal response and motor response to stimuli according to glasgow scale
 - Assessment of cranial nerves
 - Examining motor functions
 - Motor ability size and tone
 - Muscle strength
 - Balance and coordination
- Examine the sensory system
- Examine the reflex

Congenital anomaly of CNS



Mainly two types

- Neural tube defects
- Associated spinal cord malformations

Neural tube defects

- Account for the largest proportion of congenital anomalies of the CNS
- Result from failure of the neural tube to close spontaneously between the 3rd and 4th wk of in utero development.
- The precise cause is unknown
- Risk factors: hyperthermia, drugs (valproic acid), malnutrition, low red cell folate levels, chemicals, maternal obesity or diabetes, and genetic determinants

- 
- The major NTDs include spina bifida occulta,
 - meningocele, myelomeningocele, encephalocele, anencephaly, caudal regression syndrome, dermal sinus, tethered cord, syringomyelia, diastematomyelia, and lipoma involving the conus medullaris and/or filum terminale and the rare condition iniencephaly.

Spina Bifida Occulta (Occult Spinal Dysraphism)

- Spina bifida occulta is a common anomaly involve a midline defect of the vertebral bodies without protrusion of the spinal cord or meninges.
- Some consider the term *spina bifida occulta* to denote merely a posterior vertebral body fusion defect.
- C/F: cutaneous manifestations such as a hemangioma, discoloration of the skin, pit, lump, dermal sinus, or hairy patch.

Meningocele

- A meningocele is formed when the meninges herniate through a defect in the posterior vertebral arches or the anterior sacrum.
- Usually Patients with leaking (CSF) or a thin skin covering should undergo immediate surgical treatment to prevent meningitis.

Microcephaly

- Microcephaly is defined as a head circumference that measures more than 3 SD
- Common among developmentally delayed children.

Ethiology

- Primary (genetic) microcephaly
- Secondary (non-genetic) microcephaly.

Hydrocephalus

- Is a diverse group of conditions that result from impaired circulation and/or absorption of CSF or,
- It is an increased production of CSF
- **Obstructive or non-communicating hydrocephalus** develops most commonly in children because of an abnormality of the aqueduct of Sylvius or a lesion in the fourth ventricle.



- Non-obstructive or communicating

hydrocephalus most commonly follows a subarachnoid hemorrhage, which is usually a result of intraventricular hemorrhage in a premature infant.



MENINGITIS

4/24/2020

INTRODUCTION

- **Meningitis**, inflammation of the meninges
- Caused by
 - ▣ bacteria
 - ▣ Virus
 - ▣ Fungus
- The most common bacterial infections

Age Group**Causes**

Newborns

**Group B *Streptococcus*,
Escherichia coli, *Listeria
monocytogenes***

Infants and Children

***Streptococcus pneumoniae*,
Neisseria meningitidis,
Haemophilus influenzae type b**

Adolescents and Young Adults

***Neisseria meningitidis*,
*Streptococcus pneumoniae***

CLINICAL FEATURES

- Preceding upper respiratory tract symptoms are common.
Rapid onset is typical of *S. pneumoniae* and *N. meningitidis*.
- Fever
- Altered consciousness, irritability, photophobia
- Vomiting, poor appetite
- Seizures 20 - 30%
- Bulging fontanel 30%
- Stiff neck or nuchal rigidity
- Meningismus (stiff neck + Brudzinski + Kernig signs)

Clinical signs of meningeal irritation

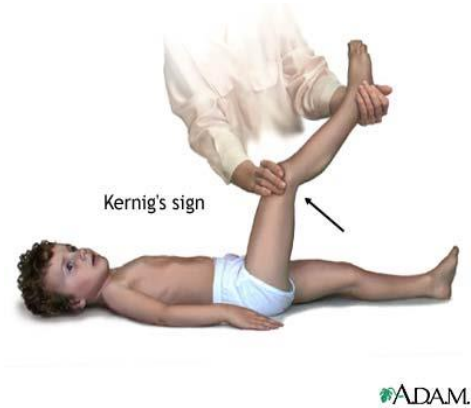

CLINICAL FEATURES

- In young infants, signs of meningeal inflammation may be minimal with only irritability, restlessness, depressed mental status, and poor feeding.
- Focal neurologic signs, seizures, arthralgia, myalgia, petechial or purpuric lesions, sepsis, shock, and coma may occur.
- Increased intracranial pressure is reflected in complaints of headache, diplopia, and vomiting.
- A bulging fontanel may be present in infants.

Signs of raised intracranial pressure:



- Opisthotonus and rigid posture in any of the limbs or trunk
- unequal pupils
- Irregular breathing

Diagnosis – lumbar puncture

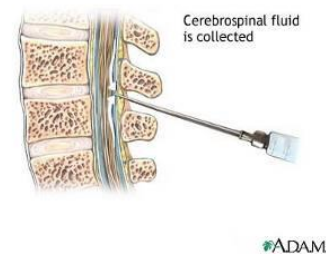

- **Contraindications:**
 - Respiratory distress (positioning)
 - ↑ ICP reported to increase risk of herniation
 - Cellulitis at area of tap
 - Bleeding disorder

CSF EVALUATION

Condition	WBC	Protein (mg/dL)	Glucose (mg/dL)
Normal	<7, lymphs mainly	5-45	>50
Bacterial, acute	100 – 60K PMN's	100-500	Low
Bacterial, part rx'd	1 – 10,000	100+	Low to normal
TB	10 – 500	100-500	<50
Fungal	25 – 500	25-500	<50
Viral	<1000	50-100	Normal

Consider tuberculous meningitis

- Fever persists for 14 days
- Fever persists for more than 7 days and there is a family member with tuberculosis
- chest X-ray suggests tuberculosis
- patient remains unconscious
- CSF continues to have moderately high white blood cell counts (typically, <500 white cells per ml, mostly lymphocytes), elevated protein levels (0.8–4 g/l) and low glucose levels (< 40 mg/dl).
- In children known or suspected to be HIV-positive, tuberculous or cryptococcal meningitis should also be considered.

TREATMENT

- If there is any suspicion, treat immediately with antibiotics before the results of laboratory CSF examination are available.
- If the child has signs of meningitis and a lumbar puncture is not possible, treat immediately.

Antibiotic treatment

- Give antibiotic treatment as soon as possible.

Choose one of the following two regimens:

- Crystalline penicillin loading dose of 250,000IU/kg IV. Stat followed by 500,000IU/kg/24 hours IV divided in 8 doses (Q3hourly) **PLUS**
- Chloramphenicol, 50 mg/kg IV stat followed by 100mg/kg/day IV Q6 hourly .
- Duration of treatment depends on the etiology but in general course of treatment ranges between 10-15 days.

- Haemophilus Influenza B: Chloramphenicol, 100mg/kg/day i.v. Q6hourly for 10 days
- Pneumococcus : penicillin G 500,000IU /kg/day i.v. Q 3 hourly for 14 days
- Meningococcus: penicillin G 500,000IU /kg/day i.v. Q 3hourly for 7 days OR
- Ceftriaxone, 100mg/kg IV , in two divided doses for 10 days for all cases
- Adjunct therapy: Dexamethasone, 0.6mg/kg/day div Q6 hours for two days.

SUPPORTIVE CARE

- Examine all children with convulsions for hyperpyrexia and hypoglycemia.
- ❖ In unconscious child:
 - Maintain a clear airway.
 - Nurse the child on the side to avoid aspiration of fluids.
 - Turn the patient every 2 hours.
 - Do not allow the child to lie in a wet bed.
 - Pay attention to pressure points.

Fluid and nutritional management

- Give half to two third of the daily fluid requirement.
- Monitor IV fluids very carefully and examine frequently for signs of fluid overload.
- Fluid restriction is not appropriate in the presence of systemic hypotension because reduced blood pressure may result in reduced cerebral perfusion and CNS ischemia.
- Feed the child as soon as it is safe.
- Breastfeed every 3 hours, if possible, or give milk feeds of 15 ml/kg if the child can swallow.
- Continue to monitor the blood glucose level and treat accordingly, if found to be <2.5 mmol/ litre or <45 mg/dl.

□ **Hypoglycaemia**

- Give 2 ml/kg of 10% glucose (dextrose) solution IV rapidly.
- Recheck the blood glucose in 30 minutes and if the level is low (<2.5 mmol/litre or <45 mg/dl), repeat the glucose (2ml/kg)
- Prevent further hypoglycaemia by feeding; where possible
- **Convulsions** - If convulsions occur, give anticonvulsant treatment with rectal diazepam.

COMPLICATIONS

- Neurologic complications include seizures, increased ICP, cranial nerve palsies, brain abscess, hydrocephalus, stroke, herniation and subdural effusion.
- Sensorineural hearing loss is the most common sequelae of bacterial meningitis.
- Other common sequelae include mental retardation, seizures, and delay in the acquisition of language and visual impairment.

PREVENTION

- Routine **immunizations** against Hib and *S. pneumoniae* are recommended for children beginning at 2 months of age.
- Vaccines against *N. meningitidis* are recommended for young adolescents and college freshmen as well as military personnel and travelers to highly endemic areas.
- **Chemoprophylaxis** is recommended for close contacts of *N. meningitidis* infections and the index case and for close contacts of Hib and the index case; rifampin, ciprofloxacin, or ceftriaxone is recommended

SEIZURE DISORDERS IN CHILDREN

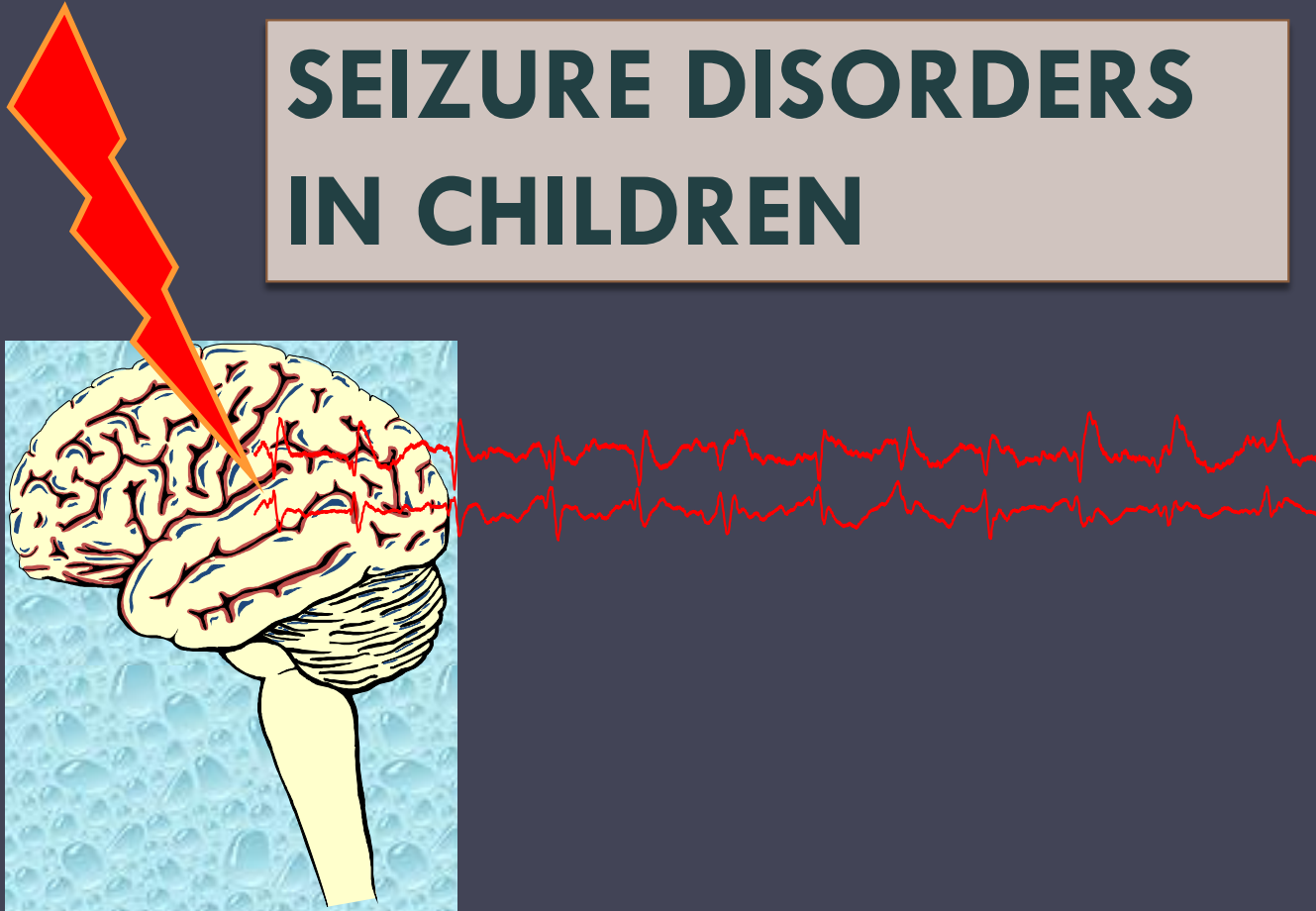

INTRODUCTION

Seizures are common in the paediatrics age group

- **Seizure:** A sudden, involuntary, time-limited alteration in behavior, motor activity, autonomic function, consciousness, or sensation, accompanied by an abnormal electrical discharge in the brain
- **Epilepsy** is a paroxysmal neurological disorder and is characterized by recurrent episodes of convulsive movements or other motor activity, loss of consciousness, sensory disturbances, and other behavioural abnormalities.

MECHANISMS OF SEIZURES

688

- ❑ Mechanisms of seizures are unknown
- ❑ Excitatory and inhibitory currents or neurotransmission in the brain.
- ❑ A number of cellular and electrophysiologic changes in the developing brain make it vulnerable to epileptogenesis
- ❑ Seizures may arise from areas of neuronal death
- ❑ The origin of seizures after brain injury
- ❑ The underdeveloped brain is more susceptible to specific seizures than is the brain of an older child or adult.
- ❑ Genetic factors account for at least 20% of all cases of epilepsy.

ETIOLOGY

For some, but not all, forms of epilepsy, the pathogenesis is at least partially understood.

❖ PERINATAL CONDITIONS

- Intrauterine infection
- Hypoxic-ischemic
- Hemorrhage

❖ METABOLIC CONDITIONS

- Hypoglycemia
- Hypocalcemia
- Hyponatremia

INFECTIONS

- Meningitis
- Encephalitis

OTHERS

- Trauma
- Tumor
- Febrile
- Idiopathic
- Familial

SEIZURES



PARTIAL

- Electrical discharges in a relatively small group of dysfunctional neurones in one cerebral hemisphere
- Aura may reflect site of origin
- + / - LOC

Generalized

- Diffuse abnormal electrical discharges from both hemispheres
- Symmetrically involved
- No warning
- Always LOC

INTERNATIONAL CLASSIFICATION OF EPILEPTIC SEIZURES

- ❑ **PARTIAL/ FOCAL SEIZURES**
- ❑ simple partial (consciousness retained)
- ❑ Complex partial (consciousness impaired)
- ❑ **GENERALIZED SEIZURES**
- ❑ Absences
- ❑ Generalized tonic-clonic
- ❑ Tonic
- ❑ Clonic
- ❑ Myoclonic
- ❑ Atonic

INTERNATIONAL CLASSIFICATION OF EPILEPTIC SEIZURES

692

- ❑ **EPILEPTIC SYNDROMES**
- ❑ Benign focal epilepsy
- ❑ Juvenile myoclonic epilepsy
- ❑ Infantile spasms (West syndrome)
- ❑ Lennox-Gastaut syndrome
- ❑ Landau-Kleffner syndrome)
- ❑ Benign neonatal convulsions
- ❑ Febrile convulsions
- ❑ Rasmussen encephalitis

SIMPLE PARTIAL SEIZURES (SPS)

- Motor activity is the most common symptom of SPS.
- Asynchronous clonic or tonic movements, and they tend to involve the face, neck, and extremities.
- **Automatisms do not occur with SPS**, but some patients complain of **aura** (chest discomfort, headache), which may be the only manifestation of a seizure.
- The patients remain conscious and may verbalize during the seizure.
- No postictal phenomenon follows the event.

COMPLEX PARTIAL SEIZURES (CPS).

- May begin with a simple partial seizure with or without an aura, followed by **impaired consciousness**
- The periods of altered consciousness may be brief and infrequent, and only an experienced observer or an EEG may be able to identify the abnormal event.
- **Automatisms** are a common feature of CPS in infants and children, occurring in $\approx 50\text{--}75\%$ of cases
- The average duration of a CPS is 1–2 min, which is considerably **longer than an SPS or an absence seizure.**

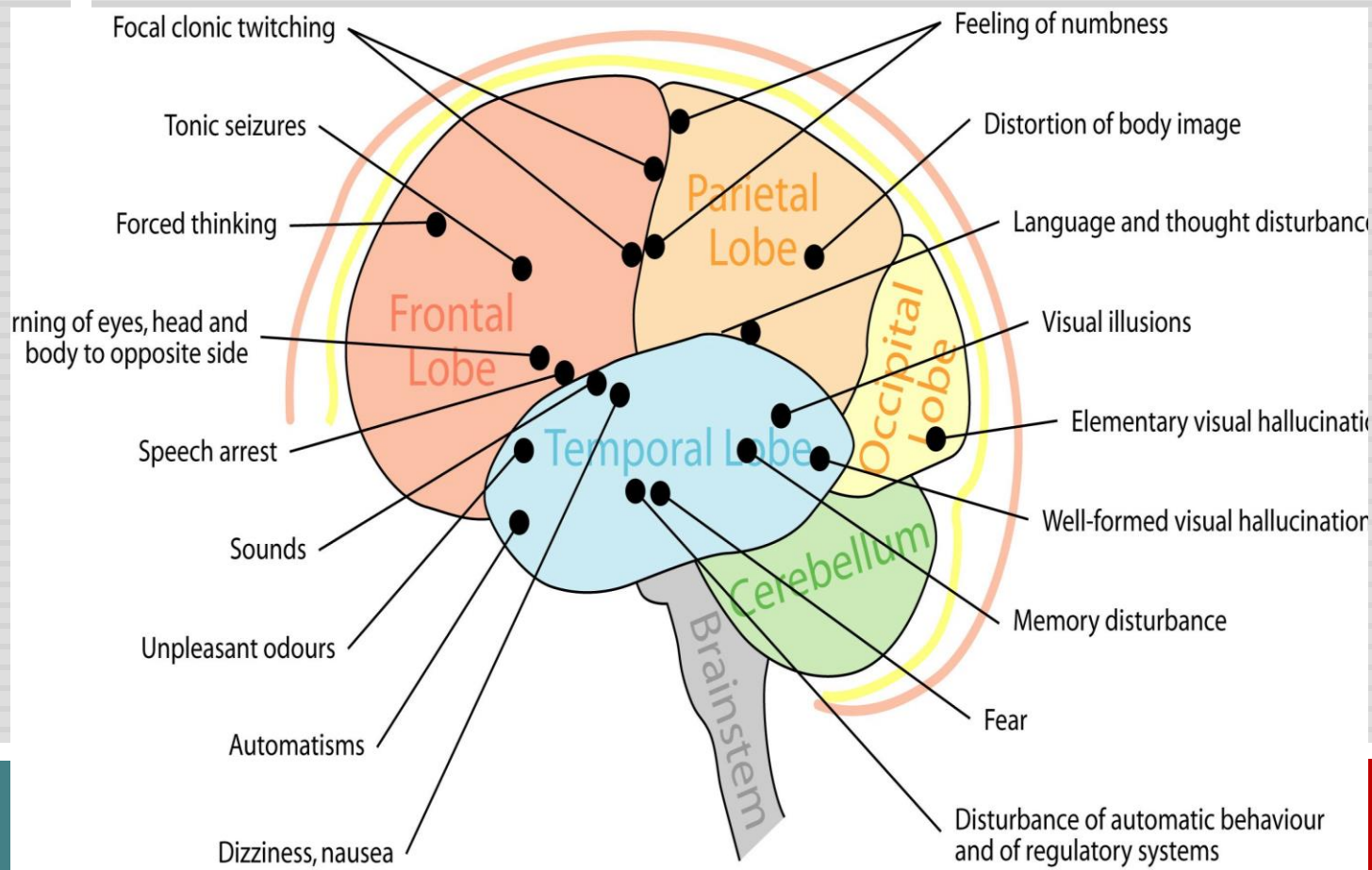

Origin of symptoms and signs in focal seizures - Visual display over the dominant hemispheres

ABSENCE SEIZURES

- ❖ **Simple (typical) absence (Formerly called petit mal) seizures**
- ✓ **sudden cessation of motor activity or speech**
- ✓ **A blank facial expression and flickering of the eyelids**
- ✓ **No loss of body tone, but their head may fall forward slightly**
- ✓ **Automatic behaviour frequently accompanies simple absence seizures**
- ✓ **Hyperventilation for 3–4 min routinely produces an absence seizure**
- ✓ **Immediately resume pre seizure activity with no indication of postictal impairment.**

Tonic-clonic seizures

(Formerly called grand mal)

Tonic Phase

- ❑ Sudden sharp tonic contraction of respiratory muscle: stridor / moan
- ❑ Falls
- ❑ Respiratory inhibition cyanosis
- ❑ Tongue biting
- ❑ Urinary incontinence

Clonic Phase

- ❑ Small gusts of grunting respiration
- ❑ Frothing of saliva
- ❑ Deep respiration
- ❑ Muscle relaxation
- ❑ Remains unconscious
- ❑ Goes into deep sleep
- ❑ Awakens feeling sore, headaches

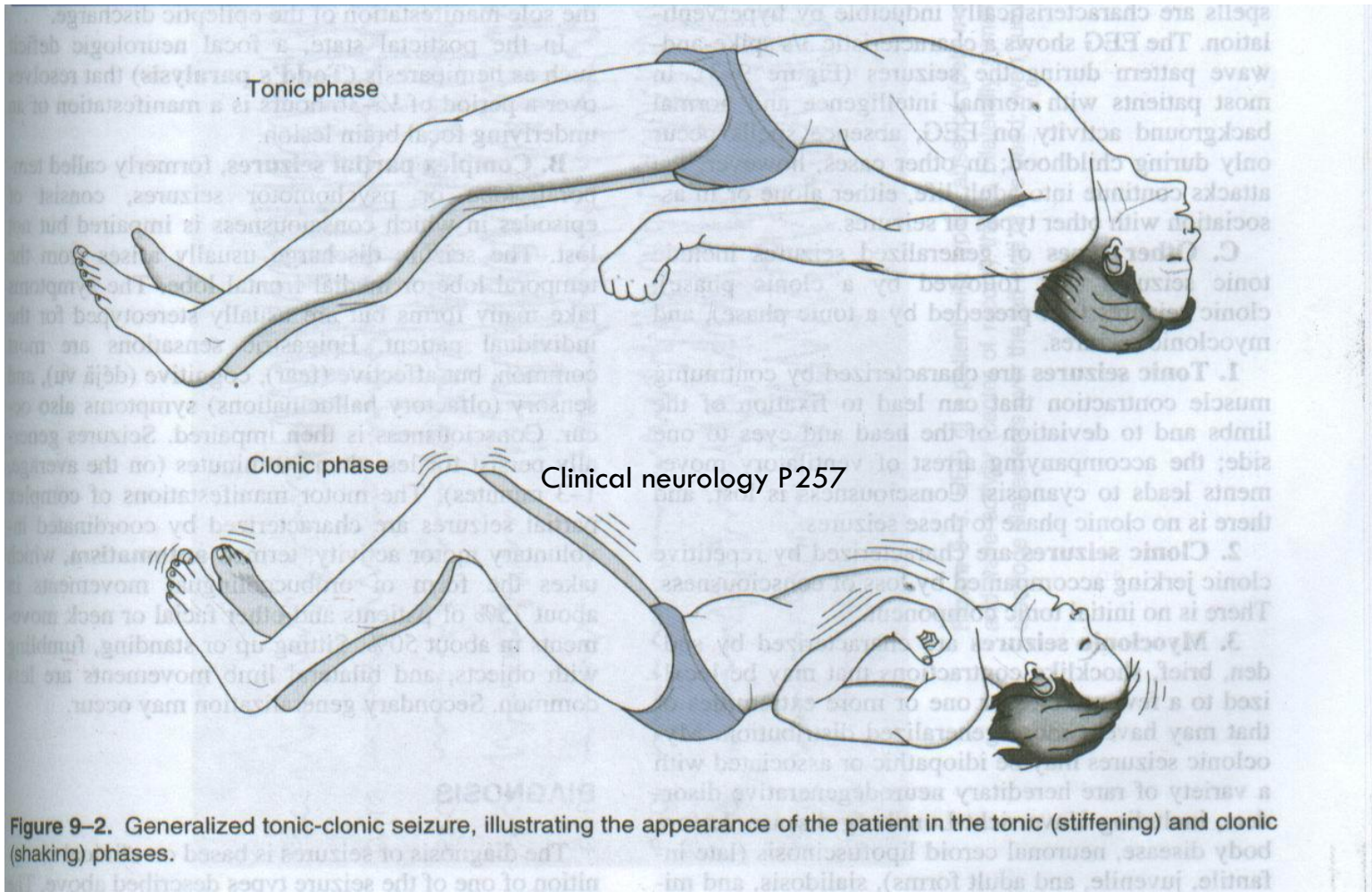

Figure 9-2. Generalized tonic-clonic seizure, illustrating the appearance of the patient in the tonic (stiffening) and clonic (shaking) phases.

MYOCLONIC EPILEPSIES OF CHILDHOOD

699

- Repetitive seizures consisting of brief, often symmetric muscular contractions with loss of body tone
 - Falling or slumping forward, which has a tendency to cause injuries to the face and mouth.
 - Myoclonic epilepsies include a heterogeneous group of conditions with multiple causes and variable outcomes.
-
- BENIGN MYOCLONUS OF INFANCY
 - TYPICAL MYOCLONIC EPILEPSY OF EARLY CHILDHOOD
 - JUVENILE MYOCLONIC EPILEPSY (JANZ SYNDROME)

BENIGN MYOCLONUS OF INFANCY

700

- Begins during **infancy**
- consists of clusters of myoclonic movements confined to the neck, trunk, and extremities.
- The EEG is **normal** in patients with benign myoclonus.
- The prognosis is good, with normal development and the cessation of myoclonus by 2 yr of age.
- **An anticonvulsant is not indicated.**

TYPICAL MYOCLONIC EPILEPSY OF EARLY CHILDHOOD

701

- The frequency varies; may occur several times daily or seizure-free for weeks.
- A few patients have febrile convulsions or generalized tonic-clonic afebrile seizures that precede the onset of myoclonic epilepsy.
- Approximately half of patients occasionally have tonic-clonic seizures in addition to the myoclonic epilepsy
- At least one third of the children have a positive family history of epilepsy, which suggests a genetic etiology in some cases.
- Learning and language problems and emotional and behavioural disorders may occur.

JUVENILE MYOCLONIC SEIZURE (JANZ SYNDROME)

1. Around time of puberty
2. Myoclonic (sudden spasm of muscles) jerks → generalized tonic clonic seizure without loss of consciousness
3. Precipitated by sleep deprivation

INFANTILE SPASMS (West syndrome)

703

- Infantile spasms usually begin between the ages of 4 and 8 months.
- characterized by brief symmetric contractions of the neck, trunk, and extremities.
- There are **at least three types of infantile spasms: Flexor, Extensor, and mixed.**
- The spasms occur during **sleep or arousal** but have a tendency to develop while patients are **drowsy or immediately on awakening.**

- Brief contractions of the neck, trunk, and arm muscles, followed by a phase of sustained muscle contraction lasting 2 to 10 seconds.
- The initial phase consists of flexion and extension in various combinations such that the head may be thrown either backward or forward.
- The arms and legs may be either flexed or extended.

BENIGN FOCAL EPILEPSY (ROLANDIC EPILEPSY)

705

- Focal motor seizures involving the face and arm
- Tend to occur only during sleep or on awakening in more than half of patients.
- Abnormal movement or sensation around the face and mouth with drooling and a rhythmic guttural sound.
- Speech and swallowing are impaired.
- The disorder is called benign because seizures usually respond promptly to anticonvulsant therapy
- Intellectual outcome and brain imaging are normal, and epilepsy resolves after puberty.

BENIGN NEONATAL CONVULSIONS

706

- An autosomal dominant genetic disorder
- Generalized clonic seizures occur toward the end of the first week of life
- Response to treatment varies, but the outlook generally is favorable.

ACQUIRED EPILEPTIC APHASIA (LANDAU-KLEFFNER SYNDROME)

707

- Abrupt loss of previously acquired language in young children.
- The language disability is an acquired cortical auditory deficit (auditory agnosia).
- Some patients develop partial and generalized epilepsy.
- The EEG is highly epileptiform in sleep, the peak area of abnormality often being in the dominant perisylvian region (language areas).

- May be caused by infection of the nervous system (meningitis, encephalitis, or brain abscess)
 - **simple febrile convulsions**
- < 15 minutes
- Generalized-tonic-clonic
- Fever > 100.4 rectal to 101 oF (38 to 38.4 C)
- No recurrence in 24 hours
- No post-ictal neuro abnormalities
- common 6 months to 5 years
- Normal development
- No CNS infection or prior afebrile seizures

COMPLEX OR ATYPICAL FEBRILE SEIZURE

709

- The seizures last longer than **15 minutes**,
- The child has pre existing neurologic challenges, or the seizures occur multiple times within one febrile event
- The prognosis of children with simple febrile seizures is excellent. Intellectual achievements are normal..
- The risk of multiple recurrences is greater in infants with onset in the first year.

FEBRILE SEIZURES

710

- ❖ **Factors that increase the risk for the development of epilepsy:**
 - Abnormal neurologic examination or development
 - Family history of epilepsy
 - Complex febrile seizures

TREATMENT

- Because febrile seizures are brief, and the outcome is benign, most children require no treatment.
- Rectal diazepam can be administered during a seizure to abort a prolonged event

Neonatal seizures

712

- Neonates are at particular risk for the development of seizures because metabolic, toxic, structural, and infectious diseases are more likely to be manifested during this time than at any other period of life.
- Neonatal seizures are dissimilar from those in a child or adult because generalized tonic-clonic convulsions tend not to occur in the **1st month of life**

NEONATAL SEIZURES

713

- several clinical features distinguish seizures from nonepileptic activity in neonates.
- Autonomic changes such as tachycardia and elevation of the blood pressure are common with seizures but do not occur with nonepileptic events.
- Nonepileptic movements are suppressed by gentle restraint, but true seizures are not.

Probable Mechanisms of Some Neonatal Seizures

PROBABLE MECHANISM	DISORDER
Failure of Na ⁺ -K ⁺ pump secondary to ↓ adenosine triphosphate	Hypoxemia, ischemia, and hypoglycemia
Excess of excitatory neurotransmitter (eg. glutamic acid—excessive excitation)	Hypoxemia, ischemia and hypoglycemia
Deficit of inhibitory neurotransmitter (i.e., relative excess of excitatory neurotransmitter)	
Membrane alteration— ↑ Na ⁺ Permeability	Hypocalcemia and Hypomagnesemia

Volpe JJ. Neonatal Seizures: Neurology of the Newborn. 4th ed.

HISTORY

- A complete history is the cornerstone for establishing a diagnosis of epilepsy.

Physical examination

Findings on neurologic examination are usually normal in patients with epilepsy, but occasionally may provide etiologic clues.

Focal signs indicate an underlying cerebral lesion.

DIAGNOSIS

716

- The **EEG** is the most useful neuro diagnostic test in distinguishing seizure from non epileptic paroxysmal disorders.
- The EEG must be interpreted in the context of the clinical history because many normal children have epileptiform EEG patterns
- CT or MRI may reveal structural lesions
- Metabolic or toxic disorders should be excluded

STATUS EPILEPTICUS

717

- Seizure activity for greater than 20 minutes or repetitive seizures without return of consciousness for greater than 30 minutes.
- Functionally, any convulsive seizure associated with reductions in oxygen saturations and cortical perfusion produces a risk for irreversible brain injury and may be managed as status epilepticus.

ETIOLOGY

718

There are three major subtypes of status epilepticus in children:

1. Prolonged febrile seizures
2. Idiopathic status epilepticus, in which a seizure develops in the absence of an underlying CNS lesion or insult
3. Symptomatic status epilepticus, when the seizure occurs as a result of an underlying neurologic disorder or a metabolic abnormality.

- About 25% of children with status epilepticus have **an acute brain injury.**
- Twenty percent have a history of **brain injury or congenital malformation.**
- In 50%, there is no definable etiology, but in 50% of this group, **status is associated with fever.**
- Sudden cessation of anticonvulsant medication is another frequent cause
- Postictally, children are initially semicomatose and typically remain in **a deep sleep from 30 min to 2 hr.**
- The postictal phase is often associated with vomiting and an intense **bifrontal headache.**

- In general, the management of seizures is done pharmacologically.
- If there is a delay in treatment, or if the patient is unresponsive to treatment, irreversible brain damage, coma, or death can occur.
- Data are reported The causes of death were epilepsy related in 50% of the patients and were due to status epilepticus, drowning, burns, or sudden death.

MANAGEMENT

- The patient with status epilepticus is considered a medical emergency.
- **Stabilization**
- ABCs (airway, breathing, circulation)
- ECG monitoring
- Oxygen and pulse oximetry
- Antiepileptic drug levels

ANTIEPILEPTIC DRUG

- The choice of an antiepileptic drug (AED) for the treatment of seizure disorders in infants and children must be made not only on the basis of efficacy but also taking into account a number of development-sensitive considerations.
- These include age-specific organ toxicities, the impact of the AED on behavior and learning, and co-morbidities that may exist in the pediatric patient.

AED

723

- phenytoin
- Phenobarbital
- Benzodiazepine
- Lorazepam
- Diazepam
- Midazolam
- Fosphenytoin
- Valproic acid
- General anesthesia

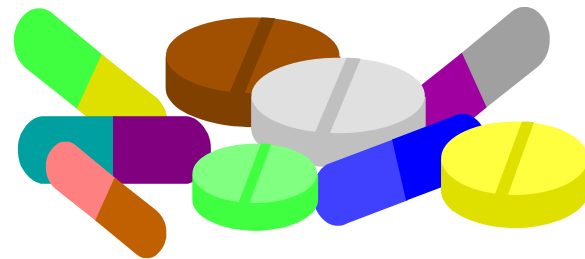

LONG-TERM THERAPY

724

- The decision to institute daily seizure medications for a first unprovoked seizure must be based on the likelihood of recurrence balanced with the risk of long-term drug therapy.
- Determination of the recurrence risk is based on the clinical history and results of neuro diagnostic testing.
- **When treatment is initiated, the goal is to maintain an optimal functional state.**
- Medication toxicity should be weighed against the risk of seizure itself.

SUPPORTIVE MANAGEMENT

725

- The primary goal of care is to minimize the impact of seizure disorders on the lives of individuals with developmental disabilities
- To lower the risk of injury, provide a safe environment at all times.
- Maintain adequate ABC during the seizure and prevent injury.
- Help the patient to a lying position
- Remove constricting clothing, and place a pillow or sheet under the patient's head to cushion her or him from injury.

Management cont'd

726

- Do not restrain the patient's movement during the seizure.
- Assist the patient with hygiene and linen changes, should incontinence occur during the seizure.
- Educate the patient and family *
- Family members should be able to verbalize what to do during a seizure.
- Appropriate documentation on the nursing note



Hematologic system

Objectives



At the end of this chapter you will be able to

- Assess, diagnose and manage a child with common hematologic disorders.

Anatomy and physiology

The main components of the circulatory system

- it contains the blood components and the place where it is formed.
- The main functions of the hematologic systems are:
 - ▣ Transporting nutrients and oxygen to the cells and wastes away from the cells
 - ▣ Used as innate immunity disease prevention

Blood

730

- **Blood is formed from the bone marrow**
- **Hematologic Stem Cell has 10 blood lineages**
- **Erythrocytes, platelets, neutrophils, eosinophils, basophils, monocytes, T and B lymphocytes, natural killer cells, and dendritic cells**

Hematopoiesis

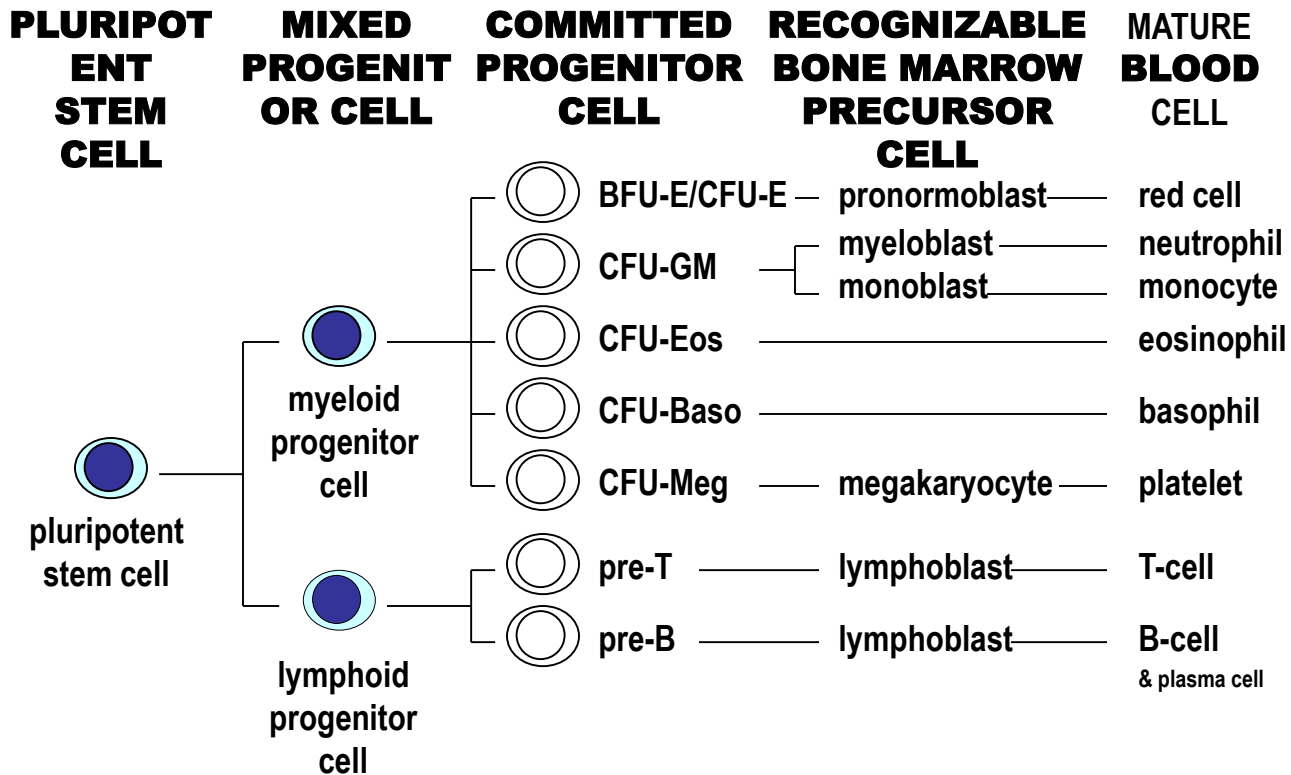

Anemia

- Anaemia is significant reduction in red cell mass and a corresponding decrease in the O₂ carrying capacity of the blood.
- **It is a reduction of the Hemoglobin concentration, red cell mass or Hematocrite, to below normal levels.**
- In women of the child bearing age, their blood values are 10% lower than men.
- Therefore, Anemia may be defined as a HCT of less than 10% below the mean values for age,

- **NB: blood values may not accurately reflect alteration in red cell mass. For instance;**
- Hgb or Hematocrite could be falsely elevated (↓ plasma volume) e.g. hemorrhage, burns, vigorous diuresis, dehydration all leading to *Hemoconcentration*
- Hgb or Hct may be falsely low (↑ plasma volume) leading to *Hemodilution* E.g.

Cause of anemia



1. Under production
2. Increased destruction/Hemolysis
3. Blood loss /bleeding
4. Multifactorial : a combination of these

Approaches of a child with anemia

- **History: Accurate history provides information crucial to the diagnosis of the underlying cause.**
 - ▣ Nutritional /Dietary history
 - ▣ Underlying diseases
 - ▣ Blood loss : GI or Genito uirinary blood loss
 - ▣ Family history of anemia
 - ▣ Exposure to drugs/toxins E.g. - *Methyldopa*
 - ▣ Geographical location
 - ▣ Pregnancy

Symptoms

- Fatigue, dizziness, dyspnea, palpitation, syncope, exercise and cold intolerance, angina,
- Tinnitus, vertigo, throbbing head ache,
- Anorexia, indigestion, nausea, bowel irregularity (due to shunting of blood from the splanchnic bed)
- Irritability, difficulty in concentration, worsened dementia and.
- Impotence or decreased libido
- Intermittent claudication

- ❑ Pelvic and rectal examination: to look for possible site of bleeding.
- ❑ Bone tenderness and Lymphadenopathy to rule out hematologic malignancies and
- ❑ Neurological: gait, reflexes, vibration and position sense which may help to look for neurologic changes associated with Vit B-12 deficiency.
- ❑ Fundoscopy: retinal hemorrhage
- ❑ Cardiovascular system; modest tachycardia, wide pulse pressure hyper dynamic precordium, flow murmur.
- ❑ In severe form of Chronic anemia patients may develop CHF with S3 gallops.

Laboratory study

1. Complete blood count

Hgb, Hct, ESR, Platelet count, WBC with differential

2. Red blood cell indices

a. Mean Corpuscular volume (MCV): Hct/RBC :
normal value is 80 – 95 fl

b. Mean corpuscular Hemoglobin(MCH) : Hgb/RBC :
27 – 32 pg

c. Mean corpuscular Hemoglobin (MCHC): Hgb/Hct
32 – 36%

3. Examination of the peripheral blood smear:
examine a cellular morphology, shape, size, color, abnormality of other cells.

□ **Red cell morphology**

□ Normochromic Normocytic RBCs are seen in normal individuals and in anemia of chronic diseases

□ Anisopoikilocytes: Variation in size and shape may be seen in iron deficiency anemia

- Hypochromic microcytic anemia: is seen in iron deficiency anemia , anemia of chronic diseases , thalassemia and sideroblastic anemia (SBA)
- Macrocytic RBCs : Macro – ovalocytes with hyper segmented neutrophils indicate megaloblastic anemia and myelodysplasia
- Schistocytes (fragmented RBC/Helmentcells):- microangiopathies , DIC, vasculitis, prosthetic heart valve

Classification of anemia

A. Pathophysiologic Classifications (based on underlying disease)

1) Anemia associated with impaired RBC Production

- a) Aplastic anemia***
- b) Iron deficiency***
- c) Myelodysplastic syndrome.***
- d) Megaloblastic anemia***
- e) Anemia of CRF***
- f) Anemia of chronic diseases***
- g) Drug related***

2) Anemia associated with increased RBC loss or destruction

a) Bleeding

b) Hereditary hemolytic anemia

i) Hemoglobinopathies, sickle cell disease,

Thalassemia

ii) Primary disorder of RBCs

iii) RBC erythropathies (G6 PDH, PK deficiency)



c) Acquired hemolytic anemia

- i) Autoimmune
- ii) Drug induced hemolytic anemia
- iii) Microangiopathies (e.g. DIC)
- iv) Traumatic

B. Morphological classification

1) Hypochromic microcytic anemia

- a) Inherited: *Thalassemia, sideroblastic anemia***
- b) Acquired: *IDA, Anemia of chronic diseases***

2) Macrocytic anemia : (MCV > 100 fl)

- a) With megaloblastic marrow: *megaloblastic anemia***
- b) With normoblastic marrow: *Hemolysis, acute bleeding,***

3) Normchromic normocytic:-

- a) *Anemia of chronic disease***
- b) *Early iron deficiency anemia***
- c) *Aplastic anemia***
- d) *Anemia of CRF***

Microrocytic Anemias

A) *Iron deficiency anemia (IDA)*

- Iron deficiency anemia occurs when body iron stores become inadequate for the needs of normal RBC production (erythropoiesis)

It's characterized by:

- Hypochromia and microcytosis of the circulating erythrocytes (RBCs)
- Low plasma iron and ferretine concentration.
- A transferrin saturation of $< 15\%$ (Normally $\sim 35\%$)
- Iron deficiency anemia is a manifestation of diseases, not by itself a complete diagnosis
- It is the commonest cause of anemia world wide

Etiologies of Iron deficiency Anemia

1. *Chronic blood loss*

- ❑ Uterine
- ❑ Gastrointestinal, e.g. esophageal varices; Hiatal hernia; peptic ulcer disease; aspirin
- ❑ ingestion; Carcinoma of the stomach, caecum, colon or rectum; ***hook worm infestation; colitis; piles; Diverticulosis; etc***
- ❑ Rarely hematuria, hemoglobinuria, pulmonary hemosiderosis, self inflicted blood loss
- ❑ Disorders of hemeostasis, intravascular hemolysis

2. Increased demands

- ❑ Prematurity in newborns
- ❑ Rapid growth (as in adolescent) growth spurt
- ❑ Pregnancy

3. Mal absorption of iron

- ❑ Gastrectomy, Celiac disease

4. Poor diet

⇒ Contributory factor in many countries but rarely sole cause

Clinical manifestation:

- ❑ Is insidious in onset and progressive in course
- ❑ Patients often present with nonspecific symptoms mentioned above with/without some specific symptoms.
- ❑ ***Specific symptoms***
 - ❑ Pica: craving for unusual food substance (amylophagia, geophagia, pagophagia)
 - ❑ Increased GI absorption of lead – lead poisoning
 - ❑ Koilonychia – spooning of the finger nails
 - ❑ Plummer – Vinson/Peterson - Kelly syndrome: characterized by IDA, koilonychia, and dysphagia due to post cricoid esophageal web)

Treatment of Iron deficiency Anemia

1. Identify underlying cause and treat it
2. **Correct anemia and replenish stores by oral iron,**
 - ***Ferrous sulfate***
 - ***Elemental iron***
 - ***Blood transfusions***

Cancer

Leukemia is a type of cancer that affects the blood and the bone marrow.

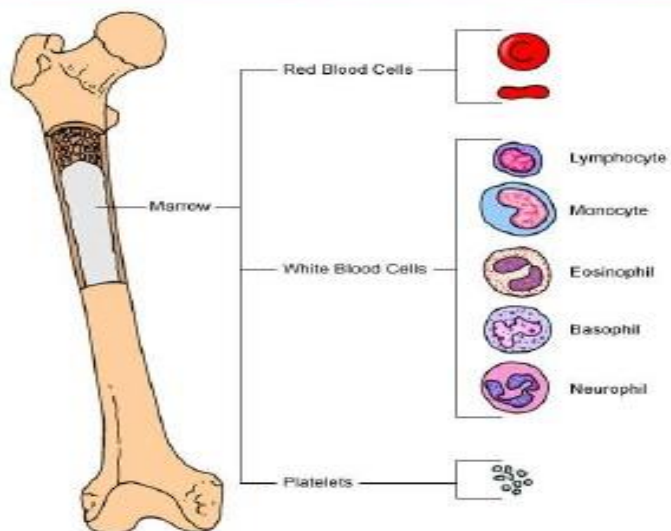

The disease develops when blood cells produced in the bone marrow grows out of control.

Leukemia

751

- It is a group of **malignant diseases** in which genetic abnormalities in a hematopoietic cell give rise to an **unregulated clonal proliferation** of cells.
- The progeny of these cells have a growth advantage over normal cellular elements, because of their increased rate of proliferation and a decreased rate of spontaneous apoptosis.
- The result is a disruption of normal marrow function and, ultimately, marrow failure.

Classification



- Based on time course of disease
 - ▣ Acute Leukemia
 - ▣ Chronic Leukemia
- Based on the origin of cells
 - ▣ Myeloid Leukemia
 - ▣ Lymphoid Leukemia

Acute leukemia

- **Acute Leukemia (AL)** is a **clonal neoplastic disorder** characterized by the **proliferation & accumulation** of immature and malignantly transformed cells in the **BM or PB**.
- **The abnormal cells replace the normal BM tissue.**
- **The result is abnormal /insufficient hematopoiesis.**
 - **Anemia**
 - **Thrombocytopenia**
 - **Leukocytosis/leukopenia**
- **Infiltrate other organ tissues (Up-to-date 21.2)**

Epidemiology

754

- Leukemia are the **most common malignant neoplasms** in children.
- It accounts approximately 31% of all malignancies that occur in children younger than 15 yr of age.
- The annual incidence of leukemia **4.5** cases per 100,000 children (**Nelson text book 20 edition**)

ALL

- 77% of cases of childhood leukemia,
- Acute myelogenous leukemia (AML) for approximately 11%.
- Chronic myelogenous leukemia (CML) for 2-3%, and
- Juvenile myelomonocytic leukemia (JMML) for 1-2% (Up-to-date 21.2).

Etiology

756

- **Unknown** in most of the cases.
- ***Genetics***
 - There is a greatly increased incidence of leukemia in the **identical twin of patients** with leukemia.
 - Increased incidence of leukemia also occurs in people with **chromosomal abnormalities** such as **Down's syndrome (trisomy 21)** (**Internal medicine lecture note 2006**).

Environmental factors like

- ***Ionizing radiation:*** increases the risk of CML, AML and ALL.
- ***Chemicals:*** like benzene, aromatic hydrocarbons, and treatment with alkylating agents and other chemotherapeutic drugs.
- ***RNA based retroviruses***
- Infection with HTLV - I is related to human T-cell leukemia & similarly Epstein Barr virus is related to ALL.

Clinical features

758

- **Early they manifests with**
 - ❖ **Anorexia**
 - ❖ **Fatigue, malaise, and irritability often are present.**
 - ❖ **Intermittent fever**
 - ❖ **Bone or joint pain**

- **As the disease progresses**
 - ❖ **Pallor, fatigue, exercise intolerance, bruising, or epistaxis,**
 - ❖ **Lymphadenopathy, hepatosplenomegaly, testicular enlargement, or central nervous system (CNS) involvement.**
 - ❖ **Respiratory distress may be due to severe anemia or mediastinal node compression of the airways.**

- **On physical examination**
- **Pallor, listlessness, purpuric and petechial skin lesions,**
- **Mucous membrane hemorrhage can reflect bone marrow failure.**
- **Lymphadenopathy, splenomegaly, hepatomegaly.**
- **In patients with bone or joint pain, there may be exquisite tenderness over the bone or objective evidence of joint swelling and effusion.**

- ❖ **Rarely increased intracranial pressure that indicate leukemic involvement of the CNS.**
- ❖ **These include papilledema, retinal hemorrhages, and cranial nerve palsies.**

Diagnostic modalities

762

- **Complete history and physical examination**
- **CBC, differential, platelets, ESR, Blood group**
- **Serological screening (HIV, HBV, HCV, CMV...)**
- **Examination of peripheral smear**

- 
- BM aspiration & biopsy
 - ▣ Morphology
 - ▣ Flowcytometry
 - ▣ Cytochemical studies
 - Cytogenetic study

Treatment

764

- **Risk-directed therapy has become the standard of current ALL treatment**
- **Takes into account**
 - ❖ **Age at diagnosis**
 - ❖ **Initial white blood cell count**
 - ❖ **Immune-phenotypic**
 - ❖ **Cytogenetic characteristics of blast populations**
 - ❖ **Rapidity of early treatment response (i.e., how quickly the leukemic cells can be cleared from the marrow or peripheral blood),**
 - ❖ **Assessment of MRD at the end of induction therapy**

- **As the National Cancer Institute define standard risk.**
- **High risk**
 - **Age < 1 or >10 yr**
 - **Initial leukocyte count of >50,000/ μ L**
 - **T-cell immune-phenotype or a slow response to initial therapy.**
 - **Chromosomal abnormalities, including hypodiploidy, the Philadelphia chromosome, and *MLL* gene rearrangements, portend a poorer outcome.**

- **More favorable characteristics include a rapid response to therapy,**
 - ▣ **Hyperdiploidy,**
 - ▣ **Trisomy of specific chromosomes (4, 10, and 17), and**
 - ▣ **Rearrangements of the *ETV6-RUNX1* (formerly *TEL-AML1*) genes (Yeoh et al. 2002).**

A. Induction therapy (28 days)

767

- **Vincristine 1.5mg/m² weekly,**
- **Prednisone 40mg/m² daily ,**
- **Asparaginase 6000IU/m² IM 3x/week**
- **Intrathecal chemotherapy is always given at the start of treatment and at least once more during induction**
- **Patients at higher risk also receive daunomycin at weekly intervals.**
- **With this approach, 98% of patients are in remission, as defined by <5% blasts in the marrow and a return of neutrophil and platelet counts to near-normal levels after 4-5 wk of treatment.**

B. Consolidation (28 days)

768

- **Focuses on intensive CNS therapy in combination with continued intensive systemic therapy in an effort to prevent later CNS relapses.**
 - ❖ **Vincristine 1.5mg/m² on the start**
 - ❖ **Prednisone 20mg/m² daily x 2days then taper**
 - ❖ **Mercaptopurine 75mg/m² PO for 27 days**
 - ❖ **Intrathecal chemotherapy is given repeatedly by lumbar puncture.**
 - ❖ **Radiotherapy if it involve CNS.**

C. Intensification

769

- **Includes phases of relatively nontoxic phases of treatment (interim maintenance) (56 days).**
 - ▣ **Prednisolone 40mg/m² (0-4days, & 28-32days)**
 - ▣ **Methotrexate 20mg/m² weekly**
 - ▣ **Mercaptopurine 75mg/m² daily**
 - ▣ **Vincristine 1.5 mg/m² weekly for x3**

- **Aggressive treatment (delayed intensification) (56 days)**
 - **Vincristine 1.5mg/m² wkly x3**
 - **Asparaginase 6000IU/m² 3x/wk x6**
 - **Doxorubicin 25mg/m² wkly x3**
 - **Dexamethasone 10mg/m² IV 0-6 14-20**
 - **Cyclophosphamide 1gm/m² IV on day 28 is used during these phases to eradicate residual disease.**

Maintenance (84 days)

771

- **Which lasts for 2-3 yr, depending on the protocol used.**
 - ▣ **Prednisolone 40mg/m² (0-4days, 28-32days & 56-60days)**
 - ▣ **Methotrexate 20mg/m² weekly**
 - ▣ **Mercaptopurine 75mg/m² daily**
 - ▣ **Vincristine 1.5 mg/m² on day 0,28 &56**

- ❖ **A small number of patients with particularly poor prognostic features, such as those with induction failure or extreme hypodiploidy, may undergo bone marrow transplantation.**

Treatment of Relapse

772

- **The major impediment to a successful outcome is relapse .**
- **15-20%**
- **Intensive chemotherapy**
- **Allogeneic stem cell transplantation can result in long-term survival for some patients with bone marrow relapse.**
- **Umbilical cord blood transplant**

Nursing interventions

773

- **Successfully administering aggressive chemotherapeutic programs.**
- **Chemotherapy often produces **severe myelosuppression****
- **Require **erythrocyte and platelet transfusion****
- **Always requires a high index of suspicion and aggressive **empiric antimicrobial therapy for sepsis in febrile children with neutropenia.****

- **American society of hematology recommends social development, emotional health, and academic progress support should be implemented (Robison 2013)**
- **Relieving Psychosocial costs, financial costs and stress for their families (Mertens et al. 2012).**
- **Proper counseling, advice and health education (Sherief et al. 2015). (Moynihan 2014).**



Endocrine system

Objectives

Friday, April 24,
2020

At the end of this course you will be able to:

- Assess, diagnose and manage a child with endocrine system disorders.

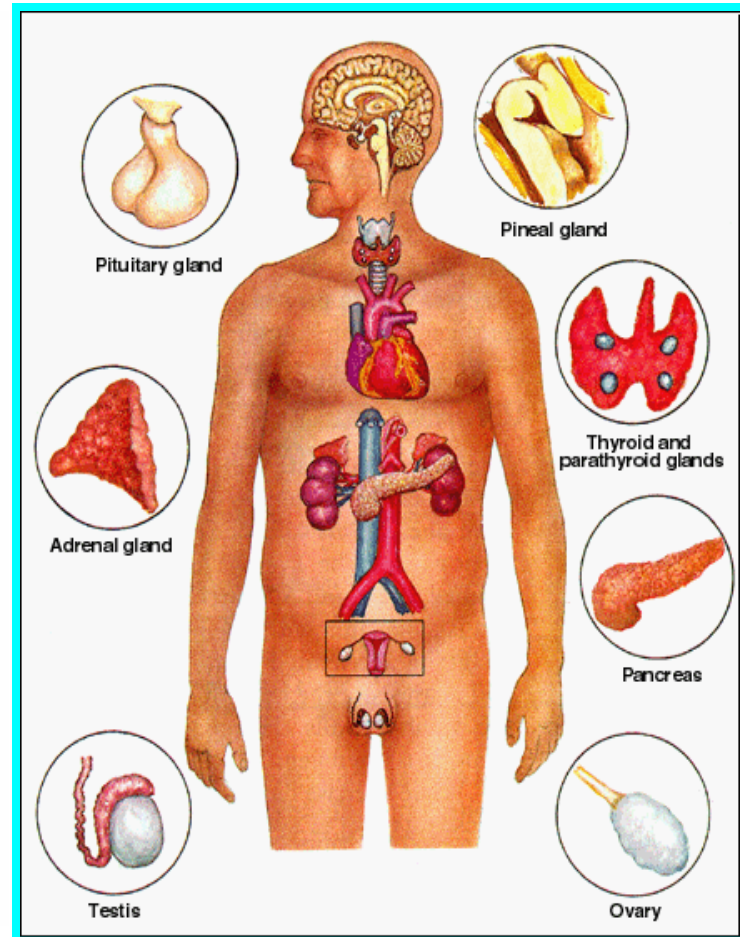
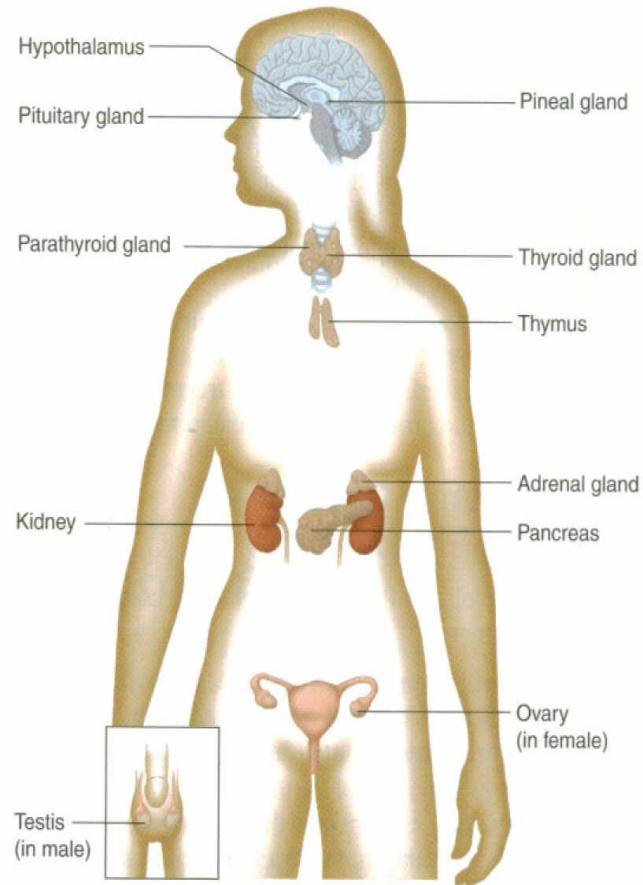

Introduction

- The endocrine system includes the organs of the body that secrete hormones directly into body fluids such as blood
 - ▣ Regulates chemical reaction in cells and therefore control functions of the organs, tissues, and other cells

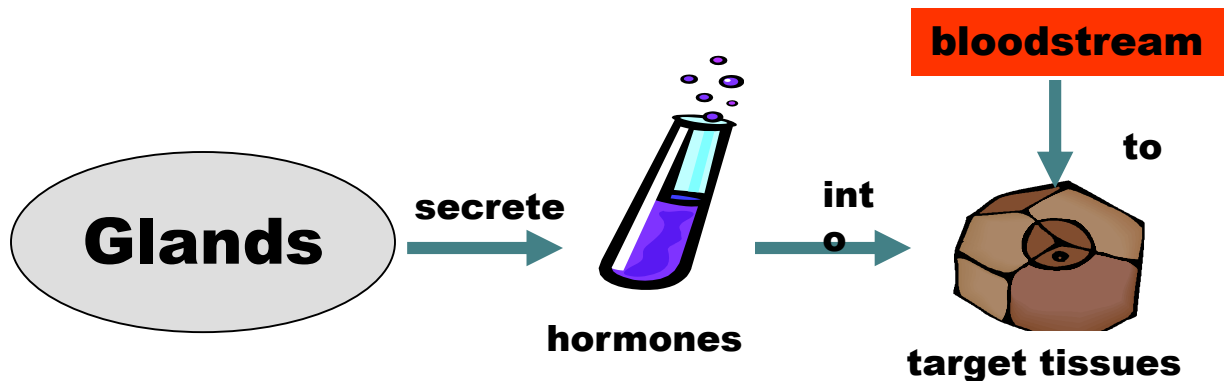

Function of hormones

- ❖ Growth & differentiation.
- ❖ Maintenance of homeostasis.
- ❖ Reproduction

Diabetes Mellitus

780

- The term diabetes was probably coined by Apollonius of Memphis around 250 BC. It was in 1675 that Thomas Willis added the word “mellitus” to the word diabetes (Mandal A,2012).
- Greek word *diabetes* meaning siphon - to pass through and the Latin word *mellitus* meaning honeyed or sweet.
- It was known in the 17th century as the “pissing evil” (Mandal A,2012).
- Metabolic disease characterized by hyperglycemia. (Nelson,20th edition).

Statistics of Dm

781

World data 442 million people have diabetes mellitus worldwide, and that this number may well double by the year 2025. WHO

Update

DM type I 90% in children

Girls=Boys

Every year in Children increasing in 4.8%

Every year increasing DM type I in adults in 3%

Every 10 seconds one patient die from DM

4/24/2020

Cont...

782

In Africa & Ethiopia

- **Africa** is the region with the lower **prevalence of diabetes (4.9%) (WHO,2013)**.
- The prevalence of DM in Ethiopia stands at 3.32 % (**IDF 2012 report**).
- DM prevalence of as high as 8% has been reported in 2013 on HIV/AIDS patients taking HAART, in Ethiopia. (**Sachithananthan V et al, 2013**)

4/24/2020

Types of Diabetes in Children

783

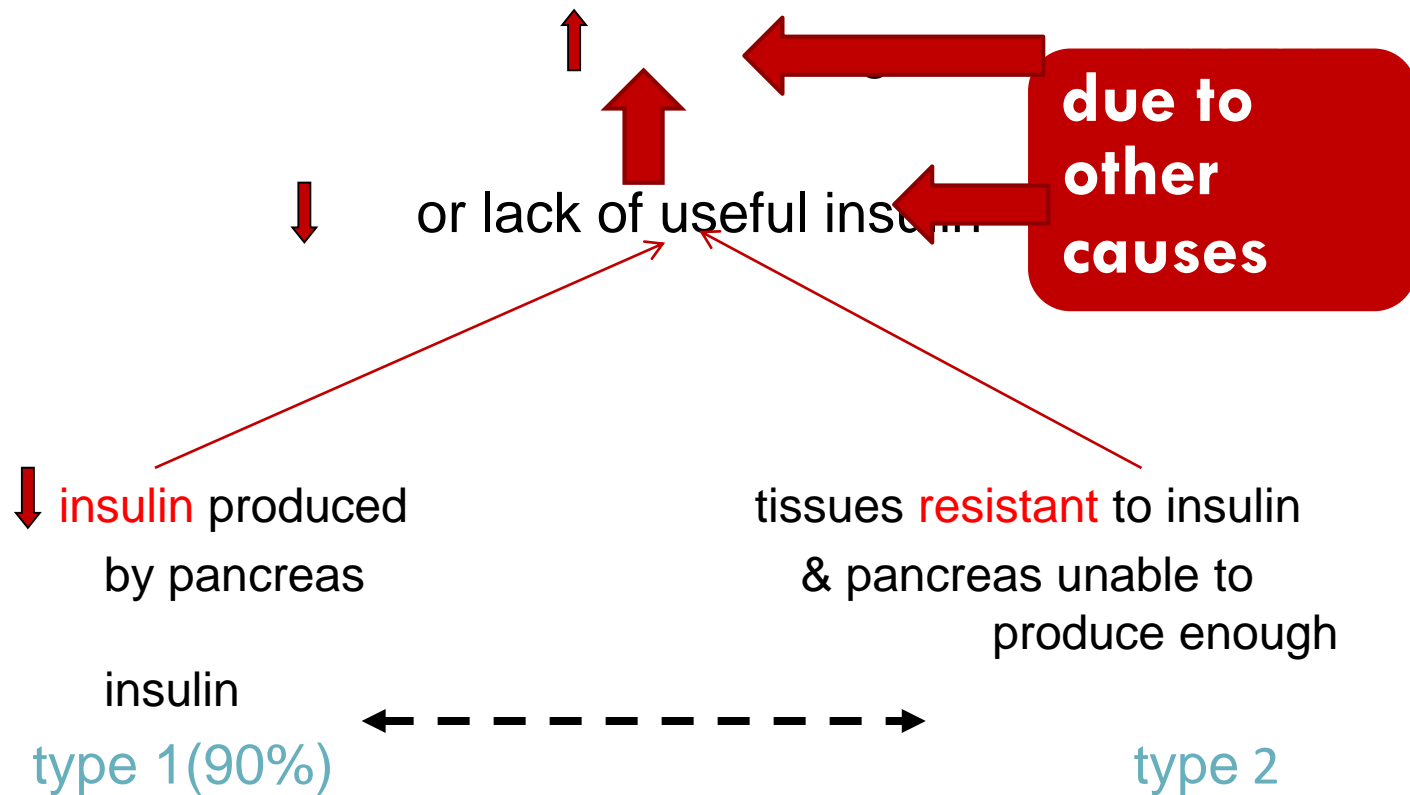

- **Specific types of diabetes** due to other causes, e.g., monogenic diabetes syndromes, diseases of (ADA,2016) the exocrine pancreas, and drug- or **chemical-induced** diabetes.



The onset DM type I occurs predominantly in childhood, with median age of **7 to 15 yrs**, but it may present at any age.

(Nelson, 20th edition).

Unlike type 1, type 2 diabetes is

786

- Insidious onset
- More common in adult
- Incidence: 80 % new case of diabetes in child
- Cause: Insulin resistance due to obesity
- Complaint with weight gain & fatigue.
- 3 poly is not cardinal sign.
- Treated by oral hypoglycemic agents(Metformin-500mg, Biguanide-10 mg tablet form in UoGRH.

(Nelson,20th edition

Pathophysiology of DM

787

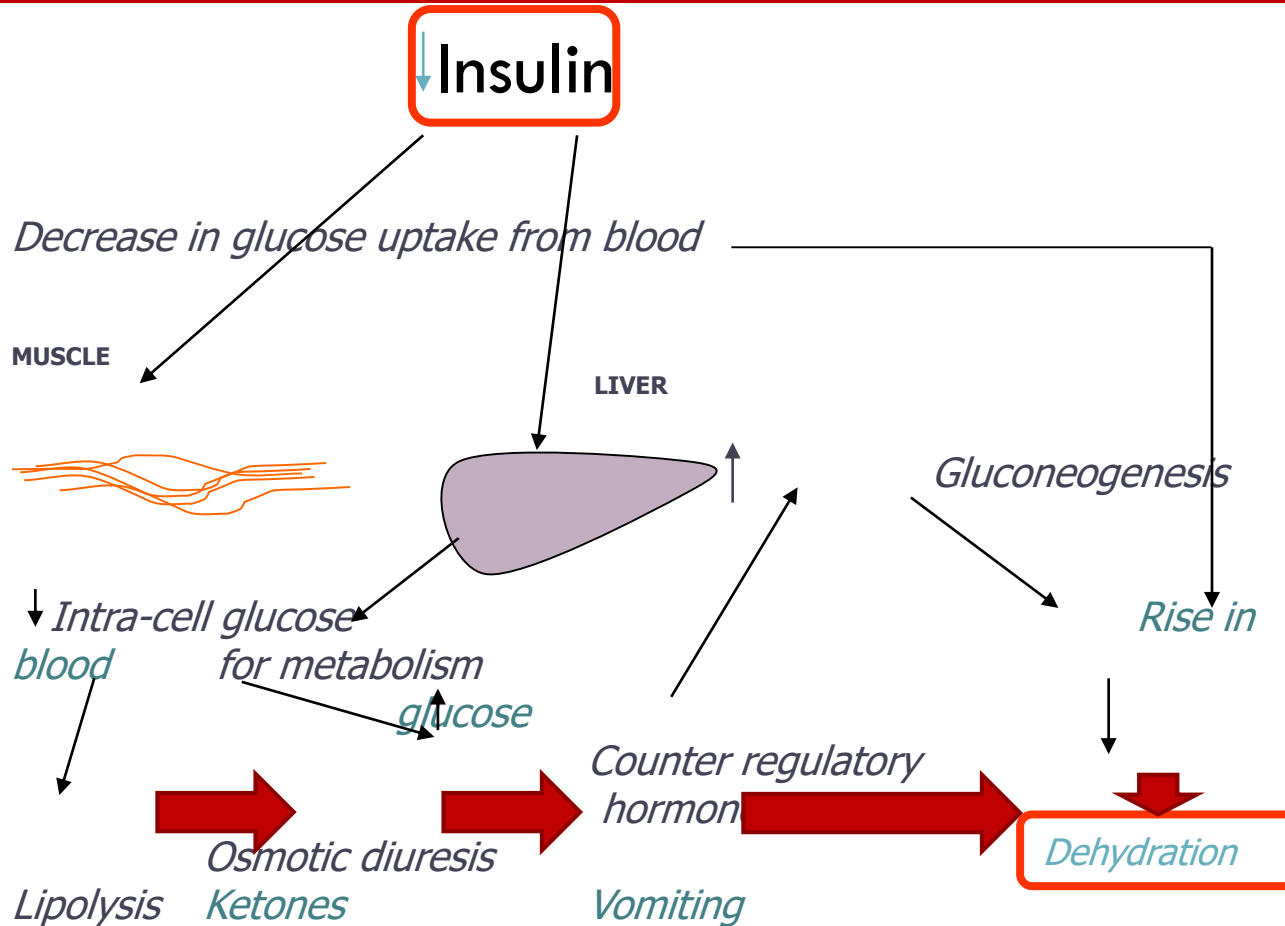

What are the abnormal results & what do they signify?

788

- 3-Polyuria
- Weight loss
- Lethargy
- weakness

These symptoms may be present for days to weeks.

- Vaginitis in teenage may occur.
- Skin infections less common.

Diagnosis of DM

789

- Symptoms of diabetes mellitus plus random or casual plasma glucose ≥ 200 mg/dL or
- Fasting (at least 8 hr) plasma glucose ≥ 126 mg/dL or 2 hr plasma glucose during the OGTT ≥ 200 mg/dL or Hemoglobin A1C $\geq 6.5\%$.
- **Results should be confirmed by repeat testing if in absence of unequivocal hyperglycemia. (Nelson, 20th edition).**

Complications of DM (acute)

790

- Diabetic ketoacidosis
- Nonketotic hyperosmolar coma
- Hypoglycemia,
- Somogyi phenomenon
- Dawn phenomenon
- Brittle Diabetes

Complications of DM (long-term)

791

- Diabetic **retinopathy**
- Diabetic **nephropathy**
- **Angiopathy** of lower extremities
- Diabetic **neuropathy** (peripheral, central, autonomic)
- Hairopathy
- **Skin pathology** (, lipodystrophy, paronychia,



4/24/2020

Diabetic ketoacidosis

792

Biochemical criteria for the diagnosis of DKA (up to date 2.21):

- Hyperglycemia: a blood glucose of >200 mg/dL (11 mmol/L) **AND**
- Metabolic acidosis: venous pH <7.3 and/or a plasma bicarbonate <15 meq/L (15 mmol/L).
- Accompanied by disturbances in **fluid** and **electrolyte** balance.

Cont...

Findings in DKA:

- Air hunger
- Kussmaul's respiration
- Acetone on the breath
- Mentation change
- Vomiting & dehydration
- Elevated blood urea nitrogen and hematocrit but not elevated urine specific gravity=> used as a measure of **hypovolemia** in patients with DKA.

Moderate and severe DKA

1. Fluid and electrolyte deficits and repletion:

- Start with isotonic fluids: reduce the risk for cerebral edema [[10-12](#)].

Initial volume expansion: RL Or NS

- Start with **10 mL/kg** over one hour. Still volume compromise **10 ml/kg** for next an **hour**. Generally do not give more than **20 mL/kg** in total boluses unless the patient's cardiovascular status is

Cont...

795

Subsequent fluid administration

- It should initially consist of isotonic saline (normal saline or lactated Ringers) for approximately **four to six hours**.
- The rate over the first 24 hours should not exceed 1.5 to 2 times the usual rate of administration of maintenance fluid.
- For most patients, **40 mEq/L** of potassium salts should be added.

Cont...

- After the first **four to six hours** of treatment, reduce the sodium concentration to not less than one-half isotonic.
- The total fluid intake should be no greater than 3500 mL/m² for 24 hours.

Cont...

797

2. Insulin — After the initial fluid bolus is complete, an insulin infusion is begun at a rate of 0.1 unit/kg per hour.

- A lower dose of 0.05 unit/kg per hour may be used initially in younger children.
- It can be mixed in one-half isotonic saline and administered in a syringe infusion.
- Do not give an **initial bolus** of insulin.

Cont...

798

- When the serum glucose concentration decreases to **250 to 300 mg/dL**, the intravenous fluid infusion should be changed to **5 percent dextrose** in isotonic saline or lactated Ringer's solution[[11](#)].
- If the serum glucose falls below **250 mg/dL** before complete resolution of the ketoacidosis, the concentration of dextrose in the intravenous solution should be ^{4/24/2020}

Cont...

799

- **Insulin pump therapy:** it should be considered for patients with one or more of the following characteristics [[Phillip M,et.al, 2007](#)].
 - ✓ Recurrent severe hypoglycemia
 - ✓ Wide fluctuations in blood glucose levels (regardless of A1C).
 - ✓ Suboptimal diabetes control.
 - ✓ Micro-vascular complications and/or risk factors for macro-vascular complications
 - ✓ Good metabolic control, but insulin regimen that compromises lifestyle.

Cont...

800

- For patient safety reasons, it is advisable to keep serum glucose concentrations around 150 to 200 mg/dL for younger children; or 100 to 150 mg/dL in older children, before switching to **subcutaneous insulin.**

Cont...

801

- **Rapid-acting** (eg, lispro, aspart, glulisine) and **short-acting types** (eg, regular insulin) are typically administered as a pre-meal bolus (typically 5 to 15 minutes before the meal for the rapid-acting insulins, and **20 to 30 minutes** before meals for the short-acting type).

4/24/2020

Cont...

802

Intermediate-acting NPH insulin is usually given **two or three times** a day, but may be given in a targeted manner in combination with long-acting insulin.

- Intermediate-acting insulin thus provides some coverage for meals (eg, NPH insulin given before breakfast will cover lunch).

4/24/2020

Cont...

Long-acting insulin preparations
(eg, insulin glargine and insulin detemir)
are given **once** or twice a day.

NB. Insulin glargine cannot be mixed
with any other form of insulin and must
be administered separately.

Value of an intensive regimen

804

1. Conventional regimen: **Two-thirds** of the total daily dose is administered before breakfast ($2/3$ as NPH and $1/3$ as rapid- or short-acting insulin) and **one-third** before dinner and at bedtime ($1/3$ to $1/2$ as rapid- or short-acting insulin before dinner

4/24/2020

and $2/3$ to $1/2$ as NPH at bedtime)

Cont...

2.Intensive regimens: Delivered either by multiple daily injections, or by continuous insulin infusion (pump).

- **Multiple daily injections** : a long-acting insulin analog ([insulin glargine](#) or detemir) with **pre-meal/snack** boluses of rapid- or short-acting insulin. It results in more stable glycemic control and fewer episodes of hypoglycemia in children [[Hathout EH et.al,2003](#)]

Cont...

- **Insulin Dose:** The newly diagnosed child requires an initial total daily insulin dose of 0.5 to 1.0 units/kg.
- As a child enters puberty, daily insulin requirements may increase to more than 1 unit/kg because puberty increases insulin resistance (upto date, 2.21).

Cont...

807

- **Blood glucose monitoring:** Frequent monitoring has been shown to improve glycemic control in children([Ziegler R, et.al,2011](#)).
- **Finger sticks** — it is recommended testing of blood glucose at least four times a day ([ADA, 2011](#)).
- Age-based care is recommended ([Silverstein J et.al,2005](#)).

Cont...

808

- Providing age-appropriate psychosocial support for the patient and the family=>improved glycemic control and reduced hospitalization rates ([Ellis DA et.al,2005 RCT](#)).
- Immunization: All vaccine on a standard schedule should be provided.

4/24/2020

Cont...

- **Parental and caregiver involvement:**
important for diabetes management in children & adolescents [[Shorer M, et.al, 2011](#)]
- Information for parent and patients regarding disease process, medication, exercise and nutrition.
- Follow-up visits at least every three months
- Screening : at least twice a year.



Thank you

UNIT VII: EXPANDED PROGRAM ON IMMUNIZATION (EPI)

4/24/2020

Objectives

812

1. Describe the main types of vaccines.
2. Differentiate the immunization schedules
3. Demonstrate the dose and route of administration for different vaccines
4. Identify some complications of vaccination
5. Describe how to reconstitute BCG and measles vaccines with a diluents

EPI strategies

813

- Increase and sustain high immunization coverage rates
- Increase the quality of immunization services
- Reduce missed vaccination opportunities and trace defaulters

- Improve public awareness and community participation in immunization programmes

- Ensure prompt reporting and improved control of vaccine-preventable diseases.

Five key operations for an effective immunization service

814



Vaccine-preventable Diseases

815

- Tuberculosis
- Poliomyelitis
- Diphtheria
- Pertussis (whooping cough),
- Tetanus
- Measles
- *Haemophilus influenzae type b* causes (Pneumonia and Meningitis)
- *Hepatitis B*
- *Pneumonia*
- *Diarrhea caused by Rota virus*

Function of immune cells

8

Lymphocytes

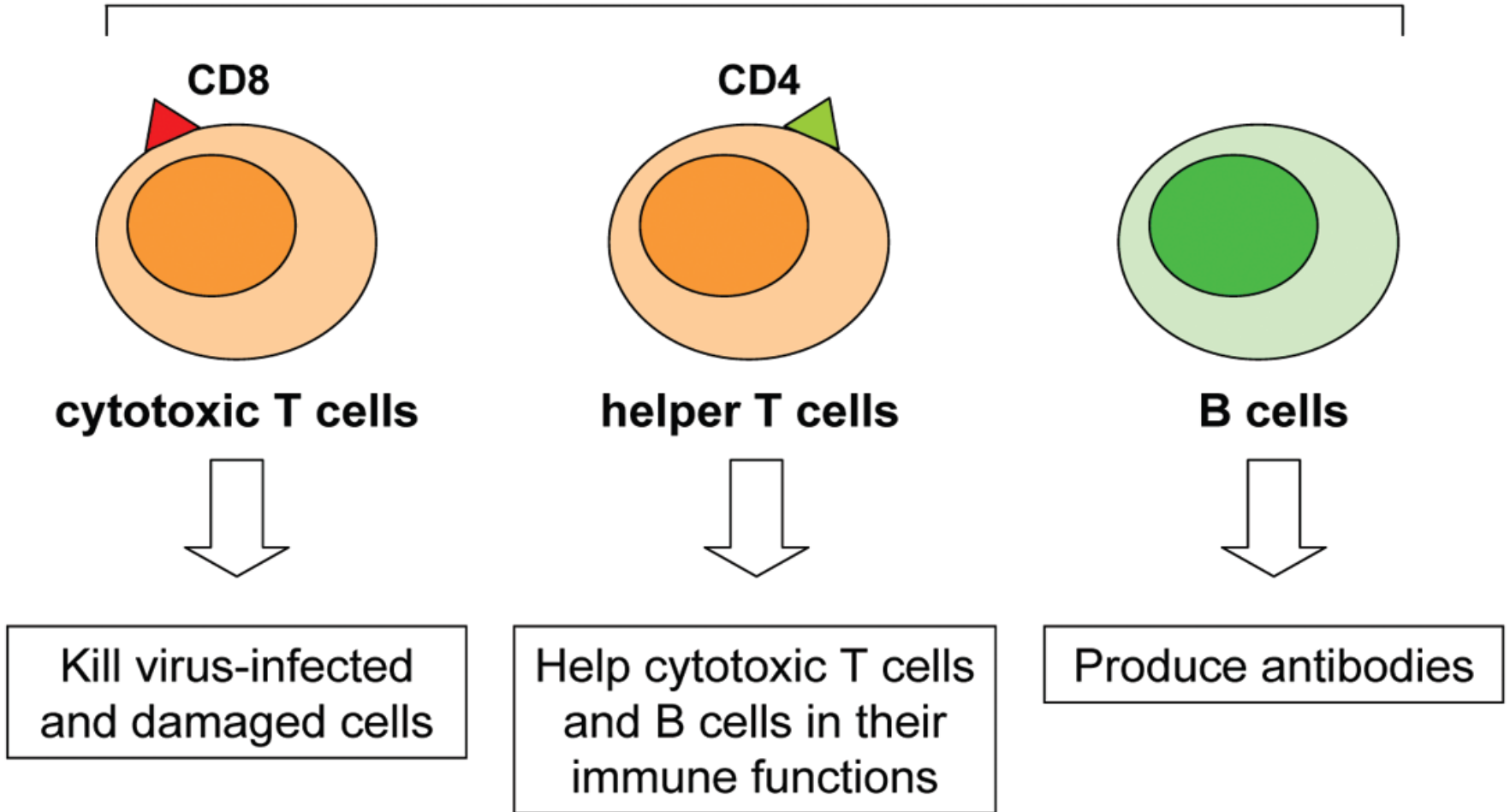

Summary of types of specific immunity

Type of specific immunity

Example of how immunity might be acquired

Naturally acquired immunity

Active

Infection

Passive

Maternal antibodies crossing the placenta, or in breast milk

Artificially acquired immunity

Active

Intentional exposure to antigens in a vaccine

Passive

Injection or transfusion of someone else's antibodies

Types of vaccines

818

1. **Live-attenuated vaccines** (Measles, OPV, yellow fever and BCG)
2. **Inactivated vaccines** (pertussis component of DPT)
3. **Sub-unit vaccines** (diphtheria and tetanus components of DPT toxoids)
4. **Recombinant vaccines** (HepB)
5. **Conjugate vaccines** (Hib, PCV) vaccine.

The four routes of administration

819

1. **Intradermal (ID):** the vaccine is injected into the top layers of the skin.
2. **Subcutaneous (SC):** the vaccine is injected into the fatty tissue below the skin and above the muscle.
3. **Intramuscular (IM):** the vaccine is injected into the muscle.
4. **Oral:** the vaccine is given by drops into the mouth.

Routes of administration

820

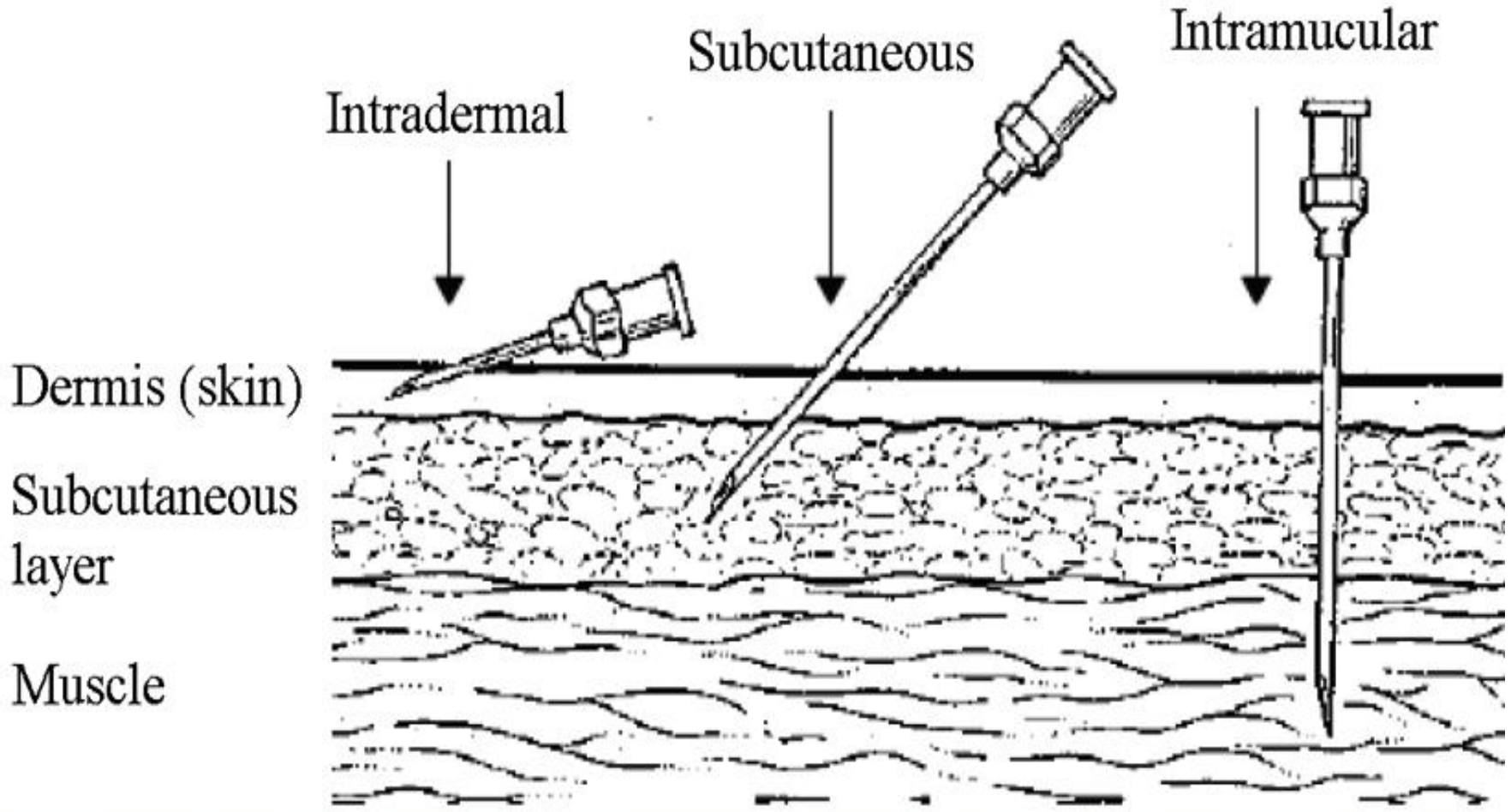

Preparing to give injectable vaccines

821

1. Standard procedures (universal precautions) for giving safe injections.
2. Preparing injection equipment.
3. Inspecting vials and ampoules of vaccines and diluents.
4. Reconstituting BCG and measles vaccines with diluents.
5. The skin at the site of the injection should be swabbed cleaned with an appropriate antiseptic such as alcohol. After giving the injection, press a clean cotton swab onto the site until all bleeding stops.

standard procedures

822

- ❑ Wash your hands thoroughly with soap and water, and allow them to 'air dry'.
- ❑ Prepare all the equipment you need and lay it out on a clean tray that has been swabbed with alcohol.
- ❑ Organize your equipment to minimize the risk of injury from needles and broken glass.

- ❑ Make sure there is a safety box nearby for the safe disposal of used syringes and needles.
- ❑ Make sure that children are securely held by someone

Parts of a syringe and a hollow needle

823

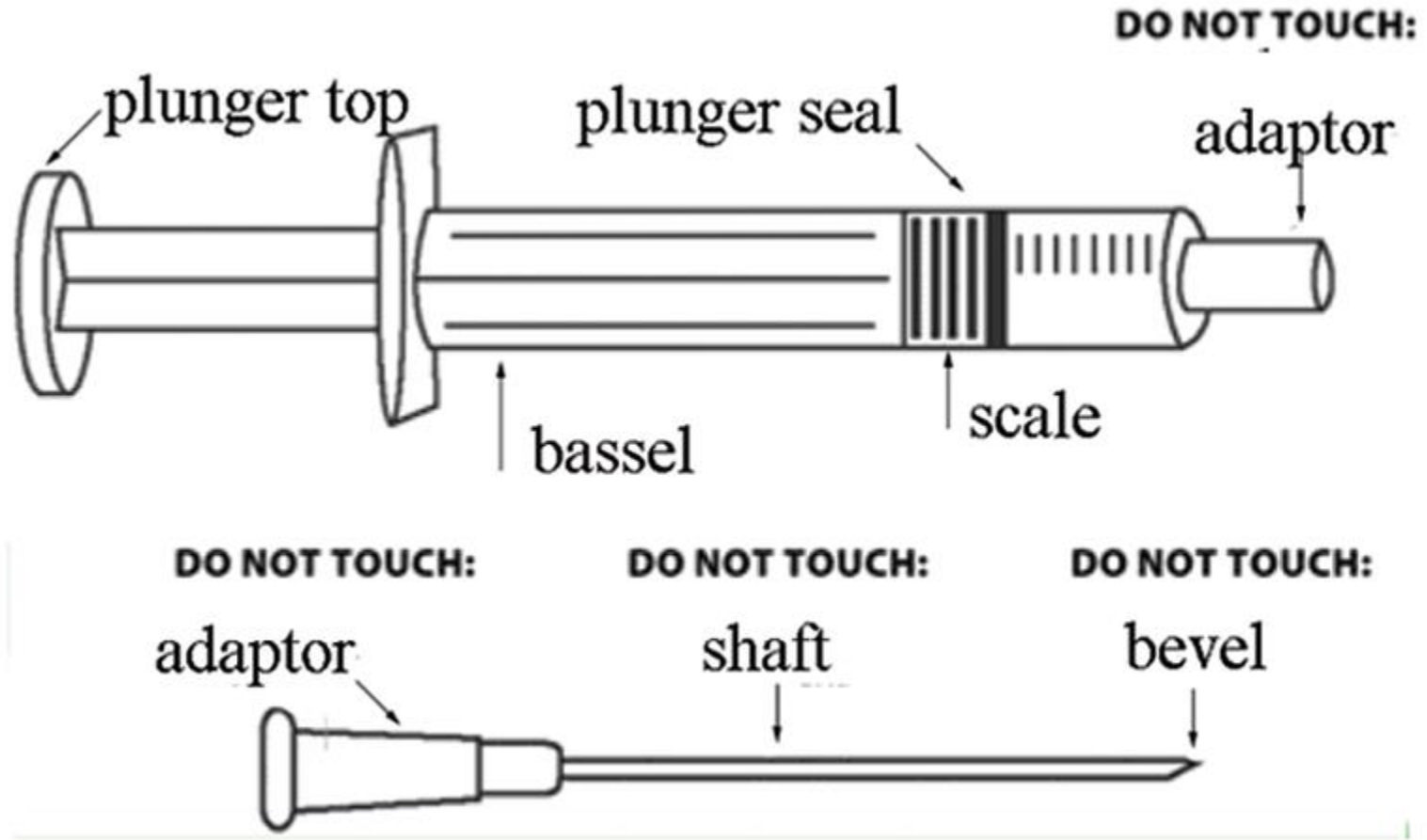

Reconstituting BCG and measles vaccines

824

1. Wash your hands and organize your equipment and work area
2. Inspect the vaccine vial or ampoule
3. Tap the vial or ampoule
4. Open the vaccine vial
5. Inspect the diluent
6. Open the ampoule of diluent
7. Draw diluent into the mixing syringe
8. Reconstitute the vaccine
9. Keep reconstituted vaccines cold

BCG vaccine

825

- B, C and G stand for **B**acillus of **C**almette and **G**uerin
- Live-attenuated antibacterial (TB)
- **Effectiveness** - from 0–80% of those vaccinated
- **Storage** between 2°C and 8°C
- It should be used within 6 hrs of reconstitution
- **Syringe** - sterile 0.1 ml syringe with a 26 gauge needle
- **Dosage** – 0.05mg/0.05ml Id for < 1 yr infants
- 0.1mg/0.1ml Id for > 1 yr children
- **Injection site** - Outer upper **right** arm or shoulder
- **Booster** (additional dose) – None (only 1 dose)
- **Contraindications** – child with **AIDS disease**

Intradermal BCG injection

FBI

Dermis (skin)

Subcutaneous
layer

Muscle

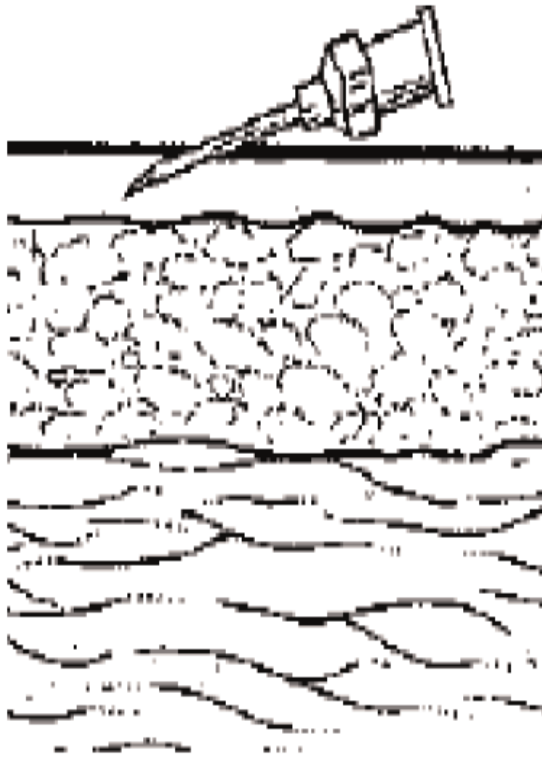

Causes of Swollen glands or abscesses

- An unsterile needle or syringe was used
- Too much vaccine was injected
- The vaccine was injected too deeply under the skin, instead of into its top layer.



Pentavalent vaccine

828

- It described as DPT-HepB-Hib vaccine.
- **Effectiveness** - 78–95% of individuals received three vaccine doses
- **Storage** - at between 2°C and 8°C.
- **Number of doses** - three (Penta1, Penta2 and Penta3)
- **Schedule** - at 6, 10 and 14 weeks of age
- **CI** - Severe allergic reaction or encephalopathy to a previous pentavalent immunization
- **Special precautions** - Usually not given after 6 years of age due to increased risk of serious adverse reactions
- **Dosage/site/type** – 0.5ml left outer mid-thigh IM with 1 ml syringe

Pentavalent, DPT, Hib and HepB vaccines

EPI

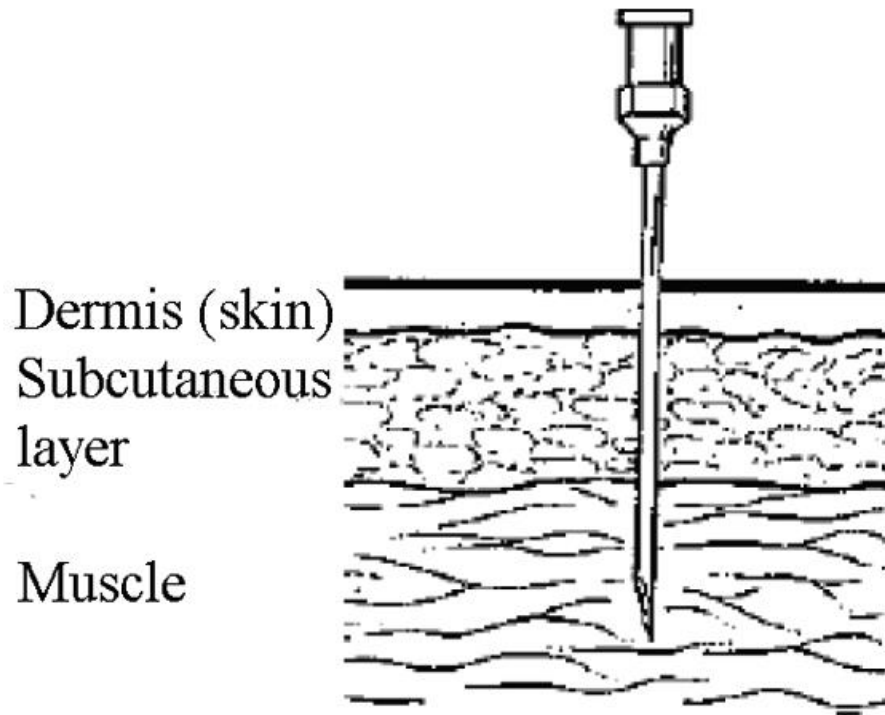

Oral polio vaccine (OPV)

830

- **Number of doses** - Four (OPV0, OPV1, OPV2 and OPV3)
- **Schedule** - At birth, 6, 10 and 14 weeks

- **Additional dose** - If the child spits or vomits after OPV, repeat the dose immediately; if the child has diarrhea, give a fifth dose at least 4 weeks after the scheduled fourth dose

- **Dosage/route** - 2 drops into the mouth (oral)
- **Contraindications** - None
- **Storage** - between 2°C and 8°C (may be frozen for long term storage)

A child receiving oral polio vaccine drops

831



Measles vaccine

832

- **Type of vaccine** - Live-attenuated antiviral vaccine
- **Number of doses** - One
- **Schedule** - At 9–11 months; at **9 months** (preferred)
- **Additional early dose** - At 6 months in some circumstances
- **CI** - Severe allergic reaction to previous dose
- **Adverse effects** - Fever, rash and (rarely) severe allergic reaction
- **Dosage/Site/Route** - 0.5 ml; left upper arm; Sc.
- **Syringe** – 1 ml with 23 gauge needle
- **Storage** - between 2°C and 8°C (Note: the vaccine powder may be frozen for long term storage, but not the diluents or the reconstituted vaccine)

Subcutaneous injection of measles vaccine

Dermis (skin)
Subcutaneous
layer
Muscle

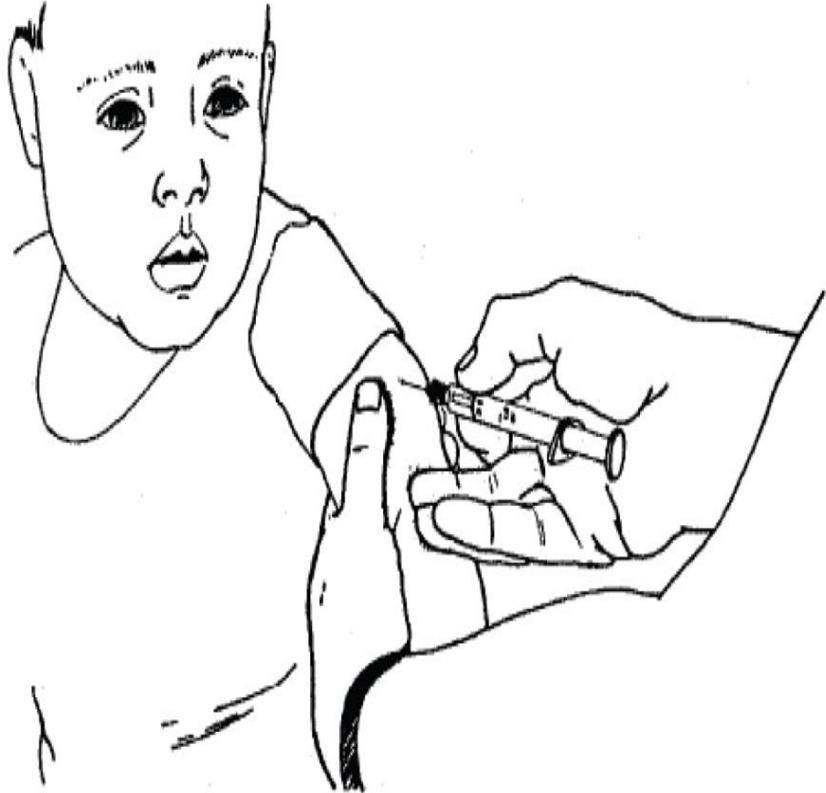
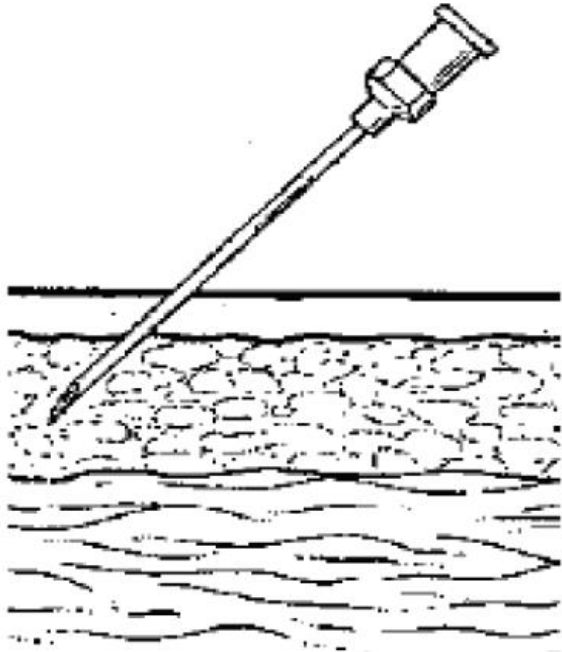

signs and symptoms of measles

EPI



(a)



(b)

Vitamin A treatment dosages for children with measles

835

Age	Immediately on diagnosis	After 24 hours	Follow-up
Infant < 6 months	50,000 IU	50,000 IU	Third dose given two to four weeks later if there are still signs of vitamin A deficiency
Infant 6-11 months	100,000 IU	100,000 IU	
Children 12 months and above	200,000 IU	200,000 IU	

ANY QUESTION

836



EPI 4/24/2020

EPI Program in Ethiopia

837

- **Each country has its own vaccine policies**
- **Vaccines recommended by WHO & launched by Ethiopia in its EPI are:**
 - **BCG**
 - **DPT-HepB-Hib (pentavalent)**
 - **PCV**
 - **OPV**
 - **Measles**
 - **Rota vaccine (*Rotarix*®) (RV1)**
 - **TT**

Target groups for EPI in Ethiopia

- All children < 1 year
- All women of child bearing age (15-49) years.
- Any more???

DISEASE	VACCINE	NATURE OF VACCINE	FORM	PREPARATION	Storage	EFFICACY
TB	BCG	Attenuated m.bovis	Freeze dried	20 dose	Damaged by sunlight	0-80% primary TB 75-86% meningitis & millary TB
Diphtheria	D. toxiod	toxoid	L	Fully	Never freeze	>87%
Tetanus	T. toxiod	toxoid	Q	Liquid Single Dose		>95%(>80%, after 2 dose)
pertusis	pertusis	Killed whole cell bacterium	U	Pentavale nt		Higher against severe disease(at least 80%)
Hepatitis B	Hepatitis B	DNA Recombinant	I	Vail (DPT- HepB- Hib)		75%-95% against chronic infection
Hib	Hib	conjugated	D			>95% for invasive disease
Poliomyelitis	OPV	Attenuated live virus of 3 serotypes	liquid	10	damaged by heat	98%
Measles	measles	Attenuated live virus	Freeze dried	10	damaged by heat	85% at 9 months
Pneumococcal disease	PCV 10	conjugated	liquid	2	Don't freeze	

Contact

Vaccine

Age of child

840

❖ 1st vaccination

OPV-0 & BCG →

at birth

❖ 2nd vaccination

pentavalent-1
PCV1 and OPV-1

6wks

❖ 3rd vaccination

pentavalent-2
PCV2 and OPV-2

10 wks.

❖ 4th vaccination

Pentavalent-3
PCV3 & OPV-3

14 wks.

❖ 5th vaccination

Measles →

9 month

Dose & route of administration of vaccine

VACCINE	DOSE	NO OF DOSE	ROUTE	SITE	Side Effects
BCG	<1yr=0.05 >1yr=0.1ml	one	I.D	right upper arm	-Local inflammation or deep abscess.
Polio	2 drops	Four	Orally	Mouth	-Usually none
DPT-Hep B-Hib	0.5 ml	Three	I.M	Left anterior-mid-thigh	-Fever -Local swelling -Convulsion
PCV	0.5 ml	Three	IM	Right Upper outer thigh	Local reaction Fever irritability
Measle	0.5 ml	one	SC.	left upper arm	-Fever & Rash

Tetanus immunization schedule for women.

Contact	Minimum interval	Duration of protection	S/E (Side effect)
TT1	At the 1st contact during pregnancy or all women child bearing age (15-49)	0	-Pain -Redness -Swelling for a few days at the injection.
TT2	At least 4wks after TT1	3 Years	
TT3	At least 6 months after TT2	5 Years	
TT4	at least 1 years after TT3	10 Years	
TT5	at least 1 years after TT4	Life long years	

Rota Virus Vaccine (RVV)

843

Introduction:

- **Rotavirus** is the most common cause of **severe vomiting and diarrhea** among infants and young children.
- There are eight species of this virus, referred to as **A**, B, C, D, E, F, G and H.
- *Rotavirus A*, the most common species, causes more than 90% of rotavirus infections in humans.
- RVV is a proven prevention of diarrhea caused by RV
- **The vaccine is *not* effective for prevention of diarrhea caused by other etiologic agents**

RVV...

844

- Two vaccines against **Rotavirus A** infection are safe and effective in children:
- **Rotarix** and **RotaTeq**; both are taken **orally** and contain **attenuated live virus**
- RotaTeq® (RV5) is given in **3 doses** at ages 2 months, 4 months, and 6 months, and
- Rotarix® (RV1) is given in **2 doses** at ages 2 months and 4 months.
- ***Rotarix has been launched and given in Ethiopia*** ^{EPI} 4/24/2020

RVV...

845

The child must get the first dose of RVV before 15 weeks of age, and the last by age 8 months.

- Rotavirus vaccine may safely be given at the same time with other vaccines.
- Contraindications:
 - ✓ Baby with life threatening allergic reaction to the 1st dose
 - ✓ Baby with severe combined immunodeficiency
 - ✓ Baby with history of intussusceptions (bowel blockage)
- Side-effects:
 - ✓ Irritable
 - ✓ Mild, temporal diarrhea and vomiting
 - ✓ Intussusceptions
 - ✓ Life threatening allergic reaction

Think-pair-share !

846

What damages vaccines?

What damages vaccines?

847

- ❑ **Improper handling** can easily damage vaccines
- ❑ Vaccine damage lost its potency; no potency after all
- ❑ **Heat and sunlight** damage all vaccines, but (live vaccines are most sensitive)
- ❑ **Freezing** damage DPT and TT vaccine
- ❑ Vaccine has an **expiry date**

=> We have to check the *vaccine vial monitor (VVM)*

EPI 4/24/2020

Temperature

848

- The correct temperature to store all vaccine is between (+2c⁰ to +8c⁰)
- Use thermometer in your refrigerator or vaccine carrier to measure the temperature of your vaccine.
- Always maintain the cold chain while manipulating vaccines

Heat sensitivity

Range	vaccine
Most sensitivity  Least sensitivity	OPV
	Pentavalent
	Measles
	BCG
	TT

Freeze sensitivity

Range	vaccine
Most sensitivity  Least sensitivity	Hep.B
	PCV Pentavalent
	TT
	OPV, Measles, BCG

COLD CHAIN

850

- Is an equipment and/or a system that **ensure vaccine potency** by **keeping vaccine cold** from the manufacturer to the mother /child?
- **Manufacturer → national airport → central vaccine stores → regional stores → zonal stores → district - health center → health post or child & mother.**

Cold chain...

851

- **Equipment for cold chain includes:**
 - Refrigerator
 - Cold boxes
 - Vaccine carriers
 - Ice packs
 - Thermo-meter
- Check the temperature **twice** daily at the morning & evening.

Figure-A : Cold box

852

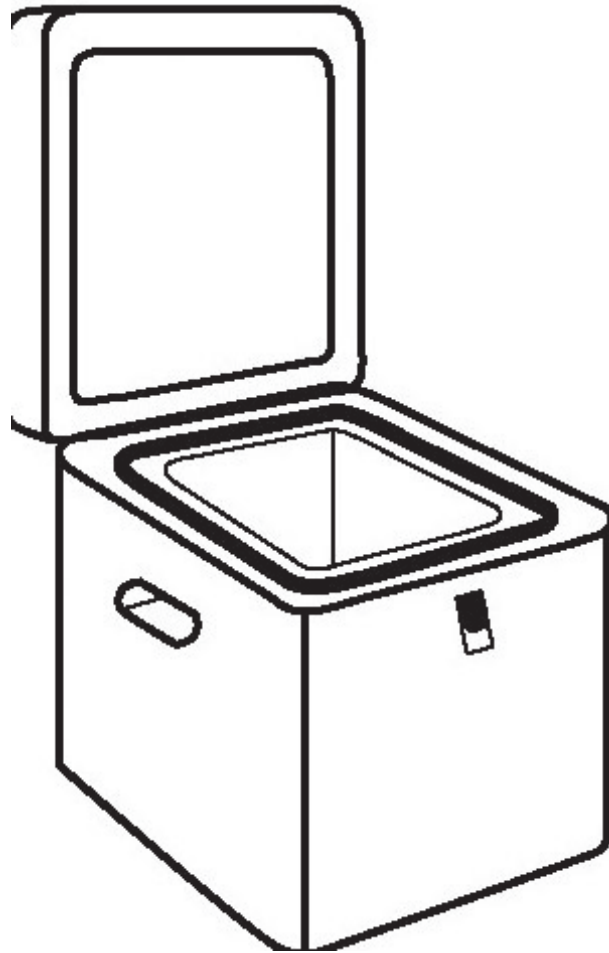

Figure-B: Vaccine carrier

853

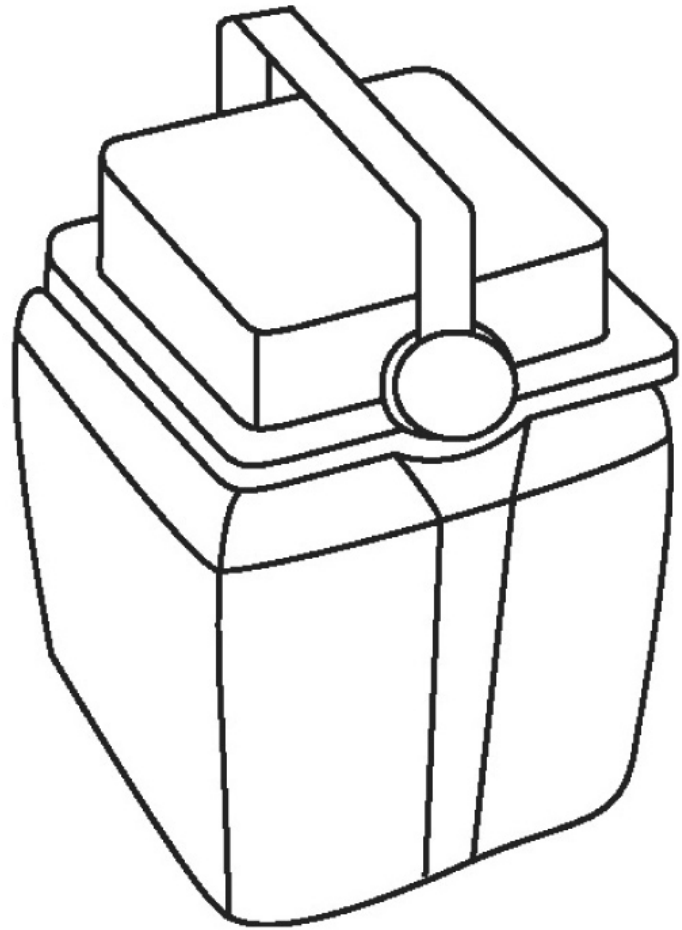
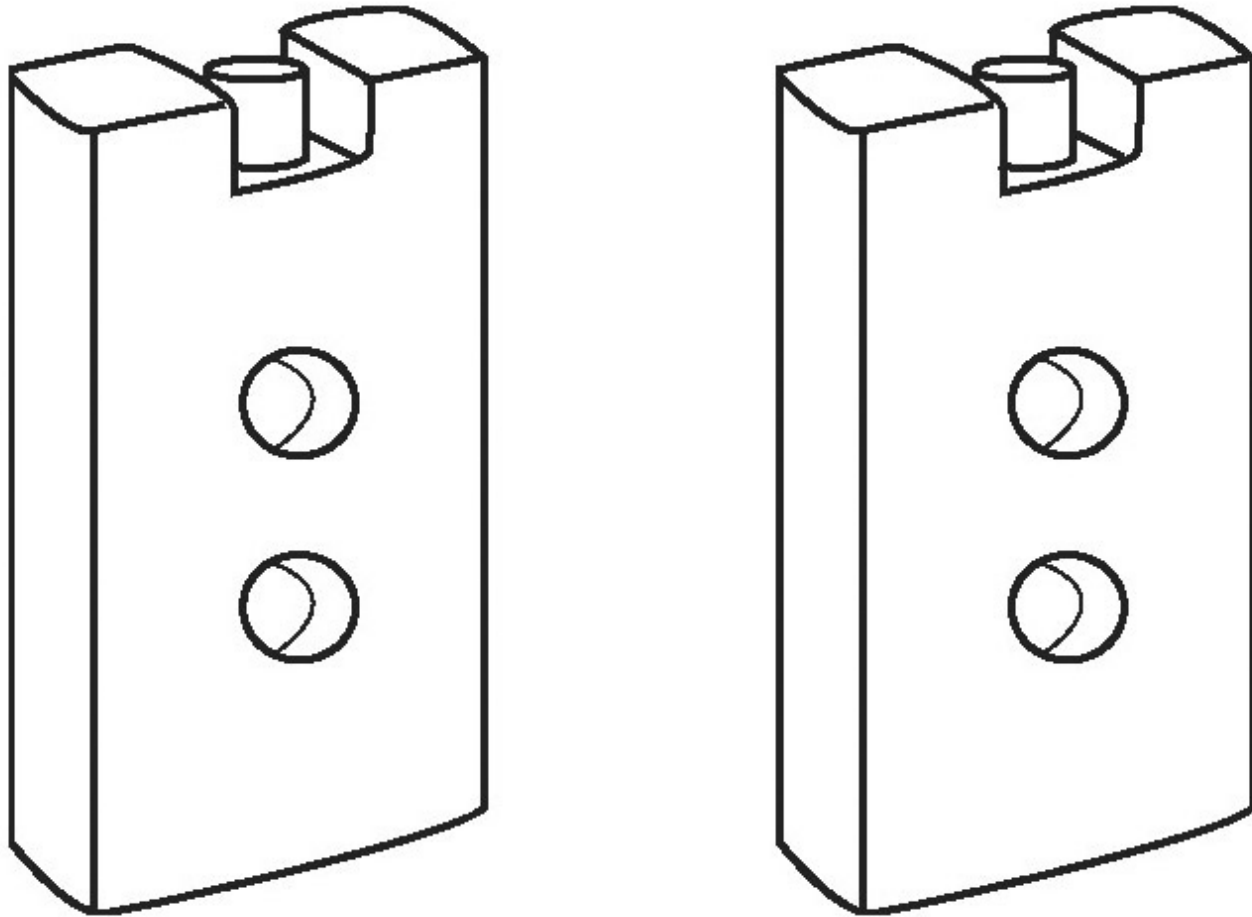

Figure-C: Ice-packs

854



Cold chain monitoring equipment

855

- **vaccine vial monitors (VVM)**
- **Thermometer**
- **The shake test**

vaccine vial monitors (vvm)

Figure: VVM on vial label or cap

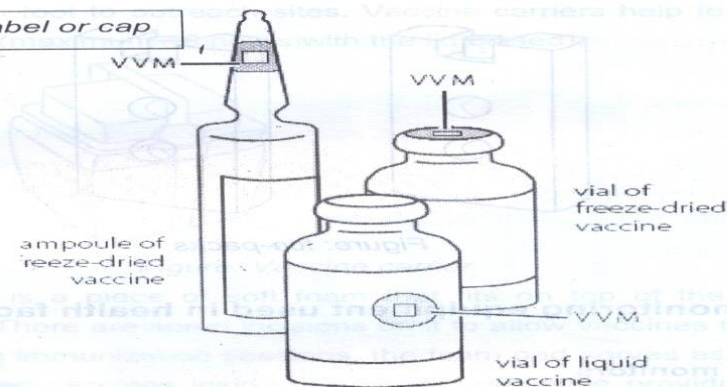

	✓	Inner square lighter than outer circle. <i>If the expiry date has not been passed, USE the vaccine.</i>
	✓	At a later time, inner square still lighter than outer circle. <i>If the expiry date has not been passed, USE the vaccine.</i>
	✗	Discard point: Inner square matches colour of outer circle. DO NOT use the vaccine. <i>Inform your supervisor.</i>
	✗	Beyond the discard point: Inner square darker than outer circle. DO NOT use the vaccine. <i>Inform your supervisor.</i>

Figure: How to read a vaccine monitor(VVM)

VVM...

857

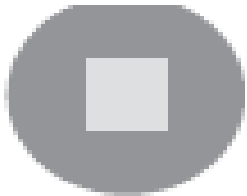

Inner square lighter than outer circle.
*If the expiry date has not been passed,
USE the vaccine.*

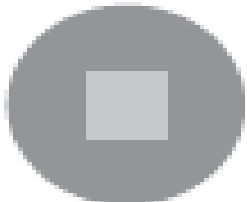

At a later time, inner square still lighter than
outer circle. *If the expiry date has not been
passed, USE the vaccine.*

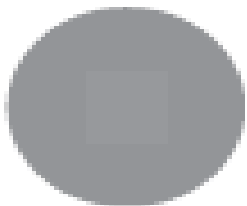

Discard point:
Inner square matches colour of outer circle.
*DO NOT use the vaccine.
Inform your supervisor.*

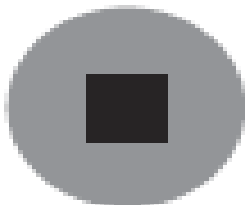

Beyond the discard point:
Inner square darker than outer circle.
*DO NOT use the vaccine.
Inform your supervisor.*

Why we need vaccine management

Vaccine management

Reasons:

- Wrong estimation of vaccine needs, with **overstocks** or **stock-outs**
- Wrong vaccine storage with freezing of cold-sensitive vaccines.
- Vaccine not reconstituted properly
- **Global capacity for vaccine production is limited.**
- **Vaccines are expensive.**



Estimating vaccine needs

Three methods based on:

- Target populations
- Past consumption
- Vaccination sessions (rarely used)



Target population Method (most popular)

- Target population (P_{targ})
- Vaccination coverage (T_{vc})
- Vaccination schedule (N_{dose})
- Wastage factor (F_{waste})

$$P_{\text{targ}} \times T_{\text{vc}} \times N_{\text{dose}} \times F_{\text{waste}}$$



Calculating the wastage factor from the wastage rate

862

100

Wastage factor = (100 - Wastage Rate)

Acceptable wastage

50% for BCG

20%-40% for measles vaccine

5% for DPT-HepB-Hib

10% TT and OPV (in vial of 10 and more doses).

Calculating vaccine wastage factor

Wastage Rate	5%	10%	15%	20%	25%	30%	35%	40%	50%	60%	70%
Wastage Factor	1.05	1.11	1.17	1.25	1.33	1.43	1.54	1.67	2	2.5	3.33



Target population Method, example

- Target population, 100,000 for BCG
- Vaccination coverage 90%
- Vaccination schedule 1 dose
- Wastage factor 2.00

$$P_{\text{targ}} \times T_{\text{vc}} \times N_{\text{dose}} \times F_{\text{waste}}$$



Answer

865

$$100,000 \times 0.90 \times 1 \times 2.00 = 180,000$$

doses needed annually

Consumption Method (second popular method)

- Stock at the beginning of the year (S_{ini})
- Quantity received during the year (Q_{rec})
- Stock at the end of the year (S_{end})
- Quantity wasted during the year (Q_{waste})

$$S_{ini} + Q_{rec} - S_{end} - Q_{waste}$$



Consumption Method, example

- Stock at the beginning of the year 40,000 BCG
- Quantity received during the year 150,000
- Stock at the end of the year 15,000
- Quantity wasted during the year 80,000



Answer

868

$$40,000 + 150,000 - 15,000 - 80,000 = 95,000 \text{ doses}$$

Vaccine supply period

Examples...

- **Central cold store..... 6 months**
- **Regional cold store.... 3 months**
- **District cold store..... 1 month**
- **Health center..... 1 month**
- **Health post..... 1 week**



Vaccine supply

- Minimum Stock is how much you need to avoid stock outs. If you have a 1 month supply interval, it's 26% of months' stock

- Maximum Stock is how much you can have without risking overstocks and expiry in place of excess vaccines.
- If you have a 1 month supply intervals, it's 125% of months' stock.



Arranging Vaccine in the compartment

Vertical refrigerators:

- **Top:** Ice packs
- **Shelf 1:** Live viral vaccines (OPV, Measles)
- **Shelf 2:** BCG
- **Shelf 3:** Pentavalent, TT on lowest shelf away from freezer space
- **Bottom:** Water bottles
- **Diluents:** next to its vaccine or clearly marked

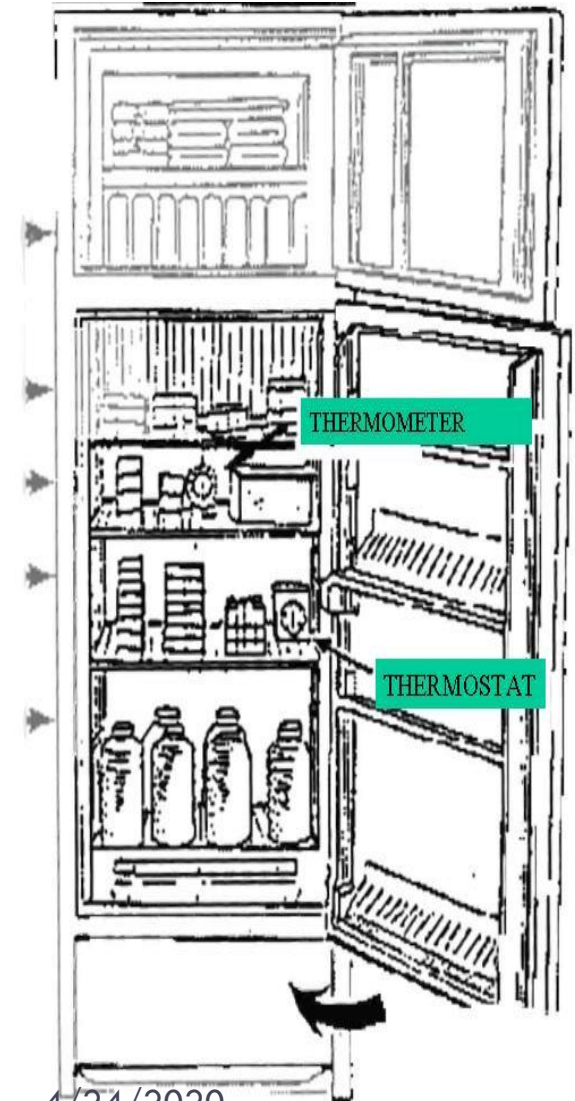

Vertical refrigerators

87%

Figure 3M: Loading a front loading vaccine refrigerator

frozen icepack put on the left

Unfrozen icepack put on the right

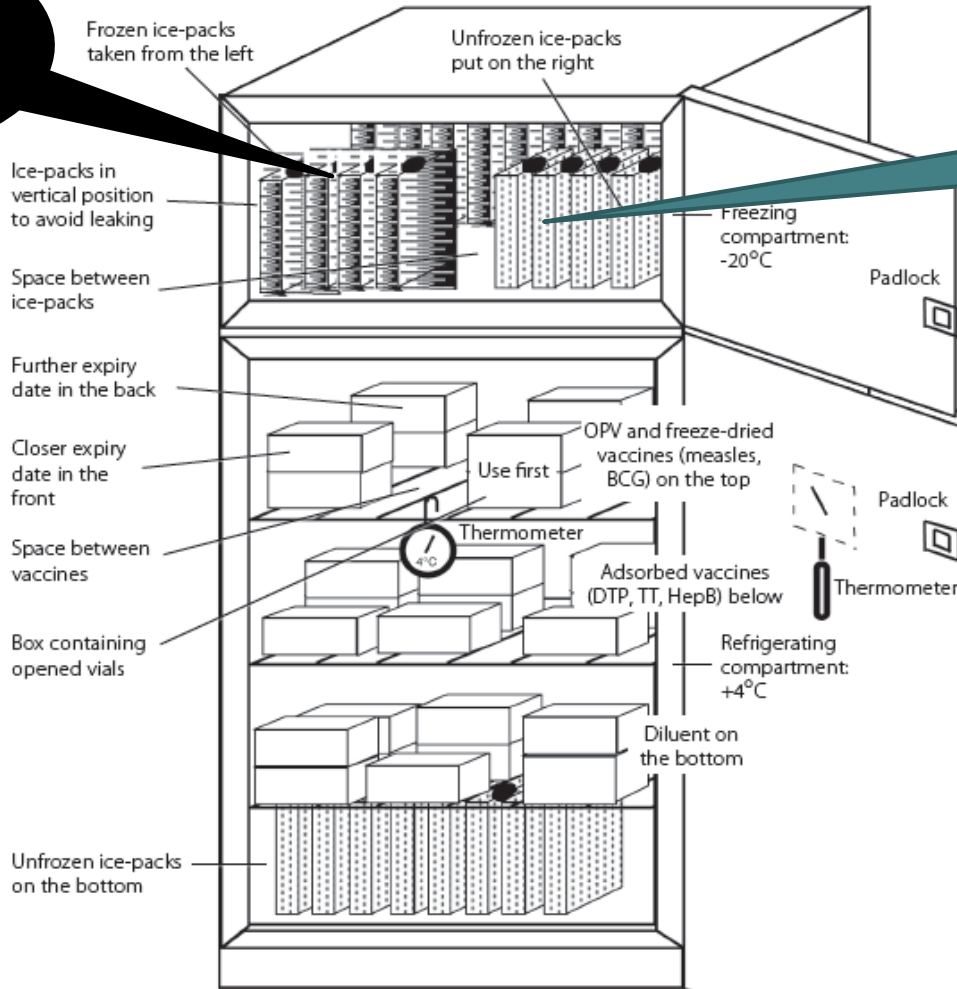

Loading top-opening (chest) refrigerators

873

All the vaccines should be stored in the basket provided with the refrigerator

1. Measles, BCG and OPV in the **bottom only**
2. Freeze-sensitive vaccines (DTP, TT, hepB, Hib, DTP-hepB,, DTP-hepB+Hib, meningococcal and yellow fever vaccines) in the **top only**.

Loading top-opening (chest) refrigerators

87

Figure 3N: Loading top-opening (chest) refrigerators

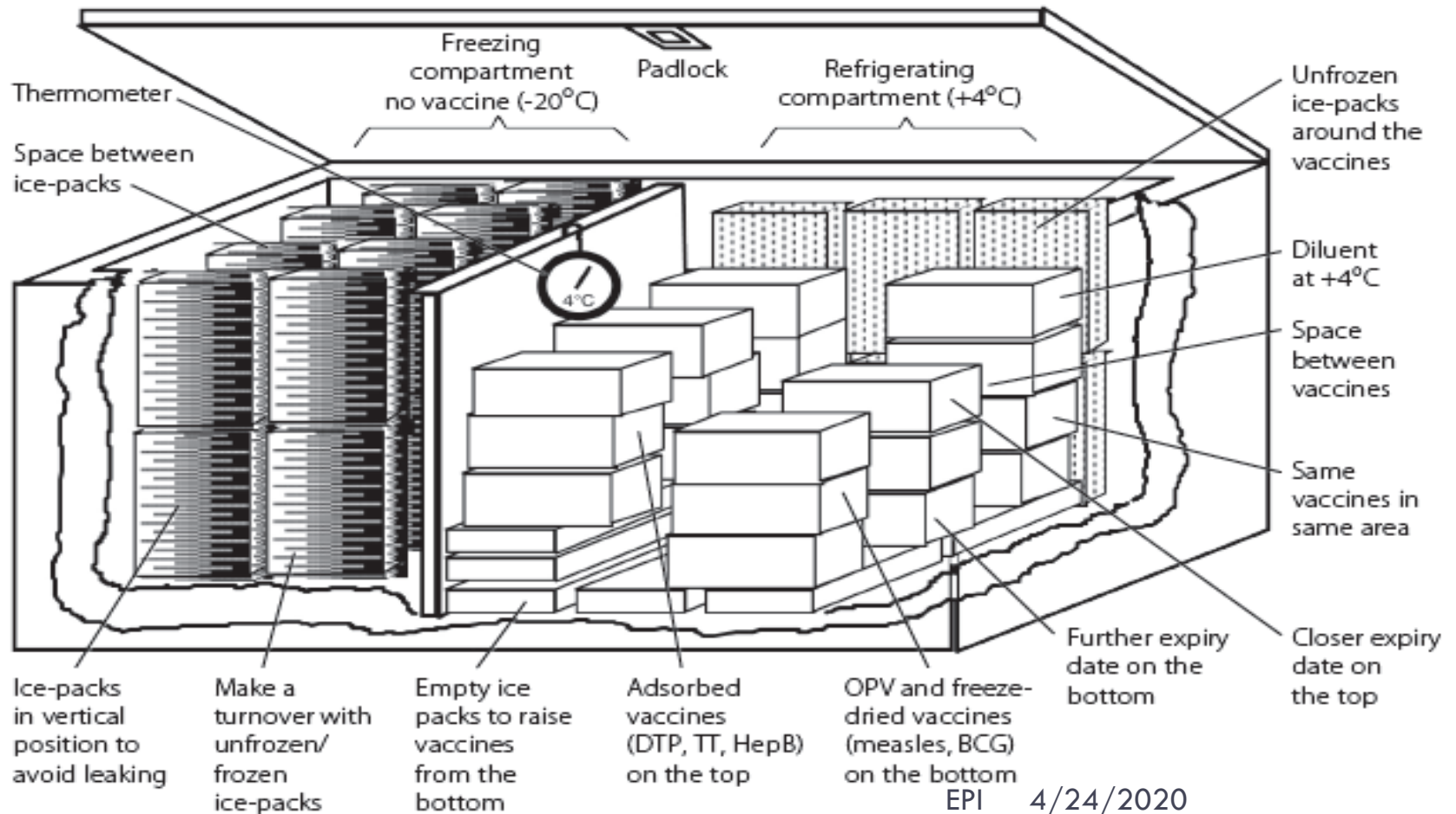

Vaccination Delivery sites.

875

There are “4” types of vaccination delivery strategies.

- **Static site**
 - vaccination is given at the health facility.
 - Performed as part of routine activity of the health units.
- **Outreach**
 - the health staffs go out & administer vaccine to the mothers & children in their catchments area.
 - It is scheduled sessions.

Cont...

▪ **Mobile**

- **used in a single doses of vaccination.**
- **used to control epidemic / such as meningitis & measles/**

▪ **Campaign**

- **conducted by mobilization of the community. e.g. polio-vaccination.**

Indicators of vaccine monitoring & evaluation

877

Calculation of target population and EPI coverage

A) Target for infant vaccines

Children <1 Yr age = total population x k*/100

K = % of children < 1 Yr of age in the total population
[usually 3-4%]

- yearly target children = total population X k/100
- monthly target children = yearly target children / 12

- **Monthly coverage =** $\frac{\text{No of children who received DPT1 in the specific month} \times 100}{\text{target popun for the month}}$
- **Annual coverage =** $\frac{\text{No of children who received DPT3 in the specific year} \times 100}{\text{target popun for the year}}$

Coverage con't...

879

B) Target for tetanus toxoid

Pregnant women = total population \times K/100

K= % of women 15-49 years of age in the total population [usually 4%]

Challenges in Vaccination

Dropout:

880

- a child or women who failed to return for subsequent doses of vaccine.

- **Possible causes of dropout from vaccination:**
 - **Unsure date of return.**
 - **Long wait at the vaccination center.**
 - **Failure to explain the need of completing vaccination.**
 - **Negative attitude of health workers to words the program.**
 - **Mother usually busy...**

Possible causes...

881

- **Missed opportunities**
- **Culture beliefs.**
- **Lack of accessibility (distance, cost of transportation, lack of vaccines e.t.c)**
- **Lack of inter-sector collaboration.**
- **The problem associated with the vaccine.**
e.g. **BCG :efficacy is uncertain .**
- **Ineffective management.**

Drop out rate calculation.

882

Over all drop out rate

$$= \frac{\text{coverage with BCG} - \text{coverage with measles} * 100}{\text{Coverage with BCG}}$$

or

More applicable Formula

$$\underline{\text{DROP OUT RATE}} = \frac{\text{DTP1} - \text{DTP3} * 100}{\text{DTP1}}$$

□ **Drop out rate for single antigen e.g. (opv).**

$$= \frac{\text{Coverage with opv1} - \text{coverage with opv3} * 100}{\text{Coverage with opv1}}$$

Dropout rate calculation...

883

- **There is a problem when the drop out rate is exceeds 10%.**
- **It is essential to determine why the failure occurred.**

Missed opportunities

884

- All children & mothers present at health facility for any reason should be **screened for immunization status & vaccinate if they are eligible.**
- **Not vaccination of eligible candidates called missed opportunities (MO).**
- **Common causes of MO**
 - ▣ Health worker (H.W) screen but tell clients to return later.
 - ▣ H.W only open a vial if there are enough client.
 - ▣ logistic problems (lack of vaccines, cold chain, fridge ...)

NOTE: drop out & missed opportunities are the major cause of low vaccination coverage.

Potential solution

- Social mobilization
- Drop out tracing mechanisms.
- Get commitment by the local leaders.
- Monitoring & supervision of the EPI program
- In service training to community health worker
- Ensure financial & logistic support for the health institutions.



UNIT VIII: Pediatrics HIV

Human Immune Deficiency Virus – HIV/AIDS

- **Learning Objectives:** at the end of the lesson we will be able to
 - Define HIV and AIDS
 - Describe the natural history of HIV/AIDS
 - Describe the life cycles of HIV/AIDSs
 - Identify the common opportunistic infections
 - Make appropriate WHO clinical staging of HIV/AIDS
 - Treat a child with HIV/AIDS



INTRODUCTION

- **1981:** AIDS was first recognized in USA among Homosexual males
- **1983:** HIV virus was isolated from a patient with lymphadenopathy
- **1984:** HIV virus was clearly demonstrated to be the causative agent for AIDS
- In Ethiopia-First confirmed case-1984
- In 2003- fee based ART
- March 2005- Free ART

Definitions

HIV

- A specific type of virus (a retrovirus) that causes AIDS
- **HIV infection:** w/n the virus is available/ present in ones blood. [transmit the diseases]
- **HIV disease** is a chronic infectious disease caused by the Human Immune Deficiency Virus.
- **ADIS:** Is a disease that limits the body's ability to fight infection.

Epidemiology

891

- There were 36.7 million people living with HIV of them 46% i.e. 18.2 million were on ART.
- Incidence of HIV in 2015 were 2.1 million of them **150 000 were children.**
- 1.1 million people died from AIDS-related causes worldwide (**FACT SHEET NOVEMBER 2016**).

In Ethiopia

892

- The national prevalence of HIV infection is 1.16 %
 - ▣ There are a total of 722,248 people living with HIV,
 - ▣ of which 60.5 % are female.
 - ▣ Besides, there were an estimated 22,827 people newly infected during 2017,
 - ▣ of whom 60.5% are females. Annual AIDS deaths during the same period are 14,872 ([Consolidated HIV training manual 2018](#)).

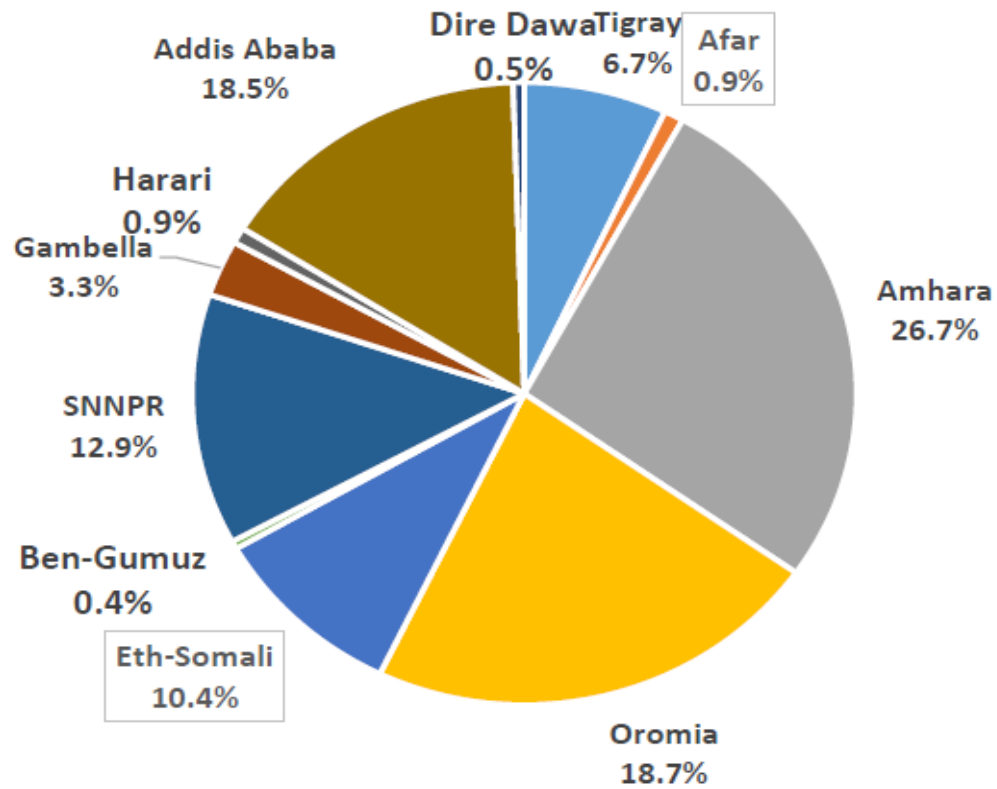

- Tigray
- Afar
- Amhara
- Oromia
- Eth-Somali
- Ben-Gumuz
- SNNPR
- Gambella
- Harari
- Addis Ababa
- Dire Dawa

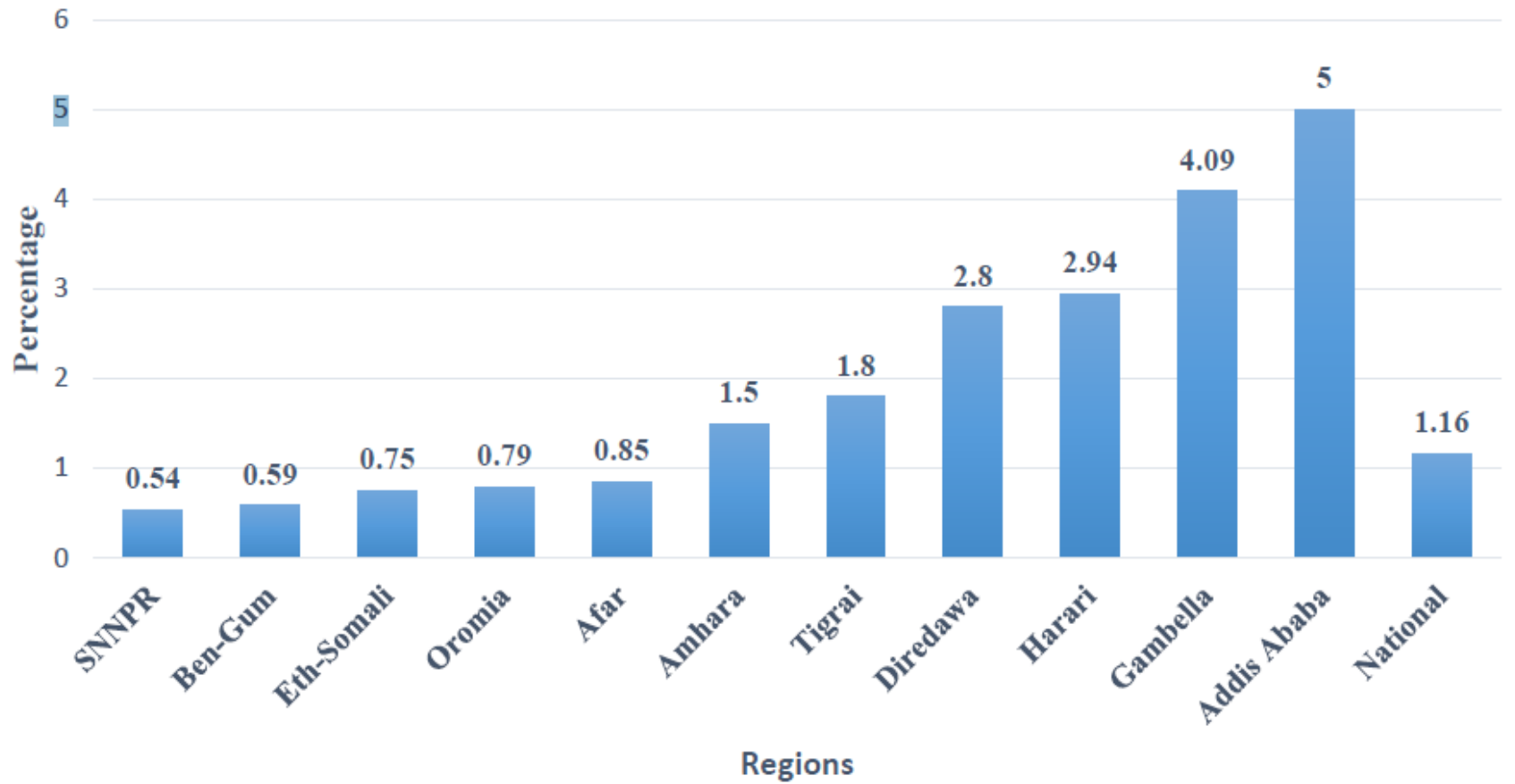

Modes of HIV Transmission of HIV



Transmissions

Mother to Child Transmission

- 90% of HIV infection in children is as a result of MTCT.
- MTCT is 7 of 20 (one – third) or 35%.
 - Pregnancy:- 5 -10 %
 - Labor and Delivery:- 10-15 %
 - Breast Feeding: - 5-15 %

Factors affecting MTCT

- Maternal
- Infant factors

Prevention of mother to child transmission of HIV

Prong 1: Primary prevention of HIV infection

Prong 2: Prevention of unintended pregnancies among women infected with HIV.

Prong 3: Prevention of HIV transmission from women infected with HIV to their infants.

Prong 4: Provision of treatment, care, and support for women infected with HIV, their infants, and their families.

Etiologic agent

- HIV is a retrovirus which belongs to the sub family of lente virus.

- There are 2 main Types of the virus
 - ✓ HIV 1 and
 - ✓ HIV 2

How HIV Works

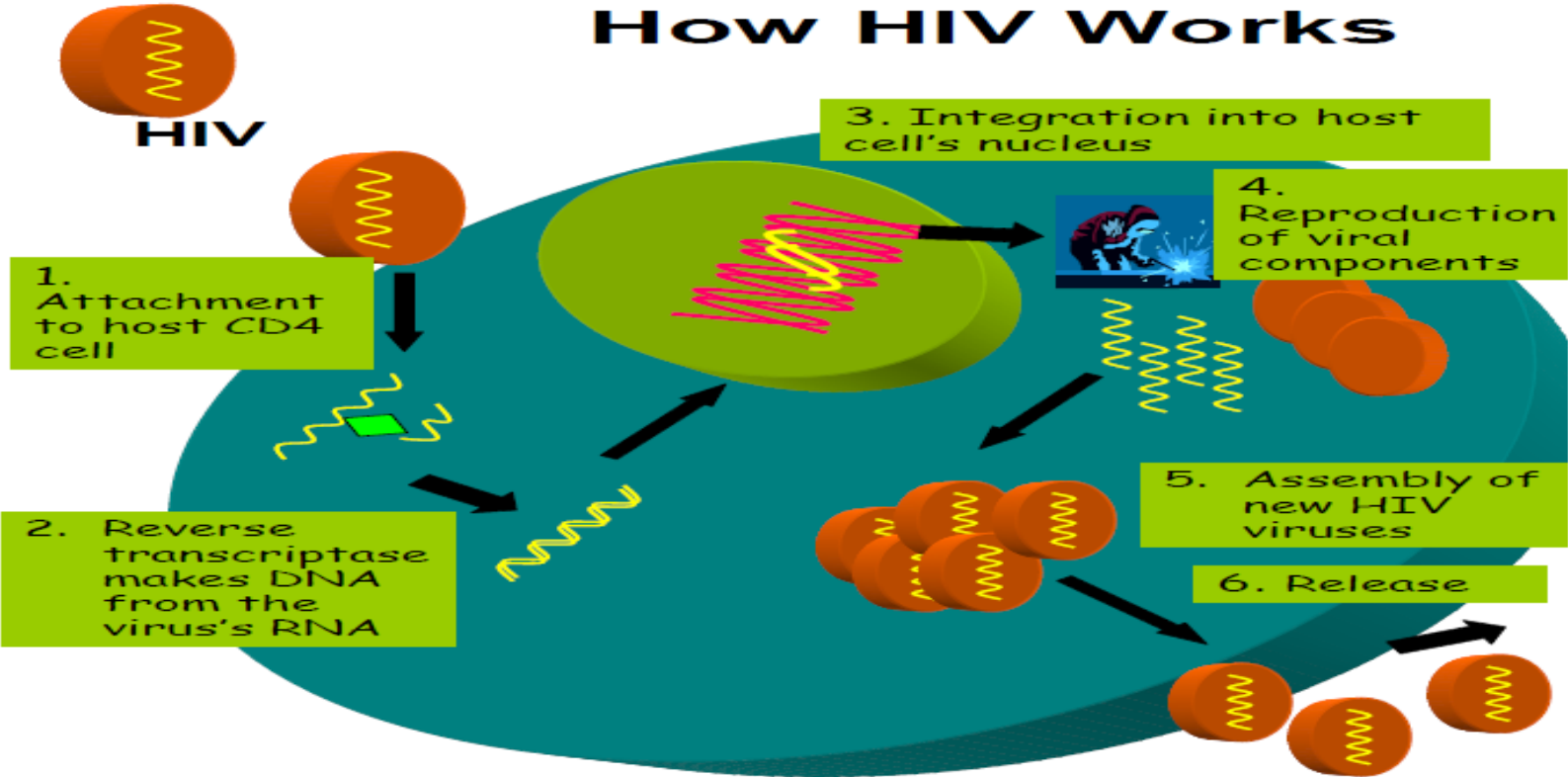

Natural History and Clinical Manifestations of HIV infection

- 1. Primary HIV Infection:** Acute HIV syndrome and Sero-conversion.
- 2. Asymptomatic stage –** Clinical latency
- 3. Early Symptomatic Diseases –** mild immunodeficiency
- 4. AIDS defining illnesses:** Advanced immunodeficiency

Diagnosis of HIV in infant and children

902

HIV test in children born to known HIV positive women			
Age	HIV test	What a result mean	Considerations
<18 months	Rapid HIV anti-body test	+Ve Either mother or child's AB -Ve not infected if breast feed repeat after 6 wks.	Confirm the result with PCR Negative may be in latter if breast feed
	HIV virologic test (DNA PCR)	+Ve start HAART and repeat DBS -Ve never breast feed in the last six wks. not infected	Best to perform when the child is 6 wks. old 9-12 months AB can be used before virologic test
>18 months	HIV antibody test	+Ve infected -Ve not infected	If still breast feed repeat after 6 wks.

Presumptive diagnosis

903

HIV antibody positive infant with

- *Diagnosis of stage 4 or any AIDS defining condition OR*
- *Symptoms with two of the following*
 - o *Oral thrush*
 - o *Severe pneumonia*
 - o *Severe sepsis*
- **Supporting factors are**
 - o Recent maternal death
 - o Advanced HIV disease in the mother
 - o Cd4 percentage of infant < 20%

HIV/AIDS associated illnesses /OIs and OMs

- OIs are leading causes of morbidity and mortality in HIV-infected persons
- Most of the common OIs are preventable as well as treatable.
- Most OIs develop when the CD4 count drops below 200 cells /ml

Common OI's Correlating with

905

Time and CD4 Count

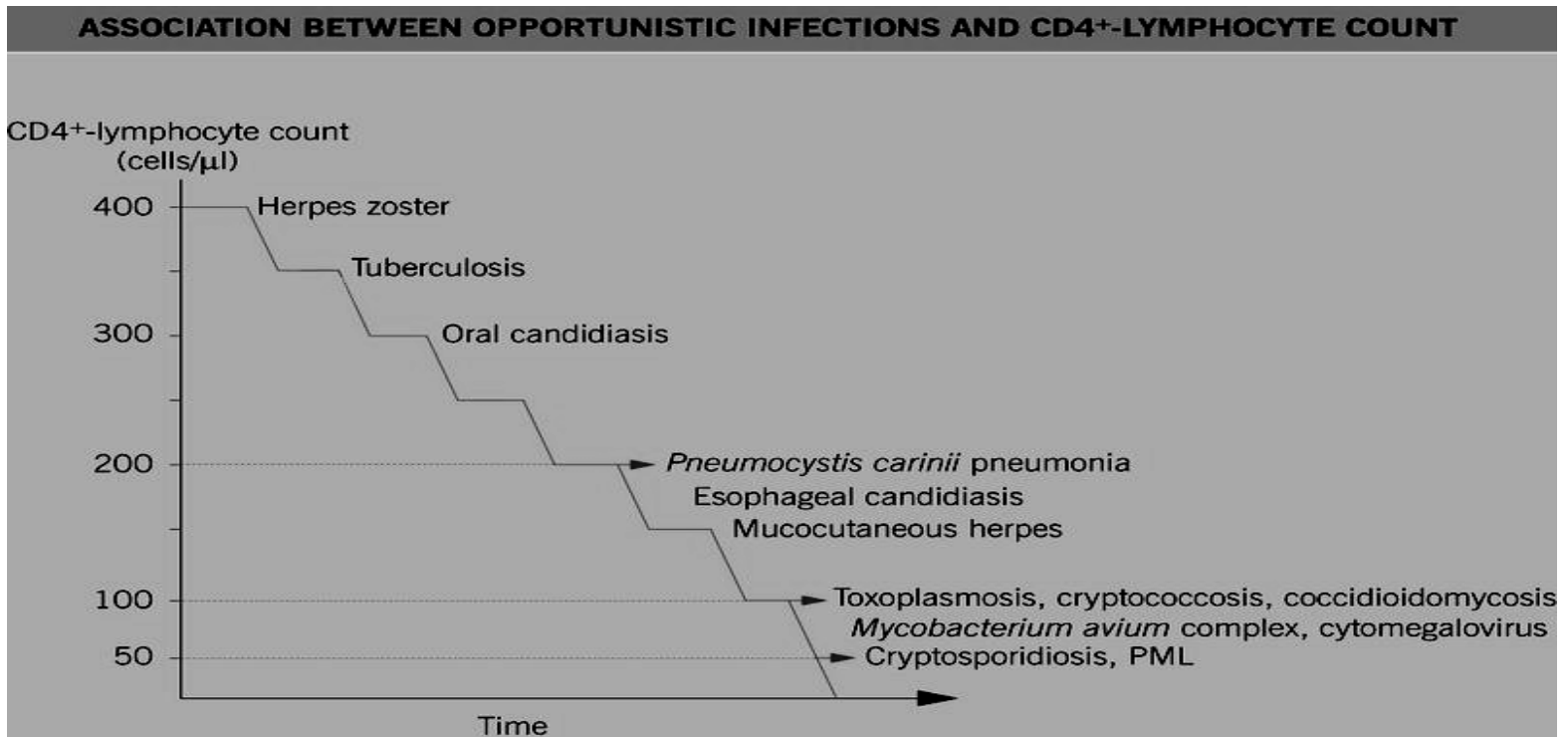



Fungal Infections

- Candidiasis (Thrush)
 - Esophageal Candidiasis
 - Pneumocystis Jiroveci Pneumonia (PCP)
 - Cryptococcal meningitis/Disease
- 

Candidiasis (Thrush)

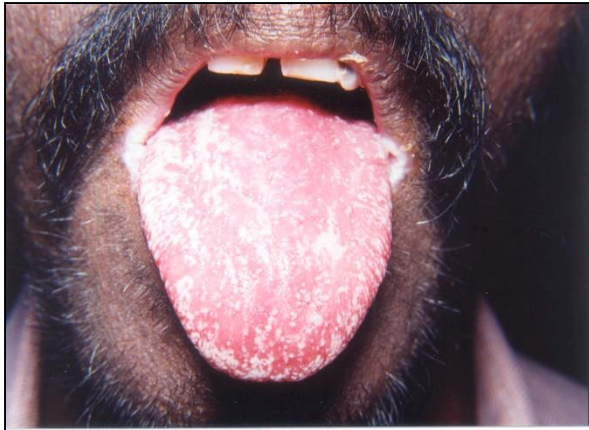

Viral Infections

- Oral Hairy Leukoplakia
- Herpes Simplex I & II (mouth, penile, vaginal)
- Herpes Zoster
- Molluscum Contagiosum
- Cytomegalovirus (CMV)
- Encephalopathy (PML)

Oral Hairy Leukoplakia



Herpes Simplex Lesions: Mouth



Herpes Simplex Lesions: Penile

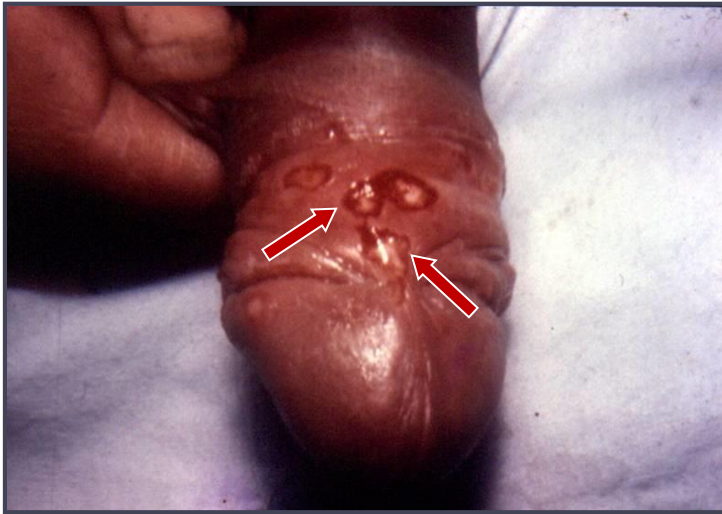

Varicella Zoster Lesions



Varicella Zoster Lesions



Molluscum Contagiosum Lesions

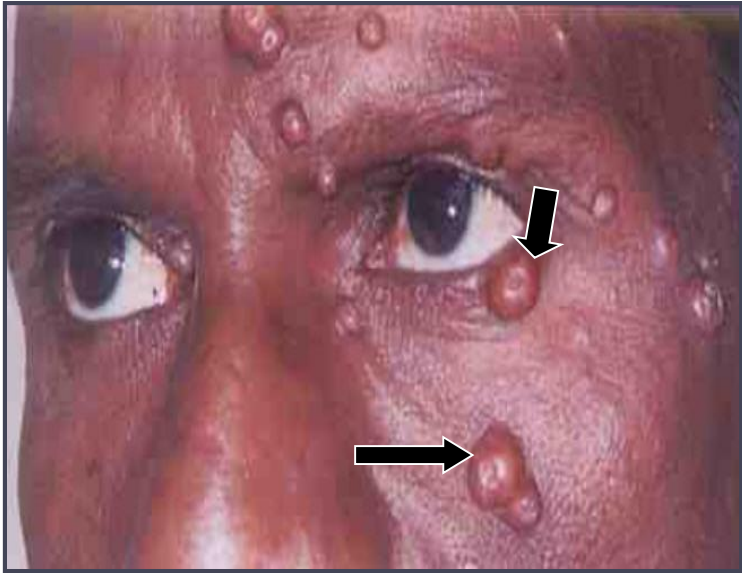

Severe Molluscum Contagiosum covering the eyes



Parasitic Infections

- Toxoplasmosis
- Cryptosporidiosis
- Isosporiasis

Common OIs: Bacterial Infections

- Pneumonia
- Mycobacterium Tuberculosis
- Other systemic bacterial infections

Neoplasm (Malignancies)

- Kaposi's Sarcoma (KS)
- Non-Hodgkin's Lymphoma (NHL)

Kaposi's Sarcoma (KS) Lesions



Disseminated Kaposi sarcoma with diffuse lymphoedema



WHO Clinical Staging System for HIV/AIDS

- It is a system designed for estimating the degree of immuno -suppression on clinical criteria
- Intended for use in patients known to have HIV (i.e. HIV+ antibody test)

WHO clinical stageing of childrens

Stage 1

Asymptomatic, Persistent generalized lymphadenopathy

Stage 2

Unexplained persistent hepato-splenomegaly

Recurrent or chronic upper respiratory tract infections (otitis media, otorrhoea, sinusitis, tonsillitis)

Herpes zoster, Lineal gingival erythema, Recurrent oral ulceration, Papular pruritic eruption, Fungal nail infections, Extensive wart virus infection, Extensive molluscum contagiosum, Unexplained persistent parotid enlargement

Stage 3

Unexplained moderate malnutrition, not adequately responding to standard therapy, Unexplained persistent diarrhea, Unexplained persistent fever, Persistent oral candidiasis, Oral hairy leukoplakia, Lymph node tuberculosis, Pulmonary tuberculosis, Severe recurrent bacterial pneumonia, Acute necrotizing ulcerative gingivitis, Unexplained anemia, neutropaenia, chronic thrombocytopenia, Symptomatic lymphoid interstitial pneumonitis.

**Sta
ge 4**

Unexplained severe malnutrition, PCP, Recurrent severe bacterial infections, Chronic HSV, Esophageal candidiasis, Extra-pulmonary tuberculosis, Kaposi sarcoma, CMV, Central nervous system toxoplasmosis, HIV encephalopathy, Extra-pulmonary Cryptococcus's,, Progressive multifocal leuko-encephalopathy, Chronic cryptosporidiosis (with diarrhea), Chronic isosporiasis, Disseminated endemic mycosis, Cerebral or B-cell non-Hodgkin lymphoma, HIV-associated nephropathy or cardiomyopathy

Prophylaxis

- A) **Cotrimoxazole *preventive therapies /CPT***
- B) ***Isoniazid prophylaxis for TB preventions***
- C) **Fluconazole prophylaxis**

ARV PROPHYLAXIS

926

For HIV exposed infants

- If Infant on breastfeeding:
 - ▣ Initiate ART for the mother
 - ▣ Provide NVP syrup for the infant for 6 week (consider extending it for 12weeks)
 - ▣ Collect specimen for DNA PCR testing

➤ **Infant not breast feeding**

- ❑ Initiate ART for the mother based on eligibility criteria
- ❑ If the infant is brought within 72 hours of birth provide NVP prophylaxis otherwise there is no need to provide NVP syrup for the infant.
- ❑ Collect specimen for DNA PCR testing

Antiretroviral Drugs (ARTs)

- HIV is a retrovirus. So drugs against HIV are called anti-retroviral drugs: shortened to **ARV drugs**.
- Giving ARV drugs in the correct way, with adherence support, is called **ARV Therapy** - shortened to **ART**.

Goal of ART

- 1) Improve the length and quality of the patient's life
- 2) Increase total lymphocyte count (TLC) and CD4 cell count, allowing preservation or improvement of immune function
- 3) HIV RNA < 400 copies/ml or “undetectable” within 4-6 months of ART initiation
- 4) Reduce HIV-related morbidity and mortality.

Complete base line

- **assessment** Baseline medical history
- Physical examination
- Clinical staging(WHO)
- Laboratory testing [e.g. Hcg test, HBV/HCV, CBC ,
ESR, SGOT and SGPT]
- Development of the patient care plan

Classes and mechanism of actions of antiretroviral drugs

- 1) *Nucleoside reverse transcriptase inhibitors (NRTIs)*
- 2) *Non Nucleoside reverse transcriptase inhibitors (NNRTIs)*
- 3) *Protease inhibitors*
- 4) *Integrase inhibitors*
- 5) *Fusion inhibitors*

ARV drugs and their action sites on the virus

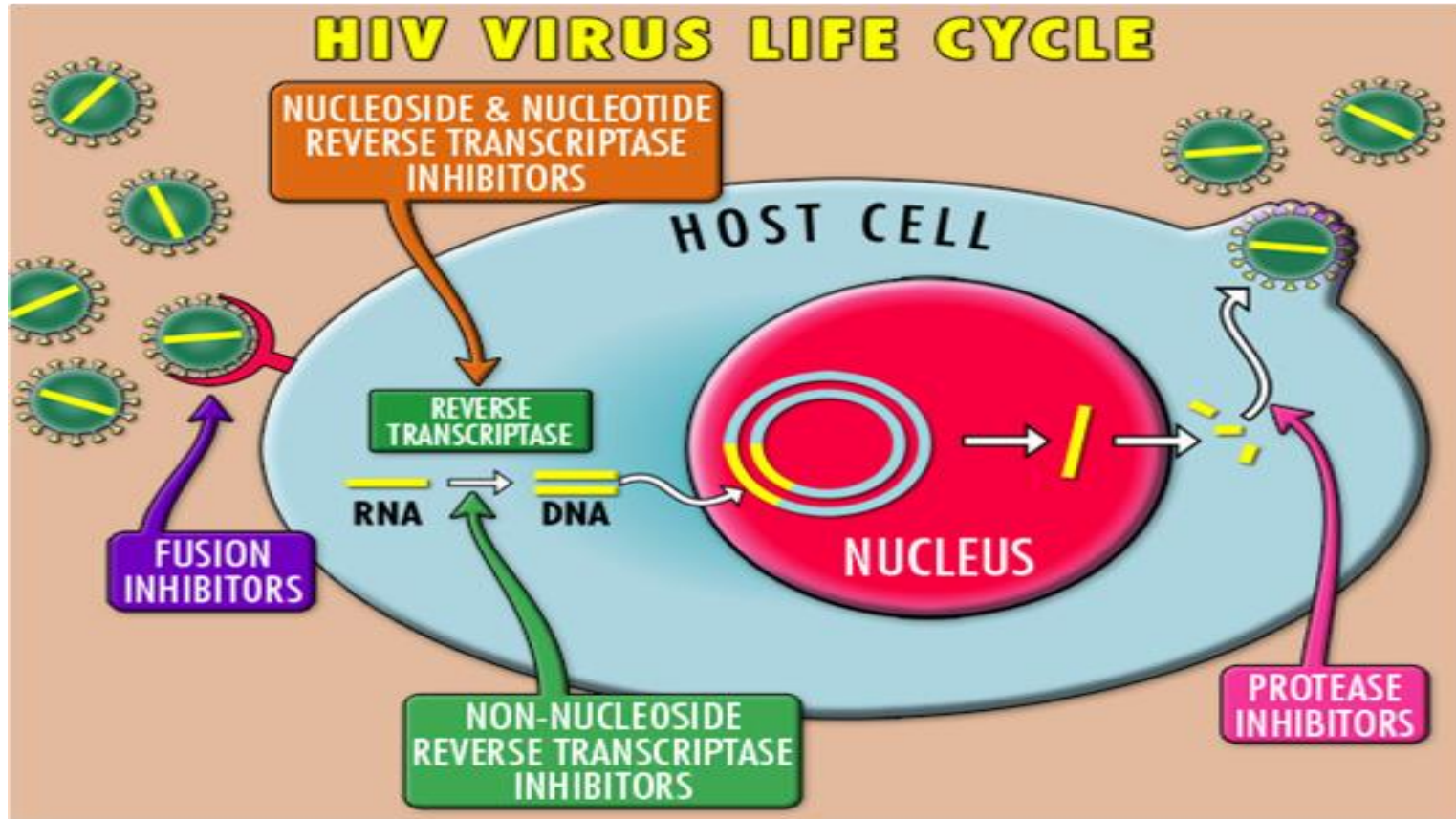

Combinations

933

1st line

- 2NRTIs+1NNRTI

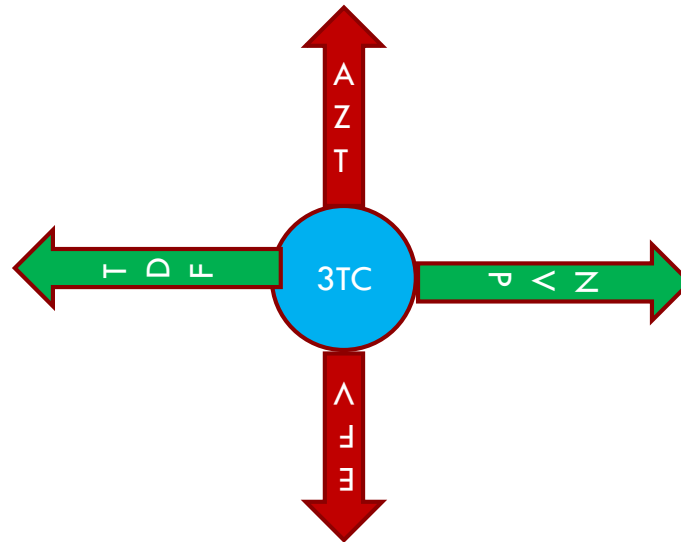

4/24/2020

BY KENDALEM ASMARE

- For children less than 3 years
- Preferred 1st line
 - ▣ ABC + 3TC + LPV/r
 - ▣ AZT + 3TC + LPV/r
- Alternatives
 - ▣ ABC + 3TC + NVP
 - ▣ AZT + 3TC + NVP

- Preferred 1st line drugs for children between 3-10 years
 - ▣ ABC/3TC/EFV
 - ▣ AZT/3TC/EFV
- Alternatives
 - ▣ ABC + 3TC + NVP
 - ▣ AZT + 3TC + NVP
 - ▣ TDF + 3TC + EFV
 - ▣ TDF + 3TC + NVP

- For adolescent the preferred 1st line drug
 - ▣ TDF/3TC/EFV

- Alternatives
 - ▣ AZT + 3TC + EFV
 - ▣ AZT + 3TC + NVP
 - ▣ TDF + 3TC + NVP
 - ▣ ABC + 3TC + EFV

Fig. Impact of ART on CD4 & viral load

Figure showing the most common impact of ART on CD4 and viral load (CD4 increases and viral load declines as viral replication is suppressed)

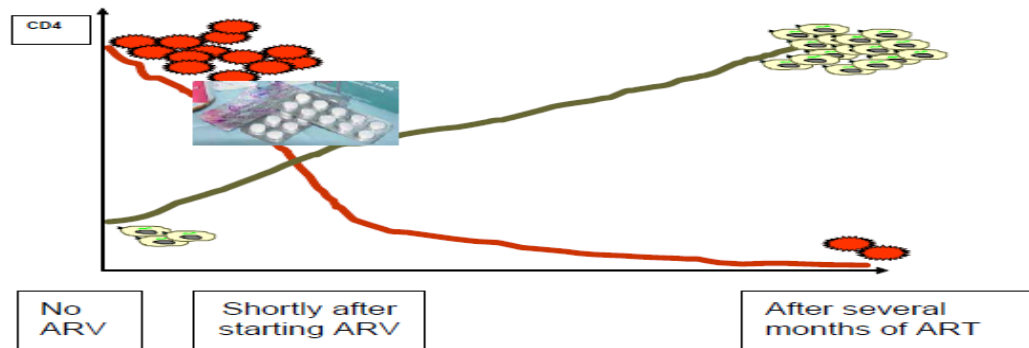

 = HIV

 = CD4

NB: This inverse relationship may not hold true in some cases

Problems with ART

- ❖ ARV drug side effect
- ❖ IRIS
- ❖ Treatment failure



Thank you

Reading assignments

- Management of mentally handicapped children
- Management of physically handicapped children
- Management of socially handicapped children
- School health services

UNIT IX: IMNCI AND BEHAVIORAL DISORDERS IN CHILDREN

4/24/2020

Introduction to Integrated Management of Newborn and Childhood Illnesses (IMNCI)

Objective

944

At the end of this session the students should be able to:

- Define IMNCI
- Identify the commonest child health problems that can be managed by IMNCI
- Recognize the steps of the case mgt process
- Select the appropriate case mgt charts
- Describe the steps of immediate newborn care.
- List the new born and infant danger signs

Objective ...

945

- Assess and classify sick young and older infants
- Recognize the general danger signs in sick children.
- Use or fill-in the recording form correctly
- Identify treatments or measures.
- Treat the sick child or young infant
- Counsel mothers or significant others about the disease, management, when to return and prevention.
- Give follow up care.
- Demonstrate skills in referring sick child to the hospital.

Child health

946

INTRODUCTION

- Under 15 years constitute **44.7%** of the population
- Of which **40% are under five** and **8% are under one year.**
- Infant mortality rate is 48/1000 live births
- Under five mortality rate 67/1000 live births

Introduction

947

Fig. 1 Trends in Early Childhood Mortality, EDHS 2016

IMNCI

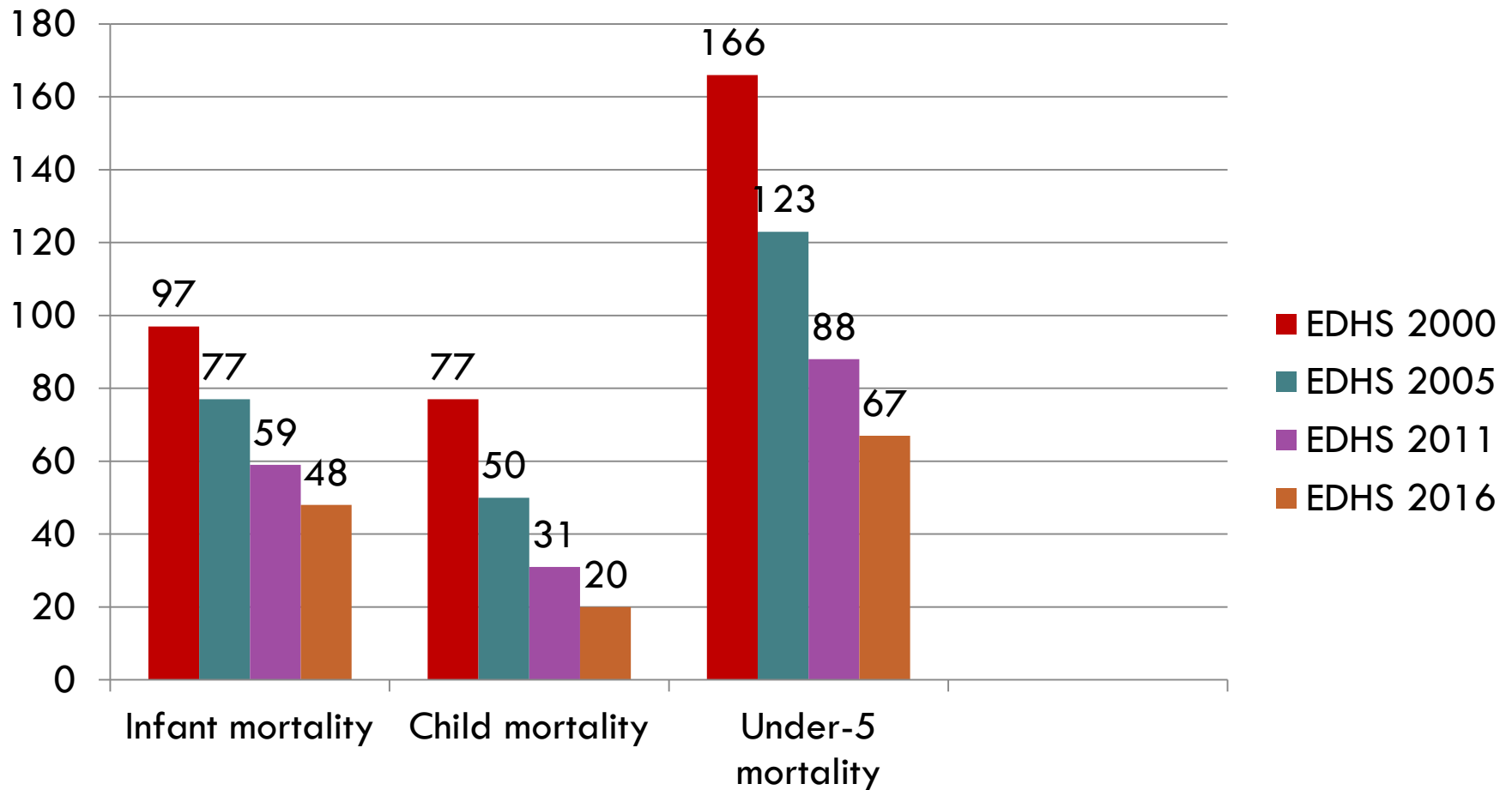

4/24/2020

Child health...

948

- More than 70% of these deaths are due to the five diseases.
 - ▣ Pneumonia 28.9%
 - ▣ Malaria 21.6%
 - ▣ Diarrhea 12%
 - ▣ Measles 5%
 - ▣ 60% of these deaths are associated with malnutrition
 - ▣ HIV/AIDS 11%

Child health

949

- Ethiopian Ministry of Health document shows that :
 - ▣ 47% of under fives are **stunted**
 - ▣ 8% are **wasted**
 - ▣ 37% are **underweight**
 - ▣ 15% are **low birth weight**

- **Pneumonia, diarrhea, malnutrition, measles & malaria cause more than 70% of the death in children under five years of age.**

SOLUTIONS

950

- **There are feasible & effective ways that Health Workers can prevent most of these deaths.**
- **Mixed community and facility-based interventions**
- **Integrated child health approaches**
- **Integrated management of neonatal and child hood illnesses is proven tool**

WHAT IS IMNCI?

- **IMNCI is a strategy to reduce morbidity & mortality associated with the major illness.**
- **Is the integrated strategy that combines and links together existing child health programs.**

IMNCI

952

- Action-oriented **CLASSIFICATIONS** , rather than **EXACT DIAGNOSES** are used.
- Using **FEW CLINICAL SIGNS** as possible which health workers of diverse background can be trained to recognize.
- The IMNCI guidelines rely on detection of cases based on **SIMPLE CLINICAL SIGNS** without laboratory tests and offer **EMPIRIC TREATMENT**.

IMNCI Cont...

953

- **WHO/UNICEF suggested the management of these illnesses in as set of **integrated (combined) guidelines** instead of **separate guidelines** for each illness.**
- **There are also important relationship between the illnesses. E.g. repeated diarrhea episodes often lead to malnutrition.**

IMNCI...

954

- ❑ **Effective case mgt needs to consider all of the child symptoms.**
- ❑ **Case mgt can be effective only the families bring their sick children to trained H.W on timely.**
- ❑ **If a family waits to bring a child to a clinic until the child is extremely sick, the child is more likely to die from the illness.**
- ❑ **Therefore, teaching families to bring the sick child to the clinic immediately is an important part of the case mgt process.**

THE INTEGRATED CASE MANAGEMENT PROCESS

955

- **Integrated case management** relies on case detection using simple clinical signs and research-based empirical treatment.
- The signs are based on expert clinical opinion and research results.
- The IMNCI describes how to care for a child who is brought to the health institution with an illness, or for a scheduled follow-up visit to check the child's progress.

The case mgt process

956

- The case mgt process is presented on series of charts which shows the sequence of steps.

The charts described the following steps.

1. **Assess the child or young infant:** - assess a child by checking *first for general danger signs* (or possible *series bacterial infection* in a young infant)

Assess means taking Hx & P/E.

2. **Classify the illness:** means select category or classification based on the major symptoms, or classify a child's illnesses using a **colour-coded triage system.**

- 3. Identify Rx=** After classifying all conditions, identify specific treatments for the child.
 - **Selecting & classification on the chart is sufficient to identify Rx.**

- 4. Treat the child:-** Provide practical treatment instructions, including teaching the caretaker how to give oral drugs, how to feed and give fluids during illness, and how to treat local infections at home.

5. Counsel the mother.

Assess feeding, including assessment of breast feeding practices, and counsel to solve any feeding problems found.

Telling her about foods & fluids to give the child & to bring the child back to the clinic.

6. Give follow up care: -

When a child is brought back to the clinic as requested, give follow-up care and, if necessary, reassess the child for new problems.

Case mgt process...

959

- The case management process is presented on two different sets of charts:
 - **infant age birth up to 2 months and**
 - **children age 2 months up to five years**

SELECTING THE APPROPRIATE CASE MANAGEMENT CHARTS

960

FOR ALL SICK CHILDREN age birth up to 5 years who are brought to the clinic:

ASK THE CHILD'S AGE

IF the child is
from birth up to 2 months

IF the child is
from 2 months up to 5 years

USE THE CHART:
ASSESS, CLASSIFY AND TREAT THE SICK YOUNG INFANT

USE THE CHARTS:
• *ASSESS AND CLASSIFY THE SICK CHILD*
• *TREAT THE CHILD*
• *COUNSEL THE MOTHER*

THE LEGEND

96

RED

A CLASSIFICATION THAT NEEDS URGENT REFERRAL AFTER FIRST DOSE OF APPROPRIATE ANTIBIOTIC

YELLOW

A CLASSIFICATION THAT NEEDS TREATMENT AT HOME, ANY HEALTH INSTITUTION AND HEALTH EDUCATION

GREEN

A CLASSIFICATION THAT NEEDS HEALTH PROMOTION & EDUCATION

□ **RED CLASSIFICATION:**

- Child needs Drugs & inpatient care
- Mostly serious infections

□ **YELLOW CLASSIFICATION:**

- Child needs specific treatment, (e.g. antibiotics, anti-malarial, ORT) for Mild infections can be **Provided at home / community level**

□ **GREEN CLASSIFICATION:**

- Child needs no medicine, advise home care

ESSENTIAL NEW BORN CARE

963

- 98% of the 3 million stillbirths occur in developing countries/year
- 50% of neonatal death occur in the first **2 days of life.**
- 3 out of 4 newborn deaths occur in the week of life
- So **timely** provision of **essential new born care** can improve child survival and reduce significant morbidity and mortality.

Essential New born Care (ENC)

964

Definition

- Is a comprehensive strategy designed to improve the health of newborns through interventions **before conception, during pregnancy, soon after birth,** and in the **postnatal period.**
- Simple, to-the-point, globally accepted evidence-based protocol

Steps in immediate newborn care

965

Step 1

Deliver baby onto mother's abdomen or a dry warm surface close to the mother.

Step 1
Deliver
baby
on to
mother
s
abdom



Steps in immediate care...

966

Step 2

- **Dry baby's body with dry towel. Wrap with another dry warm cloth and cover head.**
- Dry the baby, including the head, immediately. Wipe the eyes. Rub up and down the baby's back, using a clean, warm cloth.

Drying The Newborn

967



Drying the newborn:- Stimulates the newborn to breathe normally and minimizes heat loss.

**BUT do not
remove the
vernix !!**

Step 3

Assess breathing and color

968

- As you dry the baby, assess its breathing.
- Thus, check if the baby is:
 - 1) breathing normally.
 - 2) having trouble breathing,
 - 3) the baby breaths less than 30 per minute or
 - 4) not breathing at all.

Step 3...

969

if the new born is:-

- ❖ **Not breathing,**
- ❖ **Gasping or < 30 BPM**

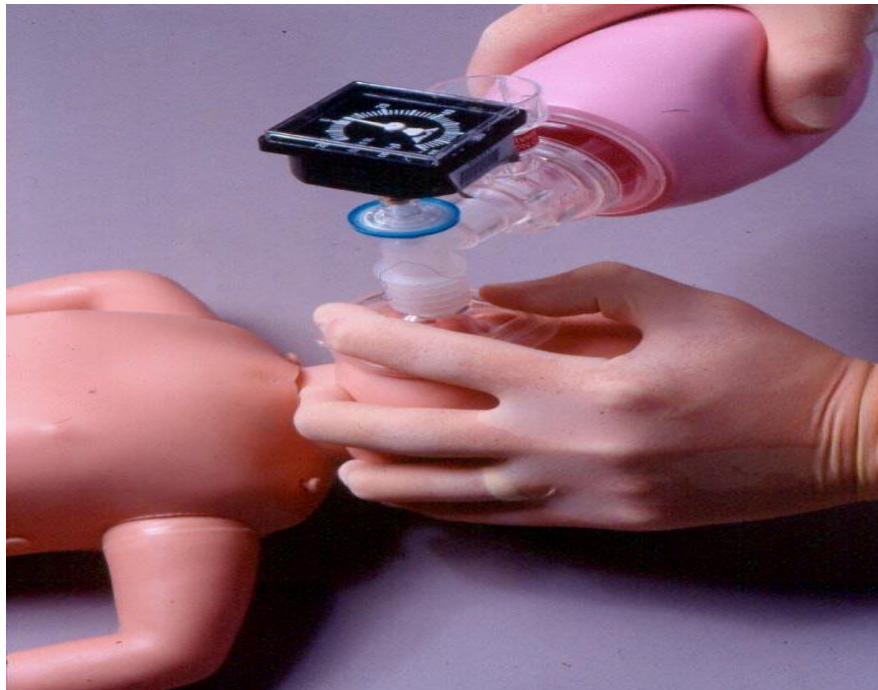

**Then
resuscitate**

Step 4

970

Tie the cord



- **Tie the cord two fingers from abdomen and another tie two fingers from the first one. Cut the cord between the first and second tie.**
 - **Make sure that tie is well secured.**
 - **Make sure that the thread you used to tie the cord is clean and safe.**

Do not put anything on the cord stump

Step 5

971

- **Place the baby in skin-to-skin contact and on the breast to initiate breastfeeding**
- The warmth of the mother passes easily to the baby and helps stabilize the baby's temperature → **prevents hypothermia**

Immediate skin-to-skin contact

972



Breast Crawling

Immediate skin-to-skin contact...

973

- The first skin-to-skin contact should last uninterrupted for at least 1 hour after birth or until after the first breastfeed.
- The baby should not be bathed at birth because a bath can cool him dangerously. After 24 hours, he can have the first sponge bath, if his temperature is stabilized.

Immediate skin-to-skin contact...

974

- If everything is normal, immediately start breastfeeding and continue doing the following recommendation for optimal breastfeeding
 1. Help the mother begin breastfeeding within the first hour of birth.
 2. Help the mother at the first feed. Make sure the baby has a good position, attachment, and suck.

Step 6



Give eye care

- Give the newborn eye care with an antimicrobial medication.
- Eye care protects the baby from serious eye infection which can result in blindness or even death.

Prevent and manage ophthalmia neonatorum.

Steps for giving eye care

976

1. Wash your hands
2. Tetracycline 1% eye ointment
3. Hold one eye open and apply a rice grain size of ointment along the inside of the lower eyelid.
Make sure not to let the medicine dropper or tube touch the baby's eye or anything else.
4. Do not rinse out the eye medication.

Step 7

977

- **Give Vitamin K, 1mg IM on anterior lateral thigh (while baby held by his mother)**

Step 8

978

Weigh baby (if <1,500 gm refer urgently)

Weigh the baby after an hour of birth or after the first
breastfeed

Newborn danger signs

979

- ❑ **Breathing ≤ 30 or ≥ 60 breaths per minute, grunting, severe chest indrawing, blue tongue & lips, or gasping**
- ❑ **Unable to suck or sucking poorly**
- ❑ **Feels cold to touch or axillary temperature $< 35^{\circ}\text{C}$**
- ❑ **Feels hot to touch or axillary temperature $\geq 37.5^{\circ}\text{C}$**
- ❑ **Red swollen eyelids and pus discharge from the eyes**
- ❑ **Convulsion**
- ❑ **Jaundice /yellow skin - at age < 24 hours or > 2 weeks**
 - Involving soles and palms
- ❑ **Pale, bleeding**
- ❑ **Vomiting, no stool, swollen abdomen**

Assess and Classify The Sick Young Infant Age Birth Up to 2 Months:

LEARNING OBJECTIVES

981

- * Assess and classify a young infant for birth asphyxia.
- * Assess & classify for birth wt. and gestational age.
- * Assess and classify a young infant for possible bacterial infection and jaundice.
- * Assessing and classifying a young infant with diarrhea.
- * Assess and classify a young infant for HIV infection.
- * Checking for a feeding problem or low weight, assessing breastfeeding and classifying feeding.
- * Checking immunization status.

YOUNG INFANT

982

Young infants have special characteristics:

- ❑ **sick and die very quickly from serious bacterial infections.**
- ❑ **frequently have only general signs such as few movements, fever, or low body temperature.**
- ❑ **Mild chest indrawing is normal in young infants.**
- **For these reasons, you will assess, classify and treat the young infant somewhat differently than an older infant or young child.**

Assess & classify for **birth asphyxia**.

983

- **Asses** for birth asphyxia if you are attending delivery or if baby is brought immediately after birth.

Assess

- **If not breathing:**

- **Gasp**ing: the attempts to make some effort to breath with irregular & slow breathing movements.
- **Count breathing:** normal breathing rate of the new born is **30-60 beat/min.**

Classify: there are two possible classifications

- **Birth asphyxia**
- **No birth asphyxia**

Signs	Classify	Treatment
<p>If any of the following sign:</p> <ul style="list-style-type: none">- not breathing- gasping- breathing less than 30 per minute	<p>BIRTH ASPHYXIA</p>	<p>Start resuscitation</p> <ul style="list-style-type: none">- position the new born supine with neck slightly extend.- clear the mouth & nose with gauze or clean cloth.- ventilate with appropriate size mask & self inflating bag- If the resuscitation is successful continue giving immediate new born care- if the baby is having irregular breathing after 20 minutes resuscitation; refer urgently to hospital.- Monitor continuously for 6 hrs.- follow after 12hrs, 3days & 6weeks

- **Strong cry**
- **Breathing more than 30b/m**

NO BIRTH ASPHYXIA

- **Give immediate new born care**
- **cord care**
- **eye care**
- **vitamin K**
- **initiate skin to skin contact**
- **initiate exclusive breast feeding**
- **advice the mother when to return**
- **follow after 6hrs; 3days, & 6 weeks**

Assess & classify for birth weight & Gestational age/G.A

986

Assess for Birth weight & Gestational age :

if you are attending delivery or brought to you with in 7 days after birth.

Assess

- Ask the **Gestational age /duration of pregnancy in wks**, if not possible use weight to classify the new born.

Classify

There are 3 possible classifications

- Very low birth weight & or very preterm
- Low birth weight & or preterm
- Normal weight & or term.

Classify for birth weight & Gestational age...cont...

Signs	Classify as	Treatment
Weight < 1500gm or Gestational age < 32 wks	VERY LOW BIRTH WEIGHT AND /OR VERY PRETERM	-Give first dose of I.M Ampicillin & Gentamycin - continue feeding with <u>expressed breast milk</u> - continue KMC - Give vitamin K 1mg I.M on anterior mid thigh - refer urgently to hospital.

Classify for birth wt. & Gestational age cont...

988

Weight 1500 to <2500gm or Gestational age 32-37 wks	LOW BIRTH WEIGHT AND/OR PRETERM	<ul style="list-style-type: none">-kangaroo mother care-counsel on optimal breast feeding-counsel mother/family on prevention of infection-give vitamin K 1mg I.M on anterior mid thigh-provide follow up visits at age 6 hrs 2 days & then every week for 6weeks-advise the mother when to return immediately
---	--	---

Classify for birth wt. & Gestational age cont...

Weight
≥2500gm or
Gestational
age ≥ 37
wks

NORMAL WEIGHT
AND/OR
TERM

- counsel on optimal breast feeding
- counsel mother/family on prevention of infection
- provide three follow up visits at the age 6- 24hrs, 3days & 6weeks.
- Give vitamin K 1mg I.M on anterior mid thigh
- advice the mother when to return immediately

Assess & classify the sick young infant for possible bacterial infection & jaundice.

990

- The young infant must be **calm** & may be **sleep** while you assess the **first 3 signs**, i.e. **count breathing, chest in drawing & grunting/stridor.**
- **Ask the family what the young infant's problems are**
- determine if this is an **initial** or **follow up** visits for this problem.

Check for possible bacterial infection & jaundice..

991

Ask:

- has the infant had convulsion?
 - is there any difficulty of feeding?/ check by offering breast feeding (B/F)
- **Look:** count the breaths in one minute.
- If the 1st count is 60 breaths or more repeat count
- **Look** for chest in drawing: when the infant breath in.

Check for possible bacterial infection... con't...

992

Look & Listen for grunting.

- **Grunting**= is the soft, short sounds a young infant makes when breathing out.

Look at the umbilicus: is red or draining pus?

- There may be some redness around the umbilicus or the umbilicus may be draining pus.

- **Measure temperature/** or feel for fever or low body temperature.

Fever - axillary T° greater or equal to 37.5 °c.

Low body T° - b/n 35.5 & 36.4 °c

possible bacterial infection ...Cont...

993

Look for skin pustules:

- **examine the skin on the entire body**

Skin pustules are red spots or blisters when contains pus.

possible bacterial infection ...Cont...

994

- **Look at the young infant's movements; are they less than normal?**
 - **A wake young infant will normally move his arms or legs or turns his head several times in a minute.**
 - **Does the infant moves only when stimulated?**
 - **Does not move even when stimulated.**
- **Look for jaundice: yellow discoloration of the skin.**

Assess & classify the sick young infant for possible bacterial infection & jaundice.

Signs	Classify as	Treatment
<ul style="list-style-type: none">- not feeding well or- convulsion/convulsing now- fast breathing/60b/m or- severe chest in drawing	POSSIBLE SERIOUS BACTERIAL INFECTION OR VERY SEVERE DISEASE	<ul style="list-style-type: none">- Give first dose of I.M Ampicillin & Gentamycin- warm the young infant by skin to skin contact if T^o less than 36.5°C (or feels cold touch) while arranging referral

Classify possible bacterial infection & jaundice...Con...

-grunting or
-fever(38°c or above or feels hot) or
-Body temperature $<35.5^{\circ}\text{c}$ or feels cold) or
-movement only when stimulated or no movement even stimulated

POSSIBLE SERIOUS BACTERIAL

INFECTION OR

VERY SEVERE DISEASE

- advice the mother how to keep the young infant warm on the way to hospital
- refer urgently to hospital

Classify possible bacterial infection & jaundice...Con...

<ul style="list-style-type: none">• Red umbilicus or draining pusor• Skin pustules	LOCAL BACTERIAL INFECTION	<ul style="list-style-type: none">„Give Cotrimoxazole or Amoxicillin for 5 days„Teach the mother to treat local infections at home„Advise mother when to return immediately„Follow-up in 2 days
<ul style="list-style-type: none">- None of the signs of possible serious bacterial infection or local bacterial infection.	BACTERIAL INFECTION UNLIKELY	<ul style="list-style-type: none">- Advice the mother to give home care for the young infant.

Classify possible bacterial infection & jaundice...Con...

-Temperature
b/n 35.5-
36.4c⁰ (both
values
inclusive)

LOW BODY TEMPERATURE

- Treat to prevent low body T^o
- Warm the young infant using skin- to skin contact for 1hr & re-assess. If T^o remains the same or worse, refer
- advice mother when to return immediately
- follow up in 2days

Classify possible bacterial infection...con't...

- palms and Or soles yellow or
- age <24hrs or
- age 14days or more

SEVERE JAUNDICE

- Treat to prevent low blood sugar
- warm the young infant by skin to skin contact if T° less than 36.5°c (or feels cold touch) while arranging referral
- advice the mother how to keep the young infant warm on the way to hospital
- Refer urgently to hospital

Classify possible bacterial infection con't...

✓ **Only skin
or eyes
yellow.**

JAUNDICE

- **Advice the mother to
give home care**
- **Advice the mother
when to return**
- **Follow up in 2 days**

Assess Diarrhea

1001

Young infant with diarrhea is assessed for:

- How long the child has had diarrhea
- Blood in the stool to determine if the young infant has dysentery
- Signs of dehydration.

Ask: does the young infant have diarrhea?

- If the answer is **no**, you don't **need to assess** the child further for signs to diarrhea.
- If **yes**; assess the child for signs of **DHN, dysentery & persistent diarrhea.**

Assess Diarrhea...

1002

Check for signs of DHN:

- Restless & irritable
- If DHN continues the infants spontaneous & stimulated movement will decreased and becomes lethargy.
- As the child's body loses fluids, the **eyes may be look sunken.**
- When pinched, the skin will go back slowly or very slowly (>2 sec).

Cont...

1003

Classify Diarrhea

- **Sever DHN**
- **Some DHN**
- **No DHN**
- **Persistent diarrhea**
- **Dysentery**

Con...

Signs	Classify as	Treatment
<p>Two of the following signs</p> <ul style="list-style-type: none">- movement only when stimulated or no movement even stimulated- sunken eyes- skin pinch goes back very slowly	<p>SEVERE DHN</p>	<ul style="list-style-type: none">-Give the first dose of I.M Ampicillin and Gentamycin-If infant has another severe classification: Refer URGENTLY with mother giving frequent sips of ORS-Advise mother to continue BF <p><i>Plan C ??????????</i></p>

<p>Two of the following signs</p> <ul style="list-style-type: none"> - Restless, irritable - sunken eyes - skin pinch goes back slowly 	<p>SOME DHN</p>	<p>Give fluid, Zinc supplement & food for some DHN (<i>plan- B??????</i>)</p> <ul style="list-style-type: none"> - If the child has severe classification: . Refer urgently to hospital with mother giving frequent sips of ORS on the way - Continue B/F - Advise the mother when to return immediately. - Follow up for “5” day
<p>No enough sign to classify as some or sever dehydration</p>	<p>NO DHN</p>	<ul style="list-style-type: none"> -Give Fluid, Zinc supplement & food to treat diarrhea (<i>plan – A</i>) -Advise the mother when to return immediately -Follow up in 5 days if not improving

Con...

- **Diarrhea lasting 14 days or more with dehydration**

SEVERE PERSISTENT DIARRHEA

- **Give the first dose of IM Ampicilline Or Gentamycin**
- **Treat to prevent low blood sugar**
- **Advice how to keep infant warm on the way to the hospital**
- **Refer to hospital**

Con...

1007

**Blood
in the
stool**

Dysentery

- Give the first dose of I.M Ampicillin or Gentamycin**
- Treat to prevent low blood sugar.**
- Advice how to keep infant warm on the way to the hospital**
- Refer to hospital**

[Diarrhea video](#)

Assess for HIV infection

1008

Ask: - has the mother or the child have positive HIV test?

- If the child has had an HIV test, determine whether the test was an Antibody test or a PCR test.

Positive HIV test

- HIV infection diagnosed by serological & virological tests.**
- Serological is anti body test, from the mother pass on to the child & in some instances does not disappear until the child is 18 months of age.**

Con...

1009

- This means that a positive antibody test in children under the age of 18 months is **not reliable & does not confirm** that the child is truly **HIV infected**.
- On the other hand, **virological** tests, such as **PCR** test directly detect HIV in the blood.
- PCR tests can therefore detect HIV infection in the child **before** the child is 18 months old.

Con...

SIGN	CLASSIFY AS	TREATMENT
Positive PCR test in the young infant	CONFIRMED HIV INFECTION	<ul style="list-style-type: none">- Give cotrimoxazole prophylaxis from 6wks of age.- Refer for ARV- Assess feeding & counsel as necessary- Advice the mother on home care- Follow up in 14dys

Con...

<ul style="list-style-type: none">- Mother HIV positive OR- Infant has positive HIV antibody test	<p>POSSIBLE HIV INFECTION (HIV EXPOSED)</p>	<ul style="list-style-type: none">- Assess feeding & counsel as necessary- Give cotrimoxazole prophylaxis from 6wks of age- Confirm HIV status as soon as possible using PCR- Follow up in 14dys
<p>Negative HIV test in the mother or the child</p>	<p>HIV INFECTION UNLIKELY</p>	<ul style="list-style-type: none">- Advice the mother to give home care for the young infant

Check for feeding problem or low weight

1012

- Adequate feeding is essential for growth & dev't.
- Poor feeding during infancy can have lifelong effects.
- The **best way** to feed a young infant is to breastfeed exclusively.
- **EBF** means that the infant takes **only breast milk, and no additional food, water or other fluids.** (Medicines and vitamins are exceptions.)

Check for feeding problem or low weight..

1013

- The recommendation is that the young infant be breastfed **as often** and **for as long as the infant wants, day and night**. This should be a minimum of 8 times or more times in 24 hours.



Check for feeding problem or low weight..

1014

Ask about feeding & determine wt. for age.

Ask if there is any difficulty of feeding.

- is the infant B/F, if **yes** for how long?**
- Do you empty one breast before switching to the other?**
- Do you increase frequency of B/F during illness?**
- Does the infant receive any other foods or drinks?**
- What do you use to feed the infant? / Cup, bottle or other.**

Check for feeding problem...

1015 Determine weight for age

use wt. for age chart to determine if the young infant is low wt. for age.

- For young infant you should use the low wt. for age line, instead of very low wt. for age.

Assess breast feeding

- If the infant is **exclusively breast feed with out difficulty & is not low wt. for age, there is no need to assess B/F.**
- **If the infant is not breast feed at all, do not assess B/F.**

WEIGHT FOR AGE CHART

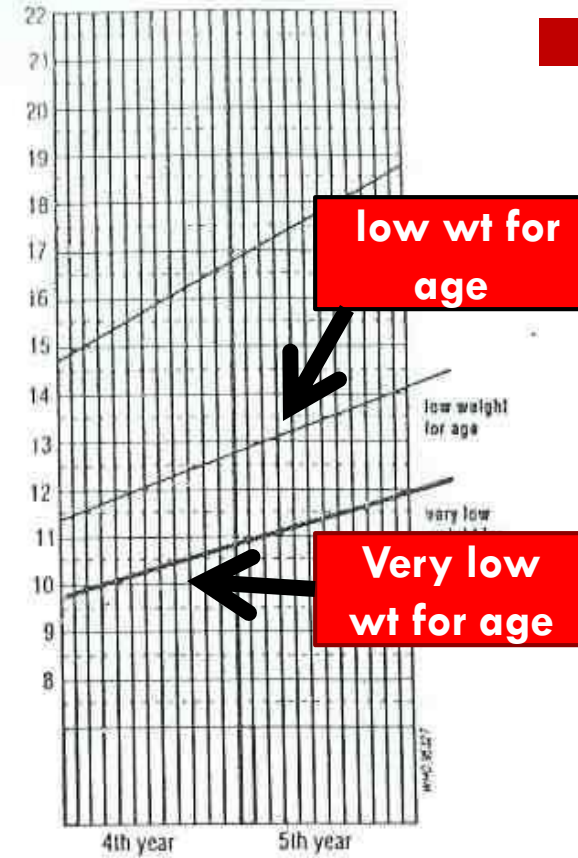
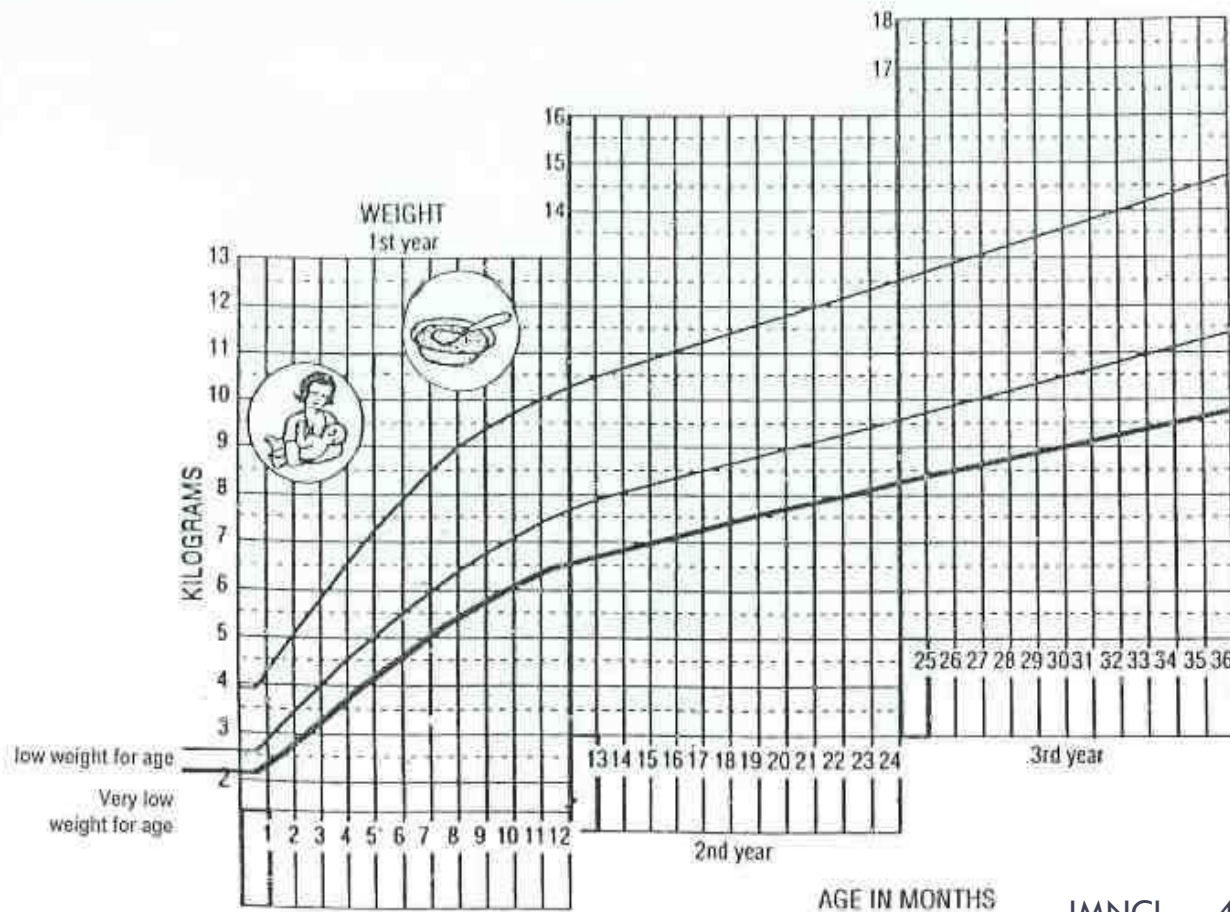

Check for feeding problem...

1017

- If the infant has serious problem requiring urgent referral to hospital **do not assess B/F.**

If an infant

- has any difficulty of feeding
- is breast feeding less than 8 times in 24hrs
- is the mother switching the breast frequently
- Breast feeding not increased during illness
- is taking any other foods or drinks, or
- is low wt. for age &
- has no indications to refer urgently to hospital **assess breast feeding.**

Cont....

Assess breast feeding

1018

- has the infant B/F in the previous hr?
- If the infant has not feed in the previous hr ask the mother to put her infant to breast, observe the breast feeding for 4 minutes.
 - is the infant well positioned?
looks for the sign of good positioning (not well positioned, good positioned)
 - is the infant able to attach? (No attach at all, not well attached, good attachment)

GOOD POSITIONING

- Infant's head and body straight
- Facing her breast
- Infant's body close to her body
- Supporting the infant's whole body
- **all of these signs should be present if the positioning is good**

GOOD ATTACHMENT

- Chin touching the breast
- Mouth wide open
- Lower lip turned outward
- More areola visible above than below the mouth
- **all of these signs should be present if the attachment is good**

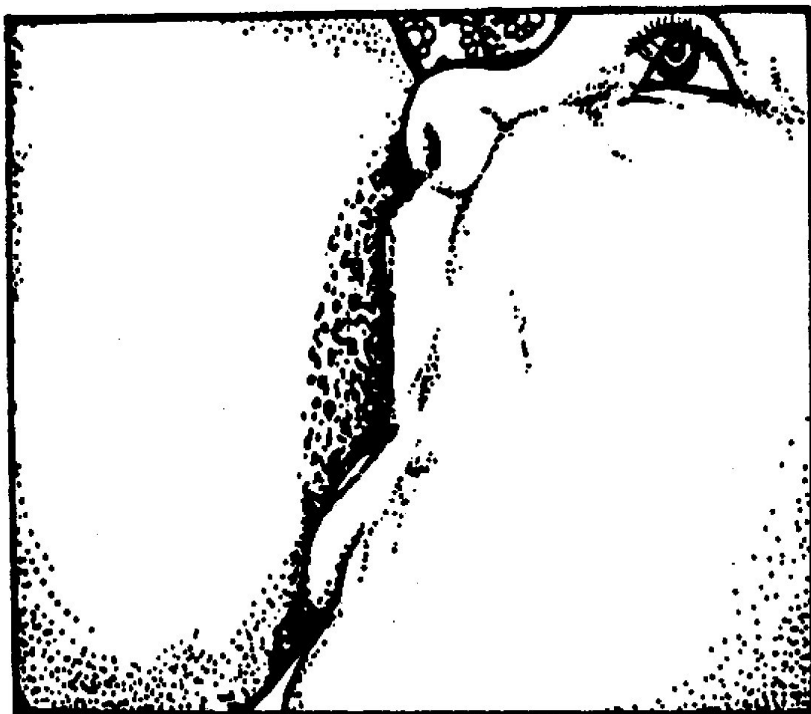

***A baby well attached
to his mother's breast***

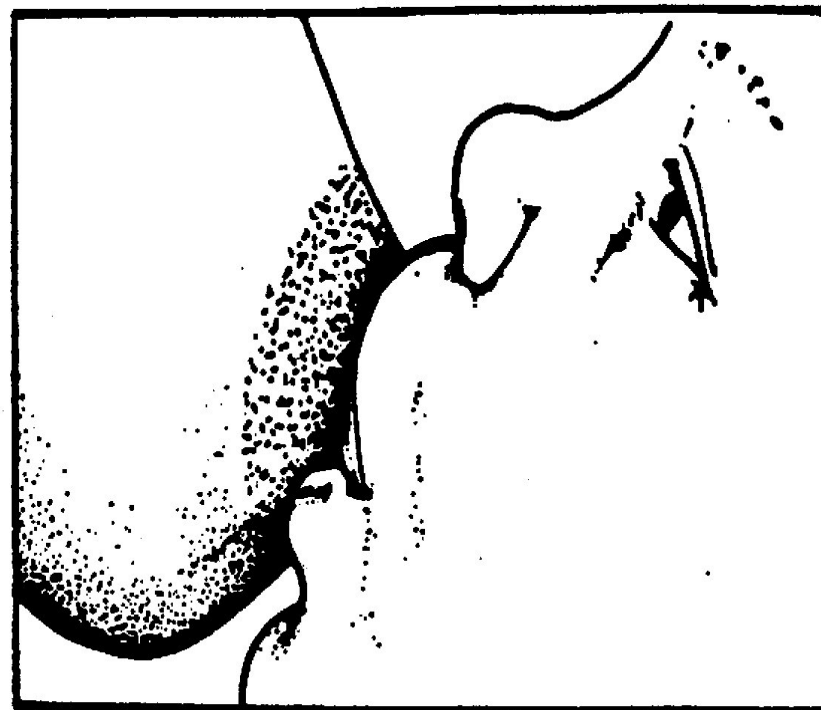

***A baby poorly attached
to his mother's breast***

Classification of feeding problem

SIGN	CLASSIFY	TREATMENT
<p>If any of the following</p> <ul style="list-style-type: none"> - Not well positioned or - Not well attached to breast or - Not suckling effectively or - Less than 8 breast feeds in 24hrs or 	<p>AS</p> <p>FEEDING PROBLEM OR LOW WEIGHT</p>	<ul style="list-style-type: none"> - Advise the mother to breast feed as often & for as long as the infant wants, day & night - if not well attached or not suckling effectively, teach correct positioning & attachment - If breast feeding less than 8 times in 24hrs, advise to increase frequency of feeding - empty one breast completely before switching to the other - . - . - .

Classification of feeding problem Con...

<p>-Switching the breast frequently or</p> <p>-Not increasing frequency of breast feeding during illness or</p>	<p>FEEDING PROBLEM OR LOW WEIGHT</p>	<p>-increase the frequency of breast feeding during & after illness</p> <p>-If receiving other foods or drinks counsel mother about breast feeding more, reducing other foods or drinks & using a cup</p> <p>-If not breast feed at all, refer for breast feeding counseling.</p> <p>...</p>
---	---	--

Classification of feeding problem Con...

<ul style="list-style-type: none">-Receive other foods or drinks or-The mother not breast feeding at all or-Low weight for age or-Thrush(ulcers or white patches in mouth)	<p>FEEDING PROBLEM OR LOW WEIGHT</p>	<ul style="list-style-type: none">-Advice about correctly preparing breast milk substitutes & using a cup-If thrush, teach the mother to treat thrush at home-Advise the mother to give home care-Follow up any feeding problem or thrush in 2 days.-Follow up low weight for age in 14days.
--	---	--

Classification of feeding problem Con...

10
Not low
weight for
age & no
other sign of
inadequate
feeding

NO FEEDING PROBLEM

-Advise mother to give
home care
-Praise the mother for
feeding the infant well

HOW TO CHECK THE YOUNG INFANT'S IMMUNIZATION STATUS

1025

- **The vaccine that should be given to Y/I are**
 - **BCG and polio zero at birth**
 - **OPV, DPT, Hib, Hep B, PCV, and ROTA 1 at the age of 6 weeks**

- **Remember that you should not give OPV 0 to an infant who is more than 14 days old. Therefore, if an infant has NOT received OPV 0 by the time he is 15 days old, you should wait to give OPV1 until s/he is 6 weeks old.**

THE YOUNG INFANT CASE RECORDING FORM

Example 1: Top three sections of the young infant case recording form.

MANAGEMENT OF THE SICK YOUNG INFANT AGE birth UP TO 2 MONTHS	
Child's Name: <u>Jamal</u> Age: <u>6 weeks</u> Weight: <u>4.5</u> kg Temperature: <u>37</u> °C ASK: What are the Infant's problems? <u>Diarrhoea and rash</u> Initial Visit? <input checked="" type="checkbox"/> Follow-up Visit? <input type="checkbox"/>	
ASSESS (Circle all signs present)	CLASSIFY
CHECK FOR POSSIBLE BACTERIAL INFECTION and Jaundice <ul style="list-style-type: none"> • Has the infant had convulsions? <ul style="list-style-type: none"> • Count the breaths in one minute, <u>55</u> breaths per minute. Repeat if elevated <u>Fast</u> breathing? • Look for severe chest indrawing. • Look and listen for grunting • Look at the umbilicus. Is it red or draining pus? Does the redness extend to the skin? • Fever (temperature <u>37.5</u> °C or feels hot) or low body temperature (below 35.5 °C or feels cool). • Look for <u>skin pustules</u>. • Movement only when stimulated or no movement even when stimulated • Look for Jaundice: <ul style="list-style-type: none"> Are the palms and soles yellow? Are skins on the face or eyes yellow? 	Local bacterial infection <div style="border: 1px solid black; width: 100px; height: 80px; margin: 0 auto;"></div>
DOES THE YOUNG INFANT HAVE DIARRHOEA? Yes <input checked="" type="checkbox"/> No <input type="checkbox"/> <ul style="list-style-type: none"> • For how long? <u>3</u> Days • Is there blood in the stool? • Look at the young infant's general condition. Is the infant: <ul style="list-style-type: none"> • Movement only when stimulated or no movement even when stimulated <u>Restless or Irritable?</u> • Look for sunken eyes. • Pinch the skin of the abdomen. Does it go back: <ul style="list-style-type: none"> Very slowly (longer than 2 seconds)? <u>Slowly?</u> 	Some dehydration <div style="border: 1px solid black; width: 100px; height: 40px; margin: 0 auto;"></div>

Summary

1027

- Possible classification of jaundice?
- What are the two major questions that we need to ask the mother to assess Diarrhea in infant?
- What are the classification of HIV ?
- List the 4 positioning and 4 attachments?
- Feeding problem

Assess and Classify The Sick child Age 2 Months Up to 5 yrs

LEARNING OBJECTIVES

1029

After the end of this session the students will be able to:

- Identify the presence or absence of general danger sign in older children
- List the four main symptoms
- Assess and classify cough and difficulty of breathing.
- Assessing and classifying diarrhea in children.
- Assessing and classifying fever in children.

2 Months – 5 years sick children

1030

This age group of children are usually assessed by : -

- 1. Checking the presence or absence of general danger sign.

[Checking general danger sign CD1, 2:58-6:08](#)

2 Months – 5 years sick children..

1031

2. Ask the four main symptoms

- Cough or difficult breathing,
- Diarrhoea,
- Fever, and
- Ear problem.

Main symptoms of 450 sick children

1032

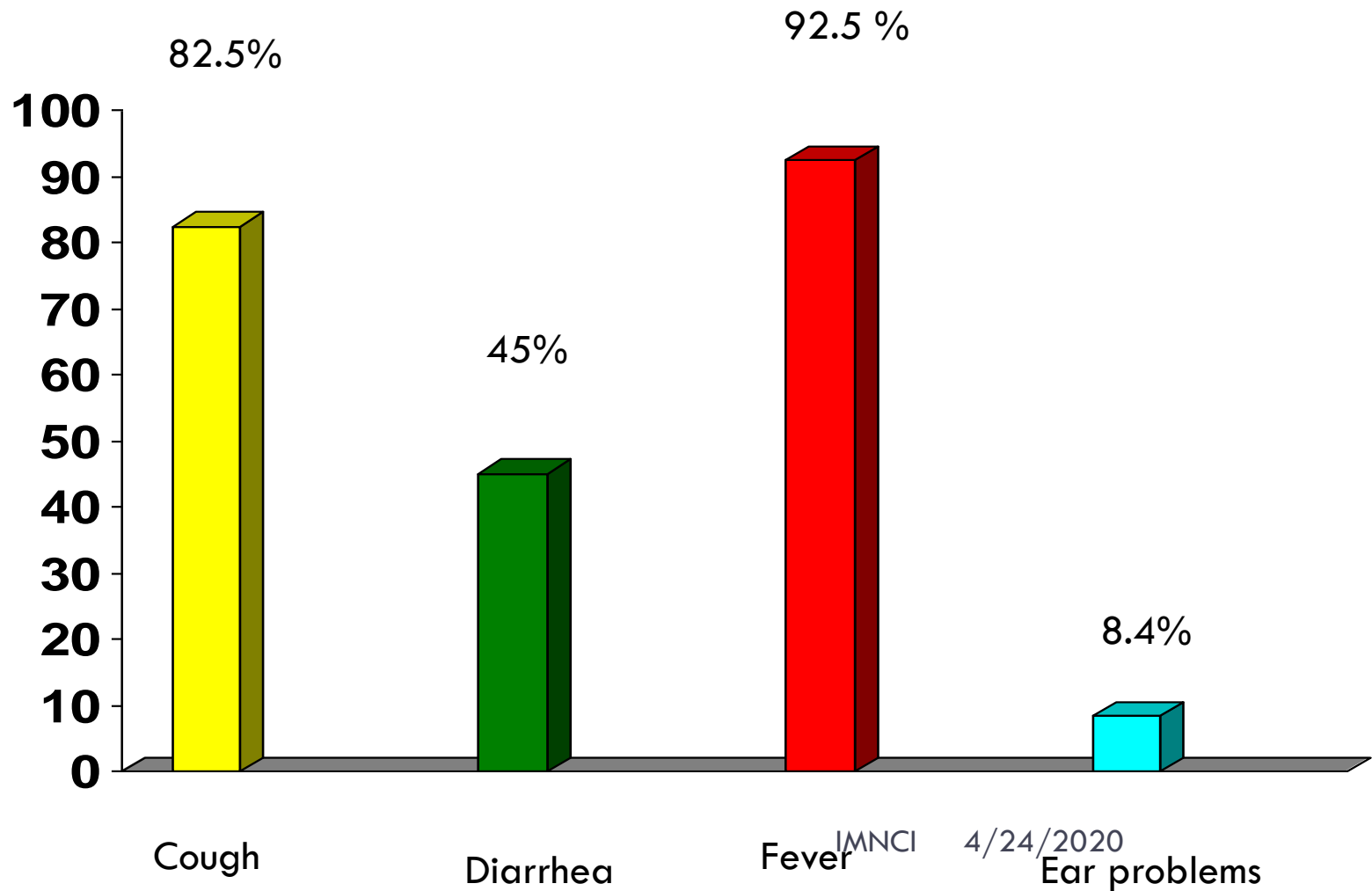

CHECK FOR GENERAL DANGER SIGNS

1033

ASK:

- Is the child able to drink or breastfeed?
- Does the child vomit everything?
- Has the child had convulsions?

LOOK:

- See if the child is lethargic or unconscious.
- See if the child is convulsing now.

A child with any general danger sign needs **URGENT** attention; complete the assessment and any pre-referral treatment immediately so referral is not delayed

Top part of the case recording form for 2mth -5 yrs

1034

MANAGEMENT OF THE SICK CHILD AGE 2 MONTHS UP TO 5 YEARS

Child's Name: xxxx Age: x months Weight: x Temperature: x

ASK: What are the child's problems? cough, trouble breathing Initial Visit? Follow-up Visit?

ASSESS (Circle all signs present)

CLASSIFY

CHECK FOR GENERAL DANGER SIGNS

NOT ABLE TO DRINK OR BREASTFEED

LETHARGIC OR UNCONSCIOUS

VOMITS EVERYTHING

CONVULSIONS

General danger sign present?

Yes No

Remember to use danger sign

when selecting classifications

Classify COUGH or DIFFICULT BREATHING

1035

**IF YES,
ASK:**

- For how long?

LOOK, LISTEN, FEEL:

- Count the breaths in one minute.
- Look for chest indrawing
- Look and listen for stridor

**CHILD
MUST BE
CALM**

**Classify
COUGH or
DIFFICULT
BREATHING**

ASSESS AND CLASSIFY THE SICK CHILD AGE 2 MONTHS UPTO 5 YEARS

ASSESS

CLASSIFY

IDENTIFY TREATMENT

ASK THE MOTHER WHAT THE CHILD'S PROBLEMS ARE

- Determine if this is an initial or follow-up visit for this problem.

- If follow-up visit, use the instructions on 'GIVE FOLLOW UP CARE' chart.

- If initial visit, assess the child as follows:

CHECK FOR GENERAL DANGER SIGN

ASK:

- ▶ Is the child able to drink or breastfeed?
- ▶ Does the child vomit everything?
- ▶ Has the child had convulsions?

LOOK:

- ▶ See if the child is lethargic or unconscious.
- ▶ Is the child convulsing now?

URGENT attention

A child with any general danger sign needs urgent attention, complete the assessment and any pre-referral treatment immediately so referral is not delayed

THEN ASK ABOUT MAIN SYMPTOMS:

Does the child have cough or difficult breathing?

IF YES, ASK:

LOOK, LISTEN, FEEL:

- Count the breaths in one minute
- Look for chest indrawing
- Look and listen for stridor
- Look and listen for wheezing

CHILD MUST BE CALM

Classify COUGH or DIFFICULT BREATHING

• For how long?

If wheezing with either fast breathing or chest

• Contact with TB patient

indrawing: Give a trial of rapid acting inhaled bronchodilator for up to three times 15-20 minutes apart. Count the breaths and look for chest indrawing again, and then classify.

If the child is:

Fast breathing is:

2 months up to 12 months

≥50 breaths per minute more

12 months up to 5 years

≥40 breaths per minute more

**If pulse oximeter is available, determine oxygen saturation and refer if < 90%.*

*** If referral is not possible, manage the child as described in the pneumonia section of the national referral guidelines or as in Ethiopian pocket book for hospital care for children.*

**** If inhaled bronchodilator is not available, oral salbutamol may be tried but not recommended for treatment of severe acute wheeze.*

***** Assess for TB infection (see page 32)*

▶ Refer Page 60 for Wheezing

SIGNS	CLASSIFY AS	TREATMENT (Urgent pre-referral treatments are in bold print)
<ul style="list-style-type: none"> • Any general danger sign 	VERY SEVERE DISEASE	<ul style="list-style-type: none"> ▶ Give diazepam if convulsing now ▶ Quickly complete the assessment ▶ Give appropriate pre-referral treatment immediately ▶ Treat to prevent low blood sugar ▶ Keep the child warm ▶ Refer URGENTLY.
<ul style="list-style-type: none"> • Any general danger sign OR • Stridor in calm child. 	SEVERE PNEUMONIA OR VERY SEVERE DISEASE	<ul style="list-style-type: none"> ▶ Give first dose of IV/IM Ampicillin and gentamycin* ▶ Refer URGENTLY to hospital**
<ul style="list-style-type: none"> • Fast breathing OR • Chest indrawing 	PNEUMONIA	<ul style="list-style-type: none"> ▶ Give oral Amoxicillin for 5 days ▶ If wheezing (or disappeared after rapidly acting bronchodilator) give an inhaled bronchodilator for 5 days*** ▶ Soothe the throat and relieve the cough with a safe remedy ▶ If Chest indrawing in HIV exposed child, give first dose of amoxicillin and refer ▶ If coughing for ≥ 14 days or there is contact with TB patient do assessment for TB**** ▶ Advise mother when to return immediately ▶ Follow-up in 2 days
No signs of: <ul style="list-style-type: none"> • Very severe disease OR • Pneumonia 	COUGH OR COLD	<ul style="list-style-type: none"> ▶ If wheezing (or disappeared after rapidly acting bronchodilator) give an inhaled bronchodilator for 5 days*** ▶ Soothe the throat and relieve the cough with a safe remedy ▶ If coughing for > 7 days or there is contact with TB patient assess for TB**** ▶ Advise mother when to return immediately ▶ Follow-up in 5 days if not improving

After checking the general danger sign and asking the presence or absence of cough then we need to ask does the child have diarrhea?

Does the child have diarrhea?

IF YES, ASK

LOOK AND FEEL

For how long?

-Look at the child general condition. is the child:

Is there blood in the stool ?

-Lethargic or Unconscious?

-Restlessness or irritable

-Look for sunken eye

- offer the child fluid. is the child:

-not able to drinking or drinking poorly ?

-Drinking – eagerly, thirsty?

- pinch the skin of abdomen, does it go back very slowly (longer than 2 second, or slowly)

- If the mother says the child does **not have diarrhea**

1038

**Then ASK about the next main symptoms:
fever, and ear problem.**

- **Diarrhoea occurs when stools contain more water than normal. Diarrhoea is also called loose or watery stools. It is common in children, especially those between 6 months and 2 years of age. It is more common in babies under 6 months who are drinking cow's milk or infant formulas. Frequent passing of normal stools is not diarrhoea.**

Skin pinch technique

1039



HOW TO CLASSIFY DIARRHOEA

1040

- **DHN** all children with diarrhoea are classified for dehydration
- **PERSISTANT** if the child has had diarrhoea for 14 days or more, classify the child for persistent diarrhoea
- **DYSENTERY** if the child has blood in the stool, classify the child for dysentery.

Classify Dehydration (DHN)

1041

They are “3” possible classification DHN

1. Severe DHN
2. Some DHN
3. No DHN

Classification of DHN

Assess	Classify	-Identify Rx
<p>Two of the following signs</p> <ul style="list-style-type: none">-Lethargic or unconscious-Sunken eye-Not able to drink or drinking poorly-Skin pinch goes back very slowly	<p>Sever DHN</p>	<p>-Identify Rx</p> <ul style="list-style-type: none">-If the child has no other sever classification-Given fluid for sever DHN (<i>plan-C ???</i>) or-If the child also has another sever classification:<ul style="list-style-type: none">-Refer urgently to hospital with mother giving frequent sips of ORS on the way.-Advise mother to continue breast feeding.

Classification of DHN Cont...

<p>Two of the following signs</p> <ul style="list-style-type: none">- Restless, irritable- Sunken eye- Drinks eagerly, thirsty- Skin pinch goes back slowly	<p>Some DHN</p>	<ul style="list-style-type: none">- Give fluid, Zinc supplement & food for some DHN (<i>plan- B</i>)- If the child has sever classification:. Refer urgently to hospital with mother giving frequent sips of ORS on the way- Advise the mother to continue B/F- Advise the mother when to return immediately.- Follow up for “5” day if not improving
---	------------------------	--

Classification of DHN Cont...

1044

- No enough sign to classify some or severe DHN

NO DHN

- Give Fluid ,Zinc supplement & food to treat diarrhea (plan – A)
- Advise the mother when to return immediately
- Follow up in 5 days if not improving
- If confirmed/ suspected symptomatic HIV, follow up in 2 days if not improving

Classify Persistent Diarrhea

1045

- If the diarrhea lasts 14 days or more classify for persistent diarrhea.

Two classifications

1. Severe persistent diarrhea if **some or sever DHN present**
2. Persistent diarrhea if **no some or sever DHN present.**

Classify Persistent Diarrhea con't...

DHN present	Sever - persistent diarrhea	<ul style="list-style-type: none">➤ Treat DHN before referral if the child has no sever disease classification➤ Refer to hospital➤ Vit – A supplementation
No DHN	Persistent diarrhea	<ul style="list-style-type: none">✓ Advise the mother on feeding a child✓ Follow up for in 05 day✓ Give vit – A

Classify dysentery

1047

III. Dysentery: Diarrhea with blood in the stool, with or without mucus.

- If the child has blood in the stool classify for dysentery

Blood in the stool	Dysentery	-Treat for 05 days with oral antibiotic (<i>ciprofloxacin</i>) - Follow up for 2 days
---------------------------	------------------	--

Assess and classify FEVER

1048

- **DOES THE CHILD HAVE FEVER?** (by history or feels hot or temperature 37.5 °C or above)

IF YES:

- **Decide Malaria** Risk: high or low or no
- if “Low or no” malaria risk, then ask:
 - Has the child travelled outside this area during the previous 2 weeks?
 - If yes, has he been to a malarious area?

Then ask

Look and feel

IMNCI

For how long?

- If more than 7 days, has fever been present every day?
- Has the child had measles within the last 3 months?

Look or feel for stiff neck

- Look or feel for bulging fontanel (< 1 year old)
- Look for runny nose
- Look for signs of **MEASLES**

Generalized rash and one

If the child has measles now or within the last 3 months:

- Look for mouth ulcers**
- Are they deep and extensive?**
- Look for pus draining from the eye.**
- Look for clouding of the cornea.**

Classification of FEVER for high malaria risk.

SIGN	CLASSIFY AS	IDENTIFY TREATMENT
<ul style="list-style-type: none"> • Any general danger sign or • Stiff neck or Bulging fontanel 	<p>VERY SEVERE FEBRILE DISEASE</p>	<ul style="list-style-type: none"> ➤ Give quinine for severe malaria (first dose). ➤ Give first dose of an appropriate antibiotic. ➤ Treat the child to prevent low blood sugar. ➤ Give one dose of paracetamol in clinic/HC for high fever (38.5° C or above). ➤ Refer URGENTLY to hospital.
<ul style="list-style-type: none"> • Positive blood film/positive RDT (if blood film/RDT available), or • Fever (by history or feels hot or temperature 37.5° C** or above) 	<p>MALARIA</p>	<ul style="list-style-type: none"> ➤ Treat with oral antimalarial. ➤ Give one dose of paracetamol in clinic for high fever (38.5° C or above). ➤ Advise mother when to return immediately. ➤ Follow-up in 2 days if fever persists. ➤ If fever is present every day for more than 7 days, REFER for assessment.

Classification of FEVER in Low Malaria Risk

SIGN	CLASSIFY AS	IDENTIFY TREATMENT
<ul style="list-style-type: none"> • Any general danger sign⁰⁵¹ • Stiff neck 	<p style="text-align: center;">VERY SEVERE FEBRILE DISEASE</p>	<ul style="list-style-type: none"> ➤ <i>Give quinine for severe malaria (first dose).</i> ➤ <i>Give first dose of an appropriate antibiotic.</i> ➤ <i>Rx to prevent low blood sugar.</i> ➤ <i>Give one dose of paracetamol in clinic for high fever (38.5° C or above).</i> ➤ <i>Refer URGENTLY to hospital.</i>
<ul style="list-style-type: none"> • Positive blood film/positive RDT (if blood film/RDT available), or -NO runny nose and -NO measles and -NO other cause of fever 	<p style="text-align: center;">MALARIA</p>	<ul style="list-style-type: none"> ➤ <i>Treat with oral antimalarial.</i> ➤ <i>Give one dose of paracetamol in clinic for high fever (38.5° C or above).</i> ➤ <i>Advise mother when to return immediately.</i> ➤ <i>Follow-up in 2 days if fever persists.</i> ➤ <i>If fever is present every day for more than 7 days, REFER for assessment.</i>

Classification of FEVER in Low Malaria Risk...

SIGN	CLASSIFY AS	IDENTIFY TREATMENT
<p>1052</p> <ul style="list-style-type: none">• Runny nose PRESENTOR• Measles PRESENTOR• Other cause of fever PRESENT.	<p>FEVER - MALARIA UNLIKELY</p>	<ul style="list-style-type: none">➤ Give one dose of paracetamol in clinic for high fever (38.5° C or above).➤ Treat other obvious cause of fever➤ Advise mother when to return immediately.➤ Follow-up in 2 days if fever persists.➤ If fever is present every day for more than 7 days, REFER for assessment. <p>IMNCI 4/24/2020</p>

Classification for **NO malaria risk and NO travel to a malaria risk area.**

1053

<p>- Any general danger sign or -Stiff neck</p>	<p>VERY SEVERE FEBRILE DISEASE</p>	<ul style="list-style-type: none">➤ Give first dose of an appropriate antibiotic.➤ Treat the child to prevent low blood sugar.➤ Give one dose of paracetamol in clinic for high fever (38.5° C or above).➤ Refer URGENTLY to hospital.
<p>-NO general danger sign AND -NO stiff neck.</p>	<p>FEVER - (NO MALARIA)</p>	<ul style="list-style-type: none">-Give one dose of paracetamol in clinic for high fever (38.5° C or above).➤ Treat other obvious causes of fever➤ Advise mother when to return immediately.➤ Follow-up in 2 days if fever persists.➤ If fever is present every day for more than 7 days,➤ REFER for assessment.

Classification table for measles

(if measles now or within the last 3 months).

<p>054</p> <ul style="list-style-type: none">• Any general danger sign or• Clouding of cornea or• Deep or extensive mouth ulcers.	<p>SEVERE COMPLICATED MEASLES</p>	<ul style="list-style-type: none">➤ Give vitamin A therapeutic dose.➤ Give first dose of an appropriate antibiotic.➤ If clouding of the cornea or pus draining from the eye, apply tetracycline eye ointment.➤ Refer URGENTLY to hospital.
<ul style="list-style-type: none">• Pus draining from the eye or• Mouth ulcers	<p>MEASLES WITH EYE OR MOUTH COMPLICATIONS</p>	<ul style="list-style-type: none">➤ Give vitamin A, therapeutic dose..➤ If pus draining from the eye, treat eye infection with tetracycline eye ointment.➤ If mouth ulcers, treat with gentian violet.➤ Follow-up in 2 days.
<ul style="list-style-type: none">• Measles now or within the last 3 months	<p>MEASLES</p>	<ul style="list-style-type: none">➤ Give vitamin A, therapeutic dose.➤ Advise when to return immediately

Assess and classify EAR PROBLEM

1055

- Ask if the child has ear problem

IF YES, ASK:

- Is there ear pain?
- Is there ear discharge?

If yes, for how long?

LOOK AND FEEL:

- Look for pus draining from the ear
- Feel for tender swelling behind the ear

Then CHECK for malnutrition and anaemia, HIV infection, immunization status and for other problems.

Does the Child Have an Ear Problem?

IF YES, ASK:

- Is there ear pain?
- Is there ear discharge?
If yes, for how long?

LOOK, AND FEEL:

- Look for pus draining from the ear
- Feel for tender swelling behind the ear

Classify
EAR
PROBLEM

SIGNS	CLASSIFY AS	TREATMENT (Urgent pre-referral treatments are in bold print)
<ul style="list-style-type: none"> • Tender swelling behind the ear 	MASTOIDITIS	<ul style="list-style-type: none"> ▶ Give first dose of Ampicillin and Choramphenicol MIM ▶ Give first dose of Paracetamol for pain ▶ Refer URGENTLY to hospital
<ul style="list-style-type: none"> • Ear pain, OR • Pus is seen draining from the ear and discharge is reported for less than 14 days 	ACUTE EAR INFECTION	<ul style="list-style-type: none"> ▶ Give Amoxicillin for 5 days ▶ Give Paracetamol for pain ▶ Dry the ear by wicking ▶ Follow-up in 5 days
<ul style="list-style-type: none"> • Pus is seen draining from the ear and discharge is reported for 14 days or more 	CHRONIC EAR INFECTION	<ul style="list-style-type: none"> ▶ Dry the ear by wicking ▶ Treat with topical Quinolone eardrops for 2 weeks ▶ Follow-up in 5 days
<ul style="list-style-type: none"> • No ear pain and • No pus seen draining from the ear 	NO EAR INFECTION	<ul style="list-style-type: none"> ▶ No additional treatment

CHECK FOR ANEMIA

LOOK

- Look for palmar pallor, is it;
 - Severe palmar pallor?
 - Some palmar pallor?
 - No palmar pallor?

Classify
ANEMIA

SIGNS	CLASSIFY AS	TREATMENT (Urgent pre-referral treatments are in bold print)
• Severe palmar pallor	SEVERE ANEMIA	▶ Refer URGENTLY to hospital
• Some palmar pallor	ANEMIA	▶ Assess the child's feeding and counsel the mother on feeding according to the FOOD box on the COUNSEL THE MOTHER chart ▶ Give Iron** ▶ Do blood film or RDT for malaria, if malaria risk is high or has travel history to malarious area in last 30 days. ▶ Give Mebendazole or Albendazole, if the child is ≥ 2 years old and has not had a dose in the previous six months ▶ Advise mother when to return immediately ▶ Follow-up in 14 days
• No palmar pallor	NO ANEMIA	▶ No additional treatment ▶ Counsel the mother on feeding recommendation

**If child has severe acute malnutrition and is receiving RUTF, DO NOT give iron because there is already adequate amount of iron in RUTF.

CHECK FOR ACUTE MALNUTRITION, IN INFANTS < 6 MONTHS

LOOK AND FEEL

1. Check for presence of oedema of both feet (or sacrum) Does the child have oedema?

2. Check the weight and Length

- What is the weight for length Z score?

3. Check for signs of medical complications:

- Any General Danger Sign
- Any severe classification
- Pneumonia
- Dehydration*
- Persistent diarrhoea
- Dysentery
- Fever $\geq 38.5^{\circ}\text{C}$
- Measles [now or with eye/mouth complications]
- Low body temperature ($<35^{\circ}\text{C}$ axillary)
- Dermatitis+++

SIGNS	CLASSIFY AS	TREATMENT
<ul style="list-style-type: none"> • WFL $< -3Z$ score, and presence of complications OR • Oedema of both feet 	COMPLICATED SEVERE ACUTE MALNUTRITION	<ul style="list-style-type: none"> ▶ Give first dose of Ampicillin and Gentamycin IM ▶ Treat the child to prevent Low Blood Sugar ▶ Advise mother on the need of referral ▶ Refer Urgently to Hospital
<ul style="list-style-type: none"> • WFL $< -3Z$ score AND no complications AND • No oedema of both feet 	UNCOMPLICATED SEVERE ACUTE MALNUTRITION	<ul style="list-style-type: none"> ▶ Counsel on breast feeding and care ▶ Undertake appropriate counseling and feeding advise in cases where a child is orphaned with no other option for breastfeeding ▶ Assess for TB infection (Refer table on page 32)*
<ul style="list-style-type: none"> • WFL $\geq -3Z$ to $< -2Z$ score, AND • No oedema of both feet 	MODERATE ACUTE MALNUTRITION	<ul style="list-style-type: none"> ▶ Assess feeding and advise the mother on feeding ▶ Assess for TB infection (Refer table on page 32)* ▶ Follow up in 5 days if feeding problem ▶ Follow up in 30 days
<ul style="list-style-type: none"> • WFL $\geq -2Z$ score AND • No oedema of both feet 	NO ACUTE MALNUTRITION	<ul style="list-style-type: none"> ▶ Assess feeding and advise the mother on feeding ▶ Follow up in 5 days if feeding problem ▶ If no feeding problem-praise the mother

• Diagnosis of dehydration in SAM is mainly used on the history rather than on patient's examination alone.

CHECK FOR ACUTE MALNUTRITION, IN CHILDREN 6 - 59 MONTHS

LOOK AND FEEL

1. Check for presence of oedema of both feet (orsacrum)

- ◆ Does the child have oedema**? (+, ++, +++)

2. Check the weight and height

3. Check MUAC

4. Check for signs of medical complications:

- Any General Danger Sign
- Any severe classification
- Pneumonia
- Dehydration*
- Persistent diarrhea
- Dysentery
- Fever $\geq 38.5^{\circ}\text{C}$
- Measles [now or with eye/mouth complications]
- Low body temperature ($<35^{\circ}\text{C}$ axillary)
- Dermatitis+++

Do Appetite test (Passed, Failed)

- Appetite test should be done ONLY when there is:

- NO medical complication, and
- NO +++ oedema, and
- NO +++ dermatosis***, and
- NO marasmic kwashiorkor****

* Diagnosis of dehydration in SAM is mainly used on the history rather than on patient's examination alone.

** Oedema grading: bilateral oedema below ankles (+); below the knees & the elbows (++); generalized oedema involving the upper arms & face (+++).

*** Dermatitis grading: few discolored or rough patches of skin (+); multiple patches on arms and/or legs (++); flaking skin, raw skin or fissures (openings in the skin) is grade +++ dermatosis.

**** Child with WFLH < -3 Z plus oedema, or with MUAC < 11.5 cm plus oedema.

SIGNS	CLASSIFY AS	TREATMENT
<ul style="list-style-type: none"> • WFLH $< -3\text{Z}$ score or MUAC < 11 cm or Oedema of both feet (+, ++), and any of the following: <ul style="list-style-type: none"> • Any one of the medical complications, or • Failed Appetite test • +++ Oedema OR • Marasmic Kwashiorkor (WFLH $< -3\text{Z}$ with oedema or MUAC < 11 cm with oedema) 	COMPLICATED SEVERE ACUTE MALNUTRITION	<ul style="list-style-type: none"> ▶ Give 1st dose of Ampicillin and Gentamycin IM ▶ Treat the child to prevent low blood sugar ▶ Advise the mother to feed and keep the child warm ▶ Advise mother on the need of referral ▶ Refer Urgently to Hospital or admit to inpatient care
<ul style="list-style-type: none"> • WFLH $< -3\text{Z}$ score or MUAC < 11 cm or oedema of both feet (+, ++) AND • No medical complication and • Pass appetite test 	UNCOMPLICATED SEVERE ACUTE MALNUTRITION	<ul style="list-style-type: none"> ▶ If Outpatient Treatment Program (OTP) is available, manage as follows: <ul style="list-style-type: none"> ▶ Give RUTF for 7 days, ▶ Give oral Amoxicillin for 7 days ▶ Give single dose of 5 mg folic acid for those with anemia ▶ Counsel on how to feed RUTF to the child ▶ Advise the mother when to return immediately ▶ Assess for TB infection (Refer table on page 32) ▶ Follow-up in 7 days ▶ If OTP is not available, refer to a facility with OTP service ▶ If there is any social problem at home treat as inpatient
<ul style="list-style-type: none"> • WFLH $\geq -3\text{Z}$ to $< -2\text{Z}$ score or MUAC 11 cm to < 12 cm AND • No oedema of both feet 	MODERATE ACUTE MALNUTRITION	<ul style="list-style-type: none"> ▶ Refer to Supplementary Feeding Program if available ▶ Assess for feeding and counsel the mother accordingly ▶ Assess for possible TB infection (Refer table on page 32) ▶ If feeding problem, follow up in 5 days
<ul style="list-style-type: none"> • WFLH $\geq -2\text{Z}$ score or MUAC ≥ 12 cm AND • No oedema of both feet 	NO ACUTE MALNUTRITION	<ul style="list-style-type: none"> ▶ Assess feeding and advise the mother on feeding ▶ Follow up in 5 days if feeding problem ▶ If no feeding problem-praise the mother

CHECK FOR HIV EXPOSURE AND INFECTION, IN CHILDREN 2 - < 18 MONTHS

ASK:

- What is the HIV status of the mother?
 - Positive
 - Negative
 - Unknown
- What is the HIV antibody test result of the sick child?
 - Positive
 - Negative
 - Unknown
- What is the DNA/PCR test result of the sick child? *
 - Positive
 - Negative
 - Unknown
- Is child on breastfeeding?
 - Yes
 - No
- If no, was child breastfed in the last 6 weeks?
 - Yes
 - No

Classify
for
HIV
Infection

SIGN	CLASSIFY	TREATMENT
<ul style="list-style-type: none"> • Child DNA PCR positive 	HIV INFECTED	<ul style="list-style-type: none"> ▶ Give Cotrimoxazole prophylaxis ▶ Assess feeding and counsel ▶ Assess for TB infection (Refer table on page 32) ▶ Ensure mother is tested & enrolled in HIV care & treatment ▶ Advise on home care ▶ Refer to ART clinic for ART initiation/care & treatment
<ul style="list-style-type: none"> • Mother positive, and child Antibody or DNA/PCR negative, and breastfeeding OR • Mother positive, and child antibody & DNA/PCR unknown OR • Child antibody positive 	HIV EXPOSED	<ul style="list-style-type: none"> ▶ Give Co-trimoxazole prophylaxis ▶ Assess feeding and counsel ▶ If child DNA/PCR is unknown, test as soon as possible ▶ Ensure mother is tested & enrolled in mother-baby cohort follow up at ANC/PMTCT clinic
<ul style="list-style-type: none"> • Mother and child not tested 	HIV STATUS UNKNOWN	<ul style="list-style-type: none"> ▶ Counsel the mother for HIV testing for herself & the child ▶ Advise the mother to give home care ▶ Assess feeding and counsel
<ul style="list-style-type: none"> • Mother negative, OR • Mother positive, and child DNA PCR negative, and not breastfeeding, OR • Mother HIV status unknown, and child antibody negative 	HIV INFECTION UNLIKELY	<ul style="list-style-type: none"> ▶ Advise on home care ▶ Assess feeding and counsel ▶ Advise on HIV prevention ▶ Encourage mother to be tested ▶ If mother HIV status is unknown, advise her on HIV testing

Note:

- If DNA PCR isn't available, AND child antibody is positive, AND two of the following are present (Oral thrush, Severe pneumonia or Very Severe Disease); Consider this child to have 'PRESUMPTIVE SEVERE HIV DISEASE'. And this child should be referred to ART clinic and treated as "HIV INFECTED" child.

CHECK FOR HIV EXPOSURE AND INFECTION, IN CHILDREN 18 - 59 MONTHS

ASK:

- What is the HIV status of the mother?
 - Positive
 - Negative
 - Unknown
- What is the HIV antibody test result of the sick child?
 - Positive
 - Negative
 - Unknown
- Is child on breastfeeding?
 - Yes
 - No
- If no, was child breastfed in the last 6 weeks?
 - Yes
 - No

Classify
for
HIV
infection

SIGN	CLASSIFY	TREATMENT
<ul style="list-style-type: none"> • Child antibody positive 	HIV INFECTED	<ul style="list-style-type: none"> ▶ Consider Cotrimoxazole prophylaxis ▶ Assess feeding and counsel ▶ Advise on home care ▶ Refer to ART clinic for ARV initiation ▶ Ensure mother is tested & enrolled in HIV care & treatment
<ul style="list-style-type: none"> • Mother positive, AND • Child antibody negative or unknown, and breastfeeding 	HIV EXPOSED	<ul style="list-style-type: none"> ▶ Give Cotrimoxazole prophylaxis ▶ Assess feeding and counsel ▶ If child antibody test is unknown, test as soon as possible ▶ If child antibody test is negative, repeat 6 wks after complete cessation of breastfeeding ▶ Ensure mother is tested & enrolled in mother-baby cohort follow up at ANC/PMTCT clinic
<ul style="list-style-type: none"> • Mother and child not tested 	HIV STATUS UNKNOWN	<ul style="list-style-type: none"> ▶ Counsel the mother for HIV testing for herself and the child ▶ Advise the mother to give home care ▶ Assess feeding and counsel
<ul style="list-style-type: none"> • Mother negative and child not known 	HIV INFECTION UNLIKELY	<ul style="list-style-type: none"> ▶ Advise on home care ▶ Assess feeding and counsel ▶ Advise on HIV prevention ▶ If possible, do HIV antibody test for the child
<ul style="list-style-type: none"> • Child antibody negative at least 6 weeks after complete cessation of breastfeeding 	HIV UNINFECTED	<ul style="list-style-type: none"> ▶ Advise on home care ▶ Assess feeding and counsel ▶ Advise on HIV prevention

ASSESS AND CLASSIFY THE CHILD FOR TUBERCULOSIS

THEN ASK:

- Cough of ≥ 14 days
- Fever and night sweats*
- Contact history with TB patient **

LOOK AND FEEL:

- Swelling or discharging wound***
- Signs of acute malnutrition ****

Classify

DO THE FOLLOWING IF AVAILABLE:

- AFB or Gene Xpert if there is sputum production
- Chest X-ray*****

* Fever $>38^{\circ}\text{C}$ that continues for greater than two weeks after common causes are excluded.

**Contact history with TB patient : a newly diagnosed TB case (within the past one year) in the close contact or household member

***the swelling and discharging wound in the neck or armpit not due to injury, and staying for a duration of more than one month should not be due to injury of any kind.

**** SAM/MAM: severe or moderate acute malnutrition classification from the assessment and classification table for malnutrition.

***** X-Ray suggestive of TB: however x-ray is not commonly available in health centers and primary hospitals but if it is available

SIGNS	CLASSIFY AS	TREATMENT (Urgent pre-referral treatments are in bold print)
<ul style="list-style-type: none"> • Contact with a known MDR TB patient 	Suspected MDR TB	<ul style="list-style-type: none"> ▶ Advise mother on the need of referral ▶ Refer Urgently to Hospital for MDR TB investigation and Treatment
<ul style="list-style-type: none"> • Contact with TB patient And two or more of the signs / One or more of the signs if known HIV+ And/ Or • A sign AND AFB/ GeneXpert +ve Or • A sign AND Chest X ray suggestive of TB (eg. miliary pattern) 	TB	<ul style="list-style-type: none"> ▶ Counsel the mother on DOTS principle ▶ Advise mother to bring any other contacts ▶ Do provider initiated HIV testing and Counseling ▶ Link to TB clinic for initiation of treatment and follow up
<ul style="list-style-type: none"> • Contact to TB patient (non-MDR) and no other finding 	TB Exposed Child	<ul style="list-style-type: none"> ▶ Counsel the mother on the diagnosis of TB exposure and the need for INH prophylaxis ▶ Link to TB clinic for INH prophylactic-treatment initiation and follow up
<ul style="list-style-type: none"> • No conclusive sign and • No Contact with TB patient • AFB/GeneXpert -ve And • Chest X-ray not suggestive 	No TB Infection	<ul style="list-style-type: none"> ▶ Look and treat for other causes for the main complaint ▶ Counsel the mother on the need for INH prophylaxis in the presence of HIV infection for HIV +ve children ▶ Link to TB clinic for INH prophylactic-treatment initiation and follow up for HIV +ve children ▶ Follow up in 30 days

CHECK THE CHILD'S IMMUNIZATION AND VITAMIN A STATUS

IMMUNIZATION SCHEDULE:	AGE	VACCINE	
	Birth	BCG	OPV - 0
	6 weeks	DPT1-HepB1-Hib1, PCV-1	OPV - 1 Rota -1
	10 weeks	DPT2-HepB2-Hib2, PCV-2	OPV - 2 Rota -2
	14 weeks	DPT3-HepB3-Hib3, PCV-3	OPV - 3
	9 months	Measles	Vitamin A (if not given with in last 6 months)

VITAMIN A SUPPLEMENTATION

If 6 months or older

- Check if child has received a dose of Vitamin A during the previous 6 months. If not, give Vitamin A supplementation every 6 months up to the age of 5 years.
- Record the dose on the child's card.

ROUTINE WORM TREATMENT

If 2 years or older

- Check if child has received Mebendazole or Albendazole during the previous 6 months. If not, give child Mebendazole or Albendazole every 6 months.
- Record the dose on the child's card.

EXAMPLE OF REFERRAL NOTE

1064

12/9/2006 11:00 a.m.

Urgent referral to Gondar University Referral Hospital

Child name: - Birhanu Asfaw, age 12 months

Referred for:

SEVERE DEHYDRATION

SEVERE MALNUTRITION

Also has cough – no fast breathing, no chest indrawing

Treatment given at poly Health Center:

Vitamin A 200 000 IU

ORS – Mother to give sips on the way to hospital

Needs measles immunization – not given

Handwritten signature and initials in blue ink. The signature is a stylized name, and the initials are 'M^R'.





References

1067

- Nelson textbook of pediatrics, 20th Edition
- National guideline for the management acute malnutrition in Ethiopia, 2019
- Neonatal intensive care unite manual, 2014
- National Comprehensive HIV Care and Treatment Training for Health care Providers,2014
- **Uptodates 21.2**
- Integrated Management of Newborn and Childhood Illness (IMNCI) guideline,2016