

Housekeeping

Maclaren Scott



First Edition, 2009

ISBN 978 93 80075 15 0

© All rights reserved.

Published by:

Global Media
1819, Bhagirath Palace,
Chandni Chowk, Delhi-110 006
Email: globalmedia@dkpd.com

Table of Contents

1. Housekeeping
2. Up-keeping of Hotels
3. Public Area
4. How to Clean Naturally
5. How to Fold a Fitted Sheet

What kind of work do people do in housekeeping in a hotel?

Housekeeping in a hotel is a very physically demanding job that includes many, varied tasks. Typically, in this case study, housekeepers were responsible for cleaning 16 rooms per shift. The actual amount of work depends on the size of the room and the number of beds. A housekeeper needs between fifteen and thirty minutes to do one room. A housekeeper carries out the following tasks:

- making beds (Figures 1a, 1b, 1c),
- tidying rooms (Figure 2),
- cleaning and polishing toilets, taps, sinks, bathtubs and mirrors (Figures 3a, 3b),
- washing floors,
- removing stains, and
- vacuuming .



Figure 1a

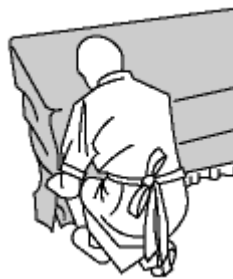

Figure 1b
Making Beds

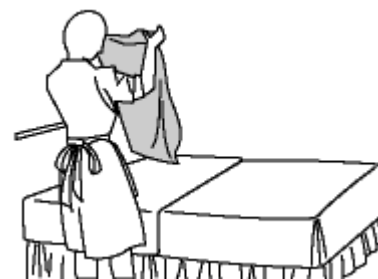

Figure 1c

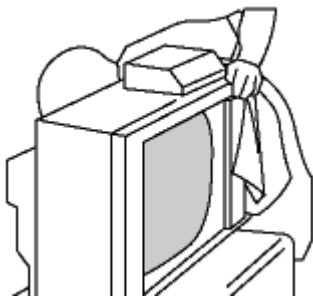

Figure 2
Tidying a room

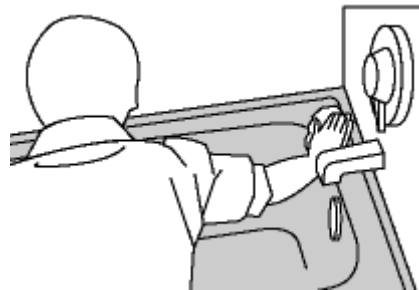

Figure 3a
Cleaning



Figure 3b

What are the risk factors of housekeeping?

The main risk factors for repetitive motion injuries (RMIs) in housekeeping are:

- heavy physical workload and excessive bodily motions which are a high risk for back injuries and

- forceful upper limb motions in awkward positions which are a high risk for neck or shoulder and arm injuries.

Space limitations require workers to use many uncomfortable postures. These are:

- standing or walking,
- stooping,
- squatting,
- kneeling,
- stretching,
- reaching,
- bending,
- twisting, and
- crouching.

A housekeeper changes body position every three seconds while cleaning a room. If we assume that the average cleaning time for each room is twenty-five minutes, we can estimate that a housekeeper assumes 8,000 different body postures every shift.

In addition, forceful movements while using awkward body positions include lifting mattresses, cleaning tiles, and vacuuming every shift. Housekeeping is a physically demanding and very tiring job. It can be classified as "moderately heavy" to "heavy" work because the energy required is approximately 4 kilocalories per minute (4 kcal/min.)

How can we reduce the risk factors for RMI?

Hotel housekeepers work in a unique place. Hotels are usually designed for the comfort of their guests rather than their housekeeping staff. This fact makes it very difficult to improve working conditions for housekeepers by means of better engineering. However, some improvements can be made by selecting more appropriate equipment.

Lighter vacuum cleaners (preferably the self-propelling type), and lighter service carts with wheels designed for carpeted floors would ease the workload for their operators providing this equipment is always kept in good repair. When new vacuum cleaners are purchased, low noise emissions should be one of the criteria.

Improving the body postures that pose a major risk for musculoskeletal disorders seems an unachievable task. Again, this fact results from the peculiarity of hotels as a workplace. To attract guests and remain competitive, hotel management pursues a policy that everything should be "so clean it sparkles". Floors, walls, windows, mirrors, and bathroom fixtures might be adequately cleaned with some form of an extension tool to reduce bending and over-stretching. However, the demand for spotless cleanliness and hygiene, management often requires their cleaning staff to spend extra time and effort cleaning by kneeling, leaning, squatting, crouching, slouching and stretching. These postures will in time contribute to new musculoskeletal injuries and aggravate old ones.

New approaches, other than strictly ergonomic ones, need to be investigated. For example, action can be taken from the administrative level. Options for improvement include:

- job rotation,
- job enrichment and job enlargement,
- team work, and
- education and training on work practices.

How can job rotation reduce the risk for RMI?

Job rotation is one possible approach. It requires workers to move between different tasks, at fixed or irregular periods. However, it must be a rotation where workers do something completely different. Different tasks must use different muscle groups to allow muscles already stressed to recover.

How can job enlargement and enrichment reduce the risk for RMI?

Another approach is job enlargement. This increases the variety of tasks built into the job. It breaks the monotony of the job and avoids overloading one part of the body. Job enrichment involves more autonomy and control for the worker.

How can team work reduce the risk for RMI?

Team work can provide greater variety and more evenly distributed muscular work. The whole team is involved in the planning of the work. Each team member carries out a set of operations to complete the whole product, allowing the worker to alternate between tasks. This reduces the risk of RMI.

How can improved work practices reduce the risk for RMI?

A well-designed job, supported by a well-designed workplace and proper tools, allows the worker to avoid unnecessary motion of the neck, shoulders and upper limbs. However, the actual performance of the tasks depends on individuals.

Training should be provided for workers who are involved with housekeeping activities. It is important that housekeeping staff be informed about hazards in the workplace, including the risk of injuries to the musculoskeletal system. Therefore, identification of the hazards for such injury at any given hotel is fundamental.

Individual work practices, including lifting habits, are shaped by proper training. Training should encourage employers and workers to adopt methods that reduce fatigue. For example, it is advisable to plan one's workload and do the heavier tasks at the beginning of the workshift, rather than at the end, when fatigue is at its maximum. When a person is tired, the risk of injuring a muscle is higher.

Training should also explain the health hazards of improper lifting and give recommendations on what a worker can do to improve lifting positions. Training should also emphasize the importance of rest periods for the workers' health and explain how active rest can do more for keeping workers healthy than passive rest. The effect of such training can reach far beyond occupational situations because the workers can apply this knowledge also in their off-job activities.

How To Clean a Mattress

Difficulty: Average

Time Required: Varies

Here's How:

1. **Every six months, flip your mattress over.**

To provide even wear, flip the mattress so that the top is now on the bottom, and turn it so that the foot of the mattress is now at the head. Depending on the size of your mattress, this can easily be a two person job.

2. **Cover the mattress, to protect it and extend time between cleanings**

Consider purchasing a mattress cover to protect the surface of your mattress. Choose a washable cover that is easy to remove and replace on your mattress. Some covers are even designed to reduce dust mite allergies, and reduce the need to vacuum your mattress.

3. **Remove dust from the mattress surface.**

Dust, dander, and dust mites build up in your mattress. Even those of us without allergies can begin to notice dust and dirt in our mattress. Vacuum your mattress using the upholstery attachment on your vacuum cleaner. If someone does have allergies in your home, you may need to vacuum more frequently and/or purchase mattress covers.

4. **If the mattress surface becomes dirty or soiled, use an upholstery shampoo.**

Following the directions exactly, use an upholstery shampoo to clean dirt and soil from your mattress surface. Or, mix a mild detergent with water until suds form. Apply the dry suds only to the soiled area using a sponge. Wipe the area with a sponge that has had warm water wrung from it. Allow the area to dry thoroughly.

Tips:

1. Do not allow the interior padding of the mattress to get wet.
2. If it's warm outside, you can dry a mattress quickly outside. You can also use a fan blowing across the mattress surface to insure that it dries quickly.

What You Need:

- Vacuum cleaner with upholstery attachment
- Upholstery shampoo
- Mattress cover
- Mild detergent
- Water
- Sponges

- Fan

How to Clean an Oiled Hardwood Floor

Some older hardwood floors have oiled surfaces. To keep them in top shape, periodic cleaning and re-application of oil is necessary. It's a lot like polishing a large tabletop. Let's run through the process.

Instructions

Difficulty: Easy

Things You'll Need:

- Brooms
- Dustpans
- Rags
- Oil Soaps

Step1



Sweep or use a good vacuum to pick up any dirt and debris.

Step2

Use clean rags to apply oil soap or any cleaning oil designed for wood floors.

Step3



Apply the oil to the rag, not the floor, and wipe the floor with the wet rag.

Step4

Use firm, straight strokes going with the grain of the wood.

Step5



Spread the oil as evenly as possible to ensure that color is affected equally over the entire surface.

Step6

Change to a new, clean rag as often as needed. An average-size room will require several rags.

Step7

Let oil seep into the wood for 1 to 2 hours.

Step8

Make a second, lighter pass with the oil as needed to even up any light spots.

Step9

Continuing to buff the floor with clean, dry rags will heighten the shine and bring out the patina of the wood.

Tips & Warnings

- Sweeping any hardwood floor on a regular basis will prolong the life of the finish by years.

- Oil cleaners or polishes are best used on older, unwaxed and bare-wood floors only. Wax- or polyurethane-finished floors generally need only to be mopped with regular soap and water, or with water and vinegar. Add 1/2 cup vinegar to a gallon of water to keep your vinyl no wax floors clean and shining.
- Pouring oil on the floor and wiping it with a dry rag may cause the oil to spread unevenly and may stain the floor.

How to Mop a Floor



Instructions

Difficulty: Easy

Things You'll Need:

- Brooms
- Detergents Or Floor Cleaner
- Mops
- Vacuum Cleaners
- Water
- Buckets

Step1



Sweep or vacuum the floor clean of dust and dirt.

Step2

Sweep or vacuum a second time. Make sure there is no debris.

Step3

Fill a bucket with hot water.

Step4

Add a small amount of detergent, ammonia or floor cleaner to the water; the directions on the container should tell you how much to use.

Step5



Dip your mop in the bucket.

Step6



Wring out the mop using your hands or, depending on the type of mop you are using, with a lever near the mop head.

Step7



Scrub the floor in straight lines if you're using a sponge mop. If using a rag mop, swirl the mop head in figure-eight shapes. Push the mop vigorously to remove stains or spots on the floor.

Step8

Rinse and wring the mop out in a sink or the bucket occasionally, and continue mopping.

Step9

Let the floor dry before walking on it.

Tips & Warnings

- If a sponge mop head is becoming crumbly or falling apart, change it. If a rag mop is dirty, rinse it and squeeze it out repeatedly until clean, or toss it in the washing machine as directed.
- Some modern floors, such as polyurethane-coated hardwood floors, should not be washed with harsh detergents. Check with your floor covering professional if you have questions.

How to Defog Bathroom Mirrors

Things You'll Need:

- Blow Dryers

Step1

Point a hair dryer at the mirror and turn it on at its hottest setting. Hold the hair dryer about 6 inches from the mirror.

Step2

Wave the hair dryer over the mirror until it is completely defogged.

Step3

If you do not have a hair dryer, open the bathroom door and wait a few seconds.

Tips & Warnings

- Keeping a window open a crack and a fan running while you shower decreases the chances of the mirror fogging up.
- Dry yourself off before using the hair dryer. Do not use electrical equipment in the tub.

How to Clean a Toilet



Instructions

Difficulty: Moderately Easy

Things You'll Need:

- Disinfectant Sprays
- Toilet Brush
- Toilet Cleaner
- Pumice Stones
- Rubber Gloves

Step1

Open the bathroom windows and door, or turn on the fan. You need good ventilation when working with household cleaners.

Step2

Put on rubber gloves and lift the toilet seat. Flush the toilet to wet the sides of the bowl.

Step3



Apply a generous amount of powder or liquid toilet cleaner to the bowl, focusing on getting it along the sides, not just in the water. Be sure to follow the directions for your type of toilet bowl cleaner.

Step4

Let the cleaner stand for a minute.

Step5

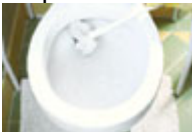

Using the toilet brush, swab all around the interior of the bowl, paying special attention to the area immediately beneath the rim, and to the water line.

Step6

Flush the toilet to rinse. As the water in the bowl is replaced, thoroughly rinse the toilet brush in the incoming water.

Step7

Notice if the toilet bowl has developed a ring. If it has, scrub the stain with a wet pumice stone. Be sure the pumice remains wet throughout the process.

Step8



Spray the seat, the underside of the seat and the rim with disinfectant.

Step9

Wipe down the base, lid and tank top with disinfectant.

Step10

Allow the disinfectant to dry before using the toilet.

Tips & Warnings

- Never mix cleaners. The fumes could be deadly.

How to Clean Shower Door Tracks

Instructions

Difficulty: Moderate

Things You'll Need:

- Liquid Spray Cleaners
- Cleaning Cloths
- Shower Wands
- Towels
- Vacuum Cleaners With Long-nosed Attachment
- Old Toothbrushes
- Scrubbing Pads

Step1

Loosen up grunge and remove hair from completely dry tracks with an old toothbrush, then vacuum with a long-nosed attachment.

Step2

Spray tracks with liquid spray cleaner.

Step3

Scrub with a tile brush and - for those hard-to-reach places - a toothbrush.

Step4

Fold a scrub pad to fit the track and continue to scrub if more cleaning is necessary.

Step5

Rinse tracks with a shower wand (if you have one), or simply pour water into tracks. The tracks contain drain holes that lead to the tub or shower stall, so direct the water in that direction and away from the floor.

Step6

Use cleaning cloths to wipe away any dirt left behind during rinsing process.

Tips & Warnings

- Place towels on the floor to catch overflowing water when rinsing.
- If you have gold or brass doors, use cleaners as directed, and avoid harsh scrubbing.

How to Replace a Shower-Door Sweep

If floor gets a shower when you take one, chances are your shower-door sweep--the rubberlike strip that lines the bottom of the door--needs to be replaced. A worn strip lets water seep beneath the door and onto your floor. Left unchecked, that leaky little strip could leave you drowning in some serious water damage.

Things You'll Need:

- New Shower-door Sweep
- Petroleum Jelly
- Scissors
- Screwdriver

Step1

Open the shower door from the outside.

Step2



Grab the edge of the sweep and pull it toward the outside of the door until the strip is removed from its track (see A). In some cases, you may need to unscrew the sweep from the track.

Step3

Bring the old shower-door sweep to a hardware or home supply store to purchase a new one that matches its height. Sizes vary slightly.

Step4



Using the old sweep as a pattern, cut the new sweep to the same length with scissors (see B).

Step5

Install the new shower sweep. If a sweep that's supposed to fit in a track sticks going in, lightly coat the edge of the sweep with petroleum jelly.

Step6

If the new sweep doesn't stop the leak, consider recaulking around the shower door area (see How to Fix a Shower Door) or checking the grout around the shower.

Tips & Warnings

- Keep a bathmat in front of the shower entrance to protect the floor from excess moisture and to reduce the chances of someone slipping after a shower.

How to Keep a Sliding Shower Door in its Tracks

Instructions

Difficulty: Easy

Things You'll Need:

- Lubricating Oils
- Screwdriver Sets

Step1

Check the rail (or track as some people or manufactures call it). The rail could be fouled with some kind of debris. (Some manufacturers provide a lubricant that is applied at installation.) This lubricant can collect grime over time, causing problems with door movement.

Step2

Use a grease-cleaning product to fix this problem.

Step3

Fixing corrosion may require replacement of the rail section or the entire door.

Step4

Check the rollers themselves - sliding the door can also be hampered by problems with the rollers. Check to see whether the roller may need a drop of lubricant on its axle. Years of use can cause worn spots on the surface of the rollers, making the door difficult to move.

Step5

See whether adjusting the track cover that comes with some models stops the problem.

Step6

Consider replacing the entire unit - this may be the best option to get rid of an older or inferior product.

Tips & Warnings

- Some rollers are made to be replaced, others may require replacement of roller and mounting bracket assembly.

How to clean a fiberglass tub

Instructions

Difficulty: Moderately Easy

Things You'll Need:

- tub cleaner
- soft scrub brush
- car polish

Step1

clean tub very well

Step2

rinse and let dry

Step3

coat tub with car polish and buff off,this will keep your tub from cracking with age

How to Clean a Stained Toilet



There are so many different ways to clean an old or stained toilet.

Instructions

Difficulty: Easy

Things You'll Need:

- a dirty or stained toilet
- "The Works" toilet bowl cleaner from Walmart
- other cleaning products listed below
- a pumice stone

Step1



My most favorite way to clean a toilet (as if cleaning a toilet is at all fun) is to use The Works. I love this stuff. It can be found at Walmart, usually on the bottom shelf where the other toilet cleaners are. I bought this after I moved into a house with old, rusty, stained toilets. I bought it thinking it wasn't going to work very well because it was very cheap. I followed the instructions and left the cleaner in the toilet for 10 minutes. It came completely clean, like a new toilet. It is now my regular cleaner and now they have a shower and tub cleaner that works just as well.

Step2



There are also other cleaners like bleach that require more elbow grease. You can also use denture tablets but again more elbow grease.

Step3



You can remove stubborn stains and marks with a pumice stone as well but I don't know about you I don't like getting my hands that close to the toilet gloves and all.

Tips & Warnings

- use 6 oz. or more of The Works for best outcome
- wear gloves
- DON'T MIX CLEANERS
- If you are going to use the bleach be careful with the kids and your clothes
- don't get in eyes or on skin

How to Remove Toilet Base Stains

Instructions

Difficulty: Easy

Things You'll Need:

- Brushes
- Cleaner
- Rag

Step1

Get a good scrub brush with stiff bristles. You may want to use a large brush for overall area cleaning and a smaller brush, or even an old toothbrush, for hard-to-get areas.

Step2

Wear rubber gloves when cleaning the area at the base of the toilet. Take sanitary issues into consideration for stain removal and protect your skin and health.

Step3

Find a good disinfectant cleaner that works well on tile and ceramic. If your floors are hardwood or marble, make sure you find a cleaner that won't stain or damage them.

Step4

Spray or pour the cleaner on the toilet base and on the floor around the toilet.

Step5

Use the brush to scrub the base and floor, and wipe clean with a rag.

Step6

Repeat Steps 5 and 6 for stubborn stains. Let the cleaner soak onto the stain for a minute or so before scrubbing to hopefully break it up.

Tips & Warnings

- If your toilet base stains are coming from too many young boys in the house, invest in a toilet mat that can protect your floors until you get them trained better.
- When you've got a stain that just won't budge, try products that bleach if you have a white floor. Use oven cleaner on the base of the toilet, but be careful it doesn't get on your floor.
- Make sure the stain isn't coming from a leak under the tiles, which is really a mildew or mold build-up. If it is, you'll have to replace the area around the toilet--or worse, the whole floor.

How to Remove Red Wine Stains From Fabric

There are some stains you hardly have to worry about right away and then there are those that need to be taken care of right away. Red wine stains would be in the latter category. From painstakingly washing the fabric by hand to simply tossing it into the washing machine, effective methods are available for getting rid of those dreadful red



Instructions

Difficulty: Easy

Things You'll Need:

- Laundry detergent, laundry pretreatment or dish soap
- Clean sponge
- Washing machine
- Paper towels
- Hydrogen peroxide

- Towel or washcloth

Step1

Blot the stain immediately with paper towels. If it is a dry clean only garment do not pretreat the stain and get it as fast as you can to the cleaners. Pretreatment of the stain can cause irreversible damage and the dry cleaner may not be able to remove the stain.

Step2

Combine 1 teaspoon laundry soap or pretreatment (or dish soap, like Dawn) and 1 cup hydrogen peroxide in a small bowl. Soak a clean sponge in the mixture, squeeze it halfway dry, then gently blot the stain.

Step3

Place a dry towel or washcloth between the front and back of the garment if the stain has not penetrated through to the back of the fabric. This will prevent staining on the back of the material.

Step4

Review the washing instructions on the label of the fabric. Heed any special care instructions.

Step5

Wash in cool water and air dry if the fabric is machine-washable.

Step6

Wash gently in the sink with a mild detergent if the fabric is hand-wash only.

Tips & Warnings

- Always use white paper towels, as colored towels may stain.
- Avoid scrubbing or rubbing the stain excessively. This can cause the stain to further penetrate the fabric.

How to Remove Red Wine Stains From a Carpet



Don't worry-- while that bright red stain on your carpet might look like the end of the world, it doesn't stand a chance against these stain-busting instructions. Follow them with patience and determination and you can have it out in no time.

Instructions

Difficulty: Moderate

Things You'll Need:

- Paper towels or clean cloth
- Rug Doctor brand carpet shampoo or dish soap
- Warm Water
- Sponge
- Hydrogen peroxide

Step1

Blot the spill with paper towels or a clean cloth.

Step2

Combine 1 teaspoon carpet shampoo (or dish soap, like Dawn) and 1 cup hydrogen peroxide in a small bowl. Soak a clean sponge in the mixture, squeeze it halfway dry, then gently blot the stain. Continue until the stain lifts.

Step3

Sponge the stained area with warm water.

Step4

Blot dry with a clean cloth or paper towels.

Tips & Warnings

- Act immediately. The longer a stain sits, the harder it is to remove.
- Commercial products like Oxy Clean and Wine Away do an excellent job of removing red wine stains, but try this homemade version if you don't have either of those on hand.

How to Eliminate Wine Stains From a Rug or Tablecloth

Instructions

Difficulty: Easy

Things You'll Need:

- Dishwashing Liquid
- Color-safe Bleach
- Liquid Laundry Detergent
- White Absorbent Cloths
- Coarse Salt

Carpet

Step1

Move fast! To keep red wine stains from setting in carpets or linens, quick blotting or rinsing with cold water is key. On a wet stain, dab the carpet or tablecloth with a dry, white absorbent cloth to remove the excess liquid. If it's the next morning or the stain has dried, skip to step 2.

Step2

Apply a small amount of detergent solution--1/4 tsp. dishwashing liquid and 1 cup (8 fl oz/250 ml) lukewarm water--to a white cloth and gently blot, working from the edges of the spill to the center to prevent spreading. Let it sit for several minutes.

Step3

Repeat as needed until the stain is removed.

Step4

Rinse with cold water. Dab with a clean rag until dry.

Tablecloth

Step1

On a new, wet stain, sprinkle coarse salt to absorb liquid from the fabric. Then blot with cold water or rinse under cold water to remove excess sugars and prevent oxidation.

Step2

For an older, dry stain, rub a bit of liquid laundry detergent into the stained area. Launder in the hottest water safe for the fabric with laundry detergent and color-safe bleach.

Step3

Repeat as needed until the stain is gone.

Tips & Warnings

- If at first you don't succeed, blot, blot (or wash, wash) again. It often takes several times for the remedy to do the trick.
- To remove wine stains from clothing, see How to Remove Clothing Stains.

How to Clean Stains From Furniture

Big-ticket items like furniture and upholstery should be dusted and vacuumed regularly. It's the only way to keep in check the airborne cooking oils and dust that inevitably settle on these pieces. But what's the solution to little Jack's chocolate snack that ended up sweetening the ottoman? Or Grandma's makeup smudges on the sofa? Busting these and other stains is a piece of cake.

Instructions

Difficulty: Easy

Step1

Blot the excess stain, do not soak it. This is true for all stain types.

Step2

Determine what kind of stain it is.

Step3

For grease stains, butter, gravy and salad dressing, blot on a small amount of rubbing alcohol or dry-cleaning fluid. Repeat until there is no more transfer of stain to white cloth or plain white paper towel. Then blot with a solution of dishwashing liquid and warm water, blotting from the outside of the stain in.

Step4

For makeup, rub a small amount of rubbing alcohol or dry-cleaning fluid on the stain and blot dry immediately. If the stain is particularly stubborn, then blot it with a solution of vinegar and warm water, and blot dry it immediately.

Step5

For ink, blot the fabric with rubbing alcohol and blot dry immediately. Repeat until the stain disappears. Then, rinse with a solution of white vinegar and warm water and blot dry again.

Step6

For juices, wines and tomato-based sauces, wet the fabric slightly with warm water and let soak for one minute. Then blot dry with a paper towel. Repeat until no stain substance is visible on the paper towel. Then, rub in a detergent solution of dishwashing liquid and warm water and repeat until no stain transfers to the paper towel. Finally, blot with club soda or tonic water.

Step7

Blot in with warm water and pat dry with a paper towel. This is a universal step to be performed after the specific removal process, regardless the type of stain.

Step8

Brush dry with a clean, dry wash towel or soft-bristle brush.

How to Get Rid of Ceiling Stains

Instructions

Difficulty: Moderately Easy

Things You'll Need:

- Pigmented Stain Blocker
- Ceiling Paint
- Damp Rag
- Drop Cloth Or Plastic Sheet
- Paint Roller Or Paintbrush
- Paint Tray
- Stepladder

Step1

Make sure the leak is fixed before removing a ceiling stain. Lay a drop cloth or a plastic sheet below the stained area of the ceiling to protect your carpeting or floor from drips. Standing on a stepladder, wipe the stained ceiling surface clean with a damp rag.

Step2

Apply a pigmented stain blocker such as Kilz or Bullseye on the stained area using a paint roller (for center stains) or a paintbrush (for corner stains). Paint 6 to 12 inches (15 to 30 cm) beyond the stain's edges.

Step3

Let the ceiling dry for 1 to 24 hours (follow the manufacturer's directions).

Step4

Apply a coat of ceiling paint. Let dry. Repeat if necessary.

How to Remove Mildew From Walls and Ceilings

Seeing fuzzy black or green spots on a bathroom wall or kitchen ceiling? Chances are it's mildew--the common name for the various spores that are both a health hazard and a homeowner's nightmare. Once inside walls and ceilings, mildew is tough to remove. Send these nasty interlopers packing quickly.

Instructions

Difficulty: Moderately Easy

Things You'll Need:

- Chlorine Bleach
- Plastic Spray Bottle
- Anti-mildew Paint
- Plastic Scrubber Sponge
- Powder Laundry Detergent
- Rubber Or Latex Gloves
- Bucket
- Stepladder

Walls

Step1

Wear rubber or latex gloves. Spray the wall with a solution of 1/2 cup (4 fl oz/125 ml) chlorine bleach, 1/3 cup (3 fl oz/80 ml) powder laundry detergent and 1 gallon (4 l) hot water, working from

the base of the wall up. (Or you can use a commercial mildewcide, though it's much more expensive than mixing your own.)

Step2

Gently scrub away surface mildew using a plastic scrubber sponge.

Step3

Using the scrubber sponge, rinse thoroughly with fresh water.

Step4

Once dry, consider applying a coat of paint containing an antimildew agent so you don't have to do this again any time soon.

Ceilings

Step1

Wear rubber or latex gloves. Dip a scrubber sponge in a bucket filled with a solution of 1/2 cup (4 fl oz/125 ml) chlorine bleach, 1/3 cup (3 fl oz/80 ml) powder laundry detergent and 1 gallon (4 l) hot water. (Or you can use a commercial mildewcide, but it's much more expensive than mixing your own.) Squeeze out the excess.

Step2

Standing on a stepladder, carefully scrub the affected areas.

Step3

Fill the bucket with fresh water. Using the scrubber sponge, rinse thoroughly.

Step4

Once dry, consider applying an anti-mildew paint.

Tips & Warnings

- Keep cleaning solution from dripping onto carpeting or floors.
- Prevent mildew by using exhaust fans when cooking and showering.
- Throw open windows often to decrease humidity.
- See How to Troubleshoot Mold on Interior Walls for more ways to prevent mildew.
- Always wear rubber gloves when cleaning with bleach.
- Make sure the room is well ventilated to avoid inhaling hazardous bleach fumes.

How to Treat Mildew Damage

Mildew is happiest in damp, dark places where air can't circulate, so your closet can be a prime breeding ground for the fungus, which likes leather and most fabrics. When you notice mildew on clothes or accessories, get rid of it as quickly as possible; in addition to being an allergen, it smells terrible and is unsightly.

Instructions

Difficulty: Moderately Easy

Things You'll Need:

- Spray Bottle
- White Distilled Vinegar

Step1

Pour undiluted white distilled vinegar into a spray bottle. Vinegar has a high success rate for getting rid of mildew, and it also eliminates the bad odor.

Step2

Spray the vinegar onto the affected area of the garment or accessory.

Step3

Let the vinegar work its magic for several hours, ideally outside in the sun.

Step4

If you're dealing with a garment, wash it only after the sight and smell of the fungus is gone. Use warm, sudsy water, and hang the garment to dry in a clean, dry place.

Tips & Warnings

- Liquid chlorine bleach also kills mildew. Check the tags on your garment to find out if it's safe to bleach them. Other acidic substances like lemon juice or grapefruit juice can also combat mildew damage.

How to Remove Mildew from Carpet

Flooding, wet basements, high humidity - whatever the reason, living with mildewy rugs and carpets is about as unpleasant as it gets. Here's what to do if your carpeting is musty and moldy.

Instructions

Difficulty: Moderately challenging

Things You'll Need:

- Liquid Dish Soap
- Cleaning Cloths
- Ammonia
- White Towels

Step1

First, try to remove as much of the mildew as you can with a vacuum cleaner, or by beating area and throw rugs outside with a broom. If you use a vacuum cleaner, throw the vacuum cleaner bag away as soon as you're finished.

Step2

Mix a sudsy solution of 1/2 tsp. liquid hand dishwashing detergent and 1 cup lukewarm water.

Step3

Sponge the detergent solution onto the mildew stain. Allow to sit for about 10 minutes.

Step4

Rinse the area with water and blot dry with a clean, white towel.

Step5

Mix a solution of 2 tbsp. ammonia and 1 cup lukewarm water.

Step6

Blot ammonia solution into the stain with a clean, white towel.

Step7

Blot dry with a white absorbent towel.

Step8

Allow rugs to dry outside in the sun, if possible. Or, dry indoors with an electric heater and fan.

Tips & Warnings

- To prevent mildew, make sure the rug or carpet gets as much sunlight as possible: open blinds and windows and keep a fan running in rooms prone to dampness.

How to Clean Mud From Carpet

Cleaning mud from a carpet is a messy proposition. Try this simple way to get the dirt out.

Instructions

Difficulty: Easy

Things You'll Need:

- Soft Dry Cloth
- White Vinegar
- non-bleach, non-alkaline mild detergent

Step1

Apply a small amount of mild liquid detergent to the stain.

Step2

Blot the stain with a dry, white cloth.

Step3

Flood the area with white vinegar.

Step4

Blot again with the cloth.

Step5

Apply a little more liquid detergent to the stain.

Step6

Blot the stain again.

Step7

Flood the area with water.

Step8

Blot one last time.

Tips & Warnings

- This technique will work on either dry or wet mud stains.
- Always test the cleaning solutions on an inconspicuous part of the carpet before using on a large area.
- Always use a white cloth rather than a colored one to prevent any dyes from coming off on the carpet.
- As you blot, keep turning the cloth so that you are using a clean, dry section to pick up the stain and the cleaning fluids from the carpet. Don't rub.
- If using a brush to help clean the stain, always brush from the outer edges of the spill inward to prevent the stain from spreading.

How to Vacuum Carpets and Floors

Instructions

Difficulty: Easy

Things You'll Need:

- Cleaning Cloths
- Crevice Tool Vacuum Attachments
- Lightweight Vacuum Cleaners

- Vacuum Bags

Step1

Inspect the area before you vacuum. Pick up objects that could cause a clog in your vacuum cleaner.

Step2

Check the vacuum bag to make sure it isn't already full. If it is, change it.

Step3

Vacuum forward instead of backward: you'll get the job done faster and you won't wear out your cord as quickly.

Step4

Overlap your strokes to ensure that you get all dirt and residue.

Step5

Change your vacuuming direction occasionally to reduce matting in your carpet.

Step6

Use a damp cloth on corners, or use a crevice tool attachment on your vacuum cleaner.

Step7

Get rid of dust particles by occasionally waving a vacuum wand under your bed.

Tips & Warnings

- For litter on carpets and floors, use a lightweight vacuum cleaner; for cleaning deep into the carpet, use an upright vacuum and a power brush.
- Consider purchasing a vacuum with a rotating brush or combination beater/brush bar, which loosens dirt in the carpet and then sucks it up.
- Vacuuming isn't just for carpets: keeping floors free of loose dirt is one of the most effective ways to maintain them.
- Straw, string and thread can trap debris in the vacuum hose and cause a clog.

How to Remove Mildew Stains From Tile



Instructions

Difficulty: Moderately Easy

Things You'll Need:

- Sodium Hypochlorite
- Liquid Bleach
- Stiff-bristled Cleaning Brushes

- Tile Cleaners
- Old Toothbrushes
- Rubber Gloves
- Grout Coloring Agents

Step1



Remove as much mildew as possible by spraying the area with tile cleaner and scrubbing with a toothbrush or stiff-bristled brush.

Step2



Squirt persistent mildew with a solution of commercial bleach and water (1 part bleach to 10 parts water is usually effective).

Step3



Leave the room and allow the solution to work for 5 to 10 minutes.

Step4

Return and rinse with water.

How to Clean Plastic or Vinyl Shower Curtains

Instructions

Difficulty: Moderate

Things You'll Need:

- Garden Hoses
- Liquid Bleach
- Sponges

Step1

Remove the shower curtain from its hooks.

Step2

Lay the curtain on a flat surface outside.

Step3

Rinse using a garden hose.

Step4

Scrub the curtain with a sponge and mixture of diluted bleach, using one quart of water for every cup of bleach.

Step5

Rinse thoroughly.

Step6

Repeat on other side.

Step7

Allow to dry.

Tips & Warnings

- For really tough mildew stains, you might consider replacing your old shower curtain with a new one. (They're cheap!)
- If working outside, keep cleaning solutions away from plants.

How to Clean a Bath Mat

Instructions

Difficulty: Easy

Things You'll Need:

- Liquid Fabric Softeners
- Bath Mats
- Bath Rugs
- Clothes Dryers
- Mild Detergent
- Washing Machines
- Fabric Softener Sheets

Step1

Set your washing machine's water temperature according to the color of your bath mat (hot for white, warm or cold for colors) or according to the bath mat's care label instructions.

Step2

Use mild detergent.

Step3

Set your dryer at low temperature and tumble dry, or hang or spread the mat in the shade until dry.

Step4

Brush bath mat lightly to refluff.

Tips & Warnings

- Some bath mats are rubber-backed and should not be placed in the dryer. Be sure to read care label before putting your bath mat in the dryer.

How to Clean Curtains



Washing curtains is one of the most dreaded tasks on the "spring cleaning" list.

These tips will make it a bit easier.

Instructions

Difficulty: Moderately Challenging

Things You'll Need:

- Tape Measure
- Dryer
- Iron

Step1

Measure curtains before washing in case you need to stretch them back into shape. Remove all embellishments such as hooks and ties so that they lie flat.

Step2

Before washing, dust the curtains by running them through the dryer on NO heat.

Step3

After curtains are washed, lay them out to dry.

Step4

Iron while damp along the vertical length of the side that doesn't show. If parts of the fabric have already completely dried, dampen the entire curtain again to avoid water marks.

Step5

Stretch seams gently while ironing to avoid puckering, then spread the curtains out on a clean surface (like a bed) and pull them to the correct size.

Tips & Warnings

- Curtains get very heavy when wet.
- Don't dry curtains over anything wood, as the wood can stain the curtains.

How to Clean Dishes, Pots & Pans with Baking Soda

Instructions

Difficulty: Easy

Things You'll Need:

- Baking Soda
- Dirty Dishes

Step1

Fill sink with water and regular measure of dish soap.

Step2

Sprinkle a solid coat of baking soda over the trouble areas of the pans.

Step3

Gently set pans in soapy water. You want the baking soda to get wet, but not fully disperse in the water. Leave to soak for one hour or more.

Step4

Wash dirty pans as normal.

Tips & Warnings

- Serious stuck on food may require longer soaking time.
- Rinse slightly longer than normal. Baking soda is well rinsed when dishes are no longer slippery.
- Dishes, pots and pans will be VERY slippery. Use care not to drop them during the wash.
- May not be safe for teflon surfaces. I have used on teflon without any problem, but I can't promise you will have the same result.

How to effortlessly removed burned on food from pots and pans

Instructions

Difficulty: Easy

Things You'll Need:

- scorched pot or pan
- dishwasher soap
- hot water
- scouring pad

Step1

Rinse pot to remove excess food

Step2

Add 2 tablespoons dishwasher soap

(if using caked soap, cut in half)

Step3

Add hot tap water

Step4

Let sit overnight (or minimum 6 hours)

Step5

gently scrub with scouring pad

Step6

rinse and wash

Tips & Warnings

- this also works beautifully with coffee makers. Follow the same steps and the coffee pot and filter holder will come out sparkling clean!

How to Clean Glass Bottles

Instructions

Difficulty: Easy

Things You'll Need:

- vinegar, any kind works
- baking soda
- bottle brush
- time

Step1

take the glass bottle and pour about half a cup of vinegar and let it soak for about an hour.

Step2

Scrub around inside with a bottle brush and see if its come cleaner

Step3

If the vinegar alone isnt working then add a teaspoon of baking soda. This will make it FOAMY so do it over the sink. After it has finished foaming, scrub some more with the bottle brush.

Step4

Keep repeating steps 1 thru 3 as necessary. The glass bottle will come clean. Rinse well when its clean.

Tips & Warnings

- You should do this over the sink because it can be messy
- avoid getting in eyes
- dont drink this

Up-keeping of Hotels

The quality of the hotels as well as offices, restaurants, motels, hostels etc. depends on the quality and efficiency of the housekeeping. The house-keeping is a general term applied for the activities related to the upkeep of things in proper order in the premises inside and outside with sense of aesthetics and other technical ways. Good house-keeping provides the feeling of comfort, security, appeal as well as dignity to the guests and users of the facility.

HOUSE-KEEPING SERVICES

House-keeping services relate to following areas:

Hotel Bed Rooms

Standard hotels have more or less uniform pattern of arranging the rooms with single, double (suitable for two) and twin beds (two single size beds) with comfortable these materials cause discomfort in rooms having no air conditions in summer times. Average height of a bed is 2ft, from the floor. Standard length of the single bed should be 6 ft. 3 inches x 3 ft and the double bed 6 ft, 3 inches in length and 5 ft. in width. In case of small hotel having no arrangements for air-conditioning and mosquito control, beds must be provided with suitable arrangement for use of mosquito nets. Hotel beds are now additionally decorated in rooms with wide decorative head board these can be termed as 'bed top decoration' matching with the decor of the room and the bed. These are sometimes fitted with reading lights. Small side tables are also provided with the beds for water, telephone etc.





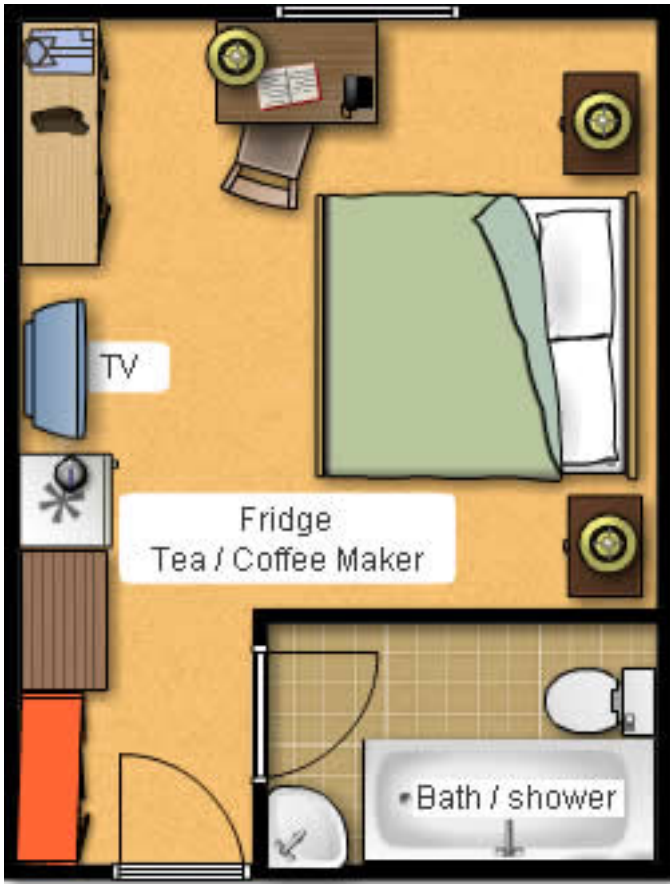

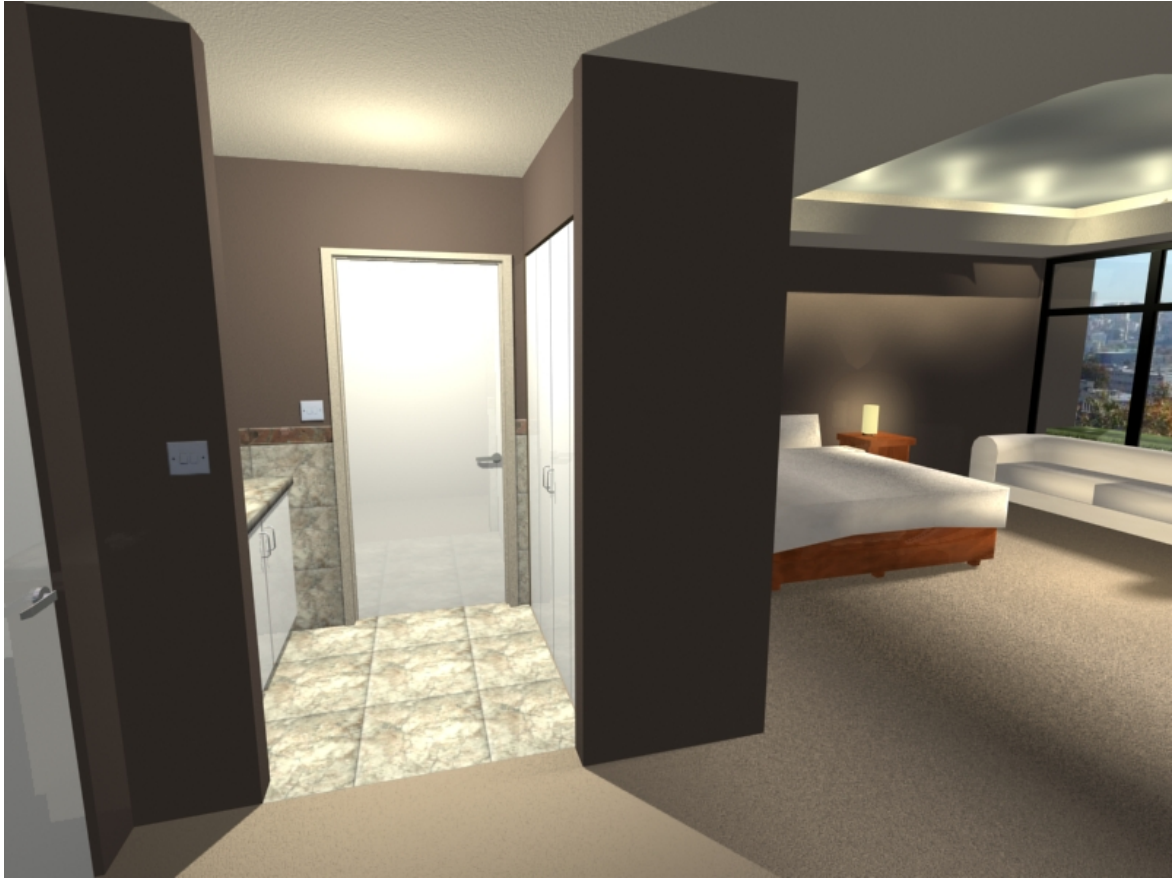



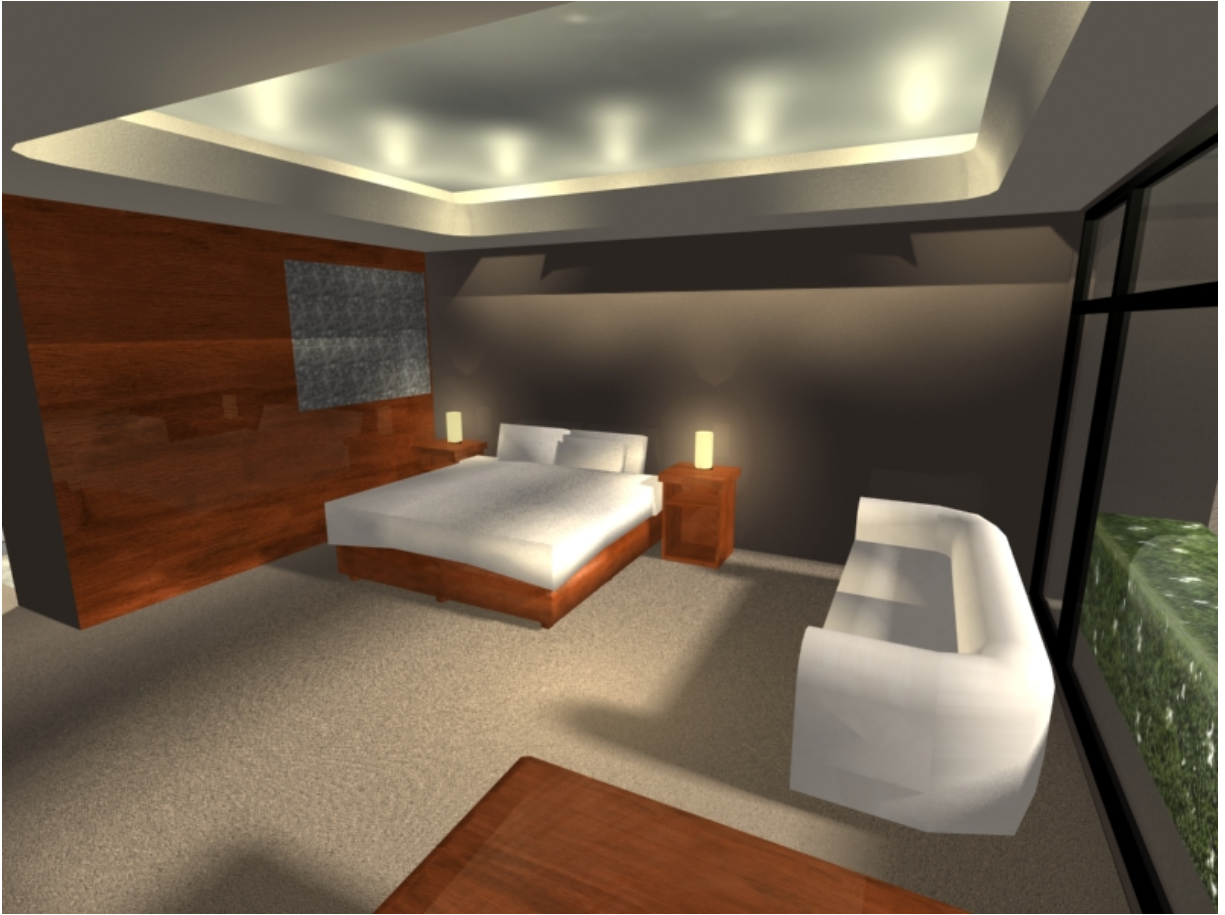



















Hotel bed rooms also have other furnitures. These are usually 2 low chairs or sofas, one tea table, dressing table-cum-writing table with drawers and one chair, mirror and the wardrobe. In some places bedrooms also have luggage racks. Depending upon the type of hotel, policy and based on the investment, the quality of the furniture varies.

Presently, television sets, mini bars are provided in many places and for these adequate space and furnitures are also needed. Bed rooms are often carpeted wall to wall or partially. But there are hotels where carpeting is not provided . Bed rooms may or may not have balconies. There are curtains usually for the windows,

Toilet

In most places these are attached with bedrooms. Present day toilet provide W.C. (Western style), wash basin combined with granite or marble slab to act as basin table with mirror preferably on the right side of the toilet entrance door and the shower-cum-bath on the left. In some places only shower cubicle is provided. In good hotels there should be arrangement for hot water particularly during winter.

Bottle opener, towel hanger, candle holders, dust bins, sani bins are provided in bath rooms. Adequate lighting and slip proof flooring are also must in the bathrooms. Indians are in the habit of washing their undergarment and handkerchief etc. in hotel bath rooms, wherever possible self washing arrangement may be provided or in order to keep the bathrooms clean, the garments may be collected by hotel staff for washing apparently free of cost.

The actual cost of washing with labour etc. may be invisibly added to the tariff of the hotel without any hint to the guest. The washing service again may be considered as one of the additional service to the guests. However, appropriate management, manpower and timely delivery system are required to organise the so-called free of charge laundry service to the guest particularly in smaller hotels having local clients.

How to Clean and Arrange Bed Rooms and Toilets

As indicated earlier the hotel bed rooms have bed as well as other furniture and fixtures. These are to be cleaned and arranged daily with replacement of guest stationeries, water tumblers, soap, towels, bed sheets. Wherever flower is given, this needs replacement as well as fresh arrangement. In fact, there is routine repetition of jobs for arranging and cleaning the rooms even when guest continues to stay more than 24 hours. Basic principles of room cleaning and arranging beds are described here.

The cleaning procedure usually starts in the morning after 10 AM (normal time to go to the office) with the general expectation that guests will be out of the rooms and it is a convenient time to clean and arrange the room. After opening the doors and windows for airing the rooms, the used linen of beds and bath are to be taken out for replacement. Guests clothes, reading articles, shaving articles etc. if any in the room are to be cleaned and arranged.











The room carpet and other furnitures are to be dusted and cleaned first before making the bed. The water in water flask is to be replaced and fault in any switches or on other items are to be reported for prompt repair. The windows are to be again closed and door locked. The total appearance of the room should be as fresh as at the time of checking in. Hotel beds are usually provided with following linen bed sheets.

-
- | | | |
|--|---|--|
| 1. Blanket (in winter and in AC room) Extra may be provided on request | | |
| 2. Night spread | - | 1 (under the blanket) |
| 3. Bed cover | - | 1 (of suitable design) |
| 4. Pillow cover | - | 2 for 2 thinner pillow or 1 for 1 standard pillow. |
| 5. Bed sheet | - | 1 for one bed. |
-

Hotel must keep adequate number of linen in stock (at least 3 sets for each bed).

In hotel where 24 hours laundry facility is not available, 5 sets may be required for undisturbed operations.

Apart from the linen, in good hotels, laundry instruction cards, TV cards, room service menu and order cards, guest's writing pad, envelop, match box etc. are provided in the room. These things should be kept in order and with fresh supplies whenever necessary so that guest need not have the chance for complaints.











Special attention should be paid to clean hotel bathrooms. Presently in most places attached bath with western fittings are used. If the bathroom is not airy, well ventilated and properly cleaned, then the very purpose of attached bath is defeated. Hotel bath rooms are sometimes provided with some amenities like toilet paper, face papers, match boxes, candles, towels, shower cap, soap, shampoo, sachets etc. In course of cleaning and arranging bath rooms adequate care should be taken to replace and arrange things side by side with routine cleaning of bath rooms.

Cleaning staff may be taught the following for proper cleaning of the toilets. Used linen from bath rooms are to be removed as also the waste materials like empty match boxes, used tissue papers, empty drink bottles. Ceiling, walls, light, shades are to be cleaned. W.C. should be washed and dry and properly flushed Before leaving the toilets, the floor, basin base and mirrors are to be wiped and cleaned with suitable agents. Bath rooms should be supplied with fresh towels every day.

Bath towel	-	2 (for use of two persons)
Face towel	-	2 (for use of two persons)
Hand towel	-	2 (for use of two persons)

Soap, shampoo, other toileting according to the policy of the hotels are to be provided. House-keeping also takes care of the linen given to a room, particularly at the time of departure of the guests. In case of any missing articles or guest items found must be brought to the notice of the managerial staff.

In many small or large hotels a further cleaning of rooms takes place before guests retire for the night. This may be carried out on request of the guests or as a policy of the hotel and with the consent of the guest. This is in fact a repetition of the morning service and arranging of the bed in particular, guest often use the carpeted floor, bed etc. as additional seats for their friends and business associates and rooms are often littered with chicken bones, paper pieces and strained due to alcohol and coffee, etc.

Hotels need to provide extra house-keeping services sometimes in odd hours and at the call for guests because of such activities in the room. This also limits the life of furniture, fixtures of a room as well and it is difficult to provide desired level of clean and timely disciplined service with adequate “off to the service staff.

Public Area

Areas not confined in rooms and attached toilets, balconies are known as public areas. Depending upon the size of the property, public areas including terraces, corridors, elevator, lounge, convention rooms, lobbies, restaurants, bars, general offices, reception areas, carpeted areas and all other areas not specifically defined. Outside walls and outer perimeters of the hotel also need upkeep on appropriate intervals.





The hotel proprietor must attach equal importance to the total house-keeping of the hotels both inside and outside. Many five star hotels have gardens, lawns and huge other areas which require expert maintenance and upkeep. Sometimes hotel staff gets very short interval between parties to organise house-keeping and this matter must be taken into account while accepting party bookings for the sake of good arrangement and maintenance of the reputation

Vigilance

Varieties of people come to the hotels for varieties of purposes Thus, it is very important that some kind of vigilance over the guest is necessary. At the same time for special guests, VIP, guest etc. privacy must also be provided. These are actually carried out by the house-keeping staff. House-keeping staff keeps an eye over the suspicious movements of guests. Guests' luggage volume, luggage movements are watched and reported to the superiors in case of suspicion. Under no circumstances there should be a feeling among the guests that they are being watched or spied and the privacy disturbed. The vigilance is for notorious guests and for the security of good guests.

Tools and Equipments for House-keeping Operation

Like any other job, the house-keeping jobs also need some specific tools and implements. Depending upon the investment, availability and requirements the type of mechanical or fixed ladders, vacuum cleaners, laundry machines, sewing machines, electrical mops, electric brushes of different types, polishes of different types, cleaning chemicals and solutions of different types are used for house-keeping.





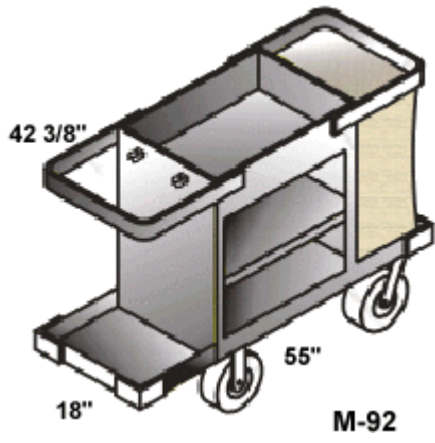





*Ties attached to
princess seam for
flexible waist
adjustment*

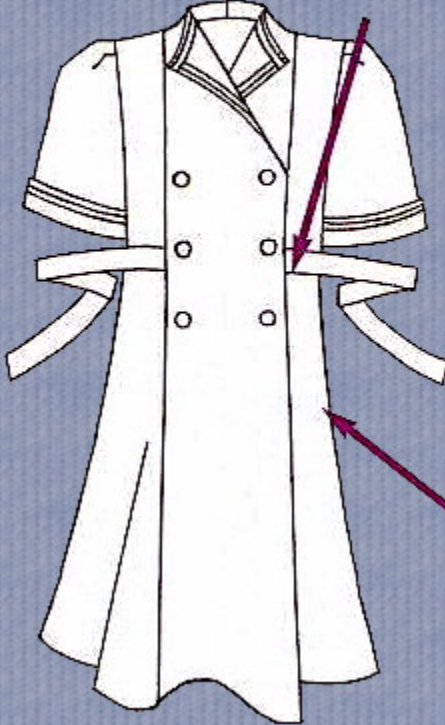

*Extra deep
side seam
pockets*





There are number of products now available in the country For brass items brasso, for silver items silvo, for wood manson polish, chromum polishes for metal fittings, sae vac for carpet freshness and odonil etc. for room and toilet freshness are used Herpic, Sunny fresh are used for W.C. cleaning. Dettol, savlon are used for cleaning mouth pieces of telephones.

House-keeping Trolley

This is practically must for methodical house-keeping in hotel rooms. These trollies are located in each floor at a suitable place already designed and contains the following:

2 bags—one for garbage and one for dirty linen, cleaning items and polishes, brushes for room and W.C. other brushes feather duster and mopes etc. are taken in the trolley, guest stationery items for room and toilets, glasses, bulbs etc. Information cards for the use of guests are carried in the trolley.

Trolley also contains all the fresh linen for replacement and charge in the rooms.



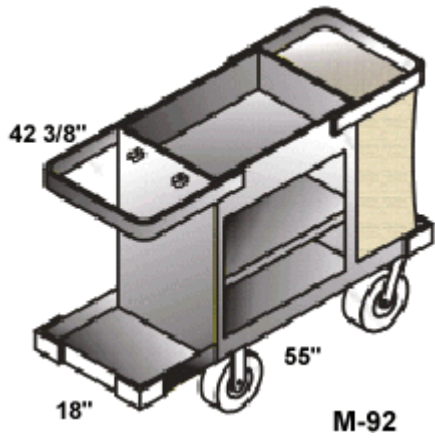



Where there is no prior design to place the house-keeping trolley suitable other arrangement should be made or the trolley function may be carried out through other alternative ways using sweepers kit, linen kit etc. and suitably locating them. In fact the House-keeping trolley (HKT) is a mobile house-keeping stores as well as collecting vehicle for used and dirty items from rooms.

Room for Flower Arrangement

In order to provide beauty and aesthetics there is nothing to beat fresh and colourful flowers. In good hotels there is a separate section under house-keeping for daily arrangement of fresh flowers for reception desk, banquet hall, conference rooms, restaurant etc. Sometimes, guest rooms are also provided with flowers in flower vases. There are many detailed techniques for arranging and choosing flowers for various occasions. These must be followed at the time of flower arrangement.







The arrangement should not be monotonous. It should be variable with matching contrast and befitting for the occasions. Placement is also important and should not create disturbance to the guests. On top table for conference etc. the faces of speakers should not be covered due to any tall arrangement. The base of the vases should be firm and should not easily tilt due to small movements. Bad smelling flowers or foliage must be avoided as well as materials which are not fresh. Timely replacement of dried or otherwise non-attractive flowers and foliage should be promptly carried out.

Linen and Uniform Room

A well designed and furnished space is necessary for a good housekeeping department. In very large hotel the house-keeping department is specially designed keeping in view the requirements and services to be offered. The house-keeping department of large hotels must have place for fixing laundry equipments, flower arrangement room, tailoring room, upholstery repair room etc. There should be well defined adequate space and counters for storage of supplies and exchange of soiled and fresh linen and uniforms.

Mat Placement Guide

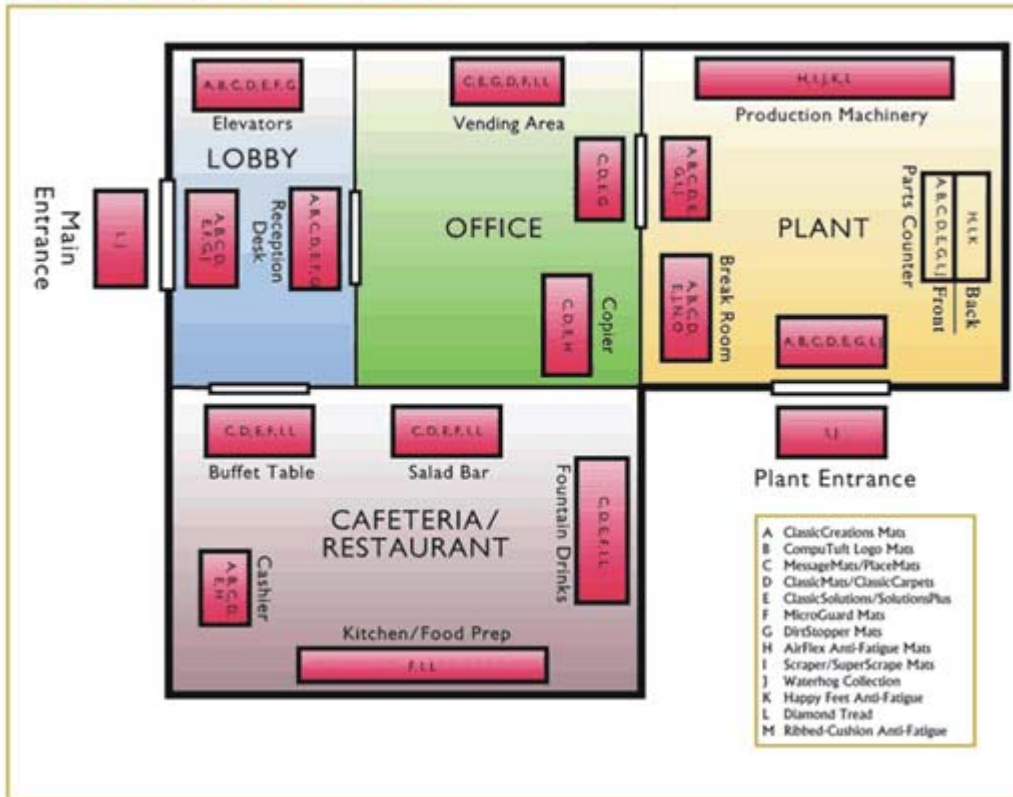



**Need A Little More
Storage Space?**

...In Your Garage?

- Save floor space
- Increase storage capacity
- Reduce access time
- Reduce operating expense
- Work with existing and/or new shelving



...In Your Office?



...In Your Warehouse?



In smaller places at least one adequate size room fixed with racks and front counter with cupboards is necessary to function as a linen room Basic function of the linen room are as follows:

1. Maintain the laundry of restaurant and bed rooms and staff uniform,
2. Counting group wise and send them for laundry.
3. To receive the clean linen from laundry, count them and arrange properly and issue.
4. Receive and issue the dirty and clean linen from floor wise preferably. This work is usually done twice a day.

Where there is no arrangement in house laundry, outside firm is fixed for washing the hotel's linen as well as that of the guest's garments.

It is very important to take care of guest's garments against loss or damage and also for timely delivery. Staff uniforms are also generally supplied by the hotels. Cotton uniforms are issued for one year and terry cotton materials are for two years. Uniforms should be exchanged every alternate day. Record of staff uniform for different departments may be maintained with appropriate symbols such as 'K' for kitchen—'R' for restaurants etc. Kitchen uniforms are then further marked for individual staff.

Linen keeper is the incharge of the linen rooms—he/she maintains the records of incoming as well outgoing linens as also other official records. Every month damaged linen inventory should be taken for verifications and every three month total position of the linen and its status should be taken. The condemned linen may be used for duster etc. Because of its nature of operations it is seen that house-keeping department is very vulnerable to pilferage. Thus, special care should be taken for the outgoing goods. It is for this reason, only entrance-cum-exit is provided in

General Techniques for House-Keeping Operation

Because of changes of present day life style, the hotel keeping has also undergone changes. The house-keeping job is no longer simple cleaning of the rooms. In good hotels the house-keeping department has to keep link with the reception for the arrival and departure records, with the maintenance department for repairs etc.

Apart from these two departments, it has to keep in touch with food and beverage department, stores department and personnel department. The house-keeping departments' activities are generated from the house-keeping desk or house keeping office.

It plans daily, weekly, monthly cleaning schedule. Some general procedures for daily cleaning of some areas are given in table. It helps to advice the grooming of staff and provides appropriate training and knowledge for performance of the tasks. The house-keeping department should be aware of latest knowledge of cleaning appliances, chemicals and use of fire fighting equipments and practice.

Daily Cleaning	Methods of Cleaning
1 Toilet	All litter is to be removed after emptying the sani bins W.C. be washed, dried and floor mopped.
2. Windows and Walls	Dust and dirt be removed, metal fitting and handles in particular be polished and cleaned.
3. Bed	Should be rearranged with dusting of head and foot boards. May be covered with bed covers.
4. Room Floors	Must be swept vacuum cleaned and naked floors may be damp mopped.
5. Curtains	Should be checked for dust and neatness.
6. Furnitures	Be dusted and stickness should be removed.

Stain Removal

Stain is a mark left on linen by the contact and absorption of some foreign substance. Some stains are easily removed by ordinary methods. But there are some which need special treatment. This entirely depends on the nature of the stain.



Cleaning Boats



Removing Pen



Cleaning Showers



Cleaning Tiles



Cleaning Floors



Cleaning Appliances



Staff, therefore must be familiar with the appearance of many of the common stains such as mud, ink, rust, blood, urine, semen, pan etc. Some common stain that appear on hotel linens and their methods of removal are discussed here in following Table.

Stain	Condition	White Cotton and Linen	Colour Cotton and Linen
Butter (grease & colouring)	Fresh	Wash with warm soapy solution	Same as cotton
Catachup (Katha or beetle leaf spots)	Dry	Apply dil. Pot. Permanganate solution then sodium bisulphate. wash.	Same as cotton
Curry (Grease & Haldi)		1. Wash with soap and water 2. Bleach in sunlight and air	i. Treat with solvent soap 2. Fast colours to bleach in sunlight and air
Grease oil & Ghee	Fresh	Wash with hot water and soap	Same as white cotton
	Dry	Treat with a grease solvent and wash with hot water and soap	Same as white cotton
Haldi		Refer to curry stain for treatment	
Henna (Mhendi)		Dip in warm milk for half an hour then wash with soap	
Ice-cream and Chocolate	Fresh	1. Wash in cold water and soap	

	2. Steep in warm borax solution	
	3. Sponge with petrol or carbon tetrachloride	Same as white cotton
	Dry Treat with alternate application of dilute potassium permanganate solution and exalic acid.	Same as white cotton.
Ink (Black and blue)	Fresh Rub the stain with a cut tomato wash, rub salt. wash, Repeat the process till stain is removed.	Same as cotton
Ball point ink	Swab with methylated spirit using a pad of blotting paper below	Same as cotton
Iron rust	Steep in-oxalic acid sol. and then rinse with dilute borax solution Steep in solution of salts of lemon.	Same as for white cotton
Lip stick	Steep in methylated spirit and wash with solvent soap	Same as for white cotton
	Moisten and soften by working glycerine into the stain. Leave for a short while Rinse and then wash with surf or soap.	Same as for white cotton
Nail varnish	Apply amylacetate (this has smell like bananas) to the stained area with a cotton wool pad. This must not be used on any acetate rayon fabric.	
Oil, paint and varnish soap.	1. Steep in turpentine, wash with solvent soap.	kerosene or Wash with
	2. Steep in alcohol. Wash with solvent soap	
	3. Sponge with equal parts of alcohol and benzine.	
Shoe polish	1. Scrape off the stain if dry. Apply a little grease. Wash with hot water and soap.	Wash with solvent soap.
	2. Steep in turpentine Wash with solvent soap.	
Urine stains	Apply ethyl alcohol and allow to evaporate. Then apply chloroform and allow to evaporate	Same as for white cotton.

Dye stains may be acidic or alkaline and so the nature of the stain is ascertained before a specific removing reagent is used.

Mineral stains, such as iron mould black ink, and certain medicine stains are compounds of a metal and a dye. These are first treated by acid reagents to act on the metal and then by an alkaline solution to neutralise the acid reagent and act on the dye.

Neither perspiration nor scorch marks fall into any of the above groups. Perspiration has no protein component and cannot, therefore fall under the group animal. It cannot obviously fall under the vegetable group, even though it is acidic.

Scorch is brown stain caused by a very hot iron and is in a class by itself.

Grass stains come under vegetable groups but a different method is used for removing the green colouring matter (chlorophyll)

Stain removing must be carried out with care and in such a manner as to restore the garment to its original appearance and texture,

Removal of Stain from Carpets

Stains or spots on carpeting are essentially of four types—

- (a) Water soluble
- (b) Oil soluble
- (c) Combination of both, such as food etc.
- (d) Colour stains such as dyes.



1
Spill in carpet backing & pad

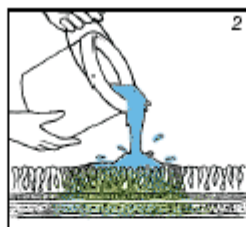

2
Saturate carpet & pad with spotting solution

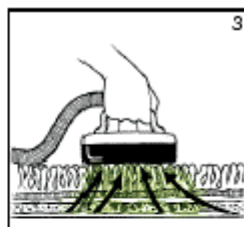

3
Perform sub-surface extraction

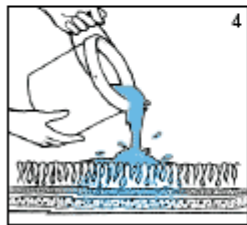

4
Saturate carpet & pad to rinse

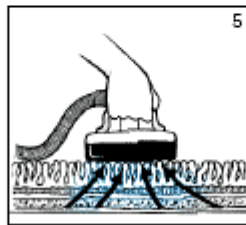

5
Perform sub-surface extraction

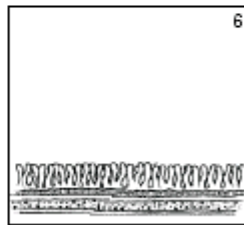

6
Voika! No more spot!



Normal stain problems faced in a hotel and their removal procedures are as follows:

Type of Stain	Removal Procedure
1. Alcohol, Candy (Sugar)	Detergent-Blot-Citric Acid-Blot
2. Blood, Tomato Sauce, Dyes Soft Drinks, Vomit	Detergent-Blot- Ammonia-Blot Citric Acid-Blot. (Note-Red dye in carpet may bleed)
3. Butter	Solvent-Blot-Detergent-Blot Ammonia - Water-Blot
4. Candle Wax, Chewing Gum	Solvent-Blot
5. Coffee, Tea, Earth, Urine	Detergent-Blot-Citric Acid-Blot
6. Cosmetics, Ink, Shoe Polish	Paint, Oil & Grease Remover- Blot-Solvent Blot-Detergent-Blot- Ammonia-Blot-Citric Acid-Blot
7. Nail Polish	Non oily Nail Polish Remover-Blot-Solvent-Blot
8. Cigarette Burn	Clip off burned tips with small scissors

- A small amount of reagent used should first be tested in an inconspicuous part of the carpet to see if it will damage carpet fibre or dye.
- Remove residue with a dull knife.
- Remember, identifying the stain is 90% of the solution.

Cleaning of Glass

Equipment

- Delwin-window cleaningtool.
- Cleaning mixture (There are many glass cleaning mixture already commercially prepared),
- A lint free cloth





Hand Washing

- Dampen the cloth with solution and wipe pane from side to side covering total area.
- Dry off with clean dry cloth using same stroke.
- Wipe any spillage immediately.



Be A Germ-Buster

WASH YOUR HANDS



NIH National Institutes of Health
U.S. Department of Health and Human Services
Centers for Disease Control and Prevention
www.cdc.gov



6 Dry with paper towel



1 Wet your hands



2 Apply solution and scrub for at least 15 seconds



5 Turn off water lever using your elbows



4 Rinse your hands



3 Scrub back of hands, wrists, between fingers and under fingernails

Squeegee Washing

- Use Delkleen 'Delwin'
- Wash glass with even strokes from top to bottom. Squeegee off in horizontal strokes at 60 angle, keeping edge of squeegee dry by wiping edge of blade with absorbent cloth after each stroke.
- Carefully clean and wipe bottom ledge. 'Delwin' has a telescopic handle to help you reach glasses at considerable height.



Safety

- Do not use powder, paste or abrasive cleaners on glass.
- Do not climb onto window ledges above ground level.
- Always wipe spillage from surrounding wood work as this may permanently stain.
- Treated or painted glass such as 2 way mirrors should be cleaned as specified by the manufacturer as mirror coating will lift easily if incorrect solutions are used.
- Take extra care when cleaning windows in carpeted areas. Put protective cover on floor.
- Paint spots can be easily removed with a window scraper.

Cleaning of Curtains

Equipment

- Vacuum cleaner, Comvac fitted with long rigid extension pipe and upholstery brush.

How?

- Vacuum or dust mop top of pelmet.
- Vacuum or dust mop total curtain from top to bottom.
- Check for heavy soiling and refer to supervisor if further action such as laundering or dry cleaning is required.

Safety

- Check condition of curtains before vacuuming.
- Do not brush dust from top of pelmet to other areas,
- Take care that very fine-curtains are not sucked into vacuum.

Care of Equipment

- Empty vacuum cleaner container.

- Replace all equipment in store.



Cloths used for Cleaning

Cloth	Use
1 Duster	(a) Collecting dust (b) Rubbing surfaces up to a shine.
2 Rag	Applying polish or strong cleaning agent
3 Cloth	(a) Damp dusting all surfaces above floor. (b) Removing marks from surfaces above floor. (c) Daily cleaning of sanitary fittings.
4 Floor cloth	Used to wipe up spills from floors.
5 Scrim	Windows, mirrors etc.

- 6 *Chamois leather* (a) *When wet, used on windows and mirrors.*
(b) *When dry, used to polish up metals.*

Staffing Pattern of the House-Keeping Department

In general three categories of staff are required in hotels.

- Managerial category
- Supervisory category
- Unskilled or semiskilled category

Depending upon the policy, size of the establishment, nature of the service and location etc. the staffing pattern particularly that of managerial and supervisory category varies. In India more of unskilled workmen are found in hotels.

In a moderately big hotel the organisation of the house-keeping department may be as follows:

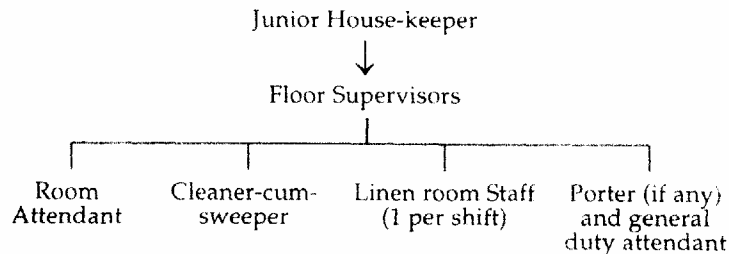

Floor supervisor for one shift or on the basis of 1:25 rooms for day shift and 1:50 during the night shift.

The room attendant for every 10 to 12 rooms depending upon the types and facilities. Work distribution if followed on the basis of 8 hourly shift, then adequate increase in staff will be necessary to maintain the work schedule.

QUESTIONS FOR ANSWER

1. Discuss various areas of house-keeping services in the hotel.
2. Write a note on cleaning and arranging bed-rooms and toilets in the hotel.
3. Write short notes on the following:
 - (a) House-keeping trolley.
 - (b) Areas of daily cleaning in the hotel.
 - (c) Normal stain problems faced in a hotel and their removal procedures.
 - (d) Linen and uniform room.
 - (e) Room for flower arrangement.
 - (f) Staffing pattern of the House-keeping Department.

How to Clean Naturally

Although there are a plethora of cleaning products on the market today, most contain chemicals that many would prefer not to use in their home. Luckily there are many household products that are safe and natural to use to clean your home. Chances are you have them on your pantry shelf everyday

Instructions

Difficulty: Easy

Things You'll Need:

- Baking Soda
- Vinegar
- Lemon Juice
- Salt
- Olive or other light vegetable oil

Step1

Mix baking soda and water together to form a paste. Use this paste to clean counter tops, sinks and other surfaces.

Step2

Add salt to the baking soda/water mixture for extra scrubbing power.

Step3

Sprinkle baking soda on carpets and rugs to absorb odors. It can then be vacuumed up.

Step4

Use vinegar to clean chrome, windows, mirrors and other shiney surfaces.

Step5

Fill a bowl with vinegar to help remove odors from the kitchen and refrigerator. A box of baking soda kept in the refrigerator will absorb odors for approximately three months.

Step6

Pour lemon juice on a sponge or paper towel and rub on pots and pans to bring back the brightness and shine.

Step7

Mix olive or other light vegetable oil with water to clean wooden surfaces.

Tips & Warnings

- Water and elbow grease go a long way to keeping your home clean without using chemical ingredients.
- Never mix vinegar and baking soda or you will have the volcano effect of elementary school science project

How to Clean Out Drawers

Instructions

Difficulty: Easy

Things You'll Need:

- Portable Vacuums

- Marking Pens
- Trash Bags
- 3 shoeboxes

Step1

Obtain three shoeboxes and a garbage bag. Label one box "keep" and another box "store." Write today's date on the third box.

Step2

Remove items from the drawer one at a time.

Step3

Place items that are handy and should be kept nearby in the "keep" box.

Step4

Place items that are useful but can be kept elsewhere in the "store" box.

Step5

Place items that may or may not come in handy some day in the dated box.

Step6

Put any useless or duplicate items in the trash bag.

Step7

Use a portable vacuum cleaner to clean out any dust from the now-empty drawer.

Step8

Toss out the trash bag.

Step9

Place the items from the "keep" box back into the drawer in an organized and accessible manner.

Step10

Find places for the various items in the "store" box and store these items appropriately.

Step11

Place the dated box in a closet or other safe place. Over the course of the next three months, find appropriate places for anything you use from the dated box. At the end of three months, throw away anything from the box that you haven't used.

& Warnings

- When cleaning out the drawer, you should be able to confidently throw away anything you haven't used in the past year. However, if something has sentimental value, don't feel obligated to throw it away. These things have their places in the home as well.

How to Repair a Broken Sliding Drawer

Instructions

Difficulty: Moderately Easy

Things You'll Need:

- New Plastic Drawer Guide
- Screwdriver
- Small Screws

Step1

Remove the drawer's contents.

Step2



Pull the drawer gently by the handle until it comes all the way off the track (see A). You may need to lift the drawer above the track or press a release lever to release the drawer.

Step3

Turn the drawer over and locate the drawer guide. Look for a small semicircular or square plastic piece located at the drawer's rear center.

Step4

Examine the condition of the drawer guide. If the guide is in good condition but merely loose, tighten the screws and replace the drawer. If the guide is held into place with metal staples, replace the staples with small screws, which are sturdier. If the guide needs to be replaced, proceed to step 5.

Step5

Unscrew the old drawer guide and buy an exact replacement.

Step6

Position the new drawer guide in place, matching the existing screw holes in the wood or particleboard drawer with the new guide's holes.

Step7



Tighten all the screws to secure the guide firmly in place (see B). Don't tighten the screws excessively--you could crack the drawer.

Step8

Gently slide the drawer back onto the drawer track.

Step9

If a wooden strip on the bottom of the drawer guides the sliding drawer instead of a steel track, tighten the screws that hold the strip in place. You can buy a replacement strip for the drawer at the hardware store if the old one is worn out.

Tips & Warnings

- Take care to gently remove the old plastic guide so as not to damage the drawer.
- Lightweight plastic guides like these are only meant to support a few pounds. For heavy drawers, consider installing roller guides on each side of the drawer.
- See How to Fix a Drawer That Sticks for more drawer fixes.

How to Clean Rough Wood Furniture

Picnic tables, benches and other rough wood furniture can be difficult to clean. Sap and mildew can stain the rough wood, and cobwebs can be a nightmare to remove. There are several ways to clean rough wood furniture, but you must clean it in a step-by-step process. Here are a few tips to help you clean rough wood furniture.

Instructions

Difficulty: Moderately Easy

Step1

Clean the obvious surface dust or cobwebs using a leaf blower first. Use the leaf blower on dry wood to blow away leaves and surface dirt by blowing in the same direction as the wood grain. If you don't have a leaf blower, go on to the next step.

Step2

Brush away cobwebs and deeper surface dirt with a stiff-bristled whisk broom. Brush in the direction of the wood grain. If you brush against the grain on rough wood, you'll cause splinters

and dirt can get caught in the grain. It's important to clean rough wood furniture by brushing or blowing first; remove loose dirt before the wood is wet.

Step3

Wet the wood after brushing it; use a hose with a sprayer nozzle. Spray the wood with the hose, in the same direction as the grain of the wood. Although you may be tempted to use a pressure washer, it's best to use a garden hose to clean the wood. Pressure-washing rough wood can cause strips of wood to become loose and be ripped off.

Step4

Spray on a cleaner specific for wood and brush it in. Allow the cleaner to work for the recommended time before rinsing off. Cleaners can be an oil-soap base or a deck cleaner from a paint store. Rinse the cleaner from the rough wood after cleaning. Make sure you follow manufacturer directions to clean the wood without damage. Apply a protective coating to the rough wood if desired.

How to Clean Tile and Grouted Countertops



Tile Counter tops Look Really Great, but can be really difficult to keep clean. Getting rid of that dirty grouted in between the tile can be a hard chore. Here is an easy way to clean the grouted counter tops

Instructions

Difficulty: Easy

Things You'll Need:

- Tile Grouted Counter tops
- Used Fabric Softener Sheet
- Baking Soda
- Vinegar

Step1



Vinegar and Baking Soda Pour a little Baking Soda on the Grout, then a little bit of Vinegar, watch it make a little volcano. This will get the dirty grout nice and clean.

Step2



Used Fabric Softener Sheet Then scrub it down with a used fabric softener sheet. You will see it clean immediately or after a few minutes, depending how dirty the grout is.

Step3

Your Tile Counter Top Should Really Look Nice and Clean, After Cleaning it This Way.

Tips & Warnings

- If you want, you can use a new fabric softener sheet, instead of a used one.
- They are not only used for laundry anymore.
- See how this article is short and easy.

How to Remove Tar From Fabric

Instructions

Difficulty: Easy

Things You'll Need:

- White Kerosene
- Clothes Dryers
- Clotheslines
- Laundry Detergents
- Stain Removers
- Washing Machines
- Ice Cubes
- Plastic Bags
- Paper Towels

Removing the Tar

Step1



Place some ice cubes in a small plastic bag and apply the bag to the tar, if a great deal of tar is stuck to the fabric.

Step2

Allow the tar to freeze and harden.

Step3

Peel away the tar after it has completely hardened.

Removing the Stain

Step1

Apply stain remover to the stain if the fabric is machine-washable.

Step2

Wash according to the fabric's care instructions.

Step3

Allow the fabric to air dry.

Step4



Dab a small amount of white kerosene onto a persistent stain with a white paper towel.

Step5

Wash separately from other clothes and according to the fabric's care instructions.

Tips & Warnings

- Avoid exposing the fabric to heat until the stain has been completely lifted.
- Stains on dry-clean-only fabrics should be professionally treated.

How to Remove Chocolate Stains From Fabric



It's hard to say what's worse - the chocolate stain on shirt or the fact that that delicious morsel has been wasted. While you ponder on that, read these instructions on how to get rid of the stain.

Instructions

Difficulty: Easy

Things You'll Need:

- Laundry Detergents
- Stain Removers
- Washing Machines
- Dull Knife

Step1

Allow melted chocolate to dry and harden.

Step2



Scrape away hardened chocolate with blunt knife.

Step3



Pretreat stain with stain remover or detergent.

Step4



Wash as usual.

How to Do Laundry

Instructions

Difficulty: Easy

Things You'll Need:

- Washing machine
- Lingerie soap
- Stain removers
- Anti-static sheet
- Liquid fabric softeners
- Liquid bleach
- Laundry detergents
- Clothes dryer
- Laundry baskets

Step1

To do laundry, first sort your dirty clothes, making separate piles for whites, bright colors and darks. If you mix whites with colors in the wash, the colors may bleed onto and ruin your whites. Also separate clothes that tend to produce lint (towels, sweatshirts, chenille and flannel) from clothes that tend to attract lint (corduroy, velvets and permanent-press clothes).

Step2

As you sort, close zippers to prevent snagging, and empty pockets (you don't want soggy shreds of facial tissue all over your clothes!).

Step3

Pre-treat heavy stains with laundry detergent or stain remover, heeding instructions on the product label.

Step4

Use the measuring cap of the detergent bottle or the cup found in detergent boxes to measure out the right amount of laundry soap according to the manufacturer's instructions.

Step5

Pour the soap into your washer or its detergent dispenser. Add liquid fabric softener, if desired, according to the product instructions.

Step6

Choose the water temperature for the wash cycle: hot, warm or cold; save on energy and opt for a cold rinse cycle for any load. Consult the labels on your clothes, your washing machine's instruction manual or the detergent container for recommendations on washing temperature. In general, use cold water to protect colors and darks from bleeding or fading, and to avoid shrinkage. Use warm or hot water for durable fabrics like cotton (make sure they're preshrunk), and to ensure that your whites stay white.

Step7

Start the washer before adding clothes, if you have time, to allow the detergent to dissolve in the water. The regular cycle suffices for most laundry, but use the gentle cycle for sheer or delicate fabrics. Adjust the water level to the size of your load.

Step8

If you need to add bleach, allow the machine to run for a few minutes to mix the detergent and water, then add about a cup of bleach to the washer or the bleach dispenser.

Step9

Add your clothes, close the lid and let the machine do its dirty work. Washing takes approximately 45 minutes.

Step10

Put the clothes (and an anti-static sheet, if desired) in the dryer after the wash is complete. Hang delicates (such as bras and certain sweaters) to air dry on a clothing rack or hanger. Check tags if in doubt.

Step11

Remove lint from the dryer's lint tray.

Step12

Select the correct drying temperature for your laundry load: low for delicates, medium for most fabrics and high for cotton. When in doubt, low or medium is the safest bet.

Step13

Close and turn on the dryer. Expect the drying cycle to take an hour or more for a full load.

Step14

Once the clothes are completely dry, remove them from the dryer or drying rack and fold your clean laundry.

Tips & Warnings

- If you stuff too many clothes into the washer, it won't clean them well. Allow room for clothes to agitate during the wash cycle.
- Remember that you should typically dry-clean some fabrics: silk, wool, linen and rayon, for example. You should hand-wash lingerie in the sink with laundry soap designed for delicates.
- Never add bleach to wash water while clothes are in the washer. The concentrated bleach will whiten and dissolve clothing. Add clothing to the washing machine once the bleach has been mixed well with the water and the washer is half-full.
- Handle bleach carefully. Avoid splashing it directly onto clothes or yourself.

How to Iron Pants

Instructions

Difficulty: Moderately Easy

Things You'll Need:

- Men's Casual Pants
- Mens' Dress Pants
- Women's Casual Pants
- Women's Dress Pants
- Clean Cotton Cloth
- Ironing Boards
- Irons

Step1

Turn the pants inside out. Look for the tag that gives ironing and fabric information for the garment.

Step2

Choose the heat setting on your iron appropriate for that fabric. Linen and 100 percent cotton take a high setting; wools and cotton blends call for medium heat; polyester, rayon, nylon, silk, acetate and acrylic all require a low heat setting.

Step3

Fill the iron with distilled water if you will be using the steam setting on cottons or linens.

Step4

Test the iron on a small area to make sure you don't have the setting too high'this can damage or discolor the fabric.

Step5

With the pants still inside out, iron the waistband, pockets (on both sides), fly area, seams and hems, in that order.

Step6

Turn the pants right side out and pull the waistband over the pointed end of the board. Iron the waistband area and any pleats along the front of the pants below the waistband.

Step7

Lay the pants lengthwise along the ironing board with both legs together and carefully line up any preexisting creases.

Step8

Take the hem of the top pant leg and bring it toward the waistband, folding the top leg away from the bottom leg. Iron the inside (hem to crotch) of the lower leg. Turn the pants over and repeat for the other leg.

Step9

Smooth out both legs carefully and iron the outside of the top leg. Give extra attention to cuffs, if the pants have them.

Step10

Turn the pants over and iron the outside of the other leg.

Step11

Hang warm pants immediately to avoid wrinkling. Fold them through a suit hanger to avoid crushing them in a pant hanger.

Tips & Warnings

- The material in many suits can become shiny with too much ironing. You can avoid this by placing a clean cotton cloth over the area before ironing it.
- Avoid spot-cleaning pants just before ironing. Any wet spots may become permanent stains if ironed.
- Irons are very hot and heavy; avoid ironing when small children are near, and never leave a hot iron unattended.

How to Clean an Ironing Board

Instructions

Difficulty: Easy

Things You'll Need:

- Clean Cloth
- Water

Step1

Set up your ironing board.

Step2

Remove the ironing board cover and pad.

Step3

Wipe the entire ironing board down with a damp cloth. Since most ironing boards are made of metal, be sure to dry the board thoroughly to prevent rust.

Step4

Spot clean the ironing board cover with a slightly damp cloth. Most ironing board covers are coated with a scorch and stain protectant, so blot cleaning should be easy.

Step5

Replace the ironing board's cover by stretching it evenly on top of the ironing board and making sure it doesn't form any wrinkles that could leave marks on clothes. Be sure the surface of the ironing board is completely dry before reattaching the pad and cover.

Tips & Warnings

- Keep a spray bottle filled with half white vinegar and half water near your ironing station. To freshen up the ironing board cover, give it a quick spray now and then.
- Clean or replace your ironing board cover fairly frequently. If the cover is dirty, the problem may transfer to your clothes when you iron them.
- If you're not ready to replace your ironing board cover but it has a tear in it, simply repair it with an iron-on patch of any kind.
- Most ironing board covers are not washable and should be replaced when worn or soiled.

How to Clean an Iron

Regular maintenance of your iron is essential. The sole plate will need to have residue and stains wiped away, and the steam ducts will need to be cleaned to make sure they remain open.

Instructions

Difficulty: Easy

Things You'll Need:

- White Vinegar
- Baking Soda
- Pipe Cleaners
- clean cloths

Step1

Turn the iron off, unplug it and let it cool.

Step2

Pour any remaining water out of the iron.

Step3

Make a paste of 2 tbsp. baking soda and water.

Step4

Apply the paste to the sole plate of the iron, rubbing with a clean cloth.

Step5

Wipe the plate clean with a damp cloth.

Step6

Unclog steam ducts by inserting the end of a pipe cleaner in each hole and twisting it back and forth.

Step7

Fill the iron half-full of water.

Step8

Add white vinegar and fill the reservoir to the top.

Step9

Plug the iron in, turn it to High and leave it on for 15 minutes.

Step10

Unplug the iron and let it cool.

Step11

Dump out the water.

Step12

Repeat steps 7-11 using water only.

Step13

Get back to work!

Tips & Warnings

- To save yourself the trouble of routine maintenance, invest in a self-cleaning iron.
- Several companies make iron cleaners - some that work as you use the iron. These are generally available in hardware or home improvement stores, or do a search online for "iron cleaner".
- After you clean the bottom, or sole, of the iron, keep it from dragging on clothes by first ironing a few pieces of wax paper.
- Use distilled water in the iron if your local tap water is heavy with minerals and other impurities which can clog the ducts.
- Do not immerse an iron in water.

How to Correct a Steam Iron That Sputters

If your iron sputters when it should be steaming, it's often because minerals from your water have hardened and clogged the steam jets and spray nozzle. Here's an easy cure.

Instructions

Difficulty: Moderately Easy

Things You'll Need:

- Fine Needle
- White Vinegar
- Distilled Water
- Oven Rack
- Toothpick Or Small Ice Pick

Step1

Unplug the iron and let it cool.

Step2

Scrape any visible mineral deposits from the jets on the bottom of the iron, using a toothpick or the tip of a small ice pick.

Step3

Clean the spray nozzle with a fine needle.

Step4

Fill the iron with equal parts white vinegar and distilled water. Place an oven rack over your sink and position the iron on top, with the steam vents facing down. Plug in the iron and turn it to the steam setting. Run it until the steam stops.

Step5

Fill the iron with plain distilled water and repeat the process.

Tips & Warnings

- To prevent mineral buildup in your iron, always use distilled water.

How to Clean Starch Residue from the Bottom of an Iron

Instructions

Difficulty: Easy

Things You'll Need:

- Clean Rags
- Baking Soda

Step1

Unplug the iron and make sure it is cool to the touch.

Step2

Mix a thick paste out of 2 tbsp. baking soda and a bit of water.

Step3

Dip a clean rag into the mixture and scrub the iron's sole plate until the caked-on spray starch loosens and wipes away. You may need to use some elbow grease.

Step4

Wipe the sole plate clean with a second clean, wet rag.

How to Wash a Cashmere Sweater

Instructions

Difficulty: Easy

Things You'll Need:

- Clean Dry Bath Towels
- Stain Removers
- Baby Shampoo

Step1

Buy a detergent specifically intended for fine garments.

Step2

Fill your sink or basin with lukewarm or cool water, depending on the garment's washing instructions. Add the recommended amount of fine-garment detergent to the basin.

Step3

Briskly run your hand through the water to distribute the detergent and generate suds.

Step4

Submerge the sweater and gently squeeze the suds through it.

Step5

Let it soak for 20 minutes.

Step6

Drain the sink and rinse your sweater with lukewarm water until the water rinses clear.

Step7

Gently press water out of the sweater and place it lengthwise on a clean, dry bath towel.

Step8

Roll up the towel. Press with your palms to squeeze out excess water.

Step9

Remove the sweater from the towel and smooth it out so it is back in its original shape.

Step10

Lay the sweater flat on a dry towel and let it air-dry, or use a drying rack if you have one.

Tips & Warnings

- Dry-cleaning cashmere is also a viable option. However, as cashmere is a delicate fiber, excess chemical treatments may shorten your sweater's life.
- Wringing out your sweater may pull it out of shape.
- Sunlight can fade your sweater, and other heat sources may wear fibers prematurely. It's better to let your sweater dry naturally indoors, away from sunny windows and heat vents.

How to Dry Delicate Clothing



Instructions

Difficulty: Easy

Things You'll Need:

- Clothes Dryers
- Clothes Drying Screens
- Clotheslines
- Clothespins
- Laundry Baskets
- Fabric Softener Sheets

Step1



Read care tags to determine if your delicates require line drying or flat drying, or if they can withstand being in the dryer.

Step2



Flat dry clothes using a screen made for that purpose. If you don't have a drying screen, you can use clean towels spread on a table. Lay clothes on the screen or towel and leave until dry.

Step3



Line dry clothes over a sturdy, taut line stretched between two points. Use clothespins to attach clothes to the line, spreading them out for faster drying. You can also hang clothes over shower curtain rods for line drying.

Step4

Set dryer setting to "Delicates" if your delicates can be put in the dryer.

Tips & Warnings

- Sweaters and other clothing that will stretch out of shape when hung wet should be dried flat.
- It's best to line dry clothes outdoors on sunny warm days if possible.
- Good air circulation is a necessity for avoiding musty odors and mold.
- Dripping clothes can ruin wood floors and linoleum.
- The dryer can damage delicate clothes. Read labels before using the dryer.

How to Dry Clothes

Instructions

Difficulty: Easy

Things You'll Need:

- Clothes Dryers
- Clotheslines
- Clothespins
- Laundry Baskets
- Towel Racks
- Towels
- Fabric Softeners Sheets

Step1

Find the lint tray in your dryer and remove it. Clean off all the lint and throw the lint in the trash. Put the tray back in its slot in the dryer.

Step2

Open the dryer and put the wet clothes inside.

Step3

Add a fabric softener sheet if you like.

Step4

Close the door.

Step5

Choose the appropriate settings for the clothes in the dryer.

Step6

Push (or pull) the start button.

Step7

Remove clothes promptly once they are dry.

Tips & Warnings

- If you don't have a dryer, hang clothes outside on a line to dry. Use clothespins to keep clothes from falling off, and remove when clothes are dry. This works best on warm sunny days.
- Underwear, panty hose and bathing suits can be hung over a towel rack or shower curtain rod to dry. You may wish to place a towel over the rack first.
- Some clothes may shrink in the dryer, especially on high heat settings. Always check labels for drying instructions before putting clothes in the dryer.

How to Fold a Sweater

Instructions

Difficulty: Easy

Things You'll Need:

- Sweaters
- Drawer Chests

Step1

Lay sweater face-down on a flat surface.

Step2

Bring in one side lengthwise to just before the neckline. Flatten out this fold.

Step3

Fold sleeve down so that it lines up vertically with the length of the fold.

Step4

Repeat on the other side.

Step5

Fold up the bottom of the sweater halfway.

Step6

Fold up again, this time to the top of the sweater.

How to Wash a Wool Sweater

Difficulty: Moderately Easy

Things You'll Need:

- Wool Detergents
- Men's Wool Sweaters
- Women's Wool Sweaters
- Hammocks
- Towels
- At-home Dry-cleaning Kits
- Notebook Papers
- Pens

Step1

Lay sweater flat on a sheet of clean paper.

Step2

Draw outline of sweater on the paper.

Step3

Hand-wash sweater gently using cool water and a wool detergent, being careful not to rub the product in.

Step4

Rinse with fresh water until it runs clear.

Step5

Squeeze out excess water, then roll sweater in a towel to absorb moisture.

Step6

Lay sweater on the paper again, and gently stretch it to fit the previously drawn outline. Pat sweater into the desired shape with a towel.

Step7

Dry flat by spreading the sweater out, preferably on a hammock, in cool air and out of the sun.

Tips & Warnings

- A variety of products are available to care for wool, including some that allow you to care for "dry-clean only" products at home.
- Soften sweaters by adding a capful of cream hair conditioner when rinsing.
- To speed up the flat-drying process, purchase a screen that is designed to fit over the bathtub. Turn the garment over from time to time while it is drying.
- Using such products as ammonia, enzyme digestants, alcohol, harsh alkaline cleaners and chlorine bleach can damage wool garments.

How to Remove Mustard and Ketchup Stains From Fabric

Instructions

Difficulty: Easy

Things You'll Need:

- Ammonia
- Laundry Detergents
- Stain Removers
- Dull Knife
- Paper Towels

Step1

Remove excess mustard or ketchup by scraping with a dull knife or blotting with paper towels.

Step2

Sponge stain with cool water.

Step3

Gently work a mild detergent into stain.

Step4

Rinse in cool water.

Step5

Apply a laundry stain remover.

Step6

Wash and air dry.

Tips & Warnings

- Avoid exposing the fabric to heat until the stain is completely lifted.
- Treat dry-cleanable fabrics professionally.
- Mix a solution of 1 tbsp. ammonia and 2 cups water if stain persists, and blot on spot

How to Remove Mystery Stains From Clothing

Instructions

Difficulty: Moderately Easy

Things You'll Need:

- Color-safe Bleach
- Laundry Detergent
- Sponge
- Zippered Nylon Mesh Bag
- Prewash Stain Remover
- Enzyme-containing Laundry Detergent
- Mild Liquid Laundry Detergent
- Dry-cleaning Fluid

General rules

Step1

Rinse or soak unknown stains in cold water before laundering or applying a stain remover. Some stains, such as blood, coffee and wine, can set in warm water.

Step2

Sponge a stain, don't rub it. Rubbing only spreads the stain and may damage the fabric.

Step3

Read and follow label directions before applying stain treatments. If it says no bleach, even color-safe bleach is a no-no.

Step4

Protect delicates by washing them in a zippered nylon mesh bag.

Step5

Check that a stain is completely gone before drying the garment. Heat can set stains.

Small spots and fresh stains

Step1

Sponge directly on the stain a prewash stain remover, a liquid laundry detergent, or a paste made from powder laundry detergent and a little water. Or dab with dry-cleaning fluid. Let the garment sit for several minutes or leave it overnight.

Step2

Launder in the hottest water safe for the fabric, using detergent and color-safe bleach. For bleach amounts, follow instructions on the bottle. Repeat if needed.

Step3

Tumble dry at the setting safe for your fabric.

Large spots and old stains

Step1

Soak the garment overnight in the warmest water safe for the fabric in a washing machine or sink with 1/2 cup (4 fl oz/125 ml) to 1 cup (8 fl oz/250 ml) enzyme-containing laundry detergent (adjust amount according to size of garment).

Step2

Launder as usual, using an enzyme detergent, color-safe bleach and the warmest water that is safe for the fabric. Repeat if needed.

Step3

Tumble dry.

Delicates and Unwashables

Step1

Delicate fabrics such as lingerie, silk and lace. Rub mild liquid laundry detergent directly on the stain. Let the clothing sit for several minutes. Toss the garment in the washing machine or sink, fill with cold water and add mild detergent. Soak overnight. Wash using the delicate or hand-wash cycle on your machine. Repeat as needed. Lay flat to dry.

Step2

Unwashables. Take your stained garment to the dry cleaner if the label contains the word only or if you cannot live without the item. Otherwise, go to step 2. Sponge on dry-cleaning fluid, then allow the garment to dry.

Step3

Repeat as necessary.

Drying tricks

Step1

Now that you've cleared up the mystery, here's how to dry your formerly stained garment the right way. (These techniques work equally well on most of your other laundered, stain-free fabrics, too.)

Step2

Check wet garments for lingering blights to prevent stains from setting in fabric via dryer heat.

Step3

To prevent broken and loosened fibers, separate lint shedders (fuzzy sweatshirts, chenille robes, flannels and towels) from lint grabbers (knits, corduroys and synthetics).

Step4

Dry like items (such as towels and cottons) together, and dry lingerie and permanent press separately, to prevent fabric damage from friction.

Step5

Loosely shake clothes before tossing them into the dryer to prevent wrinkles and shorten drying time.

Step6

Zip zippers, button buttons, and hook eye-hooks to prevent snags and fabric tears.

Step7

Empty pockets of paper, money and tissues to reduce lint.

Step8

Add fabric softener to make clothes fluffier.

Step9

Wipe lint from the filter to reduce wear and tear on the machine.

Tips & Warnings

- Resist the urge to wash in cold water. Many fabrics respond best to warm or hot water, and the enzymes in your detergent are activated by higher temperatures, resulting in cleaner clothes.

- Resist the urge to wash in cold water. Many fabrics respond best to warm or hot water, and the enzymes in your detergent are activated by higher temperatures, resulting in cleaner clothes.
- Resist the urge to wash in cold water. Many fabrics respond best to warm or hot water, and the enzymes in your detergent are activated by higher temperatures, resulting in cleaner clothes.
- Resist the urge to wash in cold water. Many fabrics respond best to warm or hot water, and the enzymes in your detergent are activated by higher temperatures, resulting in cleaner clothes.

How to Remove Oil or Grease Stains From Fabric



Whether it's a cooking, automotive or lubricating oil mark, the sooner you deal with a greasy stain, the better the outcome. Follow the directions below to minimize the risk of permanent stains

Instructions

Difficulty: Moderately Easy

Things You'll Need:

- Laundry Pretreatment
- Paper towels
- Dry-cleaning Solvent
- Talcum Powder
- Cornstarches

Step1

Apply an absorbent such as talcum powder or cornstarch to the affected area, then brush away. If the stain is heavy or old, proceed to Step 2; if fresh, skip to Step 3.

Step2

Place stain facedown on paper towels. Blot back of stain with a dry-cleaning solvent. Replace paper towels as they soak up the stain.

Step3

Spray with laundry pretreatment.

Step4

Wash in the hottest water that's safe for the garment.

Step5

Air dry.

How to Remove Wax From a Carpet

Instructions

Difficulty: Easy

Things You'll Need:

- Denatured Alcohol
- Household Rags
- Irons
- Sponges
- Rolls Of Paper
- Putty Knife

Step1



Scrape away as much wax as you can.

Step2



Place a sheet of butcher paper, glossy side up, or a portion of a brown paper bag on top of the wax.

Step3



Press the tip of a warm iron gently over the affected area until the wax melts and attaches to the paper.

Step4

Lift the paper from the carpet.

Step5



Dab a small amount of denatured alcohol onto the stain if any candle dye is left on the carpet.

Step6

Sponge with water.

Tips & Warnings

- Try not to let the iron touch the carpet, as it may leave scorch marks.

How to Remove Coffee and Tea Stains From Fabric



Instructions

Difficulty: Easy

Things You'll Need:

- Ammonia
- Sponges
- Stain Removers
- Water
- Paper Towels

Step1



Blot the stain immediately with paper towels.

Step2



Sponge the stain using cool water.

Step3



Apply a laundry stain remover.

Step4



Wash and allow to air dry.

Tips & Warnings

- Avoid exposing the fabric to heat until the stain has been completely lifted.
- Fabrics that require dry cleaning should be treated professionally.
- Mix a solution of 1 tbsp. ammonia and 2 c. water if the stain persists, and blot the solution onto the spot.

How to Remove Lipstick Stains From Fabric



Instructions

Difficulty: Easy

Things You'll Need:

- White Soft Dry Cloth
- Denatured Alcohol
- Stain Brushes
- Stain Removers
- Dishwashing Liquid

Step1



Dab stain very lightly with denatured alcohol using a soft, white cloth.

Step2



Rub dishwashing detergent gently into the stain with your finger.

Step3



Try using a stain stick and leaving it on for several minutes before washing, if the mark is stubborn.

Step4

Wash fabric as usual. It would be best to air dry the garment so that the stain does not set in. This way you can take it to the dry cleaner if it does not come out.

Tips & Warnings

- If you are out and don't have access to alcohol, leave the stain alone until you get home. If you're desperate, try dabbing it with cold water.
- Remember to dab, not rub, as rubbing can ground in the stain.
- Remember if a fabric is dry clean only it is best to take it to your dry cleaner. Do not pretreat. Pretreating can make the cleaning process hard for your cleaners and hinder them from removing the stain for you.

How to Remove Red Wine Stains From Upholstery

Instructions

Difficulty: Moderate

Things You'll Need:

- Brushes
- Sponges
- Salt
- Talcum Powder
- Paper Towels

Step1



Blot the fresh stain with paper towels.

Step2



Sponge with warm water to dilute the stain.

Step3

Blot again.

Step4



Apply talcum powder to any remaining stain.

Step5

Let the powder stand for two to three minutes.

Step6



Gently brush off talcum powder.

Step7

Repeat sponging and blotting if stain persists.

How to Choose a Clothesline



Hanging laundry on a line to dry is not only energy-saving, it gives clothes a natural clean smell. And if the sun is shining, you'll get extra benefits with whiter whites. In addition to saving energy since you are not using a power-generated clothes dryer, using a clothesline saves you money.

There's more: in time, with the money saved from not using the clothes dryer, purchasing a clothesline will pay for itself and soon, you'll be saving money! What kind of clothes line to buy can be perplexing. Here are some tips to help you in the selection of a clothes line that will meet your needs and available space.

Instructions

Difficulty: Moderate

Things You'll Need:

- Desire to hang laundry outside to dry
- Purchase and install the clothesline best suited for your needs

Step1



Post to Post The pole-to-pole clothesline is very popular. Wire, thin braided rope, or vinyl cord are suspended between two poles. The poles may be in a shape of a cross so multiple lines can be attached.

ADVANTAGE: Sturdy and always ready to use.

DISADVANTAGE: When not in use, the line will become dirty so before hanging clothes, you will need to run a damp cloth down the lines to clean them. In addition, this type of clothesline presents an obstacle in the yard, which can be a great hindrance in small yards, particularly in play areas.

Step2



Retractable The retractable line (which can also be installed indoors on a covered porch) can be installed on an outside wall of your house or other building. The cord is then pulled to hook onto another side of an L-shaped house, another nearby building, or a pole.

ADVANTAGE: The line retracts when not in use. Because the line is retracted when not in use, it remains clean, eliminating the need to clean the line before use. The retracted line when not in use means no hanging obstacle in the yard.

DISADVANTAGE: This type of line has lower stability, causing it to sag with wet laundry. Smaller clothes, like children's laundry, are more suitable to this type of line.

Step3



Umbrella The author's choice is the umbrella clothes dryer, which is inserted into a base that has been cemented into the ground. This type of line can be removed and folded like an upside-down umbrella for indoor storage. There is a variety of umbrella clothes dryer that spins with the breeze, further accentuating its drying potential.

ADVANTAGE: Lightweight, it can be removed for indoor storage so the lines are always clean. In addition, if you use pinch-type clothes pins, you can leave the clothes pins on the line after you remove the clothes. The location in the yard where the umbrella tree is installed is recessed so a

lawn mower can safely mow over the area when the line is removed. This type of clothesline works well in confined spaces.

DISADVANTAGE: Hanging wide items, like sheets, takes a little ingenuity.
Step4



Sunshine With the line of your choice installed, all you need is the sun or a breeze to dry your clothes. Both sun and breeze makes the process of drying go fast!

Tips & Warnings

- If possible, plan wash days around the weather so you can hang clothes on non-rainy days.
- There are drawbacks to hanging clothes outside. For pollen sufferers, the pollen floating in the air may cling to the laundry, further aggravating symptoms.

How to Fold a Fitted Sheet

Instructions

Difficulty: Easy

Things You'll Need:

- Liquid Fabric Softeners
- Fitted Sheet
- Laundry Detergents
- Washing Machines

Step1

Wash and dry your sheets before folding and storing them.

Step2

Remove sheets from dryer while they are still warm so that they do not wrinkle. If the sheets are already cool, put them back in the dryer with a moist cloth for a couple of minutes.

Step3

Put your right hand in the right top corner of the sheet, and fold the left top corner of the sheet over your right hand.

Step4

Keep holding the sheet with your right hand and gather up a bottom corner, folding it over the right hand as well.

Step5

Take the remaining corner and fold it over your right hand.

Step6

Fold the sheet into a square, then continue folding in half until you have reached the desired size.

How to Clean Fine Linen

Linen is a very durable fabric and can be machine-washed with the rest of your laundry. Linens get softer every time you wash them.

Instructions

Difficulty: Easy

Things You'll Need:

- Washing Machines
- Irons
- Starches
- "nonbleach, Nonalkaline Mild Detergent"
- Mildewcide Or Bleach

Step1

Machine-wash linens with like colors according to their care instructions. Use the delicate cycle for fine linens with lace.

Step2

Iron linen while it is still very damp. Starch can help prevent excess creasing.

Step3

For particularly soiled or stained linen, wash frequently with plenty of detergent and bleach.

Step4

Brighten yellowed linen by dissolving a few denture-cleaning tablets in a tub of warm water. Soak the linen in this mixture for at least 20 minutes.

Step5

Tumble dry and iron again if necessary.

How to Clean Porcelain

Instructions

Difficulty: Easy

Things You'll Need:

- Mild Detergent
- Sponges
- Bristle Brushes

Step1

Hand wash painted or decorated porcelain surfaces with a very mild dish detergent. Rinse in warm water; hand dry with a soft towel.

Step2

Use an all-purpose kitchen or bathroom cleaner for plain, more resilient surfaces such as toilets and sinks. Take a scrub brush to stains; rinse with warm water.

Step3

Use a very mild abrasive cleaner and scrub sponge as a last resort for particularly persistent stains, scrubbing only the affected area; rinse with warm water.

Tips & Warnings

- Avoid abrasive cleaners if possible, as they can dull the surface of porcelain.
- Decorated porcelain should not be washed in a dishwasher.

How to Clean and Dry Dishes by Hand



With automatic dishwashers doing all the work for us, you may have forgotten how to do the simple task of washing dishes by hand. Here's a quick review.

Instructions

Difficulty: Easy

Things You'll Need:

- Liquid Dish Soap
- Baking Soda

- Latex Gloves
- Dish Drainers
- Scouring Pad
- Spatulas

Step1

Start with a clean sink.

Step2



Set a dish drainer on a clean countertop.

Step3



Scrape dishes and pots and pans clean of residual food matter with a table knife or rubber spatula.

Step4

Pile scraped dishes next to the sink along with glassware, silverware, and pots and pans.

Step5

Plug up sink.

Step6

Turn on faucet and begin to run warm water into sink.

Step7

Read instructions on dishwashing liquid to see how much to add - generally a generous squeeze.

Step8

Fill sink one-half to two-thirds full with warm soapy water.

Step9



Add plates and silverware to sink.

Step10



Thoroughly wash each item with a dishcloth or scrub pad.

Step11

Rinse each dish or utensil as you wash it in warm or hot clean water.

Step12

Put dishes in dish drainer.

Step13



Let dishes air dry.

Step14

Drain sink.

Tips & Warnings

- Wash glassware first, before greasy pots and pans.
- Rubber gloves will protect hands and manicures, and allow you to use hotter water for washing and/or rinsing.
- Dishes may be hand dried with a clean cloth.
- Try adding a tablespoon of baking soda to your soapy water, to soften hands while cutting grease.
- Never dump sharp knives into soapy dishwater where they cannot be seen.
- Laundry detergents or automatic dishwasher detergents should not be used for hand washing dishes.
- Keep dishwashing liquid out of the reach of children.

How to Use a Dishwasher

Instructions

Difficulty: Easy

Step1

Using a knife or rubber spatula, scrape residual food off of dishes, pots and pans.

Step2

Place dishes in designated slots: glasses and cups on top rack, plates on lower rack, silverware in silverware rack.

Step3

Place pots and pans around other dishes, making sure other dishes do not block spray access to pots and pans.

Step4

Fill both dishwasher cups with dishwasher detergent.

Step5

Close tops of cups where appropriate.

Step6

Add rinse agent to rinse agent dispenser; replace top of dispenser.

Step7

Close door securely.

Step8

Choose a wash cycle appropriate to the load.

Step9

Choose a dry cycle. Air drying saves energy, but may cause spotting.

Step10

Start dishwasher.

Tips & Warnings

- Keep dishwasher detergent and rinse agent out of the reach of children.
- Not all items are "dishwasher safe." If you are not sure, look for instructions printed on the item, or read instruction pamphlets or tags.

How to Clean Greasy Pots and Pans

Instructions

Difficulty: Easy

Things You'll Need:

- Liquid Dish Soap
- Oven Cleaner
- Baking Soda
- Dishtowels
- Powdered Dishwashing Detergent
- Scouring Pad

Step1

Let any remaining grease in the pan cool slightly.

Step2

Pour grease into a can.

Step3

Set pan to soak in hot soapy water.

Step4

Pour off soapy water.

Step5

Arrange pan in lower rack of the dishwasher and run on "pots and pans" or "heavy" cycle. Or,

Step6

Wash by hand using very warm, soapy water and scrub with a scouring pad.

Step7

Rinse and dry pan.

Tips & Warnings

- Save greasy pots and pans for last when washing by hand.
- If glass baking dishes have baked-on food, spray the pan with oven cleaner and let it sit for 45 minutes.
- Sprinkle scorched pans with baking soda or powdered dishwashing detergent; add a small amount of water and let stand for an hour or more.
- Try adding a drop or two of dish soap and enough water to cover bottom of pot or pan, and bring to a boil on the stove top before cleaning.
- Avoid pouring grease down the sink and causing damage to pipes.

How to Clean Pots and Pans Without Soap



For your tough-to-clean pots and pans, here's an easy cleaning solution that requires no soap.

Instructions

Difficulty: Easy

Things You'll Need:

- Scrub Brushes
- Scrub Sponges
- Baking Soda
- Pots And Pans

Step1

Get a pot that is larger than the one you are trying to clean.

Step2



Place the dirty pot in the bigger pot.

Step3

Pour enough hot water into the bigger pot to cover the area of the pot needing washing.

Step4



Add 2 tbsp. baking soda for every 1 qt. water.

Step5

Let the pot soak until the dirt particles have loosened.

Step6

Remove smaller pot from larger pot.

Step7

Rinse both pots with clean water.

Step8



Use an abrasive sponge with baking soda to get any remaining food particles off the pot.

Tips & Warnings

- For really stubborn spills or messes, place the smaller pot (the one to be cleaned) inside a bigger pot, and place it on a burner. Fill the bigger pot with enough of the water and baking soda mixture to cover the dirty areas of the smaller pot, and boil.
- Do not use an abrasive sponge on pots or pans with Teflon or a nonstick coating.

How to Clean a Barbecue Grill

Instructions

Difficulty: Easy

Things You'll Need:

- rags, steel wool or wire grill brushes
- Heavy-duty Scouring Pad
- Garden Hoses And Attachments

- Liquid Dish Soap
- Kitchen Sponges
- Hose-end Sprayers
- Spray-on Oven Cleaner
- Nonstick Cooking Spray
- Rubber Gloves
- Cooking Oil
- Old Newspapers

Step1

After you've finished cooking and the coals have died out, brush the grill grate with a stiff wire brush. Next time you're ready to cook, fire up the grill, brush the grate again and then coat it with a thin film of oil. This regimen should keep the grate perpetually clean and ready to go.

Step2

When the ashes are cold, remove them from the collector pan beneath the grill. Allowing ashes to collect in the bottom of the grill for days or weeks will impede air flow and can collect moisture, causing your grill to rust.

Step3

Don't worry too much about baked-on grease or juices that have collected on the walls of the lid or bottom of your grill; it has no effect on how well your grill will perform. Periodically use a wire brush to brush any flakes from the interior walls.

Step4

If you really want to make your grill shine, remove the ashes and grill grates. Hose the grill out, then scrub with warm, soapy water and a fine steel wool pad.

Step5

You can also clean the grates and the exterior of the grill with warm, soapy water and fine steel wool.

Tips & Warnings

- Avoid using harsh cleansers on any part of your barbecue grill.

How to Wash an Outdoor Grill

After you remove food from a barbecue, cover the grill and allow it to stay heated for 15 to 20 minutes longer. This process will burn away a lot of the residual grease and grime between uses. A couple of times a year, though, you'll want to give the grill a thorough cleaning before you fire it up.

Instructions

Difficulty: Moderate

Things You'll Need:

- Dishwashing Liquid
- Oven Cleaner
- Brass Wire Brush
- Charcoal Grill:
- Garden Hose
- Gas Grill:
- Stiff Wire Brush
- Tape

- Vegetable Oil
- Baking Soda Or Abrasive Cleaner
- Large Plastic Bag
- Large Spoon Or Cup
- Metal Scouring Pad Or Plastic Scrubber
- Newspaper
- Paper Clip Or Toothpick
- Linseed Oil
- Rag, sponge or plastic scrubber

Charcoal grill

Step1

Use a stiff wire brush to scrape away any loose debris from the grill and grates, then remove the grill and grates.

Step2

Scoop out any ash at the bottom of the barbecue with a large spoon or cup.

Step3

Clean the inside and outside of the barbecue with baking soda (or another abrasive cleaner) and a little water using a metal scouring pad. If your barbecue has a painted, a nonstick or an aluminum surface, use dishwashing liquid, water and a plastic scrubber (not abrasive cleaners and metal scrubbers).

Step4

Place the grill and grates in a large plastic bag and cover them thoroughly with oven cleaner. Allow them to sit for several hours or overnight. If the grill and grates are aluminum, soak them in dishwashing liquid and water instead.

Step5

Remove the grill and grates from the plastic bag and place them atop several layers of newspaper.

Step6

Use a metal scouring pad or stiff brush to scrub them clean. If the grill or grates are aluminum or nonstick, use a plastic scrubber, not a metal one.

Step7

Hose off the grill and grates to remove any remnants of the oven cleaner. Use the hose to clean out the barbecue itself as well.

Step8

Allow everything to dry thoroughly, then replace the grill and grates.

Step9

Coat the grill with vegetable oil to prevent rusting and future buildup.

Gas grill

Step1

Examine the flexible hose. If it is cracked or damaged, replace it with a new one.

Step2

Consult your owner's manual for basic maintenance tips (see also How to Troubleshoot a Gas Grill). This will include checking the metal tubes under each burner. Spiders and other creepy crawlies like to nests in these tubes, which causes blockage and possibly even a fire. Use a paper clip or toothpick to clear these holes if necessary.

Step3

Remember that many gas grills are made of aluminum products, so you'll want to avoid abrasive cleaners, including oven cleaner, and metal brushes or scouring pads.

Step4

Soak the grill and any removable parts in dishwashing liquid and hot water. Scrub away buildup with a rag, sponge or plastic scrubber.

Step5

Remove the porcelain grills and flavorizer bars and run them through the dishwasher. Or scrub them with a brass wire brush.

Step6

Replace the lava rocks every year with new ones or boil them in soapy water to remove built-up grime.

Step7

Tape over any gas openings and then clean the inside of the barbecue with hot, soapy water and a rag, sponge or plastic scrubber.

Step8

Clean the outside of the barbecue with hot, soapy water and a rag or sponge.

Step9

Hose out the barbecue. Allow it to dry thoroughly before you replace all of the parts.

Step10

After everything is dry, rub the grill with vegetable oil and any wooden parts with linseed oil.

Step11

If you have a quick disconnect, make sure it is securely fastened before you use the grill.

Tips & Warnings

- Before you fire up the grill, spray it with nonstick cooking spray or wipe it with vegetable oil to make cleanup easier.
- If a grill is still warm, not hot, rub a balled-up piece of aluminum foil against it to remove any debris, just like you would a stiff brush.
- Some barbecue aficionados prefer to leave carbon buildup on the grill because they believe it adds flavor to barbecued meats and vegetables.

How to Clean Your Laundry Room in Ten Minutes



Instructions

Difficulty: Moderately Easy

Things You'll Need:

- Vinegar
- Swiffer Cloths or Wash cloths
- Dishwashing soap
- Optional: Duster
- Optional: Used dryer sheet
- Broom or swiffer duster

Step1



Vinegar Pour a bottle of vinegar into your empty washer. Set your washer to the hot water setting and use any cycle you wish.

Step2



Dryer Lint Trap Clean your lint trap out with a used dryer sheet or your hand. Either way will get the job done.

Step3



Washer and Dryer Wipe down the exterior of your washer and dryer with a damp cloth. Use the dishsoap to remove any unsightly stains.

Step4



Shelves Dust all shelves and surfaces with a duster or swiffer cloth.

Step5



Sweep If you have any extra time, give the floor a quick sweep and voila your done!

Tips & Warnings

- Effective cleaning routine you can use even when you're not in a hurry
- Doing this once a week should keep your laundry room looking fresh
- Only pour vinegar into your washer 1-3 times a year depending on how much you use your washer. A family of five should probably do it 3 times a year while a single person should only do it once a year.

How to Organize a Laundry Room

Instructions

Difficulty: Moderately Easy

Things You'll Need:

- Trash bin
- Laundry cart
- Storage containers
- Hangers
- Shelves
- Hampers and clothes baskets

Step1

Determine what is realistic for storage. Shelving, storage cabinets and ironing and folding areas are convenient assets to utilize if space is available.

Step2

Keep clothing separate by providing individual hampers for each person in the household.

Step3

Place laundry detergents, fabric softeners, starches and stain removers near the washing machine in one grouped area to avoid spills and messes. If possible, place these items on a shelf off the floor.

Step4

Create a wall storage solution for the appropriate items, especially ones you need readily available. Peg boards, hooks, racks and custom-made cabinets are all options.

Step5

Place a small trash bin near the washer and dryer to collect lint, used dryer sheets and other disposable items.

Step6

Use a laundry cart or hanging garment rack to sort and place freshly-washed items.

Step7

Remove folded, organized loads of laundry from the room immediately and place them in the proper place to avoid clutter.

Tips & Warnings

- Keep a small basket or bin nearby to collect found items such as coins, keys, paper and receipts and lipstick.
- If you have limited space, use a collapsible folding table for folding and ironing.
- Wire shelving can be a great organizational tool for the laundry, as it also allows space to hang clothing from its edges.

How to Clean a Knife

One of the most important elements of owning a knife is knowing how to take care of it, and that means keeping it clean. Knives have various uses, and some are more high maintenance than others. Here's how to keep yours in working order.

Instructions

Difficulty: Easy

Things You'll Need:

- Knife oil
- Cotton cloth
- Dry towel
- Q-Tips

Step1

Clean utility knives, such as hunting, skinning or bowie knives, of any excess grime or dirt using water and a cleaning solvent. Avoid using harsh detergents when cleaning knives.

Step2

Dry the knife completely. Cotton cloth or chamois are best for removing water spots, moisture and fingerprints.

Step3

Spray or wipe down each joint of the knife with cleaning oil and spread it thoroughly over the knife's surface as well as the handle. Break Free is a popular brand of knife oil used for cleaning utility knives. Experts also recommend Japanese sword oil made from Camellia flowers.

Step4

Check your knives often for trouble spots. You may not know that you've missed a spot until it shows up as rust. Oxidation and tarnishing are usual occurrences with knives made of carbon steel. This appears as bluish gray and can actually help protect the knife. You can distinguish this from rust by its color, as rust appears reddish brown.

Step5

Remove any sticky residue, possibly left by the adhesive from labels, with nail polish solution on a rag. Clean inside the knife with toothpicks, Q-Tips and cotton swabs.

Step6

Work slowly and patiently. Overcleaning your knife can do serious damage to it.

How to Clean Walls

Instructions

Difficulty: Moderate

Things You'll Need:

- Eraser type sponge
- Rags
- Oil soap or other gentle cleaner
- Touch up paint

Step1

Test your eraser sponge on an inconspicuous area to be sure it won't cause damage to the surface of your wall. If you have flat textured paint it may be removed by these cleaning methods.

Step2

Using a damp eraser sponge scrub away any obvious scuff marks, finger prints, crayon marks and any other noticed stains. Rinse the eraser sponge often.

Step3

Put a quarter cup of oil soap in a half of a bucket of warm water. Using rags wipe down the entire surface of your wall. Rinse your rags often.

Step4

If your walls were extremely soiled go over them a second time with fresh soap and water.

Step5

Using touch up paint go over any of the marks that you were not able to clean off.

How to deal with melted candle wax in a candle holder

Instructions

Difficulty: Easy

Things You'll Need:

- candle
- glass or other candle holder
- water

Step1

Before you light a candle remove it from the holder and add a couple or more drops of water to the holder. Replace candle. Any melted wax left behind after burning the candle should not stick.
Step2

If some wax does stick, simply place the candle holder in the freezer and allow the wax to freeze.
Step3

The wax should be easy to loosen and remove from the holder. Remove any remaining bits of wax with a gentle scrubbing.

Tips & Warnings

- The freezer method works well with most materials.
- Allow candleholder to cool completely before handling or placing in the freezer
- Avoid using water in a wooden candleholder.

How to Remove Spilled Candle Wax

Instructions

Difficulty: Moderate

Step1

Manually remove as much of the wax as possible. You can use an ice cube to make the wax more breakable. Use a dull butter knife or credit card to dislodge as many pieces of wax as you can. Vacuum away or dust off and throw out any pieces you do remove.

Step2

Decide if you need to use a hairdryer. If the surface isn't flammable, put the hairdryer on low and use the heat to slowly melt the remaining wax. Wipe up the melted wax with a cloth towel. This method is more effective on a hard surface, such as a table.

Step3

Consider using an iron if you don't have a hairdryer. Follow the same technique as you would with the hairdryer. This wax removal technique works better on fabrics and other "softer" materials.

Step4

Try using a hot spoon if it is a smaller stain. Heat a metal spoon, affix a piece of wet paper over the stain and then rub with the spoon to remove the melted wax.

Step5

Remove any color, if necessary. Remove stains from colored candle wax with a multi-surface cleaner if the wax is on a hard surface. Pre-treat any fabrics with an appropriate stain remover and wash, if possible.

How to Polish Silverware

Instructions

Difficulty: Easy

Things You'll Need:

- Silver Polish
- Large Sponge
- Plastic Sheet Or Old Towel
- White Tissue Paper
- Warm Water

Step1

Apply commercial silver polish as directed on product label, typically with a moist sponge.

Step2

Rinse sponge often, and rub polish in until tarnish disappears.

Step3

Rinse silver thoroughly in warm water to remove all polish.

Step4

Hand dry silver immediately with a soft dish towel.

Tips & Warnings

- To minimize tarnishing while storing silver, wrap it in tissue paper, put it into sealed polyethylene bags, and use 3M anti-tarnish strips as dividers.
- To avoid corrosive damage in silver salt shakers, do not store shakers with salt inside.
- Avoid using harsh chemicals, abrasive cleansers or scouring pads on silver.
- Do not polish lacquered silver.
- Putting silverware in a dishwasher may cause damage.

How to Polish Brass and Copper

Instructions

Difficulty: Easy

Things You'll Need:

- Brass Polishes
- Polishing Cloths
- Worcestershire Sauces
- Toothpaste
- Copper Polishes

Step1

Dust brass and copper regularly.

Step2

Wash in warm, soapy water; rinse and dry.

Step3

Use a commercial brass or copper cleaner as directed. A combination of toothpaste and Worcestershire sauce also works, although it is not as powerful as a commercial cleaner.

Step4

Apply with a soft cloth, wipe off, and buff with a clean, dry cloth.

Step5

Avoid using harsh chemicals, abrasive cleaners or scouring pads.

Tips & Warnings

- Do not polish lacquered brass or copper items.

How to Disinfect a Sponge

Your kitchen sponge can harbor a variety of unhealthy bacteria. Would you believe the average kitchen sponge is home to billions of these tiny creatures? Each time you use your kitchen

sponge, you're spreading bacteria all over your counters and appliances. You can help to correct this problem by taking steps to disinfect your sponges on a regular basis. Here's how to disinfect a sponge.

Instructions

Difficulty: Moderately Easy

Step1

Option One: Disinfect a sponge in the dishwasher.

You can clean your kitchen sponges by placing them in the dishwasher. The water in a dishwasher should get hot enough to kill bacteria and germs.

Step2

Option Two: Use your microwave.

This method will also kill 98% of bacteria and germs. Simply place the sponge in your microwave and zap it for two minutes. It's important that you watch the sponge the entire time since it can potentially become so hot that it ignites.

Step3

Option Three: Replace sponges on a regular basis.

The third option is more expensive. Have a supplemental supply of sponges available in your cabinet and replace a sponge after two weeks with a fresh one. Keep in mind that anytime a sponge develops an odor, it's time to replace it.

Tips & Warnings

- Another option is to use dishtowels instead of sponges. Dishtowels can be easily cleaned in the washing machine.
- Be sure to clean your sponges in soapy water and rinse them thoroughly after each use. Squeeze as much water out as you can and put them in a warm place to dry .
- Don't use sponges around raw meats or eggs because you run the risk of transferring the bacteria to your dishes and counters.

How to Disinfect Your Garbage Disposal Without Chemicals

Instructions

Difficulty: Easy

Things You'll Need:

- Lemon juice or white vinegar
- A lemon or other citrus fruit (or just the peels)
- Baking soda

Step1

Cut up the lemon (or orange, grapefruit, lime, etc.) into chunks. If you're using a whole lemon, deseed it first.

Step2

Pour about 1/2 cup of baking soda directing into the garbage disposal drain.

Step3

Put the lemons chunks in the drain.

Step4

Add 1 cup of lemon juice or vinegar to the drain. Start the COLD water and turn on the disposal. The reaction from juice or vinegar and the baking soda will help disinfect. The fruit will knock around in the disposal enough to help kill bacteria on the walls of the disposal. Keep the water and disposal running until the fruit is all gone!

How to Eliminate Odor in a Room

Instructions

Difficulty: Moderately Easy

Things You'll Need:

- An air freshener
- An air sanitizer

Step1

Find out where the unusual odor is coming from. Before you can eliminate an unusual bedroom odor, you have to find out what the exact source of the smell is. This is the first and foremost thing that you should do. Until you do it, you will not be able to get rid of it so quickly.

Step2

Change the bed sheets and wash the comforter. Both the sheets and comforter can cause your bedroom to smell. If you really want your room to start smelling better, then you should opt for a laundry detergent with a fresh scent that you really like. This will replace an unusual bedroom odor with a smell that you will love.

Step3

If you have a trash can in your bedroom, then empty it. One of the reasons that your bedroom may smell a bit funny could be because of something that is in the garbage. Even if you empty the garbage every week, you should still do this if you want to eliminate an unusual bedroom odor.

Step4

Get an air freshener. If you really want to eliminate an unusual bedroom odor, then this is a must. There are many different scents that are available on the market to choose from and they will all leave your bedroom smelling so much fresher. Whether you want it to smell like peach or cucumber melon, you'll be able to freshen up the scent of your bedroom.

Step5

Spray everything with an air sanitizer. Spray your mattress before you put the sheets on, the air, inside the closet and even a desk if you have one. Keep in mind that there are air sanitizing products available for people who want to go green, so you won't need to feel guilty about hurting the environment.

Tips & Warnings

- Clean out the bottom of your closet every three months, especially if clothes pile up.
- Don't forget about vacuuming, as it may help relieve the odor in your bedroom.
- If you have pets, they may be the source of your problem. Consider grooming them more frequently or purchasing a pet deodorant.
- Make sure that food has not been left somewhere in the room, which may be the source of your unusual bedroom odor.
- Don't become frustrated if the unusual bedroom odor doesn't go away immediately.

How to Clean Window Screens

Instructions

Difficulty: Easy

Things You'll Need:

- Dishwashing Liquid
- Garden Hoses
- Old Towels
- Scrub Brushes
- Vacuum Cleaners
- Clear Nail Polishes

Step1

Remove the screen from the window and lay it flat on an old towel.

Step2

Mix 1 tbs. dishwashing liquid in 1/2 gal. water.

Step3

Use a soft brush to gently scrub the screen with the detergent mixture.

Step4

Hold the screen upright and rinse it with a garden hose.

Step5

Shake the water from the screen and let it air dry.

Step6

Go over the screen with a vacuum attachment every couple of months to keep the dust under control.

Tips & Warnings

- Keep insects from crawling through very small holes by dabbing the holes with a spot of clear nail polish.

How to Remove Hairspray Buildup from Bathroom Walls

Removing hairspray buildup on bathroom walls is a difficult cleaning problem for many households. Hair spray buildup becomes sticky and looks unsightly in an otherwise clean bathroom. The buildup is caused by over-spray when using either an aerosol can or pump spray bottle of hair spray. Here's some easy ways to eliminate the buildup.

Instructions

Difficulty: Easy

Things You'll Need:

- Fabric softener
- Water
- Measuring cup
- Spray bottle

Step1

Try using rubbing alcohol to remove hair spray buildup. Simply wipe the walls with alcohol and then wipe off the hairspray buildup with hot soapy water.

Step2

Make a thick paste of water and baking soda and apply it to the area with the hair spray buildup. Allow the paste to sit for a couple of minutes and then wash it off with a clean damp towel.

Step3

Use an old credit card or plastic pot scraper to rub off the buildup, if there are areas of thick hair spray buildup. Once you've removed the buildup, clean with the fabric softener mixture in the following steps.

Step4

Pour 2 cups water into a spray bottle.

Step5

Add 1 cup fabric softener to the water.

Step6

Put the cover onto the spray bottle and shake, mixing the water and the fabric softener together.

Step7

Spray the mixture onto the walls to be cleaned.

Step8

Wipe the walls with a soft cloth.

Tips & Warnings

- Another method to clean hair spray buildup off bathroom walls is to spray white vinegar on the walls and wipe it off. The smell of the vinegar will quickly evaporate.
- Always test a cleaning method on a small inconspicuous area if your bathroom walls are painted.

How to Get Your Bathroom Sparkling Clean Using Vinegar

Instructions

Difficulty: Moderately Easy

Things You'll Need:

- White distilled vinegar
- Baking Sods
- water
- sponges
- rags or cleaning cloths

Step1

Remove grime, mildew, and scum from the tub, tile, shower curtain or door by wiping with undiluted white distilled vinegar. Rinse with water.

Step2

Use full-strength white distilled vinegar on dirty grout, let it sit for a few minutes and then scrub with an old toothbrush.

Step3

Spray shower doors with full-strength white distilled vinegar to release the hard water deposits.

Step4

Get rid of stubborn bathtub film: Wipe it with white distilled vinegar and then scrub with baking soda.

Step5

Kill germs all around the bathroom with a spray of full-strength white distilled vinegar. Wipe clean with a damp cloth.

Step6

Colored porcelain sinks will shine when you scrub them with (undiluted) vinegar.

How to Care for a Mattress

Instructions

Difficulty: Moderately Easy

Things You'll Need:

- Allergy-free Bedding
- Bed Linens
- Beds
- Bedsheets
- Mattress Pads
- Mattresses
- Pillows

Step1

Cover your mattress with a cotton mattress pad, which will absorb perspiration and can be removed and washed to keep the mattress clean.

Step2

Rotate your mattress twice a year, or more often if instructed by the manufacturer. Flip it over completely after the first six months. Then, after another six months, flip it over and turn it so that the head is at the foot of the bed. Some new mattresses don't need flipping. Check with the manufacturer.

Step3

Use the handles on the sides of the mattress for positioning only - not for carrying. Lifting by the handles can damage your mattress.

Step4

Air out your mattress each morning by folding back the covers to the bottom of the bed for half an hour before you make it. This will also prevent moisture buildup.

Step5

Try not to sit on the edge of the bed in the same place every day, because this can lead to sagging.

Tips & Warnings

- Leave the 'do not remove' tag attached to the mattress. You will need this for filing warranty claims.
- Avoid spill and stain damage to your mattress. Many manufacturers void their warranties if there are stains.

How to Care for a Futon

Instructions

Difficulty: Easy

Things You'll Need:

- Carpet Cleaner
- Futon Covers
- Futon Frames
- Futon Mattress
- Mattress Pads

Step1

Purchase a futon cover if using your futon as a couch, to protect it from stains, dust and oils. Most covers are a little thicker than a fitted sheet and are machine washable.

Step2

Buy a mattress pad or a vinyl sheet to protect it from stains if the futon is being used as a bed. The sheet or pad goes between the fitted sheet and futon mattress.

Step3

Flip your futon once a month if you are using it as a sofa. Rotate it each time you change the sheets if the futon is being used as a bed.

Step4

Hang your futon outside in the sun to keep it fresh. Once every six months, if possible.

Step5

Air your mattress out each morning - if using your futon as a bed - by folding back the covers to the bottom of the bed for half an hour before you make it. This will also prevent moisture buildup.

Step6

Vacuum the mattress regularly to remove dust.

Step7

Use a scrub brush, warm water and laundry detergent to clean entire mattress or individual spots. Be careful not to get it too wet. Allow it to dry outdoors.

Step8

Try a rug cleaner for stains.

Tips & Warnings

- Avoid leaving damp clothes or towels on your mattress, as this will add moisture to it.
- Futon mattresses last from 2 to 10 years, depending on the quality.

How to Clean Hard Water Stains off a Waxed Table

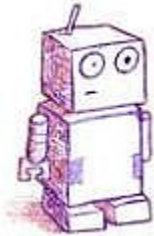

Instructions

Difficulty: Easy

Things You'll Need:

- Virgin Olive Oil
- White Vinegar
- Soft Cloth or Mr. Clean Magic Eraser.

Step1

Mix equal parts of the vinegar and olive oil.

Step2



This sponge makes most cleaning jobs easier. Apply to the affected area,do not rub back and forth,rub only in one direction,using brief light strokes.

Step3

When you are finished repairing the area,then clean it properly to remove the cleaning solution.

Step4

Pat dry.

How to Cover Up Scratches on Dark Wood Surfaces

Instructions

Difficulty: Easy

Things You'll Need:

- 2 cleaning clothes
- 2 tsp. instant coffee granules
- Water
- Bowl

Step1

Add 2 tsp. instant coffee granules and just enough water to turn the coffee into a thick paste in small bowl.

Step2

Dip a cleaning cloth into the paste.

Step3

Work paste into the scratches.

Step4

When all scratches have been filled in, buff the surface with second cloth.

How to Fix Scratches in Furniture



Instructions

Difficulty: Easy

Things You'll Need:

- Lint-free Cloths
- Colored Crayons

- Lemon Juices
- Olive (not Virgin) Oil
- Vegetable Oils
- Men's Razor Blades

Step1



Mix 1 part of lemon juice and 1 part vegetable or olive oil.

Step2

Apply a generous amount of this mixture to a clean, dry, lint-free cloth.

Step3



Rub the cloth firmly into the scratch, going in the direction of the scratch until it disappears.

Step4



Find a crayon the same color as the wood for deeper scratches. Color in the scratch in with the crayon.

Step5



Remove excess wax using a single-edged razor held at a 45 degree angle to the wood.

Step6



Wax the entire piece of furniture.

Tips & Warnings

- Remove any pulp from the lemon juice.
- Make sure to keep razor flat against wood and work away from you

How to Maintain Copper Clad Pots

Instructions

Difficulty: Moderately Easy

Cleaning Copper Pots

Step1

Clean and polish copper clad pots. Copper pots must be cleaned after cooking.

Step2

Clean copper between polishing, using a lemon sliced in half. Add salt to the lemon and rub it on the copper. Rinse well with warm water. Dry thoroughly to avoid water spots.

Step3

Use tomato juice as another natural cleaner. Apply evenly to copper bottoms and let stand for a few minutes. Rinse with hot water and dry well to avoid water spots.

Step4

Use a steel wool pad, if necessary. The steel wool will get rid of stains and baked on foods, and will make your pots shine between polishing. Wet the copper and the steel wool. Clean the copper in gentle circular motions. Rinse well and dry. Use a light touch with steel wool pads, or you may remove some copper from the pots.

Polishing Copper Pots

Step1

Polish copper pots once a week. In reality, most people polish their copper every six to eight weeks. Polish comes in paste or liquid, much as silver polish does. The paste type of polish may have fine abrasives to clean the copper bottoms as it shines. Both types of polish remove tarnish and add a layer of protection safe for cooking. Use the polish on the stainless parts of the pots as well.

Step2

Wet the outside of the pot and apply the polish with the applicator, or according to the directions.

Step3

Rub the polish in well, then rinse with very warm water. Rinse again.

Step4

Dry the whole pot immediately to avoid any water spots; you will probably need at least 2 towels when doing a whole set.

Instructions

Difficulty: Moderately Easy

Cleaning Copper Pots

Step1

Clean and polish copper clad pots. Copper pots must be cleaned after cooking.

Step2

Clean copper between polishing, using a lemon sliced in half. Add salt to the lemon and rub it on the copper. Rinse well with warm water. Dry thoroughly to avoid water spots.

Step3

Use tomato juice as another natural cleaner. Apply evenly to copper bottoms and let stand for a few minutes. Rinse with hot water and dry well to avoid water spots.

Step4

Use a steel wool pad, if necessary. The steel wool will get rid of stains and baked on foods, and will make your pots shine between polishing. Wet the copper and the steel wool. Clean the copper in gentle circular motions. Rinse well and dry. Use a light touch with steel wool pads, or you may remove some copper from the pots.

Polishing Copper Pots

Step1

Polish copper pots once a week. In reality, most people polish their copper every six to eight weeks. Polish comes in paste or liquid, much as silver polish does. The paste type of polish may have fine abrasives to clean the copper bottoms as it shines. Both types of polish remove tarnish and add a layer of protection safe for cooking. Use the polish on the stainless parts of the pots as well.

Step2

Wet the outside of the pot and apply the polish with the applicator, or according to the directions.

Step3

Rub the polish in well, then rinse with very warm water. Rinse again.

Step4

Dry the whole pot immediately to avoid any water spots; you will probably need at least 2 towels when doing a whole set.

How to Make a Non-Toxic Disinfectant



With so many allergens and toxic chemicals in the home, it's nice to have the ability to clean SAFELY.

Instructions

Difficulty: Easy

Things You'll Need:

- Opaque spray bottle x 2
- Vinegar (white)
- Hydrogen Peroxide

Step1

Rinse the inside of both spray bottles in any household faucet.

Step2



Fill one bottle with hydrogen peroxide.

This handy chemical will kill any bacteria on contact, leaving any surface in your house clean and safe. You should spray the surface and allow the hydrogen peroxide to act for at least 30 seconds for best effect.

Step3



Fill the other bottle with vinegar.

After the peroxide has had time to act, wipe down the surface and respray with vinegar. This chemical will dissolve any soil or stains on the surface after a short time (15 - 30 seconds should suffice). Wipe down the surface with a clean cloth and you're done!

How to Make a Spray Bottle Air Freshener

Instructions

Difficulty: Easy

Things You'll Need:

- Essential oils (like Lavender, Jasmine, Lemon, or Peppermint)
- Distilled Water
- A spray bottle (or several for making different scents)

Step1

First you should choose your scents. There are hundreds of essential oils available for around \$5-10 a bottle.

Step2

Fill your spray bottle(s) 3/4 of the way with distilled water. Add drops of the essential oils you've chosen to create your scent. A calming scent should start with Lavender oil. An invigorating scent should start with Orange or Lemon. A healing scent might start with Eucalyptus oil.

Step3

Close the spray bottles and shake lightly. You may spray into a room, onto your bedsheets, in your car, or on yourself as a perfume. You can make adjustments to a scent by adding more oil or more water.

Tips & Warnings

- Keep your scent bottles out of the sun. Oils like to be kept where it is cooler or darker.
- Refresh smells that have lost their strength with a few more drops of the base oil of the scent every few weeks.
- Spray a small towel with your favorite scent and throw it in with your clothes in the dryer to have a fresh scent in all your laundry
- Drop some essential oil in your bath to freshen the whole room and to relax you.
- Essential oils are not always safe for your skin directly. Be sure to diffuse the oils in water.

How to Set a Formal Table

Instructions

Difficulty: Easy

Things You'll Need:

- Silverware

Step1

Use white, damask tablecloth.

Step2

Rent or assemble enough tableware and glasses for a five-course meal.

Step3

Space place settings equidistance apart.

Step4

Fold linen napkins and place in the center of the dinner plates.

Step5

Place knives to the right of the plate. Use maximum of three: one for first course, one for main course and one for a salad course. Blades face the plate, not outwards.

Step6

Place forks to the left. Use no more than three: one for first course, one for main course and one for a salad course.

Step7

Place soup or melon spoons to the right of the knives. The dessert spoon lies at the head of the plate.

Step8

If you like, an old-fashioned finger bowl might be presented on the dessert plates after the meal.

Step9

Set out glasses in order of use above the knives. Usually that means setting water glass to the left, then to its right are the red wine, white wine, sherry and then champagne glasses.

Tips & Warnings

- The silverware at a formal dinner is generally silver or silverplate.
- Butter dishes are not traditionally included in a formal table setting.
- Rolls are placed directly on the tablecloth.
- Dessert forks come with the course.