

CONTENTS

- Introduction
- Oxidation of Fatty Acids
- Oxidation of Even-chain Saturated Fatty Acids (= Knoop's β oxidation pathway)
- Oxidation of Unsaturated Fatty Acids
- Oxidation of Odd Chain Fatty Acids
- α Oxidation of Fatty Acids
- ω Oxidation of Fatty Acids
- Ketogenesis
- Fatty Acid Oxidation in Peroxisomes
- Metabolic Water



Fats provide an efficient means for storing energy for later use.

The processes of fatty acid synthesis (preparation for energy storage) and fatty acid degradation (preparation for energy use) are, in many ways, the reverse of each other. Studies of mice are revealing the interplay between these pathways and the biochemical bases of appetite and weight control.

[Courtesy : Jackson/Visuals Unlimited]

CHAPTER

24

Oxidation of Fatty Acids

INTRODUCTION

The lipids of metabolic significance in the mammalian organisms include triacylglycerols (= triglycerides, neutral fats), phospholipids and steroids, together with products of their metabolism such as long-chain fatty acids, glycerol and ketone bodies. An overview of their metabolic interrelationships and their relationship to carbohydrate metabolism is depicted in Fig. 24-1.

At least 10 to 20% of the body weight of a normal animal is due to the presence of lipids, a major part of which is in the form of triglycerides which are uncharged esters of glycerol. Body lipids are distributed in varying amounts in all organs and stored in highly specialized connective tissues called *depot*. In these depots, a large part of the cytoplasm of the cell is replaced by droplets of lipids. Body lipids serve as an important source of chemical potential energy.

Fats (or triacylglycerols) are highly concentrated stores of metabolic energy. They are the best heat producers of the three chief classes of foodstuffs. Carbohydrates and proteins each yield 4.1 kilocalories (4.1 kcal) of heat for every gram oxidized in the body ; whereas fats yield 9.3 kcal more than twice as much. The basis of this large difference in caloric yield is that fats contain relatively

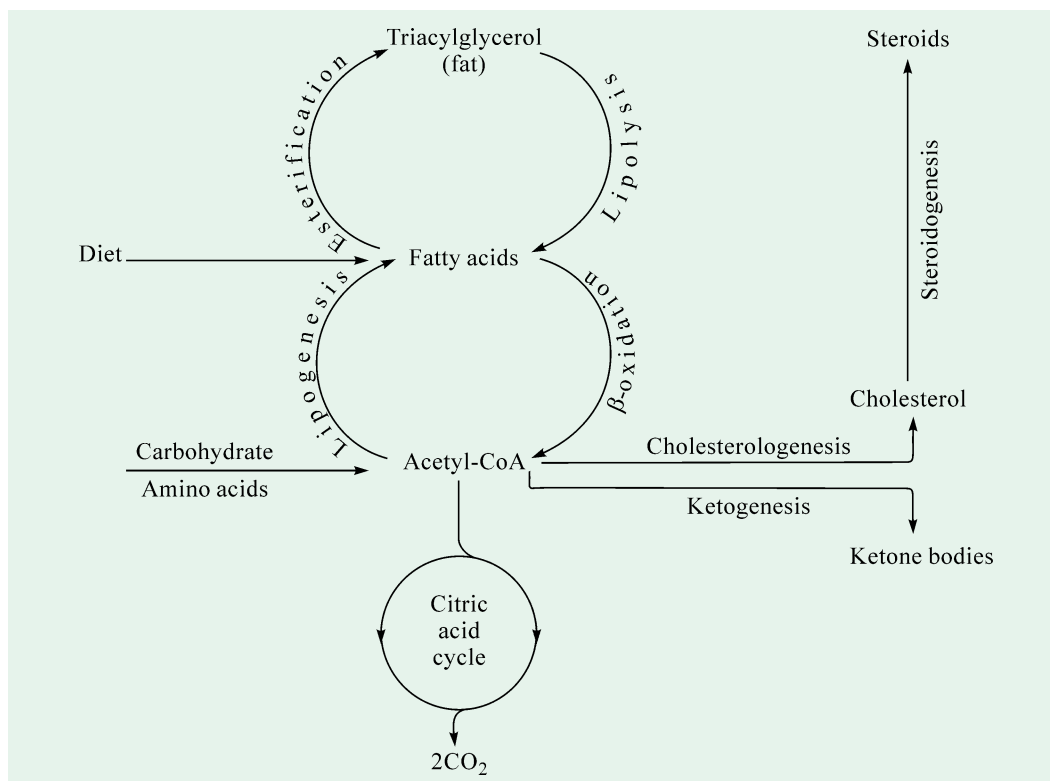

Fig. 24-1. An overview of the principal pathways of lipid metabolism

(Adapted from Harper, Rodwell and Mayes, 1977)

more carbon and hydrogen in relation to oxygen as compared to proteins or carbohydrates. In other words, fats are compounds that are less completely oxidized to begin with and therefore can be oxidized further and yield more energy. Furthermore, triacylglycerols are very nonpolar and so they are stored in a nearly anhydrous form, whereas carbohydrates and proteins are much more polar and more highly hydrated. In fact, a gram of dry glycogen (a carbohydrate) binds about 2 grams of water. Consequently, a gram of nearly anhydrous fat stores more than 6 times as much energy as a gram of hydrated glycogen, which is the reason that triacylglycerols, rather than glycogen, were selected in evolution as the major energy reservoir. A normal man, weighing 70 kg, possesses fuel reserves of 10,000 kcal in triacylglycerols, 25,000 kcal in proteins (mostly in muscles), 600 kcal in glycogen and 40 kcal in glucose. As mentioned, triacylglycerols constitute about 11 kg of his total body weight. If this amount of energy were stored in glycogen, his total body weight would be 55 kg greater.

An overview of the intermediary metabolism with special emphasis on fatty acids and triglycerides is given in Fig. 24-2.

The normal animal contains a greater quantity of easily mobilized lipids than of carbohydrates or proteins. About 100 times more energy is stored as mobilizable lipids than as mobilizable carbohydrate in the normal human being. In times of caloric insufficiencies, an animal can meet the endogenous requirements necessary for the maintenance of life by drawing on its lipid depots. In addition, neutral lipids serve as insulators of delicate internal organs of the body. This function is best exemplified in marine animals, whose water environment is both colder than body temperature and a far better thermal conductor than air. Lipids also serve as shock absorbers in protecting joints, nerves and other organs against mechanical trauma.

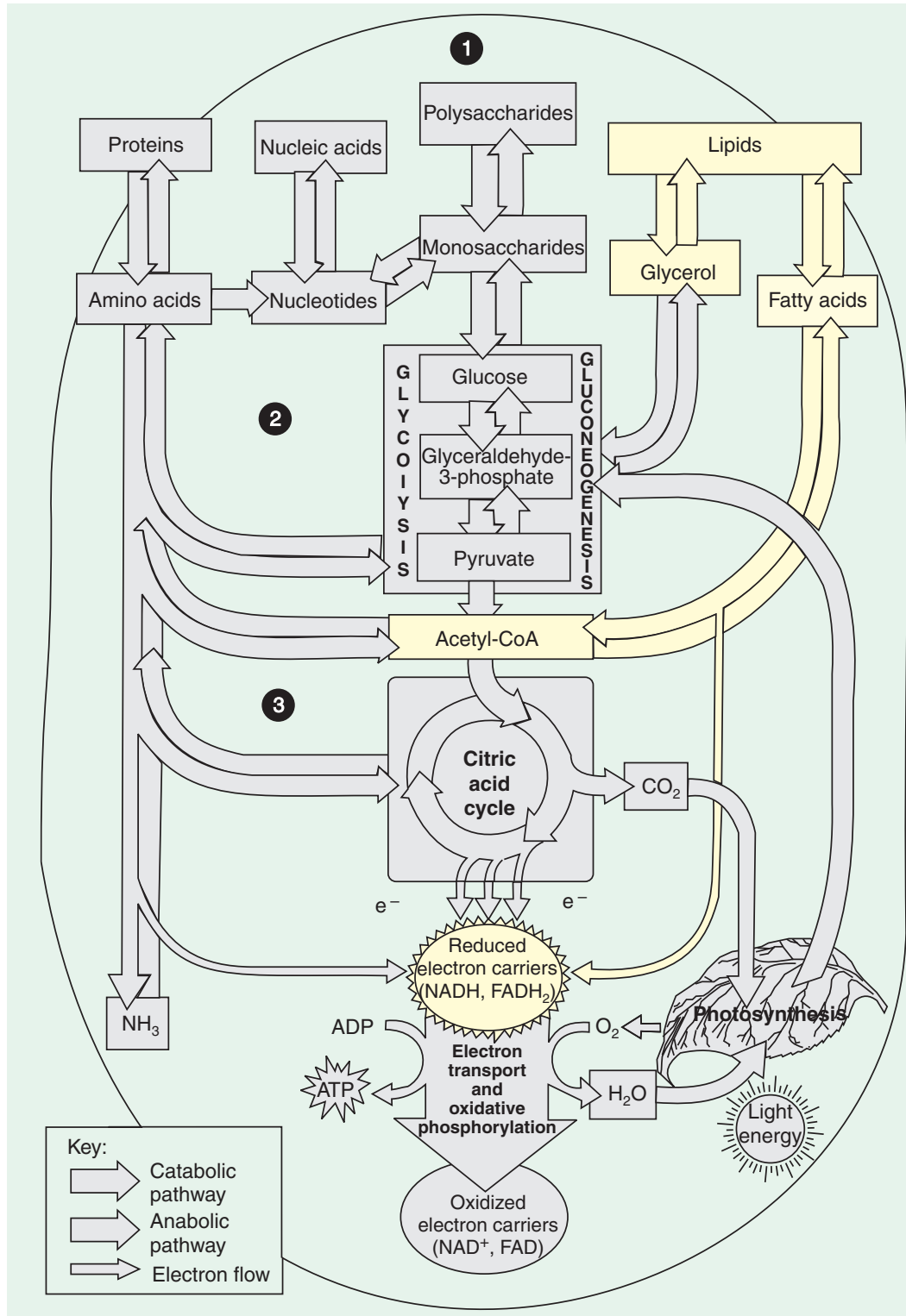

Fig. 24-2. An overview of intermediary metabolism with fatty acid and triglyceride pathways highlighted

When food intake exceeds caloric utilization, the excess energy is invariably stored as fat for the body cannot store any other form of food in such large amounts. The capacity of the animal to store carbohydrates (such as glycogen) is strictly limited, and there is no provision for the storage of excess proteins. Moreover, in an adult organism in which active growth has ceased, nitrogen output is more or less geared to nitrogen intake, and the organism shows no tendency to store surplus proteins from the diet. Plants differ from animals in that the energy reserves needed for reproduction are stored in the form of carbohydrates (as in corn or wheat) or as a combination of reserve proteins and oils (as in oil seeds, flax seed, safflower seed or sunflower seed).

In mammals, the major site of accumulation of triacylglycerols is the cytoplasm of adipose cells (= fat cells). Droplets of triacylglycerol coalesce to form a large globule, which may occupy most of the cell volume. Adipose cells are specialized for the synthesis and storage of triacylglycerols and for their mobilization into fuel molecules that are transported to other tissues by the blood. More than 99% of the lipid of human adipose tissue is triacylglycerol, regardless of anatomical location. In general, depot lipid is richer in saturated fatty acids than liver lipid. The more nearly saturated a sample of lipid, the higher the energy yield available from oxidation.

Fig. 24-3 presents, schematically, the flow of lipids in the body. Three important compartments are the liver, blood and adipose tissue. Both liver and adipose tissue are the principal sites of metabolic activity while the blood serves as a transport system. Other compartments, such as cardiac and skeletal muscle, are important utilizers of fatty acids and ketone bodies.

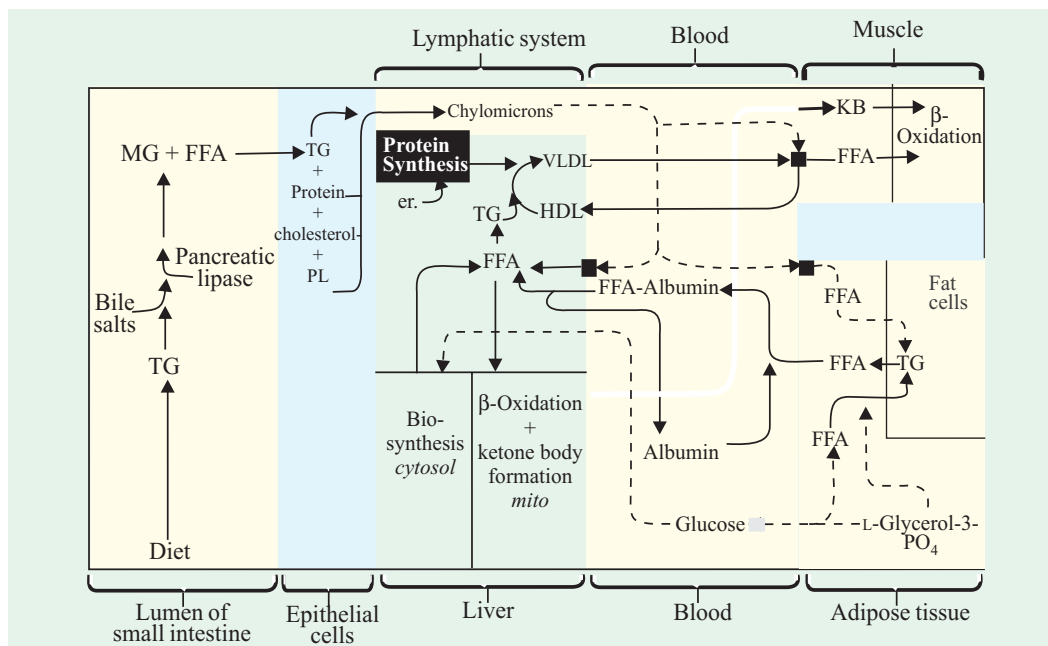

Fig. 24-3. Scheme depicting role of compartments in the utilization of lipids in the animals

TG = triacylglycerol, MG = monoacylglycerol, FFA = free fatty acids, PL = phospholipids, KB = ketone bodies, VLDL = very low-density lipoprotein, HDL = high density lipoprotein, ■ = lipoprotein lipase

(Adapted from Conn EE, Stumpf PK and Doi RH, 1997)

A diagrammatic representation of the metabolic interrelationships of fatty acids is presented in fig. 24-4.

OXIDATION OF FATTY ACIDS

General Considerations

The importance of oxidation of fatty acids is not limited to the obese or to devotees of greasy

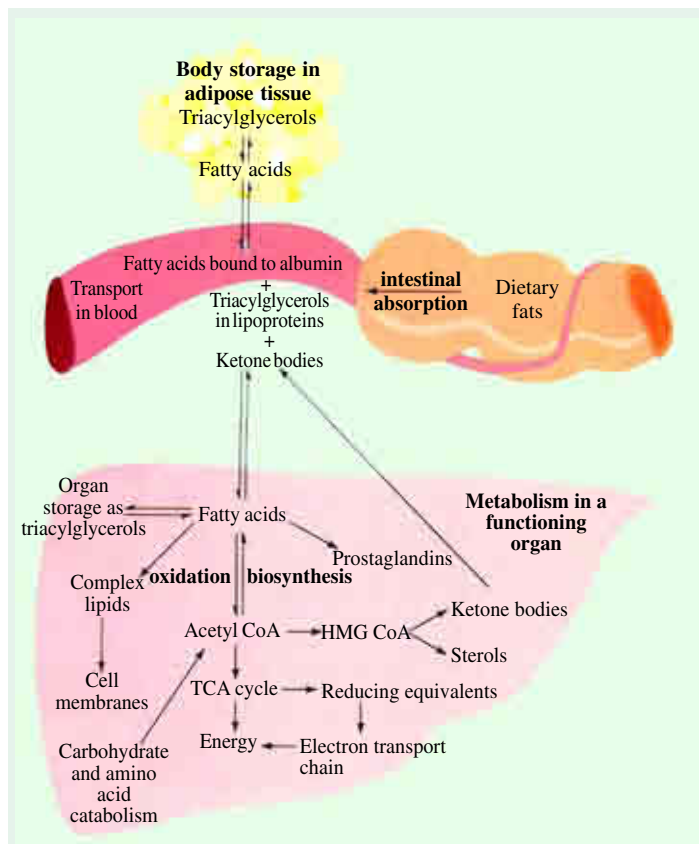
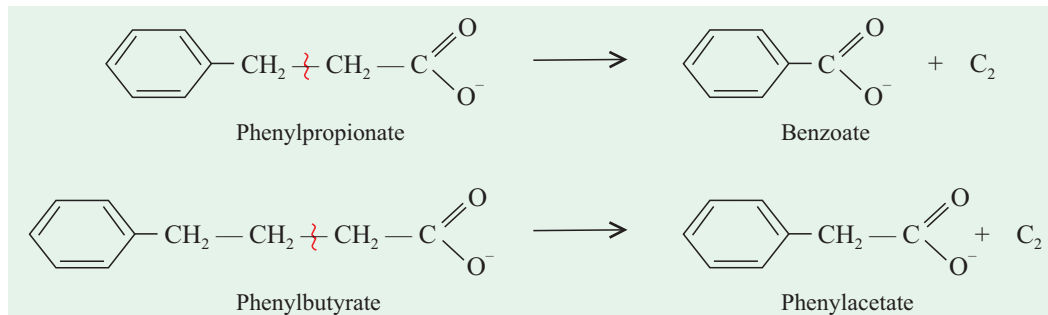

Fig. 24-4. Metabolic interrelationships of fatty acids in the human

role of fatty acid oxidation differs from one organism to another, the mechanism is essentially the same.

In 1904, Franz Knoop elucidated the mechanism of fatty acid oxidation. He fed dogs straight-chain fatty acid in which the ω -carbon atom was joined to a phenyl group. Knoop found that the urine of these dogs contained a derivative of phenylacetic acid when they were fed phenylbutyrate. In contrast, a derivative of benzoic acid was formed when they were fed phenylpropionate. In fact, benzoic acid was formed whenever a fatty acid containing an odd number of carbon atoms was fed, whereas phenylacetic acid was produced whenever a fatty acid containing an even number of carbon atoms was fed. Knoop deduced from these findings that *fatty acids are degraded by oxidation at the β -carbon*. In other words, the fatty acids are degraded in two-carbon units and



that the obvious two-carbon unit is acetic acid. This finding later came to be known as **Knoop's**

foods ; it is a critical part of the metabolic economy in the lean as well as the lardy. The oxidation of long-chain fatty acids to acetyl-CoA is a central energy-yielding pathway in animals, many protists and some bacteria. Complete combustion or oxidation of a typical fatty acid, palmitic acid, yields 2,380 kcal per mole.

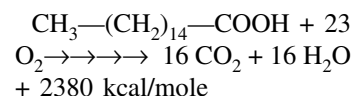

In some organisms, acetyl-CoA produced by fatty acid oxidation has alternative fates. In vertebrate animals, acetyl-CoA may be converted in the liver into ketone bodies, which are water-soluble fuels exported to the brain and other tissues when glucose becomes unavailable. In higher plants, acetyl-CoA from fatty acid oxidation serves primarily as a biosynthetic precursor and only secondarily as fuel. Although the biological

hypothesis. These experiments are a landmark in Biochemistry because they were the first to use a synthetic level to elucidate synthetic mechanisms. Deuterium and radioisotopes came into Biochemistry several decades later.

The complete combustion of fatty acids to CO_2 and H_2O occurs in the mitochondria, where the transfer of electrons from the fatty acids to oxygen can be used to generate ATP. The combustion occurs in 2 stages :

- the fatty acid is sequentially oxidized so as to convert all of its carbons to acetyl-coenzyme A, and
- the acetyl-coenzyme A is oxidized by the reactions of the citric acid cycle.

Both stages generate ATP by oxidative phosphorylation.

Activation of a Fatty Acid

Because of their hydrophobicity and extreme insolubility in water, triacylglycerols are segregated into lipid droplets, which do not raise osmolarity of the cytosol and, unlike polysaccharides, do not contain extra weight as water of solvation. The relative chemical inertness of triacylglycerols allows their extracellular storage in large quantities without the risk of undesired chemical reactions with other cellular constituents.

But the same properties that make triacylglycerols good storage compounds present problems in their role as fuels. Because of their insolubility in water, the ingested triacylglycerols must be

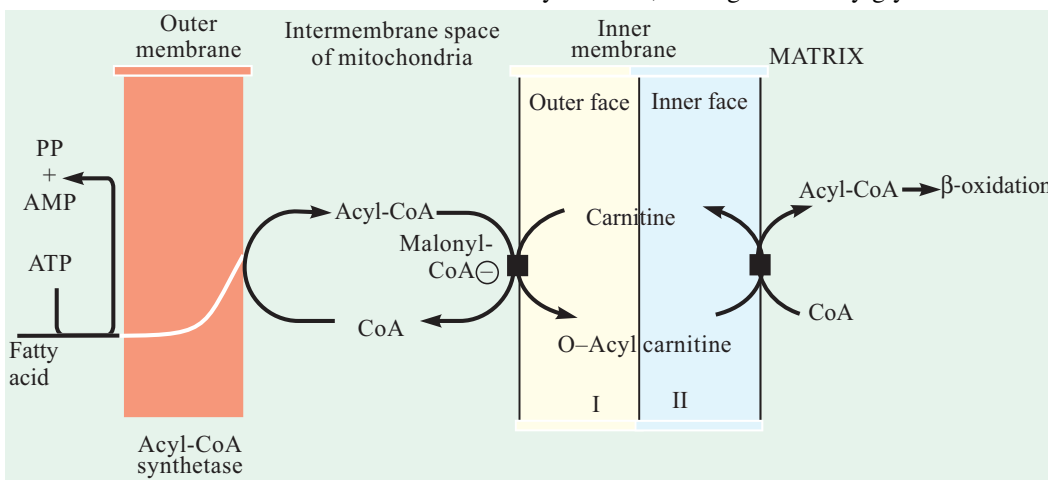

Fig. 24-5. Transport mechanism of fatty acids from cytosol to the β -oxidation site in the mitochondrion

■, Carnitine : acyl-CoA transferase I (outer face) and carnitine : acyl-CoA transferase II (inner face), the two distinct enzymes that catalyze the same reaction; malonyl-CoA \ominus indicates inhibition of transferase I.

(Redrawn from Conn EE, Stumpf PK and Doi RH, 1997)

emulsified before they can be digested by water-soluble enzymes in the intestine, and triacylglycerols absorbed in the intestine must be carried in the blood by proteins that counteract their insolubility. The relative stability of the C—C bonds in a fatty acid is overcome by activation of the carboxyl group at C-1 by attachment to coenzyme A, which allows stepwise oxidation of the fatty acyl group at the C-3 position. This later carbon atom is also called the *beta* (β) carbon in common nomenclature, from which the oxidation of fatty acids gets its common name : β **oxidation**.

An unusual property of liver and other tissue mitochondria is their inability to oxidize fatty acids or fatty acyl-CoA's unless (–)-carnitine (3-hydroxy-4-trimethyl ammonium butyrate) is added in catalytic amounts. Evidently, free fatty acids or fatty acyl-CoA's cannot penetrate the inner membranes of liver and other tissue mitochondria, whereas acyl carnitine readily passes through

570 FUNDAMENTALS OF BIOCHEMISTRY

the membrane and is then converted to acetyl-CoA in the matrix. Fig. 24–5 outlines the translocation of acetyl-CoA from outside the mitochondrion to the internal site of the β oxidation system. The key enzyme is *carnitine acetyl-CoA transferase*.

Reactions of Fatty Acid Oxidation

The free fatty acids that enter the cytosol from the blood cannot pass directly through the mitochondrial membranes, but must first undergo a series of 3 enzymatic reactions. These are described as under :

First Reaction : It is catalyzed by a series of family of isozymes present in the outer mitochondrial membrane, **acyl-CoA synthetases** (also called **fatty acid thiokinases**), which promote the general reaction.

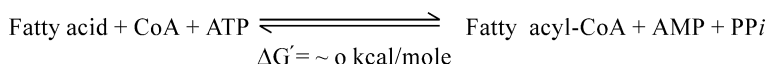

Three different acyl-CoA synthetases occur in the cell and act on fatty acids of short, intermediate and long carbon chains, respectively. One type of synthetase activates acetate and propionate to corresponding thioesters, another activates medium chain fatty acids from C_4 to C_{11} , and the third activates fatty acids from C_{10} to C_{20} . Acetyl-CoA synthetase catalyzes the formation of thioester linkage between the fatty acid carboxyl group and the thiol ($-\text{SH}$) group of coenzyme A to yield a fatty acyl-CoA ; simultaneously, ATP undergoes cleavage to AMP and PP_i . The reaction actually takes place in 2 steps :

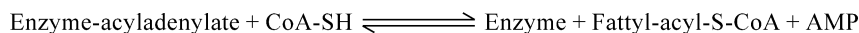
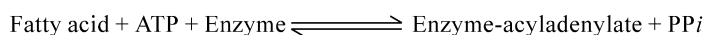

Fatty acyl-CoAs, like acetyl-CoA, are high-energy compounds ; their hydrolysis to free fatty acid and CoA has a large negative standard free-energy change ($\Delta G^{\circ'} \approx -31 \text{ kJ/mol}$). The formation of fatty acyl-CoAs is made more favourable by the hydrolysis of 2 high energy bonds in ATP; the pyrophosphate formed in the activation reaction is immediately hydrolyzed by a second enzyme, **inorganic pyrophosphatase**, which pulls the preceding activation reaction in the direction of the formation of fatty acyl-CoA. The overall reaction is :

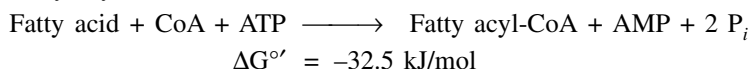

Second Reaction : Fatty acyl-CoA esters, formed in the outer mitochondrial membrane, do not cross the inner mitochondrial membrane intact. Instead, the fatty acyl group is transiently attached to the hydroxyl group of carnitine and the fatty acyl-carnitine is carried across the inner mitochondrial membrane by a specific transporter. In this enzymatic reaction, **carnitine acyltransferase I**, present on the outer face of the inner membrane, catalyzes transesterification of the fatty acyl group from coenzyme A to carnitine. The fatty acyl-carnitine ester crosses the inner mitochondrial membrane into the matrix by facilitated diffusion through the acyl-carnitine/carnitine transporter.

Third Reaction : In this final step of the entry process, the fatty acyl group is enzymatically transferred from carnitine to intramitochondrial coenzyme A by **carnitine acyltransferase II**. This isozyme is located on the inner face of the inner mitochondrial membrane, where it regenerates fatty acyl-CoA and releases it, along with free carnitine, into the matrix. Carnitine reenters the space between the inner and outer mitochondrial membranes via the acyl-carnitine/carnitine transporter. Once inside the mitochondrion, the fatty acyl-CoA is ready for the oxidation of its fatty acid component by a set of enzymes in the mitochondrial matrix.

OXIDATION OF EVEN-CHAIN SATURATED FATTY ACIDS (= KNOOP'S β OXIDATION PATHWAY)

Mitochondrial oxidation of fatty acids takes place in 3 stages (Fig. 24–6) :

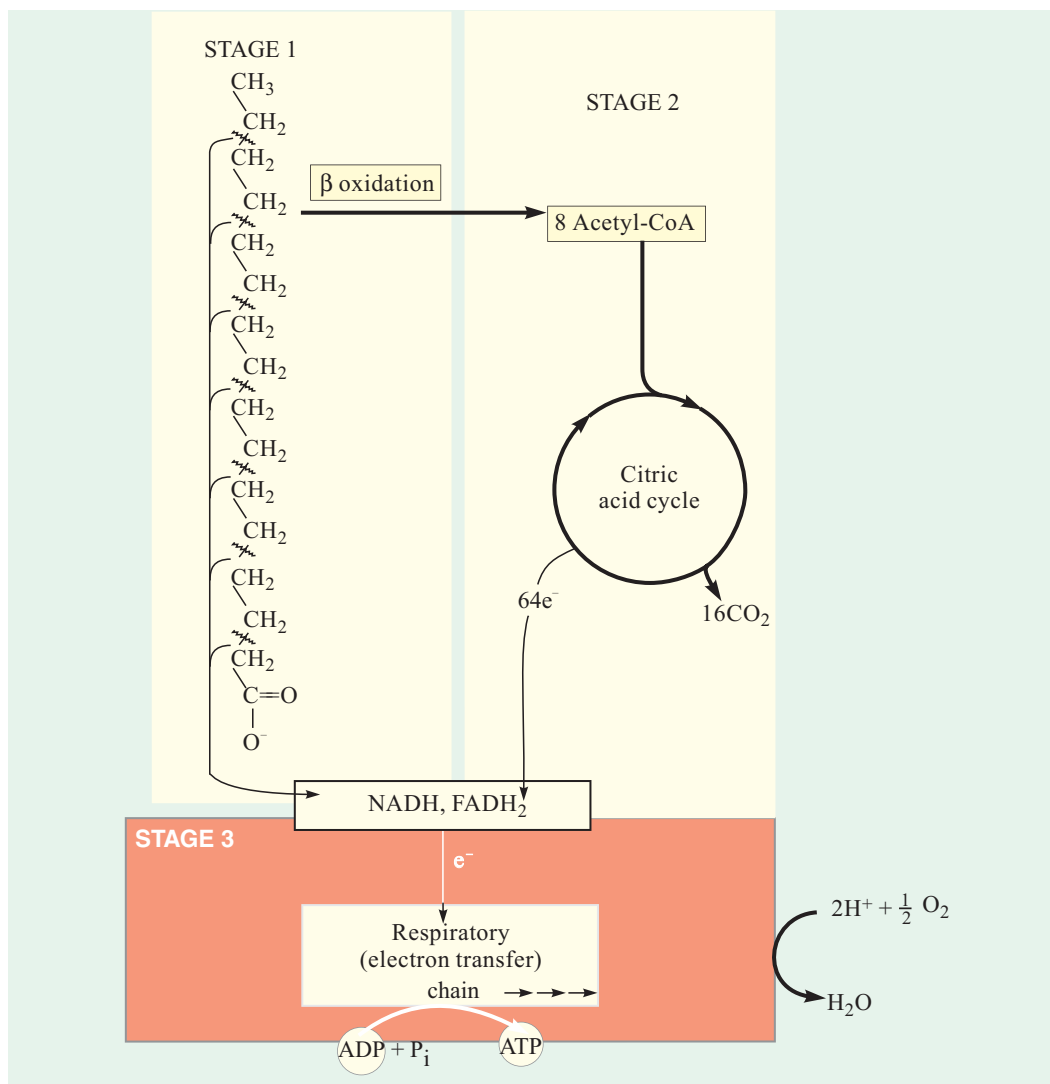

Fig. 24-6. Three stages of fatty acid oxidation

- Stage 1 :** A long-chain fatty acid is oxidized to yield acetyl residues in the form of acetyl-CoA.
- Stage 2 :** The acetyl residues are oxidized to CO₂ via the citric acid cycle.
- Stage 3 :** Electrons derived from the oxidations of Stages 1 and 2 are passed to O₂ via the mitochondrial respiratory chain, providing the energy for ATP synthesis by oxidative phosphorylation.

(Adapted from Lehninger, Nelson and Cox, 1993)

First Stage : β oxidation pathway

In this stage, the fatty acids undergo oxidative removal of successive two-carbon units in the form of acetyl-CoA, starting from the carboxyl end of the fatty acyl chain. For example, the C-16 fatty acid palmitic acid (palmitate at pH 7) undergoes 7 passes through this oxidative sequence, in each pass losing two carbons as acetyl-CoA. At the end of seven cycles, the last two carbons of palmitate (originally C-15 and C-16) are left as acetyl-CoA. The overall result is the conversion of 16-carbon chain of palmitate to 8 two-carbon acetyl-CoA molecules. Formation of each molecule of acetyl-CoA requires removal of 4 hydrogen atoms (two pairs of electrons and 4 H⁺) from the fatty acyl moiety by the action of dehydrogenases.

572 FUNDAMENTALS OF BIOCHEMISTRY

Second Stage : Citric acid cycle.

In this stage of fatty acid oxidation, the acetyl residues of acetyl-CoA are oxidized to CO_2 via the citric acid cycle, which also takes place in the mitochondrial matrix. Acetyl-CoA derived from fatty acid oxidation, thus, enters a final common pathway of oxidation along with acetyl-CoA derived from glucose via glycolysis and pyruvate oxidation.

Third Stage : Mitochondrial respiratory chain

The first two stages of fatty acid oxidation produce the electron carriers, NADH and FADH_2 , which in the third stage donate electrons to the mitochondrial respiratory chain, through which electrons are carried to oxygen. Coupled to this flow of electrons is the phosphorylation of ADP to ATP. Thus, energy released by fatty acid oxidation is conserved as ATP.

The first stage of fatty acid oxidation for the simple case of a saturated chain with an even number of carbons, and for the slightly more complicated cases of unsaturated and odd-number chains, will now be described in detail.

Four Steps of β Oxidation

β Oxidation of saturated fatty acids is accomplished by a 4-step mechanism, illustrated in Fig. 24-7. The four steps of the **fatty acid spiral**, as it is also called, are described below :

First Step : α , β dehydrogenation of acyl-CoA

In this step, acyl-CoA is oxidized by an acyl-CoA dehydrogenase to produce an enoyl-CoA with a *trans* double bond between α and β carbon atoms (C-2 and C-3). It is thus, better written as *trans*- Δ^2 -enoyl-CoA (Recall that naturally occurring unsaturated fatty acids normally have their double bonds in the *cis* configuration).

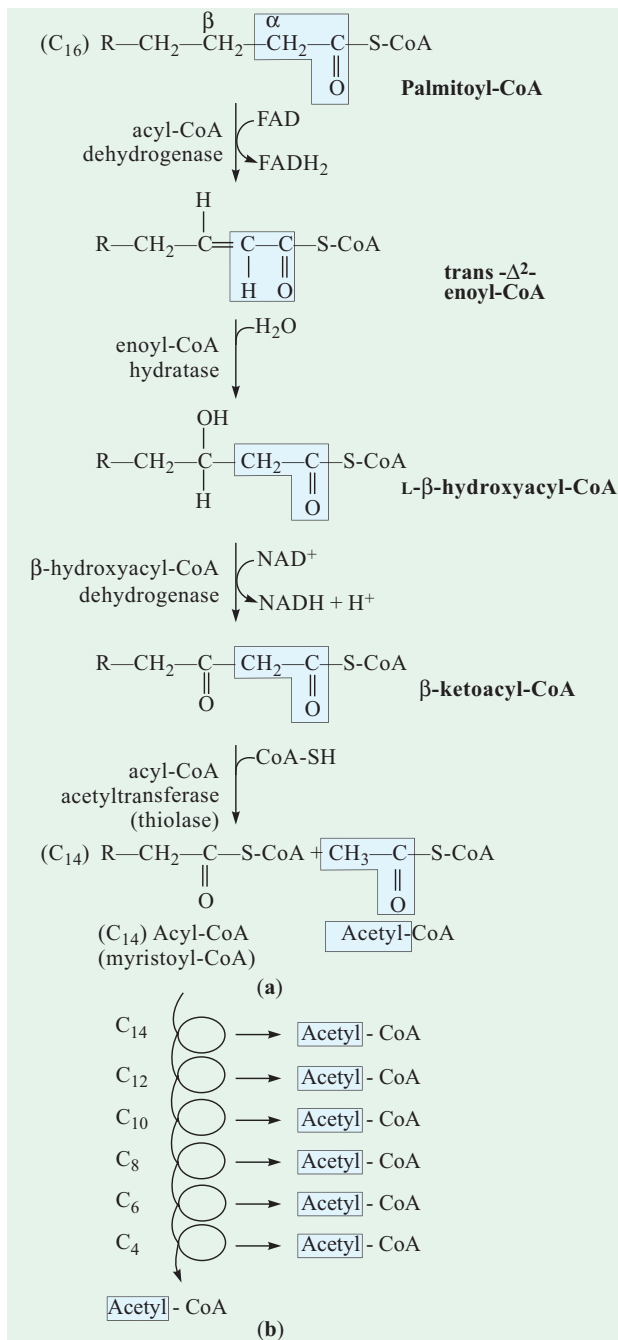
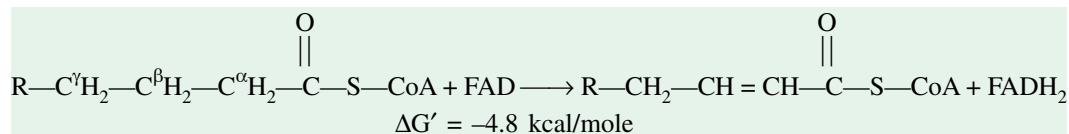

Fig. 24-7. The fatty acid oxidation pathway (= β oxidation cycle)

(a) In each pass through this sequence, one acetyl residue (shaded) is removed in the form of acetyl-CoA from the carboxyl end of palmitate (C_{16}) which enters as palmitoyl-CoA.

(b) Six more passes through the pathway yield 7 more molecules of acetyl-CoA, the seventh arising from the last 2 carbon atoms of the C_{16} chain. In all, 8 molecules of acetyl-CoA are formed.



Three *acyl-CoA dehydrogenases* (E.C. No. 1.3.99.3) are found in the matrix of mitochondria. They all have FAD as a prosthetic group. The first has a specificity ranging from C₄ to C₆ acyl-CoAs, the second from C₆ to C₁₄ and the third from C₆ to C₁₈. The FADH₂ is not directly oxidized by oxygen but traces the following path :

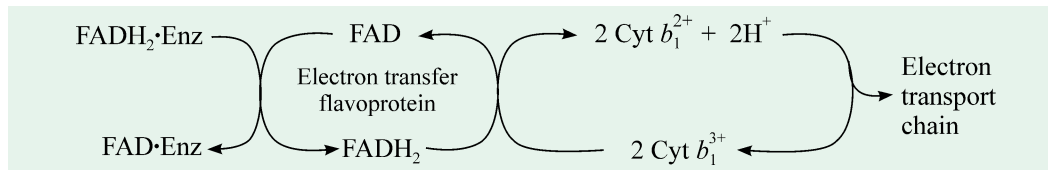

The oxidation catalyzed by acetyl-CoA dehydrogenase is analogous to succinate dehydrogenation in the citric acid cycle (see page 400), as in both the reactions :

- the enzyme is bound to the inner membrane,
- a double bond is introduced into a carboxylic acid between the α and β carbons,
- FAD is the electron acceptor, and
- electrons from the reaction ultimately enter the respiratory chain and are carried to O₂ with the concomitant synthesis of 2 ATP molecules per electron pair.

Second Step : Hydration of α , β -unsaturated acyl-CoAs

In this step, a mole of water is added to the double bond of the *trans*- Δ^2 -enoyl-CoA to form the L-stereoisomer of β -hydroxyacyl-CoA (also called 3-hydroxyacyl-CoA). The reaction is catalyzed by **enoyl-CoA hydratase** or **crotonase** (E.C. No. 4.2.1.17), and has broad specificity with respect to the length of the acyl group. However, its activity decreases progressively with increasing chain length of the substrate (It may be noted that the enzyme will also hydrate α , β -*cis* unsaturated acyl-CoA, but in this case D (-)- β -hydroxyacyl-CoA is formed).

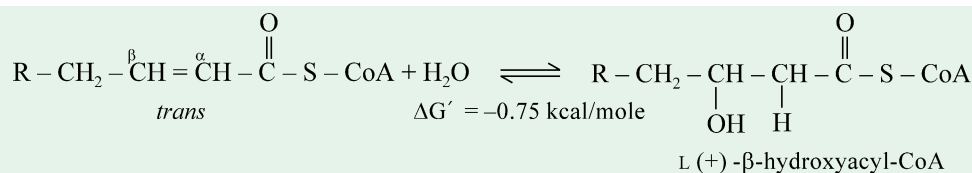

This reaction catalyzed by enoyl-CoA hydratase is formally analogous to the fumarase reaction in the citric acid cycle, in which water adds across an α - β double bond (see page 401). The hydration of enoyl-CoA is, in fact, the prelude to the second oxidation reaction, *i.e.*, Step 3.

Third Step : Oxidation of β -hydroxyacyl-CoA

In this step of fatty acid oxidation cycle, the L- β -hydroxyacyl-CoA is dehydrogenated (or oxidized) to form β -ketoacyl-CoA by the action of an enzyme, **β -hydroxyacyl-CoA dehydrogenase** (E.C. No. 1.1.1.35), which is absolutely specific for the L stereoisomer of the hydroxyacyl substrate. NAD⁺ is the electron acceptor in this reaction and the NADH, thus formed, donates its electrons to NADH dehydrogenase (complex I), an electron carrier of the respiratory chain. Three ATP molecules are generated from ADP per pair of electrons passing from NADH to O₂ via the respiratory chain.

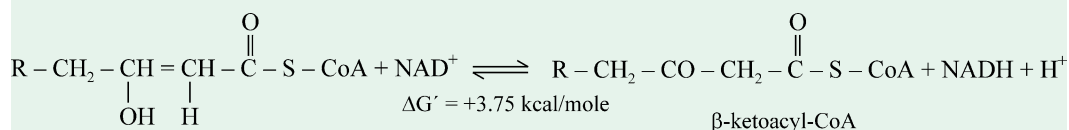

574 FUNDAMENTALS OF BIOCHEMISTRY

This reaction, catalyzed by β -hydroxyacyl-CoA, is closely analogous to the malate dehydrogenase reaction of the citric acid cycle (see page 401). Thus, we see that the first three reactions in each round of fatty acid oxidation closely resemble the last steps in the citric acid cycle :

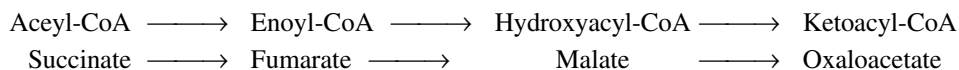

The net result of the first three reactions is the oxidation of methylene group at β (or C-3) position to a keto group of the substrate, acyl-CoA.

Fourth Step : Thiolytic cleavage

Thiolytic cleavage is a splitting by thiol ($-\text{SH}$) group, aided by enzymatic catalysis. This is the final step and brings about the cleavage of β -ketoacyl-CoA by the thiol group of a second mole of CoA, which yields acetyl-CoA and an acyl-CoA, shortened by two carbon atoms. This thiolytic cleavage is catalyzed by the enzyme, **acyl-CoA acetyltransferase** (E.C. No. 2.3.1.16), which also has broad specificity. This enzyme is more commonly called **β -ketothiolase** or simply **thiolase**.

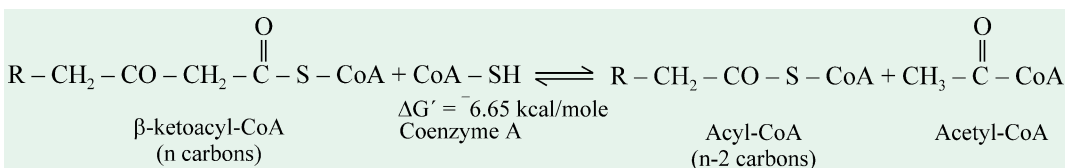

Although the overall reaction is reversible, the equilibrium position is greatly in the direction of cleavage.

As to the mechanism of thiolase action, the enzyme protein has a reactive thiol ($-\text{SH}$) group on a cysteinyl residue that is involved in the following series of reactions :

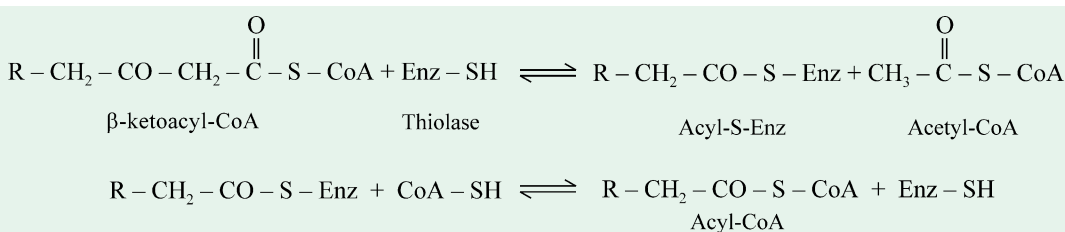

In summary, the shortening of a fatty acyl-CoA derivative by two carbon atoms can be represented by the equation :

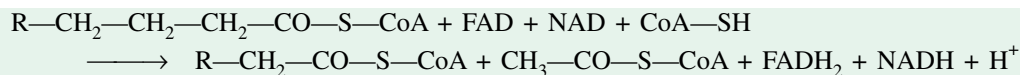

The shortened acyl-CoA then undergoes another cycle of oxidation, starting with the reaction catalyzed by acyl-CoA dehydrogenase. Beta-ketothiolase, hydroxyacyl dehydrogenase and enoyl-CoA hydratase all have broad specificity with respect to the length of the acyl group. Thus, by repeated turns of the cycle, a fatty acid is degraded to acetyl-CoA molecules with one being produced every turn until the last cycle, wherein two are produced. The β -oxidation of fatty acids is presented in a cyclical manner in Fig 24-8.

The β oxidative system is found in all organisms. However, in bacteria grown in the absence of fatty acids, the β oxidative system is practically absent but is readily induced by the presence of fatty acids in the growth medium. *The bacterial β oxidation system is completely soluble and hence is not membrane-bound.* Curiously, in germinating seeds possessing a high lipid content, the β oxidation system is exclusively located in microbodies called glyoxysomes, but in seeds with low lipid content, the enzymes are associated with mitochondria.

Stoichiometry of β Oxidation

The energy yield derived from the oxidation of a fatty acid can be calculated. In each reaction

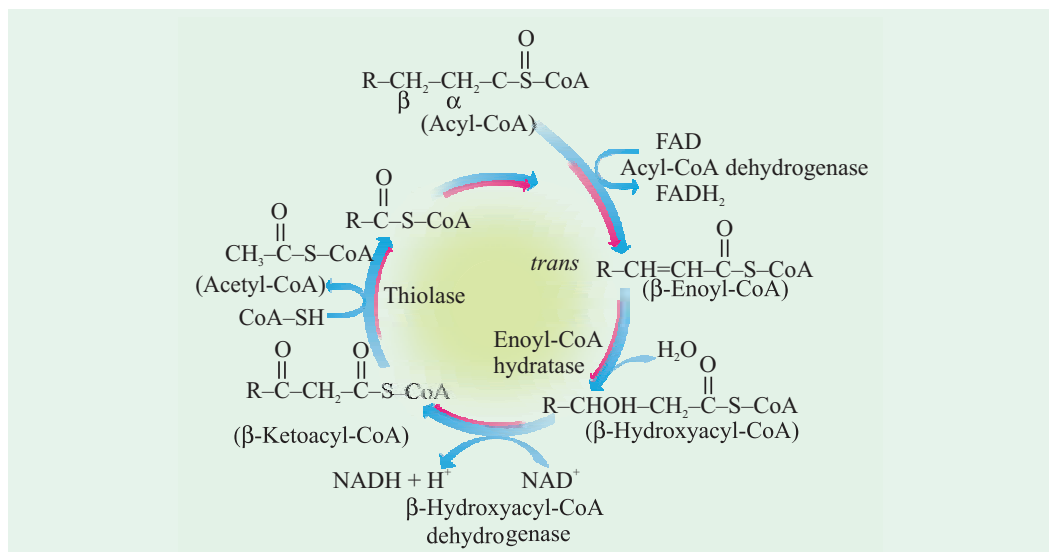
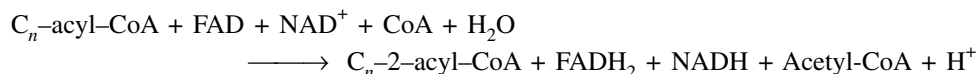
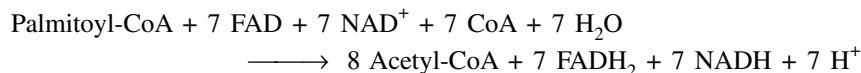

Fig. 24-8. The β -oxidation cycle for fatty acids

cycle, an acyl-CoA is shortened by two carbons and one mole each of FADH_2 , NADH and acetyl-CoA are formed.



The degradation of palmitoyl-CoA (C_{16} -acyl-CoA), for example, requires 7 reaction cycles. In the seventh cycle, the C_4 -ketoacyl-CoA is thiolized to 2 moles of acetyl-CoA. Hence, the stoichiometry of oxidation of palmitoyl-CoA is :



Three ATP are generated when each of these NADH is oxidized by the respiratory chain, whereas two ATP are formed for each FADH_2 because their electrons enter the chain at the level of coenzyme Q. Recall that the oxidation of one mole of acetyl-CoA by the citric acid cycle yields 12 ATP molecules. Hence, the number of ATP moles formed in the oxidation of palmitoyl-CoA is 14 from the 7 FADH_2 , 21 from the 7 NADH , and 96 from the 8 moles of acetyl-CoA. This totals to 131. Two high-energy phosphate bonds are consumed in the activation of palmitate, in which ATP is split into AMP and 2 P_i . Thus, *the net yield from the complete oxidation of a mole of palmitate is $131 - 2 = 129$ ATP molecules.*

The efficiency of energy conservation in fatty acid oxidation can be estimated from the number of ATP formed and from the free energy of oxidation of palmitic acid to CO_2 and H_2O , as determined by calorimetry. The standard free energy of hydrolysis of 129 ATP is $129 \times -7.3 \text{ kcal} = -941.7 \text{ kcal}$ or roughly -942 kcal . The standard free energy of oxidation of palmitic acid is $-2,340 \text{ kcal}$.

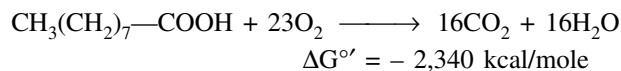

Hence, the efficiency of energy conservation of the *in vivo* oxidation of fatty acids, under standard conditions, is $942/2340 \times 100 = 42.56\%$, a surprisingly high figure. This value is similar to those of glycolysis, the citric acid cycle and oxidative phosphorylation. In other words, the 129 ATP produced account for a conservation of 942 kcal of the 2,340 kcal released by the oxidation of one mole of palmitic acid, *i.e.*, roughly 42% efficiency of energy conservation. The remaining energy is lost probably as heat. It, hence, becomes clear why, as a food, fat is an effective source



Fig. 24-9. A grizzly bear preparing its hibernation nest, near the McNeil River in Canada.

of available energy. In this calculation, we neglect the combustion of glycerol, the other component of a triacylglycerol.

In hibernating animals such as grizzly bear (Fig. 24-9) and the tiny dormouse, fatty acid oxidation provides metabolic energy, heat and water — all essential for survival of an animal that neither eats nor drinks for long periods. The camel, although not a hibernator, can synthesize and store triacylglycerols in large amounts in its hump, a metabolic source of both energy and water under desert conditions.

OXIDATION OF UNSATURATED FATTY ACIDS

The fatty acid oxidation scheme described above operates only when the incoming fatty acid is a saturated one (having only single bonds) and possesses an even number of carbon atoms. However, most of the fatty acids in the triacylglycerols and phospholipids of animals and plants are unsaturated, having one or more double bonds in its carbon chain. These bonds are in *cis* configuration and cannot be acted upon by the enzyme, enoyl-CoA hydratase which catalyzes the addition of H₂O to the *trans* double bond of the Δ^2 - enoyl-CoA generated during β oxidation. However, by the action of two auxiliary enzymes, the fatty acid oxidation sequence described above can also break down the common unsaturated fatty acids. The action of these two enzymes, one an isomerase and the other a reductase, will be illustrated by the following two examples :

(a) Oxidation of Monounsaturated Fatty Acids

This requires only one additional enzyme, enoyl-CoA isomerase. Oleate, an abundant C-18 monounsaturated fatty acid with a *cis* double bond between C-9 and C-10 (denoted *cis*- Δ^9) is taken as an example (Fig. 24-10). Oleate is converted into oleoyl-CoA which is transported through the mitochondrial membrane as oleoyl carnitine and then converted back into oleoyl-CoA in the matrix. Oleoyl-CoA then undergoes 3 passes through the β oxidation cycle to yield 3 moles of acetyl-CoA and the coenzyme A ester of a Δ^3 , 12-carbon unsaturated fatty acid, *cis*- Δ^3 - dodecenoyl-CoA (Fig. 24-10). This product cannot be acted upon by the next enzyme of the β oxidation pathway, *i.e.*, enoyl-CoA hydratase, which acts only on *trans* double bonds. However, by the action of the auxiliary enzyme, **enoyl-CoA isomerase**, the *cis*- Δ^3 -enoyl-CoA is isomerized to yield the *trans*- Δ^2 -enoyl-CoA. The latter compound is now converted by enoyl-CoA hydratase into the corresponding L- β -hydroxyacyl-CoA (*trans*- Δ^2 -dodecenoyl-CoA). This intermediate is now acted upon by the remaining enzymes of β oxidation to yield acetyl-CoA and a C-10 saturated fatty acid as its coenzyme A ester (decanoyl-CoA). The latter undergoes 4 more passes through the pathway to yield altogether 9 acetyl-CoAs from one mole of the C-18 oleate.

(b) Oxidation of Polyunsaturated Fatty Acids

This process requires two auxiliary enzymes, enoyl-CoA isomerase and 2, 4-dienoyl-CoA-reductase. The mechanism is illustrated by taking linoleate, a C-18 polyunsaturated fatty acid with 2 *cis* double bonds at C₉ and C₁₂ (denoted *cis*- Δ^9 , *cis*- Δ^{12}), as an example. Linoleoyl-CoA undergoes 3 passes through the typical β oxidation sequence to yield 3 moles of acetyl-CoA and the coenzyme A ester of a C-12 unsaturated fatty acid with a *cis*- Δ^3 , *cis*- Δ^6 configuration. This intermediate cannot be used by the enzymes of the β oxidation pathway ; its double bonds are in the wrong position and have the wrong configuration (*cis*, not *trans*). However, the combined action of **enoyl-CoA isomerase** and **2, 4-dienoyl-CoA reductase** (Fig. 24-11) allows reentry of

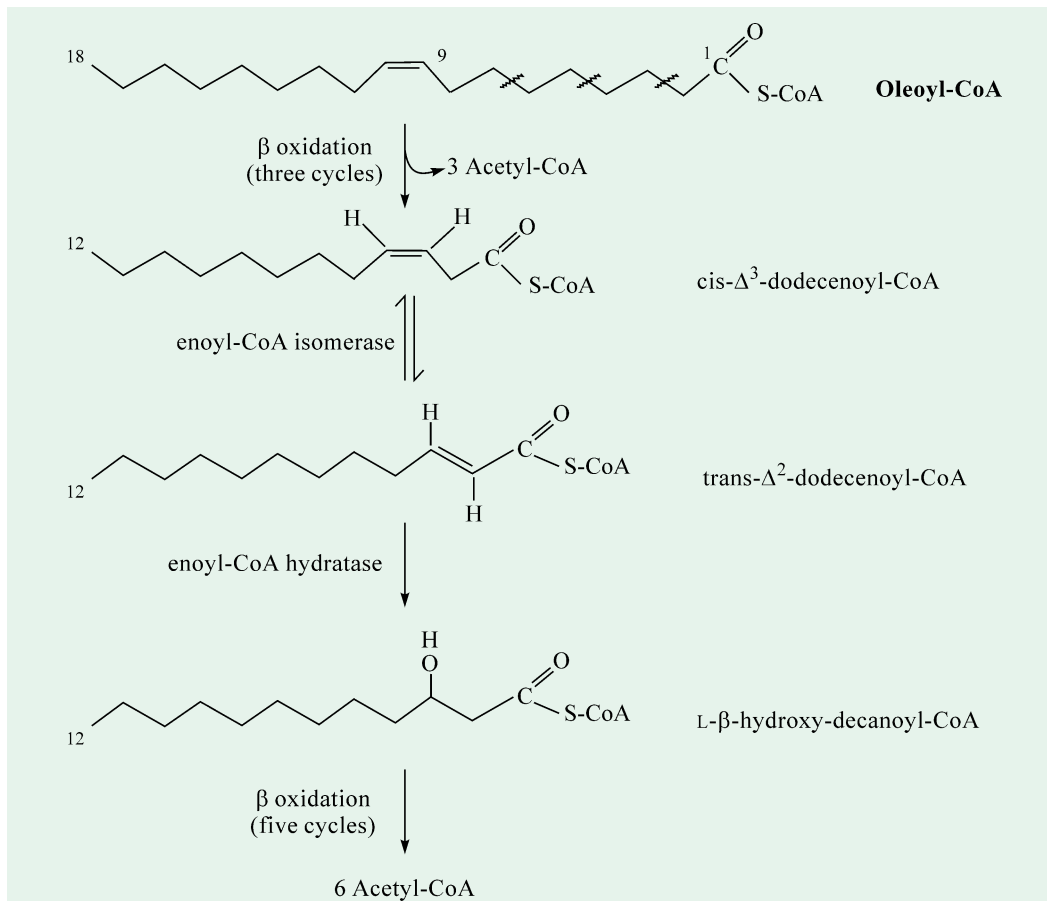

Fig. 24-10. The oxidation of a monounsaturated fatty acyl-CoA such as oleoyl-CoA (Δ^9) requiring an additional enzyme, enoyl-CoA isomerase

Note that the enzyme repositions the double bond converting the *cis* isomer to a *trans* isomer, a normal intermediate in β oxidation. Thus, both position and configuration of the double bond are shifted by the action of the enzyme.

this intermediate into the typical β oxidation pathway and its degradation to 6 acetyl-CoAs. The overall result is the conversion of linoleate to 9 moles of acetyl-CoA.

Here is an excellent example of the beautiful economy of organization of metabolism. The introduction of 2 additional types of enzymes (an enoyl-CoA isomerase and a 3-hydroxyacyl-CoA racemase) makes it possible to handle any combination of double bonds found in an unsaturated chain through the same route used for saturated fatty acids.

The roles of the 3 additional enzymes which are necessary for the oxidation of a dienoic (or polyenoic) acid may be shown in outline below, where A is enoyl-CoA isomerase ; B, enoyl-CoA hydratase ; and C, 3-hydroxyacyl-CoA epimerase. Monoenoic and dienoic acids are oxidized at comparable rates.

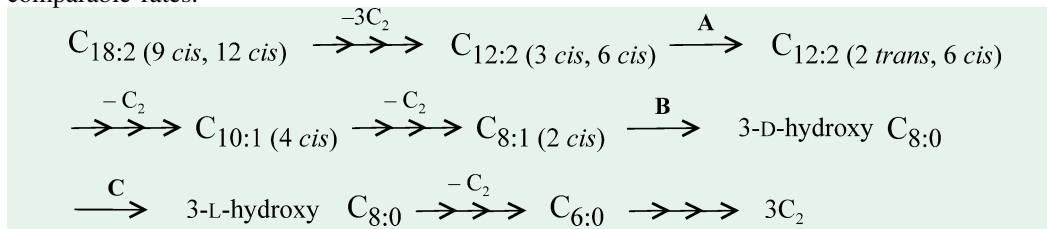

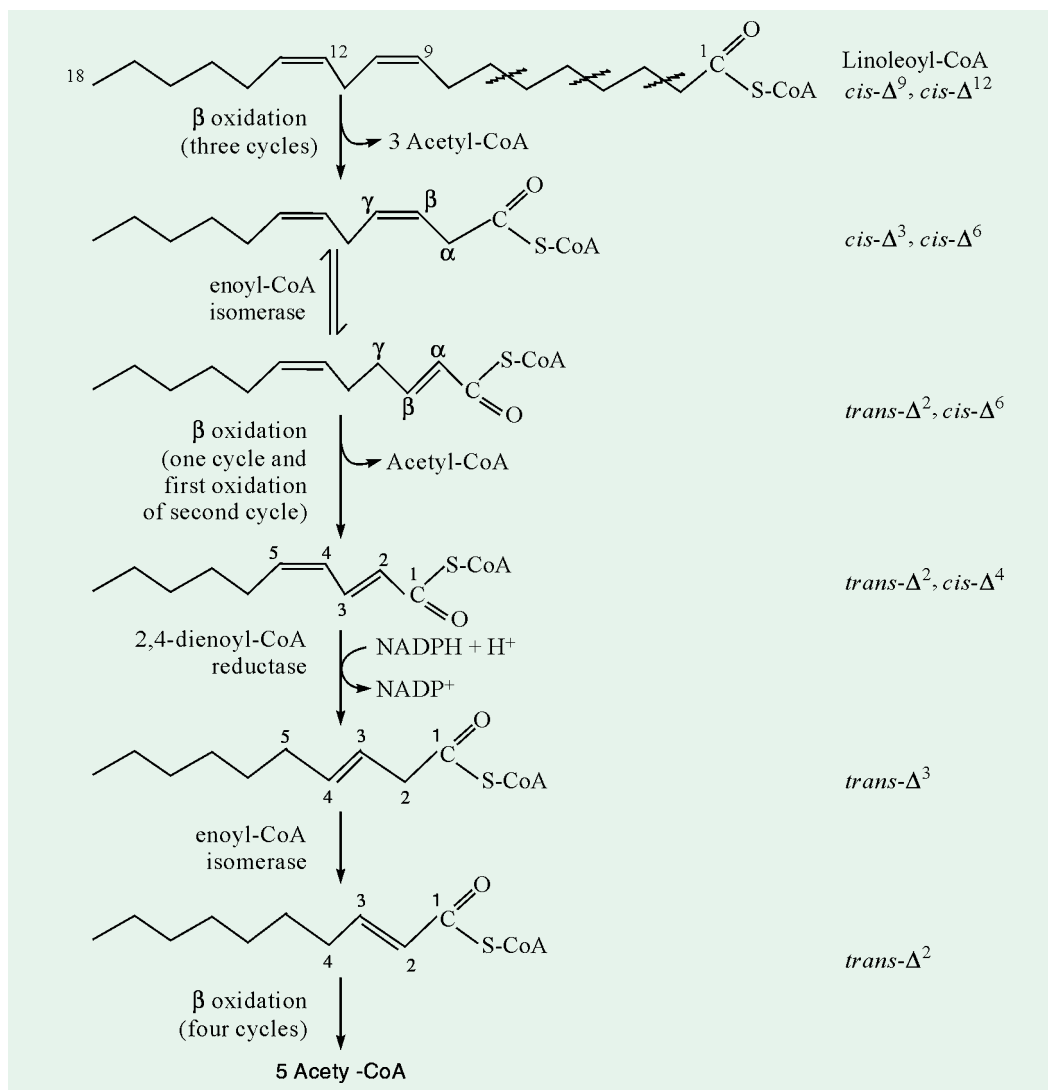

Fig. 24-11. The oxidation of polyunsaturated fatty acids requiring two additional enzymes, enoyl-CoA isomerase and 2, 4-dienoyl-CoA reductase

Note that the combined action of these two enzymes converts a trans- Δ^2 , cis- Δ^4 -dienoyl-CoA intermediate into the trans- Δ^2 -enoyl-CoA substrate, necessary for β oxidation.

OXIDATION OF ODD-CHAIN FATTY ACIDS

Most naturally-occurring lipids contain fatty acids with an even number of carbon atoms, yet fatty acids with an odd number of carbon atoms are found in significant amounts in the lipids of many plants and some marine animals. Small quantities of C-3 propionate are added as a mould inhibitor to some breads and cereals, and thus propionate enters the human diet. Besides, cattle and other ruminants form large amounts of propionate during fermentation of carbohydrates in the rumen. The propionate so formed is absorbed into the blood and oxidized by the liver and other tissues.

A generalized scheme of the oxidation of an odd-chain fatty acid is presented in Fig. 24-12.

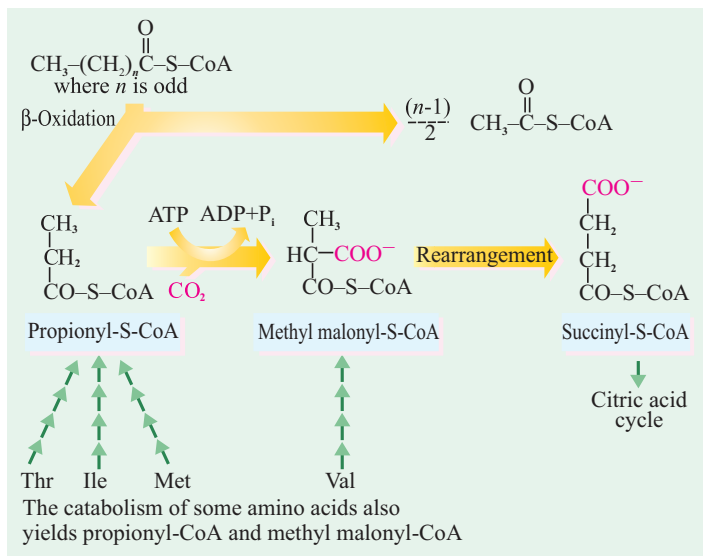

The odd-carbon long-chain fatty acids are oxidized by the same pathway as the even-carbon fatty acids, starting at the carboxyl end of the chain. However, the substrate for the last pass through the β oxidation cycle is a fatty acyl-CoA, in which the fatty acid has 5 carbon atoms. When this is oxidized and finally cleaved, the products are acetyl-CoA and propionyl-CoA, rather than 2 moles of acetyl-CoA produced in the normal β oxidation cycle. The acetyl-CoA is, of course, oxidized *via* the citric acid cycle but the oxidation of propionyl-CoA presents an interesting problem, since at first glance the propionic acid (or propionyl-CoA) appears to be a substrate unsuitable for β oxidation.

Fig. 24-12. The oxidation of a fatty acid containing an odd number of carbon atoms

However, the substrate is held by two strikingly dissimilar pathways: methylmalonate pathway and β -hydroxy-propionate pathway.

(a) Methylmalonate Pathway

This pathway is found only in animals and occurs in the mitochondria of liver, cardiac and skeletal muscles, kidney and other tissues. Propionate (or propionyl-CoA) is also produced by the

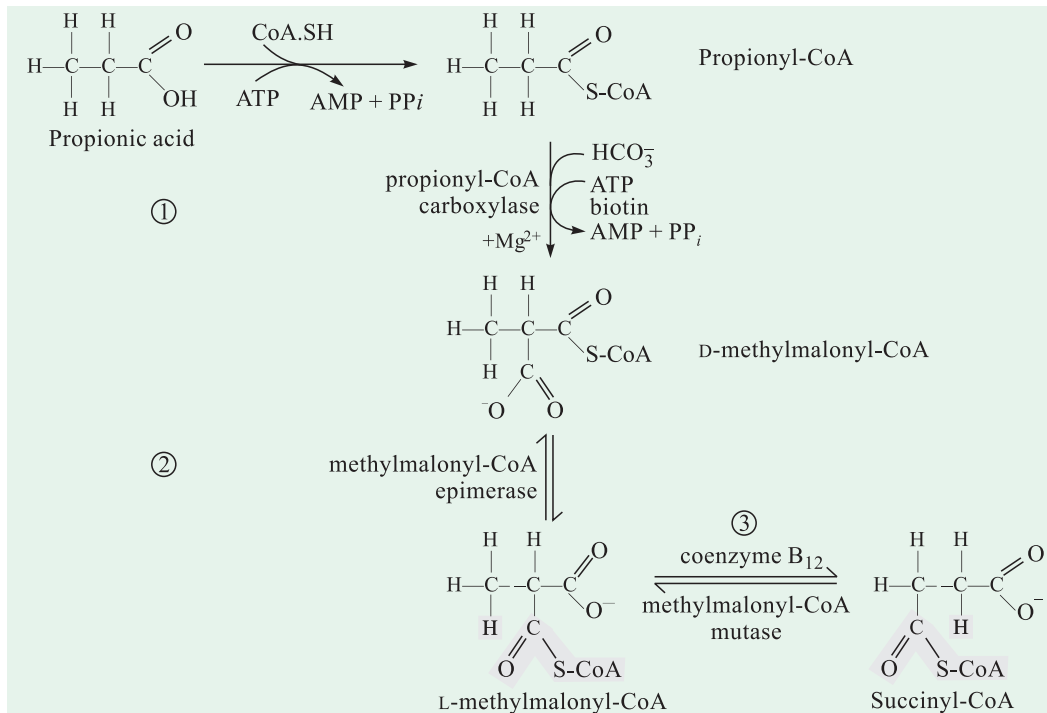

Fig. 24-13. The methylmalonate pathway of propionate metabolism, as found in animals

Note the third remarkable reaction in which substituents on adjacent carbon atoms exchange positions ; the coenzyme B_{12} playing a key role in it.

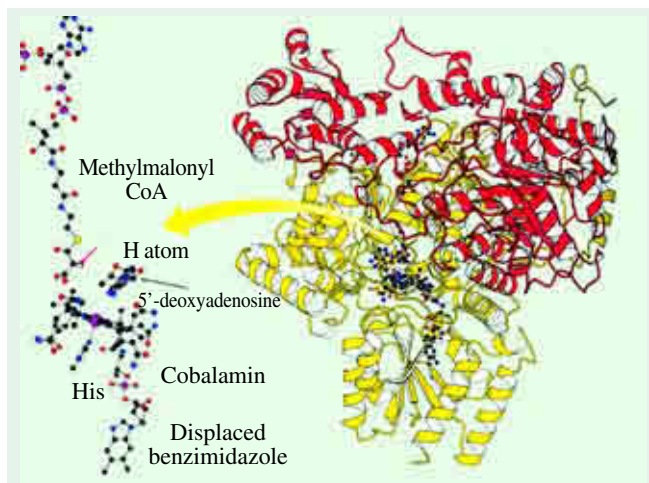
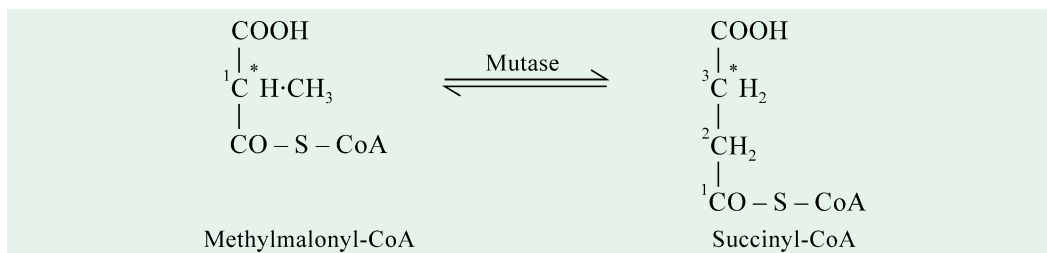

Fig. 24-14. Active site of methylmalonyl CoA mutase

The arrangement of substrate and coenzyme in the active site facilitates the cleavage of the cobalt-carbon bond and the subsequent abstraction of a hydrogen atom from the substrate.

The d-methylmalonyl-CoA, thus formed, is enzymatically epimerized to L-methylmalonyl-CoA, by the action of methylmalonyl-CoA epimerase (The epimerase labilizes the α -hydrogen atom, followed by uptake of a proton from the medium, thus catalyzing interconversion of D- and L-methylmalonyl-CoA). The L-methylmalonyl-CoA undergoes an intramolecular rearrangement to form succinyl-CoA by the enzyme methylmalonyl-CoA mutase (Fig 24-14), which requires as its coenzyme deoxyadenosyl-cobalamin or coenzyme B₁₂. When [2-¹⁴C] methyl-malonyl-CoA was converted by the mutase enzyme, the label (marked by an asterisk, below) was found in the 3 position of succinyl-CoA, thus indicating an intramolecular transfer of the entire thioester group, -CO-S-CoA, rather than migration of the carboxyl carbon.



The role of the coenzyme B₁₂ is to remove a hydrogen from one carbon atom by transferring it directly to an adjacent carbon atom, simultaneously effecting the exchange of a second (R) substituent. The H and R are not released into solution.

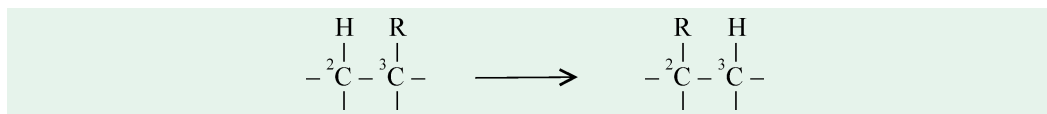

At equilibrium, formation of succinyl-CoA favoured by a ratio of 20 : 1 over methylmalonyl-CoA. The succinyl-CoA can then be oxidized via succinate and the citric acid cycle to CO₂ and H₂O. In patients with vitamin B₁₂ deficiency, both propionate and methylmalonate are excreted in the urine in abnormally large amounts.

The odd-chain fatty acids are only a small fraction of the total, and only the terminal 3 carbons appear as propionyl-CoA. The metabolism of propionyl-CoA is, therefore, not of quantitative significance in fatty acid oxidation.

oxidation of isoleucine, valine, methionine and threonine. Propionate is catalyzed by acetyl-CoA synthetase to produce propionyl-CoA (Fig. 24-13). The propionyl-CoA is carboxylated to form the D stereoisomer of methylmalonyl-CoA by an enzyme propionyl-CoA carboxylase, which contains the cofactor biotin. In this reaction, as in pyruvate carboxylase reaction (see page 413), the CO₂ (or its hydrated ion, HCO₃⁻) is activated by attachment to biotin before its transfer to the propionate moiety. The formation of the carboxybiotin intermediate requires energy, which is provided by the cleavage of ATP to AMP and P*P*_i. The d-

Two inheritable types of **methylmalonic acidemia** (and **aciduria**) are associated in young children with failure to grow and mental retardness. In *one type*, the mutase protein is absent or defective since addition of coenzyme B₁₂ to liver extracts does not restore the activity of the mutase. In the *other type*, feeding large doses of vitamin B₁₂ relieves the acidemia and aciduria, and addition of coenzyme B₁₂ to liver extracts restores the activity of the mutase ; in these cases, there is limited ability to convert the vitamin to the coenzyme.

Another inheritable disorder of propionate metabolism is due to a defect in propionyl-CoA carboxylase, resulting in **propionic acidemia** (and **aciduria**). Such individuals, as well as those with methylmalonic acidemia, are capable of oxidizing some propionate to CO₂, even in the absence of propionyl-CoA carboxylase.

(b) β-hydroxypropionate Pathway

This pathway is ubiquitous in plants and is a modified form of β oxidation scheme. It nicely resolves the problem of how plants can cope with propionic acid by a system not involving vitamin B₁₂ as cobamide coenzyme. Since plants have no B₁₂ functional enzymes, the methylmalonate pathway does not operate in them. This pathway (Fig. 24–15), thus, bypasses the B₁₂ barrier in an effective way.

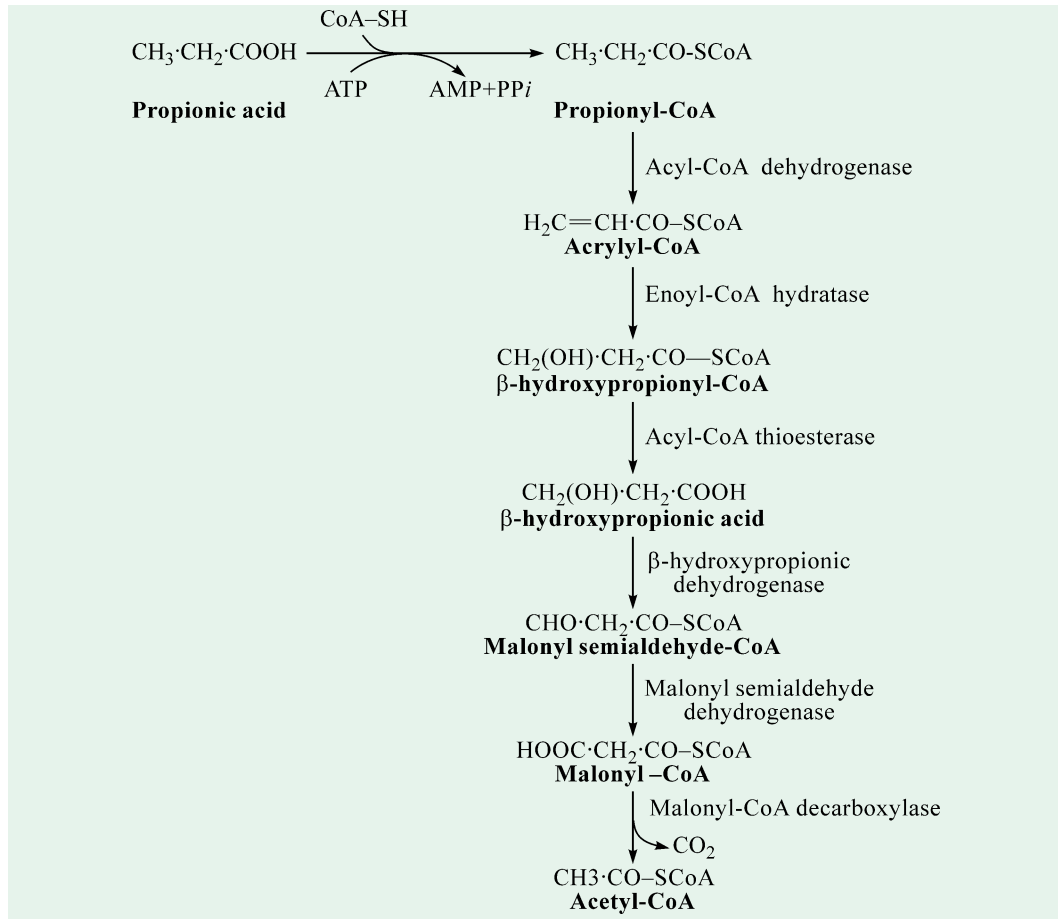

Fig. 24–15. The β-hydroxypropionate pathway of propionate metabolism, as found in plants

α OXIDATION OF FATTY ACIDS

Although β oxidation is major pathway for the oxidation of fatty acids, two other types of oxidation also occur, α and ω oxidation. α oxidation is the removal of one carbon atom (*i.e.*, α

582 FUNDAMENTALS OF BIOCHEMISTRY

carbon) at a time from the carboxyl end of the molecule. α oxidation was first observed in seeds and leaf tissues of plants. α oxidation of long-chain fatty acids to 2-hydroxy acids and then to fatty acids with one carbon atom less than the original substrate have been demonstrated in the microsomes of brain and other tissues also. Long-chain α hydroxy fatty acids are constituents of brain lipids, e.g., the C_{24} cerebronic acid (= 2 hydroxylignoceric acid), $CH_3(CH_2)_{21}.CH(OH).COOH$. These hydroxy fatty acids can be converted to the 2-keto acids, followed by oxidative decarboxylation, resulting in the formation of long-chain fatty acids with an odd number of carbon atoms :

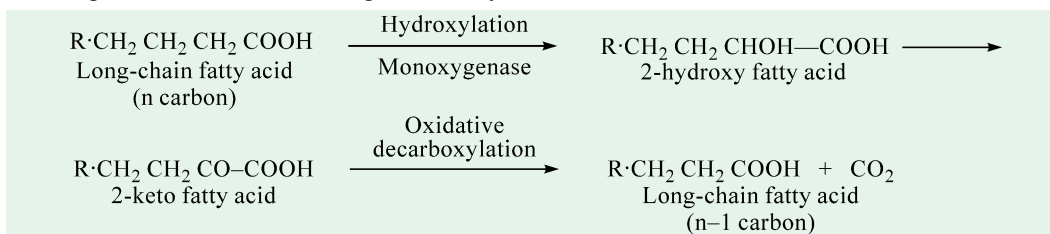

The initial hydroxylation reaction is catalyzed by a mitochondrial enzyme, monoxygenase that requires O_2 , Mg^{2+} , NADPH and a heat-stable cofactor. Conversion of the α hydroxy fatty acid to CO_2 and the next lower unsubstituted acid appears to occur in the endoplasmic reticulum and to require O_2 , Fe^{2+} and ascorbate.

The salient features of α oxidation are as follows :

1. Only free long-chain fatty acids serve as substrates.
2. Molecular oxygen is indirectly involved.
3. It does not require CoA intermediates.
4. It does not lead to generation of high-energy phosphates.

This mechanism explains the occurrence of α hydroxy fatty acids and of odd-numbered fatty acids in the biomolecules. The latter may, in nature, also be synthesized *de novo* from propionate.

The α oxidation system plays a key role in the capacity of mammalian tissues to oxidize **phytanic acid** (= 3,7,11,15-tetramethylhexadecanate). Phytanic acid is an oxidation product of phytol and is present in animal fat, cow's milk and foods derived from milk. The phytol presumably originates from plant sources, as it is a substituent of chlorophyll and the side chain of vitamin K_2 .

Normally, phytanic acid is rarely found in serum lipids because of the ability of normal tissue to degrade (or oxidize) the acid very rapidly. But large amounts of phytanic acid accumulate (as much as 20% of the serum fatty acids and 50% of the hepatic fatty acids) in the tissues and serum of individuals with **Refsum's disease**, a rare inheritable autosomal recessive disorder affecting the nervous system because of an inability to oxidize this acid. Diets low in animal fat and milk products appear to relieve some of the symptoms of Refsum's disease.

The presence of 3-methyl group in phytanic acid (Fig. 24-16) blocks β oxidation. In the mitochondria of normal individuals, α hydroxylation of phytanic acid by *phytanate α hydroxylase* is followed by oxidation by phytanate α oxidase to yield CO_2 and pristanic acid (= 2,6,10,14-tetramethylpentadecanoic acid), which readily undergoes β oxidation after conversion to its CoA derivative. *In Refsum's disease, there is a lack of the enzyme, phytanate α hydroxylase.*

ω OXIDATION OF FATTY ACIDS

The biological oxidation of fatty acids at the omega (ω) carbon atom was first reported by Verkade and his group, who isolated from the urine dicarboxylic acids of the same chain length as those that were fed in the form of triglycerides. He proposed that certain acids were first oxidized at the ω carbon atom and then further metabolized by β oxidation proceeding from both ends of the dicarboxylic acid.

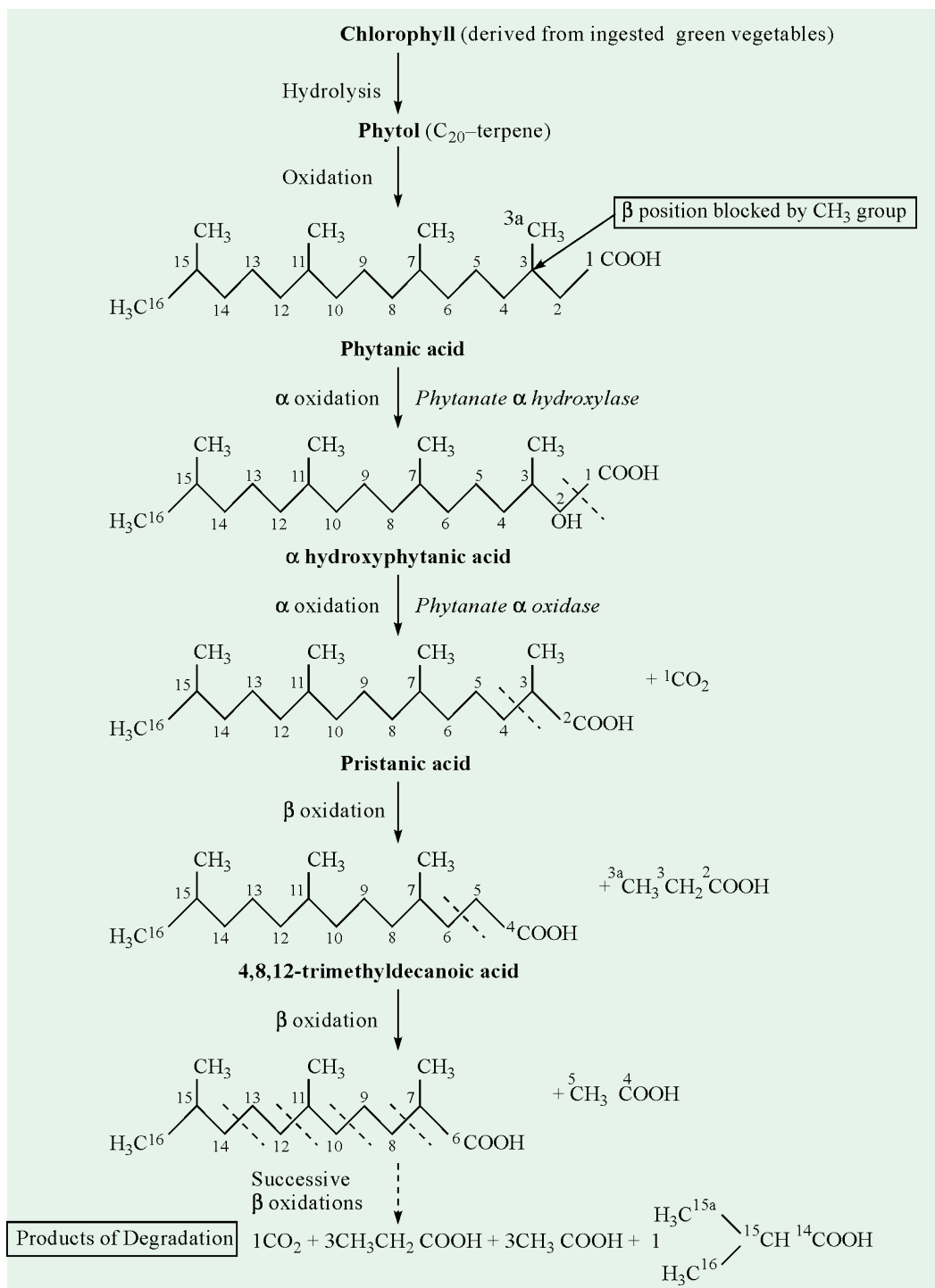

Fig. 24-16. The metabolism of phytanic acid by the normal animal cell

Dashed lines show the successive points of cleavage of the molecule.

The ω oxidation scheme responsible for the oxidation of alkanes in both the animal and plant bacterial systems has been depicted in Fig. 24-17. The mechanism involves an initial hydroxylation

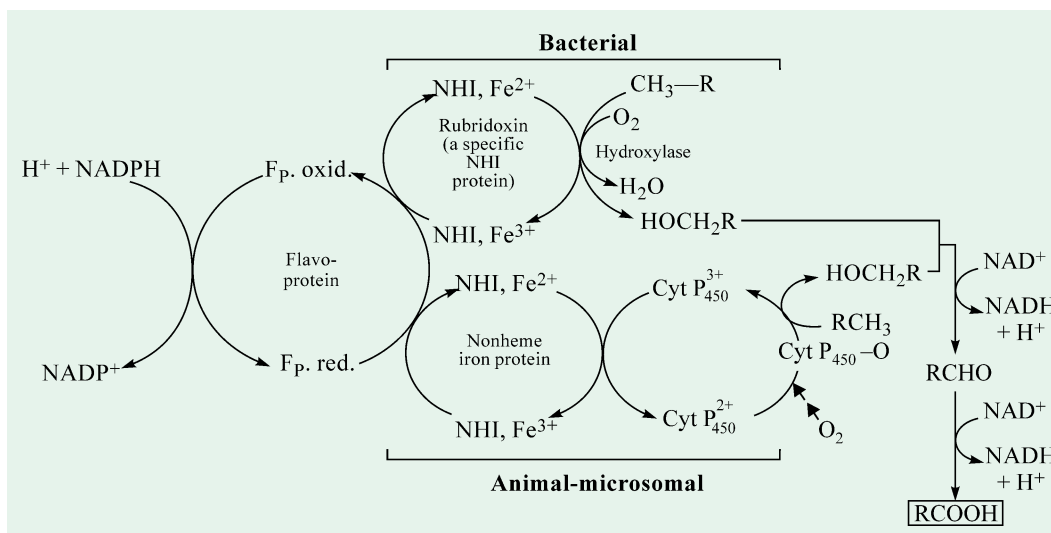

Fig. 24-17. The ω oxidation system responsible for the oxidation of alkanes in bacteria and animal systems

[Fp oxi = flavoprotein oxidized, Fp red = flavoprotein reduced, NHI = Nonheme iron protein]

(Adapted from Conn EE and StumpfPK, 1976)

of the terminal methyl group to a primary alcohol. In animals, the cytochrome P_{450} system is the hydroxylase responsible for this alkane hydroxylation; whereas in bacteria, rubridoxin is the intermediate electron carrier which feeds electrons to ω hydroxylase system. The immediate product, RCH_2OH is oxidized to an aldehyde by an *alcohol dehydrogenase*, which in turn is oxidized to a carboxylic acid by an *aldehyde dehydrogenase* in both systems. Summarily, the -CH_3 group is converted to a $\text{-CH}_2\text{OH}$ group which subsequently is oxidized to -COOH , thus forming a dicarboxylic acid. Once formed, the dicarboxylic acid may be shortened from either end of the molecule, by the β oxidation sequence, to form acetyl-CoA.

These series of reactions now have assumed an extremely important scavenging role in the bacterial biodegradation of both detergents derived from fatty acids and even more important the large amounts of oil spilled over the ocean surface. The rate of bacterial oxidation of floating oil under aerobic conditions is estimated as high as 0.5g/day per square metre of oil surface. The bacterial oxidation of oils is brought about primarily by ω oxidation mechanism.

KETOGENESIS

General Considerations

The term **ketogenesis** means formation of ketone bodies. The acetyl-CoA, formed in fatty acid oxidation, enters the citric acid cycle if fat and carbohydrate degradation are approximately balanced. The molecular basis of the adage that *fats burn in the flame of carbohydrates* is now evident. The entry of acetyl-CoA into citric acid cycle depends on the availability of oxaloacetate for the formation of citrate. However, if fat breakdown predominates, the acetyl-CoA undergoes a different fate. This is because the concentration of oxaloacetate is lowered if carbohydrate is not available or else poorly utilized. Also, in fasting or in diabetes, the oxaloacetate is utilized in the formation of glucose and is thus unavailable for condensation with acetyl-CoA. Under these conditions, acetyl-CoA is diverted to the formation of acetoacetate (**3-oxobutyrate**, in systematic nomenclature) and **D-3-hydroxybutyrate**. Acetoacetate continually undergoes spontaneous decarboxylation to yield acetone, which is exhaled. The reaction is slow, but if the concentration of acetoacetate becomes high, enough acetone may be formed to make its characteristic odour

detectable in the breath of the individuals. This is the part of the reason that the 3 substances (acetoacetate, D-3-hydroxybutyrate and acetone) were collectively but inaccurately called the “**ketone bodies**” (or “**acetone bodies**”) by early investigators even though acetone is the minor part of the total. The term now seems quaint, but it is still in use. And an increase in blood concentrations, of these compounds is called **ketonemia**.

Biosynthesis and Utilization of Ketone Bodies

Biosynthesis. Ketone bodies are formed by a series of unique reactions (Fig. 24–18), primarily in the liver and kidney mitochondria. The enzymes involved in the synthesis of ketone bodies are localized primarily in liver and kidney mitochondria. *Ketone bodies cannot be utilized in the liver since the key utilizing enzyme, β -ketoacyl : CoA transferase (= 3-oxoacid : Coa transferase) is absent in the tissue* but is present in all tissues metabolizing ketone bodies, namely red muscle, cardiac muscle, brain and kidney.

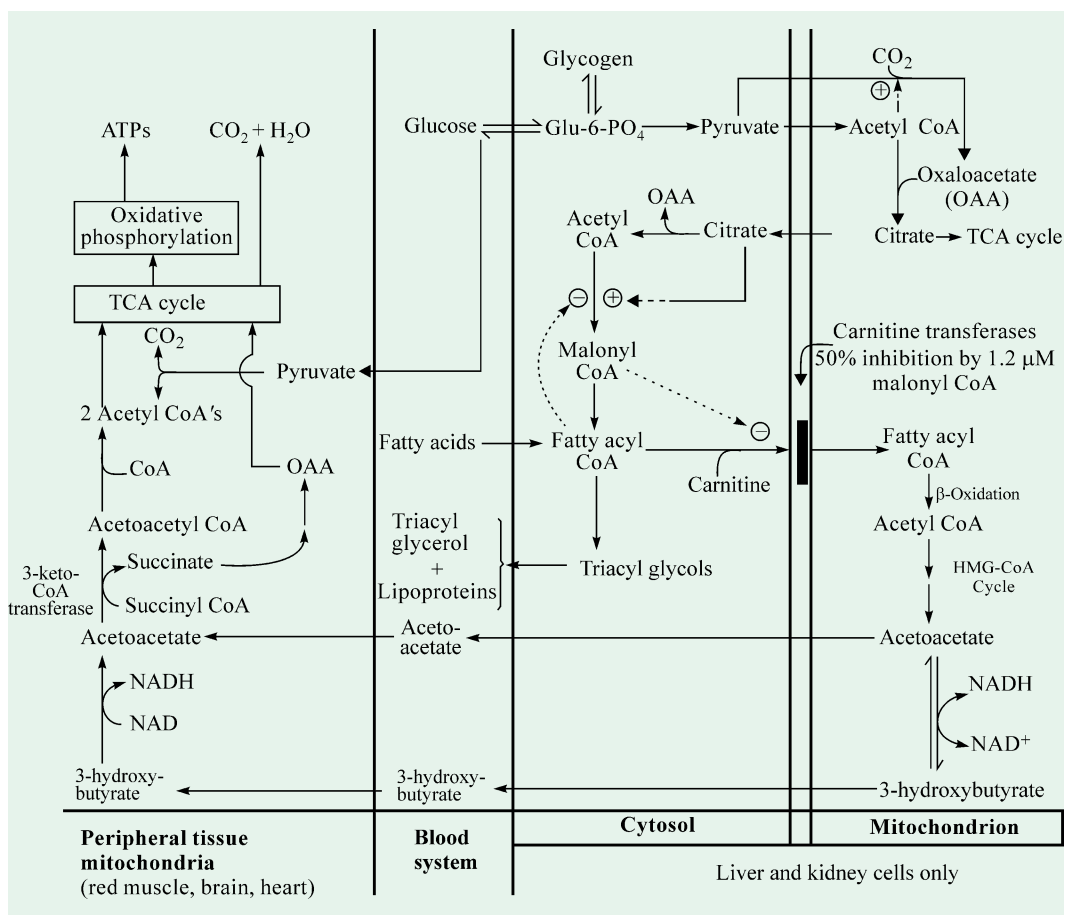

Fig. 24–18. Biosynthesis of ketone bodies and their utilization

Note that the C-6 compound, β -methylglutaryl-CoA (HMG-CoA) is also an intermediate of sterol biosynthesis, but the enzyme that forms HMG-CoA in that pathway is cytosolic. HMG-CoA lyase is present in the mitochondrial matrix but not in the cytosol.

Acetoacetate is produced from acetyl-CoA in the liver and kidneys by a simple three-step process. The first step in the formation of acetoacetate, one of the 3 ketone bodies, is the reversible head-to-tail condensation of 2 moles of acetyl-CoA, to produce a mole of acetoacetyl-CoA enzymatically by *thiolase* (**Step 1**). This step is simply the reversal of the last step of β

586 FUNDAMENTALS OF BIOCHEMISTRY

oxidation, *i.e.*, thiolysis. The acetoacetyl-CoA then condenses with acetyl-CoA and water to form β -hydroxy- β -methylglutaryl-CoA, HMG-CoA (**Step 2**). The unfavourable equilibrium in the formation of acetoacetyl-CoA is compensated for by the favourable equilibrium of this reaction, which is due to the hydrolysis of a thioester linkage.

If we think of acetoacetyl-coenzyme A as being analogous to oxaloacetate, we find that the condensation reaction (Step 2) is exactly analogous to the formation of citrate in the first step of the citric acid cycle. However, it is catalyzed by a quite different enzyme, 3-hydroxy-3-methylglutaryl-CoA synthetase. HMG-CoA is ultimately cleaved at a different point to yield acetoacetate and acetyl-CoA in an irreversible reaction (**Step 3**). The sum of these reactions is :

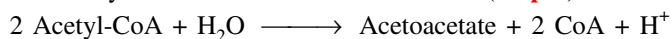

The acetoacetate so produced is reversibly reduced by a mitochondrial enzyme, D- β -hydroxybutyrate dehydrogenase to produce D- β -hydroxybutyrate (Fig. 24–18). This enzyme is specific for the D-stereoisomer ; it does not act on L- β -hydroxyacyl-CoAs and is not to be confused with L- β -hydroxyacyl-CoA dehydrogenase, which participates in the β -oxidation pathway. The ratio of hydroxybutyrate to acetoacetate depends on the NADH/NAD⁺ ratio inside mitochondria. Acetoacetate is also easily decarboxylated to acetone, either spontaneously or by the action of *acetoacetate decarboxylase*.

Utilization. The acetoacetate and D- β -hydroxybutyrate diffuse from the liver mitochondria into the blood and are transported to peripheral tissues. George Cahill and others have shown that these two acetyl-CoA products are important molecules in energy production. *Acetoacetate and D- β -hydroxybutyrate are normal fuels of respiration and are quantitatively important as source of energy.* In fact, heart muscles and renal cortex use acetoacetate in preference to glucose. On the contrary, glucose is the major fuel for the brain in well-nourished persons on a balanced diet. However, brain adapts to utilization of acetoacetate during fasting, starvation and diabetes. In prolonged starvation, 75% of the fuel needs of the brain are met by acetoacetate.

Fatty acids are released by adipose tissue and converted into acetyl units by the liver, which then exports them as acetoacetate. *Acetoacetate can, thus, be regarded as a water-soluble transportable form of acetyl units.*

To sum up, ketone bodies are alternative substrates to glucose, for energy sources in muscle and brain. The precursors of ketone bodies, namely free fatty acids are toxic in high concentrations, have very limited solubility, and readily saturate the carrying capacity of the plasma membrane. On the other hand, the ketone bodies are low in toxicity, and tolerated at high concentrations, are very soluble, diffuse rapidly through membranes, and are rapidly metabolized to CO₂ and H₂O.

The importance of this pathway is indicated by the fact that the normal human liver is potentially capable of making the equivalent of half its weight as acetoacetate each day !

In the extrahepatic tissues, D- β -hydroxybutyrate is oxidized to acetoacetate by an enzyme, D- β -hydroxybutyrate dehydrogenase. Acetoacetate is activated to form its coenzyme A ester by transfer of CoA from succinyl-CoA, an intermediate of the citric acid cycle, in a reaction catalyzed by b-ketoacyl-CoA transferase. The acetoacetyl-CoA is then cleaved by thiolase to yield 2 moles of acetyl-CoA, which enter the citric acid cycle.

Ketogenic and Antiketogenic Substances

The *ketogenic substances* are, of course, all the fatty acids. In addition, at least 3 amino acids belong to this category : leucine, phenylalanine and tyrosine. *Antiketogenic substances*, in the sense of preventing the accumulation of ketone bodies, are the carbohydrates, the glycerol fraction of fat, and the following amino acids : glycine, alanine, valine, serine, threonine, cysteine, methionine, aspartic acid, glutamic acid, arginine, histidine, proline and ornithine. These are antiketogenic because their non-nitrogenous residues are convertible to glucose.

Regulation of Ketogenesis

Ketosis arises as a result of deficiency in available carbohydrate. This leads to the enhanced rate of ketogenesis. There are 3 crucial steps in the pathway of metabolism of free fatty acids (FFAs) that determine the magnitude of ketogenesis (Fig. 24–19). These are :

1. It causes an imbalance between esterification and lipolysis in adipose tissue, with consequent of free fatty acids into the circulation. FFAs are the principal substrates for ketone body formation in the liver and therefore all factors, metabolic or endocrine, affecting the release of free fatty acids from adipose tissues, influence ketogenesis.
2. Upon entry of free fatty acids into the liver, the balance between esterification and oxidation of FFAs is influenced by the hormonal state of the liver and possibly by the availability of glycerol-3-phosphate or by the redox state of the tissue.

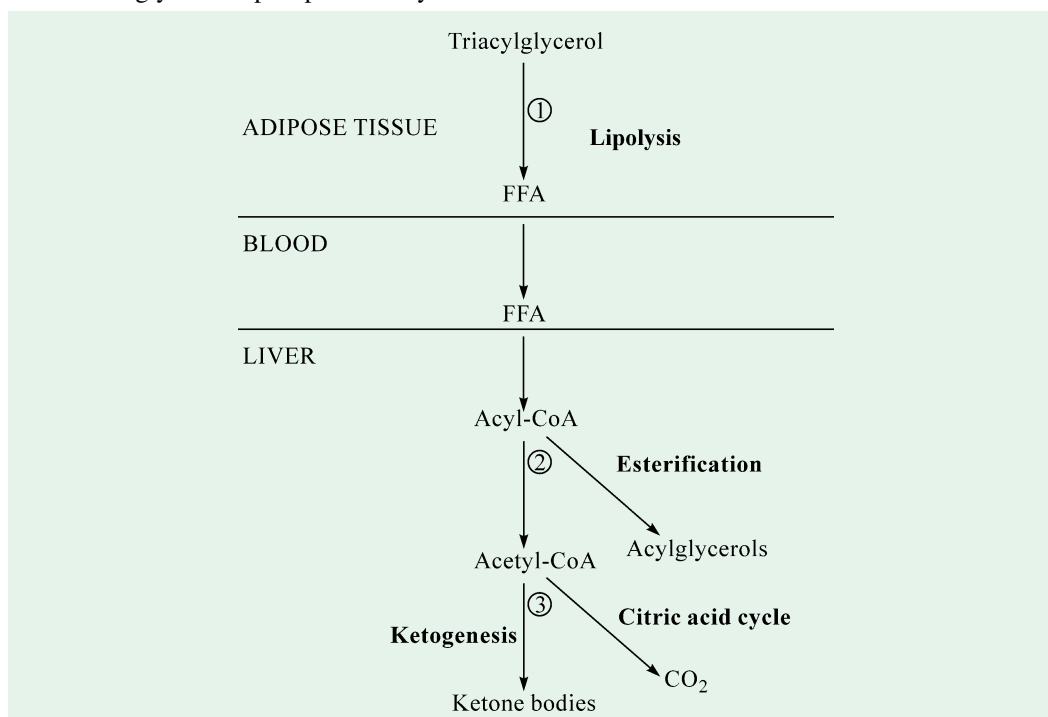

Fig. 24–19. Regulation of ketogenesis

The 3 crucial steps in the pathway of free fatty acids (FFAs) that determine the rate of ketogenesis are numbered as ①, ②, and ③.

(After Harper, Rodwell and Mayes, 1977)

3. As the quantity of fatty acids presented for oxidation increases, more form ketone bodies and less form CO₂, regulated in such a manner that the total energy production remains constant.

Under circumstances of limited utilization of carbohydrates and/or substantial mobilization of fatty acids to the liver, there is a markedly diminished rate of operation of two of the three pathways for metabolizing acetyl-CoA, viz., the citric acid cycle and fatty acid synthesis. The result is a channeling of acetyl-CoA into β -hydroxy- β -methylglutaryl-CoA (HMG-CoA). This results in increased formation of acetoacetate, D- β -hydroxybutyrate and acetone, whereby elevating the concentration of the total ketone bodies in the blood and urine above normal (Table 24–1). Higher than normal quantities of the ketone bodies present in the blood or urine constitute ketonemia

588 FUNDAMENTALS OF BIOCHEMISTRY

(= hyperketonemia) and ketonuria, respectively. D- β -hydroxybutyrate is quantitatively the predominant ketone body present in the blood and urine in ketosis. Whenever a marked degree of ketonemia and ketonuria exists, the odour of acetone is likely to be detected in the exhaled air. The triad of ketonemia, ketonuria and acetone odour of the breath is collectively termed **ketosis**.

Table 24–1. Accumulation of ketone bodies in untreated diabetics with severe ketosis

<i>State of individual</i>	<i>Blood concentration*</i> (mg/100 mL)	<i>Urinary excretion</i> (mg/24 hr)
Normal	<3	≤ 125
Extreme ketosis (untreated diabetic)	90	5,000

*as acetone equivalents

Since H^+ is produced along with oxybutyrates, ketosis is frequently accompanied by acidosis. **Acidosis** is the lowering of blood pH due to the rise in blood levels of acetoacetate and D- β -hydroxybutyrate. Ketosis and acidosis taken together are termed as **ketoacidosis**. The ketoacidosis is characterized by the continual excretion in quantity of the ketone bodies which entails some loss of buffer cation, thus progressively depleting the alkali reserve. Ketoacidosis is of frequent occurrence in the untreated juvenile diabetic because of failure to secrete sufficient insulin and may be fatal. In late-onset diabetes after age 40, severe ketoacidosis is less frequent.

FATTY ACID OXIDATION IN PEROXISOMES

Although the major site of fatty acid oxidation in animal cells is the mitochondrial matrix, other compartment in certain cells also contain enzymes which are capable of oxidizing fatty acids to acetyl-CoA, by a pathway similar to, but not identical with, that in mitochondria. **Peroxisomes** are membrane-bound cellular compartments in animals and plants. The fatty acids are oxidized in peroxisomes to produce hydrogen peroxide which is then destroyed enzymatically. As in the oxidation of fatty acids in mitochondria, the intermediates are coenzyme A derivatives. The whole process consists of 4 steps (Fig. 24–20) :

- (a) dehydrogenation of long-chain acyl-coenzyme A,
- (b) addition of water to the resulting double bond,
- (c) oxidation of the β -hydroxyacyl-CoA to a ketone, and
- (d) thiolitic cleavage by coenzyme A.

The fatty acid oxidation in **glyoxysomes** occurs by the peroxisomal pathway.

The peroxisomal pathway differs from the mitochondrial pathway in 3 respects:

1. In peroxisomal pathway, the flavoprotein dehydrogenase, that introduces the double bond, passes electrons directly to O_2 , producing H_2O_2 . This strong and potentially damaging oxidant is immediately cleaved to H_2O and O_2 by *catalase*. Whereas in mitochondrial pathway, the electrons removed in first oxidative step pass through the respiratory chain to O_2 , forming H_2O . This process is accompanied by ATP synthesis. In peroxisomes, the energy released in the first oxidative step of fatty acid breakdown is dissipated as heat.

2. The NADH formed in β oxidation cannot be reoxidized, and the peroxisomes must export reducing equivalent to the cytosol (These equivalents are eventually passed on to mitochondria).

3. In mitochondria, the acetyl-CoA is further oxidized via the citric acid cycle. Acetyl-CoA produced by peroxisomes (and also glyoxysomes) is exported. The acetate from glyoxysomes serves as a biosynthetic precursor of polysaccharides, amino acids, nucleotides and some metabolic intermediates.

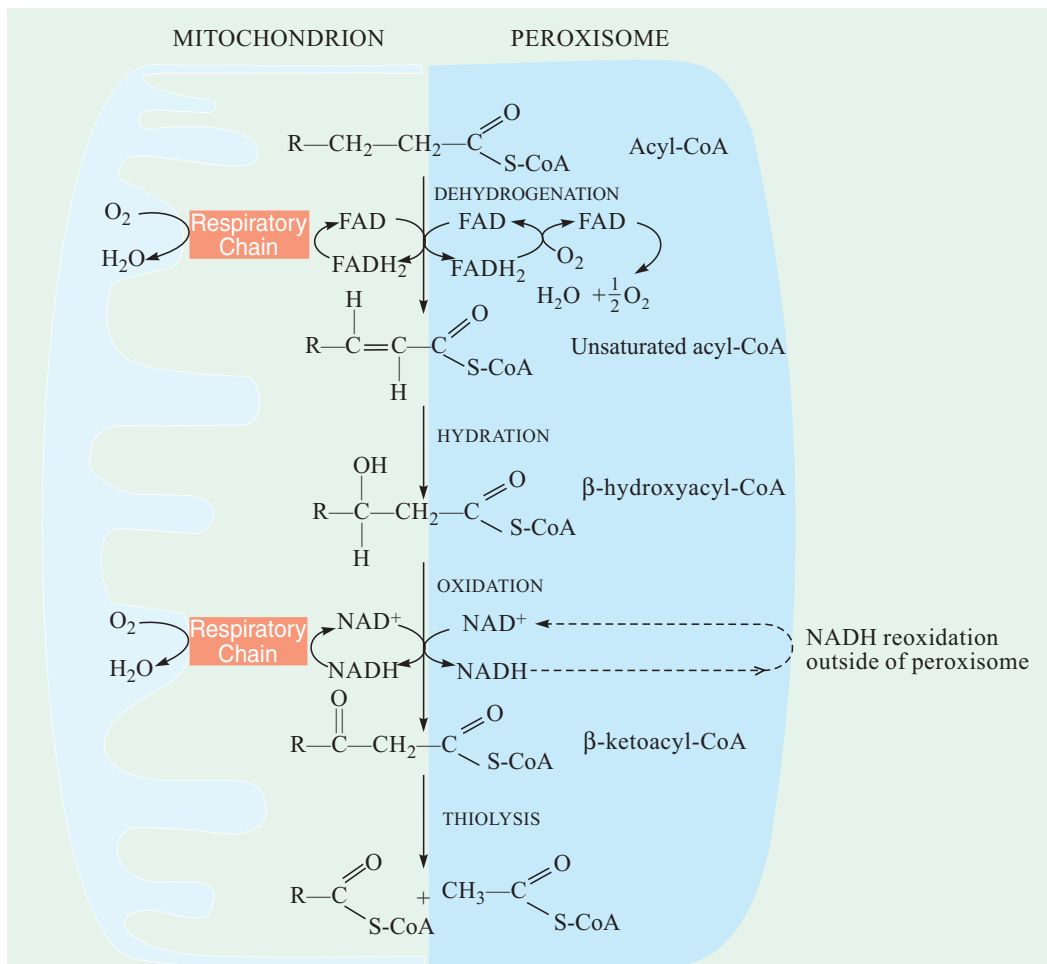

Fig. 24-20. Comparison of β oxidation of fatty acids as it occurs in animal mitochondria and in animal and plant peroxisomes

METABOLIC WATER

Another important biological feature of fatty acid oxidation (and of aerobic respiration, in general) is the production of metabolic water. For example, a mole of palmitic acid upon oxidation



Fig. 24-21. Adaptation of animals to arid environment
(a) Camel (b) Kangaroo rat

590 FUNDAMENTALS OF BIOCHEMISTRY

produces 16 moles of H₂O. This metabolic production of water is of significant importance to many organisms (Fig. 24–21). In the case of a **camel**, for example, the lipids stored in its humps serve both as a source of energy and as a source of the water needed to help sustain the animal for extended periods of time in the desert. The **kangaroo rat** is an even more striking example of adaptation to an arid environment. This animal has been observed to live indefinitely without having to drink water. It lives on a diet of seeds, which are rich in lipids but contain little water. The metabolic water that the kangaroo rat produces is adequate for all its water needs. This metabolic response to arid conditions is usually accompanied by a reduced output of urine.

REFERENCES

1. **Bondy PK, Rosenberg EE (editors)** : Metabolic Concepts and Disease. 8th ed. W.B. Saunders, Philadelphia. 1980
2. **Breslow JL** : Apolipoprotein genes and atherosclerosis. *Clin. Invest.* **70** : 377-384, 1992.
3. **Brown MS, Goldstein JL** : How LDL receptors influence cholesterol and atherosclerosis. *Sci. Amer.* **251** (5) : 58-66, 1984.
4. **Chan L** : Apolipoprotein B, the major protein component triglyceride-rich and low density lipoproteins. *J. Biol. Chem.* **267** : 25621-25624, 1992.
5. **Coon MJ, Ding X, Pernecky SJ, Vaz ADN** : Cytochrome P 450: Progress and predictions. *FASEB J.* **6** : 686-694, 1992.
6. **Endo A** : The discovery and development of HMG-CoA reductase inhibitors. *J. Lipid Res.* **33** : 1569-1582, 1992.
7. **Goldstein JL, Brown MS** : Regulation of the mevalonate pathway. *Nature.* **343** : 425-430, 1990.
8. **Greville GD, Tubbs PK** : The catabolism of long-chain fatty acids in mammalian tissues. *Essays Biochem.* **4** : 155-212, 1968.
9. **Gurr MI, Harwood JL** : Lipid Biochemistry : An Introduction. 4th ed. Chapman & Hall, London. 1991.
10. **Hakomori S** : Glycosphingolipids. *Sci. Amer.* **254** (5) : 44-53, 1986.
11. **Hardwood JL** : Fatty acid metabolism. *Ann. Rev. Plant Physiol. Plant Mol. Biol.* **39** : 101-138, 1988.
12. **Hawthorne JN, Ansell GB (editors)** : Phospholipids. Elsevier. 1982.
13. **Hayaishi O (editor)** : Molecular Mechanisms of Oxygen Activation. Academic Press Inc., New York. 1974.
14. **Jain MH** : Introduction to Biological Membranes. 2nd ed. Wiley, New York. 1988.
15. **Majerus PW** : Inositol phosphate biochemistry. *Ann. Rev. Biochem.* **61** : 225-250, 1992.
16. **Masters C, Crane D** : The role of peroxisomes in lipid metabolism. *Trends Biochem. Sci.* **9** : 314, 1984.
17. **Numa S (editor)** : Fatty Acid Metabolism and its Regulation. Elsevier, Amsterdam. 1984.
18. **Osumi T, Hashimoto T** : The inducible fatty acid oxidation system in mammalian peroxisomes. *Trends Biochem. Sci.* **3** : 317, 1984.
19. **Owen JS, McIntyre N** : Plasma lipoprotein metabolism and lipid transport. *Trends Biochem. Sci.* **7** : 92, 1982.
20. **Raetz CR** : Bacterial endotoxins : Extraordinary lipids that activate eucaryotic signal transduction. *J. Bacteriol.* **175** : 5745-5753, 1993.
21. **Ross R** : The pathogenesis of atherosclerosis : A perspective for the 1990s. *Nature.* **362** : 801-809, 1993.

OXIDATION OF FATTY ACIDS 591

22. **Russell DW** : Cholesterol biosynthesis and metabolism. *Cardiovasc Drugs Therapy*. **6** : 103-110, 1992.
23. **Schulz H** : Oxidation of fatty acids. In *Biochemistry of Lipids and Membranes* (Vance DE & Vance JE, editors). 116-142. *The Benjamin/Cummings Publishing Company, Menlo Park, CA*. 1985.
24. **Schulz H, Kunau WH** : Beta-oxidation of unsaturated fatty acids : A revised pathway. *Trends Biochem. Sci.* **12** : 403-406, 1987.
25. **Scriver CR, Beaudet AL, Sly WS, Valle D (editors)** : *The Metabolic Basis of Inherited Disease*. 6th ed. *McGraw-Hill, New York*. 1989.
26. **Snyder F (editor)** : *Lipid Metabolism in Mammals*. Vols. 1 and 2. *Plenum, New York*. 1977.
27. **Vance DE, Vance JE (editors)** : *Biochemistry of Lipids, Lipoproteins and Membranes*. New Comprehensive Biochemistry. Vol. 20. *Elsevier Science Publishing Co., Inc., New York*. 1991.
28. **Vanden BT, Cronan JJ** : Genetics and regulation of bacterial lipid metabolism. *Ann. Rev. Microbiol.* **43** : 317-343, 1989.
29. **Vaz AD, Coon MJ** : On the mechanism of action of cytochrome P 450 : Evaluation of hydrogen abstraction in oxygen-dependent alcohol oxidation. *Biochemistry*. **33** : 6442-6449, 1994.
30. **Wakil SJ (editor)** : *Lipid Metabolism*. *Academic Press Inc., New York*. 1970.

PROBLEMS

1. A number of genetic deficiencies in acyl CoA dehydrogenases have been described. This deficiency presents early in life after a period of fasting. Symptoms include vomiting, lethargy, and sometimes coma. Not only are blood levels of glucose low (hypoglycemia), but starvation-induced ketosis is absent. Provide a biochemical explanation for these last two observations.
2. High blood levels of triacylglycerides are associated with heart attacks and strokes. Clofibrate, a drug that increases the activity of peroxisomes, is sometimes used to treat patients with such a condition. What is the biochemical basis for this treatment ?
3. Suppose that, for some bizarre reason, you decided to exist on a diet of whale and seal blubber, exclusively.
 - (a) How would lack of carbohydrates affect your ability to utilize fats ?
 - (b) What would your breath smell like ?
 - (c) One of your best friends, after trying unsuccessfully to convince you to abandon this diet, makes you promise to consume a healthy dose of odd-chain fatty acids. Does your friend have your best interests at heart ? Explain.
4. An animal is fed stearic acid that is radioactively labeled with [¹⁴C]carbon. A liver biopsy reveals the presence of ¹⁴C-labeled glycogen. How is this possible in light of the fact that animals cannot convert fats into carbohydrates ?
5. Adipose tissue cannot resynthesize triacylglycerols from glycerol released during lipolysis (fat breakdown). Why not ? Describe the metabolic route that is used to generate a glycerol compound for triacylglycerol synthesis.
6.
 - (a) Briefly describe the relationship between intracellular malonyl-CoA levels in the liver and the control of ketogenesis.
 - (b) Describe how the action of glucokinase helps the liver to buffer the level of blood glucose.

592 FUNDAMENTALS OF BIOCHEMISTRY

7. The action of glucagon on liver cells leads to inhibition of pyruvate kinase. What is the most probable mechanism for this effect ?
8. What is the approximate maximum net synthesis of ATP-associated high-energy phosphate bonds (\sim P) for complete oxidation of 1 mol of oleic acid in a muscle cell ?
9. How does oxidation of a 17-carbon fatty acid (from plants) lead to the production of propionyl-CoA? Be specific in your answer.
10. On a per-carbon basis, where does the largest amount of biologically-available energy in triacylglycerols reside : in the fatty acid portions or the glycerol portion ? Indicate how knowledge of the chemical structure of triacylglycerols provides the answer.
11. Triacylglycerols have the highest energy content of the major nutrients.
 - (a) If 15% of the body mass of a 70 kg adult consists of triacylglycerols, calculate the total available fuel reserve, in both kilojoules and kilocalories, in the form of triacylglycerols. Recall that 1.00 kcal = 4.18 kJ, and that 1.0 kcal = 1.0 nutritional Calorie.
 - (b) If the basal energy requirement is approximately 8,400 kJ/day (2,000 kcal/day), how long could this person survive if the oxidation of fatty acids stored as triacylglycerols were the only source of energy ?
 - (c) What would be the weight loss per day in pounds under such starvation conditions (1 lb = 0.454 kg) ?
12. Cells often follow the same enzyme reaction pattern for bringing about analogous metabolic reactions. For example, the steps in the oxidation of pyruvate and α -ketoglutarate to acetyl-CoA and succinyl-CoA, although catalyzed by different enzymes, are very similar. The first stage in the oxidation of fatty acids follows a reaction sequence closely resembling one in the citric acid cycle. Show by equations the analogous reaction sequences in the two pathways.
13. Free palmitate is activated to its coenzyme A derivative (palmitoyl-CoA) in the cytosol before it can be oxidized in the mitochondrion. If palmitate and [14 C] coenzyme A are added to a liver homogenate, palmitoyl-CoA isolated from the cytosolic fraction is radioactive, but that isolated from the mitochondrial fraction is not. Explain.
14. Contrary to legend, camels do not store water in their humps, which actually consist of a large fat deposit. How can these fat deposits serve as a source of water ? Calculate the amount of water (in litres) that can be produced by the camel from 1 kg (0.45 lb) of fat. Assume for simplicity that the fat consists entirely of tripalmitoylglycerol.
15. When the acetyl-CoA produced during β oxidation in the liver exceeds the capacity of the citric acid cycle, the excess acetyl-CoA reacts to form the ketone bodies acetoacetate, D- β -hydroxybutyrate, and acetone. This condition exists in cases of severe diabetes because the patient's tissues cannot use glucose ; they oxidize large amounts of fatty acids instead. Although acetyl-CoA is not toxic, the mitochondrion must divert the acetyl-CoA to ketone bodies. Why ? How does this diversion solve the problem ?
16. Suppose you had to subsist on a diet of whale and seal blubber with little or no carbohydrate.
 - (a) What would be the effect of carbohydrate deprivation on the utilization of fats for energy ?
 - (b) If your diet were totally devoid of carbohydrate, would it be better to consume odd- or even-numbered fatty acids ? Explain.
17. Write the net equation for the complete oxidation of D- β -hydroxybutyrate in the kidney. Include any required activation steps and all oxidative phosphorylations.

OXIDATION OF FATTY ACIDS 593

18. The complete oxidation of palmitate to carbon dioxide and water is represented by the overall equation

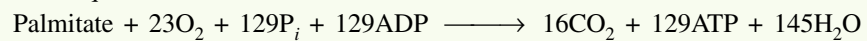

The 145 H₂O molecules come from two separate reactions. What are they, and how many H₂O molecules are produced in each ?