

CONTENTS

- Introduction
- Electron Flow as Source of ATP Energy
- Site of Oxidative Phosphorylation
- ATP Synthetase (=F₀F₁ ATPase)
- Electron-Transferring Reactions
- Standard Oxidation-Reduction Potential
- Electron Carriers
- Electron-Transport Complexes
- Incomplete Reduction of Oxygen
- Mechanisms of Oxidative Phosphorylation
- Oxidation of Extramitochondrial NADH
- ATP Yield and P : O Ratio
- Roles of Electron Transport Energy
- Respiratory Inhibitors
- Regulatory Controls

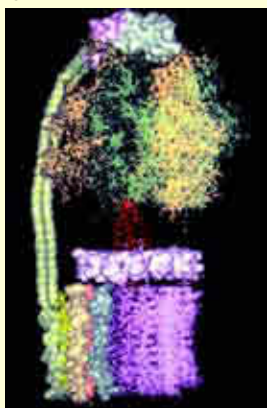

A model for mitochondrial F₀F₁-ATP synthetase, a rotating molecular motor

ATP synthesis occurs on F₁ domain, while F₀ domain contains a proton channel. The a, b, α, β, and δ subunits constitute the stator while the c, γ, and ε subunits provide the rotor. Protons flow through the structure causing the rotor to turn, resulting in conformational changes in the β, subunits where ATP is synthesized.

(Courtesy : Drs. Peter L. Pedersen, Young Hee Ko, and Sangjin Hong)

CHAPTER

23

Electron Transport and Oxidative Phosphorylation

INTRODUCTION

All the enzyme-catalyzed steps in the oxidative degradation of carbohydrates, fats and amino acids in aerobic cells converge into electron transport and oxidative phosphorylation, the final stage of cell respiration. This stage consists of flow of electrons from organic substrates to oxygen with the simultaneous release of energy for the generation of ATP molecules. The importance of this final stage of respiration in the human body can be realized by the fact that a normal adult businessman with a 70 kg weight requires about 2,800 kcal of energy per day. This amount of energy can be produced by the hydrolysis of about $2,800/7.3 = 380$ mole or 190 kilograms of ATP. However, the total amount of ATP present in his body is about 50 grams. In order to provide chemical energy for the body need, the 50 g of ATP must be broken down into ADP and phosphate and resynthesized thousands of times in a day. *i.e.*, 24 hours.

ELECTRON FLOW AS SOURCE OF ATP ENERGY

Fig. 23–1 shows the electron transport chain in abbreviated form. In each turn of citric acid cycle, 4 pairs

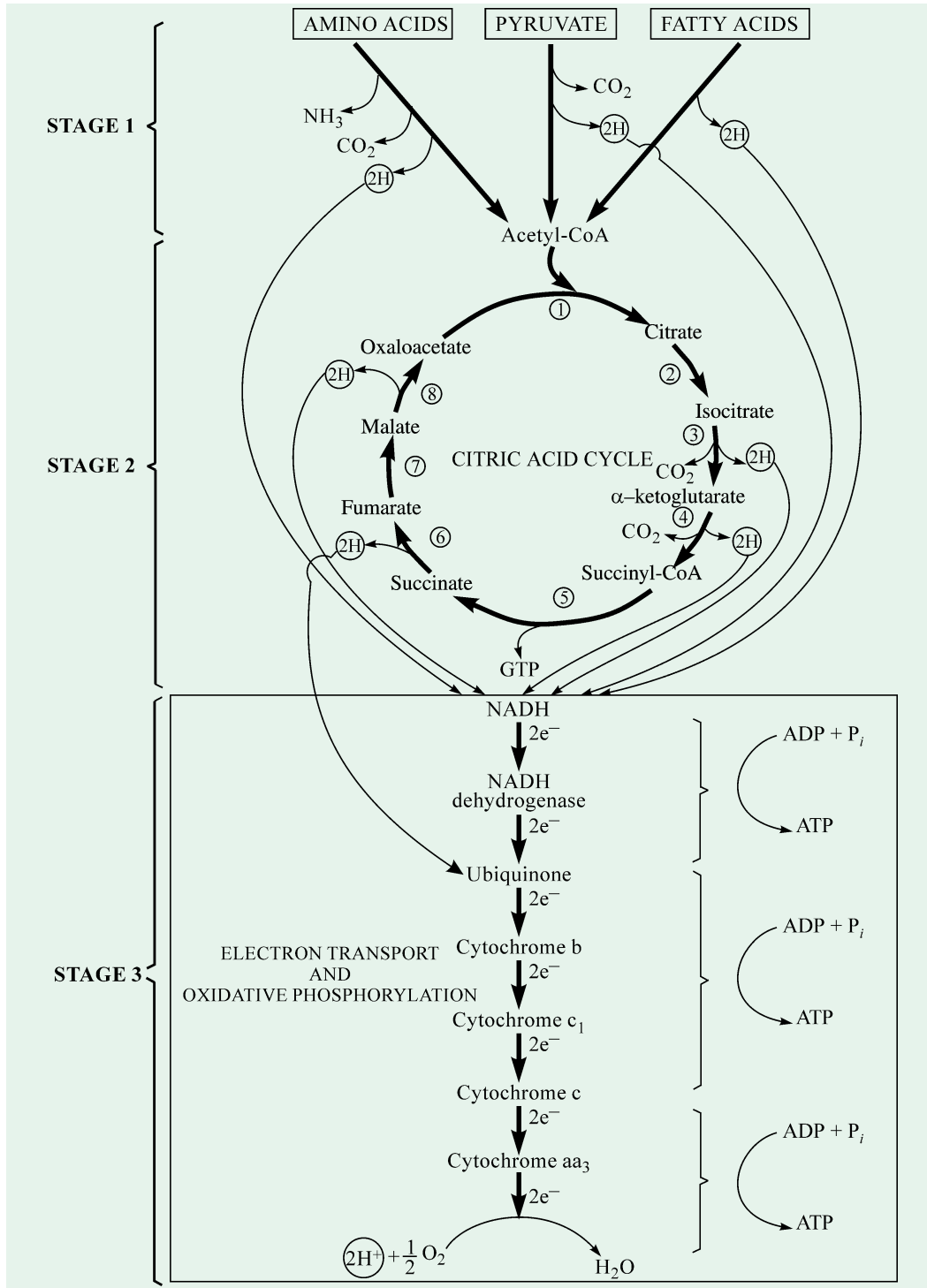

Fig. 23-1. The flow sheet of respiration with special reference to the electron transport and oxidative phosphorylation

The electron transport chain is shown here in abbreviated form. The circled numbers represent the various steps of the citric acid cycle.

524 FUNDAMENTALS OF BIOCHEMISTRY

of hydrogen atoms are eliminated, one each from isocitrate, α -ketoglutarate, succinate and malate, by the action of specific dehydrogenases. These hydrogen atoms donate their electrons to the electron transport chain and become H^+ ions, which escape into the aqueous medium. These electrons are transported along a chain of electron-carrying molecules to ultimately reach cytochrome aa_3 or cytochrome oxidase, which promotes the transfer of electrons to oxygen, the final electron acceptor in aerobic organisms. As each atom of oxygen accepts two electrons from the chain, two H^+ are taken up from the aqueous medium to form water.

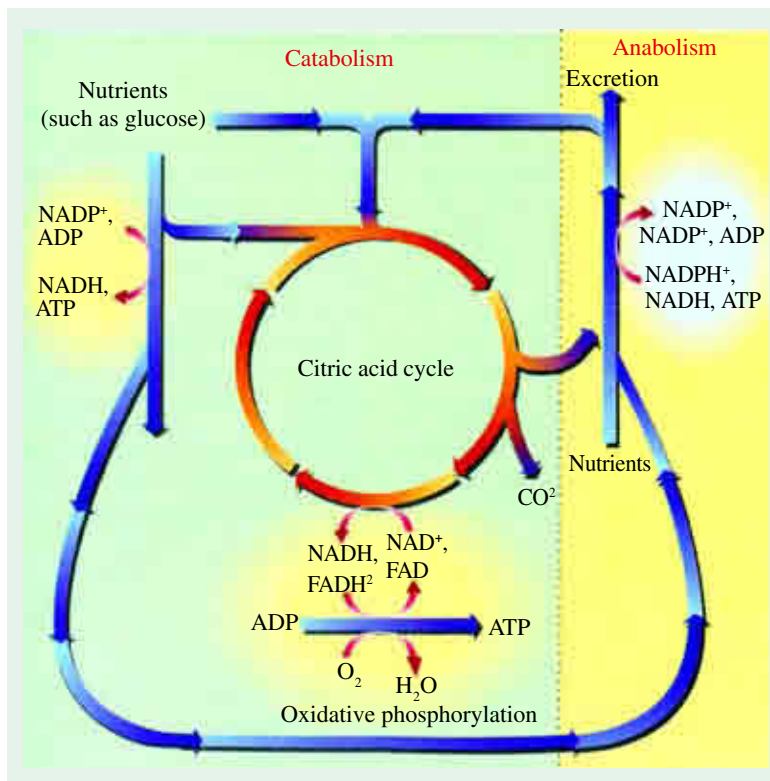

Fig. 23-2. The role of electron transfer and ATP production in metabolism
NAD⁺, FAD, and ATP are constantly recycled.

Besides the citric acid cycle, other pairs of hydrogen atoms are also released from the dehydrogenases that act upon pyruvate, fatty acid and amino acids during their degradation to acetyl-CoA and other products. All these hydrogen atoms virtually donate their electrons ultimately to the respiratory chain with oxygen as the terminal electron acceptor.

The respiratory chain consists of a series of proteins with tightly bound prosthetic groups capable of accepting and donating electrons. Each member of the chain can accept electrons from the preceding member and transfer them to the following one, in a specific sequence. The electrons entering the electron-transport chain are energy-rich, but as they pass down the chain step-by-step to oxygen, they lose free energy. Much of this energy is conserved in the form of ATP in the inner mitochondrial membrane. As each pair of electrons passes down the respiratory chain from NADH to oxygen, the synthesis of 3 moles of ATP from ADP and phosphate takes place. The 3 segments of the respiratory chain that provide energy to generate ATP by oxidative phosphorylation are called their **energy-conserving sites**.

The role of electron flow and ATP production is highlighted in Fig- 23-2.

SITE OF OXIDATIVE PHOSPHORYLATION

Mitochondria (Fig. 23-3) are ovate organelles, about 2 μm in length and 0.5 μm in the diameter. Eugene P. Kennedy and Albert L. Lehninger discovered that *mitochondria contain the respiratory assembly, the enzymes of the citric acid cycle and the enzymes of fatty acid oxidation*. Electron microscopic studies by George Palade and Fritjof Sjöstrand have revealed that each mitochondrion (Fig. 23-4) has two membrane systems : an outer membrane and an extensive *inner membrane*, which is highly-folded into a series of internal ridges called *cristae*. Obviously, there are two

ELECTRON TRANSPORT AND OXIDATIVE PHOSPHORYLATION 525

compartments in mitochondria : the intermembrane space between the outer and inner membranes and the *matrix*, which is bounded by the inner membrane.

The **outer membrane** is freely permeable to most small molecules and ions and contains some enzymes. In contrast, the **inner membrane** is impermeable to nearly all ions and most uncharged molecules and contains the electron-transport chains, succinate dehydrogenase and ATP-synthesizing enzymes. The inner membrane of a single liver mitochondrion may have over 10,000 sets of electron-transport chains and ATP synthetase molecules. The heart mitochondria have profuse cristae and therefore contain about 3 times more sets of electron-transport chains than that of liver mitochondria. The **intermembrane space** contains adenylate kinase and some other enzymes whereas the **matrix** compartment contains most of the citric acid cycle enzymes, the pyruvate dehydrogenase system and the fatty acid oxidation system. It also contains ATP, ADP, AMP, phosphate, NAD, NADP, coenzyme A and various ions such as K^+ , Mg^{2+} and Ca^{2+} .

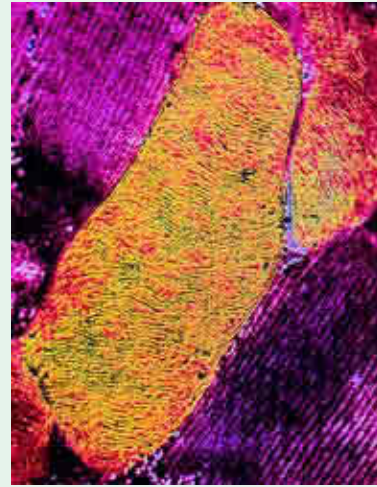

Fig. 23-3. Mitochondria, shown here, are the sites of the citric acid cycle, electron transport, and oxidative phosphorylation.

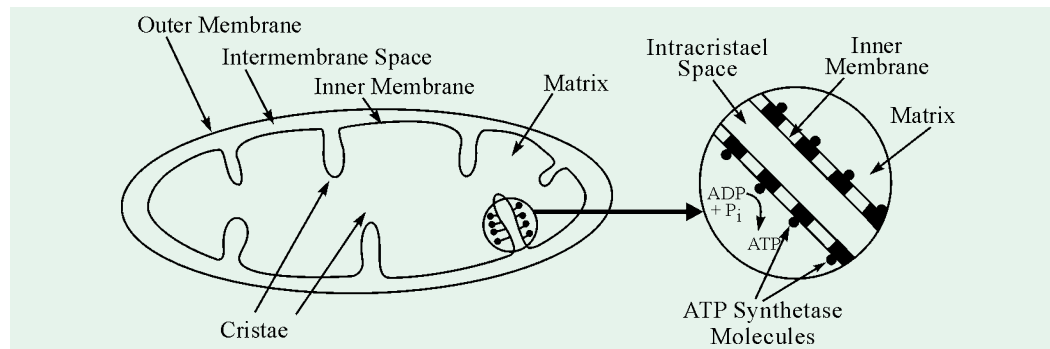

Fig. 23-4. Biochemical anatomy of a mitochondrion

The base piece of ATP synthetase molecules are located with the inner membrane. ATP is made in the matrix, as shown.

ATP SYNTHETASE (=F₀F₁ ATPase)

The mitochondrial inner membrane contains the ATP-synthesizing enzyme complex called *ATP synthetase* or *F₀F₁ ATPase* (Figs. 23-5 and 23-6). This enzyme complex has 2 major components F₀ and F₁ (F for factor). The F₁ component is like a doorknob protruding into the matrix from the inner membrane. It is attached by a stalk to F₀ component, which is embedded in the inner membrane and extends across it.

The **subscript of F₀** is not zero but the letter O which denotes that it is the portion of the ATP synthetase which binds the toxic antibiotic, oligomycin. Oligomycin is a potent inhibitor of this enzyme and thus of oxidative phosphorylation.

The F₁ components was first extracted from the mitochondrial inner membrane and purified by Efraim Racker and his collaborators in 1960. During the sonic treatment of the inner mitochondrial membrane (Fig. 23-7), the cristae membranes are fragmented which, later on, reseal to form vesicles called *submitochondrial particles*, in which the F₁ spheres are on the outside, rather than the inside. In other words, the vesicles are “inside out”. When these inverted vesicles are treated with urea or trypsin, the F₁ spheres become detached. The isolated F₁ alone cannot make ATP from ADP and inorganic phosphate but it can hydrolyze ATP to ADP and phosphate. It is, therefore, also called as F₁

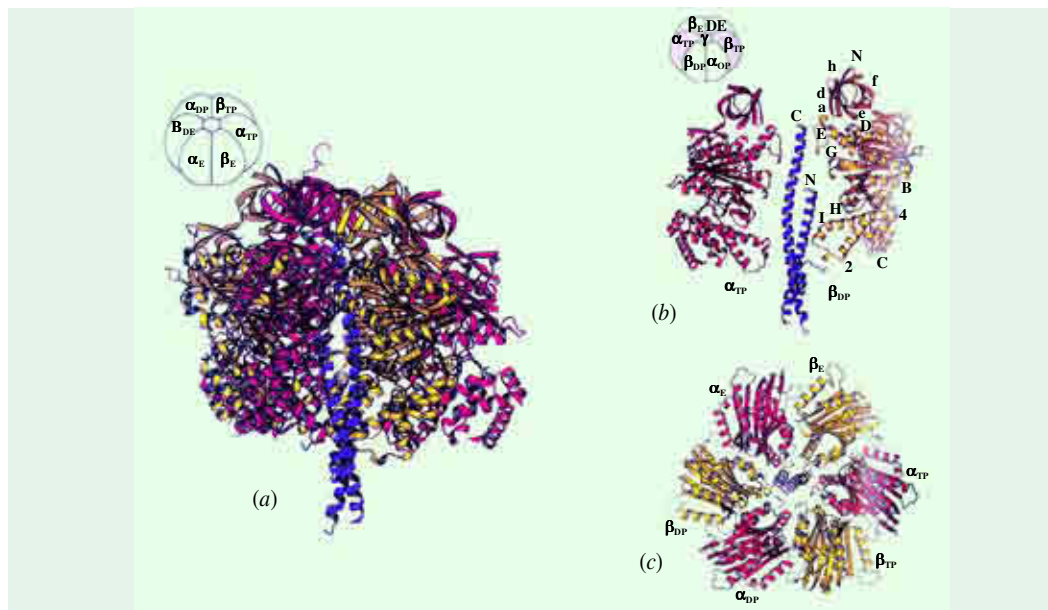

Fig. 23-5. Ribbon model of the 3-dimensional structure of mitochondrial ATP synthase complex (=F₀F₁ ATPase)

- (a) Side view of F₁ complex structure deduced from the crystal structure. Three α (red) and three β (yellow) subunits alternate around a central shaft, the γ subunit (blue).
- (b) Side view of F₁ subunit in which two α and β subunits have been removed to reveal the central γ subunit. subunits are colored as indicated for part (a).
- (c) Top view of F₁ complex shows alternating α and β subunits surrounding central γ subunit.

(Courtesy : Abrahams JP et al, 1994)

ATPase. The stripped submitochondrial particles (*i.e.*, those lacking F₁ spheres but containing the F₀ component within the inner membrane) can transfer electrons through their electron-transport chain, but they can no longer synthesize ATP. Interestingly enough, Racker found that the addition of these F₁ spheres to the stripped mitochondrial particles restored their capacity to synthesize ATP. Thus, the physiological role of the F₁ component is to catalyze the synthesis of ATP.



Fig. 23-6. ATP synthase (F₀F₁ complex), the site of ATP synthesis

A. The F₀F₁ complex harnesses energy stored in the proton gradient across the inner mitochondrial membrane. F₀ serves as a channel for protons flowing back into the matrix, and F₁ is an enzyme that makes ATP as the protons pass. B. A windmill's blades spin around as it generates electricity. In the same way, the F₁ blades of the F₀F₁ complex spin around as the complex generates ATP.

(Courtesy : (B) Alan Reininger)

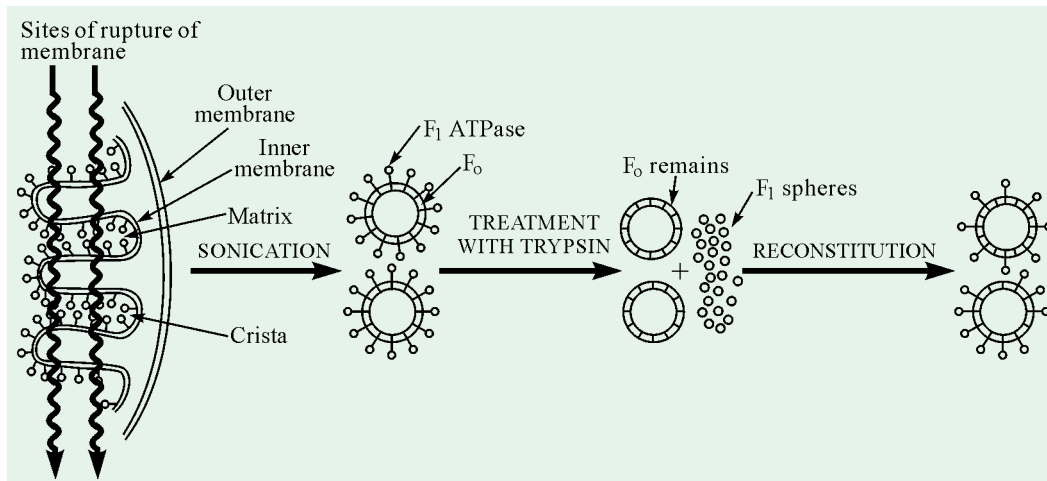

Fig. 23-7. Sonication of the mitochondrial inner membrane

(After Lehninger AL, 1984)

Table 23-1 lists some characteristics of the various components of the mitochondrial ATP-synthesizing complex.

The spheric **F₁ component** (MW = 360 kdal) contains 9 polypeptide chain subunits of five kinds (designated as α , β , γ , δ and ϵ) arranged into a cluster. It has many binding sites for ATP and ADP. The cuboidal **F₀ component** is a hydrophobic segment of 4 polypeptide chains. It acts as a base piece and normally extends across the inner membrane. *F₀ is the proton channel of the enzyme complex.* The cylindrical stalk between F₀ and F₁ includes many other proteins. One of them renders the enzyme complex sensitive to oligomycin, an antibiotic that blocks ATP synthesis by interfering with the utilization of the proton gradient. *The stalk is the communicating portion of the enzyme complex.* Fo F1 ATPase is called an ATPase because, in isolated form, it hydrolyzes ATP to ADP plus Pi. However, since its major biological role in intact mitochondria is to produce ATP from ADP and Pi, it is better called ATP synthetase.

Table 23-1. Components of the mitochondrial ATP synthetase

Subunits	Mass (in kcal)	Role	Location
F ₁	360	Contains catalytic site for ATP synthesis	Spherical headpiece on matrix side
α	53		
β	50		
γ	33		
δ	17		
ϵ	7		
F ₀	29 22 12 8	Contains proton channel	Transmembrane
F ₁ inhibitor	10	Regulates proton flow and ATP synthesis	Stalk between F ₀ and F ₁
Oligomycin-sensitivity conferring protein (OSCP)	18		
Fc ₂ (F ₆)	8		

(Adapted from De Pierre and Ernster, 1977)

528 FUNDAMENTALS OF BIOCHEMISTRY

It is interesting to note that similar phosphorylating units are found inside the plasma membrane of bacteria but outside the membrane of chloroplasts. A noteworthy point is that the proton gradient is from outside to inside in mitochondria and bacteria but in the reverse direction in chloroplasts.

ELECTRON-TRANSFERRING REACTIONS

Chemical reactions in which electrons are transferred from one molecule to another are called **oxidation-reduction reactions** or **oxidoreductions** or **redox reactions**. In fact, the electron-transferring reactions are oxidation-reduction reactions. The electron-donating molecule in such a reaction is called the *reducing agent* (= *reductant*) and the electron-accepting molecule as the *oxidizing agent* (= *oxidant*). The reducing or oxidizing agents function as *conjugate reductant-oxidant pairs* (= redox pairs). The general equation can be written as :

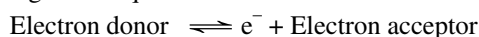

A specific example is the reaction,

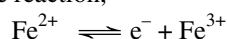

where ferrous ion (Fe^{2+}) is the electron donor and the ferric ion (Fe^{3+}) the electron acceptor. Fe^{2+} and Fe^{3+} together constitute a conjugate redox pair.

Electrons are transferred from one molecule to another in one of the following ways (Lehninger AL, 1984) :

1. *Directly in the form of electrons* — For example, the $\text{Fe}^{2+} - \text{Fe}^{3+}$ redox pair can transfer an electron to the $\text{Cu}^+ - \text{Cu}^{2+}$ pair.



2. *In the form of hydrogen atoms* — A hydrogen atom consists of a proton (H^+) and a single electron (e^-). The general equation can be written as :

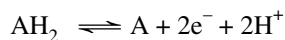

in which AH_2 is the hydrogen (or electron) donor, A is the hydrogen acceptor and AH_2 and A together constitute a conjugate redox pair. This redox pair can reduce the electron acceptor B by the transfer of H atoms as follows :



3. *In the form of a hydride ion*— The hydride ion ($:\text{H}^-$) bears two electrons, as in the case of NAD-linked dehydrogenases.“

4. *During direct combination of an organic reductant with oxygen*— In such reactions a product is formed in which the oxygen is covalently incorporated, for example in the oxidation of a hydrocarbon to an alcohol,

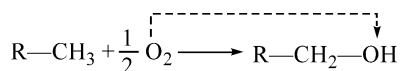

where the hydrocarbon is the electron donor and the oxygen atom, the electron acceptor.

All four types of electron transfer occur in cells. The neutral term reducing equivalent is commonly used to designate a single electron equivalent participating in redox reactions, whether it is in the form of an electron *per se*, a hydrogen atom, a hydride ion, or as a reaction with oxygen to yield an oxygenated product. Because biological fuel molecules usually undergo dehydrogenation to lose two reducing equivalents at a time and also because each oxygen atom can accept two reducing equivalents, it is customary to treat the unit of biological oxidations as a pair of reducing equivalents passing from substrate to oxygen.

STANDARD OXIDATION-REDUCTION POTENTIAL

The tendency of a given conjugate redox pair to lose an electron can be specified by a constant variously called as the *standard oxidation-reduction potential*, *standard redox potential* or simply

ELECTRON TRANSPORT AND OXIDATIVE PHOSPHORYLATION 529

standard potential and is denoted by the symbol, E'_o . This is defined as the electromotive force (e.m.f.) in volts given by a responsive electrode placed in solution containing both the electron donor and its conjugate electron acceptor at 0.1 M concentration, 25°C and 7.0 pH. Although standard potentials are given in units of *volts*, they are often expressed in *millivolts* for convenience. Each conjugate redox pair has a characteristic standard oxidation-reduction potential. By convention, the standard potentials of conjugate redox pairs are expressed as reduction potentials, which assign increasingly negative values to systems having an increasing tendency to lose electrons, and increasingly positive values to systems having an increasing tendency to accept electrons. In other words, the more negative the E'_o , the lower is the affinity of the system for electrons and conversely, the more positive the E'_o of a system, the greater is its *electron affinity*. Thus, electrons tend to flow from one redox couple to another in the direction of the more positive system.

Table 23–2 gives the standard redox potentials of some systems useful in biological electron transport. They are listed in order of increasing potential, *i.e.*, in the order of decreasing tendency to lose electrons. Thus, conjugate redox pairs having relatively negative standard potential tend to lose electrons to those lower in the table. For example, when the isocitrate/ α -ketoglutarate + CO_2 couple is present in 1.0 concentration, it has a standard potential E'_o of -0.38 V. This redox couple tends to pass electrons to the redox couple NADH/NAD⁺, which has a relatively more positive potential in the

Table 23–2. Standard redox potentials, E'_o of some redox pairs participating in oxidative metabolism*

<i>Redox couple</i>	E'_o (in volts)
Some substrate couples	
Acetyl-CoA + CO_2 + 2H^+ + 2e^- \longrightarrow Pyruvate + CoA	– 0.48
α -ketoglutarate + CO_2 + 2H^+ + 2e^- \longrightarrow Isocitrate	– 0.38
3-phosphoglyceroyl phosphate + 2H^+ + 2e^- \longrightarrow Glyceraldehyde 3-phosphate + Pi	– 0.29
Pyruvate + 2H^+ + 2e^- \longrightarrow Lactate	– 0.19
Oxaloacetate + 2H^+ + 2e^- \longrightarrow Malate	– 0.18
Fumarate + 2H^+ + 2e^- \longrightarrow Succinate	+ 0.03
Components of the electron-transport chain	
2H^+ + 2e^- \longrightarrow H_2	– 0.41
NAD ⁺ + H^+ + 2e^- \longrightarrow NADH	– 0.32
NADP ⁺ + H^+ + 2e^- \longrightarrow NADPH	– 0.32
NADH dehydrogenase (FMN form) + 2H^+ + 2e^- \longrightarrow NADH dehydrogenase (FMNH ₂ form)	– 0.30
Ubiquinone + 2H^+ + 2e^- \longrightarrow Ubiquinol	+ 0.04
Cytochrome <i>b</i> (oxi.) + e^- \longrightarrow Cytochrome <i>b</i> (red.)	+ 0.07
Cytochrome <i>c</i> ₁ (oxi.) + e^- \longrightarrow Cytochrome <i>c</i> ₁ (red.)	+ 0.23
Cytochrome <i>c</i> (oxi.) + e^- \longrightarrow Cytochrome <i>c</i> (red.)	+ 0.25
Cytochrome <i>a</i> (oxi.) + e^- \longrightarrow Cytochrome <i>a</i> (red.)	+ 0.29
Cytochrome <i>a</i> ₃ (oxi.) + e^- \longrightarrow Cytochrome <i>a</i> ₃ (red.)	+ 0.55
$1/2\text{O}_2$ + 2H^+ + 2e^- \longrightarrow H_2O	+ 0.82

* Assuming 1 M concentrations of all components, pH = 7.0 and temperature = 25°C.

E'_o refers to the partial reaction written as :



Note the two landmark potentials (in boldface) which are for the $\text{H}_2/2\text{H}^+$ and the $\text{H}_2\text{O}/\frac{1}{2}\text{O}_2$ couple.

530 FUNDAMENTALS OF BIOCHEMISTRY

presence of isocitrate dehydrogenase. Conversely, the strongly positive standard potential of $\text{H}_2\text{O}/\text{O}_2$ couple, 0.82 V, indicates that water molecule has very little tendency to lose electrons to form molecular oxygen. In other words, molecular oxygen has a very high affinity for electrons or hydrogen atoms.

In oxidation systems, the electrons will tend to flow from a relatively electronegative conjugate redox pair, such as NADH/NAD^+ ($E'_0 = -0.32$ V), to the more electropositive pair, such as reduced cytochrome *c*/oxidized cytochrome *c* ($E'_0 = +0.25$ V). Likewise, they will also tend to flow from the cytochrome *c* redox pair to the water/oxygen pair ($E'_0 = +0.82$ V). The greater the difference in the standard potentials between two redox pairs, the greater is the free-energy loss as electrons pass from the electronegative to the electropositive pair. Therefore, when electrons flow down the complete electron-transport chain from NADH to oxygen *via* several electron-carrying molecules, they lose a large amount of free energy.

The amount of free-energy which becomes available as a pair of electrons passes from NADH to O_2 can also be calculated. The standard-free-energy change of an electron-transferring reaction is given by the equation,

$$\Delta G^{\circ'} = -nF \Delta E'_0$$

where, $\Delta G^{\circ'}$ is the standard-free-energy change in calories, n is the number of electrons transferred, F is the caloric equivalent of the constant, the faraday (23.062 kcal/V. mol) and $\Delta E'_0$ is the difference between the standard potential of the electron-donor system and that of the electron-acceptor system. The standard-free-energy change as a pair of electron equivalents passes from the NADH/NAD^+ pair ($E'_0 = -0.32$ V) to the $\text{H}_2\text{O}/\text{O}_2$ pair ($E'_0 = +0.82$ V) is

$$\begin{aligned} \Delta G^{\circ'} &= -2 (23.062) [0.82 - (-0.32)] \\ &= -2 \times 23.062 \times 1.14 \\ &= -52.58 \text{ kcal/mol} \end{aligned}$$

This amount of free energy (*i.e.*, -52.58 kcal) is more than sufficient to bring about the synthesis of 3 moles of ATP, which requires an input of 3 (7.3) = 21.9 kcal under standard conditions.

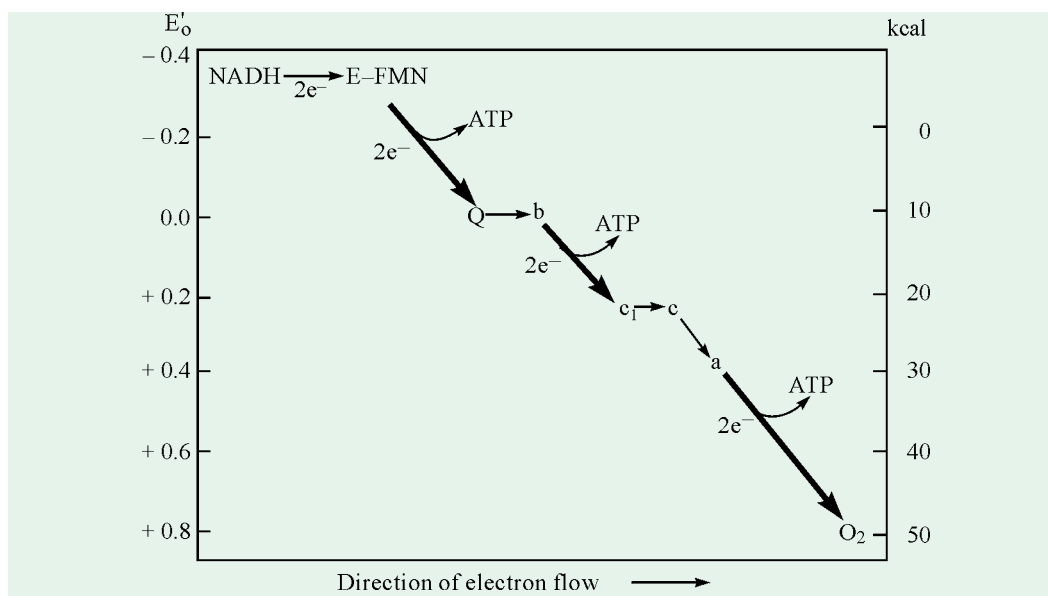

Fig. 23-8. The energy relationships in the respiratory chain of mitochondria

[E-FMN = NADH dehydrogenase; *Q* = ubiquinone; *b*, *c*₁, *c* and *a* = cytochromes]

Note that there are 3 steps (shown with boldface arrows) in the electron-transport chain in which relatively large decreases in free-energy occur as electrons pass. These are, in fact, the steps that provide free energy for ATP synthesis.

ELECTRON TRANSPORT AND OXIDATIVE PHOSPHORYLATION 531

Likewise using the expression $\Delta G^{\circ'} = -nF\Delta E_0'$, the free-energy changes for individual segments of the electron-transport chains can be calculated from the differences in the standard potentials of the electron-donating redox pair and the electron-accepting pair. Fig. 23–8 is an energy diagram showing (a) the standard potentials of the electron carriers of the respiratory chain, (b) the direction of electron flow, which is always “downhill” toward oxygen, and (c) the relative free-energy change at each step.

ELECTRON CARRIERS

Electrons are transferred from substrates to oxygen through a series of electron carriers—flavins, iron-sulfur complexes, quinones and hemes (Fig. 23–9). The 3 noteworthy features of the electron carriers are enumerated below :

1. Although the figure shows the respiratory chain to have 17 electron carriers, there are some 15 or more chemical groups in the electron-transport chain that can accept or transfer reducing equivalents (hydrogen and electrons) in sequence.
2. All electron carriers, except for the quinones, are prosthetic groups of proteins. They include nicotinamide adenine dinucleotide (NAD), active with various dehydrogenases ; flavin mononucleotide (FMN), in NADH dehydrogenases; ubiquinone or coenzyme Q, which functions in association with one or more proteins ; two different kinds of iron-containing proteins, the iron-sulfur centres (Fe-S) and the cytochromes ; and copper of cytochrome aa_3 .
3. Almost all the electron-carrying proteins are water insoluble and are embedded in the inner mitochondrial membrane.

1. Pyridine Nucleotides

Most of the electron pairs entering the respiratory chains arise from the action of dehydrogenases that utilize the coenzymes NAD^+ or NADP^+ (Fig. 23–6) as electron acceptors. As a group, they are designated as NAD(P)-linked dehydrogenases. They catalyze the reversible reactions of the following general types :

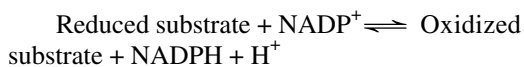
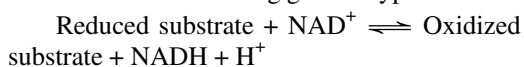

Most of the pyridine-linked dehydrogenases are specific for NAD^+ (refer Table 23–3). However, certain others require NADP^+ as electron acceptor, such as glucose 6-phosphate dehydrogenase. Very few, such as glutamate dehydrogenase can react with either NAD^+ or NADP^+ . Some pyridine-linked dehydrogenases are located in the mitochondria, some in the cytosol and still others in both.

The pyridine-linked dehydrogenases remove 2 hydrogen atoms from their substrates. One of these is transferred as a hydride ion (H^-) to the NAD^+ or NADP^+ ; the other appears as H^+ in the medium. Each hydride ion carries two reducing

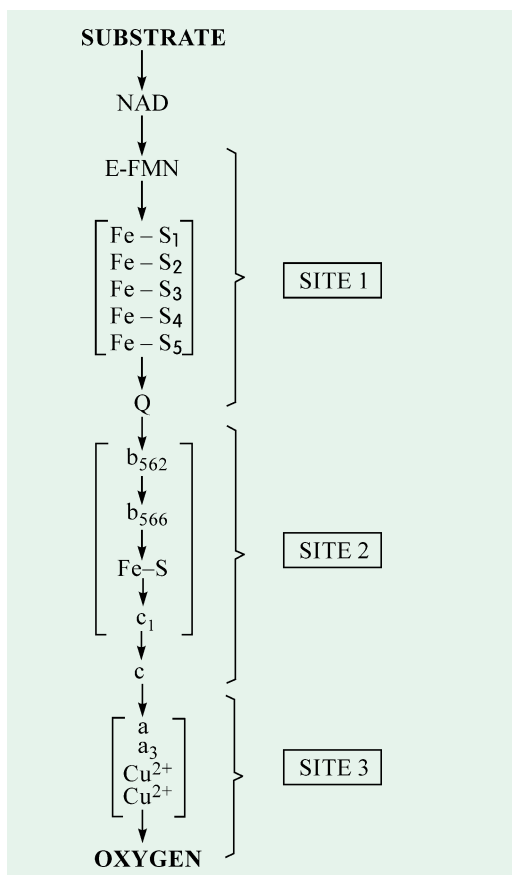

Fig. 23–9. The complete set of electron carriers of the respiratory chain

The precise sequence and function of all the oxidation-reduction centres is not exactly known.

532 FUNDAMENTALS OF BIOCHEMISTRY

equivalents : one is transferred as a hydrogen atom to C₄ of the nicotinamide ring, the other as an electron to the ring nitrogen (Fig. 23–10).

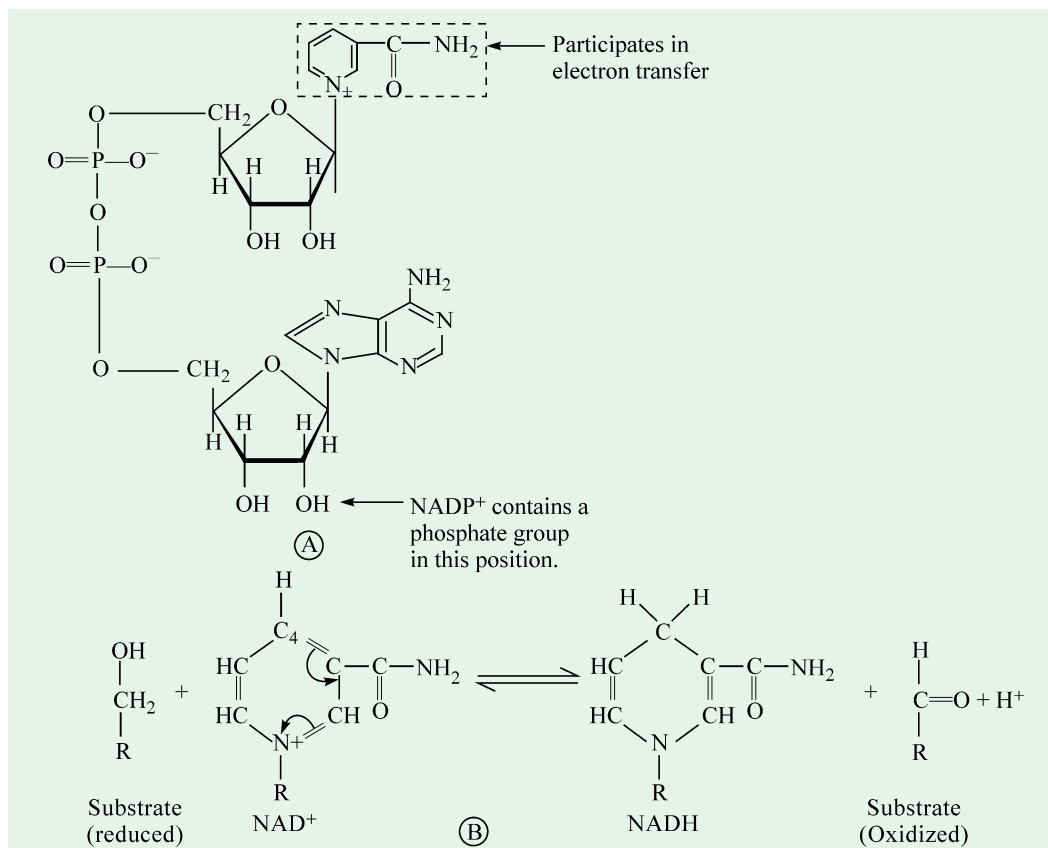

Fig. 23–10. Nicotinamide adenine dinucleotide (NDA⁺) and nicotinamide adenine dinucleotide phosphate (NADP⁺)

(A) Oxidized forms of NAD⁺ and NADP⁺; (B) Reduction of the nicotinamide ring of NAD⁺ by substrate.

Table 23–3. Some important reactions catalyzed by NAD (or NADP)-linked dehydrogenases

Reaction	Location
NAD-linked :	
Isocitrate + NAD ⁺ ⇌ α-ketoglutarate + CO ₂ + NADH + H ⁺	Mitochondria
α-ketoglutarate + CoA + NAD ⁺ ⇌ Succinyl-CoA + CO ₂ + NADH + H ⁺	Mitochondria
L-malate + NAD ⁺ ⇌ Oxaloacetate + NADH + H ⁺	Mitochondria and cytosol
Pyruvate + CoA + NAD ⁺ ⇌ Acetyl-CoA + CO ₂ + NADH + H ⁺	Mitochondria
Glyceraldehyde 3-phosphate + Pi + NAD ⇌ 1, 3-diphosphoglycerate + NADH + H ⁺	Cytosol
Lactate + NAD ⁺ ⇌ Pyruvate + NADH + H ⁺	Cytosol
NADP-linked :	
Isocitrate + NADP ⁺ ⇌ α-ketoglutarate + CO ₂ + NADPH + H ⁺	Mitochondria and cytosol
Glucose 6-phosphate + NADP ⁺ ⇌ 6-phosphogluconate + NADPH + H ⁺	Cytosol
NAD or NADP:	
L-glutamate + H ₂ O + NAD ⁺ (NADP ⁺) ⇌ α-ketoglutarate + NH ₃ + NADH(NADPH) + H ⁺	Mitochondria

Since most dehydrogenases in cells transfer H atoms from their substrates to NAD^+ , this coenzyme *collects* pairs of reducing equivalents from many different substrates, in one molecular form, NADH (Fig. 23–11). Ultimately, NAD^+ can also collect reducing equivalent from substrates acted upon by NADP-linked dehydrogenases in the presence of *pyridine nucleotide transhydrogenase*.



2. NADH Dehydrogenase (=NADH-Q Reductase)

The transfer of electrons from NADH in the mitochondrial matrix to ubiquinone in the membrane core, and the accompanying pumping of protons, is catalyzed by a highly organized enzyme complex, *NADH dehydrogenase*. This complex includes a flavoprotein and iron-sulfide proteins as electron carriers. In the next step of electron transfer, a pair of reducing equivalents is transferred from NADH to NADH dehydrogenase. In this reaction, the tightly bound prosthetic group of NADH dehydrogenase becomes reduced. This prosthetic group is flavin mononucleotide (FMN), which contains a molecule of vitamin B_2 or riboflavin.

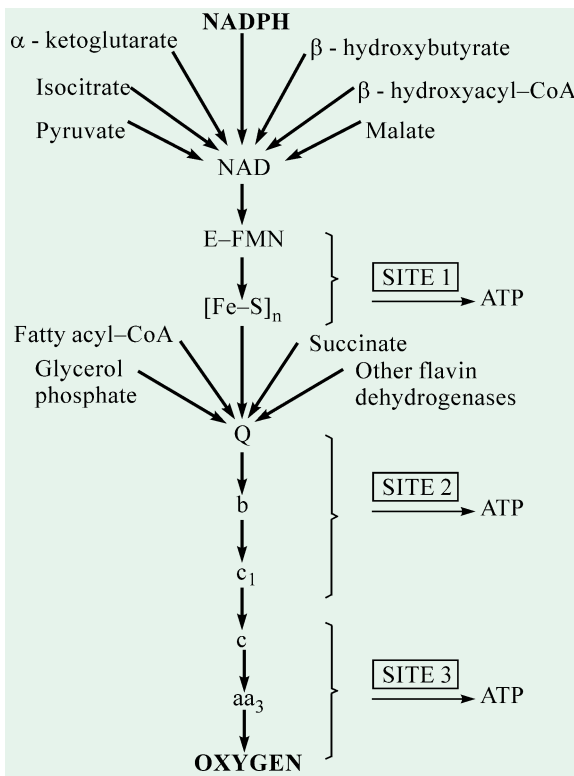
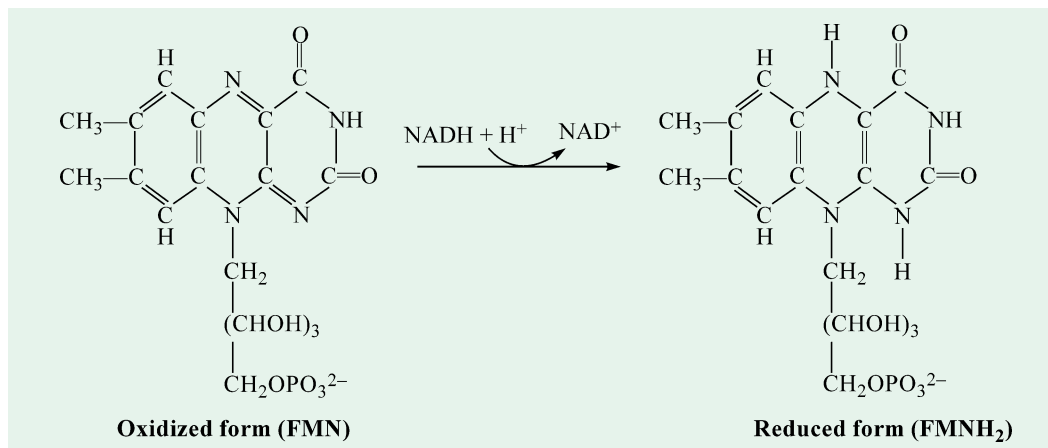
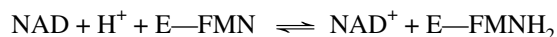

Fig. 23–11. The collecting function of nicotinamide adenine dinucleotide (NAD) and ubiquinone (Q)

Pairs of reducing equivalents collected from flavin dehydrogenases do not pass through the first phosphorylation site and thus give rise to only two ATP molecules.



NADH dehydrogenase is a complex and highly organized flavoprotein enzyme and consists of at least 16 polypeptide chains. It is located in the inner mitochondrial membrane. Transfer of two reducing equivalents from NADH to NADH dehydrogenase (here designated as E-FMN) reduces the FMN to FMNH₂ as follows :



534 FUNDAMENTALS OF BIOCHEMISTRY

The electrons are then transferred from FMN₂ to a series of iron-sulfur complexes (abbreviated as Fe—S), the second type of prosthetic group in NADH dehydrogenase. The iron is not a part of a heme group and so iron-sulfur proteins were referred to in the older literature as nonheme iron proteins (NHI proteins). Recall that Fe—S centres are also associated with succinate dehydrogenase (see page 400). Three principal types of Fe—S complexes are known (Fig. 23-12). In all of these, the iron atoms are chelated with sulfur atoms, which are in part supplied by cysteine residues in the associated protein and in part as inorganic sulfide ions. The number of iron and acid-labile-sulfur atoms in these complexes is always equal.

1. FeCys₄ (or FeS) type—In this simplest kind, a single iron atom is tetrahedrally coordinated to the sulfhydryl groups of 4 cysteine residues of the protein ; there being no inorganic sulfides.

2. Fe₂S₂Cys₄ (or Fe₂S₂) type— This contains 2 iron atoms and 2 inorganic sulfides, in addition to 4 cysteine residues. The bonding occurs in such a manner that a total of 4 sulfur atoms is linked to each iron atom.

3. Fe₄S₄Cys₄ (or Fe₄S₄) type — This contains 4 iron atoms, 4 inorganic sulfides and 4 cysteine residues. Here also, 4 sulfur atoms are linked to each iron atom.

The iron atoms in these complexes can be in the reduced (Fe²⁺) or oxidized (Fe³⁺) state. An important feature of the iron-sulfur proteins is that their relative affinity for electrons can be varied over a wide range by changing the nature of the polypeptide chain. Some are relatively strong oxidizing agents ; others are powerful reducing agents — even stronger than NADH. NADH dehydrogenase contains both the Fe₂S₂Cys₄ and Fe₄S₄Cys₄ types of complexes.

3. Ubiquinone (=Coenzyme Q)

The next carrier of reducing equivalents in the respiratory chain is ubiquinone (UQ), a name reflecting its ubiquitous nature, as it occurs virtually in all cells. It was formerly called as **coenzyme Q** (Q for quinone) and abbreviated as CoQ or simply Q.

Ubiquinone is actually a group of compounds, all containing the same quinone structure but substituted with a long side chain composed of varying numbers (from 6 to 10) of isoprene units (=prenyl groups), linked head to tail. For example, certain microorganisms contain 6 isoprene units, and in which case the compound is referred to as Q₆ or CoQ₆ or also as UQ₃₀, where the subscript number 30 represents the total number of carbon atoms in the side chain. However, the most common form in mammals contains 10 isoprene units, and when its designation is Q₁₀ or CoQ₁₀ or UQ₅₀. The

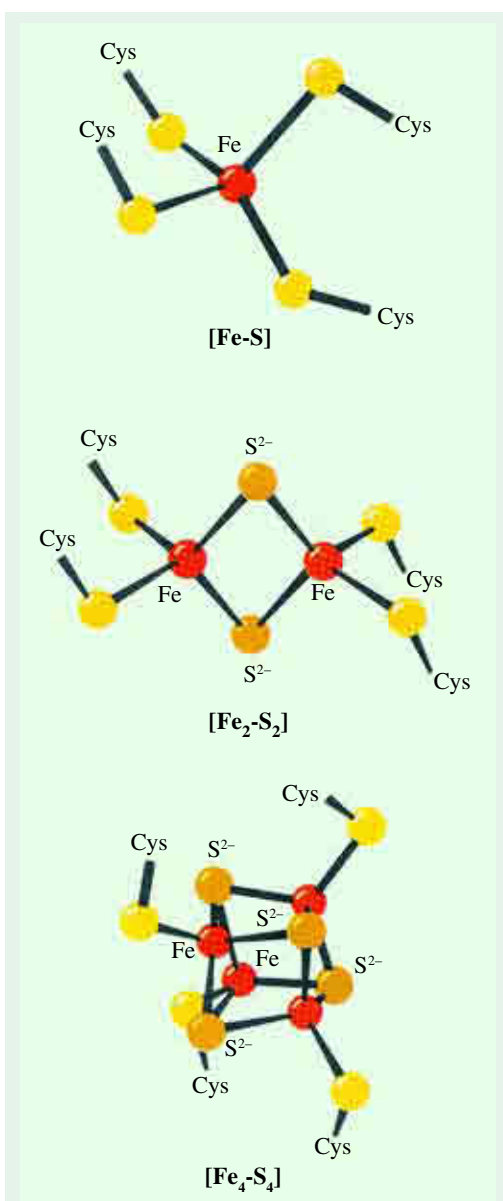

Fig. 23-12. Three principal forms of iron-sulfide proteins.

ELECTRON TRANSPORT AND OXIDATIVE PHOSPHORYLATION 535

isoprenoid tail makes ubiquinone highly nonpolar which enables it to diffuse readily in the hydrocarbon phase of the inner mitochondrial membrane. *Ubiquinone is the only electron carrier in the respiratory chain that is not tightly bound or covalently attached to a protein.* In fact, it serves as a highly mobile carrier of electrons between the flavoproteins and the cytochromes of the electron-transport chain.

The closely related plastoquinones, which function as an analogous carrier of electrons in photosynthesis, differ from ubiquinones in the alkyl substituents of the benzene ring : two $-\text{CH}_3$ groups instead of two $-\text{OCH}_3$ and H instead of $-\text{CH}_3$. Plastoquinones B and C carry one hydroxyl group in the side chain.

Like other quinones, the ubiquinones may be reduced one electron at a time through the semiquinone free radical or may be reduced directly to the quinol by two electrons (Fig. 23–13).

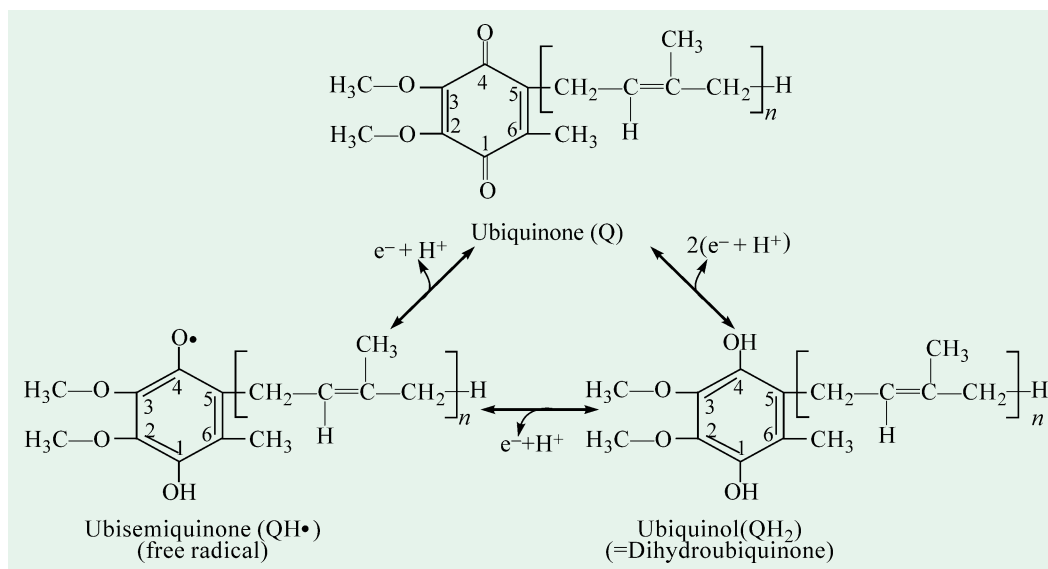
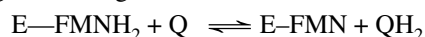

Fig. 23–13. Reduction of ubiquinone

When reduced NADH dehydrogenase (E-FMNH_2) donates its reducing equivalents via the Fe—S centres to ubiquinone, the latter becomes reduced to ubiquinol (QH_2) and the oxidized form of NADH dehydrogenase is regenerated.



The function of ubiquinone is to collect reducing equivalents not only from NADH dehydrogenase but also from other flavin-linked dehydrogenases of mitochondria (see Fig. 23–10).

4. Cytochromes

The enzyme complex catalyzing the oxidation of ubiquinol (QH_2) contains an iron-sulfide protein of Fe_2S_2 Cys₄ type and 2 types of cytochromes. The cytochromes are electron-transferring, red or brown proteins that contain a heme prosthetic group and act in sequence to carry electrons from ubiquinol to molecular oxygen. They are, thus, *heme proteins* (or *hemoproteins*) like hemoglobin but, unlike hemoglobin, their iron atoms are oxidized and reduced to transfer electrons between other compounds. The cytochromes were discovered in 1886 by MacMunn, a Scottish physician who also named them as *histohematin* and *myohematin*, since they appeared to him to be related to heme and hemin. But their role in biologic oxidation was first shown by David Keilin in 1925. He also renamed these pigments as 'cytochromes'. The iron atom in cytochromes alternates between a reduced ferrous (Fe^{2+}) state and an oxidized ferric (Fe^{3+}) state during electron transport. *A heme group, like an Fe—S centre, is one-electron carrier, in contrast with NADH, flavins and ubiquinone, which are two-electron carriers.*

536 FUNDAMENTALS OF BIOCHEMISTRY

There are 5 types of cytochromes between ubiquinol (QH_2) and oxygen in the electron-transport chain. Each type is given a letter designation— *a*, *b*, *c* and so on, based on the differences in their light-absorption spectra — the form absorbing at the longest wavelength called cytochrome *a*, that absorbing the next longest wavelength called cytochrome *b*, and so on. *Unfortunately, the order of wavelength does not correspond to the physiological sequence in which they function :*

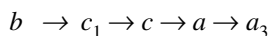

The subscript numbers were added as new individual cytochromes within the same type were found, *i.e.*, those with similar prosthetic groups but with different apoproteins.

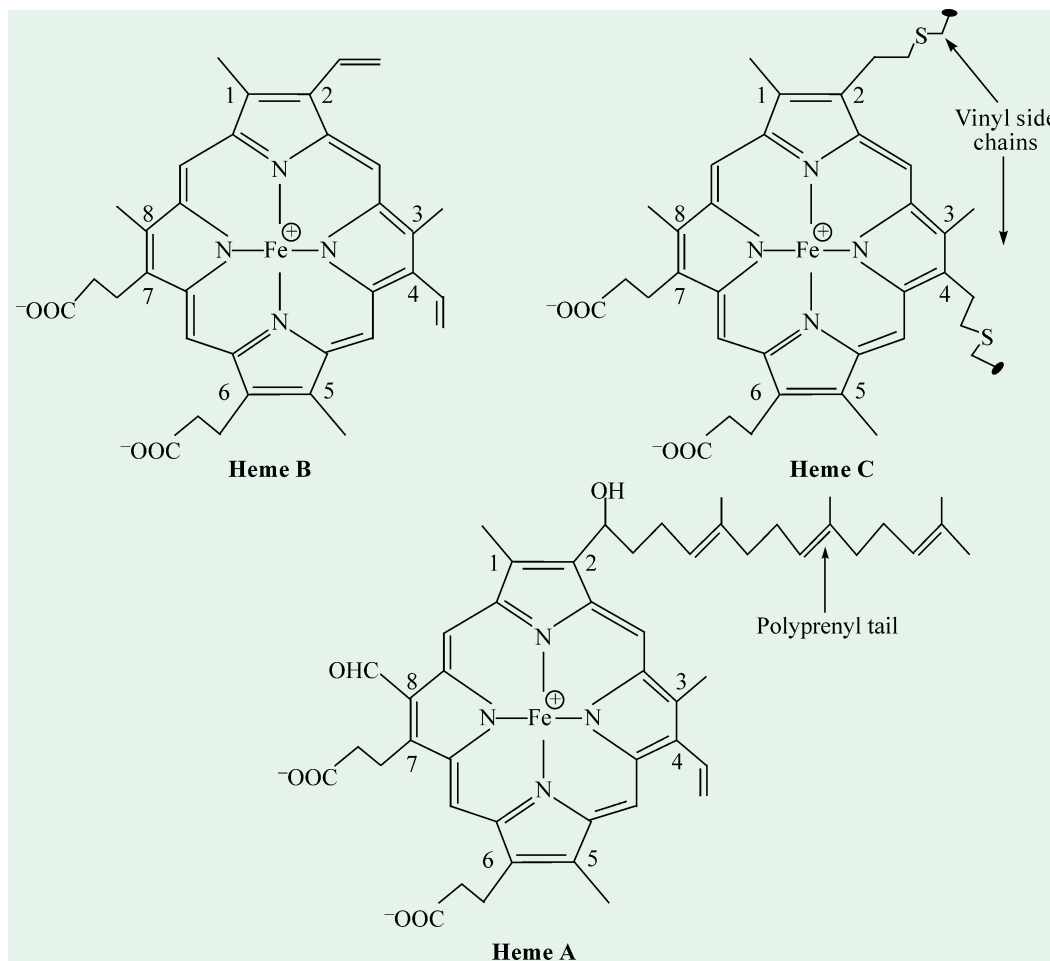

Fig. 23-14. The three principal types of cytochrome hemes

Heme B is the prosthetic group of cytochrome *b*; heme C, that of cytochromes *c* and c_1 ; and heme A, that of cytochromes *a* and a_3 .

The various cytochromes differ from each other in the nature of the prosthetic group and its mode of attachment to the apoprotein part (Fig. 23-14). The prosthetic group of cytochromes *b*, *c* and c_1 is iron-protoporphyrin IX, commonly called *heme* or *hemin*. Heme is also the prosthetic group of myoglobin, hemoglobin, catalase and peroxidase. In cytochrome *b*, the heme is not covalently bonded to the protein, whereas in cytochromes *c* and c_1 , the heme is covalently attached to the protein by thioether linkages. These linkages are formed by the addition of the sulfhydryl groups of two cysteine residues to the vinyl groups of the heme. The type of heme present in cytochrome *b* is called heme *B* and the one present in cytochromes *c* and c_1 as heme *C*.

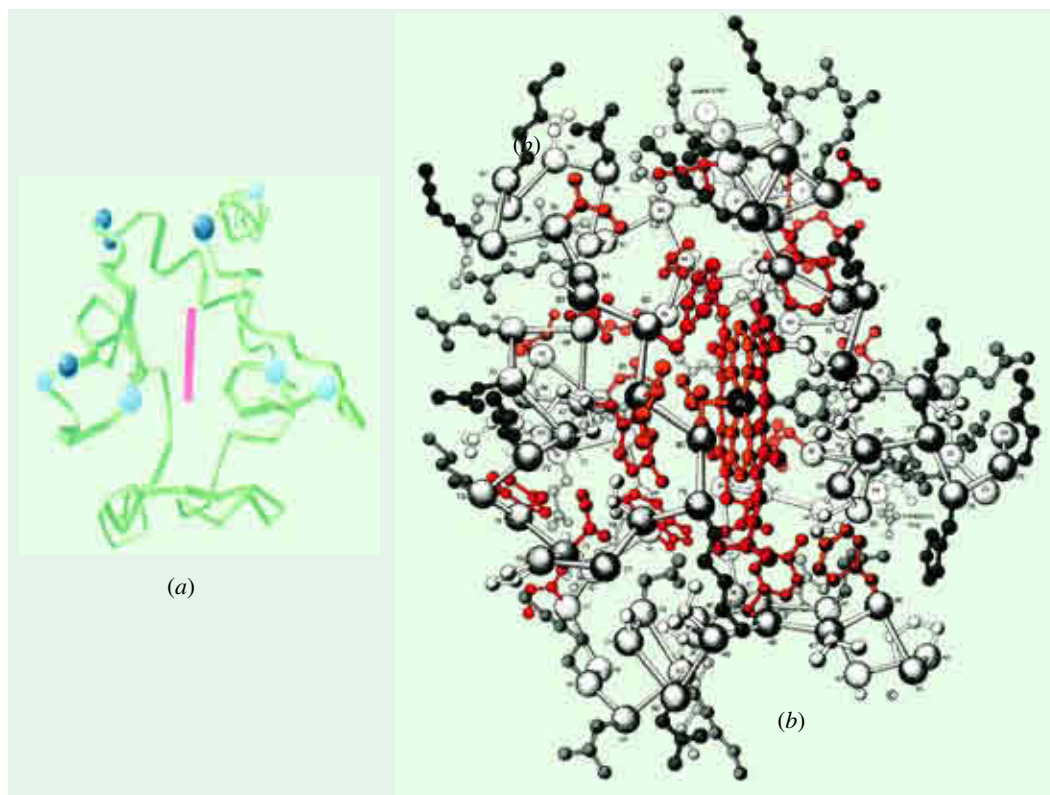

Fig. 23–15. Three dimensional structure of the protein, cytochrome *c*

- (a). **Ribbon model.** The diagram shows the Lys residues involved in intermolecular complex formation with cytochrome *c* oxidase or reductase as inferred from chemical modification studies. Dark and light blue balls, respectively, mark the positions of Lys residues whose ϵ -amino groups are strongly and less strongly protected by cytochrome *c* oxidase and reductase against acetylation by acetic anhydride. Note that these Lys residues form a ring around the heme (*solid bar*) on one face of the protein.
- (b). **Ball-and-stick model.** Amino acids with nonpolar, hydrophobic side chains (color) are found in the interior of the molecule, where they interact with one another. Polar, hydrophilic amino acid side chains (grey) are on the exterior of the molecule, where they interact with the polar aqueous solvent.

(Courtesy : (a) MS Mathews, and (b) Irving Geis)

The cytochromes *a* and *a*₃ have a different iron-porphyrin prosthetic group, called heme *A*. It differs from the heme in cytochromes *c* and *c*₁ in that a formyl group replaces one of the methyl groups, and a hydrophobic polyprenyl chain replaces one of the vinyl groups. Cytochromes *a* and *a*₃ are the terminal members of the respiratory chain. They exist as complex, which is sometimes called cytochrome oxidase. The cytochrome *aa*₃ complex, thus, differs from other cytochromes as it contains 2 moles of highly-bound heme *A*. Moreover, cytochrome *aa*₃ also contains 2 essential copper atoms. It is the terminal member of the electron-transport chain and was first identified by Warburg as *Atmungsferment*.

Cytochrome *c* is the best known of cytochromes. It is the only electron-transport protein that can be separated from the inner mitochondrial membrane by gentle treatment. The solubility of this peripheral membrane protein in water has facilitated its purification and crystallization. It is a small protein (MW = 12,500) with an iron-porphyrin group (or *heme C*) covalently attached to its single polypeptide chain, containing about 100 amino acid residues (104 in a fish called tuna) in most species. Cytochrome *c* from tuna (Fig. 23–15) is roughly spherical, with a diameter of 34 Å. The heme group is surrounded by many closely-packed hydrophobic side chains. The iron atom is bonded to the sulfur atom of a methionine residue and to the nitrogen atom of a histidine residue. The

538 FUNDAMENTALS OF BIOCHEMISTRY

hydrophobic nature of the heme environment makes the redox potential of cytochrome *c* more positive, corresponding to a higher electron affinity.

The overall structure of the cytochrome *c* molecule resembles that of a shell, one residue thick surrounding the heme. The side chains make up the interior of the shell. The main polypeptide chain comes next, followed by charged side chains on the surface. *There is a very little α -helix and no β -pleated sheet.* In essence, the polypeptide chain is coiled around the heme. Residues 1 to 47 are on the histidine-18 side of the heme (called the right side), and residues 48 to 91 are on the methionine-80 side (called the left side). The remaining 92 to 104 residues come back across the heme to the right side. Cytochrome *c* is an ancient protein, since its amino acid sequence has many points of similarity in all eukaryotes—microbes, plants and animals.

ELECTRON-TRANSPORT COMPLEXES (= Complexes of the Respiratory Chain)

It is now a well-established fact that the electron carriers in the respiratory chain function in a specific sequence. The following evidences support the statement :

1. Firstly, as expected their standard redox potentials (refer Table 23–2 and Fig. 23–6) are more positive going toward oxygen, since electrons tend to flow from electronegative to electropositive systems, causing a decrease in free energy.
2. Secondly, each member of the chain is specific for a given electron donor and acceptor. For instance, NADH can transfer electrons to NADH dehydrogenase but cannot transfer them directly to cytochrome *b* or to cytochrome *c*.
3. Lastly, four structured complexes of functionally related electron carriers have been isolated from mitochondrial membrane (refer Fig. 23–16) :

Complex I consists of NADH dehydrogenase and its iron-sulfur centres, which are closely linked in their function. Complex I carries out the following characteristic reaction :

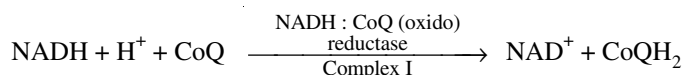

Complex II consists of succinate dehydrogenase and its iron-sulfur centres. This complex carries out the following characteristic reaction :

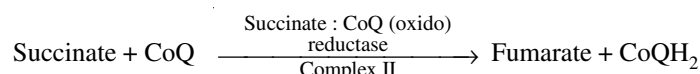

Complex III consists of cytochromes *b* and *c*, and a specific iron-sulfur centre. This brings about the following characteristic reaction :

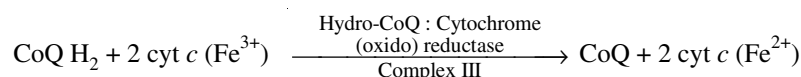

Complex IV consists only of cytochromes *a* and *a*₃, which is sometimes called as cytochrome oxidase. This brings about the following characteristic reaction :

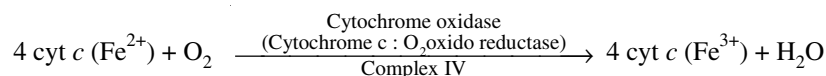

Ubiquinone is the connecting link between complexes I, II and III, and cytochrome *c* connects the complexes. III and IV. It is evident that in the presence of 2 mobile carriers (CoQ and cytochrome *c*), this accounts for all the oxidoreductions of the mitochondrial electron transport system. Thus, complex I plus complex III reconstitute the mitochondrial NADH : cytochrome *c* (oxido) reductase ; complex II plus III, the mitochondrial succinate : cytochrome *c* (oxido) reductase ; complex I plus III

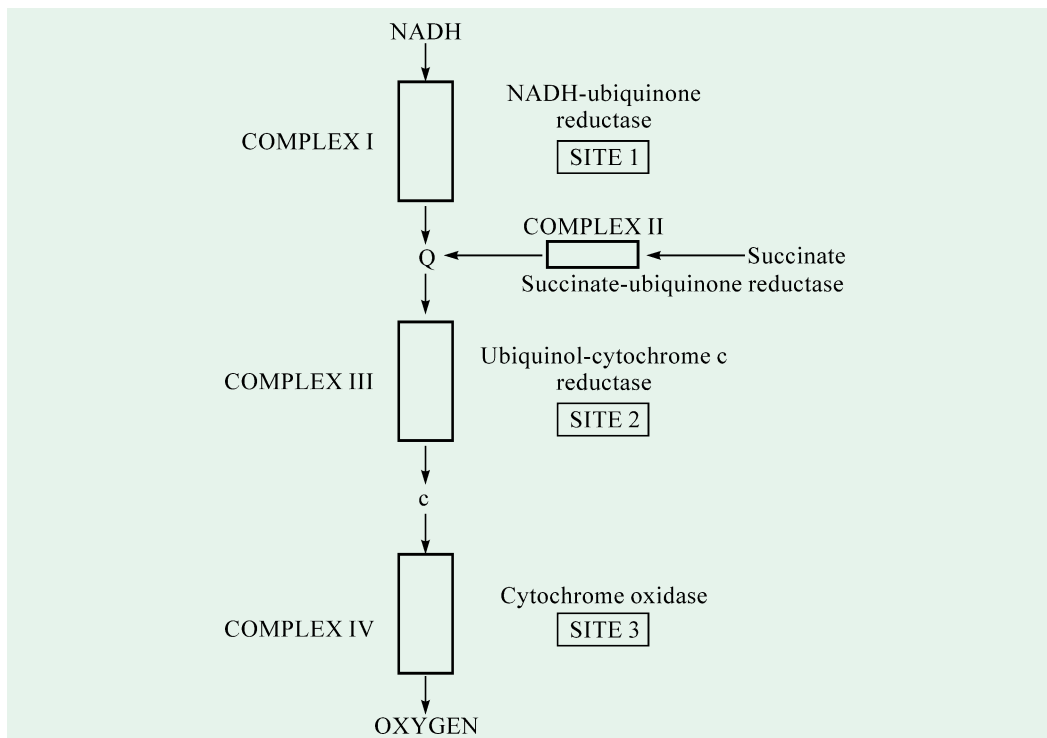

Fig. 23–16. The electron transport complex

The various complexes can be isolated as functional assemblies.

plus IV, the mitochondrial succinoxidase ; and finally complex I plus II plus III plus IV, the complete electron-transport sequence, *i.e.*, a combined NADH and succinoxidase equation :

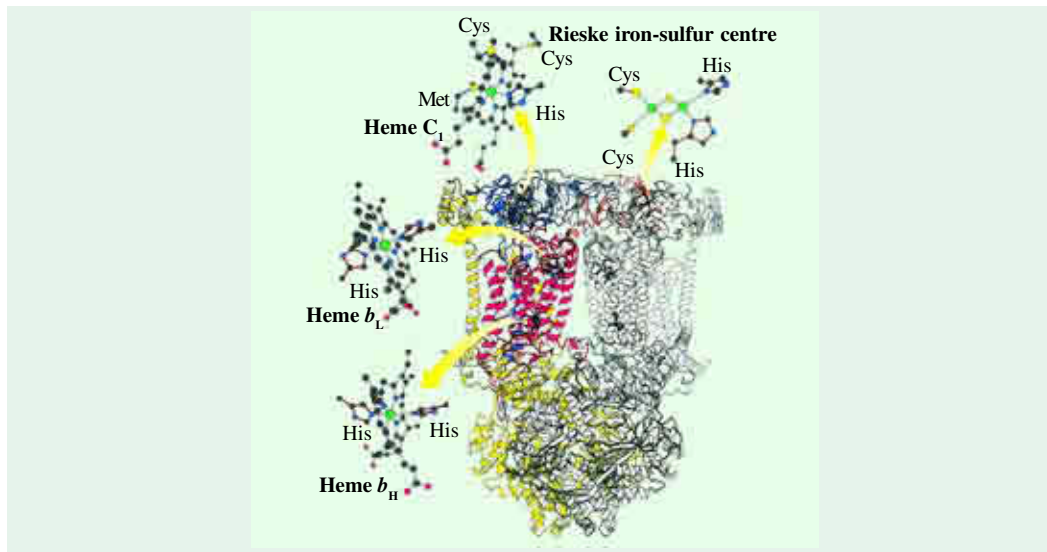
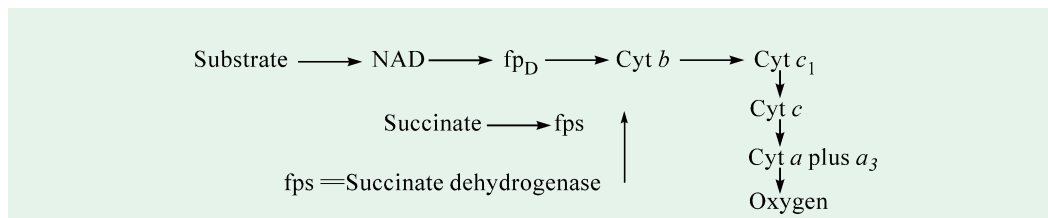
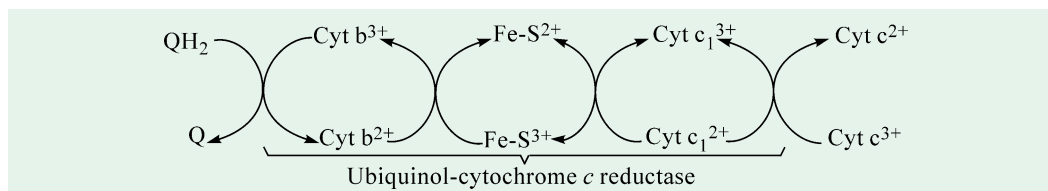

Fig 23–17. Structure of Q-cytochrome c oxidoreductase or cytochrome bc_1 complex or complex III

This enzyme is a dimer of identical monomers (*i.e.*, homodimer), each with 11 distinct polypeptide chains. The major prosthetic groups, three hemes and a 2Fe-2S cluster, mediate the electron-transfer reactions between quinones in the membrane and cytochrome c in the intermembrane space. The enzyme protrudes 75 Å into the matrix and 38 Å into the intermembrane space.



The ubiquinol-cytochrome *c* reductase complex (Fig 23-17) transfers electrons from ubiquinol (QH₂) to cytochrome *c*.



Reduced cytochrome *c* then transfers its electrons to the cytochrome *c* oxidase complex (Fig. 23-18). The role of cytochrome *c* is analogous to that of coenzyme Q, *i.e.*, it is a mobile carrier of electrons between different complexes in the respiratory chain.

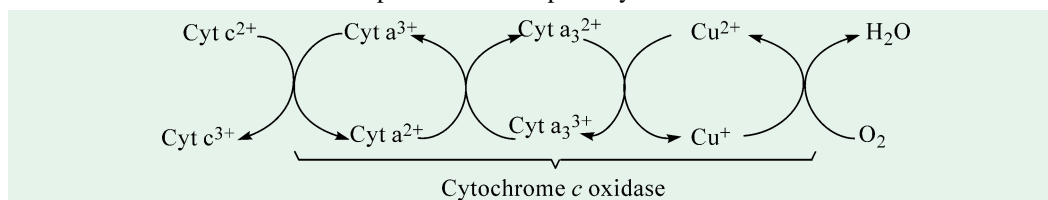

Electrons are transferred to the cytochrome *a* moiety of the complex, and then to cytochrome *a*₃, which contains copper. This copper atom alternates between an oxidized (2+) form and a reduced (1+) form as it transfers electrons from cytochrome *a*₃ to molecular oxygen. *The formation of water is a four-electron process*, whereas heme groups are one-electron carriers. It is not yet certain as to how four electrons converge to reduce a molecule of oxygen.

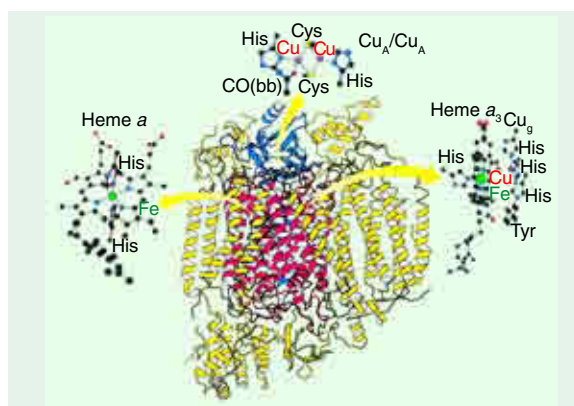
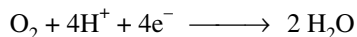

Fig. 23–18. Three dimensional structure of cytochrome *c* oxidase (complex IV)

This enzyme consists of a dimer in which each monomer is composed of 13 different polypeptide chains. The major prosthetic groups include Cu_A/Cu_A′, heme *a*, and heme *a*₃-Cu_B. Heme *a*₃-Cu_B is the site of the reduction of oxygen to water. CO(bb) is a carbonyl group of the peptide backbone.

After the cytochrome *a* component receives electrons from cytochrome *c* and thus becomes reduced to the ferrous (Fe²⁺) form, it passes its electrons to cytochrome *a*₃. Reduced cytochrome *a*₃ then passes electrons to molecular oxygen. Participating with the two heme groups in this process are 2 bound copper atoms, which undergo cuprous—cupric redox changes (Cu⁺ – Cu²⁺) in their function. This is an important and complex step in electron transport, since 4 electrons must be passed almost simultaneously to O₂ to yield two H₂O molecules, with uptake of 4 H⁺ from the aqueous medium. *Of all the members of the electron-transport chain, only cytochrome aa₃ can react directly with oxygen.* The complete electron transport chain along with the respiratory complexes is presented in Fig. 23-19.

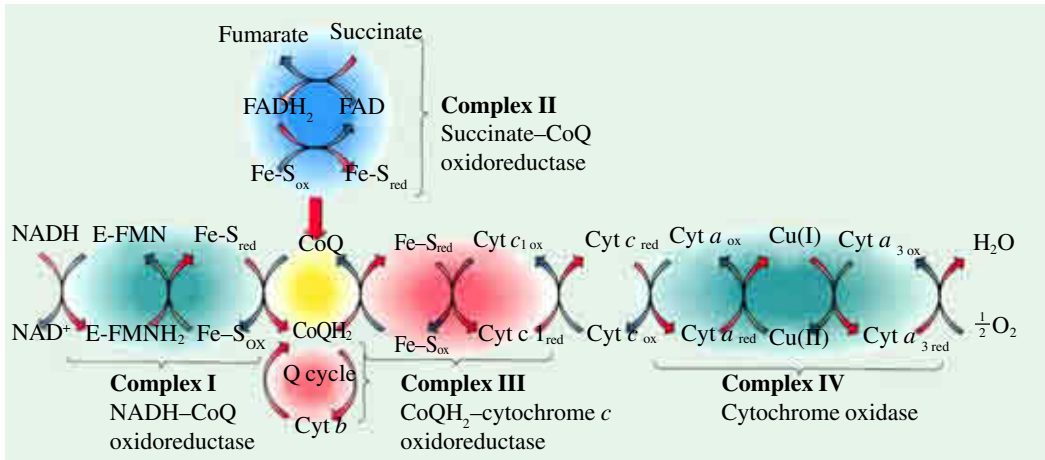
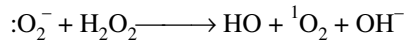

Fig. 23–19. The electron transport chain, showing the respiratory complexes

In the reduced cytochromes, the iron is in the Fe(II) oxidation state, while in the oxidized cytochromes, the oxygen is in the Fe(III) oxidation state

INCOMPLETE REDUCTION OF OXYGEN (=Toxic Metabolites of Oxygen)

It is quite important for the cell that the O₂ molecule be completely reduced to 2 molecules of H₂O by accepting 4 electrons. If, however, O₂ is only partially reduced by accepting 2 electrons, *hydrogen peroxide* (H₂O₂) is formed and if O₂ accepts only one electron, the product formed is the *superoxide radical* (:O₂⁻). Hydrogen peroxide and superoxide are extremely toxic to cells as they attack the unsaturated fatty acid components of membrane lipids, thus damaging severely the membrane structure. Superoxide is especially dangerous. It does not itself react readily with most cellular constituents, but it will spontaneously combine with peroxides to form *hydroxyl radicals* (OH) and *singlet oxygen* (¹O₂), which are disruptively reactive :



Almost without exception, the aerobic cells protect themselves against :O₂⁻ and H₂O₂ by the action of *superoxide dismutase* and *catalase*, which these cells do contain, respectively. Superoxide dismutase converts superoxide radical into H₂O₂ while catalase transforms H₂O₂ into water and molecular oxygen.

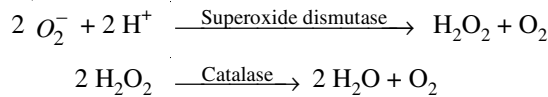

Although toxic, H₂O₂ may be useful to some organisms such as **bombardier beetle**. This insect generates a concentrated solution of H₂O₂ in one sac of its spray gland and a solution of hydroquinone

The reduction of oxygen, which is also called as dioxygen, can involve a variety of intermediates differing by one in electrons contents :

Superoxide (:O₂⁻) is the anion of the perhydroxyl radical, HO₂ and has one more electron than dioxygen.

Hydrogen peroxide (H₂O₂) is the undissociated form of the dianion, O₂²⁻, which has two more electrons than dioxygen.

Hydroxyl radical (·OH) is equivalent to half of a hydrogen peroxide molecule, but is much more reactive. Addition of one electron to each hydroxyl radical results in the formation of hydroxide ions, OH⁻, the completely reduced form of oxygen.

Singlet oxygen (¹O₂) is a form of dioxygen in which the electrons are in less stable orbitals with antiparallel spins.

542 FUNDAMENTALS OF BIOCHEMISTRY

in the other sac. When threatened, the insect frightens (and also poisons) its enemy by firing a hot (100°F) spray of toxic quinone, which is produced from the oxidation of hydroquinone by H_2O_2 .

MECHANISMS OF OXIDATIVE PHOSPHORYLATION

One of the most challenging and difficult problems in biochemical research is that how does the electron-transport chain cooperate with the ATP synthetase to bring about oxidative phosphorylation of ADP to ATP? One of the reasons is that the enzymes concerned in electron-transport and oxidative phosphorylation are very complex and they are embedded in the inner mitochondrial membrane, rendering the detailed study of their interactions difficult. However, 3 principal hypotheses have been advanced to account for the coupling of oxidation and phosphorylation. In other words, these hypotheses explain how the energy transfer between electron transport and ATP synthesis takes place.

1. Chemical Coupling Hypothesis

This is the oldest of the 3 hypotheses and proposes that electron transport is coupled to ATP synthesis by a sequence of consecutive reactions in which a high-energy covalent intermediate is formed by electron transport and subsequently is cleaved and donates its energy to make ATP. The hypothesis, thus, postulates direct chemical coupling at all stages of the process. It is similar to the concept in glycolysis which states that the ATP produced in oxidative phosphorylation results from an energy-rich intermediate encountered in electron transport. Specifically, when an oxidoreduction reaction occurs between A_{red} and B_{oxi} , the factor I is incorporated into the formation of an energy-rich structure $A_{oxi} \sim I$, where the \sim indicates a linkage having an energy-rich nature :

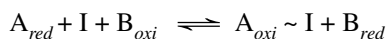

In subsequent reactions, an enzyme (E) replaces A_{oxi} in the compound $A_{oxi} \sim I$ to form an energy-rich $E \sim I$. Later, inorganic phosphate reacts with $E \sim I$ to form phosphoenzyme complex $E \sim P$ containing the energy-rich enzyme-phosphate bond :

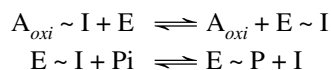

The enzyme-phosphate component finally reacts with ADP to form ATP.

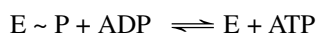

Although suggestions have been made regarding the nature of $E \sim I$ and $E \sim P$, such compounds have not been identified in mitochondria.

Oxidative phosphorylation occurs in certain reactions of glycolysis, in the citric acid cycle and in the respiratory chain. However, it is only in those phosphorylations occurring at the substrate level in glycolysis and the citric acid cycle that the chemical mechanisms involved are known. Three such equations are given below :

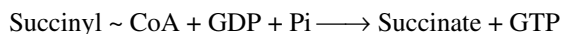
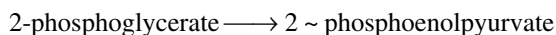
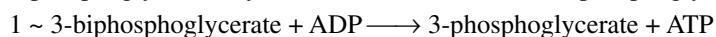
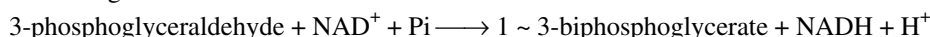

Some key differences are evident in these equations. In equation I, phosphate is incorporated into the product of the reaction after the oxidoreduction. In equation II, phosphate is incorporated into the substrate before the internal arrangement or redox change. In equation III, the redox reaction leads to the generation of a high-energy compound other than a phosphate, which in a subsequent reaction leads to the formation of high-energy phosphate.

ELECTRON TRANSPORT AND OXIDATIVE PHOSPHORYLATION 543

It is presumed that oxidative phosphorylations in the respiratory chain follow the pattern shown in equations I and 3, the latter being an extension of reaction I, to which an extra nonphosphorylated high-energy intermediate stage is added. Of the possible mechanisms shown in Fig. 23–20, mechanism © is favoured since in the presence of uncouplers (see page 452) such as 2, 4-dinitrophenol, oxidoreduction in the respiratory chain is independent of P_i . However, at present, the identities of the hypothetical high-energy carrier ($Car \sim I$), and the postulated intermediates I and X are not known. In recent years, several so-called “coupling factors” have been isolated that restore phosphorylation when added to disrupted mitochondria.

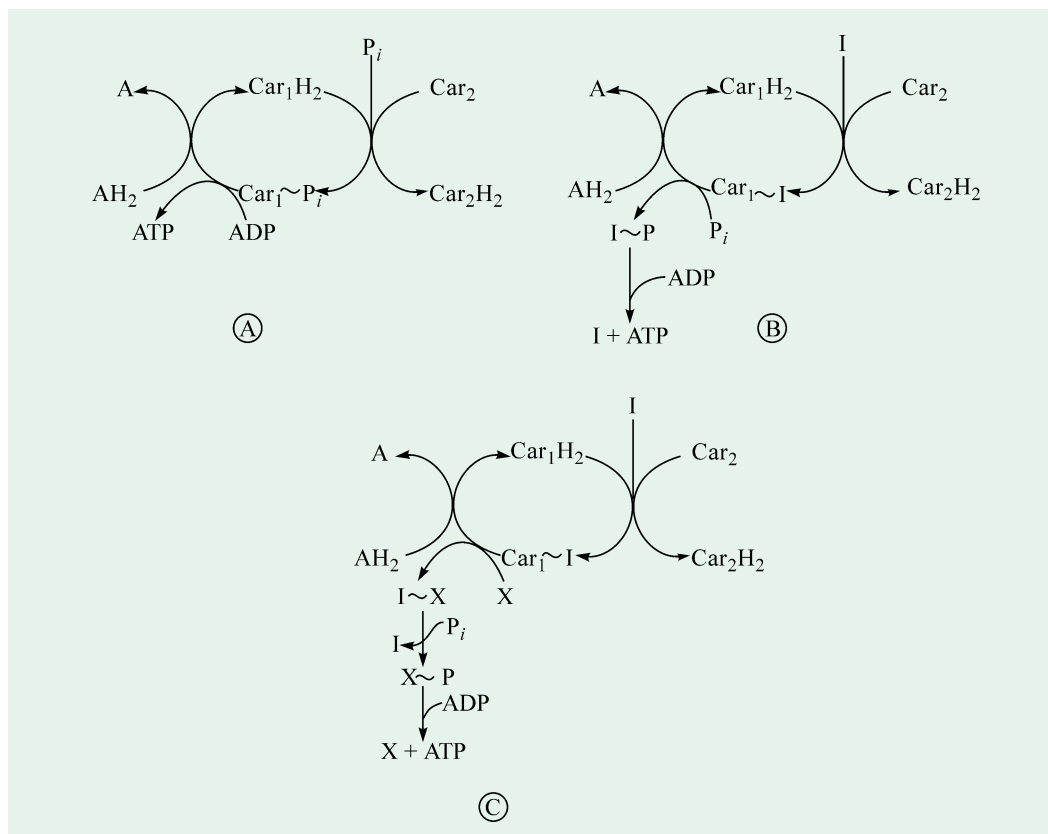

Fig. 23–20. Possible mechanisms for the chemical coupling of oxidation and phosphorylation in the respiratory chain

2. Conformational Coupling Hypothesis

In mitochondria, that are actively phosphorylating in the presence of an excess of ADP , the inner membrane pulls away from the outer membrane and assumes a “condensed state”. In the absence of ADP , the mitochondria have the normal structure or the “swollen state”, in which the cristae project into the large matrix. The propounders of this hypothesis believe that the energy released in the transport of electrons along the respiratory chain causes the conformational changes, just described, in the inner mitochondrial membrane and that this energy-rich condensed structure, in turn, is utilized for ATP synthesis as it changes to the energy-poor swollen conformation. However, the mode of the conformational changes that take place in the inner mitochondrial membrane is not yet clearly understood.

Peter Mitchell (LT, 1920 – 1992)

Mitchell, a British biochemist, is a rare example of the truly independent scientist since, in his native England, he was not affiliated with a university, industry or government. He received **1978 Nobel Prize in Chemistry** for his work on the coupling of oxidation and phosphorylation. He proposed that electron transport and ATP synthesis are coupled by a proton gradient, rather than by a covalent high-energy intermediate or an activated protein.

**3. Chemiosmotic Coupling Hypothesis**

Salient features. This is a simpler radically different and novel mechanism and was postulated by Peter Mitchell, a British biochemist, in 1961. He proposed that *electron transport and ATP synthesis are coupled by a proton gradient, rather than by a covalent high-energy intermediate or an activated protein*. According to this model (Fig. 23.21), the transfer of electrons through the respiratory chain results in the pumping of protons (H^+) from the matrix side (M-side) to the cytosol or cytoplasmic side (C-side) of inner mitochondrial membrane. The concentration of H^+ becomes higher on the

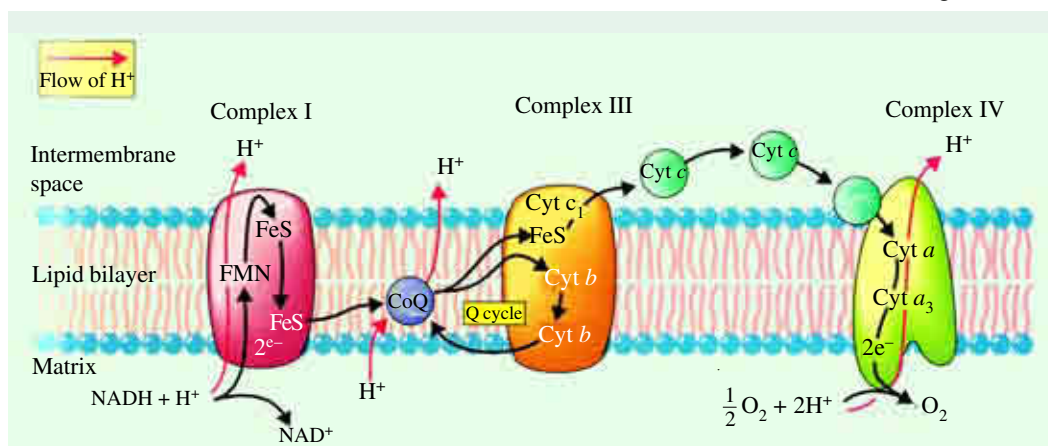

Fig. 23–21. The compositions and locations of respiratory complexes in the inner mitochondrial membrane, showing the flow of electrons from NADH to O_2

Complex II is not involved and not shown. NADH has accepted electrons from substrates such as pyruvate, isocitrate, α -ketoglutarate, and malate. Note that the binding site for NADH is on the matrix side of the membrane. Coenzyme Q is soluble in the lipid bilayer. *Complex III* contains two *b*-type cytochromes, which are involved in the Q cycle. Cytochrome *c* is loosely bound to the membrane, facing the intermembrane space. In *Complex IV*, the binding site for oxygen lies on the side toward the matrix.

The overall effect of the electron transport reaction series is to move protons (H^+) out of the matrix into the intermembrane space, creating a difference in pH across the membrane.

cytoplasmic side, thus creating an electrochemical potential difference. This consists of a chemical potential (difference in pH) and a membrane potential, which becomes positive on the cytoplasmic side. The hypothesis further proposes that the H^+ ions, ejected by electron transport, flow back into the matrix through a specific H^+ channel or 'pore' in the F_0F_1 ATPase molecule, driven by the concentration gradient of H^+ . The free energy released, as proton (H^+) flows back through the ATPase, causes the coupled synthesis of ATP from ADP and phosphate by ATP synthetase (Fig. 23–22).

The model requires that the electron carriers in the respiratory chain and the ATP synthetase be anisotropically (= vectorially) organized, i.e., they must be oriented with respect to the two faces of the coupling membrane (= inner mitochondrial membrane). Further, the inner mitochondrial membrane must be intact in the form of a completely closed vesicle (either in intact mitochondria or in submitochondrial vesicles produced during sonication of the inner membrane), since, an H^+ gradient across the inner membrane could not otherwise exist. If, however, a 'leak' of proton across the

membrane is induced by uncouplers, the proton gradient would be discharged and consequently energy-coupling would fail.

Summarily, according to the chemiosmotic hypothesis, the high-energy chemical intermediates are replaced by a link between chemical processes (“chemi”) and transport process (“osmotic” – from the *osmos*^G = push) – hence **chemiosmotic coupling**. As the high-energy electrons from the hydrogens of NADH and FADH₂ are transported down the respiratory chain in the mitochondrial inner membrane, the energy released as they pass from one carrier molecule to the next is used to pump protons (H⁺) across the inner membrane from the mitochondrial matrix into the innermembrane space. This creates an *electrochemical proton gradient* across the mitochondrial inner membrane, and the backflow of H⁺ down this gradient is, in turn, used to drive the membrane-bound enzyme *ATP synthase*, which catalyzes the conversion of oxidative phosphorylation.

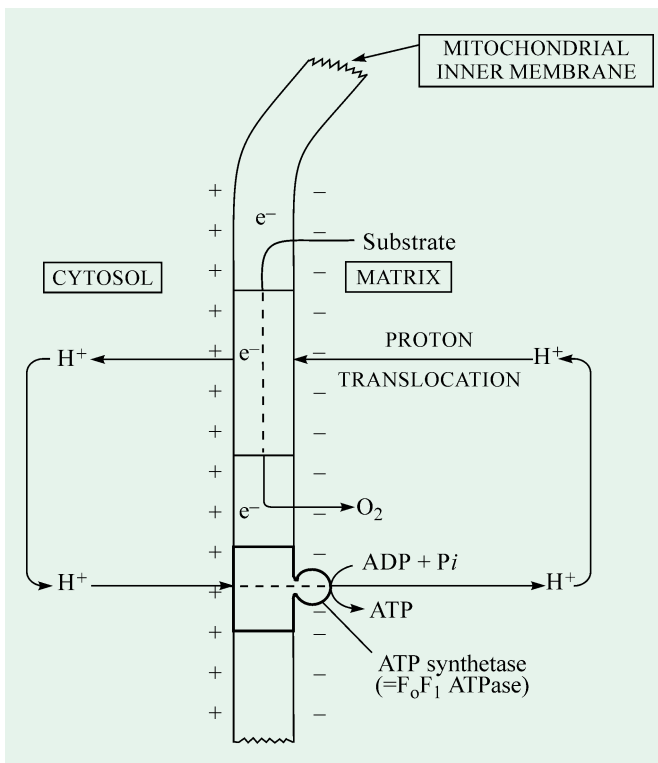

Fig. 23–22. Diagram illustrating principles of the chemiosmotic coupling hypothesis

ATP synthetase (=F₀F₁ ATPase) is responsible for oxidative phosphorylation.

Evidences in Favour. Mitchell’s hypothesis that oxidation and phosphorylation are coupled by a proton gradient is supported by a wealth of evidences :

1. No hypothetical ‘high-energy’ intermediates, linking electron transport to ATP synthesis, have been found to date.
2. Oxidative phosphorylation requires a closed compartment, *i.e.*, the inner mitochondrial membrane should be intact. Breaks or holes in the inner membrane do not allow oxidative phosphorylation, although electron transport from substrates to oxygen may still continue. ATP synthesis coupled to electron transfer does not also occur in soluble cell preparations.
3. The inner mitochondrial membrane is impermeable to H⁺, K⁺, OH⁻ and Cl⁻ ions. If the membrane is damaged in order to pass through such ions readily, oxidative phosphorylation will not take place. However, evidences available indicate the existence of specific transport systems which enable ions to penetrate the inner mitochondrial membrane.
4. Both the respiratory chain and the ATPase are vectorially organized in the coupling membrane.
5. A proton gradient across the mitochondrial inner membrane is generated during electron transport. The pH inside is 1.4 units higher than outside, and the membrane potential is 0.14 V, the outside being positive. The total electrochemical potential Δp (in volts) consists of a membrane potential contribution ($\Delta\psi$) and a H⁺ concentration-gradient contribution (ΔpH). Taking R as the gas constant, T as the absolute temperature and F as the caloric equivalent of Faraday, the value of total electrochemical potential (Δp) can be written as :

$$\Delta p = \Delta\psi - \frac{RT}{F} \Delta pH$$

546 FUNDAMENTALS OF BIOCHEMISTRY

$$\begin{aligned}
 &= \Delta\psi - 0.06 \Delta pH \\
 &= 0.14 - 0.06 (-1.4) \\
 &= 0.224 \text{ V}
 \end{aligned}$$

This total proton-motive force of 0.224 V corresponds to a free energy of 5.2 kcal per mole of protons.

6. ATP is synthesized when a *pH* gradient is imposed on mitochondria or chloroplasts in the absence of electron transport.
7. Oxidative phosphorylation can be checked by uncouplers and certain ionophores (see page 453). Uncouplers such as 2,4-dinitrophenol increase the permeability of mitochondria to protons, thus reducing the electrochemical potential and short-circuiting the vectorial ATP synthetase system for the production of ATP.
8. Addition of acid to the external medium, establishing a proton gradient, leads to the synthesis of ATP.

Oxidation-reduction loop. Perhaps the most debated issue of the chemiosmotic hypothesis is the manner in which the process of electron transport in the inner mitochondrial membrane pumps protons (H^+) from the matrix to the exterior. Mitchell has proposed a fantastic scheme which is based on the fact that reducing equivalents are transferred as H atoms by some of the electron carriers (such as ubiquinone), and as electrons by others (such as Fe—S centre and cytochromes). He opined that hydrogen-carrying and electron-carrying proteins alternate in the respiratory chain to form 3 'functional loops' called the *oxidation-reduction loops* (= *o/r loops*). Each loop corresponds functionally to the coupling sites I, II and III of the chemical hypothesis respectively. An ideal single o/r loop consists of a hydrogen carrier and an electron carrier, as depicted in Fig. 23–23. In each loop, two H^+ are carried outward through the inner membrane and deliver two H^+ to the cytosol; the corresponding pair of electrons is then carried back from the outer to the inner surface of the membrane. Thus, each pair of reducing equivalents passing through such a loop carries two H^+ from the matrix to the exterior. Each loop is thought to provide the osmotic energy to make one mole of ATP.

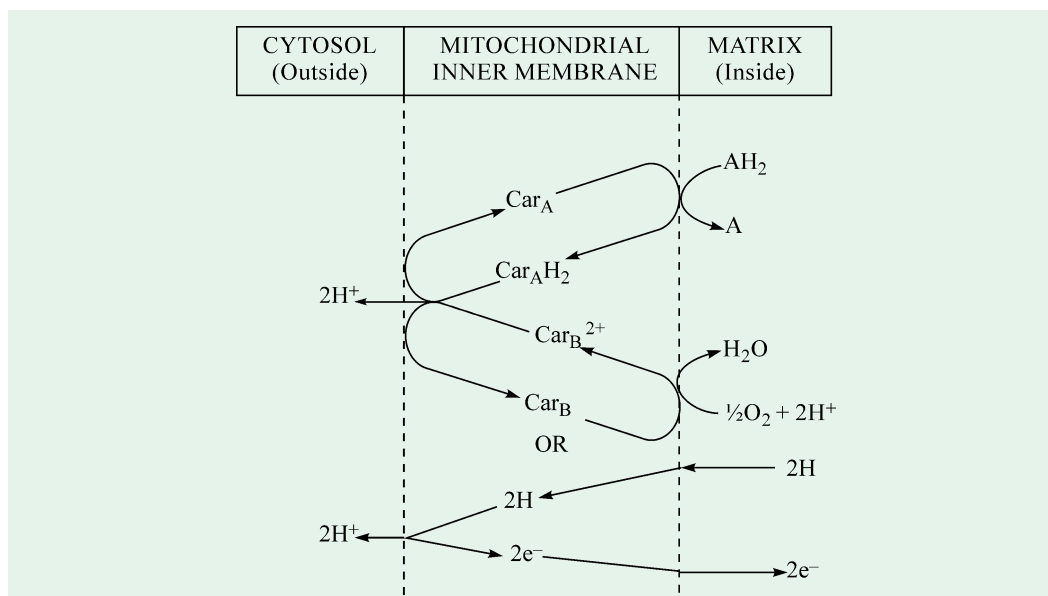

Fig. 23–23. An ideal oxidation-reduction loop as envisaged in chemiosmotic hypothesis

The oxidation-reduction (or o/r) loop translocates protons.

(After Peter A. Mayes, 1979)

Proton Transport Mechanism. In the overall scheme of electron transport, as envisaged by

ELECTRON TRANSPORT AND OXIDATIVE PHOSPHORYLATION 547

Peter Mitchell, the respiratory chain is folded into 3 oxidation-reduction (o/r) loops (Fig. 23–24). It is assumed that the members of the respiratory chain are organized in the membrane to provide the necessary sidedness. Each pair of electrons transferred from NADH to oxygen causes 6 protons to be translocated from inside to the outside of the coupling membrane. NADH first donates one H^+ and 2 electrons which, together another H^+ from the internal medium, reduce FMN to $FMNH_2$. FMN extends the full width of the membrane, so that it can release $2H^+$ to the exterior of the membrane and then return 2 electrons to the inside *via* Fe—S proteins which become reduced. Each reduced Fe—S complex donates one electron to ubiquinone (Q) which, after accepting a proton (H^+) from inside the membrane, is reduced to QH_2 . QH_2 , being a small lipid-soluble molecule, moves to the exterior of the membrane to discharge a pair of protons into the cytosol and donates 2 electrons to 2 moles of cytochrome *b*, the next carrier of electrons in the respiratory chain. Cytochrome *b* is thought to extend the mitochondrial membrane enabling the electrons to join another molecule of ubiquinone along with 2 more protons from the internal medium. The QH_2 , so produced, moves to the outer surface to liberate 2 protons and the 2 electrons are passed onto the 2 moles of cytochrome *c*. These electrons, passing through cytochrome *a*, then traverse the membrane to reach cytochrome a_3 , which is located on the inner face of the membrane. Here, 2 electrons combine with 2 protons from the internal medium and an oxygen atom to form a molecule of water.

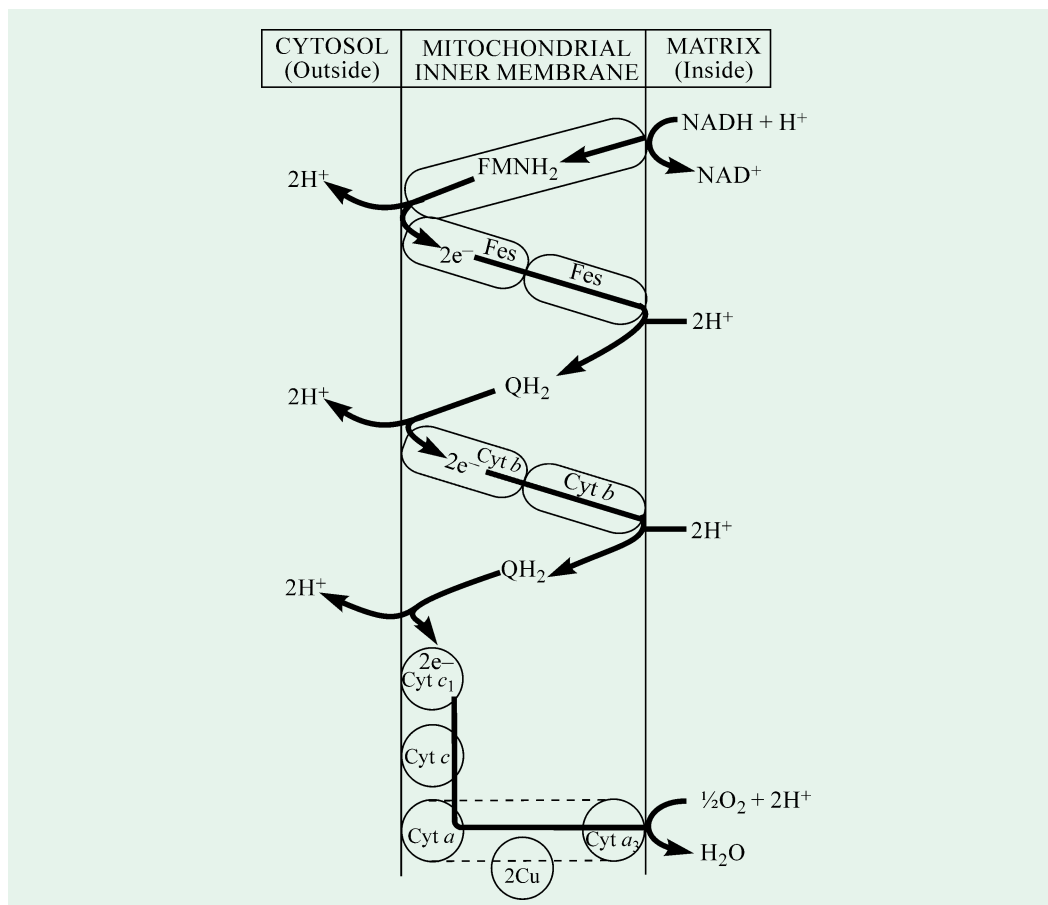

Fig. 23–24. The ‘loop’ mechanism of proton translocation in the chemiosmotic hypothesis

The 3 o/r loops carry $3 \times 2 = 6H^+$ from the matrix to the cytosol per pair electrons passing from the substrate NADH to oxygen. Much of this mechanism is still tentative, particularly around the Q/cytochrome *b* region.

Inner Membrane Transport Systems. Whereas the mitochondrial outer membrane is freely

548 FUNDAMENTALS OF BIOCHEMISTRY

permeable to most small solute molecules, the inner membrane is impermeable to H^+ , OA^- , K^+ and also many other ionic solutes. How, then, can the ADP^{3-} and HPO_4^{2-} produced in the cytosol enter the matrix and how can the newly-formed ATP^{4-} leave again, since oxidative phosphorylation takes place within the inner matrix space? Two of the many specific transport systems present in the inner mitochondrial membrane make these events possible (Fig. 23–25):

1. Adenine nucleotide translocase system. This system consists of a specific protein that extends across the inner membrane. It translocates one molecule of ADP^{3-} inward in exchange for one molecule of ATP^{4-} coming out. As the entrance of ADP is coupled to the exit of ATP , this system is better called as *ADP–ATP antiporter*. Obviously, this transport system is moving more negative charges out than it is bringing in, so it is effectively discharging the outside-positive electrical potential across the inner membrane. The adenine nucleotide transport system is specific since it carries only ATP and ADP and not AMP or any other nucleotides, such as GDP or GTP . Adenine nucleotide translocase is specifically inhibited by a toxic glycoside, *atractyloside*.

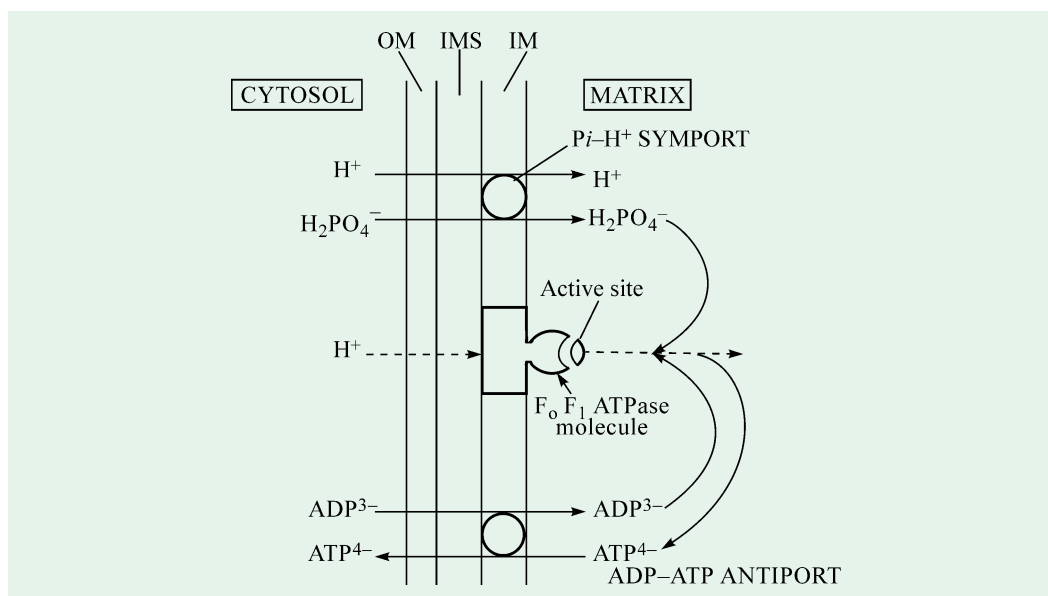

Fig. 23–25. Two principal inner membrane transport systems

[OM = Outer membrane; IMS = Intermembrane space; IM = Inner membrane]

These bring Pi and ADP into the matrix and allow the newly-synthesized ATP to move out of the matrix.

2. Phosphate translocase system. This is the second membrane system functioning in oxidative phosphorylation. It promotes transport of $H_2PO_4^-$ along with that of H^+ from the cytosol into the matrix compartment. As the entrance of inorganic phosphate is coupled to the entrance of H^+ , this system is aptly designated as *Pi–H⁺ symporter*. The *Pi–H⁺ symporter* is electroneutral since it causes no net movement of electrical charge, rather it is effectively transporting protons back into the matrix. The phosphate translocase system is specific for phosphate. It is also inhibited by certain chemical agents.

Thus, the combined action of phosphate and the *ADP–ATP* translocases allows external phosphate and ADP to enter the matrix and the resulting ATP to return to the cytosol, where most of the ATP -requiring cell activities take place. An **antiporter** exchanges ADP^{3-} and ATP^{4-} and is driven by the electrical potential across the membrane, whereas a **symporter** carries a proton and monobasic Pi and is driven by the proton concentration gradient. There is no discharge of proton gradient from the release of a proton (H^+) by the transported $H_2PO_4^-$ ion, because there is a counterbalancing uptake when the Pi is used to make ATP :

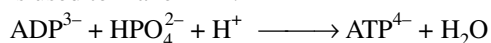

OXIDATION OF EXTRAMITOCHONDRIAL NADH (=NADH Shuttle Systems)

Although NADH cannot penetrate the mitochondrial inner membrane, it is produced continuously in the cytosol by *3-phosphoglyceraldehyde dehydrogenase*, a glycolytic enzyme. However, under aerobic conditions, extramitochondrial NADH does not accumulate and is presumably oxidized by the mitochondrial respiratory chain. How, then, does this occur? Special shuttle systems have been proposed which are based on the fact that the electrons from cytosolic NADH, rather than cytosolic NADH itself, are carried across the mitochondrial inner membrane by an indirect route. Two shuttle systems, which explain these events, are described below:

1. Malate-oxaloacetate-aspartate shuttle

This shuttle is of comparatively more universal occurrence and operates in heart, liver and kidney mitochondria. This shuttle (Fig. 23–26), is mediated by two membrane carriers and four enzymes. In this shuttle, the reducing electrons are first transferred from cytosolic NADH to cytosolic oxaloacetate to yield malate by the enzymatic action of *cytosolic malate dehydrogenase*. The malate, carrying the electrons, then passes through the inner membrane into the matrix by a dicarboxylate-transport system (A). Here the malate donates its electrons to the matrix NAD^+ , reducing it to NADH in the presence of *matrix-malate dehydrogenase*. The NADH then passes its electrons directly to the respiratory chain in the inner membrane. Three moles of ATP are generated as this pair of electrons passes to oxygen. The oxaloacetate, so formed, cannot pass through the mitochondrial inner membrane from the matrix back into the cytosol but is converted by *transaminase* into aspartate which can pass *via* the amino acid-transport system (C). The function of transport system B is to regenerate oxaloacetate into the cytosol. Transport system B makes possible the exchange of glutamate for aspartate. The dicarboxylate-transport system A carries α -ketoglutarate out in exchange for malate passing inward. The net reaction of malate-aspartate shuttle, as it is also called, is:

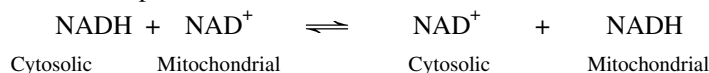

As evident, this is a readily reversible shuttle, *i.e.*, can operate in both directions either into or out of the mitochondria. The complexity of this system is due to the impermeability of the mitochondrial membrane to oxaloacetate. However, the other anions are not freely permeable and require specific transport systems for passage across the membrane.

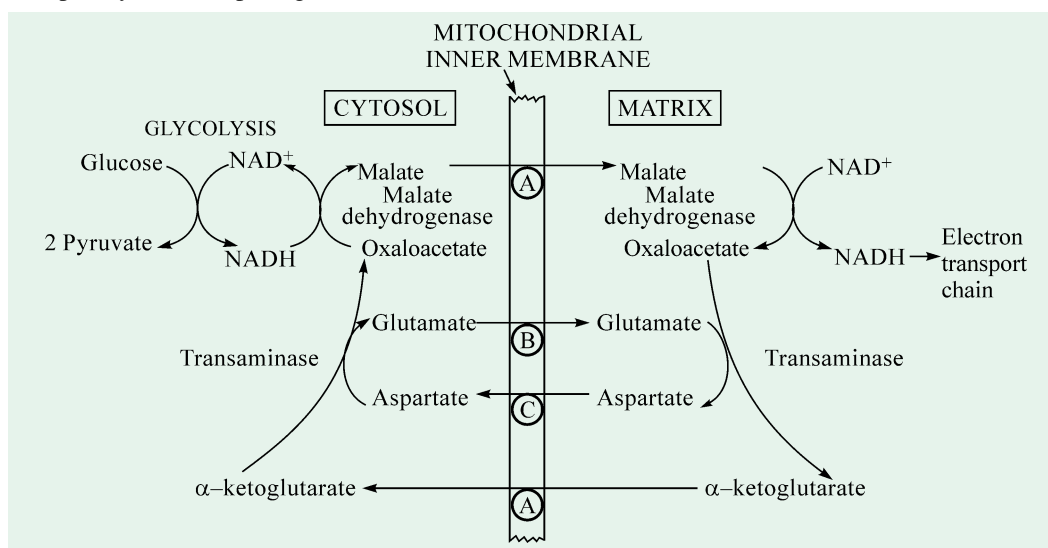
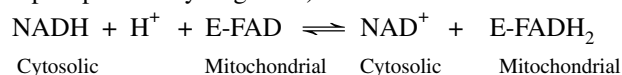

Fig. 23–26. The malate-oxaloacetate-aspartate shuttle

2. Glycerophosphate-dihydroxyacetone phosphate shuttle

This shuttle is not so common and operates prominently in the insect flight muscle and in the brain. This NADH shuttle is mediated by membrane carriers and two enzyme systems, the cytosolic and mitochondrial glycerol 3-phosphate dehydrogenase. *Glycerol 3-phosphate dehydrogenase* is NAD-linked in the cytosol whereas the enzyme found in the matrix is a flavoprotein enzyme. In this shuttle (Fig. 23–27), first of all, the electrons from cytosolic NADH are transferred to cytosolic dihydroxyacetone phosphate (DHAP) to form glycerol 3-phosphate (G-3-P). This reaction is catalyzed by cytosolic glycerol 3-phosphate dehydrogenase. Glycerol 3-phosphate then enters matrix, where it is reoxidized to dihydroxyacetone phosphate by the matrix glycerol 3-phosphate dehydrogenase which is FAD-bound. The DHAP, so formed, then diffuses out of the mitochondria into the cytosol to complete one turn of the shuttle. It is to be noted that as the mitochondrial enzyme is linked to the respiratory chain via a flavoprotein rather than NAD, only 2 rather than 3 mole of ATP are formed per atom of oxygen consumed, as also happens with succinate. The use of FAD enables electrons from cytoplasmic NADH to be transported into mitochondria against an NADH concentration gradient. The price of this transport is one ATP per electron pair. Evidently, if more reducing equivalents are passed through G-3-P—DHAP shuttle, as it is abbreviated, oxygen consumption must increase to maintain ATP production. This mechanism may, therefore, account for at least part of the extra oxygen consumption of hyperthyroid individuals (the administration of thyroxine increases the activity of the flavin-bound glycerol 3-phosphate dehydrogenase). The net reaction of G-3-P—DHAP shuttle is :



A remarkable feature of this shuttle is that it is irreversible or unidirectional. *i.e.*, can transfer reducing equivalents only from cytosol to matrix and not *vice versa*.

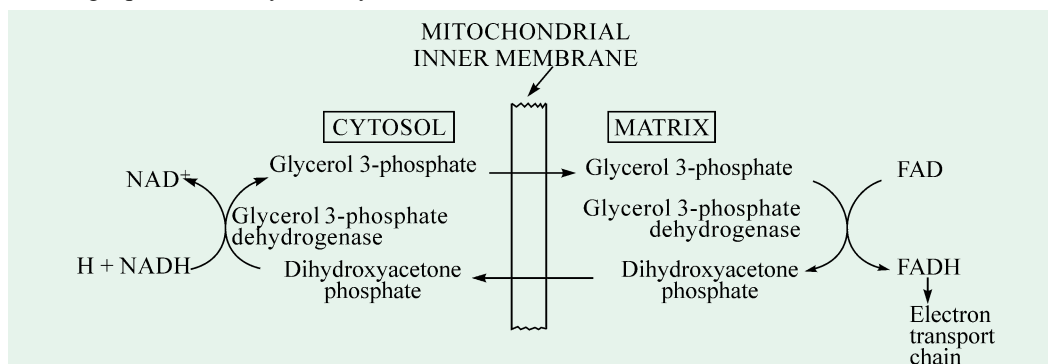
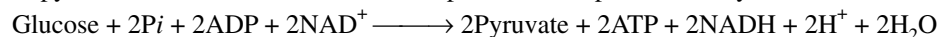

Fig. 23–27. The glycerophosphate-dihydroxyacetone phosphate shuttle

ATP YIELD AND P:O RATIO

We can now calculate step-by-step the recovery of the chemical energy in the form of ATP as a molecule of glucose is completely oxidized to CO_2 and H_2O (Table 23–4) :

1. Firstly, glycolysis of one mole of glucose, under aerobic conditions, yields two moles each of pyruvate, NADH and ATP. The entire process takes place in the cytosol.



2. Then, two pair of electrons from the two cytosolic NADH are carried into the mitochondrial matrix through the malate-aspartate shuttle. These electrons next enter the electron-transport chain and flow to oxygen. This produces 2 (3) = 6 ATP, since two NADH are oxidized.

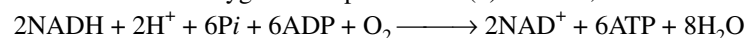

[However, if the glycerophosphate operates in place of malate-aspartate shuttle, only four ATP are generated, instead of six.

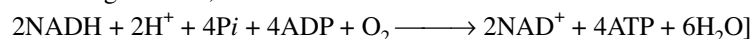

ELECTRON TRANSPORT AND OXIDATIVE PHOSPHORYLATION 551

3. Then, two moles of pyruvate are dehydrogenated to yield two moles each of acetyl-CoA and CO₂ in the mitochondria. This results in the formation of two NADH. The two electron pairs from two NADH are carried to O₂ via the electron-transport chain, each mole providing three moles of ATP.



4. Ultimately, two moles of acetyl-CoA are oxidized to CO₂ and H₂O *via* the citric acid cycle, along with the oxidative phosphorylation coupled to electron transport from isocitrate, α-ketoglutarate and malate to O₂, each of which yields 3 moles of ATP. The oxidation of succinate, however, yields 2 ATP and another two ATPs are generated from succinyl-CoA *via* GTP.

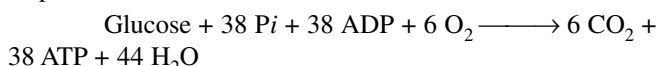

Table 23–4. ATP yield from the complete oxidation of glucose

Reaction Sequence	ATP Yield per Glucose
Glycolysis (in the cytosol)	
Phosphorylation of glucose	– 1
Phosphorylation of fructose 6-phosphate	– 1
Dephosphorylation of 2 moles of 1, 3-DPG	+ 2
Dephosphorylation of 2 moles of PEP	+ 2
2 NADH are formed in the oxidation of 2 moles of G-3-P	
Conversion of pyruvate into acetyl-CoA (inside mitochondria)	
2 NADH are formed	
Citric acid cycle (inside mitochondria)	
2 moles of GTP are formed from 2 moles of succinyl-CoA	+ 2
6 NADH are formed in the oxidation of 2 moles each of isocitrate, α-ketoglutarate and malate	
2 FADH ₂ are formed in the oxidation of 2 moles of succinate	
Oxidative phosphorylation (inside mitochondria)	
2 NADH formed in glycolysis ; each yields 2 ATP (assuming transport of NADH by malate-oxaloacetate-aspartate shuttle)	+ 6*
2 NADH formed in oxidative decarboxylation of pyruvate ; each yields 3 ATP	+ 6
2 FADH formed in the citric acid cycle ; each yields 2 ATP	+ 4
6 NADH formed in the citric acid cycle ; each yields 3 ATP	+ 18
NET YIELD PER GLUCOSE	+ 38

* If, however, 2 NADH are transported by the glycerophosphate-dihydroxyacetone phosphate shuttle, there would be an yield of 4 ATP rather than 6. In such a case, the net yield of ATP per glucose oxidized would be 36, instead of 38.

Summing up the 4 equations. On adding the above 4 equations, we get the overall equation for the process of respiration as a whole.



Thus, one mole of glucose on complete oxidation to CO₂ and H₂O in the heart, liver and kidney, *where the malate-aspartate shuttle operates*, leads to the production of 38 moles of ATP. The P:O ratio in such cases is 3.16, since 38 ATP are produced and 12 atoms of O₂ are consumed.

The **P : O ratio** is defined as the number of moles of inorganic phosphate incorporated into organic form per atom of oxygen consumed. In other words, the P : O ratio may be taken to mean the number of moles of high-energy phosphate generated per atom of oxygen consumed.

552 FUNDAMENTALS OF BIOCHEMISTRY

[However, in the skeletal muscles, *where glycerophosphate shuttle operates*, a total of 36 ATP moles is generated per mole of glucose oxidized. In that case, the overall equation is modified to:

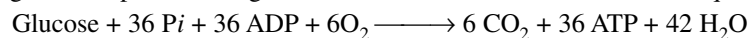

Here the P:O ratio is $36/12 = 3.0$.]

Under standard conditions (1.0 M), the theoretical recovery of free energy in the complete oxidation of glucose is :

$$38 (7.3/686) (100) = 40\%$$

[or $36 (7.3/686) (100) = 38\%$, when glycerophosphate shuttle operates]. But in the intact cell, the efficiency of this process is high (over 70%) because the cellular concentration of glucose, oxygen, Pi, ADP and ATP are unequal and much lower than the standard concentration of 1.0 M. The trapping of this amount of energy is a noteworthy achievement for the living cell.

ROLES OF ELECTRON TRANSPORT ENERGY

The main function of electron transport in mitochondria is to provide energy for the synthesis of ATP during oxidative phosphorylation. But the energy generated during electron transport is also used for other biological purposes (Fig. 23–28), which are listed below :

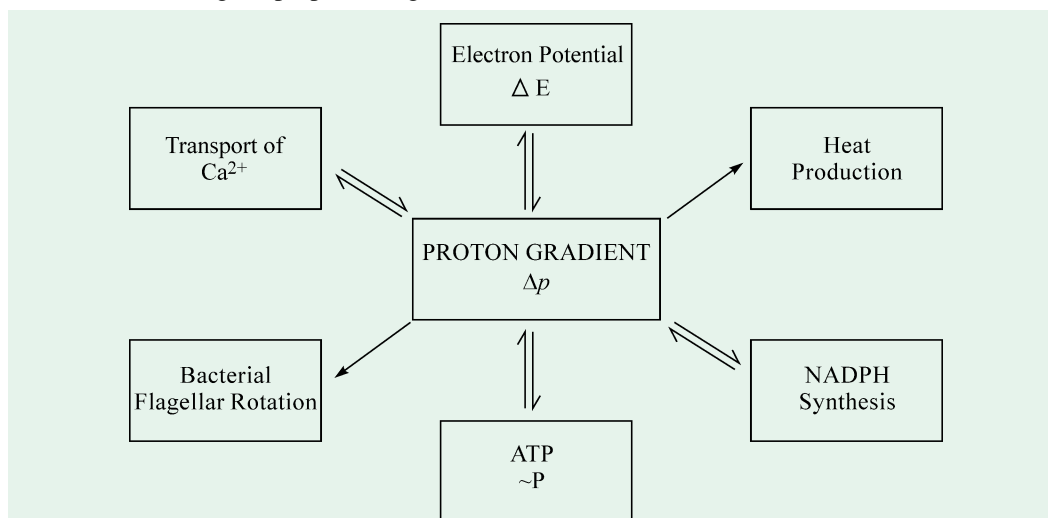

Fig. 23–28. Some key roles of the transmembrane proton gradient

1. The proton gradient generated by electron transport can be used to generate heat. For example, human infants, other mammals born hairless and some hibernating animals have a special type of **brown fat** in the neck and upper back. The brown fat is so named because it contains profuse mitochondria which, in turn, are rich in the red-brown cytochromes. These specialized brown-fat mitochondria do not usually produce ATP, rather they dissipate the free energy of electron transport as heat in order to maintain the body temperature of the young ones. This is because the brown-fat mitochondria have special *proton pores* in their inner membrane that allow the protons, pumped on by electron transport, to flow back into the matrix, rather than through the F_0F_1 ATPase or ATP synthetase. Consequently, the free energy of electron transport is diverted from ATP synthesis into heat production.
2. The electron transport energy is also used to transport Ca^{2+} from the cytosol into the matrix of animal mitochondria. In fact, the inner membrane contains two transport systems for Ca^{2+} : one transports Ca^{2+} inward and the other transports Ca^{2+} outward. The concentration of external Ca^{2+} is maintained at a very low level (about 10^{-7} M). This is due to a balance between the rates of Ca^{2+} influx and efflux. Thus, the inward transport of Ca^{2+} is counterbalanced by Ca^{2+} efflux whose rate is regulated. High Ca^{2+} concentrations initiate or

ELECTRON TRANSPORT AND OXIDATIVE PHOSPHORYLATION 553

- promote many cell functions such as muscle concentration, glycogen breakdown and the oxidation of pyruvate ; low Ca^{2+} concentrations have inhibitory effects on these functions.
3. Rotation of bacterial flagella is also controlled by the proton gradient generated across the membrane.
 4. Transfer of electrons from NADH to NADPH is also powered by the proton gradient.
 5. The entry of some amino acids and sugars is also governed by the energy generated during electron transport.

RESPIRATORY INHIBITORS

The electron transport chain contains 4 complexes (I, II, III and IV) which participate in the transfer of electrons. In general, it may be stated that the structural integrity of these complexes appears essential for its interaction with most inhibitors, since the soluble, phospholipid-free enzymes do not exhibit the characteristic inhibitory pattern. Specific inhibitors are summarized in Table 23–5.

Table 23–5. Different classes of respiratory inhibitors

<i>Class with examples</i>	<i>Affected complex*or reaction</i>	<i>Concentrations employed</i>
Inhibitors of electron transport		
Rotenone, Piericidin A	I FMN \longrightarrow Q and /or cyt b (Fe^{3+})	Stoichiometric with f_{PN}
Amytal, Seconal	I same as above	$\geq 10^{-3}$ M
Thenoyltrifluoroacetone	II Peptide-FAD \longrightarrow Q and/or cyt b	$\geq 10^{-4}$ M
Antimycin A, Dimercaprol	III cyt b (Fe^{2+}) \longrightarrow cyt c1 (Fe^{3+}) (perhaps at NH1)	Stoichiometric with cytochromes
HCN, H_2S	IV cyt c (Fe^{2+}) \longrightarrow O_2	$\leq 10^{-4}$ M (CN ⁻)
HN_3 , CO	IV same as above	Higher than above
Inhibitors of oxidative phosphorylation		
Oligomycin	Inhibit respiration ($NADH \longrightarrow O_2$ or Succinate O_2) when coupled to phosphorylation	
Rutamycin		
Atractylate		
Bongkredate		
Uncouplers of oxidative phosphorylation		
2,4 dinitrophenol	Stimulate respiration when rate is limited by phosphorylation or blocked by oligomycin.	
Dicoumarol		
Valinomycin †		
Gramicidin A †		

* The complexes are indicated by Roman numerals.

† Now classed under 'Ionophores of oxidative phosphorylation'.

A. Inhibitors of Electron Transport

(= Inhibitors of Respiratory Chain)

These are the inhibitors that arrest respiration by combining with members of the respiratory chain, rather than with the enzymes that may be involved in coupling respiration with ATP synthesis. They appear to act at 3 loci that may be identical to the energy transfer sites I, II and III (Fig. 23–29).

554 FUNDAMENTALS OF BIOCHEMISTRY

The various inhibitors of this category are described below :

1. Rotenone. Rotenone (Fig. 23–30) is a compound extracted from the roots of tropical plants such as *Derris elliptica* and *Lonchocarpus nicou*. It complexes avidly with NADH dehydrogenase and acts between the Fe—S proteins and ubiquinone. Only 30 nanomoles per gram of mitochondrial protein are effective for blocking site I. Rotenone is relatively nontoxic to mammals because it is absorbed poorly, although exposure of the lungs to dust is a little more dangerous. However, the compound is intensely toxic to the fishes and insects as it readily passes into their gills and breathing tubes respectively.

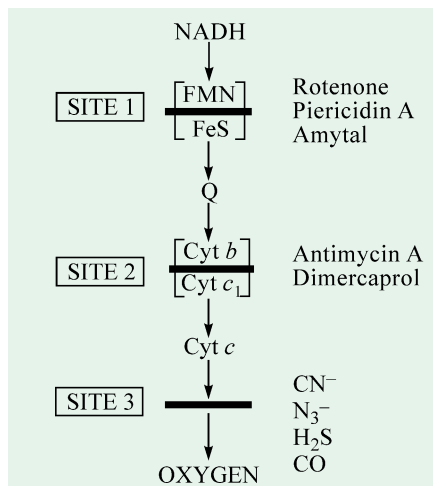

Fig. 23–29. Sites of action of some inhibitors of electron transport

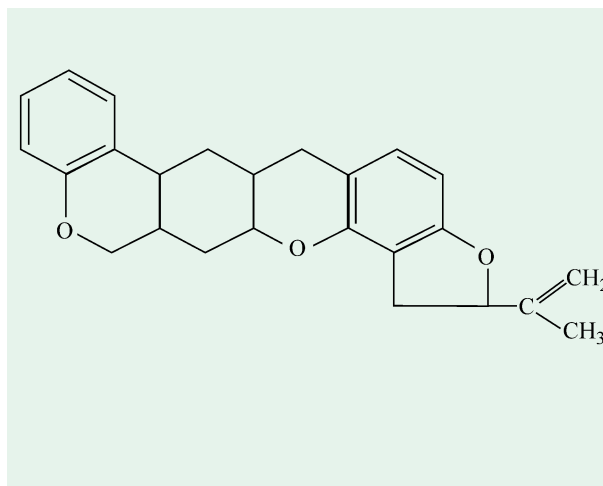

Fig. 23–30. Rotenone

2. Piericidin A. It is an antibiotic, produced by species of *Streptomyces*. It has an action similar to that of rotenone.

3. Barbiturates (Amytal, seconal). These also block NADH dehydrogenase, but are required in much higher concentrations for the purpose. The sedative actions of these compounds appear to depend on their actions on neural membranes, but inhibition of respiration may assist the effect. In contrast, amytal (and also rotenone and piericidin A) do not interfere with the oxidation of succinate, because the electrons of these substrates enter the electron-transport chain beyond the block of coenzyme Q.

4. Antimycins. These are also antibiotics, also produced by *Streptomyces*. They inhibit the respiratory chain at or around site II and block electron flow between cytochromes *b* and *c*₁, which prevents ATP synthesis coupled to the generation of a proton gradient at site II. This block can be bypassed by the addition of ascorbate, which directly reduces cytochrome *c*. Electrons then flow from cytochrome *c* to O₂, with the concomitant synthesis of ATP coupled to a proton gradient at site III. About 0.07 micromole of antimycin A per gram of mitochondrial protein is effective.

5. Dimercaprol. It is identical in action to the antimycins.

6. Cyanides. These are among the poisons better known by the general public. Although they are not extraordinarily potent (the minimum lethal dose for human beings is between 1 and 3 millimoles), they enter the tissues very rapidly so that a sufficient quantity becomes lethal within a few minutes. It is this quick effect that has gained the cyanides so much respect. The cyanide ion (CN⁻) combines tightly with cytochrome oxidase, leading to the cessation of transfer of electrons to oxygen. The previous electron carriers in the chain accumulate in their reduced state, and the generation of high-energy phosphate stops. In fact, the effect of cyanide is as fundamental as deprivation of oxygen, and like the latter causes rapid damage to the brain.

7. Azide. It also blocks the electron flow between the cytochrome oxidase complex and oxygen. Azide (N₃⁻), as also cyanides, react with the ferric form (Fe³⁺) of this carrier.

ELECTRON TRANSPORT AND OXIDATIVE PHOSPHORYLATION 555

8. Hydrogen sulfide. Few realize that H_2S is as toxic as HCN. However, its disagreeing odour gives more warning. It is a lethal menace in all drilling operations, especially so on oil-drilling platforms at sea. *In vitro* tests reveal that 0.1 mM sulfide inhibits cytochrome oxidase more than does 0.3 mM cyanide — 96% against 90%.

9. Carbon monoxide. It also attacks between cytochrome oxidase and O_2 but, unlike cyanide and azide, CO inhibits the ferrous form (Fe^{2+}) of the electron carrier.

Phosphorylation coupled to the generation of a proton gradient at site III does not occur in the presence of these inhibitors (*i.e.*, cyanides, azide, H_2S and CO) because electron flow is blocked.

B. Inhibitors of Oxidative Phosphorylation

These compounds inhibit electron transport in cells in which such transport is coupled with ATP synthesis, but they do not affect electron transport in cells in which such transport is not coupled with phosphorylation. Thus, these compounds inhibit both electron transport and oxidative phosphorylation.

1. Oligomycins. These polypeptide antibiotics are obtained from various species of *Streptomyces*. They inhibit the transfer of high-energy phosphate to ADP and, therefore, also inhibit electron transfers coupled to phosphorylation. However, they do not affect those redox reactions that are not coupled. Henceforth, they are widely employed as experimental tools for differentiating between the two kinds of reactions. The F_0 component of ATP synthetase binds oligomycin, which is a potent inhibitor of this enzyme and, thus, of oxidative phosphorylation. Apparently, oligomycin appears to block one of the primary phosphorylation steps.

2. Rutamycin. This antibiotic also inhibits both electron transport and oxidative phosphorylation.

3. Atractylate (= Atractyloside). This toxic glycoside is extracted from the rhizomes of *Atractylis gummifera*, a plant native to Italy. It blocks oxidative phosphorylation by competing with ATP and ADP for a site on the ADP—ATP antiport of the inner mitochondrial membrane. Hence, it checks renewal of ATP supply in the cytosol. Evidently, atractylate inhibits at a step beyond that blocked by oligomycin, *i.e.*, one specifically concerned with the entry and exit of ADP/ATP into a mitochondrial compartment.

4. Bongkrekate. It is a toxin formed by a bacteria (*Pseudomonas*) in a coconut preparation (called ‘bongkrek’) from Java. It also blocks the ADP—ATP antiport. Only 2 micromoles per gram of mitochondrial protein are effective.

C. Uncouplers of Oxidative Phosphorylation

Uncoupling agents are compounds which dissociate (or ‘uncouple’) the synthesis of ATP from the transport of electrons through the cytochrome system. This means that the electron transport continues to function, leading to oxygen consumption but phosphorylation of ADP is inhibited. In the intact mitochondria, these two processes are intimately associated. When they are uncoupled, the transport of electrons speeds up, thereby pointing out that the phosphorylation of ADP has been a rate limiting process. In the presence of uncouplers, the free energy released by electron transport appears as heat, rather than as newly-made ATP. Uncoupling agents greatly enhance the permeability of the inner membrane to H^+ . They are lipophilic and bind H^+ from one side of the membrane and carry it through the membrane toward the side with the lower H^+ concentration. In Mitchell’s hypothesis, uncouplers are agents that are capable of destroying the vectorial, anisotropic structure of the membrane, leading to elimination of the pH gradient. As the uncouplers bind and carry protons, they are also called **protonophores**. Uncoupling can be distinguished from inhibition. Uncoupling causes an increased oxygen consumption in the absence of increased utilization of ATP, whereas inhibition of phosphorylation (or inhibition of ADP—ATP antiport) diminishes oxygen consumption in normal coupled mitochondria. Some uncouplers commonly employed are :

556 FUNDAMENTALS OF BIOCHEMISTRY

1. 2,4-dinitrophenol (DNP). Introduced by Loomis and Lipmann, dinitrophenol (Fig. 23–31) is one of the most effective agents for uncoupling respiratory-chain phosphorylation. It does not have any effect on the substrate-level phosphorylations that take place in glycolysis. It acts at a concentration of 10 micromolar. The uncoupling action of DNP is due to the fact that both the phenol and the corresponding phenolate ion are significantly soluble in the lipid core of the inner mitochondrial membrane (Fig. 23–32). The phenol diffuses through the core toward the matrix, where it loses a proton; the phenolate ion then diffuses back toward the cytosol side, where it picks up a proton to repeat the process.

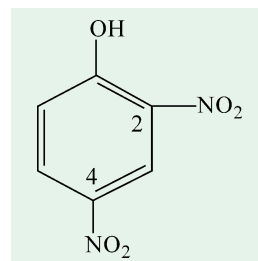

Fig. 23–31. 2,4-dinitrophenol, DNP

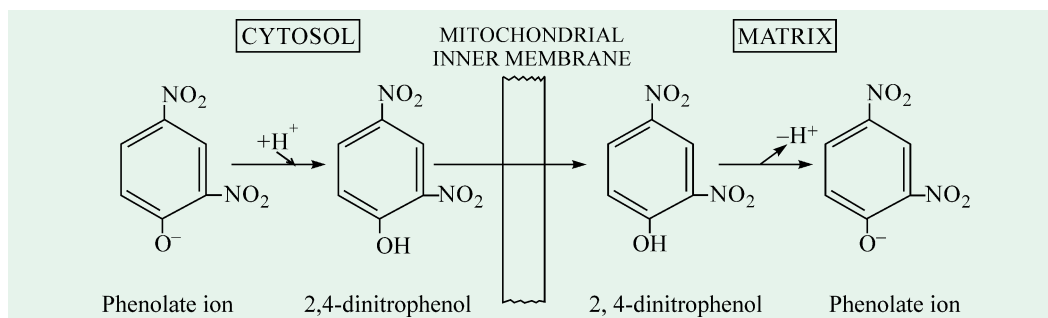

Fig. 23–32. Action of 2,4-dinitrophenol

At pH 7.0, this agent exists mainly as the anion which is not soluble in the lipids. In its protonated form, it is lipid-soluble and hence can pass through inner membrane, carrying a proton. The proton (H^+), so carried, is discharged on the other side of the membrane. In this way, uncouplers prevent formation of H^+ gradient across the membrane.

Dinitrophenol also stimulates the activity of the enzyme ATPase, which is normally inactive as a hydrolytic enzyme in mitochondria. Actually, ATP is never formed in the presence of DNP, since the high-energy intermediate is attacked *i.e.*, it acts prior to the step of ATP synthesis.

2. Dicoumarol. Dicoumarol (Fig. 23–33) arises from the action of microorganisms on coumarin, a natural constituent of sweet clover, *Melilotus indica*. It has an action identical to that of 2,4-dinitrophenol. Dicoumarol is also an antagonist of vitamin K function.

Dicoumarol is also spelt as **dicumarol**.

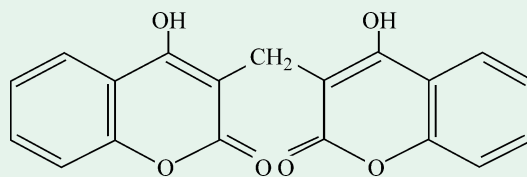

Fig. 23–33. Dicoumarol
(3, 3'-methylene-bishydroxycoumarin)

3. m-chloroacetyl cyanide phenylhydrazine (CCCP). Its action is also similar to that of 2,4-dinitrophenol but it is about 100 times more active than the latter.

D. Ionophores of Oxidative Phosphorylation

Ionophores (“ion carriers”) are lipophilic substances, capable of binding and carrying specific cations through the biologic membranes. *They differ from the uncouplers in that they promote the transport of cations other than H^+ through the membrane.*

1. Valinomycin. This toxic antibiotic (Fig. 23-34) is synthesized by *Streptomyces*. Valinomycin is a repeating macrocyclic molecule made up of four kinds of residues (L-lactate, L-valine, D-hydroxyisovalerate and D-valine) taken 3 times. The four residues are alternately joined by ester and

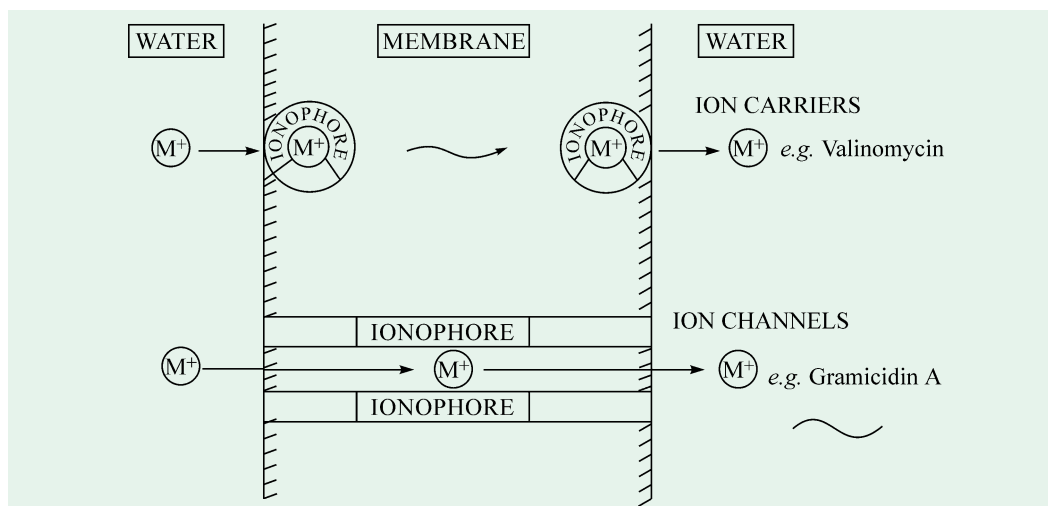

Fig. 23–36. Schematic representation of the action of ionophores on membranes

M + = metal ion

(After Ovchinnikov YA, 1979)

3. Nigericin. Like valinomycin, it also acts as an ionophore for K^+ but in exchange for H^+ . It, therefore, abolishes the pH gradient across the membrane. In the presence of both valinomycin and nigericin, both the membrane potential and the pH gradient are eliminated, and phosphorylation is, therefore, completely inhibited.

REGULATORY CONTROLS AMONG GLYCOLYSIS, THE CITRIC ACID CYCLE AND OXIDATIVE PHOSPHORYLATION

The 3 energy-yielding stages in carbohydrate metabolism are glycolysis, the citric acid cycle and oxidative phosphorylation. Each stage is so regulated as to satisfy the time-to-time need of the cell for its products. These 3 stages are coordinated with each other in such a way that they function most economically in a self-regulated way. They produce ATP and certain specific intermediates such as pyruvate and citrate, that act as precursors for the biosynthesis of other cell components. The coordination of these 3 stages is brought about by the interlocking regulatory mechanisms (Fig. 23–37). It is apparent from the figure that the relative concentrations of ATP and ADP control not only the rate of electron transport and oxidative phosphorylation but also the rates of glycolysis, pyruvate oxidation and the citric acid cycle.

When ATP concentration is high and ADP and AMP correspondingly low (*i.e.*, the $[ATP]/[ADP][P_i]$ ratio is high), the rates of glycolysis, pyruvate oxidation, the citric acid cycle and oxidative phosphorylation are at a minimum. But when there is a large increase in the rate of ATP utilization by the cell, with the corresponding increased formation of ADP, AMP and P_i the rate of electron transport and oxidative phosphorylation will immediately increase. Simultaneously, the rate of pyruvate oxidation via the citric acid cycle will increase, thus increasing the flow of electrons into the respiratory chain. These events, in turn, will enhance the rate of glycolysis, thus resulting in an increased rate of pyruvate formation. Thus, *the regulatory controls are both inhibitory and stimulatory.*

Interlocking of glycolysis and the citric acid cycle by citrate augments the action of the adenylate system. Whenever ATP, produced by oxidative phosphorylation, and citrate increase to higher levels, they produce concerted allosteric inhibition of phosphofructokinase (PFK); the two together being more inhibitory than the sum of their individual effects. In addition, increased levels of NADH and

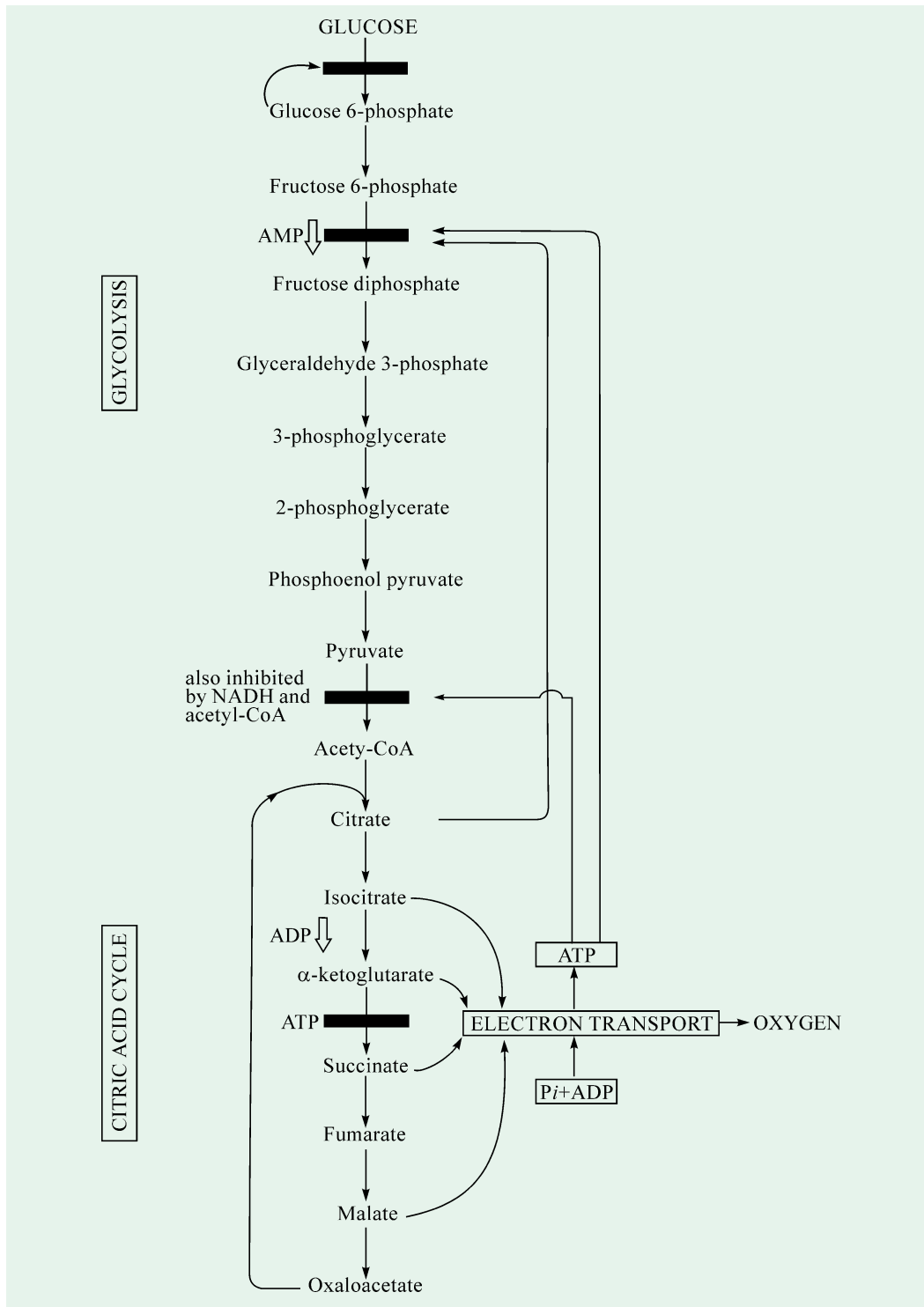

Fig. 23-37. Interlocking regulatory controls among various phases of respiration

The regulatory controls, which are both inhibitory and stimulatory, are shown by solid bars and hollow arrows, respectively.

560 FUNDAMENTALS OF BIOCHEMISTRY

acetyl-CoA also inhibit the oxidation of pyruvate to acetyl-CoA. In nutshell, interlocking and regulatory mechanisms control glycolysis so that pyruvate is produced at a rate at which it is required by the citric acid cycle, a process which donates electrons for the oxidative phosphorylation.

REFERENCES

1. **Abrahams JP, Leslie AGW, Lutter R, Walker JE** : Structure at 2.8 Å resolution of F₁-ATPase, from bovine heart mitochondria. *Nature*. **370** : 621-628, 1994.
2. **Baltscheffsky H, Baltscheffsky M** : Electron transport phosphorylation. *Ann. Rev. Biochem.* **43** : 871, 1974.
3. **Boyer PD** : A perspective of the binding change mechanism for ATP synthesis. *FASEB J.* **3** : 2164-2178, 1989.
4. **Boyer PD, Chance B, Ernster L, Mitchell P, Racker E, Slater EC** : Oxidative phosphorylation and photophosphorylation. *Ann. Rev. Biochem.* **46** : 955-1026, 1977.
5. **Capaldi RA** ; Structure and function of cytochrome C oxidase. *Ann. Rev. Biochem.* **59** : 569-596, 1990.
6. **Cross RL** : The mechanism and regulation of ATP synthesis by F₁-ATPases. *Ann. Rev. Biochem.* **50** : 681, 1981.
7. **DePierre JW, Ernster L** : Enzyme topology of intracellular membranes. *Ann. Rev. Biochem.* **46** : 201-262, 1977.
8. **Dickerson RE** : Cytochrome c and the evolution of energy metabolism. *Sci. Amer.* **242(3)** : 137-153, 1980.
9. **Erecinska M, Wilson DF** : Cytochrome oxidase. A synopsis. *Arch. Biochem. Biophys.* **188** : 1, 1978.
10. **Ernster L (editor)** : Molecular Mechanisms in Bioenergetics. *Elsevier*. 1992.
11. **Ferguson SJ, Sorgato MC** : Proton electrochemical gradients and energy-transduction processes. *Ann. Rev. Biochem.* **51** : 185, 1982.
12. **Fillingame RH** : The proton-translocating pumps of oxidation phosphorylation. *Ann. Rev. Biochem.* **49** : 1079-1114, 1980.
13. **Fridovich I** : Superoxide dismutase. *Ann. Rev. Biochem.* **44** : 147-159, 1975.
14. **Green DE, MacLennan DH** : Structure and function of the mitochondrial cristae membranes. *Bioscience*. **19** : 213 - 222, 1969.
15. **Hall DO, Rao KK, Cammack R** : The iron-sulfur proteins : Structure, function and evaluation of a ubiquitous group of proteins. *Sci. Prog.* **62** : 285-316, 1975.
16. **Harold FM** : The Vital Force : A study of Bioenergetics. *Academic Press, Inc., New York*. 1986.
17. **Hinckle PC, McCarty RE** : How cells make ATP. *Sci. Amer.* **238(3)** : 104-123, 1978.
18. **Kalckar HM (editor)** : Biological Phosphorylations : Development of Concepts. *Prentice-Hall*, 1969.
19. **Kalckar HM** : Fifty years of biological research—From oxidative phosphorylation to energy requiring transport and regulation. *Ann. Rev. Biochem.* **60** : 1-37. 1991.
20. **Keilin D** : The History of Cell Respiration and Cytochromes. *Cambridge Univ. Press*, 1966.
21. **Klingenberg M** : Structure-function of the ADP/ATP carrier. *Biochem. Soc. Trans.* **20** : 547-550, 1992.
22. **Krebs HA, Kornberg HL** : Energy Transformation in Living Matter, A Survey. *Springer, Berlin*. 1957.
23. **Lehninger AL** : How cells transform energy. *Sci. Amer.* **205 (3)** : 62, 1961.
24. **Lehninger AL** : The Mitochondrion : Molecular Basis of Structure and Function. *Benjamin, New York*. 1965.

ELECTRON TRANSPORT AND OXIDATIVE PHOSPHORYLATION 561

25. **Lehninger AL, Wadkins CL** : Oxidative phosphorylation. *Ann. Rev. Biochem.* **31** : 47-78, 1962.
26. **Lemberg R, Barrett J** : Cytochromes. *Academic Press Inc., New York.* 1973.
27. **Lovenberg W (editor)** : Iron-sulfur Proteins. vol 3. *Academic Press Inc., New York.* 1977.
28. **Malmström BG** : Enzymology of oxygen. *Ann. Rev. Biochem.* **51** : 21, 1982.
29. **Martonosi AN** : Membranes and Transport. *Plenum, New York.* 1982.
30. **Massey V, Veeger C** : Biological oxidations. *Ann. Rev. Biochem.* **32** : 579, 1963.
31. **Mitchell P** : Chemiosmotic Coupling and Energy Transduction. *Glynn Research, Bodmin, England.* 1968.
32. **Mitchell P** : Keilin's respiratory chain concept and its chemiosmotic consequences. *Science.* **206** : 1148-1159, 1979.
33. **Munn EA** : The Structure of Mitochondria. *Academic Press Inc., New York.* 1974.
34. **Nicholls DG, Ferguson SJ** : Bioenergetics 2. *Academic Press, Inc., New York.* 1992.
35. **Parsons DS** : Biological Membranes. *Oxford, London.* 1975.
36. **Pederson PL, Amzel LM** : ATP synthases. Structure, reaction centre, mechanism, and regulation of one of nature's most unique machines. *J. Biol. Chem.* **268** : 9937-9940, 1993.
37. **Racker E** : Mechanisms in Bioenergetics. *Academic Press Inc., New York.* 1965.
38. **Racker E** : The two faces of the inner mitochondrial membrane. *Essays in Biochemistry.* **6** : 1-22, 1970.
39. **Racker E** : A New Look at Mechanisms in Bioenergetics. *Academic Press Inc., New York.* 1976.
40. **Racker E** : From Pascher to Mitchell. A hundred years of Bioenergetics. *Fed. Pro.* 39 210-215, 1980.
41. **Salemme SR** : Structure and function of cytochromes *c*. *Ann. Rev. Biochem.* **46** : 299-329, 1977.
42. **Senior AE** : ATP synthesis by oxidative phosphorylation. *Physiol. Rev.* **68** : 177-231, 1988.
43. **Siekevitz P** : Powerhouse of the cell. *Sci. Amer.* **197(1)** : 131, 1957.
44. **Singer TP (editor)** : Flavins and Flavoproteins. *Elsevier, Amsterdam.* 1976.
45. **Singer TP (editor)** : Biological Oxidations. *Interscience,* 1968.
46. **Skulachev VP** : Energy transformations in the respiratory chain. *Curr. Top. Bioenerg.* **4** : 127-190, 1971.
47. **Skulachev VP** : The laws of cell energetics. *Eur. J. Biochem.* **208** : 203-209, 1992.
48. **Spiro TG** : Iron-Sulfur Proteins. *Wiley-Interscience.* 1982.
49. **Stayman CL (editor)** : Electronic ion pumps. *Curr. Top. Membr. Transp. vol. 16,* 1982.
50. **Sund H (editor)** : Pyridine Nucleotide Dependent Dehydrogenases. *Springer-Verlag, New York.* 1970.
51. **Sweeney WV, Rabinowitz JC** : Proteins containing 4Fe-4S clusters. An overview. *Ann. Rev. Biochem.* **49** : 131-162, 1980.
52. **Tedeschi H** : Mitochondria : Structure, Biogenesis and Transducing Functions. *Springer-Verlag, New York.* 1976
53. **Thomas PJ, Bianchet M, Garboczi DN, Hullihen J, Amzel LM, Pederson PL** : ATP synthase : Structure-function relationships. *Biochem. Biophys. Acta.* **1101** : 228-231, 1992.
54. **Tzagoloff A** : Mitochondria. *Plenum, New York.* 1982.
55. **Von Jagow G, Sebald W** : *b*-type cytochromes. *Ann. Rev. Biochem.* **49** : 281-314, 1980.
56. **Wainio WW** : The Mammalian Mitochondrial Respiratory Chain. *Academic Press Inc., New York.* 1970.

562 FUNDAMENTALS OF BIOCHEMISTRY

57. **Whittaker DA, Danks SM** : Mitochondria ; Structure, Function and Assembly. *Longman, London. 1978.*
58. **Wikström M, Krebs K, Suraste M** : Proton-translocating cytochrome complexes. *Rev. Biochem. 50 : 623-655, 1981.*

PROBLEMS

- What is the yield of ATP when each of the following substrates is completely oxidized to CO_2 by a mammalian cell homogenate ? Assume that glycolysis, the citric acid cycle, and oxidative phosphorylation are fully active.

(a) Pyruvate	(d) Phosphoenolpyruvate
(b) Lactate	(e) Galactose
(c) Fructose 1, 6-bisphosphate	(f) Dihydroxyacetone phosphate
- The standard oxidation–reduction potential for the reduction of O_2 to H_2O is given as 0.82 V in Table 23-2. However, the value given in textbooks of chemistry is 1.23 V. Account for this difference.
- What is the effect of each of the following inhibitors on electron transport and ATP formation by the respiratory chain ?

(a) Azide	(d) DNP
(b) Atractyloside	(e) Carbon monoxide
(c) Rotenone	(f) Antimycin A
- The number of molecules of inorganic phosphate incorporated into organic form per atom of oxygen consumed, termed the P : O ratio, was frequently used as an index of oxidative phosphorylation.
 - What is the relation of the P : O ratio to the ratio of the number of protons translocated per electron pair ($\text{H}^+ / 2e^-$) and the ratio of the number of protons needed to synthesize ATP and transport it to the cytosol (P / H^+) ?
 - What are the P : O ratios for electrons donated by matrix NADH and by succinate ?
- The immediate administration of nitrite is a highly effective treatment for cyanide poisoning. What is the basis for the action of this antidote ? (**Hint** : Nitrite oxidizes ferrohemeoglobin to ferrihemeoglobin.)
- Suppose that the mitochondria of a patient oxidizes NADH irrespective of whether ADP is present. The P : O ratio for oxidative phosphorylation by these mitochondria is less than normal. Predict the likely symptoms of this disorder.
- Years ago, it was suggested that uncouplers would make wonderful diet drugs. Explain why this idea was proposed and why it was rejected. Why might the producers of antiperspirants be supportive of the idea ?
- You are asked to determine whether a chemical is an electron-transport-chain inhibitor or an inhibitor of ATP synthase. Design an experiment to determine this.
- Years ago there was interest in using uncouplers such as dinitrophenol as weight control agents. Presumably, fat could be oxidized without concomitant ATP synthesis for re-formation of fat or carbohydrate. Why was this a bad idea ?
- The NADH dehydrogenase complex of the mitochondrial respiratory chain promotes the following series of oxidation–reduction reactions, in which Fe^{3+} and Fe^{2+} represent the iron in iron–sulfur centres, UQ is ubiquinone, UQH_2 is ubiquinol, and E is the enzyme :

$$(1) \text{NADH} + \text{H}^+ + \text{E-FMN} \longrightarrow \text{NAD}^+ + \text{E-FMNH}_2$$

ELECTRON TRANSPORT AND OXIDATIVE PHOSPHORYLATION 563

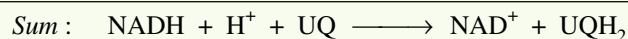
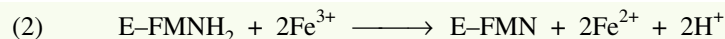

For each of the three reactions catalyzed by the NADH dehydrogenase complex, identify (a) the electron donor, (b) the electron acceptor, (c) the conjugate redox pair, (d) the reducing agent, and (e) the oxidizing agent.

- 11.** The standard reduction potential of any redox couple is defined for the half-cell reaction (or half-reaction) :

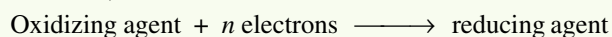

The standard reduction potentials of the NAD^+/NADH and pyruvate/lactate redox pairs are -0.320 and -0.185 V, respectively.

- (a) Which redox pair has the greater tendency to lose electrons ? Explain.
 (b) Which is the stronger oxidizing agent ? Explain.
 (c) Beginning with 1 M concentrations of each reactant and product at pH 7, in which direction will the following reaction proceed ?

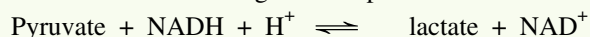

- (d) What is the standard free-energy change, ΔG° , at 25°C for this reaction ?
 (e) What is the equilibrium constant for this reaction at 25°C ?

- 12.** Electron transfer functions to translocate protons from the mitochondrial matrix to the external medium to establish a pH gradient across the inner membrane, the outside more acidic than the inside. The tendency of protons to diffuse from the outside into the matrix, where $[\text{H}^+]$ is lower, is the driving force for ATP synthesis *via* the ATP synthase. During oxidative phosphorylation by a suspension of mitochondria in a medium of pH 7.4, the internal pH of the matrix has been measured as 7.7.

- (a) Calculate $[\text{H}^+]$ in the external medium and in the matrix under these conditions.
 (b) What is the outside : inside ratio of $[\text{H}^+]$? Comment on the energy inherent in this concentration.
 (c) Calculate the number of protons in a respiring liver mitochondrion, assuming its inner matrix compartment is a sphere of diameter $15 \mu\text{m}$.
 (d) From these data would you think the pH gradient alone is sufficiently great to generate ATP ?
 (e) If not, can you suggest how the necessary energy for synthesis of ATP arises ?

- 13.** ATP production in the flight muscles of the fly *Lucilia sericata* results almost exclusively from oxidative phosphorylation. During flight, $187 \text{ ml of O}_2/\text{h} \cdot \text{g}$ of fly body weight is needed to maintain an ATP concentration of $7 \mu\text{mol/g}$ of flight muscle. Assuming that the flight muscles represent 20% of the weight of the fly, calculate the rate at which the flight-muscle ATP pool turns over. How long would the reservoir of ATP last in the absence of oxidative phosphorylation ? Assume that reducing equivalents are transferred by the glycerol-3-phosphate shuttle and that O_2 is at 25°C and 101.3 kPa (1 atm). (**Note :** Concentrations are expressed in micromoles per gram of flight muscle.)

- 14.** Iron-containing compounds that act as hydrogen acceptors in the respiratory chain are :
- (a) flavoproteins
 (b) dehydrogenases
 (c) cytochromes
 (d) oxidases