

# **Tropical Residual Soils ENGINEERING**

**BUJANG B.K. HUAT**

**GUE SEE SEW**

**FAISAL HJ. ALI**

**- EDITORS -**

# TROPICAL RESIDUAL SOILS ENGINEERING



# Tropical Residual Soils Engineering

*Edited by*

**Bujang B.K.Huat**

*University Putra Malaysia, Malaysia*

**Gue See Sew**

*Gue & Partners Sdn Bhd, Kuala Lumpur, Malaysia*

**Faisal Haji Ali**

*University of Malaya, Malaysia*



**A.A.BALKEMA PUBLISHERS**

**LEIDEN/LONDON/NEW YORK/PHILADELPHIA/SINGAPORE**

This edition published in the Taylor & Francis e-Library, 2009.

To purchase your own copy of this or any of  
Taylor & Francis or Routledge's collection of thousands of eBooks  
please go to [www.eBookstore.tandf.co.uk](http://www.eBookstore.tandf.co.uk).

Copyright © 2004 Taylor & Francis Group plc, London, UK

*All rights reserved. No part of this publication or the information contained herein may be reproduced, stored in a retrieval system, or transmitted in any form or by any means, electronic, mechanical, by photocopying, recording or otherwise, without written prior permission from the publisher.*

*Although all care is taken to ensure the integrity and quality of this publication and the information herein, no responsibility is assumed by the publishers nor the authors for any damage to property or persons as a result of operation or use of this publication and/or the information contained herein.*

Published by: A.A.Balkema Publishers, a member of Taylor & Francis Group plc  
[www.balkema.nl](http://www.balkema.nl) and [www.tandf.co.uk](http://www.tandf.co.uk)

ISBN 0-203-02462-1 Master e-book ISBN

ISBN 90 5809 660 2 (Print Edition)

## Table of Contents

Preface	xi
Acknowledgements	xiii
1 Origin, formation and occurrence of tropical residual soils <i>H.Singh &amp; Bujang B.K.Huat</i>	
1.1 Soils	1
1.2 Concept of residual soils	2
1.3 Definitions of residual soils	2
1.4 General features of residual soils	3
1.5 Origin of residual soils	4
1.6 Formation of residual soils	5
1.7 Weathering and residual soils	16
1.8 Weathering in tropical climates	24
1.9 Products of weathering	25
1.10 Structure of residual soils	28
1.11 Other forms of residual soils	30
1.12 Geographical occurrence of residual soils	31
Acknowledgement	33
References	33
2 Sampling and testing of tropical residual soils <i>Bujang B.K.Huat, A.Alias &amp; S.Jamaludin</i>	
2.1 Introduction	35
2.2 Sampling	36
2.3 Index and engineering properties tests	43

2.4	Summary	60
	References	60
3	Index, engineering properties and classification of tropical residual soils <i>S.Maail, Bujang B.K.Huat &amp; S.Jamaludin</i>	
3.1	Introduction	63
3.2	Index properties	63
3.3	Engineering properties	69
3.4	Descriptions identification and classification of tropical residual soils	75
3.5	Conclusions	95
	References	95
4	Unsaturated residual soil <i>F.H.Ali &amp; H.Rahardjo</i>	
4.1	Introduction	99
4.2	Types of problems	101
4.3	Tropical residual soil	105
4.4	Unsaturated soil theory	107
4.5	Laboratory tests on unsaturated residual soils	114
4.6	Field tests	118
4.7	Conclusion	125
	References	125
5	Slope failures in tropical residual soil <i>L.Shaw-Shong</i>	
5.1	Introduction	128
5.2	Site A—Creep movement of natural slopes at Sabah, East Malaysia	129
5.3	Site B—Cut slope in Skudai, Johore Bahru	140
5.4	Site C—Cut slope at Gua Musang, Kelantan	151
5.5	Site D—Cut slope at Kuala Lumpur	166
5.6	Site E—Filled slope at Salak Tinggi, Selangor	173
5.7	Site F—Filled slope at Putrajaya, Federal Territory	175
5.8	Conclusion	178
	References	179
6	Slope assessment and management <i>A.N.Hussein, H.Omar &amp; S.Jamaludin</i>	
6.1	Introduction	181

6.2	Definition of terms	181
6.3	Types of slope assessment	192
6.4	Methods of slope assessment	192
6.5	Slope management	193
6.6	Usage of slope assessment and slope management	194
	References	215
7	Guidelines for development on hill-sites <i>G.See-Sew &amp; T.Yean-Chin</i>	
7.1	Introduction	218
7.2	Position paper on mitigating the risk of landslide on hill-site development	219
7.3	Statute related to hill-site development in Malaysia	221
7.4	Planning, analysis and design for hill-site development	222
7.5	Construction control	229
7.6	Maintenance of slopes	230
7.7	Conclusion	231
	References	232
8	Characterization of tropical soils in the design of material as natural foundation and fill <i>T.W.Hui &amp; R.Nithiaraj</i>	
8.1	Introduction	234
8.2	Geotechnical aspects of residual soil material used for land development	234
8.3	Considerations with residual soil as natural foundation material	235
8.4	Considerations with residual soil as construction fill material	235
8.5	Review of publications	236
8.6	Characterization of tropical soils	246
8.7	Conclusion	256
	References	257
9	Stabilization of tropical residual soils <i>Bambang I.Siswosoebrotho, M.Hossain, A.Alias &amp; Bujang B.K.Huat</i>	
9.1	Introduction	259
9.2	Benefits of stabilization	260
9.3	Methods of stabilization	260



9.4	Compaction of tropical residual soils	280
9.5	Regional research in residual soil stabilization	282
9.6	Summary	296
	References	296
10	Slope stability and stabilization <i>T.Yean-Chin &amp; C.Chee-Meng</i>	
10.1	Characteristics of tropical residual soil slope	301
10.2	Measurement of strength parameters and groundwater profile for assessment of slope stability	305
10.3	Design and stabilization of residual soil slopes	316
10.4	Regrading of slope profile	318
10.5	Rock berms (toe counterweight)	318
10.6	Reinforced soil wall	319
10.7	Soil nailing	325
10.8	Control of drainage and seepage	337
10.9	Conclusion	339
	References	339
11	Soil erosion and sedimentation assessment, control and management plan for the tropical region <i>R.Z.Abidin &amp; T.K.Hui</i>	
11.1	Introduction	342
11.2	Environmental guidelines and requirements on soil erosion and sedimentation assessment	343
11.3	Soil erosion features and impacts	347
11.4	Soil erosion assessment	348
11.5	Soil erosion assessment report (SEAR)	354
11.6	Incorporating best management practices for erosion control	358
11.7	Conclusion	368
	References	368
	Appendix 11.1	369
12	Geoenvironmental aspects of tropical residual soils <i>M.R.Taha, K.Ahmad, A.A.Aziz &amp; Z.Chik</i>	
12.1	Introduction	377

12.2	Types of contaminations	379
12.3	Soil-water interaction	382
12.4	Fundamentals of clay mineralogy	384
12.5	Effects of chemical/waste on the properties of soils	387
12.6	Hydraulic conductivity	387
12.7	Adsorption	389
12.8	Contaminant transport	392
12.9	Soil liners	394
12.10	Barrier/cutoff walls	397
12.11	Soil remediation	397
12.12	Foundations and spread of contamination	399
12.13	Contributions to sustainable development	401
12.14	Conclusion	402
	Acknowledgements	403
	References	403
13	Development and application of a spatial database for residual soils <i>A.R.Mahmud, A.R.Mohamed Shariff &amp; S.B.Mansor</i>	
13.1	Introduction	407
13.2	Why GIS	407
13.3	Database	408
13.4	Data for GIS	410
13.5	Spatial modelling, analysis and queries	413
13.6	Visualization of residual soils	414
13.7	Conclusion	416
	References	417
14	Country case study: engineering geology of tropical residual soils in Malaysia <i>B.K.Tan</i>	
14.1	Introduction	418
14.2	Formation of tropical residual soils	418
14.3	Weathering profiles	419
14.4	Distribution of tropical residual soils in Malaysia	421
14.5	Physico-chemical properties of tropical residual soils in Malaysia	422

x *Contents*

14.6	Clay mineralogy	427
14.7	Engineering significance and applications	428
14.8	Conclusions	430
	Acknowledgements	430
	References	430
	Author Index	432

## Preface

Residual soils are found in many parts of the world. Like other soils, they are used extensively in construction, either to build upon or as construction materials. Residual soils are formed when the rate of rock weathering process is more rapid than the transport processes by water, gravity and wind, resulting in much of the soils formed remaining in place. The soil typically retains many of the characteristics of the parent rock. In a tropical region, residual soil layers can be very thick, sometimes extending for hundred of meters before reaching un-weathered rock. Malaysia is one of the countries in the world where the residual soil cover occupies more than 70% of the country's land area. Unlike the more familiar transported sediment soil, the engineering properties and behavior of tropical residual soils may differ and are more difficult to predict and model mathematically.

This book represents state-of-the-art knowledge of various experts who have gained extensive experience with this soil. They include researchers, practising engineers and local authorities. Despite the abundance and significance of residual soils in a tropical country like Malaysia, dedicated efforts to produce a comprehensive document is far and few in between. Compared with transported sediment soil, our knowledge and understanding of tropical and residual soils is not as extensive. Meanwhile the need for knowledge of the engineering behavior of tropical and residual soil is great thanks to the extensive construction worldwide on such soils. This book is specially written to serve as a guide for engineers, researchers and students on the state-of-the-art knowledge on engineering of tropical residual soils.

Bujang B.K.Huat  
Gue See Sew  
Faisal Hj.Ali



## Acknowledgements

We are very grateful to a many people who have contributed to the realization of this book. Many meetings had to be called and attended, countless hours were spent on writing and rewriting the chapters, and numerous letters and email messages sent and received. For all persons who have contributed to the organization of this event we herewith would like to express our sincere appreciation.

We would like to extend our thanks to all our authors and co-authors, as well as other contributors, especially Ms. Tan Tse Yuen and Ms. Nor Azwati Azmi; our language editor Ms. Sumangala Pillai of University Putra Malaysia Press.

We are indebted to the University Putra Malaysia and the Institution of Engineers Malaysia for organizing a special symposium under the same title.

Last but not least we would like to express our sincere gratitude to Mrs. Ernaleza Mahsum and Ms. Norzuwana binti Wahab who were largely responsible for the technical formatting of the book.

Editors



# CHAPTER 1

## Origin, formation and occurrence of tropical residual soils

Harwant Singh

*University Malaysia Sarawak, Malaysia*

Bujang B.K.Huat

*University Putra Malaysia*

This chapter overviews the origin, formation and occurrence of residual soils with special emphasis on those of the tropical region.

### 1.1 SOILS

Soils constitute the multi-phased interface stratum formed by the interaction of the lithosphere with the atmosphere, hydrosphere and biosphere. This dynamism may be expressed through the metaphor of the earth as an engine where the atmosphere is the working fluid of the earth's heat engine (Ingersoll 1983). This drives the dynamics on the terrestrial surface expressed through the operation of physical and chemical processes at the earth's surface resulting in the formation of soils.

Soils form a mantle of unconsolidated superficial cover that is variable in thickness. This is due to the fact that the depths to which the terrestrial materials, namely rocks, have been altered to form soils vary as function of factors such as climate, topography and the nature of the subsurface. It is also due to the varying thickness of the transported materials that come to form the unconsolidated superficial cover.

Soils may, therefore, be grouped into two broad categories: residual and transported soils. Residual soils form or accumulate and remain at the place where they are formed. Transported soils are formed from materials formed elsewhere that have moved to the present site where they constitute the unconsolidated superficial layer. The physical processes through the operation of their agents of transportation i.e. gravity, wind, water etc. have dislodged, eroded, transported soil particles to their present location.

The term 'soils' in engineering is commonly used to refer to any kind of loose, unconsolidated natural material enveloping the surface that is relatively easy to separate by even



## 2 Tropical Residual Soils Engineering

gentle means (Terzaghi & Peck 1967). According to Johnson & De Graff (1988) any mineral that lacks high strength is considered a soil. As a consequence, both the above two types of unconsolidated superficial cover are referred to as soil. The residual soils found in the tropics form the subject of this book.

### 1.2 CONCEPT OF RESIDUAL SOILS

According to McCarthy (1993) residual soils are those that form from rock or accumulation of organic material and remain at the place where they were formed. This entire unconsolidated superficial cover is referred to as soil (Press & Siever 1994). However, according to Bland & Rolls (1998) this mantle is also termed the *regolith* which is separated into an upper part referred to as *soil* i.e. of a thickness of 0.3–2.0 m or more and the portion below this that progressively grades into the bedrock called the *saprolite* that has been chemically altered especially in humid tropical regions.

Compositionally, the solid phase is constituted not only from the residue of unaltered terrestrial material but also the products of the interaction of the terrestrial material with the agents of surface processes. In addition, it also consists of aqueous (water) and gaseous phases. That portion, normally the upper *regolith* that supports plant life, also includes organic matter (both living and dead).

### 1.3 DEFINITIONS OF RESIDUAL SOILS

There is no universally accepted definition of residual soil; different workers provide different definitions. Some of these are listed below:

- a) Brand & Phillipson (1985) define it as ‘a soil formed by weathering in place, but with the original rock texture completely destroyed’. This term is commonly used in a wider sense to include highly and completely decomposed rock, which as an engineering material behaves like a soil in places like Hong Kong.
- b) Blight (1985) gave the definition of residual soil in South Africa as all material of a soil consistency that is located below the local ancient erosion surface i.e. below the pebble marker. The exceptions are the extensive deposits of ancient windblown desert sands with some cohesion. Materials of this type are also considered to be residual soils. Soil reworked in situ by termites is also strictly, residual and not transported material.
- c) Sowers (1985) defined residual soil as the product of rock weathering that remains in place above the yet-to-be weathered parent rock. The boundary between rock and soil is arbitrary and often misleading. There is a graduation of properties and no sharp boundaries within the weathering profile.
- d) The Public Works Institute of Malaysia (1996) defines residual soils as ‘a soil which has been formed in situ by decomposition of parent material and which has not been transported any significant distance’ and defines tropical residual soil as ‘a soil formed in situ under tropical weathering conditions’.

Other workers echo the above definitions as soils formed by in situ weathering of rocks in which the original rock texture is completely destroyed, or soil formed by weathering



#### 4 Tropical Residual Soils Engineering

Pakistan	Yes	No	Yes	Yes?	No	No
Philip- pines	Yes	No	Yes	Yes	Yes	No
Singapore	Yes	Yes	Yes?	Yes	?	No?
South Africa	Yes	Yes?	Yes	Yes	?	Yes
Sri Lanka	Yes	Yes	Yes	Yes	Yes	No
U.K.	Yes	Yes	Yes	Yes	No	No
U.S.A.	Yes	Yes?	Yes	Yes	No	No

? Indicates that the authors have not clearly defined these terms.

#### *Horizons*

Residual soils generally show no formational stratification but display identifiable in situ differentiated horizontal horizons. This is due to the process of leaching as water for instance rainwater moving through soils dissolves minerals, transports the solutes and precipitates these further down the soil profile resulting in the leached and precipitation levels forming visible horizons.

#### *Composition*

The composition of residual soils is initially defined principally by the nature of the parent rocks. Residual soils are derived from various rock types like granites, gabbros, basalts, limestone and others. In the case of old residual soils, however, the advanced chemical decay, alteration and leaching may render the recognition of the parent rock materials very difficult or they may be obliterated.

### 1.5 ORIGIN OF RESIDUAL SOILS

Soils may be thought of as the corollary of the Earth's *exogenic* processes. They form as a result of the dynamics of geomorphic systems through the interplay of climatic elements with materials forming the subsurface of the landscape. Residual soils originated with the formation of the climatic systems and are part of the geological cycle, which has been in existence for hundreds of millions of years of geological time, as they formed from geological material over this time.

Igneous activity leading to the formation of igneous rocks provides the beginning of the geological cycle shown in Figure 1.1. Subjection of igneous rocks to sedimentary and metamorphic processes resulted in the formation of sedimentary and metamorphic rocks. Exposure of all these three rock types at the interface with the atmosphere to *exogenic* processes resulted in the formation of a mantle of in situ soils termed residual soils as a result of the gradual breakdown of the rocks.

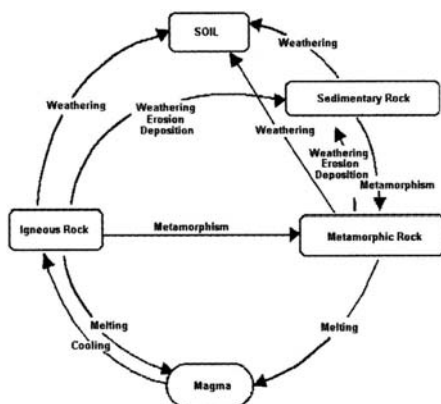

Figure 1.1. The geologic cycle (Singh & Huat 2003).

## 1.6 FORMATION OF RESIDUAL SOILS

The development of residual soils depends on the interaction of three natural features that are intrinsic variables. These variables are the chemical composition of the rock, environmental conditions and time. These give rise to natural factors that control the formation of residual soils. Consequently the character or qualities they assume express themselves through the complex natural processes involved in the formation of soils. Table 1.2 lists various factors that are responsible for the formation of soils.

### *State factors*

The factors or variables, given in Table 1.2, are also called state factors. These are briefly reviewed below before being considered in greater detail.

### *Climate*

Climate is perhaps the most important factor in soil formation. It governs the amount of precipitation and temperature available that in turn determines the various soil forming processes like the rate of rock weathering to the influence of vegetation on soil. As time passes, climate tends to play a more predominant role in soil formation and alteration.

Table 1.2. Major factors affecting soil formation (Bergman & McKnight 1993).

Factor	Description
Climatic	Refers to the effects on the surface by temperature and precipitation.
Geologic	Refers to the parent material (bedrock or loose rock fragments) that provide the bulk of most soils.

## 6 *Tropical Residual Soils Engineering*

Geomorphic/Topographic	Refers to the configuration of the surface and is manifested primarily by aspects of slope and drainage.
Biotic	Consists of living plants and animals, as well as dead organic material incorporated into the soil.
Chronological	Refers to the length of time over which the other four factors interact in the formation of a particular soil.

---

Soils tend to show a strong geographical correlation with climate, especially at the global scale. This is due to the different climatic regions developing residual soils with distinctly different characteristics as a consequence of their different temperature and precipitation patterns. High rainfall and temperatures generally increase the propensity for weathering by increasing the susceptibility of rocks to chemical reactions. Thus warm humid climatic regions generally have more weathered rock with higher rates of weathering than colder dry climates. For example, limestone in a dry desert climate undergoes very little weathering whereas limestones in a tropical climate show very rapid weathering.

### *Parent materials*

The formation of soils commences by chemical alteration and physical disintegration of rocks at their exposed surface. These rocks are termed the parent material. The parent material has the greatest influence on the incipient soils in the early stages of soil formation and in the drier regions (Birkeland 1984) but lessens over time as other soil forming factors become more active. There are a variety of parent materials as there are a variety of rock types with different mineral phases and chemical composition. As the parent materials i.e. their minerals undergo weathering, they exchange material with the environment through chemical reactions forming new minerals and assimilate water, gases and organic matter. Gerrard (2000) states concisely that parent material influences soils through the process of weathering and subsequently through the weathered material.

### *Time*

Time is a critical factor in soil formation as it determines the degree to which other factors either undergo change or are able to express themselves. The thickness of the soil layer and the chemical changes that have taken place depend upon, amongst others, on the time the soil forming processes have been occurring.

### *Topography*

Topography is important in soil formation as it exercises a significant control on surface processes like erosion and drainage. Different topographic terrains with different landscapes uniquely affect soil development.

*Biological activity*

Plants and animals play important roles in soil formation. Their primary contribution is to provide organic matter that is incorporated with the weathered parent material especially at the upper part of the *regolith*.

The five soil forming factors and some of their aspects are given Figure 1.2.

*Climate*

The weather represents atmosphere conditions at any time in a given place. Climate is the representation of the average weather conditions over the long-term (>30 years) taking into account the extremes, means and frequencies of departures from these means (Whit-tow 1988), The climate essentially determines the amount of precipitation and heat energy available for the physical, chemical and biological processes to take place.

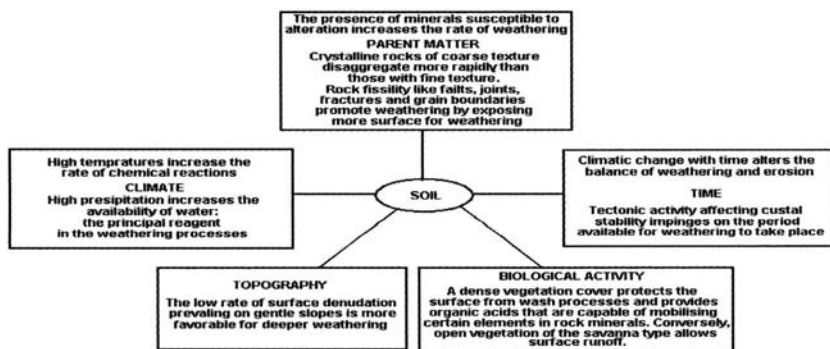

Figure 1.2. Factors responsible for soil formation (Aspects adapted from Thomas (1974)).

*Global climate classification systems*

The different climates, referred to as climatic types, enable a climate classifications based on their respective identical characteristics and areas experiencing similar climates are grouped into climatic regions. There is no single universal climate classification system. The climate classifications devised are genetic classifications based upon mechanisms like net radiation, thermal regimes or air-mass dominance over region or empirical classifications based on recorded data such as temperature and precipitation. The Köppen Climate Classification System, an empirical classification system, is the most widely used system for classifying the world's climates.

*Köppen classification system*

This system is based on the mean annual and monthly averages of temperature and precipitation that are combined and compared in a variety of ways. It defines five climate regions based on thermal criteria (temperature) and only one is based on moisture as listed in Table 1.3.

The Köppen system uses the capital letters A, B, C, D, E and H to designate these climatic categories with additional letters to further signify specific temperature and moisture conditions as illustrated in Table 1.4. The global distribution of the system is shown in Figure 1.3.

*Tropical climates*

Areas with tropical climates (the A category climate in the Köppen Classification System) are extensive, occupying almost all of the continents between latitudes 20°N to 20°S of the equator as illustrated in Figure 1.4.

The key criterion for an A category climate is for the coolest month to have a temperature of more than 18°C making it the only true winterless climate category of the world. The consistent day length and almost perpendicular sun angle throughout the year generates temperatures above 18°C. Another characteristic is the prevalence of moisture. Warm, moist and unstable air masses frequent the oceans at these latitudes. As a consequence, this climate zone has abundant sources of moisture giving rise to high humidity. The tropical climate is further classified into three types on the basis of the quantity and regime of annual rainfall as follows.

Table 1.3. The Köppen climate regions.

Category	Climate region
Based on temperature	
A	Tropical moist (equatorial regions)
C	Moist mid-latitude with mild winters (Mediterranean, humid subtropical)
D	Moist mid-Latitude with cold winters (humid continental, subarctic)
E	Polar with extremely cold winters and summers (polar regions)
H	Highland (cool to cold, found in mountains and high plateaus)
Based on moisture	
B	Dry with deficient precipitation during most of the year (deserts and steppes)

- a) Tropical wet type (Af)—it experiences relatively abundant rainfall in every month of the year.
- b) Tropical monsoonal type (Am)—it has a short dry season but a very rainy wet season.
- c) Tropical savanna type (Aw)—it is characterized by a longer dry season and a prominent but not extraordinary wet season.

*Morphoclimatic zones*

The climatic system fuels the earth's *exogenic* processes giving rise to the landscape. The different climates at the earth's surface dictating the respective geomorphic processes that operate in the regions which these influence has led geomorphologists to suggest that these different climates are associated with characteristic landform assemblages. These landforms are termed as belonging to morphoclimatic zones. The climatic elements and the relative importance of geomorphologic processes for the various morphological zones that have been delineated are described in Table 1.5. Figure 1.5 shows the geographical distribution of these zones

*Parent rocks*

The terrestrial subsurface is constituted from rocks which provide the parent materials for soils. Rocks have been divided into three main types based upon by their method of formation viz. igneous rocks, sedimentary rocks and metamorphic rocks. Each group contains a wide variety of rock types that differ from one another by either the chemical composition, texture or both.

*Igneous rocks*

Igneous rocks, as shown in Figure 1.1 above, form from molten magma that comes from the earth's interior. As the magma cools, it begins to crystallize minerals that form rocks. The two main types of igneous rocks are:

- a) Extrusive rocks—these are also referred to as volcanic rocks. They form when magmas reach and intrude onto the surface of the earth through volcanic

Table 1.4. Modified Köppen climatic classification (Bergman & McKnight 1993).

Letters			Description	Definition	Types
1st	2nd	3rd			
A			Low-latitude humid climates	Average temperature of each month above 18°C	Tropical wet (Af) Tropical monsoonal (Am)
	f		No dry season	Average rainfall of each month at least 6 cm	Tropical savanna (Aw)
	m		Monsoonal; short dry season compensated by heavy rains in other months	1 to 3 months with average rainfall less than 6 cm	
	w		Dry season in 'water' (low sun season)	3 to 6 months with average rainfall less than 6 cm	



10 *Tropical Residual Soils Engineering*

B	Dry climates; evaporation exceeds precipitation		Subtropical desert (BWh) Subtropical steppe (BSh)
w	Arid climates; 'true deserts'	Average annual precipitation less than approximate 38 cm in low latitudes; 25 cm in mid-latitudes.	Mid-latitude desert (BWk) Mid-latitude steppe (BSk)
s	Semiarid climates; steppe	Average annual precipitation less than approximate 38 cm and 76 cm in low latitudes; between about 25 cm and 64 in mid-latitudes; without pronounced seasonal concentration	
h	Low-latitude dry climate	Average annual temperature more than 18°C	
k	Mid-latitude dry climate	Average annual temperature less than 18°C	
C	Mild Mid-latitude dry climates	Average temperature of coldest month is between 18°C and -3°C; average temperature of warmest month is above 10°C	Mediterranean (Csa, Csb) Humid subtropical (Cfa, Cwa)
s	Dry summer	Driest summer month has less than 1/3 the average precipitation of wettest winter month	Marine west coast (Cfb, Cfc)
w	Dry winter	Driest winter month has less than 1/10 the average precipitation of wettest summer month	
f	No dry season	Does not fit either s or w above	
a	Hot summers	Average temperature of warmest month more than 22°C	
b	Warm summers	Average temperature of warmest month below 22°C; at least 4 months with average temperature above 10°C	
c	Cool summers	Average temperature of warmest month below 22°C; less than 4 months	
D	Humid mid-latitude climates with severe winters	with average temperature above 10°C 4 to 8 months with average temperature more than 10°C	

2nd and 3rd letters same as in C climates

	d	Very cold winters	Average temperature of coldest month less than $-38^{\circ}\text{C}$	
E		Polar climates; no true summer	No month with average temperature more than $10^{\circ}\text{C}$	Humid continental (Dfa, Dfb, Dwa, Dwb) Sub-artic (Dfc, Dfd, Dwc, Dwd)
	T	Tundra climates	At least one month with average temperature more than $0^{\circ}$ . But less than $10^{\circ}\text{C}$	Tundra (ET)
	F	Ice cap climates	No month with average temperature more than $0^{\circ}\text{C}$	Ice cap (EF)
H		Highland climates	Significant climatic changes within short horizontal distances due to altitudinal variations	Highland (H)

fissures or vents. They cool rapidly producing rocks with constituent crystals that are invisible to the eye. As a consequence these rocks are normally fine-grained or glassy.

- b) Intrusive rocks—these are also referred to as plutonic rocks. These rocks form below the earth’s surface and as the magma cools slowly at depth, it allows the growth of larger constituent crystals that are visible to the naked eye. These rocks form in fissures and other zones of weakness in the earth’s crust that when eventually uplifted are exposed at the surface by erosion.

The classification of igneous rocks is given in Figure 1.6 with the mineral and chemical compositions. It is also seen that they may also be classified into four major categories based on the mineralogical and chemical composition. This classification system is used in Table 1.6 to identify common types of igneous rocks.

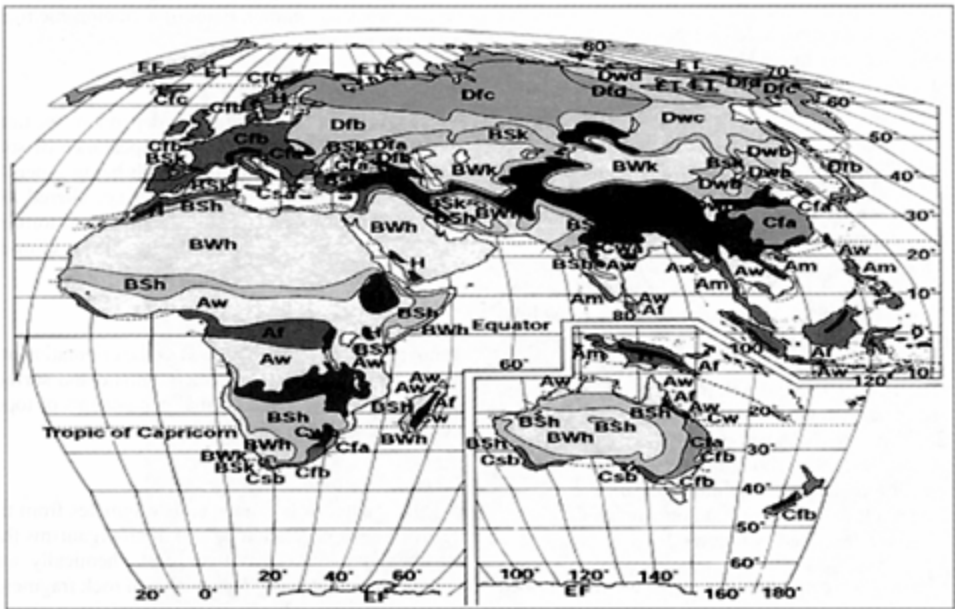
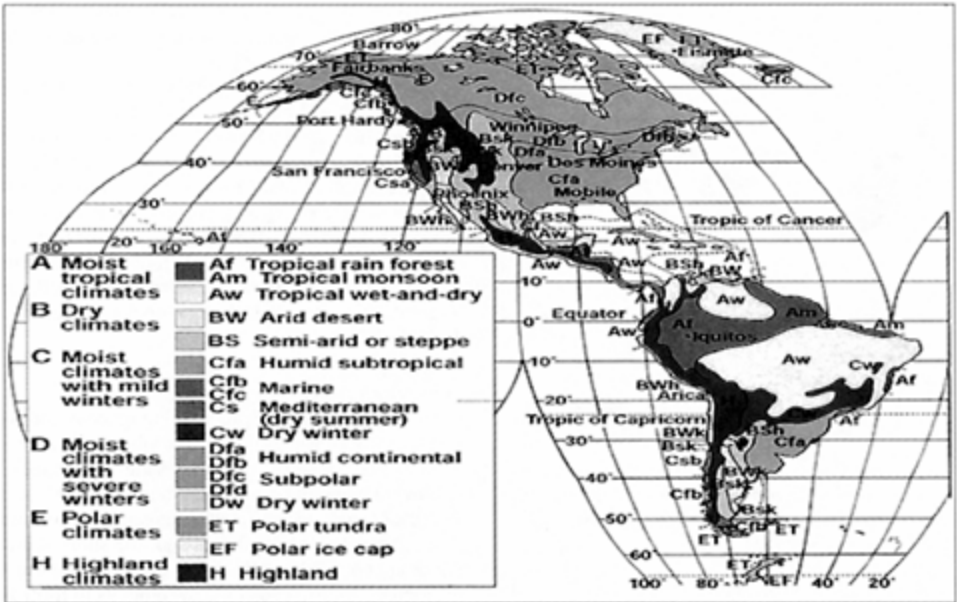

Figure 1.3. Global distribution of the Köppen classification system.

(Source: [http://calspace.ucsd.edu/virtualmuseum/climatechange1/07\\_1.shtml](http://calspace.ucsd.edu/virtualmuseum/climatechange1/07_1.shtml)).

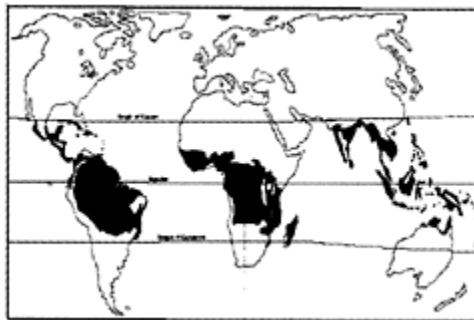

Figure 1.4. Areas with a tropical climate.  
(Source: World Wide Web).

### *Sedimentary rocks*

Sedimentary rocks are rocks formed from materials derived from pre-existing rocks. The sedimentary process forms and transports precursor materials like loose sediments or solutions and causes their deposition or chemical precipitation at or near the earth's surface. Sedimentary rocks form from the consolidation of the deposited sediments or the precipitates from solution. Figure 1.7 illustrates the sedimentary process leading to the development of different types of sedimentary rocks.

Sedimentary rocks can be classified according to their constituents or mode of origin. Their mode of origin differentiates them into three different types termed as clastic, chemical and organic rocks.

They are described as follows:

- a) **Clastic sedimentary rocks**—These are formed from sediments i.e. the fragmented older rocks broken down into smaller pieces through erosion and transportation. These sediments are then lithified i.e. consolidated and cemented together by a process called diagenesis to form rock. These clastic sedimentary rocks are further classified by the size of sediments ranging from large particles (cobbles and pebbles) to microscopic particles (clay) as given in Table 1.7. These clastic sedimentary rocks are usually stratified or layered displaying beddings.
- b) **Chemical sedimentary rocks**—these form from direct chemical precipitation from water. They are called chemical or chemical sedimentary rocks. The chemical sedimentary rocks are given in Table 1.8.
- c) **Organic sedimentary rocks**—these form from the accumulation of organic remains. For example, coal is an organic rock that forms from plant remains such as moss, leaves, twigs, roots and tree trunk while limestone may also form from shells and corals. Organic sedimentary rocks are listed in Table 1.8.

*Metamorphic rocks*

Metamorphic rocks are pre-existing igneous and sedimentary rocks (or even metamorphic rocks) forced to undergo change in the solid state by changes in temperature and pressure at depth in the earth's crust. These changes occur beyond diagenetic conditions (see sedimentary rocks above) and stop short of melting or anataxis. Material may be added or lost during the metamorphism causing new minerals to form and others to re-crystallize producing completely new types of rocks. Common types of metamorphic rocks are given in Table 1.9.

*Time*

The extent of soil formation is dependent on time. In the tropics the thickness and appearance of soils show the effects of time by older soils being generally thicker and more highly weathered i.e. altered and leached. It is also stated that the value of a soil-forming factor may change with time (e.g. due to climatic change etc).

*Topography*

Topography influences the soils as the orientation and aspect of relief affects the microclimate and surface process on slopes. The essential components of topography are given in Table 1.10.

*Biological activity*

Organic matter or humus in soils originates from the decay of dead vegetation by soil microorganisms that also produce soil acids that react chemically and weather rock materials. The mixing of rock fragments and soil particles by burrowing organisms creates pore space for aeration of the soil. Soils are reported to be thicker and formed more rapidly in areas where there is an abundance of microorganisms. Plants also extend pore spaces into deeper soil layers with their penetrating roots. This enables moisture to reach deeper material and fresh rock surfaces thus extending chemical weathering.

Table 1.5. The earth's major morphoclimatic zones according to Summerfield (1996).

Morphoclimatic zone	Mean annual temperature (°C)	Mean annual precepitation (mm)	Relative importance of geomorphic processes
Humid tropical	20–30	>1500	High potential rates of chemical weathering; mechanical weathering limited; active, highly episodic mass movement; moderate to low rates of stream corrosion but locally high rates of dissolved and suspended load transport

Tropical wet-dry	20–30	600–1500	Chemical weathering active during wet season; rates of mechanical weathering low to moderate; mass movement fairly active; fluvial action high during wet season with overland and channel flow; wind action generally minimal but locally moderate in dry season
Tropical semi-arid	10–30	300–600	Chemical weathering rates moderate to low; mechanical weathering locally active especially on drier and cooler margins; mass movement locally active but sporadic; fluvial action rates high but episodic; wind action moderate to high
Tropical arid	10–30	0–300	Mechanical weathering rates high (especially salt weathering); chemical weathering minimal; mass movement minimal; rates of fluvial activity generally very low but sporadically high; wind action at a maximum
Humid mid-latitude	0–20	400–1800	Chemical weathering rates moderate, increasing to high at lower latitudes; mechanical weathering activity moderate with frost action important at higher latitudes; fluvial processes: wind action confined to coasts
Dry continental	0–10	100–400	Chemical weathering rates low to moderate; mechanical weathering, especially frost action, seasonally active; mass movement moderate and episodic; fluvial processes active in wet season; wind action locally moderate
Periglacial	<0	100–1000	Mechanical weathering very active with frost action at a maximum; chemical weathering rates low to moderate; mass movement very active; fluvial processes seasonally active; wind action rates locally high
Glacial	<0	0–1000	Mechanical weathering rates (especially frost action) high; chemical weathering rates low; mass movement rates low except locally; fluvial action confined to seasonal melt; glacial action at a maximum; wind action significant
Azonal mountain zone	Highly variable	Highly variable	Rates of all processes vary significantly with altitude; mechanical and glacial action significant at high elevations

---

### 1.7 WEATHERING AND RESIDUAL SOILS

Residual soils are described as the residua that result from the weathering of rocks over a period of time. They are products of in situ weathering of igneous, sedimentary and metamorphic rocks and as they have suffered very little or no transport during or after their formation, they are found more or less covering the parent rocks (Singh & Kataria 1980). The degree of weathering and extent to which the original structure of the rock mass is destroyed varies with depth from the ground surface.

Weathering consists of chemical weathering operating through chemical decomposition, physical weathering involving physical disintegration and biological weathering caused by chemical or physical changes through the agency of biological organism. The former two processes are quite distinct as disintegration involves no chemical reactions but these processes often operate simultaneously abetting each other as in the case of the physical disintegration of a larger rock into smaller parts whereby increasing the total surface area and accelerating chemical decomposition. In certain situations one type of weathering may dominate other.

Thermodynamically, the rocks formed at temperatures and pressures that greatly different within the crust have a propensity to respond to surface processes when exposed at the surface because they are inherently unstable in this environment. They will tend to change in a direction forming new phases in the process that are closer to equilibrium at the surface environment. This makes them susceptible to weathering whereby they break down and alter into products that are more in equilibrium with surface conditions.

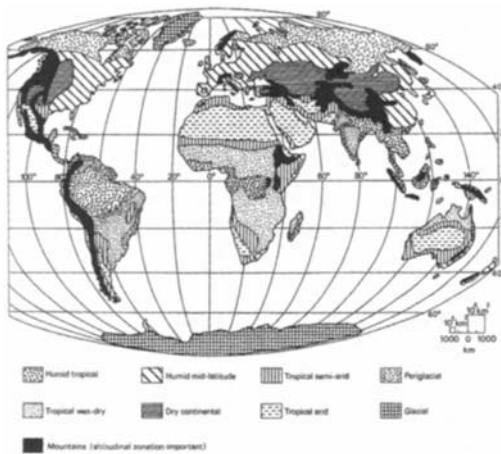

Figure 1.5. Global distribution of morphoclimatic zones (Summerfield 1996).

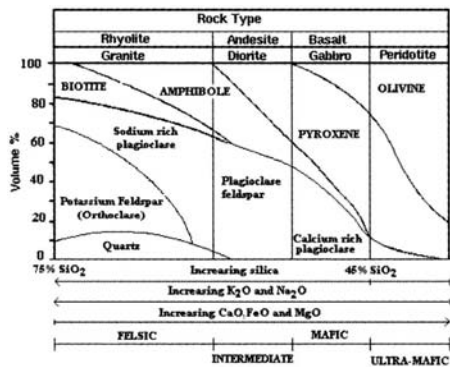

Figure 1.6. Classification of igneous rocks.

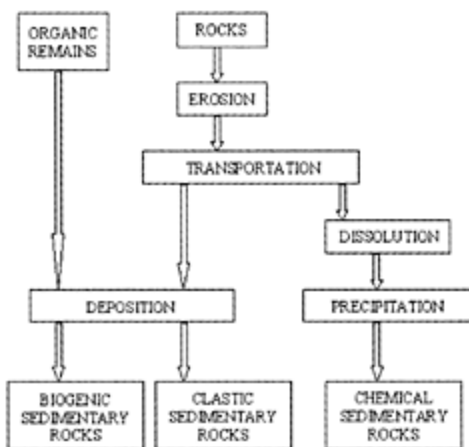

Figure 1.7. The formation of sedimentary rocks.

Table 1.6. Identification of igneous rocks.

		Rock type			
Texture	Coarse-Grained	Granite	Diorite	Gabbro	Ultramafic rocks
	Fine-Grained	Rhyolite	Andesite	Basalt	–
Minerals		Quartz, feldspars, minor ferromagnesian minerals	Feldpars, ferromagnesian minerals (30–50%), no quartz	Predominantly ferromagnesian minerals. Other mineral is feldspar	Entirely ferromagnesian minerals (normally olivine and pyroxene)
Colour		Light	Intermediate	Dark	Dark



Table 1.7. Clastic sedimentary rocks.

Size range (mm)	Particle name	Sedimentary rocks
	Boulder	Conglomerates (rounded particles) or
256	Cobble	Breccia (angular particles)
64	Pebble	
2	Sand	Sandstone
1/16	Silt	Siltstone
1/256	Clay	Shale or Mudstone

Table 1.8. Chemical and biogenic sedimentary rocks.

<i>Chemical sedimentary rocks</i>	
Cherts	Formed from the chemical precipitated of $\text{SiO}_2$
Evaporites	Formed by evaporation of sea water which produces the chemical precipitation halite (salt) and gypsum ( $\text{CaSO}_4 \cdot 2\text{H}_2\text{O}$ ) deposits
Limestone	Formed by precipitation of calcite ( $\text{CaCO}_3$ )
<i>Biogenic sedimentary rocks</i>	
Limestone	Formed from the cementation of skeletal remains of calcite ( $\text{CaCO}_3$ ) precipitated by organisms to form shells.
Diatomite	Formed from the siliceous remains of radiolarians or diatoms
Coal	Formed from the deposition of dead plant matter in a reducing environment (lack of oxygen).

Table 1.9. Common types of metamorphic rocks.

Texture	Rock Name	Precursor rock	Metamorphism		Mineral composition*									
			Type	Grade	a	b	c	d	e	f	g			
	Slate	Shale	Regional	Low	↔	↔	↔	↔	↔					
	Phyllite													
Foliated	Schist			Medium		↔	↔	↔	↔	↔	↔			
	Gneiss			High										
	Hornfels	Shale	Contact											
	Quartzite	Quartz sandstone	Contact or regional											
Non foliated	Marble	Limestone or dolomite												
			Contact or regional											

\*a- clay; b- chlorite; c- mica; d- quartz; e- amphibole; f- feldspar; g- calcite

Table 1.10. Essential topographic attributes.

Attribute	Definition	Effect
Altitude	Elevation	Elevation affects the soil wetness.
Slope	Angle of the land surface or gradient	Steepness of the slopes affects the rates of surface-water runoff and erosion as on steep slopes weathering products may be quickly washed away by rains but accumulate on gentle slopes.
Aspect	Direction the slope faces or azimuth	This deals with the direction the slope faces, South facing will generally be drier, warmer, and less moist than north facing slopes because they get more direct sunlight. This slope idea can be related to mountainsides and hillsides.

### *Types of weathering*

#### *Physical weathering*

Physical or mechanical weathering is the physical disintegration of a rock into smaller fragments. The different types of physical weathering include frost wedging, exfoliation, thermal expansion and contraction and abrasion.

*Frost wedging*—it occurs when water freezes and expands in cracks in rocks. The expansion causes the rocks to come apart causing them to break up.

*Wetting and drying*—this is also known as slaking. Slaking occurs when the accumulated layers of water molecules in the mineral grains of a rock due to their increasing thickness push the rock grains apart with great tensional stress.

*Thermal expansion and contraction*—as heating causes rock to expand and cooling results in contraction, the repeated expansion and contraction of different minerals at different rates causes stresses along mineral boundaries leading to breakdown of the rock.

*Mechanical exfoliation*—this happens when the rock breaks into flat sheets along joints that parallel the ground surface as the rock is uncovered. This phenomenon is due to the expansion of rock due to pressure release caused by the removal of overlying rock by erosion. This is also called unloading. Exfoliation commonly occurs whenever plutonic igneous rocks are exposed. Plutonic rocks that cooled at depth under great pressure are subject to removal of pressure once the overburden is removed resulting in sheets of rock peeling off.

*Abrasion*—this is the physical grinding down of rock fragments. It occurs when two rock surfaces come in contact with mechanical wearing or grinding of their surfaces.

#### *Chemical weathering*

Chemical weathering involves the chemical dissolution or alteration of the chemical and mineralogical composition of minerals. It involves the breakdown of minerals into new compounds by the action of chemical agents (e.g. acid in the air, in rain, etc). The rock forming minerals are vulnerable to attack by water, oxygen and carbon dioxide at the new surface environment they are exposed to, and tend to undergo chemical changes to form new stable minerals.

Gidigasu (1976) mentions that the main sequence of the chemical weathering process is as follows:

- a) First, the rock structure is made weaker by the selective attack on the constituent minerals in igneous and metamorphic rocks, by a more general attack on calcareous rocks and by an attack on the cements of some sedimentary rocks.
- b) Second, stresses are created within a rock by causing varying expansion of certain minerals.

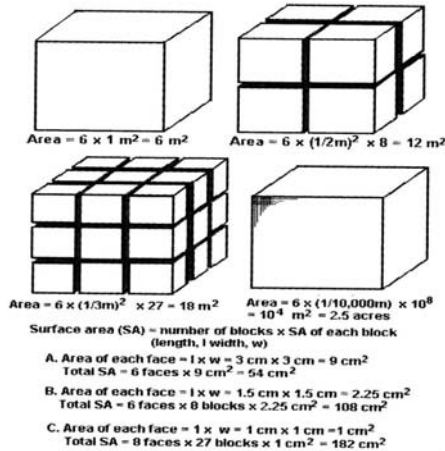

Figure 1.8. Area of surface available for weathering.

- c) Third, compounds are produced which can be removed in solution, leaving behind residual deposits. These include residual decomposition products e.g. clay minerals.

Chemical weathering is dependent on the amount of surface area, temperature and the availability of chemically active fluids. Smaller sized particles weather more rapidly due to a larger surface area. Figure 1.8 illustrates how as the particles get smaller, its total surface area available for chemical weathering increases.

The presence of water and dissolved materials like ammonia, oxygen, carbonic acid, chlorides, sulphates and other materials cause chemical weathering. An increase in temperature increases the effectiveness of carbonic acid and oxygen as shown, for example, in humid climates where the intensity of the chemical weathering processes increases on account of the higher temperature. The maximum intensity of chemical weathering processes of rocks, consequently, occurs in the tropical regions (Jumikis 1965). A number of different processes cause chemical weathering. The most common ones are hydrolysis, oxidation, reduction, hydration, carbonation and solution. These processes are described in Table 1.11.

*Biological weathering*

Biological weathering involves the disintegration of rock by biological organisms which act both as chemical and/or physical agents of weathering. Biological weathering, therefore, involves chemical or physical processes. These organisms release acids that react with rocks or mechanically break them up. A wide range of organisms ranging from micro-organisms to plants and animals can cause weathering. Some of the more important processes are:

Table 1.11. Common chemical processes.

Process	Description
Solution	Decomposition of minerals involving water as a solvent and in rainwater aided by carbonic acid ( $\text{H}_2\text{CO}_3$ ) formed due the presence of $\text{CO}_2$ .
Oxidation	The combination with oxygen, the most common oxidizing agent, to form oxides and hydroxides or any other reaction which causes the loss of an electron that results in an increase in the positive charge.
Hydration	Hydration involves the absorption of water into the mineral causing the expansion of the mineral leading to eventual weakening.
Hydrolysis	Reaction of water directly with minerals where metal cations, replaced by hydrogen ( $\text{H}^+$ ) ions, combine with hydroxyl ( $\text{OH}^-$ ) ions.
Carbonation	The carbon dioxide ( $\text{CO}_2$ ) dissolves in water to form carbonic acid ( $\text{H}_2\text{CO}_3$ ) that reacts with minerals to e.g. dissolve calcite into bicarbonate ions and calcium.
Leaching	This involves the migration of ions by dissolution into water. The mobility of ions depends upon their ionic potential. For example, Ca, Mg, Na, K are easily leached by moving water, Fe is more resistant, Si is difficult to leach while Al is almost immobile

- a) Rock fracture because of animal burrowing or the pressure from growing roots.
- b) Movement and mixing of materials by movement of soil organisms.
- c) Carbon dioxide produced by organism respiration mixing with water forming carbonic acid augments simple chemical processes like solution.
- d) Organic substances called *chelates* produced by organisms decompose minerals and rocks by the removal of metallic *cations*.
- e) The moisture regime in soils influenced by organisms induces weathering as water is a necessary component in weathering processes.

*Rate of weathering*

The rate of weathering is influenced by many factors such as climatic conditions, respective resistances of the different rocks and minerals to weathering, topography, size of rock particles, relative surface area of rock exposed and the permeability of rock mass to mention a few.

Table 1.12. Mean lifetime of one millimeter of fresh rock (Nahon 1991).

Igneous rock type	Climate	Time (years)
Acid rocks	Tropical Semi arid	65 to 200
	Tropical humid	20 to 70
	Temperate humid	41 to 250
	Cold humid	35
Basic rocks	Temperate humid	68
	Tropical humid	40

The temperature and mean annual precipitation rates resulting in different soil moisture contents affects the rate of weathering. This can be gauged from the mean lifetime of one millimeter of each of the different igneous rocks into a kaolinitic saprolite shown in Table 1.12 as they are exposed to different climatic conditions. These numbers reveal that in cold, temperate or tropical humid zones, the climate (temperature and precipitation) controls the rate of weathering.

Generally, the following conclusions are valid for the influence of climate:

- a) Wet and cold climates increases the rate of weathering dramatically.
- b) Hot and dry climates decrease the rate of weathering.

Different rocks and minerals display varying resistance to weathering as a function of their structure and mineral composition. Minerals are naturally formed crystals composed of one or more chemical elements. They are distinguished from other natural materials by their crystalline structure. Some minerals weather more quickly than others depending on the mineral stability in the weathering environment. A few minerals are readily soluble in slightly acidic water whereas others are very resistant to weathering and persist for a long time without alteration. Minerals that form at high temperatures and pressures are least stable and weather most quickly because they are furthest away from equilibrium or the conditions under which they formed. Conversely, those formed at lower temperatures and pressures are most stable under surface conditions. The Goldich's mineral stability series, as shown in Figure 1.9, gives the order of weathering for silicate minerals.

The behavior of main rock forming minerals with some selected examples is cited as follows:

- a) The mineral quartz is one of the most stable minerals as it is highly resistant to chemical decomposition and remains much as it is formed for a considerable time. It is, however, eventually eroded into sedimentary particles of various sizes over a long period of time.
- b) Feldspars weather quite rapidly into clay minerals and some constituent elements are released into solution.

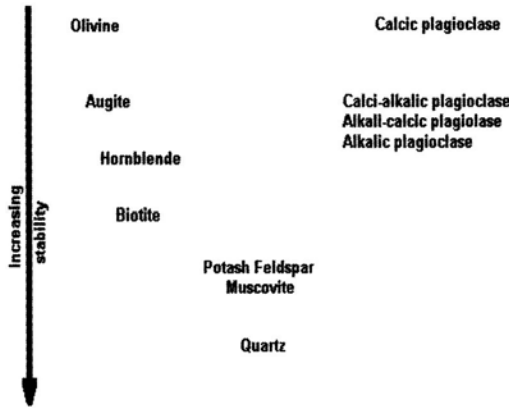

Figure 1.9. Goldich's mineral stability series (Goldich 1938).

- c) Mica minerals may remain relatively unaffected by weathering.
- d) Ferromagnesian minerals weather rapidly to form clays and iron oxides. The latter are often responsible for rich red colour stains observed in weathering rocks.
- e) Marbles and limestone are much more susceptible to chemical attack by acids in rain-water than mechanical weathering.

Silicate minerals are the most common materials in the earth's crust. These occur in rocks and also in weathered products like clays etc. The basic structural unit in silicates is the  $\text{SiO}_4$  tetrahedron where four oxygen atoms surround a silicon atom in tetrahedral arrangement. The resistance of silicate minerals to weathering is attributed to increase with the degree of sharing of oxygen atoms between adjacent  $\text{SiO}_4$  tetrahedra. The order of increasing stability of silicates is shown in Figure 1.9 above. Olivine undergoes rapid weathering as the silicon tetrahedra are joined together only by oxygen-metal cations. Quartz, on the other hand, is very resistant as it is formed of silicon tetrahedra linked together. In amphiboles and pyroxenes (the chain silicates) and micas (phyllosilicates or sheet structures) the oxygen-metal cations are the weakest points in their structures. The calcium feldspars have a lower stability in comparison to sodium and potassium feldspars as the substitution of  $\text{Al}^{3+}$  for  $\text{Si}^{4+}$  also contributes to instability as the Si-O bonds decrease and more oxygen-metal cations bonds are necessary.

### 1.8 WEATHERING IN TROPICAL CLIMATES

Considered on a global scale, decomposition by chemical weathering is more prevalent and effective in breaking down rocks than mechanical disintegration and in some regions, the dominance of this activity is very pronounced. Chemical weathering is especially effective in the presence of water (due to its reactivity) and high temperature (which influences the rates of chemical reaction by accelerating them). The predominance of chemical or mechanical weathering as a function of climatic elements especially rainfall and temperature is as shown in Figure 1.10.

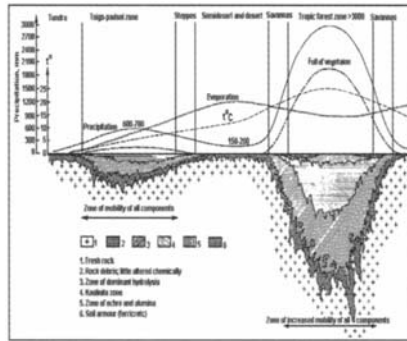

Figure 1.10. The zones of weathering in relation to latitude (after Strakhov 1967). 1. Fresh rock; 2. Rock debris; little altered chemically; 3. Zone of dominant hydrolysis; 4. Kaolinite zone; 5. Zone of ochre and alumina; 6. Soil armour (ferricrete).

These residual soils may be very thick in areas with conditions favorable for intense weathering such as the tropics or they may be very thin or absent in areas of unfavorable conditions like arid regions or steep mountains slopes subject to erosion by mass movements. Figure 1.11 shows the geographical distribution of the zones of weathering that dictate their expansiveness and depth.

## 1.9 PRODUCTS OF WEATHERING

The products of weathering are important, as these constitute the residual soils. The weathering process can result in the following outcomes shown in Table 1.13 for selected minerals:

- a) The complete loss of elements or compounds from rocks and minerals.
- b) The addition of new elements or compounds to form new phases.
- c) Only a mechanical breakdown of one mass into two or more parts without any chemical change of minerals or rocks.

### *Weathering products from rock-forming minerals*

Minerals are naturally formed crystals composed of one or more chemical elements. They are distinguished from other natural materials by their crystalline structure. Some minerals weather more quickly than others depending on the mineral stability in the weathering environment. A few minerals are readily soluble in slightly acidic water whereas others are very resistant to weathering and persist for a long time without alteration. Minerals that form at high temperatures and pressures are least stable and weather most quickly because they are furthest away from equilibrium or the conditions under which they formed. Con-



versely, those formed at lower temperatures and pressures are most stable under surface conditions. As shown in Figure 1.9, the Goldrich's mineral stability series gives the order of weathering for silicate minerals.



Figure 1.11. The geographical distribution of weathering types (after Strakhov 1967).  
 Glacial sedimentation. 2. Arid sedimentation 3. Tectonically active-no weathering mantle  
 I. Region of temperate moist climate: 4. Chemical weathering reduced by low temperatures, 5. Normally developed weathering, 6. Chemical weathering reduced by low precipitation, 7. Chemical weathering reduced by high relief  
 II. Region of tropical moist climate: 8. Chemical weathering slight because of low precipitation, 9. Chemical weathering intense, 10. Periphery of zone. 11. Mountain ranges. Ta-Tectonically active areas.

Table 1.13. Products of weathering from mineral phases (from McGeary & Plummer 1998).

Mineral	Weathering products	
	Solid products	Other products (mostly soluble)
Feldspar	Clay (New mineral phase)	Ions ( $\text{Na}^+$ , $\text{Ca}^{++}$ , $\text{K}^+$ ), $\text{SiO}_2$
Ferromagnesian (including biotite mica) minerals	Clay (New mineral phase)	Ions( $\text{Na}^+$ , $\text{Ca}^{++}$ , $\text{K}^+$ ), $\text{SiO}_2$ , Fe oxides
Muscovite mica	Clay (New mineral phase)	Ions ( $\text{Na}^+$ , $\text{Ca}^{++}$ , $\text{K}^+$ ), $\text{SiO}_2$
Quartz	Quartz (grains) (Mechanical breakdown)	Ions ( $\text{K}^+$ ), $\text{SiO}_2$
Calcite	(Dissolution)	Ions ( $\text{Ca}^{++}$ , $\text{HCO}_3^-$ )

Table 1.14. Weathering of common rock forming minerals Post-weathering residual minerals are stable at the earth's surface.

(Source: <http://www.tulane.edu/~sanelson/geol111/weathering.htm>).

Primary minerals	Residual minerals*	Leached ions
Feldspars	Clay minerals	Na <sup>+</sup> , K <sup>+</sup>
Micas	Clay minerals	K <sup>+</sup>
Quartz	Quartz	–
Fe-Mg minerals	Clay minerals+ Hematite+ Goethite	Mg <sup>2+</sup>
Feldspars	Clay minerals	Na <sup>+</sup> , Ca <sup>2+</sup>
Fe-Mg minerals	Clay minerals	Mg <sup>2+</sup>
Magnetite	Hematite, Goethite	–
Calcite	None	Ca <sup>2+</sup> , CO <sub>3</sub> <sup>2-</sup>

Table 1.14 summarizes weathering products for the common minerals. Quartz and clay minerals are the common products formed after complete chemical weathering of rock-forming minerals. Other products, such as iron oxides, are also precipitated.

#### *Weathering products from parent rocks*

Rock weathering involves the weathering of their respective constituent minerals. The mineral suite forming the respective major rock type (igneous rocks, sedimentary rocks and metamorphic rocks) determines the products of weathering from these rocks.

The character of a residual soil also depends on the parent rock it develops from. For examples, residual soil on weathered granite will initially be sandy, as sand-sized particles of quartz and partially weathered feldspar are released from the granite. The partially weathered feldspar grains will gradually over time further completely weather into fined-grained clay minerals. As the resistant quartz does not weather, the resulting soil will have both sand-sized quartz and clay. This will further change over time as this residual soil that develops from granite may become more clayey. The influence of the parent rock decreases over the passage of time. After a sufficient time period, the differences in the residual soils from different types of rocks i.e. igneous, sedimentary and metamorphic may be obliterated. The present or absence of coarse grains quartz in the parent rock becomes the only vestige that survives and has a long-term significance. The weathering products of some common rock types are listed in Table 1.15.

Table 1.15. Weathering products of some common rocktypes.

Rock type	Product
Igneous	
Granite	Quartz sand and clay minerals
Basalt	Clay minerals
Sedimentary	
Shale	Clay minerals
Sandstone	Quartz sand
Limestone	Dissolved ions and residual clay sized particles
Metamorphic	
Metasediments (schist/phyllite/ amphibolite/slate)	Clay minerals (from biotite and muscovite), micaceous silt and clay size particles.
Gneiss, granulites and other quartz rich rocks	Quartz sand

### 1.10 STRUCTURE OF RESIDUAL SOILS

Residual soils, particularly in the tropics, have a vertical soil section, called the soil profile, which consists of a distinct layering termed the soil horizons formed more or less parallel to the ground surface. These genetically related horizons are a reflection of the weathering process. The soil profile also has a weathering aspect that gives rise to a vertical weathering profile that is a critical aspect from the engineering perspective.

#### *The weathering profile*

The weathering profile reflects the state of weathering along the soil profile or vertical soil section from the bedrock (unaltered parent rock) to the ground surface. It consists of material that shows progressive stages of transformation or 'grading' from fresh rock to completely weathered material towards the ground surface.

Continuous attempts have been made over the years since Vargas (1953) to devise methods for the description or classification of residual soil. Amongst the methods developed for the description or classification are those based on the weathering profile of the residual soils. The weathering profile also portrays considerable variation from place to place due to the local variation in rock type and structure, topography and rates of erosion because of regional climatic variation, particularly rainfall. Such variations make it difficult for one to attain a broad perspective from which to view the occurrence of weathering profile.

The entire weathering profile, generally, indicates a gradual change from fresh rock to a completely weathered soil as illustrated in Figures 1.12 and 1.13 for two rock types of in a tropical terrain.

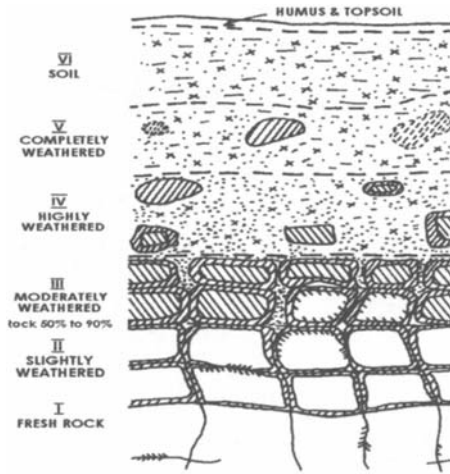

Figure 1.12. Typical weathering profile in granitic rock soil profile (Little 1969).

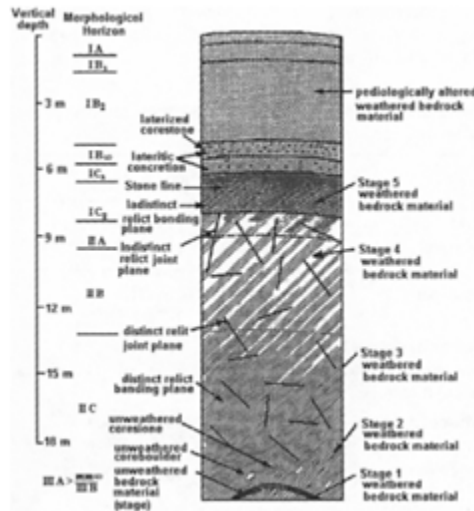

Figure 1.13. Weathering profile in a metamorphic rock\* soil profile (Raj 1994) (\*amphibole schist).

*Classifications for weathering profiles*

Parent rocks are modified with the increasing state of their weathering. This may be observed from a soil profile where the completely weathered portion may cease to resemble the parent rock. Weathering profiles have been investigated by several researchers like

Little (1969), Fookes et al. (1971), Fookes (1997), Dearman et al. (1978), Irfan & Dearman (1978), Anon (1981a) and Anon (1981b) for a descriptive scheme for grading the degree of weathering. The classifications advocated are generally suitable for most igneous rocks and some sedimentary and metamorphic rocks.

Table 1.16. Classification of the weathering profile (McLean & Gribble 1979).

Weathering classification		
Term	Grade	Description
Residual soil	VI	All rock material is converted to soil; the mass structure and material fabric are destroyed; there is a large change in volume but the soil has not been significantly transported.
Completely Weathered	V	All rock material is decomposed and/or disintegrated to soil; the original mass structure is still largely intact.
Highly Weathered	IV	More than half of the rock material is decomposed and/or disintegrated to soil; fresh or discolored rock is present either as a discontinuous framework or as corestones
Moderately Weathered	III	Less than half of the rock material is decomposed and/or disintegrated to soil; fresh or discolored rock is present either as a discontinuous framework or as corestones
Slightly Weathered	II	Discoloration indicates weathering of rock material and discontinuity surfaces; all the rock material may be discoloured by weathering.
Fresh Rock	I	No visible sign of rock material weathering; perhaps slight discoloration on major discontinuity surfaces

An example of a classification is shown in Table 1.16. A proposed classification for weathering profiles over metamorphic rock is given in Table 1.17.

### 1.11 OTHER FORMS OF RESIDUAL SOILS

The typical residual soils have been described above. As a result of more extreme weathering conditions, the chemical processes may proceed more extensively and rapidly to produce distinctive forms of residual soils.

*Laterites*, which are extremely leached soils, are examples of such forms of residual soils. In humid tropical climates when intense weathering involving leaching occurs, it leaves behind a soil rich in Fe and Al oxides giving the soil a deep red color called *laterites*.

As mentioned above, Bland & Rolls (1998) have referred to the lower portion of the soil profile that progressively grades into the bedrock as the *Saprolite*. The term *Saprolite* is also used for completely weathered or highly weathered bedrock that contain soil-like materials but retain the original relic rock structure and it reflects the operation of isovolumetric weathering where weathering occurs without any change in volume (Summerfield 1996).

Table 1.17. Classification of weathering profile over metamorphic rock\* in Peninsular Malaysia (Komoo &amp; Mogana 1988) (\* Clastic Metasediment).

Weathering classification		
Term	Zone	Description
Residual soil	VI	All rock material is converted to soil. The mass structure and material fabric (texture) are completely destroyed. The material is generally silty or clayey and shows homogenous colour.
Completely weathered	V	All rock material is decomposed to soil. Material partially preserved. The material is sandy and is friable if soaked in water or squeezed by hand.
Highly weathered	IV	The rock material is in the transitional stage to form soil. Material condition is either soil or rock. Material is completely discolored but the fabric is completely preserved. Mass structure partially present.
Moderately weathered	III	The rock material shows partial discoloration. The mass structure and material texture are completely preserved. Discontinuity is commonly filled by iron-rich material. Material fragment or block corner can be chipped by hand.
Slightly weathered	II	Discoloration along discontinuity and may be part of rock material. The mass structure and material texture are completely preserved. The material is generally weaker but fragment corners cannot be chipped by hand
Fresh rock	I	No visible sign of rock material weathering. Some discoloration on major discontinuity surfaces.

## 1.12 GEOGRAPHICAL OCCURRENCE OF RESIDUAL SOILS

Residual soils occur in all parts of the world on the various types of rocks as shown in Figure 1.14 (a)–(d). Larger expanses of residual soils with greater depths are normally found in the tropical humid regions, such as Northern Brazil, Ghana, Malaysia, Nigeria, Southern India, Sri Lanka, Singapore and the Philippines due to active weathering leading to



Figure 1.14. (a) Residual soils developed from sedimentary rocks (Rollings & Rollings 1996).



Figure 1.14. (b) Residual soils developed from intrusive igneous rocks, primary granitic shields and mountains (Rollings & Rollings 1996).



Figure 1.14. (c) Residual soils developed from extrusive igneous rocks, primary basaltic plateaus and mountains (Rollings & Rollings 1996).

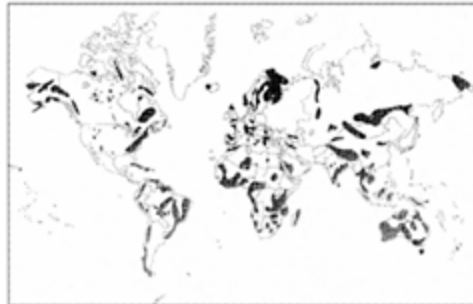

Figure 1.14. (d) Residual soils developed from metamorphic rocks (Rollings & Rollings 1996).



Figure 1.15. Distribution of tropical residual soils (Bell 2000).

residual soil formation. The distribution of tropical residual soils is shown in Figure 1.15. Conditions conducive to the formation of chemically weathered residual soils are not present in temperate zones but extensive remnant deposits of such soils are found from periods when hot humid conditions existed (Brand & Philipson 1985).

#### ACKNOWLEDGEMENT

The authors wish to express their gratitude to Ms Tan Tse Yuen for her contribution in the preparation of this chapter.

#### REFERENCES

- Anon, 1981a. *Code of practice for site investigation (BS5930)*. British Standards Institute, London.
- Anon, 1981b. Rock and soil description and classification for engineering geological mapping. Report by the IAEG commission on engineering geological mapping. *Bulletin of the International Association of Engineering geology* 24:235–274.
- Bell, F.G. 2000. *Engineering properties of soils and rocks*. 4th Ed. Blackwell Science.
- Bergman, E.F. & McKnight, T.L. 1993. *Introduction to geography*. Englewood Cliffs, New Jersey: Prentice Hall.
- Birkeland, P.W. 1984. *Soils and geomorphology*. New York: Oxford University Press.
- Blight, G.E. 1985. Residual soils in South Africa, In Brand & Philipson (ed.) Sampling and Testing of Residual Soils. Technical Committee on Sampling and Testing of Residual soils. International Society for Soil Mechanics and Foundation Engineering, 159–168.
- Blight, G.E. 1997. *Mechanics of residual soils*. A guide to the formation, classification and geotechnical properties of residual soils. Balkema.
- Brand, E.W. & Philipson, H.B. 1985. Review of international practice for the sampling and testing of residual soils. In Brand, E.W. & Philipson, H.B. (eds)—*Sampling and Testing of Residual soils—A Review of International Practices*. Technical committee on sampling and testing of residual soils, International Society for Soil Mechanics and Foundation Engineering 7–22.
- Bland, W. & Rolls, D. 1998. *Weathering*. London: Arnold.
- Dearman, W.R., Baynes, F.J. & Irfan, T.Y. 1978. Engineering grading of weathered granite. *Engineering Geology*. 345–374.
- Fookes, P.G. 1997. *Tropical residual soils*. A geological society engineering group working party revised report. London: The Geological Society.



- Fookes, P.G. Dearman, W.R. & Franklin, J.A. 1971. Some engineering aspects of rock weathering. *Quarterly Journal of Engineering Geology* 4:139–185.
- Gerrard, J. 2000. *Fundamentals of soils*. London: Routledge/ Taylor & Francis.
- Gidigas, M.D. 1976. *Laterite soil engineering. Pedogenesis and engineering principles*. Elsevier Scientific Publishing Company.
- Goldich, S.S. 1938. A study of rock weathering. *Journal of Geology* 46:17–58.
- Ingersoll, A.P. 1983. The atmosphere. *Scientific American*, Sept: 114–130.
- Irfan, T.Y. & Dearman, W.R. 1978. Engineering classification and index properties of a weathered granite. *Bulletin International Association of Engineering Geology* 17: 79–80.
- Johnson, R.B. & De Graff, J.V. 1988. *Principles of engineering geology*. John Wiley.
- Jumikis, A.R. 1965. *Soil mechanics*. New York: Van Nostrand-Reinhold.
- Komoo, I. & Mogana, S.N. 1988. Physical characterization of weathering profiles of clastic metasediments in Peninsular Malaysia. *Proc. 2nd conf. on geomech. in tropical soils, Singapore* 1:37–42.
- Little, A.L. 1969. The engineering classification of residual tropical soils. *Proceedings of the seventh international conference on soil mechanics and foundation engineering, Mexico City*, 1:1–10.
- McLean, A.C. & Gribble, C.D. 1979. *Geology for civil engineers*. London: E & FN Spon.
- McGeary, D. & Plummer, C.C. 1998. *Physical geology*. WCB McGraw-Hill.
- McCarthy, D.F. 1993. *Essentials of soil mechanics: Basic geotechnics*. Englewood Cliffs, New Jersey: Regents/ Prentice Hall.
- Nahon, D.B. 1991. *Introduction to the petrology of soils and chemical weathering*. New York: John Wiley & Sons, Inc.
- Press, F. & Siever, R. 1994. *Understanding earth*. New York: W.H. Freeman and Co.
- Public Works Institute Malaysia (IKRAM). 1996. GEOGUIDES 1–5, Tropical weathered in-situ materials.
- Raj, J.K. 1994. Characterization of the weathered profile developed over an amphibole schist bedrock in Peninsular Malaysia. *Bulletin of the Geological Society Malaysia* 35:135–144.
- Rollings, M.P. & Rollings, R.S. 1996. *Geotechnical materials in construction*. McGraw-Hill.
- Singh, P. & Kataria, D.S.K. 1980. *Engineering and general geology*. Ludhiana, India: Katson Publishing House.
- Singh, H. & Huat, B.B.K. 2003. *Basic engineering geology for tropical terrain*. Sarawak: University Malaysia Sarawak.
- Sowers, G.F. 1985. Residual soils in the United States. In Brand & Philipson (ed.) *Sampling and testing of residual soils: A Review of International Practices*. International Society of Soil Mechanics and Foundation Engineering.
- Strakhov, M.N. 1967. *Principle of lithogenesis*. Edinburgh: Oliver and Boyd.
- Summerfield, M.A. 1996. *Global geomorphology. An introduction to the study of landforms*. Singapore: Longman.
- Thomas, M.F. 1974. *Tropical geomorphology. A study of weathering and landform development in warm climates*. Macmillan.
- Terzaghi, K. & Peck, R.B. 1967. *Soil mechanics in engineering practice*. New York: John Wiley.
- Vargas, M. 1953. Some engineering properties of residual clay soils occurring in southern Brazil. *Proceedings of the 3rd international conference on soil mechanics and foundation engineering, Zurich* 1:259–268.
- Whittow, J. 1988. *The Penguin Dictionary of Physical Geography*. Penguin Books.

## CHAPTER 2

# Sampling and testing of tropical residual soils

Bujang B.K.Huat & Asmidar Alias  
*University Putra Malaysia*

Suhaimi Jamaludin  
*Public Works Department, Malaysia*

Sampling and testing are prerequisites in determining the index and engineering properties of soils. This chapter is an overview of the sampling and testing of tropical residual soils, and highlights the distinctive procedures in the handling and constraints of calibration for commonly used equipment. Procedures for handling tropical residual soils are different due to the unconventional properties of the soil.

### 2.1 INTRODUCTION

Formation processes of tropical residual soils are very different compared to formation of sedimentary soils. These soils are formed in situ by deep chemical weathering of rocks, usually in a tropical climate. The degree of weathering and extent to which original structure of the rock mass is destroyed varies with depth from the ground surface. Some components are removed as a result, usually leaving a clay-based deposit. This factor causes the behavior and properties of both soils to be different. Besides, behavior and properties of tropical residual soil also vary by location based on geological formation, surrounding environment and climate: the main factors in their formation processes. Because of these differences, testing and sampling procedures in the determination of their properties and strength of tropical residual soils cannot be directly adopted from the conventional method of testing and sampling for sediments type soils, without some modifications.

Preparation and handling of samples for tropical residual soil some times need special care and methods as conventional methods normally used on sedimentary soils may not be applicable. Residual soils that are frequently encountered in tropical regions require special procedures to obtain reliable and consistent test results. This applies particularly to the treatment of the soil before testing, and to the selection and preparation of a test specimen. For example drying, even partial drying by exposure to air at room temperature can cause changes in the physical behavior of residual soils. Some tropical soils break down further the more they are handled. The results of laboratory tests can vary according to the amount

of working, such as by the use of pestle and mortar, sieving or the length of time for which they are worked (Head 1992). Preparation and handling of undisturbed samples of tropical residual soils for classification, compaction test, shear strength, compressibility and permeability tests may not be identical to methods used for normal sediment soils.

## 2.2 SAMPLING

The first collection of state-of-the-art papers in sampling of residual soils was presented at a symposium in Singapore organized by International Society for Soil Mechanics and Foundation Engineering (ISSMFE) in 1979 (Nicholls 1990). International practice on sampling and testing of residual soils was reviewed by ISSMFE in 1985. ISSMFE needs to take care in sampling residual soil which usually behave differently from other conventional soils particularly in relation to the properties and structure. Further description on how sampling will be done is described below.

### *Criteria of good quality samples*

Soil samples provide some of the most important evidence from a subsurface investigation. The preparation of soil samples for testing demands special care and accepted practices may not be suitable and should not be applied for the preparation both of disturbed samples for classification testing and for the handling of disturbed samples for shear strength, compressibility and permeability tests. Conventional index tests should be used with caution when correlating with engineering behavior. The void ratio of these soils varies considerably and strongly influences their engineering properties.

As stated in Geoguide 3 (1996), assessment for in situ material is essential. The assessment should be done with great care and should not be influenced either by optimistic estimations of a lack of disturbance or by the requirements of any analytical programs to be used for design. A project requirement for a particular undisturbed parameter value does not necessarily mean that it can or should be supplied by direct sampling and testing methods. Disturbance needs to be assessed both with respect to sampling in the field, transport of the sample and transfer for the recovered sample to the test apparatus in the laboratory. Geoguide 3 (1996) also states that test procedures require to be selected on the basis of project requirements, general material types, sample quality and the capability of the test laboratory.

The 'Good Quality Samples' or 'Perfect Samples' is defined by Ladd & Lambe (1963) as 'sample which has not been disturbed by boring, sampling and trimming but has experienced stress released'. In actual conditions there is no truly undisturbed sample, as all drilling techniques will eventually initiate some mechanical disturbance and stress relief. Samples are classified as undisturbed or disturbed depending on how much alteration there is to the soil structure after it is removed from its in situ state. The validity of investigations carried out in laboratory tests rests solely on the quality of the samples and on how far they are representative of the stratum from which they are taken (Cooling 1949). The samples taken are said to be 'Good Quality Samples' depending on various factors such as purpose of sampling (what type of testing will be performed), the location of samples taken (must

be representative of an area), the method of sampling applied, and how the sample taken was handled before (including preparation for testing) and during testing.

*Purpose of sampling*

The samples must be taken according to the type of test to be performed, and whether an undisturbed sample is needed. If an undisturbed sample is needed, it must be taken and handled accordingly before and during testing to preserve samples. Undisturbed sample should represent the actual condition on site where the structure and water content is preserved as far as possible and can be obtained by using a suitable coring method. As far as residual soils are concerned, the disturbance of mechanical force can alter the structure and soil fabric. Therefore to handle this type of soil, special mechanical tools are used. It is important to minimize disturbance of the samples as far as possible especially for tests of shear strength, compressibility and permeability. The number and spacing of disturbed samples usually depend on the anticipated testing programs and design problems. Some of the methods used to preserve the actual condition of the soil are the location of samples taken, techniques for sampling, and sample storage.

For the purpose of sampling which involves remolding soil or changing of moisture condition from the field condition, there is no need to preserve the samples in an undisturbed state. However, the need for undisturbed samples is for soil identification and classification and quality tests in which case the samples are usually collected and sealed in glass or plastic containers, tins or plastic bags. The representative disturbed samples should be taken vertically not less than 1.5m and at every change in strata.

*The location of samples taken*

The samples must be representative of an area for the purpose of generalization of the properties for identification and use in engineering design. Generally obtaining representative soil samples is still a challenge since, by nature, soils type and their properties vary greatly both vertically and horizontally. It is more difficult when dealing with tropical residual soils due to their non-homogeneous and anisotropic condition. It is important to establish a well-planned sampling program that ensures representativeness of the area.

The correct method of sampling applied is important for good quality samples. The sample for tests which require undisturbed samples should be obtained by the way it should be, so for the disturbed sample. Personnel who are given the task for sampling should be familiar with various sampling techniques, and should be able to decide the right technique for undisturbed sample purposes. The soil fabric, bonding between particles, void ratio and moisture content of the soil must be preserved because these factors have a significant influence on their shear strength. The only way to get good quality samples of tropical residual soils is by fully utilizing the experience, competence and capabilities of personnel involved with the sampling and testing processes. Besides personnel capabilities, the laboratory and testing equipment must also be capable of produce good quality results. It is important to note that some of conventional testing methods might not reliable for tropical residual soils which may need some calibration and special tools.

*Drilling and sampling techniques*

The most popular sampling technique is by drilling. There are various methods of drilling widely used in obtaining soil samples namely hollow-stem auger, solid flight and bucket augers, direct air rotary, cable and rotary diamond drilling. Different drilling techniques are necessary depending on whether the goal of the investigation is to collect undisturbed samples or if disturbed samples will suffice. A principal drilling requirement is that the driller must be prepared to encounter all inconsistencies of material from very soft to extremely hard rock, and for sudden and repeated changes from one to another. Other alternative sampling techniques are by open hand dug pit or machine dug pit. Brand & Phillipson (1985) stated the main reason for using this method is that the detailed inspection of a relatively large exposure of residual soil is highly desirable to enable an examination to be made of the occurrence of relict joints and other structural features, which can often dominate the engineering behavior of the material. This method is most suitable at shallow depths in the completely weathered material. The pit must have enough space for man-access. Through this technique, a visual inspection of the soil profile can be made. Hand-cut samples can be taken and other in situ testing can be performed as required. As mentioned above, several sampling techniques can be applied to tropical residual soil but with careful drilling techniques. Some practices use core barrels for high quality drilling and sampling. Types of core barrels used include 63 mm diameter standard triple tube core barrel with retraction shoe and split steel liners (HMLC), a 83mm diameter non-retractable triple tube core barrel incorporating a wireline mechanism for withdrawing the liner barrel (PQ-Wireline) and a 74 mm Mazier automatic core barrel. Use of water in drilling especially in dry tropical residual soils above the water table must be avoided because it can disturb the samples. Sometimes, water from drilling activities in the hole is misunderstood as groundwater table. The water flush during coring causes erosion and loss of core. Water also increases moisture content on the surface of the sample. It is suggested that foam, mud, air or special drilling fluid is used. In the case of water being used in the drilling process, it is suggested that Mazier automatic core barrel be used. Mazier automatic core barrel using triple wall core barrel permits removal of the sample as it is taken from the ground, guaranteeing the 'in situ condition' of the core. Figure 2.1 shows the diagram of a typical Mazier automatic core barrel.

Driven sample is also another alternative in obtaining undisturbed samples. The quality varies depends on the drilling tube used and its material, the condition of the cutting shoe, the area ratio and the method of driving. 35 mm diameter samples are frequently obtained in conjunction with Standard Penetration Test. A strong open-driver sampler which is sometimes used and which produces samples of much higher quality than the SPT is the British U100. This gives 100 mm diameter samples up to 450mm long. In order to obtain least disturbed samples, thin-walled stainless steel tubes of low area ratio is used on clayey saturated materials.

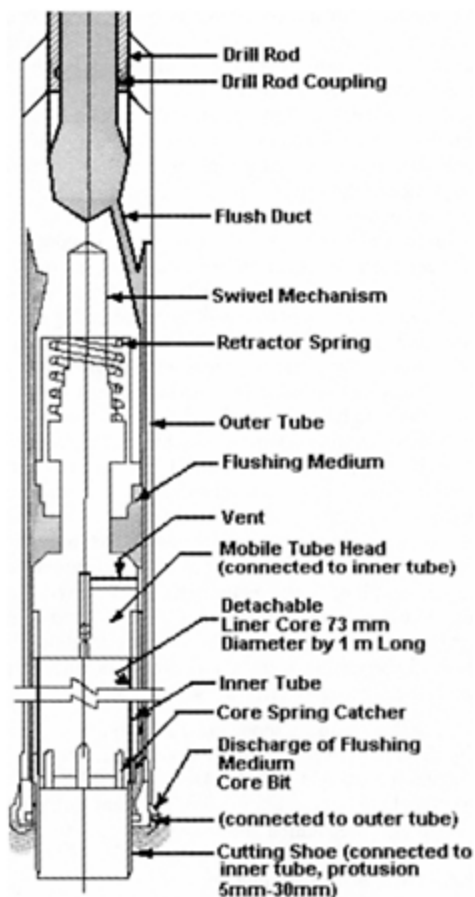

Figure 2.1. Typical details of Mazier triple-tube core barrel.

### *Samples storage*

As suggested by Head (1992), samples should be kept in a cool room to protect them from extremes cold and heat. Disturbed samples in glass jars can be conveniently stored in milk bottle crates. Large disturbed samples in polythene bags should not be piled one on top of another, but placed individually on shelves or racks. Undisturbed samples must be laid on racks designed for storage; however tubes containing wet sandy or silty soil should be stored upright to prevent segregation of water.

### *Sampling of undisturbed samples*

Undisturbed samples are needed to obtain properties of tropical residual soils from laboratory testing. A completely disturbed sample is better than a bad undisturbed sample. It is

important to preserve the samples in an undisturbed state as close as possible to site condition because some of the characteristics of tropical residual soils are sensitive or have significant influence especially on their shear strength. Laboratory tests results from a bad sample will distort the real properties of the soil, and the data cannot be used for safe and economic engineering design.

In tropical residual soils, the presence of bonding between particles either by cementation or interlocking gives a component of strength and stiffness which can be easily destroyed by any disturbance during sampling and testing of the sample. A second characteristic of tropical residual soils that may be affected by disturbance during sampling and testing of the sample is the void ratio. Tropical residual soils have wide variable void ratios in their mass which is unrelated to stress history. Changes of this void ratio due to rough handling may give false results in shear strength and permeability tests. Another characteristic of tropical residual soil is partial saturation, possibly to considerable depth, which can be responsible for disturbance during sampling as well as the behavior observed in a test. Moisture in the samples must be preserved so it can be as close as possible to the moisture condition at the site upon testing. General types of disturbance that can cause significant effect on samples are:

- i) Friction—cutting shoe during sampling,
- ii) Reduction of pore water pressure when the samples are brought to the surface,
- iii) Shocking and vibration during transportation, storage, preparation and testing.

### *Sampling of disturbed sample*

Disturbed samples can be readily gathered from all methods of site investigation. Tests for classification of soils such as moisture content, plasticity tests, shrinkage tests, particle size distribution and other related tests normally use disturbed or remolded samples. All these tests involve drying and disaggregation of samples, which needs special attention.

Drying of samples at temperature between 105 to 110°C to determine water/moisture content has a substantial effect on soil properties. Tropical residual soils are very sensitive to drying. Drying even at moderate temperatures may change the structure and physical and chemical behavior of tropical residual soils. These changes are strongly influenced by the alteration of clay particles on partial dehydration and the aggregation of fine particles to form larger particles. The reformed particles remain in bonded position even on a re-wetting process. Results that reflect the drying effect are overviewed in the following chapter.

Crushing or splitting technique must be avoided in disaggregating tropical residual soils for purposes of the classification test (Blight 1997, Fookes 1997). Disaggregation process must be done with care and with regard for what is meant by 'individual particles'. The samples should be soaked in the water overnight. For particles which have a cemented characteristic, the disaggregation should be done by applying finger pressure only. Discussion on the need for dispersion of fine particle is described under particle size distribution test section.

The degree of disturbances that occurs in a fabricinfluenced material may vary considerably depending on the project or sampling conditions. A fundamental aspect of the characterization of materials for civil engineering construction is in recognizing, and establishing

various levels of behavior based not only on scale but upon the influencing elements. The recognition of these levels of behavior allows an important distinction to be made between inherent in situ characteristics and those that become apparent during various aspects of construction. This facilitates a more relevant correlation between in situ character, laboratory testing and likely project performance as shown in Table 2.1.

These aspects should be considered in preparing remoulded residual soil; drying, disaggregation and subdividing. As soil is formed by the decomposition of rock in situ by chemical decay and may retain signs of their original structure, residual soils are likely to be highly variable and testing programs needs to consider the use of both soil mechanics and rock mechanics testing procedures. The material might be considered in terms of being soils, rocks or soil-rock mixtures. General classification should be an early indication of the general range of tests methods that will be appropriate to conduct (Geoguide 3 1996).

### *Drying*

Partial drying at moderate temperatures may change the structure and physical behavior of tropical residual soils. Some of the structures are changed by chemical means and not reversed when re-mixed with water. Physical changes can be seen according to these aspects:

- i) Alteration of the clay minerals
- ii) Aggregation of fine particle to become larger particles that remain bonded even on re-wetting.

Fookes (1997) reported that clay soils often become more silt- or sand-like with a lower plasticity; although in some instances the opposite can occur. Oven drying from 105 to 110°C frequently has a substantial effect on soil properties but drying at a lower temperature (e.g. 50°C) and even partial air-drying at ambient laboratory temperature can also produce significant changes. Blight (1997) and Fookes (1997) both agreed that generally all tropical residual soils will be affected in some way by drying. In preparation for a classification test, natural soil with as little drying as possible should be applied, at least until it can be established from comparative tests that drying has no significant effect on the test result. The method of preparation should be reported from time to time.

Table 2.1. General divisions of geotechnical behavior (Nik Ramlan et al. 1994 in Geoguide 3 1996).

Behavior pattern	Description	Laboratory modelling	Projectactivity
Intrinsic Remoulded, de-structured material	Behavior a function of particle type (mineralogy), shape and size (texture). Dependant on moisture condition.	Completely remoulded index tests	Well compacted fill, haul road performance, erosion.



Meso-Structured Undisturbed material.	Behavior is a function of intrinsic properties and the material fabric and meso-structure.	Standard 'undisturbed' testing, triaxial, shear box, oedometer etc	Possibly lightly compacted fill, erosion, aggregates
In situ Mass Macrostructured mass	Behavior a function of intrinsic and meso, and macro-structural properties of the mass and component materials, allied to the influence of relict mega-discontinuities and material boundaries	Only possible directly by combining relevant material tests with macro-structural data to give a mass character. Indirectly by semi-empirical, terrain correlation or back analysis procedure.	Cut slopes, foundations

Notes:

Texture: The morphology, type and size of component particles

Fabric: The spatial arrangement of component particles

Discontinuities: The nature and distribution of surfaces separating elements of fabric, material or soil-rock mass

Structure: The fabric, texture and discontinuity patterns making up the soil-rock material, mass or unit.

The above may be described at number of scale levels:

Micro: <0.5 mm Generally only described with the aid of SEM or petrographic microscope.

Meso: 0.5–5 mm Generally seen with the aid of field microscope or a good hand lens.

Macro: 5 mm–50 m Patterns visible to the naked eye in the field

Mega: >50 m Patterns that become apparent by means of maps or remote sensing, although individual elements may be visible at field level.

### *Disaggregation*

Fookes (1997) stated that disaggregation should be handled with care, validation the meaning of individual particle. The objective of this process is to separate the discrete particle without the act of crushing and splitting. It is suggested for some soil to be soaked overnight without any interference with mechanical force to obtain better results. Particles with cemented bond should be split only by using finger pressure.

### *Sub-dividing*

Samples are sub-divided by riffing box and poured evenly by using a scoop or shovel. The sub-dividing procedures must be accepted for residual soil use so that representative samples are obtained and ready for testing. The soil should be evenly distributed along all or most of the slots to ensure that each container receives an identical sample. Other accepted quartering procedures can also be used to obtain required samples.

### 2.3 INDEX AND ENGINEERING PROPERTIES TESTS

It is accepted that residual soil behave differently from conventional soils (e.g. transported soil) as the soils are formed in situ and have only slight changes in stress history. The changes sturdily depend on mineral bonding and soil suction. Geoguide 3 (1996) distinguished major differences in undertaking and interpreting geotechnical laboratory tests in tropically weathered soil as opposed to sedimentary soils as follows:

- i) The materials are chemically altered and sometimes bonded rather than produced by a physical sedimentation process.
- ii) The materials are in many cases non saturated, exhibiting negative pore water pressures (soil suction).
- iii) There is difficulty in obtaining high quality undisturbed samples in these materials which may have a sensitive fabric.
- iv) There is difficulty in obtaining truly representative geotechnical parameters from these heterogeneous materials and masses.

Therefore modeling residual soil testing might have to take into consideration these aspects which would require calibration of test equipments.

Table 2.2. Categories of water (Geoguide 3 1996).

Category	Description	Availability
Structural water	Water held within the structure of component minerals	Generally not removable below 110°C except for clays such as halloysite, allophane and gypsum
Strongly adsorbed water	Held on particle surface by strong electrical attraction	Not removed by drying at 110°C
Weakly adsorbed water	Held on particle surface by weak electrical attraction	Can be removed by drying at 110°C but not by air drying
Capillary water (Free water)	Held by surface tension	Removed by air drying
Gravitational water (Free water)	Moveable water held in the materials	Removed by drainage

#### *Moisture content*

The conventional definition of moisture content is based on the amount of water within the pore space between the soil grain when a soil or rock material is dried to a constant mass at a temperature between 105 and 110°C, expressed as percentage of the mass of dry soil. This loss in weight due to drying is associated with the loss of the 'free water' as listed in Table 2.2 above.

For some tropical residual soils in addition to 'free water' that is available to influence engineering behavior there may exist crystallized water within the structure of minerals that is released at these drying temperatures. As suggested by Fookes (1997), to identify this type of soil, comparative tests should be carried out on duplicate samples taking the measurement of moisture content by drying to constant mass at between 105° and 110°C and at a temperature not exceeding 50°C until successive weighing shows no further loss of mass. The significance difference should indicate that intraparticle water is present. This water exists as a part of solid particles and should be excluded from the calculation of moisture content. The releasability of this additional water varies with mineral types and in some cases results in highly significant differences in moisture content between conventional testing temperature and engineering working temperatures.

### *Plasticity*

Plasticity or Atterberg limits, namely the Liquid Limit (LL) and Plastic Limit (PL) are often employed in the classification of fine-grained soils. Although water in a soil sample can be removed by oven-drying at a temperature of 110°C±5°C as in normal practice, it can also be removed by air-drying or it can be tested at its natural moisture condition as suggested in BS 1377:1990 (BSI 1990). There are significant effects in determining plasticity of the soil which regard to pre-test drying, duration and mixing methods. Many researchers and writers state that tropical residual soils are very sensitive to drying because drying may change the physical and chemical properties of the affected soils. Table 2.3 shows some examples of the effects on index properties of tropical residual soil (Fookes 1997).

### *Shrinkage*

Some tropical residual soils exhibit considerable volume change in response to wetting or drying and the shrinkage limit test may provide an indication of an intrinsic capacity for shrinking or swelling. The shrinkage limit test as in BS1377 (1990) was initially intended for undisturbed samples although remolded material can be used. Linear shrinkage BS1377 (1990) is a simpler test on remolded materials, which gives a linear rather than volumetric shrinkage. The established relationship between linear shrinkage and the Plasticity Index for sedimentary soils may not hold true for tropical residual soils. It is important to differentiate between materials that shrink irreversibly and those that expand again on re-wetting.

Studies by Mutaya & Huat (1993) on the degree of drying of Malaysian tropical residual soils on linear shrinkage show that when the degree of drying is increased, the linear shrinkage value reduces. This is due to the presence of moisture and clay content. A soil having higher moisture and clay content tends to shrink more compared to that of lower moisture and clay content.

### *Particle size distribution*

Particle size distribution test is done to determine the range of soil particle within a mass of soil sample by the act of sieving. The complete test procedure can be reviewed in BS1377

(1990). Residual soil can be visualized as complex functions of particle size, fabric and the nature of the particles. Standard particle size distribution test should be applied with extra care on the discussed aspects as describe in Table 2.4.

In one soil sample, the variation of particles sizes encountered may very widely. Although natural soils are mixtures of various-sized particles, it is common to find a high proportion of types of soil occurring within a relatively narrow band of sizes. In some test procedures, some of the soils might undergo sedimentation process by applying dispersants into the solution. The need of sedimentation of fine particles is to ensure that discrete particles are separated. Geoguide 3 (1996) explains that soils that undergo sedimentation process should have proper dispersion of the fine particles. Alkaline sodium hexametaphosphate has been found to be suitable for a wide range of soils. Alternative dispersants such as trisodium phosphate may be more effective.

Table 2.3 Some examples of the effect on index properties of tropical residual soils, (Fookes 1997).

Soil location	Soil type	Liquid limit			Plasticity		
		AR	AD	OD	AR	AD	OD
Costa	Laterite	81	–	56	29	–	19
Rica	Andosol	92	–	67	66	–	47
Dominica	Allophane	101	56	–	69	43	–
	Latosolic	93	71	–	56	43	–
	Smectoid	68	47	–	25	21	–
Hawaii	Humic Latosol	164	93	–	162	89	–
	Hydrol Latosol	206	61	–	192	NP	–
Java	Andosol	184	–	80	146	–	74
Kenya	Red Clay, Sasumua	101	77	65	70	61	47
Malaysia	Weathered Shale	56	48	47	24	24	23
	Weathered Granite	77	71	68	42	42	37
	Weathered Basalt	115	91	69	50	49	49
New Guinea	Andosol	145	–	NP	75	–	NP
Vanuatu	Volcanic Ash, Pentecost	261	192	NP	184	121	NP

AR: Air Received, AD: Air Dried, OD: Oven Dried, NP: Indicates Non-Plastic.

Table 2.4. Effect of sample preparation on particle size distribution test (Fookes 1997, Blight 1997).

Aspect	Description
Drying	Drying can cause a reduction in the percentage of clay fraction. It is accordingly recommended that drying of the soil prior to testing be avoided. The initial soil sample should be weighed and a duplicate sample taken for moisture content determination so that the initial dry mass can be calculated.
Chemical pre-treatment	This treatment should be avoided wherever possible. Pretreatment with hydrogen peroxide is only necessary when organic matter is present. To eliminate carbonates or sesquioxides, pretreatment with hydrochloric acid is used.
Sedimentation	The dispersion of fine particles should be carried out by using alkaline sodium hexametaphosphate. In some instances a concentration of twice the standard value may be required. Solution must be made before conducting any sedimentation process.
Sieving	If accepted standard procedure is to be used, experience is needed to judge carefully. Care is necessary at every stage, especially to avoid breakdown of individual particles.

### *Density*

Measurement of the quantity of material related to the amount of space it occupies is referred to by the term density. It is also normally understood as mass per unit volume. Density is widely used to obtain the relation between density and moisture content in the determination of compaction characteristics. Another test, the in situ density, is another requirement for the assessment of the structural stability and determination of void ratio. This value can prove to be a useful index test, particularly as it may be used to correlate between soil and rock materials. Bulk density may be recommended using a variety of test procedures as summarized in Table 2.5.

### *Specific gravity*

Specific gravity refers to the ratio of the mass of a given volume of a material to the mass of the same volume of water. This term however has been replaced by particle density as described below.

### *Particle density*

The term 'Particle Density' (Ps) is replacing the previously used term 'Specific Gravity' (Gs) in the current British practice, BS 1377:1990 (BSI 1990) to comply with international used. This term refers to the average mass per unit volume of the solid particles in a sample of soil, where the volume includes any preserved voids contained within solid particles. In other words, particle density is a measure of the average density of the solid particles which make up a soil mass. Particle density has the same numerical value as specific grav-

ity although it has the units Mg/m<sup>3</sup> rather than being dimensionless. Particle density value is needed as the value can be used to determine other soil properties such as void ratio, clay fraction and porosity which can be related to fabric structure.

Table 2.5. Methods of density measurement (Geoguide 3 1996).

Method	Reference	Comment
Measured dimensions. Hand trimmed from block or tube	Part 2:7.2 BS 1377 (1990)	Material has to be suitable for trimming; eg robust soil or weak rock.
Measured dimensions. Sample within tube	Part 1:8.4 BS 1377 (1990)	Used where extrusion may disturb sample; eg loose or weakly bonded soil material.
Water displacement (waxed sample)	Part 2:7.4 BS 1377 (1990)	Simple test used for irregular shaped water sensitive samples.
Weighed in water (waxed sample)	Part 2:7.3 BS 1377 (1990)	As above, generally more accurate.
Weighed in water (non waxed sample)	ISRM (1981), Part 1	Used for irregular lumps of rock-like material not susceptible to swelling or slaking.

Tropical residual soils may have highly variable particle densities. Some soils indicate unusually high and some unusually low densities. For this reason the value should be measured whenever it is needed in the calculation. An assumed value is not encouraged. The test should be conducted at its natural moisture content and due regard should be taken of moisture availability problems discussed above. Natural moisture content is to be used in obtaining particle density. Any pre-treatment is not advisable as the value could be mystified and tends to reduce the measured value as compared with natural moisture content samples. The dry mass of solid particles should be taken after the particle density test has been conducted. The dry mass is taken by oven dried at 105°C to 110°C. Note that, whenever coarse grain particles are present (gravel size), gas-jar method is to be used so that the whole sample will be presented (Head 1992). Some particle density values gathered from regional studies by Geoguide 3 (1996) are shown in Table 2.6.

### *Samples for compaction test*

Fookes (1997) reported that tropical residual soils with coarser particles are susceptible to crushing and therefore a separate sub-sample of soil is needed for compaction at each moisture content to avoid successive degradation. This also applies to the breakdown of the <425 µm fraction.

Care should be taken for soil samples that are sensitive to drying methods. Problems can arise when applied for compaction field control. The soil should not be dried before testing in the laboratory. If it is necessary to compact the soil lower than the natural moisture

Table 2.6. Typical particle densities of minerals in tropical residual soils (Geoguide 3 1996).

Mineral	Particle density (Mg/M3)
Calcite	2.71
Feldspar-orthoclase	2.50–2.60
Feldspar-plagioclase	2.61–2.75
Gibbsite	2.40
Haematite	4.90–5.30
Halloysite	2.20–2.55
Kaolinite	2.63
Magnetite	5.20
Quartz	2.65

content, partial drying at room temperature is essential until the desired moisture content is achieved. Excessive drying, requiring re-wetting, should be avoided. For a given degree of compaction, drying has generally been found to increase the maximum dry density and to reduce the optimum moisture content. Data obtained from tests on dried soil are not applicable to the field behavior and could result in inappropriate criteria being applied in field conditions (Fookes 1997).

### *Shear strength tests*

Shear strength problems are usually encountered in the calculation and analysis for foundation and earthwork stability. The shear strength parameters can be found by using laboratory and field tests, and by approximate correlations with size, water content, density, and penetration resistance. Some of the shear strength tests applicable to residual soil are discussed below:

#### *Shear box test*

The most common test used for determining shear strength of a soil is by using shear box test. Shear box test is preferred because of its simplicity, ease of conducting compared with other tests, less potential disturb sample preparation procedure than in the triaxial test. Another advantage is that the test can be used in fabric-sensitive materials by reverting to the use of a circular shear box which eliminates problems of sample disturbance at box corners. Despite its advantages, it does have disadvantages in some aspect: Drainage conditions cannot be controlled; determination of pore water pressure is not available, thus only total normal stress can be determined. Total stress is equal to effective stress if full drainage is allowed and this requires the adoption of a suitable strain rate. This test however, enables relatively large strains to be applied and thus the need to determine both peak and residual soil strength. The principle is on the act of sliding movement to soil sample and while applying constant load to the plane of relative movement. The soil sample can be directly sheared unconsolidated and undrained, but can also be consolidated and test drained or undrained. Various shear tests can be conducted depending on the designated model to present the actual condition. The tests are mainly unconsolidated undrained (UU), consolidated undrained (CU) and consolidated drained (CD) direct shear. Table 2.7 shows variations of test that can be conducted in the laboratory depending on the soil sample.

Table 2.7. Types of shear box tests.

Soil sample	Type of shear box test
Coarse-grained soil	CD test—strength parameter $c'$ and $\phi'$
Fine-grained cohesive soils (clays and clayey silts)	UU, CU and CD test For UU and CU tests, the strength parameters in terms of total stress and the shearing rate has to be rapid as possible.

In slow 'drained' shear tests, the specimen is consolidated prior to shearing and a slow rate of displacement is applied during shearing. This method enables the consolidated drained or effective stress shear strength parameters to be determined.

Sampling of residual soils to verify shear strength of weathered zones should be carried as an additional concern. In almost all cuttings in tropical residual soils, there exist weathering zones which exhibit various degrees of alternating weathering grades, which is due to the nature of the parent rock. It is therefore inevitable that failures occur at the interfaces or relict joints. In anticipation of this situation specimens were obtained, as far as possible, at positions of these discontinuities where the joint coincides with the sliding plane of the shear box. Undisturbed samples were obtained from the site using different types of sampling, from which test specimens were prepared. Briefly, the following test procedures were suggested (Blight 1997):

- Test specimens are prepared and placed in the shear box with minimum disturbance. The specimens are then inundated with water,
- The normal stress is applied. In certain cases, the normal stress is equivalent to the overburden pressure of the specimen. When relatively soft specimens were tested, the load is applied in increments,
- Prior to shearing, in certain cases, the normal stress is reduced to the design overburden. Readings are taken until a stabilized condition is achieved (swelling has ceased).

Typical sizes of the square box sample for shear box test are 60mm, 100 mm and rarely 300 mm or more. For circular shear boxes, common sizes are 50mm and 75 mm diameter. The maximum particle size of the soil dictates the minimum thickness of the test sample. A study by Brenner et al (1997) found that the drained strength of fissured dense soil (residual basalt) from 500×500 mm and 290 mm high shear box samples was 1.5 to 3 time less than the strength from 36mm diameter triaxial samples in the normal stress range of 50 to 350 kPa. With relatively uniform samples, the size of the shear box was found to be less significant.

#### *Triaxial tests*

Triaxial test procedures play a large role in geotechnical testing programmes but have largely been derived for use on traditional sedimentary soils in temperate climates. The triaxial test is beneficial to obtain a variety of test results such as triaxial strength, stiffness and characteristics of stress ratios of soil specimen. The samples are either remoulded or from undisturbed sample trimmed and cut into cylindrical shape. Commonly used samples



have a height/diameter ratio of 2:1. Most common sizes used are 76mm×38 mm and 100 mm×50mm. Samples will be sealed in thin rubber membrane and subjected to fluid pressure. Axial load is then applied through a piston acting on the top cap and controlling the deviator stress.

Types of triaxial tests conducted in the laboratory are unconsolidated undrained (UU) test with or without pore pressure measurement, isotropically consolidated undrained compression (CIU) test with or without pore pressure measurement and isotropically consolidated drained compression (CID) test. Unconfined compression (UCS) test is also an accepted method to test the strength of the more robust tropically weathered materials, from hard soils to strong rocks. Good samples recovered from high quality drilling techniques are particularly adaptable to this method provided steps are taken to preserve the in situ moisture condition.

Since a variety of conditions of residual exist in reality, especially the partially saturated condition, will give an erratic result if common methods of triaxial test were carried out. Some of the routine triaxial tests require the sample to be fully saturated to present a saturated condition but this is rather controversial for residual soils. Application to partially saturate fabric-influenced materials in climatic environments that impose rapid changes in moisture condition can cause difficulties both in establishing relevant test procedures and in the modeling of site conditions. The standard procedure of imposing saturation on under-saturated materials appears difficult to justify on the grounds of modeling site conditions. As reviewed by Brand & Phillipson (1985), pre-saturation which normally needs high back pressure is actually severe compared to the actual conditions. This technique can only be applied to achieve consistent effective strength parameters. However Blight (1985) stated that the saturation condition can be applied considering that in unusually wet weather years, the water table can rise for several meters. Saturation therefore represents the least favourable condition of the residual soil.

A soil that is partly saturated consists of a three phases system: gas (including air and water vapour), water and solid particles. Analysis of partial saturation is complex. The determination of effective stresses in partly saturated soils requires measurement of air pressures as well as pore water pressure. The following extended Mohr-Coulomb equation has been proposed for the solution of partial saturation problems (Fredlund 1987):

$$\tau = c' + (\sigma_n - u_a) \tan \sigma_n + (u_a - u_w) \tan \theta^b$$

where  $\tau$  = shear strength;  $c'$  = effective cohesion,  $\sigma_n$  = normal stress;  $\sigma_n$  = effective friction angle;  $\theta^b$  = angle of shear strength change with a change in matric suction;  $u_a$  = pore air pressure;  $u_w$  = pore water pressure.

Undisturbed triaxial testing of suitable samples can be of practical use in a tropical residual soil environment although the resulting parameter must be interpreted in the light of field data and may in some cases serve only as a back up to empirical established figures (Geoguide 3 1996). The following comments apply to the general use of triaxial testing of tropical residual soils:

- a. Multistage triaxial testing is not recommended for tropical residual soils especially in those with an unstable fabric liable to collapse, brittle soils and those that show strain-

softening characteristics. Multi-stage tests might give misleading strength values for design.

- b. Quick undrained tests are not suitable for unsaturated materials. However, the test is appropriate for partially saturated soils.
- c. Special procedures are likely to be required for high void ratio or bonded materials, eg low confining pressure, slow loading rate.
- d. Significant numbers of slope failures in tropical environments are shallow in nature and analysis of these would require parameters derived at appropriate (low) confining pressures.
- e. For undrained tests with pore pressure measurements, rate of deformation must be slow enough to allow the non-uniform pore pressure to equalize and in drained tests complete drainage condition must be achieved.

Sample size for triaxial testing in tropical residual soils should be about 75 mm in diameter. The common test specimen using 38 mm in diameter is not applicable due to the disturbance caused in extruding or trimming small diameter specimens from borehole samples. Brand & Phillipson (1985) stated that a specimen of 100 mm is commonly used in Australia, Brazil, Germany, Hong Kong and UK. Samples with smaller diameters are not considered representative, because of the scale effect relating to fissures and joints in the soil (Brenner et al. 1997). In addition, the sample diameter should not be less than eight times the maximum particle size. The ratio of sample length to diameter must be at least 2 to 1.

### *Permeability tests*

Permeability of undisturbed samples can be derived from data obtained from consolidation tests; either triaxial, standard oedometer or Rowe cell. It may also be obtained from specific procedures using the permeameter equipment. Applications for the value of permeability are for drainage, analyzing influence of seepage on slope stability, consolidation analysis and design of foundations for dams and excavations. Extrapolation to mass in situ permeabilities of laboratory derived material permeameters for tropical residual soils should be viewed with extreme caution. Despite conducting laboratory permeability test, in situ tests are more likely to represent the actual condition of residual soil (Brand & Phillipson 1985). Field permeability will consider the relict joint and other preferential drainage paths that are most likely to be not identified by laboratory testing.

Permeability of undisturbed samples can be obtained by in situ testing (falling head method) at various depths as the drilling of borehole proceeds. The falling head, rising-head and constant head tests can be used in boreholes and employing packers to isolate a particular hole length. It is important that the inside surface of the hole used for permeability testing is free of loose or smeared material which can make imprecise the results of testing.

Permeability of residual soils are affected by the variations in grain size, void ratio, mineralogy, degree of fissuring and the characteristics of the fissures. Garga & Blight (1987) explained permeability of some residual soils is strongly controlled by the relict structure of the material where the flow takes place along relict joints, quartz veins, termite and other biochannels. A permeability test is needed when seepage problems are involved or

expected. They are two methods concerning permeability which are feed water and extract water. General guidelines for in situ permeability tests are described as follows:

- Ponding tests or infiltration test can be conducted when the water table is low.
- Pumping test from test pits or holes can be used when the water table is near to surface.

The permeability test for residual soils is observed best performed under back pressure in a triaxial cell, but should have a diameter of more than 75 mm and be 75mm high as reviewed by Brand & Phillipson (1985).

A laboratory permeability test for residual soil can be conducted on compacted soil and more uniformly structured mature residual soils, particularly when the coefficient of permeability is determined in both directions, vertical and horizontal trimmed samples. The test than will result in estimating the mass permeability of uniformly textured soils. Other advantages of using laboratory test are for indication of the variation in the coefficient of permeability with changes in effective stress. Results obtained from the test can be used in designing earthworks.

#### *Pore water pressure and suction test*

Many soil-rock profiles of tropical residual soils particularly on slopes, are known to be in an unsaturated condition. The stability of slope is a major concern in most tropical residual soil countries due to the frequent periods of heavy rainfall. Gasmu et al. (1999) stated that rainfall has a detrimental effect on the stability of residual soil slopes. Negative pore pressures or matric suction is found to play an important role in the stability of slopes. These suctions have an important bearing on water entry, structural stability, stiffness, shear strength and volume change. The additional shear strength that exists in unsaturated soils due to negative pore-water pressures is lost as a result of rainwater infiltration into the soil. As a result, their in situ geotechnical performance is likely to be influenced by variations in soil suction, in response to rainfall infiltration. Another study by Richards (1985) found that fine grain residual soils have high solute contents which also affect the physical properties of the soil and the total soil suction due to the solute component. The total soil suction, the water content and the solute content and how they vary with time are often the most important variables in soil engineering design.

In situ soil suction can be measured with suitable sophisticated methods/equipments such as various types of tensiometers. The installation of a tensionmeter is also incorporated with the use of piezometers to measure groundwater level, and a rain gage to estimate rainfall intensities on the slope. A tensionmeter generally comprises a water-filled plastic tube with a high air entry ceramic cup sealed at one end and a vacuum pressure gage and a jet-fill cup sealed at the other end. When installed in soil, the pore-water pressure in the soil equalibrate with the water pressure in the tube and the pressure is measured by the vacuum pressure gage or by a pressure transducer. The jet-fill cup is used as a reservoir to allow for easy refilling and de-airing of the tensionmeter. Another alternative is to measure suction indirectly in the laboratory by means of the filter paper method. This method involves placing Whatman's No. 42 filter paper in contact with the soil for a period of 7 days and

measuring the amount of moisture taken up by the paper ( $W_{fp}$ ). Matrix suctions may be arrived by the following empirical relationships, Chandler et al. (1992).

$$\text{Suction (kPa)} = 10^{(4.84 - 0.0622W_{fp})}; \text{ for } W_{fp} < 47\%$$

$$\text{Suction (kPa)} = 10^{(6.05 - 2.48 \log W_{fp})}; \text{ for } W_{fp} > 47\%$$

### *Compressibility and consolidation*

There are a number of methods, both in situ or laboratory, that can be used to determine the compressibility of tropical residual soils. The oedometer and triaxial compression tests are the main laboratory methods of testing while for in situ testing, standard penetration test, pressure meter test and plate loading test, have been used.

Oedometer is a one-dimensional consolidation test where complete lateral confinement is used to determine total compression of fine-grained soil under an applied load. The test is also used to determine the time rate of compression caused by a gradual volume decrease that accompanies the squeezing of pore water from the soil. An undisturbed sample is usually used for consolidation test to obtain high quality results. The test first requires samples representatives of principal compressible strata. Some two to eight tests should be conducted depending on the complexity of conditions (Brand & Phillipson 1985).

The oedometer test is accepted for direct application for full analysis of amounts and rate of settlement only for intact clays. However, oedometer tests are not suitable for measuring compressibility of coarse grain soil and is thus not advisable for testing predominantly coarse grain residual soils. Whenever the consolidation or compression characteristic is needed, the use of triaxial test data is applicable. Brand & Phillipson (1985) noted that residual soils have most high-rise buildings and the foundations are usually taken down below the residual soils, such that consolidation tests are regularly used. Trimming the residual soil samples is truly challenging because of the gravel content in some soils. They are various consolidation tests that have been carried out and the recognized features are described as follows:

- Oedometer can be used to assess the swelling characteristics of residual soil.
- Suction-controlled consolidometers can be used to control stress, soil suction and equilibrium electrolyte solution.

Geoguide 3 (1996) suggests the uses of the more adaptable Rowe Cell which can accommodate larger samples. This is due to the substantial evidence that larger, good quality undisturbed samples provide a better model of in situ behavior. Rowe cells also provide much greater versatility in terms of drainage conditions.

### *Penetration resistance test*

Penetration resistance test refers to the measurement of the penetration of soil of a standard sampler in borings. The method is rapid, and when tests are properly conducted in the field, they will produce useful results. They are various methods applicable such as Standard Penetration Test and Cone Penetrometer Test (CPT).

*Standard penetration test (SPT)*

SPT is the most used in situ test for soil identification. It is almost invariably carried out in every site investigation work along with boring. Application of SPT tests are to determine subsoil profiles and to obtain quantitative parameters for design purposes. This test is conducted by allowing a standard hammer 63.5 kg (140 lb) in weight, to drop freely over a distance of 76 cm (30 in.). The number of blows required to drive a split spoon sampler a distance of 30 cm (12 in) after initial penetration of 15 cm (6 in) is referred to as an 'N' value or SPT 'N' value. Although this is a common test carried out in the field, various factors affect the N value including personnel, equipment and procedures. These factors affect the energy that is transferred through the drill rods to the sampler, and thus the N value. SPT-N values are often used for empirical characterization of soils and for preliminary geotechnical analyses and designs. Therefore it is important to realize the accuracy of N value for use in any calculation and design.

*Cone penetrometer test (CPT)*

CPT involves cones that penetrate down into the soil layers and measuring the pressure needed for each penetration increment. The principle behind CPT is the notion that the resistance to penetration of different types of soil will be different; the resistance will be high in firm soil. Classification of CPT depends on the method of advancing the cone into soil layers, i.e. the categories that are static, dynamic and static-dynamic penetrometers. The mobility of the equipment makes this kind of test preferable and has been adopted in many countries under different terms with some modification. The most commonly used cone test is the Dutch Cone Test (DCT).

The Dutch cone has an apex angle of 60 degrees and cross-sectional areas of 10 cm sq. The load is transferred through metal rods. With friction sleeve, the cone resistance and local friction can be determined. Brand and Philipson (1985) highlighted the major problem using DCT as the provision of sufficient dead load or anchor reaction to enable the cone to penetrate the more dense residual soils. Static penetrometers cannot penetrate into residual soils which contain many corestones.

Research by Mun (1985) on residual soil in Malaysia by using light dynamic cone penetrometer known as JKR probe showed the results to be reliable because the soil is relatively uniform and does not vary greatly in the horizontal direction. JKR probe has been used extensively in Malaysia for preliminary investigation to assess the consistency of clayey material and the relative packing of sandy materials.

*Plate load test*

Plate load test has widely been used to determine stiffness for foundation design. It is recorded that the test is also used to measure the bearing capacities of residual soils and make rough estimations of the history of preloading of residual soils. According to Barksdale & Blight (1997), plate load test features results of increasing soil stiffness with the size of loaded area, the same occurrence as in granular sedimentary soils. In plate load test, the load is applied to a rigid plate and then the resulting vertical deformation is measured. Less soil disturbance will occur since the test is conducted in situ. Figure 2.2 shows the set-up of equipment used in plate load test.

For a plate of breadth  $B$ , the plate load test gives a modulus of elasticity representative of the soil located within a depth of  $B$  to at most  $2B$  beneath the plate (Barksdale & Blight 1997). The test is usually conducted at the level of the bottom of the footing or below. According to Barksdale & Blight (1997), plate tests should only be conducted in the desiccated crust at the ground surface if the zone of actual footing influence lies primarily in that stratum. Frequently, plate load tests are performed at several depths in different strata. Barksdale & Blight (1997) recommended that before conducting a plate load test, the unsaturated soil beneath the plate should be soaked if it may be wetted during periods of prolonged wet weather. Soaking should be continued for a sufficiently long period of time to wet the soil for a depth of at least  $1.5B$  below the bottom of the plate.

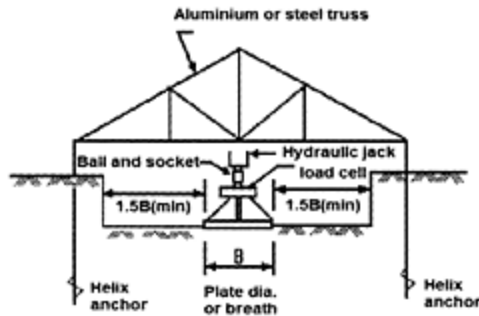

Figure 2.2. Typical set-up of equipment in plate load test (Barksdale & Blight 1997).

Barksdale & Blight (1997) also notes that usually the plate load test is performed in a pit excavated down to the desired level. However, elastic half-space theory, which is frequently used to calculate the modulus of elasticity, assumes that load is applied at the surface of a soil mass of wide lateral extent. If elastic half space theory is used to reduce the data, then an unconfined plate load test should usually be performed. Barksdale & Blight (1997) suggest that to perform this type of test, the soil overburden adjacent to the plate should be removed for a distance of at least  $1.5B$  and preferably  $2B$  away from the edge of the plate, where  $B$  is the diameter or least dimension of the plate. For a confined test, the soil surcharge should be left as close as possible to the plate.

General guideline for conducting plate load test as suggested by Barksdale & Blight (1997) are as follows:

- Numerous plate sizes can be used including square, circular and cast in place a concrete footing. Enviably plate size is 0.8 m with a minimum of about 0.3 m. Since plate load test is conducted in association with foundation design, it is worth providing a similar size of footing.
- Test pit to allow plate load test to be conducted is to be excavated to desired level with the consideration of elastic half-space theory. Elastic half-space theory which is usually used to calculate the modulus of elasticity assumes the load is applied at the surface of a soil mass of wide lateral extent.

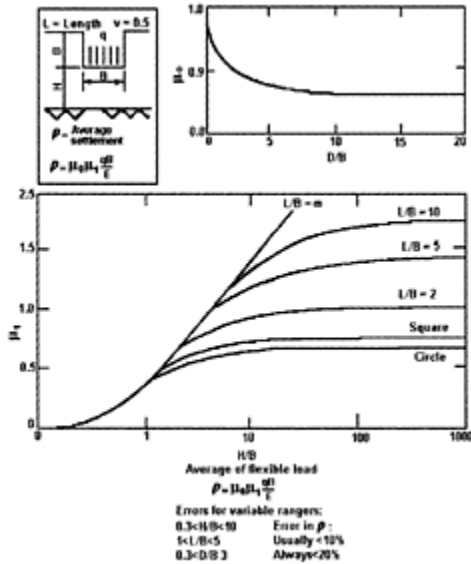

Figure 2.3. Elastic settlement calculation method for homogeneous soil: rigid layer and foundation embankment (Christian & Carrier 1978 in Barksdale & Blight 1997).

- The plate settlement is measured by using at least two dial indicators (or other types of measurement devices such as LVDTs) placed diametrically opposite each other and at equal distance from the centre of the plate.
- Load is applied to the plate usually by a hydraulic jack. The jack can react against either a dead load platform or a portable lightweight truss held down by helix anchors or tension piles.
- Load can be stacked with five equal incremental pressure and should not be more than the foundation design pressure to avoid excessive shear strain. There must be a gradual increment to allow the settlement to stop before applying a subsequent increment. To determine the immediate settlement, dial readings are taken as soon as possible after applying the load for each increment. However, this method will be not appropriate for some saturated and/or clayey residual soils as it might take some time for full settlement to occur and may not be practical to perform.

According to Barksdale & Blight (1997), residual soils usually have instantaneous deformations greater than 60 to 70% of the total settlement. The modulus of elasticity is calculated from the theory of elasticity. For a confined test, the elasticity approach is summarized in Figure 2.3 below which considers the depth of embedment used in the plate load test. Gidigas (1985) reports that plate load test is useful for evaluating the compressibility of high void ratio soils whose insitu structure may be disturbed by soil sampling procedure. Brand & Phillipson (1985) reviewed that plate load test can be particularly useful for the design of large foundations where other test methods are not satisfactory on their own. Failure

however is often difficult to define, and the results of the test must generally be interpreted in terms of deformations.

### *Pressuremeter test*

Instrument to measure the load-deformation characteristics of soils and rock in situ is known as pressuremeter. A pressuremeter is used to establish deformation modulus and earth pressure at rest, and for foundation design to evaluate settlement and failure load of foundation. The advantages of using a pressuremeter are as follow:

- It can be conducted in situ and therefore represent the actual field characteristics of the soil.
- Test can be carried out in soil deposit where undisturbed sampling is particularly difficult.

The pressuremeter unit consists of three components: the probe, the control unit and connecting tubing. Two types of pressuremeter probes which are commonly in use are Menard pressuremeter and single cell pressuremeter.

The use of pressuremeter of the Menard type is becoming increasingly widespread. According to Barksdale & Blight (1997), the Menard type pressuremeter test should be performed in a smooth-sided hole. In residual soils, pushing a thin walled tube sampler ahead of a machine-augured borehole has been found to work well. Barksdale & Blight (1997) suggested that in order to obtain good results in residual soils, the cavity should be expanded by the pressure meter to the stress level applied by the foundation at working load.

Pressuremeter test results and hence the modulus of elasticity determined from the tests are quite sensitive to equipment calibration. According to Barksdale & Blight (1997) these system calibrations should take into consideration the following;

*System compliance.* System compliance includes both decrease in membrane thickness and also changes in the volume of pressure transmission tubes, etc. both of which become increasingly important as the test pressure increases.

*Pressure effects.* Pressure loss must be accounted for due to membrane and sheath resistance to expansion. Also, differences in elevation between the pressuremeter and the pressure-measuring system must be considered if the pressure is measured at the surface.

All pressure gauges, transducers and deflection measurement devices must be accurately calibrated using reliable test standards.

A smaller version of the Menard pressuremeter has been developed at University Putra Malaysia (Omar et al. 2001, Omar & Salsidu 2001). Named the H-Ometer, it is used to measure strength and stiffness of weak rock and hard soil by producing failure in tension, inside the prebored hole in the specimen of soil or rock, into which the pressuremeter is inserted. The pressuremeter consist of six main components i.e, main body, head, special clip, tails, tubing and rubber membrane as shown in Figure 2.4.

Empirical relations between pressuremeter modulus and standard penetration resistance or cone resistance have been successfully used in practice for the soils for which the correlations were developed.



*Compaction and CBR test*

Compaction is used to densify soils during placement to minimize post-construction consolidation and to improve strength characteristics. Compaction characteristics are determined by moisture density testing; structural and supporting capabilities are evaluated by appropriate tests on samples of compacted soil. Compaction in general will modify the properties of tropical residual soils. For laboratory testing, the BS 2.5 kg rammer is usually adequate to correlate with the compaction equipment used in the working field. Greater compaction energy is not advisable since it tends to cause excessive soil particle breakdown.

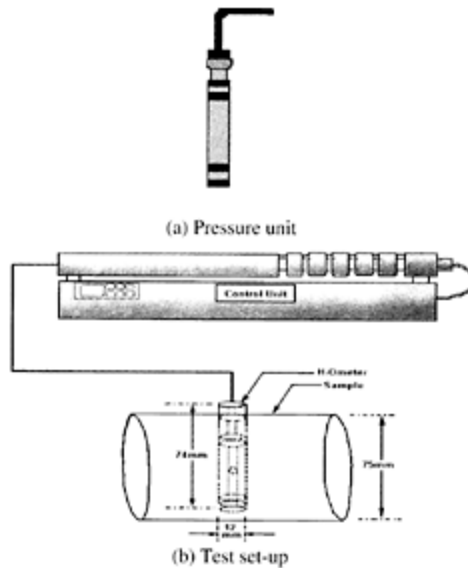

Figure 2.4. Schematic diagram of the H-Ometer pressuremeter (Omar et al. 2001, Omar & Salsidu 2001).

It has been shown by many researchers that sample condition and preparation, and the compaction methodology have a significant effect on the shape of the density-moisture curve. The following points are therefore particularly relevant to the testing for the density-moisture relationship in the compaction of tropical residual soils (Geoguide 3 1996):

- i) Drying of samples should be avoided as much as possible.
- ii) Fresh samples should be used for each moisture point.
- iii) The susceptibility of measured moisture content to drying temperature must be appreciated and the amount of 'engineering' moisture that will be available for site working must be assessed.
- iv) The relationship between the laboratory compactive effort and that which will be imparted on site must be understood.

The compaction test carried out in the laboratory is done to provide a standard comparison with field density tests. However, considering residual soil as fill whose properties can be very variable and an unacceptably large number of compaction tests may be required to ensure meaningful results.

Brand & Phillipson (1985) report to research carried out in Hong Kong in relation to compaction test. Compaction testing has been used as a major part of earth works site control. The most used test to measure field density is the in situ sand replacement tests besides occasionally using Washington densometer. British standard compaction tests are also used widely, but because the residual properties are so variable, a large number of density tests are required to ensure representative results. Brand & Phillipson (1985) also reported the use of Hilf method in determining soil density. Fookes (1997) stated the differences between densities of soils are measured after compaction in the field, as they may be greater for tropical residual soils than for sediment soils. The energy applied in the field is not adequate to produce complete structural breakdown as obtained in the laboratory. Simmons & Blight (1997) explained that compaction should include monitoring the source materials to ensure meeting specification requirements since there is wide variability in residual soils. Field compaction tests are more desirable because they enable the work to be controlled as much as possible by factors that have been proven in the field.

California Bearing Ratio is a test procedure that covers the evaluation of subgrade, sub-base, and base course materials for pavement design for highways and airfields. The resistance of a compacted soil to the gradual penetration of a cylindrical piston is measured in the CBR test. Simmon & Blight (1997) recommend that the California Bearing Ratio (CBR) test in tropical environments incorporates a soaking procedure. The CBR test is frequently closely related to compaction testing for the pavement supporting elements of a road-fill. As such it is important to obtain CBR samples at conditions of density and moisture appropriate to those likely to occur on site (Simmons & Blight 1997).

### *Chemical test*

There are a number of standard chemical tests that are routinely undertaken for civil engineering works. Chemical data have always been key part of the classification of clay minerals and hence can be of importance in understanding the character of tropical residual soils. Chemical data from whole material samples may also be used directly in the classification of tropical residual soils. Table 2.8 shows the standard chemical test for civil engineering.

Table 2.8. Standard chemical tests for civil engineering soils and groundwater (Geoguide 3 1996).

Test	Reference In BS 1377:1990	Comment
PH	Part 3.9	
Sulphate content		Class. As BRE Digests 250
Total sulphates in soils	Part 3:5.2, 5.5	Expressed as total SO <sub>3</sub> %

Water soluble sulphates in soils	Part 3:5.3, 5.5, 5.6	Expressed as total SO <sub>3</sub> %
Sulphates in ground water	Part 3:5.6–6	Expressed g/l or ppm
Organic content	Part 3.3	Suitable for most soils; ties in with pH test.
Carbonate content	Part 3.6, 3–4	Expressed as a CO <sub>2</sub> .
Chloride content		
Water soluble	Part 3:7.2	Expressed as amount of chloride to 0.01%
Acid soluble	Part 3:7.3	
Loss on ignition	Part 3:4	Potentially unreliable in materials containing clay minerals, specially holloysite or allophance.

---

### *Mineralogy test*

As stated in Fookes (1997), for tropical residual soils, the influence of microstructure is important as the effects of swelling clay minerals and colloidal size constituents can be significant. The most commonly used test use to study the soil microstructure and confirm the presence of specific mineralogies from their characteristic morphologies are as follows:

- Scanning electron microscopy (SEM)
- X-ray diffraction (XRD)
- Optical microscopy

## 2.4 SUMMARY

Conventional approaches to testing and sampling sedimentary soil may not always be applicable to residual soils. This chapter describes some modifications to conventional testing to account for the unique behavior of residual soils.

## REFERENCES

- Barksdale, R.D. & Blight, G.E. 1997. Compressibility and settlement of residual soils. In Blight (eds). *Mechanics of residual soils*. ISSMFE (TC 25): Balkema, 95–152.
- Blight, G.E. 1985. Residual soils in South Africa. In Brand & Phillipson (eds), *Sampling and testing of residual soils*. Hong Kong: Scorpion Press, 159–168.
- Blight, G.E. 1997 (ed). *Mechanics of residual soils*. ISSMFE (TC 25): Balkema
- Brand, E.W. & Philipson, H.B. 1985. Sampling and testing of residual soil. A Review of International Practice. Southeast Asian Geotechnical Society. Hong Kong: Scorpion Press. 7–22.
- Brenner, R.P., Garga, V.K. & Blight, G.E. 1997. Shear strength behavior and the measurement of shear strength in residual soils. In Blight (eds) *Mechanics of residual soils*. Balkema, 155–217.
- BSI, 1990. BS1377. Soil for civil engineering purposes. British Standards Institution.

- Chandler, R.J., Crilly, M.S. & Montgomery-Smith, G. 1992. A low-cost method of assessing clay desiccation for lowrise buildings. *Civil Eng., Proc. ICE*: 92(2): 82–89.
- Fookes, P.G., 1997 (ed). Tropical residual soils. A geological society engineering group working party revised report. The Geological Society.
- Fredlund, D.G. 1987. Slope stability analysis incorporating the effect of soil suction. In Anderson & Kemp (eds). *Slope stability*. John Wiley & Sons.
- Garga, V.K. & Blight, G.E. 1997. Permeability. In Blight (ed) *Mechanics of residual soils*. ISSMFE (TC 25): Balkema, 79–93.
- Gasmo, J., Hritzuk, K.J., Rahardjo, H. & Leong, E.C. 1999. Instrumentation of an unsaturated residual soil slope. *Geotechnical Testing Journal, GTJODJ*. 22(2):128–137.
- Geoguide 3, 1996. Tropical weathered in situ materials—Laboratory testing. JKR (Public Works Department, Malaysia).
- Gidigasu, M.D. 1985. Sampling and testing of residual soils in Ghana. In Brand & Phillipson (eds) *Sampling and testing of residual soils*. Hong Kong: Scorpion Press, 65–74.
- Head, K.H., 1992. Manual of soil laboratory testing. Volume 1: Soil classification and compaction tests. London: Pentech Press.
- Mun, K.P. 1985. Sampling & testing of residual soils in Malaysia. Sampling & testing of residual soils. A review of International Practice. SEA Geotechnical Society, 109–120.
- Mutaya, P. & Huat, B.B.K. 1993. Effect of pretest treatment on engineering properties of local residual soils. *Journal, Institution of Engineers Malaysia* 55:29–41.
- Nicholls, R.A. 1990. Sampling techniques in soft ground and residual soils. *Proc. of seminar on geotechnical aspects of the north—south expressway*. Kuala Lumpur: 1–7
- Omar, H., Ahmad, J. & Aziz, A.A. 2001. The undrained shear strength of hard soil from the H-Ometer tests. *Geotechnical engineering and geological engineering*. Huat & Yusoff (eds). University Putra Malaysia, 31–38.
- Omar, H. & Salsidu, M.S. 2001. A new indirect tensile strength measuring device for weak rock. *Journal of the Southeast Asian Geotechnical Society* 32(2):75–81.
- Richards, B.G. 1985. Geotechnical aspects of residual soils in Australia. In Brand & Phillipson (eds). *Sampling and testing of residual soils*, Hong Kong: Scorpion Press, 23–30.
- Simmons, J.V. & Blight, G.E. 1997. Compaction. In Blight (eds) *Mechanics of residual soils*. Balkema, 65–77.
- Singh, M. & Ho, H.S. 1990. Strength testing of residual soils. *Proc. of seminar on geotechnical aspects of the north—south expressway*. Kuala Lumpur; 149–152.



## CHAPTER 3

# Index, engineering properties and classification of tropical residual soils

Shukri Maail & Bujang B.K.Huat  
*University Putra Malaysia*

Suhaimi Jamaludin  
*Public Works Department Malaysia*

Tropical residual soils have a wide range of index and engineering properties depending on their parent rock forming minerals, intensity of weathering, amount of rainfall and temperature. These factors are in turn governed by the geographical location and the prevailing weather conditions. Engineering properties not only vary with spatial locations but also with depth. This chapter provides an overview of the index and engineering properties of some tropical residual soils. Description, identification and classification of tropical residual soils are also discussed.

### 3.1 INTRODUCTION

Soil index and engineering properties are used extensively by engineers to classify different kinds of soil into broad categories such as clay and sand. It may be further categorized into sub-groups based on their physical and engineering properties.

Classification tests to determine index and engineering properties will provide the engineer with valuable information on soil characteristics when the results are compared against empirical data relative to index properties.

### 3.2 INDEX PROPERTIES

The principle indices used in geotechnical engineering include plastic limit, liquid limit, shrinkage limit and particle size distribution. Plastic limit is the lowest water content at which the soil exhibits plastic behavior. Liquid limit is the upper boundary of the plastic behavior and at this moisture content the soil behaves as a viscous liquid, flows under its

own weight and will not hold a specific shape. Shrinkage limit is the water content at which the volume of soil remains constant even with further reduction in water content.

Most tropical residual soils are affected by drying. Index properties of tropical residual soils may change drastically even by partial drying. It could be due to alteration of the clay minerals on partial dehydration or due to aggregation of fine particles to form larger particles which remain bonded together even on re-wetting (Fookes 1997, Blight 1997).

### *Moisture content*

The moisture content  $m$  (or water content  $w$ ) of soil is an important characteristic in soil physics. It should be determined for both disturbed and undisturbed but not dried-out cohesive and granular soils samples taken from above and below the water table.

The definition of moisture content of the soil is the ratio of the mass of water removed from the wet soil to the mass of dry solid particles after drying at a temperature of  $105^{\circ}\text{C}\pm 5^{\circ}\text{C}$ . Sometime it is expressed in the form of a percentage.

The natural moisture content varies according to the dominant type of soils. For example, moisture content for peat soil ranges between 650 to 1100% (Bell 1983b) and for tropical peat soil it ranges between 200 to 2200% (Huat 2004), whereas for tropical residual soil it is between 16 to 49% (Nixon et al. 1957). However, in the tropical region, higher values of moisture content have been observed.

In many residual soils, some moisture exists as water of crystallization, within the structure of the minerals present in the solid particles (Blight 1997). This water may be removed by drying at a temperature of  $110^{\circ}\text{C}\pm 5^{\circ}\text{C}$ .

Table 3.1 shows some values of natural moisture contents of tropical residual soils.

### *Plasticity*

The term plasticity is applied to fine soils such as silts and clays and indicates an ability to be rolled and molded without breaking apart. The Atterberg Limits are defined as the water content corresponding to different behavior and conditions of the fine soil. Although originally six limits were defined by Albert Atterberg, in geotechnical engineering, the term Atterberg Limits only refers to Liquid Limit ( $LL$ ), Plastic Limit ( $PL$ ) and Shrinkage Limit ( $SL$ ).

Due to the sensitivity of tropical residual soils to drying processes as discussed earlier in Chapter 2, it is recommended that the working time or working process to determine the Atterberg Limits must be as short as possible, and with an appropriate method of drying applied (Blight 1997).

Many researchers and writers state that tropical residual soils are very sensitive to drying because drying may change the physical and chemical properties of the affected soils.

Table 3.2 shows the effect of various pretest treatments on Atterberg Limits of some Malaysian tropical residual soils (Mutaya & Huat 1994).

Due to the inconsistencies of the Atterberg limits, the Plasticity index derived from these values also varies quite considerably as shown in Table 3.3.

Table 3.1. Moisture content of some tropical residual soils.

Parent material	Natural moisture content (%)	Location	Source
Andesite	26	Malaysia	Newill & Dowling (1996)
Basalt	23	Hawaii	Lohnes & Demirel (1983)
Granite	30	Malaysia	Ting et al. (1972)
Granite	31	Malaysia	Taha et al. (1999)
Granite	20–22	Singapore	Leong & Rahardjo (1995)
Rhyolites	76	Malaysia	Soong & Yap (1973)
Volcanic Ash	39–46	Hawaii	Lohnes & Demirel (1983)
Schist	10–48	Malaysia	Komoo (1985)
Schist	7–49	Malaysia	Nithiaraj et al. (1996)
Sandstone	46	Malaysia	Soong & Yap (1973)
Shale	47	Malaysia	Mun (1985)
Jurong Formation (sedimentary)	18–33	Singapore	Leong & Rahardjo (1995)

Note: Drying temperature/method not available.

### *Shrinkage*

Studies by Mutaya & Huat (1994) on the effect of methods of drying and dispersing agents on linear shrinkage of some Malaysian tropical residual soils showed that there was a marked difference between air dried and oven-dried. However the difference was not significant when dried at 50°C or 100°C for 24 hours.

Table 3.2. Effect of various pretest treatments on Atterberg Limits of some Malaysian tropical residual soils (Mutaya & Huat 1994).

Parent material	Shale		Schist		Sandstone	
	LL	PL	LL	PL	LL	PL
Atterberg Limits (%)	64	44	67	45	51	39
At natural moisture content.	64	44	67	45	51	39
Air dried for 3 days.	61	40	70	38	48	30



Oven dried at 50°C for 24 hours.	51	38	50	36	42	27
Oven dried at 100°C for 24 hours.	46	33	46	32	39	22
Treated with hydrogen peroxide.	39	24	41	31	27	18
Treated with sodium hexametaphosphate.	36	–	41	31	26	–

Table 3.3. Atterberg Limits of some tropical residual soils.

Parent Material	Liquid limit (%)	Plastic index (%)	Location	Source
Basalt	92–105	48–59	Malaysia	West & Dumbleton (1970)
Basalt	46–52	15–19	Malaysia	West & Dumbleton (1970)
Basalt	45–49		Hawaii	Lohnes et al (1983)
Granite	42–107	20–21	Malaysia	West & Dumbleton (1970)
Granite	79	44	Malaysia	Ting et al. (1982)
Granite	69	33	Malaysia	Taha et al. (1999)
Granite	60	19	Malaysia	Yee et al. (1975)
Granite	34	20	Singapore	Leong & Rahardjo (1995)
Schist	25–90	18–38	Malaysia	Komoo (1989)
Schist	59.5	28.5	Malaysia	Raj (1988)
Shale	64	22	Malaysia	Mun (1985)

Note: Methods of sample preparation are not available.

Table 3.4 shows the effect of degree of drying and dispersing agents on linear shrinkage of some Malaysian tropical residual soils (Mutaya & Huat 1994).

Very small difference in shrinkage limit value were observed when samples were treated with either sodium haxametaphosphate or hydrogen peroxide.

### *Particle size distribution*

Sieving and sedimentation tests are used to determine particle size distribution within a soil sample. The sieving test is normally used for particle size larger than 63  $\mu\text{m}$  (0.063 mm) whereas for particles smaller than 63  $\mu\text{m}$ , sedimentation test is used. The distribution is normally shown as a grading curve in a plot of particle size (log scale) on the abscissa and percentage passing (linear scale) on the y-axis as shown in Figure 3.1. The grading curve

is particularly important in identification and classification of coarse grained soils. Some-time the curve is also used to estimate the permeability of course soil (Kozeny-Carmen equation).

Table 3.4. The effect of degree of drying and dispersing agents on linear shrinkage (%) of some Malaysian tropical residual soils (Mutaya & Huat 1994).

Pre-treatment	Shale	Schist	Sandstone
Not dried nor dispersed	13.1	14.2	9.1
Air dried for 3 days.	10.7	10.6	6.4
Oven dried at 50°C for 24 hours.	9.7	10.6	5.9
Oven dried at 100°C for 24 hours.	9.7	9.3	5.1
Treated with hydrogen peroxide.	9.6	9.1	–
Treated with sodium hexametaphosphate.	9.5	9.0	–

Using this Particle Size Distribution Curve, the Coefficient of Uniformity ( $C_u$ ) and Coefficient of Curvature ( $C_c$ ) of the soil can be computed as follows:

$$C_u = \frac{D_{60}}{D_{10}} \tag{3.1}$$

where  $D_{60}$  is the particle size corresponding to 60% finer by dry weight, and  $D_{10}$  is the particle size corresponding to 10% finer by dry weight.

$$C_c = \frac{(D_{30})^2}{D_{10}D_{60}} \tag{3.2}$$

where  $D_{30}$  is the particle size corresponding to 30% finer by dry weight.

These two coefficients are used in the Unified Soil Classification System to determine whether a soil is well graded or poorly graded.

In preparing tropical residual soils samples for sieving, breakdown of individual particles by crushing must be avoided (Fookes 1997). For this reason, wet sieving is preferred to dry sieving. Too long an exposure of the samples to the atmosphere especially in the dry region before wet sieving should also be avoided because it may lead to aggregation of fine particles to form larger particles which may remain bonded together even on re-wetting (Blight 1997). Longer working time also may lead to breaking of particles in the soil sample.

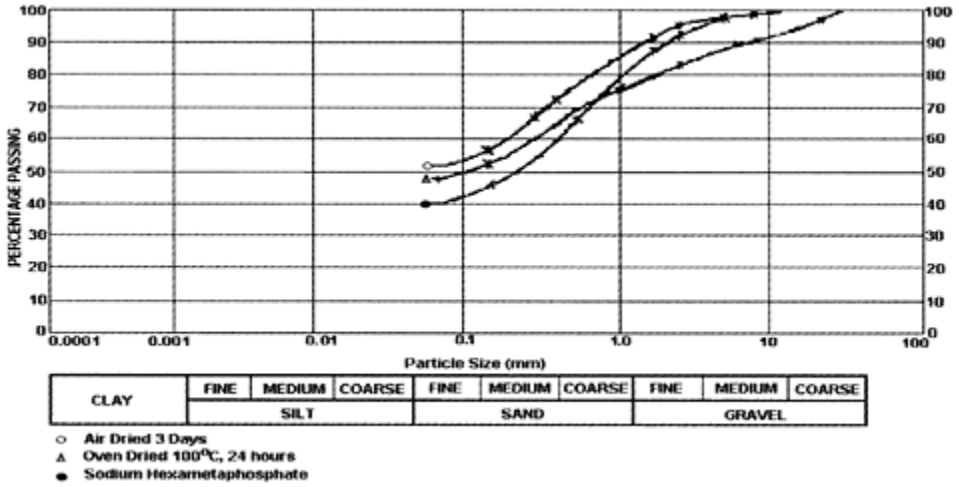

Figure 3.1. Effect of sample preparation on a tropical residual soil (weathered shale) (Mutaya & Huat 1994).

Table 3.5. Particle size distribution of some tropical residual soils.

Parent material	Clay (%)	Silt (%)	Sand (%)	Location	Sources
Andesite	57	15	4	Malaysia	Pushparajah & Amin (1977)
Basalt	63	20	11	Malaysia	Pushparajah & Amin (1977)
Basalt	30	39	31	Hawaii	Lohnes & Demirel (1983)
Granite	52	4	5	Malaysia	Pushparajah & Amin (1977)
Granite	28	17	48	Malaysia	Ting et al. (1982)
Granite	42	23	35	Malaysia	Taha et al. (1999)
Rhyolites	53	14	9	Malaysia	Pushparajah & Amin (1977)
Volcanic ash	6	25	69	Hawaii	Lohnes & Demirel (1983)
Schist	5–58	9–40	7–49	Malaysia	Nithiaraj et al. (1996)
Sand-stone	27	2	27	Malaysia	Pushparajah & Amin (1977)
Shale	67	14	8	Malaysia	Pushparajah & Amin (1977)
Jurong Formation	25	43	30	Singapore	Parashar et al. (1995)
Unknown	9	9	17	Nigeria	Madu (1977)
Unknown	7	3	32	Nigeria	Madu (1977)

Note: Method of sample preparation was not available.

Figure 3.1 show the result of the study by Mutaya & Huat (1994) on the effect of method of sample preparation on particle size distribution of tropical weathered shale.

It indicates that oven drying reduces apparent fine content of the soils compared to air-dried sample. This showed that fine particles may have aggregated and bonded together to become larger particles. A dispersing agent such as sodium hexametaphosphate is used to break the particle down and wash away the fine silt and clay particles.

Particle size distribution may not be used to classify whether a soil is a residual soil or otherwise.

Composition and particle size distribution of the soils often depends on their parent materials and degree of weathering as shown in Table 3.5 which shows the percentage of composition of particles after weathering for different parent rock minerals. These are examples of tropical soils from Malaysia, Singapore, Nigeria and Hawaii.

### *In situ density and specific gravity*

In situ density of tropical residual soils may be obtained by weighing and measuring the volume of an undisturbed sample (prepared for strength or compression test) in the laboratory. It may also be measured in situ using field density methods such as sand replacement method, or nuclear technique.

Specific gravity (also known as density solid particles) is normally determined in the laboratory and used for the purpose of determining porosity and void ratio of the soil. For tropical residual soils, its variation is, uncommonly large. Table 3.6 shows the density and specific gravity of some tropical residual soils.

### 3.3 ENGINEERING PROPERTIES

Principle engineering properties used in Geotechnical Engineering are shear strength, compressibility, consolidation and settlement, and permeability of the soil.

Table 3.6. Densities and specific gravity of some tropical residual soils.

Parent material	Bulk density (mg/m <sup>3</sup> )	Dry density (mg/m <sup>3</sup> )	Specific Gravity	Location	Sources
Andesite	NA	1.7	3.4	Malaysia	Newill & Dowling (1969)
Basalt	NA	1.4	3.0	Hawaii	Lohnes & Demirel (1983)
Granite	NA	NA	2.6	Malaysia	Pushparajah & Amin (1977)
Granite	1.9	1.47	2.6	Malaysia	Ting et al. (1972)
Granite	1.8–2.0	NA	2.6	Singapore	Leong & Rahardjo (1995)

Volcanic ash	NA	0.8	3.1	Hawaii	Lohnes & Demirel (1983)
Schist	1.4–2.0	NA	2.6–2.7	Malaysia	Nithiaraj et al. (1996)
Sand-stone	1.3	NA	2.6	Malaysia	Pushparajah & Amin (1977)
Shale	NA	NA	2.6	Malaysia	Pushparajah & Amin (1977)
Shale	NA	2.1	3.3	Malaysia	Newill & Dowling (1969)
Jurong formation	1.9–2.1	NA	2.6–2.7	Singapore	Leong & Rahardjo (1995)

Note: Method of sample preparation not available.

### *Shear strength*

All failures in soil mass are shear failures. It cannot withstand tension stress, and compression leads to shear. The shear strength of a soil is its maximum resistance to shear usually expressed as a stress. The stress-strain relationship in soil is usually non-linear, unlike many engineering materials. However in some design calculations, it may be assumed to be linear.

### *Strength parameters*

There are two components of shear strength of soil: a cohesive element and a frictional element. The cohesive element is derived from the interparticulate forces, which draws particles together. Cohesion ' $c$ ' is sensitive to water and porewater chemistry. Cohesive resistance develops quickly to the maximum value under small strains and decreases as strain increases.

The frictional element is derived from inter-granular contact and is not developed to its maximum value until significant amounts of strain have occurred. The internal friction angle is represented as ' $\phi$ '.

Table 3.7 shows strength parameters of some tropical residual soils, mostly found in South East Asia. It must however be noted here that the methods of testing are not available.

Table 3.7. Strength parameters of some tropical residual soils.

Parent Material	Cohesion ( $c$ ) (kN/m <sup>2</sup> )	Internal friction ( $\phi$ )	Location	Sources
Basalt	22	45	Hawaii	Lohnes & Demirel (1983)
Basalt	40	58	Hawaii	Lohnes & Demirel (1983)
Granite	2–8	40–50	Malaysia	Komoo (1985)
Granite	4–7	23–28	Malaysia	Ting et al. (1972)
Schist	13–40	10–38	Malaysia	Nithiaraj et al. (1996)
Phyllite	30–65	20–28	Malaysia	Singh & Ho (1990)
Sand-stone	36–39	42–44	Malaysia	Komoo (1985)
Shale	20	30	Malaysia	Ting et al (1972)
Jurong Formation	23–123	14.5–25.5	Singapore	Leong & Rahardjo (1995)
Jurong formation	97	27	Singapore	Parashar et al. (1995)

Note: Methods of testing are not available.

### *Factors affecting strength*

Generally the factors influencing the strength and behavior of tropical residual soil are inter-particle bonding, relict structures and discontinuities, anisotropy, partial saturation and lastly void ratio (Blight 1997).

### *Inter-particle bonding*

The particles that constitute soil and other earth materials can stick together by cohesion. Cohesion is a result of bonding and cementation of fine particles. The mineral particles bond together to form soil by chemical or electrostatic forces. Chemical bonding exists in rocks. Elements are chemically bonded together giving cohesion to rocks.

Electrostatic bonding exists with clays. Clays tend to have an overall negative charge. Water is dipolar, and most natural water has ions in it (charged particles). These electrical charges attract water molecules, ions and clay particles to one another, resulting in cohesion. The strength of the electrostatic cohesive forces is inversely proportional to the distance separating these elements. As more water is added to clay rich soils, particles become farther apart and the strength of the attraction decreases.

Another type of bonding is physical bonding which refers to the bonding of the coarser grains such as sand and gravel by frictional forces that include the interlocking of particles.

Inter-particle bonding also can be developed by cementation, solution and re-precipitation of cementing agents, and chemical alteration of minerals (Blight 1997). The strength of inter-particle bonding is greatly dependent on mineral content and their degree of weathering.

The inter-particle bonding may be destroyed by disturbances during sampling and handling, sample preparation and shearing during strength testing. These factors may account for lower shear strength observed in the laboratory. Hence, samples handling and specimen preparation have to be done with utmost care, if high quality results are to be expected.

### *Relics structures and discontinuities*

In rock, a discontinuity represents a plane of weakness within a rock mass across which the rock material is structurally discontinuous (Bell 1983a). The most common discontinuities are joints and bedding planes. Other important discontinuities are planes of cleavage and schistosity, fissures and faults. These discontinuities have a low strength due weathering or it is filled with low strength clay.

After decomposition of the parent rock mass to form a soil, these relicts of discontinuities will also exist in the residual soil. These relict discontinuities are very difficult to identify, and test specimens will usually fail along these planes of weaknesses (Blight 1997). Angles of shearing resistance on these weak planes may be in order of  $\phi' = 15-20^\circ$  when the seams are unsheared, dropping to about  $\phi' = 10^\circ$  when they are pre-sheared and slickensided (Fookes 1997).

### *Anisotropy*

In tropical residual soils particularly for soil derived from metamorphic rocks and where mica is present, anisotropic behavior is usually influenced mainly by the fabric of the parent rock, although in situ stress may also play a significant role (Blight 1997). Due to stress anisotropic in a soil, the direction of stress will influence the response to a shear stress application. For example platy clay minerals in a weathered rock can become oriented during the shearing process which leads to a polished shear surface. This polished shear surfaces may develop in situ, by strains accompanying soil genesis, but also by swelling and shrinkage. The stress anisotropy of tropical residual soil may vary from sample to sample due to randomness of the above processes and anisotropy of tropical residual soils fabrics (Blight 1997).

### *Partial saturation*

In topical regions, due to climatic condition and dense vegetation, evapotranspiration often exceeds infiltration and groundwater tables are often low, creating an unsaturated top layer with continuous air in their voids above the water table. Such a condition will produce apparent cohesion resulting from capillary effects. The capillary effects result from surface

tension of water films which creates a negative pore pressure, sometime known as matric suction between the soil particles and it helps to attract the particles to one another. Matric suction is hydrostatic or isotropic pressure in that it has equal magnitude in all directions (Fredlund & Rahardjo 1993). This negative pore water pressure produces a higher effective stress, meaning that the effective stress becomes greater than the total stress (Blight 1997).

Positive pore pressure exists when water fills all pore spaces between particles pushing the particles apart from one another. During shear strength laboratory testing, particle bonding may be partly destroyed during saturation and the application of confining stresses to a test specimen, if stresses are not carefully applied.

*In situ void ratio*

In the tropical climates with high annual precipitation and temperature, intense weathering with high degree of leaching of finer particles and minerals always occurs. The type of parent rock, type of weathering and the stress state produce a considerable variation of in situ void ratio in the residual soils (Fookes 1997).

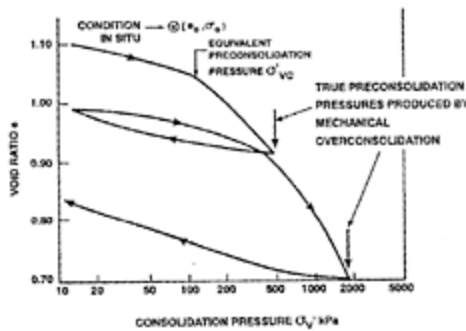

Figure 3.2. Typical consolidation curve for residual andesite lava, Blight (1997).

In a weakly bonded soil, the void ratio has strong influence on the drained strength, which increases with density, and the deformation behavior of the soil (Blight 1997).

*Compressibility and settlement*

There are various types of in situ method of tests to measure compressibility of soils namely the plate load test, cross-hole plate test, screw plate test, pressuremeter test, etc. The oedometer and triaxial tests are frequently used in the laboratory.

Compressibility and settlement of tropical residual soils depend on soil grading, the type of clay minerals present and on the density achieved by compaction, Fookes (1997).

Residual soils often behave as if they are over consolidated, and their compressibility is relatively low at low stress levels (Blight 1997). Once a threshold yield stress or equivalent pre-consolidation stress has been exceeded, the compressibility increases. In most cases,



the stress range will be such that the soil will remain within the pseudo-over-consolidated range of behavior.

Figure 3.2 shows typical characteristics of the compression curve for residual andesite lava (Blight 1997).

### *Permeability*

The permeability of a soil is a measure of how easily fluids (usually water) pass through the soil and is related to the degree to which the pores or spaces of the soil are connected to each other. The permeability of a particular soil is defined by its coefficient of permeability,  $k$ .

The permeability of the soil is geologically controlled by factors such as the shape of the mineral grains in the soil, their grain shape and size, and the manner in which the grains are held together, soil porosity, density and viscosity of water inside soil, degree of soil saturation and type of flow of water inside the soil. To some extent, the permeability of soil is also controlled by the confining effective stresses within the soil mass.

Table 3.8. Permeability of some tropical residual soils.

Parent Material	Permeability (m/s)	Location	Sources
Basalt	$9 \times 10^{-10}$ to $9 \times 10^{-5}$	Brazil	Costa Filho & Vargas Jr. (1985)
Granite	$1 \times 10^{-9}$ to $1 \times 10^{-8}$	Singapore	Poh et al. (1985)
Granite	$5 \times 10^{-6}$ to $2 \times 10^{-4}$	Hong Kong	Lumb (1962)
Granite	$5 \times 10^{-9}$ to $5 \times 10^{-8}$	Malaysia	Ting & Ooi (1972)
Gneiss	$9 \times 10^{-7}$ to $5 \times 10^{-5}$	Brazil	Costa Filho & Vargas Jr. (1985)
Gneiss	$9 \times 10^{-7}$	Brazil	Costa Filho & Vargas Jr. (1985)

Note: Methods of testing are not available.

For tropical residual soils, their particle shape and size and the manner in which the grains are held together, soil porosity, soil mineralogy, degree of fissuring and the characteristics of the fissures vary, both in lateral direction as well as with depth. Generalizations of the values of permeability for various types of tropical residual soils must be avoided (Blight 1997). The permeability of undisturbed tropical residual soils can be determined by both in situ and in the laboratory testing.

Table 3.8 shows the permeability of some tropical residual soils. Significant difference in values of permeability from location to location are clearly shown.

### 3.4 DESCRIPTION, IDENTIFICATION AND CLASSIFICATION OF TROPICAL RESIDUAL SOILS

#### *Soil series and group*

In agriculture practice, residual soils are often classified and categorized as soil series. A soil series is a group of soils with similar profile characteristics and formed from parent material of the same geologic origin. When classifying soils at the series level, they are therefore grouped on the basis of their common properties.

Examples of some soil series used in Malaysia and Hawaii are shown in Table 3.9 below.

In soil science, soils are also classified into various group based on pedogenic factors. There are seven major classes of tropical residual soils proposed by Duchaufour (Fookes 1997) namely fersialitic soils, andosols, ferruginous soils, ferrisols, ferrallitic soils, vertisols and pedzols. Table 3.10 shows descriptions of some terms used to classify tropical residual soils.

Table 3.9. Some samples of soil series.

Rock type	Parent material	Soil series	Source (see note)
Igneous	Andesite	Segamat	1
	Basalt	Kuantan	1
	Basalt	Molokai, Laihana	2
	Granite	Rengam, Baling	1
	Granodiorite	Lanchang	1
	Rhyolites	Kulai	1
	Volcanic tuff	Jempol	1
	Volcanic Ash	Kilohana, Waimes	2
Metamorphic	Schist	Prang, Munchong	1
Sedimentary	Sandstone	Serdang, Kedah	1
	Shale	Durian, Malacca	1

Note:

1. Malaysia/Tessens & Shamsuddin (1983).

2. Hawaii/Lohnes & Demirel (1983).

There are a number of different organisations classifying residual soil into into different groups based on their parent material of the same geologic origin. Unfortunately, this led to further confusions. In an effort to clear the air, tabulated in Table 3.11 are approximate equivalents terms of various major classes of tropical residual soils based on Duchaufour,

Food and Agriculture Organization of the United Nations (FAO-UNESCO) and USA Soil Survey.

### *Color*

Soils can also be identified and classified by their color. Soil color is an important property of soils that reflects many of the soil properties and so is used widely in classifying soils. A change in surface color from one area to another may reflect a change in the mineral composition or the amount of water present.

Soil temperature is greatly affected by color. Black soils absorb more energy from the sun's radiation than do grey soils. Differences in soil temperature will allow different types of plants to grow. Darker soils generally mean more organic matter in the soil mass.

Table 3.10. Group and sub-groups of tropical residual soils and their description (Fookes 1997).

Group/ sub-group	Descriptions
Andosols	Porous soils of low bulk density formed by rapid weathering of volcanic ash and containing complexes of humus and imperfectly crystallized aluminosilicate clay
Ferruginous soils	Intermediate between fersiallitic and ferallitic soil. Newly formed clays are usually kaolinitic. Some smectite clays persist but lessived gibbsite absent
Ferrisols	Soil type transitional between ferruginous and ferallitic types
Ferallitic soils	Group of soils formed in hot humid tropics principally by hydrolysis of primary minerals, leaving iron and aluminium as residues. Silica, alkalis, and alkaline earth are removed in solution.
Oxisol	Intensively weathered soil rich in iron and aluminium oxides
Podzol	A soil having a surface layer rich in organic matter overlaying a bleached (iron depleted) or albic horizon (which over highly permeable substrates in the humid tropics may be developed to a depth exceeding 3 m; such a soils have been described as 'giant' podzols) and then a brown iron enriched (spodic) horizon.
Ultisol	Soil less weathered than oxisols, containing kaolinitic clays together with hydrated oxides of iron and aluminium, and broadly equivalent to ferruginous soils and ferrisols.
Vertisols	Soil (cracking clays) showing a wide range of seasonal volume change, and usually containing clay minerals of the montmorillonite group. Clay-humus complexes are often incorporated to some depth by top common name of black cotton soil. soil falling down the cracks, hence the

The color of soil horizons is an important criterion which enables soil scientists to classify soils. As an obvious example is a soil profile that has been cut through an area that is waterlogged or flooded periodically, and light grey horizons will be seen. These layers have

been ‘gleyed’ or subject to reducing conditions. Red and brown stripes, spots or mottles indicate alternate waterlogged and dry conditions. The spots are composed of oxidized iron compounds (rust).

Soil Scientists use a system called Munsell Color System or Munsell Color Chart as shown in Figure 3.3, to classify the soil. Munsell Color System consists of 175 different colored chips arranged systematically. The Munsell notation allows for uniformity in color description, first published by American Professor and teacher of art, Albert Henry Munsell in 1905. Soils are compared to books of standard colors.

Table 3.11. Approximate equivalents of various major classes of tropical residual soils (after Fookes 1997).

Duchaufour (1982)	Food and Agriculture Organization of the United Nations, 1988 (FAO-UNIESCO)	USA Soil Survey (1975, 1992)
Fersialitic soils	Cambisols, calcisols, luvisols, alisols.	Alfisols inceptisols.
Andosols	Andosols	Inceptisols
Ferruginous soils	Luvisols, alisols, lixisols, plinthosols.	Alfisols, ultisols
Ferrisols	Nitisols, acrisols, lixisols, luvisols, plinthosols.	Ultisols, oxisols
Ferrallitic soils	Ferrasols, plinthosols	Oxisols
Vertisols	Vertisols	Vertisols
Podzols	Podzols	Spodosols

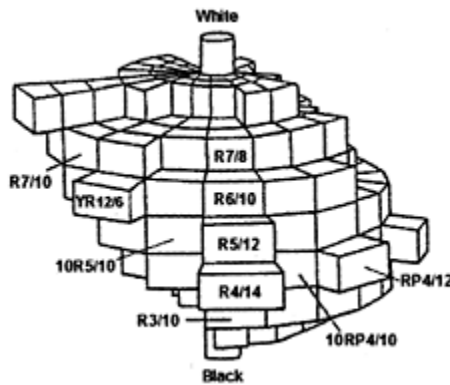

Figure 3.3. Munsell color system.

The Munsell color system is a typical color appearance system, in which color is represented with hue (H), saturation (S) and intensity (I) as a psychological response. Hue is composed of the five basic color; red (R), yellow (Y), green (G), blue (B) and purple (P) which are located along a hue ring with intervals of 72 degrees.

Intermediate colors between the above five basic colors; YR, GY, BG, PB and RP are located in between each other. Finally each hue is divided into ten but actually four. For example 1R, 5R, 10R, 1YR, 5YR, 10YR, 1Y, are a series along the hue ring.

Intensity is an index of brightness with 11 ranks from 0 (dark) to 10 (light). Saturation is an index of pureness ranging from 0 to 16 depending on the hue and intensity. Color in the Munsell color system is identified as a combination of hue, intensity/saturation, for example 5R4/10, which means 5R (hue), 4 (intensity) and 10 (saturation).

Table 3.12. Color of some Malaysian tropical residual soils (Tessens & Shamsuddin 1983, Pushparajah & Amin 1977).

Parent material	Soil series	Color	Location
Andesite	Segamat	Red (2.5YR 4/6)	Temerloh-Kuantan Road, Pahang
Basalt	Kuantan	Dark brown (10YR 3/3)	Kuantan, Pahang
Granite	Bukit Temiang	Reddish yellow (5YR 6/8)	Trengganu
Granodiorite	Lanchang	Strong brown (7.5YR 5/8)	Lanchang, Pahang
Rhyolites	Kulai	Brownish yellow (10YR6/6)	Kulai, Johor
Tuffs	Jempol	Reddish brown (5YR 4/3)	25 milestone Kuantan-KL Road
Schist	Prang	Yellowish red (5YR 5/6)	UPM, Serdang
Sandstone	Serdang	Strong brown (7.5YR 5/8)	UPM Farm, Serdang
Shale	Munchong	Yellowish red (5YR 5/6)	MARDI, Serdang

Table 3.12 below shows the color of some tropical residual soils present in Malaysia.

### *Strength*

It is recommended that the strength of tropical residual soils for disturbed and undisturbed samples be described using standard definitions for both soil and rock materials (BS5930; Weltman & Head 1983 in Fookes 1997). The suggested definitions to be used are as in Table 3.13, Table 3.14 and Table 3.15. These definitions are relevant to engineering perspectives.

### *Texture and fabric*

#### *Soil texture*

Soil texture can be defined as ‘the relative proportion of clay, silt and sand sized particles in a soil’. The texture is an important property which affects the porosity of soils. Porosity

in turn determines how much moisture the soil can hold and how fast water moves through the soil.

Table 3.13. Definition of strength; cohesive soil (after Weltman & Head 1983 in Fookes 1997).

Term	Undrained Shear Strength (kN/m <sup>2</sup> )	Field Test
Very Soft	<20	Exudes between fingers when squeezed in hand
Soft	20–40	Easily penetrated by thumb. Moulded by light finger pressure.
Firm	40–75	Penetrated by thumb. Moulded by strong finger pressure.
Stiff	75–150	Indented by a thumb. Cannot be moulded by fingers.
Very Stiff	150–300	Indented by thumbnail. Penetrates to about 15 mm with knife.
Hard	>300	Cannot be indented by thumbnail.

Table 3.14. Definition of strength; non-cohesive soil (after Weltman & Head 1983 in Fookes 1997).

Term	Field test
Loose	Can be excavated by spade. 50 mm peg can be easily driven. Easily crushed in fingers.
Dense	Requires pick for excavation. 50 mm peg hard to drive. Crushed by strong finger pressure.
Slightly cemented	Pick removes soil in lumps which can be abraded.

Table 3.15. Definition of strength; rock and intruded materials (after BS5930 1981; ISRM 1981 in Fookes 1997).

Term	Confined compressive strength (MN/m <sup>2</sup> )	Field test
Very weak	0.6–1.25	Easily broken by hand. Penetrates to about 5 mm with knife
Weak	1.25–5.0	Broken by leaning on sample sample with hammer. No penetration with knife. Scratched with thumbnail.

Moderately weak	5.0–12.5	Broken in hand by hitting with hammer. Scratched with knife
Moderately strong	12.5–50	Broken against solid object with hammer
Strong	50–100	Difficult to break against solid object with hammer
Very strong	100–200	Requires many blows of hammer to fracture sample
Extremely strong	>200	Sample can be chipped with hammer

The mineral fraction of soil is made up of particles of different sizes called soil separates. Depending on the individual size of each particle, it will fall into sand, silt and clay. The relative proportion of each separate determines the soil texture using Soil Textural Triangle as shown in Figure 3.4.

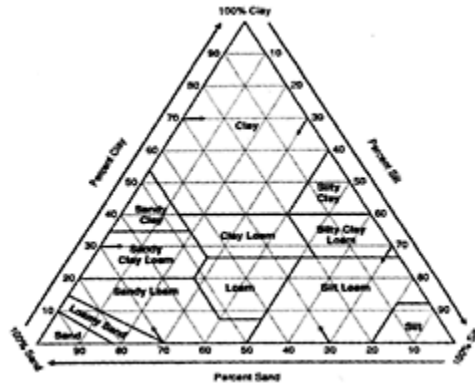

Figure 3.4. Soil textural triangle (<http://www.soils.org/sssagloss/figure1.htm>).

Table 3.16. Texture of some tropical residual soils.

Parent material	Texture	Location	Sources
Andesite	Clay	Malaysia	Pushparajah & Amin
Basalt	Clay	Malaysia	Pushparajah & Amin (1977)
Basalt	Silt loam	Hawaii	Lohnes & Demirel (1983)
Basalt	Clay loam	Hawaii	Lohnes & Demirel (1983)
Granite	Clay	Malaysia	Pushparajah & Amin (1977)
Granite	Clayey	Singapore	Leong & Rahardjo

Granodiorite	Clay sand	Malaysia	Pushparajah & Amin (1977)
Rhyolites	Clay	Malaysia	Pushparajah & Amin (1977)
Volcanic Ash	Sandy loam	Hawaii	Lohnes & Demirel (1983)
Volcanic Ash	Silt loam	Hawaii	Lohnes & Demirel (1983)
Schist	Sandy clay loam	Malaysia	Pushparajah & Amin (1977)
Sandstone	Sandy clay loam	Malaysia	Pushparajah & Amin (1977)
Shale	Clay	Malaysia	Pushparajah & Amin (1977)
Jurong Formation	Sandy clay	Singapore	Leong & Rahardjo (1995)

Estimation of soil texture can also be made by hand texturing method: by rubbing a moist sample of soil between thumb and forefinger. Sands feel gritty, silt feel smooth and silky, and clay feel sticky.

Sand, silt and clay size particles occur in various proportions in soils of different locations and result in different textural classes.

Table 3.16 shows the texture of some tropical residual soils.

### *Soil fabric*

Soil fabric is defined as the arrangement, size, shape and frequency of the individual solid soil components within the soil as a whole and within features themselves (Fitzpatrick 1983).

In nature, one finds many patterns that are irregular and fragmented, like soil fabric, which cannot be described by Euclidean geometry. The introduction of fractal geometry offers the opportunity for soil fabric quantification, and the possibility of relation soil fabric to specific soil properties and soil processes.

According to Fookes (1997) there is a system which deals with fabric analysis in pedological terminology proposed by Brewer (1968). This system is based on the concepts of units of organization and layers of organization. An outline of Brewers approach has been summaries by Fookes and shown in Table 3.17, Table 3.18, Table 3.19 and Table 3.20.

### *Grain size*

The range of grain size for tropical residual soils may be great, from discrete and compound grains to large core-stones, Fookes (1997). Particle size for tropical residual soils can be classified using standard classification system established by IAEG (1979) as reported by Fookes (1997), and shown in Table 3.21 below.

Table 3.17. Origin of fabric features (Fookes 1997).



Type	Definition
Pedogenic	Peds formed in situ by soil forming process
Organic	Organic debris, root channel etc.
Secondary	Nodules, mineral coatings, aggregates. mineral
Inherited	Largely unaltered parent material fabric
Weathered	Parent fabric modified by weathering processes

Table 3.18. Void ratio and porosity (Fookes 1997).

Term	Void ratio	Porosity (%)
Very high	>1.00	>50
High	1.00–0.80	50–45
Medium	0.80–0.55	45–35
Low	0.55–0.43	30–30
Very Low	<0.43	<30

Table 3.19. Particle distribution (Fookes 1997).

Description	Definition
Porphyritic	The matrix occurs as dense groundmass in which grains are set after the manner of a porphyritic rock
Granular	Particles only; no groundmass/matrix The matrix occurs as a loose or incomplete filling in spaces between accumulations of grains
Agglomerate	The grains are linked by intergranular braces or are imbedded in a porous groundmass
Matrix dominant	Almost all groundmass/matrix
Interlocked	Grains or peds tightly interlocked
Separated	Grains or peds in a loosely interlocked formation.

Table 3.20. Fabric orientation (after Brewer 1968 in Fookes 1997).

Orientation	Definition
Strong	>60% of the particles are oriented with their principal axes within 30° of each other.
Moderate	40–60% of the particles are oriented with their principal axes within 30° of each other.
Weak	20–40% of the particles are oriented with their principal axes within 30° of each other.
Non-existent	No fabric orientation visible.
Random	Fabric visible but with no preferred orientation.

Table 3.21. Particle size classification (Fookes 1997).

Size limits (mm)	Term
>60	Very coarse grained (cobble/boulder)
60–2.0	Coarse grained (gravel)
1.0–0.06	0.06–0.006 Medium grained (sand) Fine grained (silt)
<0.006	Very fine grained (fine silt/clay)

Table 3.22 shows the grading description for coarse grained soils for use with field sieves adopted from Unified Soil Classification System (USCS) for field use on suitable tropical soil materials.

### *Grain shape*

A soil ped having almost similar vertical and horizontal axes but with rounded corners is classified as subgranular blocky structure. If the corners and edges are sharp and distinct, it is described as angular blocky. Such peds are found in soils of the Rengam, Jerangau and Munchong of Malaysian Soils Series.

Less common structural units encountered in Peninsular Malaysia are those of the prismatic and columnar types where the vertical axis is longer than the horizontal axis. The former has an upper end bounded by an irregular surface whereas the latter has a rounded cap. Such structures are often found in the heavy alluvial clay soils of marine or riverine origin. Topsoil especially those with high organic matter have a granular structure, where the units are more or less rounded in shape. Platy structure, with particles arranged in a horizontal plane, has so far, not been encountered in Malaysian tropical residual soils (Pushparajah & Amin 1977).

*Mineralogy*

Generally, mineralogy of soils is associated with the process of soils formation either by chemical weathering or physical weathering. Decomposition, leaching and dehydration are chemical weathering processes that contribute to a wide variety of mineralogy of the soils, especially in tropical residual soils.

In the decomposition process, the chemical breakdown of constituent minerals of rock-forming minerals produce clay minerals, oxides, hydroxides, and free silica. The reactions occur intensively in a tropical condition so that recently transported soils may be modified into materials with residual soil characteristics.

Table 3.22. Grading description for coarse grained soils for use with field sieve (Fookes 1997).

Major divisions	Typical names	Description	Symbols
Gravels; more than 50% coarse fraction retained on 2 mm sieve	Clean gravels	Well graded gravels/gravel-sand mixtures. Little or no fines.	GW
		Poorly graded gravels/gravel-sand mixtures. Little or no fines.	GP
	Gravels with fines	Silty gravels, gravel-sand-silt mixtures.	GM
		Clayey gravels, gravel-sand-clay mixtures.	GC
Sands; more than 50% coarse fraction smaller than 2 mm sieve	Clean sands	Well graded sands, gravelly sands. Little or no fines.	SW
	Sands with fines	Poorly graded sands, gravelly sands.	SP
		Silty sands, sand-silt mixtures.	SM
		Clayey sands, sand-clay mixtures.	SC

Removal of silica, alkaline earths and alkalis are major activities in leaching processes. These leached materials may be redeposited and accumulate elsewhere in the soil profile. This is a consequent accumulation of residual materials such as oxides and hydroxides.

Complete or partial alteration of the composition and distribution of the sesquioxide-rich materials are one of the effects of the dehydration process. Formation processes of clay minerals are also influenced by dehydrations. The granular soil structure of cemented soils also may be formed by total dehydration.

Mineral composition of the tropical residual soils in Malaysia are mostly dominated by Kaolinite.

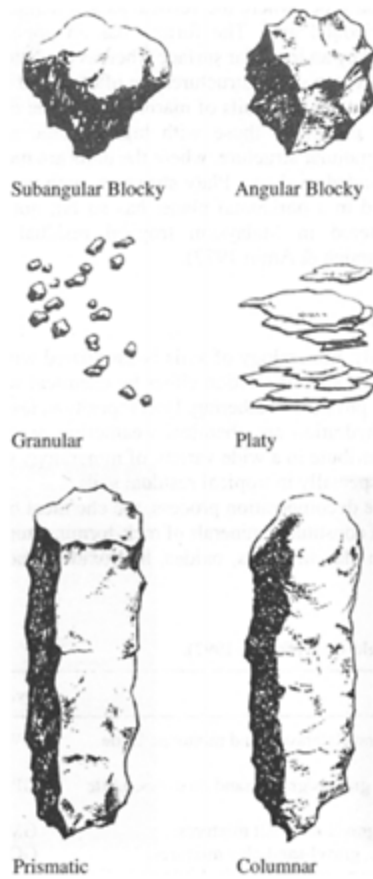
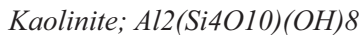

Figure 3.5. Common shape of rock fragments or soil particles of Malaysian tropical residual soils (Pushparajah & Amin 1977).

Beside Kaolinite, other minerals present are Illite, Montmorillonite, Mica, Gibbsite, Goethite, Chlorite, Muscovite and Quartz.



Kaolinite or Aluminum Silicate Hydroxide which is named for its type locality, Kao-Ling, Jianxi, China; is a common phyllosilicate mineral. Kaolinite is a 1:1 type layer silicate clay mineral. Individual crystals of the layer have a hexagonal shape and look like Figure 3.6.

Kaolinite crystals are usually 0.2–2 micrometers in size. The '1:1' indicates that each layer consists of one tetrahedral (silica) sheet and one octahedral (alumina) sheet. Layers are held together by hydrogen bonding, allowing for a fixed structure that does not ordinarily expand upon wetting. This bonding restricts cations and water from entering the particles between layers, leaving only the external surface area for adsorption activ-

ity. Little isomorphous substitution and the low surface area contribute to kaolinite's low cation exchange capacity. It also exhibits little plasticity, stickiness, cohesion, shrinkage or swelling.

Kaolinite occurs as a primary or secondary deposit, usually from rocks consisting of granite or rhyolite and from any primary silicate mineral such as feldspar. Primary kaolinite is formed from weathering or hydrothermal alteration and is referred to as residual; secondary kaolinite is a sedimentary mineral and is referred to as sedimentary. Residual kaolinite is far more common than sedimentary due to the special geologic conditions necessary for deposition and preservation of secondary kaolinite.

Kaolinite occurs in the landscape in two ways: in widespread trace amounts and as relatively pure deposits.

Kaolinite occurs in the landscape in trace amounts in the clay fraction of every mineral soil order. It forms where soil weathering is intense, such as in humid or tropical areas. Thus, it can be found as the dominant mineral in the clay fractions of Ultisols and as a major component in Oxisols.

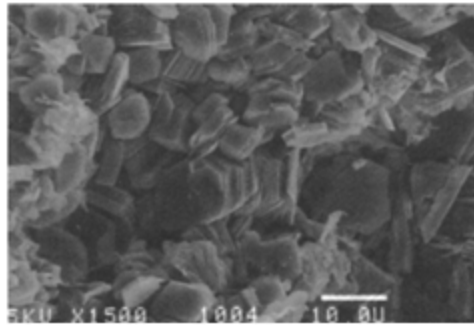

Figure 3.6. This Kaolinite, magnified 1500 times using a scanning electron microscope (SEM), shows the classic platy, accordion- or book-like mineral form (<http://www.ktgeo.com/tSEM4C.jpg>)

Over extended periods of time and under optimum conditions, kaolinite forms in large, relatively pure deposits. Such conditions include the presence of primary silica minerals, high rainfall, rapid drainage and humid or temperate climate.



Illite or Hydrous Mica usually greyish-white to silvery-grey, sometimes greenish-grey in color was named by geologist from the Illinois Geological Survey (Miller & Gardiner 2002).

Illite refers to a group of clay minerals formed by weathering or hydrothermal alteration of other aluminum-rich minerals. It occurs intermixed with kaolinite and other clay minerals. Where other clay minerals such as kaolinite, montmorillonite, dickite, halloysite etc occur, it is also likely that illite occurs as well. Only a few of the more typical or unusual occurrences of illite are reported.

*Montmorillonite;  $(Al_{2-x}Mg_x)(Si_{4-y}Al_y)(O_{10})(OH)_8$*

Montmorillonite (or Hydrated Sodium Calcium Aluminum Magnesium Silicate Hydroxide) is usually white, gray or pink with tints of yellow or green in color. Montmorillonite is named after a town of Montmorillon in France (Miller & Gardiner 2002).

Montmorillonite is a member of the general mineral group of clays. It typically forms microscopic or at least very small platy micaceous crystals. In Montmorillonite, water easily penetrates between planes of adjacent oxygen ions, causing the individual layers of clay particles to separate and swell. The water content is variable, and in fact when water is absorbed by the crystals, they tend to swell to several times their original volume.

The swelling properties make montmorillonite a useful mineral for several purposes. It is the main constituent in a volcanic ash called bentonite, which is used in drilling muds. The bentonite gives the water greater viscosity ('thickness' of flow), which is very important in keeping a drill head cool during drilling and facilitating removal of rock and dirt from within a drill hole. Another important use of montmorillonite is as an additive to soils and rocks. The effect of the montmorillonite is to slow the progress of water through the soil or rocks.

*Mica*

Mica is the name of a group of minerals characterized by highly perfect cleavage, so that they readily separate into very thin leaves, more or less elastic. Layering in the divalent, or brittle, micas also results in perfect basal cleavage; the greater bond strengths, however, makes them more brittle and less flexible. They differ widely in composition, and vary in colour from pale brown or yellow to green or black. The transparent forms are used in lanterns, doors of stoves, etc., being popularly called isinglass. Formerly it was also called cat-silver, and glimmer.

The important species of the mica group are: muscovite, common or potash mica, pale brown or green, often silvery, including damourite (also called hydromica); biotite, iron-magnesia mica, dark brown, green, or black; lepidomelane, iron mica, black; phlogopite, magnesia mica, colorless, yellow, brown; lepidolite, lithia mica, rose-red, lilac. Mica (usually muscovite, also biotite) is an essential constituent of granite, gneiss, and mica slate; biotite is common in many eruptive rocks.

*Gibbsite;  $Al(OH)_3$*

Gibbsite or Aluminum Hydroxide is an important ore of aluminum and is one of three minerals that make up the rock Bauxite. Bauxite is often thought of as a mineral but is really a rock composed of aluminum oxide and hydroxide minerals such as gibbsite, boehmite,  $AlO(OH)$  and diaspore,  $HAIO_2$ , as well as clays, silt and iron oxides and hydroxides. Bauxite is a laterite, a rock formed from intense weathering environments such as found in richly forested, humid, tropical climates.

The structure of Gibbsite is interesting and analogous to the basic structure of micas. The basic structure forms stacked sheets of linked octahedrons of aluminum hydroxide. The octahedrons are composed of aluminum ions with a +3 charge bonded to six octa-

hedrally coordinated hydroxides with a  $-1$  charge. Each of the hydroxides is bonded to only two aluminums because one-third of the octahedrons are lack a central aluminum. The result is a neutral sheet since  $+3/6=+1/2$  ( $+3$  charge on the aluminums divided by six hydroxide bonds times the number of aluminums) and  $-1/2=-1/2$ , the charges cancelled ( $-1$  charge on the hydroxides divided between only two aluminums). The lack of a charge on the gibbsite sheets means that there is no charge to retain ions between the sheets and act as a 'glue' to keep the sheets together. The sheets are only held together by weak residual bonds and these results in a very soft easily cleaved mineral.

*Goethite; FeO(OH)*

Goethite is a hydrous oxide of iron, occurring in prismatic crystals, also massive, with a fibrous, reniform, or stalactitic structure. The color varies from yellowish to blackish brown.

Goethite is a common iron mineral. It often forms by weathering of other iron-rich minerals, and is thus a common component of soils. It may form excellent pseudomorphs after the original minerals particularly pyrite or marcasite. Goethite may also be precipitated by groundwater or in other sedimentary condition, or form as a primary mineral in hydrothermal deposits. When present in sufficient quantities, it constitutes an important iron ore mineral.

*Chlorite; (Fe, Mg,Al)6(Si,Al)4O10(OH)8*

Chlorite is a general name for several minerals that are difficult to distinguish by ordinary methods. These minerals are all apart of the Chlorite Group of minerals. The chlorites are often, but not always considered a subset of the larger silicate group, the Clays.

The general formula for chlorite is  $(\text{Fe, Mg, Al})_6(\text{Si, Al})_4\text{O}_{10}(\text{OH})_8$ . However there are several different minerals that are apart of the chlorite group of minerals. The above formula is only a generalization of the more common members of this group.

For practical reasons, most of the chlorites will be considered here as a single mineral, chlorite. Chlorites are generally green and crystallize in the monoclinic symmetry system. They all have a basal cleavage due to their stacked structure. Chlorites typically form flaky microscopic crystals and it is for this reason that they are sometimes included in the clay group of minerals. However, chlorites also form large individual tabular to platy crystals that are unlike most of the other clay minerals.

*Muscovite; KAl2(AlSi3O10)(OH)2*

Muscovite is common mica occurring often. It forms fine to coarse platy books and scales ranging in color from clear to silvery white to gray to green to, less frequently, yellow or pale pink. Muscovite is common in granitic rocks. In granitic pegmatites, sheets may grow up to several meters in diameter. It is also common in metamorphic rocks, especially phyllites and schist derived from potassic, aluminous protoliths such as shales. A green chromium-rich variety called 'fuchsite' occurs in certain quartzites. It also survives weathering where it occurs as detrital flakes in sandstones such as arkose. Muscovite also forms

from the breakdown of feldspars where it occurs with other minerals such as paragonite as fine aggregates referred to as sericite.

*Quartz; SiO<sub>2</sub>*

Quartz or silicon dioxide is the most common mineral on the face of the earth. It is found in nearly every geological environment and is at least a component of almost every rock type. It frequently is the primary mineral, >98%. It is also the most varied in terms of varieties, colors and forms. This variety comes about because of the abundance and widespread distribution of quartz.

Table 3.23. Mineralogical composition of some Malaysian tropical residual soils (Tessens & Shamsuddin 1983).

Parent material	Dominant mineral	Present	Marginal
Basalt	Gibbsite	K, Go	
Granite	Kaolinite	M	
Granite	Kaolinite	C	M
Granite	Kaolinite	Gi, Go	C, Feldspar
Granite	Kaolinite	Gi	Go, Q
Granite	Kaolinite	Gi	
Granodiorite	Kaolinite	Go	Gi
Ryolites	Kaolinite	Q, M	
Tuffs	Mica	K, Q	
Schist	Kaolinite	Gi	
Schists	Kaolinite	Gi	Go, M, M-C
Sandstone	Kaolinite		Go, C
Sandstone	Kaolinite	M	
Shale	Kaolinite	Go, Gi	

K=Kaolinite; M=Mica; Gi=Gibbsite; Go=Goethite; C=Chlorite; ML=Mixed Layers; Q=Quartz.

The color of quartz is as variable as the spectrum, but clear quartz is by far the most common color followed by white or cloudy (milky quartz). Purple (Amethyst), pink (Rose Quartz), gray or brown to black (Smoky Quartz) are also common. Cryptocrystalline varieties can be multicolored.

Table 3.23 shows the mineralogy composition of some tropical residual soils present in Malaysia.



A study by Aminaton et al. (2002) on mineralogy, microstructure and chemical composition of granitic soils at central region of Peninsular Malaysia shows that quartz and kaolinite are two major minerals while muscovite, illite, montmorillonite and gibbsite are the minor minerals. They also found that percentages of quartz in most soil samples are higher than total percentages of aluminium oxide ( $Al_2O_3$ ) and iron oxide ( $Fe_2O_3$ ), which indicates the major presence of quartz and kaolinite in the central region.

Table 3.24 shows the pH values, anion concentration, three major oxide elements and major minerals in granite residual soils in Peninsular Malaysia. Quartz and kaolinite are the major minerals throughout the granite residual soil profiles.

### *Classification*

The need for a special classification system for tropical residual soils is discussed in detail by Wesley & Irfan (1997). The conventional methods of classification such as Unified Soil Classification System

Table 3.24. pH values, anion concentration, 3 major oxide elements and major minerals on granite residual soils in Peninsular Malaysia (after Aminaton et al. 2002).

pH values	$SO_4^{2-}$ (ppm)	$Cl^-$ (ppm)	$SiO_2$ (%)	$Al_2O_3$ (%)	$Fe_2O_3$ (%)	Major minerals	Location/References
3.9–5.8	–	–	–	–	–	Q & K	Thailand/Za-Chieh & Mirza (1969)
–	–	–	70–72	12–14	3–4	Q & K	Peninsular Malaysia/West & Dumbleton (1970)
–	–	–	–	–	–	Q & K	Eastern Peninsular Malaysia/Zaayah (1985)
–	–	–	66–69	19–20	1.3–1.6	–	Peninsular Malaysia/Hamzah & Abdul Ghani (1993)
4.6–7.8	0.5–45.5	7.1–202.1	–	–	–	–	Peninsular Malaysia/Tan (1996)
4.5–6.0	–	–	–	–	–	–	Peninsular Malaysia/Mohd Raihan (1997)
5.3–5.6	–	–	–	–	–	Q & K	Southern Peninsular Malaysia/Aminaton et al (2001)
4.7–5.9	–	12–75	38.9–87.4	2.5–35.2	1.3–13.5	–	Southern Peninsular Malaysia/Aminaton et al. (2001)
5.2–6.8	3.3–17.6	12–26	–	–	–	Q & K	Northern Peninsular Malaysia/Aminaton et al. (2002)
4.7–6.3	–	–	37.3–62.0	19.6–32.6	5.5–14.7	Q & K	Eastern Peninsular Malaysia/Aminaton et al. (2002)
–	2.2–12.1	7–25	–	–	–	–	Eastern Peninsular Malaysia/Aminaton et al. (2002)

5.1–5.7	7.2–14.7	13–38	46.2– 64.3	18.9– 25.0	1.4– 12.4	Q & K	Central Regions of Peninsular Malaysia/Aminaton et al. (2002)
---------	----------	-------	---------------	---------------	--------------	-------	---

Note:  $\text{SO}_4^{2-}$ —Sulphate; Cl—Chloride;  $\text{SiO}_2$ —Quartz;  $\text{Al}_2\text{O}_3$ —Aluminium oxide;  $\text{Fe}_2\text{O}_3$ —Iron oxide; Q—Quartz minerals; K—Kaolinite;—Data not available

(USCS) did not adequately cover the specific features or characteristics of tropical residual soils. There are three features listed by Wesley & Irfan (1997) which are not adequately covered by USCS and other classification system. They are:

- a) The unusual clay mineralogy of some tropical and sub-tropical soil gives them characteristics that are not compatible with those normally associated with the group to which the soil belongs according to existing systems such as the USCS
- b) The soil mass in situ may display a sequence of materials ranging from true soil to a soft rock depending on degree of weathering, which cannot be adequately described using the existing system based on classification of transported soils in temperate climates.
- c) Conventional soil classification systems focus primarily on the properties of the soil in its remoulded state; this is often misleading with residual soils, whose properties are likely to be most strongly influenced by structural characteristics inherited from the original rock mass or developed as a consequence of weathering.

Wesley & Irfan (1997) also suggested that the term residual soil should be referred only to the upper horizon (weathering grade of IV, V and VI) of a weathered rock mass profile established by Little (1969).

The classification system proposed by Wesley & Irfan (1997) are based on a grouping framework designed to enable engineers to find their way around the rather confused world of residual soils and enable them to place any particular residual soil into a specific category on the basis of common engineering properties.

The system is based on the specific characteristics of the residual soils which distinguishes them from transported soils, and can generally be attributed either to the presence of specific clay minerals found only in residual soils, or to particular structural effects, such as the presence of unweathered or partially weathered rock, relict discontinuities and other planes of weakness, and inter-particle bonds.

Table 3.25 shows the summary of classification system proposed by Wesley & Irfan (1997) while Table 3.26 show the lists of some of the more distinctive characteristics of these soil groups and indicates the means by which they may possibly be identified (Wesley & Irfan 1997).

Examples of how residual soils are classified are also given by Wesley & Irfan (1997) as in Figure 3.7 and the mineralogy of the profile is shown in Figure 3.8.

Table 3.25. Classification of residual soils (Wesley & Irfan 1997).

Grouping system		Common pedological names used for group	Descriptive information on in situ state	
Major division	Sub-group		Parent rock	Information on structure
Group A (Soil without a strong minerological influence)	(a) Strong macro-structure influence	Give names if appropriate	Gives details of type of rock from which the soil has been derived	Describes nature of structure: –tratification, reflecting parent rock –fractures, fissures, faults etc. –presence of partially weathered rock (state % and physical form, eg 50% corestones)
	(b) Strong micro-structure influence	-as above		Describes nature of micro-structure or evidence of it: –effect of remoulding, sensitivity –liquidity index or similar index
	(c) Little or no structure influence	-as above		Describes evidence for little or no structural influence
Group B (Soil strongly influenced by commonly occurring minerals)	(a) Montmorillonite (smectite group)	Black cotton soils, black clays, tropical black earths, Grumusol, Vertisols		Describes any structural effects which may be present, or other aspects relevant to engineering properties. Evidence of swelling behavior, extent of surface cracking in dry weather, slickensides below surface etc.
	(b) Other minerals			
Group C (Soil strongly influenced by clay minerals essentially found only in residual soil)	(a) Allophane sub group	Tropical red clays, Latosols, Oxisols, Ferralsols		
	(b) Halloysite sub group			
	(c) Sesquioxide sub group (gibbsite, geotite, haematite)	Lateritic soils, Laterites, Ferralitic soils, Duricrusts		Gives basis for inclusion in this group.  Describes structural influences—especially cementation effects of the sesquioxides.

Table 3.26. Characteristics of residual soils groups (Wesley & Irfan 1997).

Group		Example	Means of identifications	Comments on likely engineering properties and behavior
Major-group	Sub-group			
Group A (Soil without a strong minerological influence)	(a) Strong macro-structure influence	High weathered rocks from acidic or intermediate igneous rocks, and sedimentary rocks	Visual inspection	This is a very large group of soil (including the 'saprolite') where behavior (especially in slopes) is dominated by the influence of discontinuities, fissures, etc.
	(b) Strong micro-structure influence	Completely weathered rocks formed from igneous and sedimentary rocks	Visual inspection and evaluation of sensitivity, liquidity index, etc.	These soils are essentially homogeneous and form a tidy group much more amenable to systematic evaluation and analysis than group (a) above. Identification of nature and role of bonding (from relic primary bonds to weak secondary bonds) important to understanding behavior.
	(c) Little structure influence	Soil form from very homogeneous rocks	Little or no sensitivity, uniform appearance	This is a relatively minor sub-group. Likely to behave similarly to moderately overconsolidated soils.
Group B (Soil strongly influenced by commonly occurring minerals)	(a) Montmorillonite (smectite group)	Black cotton soils, many soils formed in tropical areas in poorly drained conditions	Dark colour (grey to black) and high plasticity suggest soils of this group	These are normally problem silt found in flat or low laying areas, of low strength, high compressibility, and high swelling and shrinkage characteristics.
	(b) Other minerals			This is likely to be a very minor sub-group
Group C (Soil strongly influenced by clay minerals essentially found only in residual soil)	(a) Allophane group	Soils weathered from volcanic ash is the wet tropics and in temperate climates	Very high natural water content, and irreversible changes on drying	These are characterized by very high natural water contents, and high liquid and plastic limits. Engineering properties are generally good, though in some cases high sensitivity could make handling and compaction difficult.

(b) Halloysite group	Soil largely derived from older volcanic rocks; especially tropical red clays	Reddish color, well drained topography and volcanic parent rock are useful indicators	These are generally very fine grained soils, of low to medium plasticity, but low activity. Engineering properties generally good. (note that there is often some overlap between allophone and halloysitic soils).
(c) Sesquioxide group	This soils group is loosely referred to as 'lateritic', or laterite	Granular, or nodular appearance	This is a very wide group, ranging from silty clay to coarse sand and gravel. Behavior may range from low plasticity to non-plastic gravel.

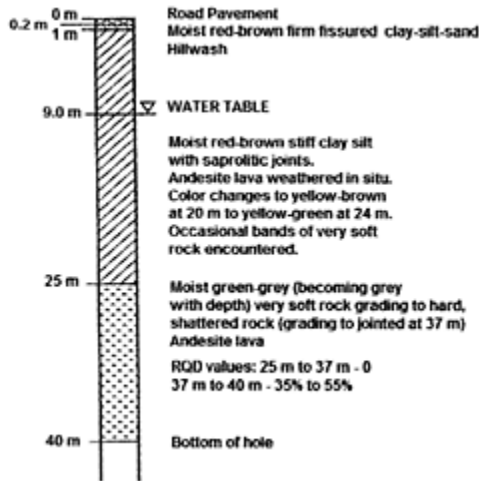

Figure 3.7. Typical profile of residual andesite lava (Blight 1997).

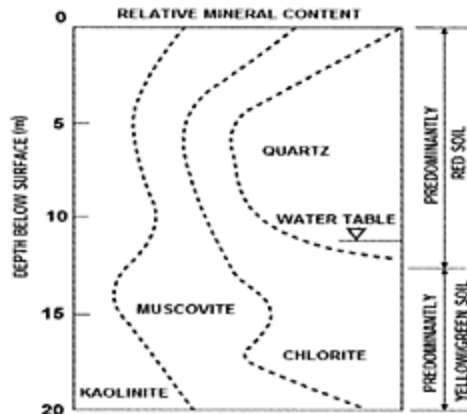

Figure 3.8. Mineral distribution in a profile of weathered andesite lava (Queiroz de Carvalho & Simmons 1997).

Figure 3.7 shows that clay minerals in the soil consist of kaolinite, muscovite and chlorite, together with quartz. The relative proportions of these minerals vary with depth, but cannot be said to have strong influence on the properties of the soil. Thus the soil falls within Group A.

Figure 3.8 shows that saprolitic joints in soil exercise an important influence on the strength of the soil, so it falls into sub-group (a). As the joints in the parent andesite probably resulted mainly from cooling stresses. The discontinuities are of the type (b).

Hence the soil is classified as: A (a) (b).

### 3.5 CONCLUSIONS

Due to the wide differences in soil formation by location and depth, index and engineering properties of tropical residual soils vary greatly. Values of some index properties shown in this chapter range from 7 to 49% for moisture content, 25 to 107% and 15 to 59% for Liquid Limits and Plastic Index respectively and 1.2 to 2.1 Mg/m<sup>3</sup> for bulk density. For particle size distributions, clay content ranges from 5 to 67%, 2 to 43% silt and 5 to 69% sand.

For engineering properties, it had been shown that strength also varies; from 2 to 123 kN/m<sup>2</sup> for cohesion (c) and 10° to 58° for internal friction angle ( $\phi$ ). The permeability of tropical residual soils is controlled by many geological factors such as the shape of the mineral grains in the soil, their grain size and the manner in which the grains are held together, etc, thus the *k* values shown in this chapter vary greatly from  $9.5 \times 10^{-10}$  to  $2 \times 10^{-4}$  m/s.

### REFERENCES

- Aminaton, M., Fauziah, K. & Khairul Nizar, M.Y. 2002. Mineralogy, microstructure and chemical properties of granitic doils at central regions of Peninsular Malaysia. -1 unpublished: 15.
- Bell, F.G. 1983a. *Fundamental of engineering geology*. Butterworths.
- Bell, F.G. 1983b. *Engineering properties of soils and rocks*. 2nd Edition, Butterworths.
- Blight, G.E. (ed) 1997. *Mechanics of residual soils*. ISSMFE (TC 25). Balkema
- Brewer, R. 1968. *Fabric and mineral analysis of soils*. New York: Wiley.
- Chan, S.F & Chin, F.K. 1972. Engineering characteristics of the soils along the federal highway in Kuala Lumpur. *Proc. 3rd SEA Conf. on soil engineering*, Hong Kong: 41–45.
- Costa Filho, L.M. & Vargas, Jr. E. 1985. Topic 2.3 hydraulic properties; Peculiarities of geotechnical behaviour of tropical lateritic and saprolitic soils. Progress report (1982–1985). Brazilian society of soil mechanics: 67–84.
- Fitzpatrick, E.A. 1983. *Soils, their formation, classification and description*. Longman.
- Fookes, P.G. (ed) 1997. Tropical residual soils. A geological society engineering group working party revised report, The Geological Society.
- Fredlund, D.G. & Rahardjo, H. 1993. *Soil mechanics for unsaturated soils*. Canada: John Wiley & Sons.
- Geoguide 3. 1996. Tropical weathered in situ materials—laboratory testing. Malaysia: Public Works Department Malaysia.
- Huat, B.B.K. 2004. *Tropical peat and organic soil engineering*. University Putra Malaysia Press.
- International Society of Rock Mechanic (ASRM). 1981. *Rock characterization, testing and monitoring: Suggested methods*. E.T Brown. Pergamon.
- Komoo, I. 1985. Engineering properties of weathered rock profiles in Peninsular Malaysia. *Proc. 8th SEA geotechnical conference, Kuala Lumpur*: 3–81 to 3–86.

- Leong, E.C. & Rahardjo, H. 1995. Typical soil-water characteristic curves for two residual soils from granitic and sedimentary formations. *Proc. unsaturated* 1995:519–524.
- Little. 1969. The engineering classification of residual tropical soils. *Proc. of the specialty session engineering properties of lateritic soils VII ICSMFE AIT Bangkok*:1–10.
- Lohnes, R.A & Demirel, T. 1983, Geotechnical properties of residual tropical soils. *Proc. ASCE Convention, Huston, Texas*: 150–166.
- Madu, R.M. 1977. An investigation into the geotechnical and engineering properties of some laterites of Eastern Nigeria, *Engng.Geol* 11:101–125.
- Miller, R.W. & Gardiner, D.T. 2002. *Soils in our environment*, Prentice Hall.
- Mun, K.P. 1985. Sampling and testing of residual soils in Malaysia. *Sampling and testing of residual soils: A review of international practice*. SEA geotechnical society. Hong Kong: Scorpion Press.
- Muttaya, P. & Huat, B.B.K. 1994. Effect of treatment on engineering properties of local residual soils. *Journal Institution of Engineers Malaysia* 55:29–41.
- Newill, D. & Dowling, J.W.F. 1969. Laterites in West Malaysia and Northern Nigeria. *Proc. of the specialty session engineering properties of lateritic soils VII ICSMFE AIT Bangkok* 2:133–150.
- Nithiraj, R., W.H.Ting & Balasubramaniam, A.S. 1996. Strength parameters of residual soils and application to stability analysis of anchored slopes. *Geotechnical Engineering* 27:55–81.
- Nixon, I.K. & Skipp, B.O. 1957. Airfield construction on overseas soil: Part 5, laterite. *Proc. Inst. Civ. Engrs.* 36(6258): 253–275.
- Parashar, S.P., Wong K.S., Choa, V & Rahardjo, H. 1995. Shear Strength, volume change and permeability characteristics of a compacted residual soil. *Proc. Unsaturated* 1995:165–170.
- Poh, K.B., Chuah, H.L. & Tan S.B. 1985. Residual granite soil of Singapore. *Proc. 8th SEA geotechnical conference, Kuala Lumpur*: 3.1–3.9
- Pushparajah, E. & Amin, L.L. (ed). 1977. *Soils under Hevea in Peninsular Malaysia and their management*, Rubber Research Institute of Malaysia.
- Queiroz de Carvalho, J.B. & Simmons, J.V. 1997. Mineralogy and microstructure. Chap. 3 In Blight, G.E. (ed) *Mechanics of residual soils*, ISSMFE (TC 25). Balkema
- Raj, J.K. 1988. Drained shear strength of a weathered Graphitic-Quartz-Mica Schist. *Journal of Geotechnical Engineering*. 19:253–267.
- Singh, M. & Ho, H.S. 1990. Strength testing of residual soils. *Proc. of seminar on geotechnical aspects of The North—South Expressway. Kuala Lumpur*:149—152.
- Soil science. Society of America. <http://www.soils.org/>.
- Soong, N.K. & Yap, W.C. 1973. A study of the moisture characteristics of soils under rubber in Peninsular Malaysia. *Proc. Malaysian soc. soil sci. conf. on fert. and chem. of tropical soils, Kuala Lumpur*.
- Taha, M.R, Hossain, M.K, Chik, Z. & Nayan, K.A.M. 1999. Geotechnical behaviour of a Malaysian residual granite soil. *Pertanika J. Sci. & Tehnology*: 151–169.
- Tessens, E. & Jusop, S. 1983. *Quantitative relationships between mineralogy and properties of tropical soils*. Universiti Pertanian Malaysia.
- Ting, W.H., Mun, K.P. & C.T. Toh. 1982. Characteristics of a composite residual granite soil. *Proc. 7th SEA geotechnical conference. Hong Kong*: 879–887.
- Ting, W.H. & Ooi, T.A. 1972. Some properties of a Malaysian residual granite soil. *Proc. 3rd SEA conf. on soil engineering, Hong Kong*: 67–71.
- Ting, W.H., Toh, C.T. & Chee, S.K. 1972. Movement and stability of slopes in residual soil fills. *Proc. 3rd SEA conf. on soil engineering, Hong Kong*: 503–507.
- Weltman, A.J. & Head, J.M. 1983. Site investigation manual. CIRIA Spec. Pub.No.25.

- Wesley, L.D. & Irfan, T.Y. 1997. Classification of residual soil. Chap. 2 In Blight, G.E. (ed) *Mechanics of residual soils*, ISSMFE (TC 25). Balkema.
- West, G. & Dumbleton, M.J. 1970. The mineralogy of tropical weathering illustrated by some West Malaysian soils. *Q.J. Engng. Geol* 3:25–40.
- X-ray Diffraction (XRD) Mineralogy. <http://www.ktgeo.com/>





## CHAPTER 4

# Unsaturated residual soil

Faisal Haji Ali

*University of Malaya, Malaysia*

Hariato Rahardjo

*Nanyang Technological University, Singapore*

Soils located above the groundwater table such as residual soils are generally unsaturated and possess negative pore-water pressures. Climatic changes (i.e. evaporation and infiltration) and transpiration influence the water content and the negative pore-water pressure of the unsaturated soil, especially those located in the proximity of the ground surface. As a result, hydraulic properties, shear strength and volume of the soil change in response to climatic changes. Traditional soil mechanics practices have experienced significant changes during the past few decades. Some of these changes are related to increased attention being given to the unsaturated soil zone above the ground water table. The computational capability available to the geotechnical engineer has strongly influenced the engineers' ability to address these complex problems. The unsaturated soil zone is subjected to a flux type boundary condition for many of the problems faced by the geotechnical engineers. Unsaturated soil mechanics has become a necessary tool for analyzing the behavior of soils in this zone. This chapter presents some examples of unsaturated soil problems. Some basic physical relationships associated with unsaturated soil mechanics are outlined. Some examples of laboratory and field tests carried out on unsaturated residual soil are also presented.

### 4.1 INTRODUCTION

The behavior of numerous materials encountered in engineering practice is not consistent with the principles and concepts of classical, saturated soil mechanics. Commonly, it is the presence of more than two phases that results in a material that is difficult to deal with in engineering practice. Soils that are unsaturated form the largest category of materials which do not adhere to behavior of classical, saturated soil mechanics. An unsaturated soil has more than two phases, and the pore-water pressure is negative relative to the pore-air pressure. Any soil near the ground surface, present in a relatively dry environment, will be subjected to negative pore-water pressures and possible desaturation. The process

of excavating, remolding and recompacting a soil also results in an unsaturated material. These materials form a large category of soils that have been difficult to consider within the framework of classical soil mechanics. Natural surficial deposits of soil are at relatively low water content over a large area of the earth. Residual soils have been of particular concern in recent years. Once again, the primary factor contributing to their unusual behavior is their negative pore-water pressures. Attempts have been made to use saturated soil mechanics design procedures on these soils with limited success.

Climate plays an important role as to whether a soil is saturated or unsaturated. Water is removed from the soil either by evaporation from the ground surface or by evapotranspiration from a vegetative cover (Figure 4.1).

These processes produce an upward flux of water out of the soil. On the other hand, rainfall and other forms of precipitation provide a downward flux into the soil. The difference between these two flux conditions on a local scale largely dictate the pore-water pressure conditions in the soil. A net upward flux produces a gradual drying, cracking, and desiccation of the soil mass, whereas a net downward flux eventually saturates a soil mass. The depth of the water table is influenced; amongst other things, by the net surface flux. Grasses, trees, and other plants growing on the ground surface dry the soil by applying a tension to the pore-water through evapotranspiration. Most plants are capable of applying 1–2 MPa of tension to the pore-water prior to reaching their wilting point.

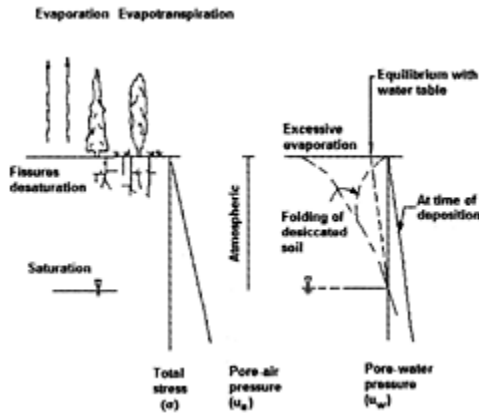

Figure 4.1. Stress distribution during the desiccation of a soil (Fredlund & Rahardjo 1993b).

Evapotranspiration also results in the consolidation and desaturation of the soil mass.

Year after year, the deposit is subjected to varying and changing environmental conditions. These produce changes in pore-water pressure distribution, which in turn results in shrinking and swelling of the soil deposit. The porewater pressure distribution with depth can take on a wide variety of shapes as a result of environmental changes (Figure 4.1).

Arid and semi-arid areas usually have a deep groundwater table. Soils located above the water table have negative pore-water pressures. The soils are desaturated due to the excessive evaporation and evapotranspiration. Climatic changes highly influence the water

content of the soil in the proximity of the ground surface. Upon wetting, the pore-water pressures increases, tending toward positive values. As a result, changes occur in the volume and shear strength of the soil with many soils exhibiting extreme swelling or expansion when wetted. Other soils are known for their significant loss of shear strength upon wetting. Changes in the negative pore-water pressures associated with heavy rainfalls are the cause of numerous slope failures. Reductions in the bearing capacity and resilient modulus of soils are also associated with increases in pore-water pressures. These phenomena indicate the important role that negative pore-water pressure plays in controlling the mechanical behavior of unsaturated soils.

#### 4.2 TYPES OF PROBLEMS

The types of problems of interest in unsaturated soil mechanics are similar to those of interest in saturated soil mechanics. Common to all unsaturated soil situations are the negative pressures in the pore-water. Some of these problems are given below.

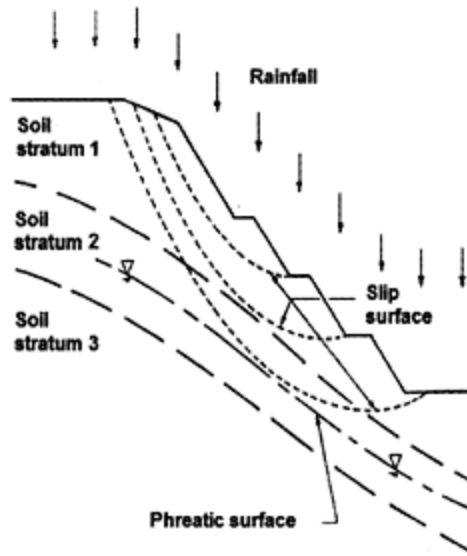

Figure 4.2. An example of the effect of excavations on a natural slope subjected to environmental change (Fredlund & Rahardjo 1993b).

#### *Natural slopes subjected to environmental changes*

Natural slopes are subjected to a continuously changing environment (Figure 4.2). An engineer may be asked to investigate the present stability of a slope, and predict what would happen if the geometry of the slope were changed or if the environmental conditions should happen to change. Most or all of the potential slip surfaces may lie above the

groundwater table. In other words, the potential slip surface may pass through unsaturated soils with negative porewater pressures. Typical questions that might need to be addressed are (Fredlund & Rahardjo 1993b):

- What effect could changes in the geometry have on the pore pressure conditions?
- What changes in pore pressures would result from a prolonged period of precipitation?
- How could reasonable pore pressures be predicted?
- Could the location of a potential slip surface change as a result of precipitation?
- How significantly would slope stability analysis be affected if negative pore-water pressures were ignored?
- What would be the limit equilibrium factor of safety of the slope as a function of time?
- What lateral deformations might be anticipated as a result of changes in pore pressures?

Similar questions might be of concern with respect to relatively flat slopes. Surface sloughing commonly occurs on slopes following prolonged periods of precipitation. These failures have received little attention from an analytical standpoint. One of the main difficulties appears to have been associated with the assessment of pore-water pressures in the zone above the groundwater table. The slow, gradual, downslope creep of soil is another aspect which has not received much attention in the literature. It has been observed, however, that the movements occur in response to seasonal environment changes. Wetting and drying are known to be important factors. It would appear that an understanding of unsaturated soil behavior is imperative in formulating an analytical solution to these problems.

#### *Stability of vertical or near vertical excavations*

Vertical or near vertical excavations are often used for the installation of a foundation or a pipeline (Figure 4.3). It is well known that the backslope in a moist silty or clayey soil will stand at a near vertical slope for some time before failing. Failure of the backslope is a function of the soil type, the depth of the excavation, the depth of tension cracks, the amount of precipitation, as well other factors. In the event that the contractor should leave the excavation open longer than planned or, should a high precipitation period be encountered, the backslope may fail, causing damage and possible loss of life. The excavations being referred to are in soils above the groundwater table where the pore-water pressures are negative. The excavation of soil also produces a further decrease in the pore-water pressures. This results in an increase in the shear strength of the soil. With time, there will generally be a gradual increase in the pore-water pressures in the backslope, and correspondingly, a loss in strength. The increase in the pore-water pressure is the primary factor contributing to the instability of the excavation. Engineers often place the responsibility for ensuring backslope stability onto the contractor. Predictions associated with this problem require an understanding of unsaturated soil behavior. Some relevant questions that might be asked are (Fredlund & Rahardjo 1993b).

- How long will the excavation backslope stand prior to failing?
- How could the excavation backslope be analytically modeled, and what would be the boundary conditions?
- What soil parameters are required for the above modeling?

- What in situ measurements could be taken to indicate incipient instability?

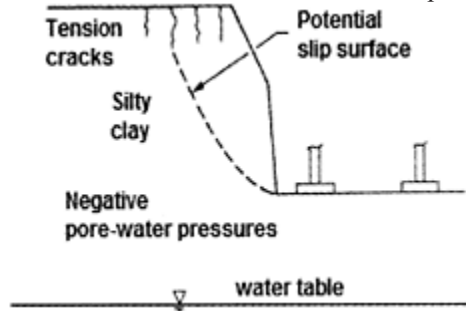

Figure 4.3. An example of potential instability of a near vertical excavation during the construction of a foundation (Fredlund & Rahardjo 1993b).

- Also, could soil suction measurements be of value?
- What effect would a ground surface covering (e.g., plastic sheeting) have on the stability of the backslope?
- What would be the effect of temporary bracing, and how much bracing would be required to ensure stability?

### *Lateral earth pressures*

Figure 4.4 shows two situations where an understanding of lateral earth pressures is necessary. Another situation might involve lateral pressure against a grade beam placed on piles. Let us assume that in each situation, a relatively dry clayey soil has been placed and compacted. With time, water may seep into the soil, causing it to expand in both vertical and horizontal directions. Although these situations may illustrate the development of high lateral earth pressures, they are not necessarily good design procedures. Some questions that might be asked are (Fredlund & Rahardjo 1993b):

- How high might the lateral pressures be against a vertical wall upon wetting of the backfill?
- What are the magnitudes of the active and passive earth pressures for an unsaturated soil?
- Are the lateral pressures related to the 'swelling pressure' of the soil?
- Is there a relationship between the 'swelling pressure' of a soil and the passive earth pressure?
- How much lateral movement might be anticipated as a result of the backfill becoming saturated?

The foundations for light structures are generally shallow spread footings (Figure 4.5). The bearing capacity of the underlying (clayey) soils is computed based on the unconfined compressive strength of the soil. Shallow footings can easily be constructed when the water table is below the elevation of the footings.

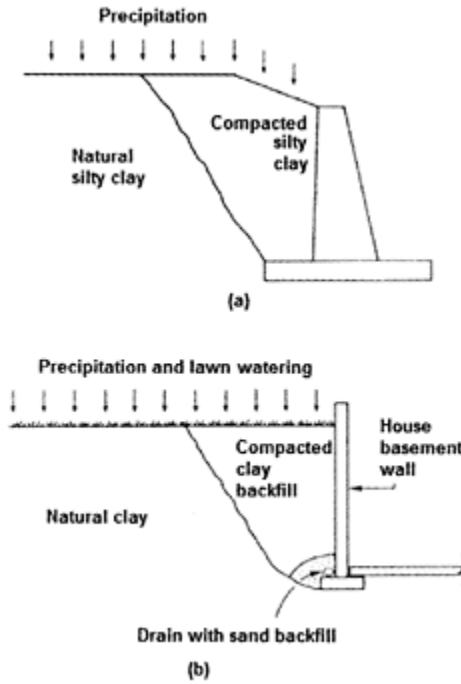

Figure 4.4. Examples of lateral earth pressures generated subsequent to backfilling with dry soils. (a) Lateral earth pressures against a retaining wall as water infiltrates the compacted backfill; (b) lateral earth pressure against a house basement wall (Fredlund & Rahardjo 1993b).

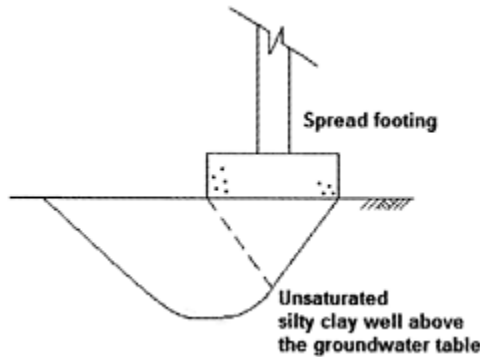

Figure 4.5. Illustration of bearing capacity conditions for a light structure on soils placed on soils with negative porewater pressure (Fredlund & Rahardjo 1993b).

In most cases, the water table is at a considerable depth, and the soil below the footing has a negative pore-water pressure. Undisturbed samples, held intact by negative pore-water pressures, are routinely tested in the laboratory. The assumption is that the porewater

pressure conditions in the field will remain relatively constant with time, and therefore, the unconfined compressive strength will also remain essentially unchanged. Based on this assumption, and a relatively high design factor of safety, the bearing capacity of the soil is computed.

The above design procedure has involved soils with negative pore-water pressures. It appears that the engineer has almost been oblivious to the problems related to the long term retention of negative porewater pressure when dealing with bearing capacity problems. Almost the opposite attitude has been taken towards negative pore-water pressures when dealing with slope stability problems. That is, the attitude of the engineer has generally been that negative porewater pressures cannot be relied upon to contribute to the shear strength of the soil on a long-term basis when dealing with slope stability problems. The two, seemingly opposite attitudes or perceptions, give rise to the question, 'How constant are the negative porewater pressures with respect to time'. Other questions related to the design of shallow footings that might be asked are (Fredlund & Rahardjo 1993b).

- What changes in pore-water pressures might occur as a result of sampling soils from above the water table?
- What effect does the in situ negative pore-water pressure and a reduced degree of saturation have on the measured, unconfined compressive strength?
- How should the laboratory results be interpreted?
- Would confined compression tests more accurately simulate the strength of an unsaturated soil for bearing capacity design?
- How much loss in strength could occur as a result of watering the lawn surrounding the building?

The above examples show that there are many practical situations involving unsaturated soils that require an understanding of the seepage, volume change, and shear strength characteristics. In fact, there is often an interaction among, and a simultaneous interest in, all three of the aspects of unsaturated soil mechanics. Typically, a flux boundary condition produces an unsteady-state saturated/unsaturated flow situation which results in a volume change and a change in the shear strength of the soil. The change in shear strength is generally translated into a change in factor of safety. There may also be an interest in quantifying the change of other volume-mass soil properties (i.e. water content and degree of saturation).

#### 4.3 TROPICAL RESIDUAL SOIL

The microclimatic conditions in an area are the main factors causing a soil deposit to be unsaturated. Therefore, unsaturated soils or soils with negative porewater pressures can occur in essentially any geological deposit. An unsaturated soil could be a residual soil, a lacustrine deposit, a bedrock formation, and so on.

Tropical residual soils have some unique characteristics related to their composition and the environment under which they develop. Most distinctive is the microstructure which changes in a gradational manner with depth. The in situ water content of residual soils is generally greater than its optimum water content for compaction. Their density, plasticity



index, and compressibility are likely to be less than corresponding values for temperate zone soils with comparable liquid limits. Their strength and permeability are likely to be greater than those of temperate zone soils with comparable liquid limits.

Most classical concepts related to soil properties and soil behavior have been developed for temperate zone soils, and there has been difficulty in accurately modeling procedures and conditions to which residual soils will be subjected. Engineers appear to be slowly recognizing that residual soils are generally soils with negative in situ pore-water pressures, and that much of the unusual behavior exhibited during laboratory testing is related to a matric suction change in the soil (Fredlund & Rahardjo 1985).

A typical deep, tropical weathering profile is shown in Figure 4.6 (Little 1969). Boundaries between layers are generally not clearly defined. Numerous systems of classification have been proposed based primarily on the degree of weathering and engineering properties.

Zones of completely weathered or highly weathered rock that contain particulate soil but retain the original rock structure are termed saprolite. Once the deposit has essentially no resemblance of the parent rock, it is termed a lateritic or residual soil.

There is the need for reliable engineering design associated with residual soils. Inhabited areas with steep slopes consisting of residual soils are sometimes the site of catastrophic landslides which claim many lives. The soils involved are often residual in genesis and have deep water tables. The surface soils have negative porewater pressures which play a significant role in the stability of the slope. However, heavy, continuous rainfall can result in increased pore-water pressures to a significant depth, resulting in the instability of the slope. The pore-water pressures along the slip surface at the time of failure may be negative or positive.

There appear to be two main reasons why a practical science has not developed for unsaturated soils (Fredlund 1979). First, there has been the lack of appreciation of the engineering problems and an inability to place the solution within a theoretical context. The stress conditions and mechanisms involved, as well as the soil properties that must be measured, do not appear to have been fully understood. The boundary conditions for an analysis are generally related to the environment and are difficult to predict. Research work has largely remained empirical in nature, with little coherence and synthesis. Second, the possible liability to the engineer is often too great relative to the financial remuneration. Certainly, there is a need for an appropriate technology for unsaturated soil behavior. Such a technology must: (1) be practical, (2) not be too costly to employ, (3) have a sound theoretical basis, and (4) run parallel in concept to conventional saturated soil mechanics.

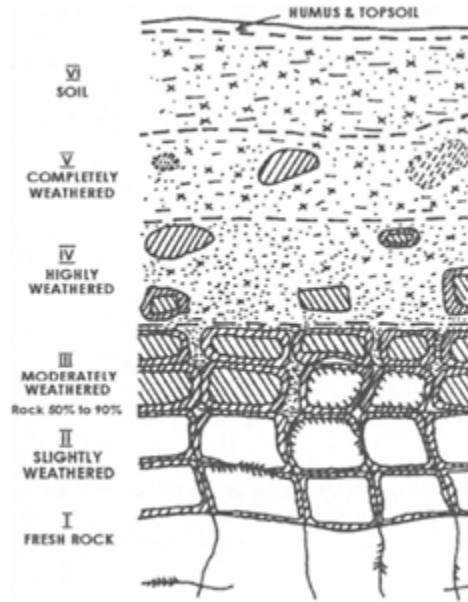

Figure 4.6. Schematic diagram showing a typical tropical residual profile (Little 1969).

#### 4.4 UNSATURATED SOIL THEORY

##### *Stress state variables*

When the degree of saturation of a soil is greater than about 85%, saturated soil mechanics principles can be applied. However, when the degree of saturation is less than 85%, it becomes necessary to apply unsaturated soil mechanics principles (Fredlund & Rahardjo 1987). The transfer of theory from saturated soil mechanics to unsaturated soil mechanics and vice versa is possible through the use of stress state variables.

Stress state variables define the stress condition in a soil and allow the transfer of theory between saturated and unsaturated soil mechanics. The stress state variables for unsaturated soils (Fredlund & Morgenstern 1977) are net normal stress  $(\sigma - u_a)$  and matric suction  $(u_a - u_w)$ , where  $\sigma$  is the total stress,  $u_a$  is the pore-air pressure and  $u_w$  is the pore-water pressure. The stress state in an unsaturated soil can be represented by two independent stress tensors as (Fredlund & Morgenstern 1977):

$$\begin{bmatrix} (\sigma_x - u_a) & \tau_{xy} & \tau_{xz} \\ \tau_{yx} & (\sigma_y - u_a) & \tau_{yz} \\ \tau_{zx} & \tau_{zy} & (\sigma_z - u_a) \end{bmatrix} \quad (4.1)$$

$$\begin{bmatrix} (u_a - u_w) & 0 & 0 \\ 0 & (u_a - u_w) & 0 \\ 0 & 0 & (u_a - u_w) \end{bmatrix} \quad (4.2)$$

where,  $\sigma_x$ ,  $\sigma_y$ ,  $\sigma_z$  in Equation 4.1 are the total normal stresses in the  $x$ -,  $y$ -, and  $z$ -directions, respectively; and  $\tau_{xy}$ ,  $\tau_{yx}$ ,  $\tau_{xz}$ ,  $\tau_{zx}$ ,  $\tau_{yz}$ ,  $\tau_{zy}$  are the shear stresses.

### *Constitutive equations*

Stress state variables are used with measurable soil properties to form single-valued equations known as constitutive equations. Constitutive equations are used to express the relationship between the stress variables and shear strength or volume change when analyzing soil behavior.

Soil mechanics equations for describing the mechanical behavior of unsaturated soils can be presented as an extension of the equations commonly applied to saturated soils. Table 4.1 summarizes and compares some of the saturated and unsaturated soil mechanics equations pertinent to rainfall-induced slope failure studies. The constitutive equations for unsaturated soils show a smooth transition to the constitutive equations for saturated soils when the degree of saturation approaches 100% or when the matric suction goes to zero. In other words, the saturated soil mechanics is a special case of the general unsaturated soil mechanics.

### *Soil-water characteristic curve (SWCC) & permeability functions*

A soil-water characteristic curve (SWCC) which relates the water content of a soil to matric suction is an important relationship for the unsaturated soil mechanics. The SWCC essentially shows the ability of an unsaturated soil to retain water under various matric suctions. It has a similar role as the consolidation curve of a saturated soil that relates void ratio or water content to effective stress. The SWCC of a soil dictates the manner by which the permeability, shear strength and volume change of the soil will behave at different matric suctions upon drying and wetting (Fredlund & Rahardjo 1993a).

Unlike the saturated coefficient of permeability  $k_s$ , the coefficient of permeability  $k_w$  in an unsaturated soil is not a constant, but rather a function of matric suctions (see Equations 4.7 and 4.8 in Table 4.1). Direct measurements of the water coefficients of permeability of unsaturated soils at various matric suctions can be performed in the laboratory. However, the direct measurement of permeability has some inherent problems (Leong & Rahardjo 1997) such as:

- 1) Long time is needed to complete a series of permeability measurements as the coefficient of permeability of unsaturated soils is low especially at high matric suction values.
- 2) Because of the low flow rate, the measurement of the water volume change must be very accurate. Water loss from or within the apparatus and air diffusion through water can introduce serious errors in the volume measurement.
- 3) In some cases an osmotic gradient may develop between the pore-water within the soil and pure water that is being used as the permeating fluid. This gradient will induce an additional osmotic flow across the specimen. The osmotic flow becomes more significant as the water content of the specimen decreases.

4) As matric suction increases, the specimen may shrink from the wall of the cell in the case of a rigid-walled permeameter and also from the high air-entry disk. The air gap will disrupt the continuity of water flow as air is nonconductive to water flow. For the instantaneous profile method, the soil may shrink from the instruments that are used to measure pore-water pressure changes.

Since water can only flow through the water-filled pores, the SWCC therefore, essentially indicates the space available for the water to flow through the soil at various matric suctions. The unsaturated water coefficient of permeability,  $k_w$  can be indirectly estimated from the SWCC and the saturated coefficient of permeability,  $k_s$ . The shape of the SWCC dictates the variation in the water coefficient of permeability with respect to matric suction or the permeability function. The relationship between a soil-water characteristic curve and coefficient of permeability for a sand and a clayey silt is illustrated in Figure 4.7. The indirect method of obtaining the permeability function is described in detail in Fredlund & Rahardjo (1993b). As SWCC can be determined with greater reliability and in a shorter time, this indirect method of obtaining the unsaturated permeability function is attractive.

In indirect measurements of permeability, the saturated permeability and the soil-water characteristic curve of the soil are determined from laboratory measurements. The permeability function of the soil can then be described using an empirical equation as suggested in the following form (Leong & Rahardjo 1997):

Table 4.1. Summary of classic saturated and unsaturated soil mechanics principle and equations (summarized from Fredlund & Rahardjo 1987).

Principle of equation	Saturated soil	Unsaturated soil
Stress state	$(\sigma - \mu w)$	(4.3) $(\sigma - u_a)$ and $(u_a - u_w)$ (4.4)
variables	$\tau = c' + (\sigma - u_w) \tan \phi'$	(4.5) $\tau = c' + (u_a - u_w) \tan \phi^b + (\sigma - u_w) \tan \phi'$ (4.6a)
Shear strength		$c = c' + (u_a - u_w) \tan \phi^b$ (4.6b)
Flow law for water (Darcy's law)	$v_w = -k_s (\partial h_w / \partial y)$ $h_w = y + (u_w / \rho_w g)$	(4.7) $v_w = -k_s (u_a - u_w) (\partial h_w / \partial y)$ $h_w = y + (u_w / \rho_w g)$ (4.8)
Unsteady state seepage	$k_s \left( \frac{\partial^2 h_w}{\partial x^2} \right) + k_s \left( \frac{\partial^2 h_w}{\partial y^2} \right) = m_s \rho_w g \frac{\partial h_w}{\partial t}$ (4.9)	$\frac{\partial}{\partial x} \left( k_w \frac{\partial h_w}{\partial x} \right) + \frac{\partial}{\partial y} \left( k_w \frac{\partial h_w}{\partial y} \right) = m_s \rho_w g \frac{\partial h_w}{\partial t}$ (4.10)

Slope stability based on limit equilibrium Moment equilibrium

$$F_m = \frac{\sum \left[ c' \beta R + \left\{ N - u_w \beta \frac{\tan \phi^*}{\tan \phi'} \right\} R \tan \phi' \right]}{\sum Wx - \sum Nf} \quad (4.11) \quad F_m = \frac{\sum [c' \beta R + \{N - u_w \beta\} R \tan \phi']}{\sum Wx - \sum Nf} \quad (4.12)$$

Force equilibrium

$$F_f = \frac{\sum \left[ c' \beta \cos \alpha + \left\{ N - u_w \beta \frac{\tan \phi^*}{\tan \phi'} \right\} \tan \phi' \cos \alpha \right]}{\sum N \sin \alpha} \quad (4.13) \quad F_f = \frac{\sum [c' \beta \cos \alpha + \{N - u_w \beta\} \tan \phi' \cos \alpha]}{\sum N \sin \alpha} \quad (4.14)$$

where:

$k_w(u_a - u_b)$ =Unsaturated coefficient of permeability which is a function of  $(u_a - u_w)$

$\partial(\sigma_y - u_w)$ =Change in effective vertical stress

$v_w$ =Flow rate of water

$k_s$ =Water saturated coefficient of permeability

$k_w$ =Water coefficient of permeability

$\partial h_w / \partial y$ =Hydraulic head gradient in the y direction

$\tau$ =Shear stress

$c'$ =Effective cohesion intercept

$\phi^*$ =Effective angle of internal friction

$\phi$ =Angle of shear strength change with a change in matric suction

$c$ =Cohesion intercept

$\partial k_w / \partial y$ =Change in water coefficient of permeability in the y-direction

$\partial k_w / \partial x$ =Change in water coefficient of permeability in the x-direction

$\partial h_w / \partial x$ =Hydraulic head gradient in the x-direction

$F_m$ =Factor of safety with respect to moment equilibrium

$F_f$ =Factor of safety with respect to force equilibrium

$R$ =Radius of a circular slip surface or the moment arm associated with the mobilized shear force on the base of each slice

$W$ =Total weight of a slice

$N$ =Total normal force on the base of the slice

$\alpha$ =Angle between the tangent to the centre of the base of each slice and the horizontal

$\beta$ =Sloping distance cross the base of a slice

$x$ =Horizontal distance from the centerline of each slice to the centre of rotation or to the centre of the moments

$y$ =Elevation head

$f$ =Perpendicular offset of the normal force from the centre of rotation or from the centre of moments

- $m_v$ =Coefficient of volume change
- $m$ =Coefficient of water volume change with respect to change in matric suction
- $\partial t$ =Change in time
- $\rho_w$ =Density of water
- $g$ =Acceleration due to gravity
- $h_w$ =Hydraulic head
- $u_a$ =Pore-air pressure
- $u_w$ =Pore-water pressure
- $\sigma$ =Total stress

$$k_w = k_s \Theta^p \tag{4.15}$$

where  $k_s$ =saturated permeability;  $\Theta$ =normalized volumetric water content or  $(\theta_w - \theta_r) / (\theta_s - \theta_r)$  where  $\theta_w$ =volumetric water content and the subscripts s and r denote saturated and residual, respectively; and  $p$  is a constant.

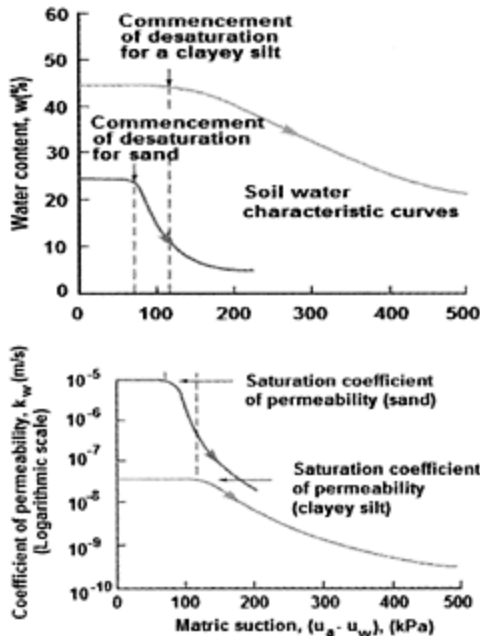

Figure 4.7. Relationship between soil-water characteristic curve and coefficient of permeability for a sand and a clayey silt (from Fredlund & Rahardjo 1993a).

If a database containing coefficients of permeability at different matric suctions exist for a soil, the unsaturated permeability function of the soil can then be best fitted with the following equation (Leong & Rahardjo 1997):

$$k_w = \frac{k_s}{\left\{ \ln \left[ e + \left( \frac{\psi}{A} \right)^B \right] \right\}^C} \tag{4.16}$$

where  $A$ ,  $B$  and  $C$  are constants and  $\psi$  is soil suction.

Having determined the hydraulic properties of unsaturated soil, the flow of water through unsaturated-saturated soil system can be described using the general governing flow equation given in Equation 10 of Table 4.1. The water flow equation for a saturated soil (Equation 4.9 of Table 4.1) is a special case of the general Equation 4.10. A seepage finite element program incorporating the governing flow equation can then be used to solve water flow through a residual soil slope during a rainfall event and the changes in the negative pore-water pressures due to rainfall can be calculated.

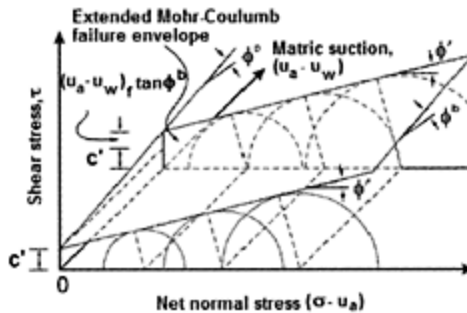

Figure 4.8. Extended Mohr-Coulomb failure envelope (from Fredlund & Rahardjo 1993b).

### Shear strength

The shear strengths of saturated and unsaturated soils are given by Equations 4.5 and 4.6, respectively (Table 4.1). Equation 4.6 is an extended form of the Mohr-Coulomb equation (Fredlund et al. 1978). The extended Mohr-Coulomb failure criterion can be represented as a three-dimensional surface as shown in Figure 4.8. The failure surface is plotted using  $(\sigma - u_a)$  and  $(u_a - u_w)$  as abscissas. The intersection line between the failure surface and the  $\tau$  versus  $(\tau - u_a)$  plane represents the Mohr-Coulomb failure envelope for the saturated condition. On this plane the pore-water pressure is equal to the pore-air pressure or the matric suction is equal to zero. The failure envelope for a saturated soil has a slope and an intercept of  $\phi'$  and  $c'$ , respectively, and the envelope is described by Equation 4.5. In other words, Equation 4.5 for a saturated soil is a special case of Equation 4.6 for unsaturated soil and there is a smooth transition when Equation 4.6 reverts to Equation 4.5 as soil becomes saturated or  $u_w$  approaches  $u_a$  (i.e.,  $(u_a - u_w)$  is equal to zero).

For an unsaturated soil, the total cohesion intercept  $c$ , at each matric suction is determined from the point where the failure envelope intersects the shear stress versus matric suction plane. The shear strength of a soil increases as the matric suction increases or

degree of saturation decreases. The increase in the shear strength can be considered as an increase in the cohesion intercept because of an increase in matric suction (Equation 4.6b in Table 4.1). The increase in the cohesion intercept with respect to matric suction is defined by the intersection between the failure surface and the  $\tau$  versus  $(u_a - u_w)$  plane. This line has a slope of  $\phi^b$  that can be measured experimentally. The value of  $\phi^b$  is generally equal to or less than  $\phi^*$ .

The shear strength envelope with respect to matric suction (i.e., the  $\tau$  versus  $(u_a - u_w)$  plane) can be nonlinear due to the non-linear soil-water characteristic curve. A relationship between soil-water characteristic curve and shear strength for a sand and a clayey silt is shown in Figure 4.9 (Fredlund & Rahardjo 1993a). At low matric suctions, where the suction is lower than the air-entry value of the soil, the soil is at or near saturation condition

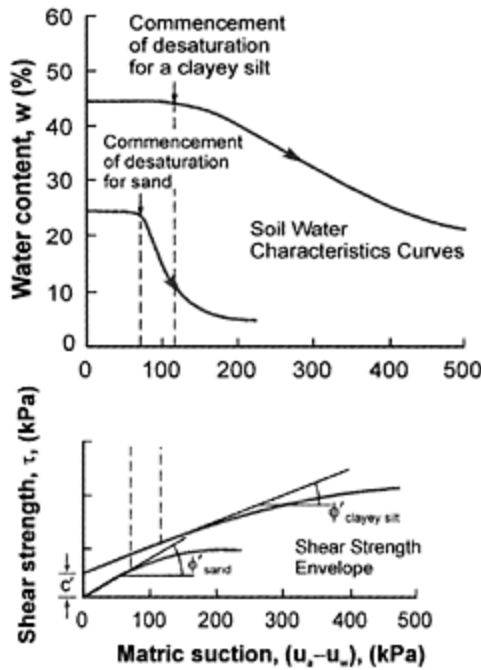

Figure 4.9. Relationship between soil water characteristic curve and shear strength for a sand and a clayey silt (from Fredlund & Rahardjo 1993a).

and the air phase consists of a few occluded bubbles (Corey 1957). The soil would be expected to behave as though it was saturated. In other words the negative pore-water pressure acts throughout the predominantly water filled pores as in the saturated soil condition. Consequently an increase in matric suction produces the same increase in shear strength as does an increase in net normal stress. As a result, the same values are obtained for  $\phi^*$  and  $\phi^b$ .

At matric suctions higher than the air-entry value of the soil, the soil starts to desaturate. The negative pore-water pressure does not act throughout the entire pores as in the



saturated soil condition. Therefore, the contribution of matric suction towards the strength of the soil is less than the contribution of the net normal stress at the same stress level. In other words the increase in shear strength with respect to matric suction is less than the increase with respect to net normal stress. As a result, the  $\phi^b$  value becomes less than  $\phi^s$  at high matric suctions as observed in Figure 4.9.

The shear strength of soil can be used to calculate factor of safety of a slope using the limit equilibrium methods of slices. The factors of safety with respect to moment and forces are given in Equations 4.12 and 4.14 of Table 4.1. Equations 4.12 and 4.14 revert to Equations 4.11 and 4.13, respectively, when the soil is saturated because the  $\phi^b$  value is equal to the  $\phi^s$  value. The changes in negative pore-water pressure during rainfall as calculated from the seepage analyses can be input into the slope stability analyses in order to compute the changes in factor of safety during a rainfall event.

#### 4.5 LABORATORY TESTS ON UNSATURATED RESIDUAL SOILS

The extended Mohr-Coulomb shear strength envelope for unsaturated soils require that three shear strength parameters be defined namely,  $c'$ ,  $\phi^s$  and  $\phi^b$ . These parameters can be measured in the laboratory. The  $c'$  and  $\phi^s$  parameters can be measured using saturated soil specimen. The tests on unsaturated are performed to obtain the  $\phi^b$ . Conventional triaxial and direct shear equipment require modifications prior to their use for testing unsaturated soils. Several factors related to the nature of unsaturated soil must be considered in modifying the equipment. The presence of air and water in the pores of the soil causes the testing procedures and techniques to be more complex than those required when testing saturated soils. The modification must accommodate the independent measurement or control of pore air and pore water pressures. In addition, the pore water pressure is usually negative and can result in water cavitation problems in the measurement. Equipment modifications and general procedures for testing unsaturated soils using modified triaxial and direct shear equipment are well documented by Fredlund & Rahardjo (1993b). Some examples on the laboratory tests performed on residual soils in Malaysia are given in the following sections.

##### *Shear strength tests*

Residual granite rock soil and sedimentary rock soil occur extensively in Malaysia i.e. cover more than 80% of the land area. Yet, not much research work have been carried out on these materials. The situation is even worst in the case of unsaturated residual soil. Some investigations have been carried out since several years ago and are still on going. The interest in the behavior of unsaturated soil began to develop after the country was faced with a number of very serious slope stability problems. The coming sections summarize some of the laboratory studies.

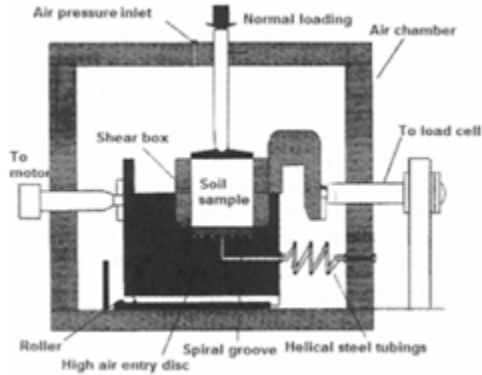

Figure 4.10. Modified direct shear apparatus.

### *Modified shear box tests*

The consolidated drained direct shear test on an unsaturated soil specimen can be conducted using the modified shear apparatus. Figure 4.10 shows an ordinary shear box which was modified to apply soil suction to the soil samples (Low et al. 1997). Suction could be applied by controlling the pore air and pore water pressures. The direct shear box was placed in a special fabricated galvanized steel air chamber as shown in the figure. A 15 bar high air entry disc was placed at the lower block of the direct shear box. The high air entry disc was used to separate soil samples with the water compartment underneath.

The total normal stress,  $\sigma$ , was applied vertically to the soil specimen through a loading ram as in the conventional shear box tests. The uplift pressure of the air in the air chamber on the loading ram was taken into account. Undisturbed samples from a granitic residual soil cut slope were used in the tests.

Typical results obtained from the tests are shown in Figure 4.11. The effect of suction on the shear strength of the soil is clearly observed. One of the advantages of carrying out the shear box test is that the time taken is shorter and it is easier to set up.

### *Triaxial tests*

Various triaxial test procedures or methods may be used for saturated soils based upon the drainage conditions adhered to during the first and second stages of the triaxial tests, namely, consolidated drained (CD) consolidated undrained (CU) constant water content (CW) and unconsolidated undrained (UU). Figure 4.12 shows the experimental set up in which the Bishop-Wesley triaxial cell set was modified to carry out the above test so that suction can be introduced into the specimen (Affendi & Faisal 1994a).

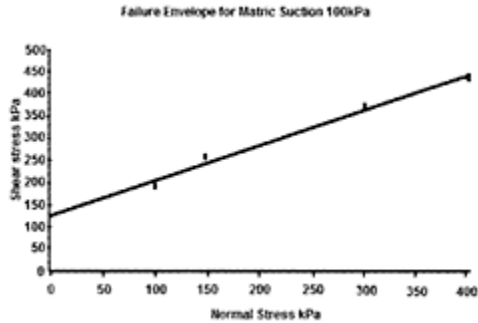

Figure 4.11. Shear stress vs normal stress.

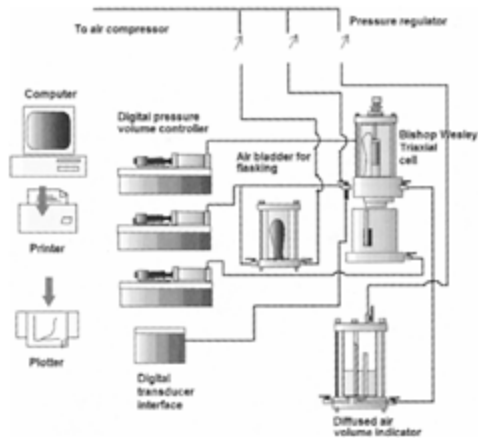

Figure 4.12. The experimental set up for triaxial tests.

Most of the unsaturated strength tests carried out on residual soils in Malaysia were related to slope stability problems. The undisturbed samples were prepared from the block samples taken from the slope being investigated. Different types of residual soils had been tested and some of them are presented below. Affendi & Faisal (1994a) carried out tests on samples taken from a granitic residual soil slope to study the effect of suction on the shear strength of the soil. Typical results of the tests are shown in Figure 4.13. The angle of shearing resistance,  $\phi^s$ , and the angle indicating the rate of increase in shear strength with respect to suction,  $\phi^b$ , are  $26^\circ$  and  $17^\circ$  respectively. Drained tests carried out by Hossain (1999) on a more or less similar type of soil yielded values of  $\phi^s$  and  $\phi^b$  equal to  $26.5^\circ$  and  $17.2^\circ$  respectively.

Saravanan et al. (1999) carried out tests on sedimentary residual soil samples taken from different weathering zones. Sample from Zone IV gave  $\phi^s$

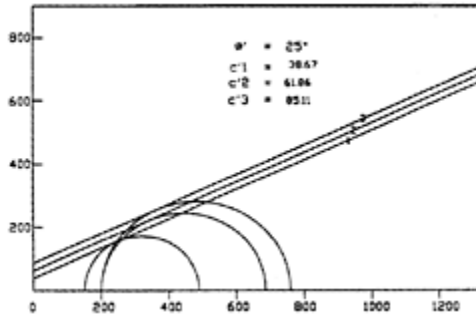

Figure 4.13a. Mohr circle plot for CD tests (Suctions: 50, 100 & 200 kPa).

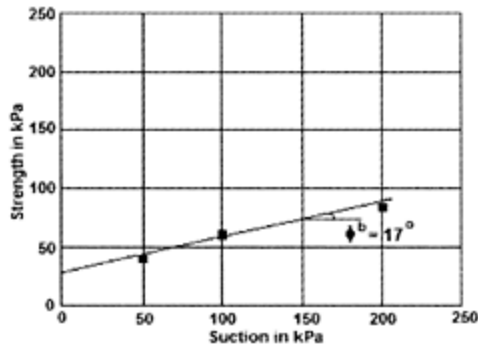

Figure 4.13b. Increase in strength with suction.

value of  $26^\circ$  and maximum  $\phi^b$  value of  $21^\circ$ . Sample from Zone III gave  $\phi^b$  value of  $33^\circ$  and maximum  $\phi^b$  value of about  $10^\circ$ .

Hossain (1999) carried out consolidated undrained tests (CU) and constant moisture tests (CW) on unsaturated granitic residual soil samples and compared the effective strength parameters obtained with those from consolidated drained tests. The values of  $\phi^b$  obtained from CU and CW tests were  $25.8^\circ$  and  $23.3^\circ$  respectively. These are significantly different from  $\phi^b$  value of  $17.8^\circ$  obtained from CD tests.

### *Volume change*

Some tests on compacted residual soil samples were carried out (Choong 1998) in order to study (a) the volume change behavior of the soil subjected to an increase in net mean stress at constant matric suction (b) The volume change behavior of the soil subjected to reduction of matric suction at constant net mean stress (c) the effect of rate of loading of net mean stress on the volume change behavior of soil, and the effect of stress history on

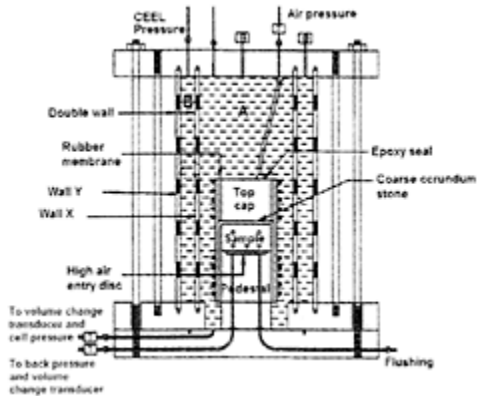

Figure 4.14. Schematic diagram of the double-walled cell.

the volume change. The tests were carried out using specially fabricated apparatus and a double-walled cell (Figure 4.14) was used in the test as the structural volume change was measured using a high precision volume change indicator installed at the cell pressure line.

The following conclusions were arrived at based on the results of the tests:

- i) The loading rate of the net mean stress has a pronounced effect on the void ratio and degree of saturation but has an insignificant effect on the water content of the soil subjected to constant applied matric suction. However, the loading rate of net mean stress has an insignificant effect on the, void ratio, water content and degree of saturation for soil not subjected to the applied matric suction
- ii) When the applied matric suction is increased at constant net mean stress condition, the void ratio of the soil decreases. However, when the matrix suction is reduced at constant net mean stress condition, the void ratio of the soil can either increase (swell) or decrease (collapse), depending on the stress history of the soil and loading rate of net mean stress.
- iii) There may be a unique relationship (or uniqueness) between the void ratio, matric suction and net mean stress. The uniqueness in void ratio was normally observed in the study when there was a collapse (decrease in void ratio) due to the reduction in applied matric suction at constant net mean stress. However, the uniqueness in void ratio appears to be sensitive to stress history and loading rate.
- iv) The stress history may have a significant effect on the void ratio and degree of saturation of the soil. The increase in applied matric suction at constant net mean stress is found to have resulted in non-uniqueness in void ratio.

#### 4.6 FIELD TESTS

The role of matric suction as one of the stress state variables for unsaturated soil was illustrated in Section 4.4 Devices commonly used for measuring matric suction include tensiometers, null-type pressure plate and thermal conductivity sensors. Matric suction can

be measured either in a direct or indirect manner. As part of the research program on slope instability a number of field tests have been carried out in residual soils in Malaysia which include field suction and rainfall measurement, soil moisture measurement and infiltration tests. Some of these tests are presented in the following sections.

### *Measurement of suction and rainfall*

The objective of the study is to determine the variation of field suction and rainfall. The measurement was done by carrying out field instrumentation on each slope under consideration. Suctions were measured using tensiometers and the rainfall was measured using an automatic logging tipping bucket rain gauge. Figure 4.15 shows the schematic arrangement of the field instrumentation. An automatic data acquisition system which allowed continuous monitoring and supported by a solar powered set was used. Instrumentation detail at one of the tensiometer locations is shown in Figure 4.16.

### *Granitic residual soil*

The site was an exposed profile of a cut slope along the Kuala Lumpur-Karak Highway. The weathering profiles were very distinctive and Figure 4.17 shows the lateral extension of the morphological horizons, within the weathering profiles and the gradings (Affendi & Faisal 1994b).

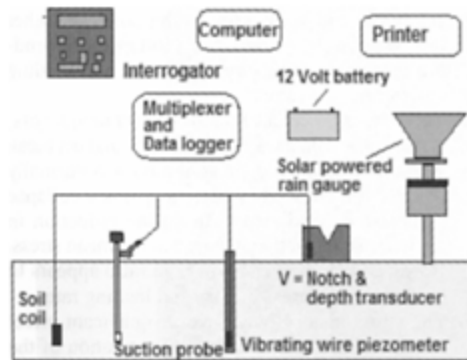

Figure 4.15. Schematic presentation of the field instrumentation.

The total number of instruments and their locations are shown in Figure 4.17. The data from the 27 sensors were automatically recorded at a preset time interval and were periodically downloaded to a computer for further analysis.

Figure 4.18 shows the responses of the tensiometers located at berm 4. The suction reading for the shallower depth seems to be higher than for the deeper locations. Furthermore the response due to rainfall is less pronounced as the depth increases. There seems to be a limiting value for suction at various depths. The suction values level up to certain values depending on the depth after a dry weather spell. The largest drop in suction is from a value of 89.2 kPa to 35.4 kPa (depth 30.5cm).

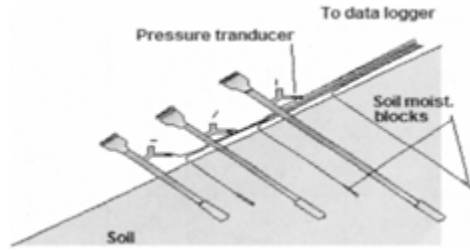

Figure 4.16. Installed tensiometers for different depths.

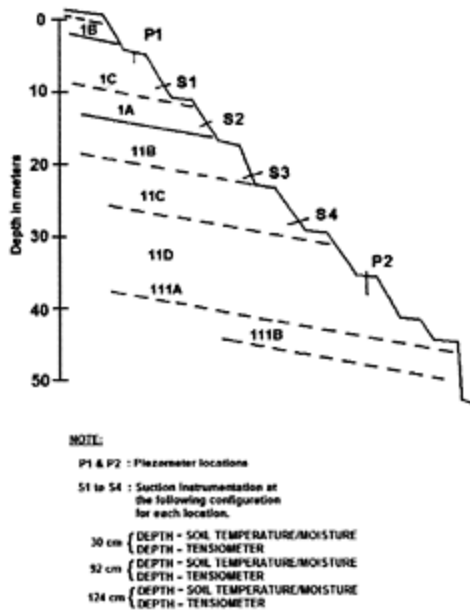

Figure 4.17. Cross-section of the cut slope.

The drop in suction decreases as the depth increases. Similar behaviour was experienced in studies conducted on residual soils in Hong Kong.

Figures 4.19, 4.20 and 4.21 show plot of suction against cumulative rainfall for various depths (30.5, 61.0 and 91.5 cm). The plots of suction variation at 30.5 cm depth for various berms show that the responses for the various grades of granite behave differently.

The suction fluctuations for different berms at 30.5 cm depth are relatively large i.e. from below 10 kPa to above 85 kPa while for depths 61.0 cm and 91.0 cm the fluctuations are smaller (i.e. between 25 kPa and 65 kPa).

*Sedimentary residual soil*

The instrumentation was attempted to study the change of soil matric suction with the rainfall on a cut slope along the link road of The Kuala Lumpur International Airport (KLIA) Malaysia (Low et al. 1999b). The cut slope mainly consists of two types of weathered sedimentary residual soil, i.e. weathered sandstone and shale. These residual soils come in

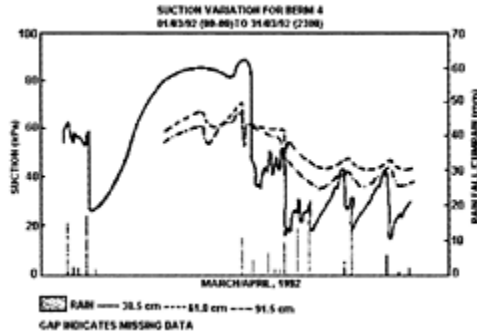

Figure 4.18. Suction variation for berm 4.

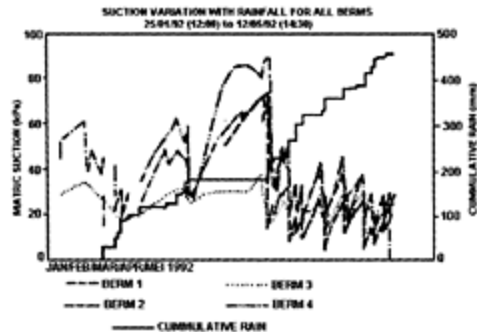

Figure 4.19. Suction variation—30.5 cm deep.

alternate bedding which is almost vertical. The weathered sandstone bed basically is the thicker bed and the study is concentrated in one of these beds. The soil consists of very fine sand and silt. Tensiometers 20 in number and twenty moisture blocks and a rain gauges were installed on the slope to monitor the changes of matric suction with respect to rainfall. The tensiometers and moisture blocks were installed at different depths. At each berm, four tensiometers and moisture blocks were installed i.e., at depths of 0.5m, 1 m, 2m and 3 m. Figure 4.22 shows the instrumentation layout.

The normal coring tools could not be used because the soil was brittle and hard. A specially designed motorised auger was fabricated for the installation purpose (Figure 4.23).

Figure 4.24 shows a typical suction variation with rainfall (one month duration) for one of the berms at the study site. It clearly shows that as the depth increases, the matric suction reduces.



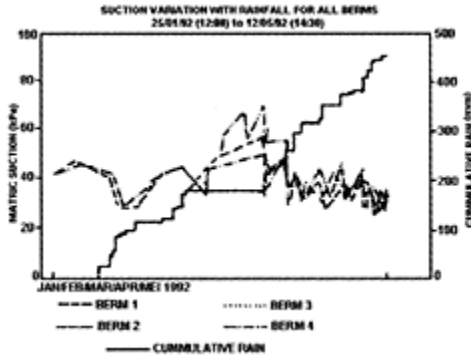

Figure 4.20. Suction variation—61 cm deep.

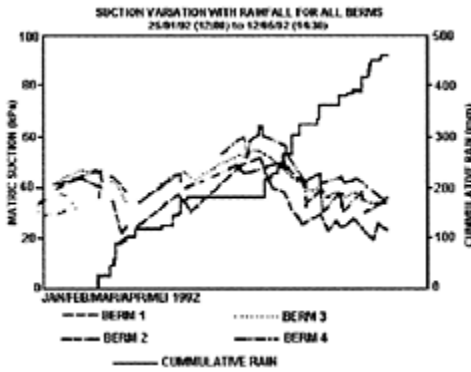

Figure 4.21. Suction variation—91.5 deep.

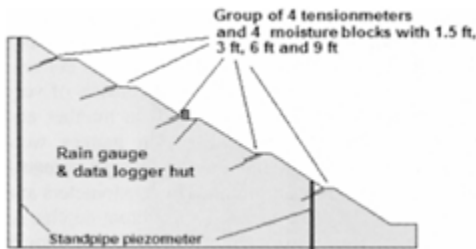

Figure 4.22. Instrumentation layout.

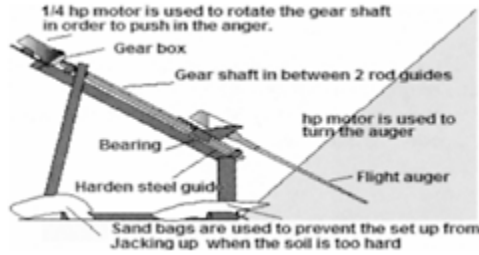

Figure 4.23. Specially fabricated augering machine.

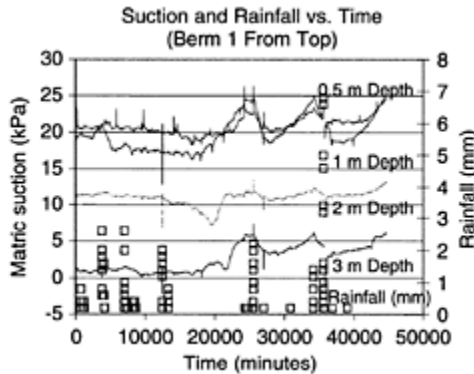

Figure 4.24. Typical suction variation with rainfall for one-month duration.

During the time interval of 14000 to 24000 minutes, there was no rainfall and all the four tensiometers recorded increments in matric suction. When the rain start, matric suction did not reduce immediately. Due to the infiltration of rain water into the ground, after rainfall the matric suction continued to reduce slowly for all depths.

From Figure 4.24, in the time interval of 0 to 13000 minutes, the 3.0m depth tensiometer gives very low suction values. This was mainly due to the water which had infiltrated during the earlier rainfall periods.

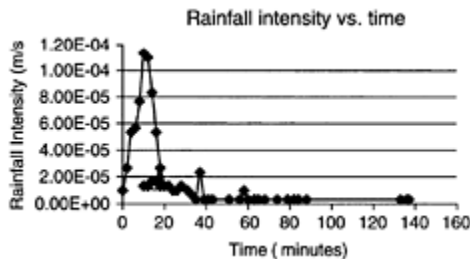

Figure 4.25. Typical rainfall intensity measured at the site.

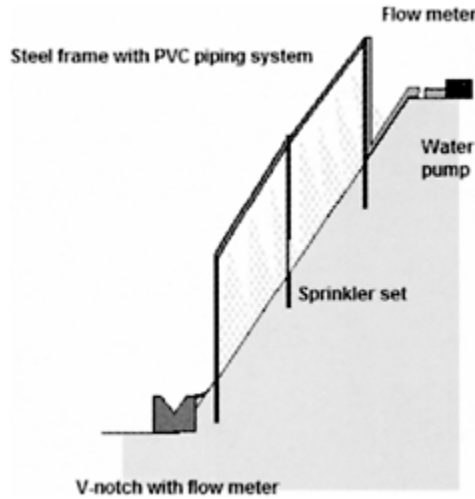

Figure 4.26. Infiltration test using a rain simulator.

Figure 4.25 shows one of the typical rainfall intensity patterns at the study site. The rainfall intensity at the site reached as high as  $1.13 \times 10^{-4} \text{ m/s}$  during the monitoring period.

Recently, an infiltration study was performed by using rain simulator. Water was sprayed on the slope using sprinklers as shown schematically in Figure 4.26. A number of large water tanks were placed at some locations on the slope in order to have enough water supply for the study. In addition to the existing tensiometers, seven small tip tensiometers were installed at 75 mm below ground surface. Four different surface conditions were studied i.e. grass+geotextile cover, geotextile only cover and bare slope. Figure 4.27 shows a typical variation of suction with time. In the figure, shallow tensiometers are represented by 1–7 and existing tensiometers are denoted by A (0.5 m), B (1.0 m) and C (2.0 m). It is interesting to note that some of the shallow tensiometers indicated initial increase in suction as soon as the sprinkling began. These were observed in every test carried out.

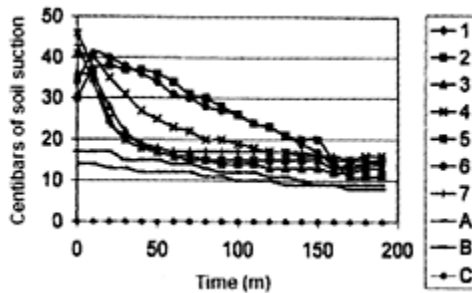

Figure 4.27. Variation of suction with time for bare slope.

## 4.7 CONCLUSION

Unsaturated soil mechanics can be used to describe the mechanical behavior of residual soils that are commonly unsaturated in nature. As an example, the principles of unsaturated soil mechanics can be used to analyze the changes in shear strength of residual soils due to rainfall infiltration and subsequently the variation in factor of safety of a residual soil slope due to rainfall.

## REFERENCES

- Affendi, A. & Faisal Haji Ali. 1994a. Strength and suction characteristics related to slope stability. *Inter. conf. On landslides, slope stability and the safety of infra-structures, Kuala Lumpur*: 1–8.
- Affendi, A. & Faisal Haji Ali. 1994b. Field measurement of soil suction. *Proceeding 13th International conference on soil mechanic and foundation engineering*. 3: 1013–1016.
- Brand, E.W. 1985. Predicting the performance of residual soil slopes. *Proceedings of 11th international conference on soil mechanics and foundation engineering, San Francisco, California*. 5:2541–25.
- Corey, A.T. 1957. Measurement of water and air permeability in unsaturated soils. *Proc. of the Soil Science Society of America*. 21(1):7–10.
- Choong Foong Heng. 1998. *Volume change behaviour of an unsaturated residual soil*. M. Eng Thesis, University of Malaya.
- Fredlund, D.G. 1979. Second Canadian geotechnical colloquium: Appropriate concepts and technology for unsaturated soils. *Canadian Geotechnical Journal*. 16(1): 121–139.
- Fredlund, D.G. et al. 1987. Non linearity of strength envelop for unsaturated soils. *Proceedings of the 6th international conference on expansive soils, New Delhi, India*: 49–54.
- Fredlund, D.G. & Morgenstern, N.R. 1977. Stress state variables for unsaturated soils. *J. of the Geotechnical Engineering Division, ASCE*. 103:447–466.
- Fredlund, D.G., Morgenstern, N.R. & Widger, R.A. 1978. The shear strength of unsaturated soils. *Canadian Geotechnical Journal*. 15(3):313–321.
- Fredlund, D.G. & Rahardjo, H. 1985. Theoretical context for understanding unsaturated residual soils behavior. *Proceeding 1st International conference Geomech. In tropical laterite and saprolitic soils, Sao Paulo Brazil*: 295–306.
- Fredlund, D.G. & Rahardjo, H. 1987. Soil mechanics principles for highway engineering in Arid regions. *In soil mechanics considerations: Arid and semiarid areas*. Transportation research record 1137:1–11.
- Fredlund, D.G. & Rahardjo, H. 1993a. An overview of unsaturated soil behaviour. *Proc. of ASCE specialty series on unsaturated soil properties, Dallas, Texas*. 1–31.
- Fredlund, D.G. & Rahardjo, H. 1993b. *Soil mechanics for unsaturated soils*. New York: John Wiley & Sons Inc.
- Hossain, M.K. 1999. Shear strength characteristics of a decomposed granite residual soil in Malaysia. Ph.D. Thesis. National University of Malaysia.
- Little, A.L. 1969. The engineering classification of residual tropical soils. *Proc. 7th International conference soil mechanics foundation engineering, Mexico*. 1:1–10.
- Leong, E.C. & Rahardjo, H. 1997. Permeability functions for unsaturated soils, *J. of Geotech. and Geoenvironmental engng, ASCE*. 123(12):1118–1126.
- Low, T.H., Faisal Haji Ali, Saravanan, M. & Phang, K.S. 1999a. Effects of perched water table on slope stability in unsaturated soil. *Proc. Int. Symp. on slope stability engg*. 1:393–397.

- Low, T.H., Faisal Haji Ali & Saravanan, M. 1999b. Field suction variation with rainfall on cut slope in weathered sedimentary residual soil. *Proc. Int. Symp. on slope stability Engg.* 1:399–403.
- Low, T.H., Hashim, S. & Faisal Ali. 1997. Shear strength of unsaturated residual soil using modified shear box. *Proceeding of 3rd Asian young geotechnical engineers, Singapore:* 607–616.
- Premchitt, J., Brand, E.W. & Phillipson, H.B. 1985. *Landslides caused by rapid groundwater changes.* In J.C. Cripp (ed.). *Groundwater in engineering geology.* Geological Society: 87–94.
- Saravanan, M, Faisal Haji Ali, & Low, T.H. 1999. Determination of shear strength parameters of unsaturated sedimentary residual soil for slope stability analyses. *Proc. Int. Sympo. on slope stability engg.* 2:687–691.



## CHAPTER 5

# Slope failures in tropical residual soils

Liew Shaw-Shong  
*Gue & Partners Sdn Bhd, Kuala Lumpur, Malaysia*

Six case histories of landslides in three cut slopes, two filled slopes and one natural slope in Malaysia with underlying formations of post-glacial deposits, weathered soils derived from igneous rocks, meta-sedimentary and sedimentary formations have been investigated and will be presented in this chapter. Investigating processes consisting of site reconnaissance, topography survey, subsurface investigation, laboratory testing, back-analyses, instrumentation scheme for slip surface detection and groundwater regime establishment will be discussed in detail. Rainfall records spanning the period before landslide incident till the end of investigation were gathered to reveal the relationship between the landslide and rainfall. Comparisons have also been carried out between the laboratory strengths interpreted from consolidated isotropically undrained triaxial tests and direct shear box tests and the back-analyzed strengths from both conventional limit equilibrium stability analyses and finite element analyses. The  $c-\phi$  strength reduction method is used in the finite element analyses for back-analyzing the mobilized strength of the slopes investigated. In some case histories, finite element analyses have successfully demonstrated the mechanism of progressive failure in the case study with high cut slopes, in which stress distribution within the slope body is highly non-uniform, particularly at the developed slip surface. Comprehensive instrumentation was implemented at certain sites to provide valuable information for investigation and to offer insight of the post-failure behavior of the distressed slopes. The back-calculated residual strengths of the failed slope are somehow deviated from the common residual strength correlation with the liquid limit and the clay size fraction.

### 5.1 INTRODUCTION

#### *General*

Generally, it is more common to hear about failures in residual soil slopes than other types of geotechnical structures. Among the failed slopes, cut slopes are the top statistics except for some man made slopes, which are poorly engineered and constructed. Unlike the engi-

neered filled slopes, the inherent variation of the earth material properties, geological structures, groundwater regime and the subsequent weathering processes in the materials of the cut slopes are usually unforeseen and difficult to be identified during the design. Following the failure in natural materials, this chapter will also discuss the failures on engineered filled slopes.

### *Characteristics of residual soils*

Common definitions of residual soil refer to it as the remaining depleted soil in which most soluble elements in the soil have been dissolved. This, in fact, implies that residual soils are normally undergoing extensive physical and chemical alteration through the processes called natural weathering. Weathering processes can result in various degree of gradual degradation or breaking down of the parent rock material from fresh rock to fine particles of clay size. Throughout the process, physical characteristics such as bonding, strength, permeability and density, will change drastically.

### *Case histories*

In this chapter, six case histories on slope instability in tropical weathered soil at various parts of Peninsular Malaysia and East Malaysia are studied. The locations of these case histories are shown in Figure 5.1. The failures involve natural slope, man made cut slopes and filled slopes.

## 5.2 SITE A—CREEP MOVEMENT OF NATURAL SLOPES AT SABAH, EAST MALAYSIA

### *Background of site*

The road authority in Sabah has experienced frequent pavement repair works for one of the access roads at Kg. Kauluan of Kundasang-Ranau area. The location of this access road is shown in Figure 5.2. The pavement of this 1.2 km stretch of road requires repair work every few months. The visible distress observed on the pavement are tension cracking, settling and lateral movements. In view of the frequent pavement repair work causing inconvenience to vehicles passing through the distressed stretch of the road, it was imperative to investigate the root causes of the problem and look for a permanent solution. A comprehensive geotechnical investigation was therefore carried out to study the problem in stages.



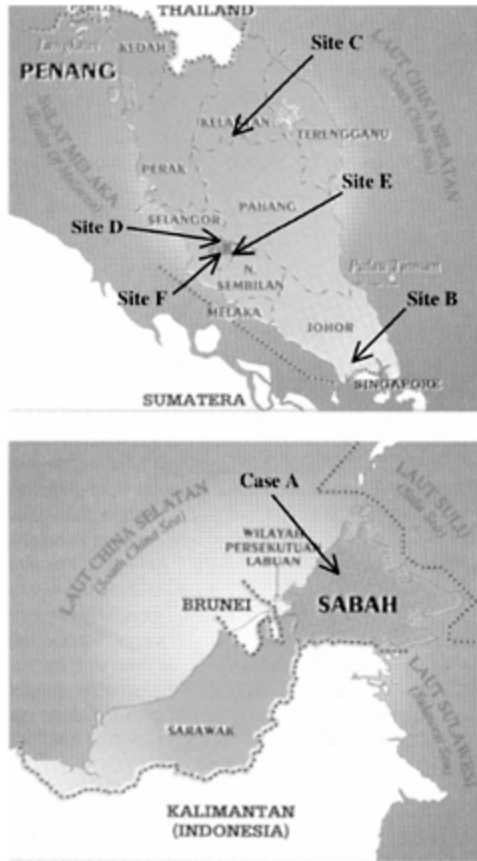

Figure 5.1. Locations of failure sites (East Malaysia & Peninsular Malaysia).

The affected road alignment generally traverses in a north-east direction at the first 600 m and changing to south-east direction for the remaining 600 m. The road level ascends from RL1335 m to RL1500 m. The overall site terrain is generally undulating in nature as shown in Figure 5.3.

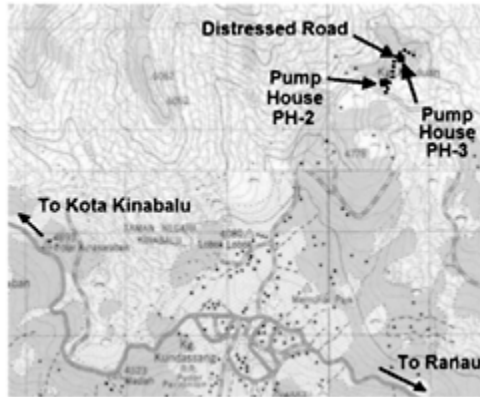

Figure 5.2. Site location.



Figure 5.3. Overview of undulating site terrain.

The surrounding ground surface of the area is featured with many clusters of large granitic boulders. Occasionally, grey shale (from Trusmadi Formation), red/grey shale and sandstone (from Crocker Formation) outcrops can be seen along the road.

Power transmission line and telephone lines running along the road, are tilted due to ground movements; tensioning of electrical cables were also observed. Figure 5.4 shows the tilted posts with tensioned cables.

There is an abandoned pump house (PH-2) at the left hand side after turning into the road and another pump house (PH-3) at the right hand side near the end of the affected chainage of the road as shown in Figure 5.2. These pump houses were built for the Mesilau Mini Hydro project as part of the irrigation scheme providing irrigation for horticulture in the Kundasang areas and was also intended to be the power scheme for Sabah Electricity Board (SEB). The Mesilau Mini Hydro project was commissioned in 1983 but has not been used since 1985. In October 1987, a massive slip occurred and tilted the pump house, PH-2 and part of the pipeline. From the site observation, the pump house has suffered serious distress due to differential settlement and lateral ground movements. Figure 5.5 shows the shear cracks on the wall as a result of the ground movements.

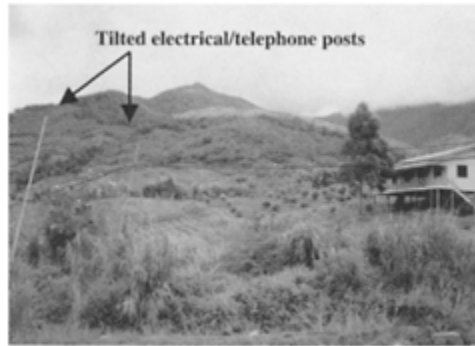

Figure 5.4. Tilted electrical & telephone posts.

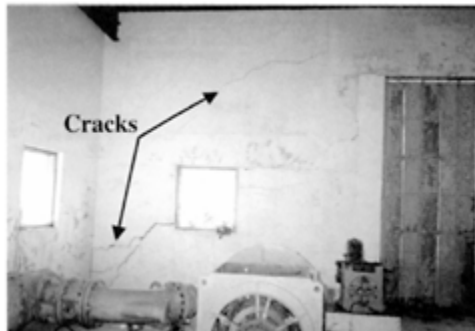

Figure 5.5. Structural cracks on the wall.

As a result of ground movement, the roadside concrete drains on the higher ground also showed serious cracks due to shearing and tensioning. No indication of damage on drains due to compressive thrust at the lower passive zone was observed except some distortions of the T-junction concrete drain sump. This is because the concrete drains were constructed within the active wedge areas where tension cracks occur and probably did not extend to the passive wedge at the lower portion of the landslide masses. Repair works have been carried out to seal the cracked drain.

The road pavement along the affected chainage generally shows tension cracks, pot-holes and settlement and bearing capacity failure, probably due to weak subgrade as a result of ground movement.

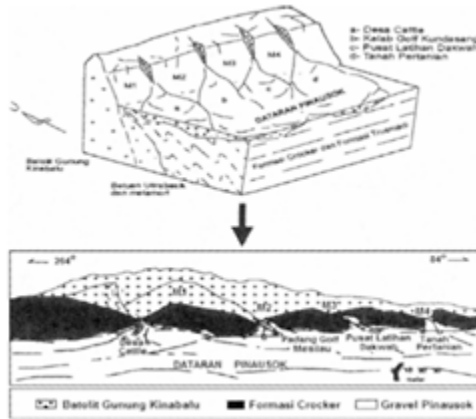

Figure 5.6. Deposition of Pinosuk Gravels (Sarma & Komoo 2000).

The rapid rate of distress on the pavement indicates that ground movements are still very active.

### *Topography & geological conditions*

The site is located at the toe of fan shaped deposits of Pinosuk Gravels from Mt. Kinabalu as shown in Figure 5.6. Rivers, namely Sg. Kuamanan, Sg. Mesilau, Sg. Tarawas and Sg. Mantaki, and their tributaries bisect the Pinosuk Plateau and form many gullies. The catchments of these rivers are shown in Figure 5.7. The overall gradient of the natural ground at the studied area is about  $10^\circ$ .

The studied area is surrounded by a number of rivers namely Sg. Mesilau on the east and Sg. Kuamanan on the west. Most rivers near the studied area originate from Mt. Kinabalu and run towards south and southeastern directions. These rivers bisect the post-glacial deposits by erosion process and form potentially unstable bisected fragments of soil masses.

The Kundasang-Ranau area is the only area in Malaysia which possesses a temperate climatic in this tropical country and a unique landscape formed by glaciation and ancient mudflow. These geological transportation processes have brought the deposits even to Ranau, a small town 13km from Kinabalu National Park.

The Pinosuk Gravels were deposited during the late Pleistocene, approximately 37,000 year BP or older. It generally consists of two units: Lower and Upper Units representing two phases of deposition. The Lower Unit consisting of sharp edged sandstone and ultrabasic rock was deposited by glaciation whereas the Upper Unit made of rounded granodiotite was by ancient mudflow due to thawing of the glacial and ice cap at Mt. Kinabalu. From the petrography study, the original sources of Pinosuk Gravels are the tertiary sediments, namely Trusmadi Formation (Lower Paleocene-Upper Eocene) and the Crocker Formation (Lower Paleocene-Upper Oligocene), in which the materials of these two formations were transported by the aforementioned geological processes and finally deposited at the current location.

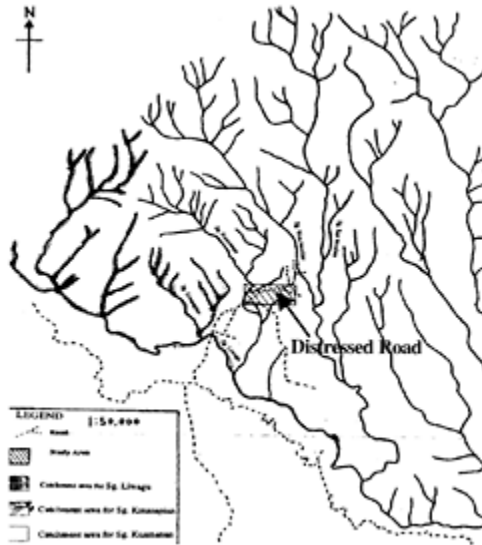

Figure 5.7. River catchment of Kundasang area.

The Trusmadi Formation comprises predominantly grey to dark grey shale/mudstone, with subordinate siltstone, sandstone and volcanics, whereas the Crocker Formation comprises predominantly sandstone with subordinate siltstone, red and grey shale/mudstone. Both tertiary rock formations are highly folded, faulted and fractured. The granodiorite materials found at the Pinosuk Gravels area were actually the emplacement of Mt. Kinabalu, while the ultrabasic boulders came from the ultrabasic rock that separates the granitoid rock from the tertiary sediments. Figure 5.8 shows the geological formation of the site. A major north-south fault (the Mensaban Fault I) separates the Trusmadi and the Crocker Formations just east of the Kundasang-Golf Course road. The 1.2 km road traverses a sheared or brecciation zone within the Trusmadi Formation. At the starting point of the road, some recent excavations reveal dark grey shale belonging to the Trusmadi Formation.

A geological walk-around at the studied area has confirmed the geological formation and aforementioned geological conditions. Figures 5.9 and 5.10 show the Pinosuk Gravels outcrops at the Sg. West Mesilau and the adjacent cut slope along the road respectively

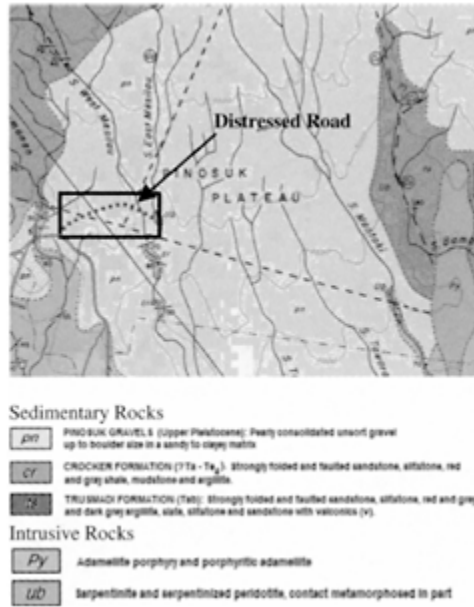

Figure 5.8. Site geological map.



Figure 5.9. Outcrop of Pinosuk Gravels at Sg. Mesilau.

### *Aerial photographs*

From the 1970 aerial photographs available at Department of Survey and Mapping Malaysia (JUPEN), the road to the golf course had not been built and the vegetation at the current road alignment (from pump house PH-2 at the junction to pump house PH-1 on the hill top near entrance to Desa Cattle Farm) is somewhat scarce. The 1984 aerial photos show a

very clear picture of this road with the two structures appearing to be the pump houses. The Kundasang areas have been extensively developed as shown in the 1984 and 1986 aerial



Figure 5.10. Outcrop of Pinosuk Gravels at cut slope beside the road.

photos and the road alignment turning into the road has shown some realignment, which can be due to either creep movement or road realignment works. A documented massive slip on the current road alignment was reported in October 1987.

#### *Subsurface investigation & instrumentation*

There was a subsurface investigation (SI) programme consisting of six exploratory boreholes with inclinometers installed in every borehole. An additional borehole was sunk to reinstall the inclinometer (IN-1A) for replacing the inclinometer IN1, which had been sheared off during the monitoring period. Beside the boreholes, standpipe piezometers were installed to a depth of 10m for groundwater monitoring. The SI and instrumentation layouts are shown in Figure 5.11.

The interpreted borelog profile and the groundwater conditions are shown in Figure 5.11. From the inclinometer results, it is observed that distinct shear surfaces can be identified, particularly at inclinometers, IN-2, IN-3, IN-4 and IN-6. The direction of lateral movement of these inclinometers is in the narrow range of between  $225^{\circ}$  and  $250^{\circ}$  from the north. The maximum lateral movement is 140 mm, which is in inclinometer IN-4. The rates of maximum lateral ground movements in these inclinometers are generally in the range of 2 mm/week to 14 mm/week with a few exceptional cases of a maximum 21 mm/week as shown in Figure 5.12. Inclinometers IN-1, IN-1A and IN-5 meanwhile show lateral movement profile of a buckling casing and indicate that there is some compression within the subsoil at these inclinometers.

Groundwater measurements recorded in the piezometers also indicate a high water table in the subsoil, which is about 1.5 m to 2.5 m below the ground level.

### *Laboratory tests*

From the interpreted consolidated isotropically undrained (C.I.U.) triaxial test results, the effective shear strength parameters of the subsoils with vertical effective stress level ranging from 50 kPa to 450 kPa are  $\phi' = 21^\circ$  and  $c' = 10$  kPa, as shown in Figure 5.13. The soil samples recovered from the boreholes are generally Silty Clay with sedimentary clast and occasionally Sandy Silt at the upper layer.

Six undisturbed soil samples near to the identified slip surface have been selected, reconstituted and tested in direct shear box to indicate the shear strength of the fine content of the soil mixtures. The test specimens were prepared from the soil particles passing through the 425  $\mu\text{m}$  sieve with adjusted moisture content. The normal effective stresses on these specimens were applied based on the corresponding vertical in situ effective stresses. The interpreted soil strength parameters from direct shear box tests is fairly near to the C.I.U. strength parameters with two data points having slightly higher values. This is also shown in Figure 5.13.

Other interesting findings from the laboratory tests are as follows:

- The natural water content in the subsoil of the moving soil mass is lower than the plastic limit of the subsoil. The natural water content of the soil samples is in the range from 7% to 13%.
- The bulk density of the subsoil is generally in the range between 21 to 23 kN/m<sup>3</sup>, except for undisturbed sample, MS-6 in borehole, BH-5, which had a bulk density of 23.69 kN/m<sup>3</sup>.
- The undrained shear strengths of most undisturbed samples are considerably low, which are slightly higher than the normally consolidated strength.

### *Site observation*

During the site visits in the months of August and September 2000, the following were observed.

The electrical posts and telephone posts showed tensioning in the wires or cables within the affected area. Some of the posts were tilted, indicating direction of ground movements. The mapping of relative ground movements based on the conditions of the tilted electrical and telephone posts is shown in Figure 5.14.

The pump house, PH-2, shows substantial displacement as the structure has tilted and displaced significantly from its original location.

Old and new tension cracks along the roadside drains were observed.

The road pavement at the affected areas was damaged primarily due to differential displacement on the road subgrade. It was also observed that the development of new tension cracks within the affected area was fairly active. Within a few months of monitoring, the changes in these tension crack widths were obvious.



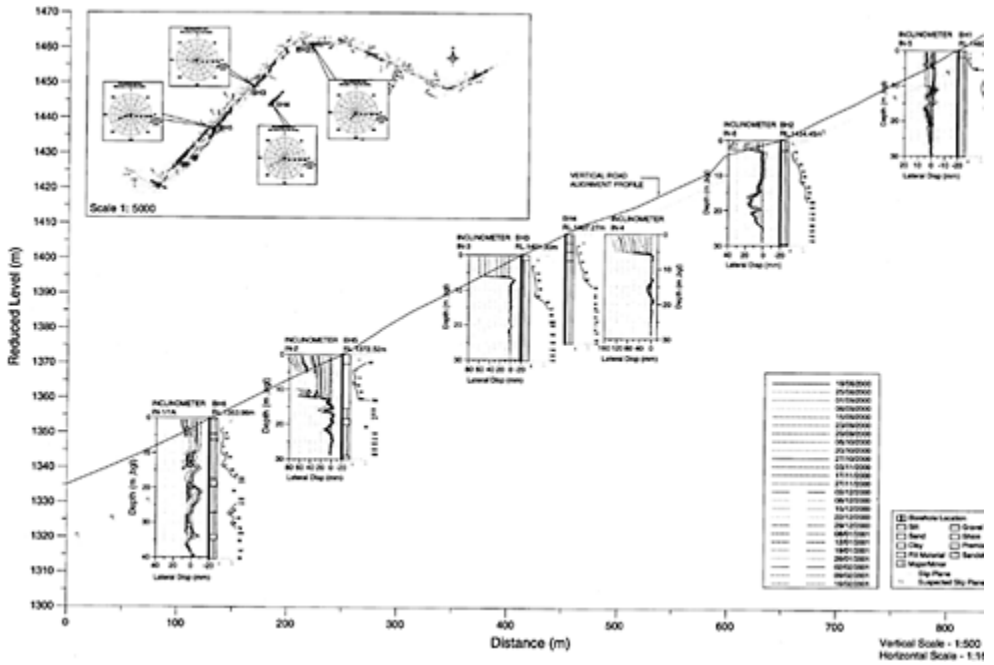

Figure 5.11. Subsoil profile and borehole layout.

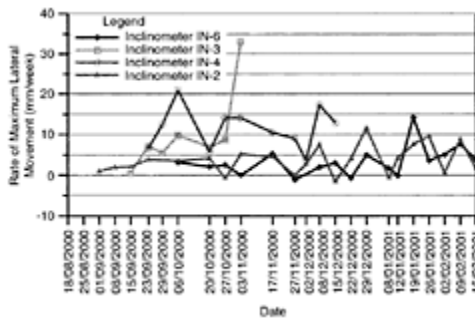

Figure 5.12. Rate of maximum lateral movement.

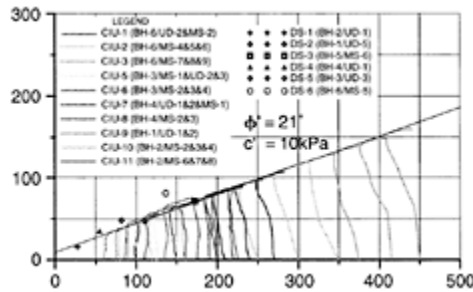

Figure 5.13. C.I.U. Tests & direct shear box tests.

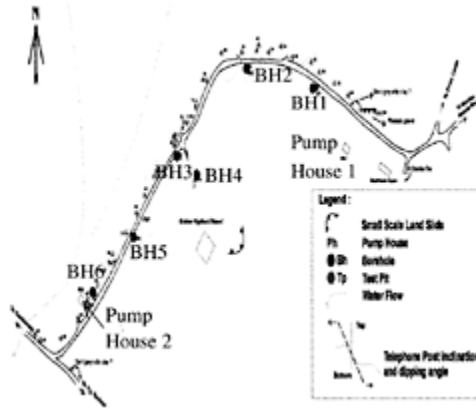

Figure 5.14. Site mapping on ground objects.

A number of large granitic boulders were observed in the surrounding area. Figure 5.15 shows the gigantic granite boulder on the opposite side of the borehole, BH-6. This provides



Figure 5.15. Granitic boulder at lower plateau.

good evidence on the historical transportation of the glacial till derived from the Mt. Kinabalu. The walk-around to identify the geological features on the outcrop and the exposure at the river confirmed that the site is within the Pinosuk Gravels. An outcrop consisting of red shale, which is believed to be the remnants of the lower Trusmadi Formation, was observed in borehole BH-5 and the adjacent boulder outcrop.

### *Engineering assessments*

Theoretically, the underlying subsoil should have sufficient strength ( $c'=10$  kPa,  $\phi' = 20.5^\circ$ ) to withstand the gravity action of the sloping soil masses against slope instability. This implies that there could be some important geological features causing the instability, which are not captured in the present investigation.

Slope stability back-analyses with the monitored groundwater profile have been carried out to reveal the possible combination of the mobilized shear strength parameters ( $c'$  and  $\phi'$ ) of the instability with safety factor of 1.0. The possible range of the back-analyzed mobilized shear strength parameters at the shear surface are  $c'=0$  to 5 kPa,  $\phi'$  to 16°.

### *Findings & recommendations*

The investigation of the distressed access road has the following findings and recommendations:

**Findings:** The existing road alignment is confirmed located on the Pinosuk Gravels of glacial deposit. An obvious slip surface has been detected from the inclinometer results and the fairly high piezometric level of groundwater has been established in the standpipes. The depth of slip surface varies from about 6m at the higher ground to about 15 m at the lower ground near the starting chainage of the distressed road. The direction of ground movement is generally towards south-west (approximately 225° to 250° clockwise direction from the north).

The interpreted peak strength parameters from the laboratory C.I.U. tests are  $c'=10$  kPa and  $\phi' = 21^\circ$ . The back-calculated mobilized strength parameters are effective cohesion,  $c'=0$  to 5 kPa and effective friction angle,  $\phi' = 13^\circ$  to 16° respectively. These ranges of mobilized strength parameters are believed to be very close to the residual strength of the landslide masses as the magnitude of slip movement is significant. These back-calculated strength parameters can be used for remedial design.

**Recommendations:** Further investigation works is needed for detailed remedial design.

A detailed second stage investigation programme and topography survey of wider coverage shall be carried out for the detailed remedial design of the unstable soil masses at the original alignment upon decision to remedy the existing road alignment. It shall include: (a) Trial pits excavated down to the detected shallow shear surface to obtain high quality block samples containing the shear surface for large scale direct shear box tests. (b) For deep seated slip surface, continuous undisturbed sampling using borehole can be considered. Multiple reversal shear box tests or ring shear tests can be carried out to obtain the residual strength at the slip surface of the landslide masses to compare the residual strength with the back-calculated mobilized strength parameters to improve confidence level.

## 5.3 SITE B—CUT SLOPE IN SKUDAI, JOHORE BAHRU

### *Background of site*

This site had encountered a slope failure after a heavy downpour at a two-berm cut slope (gradient 1V: 1.5H), which was constructed for a building. On top of the failed cut slope, there was another proposed structure yet to be constructed. A comprehensive geotechnical investigation was carried out to investigate the probable causes of the failure and to propose remedial measures.

*Topography & geological conditions*

The site is located on relatively high ground with original reduced level ranging from RL 54.0 m to RL 106.0m over a distance of about 320 m. The regional geological map of Malaysia (1982) shows that the site is situated at Jurong Formation which is underlain by mainly basic intrusive gabbro and intermediate intrusive rocks such as syenite, tonalite and diorite shown in Figure 5.16. It was observed that the vicinity of the site comprises different lithological units.

*Site conditions & observations*

A site inspection was carried out shortly after the slope collapsed. Whitish silt material was found on the cut surface of the failed slope as shown in Figure 5.17. Tension cracks were also observed at the top of the slope as shown in Figure 5.18.

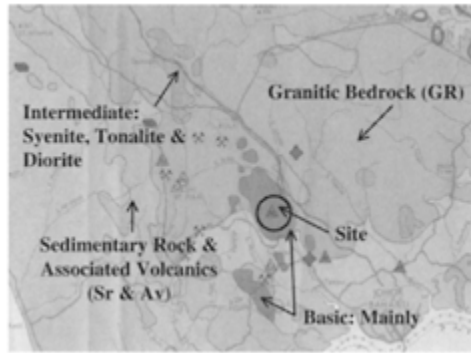

Figure 5.16. Site geology map (1982).

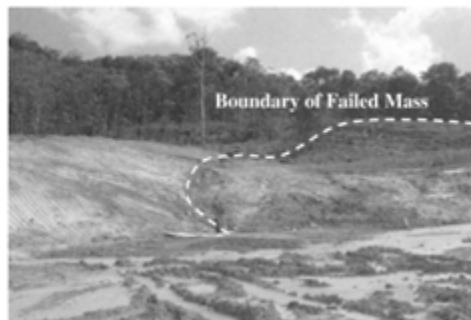

Figure 5.17. Front view of failed slope.

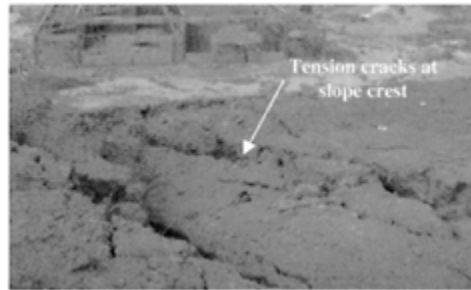

Figure 5.18. Tension cracks at top of slope.

### *Subsurface investigation & instrumentation*

Figure 5.19 shows water seepage at various locations, indicating potential high groundwater level at the failed slope. Small boulders were also observed on the slope surrounding. The existence of boulders (diorite and gabbro) within the subsoil was further confirmed during the borehole exploration.

Subsurface investigation and instrumentation programmes consisting of ten boreholes, three inclinometers, six observation wells and one standpipe piezometer were planned and implemented to investigate the causes of failure, to propose remedial measures and for geotechnical design of the upper proposed building. The layout of the boreholes and instrumentations is shown in Figure 5.20. Three boreholes, namely BH-1, BH-2 and BH-3, were sunk within the failed mass. Upon completion of boring operation and sample collection, inclinometers, IN-1, IN-2 and IN-3 were installed in the boreholes. Apart from the inclinometers, three observation wells, OW-1, OW-2 and OW-3 were also installed at 1 m away from boreholes BH-1, BH-2 and BH-3 respectively. The overburden material is generally weak, with SPT-N ranging from 0 to 15.



Figure 5.19. Water seepage at berm.

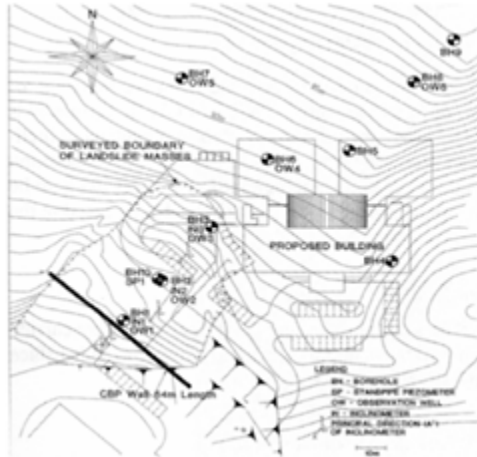

Figure 5.20. Layout of borehole and instrumentation plan.

When the inclinometers detected a slip surface within the failed slope, an additional borehole, BH-10 was sunk 1 m away from BH-2 to collect undisturbed samples near the identified slip surface for laboratory strength tests. A standpipe piezometer, SP-1 was also installed in borehole BH-10 with a piezometer tip located at 11.0m below ground surface, where the slip surface was identified.

Inclinometers IN-1 and IN-2 were sheared off at 10.5m and 12.0m below ground level shortly after installation. Subsequent monitoring revealed that inclinometer IN-2 was sheared off again at another higher location, at 6.0m below ground level. Finally, IN-3 was sheared off at 2.5 m below ground level. The first major slip surface was identified when the three inclinometers were sequentially sheared off. The three shear-off points of the inclinometers resemble a well defined circular slip surface when joined together. The circular slip surface also agrees well with the tension cracks and bulging of the slope toe indicating where the slip surface starts and ends on the slope profile. The second shear off point at inclinometer IN-2 revealed another minor slip surface formed after the first major slip surface. The inclinometer results are shown in Figure 5.21, which shows the interpreted multiple slip surfaces in the failed slope. Figure 5.21 indicates that the collapsed mass experienced resultant movements towards the south-west direction.

The rates of maximum movement of the inclinometers are shown in Figure 5.22 together with the daily and cumulative rainfall records. Inclinometer IN-2 registered the largest movement rate during the initial monitoring period as it was installed in the middle of the collapsed mass. The trend of movement rate for the other inclinometers was very similar and consistent. The movement rate started with a peak and reduced gradually. However, during investigation, the movement rate increased causing damage to the inclinometers. It is observed that the increased movement rate corresponds to an extremely heavy rain recorded on 27 December 2001.

The groundwater table was established from the six observation wells and one standpipe piezometer to obtain accurate groundwater levels. Extra precaution, such as water bailing in these groundwater instruments, has been carried out for re-establishing equilibrium of

water level during the period of investigation. The monitored groundwater table within the failed slope was high, ranging from ground surface to 2.9m below ground level as tabulated in Table 5.1.

Apart for groundwater level measurement, the observation wells and standpipe piezometer were also coincidentally used to locate the slip surface. A dipmeter was lowered into the

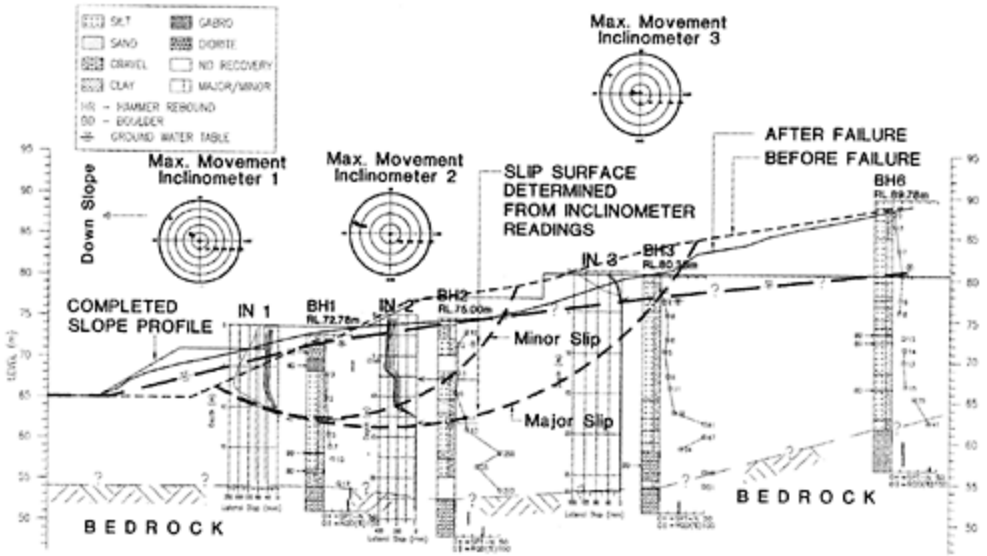

Figure 5.21. Multiple slip surfaces interpreted from inclinometers

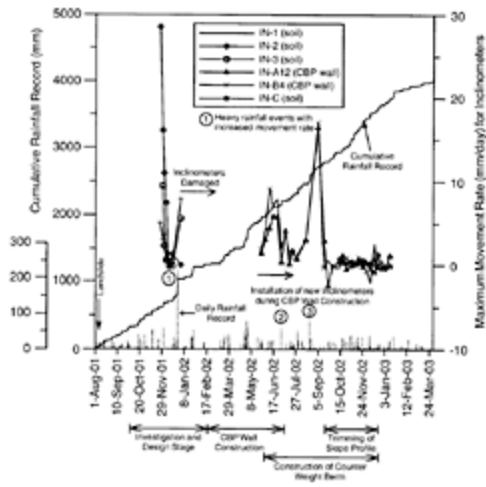

Figure 5.22. Rainfall record and maximum movement rate for inclinometers.

observation wells and standpipe piezometer. The maximum reach of the dipmeter in the tubing was recorded in each monitoring. The instrument tubing was most likely sheared off after excessive post-failure creep movement and resulting in blockage to the dipmeter which failed to reach the full depth of the tubing.

Table 5.1. Groundwater level and depth of blockage.

Instrument	Water level (m, bgl)			Depth of blockage (m, bgl)
	Highest	Average	Lowest	
OW-1*	0.76	0.80–0.90	1.70	10.98
OW-2*	0.00	0.05	0.50	8.28
OW-3*	2.63	2.70	2.90	3.03
OW-4	8.25	8.80	9.18	–
OW-5	8.08	8.80–8.90	9.00	–
OW-6	10.99	11.00	11.02	–
SP-1*	–0.02	0.15	0.20	7.18

Note: \* Instruments at the landslide area.

The slip surface interpreted from the blockage of the observation wells, OW-1 and OW-3, corresponds well to the slip surface detected in the adjacent inclinometers. The slip surface located by observation well, OW-2 and piezometer, SP-1 is most likely to be the minor slip surface, which was also detected in the inclinometer IN-2.

### *Laboratory test results*

A series of the following laboratory tests were carried out on the samples obtained from the subsurface investigation works:

- a) Atterberg limits
- b) Particle size distribution
- c) Unconfined compressive strength test on rock
- d) Unconsolidated undrained triaxial test

Table 5.2. Atterberg limits and particle size distribution.

Borehole	Depth (m)	LL	PL	Clay (%)	Silt (%)	Sand (%)	Gravel (%)
BH-1 (P4/D4)	10.5–10.95	48	33	16	58	23	3
BH-1 (P6/D6)	13.5–13.95	43	28	10	60	24	6
BH-2 (P5/D6)	12.0–12.45	52	35	16	72	12	0



BH-2 (P6/D7)	13.5–13.95	42	31	13	67	19	1
BH-3 (P1/D2)	1.5–1.95	65	44	20	76	4	0
BH-10 (UD2)	11.0–11.95	38	23	2	8	90	0
BH-10 (UD3)	12.0–12.60	49	33	15	55	26	4

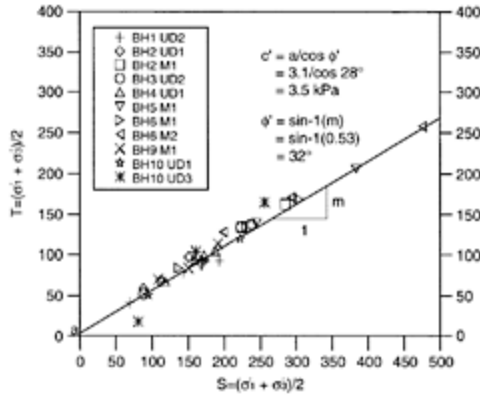

Figure 5.24. T-S Plot (Critical State Strength) for C.I.U. tests.

- e) Consolidated isotropically undrained triaxial test with pore pressure measurement
- f) Multiple reversal direct shear box test
- g) X-ray diffraction test
- h) Petrographic analysis.

Based on the British Soil Classification System, most of the soil samples collected near the slip surface were clayey silt of intermediate to high plasticity as summarized in Table 5.2.

Eleven (11) numbers of C.I.U. tests were carried out on both the thin wall samples and Mazier samples. Figures 5.23 and 5.24 show both the T-S plot for the interpreted peak strength ( $c'=3.5$  kPa and  $\phi' = 32^\circ$ ) and critical state strength ( $c'=3.0$ kPa and  $\phi' = 29^\circ$ ). As shown in these figures, the C.I.U. results are fairly consistent.

Ten (10) numbers of multiple reversal direct shear box tests were carried out on the reconstituted samples collected from the boreholes and failed mass. The main objective of the reversal shear box test is to obtain the residual strength of the subsoil. It is particularly relevant in designing remedial work for a failed slope with identified shear surface and to explore its relationship with the active creep movement of the failed soil mass. In the reversal shear

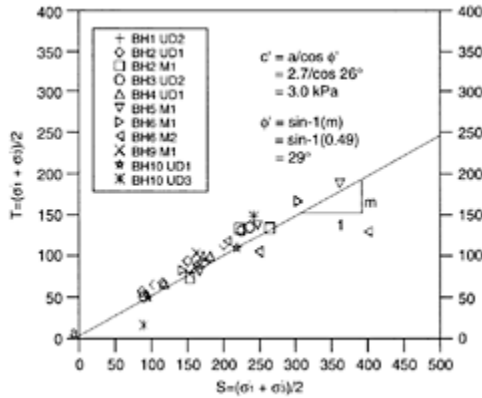

Figure 5.23. T-S Plot (Peak Strength) for C.I.U. tests.

box test, slickensided surface was artificially formed after significant re-shearing of the sample. The strength of the shearing soil is expected to be reduced to residual value when well-defined slickensided surface is fully developed. This is due to the rearrangement of the soil particle along the shear surface into a smoother surface, minimizing the interlocking effect of the soil particles. During the rapid multi-reversal, the reversal test shows gradual reduction of shear stress in each shearing.

The results of the shear box test are plotted in Figures 5.25 to 5.26. It can be observed that the results of the shear box tests are fairly scattered.

Figure 5.25 shows the upper bound of the peak strength parameters of  $c'=39.0$  kPa,  $\phi' = 30^\circ$  while the lower bound value of  $c'=5.9$  kPa,  $\phi' = 21^\circ$ . The average shear strength parameters obtained are  $c'=15.7$  kPa,  $\phi' = 24^\circ$ .

Figure 5.26 shows the upper bound of the residual strength parameters of  $c'=31.4$  kPa,  $\phi' = 21^\circ$  while the lower bound is  $c'=0$  kPa,  $\phi' = 14^\circ$ . The average shear strength parameters obtained are  $c'=5.9$  kPa,  $\phi' = 20^\circ$ . The scatter of interpreted residual strength is rather large and could be largely due to inconsistency in generating the smooth shearing surface

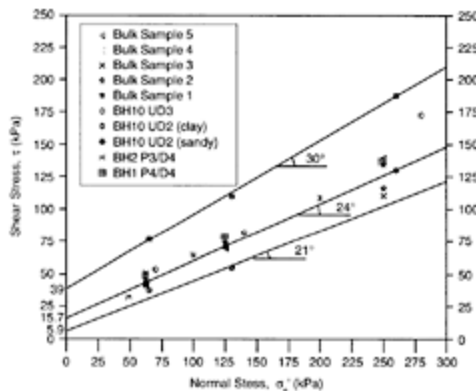

Figure 5.25. Shear stress vs. normal stress plot (Peak strength) for direct shear box test.

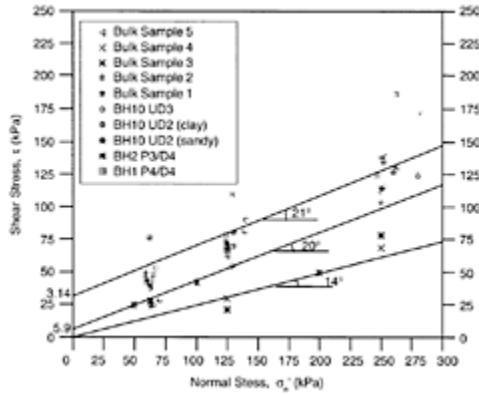

Figure 5.26. Shear stress vs normal stress plot (Residual strength) for multiple reversal direct shear box test.

in this particular soil type during the reversal shearing process. A continuous large strain shearing in one direction, like a ring shear test, could have produced a more consistent residual strength.

In order to confirm the rock type and its derivative, four rock samples were collected at the site for petrographic examination. XRD analysis was performed on the three weathered samples as a thin section cannot be prepared. Petrographic examination was carried out for the fourth rock sample, which was less weathered. The results are summarised in Table 5.3.

*Engineering assessments*

The back-analyses were performed using Bishop Circular Method in a computer program (Harald 1989) developed by Purdue University. The well-defined slip surface and groundwater table as established in the field investigation were adopted in the back-analysis model. The back analyses of mobilised shear strength at the identified slip surface were performed based on the following two conditions:

Table 5.3. Locations and types of rock samples.

Sample	Location	Color	Rock name
1	Failed scarp area	White	Weathered granite
2	Proposed building footprint (Upper platform)	Brown (result of oxidation)	Weathered medium to fine grained gabbro
3	Failed scarp area	White to light Brown	Weathered gabbro
4	BH-8	Dark grey	Medium grained olivine gabbro

*Condition (a):* Original slope profile after cutting of the lower two-berm slopes, but before failure.

*Condition (b):* Slope profile immediately after failure but continued to creep.

To obtain the back calculated mobilized shear strength along the aforementioned slip surface, the shear parameters,  $c'$  and  $\phi'$  are adjusted till the factor of safety is unity (1.0) as a prerequisite for failure in a limit equilibrium analytical model. For condition (a), the back-analysed mobilised strength parameters on the slip surface are  $c'=0$  kPa,  $\phi' = 24^\circ$ . The back-analysed mobilised strength parameters on the slip surface for condition (b) are  $c'=0$  kPa,  $\phi' = 14.4^\circ$ . These analyses are relevant to the shear strength at the respective shear strains. For the slope with the original slope geometry to fail, the mobilised shear strength shall overcome the soil strength at the slip surface. However, after the slope collapsed to a more stable slope geometry, the creep movement of significant magnitude would justify reduction of the shear strength to, probably, residual strength of the slope material.

A similar back analysis was carried out based on the abovementioned two conditions with the back-analysed soil strength to identify the most critical slip surface. It was found that the most critical slip surface is somewhat shallower than the one determined by the inclinometers. This implies that there must be a relatively weak layer existing along the identified slip surface preceding the most critical slip surface.

Back-analyses were also carried out using finite element programme (PLAXIS) with simple Mohr-Coulomb model. Firstly, the original slope profile after cutting before failure was modelled in PLAXIS. The shear strength of the predetermined soil zone to model the identified slip surface was then gradually reduced until Factor of Safety of slope was near to unity (1) using the Phi-C Reduction procedure (Brinkgreve 2002). The shear strength parameters for the slip surface are found to be  $c'=0.5$  kPa,  $\phi' = 25.9^\circ$  when the factor of safety is reduced to 1.04. The back-analysed shear strength is lower than the interpreted laboratory critical state strength parameters which are  $c'=3.0$  kPa,  $\phi' = 29^\circ$ . In a detailed review of the shear stress along the developed slip surface, it is noticed that the mobilised shear stress is highly non-uniform. This implies different levels of mobilised shear strength along the slip surface. In this case study, the average mobilised shear strength is lower than laboratory peak strength, even slightly lower than the laboratory critical state strength. This is a common phenomenon called progressive failure.

Table 5.4. Back analysed strength using PCSTABL and PLAXIS.

Methodology	Condition (a)		Condition (b)	
	$c'$ (a)	$\phi'$ (a)	$c'$ (b)	$\phi'$ (b)
1. Back Analysis (PCSTABL)	0	24°	0	14.4°
2. Back Analysis (PLAXIS)	0.5	25.9°	0.5	15°

The slope profile after failure was also modelled using the same process as mentioned above. The back analysed shear strength parameters are  $c'=0.5$  kPa,  $\phi' = 15^\circ$  with a factor of safety of 1.03.

In general, the back-analysed strength parameters in both methods are fairly similar, except the friction angle of PLAXIS in Condition (a) is about 2° higher than that of PC-STABL6. Table 5.4 summarises the back-analysed results.

The back-analyzed shear strength in conditions (a) and (b) are expected to correspond to critical state strength and residual strength respectively.

Skempton (1964), Mesri and Cepeda-Diaz (1986) presented some correlations between residual friction angle and clay size fraction, liquid limit or clay mineralogy. The residual friction angle of soil decreases with the increase in the percentage of clay size fraction and liquid limit.

In this investigation, the liquid limit of the samples generally range from 38% to 52% (refer to Table 5.2). In Figure 5.27, the corresponding residual friction angle ranging from 26° down to 18° is obtained for the abovementioned liquid limit.

The percentage of clay size fraction for collected specimen generally varies from 13% to 20%. Figure 5.28 shows the corresponding residual friction angle of 29° to 24°. This is close to the results obtained from the residual friction angle-liquid limit relationship. Table 5.5 summarizes the ranges of residual strength obtained from different methodologies.

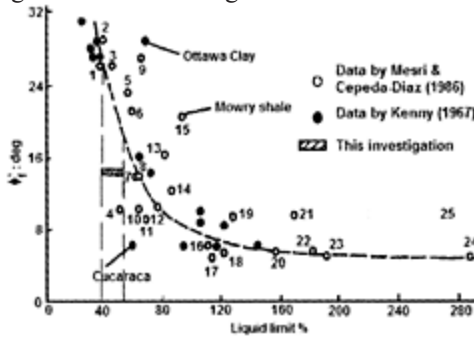

Figure 5.27. Residual friction angle vs liquid limit (reproduced from Mesri & Cepeda-Diaz 1986).

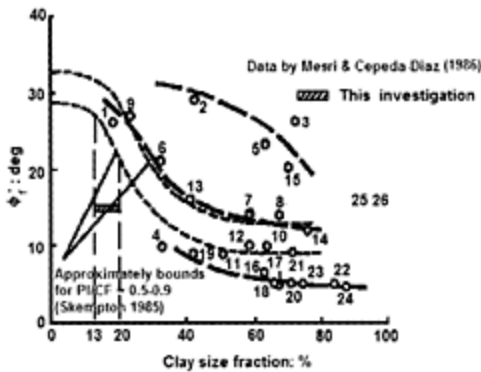

Figure 5.28. Residual Friction Angle vs Clay Size Fraction (Mesri &amp; Cepeda-Diaz 1986).

Despite the C.I.U. test results being very consistent, it does not imply that the C.I.U. test shall be used for the remedial design of a failed cut slope. If the C.I.U. shear strength parameters ( $c' = 3.5 \text{ kPa}$ ,  $\phi' = 32^\circ$ ) are applied in the slope analysis based on the identified slip surface for the slope profile before failure, then the slope would not fail. Factor of safety of 1.49 was yielded for the above slope analysis (using Bishop circular method), even when the groundwater table is close to the ground surface. Therefore, it is credible to deduce that there is an existence of a thin layer at the slip surface of exceptionally low shear strength than the corresponding shear strengths in both conditions (a) and (b). This slip surface is difficult to be determined accurately in the subsurface investigation unless with the help of inclinometer results. Such a thin weak layer is believed to have experienced substantial shearing strain prior to the incidence of failure and therefore exhibits an average mobilized shear strength lower than critical state strength in condition (a) and a lower bound of residual strength in condition (b).

Table 5.5. Comparison between residual strength and peak strength for correlations and laboratory results.

Methodology	Residual strength				Peak strength			
	Upper bound		Lower bound		Upper bound		Lower bound	
	$c'_r$	$\phi'_r$	$c'_r$	$\phi'_r$	$c'_p$	$\phi'_p$	$c'_p$	$\phi'_p$
1. Liquid limit	0	$26^\circ$	0	$18^\circ$	—	—	—	—
2. Clay size fraction	0	$27^\circ$	0	$21^\circ$	—	—	—	—
3. Reversal shear box tests on reconstituted samples	31	$21^\circ$	0	$14^\circ$	39	$30^\circ$	5.9	$21^\circ$
4. C.I.U. on undisturbed samples	Peak strength parameters: $c'_p = 3.5 \text{ kPa}$ , $\phi'_p = 32^\circ$ Critical state strength parameters: $c'_{cr} = 3.0 \text{ kPa}$ , $\phi'_{cr} = 29^\circ$							

Based on the above discussion, it can be concluded that the shear strength on the critical slip surface must be sufficiently low for the original cut slope to collapse. Therefore, the shear strength to be used for the remedial design should be close to the residual strength.

## 5.4 SITE C—CUT SLOPE AT GUA MUSANG, KELANTAN

### *Background of site*

The site is located at Gua Musang, Kelantan. The original design of failed slope consists of seven upper berms of 1V: 1H cut slope and five (5) lower berms of 4V: 1H cut slope

with soil nails. A massive slope failure occurred in mid December 2002 before soil nails were installed at the lowest berm. The slope profiles of original topography and the original design are shown in Figure 5.29. The topography plan and front view of the failed slope are shown in Figures 5.30 and 5.31 respectively. A comprehensive geotechnical investigation was carried out to investigate the causes of the failure. Remedial works were being carried out at site during the investigation period.

*Topography & geological conditions*

The site is located on relatively high ground with original reduced level ranging from RL 210.0m to RL 330.0 m. According to the draft Geological Map interpreted by Minerals and Geoscience Department, Malaysia (1974) as shown in Figure 5.32, the site is underlain by Shale facies, which is one of the facies within the Gua Musang Formation. Shale facies out-crop exists at certain parts of the Gua Musang Formation. This facies consists of mudstone and siltstone, and is extensively exposed at the western part of Gua Musang Formation.

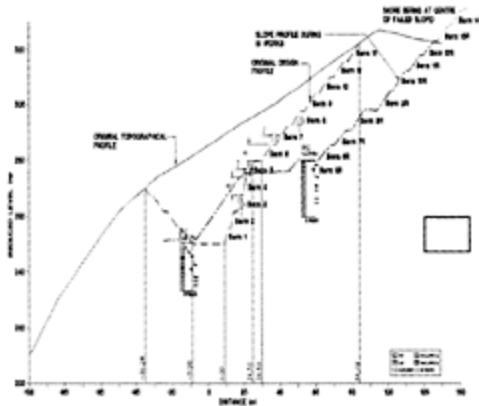

Figure 5.29. Slope profile.

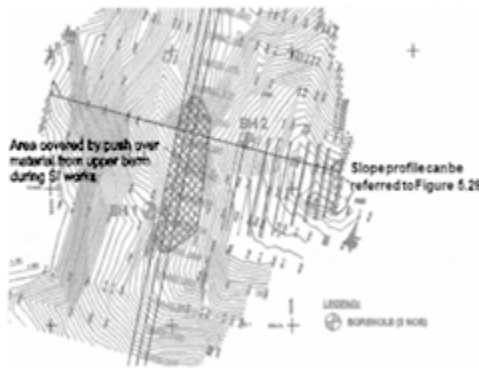

Figure 5.30. Topography plan.



Figure 5.31. Front view of failed slope.



Figure 5.32. Geological map.

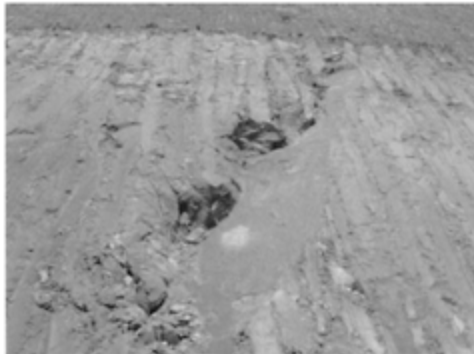

Figure 5.33. Joint sets of cut slope day-lighting towards main road at Berm 9R.



*Site conditions & observations*

During the geological mapping and subsurface investigation (SI) works after the landslide, it was observed that the cut slope face varies from a relatively smooth face to an irregular face. In general, the site was dry and no water seepage was observed on the exposed slope surface during the geological mapping. The joint sets of the slopes observed are daylighting towards the main road (Figure 5.33). Joints with in-filling material like iron oxide and silt were observed as shown in Figure 5.34. Most of the exposed materials on the slope surface are Grades III to V. Significantly different coloured materials were observed on the slope surface as shown in Figure 5.35.



Figure 5.34. Joints with infilling material.



Figure 5.35. Different colors at exposed cut slope showing soil weathering profile.

*Geological mapping*

Geological mapping was carried out using ‘Line Mapping’ method by measuring and recording any discontinuity intersecting a scanline along the exposed slope face at 15m intervals for Berms 9R and 10R, 10m intervals for Berms 11R to 14R as shown in Figure

5.29. Photographs were taken at the exposed cut slope faces. In addition, Schmidt Rebound Hammer was used to assist in identification of weathering grade of the exposed slope material.

During the geological mapping, the earthwork cutting at Berm 8R for remedial works was in progress and slope below Berm 8R was covered with pushover materials. Therefore, geological mapping was only carried out at Berms 9R to 14R. Figure 5.36 shows the panoramic view of the 6-berm upper cut slope during the geological mapping.

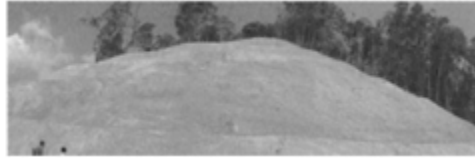

Figure 5.36. Panoramic view of cut slope.

As observed and assisted by Schmidt Rebound Hammer at site, the weathering grade of the exposed materials are mostly of Grade III to V with structural features, which can be analysed by kinematic method (stereonet) and conventional stability assessment using slice or wedge method respectively.

The cut slope surface from Berms 9R to 14R has dip angle of  $45^\circ$  and dip direction of  $288^\circ$ .

Kinematic analyses on the geological mapping data were performed using rock engineering software (Watts et al. 2003). The kinematic analyses for plane, wedge and toppling failures for Berms 9R to 14R are shown in Figure 5.37. In summary, the result shows that sizeable wedge failure and toppling failures are not probable. However, plane failure is possible at Berms 12R to 14R, as the joint sets is day-lighting towards the slope face. Similar orientation of the joint sets was also observed at Berms 6R to 8R during the SI works. In view of the above, occurrence of slope failure is likely due to presence of the day-lighting geological structure of Grade III to V material.

### *Subsurface investigation*

A subsurface investigation (SI) consisting of two boreholes was planned and implemented to establish the subsoil profile and to obtain necessary soil strength parameters for investigation purposes. The locations of boreholes are shown in Figure 5.30. The slope profile during the SI works with interpreted subsoil profile is shown in Figure 5.29.

### *Laboratory tests*

A series of laboratory tests was carried out on the samples obtained from the subsurface investigation works. The tests performed included Atterberg limits, particle size distribution, multiple reversal direct shear box test, consolidated isotropically undrained triaxial test with pore pressure measurement and petrographic analysis test. Selected test results are presented in the following section.

Based on the British Soil Classification System, most of the tested soil/rock samples are silt of intermediate to high plasticity. Table 5.6 summarises the Atterberg limits and particle size distribution of the cut slope materials.

Three numbers of Consolidated Isotropically Undrained (C.I.U.) Triaxial tests were carried out on the Mazier samples which consist of Grades III and IV material.

In addition, two numbers of multiple reversal direct shear box test were specified on the reconstituted samples from the tested C.I.U. specimens. Figures 5.38 and 5.39 show the results of both C.I.U. tests and shear box tests for Grade III and IV material respectively.

The peak and residual strengths of Grades III and IV materials are summarized in Table 5.7.

### *Petrographic examination*

In order to confirm the rock type and its derivative, four petrographic tests were carried out for rock samples collected at the site. Figures 5.40 to 5.43 show samples under X-Nicols. Table 5.8 summarizes the mineral composition of the samples.

### *Groundwater monitoring*

Groundwater level was measured during the SI works at the following events and is summarized in Table 5.9.

- Before commencement of work in the morning, and
- After cessation of work in the evening, but before water (if any) was added to the boreholes to stabilise it.

From the measurement results, the groundwater levels dropped as the boreholes advanced into greater depth. The interpreted groundwater profile is shown in Figure 5.44.

### *Rainfall record*

The rainfall record for the entire site from November 2002 to January 2003 is plotted in Figure 5.45. As quoted by Brand (1995), a major landslide event is very unlikely for the 24-hour rainfall of less than 100 mm. There was no indication of relatively higher rainfall intensity observed before the occurrence of slope failure (cracks were observed on 18 December 2002) and therefore the slope failure was not triggered by the abnormal rainfall intensity.

### *Engineering assessments*

#### ***Slope stability analyses using limit equilibrium method***

Slope stability analyses (by using Bishop method) have been carried out using the subsoil profile as shown in Figure 5.44. The shear strength parameters from Table 5.7 were used in the analyses. As there was no undisturbed samples collected for Grade V material from boreholes BH-1 and BH-2 and no C.I.U. test on Grade V material had been carried out, the adopted strength parameters ( $c'=5$ ,  $\phi' = 33^\circ$ ) for Grade V material in the analyses are there-

fore referred to the typical range of similar material. The interpreted groundwater profile as shown in Figure 5.44 is not a major influencing factor to the factor of safety for slope stability analyses as it is generally lower than the critical shear surface.

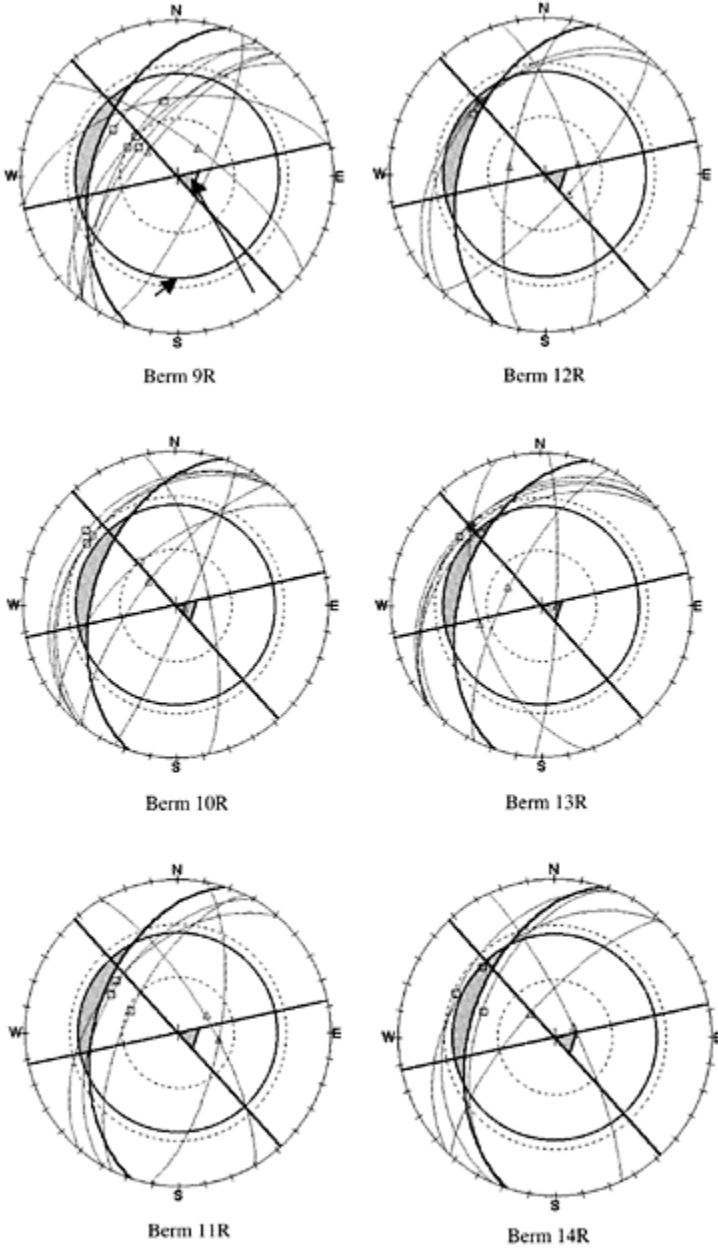

Legend:  
 — Plane of major joint set  
 △ Line of discontinuity  
 □ Joint sets

Figure 5.37. Stereonet plot for berms 9R to 14R.

Table 5.6. Atterberg limits and particle size distribution for selected specimens collected from the SI works.

Borehole	Depth (m)	LL	PL	Clay (%)	Silt (%)	Sand (%)	Gravel (%)
BH1 (P2/D3)	3.0–3.45	N.A.	N.A.	16	70	11	3
BH1 (MZ1)	6.0–7.00	48	33	10	84	6	0
BH1 (P4/D5)	7.5–7.91	55	33	9	87	4	0
BH1 (MZ2)	10.5–11.50	46	33	10	75	13	2
BH1 (P7/D8)	13.5–13.78	49	32	6	70	18	6
BH2 (P2/D3)	3.0–3.45	46	31	16	70	11	3
BH2 (MZ2)	7.5–8.50	35	26	5	73	15	7
BH2 (MZ3)	12.0–13.00	N.A.	N.A.	3	63	28	6

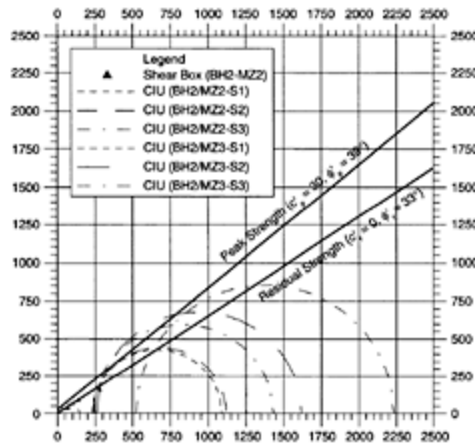

Figure 5.38. Effective shear strength for Grade III material.

The results of slope stability analyses using the interpreted peak strength indicate the global factor of safety (FOS) is marginally more than 1.0 when the excavation was down to the lowest berm as per the design. Besides, FOS for local slope stability at 1V:1H upper cut slopes is also marginally more than 1.0. The location of slip circles also tally well with the slope failures as observed at the site. This confirms that the mobilised strength during the slope failure is very close to the subsoil strength parameters interpreted from the laboratory strength test results. Any rise in groundwater profile would certainly further reduce the factor of safety.

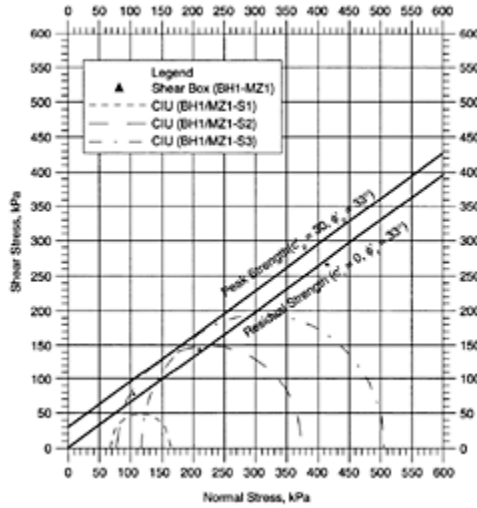

Figure 5.39. Effective shear strength for Grade IV material.

Table 5.7. The peak and residual strengths of Grades III and IV materials.

Weathering grade		Effective cohesion, $c'$		Effective friction angle, $\phi'$
Grade IV	Peak	30 kPa	Peak	33
	Residual	0 kPa	Residual	33
Grade III	Peak	30 kPa	Peak	39
	Residual	0 kPa	Residual	33

Figures 5.46 and 5.47 show the results of limit equilibrium analyses.

#### *Slope stability analyses using finite element method*

In addition to limit equilibrium analyses, finite element analyses using the typical Mohr-Coulomb strength criteria and elasto-plastic model were also performed to simulate the slope cutting at various construction stages and to reveal the likely failure mechanism. From the finite element analyses modelling each excavation stage as shown in Figures 5.48 to 5.53, it is clear that the development of plastic points within the soil body indicates mobilisation of the peak strength in these soil elements. When the cutting is in progress, significant stress relief due to massive earthwork removal tends to reduce the effective shear

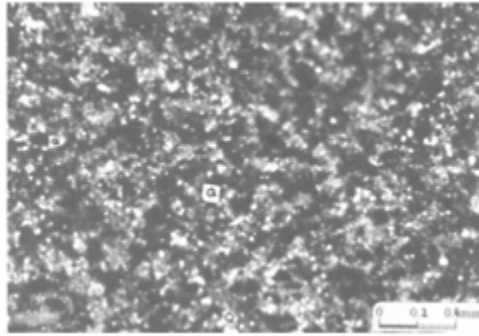

Figure 5.40. Sample 1 under X-Nicols.

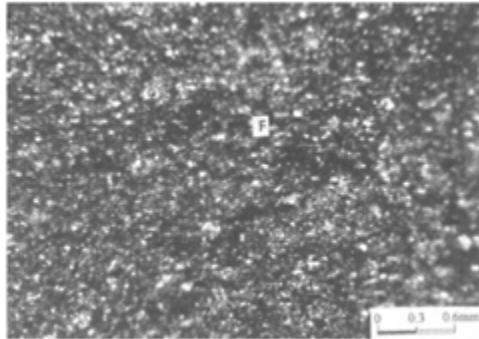

Figure 5.41. Sample 2 under X-Nicols.

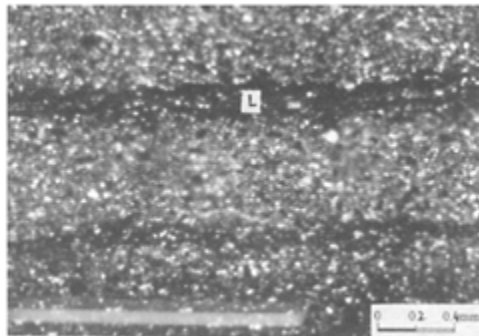

Figure 5.42. Sample 3 under X-Nicols.

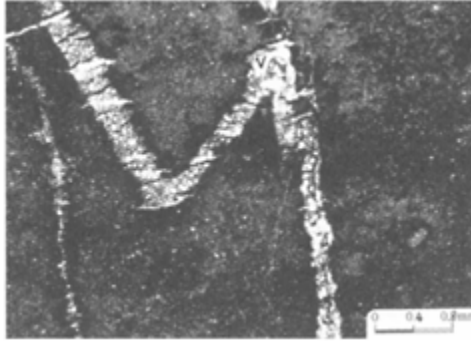

Figure 5.43. Sample 4 under X-Nicols.

Table 5.8. Summary of mineral composition for rock samples.

Sample	Location	Color	Rock name	Mineral composition
1	Berm 8R	Yellowish Orange	Fine SANDSTONE	70% Quartz 25% Matrics 5% Lithic
2	Berm 12R	Yellowish	MUDSTONE	40% Quartz 50% Matrics 5% Iron Oxide 4% Lithic 1% Feldspar
3	Berm 13R	Yellowish	Laminated MUDSTONE	60% Quartz 30% Matrics 9% Iron Oxide 1% Lithic
4	Berm 14R	Yellowish to Dark Brown	SHALE	75% Matrics 15% Quartz 9% Quartz Vein 1% Others

strength, therefore resulting in more plastic points developing and propagating to other areas. Eventually a well-defined shear surface is formed when the excavation reached the lowest berm. This finite element result demonstrates the phenomenon of progressive failure of the failed slope as the cutting is in progress. The soil nails failed to provide significant strengthening action to the overall slope due to inadequate nail length in relation to the entire failed slope geometry.



Table 5.9. Groundwater measurement during the SI works.

Borehole	Date	Time	Borehole/ Casing Depth <sup>*1</sup> (mbgl <sup>*2</sup> )	Groundwater Level (mbgl)
BH-1	27/4/2003	17:40	12.23	1.60
	28/4/2003	08:30	12.23	3.60
	28/4/2003	15:00	17.00	9.53
BH-2	30/4/2003	17:20	9.31	2.20
	1/5/2003	08:30	9.31	8.30
	1/5/2003	17:50	16.74	2.60
	2/5/2003	09:00	16.74	3.34
	2/5/2003	17:00	20.30	6.20

Note:

<sup>\*1</sup> denotes borehole/casing depth at the time of measurement.

<sup>\*2</sup> mbgl denotes meter below ground level.

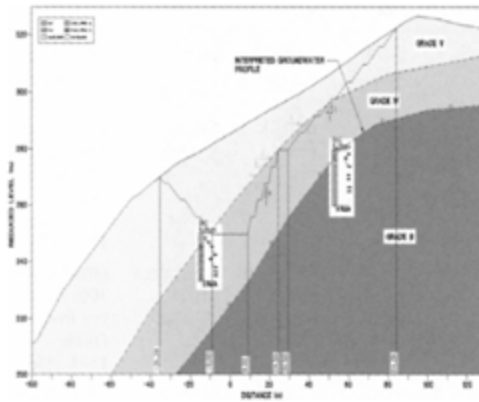

Figure 5.44. Interpreted subsoil weathering profile.

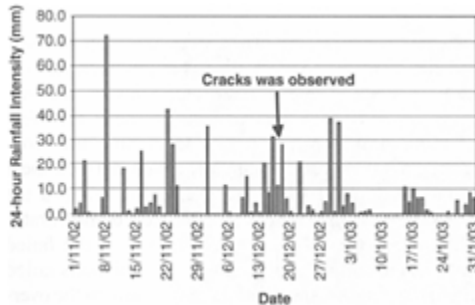

Figure 5.45. Rainfall record.

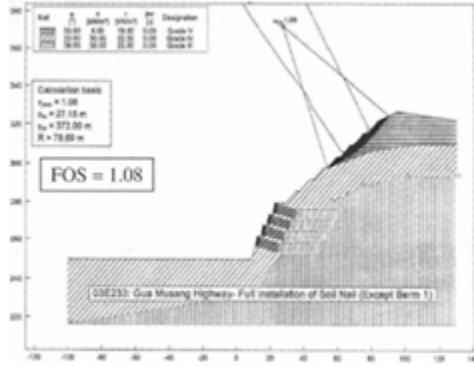

Figure 5.46. Results of limit equilibrium analyses for local slope stability at 1V:1H upper cut slopes.

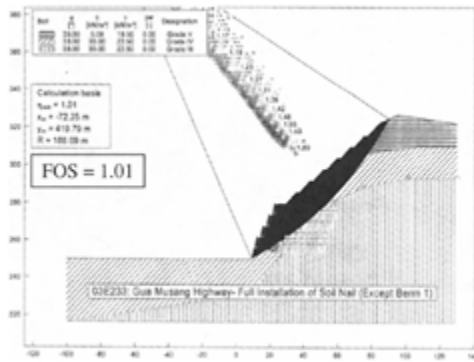

Figure 5.47. Results of limit equilibrium analyses for global slope stability.

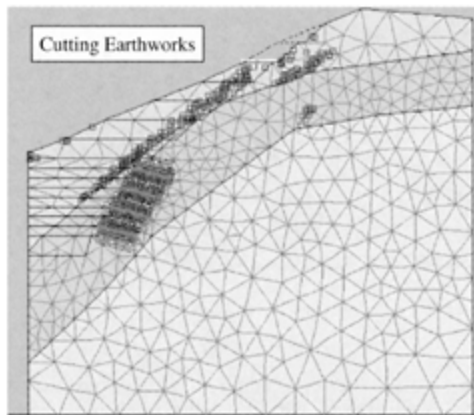

Figure 5.48. Development of plastic points in finite element model (After cutting of two upper berms).

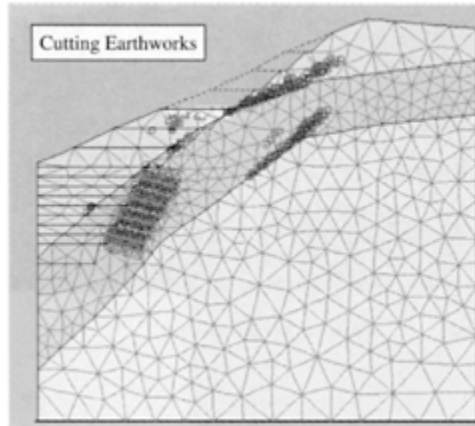

Figure 5.49. Development of plastic points in finite element model (After cutting of four upper berms).

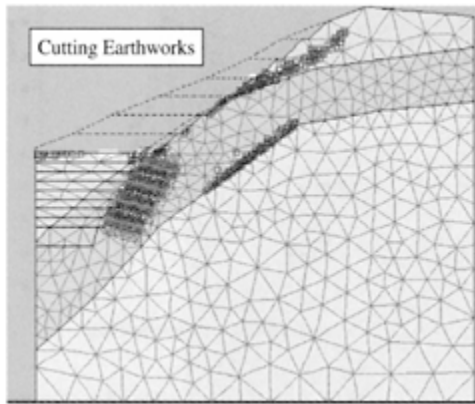

Figure 5.50. Development of plastic points in finite element model (After cutting of seven upper berms).

### *Conclusions*

Based on the analysis results, the possible causes of failure are summarised as follows:

- a. The gradient of the upper cut slope of 1V:1H is steep and is not stable in long term, as FOS for the localised stability is only about 1.08. As demonstrated in the finite element analyses, progressive failure developed a continuous shear surface with the progression of the slope cutting.
- b. The provided length of soil nail (12 m) is inadequate with respect to the global stability, in which the failure surface is mostly behind the soil nails. Hence, the soil nails cannot provide sufficient resistance to prevent instability.

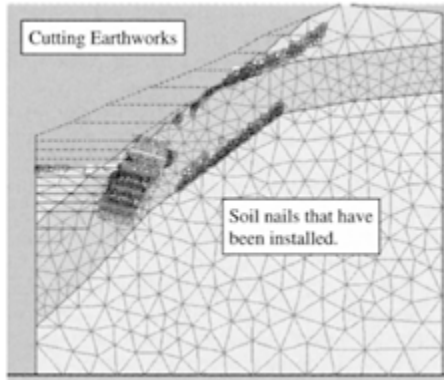

Figure 5.51. Development of plastic points in finite element model (After cutting of nine upper berms).

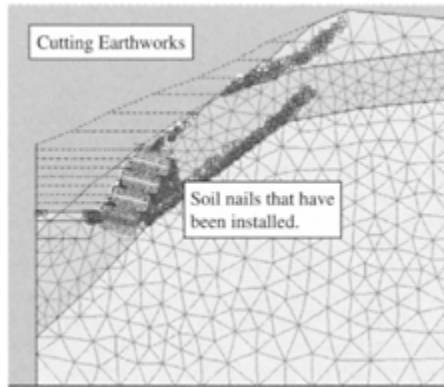

Figure 5.52. Development of plastic points in finite element model (After cutting of eleven upper berms).

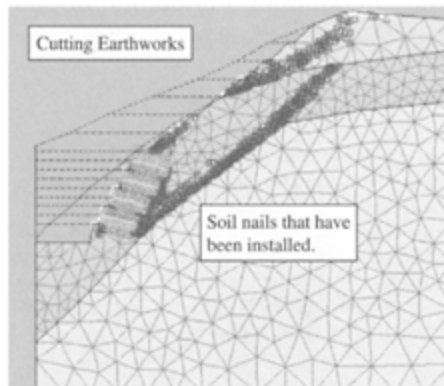

Figure 5.53. Development of plastic points in finite element model (After cutting of twelve upper berms).

- c. The day-lighting geological structures of Grade III to V materials at the cut slope of steep slope gradient forming preferential weak shear surface also contributed to the failure.
- d. Significant stress relief due to massive earthwork removal tends to reduce the effective overburden stress and the shear strength of the cut slope. Cutting of the original slope to steeper profile will therefore increase the mobilised shear stress along the slip surface and eventually reduce the FOS until failure.
- e. As demonstrated in the finite element analyses, progressive failure as a result of different degrees of strength mobilisation and localised stress concentration during various stages of slope cutting led to the development of a continuous shear surface causing the global slope failure.

## 5.5 SITE D—CUT SLOPE AT KUALA LUMPUR

### *Background of site*

The cut slope is located in Kuala Lumpur. From Aerial photographs, the cut slope was formed in 1990s and believed to have been carried out by the adjacent developer during the earthworks stage. The cut slope consists of six berms with slope gradient varies from 1V:1.72H (lowest berm) to 1V: 1H (highest berm). Berm drains were constructed when the cut slope was formed. Three layers of gabion walls of about 3.0m high were found at the toe of the slope. Slope movement was detected in November 2002 and perimeter drain of adjacent building was closed up due to the ground movement. Clearly visible tension cracks were then found at the lowest three berms. Front view and slope profile of the cut slope are shown in Figures 5.54 and 5.55 respectively. As there are residential structures at the toe of the distressed cut slope, a comprehensive geotechnical investigation was carried out to investigate the causes of the failure and propose remedial works.

### *Topography & geological conditions*

The survey plan as shown in Figure 5.56 shows the existing ground reduced level ranging from RL 75 m to RL 110 m. According to the Geological Map interpreted by Minerals and Geoscience Department, Malaysia (1976) as shown in Figure 5.57, the site is underlain by Granite Formation. The texture of granite varies from fine to course-grained biotite granite. These varieties of texture indicates different elevation of crystallization which influence the topography of the site.

### *Site conditions & observations*

During the site inspection after the incidence, a tension crack extending from Berm 3 (third lowest berm) to Berm 1 (lowest berm) is clearly visible after clearing of bushes. The depth of tension crack generally varies from 150 mm to 300 mm. In general, the slope is dry as no water seepage was observed during the site inspection. Berm drains within the failed slope were damaged due to the ground movement.



Figure 5.54. Front view of failed slope.

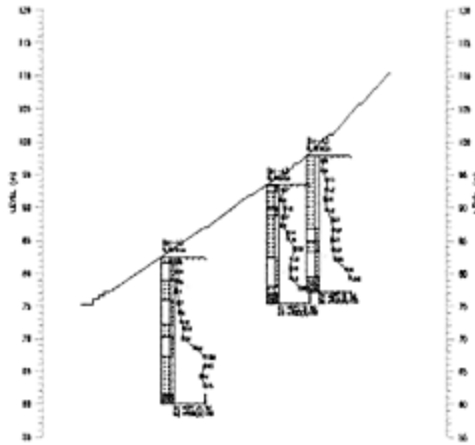

Figure 5.55. Cut slope profile with borehole logs.

### *Subsurface investigation & instrumentation*

A subsurface investigation (SI) consisting of three boreholes and twenty-two Mackintosh probes was planned and implemented to establish the subsoil profile and to obtain necessary soil strength parameters for purposes of investigation and proposal for remedial works.

In addition, instrumentation works which consisted of three observation wells and two inclinometers were carried out to monitor the groundwater level and ground movement which would also assist in establishing the shear failure surface for remedial works. The locations of SI and instrumentation works are shown in Figure 5.56. The interpreted subsoil profile is shown in Figure 5.55.

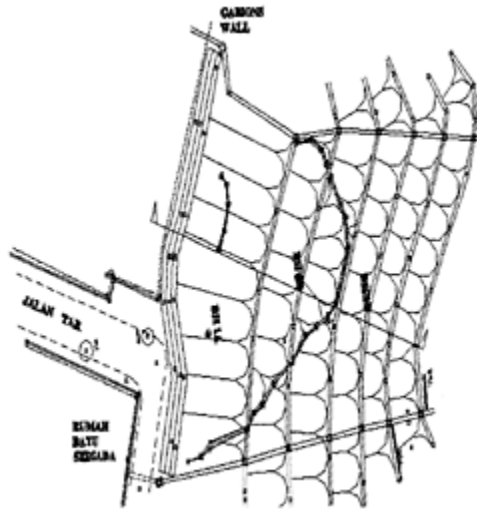

Figure 5.56. Topography survey plan.



Figure 5.57. Site geological map.

### *Laboratory tests*

A series of laboratory tests was carried out on the samples obtained from the SI works. The tests performed includes Atterberg limits, particle size distribution, multiple reversal direct shear box test, consolidated isotropically undrained triaxial test with pore pressure measurement and petrographic analysis test. The test results are presented in the following section.

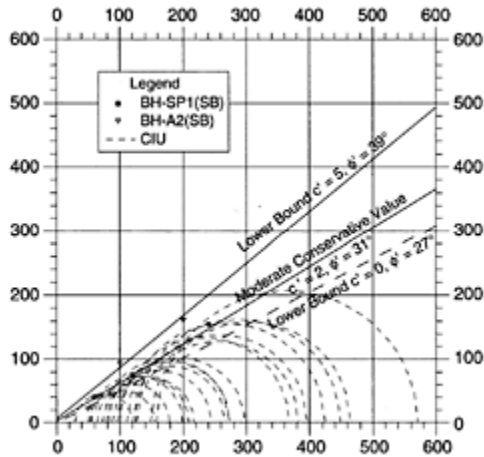

Figure 5.58. Results of C.I.U. and shear box tests.

Based on the British Soil Classification System, most of the tested soil samples are silt of intermediate plasticity.

Eight numbers of Consolidated Isotropically Undrained (C.I.U.) Triaxial tests were carried out on the collected thin wall samples and Mazier samples.

In addition, two numbers of multiple reversal direct shear box test were specified on the reconstituted samples from thin wall samples.

Figure 5.58 shows the results of both C.I.U. and shear box tests. In general, the interpreted moderate conservative soil parameters are  $c' = 2 \text{ kPa}$ ,  $\phi' = 31^\circ$ , which are within the lower bound of  $c' = 0 \text{ kPa}$ ,  $\phi' = 27^\circ$  and upper bound of  $c' = 5 \text{ kPa}$ ,  $\phi' = 39^\circ$ .

### *Instrumentation & monitoring results*

Two inclinometers were installed within the failed mass until the hard layer was reached. The monitored ground movements as recorded by Inclinometer, IN. 1 and IN. 2 are shown in Figures 5.59 and 5.60. In general, the maximum lateral movement (IN. 1) is about 8 mm with the depth of shear plane of about 7 m which tallies well with the stability analyses earlier.

The monitored groundwater level as recorded by Observation Wells, SP1 to SP3 are shown in Figure 5.61. The monitored groundwater level fluctuates within the maximum range of 2 m.

### *Rainfall record*

The rainfall record for the entire site from September 2002 to March 2003 is plotted in Figure 5.62. As quoted by Brand (1995), a major landslide event is very unlikely for the 24-hour rainfall of less than 100 mm. There was no indication of relatively higher rainfall intensity observed before the occurrence of slope failure (first site inspection was observed



on November 2002) and therefore the slope failure was unlikely to have been triggered by the abnormal rainfall intensity.

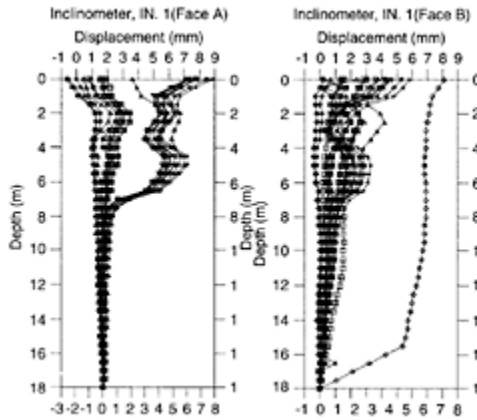

Figure 5.59. Inclinometer monitoring results (IN. 1).

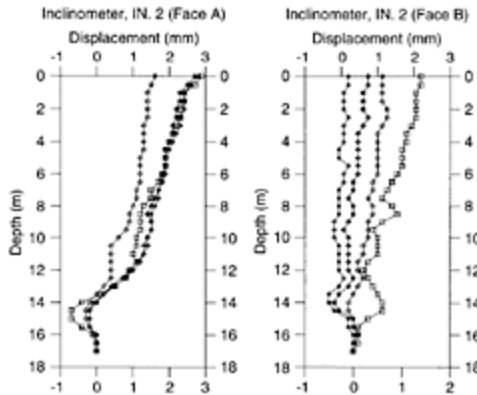

Figure 5.60. Inclinometer monitoring results (IN. 2).

***Engineering assessments***

Slope stability analyses (by using Bishop and Wedge methods) have been carried out using the subsoil profile as established based on SI results. The shear strength parameters from Figure 5.58 were used in the analyses.

The results of slope stability analyses using the interpreted strength indicate the factor of safety (FOS) of the cut slope to be approximately 1.0 as shown in Figure 5.63. The location of slip circles also tally well with the slope failures as observed at the site. This confirms that the mobilised strength during the slope failure is very close to the subsoil peak strength parameters interpreted from the laboratory strength test results.

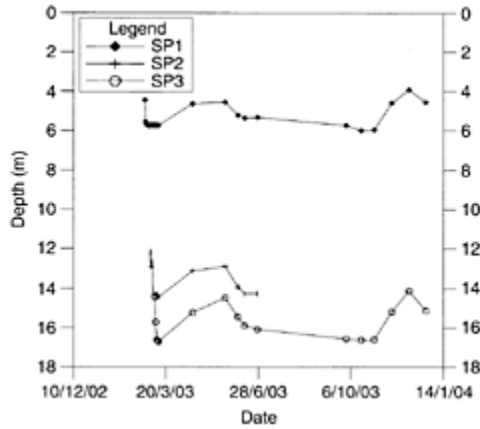

Figure 5.61. Groundwater monitoring results.

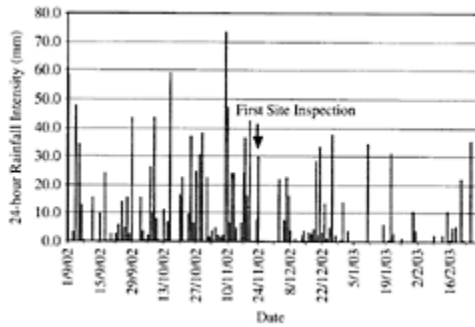

Figure 5.62. Rainfall record.

### *Remedial works slope*

Remedial work has been designed and constructed to ensure the long-term stability of the distressed slope. Due to site constraints, earthworks solution to trim the existing slope to a gentler slope was not viable. Therefore, the strengthening option using soil nails at the existing slopes was proposed. The soil nails were designed to nail the failed mass through the shear failure surface into the intact slope material. In addition to soil nails, installation of horizontal drains, construction and repairing of drains were carried out to improve the subsoil and surface drainage and minimize surface erosion.

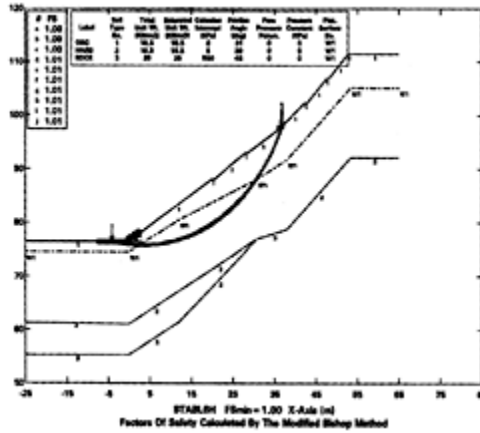

Figure 5.63. Slope stability analysis.

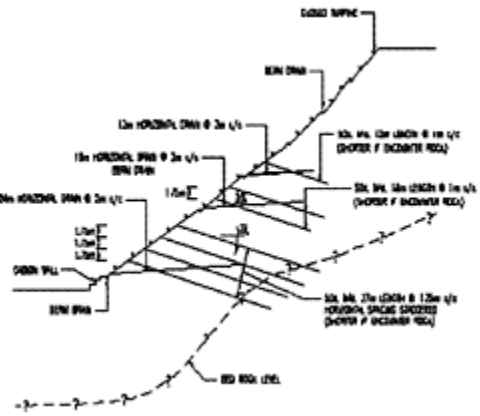

Figure 5.64. Strengthening works.

Figures 5.64 and 5.65 show the proposed slope strengthening works and the completed soil nailed slope. Monitoring results do not show any significant slope movements after the strengthening work.

### Findings

Based on the analyses, the possible causes of the failure are summarised as follows:

- a. The forming gradient of the cut slope is steep and is not stable in the long term, as FOS for the localised stability is only merely 1.0.
- b. Slope strengthening works with installation of soil nails and subsoil drainage system have proven to be an effective solution to stabilise the distressed slope.



Figure 5.65. Completed soil nailed slope.

### 5.6 SITE E—FILLED SLOPE AT SALAK TINGGI, SELANGOR

A filled slope with gabion mattress was formed over a natural valley as a construction platform for an utility pipeline carrying petrochemical products. Three berms of a total height of 20m were formed, in which the steepest gradient of some slopes is 1V:1H. On top of the filled slopes was the platform where the pipeline was laid. There were another three slopes sitting atop the platform where two of the slopes were also covered with gabion mattress. The filled platform collapsed following a series of heavy downpours. Figure 5.66 shows the extent of the collapsed slope.

The observation at the site after the collapse indicates that the platform of the pipeline was saturated with water. Debris, tree trunks and vegetation on the platform indicated that surface runoff had overflowed into the platform and traveled downslope to the lower portion of the valley. The concrete drains at the platform were also found clogged. The debris and failed mass had traveled more than 120 m downhill along the valley as shown in Figure 5.67. This indicates the high mobility of the collapsed debris, which could be in the form of mud or debris flow. Bedrock was observed at certain exposed surfaces after the collapse, indicating a shallow bedrock level and the failure resembled a slide along the bedrock surface.

The site geology reveals predominantly metasedimentary bedrock comprising interbedded sandstone and siltstone with extensive quartz bands, which is commonly known as Kenny Hill formation. The prominent geological structure of the area is an anticline. Following folding, a series of faults were also developed around the area. Figure 5.68 shows the site geological map.

Subsurface Investigation (SI) work was later carried out and a series of laboratory tests were performed. It was found that most of the soil samples are of sandy material. The interpreted shear strength from the Consolidated Isotropically Undrained Triaxial (C.I.U.) with pore water measurement is  $c'=2.0$  kPa,  $\phi' = 32^\circ$ .

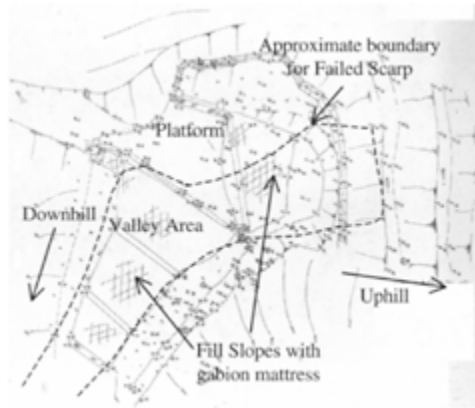

Figure 5.66. Plan showing slope and boundary of failed scarp



Figure 5.67. Travel of debris and failed mass downhill.

Back analysis was carried out on the slope profile of the three berms slope to estimate the mobilised shear strength during failure. It was found that when groundwater level rises near to the ground surface, the Factor of Safety of the filled slope geometry against failure with the interpreted peak strength parameters was only approximately 1.0.

In the remedial design, fill embankment was adopted. The fill embankment comprises rock toe, seven berms of slopes with 5 m berm height and a gradient of 1V:2H. A 1.5m wide berm with berm drain is provided at every 5 m intervals.

As the fill embankment is built on the previous valley, groundwater tends to flow towards the valley, particularly perching on the bedrock surface. Extensive subsoil drainage had been incorporated in the fill embankment. French drain and drainage blanket, in which gravels and free draining materials wrapped in geotextiles was adopted. The French drain was installed in the trench at the centre of the embankment footprint prior to filling and serves as the main subsoil drainage path for the embankment. Drainage blankets were installed in the fill slopes and discharged to the berm drains. Figure 5.69 shows the cross section at the centre of the fill embankment.

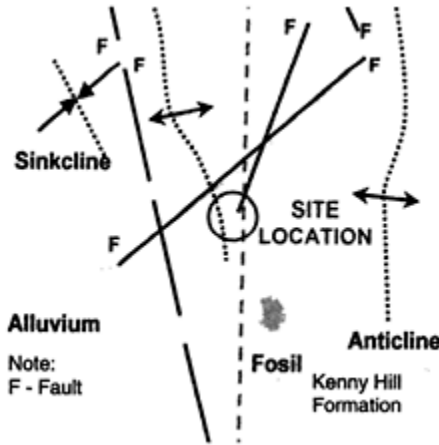

Figure 5.68. Site geological map.

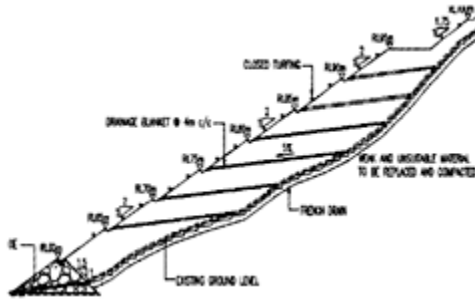

Figure 5.69. Section showing centre of fill embankment.

A new drainage system consisting of berm drains and cascading drains was designed and constructed for the fill embankment. The original drainage system at the site was also upgraded. As the quantity of the runoff discharged at the drainage outlet is expected to be significant, a wing wall was built at the outlet point. The outlet was connected to rock mattress and gabion wall which serves as silt trap to avoid debris from flowing downhill and soak away in the ground.

### 5.7 SITE F—FILLED SLOPE AT PUTRAJAYA, FEDERAL TERRITORY

The site involved a two level basement excavation at a filled ground next to a lake. The excavation is separated from the lake by an earth bund of 8 m top width with a reinforced concrete (RC) wall facing the lake. Figure 5.70 shows the typical section of the basement excavation, earth bund and the lake.

From site observation, the earth bund for the proposed basement is constructed by excavating the backfill ground formed during the early earthwork platform construction. It was observed that distinct layering of different fill materials are found within the earth bund.

The site is found to be underlain by metasedimentary rock of Kajang formation. Soil samples obtained from SI works consist of a high percentage of silt. The overburden layer is expected to be thick as the boreholes did not encounter any bedrock. Figure 5.71 shows the site geological map.

During basement construction work, there was an incident of leakage in a buried sealed culvert connecting to the lake, which led to flooding of the entire excavation. The buried culvert was later plugged and the excavation was dewatered to keep the working area dry. However, there was continuous seepage at a few locations of the earth bund. This raised concern on piping instability of the excavation. Apart from the seepage issue, instability of steep sides slope was also noticed with tension cracks found on top of the earth bund. Furthermore, certain parts of the bund were almost vertical, which is probably due to localized collapse or further cutting into the bund.

A two dimensional plane strain finite element method (FEM) analysis was carried out to assess the stability against slip failure and piping failure. The soil was modeled in drained condition and the water level within the excavation was lowered during the excavation process. Steady flow seepage was allowed in the analyses in each stage of excavation as there was a different hydraulic head in the groundwater levels between the lake and the excavation level.

It was found that upon completion of excavation, the Factor of Safety (FOS) of slope instability of the earth bund against slip failure was 1.06. This is insufficient as the minimum required FOS for temporary works is 1.2. Such an endangering situation has been best supported by the appearance of tension cracks on the earth bund after reaching the final excavation as shown in Figure 5.72.

The FOS against piping instability of 2.3 was also inadequate, which is less than the normally recommended FOS of 3 to 5 for most hydraulic structures. It was observed that fill materials in the earth bund had clear stratification, indicating different permeability. It is highly probable that there may be localized layers of high permeability soil providing express routes for water to seep under and out of the bund. In addition, the earth bund with a narrower base at certain parts would reduce the flow path, thus increasing the risk of piping

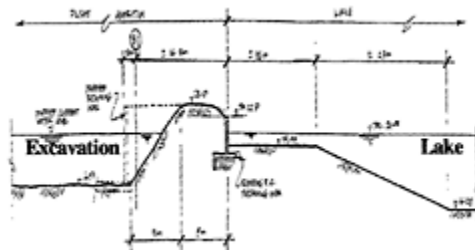

Figure 5.70. Typical section of basement excavation.

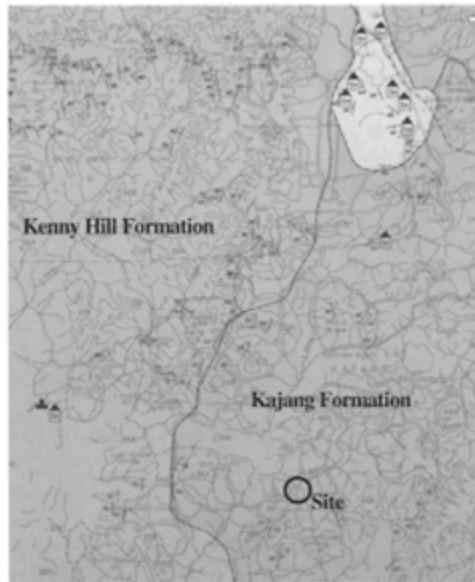

Figure 5.71. Geological map for Putrajaya.

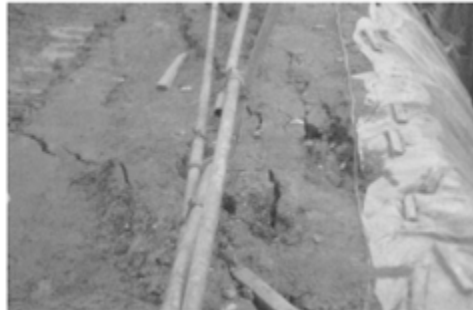

Figure 5.72. Tension cracks on top of earth bund.

failure. The observed localized seepage at a few distinct permeable soil layers suggested the potential of piping failure.

The following recommendations were made to improve the stability of the excavation:

- a. Trimming of earth bund into two berms. The FOS after trimming works was 1.22. To further increase the stability of the bund, concrete blocks or gabion rocks could be placed at the toe of the bund. Subsequent filling could be carried out to regrade the bund to a gentler gradient.



- b. Installation of 12 m length sheet piles at the centre of earth bund to lengthen flow path and reduce hydraulic gradient. The analysis showed that the FOS against piping was 3.2 after the installation of sheet piles.
- c. Setting up of comprehensive real time monitoring system by installing optical movement target markers with motorized total station to closely monitor the movements of the bund at critical locations.

## 5.8 CONCLUSION

The six case histories covering various types of formation and different parts of Malaysia are believed to have a good representation of the stability failure of residual soils in Malaysia.

In general, the findings can be summarized as follows:

- Subsurface investigation is an important tool to obtain necessary subsoil information and to establish a much better educated guess on the hydrogeological, geological and finally geotechnical models for the design.
- Instrumentation has played a vital role in the failure investigation, in which a slip surface and groundwater regime can be accurately established by inclinometer and piezometer respectively. This is particularly useful for the remedial design.
- For the laboratory tests, C.I.U. test is suggested for the interpretation of both peak and critical state strengths, whereas M.R.S.B. test, or even better, ring shear test can be used to determine the residual strength.
- It is generally believed that the mobilized strength for the intact cut slope shall be close to critical state strength. For those previously failed slopes or slopes with creeping movement, it is more appropriate to use residual strength for the stability design, particularly for remedial design.
- In the residual soil in Jurong Formation, the laboratory residual strength is somehow lower than the estimated residual strength derived from correlation proposed by Mesri & Cepeda-Diaz (1986), but is fairly close to the back-calculated mobilized strength during failure.
- In addition to the conventional limit equilibrium method, finite element or finite difference methods are strongly recommended to be carried out for the assessment of potential failure mechanism, such as progressive failure which is particularly prominent for high cut slopes.
- Progressive failure is a phenomenon whereby the stresses in the slope are mobilized to various fractions of the peak strength as a result of stress changes and relief during slope cutting. When the overstressed soil zone reaches a critical extent, the failure occurs in a brittle manner as the post peak strength is lower than the peak strength.
- Another interesting point is that when the same back-calculated mobilized soil strength for the identified slip surface is applied to the same slope, it is usually difficult to have the most critical slip surface coincide with the detected slip surface. This implies that most slip surfaces probably occur at the soil band with relatively weak strength, whereas the strength outside this weak soil band is comparatively higher.

- It seems that cut slopes have a relatively high frequency of failure. This is probably due to many uncertainties in identifying the weak structure and establishing the adverse groundwater regime during design stage. Frequent design review and design modification during earthwork cutting will certainly help to mitigate the risk of failure, particularly early identification of weak geological features on exposed slope surface for design change. However, a filled slope could be equally unstable if not designed and constructed properly.
- The building up of pore water pressure in relation to rainfall over a certain period is still not well understood. This area needs more research work and practical design approaches for slope design.
- Provision of surface and subsoil drainage should not be overlooked as one of the key failure causing factors.

## REFERENCES

- Brand, E.W. 1995. *Slope stability and landslides under tropical conditions—A review symposium on hillside development, Kuala Lumpur*.
- Brinkgreve, R.B.J. 2002. *Plaxis-Finite element code for soil and rock analyses version 8*. A.A.Balkema.
- Directorate of National Mapping, Malaysia. 1986. Topography plan of Kota Kinabalu, Sabah.
- Directorate of National Mapping, Malaysia. 1986. Topography plan of Ranau, Sabah.
- Geological Survey of Malaysia. Draft *geological map of Sepang area*.
- Geological Survey of Malaysia. 1974. *Geological map of Kuala Betis, Kelantan*.
- Geological Survey of Malaysia. 1976. *Geological map of Gunung Kinabalu area, Sabah, East Malaysia*.
- Geological Survey of Malaysia. 1976. *Geological map of Selangor*.
- Geological Survey of Malaysia. 1982. *Mineral resources map of Johor*.
- Harald, W.Van Aller, P.E. 1989. *Sted Version 6.5, The smart editor for Pcstabl*.
- Mesri, G. & Cepeda-Diaz, A.F. 1986. Residual shear strength of clays and shales. *Geotechnique* 36(2):269–274.
- Sarman, M. & Komoo, I. 2000. Kudasang-Ranau: Dataran warisan ais gunung, *Geological society of Malaysia annual geological conference 2000, 8–9 September 2000, Pulau Pinang*: 211–221.
- Skempton, A.W. 1964. Long term stability of clay slopes, *Geotechnique* 14(2):75–101.
- Watts, C.F. & Gilliam, Daniel R., Hrovatic, Marc D, & Han Hong. 2003. *User's Manual Rockpack III for Windows*.



## CHAPTER 6

# Slope assessment and management

A.N.Hussein

*Public Works Department, Malaysia*

H.Omar

*University Putra Malaysia*

S.Jamaludin

*Public Works Department, Malaysia*

Slope assessment and slope management are important aspects of slope engineering. This chapter explains the definition of common terms usually used in slope assessment and also describes types and methods of slope assessment.

### 6.1 INTRODUCTION

Slope assessment and slope management are important aspects of slope engineering. Slope assessment is used to assess the condition of slopes either on a large scale or individually while slope management is the efficient use of available funds for slope rehabilitation work based on the priority rankings of slopes using the hazard and risk techniques. Some examples of the use of slope management throughout the world with particular reference to Malaysia are described.

### 6.2 DEFINITION OF TERMS

Some of the most common terms and definition that are used to describe slope assessment are as follows.

#### *Landslide*

Landslide is defined as the movement of a mass of rock, debris or earth flowing down a slope (Cruden 1991). Hutchinson (1995) also describes landslides as relatively rapid downslope movements of soil and rock, which take place characteristically on one or more, discrete bounding slip surface which defines the moving mass.

Other definitions of landslides include the down slope transportation of soil and rock resulting from naturally occurring vibrations, changes in direct water content, removal of lateral support, loading with weight, and weathering, or human manipulation of water courses and slope composition (CERO 1998).

The term 'landslide' encompasses events such as rock falls, topples, slides, spreads, and flows (Cruden & Varnes 1996). Landslides can be initiated by rainfall, earthquakes, volcanic activity, changes in groundwater, disturbance and change of a slope by man-made construction activities, or any combination of these factors. Landslides can also occur under water causing tidal waves and damage to coastal areas. These landslides are called submarine landslides.

Other terms that have been used to describe landslides are mass movements, slope failures, slope instability and terrain instability.

### *Landslide hazard*

Varnes (1984) describes a natural hazard as the probability of occurrence of a potentially damaging phenomenon within a specified time period and within a given area. The Organization of American States (OAS 1991) describes a landslide hazard as the likelihood of a potentially damaging landslide occurring within a given area.

Hazard rating or value is usually denoted by the symbol H. Normally a hazard rating is classified into five types i.e. very high, high, moderate, low and very low hazard. Hazard analysis is seldom executed according to its definition since the probability of occurrence of potentially damaging phenomena is extremely difficult to determine for larger areas. Ideally a complete hazard evaluation should provide answers to the questions as given in Table 6.1 (Hartlen & Viberg 1995).

Table 6.1. Checklist of questions for landslide hazard evaluation and correspondent type of hazard prediction (Hartlen & Viberg 1995).

Question	Hazard prediction type
Where will the landslide(s) occur	Spatial
When will the landslide(s) occur	Temporal
What type of landslide(s) occur	Type
How hazardous/ instable is/are the slope(s)	Hazard/Instability
How much of the slope(s) will be involved? (Area and/or depth)	Volume
How fast will the landslide(s) travel	Velocity
How far will the landslide(s) travel	Travel distance

Table 6.2. Different types of hazard and correspondent methods (Hartlen &amp; Viberg 1995).

Types of hazard	Main Method
Relation hazard	Mapping
a. susceptible—not susceptible	
b. rating of susceptibility into hazard of stability classes	
c. statistical approach	
d. rockfall	
	Mapping and calculation
Absolute hazard	Calculation
a. deterministic-safety factor	
b. probabilistic-probability of failure	
Empirical hazard	Empirical
a. empirical curves	
Monitored hazard	Monitoring
a. deformation hazard	
b. precipitation hazard	
Any single hazard type or combination of 1–4	Monitoring Planning

The different types of hazard and correspondent methods are also shown in Table 6.2.

Absolute hazard refers to the danger of landslide occurrence, which can be calculated in two ways i.e. deterministic method or probabilistic method.

The determination of actual probabilities requires analysis of triggering factors such as earthquakes or rainfall or the application of complex models. In most cases there is no clear relationship between these factors and the occurrence of a landslide (Soeters & van Westen 1996).

### *Landslide consequence*

Landslide consequence is the result of injury or loss due to the landslide hazard such as effect on environmental, social and economic loss. Landslide consequence is usually denoted using the symbol *C*. Some of the factors affecting consequence values that have been used in the East-West Highway project are the size of failure and type of slope, vulnerability of the embankments in terms of distance from the potential slip back scarp to the outer edge of the road, proximity of the cuttings in terms of the distance from the road to the toe of the cut and the size and slope angle of the cutting and re-routing of the road (Fiener & Ali 1999).

Nakano & Miki (2000) divided losses caused (consequence) by rock and soil slope failures into two types, i.e. direct and indirect losses. Direct losses included losses due to injury or death and the cost of restoring damaged road while indirect losses include time losses, travel cost losses and office operating losses.

### *Landslide risk*

Varnes (1984) describes risk as the expected number of lives lost, persons injured, damage to property, or disruption to economic activity because of a particular natural phenomenon. To quantify risk, Varnes (1984) gave the following factors and definition:

- i. Vulnerability—degree of loss to a given element or set of elements at risk resulting from the occurrence of a natural phenomenon of a given magnitude.
- ii. Element of risk—population, properties, economic activities and so on at risk in a given area.
- iii. Specific risk—expected degree of loss to a particular phenomenon.
- iv. Element at risk—population, properties, economic activities including public services etc at risk in a given area.
- v. Total risk—expected number of lives lost, person injured, damage to property or disruption of economic activity due to a particular phenomenon, which is a product of specific risk and element at risk.

Table 6.3 shows vulnerability values calculated for the Cairns district in Australia (Michael-Leiba et al. 2000). The values were estimated from information gathered from the Australian Landslide database for road and hill slopes, Cairns city council and knowledge of type of event and judgement. They also mentioned that the specific annual risk of destruction for the Cairns, Australia was calculated using the following equation.

Table 6.3. Vulnerability to destruction of people, buildings and roads (Michael-Leiba et al. 2000).

Unit	A	B	C
Hill slopes	0.05	0.25	0.3
Units susceptible to proximal debris flow	0.9	1.0	1.0
Units susceptible to distal debris flow	0.05	0.1	0.3

A: Vulnerability of resident people.

B: Vulnerability of buildings.

C: Vulnerability of roads.

Table 6.4. Specific annual risk for the Cairns, Australia (Michael-Leiba et al. 2000).

Unit	A	B	C	D
Hill slopes	0.008% 1:100000+	0.004% 1:20000	0.005% 1:20000	0.02% 1:6000
Units susceptible to proximal debris flow	0.01% 1:9000	0.01% 1:8000	0.01% 1:8000	0.01% 1:10000+
Units susceptible to distal debris flow	0.005% 1:200000	0.001% 1:90000	0.003% 1:30000	0.007% 1:10000+

A: Specific annual risk of death resident people.

B: Specific annual risk of building destruction.

C: Specific annual risk of road destruction.

D: Specific annual risk of road blockage.

$$\text{Specific risk} = H \times V \quad (6.1)$$

where  $H$ =hazard

$V$ =vulnerability

The calculated specific annual risk for Cairns is shown in Table 6.4.

For total risk, Michael-Leiba et al. (2000) also described that it can be calculated using the following equation.

$$\text{Total risk} = H \times V \times E \quad (6.2)$$

where  $H$ =hazard

$V$ =vulnerability

$E$ =number of elements at risk

Normally Risk or  $R$  is calculated by multiplying the hazard values ( $H$ ) with the consequence values ( $C$ ) and is given by

$$R = H \times C \quad (6.3)$$



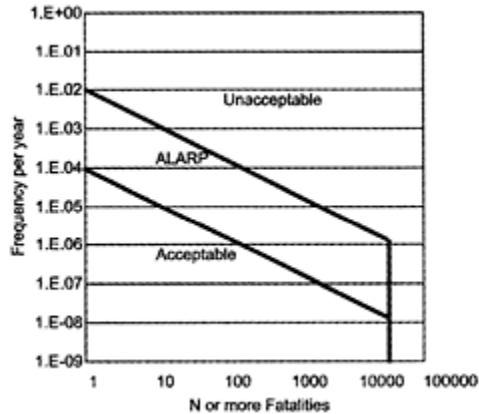

Figure 6.1. Societal risk criteria 1995 (Wong & Lee 1999).

Risk values are usually classified into five types i.e. very high, high, moderate, low and very low risk. Landslide risk can be reduced by four approaches (Kockelman 1986):

- i. Restriction of development to landslide-prone areas.
- ii. Codes for excavation, grading, landscaping and construction
- iii. Physical measures (drainage, slope-geometry modification and structures) to prevent or control landslides
- iv. Development of warning systems

The Geotechnical Engineering Office (GEO 1998) categorized the risk acceptance criteria into two types:

- i. Individual risk—the frequency of harm (fatal or major injuries) per year to an individual exposed to a hazard.
- ii. Societal risk—the predicted number of fatalities per year, often expressed as the relationship between the frequency of an incident per year,  $F$ , and the associated numbers of fatalities,  $N$ .

For individual risk criteria, unacceptable risk was risk above  $1E-04$ , (Hardingham et al. 1997), while the GEO (1998) revised the value for landslides and boulder falls from natural terrain to be  $1E-05$  for new development and  $1E-04$  for existing development. For societal risk criteria, Figure 6.1 shown the societal risk criteria in 1995 while Figure 6.2 shows the modification made by GEO in 1998. All values above  $1E-03$  were considered unacceptable.

In 1977/78 GEO divided landslide risk into six types i.e. very high, high, moderate to high, moderate, low to moderate and low risk. Two categories of slope risk were defined i.e. risk to life and economic risk (GEO 1984). Risk was then redefined as consequence (GEO 2000). The risk categories were also redefined as a consequence to life and economic consequence and each consequence was divided into three types i.e. negligible, low and high which were numbered as 1,2 and 3. The two revised categories are shown in Tables 6.5 and 6.6.

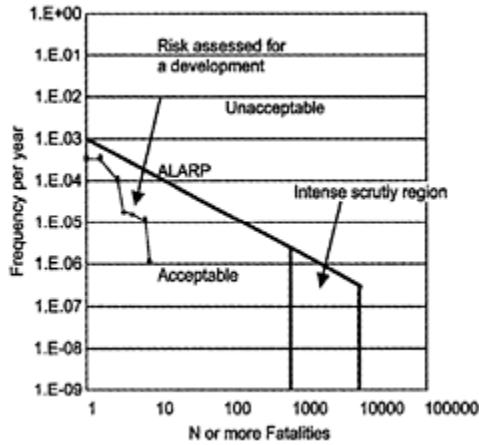

Figure 6.2. Modification of societal risk (GEO 1998).

Table 6.5. Typical examples of slope failures in each consequence to life category (GEO 1998).

Example	Consequence to life category		
	1	2	3
Failures affecting occupied building	/		
Failures affecting building storing dangerous goods	/		
Failures affecting heavily used open spaces and recreational facilities		/	
Failures affecting road with high vehicular or pedestrian traffic density		/	
Failures affecting public waiting areas		/	
Failures affecting country parks and lightly open air recreation areas			/
Failures affecting roads with low traffic density			/
Failures affecting storage compounds			/

A technical note was then produced regarding the guidelines for classification of consequence to life category for slope features, (GEO 2003). The consequence categories were also redefined from high, low and negligible to Category 1,2 and 3 as shown in Table 6.7.

Table 6.6. Typical examples of slope failures in each economic consequence category (GEO 1998).

Example	Economic consequence		
	1	2	3
Failures affecting buildings which could cause excessive structural damage	/		
Failures affecting essential services, which could cause loss of that service for an extended period	/		
Failures affecting total or urban trunk road or road of strategic importance	/		
Failures affecting essential service which could cause loss of that service for a short period		/	
Failures affecting total or primary distributor road which are not sole accesses		/	
Failures affecting open air car parks			/
Failures affecting total feeder, district distributor and local distributor road which are not sole accesses			/
Failure affecting country parks			/

### ***Hazard and risk zonation***

Hazard and risk zonation helps to divide various zones according to their degree of hazard or risk, which are quantified from hazard and risk analysis. Varnes (1984) defines landslide zonation as the division of land in homogeneous zones or domains and ranking of these areas according to their degree of actual or potential hazard caused by mass movements. Landslide hazard maps can help in the identification of land areas suitable for development by identifying potential risk of landslides. Development projects can then be developed to avoid, prevent or substantially mitigate the hazard.

The USGS National Landslide Information Center (NLIC 2003) home page mentioned that a landslide hazard map indicates the possibility of landslides occurring throughout a given area. A hazard map may be as simple as a map that uses the locations of old landslides to indicate potential instability, or as complex as a quantitative map incorporating probabilities based on variables such as rainfall thresholds, slope angle, soil type, and levels of earthquake shaking. An ideal landslide hazard map shows not only the chances that a landslide may form at a particular place, but also the chance that it may travel down slope to a given distance. This type of map shows the expected annual cost of landslide damage throughout an area. NLIC also mentioned that a landslide risk map shows the expected annual cost of landslide damage throughout the area. Risk maps combine the probability information from a landslide hazard map with an analysis of all possible consequences (property damage, casualties, and loss of service).

Table 6.7. Typical examples of facilities affected by landslides in each consequence to life category (GEO 2003).

Facilities	Consequence to life category
Group 1 a. Heavily used buildings	
—residential building, commercial office, store and shop, hotel, factory, school, power station, market, hospital	
b. Others	
—cottage, licensed and squatter area	
—bus shelter and railway platform	1
—dangerous goods storage site (e.g. petrol stations)	
—road with very heavy vehicular or pedestrian traffic density	
Group 2 a. Lightly used buildings	
—indoor car park, sewage treatment plant, civic centre, manned substation	
b. Others	
—major infrastructure facility (e.g. railway, flyover, subway, tunnel portal, service reservoir)	
—road with heavy vehicular or pedestrian traffic density	2
Group 3 Heavily used open and public waiting area	
Road with moderate vehicular or pedestrian traffic density	
Group 4 Lightly used open air recreation area	
Non dangerous goods storage site	
Road with low vehicular or pedestrian traffic density	3
Group 5 Remote area	
Road with very low vehicular or pedestrian traffic density	

The hazard and risk zonation maps are usually produced using the Geographic Information System (GIS) to quantify the extent of the hazard and risk according to the size and length of each slope and area. The maps make use of both ground and spatial data obtained from airborne survey such as LiDaR (Light Detection and Ranging) or Satellite Imagery. The hazard and risk maps also act as a tool to assist in prioritizing of slopes that need remedial and preventive works. Jamaluddin et al. (1999) presented a flowchart showing the methodology involved in the production of a hazard map (Figure 6.3).

For road projects, risk maps are usually produced to quantify the vulnerability of the hazard area in terms of potential damage to the road and the effects on traffic assess (Lloyd et al. 2001). A typical hazard and risk map produced from the East-West highway slope stability study is shown in Figure 6.4.

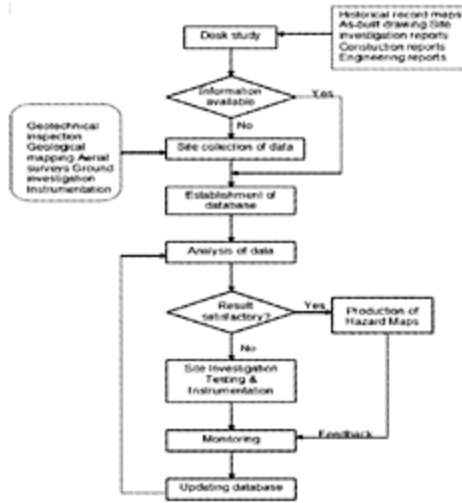

Figure 6.3. Flowchart for production of hazard maps (Jamaluddin et al. 1999).



Figure 6.4. Typical risk map for a section of the East-West Highway study in Malaysia (Lloyd et al. 2001).

Table 6.8. Time intervals between maintenance inspection (GEO 1984).

Inspecting Officer	Recommended interval	
	Slopes in high risk to life category	Slopes in low risk to life category
Technical Officer	6 months	1 year
Engineer	2 years	5 years

Table 6.9. Principal data set in slope inventory form (Jamaluddin et al. 1999).

Type	Culvert condition
Location	Natural drainage type
Slope height	Natural drainage
Slope shape	Size
Slope angle	Natural flows
Slope strike	Erosion
No. of berms	Protection
Berm geometry	
Crest length	Type of erosion
	Erosion severity
Distance to ridge/gully	Erosion gully geometry
Topographic setting	Instrumentation
Catchment area	w
Vegetation cover	Conditions of earthwork
Artificial cover	Failure modes
Logging activity	% failure

### *Landslide inventory*

Landslide/Slope Inventory or Slope Performa is usually carried out to supplement and also check the accuracy of the spatial data obtained from an airborne survey. The inventory also helps to identify all the parameters that are used for the hazard analysis as well as identify existing or potential problems on each individual slope that may need to be rectified immediately. Data from the slope inventory also acts as a database of information of all slopes along each road, railway or transmission lines route. The data needs to be upgraded from

time to time due to changes that occur or remedial measures that might have been carried out to certain slopes. The maintenance inspection time intervals as recommended by GEO Hong Kong (1984) are shown in Table 6.8.

Some of the slope features collected during the slope inventory for the East-West Highway (Jamaluddin et al. 1999) are shown in Table 6.9.

### 6.3 TYPES OF SLOPE ASSESSMENT

Slope assessment can be divided into three groups:

- i. Wide area assessment.
- ii. Linear area assessment.
- iii. Individual slope/slopes assessment.

#### *Wide area slope assessment*

Wide area slope assessment is usually carried out for land use and development planning of a large area and to delineate areas where existing land and/or new land development may be affected by landslide hazards and affect the stability of slopes in the area. Wide area assessment is also used to assist the planning or regulation of land use and development.

#### *Linear area slope assessment*

This type of assessment is usually carried for slopes along roads, railways, pipelines or transmission lines. The assessment will also assist in the planning of development along linear geomorphic features such as streams, shorelines and reservoirs.

#### *Individual slope/slopes assessment*

Individual slope/slopes assessment are usually carried out for slope/slopes near buildings or structures or in critical locations along the road to establish whether the slope/slopes are considered as potentially very high or high risk where the occurrence of slope failure can cause damage or injury to the occupants or to the buildings/structures or to the road users. Monitoring of the slope/slopes is usually carried out using geotechnical instrumentation, which can either be monitored manually or using real time monitoring system. The system can also act as an early warning system to warn occupants of imminent danger.

### 6.4 METHODS OF SLOPE ASSESSMENT

There are four main methods of slope assessment:

- i. Direct method
- ii. Overall score evaluation method
- iii. Geotechnical method
- iv. Monitoring of slope

### *Direct method*

The direct method involves geomorphological assessment (interpretation of landforms, valley pattern and type of valley side slopes to identify hazards), geological assessment and quantitative remote sensing (aerial photograph or satellite image analysis and interpretation) of an area.

### *Overall score evaluation method*

This method assess from cumulative scores that are derived from landslide/slope inventory performa using either probabilistic or statistical analysis and from empirical method using scores derived from expert judgments or heuristic approach.

### *Geotechnical method*

The geotechnical method involves detailed surveys on slopes (topographical, aerial photo, geomorphological, surface geological, soil investigation etc.) and the evaluation of slope instability (mechanisms of failure, scale of failure, stability analysis, etc.) to obtain the factor of safety for each slope. This method is usually used both for linear and individual slope assessment.

### *Monitoring of slope*

Slope monitoring helps to detect movement of the slope prior to failure so that proactive safety measures can be immediately taken. The monitoring of the slope/slopes is usually carried out using geotechnical instrumentation to detect movement. The data can be taken either manually or using real time monitoring system. Early warning system can also be established using the instrumentation as well as the addition of raingauges and tiltmeters to inform of impending danger to the area during heavy rainfall.

Usually a combination of the four methods is used for slope assessment and the development of a slope management system.

## 6.5 SLOPE MANAGEMENT

Slope management is the utilization of hazard and risk techniques to rank and prioritize slopes according to their order of importance in terms of the danger level or the urgency to repair. The ranking of each slope will enable the optimum utilization of available funds to ensure that very urgent slopes are repaired first. Slope management is complimented by the production of hazard and risk maps where each slope is ranked and colored according to their ranking. Usually hazard and risk maps are produced using spatial and ground data. Spatial data are collected using airborne survey techniques such as LiDaR (Light Detection and Ranging). The accuracy of the airborne laser techniques usually depends on the denseness of the vegetation cover. The denser the vegetation cover the less accurate the data. This data are then combined with data collected on the ground. The hazard and risk rating are then calculated and the hazard and risk maps are then produced using geographic information system (GIS).



## 6.6 USAGE OF SLOPE ASSESSMENT AND SLOPE MANAGEMENT

The usage of hazard and risk assessment for slope assessment and management both overseas and locally are described below:

*Some overseas examples*

Some of the overseas countries where slope assessment and management have been used are:

- i. Australia.
- ii. Hong Kong.
- iii. Japan.
- iv. Spain.
- v. United Kingdom.
- vi. United States of America.

*Australia*

Ko Ko et al. (1999) from the University of Wollagong, (UOW), Australia reviewed existing landslide and risk assessment methods that have been developed in the State of New South Wales (NSW). The methods were developed by the Rail Services of Australia (RSA), Road and Traffic Authority of NSW (RTA), GTR method and the Australian New Zealand Standard (AS/NZS). They then tried to develop a comprehensive hazard consequence approach for more effective, efficient and consistent assessments of hazard and risk. Seven factors were considered to have influence on slope performance. They are site history, landslide indicators, bedrock geology type and landslide material, geologic structures, morphological factors such as slope angle, seepage etc, preventive remedial works and adverse human impact. They then produced a probability chart as shown in Table 6.10.

Table 6.10. Probability rating chart (Ko Ko et al. 1999).

Score	Probability	Probability of occurrence	Annual Probability
100	Very High	Will occur	>0.2
80-<100	High	short term	0.2->0.02
60-<80	Medium	medium to long term	0.02->0.002
40-<60	Low	extreme conditions	0.002->0.0002
<40	Very Low	exceptional circumstances and adverse conditions	>0.0002

Table 6.11. Hazard assessment of the five methods carried out by an experienced professional.

Site No.	AS/NZS	GTR (1988)	RSA	RTA	UOW
1	unlikely	unlikely	very low	high	medium
2	moderate	likely	high	very high	high
3	moderate	likely	high	very high	high
4	likely	almost certain	high	very high	very high
5	moderate	likely	high	very high	high
6	moderate	almost certain	high	very high	very high

They also developed a field data sheet and tested on 6 selected sites in the Wollongong area in Australia and have found it to be quite successful. Comparisons were also made with existing methods as shown in Table 6.11.

Micheal-Leiba et al. (2000) also carried out a GIS based quantitative risk assessment in the Cairns area to provide information to the Cairns City council on landslide hazard, community vulnerability and risks for planning and emergency management purposes. Magnitude recurrence relations were established for two slope processes i.e. landslides on hill slopes and large debris flows extending from the gully systems on to the plains. Landslide hazard ( $H$ ) was then estimated as the annual probability of a point being impacted by a landslide as shown in Table 6.12. Michael-Leiba et al. (2000) produced vulnerability and specific risk values for the Cairns area as shown in Tables 6.3 and 6.4.

### *Hong Kong*

Ho et al. (2000) described the use of Quantitative Risk Assessment (QRA) in slope problems. They mentioned that risk concepts and QRA can be applied for global risk assessment, relative risk assessment and site-specific risk assessment as well the preparation of hazard or risk mapping. For landslide purposes, the QRA have been applied as shown below:

- i. Global risk assessment—quantify overall risk to facilitate measurement of performance of a system and determine optimal risk mitigation for different components.
- ii. Site specific risk assessment—to evaluate hazard and level of risk at a given site and examine the appropriate risk mitigation measures.
- iii. Relative risk assessment—determination of the priority of action.
- iv. Development of a technical framework for assessing natural hillsides.

Ho et al. (2000) mentioned some examples where global QRA have been used to assess failure of old man made slopes (Ho & Wong 2001) and for earthquake induced failures of man made slopes in Hong Kong while site specific QRA has been used for the slope assessment at the Lei Yue Mun Squatter Villages, Hong Kong in 1998 (Wong & Lee 1999, Ho &

Wong 2001) and the Fei Tsui Road landslide, Hong Kong in 1995. Relative QRA has been used for ranking of old fill slopes in Hong Kong. Ho et al. (2000) also described the development of a risk based framework for natural terrain hazard study for new development sites which adopted both the factor of safety approach and QRA approach. Ho et al. (2000) also described some of the current issues relating to the application of QRA. They are:

- i. The use of probability which tends to scare some people off.
- ii. The use of qualitative or quantitative assessment.
- iii. Skepticism towards new techniques.
- iv. Lack of standards on QRA.
- v. Interpretation of historical data.
- vi. Problems of assessment of extreme events generated by QRA.
- vii. Role of subjective judgement in QRA.
- viii. QRA is not a cure for all problems.
- ix. Use of QRA for relative assessment.
- x. Quality and recognition of expertise in geotechnical QRA.

Table 6.12. Hazard assessment from a magnitude recurrence graph

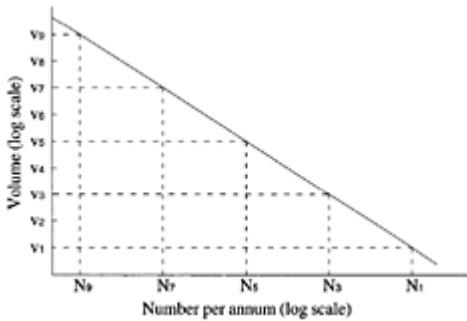

Volume interval	Number of landslide events in volume interval	Mid-point on graph of volume interval	Area of landslide = vol/thickness= $v_2$ /thickness, etc.	Probability of impact at a specified point in a polygon with area $A_{\text{polygon}}$ given that at landslide happens in the polygon	Hazard=annual probability of impact at specified point
$v_1$ to $v_3$	$N_1$ to $N_3$	$V_2$	$A_2$	$P_2 = A_2 / A_{\text{polygon}}$	$P_2 (N_1 \text{ to } N_3)$
$v_3$ to $v_5$	$N_3$ to $N_5$	$V_4$	$A_4$	$P_4 = A_4 / A_{\text{polygon}}$	$P_4 (N_3 \text{ to } N_5)$
$v_5$ to $v_7$	$N_5$ to $N_7$	$V_6$	$A_6$	$P_6 = A_6 / A_{\text{polygon}}$	$P_6 (N_5 \text{ to } N_7)$
$v_7$ to $v_9$	$N_7$ to $N_9$	$V_8$	$A_8$	$P_8 = A_8 / A_{\text{polygon}}$	$P_8 (N_7 \text{ to } N_9)$
					Sum of this column=H

Table 6.13. Risk evaluation points for slopes (Kitazono et al. 1999)

Item	Category	Risk Points
Relief energy	<50m	12
	40–50 m	12
	30–40 m	12
	20–30 m	12
	>20m	5
Tilt angle	<45°	15
	30–45°	8
	>30°	3
Crossing shape	Convex	9
	Fat	9
	Concave	11
Land use	Rice field	6
	Plowed field	6
	Fruit farm	7
	Coniferous forest	7
	Broad-leaved forest	
	Bamboo forest	7
	Wasteland	
	Urban facilities	13
		11
		6
Subsurface geology	quaternary starta volcanic rock	4
		10

Table 6.14. Slope risk criteria (Kitazono et al. 1999).

Degree of risk	Total risk point
Higher	55–61
High	48–54
Middle	41–47
Low	34–40
Lower	27–33

*Japan*

Kitazono et al. (1999) tried to carry out risk prediction from data obtained from geographical information databases and risk evaluation points. The geographical information database was made from existing topographical and subsurface geological maps. The authors also made hazard maps to predict slope failures in heavy rain and identify locations where further investigation needed to carry out. The method was tested in a mountainous area northwest of Kumamoto City, Japan where it was found to be useful but further refinement was needed to include anomaly in vegetation, lineament in micro topography.

The risk evaluation points for slopes and risk criterion used in the study by Kitazono et al. (1999) are shown in Tables 6.13 and 6.14.

Nakano & Miki (2000) attempted to develop methods of evaluating and predicting the risk of failure of rock beds and slopes facing roads in order to improve the efficiency of road disaster management under limited funds and manpower. They tried their method on the national highway route 17 in the Ayato district, which is about 1.7 km long in areas covering Komochimura and Numata city in the Gunma prefecture. A total of 34 higher rank records from a total of 122 actual records for the past 34 years were sampled and analyzed. Nakano & Miki (2000) then estimated the amount of average annual damage caused by the rock and soil slope failures. Cost benefit analysis was then carried out which helped to prioritize slopes that require prevention measures and to select adequate disaster prevention methods.

*Spain*

Irigaray et al. (1996) made a comparative study of various methods for assessing landslide susceptibility or hazards using a case study in the Rute area in Cardoba, Spain. A few methods such as the matrix method, values of information method, multiple regression method and indexation method were compared for the area and the matrix method was found the most suitable to predict landslide susceptibility for the area.

*United Kingdom*

Garland (2000) described the approach used in Scotland using Stereo Oblique Aerial Photography (SOAP) to assess risk of failure in cuttings and embankments greater than 3 m height. Photographs were taken from a low flying helicopter and interpreted by an experienced geologist for rapid assessment of the stability of slopes to be made. A rating was allocated to assess risk of failure which allowed planned maintenance program to be developed with priority given to slopes assessed as being at most risk and optimizing the efficiency of asset management and maintenance. A photographic catalogue of the slopes was also produced for future reference. The advantages of using SOAP are (i) the technique is rapid and large numbers can be quickly assessed over a wide area, and (ii) it can be used for sections of slopes which are inaccessible or dangerous or where the whole slope cannot be seen from the ground. Some limitations of SOAP are (i) presence of dense vegetation may limit the extent of slope face that can be examined from the air, and (ii) the consistency of scale between photographs and actual measurement cannot be taken from the stereo oblique photographs in the same manner as vertical photographs, however its accuracy is made up to 1 m accuracy.

Grainger & Kalaugher (1991) described the used of photographic monitoring technique for cliff management which fuses color transparency from previous visit with current viewed scene on site to update landslide hazard zonations. The method also provided early warning of increased activity of landslide movement.

Jennings et al. (1991) reviewed published indirect methods of landslide susceptibility assessment and the extent to which the models are able to predict known landslide locations as shown in Table 6.15.

They also made a comparative study of effectiveness of commonly used techniques as part of the Rhonda valley landslip project to differentiate landslide areas and non-landslide areas. They found that the prediction using statistical model i.e. discriminant analysis can achieve a >70% success rate.

#### *United States of America*

Schuster (1991) described that effective management has managed to reduce economic and social losses due to slope failures in the USA by avoiding hazards or by reducing the damage potential. The reduction was achieved through introduction of four mitigative approaches such as restriction of development in landslide prone areas, excavating, grading, landscaping and construction codes, use of physical measures to prevent or control landslides and landslide warning system.

Table 6.15. Known landslide approaches in ascending order of complexity (Jennings et al. 1991).

Major heading	Specific heading	Recognized approaches
Indirect Mapping	Hazard for forecasting avalanches, mudslides	Statistical
	Stability assessment	
	Complex statistical techniques	
	Computer drawn landslide maps	
	Landslide susceptibility maps	
	Hazard isolines	Quantitative/ Index
	Simple statistical method	
	Landslide isopleths	
	Land systems	
Direct Mapping	Maps of hazards to linear constructions	Quantitative/ Index
	Other hazards	
	Landslide oriented applied geomorphological maps	Geomorphological
	Geomorphological maps	
	Regional landslide incidence	
	Landslide registers and inventories	
	Landslide distribution map	
Inventory maps.		

*Some Malaysian examples*

Several types of hazard and risk systems have been used in Malaysia. Some are for land use, agricultural and slope management. The type of slope assessment and management systems used by various government agencies and private companies in Malaysia are briefly explained below:

- i. Public Works Department of Malaysia.
- ii. Malaysian Center for Remote Sensing (MACRES).
- iii. Mineral and Geoscience Department.
- iv. Projek Lebuhraya Utara-Selatan (PLUS).
- v. Kumpulan IKRAM Sdn Bhd (KISB).
- vi. University Putra Malaysia.

*Public works department of Malaysia*

Much of the slope management work carried out by the Public Works Department of Malaysia (PWD) is based on the linear type of slope area assessment which is carried out mainly for road projects. Slope management system was first introduced to the Public Works Department in 1993 when the first slope management system was developed to enable a proper assessment and maintenance of slopes to be carried out along the East-West highway from Gerik in Perak to Jeli in Kelantan. The slope management system introduced in the East-West highway has reduced the annual expenditure on slope remedial works from 4.2% to 2.3% of the original road construction costs (Lloyd et al. 2001).

Altogether five systems have been developed by the PWD and a summary is shown in Table 6.16.

The first two systems i.e. the Slope Maintenance System (SMS) and MEHMS (Malaysian Engineered Hillslope Management System) was developed for site specific purposes i.e. for the East West Highway from Gerik to Jeli and for the Gunung Raya road in Langkawi, Kedah. Both these systems have managed to reduce the number of slope failures along the road at that particular time it was developed.

*Slope Maintenance System (SMS)*

The SMS system uses the slope performance using the principal data set as shown in Table 6.9. Data was collected from 1123 slopes along the East-West Highway.

Table 6.16. Summary of slope management systems developed by the Public Works Department of Malaysia.

Type	Year completed	Objectives
SMS	1996	East-West Highway
MEHMS	1998	Gunung Raya road
SPRS	1999	Malaysia
SIMS	2002	Malaysia
SMART	2004	Malaysia

Spatial data was also collected using DVG (Digital Video Geographic) survey which integrates helicopter positioning, video imagery and laser profiling.

Discriminant analysis and the Factor Overlay method were used to analyze the slope variables which have significant contribution to the hazard value. Risk values were then obtained using equation 6.3. The factors affecting consequence values used in the SMS system are as described by Feiner & Ali (1999). Details of the SMS system have been described by Jamaluddin et al. (1999) and Lloyd et al. (2001).

#### *Malaysian Engineered Hillslope Management System (MEHMS)*

MEHMS was the result of a slope stability study carried out along the Gunung Raya Road in Langkawi, Kedah. The slope inspection inventory form that was used in the study is similar to that used previously for SMS in the East-West Highway. Data on 224 slopes along the Gunung Raya road were inventorized. The MEHMS is used together with CHASM (Combined Hydrological and Stability Model) for prediction of the factor of safety. CHASM is a commercially available integrated slope hydrology/ slope stability software package that aids the assessment of slope stability conditions.

The other three systems were developed with the purpose of using the slope management system for global purposes i.e for the whole country.

#### *The Slope Priority Ranking System (SPRS)*

The Slope Priority Ranking System (SPRS) was developed in 1999 as a tool for quick assessment of all slopes in Malaysia so that repair work can be prioritized and carried out. The SPRS was also developed to identify budget requirements for slope repairs. The slope inventory form used in SPRS was developed from experience gained from the first two systems i.e. SMS and MEHMS. Concepts and details of the systems are as described by Hussein et al. (2000). The slope variables collected included slope geometry, percent uncovered, drainage condition, seepage, erosion severity and geology. Simple hazard for both cut and fill slopes and consequence values were used as shown in Table 6.17 to 6.19.

Risk ratings obtained from hazard and consequence values for the SPRS system is shown in Table 6.20. The risk rating range from very high, high, moderate, low and very low.

The total risk score is computed by multiplying the maximum total hazard score and maximum total consequence score, i.e.  $24 \times 8 = 192$  for cut slope and  $25 \times 8 = 200$  for fill slope.

An example of how the rating is given to an inspected slope and the computation of Hazard Score and the assigning of a Risk Rating to a cut slope are shown in Table 6.21 below.

Table 6.17. Hazard score used for cut slopes used in SPRS.

		Score		
		0	1	2
i.	Slope angle	<45°	45–63°	>63°
ii.	Height of slope	<12m	12–24 m	>24m



iii.	Slope cover	>20%	<20%	–
iv.	Surface drains	Good	Blocked reqd	Repair
v.	Natural water path	No	–	Yes
vi.	Seepage	No	–	Yes
vii.	Ponding	No	Yes	–
viii.	Erosion	Slight	Moderate	Critical
ix.	Slope failure	No	–	Yes
x.	Surrounding upslope	No	–	Yes
xi.	Soil type			
xii.	Weathering grade	Gravel/ sand	Silt	Clay
xiii.	Discontinuities	I	II, III	IV-VI
	No	–	Yes	

Table 6.18. Hazard score used for fill slopes in SPRS.

Fill slopes hazard attributes	Score		
	1	2	3
i. Slope angle	<45°	45–63°	>63°
ii. Height of slope	<12m	12–24 m	>24m
iii. Slope cover	>20%	<20%	–
iv. Pavement fatigue	No	Yes	
v. Tension cracks	No	–	Yes
vi. Surface drains	Good	Blocked reqd	Repair
vii. Culvert condition	Good cleaning	Need repaid	Need
viii. Seepage	No	–	Yes
ix. Ponding	No	Yes	–
x. Erosion	Slight	Moderate	Critical
xi. Slope failure	No		Yes
xii. Settlement of Road	No	–	Yes
xiii. Soil type			
xiv. Surroundings downslope	Gravel/sand	Silt	Clay
	No	–	Yes

With a Hazard Score of 19 and a Consequence Score of 5, the Risk Score of assessed slope was 95, meaning that the slope is 'Very High' in term of Risk Rating.

### *Slope Information Management System (SIMS)*

The Slope Information Management System (SIMS) was developed in 2003 as a cooperation effort between the Public Works Department and JICA (Japanese International Cooperation Agency) in order to enhance the previous SPRS system. The study also evaluated shortcomings of the previous three slope management systems in use and this is in Table 6.22.

Table 6.19. Consequence score used in SPRS.

Consequence attributes	Score		
	0	1	2
i. Danger to building occupants	No	–	Yes
ii. Danger to vehicle occupants	<200	200–1000	>1000
iii. Alternative road exists	AADT	AADT	AADT
	Yes	No	–
iv. By-pass possible			
v. Angle $\beta$ (road center-line to crest or embankment toe)	Yes	No	–
	<19°	19–27°	>27°

Table 6.20. Risk score and rating used in SPRS.

Cut slope		Fill slope	
Risk score	Risk rating	Risk Score	Risk rating
76–100	Very High	80–100	Very High
56–75	High	60–79	High
36–55	Moderate	40–59	Moderate
16–35	Low	20–39	Low
0–35	Very Low	0–32	Very Low

The system uses slope inventory form modified from the previous three systems as well as experience gained by the Public Works Department and the JICA (Japanese International Cooperation Agency).

Hazard scores used in the system vary from previous systems and this is shown in Table 6.23.

The natural and possible consequences used in SIMS are as shown in Table 6.24.

Risk values are then calculated as the sum of 0.9 of the total hazard and consequence values ( $R= 0.9H+C$ ) and this is then translated to a qualitative risk rating for the slope ranging from very high, high, moderate to low. The risk rating used in SIMS is shown in Table 6.25.

*Slope Management and Risk Tracking (SMART)*

The Public Works Department is currently embarking on the latest slope management system called SMART (Slope Management and Risk Tracking System). The system has been completed but is subject to further verification before it can be used. The system is developed for the Tamparuli-Sandakan road where there have been numerous slope failures. The system uses slope inventory forms similar to previous slope management systems such as SMS, MEHMS and SIMS with some slight modifications. The system also uses spatial data taken from LiDaR (Light Detection and Ranging) survey which uses laser. Statistical analysis was then carried out to determine the hazard and risk scores.

Table 6.21. Example of how hazard score and risk rating are assigned to a cut slope in SPRS.

Fill slopes hazard attributes	Condition	Hazard score
Slope angle	55°	1
Height of slope	60 m	2
Slope cover	Bush 75%	0
Surface drains	Bench drain crack	2
Natural water path	No	0
Seepage	Yes	2
Ponding	No	0
Erosion	Severe gully	2
Slope failure	Circular tension crack	2
Surroundings upslope	Logging activity	2
Soil type	Silty clay	2
Weathering grade	VI (Residual soil)	2
Discontinuities	IV (Daylighting )	2
	Total hazard score	19
Consequence attributes	Conditions	Consequence score
Danger to building occupants	No	0

Danger to vehicle	1500 AADT	2
Alternative road occupants exist	Yes	0
By-pas possible	No	1
Angle $\beta$	30°	2
	Total consequence score	5
	Risk score	95

### *Malaysian Center for Remote Sensing (MACRES)*

Ab. Talib (1997) described the use of remote sensing data and GIS techniques for the development of hazard mapping for slope instability and prediction in Cameron Highlands in the State of Perak. The study used the Information Values method to indicate the most relevant factors influencing slope instability.

Ab. Talib (2001) also described the use of the same technique as described above to produce hazard zonation mapping for the State of Selangor in Peninsular Malaysia. Parameter maps were generated from geological, land use, geomorphological, slope and distance maps.

Table 6.22. Shortcomings of the three slope management systems (JICA-PWD 2001).

Type of system	Shortcomings
SMS	Data only for 7 geological types Referencing system confusing Part of hazard and risk analysis missing No financial estimates for repair
MEHMS	Data for 2 geological types only Referencing system confusing No form for data entry Hazard analysis not automated Cannot generate report No financial estimates for repair
SPRS	Data from earlier system cannot be put in Accuracy of hazard and risk questionable Estimates for repair not reliable No cost benefit analysis

All the parameter maps were analysed using ILWIS and ARC-Info software. It was found that part of the Hulu Langat, Cheras, Ampang and Sungei Buluh areas were the main areas of frequent landslide occurrences. Abu Talib described the Information method developed by Yin & Yan (1988) and Kobashi & Suzuki (1988) which is given by Equation 6.4.ww

$$I_i = \ln(S_i/N_i) / S/N \tag{6.4}$$

where

$I_i$ =information value associated with variable  $X_i$ ;

$S_i$ =number of pixels with mass movements (landslide) associated with variable  $X_i$ ;

$N_i$ =the number of pixels of variable  $X_i$ ;  $S$ =the total number of pixels with mass movements;  $N$ =the total number of pixels in the study area.

The degree of hazard for a pixel  $j$  is determined by the total information values  $I_j$  which is given by Equation 6.5.

$$I_j = \sum_{i=0}^m X_{ij} I_i \tag{6.5}$$

where

$m$ =number of variables

$X_{ij}$ =0 if the variable  $x$  is not present in the pixel  $j$  and 1 if the variable is present

Abu Talib also gave weightage values based on the information method for slope classes and geomorphological unit for the study areas as shown in Tables 6.26 and 6.27.

***Mineral and geoscience department***

Chow & Mohamad (2002) described the use of terrain classification maps by the Mineral and Geoscience Department of Malaysia, which are based on four attributes namely slope gradient, morphology, activity and erosion & instability. Derivative maps are then prepared using the GIS system (using Arc Info or TIN software). The various maps that are produced are the landform map, erosion map, physical constraints map, engineering geology map and land use suitability map. A case study of Cameron Highlands is described.

Table 6.23. Hazard score used in SIMS.

Condition of Slope (for slope failure/rock fall)			Score
Topography	Alluvium slope	Yes	2
		No	0
	Trace of slope failure	Yes	1
		No	0
	Clear knick point or overhanging	Yes	1
		No	0
	Concave slope or debris slope	Yes	1
		No	0

Geometry; select higher point of A or B	A: Soil slope	H>30m	30
		H≤30m, I>45°	24
	<i>H: High of soil</i>	15m≤H<30m,	20
		I≤45°	
	<i>I: Slope angle</i>	H<15m	10
	B: Rock slope	H>50m	30
		30m≤H<50m	26
15m≤H<30m		20	
Material; select A and B	A: Soil character; Swelling clay contents	Conspicuous	8
		Slightly	4
		None	0
	B: Rock quality; Sheared rock, Weathered rock	Conspicuous	8
		Slightly	4
		Not available	0
	Geological Structure	Daylight structure (Planar, wedge)	Yes
No			0
Soft soil over base rock		6	
Hard rock over weak rock		4	
Others		0	
Deformation	Slope	Visible	10
	Deformation: Erosion (gully, rill, sheet, fretting), rockfall, exfoliation etc.	Obscure	8
		None	0
	Deformation at adjacent slope (rock fall, slope failure, crack, etc.)	Visible	6
		Obscure	4
	None	0	
Surface Condition	Condition of Surface	Unstable	8
		Moderate	6
		Stable	0

		Natural spring	6
Ground Water		Water seepage	3
		Dry	0
		Bare	4
Cover		Grass+Structure	3
		Structure	1
Surface Drainage		Available (good)	0
		Available (need repair)	2
		Not available	1
Countermeasure effectiveness	Effective		-20
	Partially effective		-10
	Not effective or No countermeasure		0

Table 6.24. Consequence values used in SIMS.

Nature of probable consequence	Score	
Services, Public Utilities; If gas, oil, telecom, electric or water pipeline are available, mark 'Yes'	Yes	2
	No	0
Danger to building occupants; Only mark 'Yes' if distance from toe of slope <2H (H—Height of Slope)	Yes	2
	No	0
Volume of Traffic (AADT = Annual Average Daily Traffic)	>1,000 AADT	2
	200–1,000 AADT	1
	<200 AADT	0
Angle $\beta$ (road at center-line to crest or embankment toe)	>30°	1
	≤30°	0
Failure size: a. Cut Slope (m <sup>3</sup> ),	a. >3,000 or	1
	b. >1,000	
b. Embankment (m <sup>3</sup> )	a.<3,000 or	0
	b.<1,000	

Construction Period of	>1 day	1
Temporary Diversion	≤1 day	0
Length of Alternative Roads	>50km	1
	<50km	0

Table 6.25. Risk rating used in SIMS.

Level of slope management	Risk score	Risk rating
Level I	$R \geq 75$	Very High
Level II	$75 > R \geq 65$	High
Level III	$65 > R \geq 50$	Moderate
Level IV	$R < 50$	LOW

Table 6.26. Information value weightage for slope classes (Abu Talib 2001).

Slope classes	Slope range	Information value weightage
1	0–10 degrees	-0.3563
2	10–20 degrees	0.6225
3	20–30 degrees	0.3024
4	30–40 degrees	0.6064
5	40–50 degrees	0.6096
6	50–60 degrees	0.8093
7	>60 degrees	1.63

Landslide hazard maps are then produced after the vegetation cover and seepage is studied. The classification of hazard and the hazard score used by the Mineral and Geoscience Department is shown in Table 6.28.

Table 6.27. Information values weightage for geomorphological unit (Abu Talib 2001).

Geomorphological unit	Information value weightage
Alluvial plain	-0.9875
Water body	0.3734
Flood plain	-0.0774
River/fluvial terrace	-1.9232



Valleyfill	-0.8116
Residual hill	0.2408
Denudational hill	0.5746
Structural hill	1.1471
Piedmont zone	1.0676
Blocky hill	0.6477
Scarp	2.3586
Top Hill	2.1556

Table 6.28. Classification of landslide hazards rating (Chow &amp; Mohamad 2002).

Class	Hazard rating	Hazard score
1	Low	<0.25
2	Moderate	0.26–0.5
3	High	0.51–0.75
4	Very High	≤0.76

Landslide risk scores are then calculated using the standard equation as shown by Equation 6.3. The consequence and risk scores suggested by Chow & Mohamad (2002) are shown in Tables 6.29 and 6.30.

#### *Projek Lebuhraya Utara-Selatan (PLUS)*

PLUS has also developed their own slope ranking criteria to monitor slopes along the North-South Expressway which starts from Bukit Kayu Hitam in Kedah to Johore Baru in Johore. This is shown in Table 6.31. The slope ranking ranges from AA to C which ranges from very critical to critical but no details on the range of values and how each ranking is calculated is given (PLUS 2003).

#### *Kumpulan Ikram Sdn Bhd (KISB)*

Mahmud & Fadlee (2002) from KISB described the use of aerial photos, GIS and GPS in slope management in Malaysia. Some case studies were mentioned such as Bukit Antarabangsa landslide in Ampang and the Paya Terubung landslide in Penang.

*University Putra Malaysia (development of D-Slope)*

D-Slope is an expert system developed for the evaluation of the potential failure of the cut slopes, Omar (2002). The proposed system composed of three major elements namely Field Data, Slope Evaluation Analysis and Expert System Tool (Figure 6.5). Slope assessment system used in D-Slope is based on selected geological parameters, hydrogeology parameters and slope properties. There are nine geological parameters selected for assessment namely geology, weathering, faults, joints, numbers or major sets, orientation, aperture, persistence and spacing.

Table 6.29. Weightage for consequential score (Chow & Mohamad 2002).

Type of risk	Landuse/premises	Weightage
Risk of lives	Critical buildings affected	20
	Normal buildings affected	10
	Isolated building affected	5
	Very busy trunk road	10
	Busy trunk road	7
	Moderately used trunk road	5
	Seldom used trunk road	1
Economic loss	Damage to farm/park	3
	Business area (only access)	10
	Only access to housing area	6
	Temp. diversion (>1 day)	3
	Temp. diversion ( $\geq 1$ day)	0
	Alternative road ( $\leq 5$ km)	3
	Alternative road (<5 km)	0
Public	Affected	10
Utilities	Not affected	0
Proximity of building to suspected landslide	Very close	10
	Close	5
	Possibly affected	2
	Unlikely to be affected	0
	Not affected	0

There are two hydrogeology parameters selected for assessment i.e. rainfall and hydraulic conditions.

For the slopes properties, two attributes are selected in the assessment, namely slope height and previous instability.

In developing the G-Rating, the individual risk rating has been assigned to each of the 13 parameters for each slope based on the analysis of the field collected data. The rating is relatively simple with associated ratings of 0, 1, and 2 are used according to the definitions of each parameters. This simple rating was adopted from Mazzoccola and Hudson (1996).ww

Table 6.30. Classification of landslide risk rating (Chow & Mohamad 2002).

Rating	Total score
Low risk	<12.5
Moderate risk	12.6–25
High risk	26–35
Very high risk	>35

Table 6.31. Slope ranking criteria to monitor slopes along the North-South Expressway used by PLUS.

Slope Ranking Criteria	AA (Very Critical)	A (Critical)	B (Partially Critical)	C (Not critical)
Hazard	<ul style="list-style-type: none"> <li>• Very large earthworks close to road</li> <li>• A real risk exist</li> </ul>	<ul style="list-style-type: none"> <li>• Most large earthworks</li> <li>• Some risk to road users</li> </ul>	<ul style="list-style-type: none"> <li>• Average size earthworks</li> <li>• Quite unlikely but possibility of danger exists</li> </ul>	<ul style="list-style-type: none"> <li>• Minor risk that can be ignored</li> <li>• Most modest earthworks</li> </ul>
Failure risk	<ul style="list-style-type: none"> <li>• Large with poor maintenance and defects</li> <li>• Quite likely failure will occur at some stage</li> </ul>	<ul style="list-style-type: none"> <li>• Moderate to large, impossible to say failure will not occur</li> </ul>	<ul style="list-style-type: none"> <li>• Moderate size</li> <li>• Major failure unlikely</li> </ul>	<ul style="list-style-type: none"> <li>• Small and shallow, extremely unlikely and only minor failure</li> </ul>
Deterioration	<ul style="list-style-type: none"> <li>• Varied cover, needs urgent attention</li> </ul>	<ul style="list-style-type: none"> <li>• Non uniform cover with bare patches</li> </ul>	<ul style="list-style-type: none"> <li>• Generally good cover with isolated poor areas</li> </ul>	<ul style="list-style-type: none"> <li>• Slope that is not quite perfect</li> </ul>

	<ul style="list-style-type: none"> <li>Advanced deterioration due to poor maintenance, erosion</li> </ul>	<ul style="list-style-type: none"> <li>Deterioration significant</li> </ul>	<ul style="list-style-type: none"> <li>General deterioration noticeable</li> </ul>	<ul style="list-style-type: none"> <li>Slope cover is good with minor deterioration</li> </ul>
Cost/Nuisance	<ul style="list-style-type: none"> <li>Investment is high/failure can cause serious problems</li> </ul>	<ul style="list-style-type: none"> <li>Fairly high investment, large slope on busy section of highway</li> </ul>	<ul style="list-style-type: none"> <li>Moderate slopes where failure would not cause significant effects to normal highway operations</li> </ul>	<ul style="list-style-type: none"> <li>Moderate slopes away from centre of attention</li> <li>Slopes that would not attract adverse publicity if fails</li> </ul>
Size	<ul style="list-style-type: none"> <li>Greater than 10 berms</li> <li>Very large earthworks or deep embankment</li> </ul>	<ul style="list-style-type: none"> <li>4 berms or more</li> <li>most modest sized slopes &lt; 60m high or moderate embankment</li> </ul>	<ul style="list-style-type: none"> <li>About 3 berms</li> <li>Modest sized slopes less than 20m high</li> </ul>	<ul style="list-style-type: none"> <li>Small earthworks</li> <li>2 berms or less</li> </ul>

Where AA=maintenance carried out every 4 months; A=Maintenance carried out every 6 months; B=Maintenance carried out every 12 months; C=Maintenance carried out every 18 months.



Figure 6.5. Schematic diagram of three major elements.

Table 6.32. Level of risk established for D-Slope (Omar 2002).

Level of risk	G-Rating	PI
No risk	<0.4	YES or NO
Low risk	0.4–0.5	YES
Medium risk	0.5–0.7	YES
High risk	>0.7	YES

Table 6.33. Example of risk assessment using D-Slope (Omar 2002).

Location: Pos Selim Highway

Chainage: 09+400

Parameter	Condition	Rating
Geology	Granite	0
Weathering grade	Moderately weathered	1
Faults	Not present	0
Joints	Major	2
Number of major sets	5	2
Number of orientation	4	1
Aperture	1–2 mm	0
Persistence	10–20m	1
Spacing	2mm	1
Slope height	36m	1
Previous instability	Active	2
Rainfall	73–143 mm	1
Hydraulic condition	Flow	2
	Sum of individual rating	14
	G-Rating (14/26)	0.54

The total of individual ratings for the particular slope was determined by summing the individual rating ( $R_i$ ) collected at site. Thus,

$$\sum R_i = R_{ig} + R_{iw} + R_{ij} + R_{ij} + R_{ims} + R_{io} + R_{ia} + R_{ip} + R_{is} + R_{ir} + R_{ihc} + R_{ish} + R_{ipi}$$

The maximum rating ( $R_{max}$ ) for each individual parameter is 2. So, the total maximum rating was determined by summing the individual maximum rating, which gives the value 26. Thus,

$$\begin{aligned} \Sigma R_{max} = & R_{maxg} + R_{maxw} + R_{maxf} + R_{maxj} + R_{maxms} + R_{maxo} + R_{maxa} + R_{maxp} + R_{maxs} + R_{maxr} + \\ & R_{maxhc} + R_{maxsh} + R_{maxpi} \\ = & 26 \end{aligned}$$

For the geological rating, G-Rating, the formula is as follows;

$$\text{G-Rating} = \Sigma R_i / \Sigma R_{max}$$

where G-Rating = Risk hazard value of potential failure;  $\Sigma R_i$  = Total individual rating;  $\Sigma R_{max}$  = Total maximum rating.

The potential instability (PI) of assessed slope then was determined using stereographical plot or stereonet technique. The PI for slope potential to fail based on the analysis will be assigned as YES, otherwise NO.

Using G-Rating and PI, level of risk was established as shown in Table 6.32.

An example of how the rating was given to the inspected slope and how the risk level is assigned is shown in Table 6.33 below.

With G-rating of 0.54 and say PI is YES, the level of risk of assessed slope was 'Medium risk'. The level of risk for the assessed slope is 'No risk' if the PI is NO.

## REFERENCES

- Ab. Talib, J. 1997. Slope instability and hazard zonation mapping using remote sensing and GIS techniques in the area of Cameron Highlands, Malaysia. *Asian conference on remote sensing (ACRS)*.
- Ab. Talib. 2001. Landslide hazard zonation mapping of Selangor. *Bulletin of the Institution of Engineers Malaysia* 10(1).
- CERO. 1998. Disaster management fact file. Central emergency relief organisation of Barbados: 8.
- Chow, W.S. & Mohamad, Z. 2002. Terrain and landslide hazards mapping for disaster management. Mineral and Geoscience Department of Malaysia. Internal report.
- Cruden, D.M. 1991. A simple definition of a landslide. *Bulletin of the International Association of Engineering Geology* 43:27–29.
- Cruden, D.M. & Varnes, D.J. 1996. Landslide types and processes. In Turner, A.K. & Schuster R.L. (eds.), *Landslides: Investigation and mitigation*. Ch3. Transportation Research Board Special Report 247:36–75.
- Fiener, Y.A.G. & Ali, F. 1999. Application of hazard and risk maps for highway and slopes management and maintenance. In Yagi, Yamagani & Jiang (eds.), *Slope stability engineering*: 1287–1290. Rotterdam: Balkema.
- Garland, R.J. 2000. A method of rapid risk assessment in slopes using stereo oblique aerial photography. *Landslides in research, theory and practice*: 609–614. London: Thomas Telford.
- GEO. 1984. Geotechnical manual for slopes. Geotechnical Engineering Office, Hong Kong: 279.
- GEO. 1998. Landslides and boulder falls from natural terrain: interim risk guidelines, *Geo Report* 75. Geotechnical Engineering Office, Hong Kong: 183.
- GEO. 2000. Consequence classifications used by the Geotechnical Engineering Office. *GEO information note 8/2000*, Geotechnical Engineering Office, Hong Kong: 6.

- GEO. 2003. Guidelines for classification of consequence-to-life category for slope features. *GEO technical guidance Note No.15*, Geotechnical Engineering Office, Hong Kong: 14.
- Grainger P. & Kalaugher, P.G. 1991. Cliff management: a photographic monitoring system. *Slope stability engineering*. London: Thomas Telford.
- Hartlen, J. & Viberg, L. 1995. General report: evaluation of landslide hazard. *5th international symposium on landslides, Lausanne, Switzerland*. 2:1037–1058.
- Hardingham, A.D., Ditchfield, C.S., Ho, K.K.S. & Smallwood, A.R.H. 1997. Quantitative risk assessment for landslides—a case study for Hong Kong. *Seminar on slope engineering in Hong Kong*: 145–151.
- Hussein, A.N., Kassim, K., Lai, K.O. & Jamaludin, S. 2000. A slope management system for prioritisation of cut and fill slopes in Malaysia. *10th REAAA conference: Road development for 21st Century, Tokyo, Japan*: 9.
- Ho, K., Leroi, E. & Roberds, B. 2000. Quantitative risk assessment.: Application, myths and future direction. *GeoEng 2000*, Melbourne. CD Rom: SNES 411.
- Ho, K.K.S. & Wong, H.N. 2001. Application of quantitative risk assessment in landslide risk management in Hong Kong. In Ho & Li (Eds). *Geotechnical Engineering 1*: 123–128.
- Hutchinson, J.N. 1995. General report: morphological and geotechnical parameters of landslides in relation to geology and hydrogeology. *5th International symposium on landslides, Lausanne, Switzerland*. 2:3–36
- Irigaray, C., Hacon, J. & Fernandez, T. 1996. Comparative analysis of methods for landslide susceptibility mapping. In Chacon, Irigaray & Fernandez (eds), *Landslides*. Rotterdam: Balkema.
- Jamaludin, A., Muda, Z. & Alias, S. 1999. Application of hazard and risk mapping to a mountainous highway in Malaysia. In Yagi, Yamagani & Jiang (eds.), *Slope stability engineering*. Rotterdam: Balkema.
- Jennings, P.J., Siddle, H.J. & Bentley, S.P. 1991. A comparative study of indirect methods of landslide potential assessment. In R.J. Chandler (ed), *Slope stability engineering: Developments and applications*. U.K: Thomas Telford.
- JICA-PWD. 2001. The study on slope disaster management for federal roads in Malaysia. Interim Report: 405.
- Kitazono, Y, Suzuki, A., Nakasone, N. & Terazono, T. 1999. Risk evaluation for slope failure based on geographical information data. In Yagi, Yamagani & Jiang (eds.), *Slope stability engineering*. Rotterdam: Balkema.
- Kobashi, S. & Suzuki, M. 1988. Hazard index for the judgement of slope stability in the Rokko Mountain region. *Proceedings of INTRAPRAEVENT Graz, Austria*. 1: 223–233.
- Kockelman, W.J. 1986. Some techniques for reducing landslide hazards. *Bulletin of the Association of Engineering Geologists* 23(1): 29–52.
- Ko Ko, C., Flentje, P & Chowdury, R. 1999. Landslide risk assessment-development of a hazard-consequence approach, In Yagi, Yamagami & Jiang (eds). *Slope stability engineering*. Rotterdam: Balkema.
- Lloyd, D.M., Anderson, M.G., Hussein, A.N., Jamaludin, A. & Wilkinson, P.L. 2001. Preventing landslides on roads and railways: a new risk-based approach. *Civil Engineering* 114 (8): 129–134.
- Mahmud, M. & Fadlee, M. 2002. Application of aerial photos, GIS and GPS in slope management. *Second IKRAM international geotechnical conference, Kuala Lumpur, Malaysia*: 125–138.
- Mazzocola, D.F. & Hudson, J.A. 1996. A comprehensive method of rock mass characterization for indicating natural slope instability. *The Quarterly Journal of Engineering Geology* 29:37–56.
- Michael-Leiba, M, Baynes, & Scott, G. 2000. Quantitative landslide risk assessment of Cairns, Australia. *Landslides in research, theory and practice*. London: Thomas Telford.
- Nakano, J. & Miki. 2000. Risk evaluation method for rock bed and slope failures in road disaster management. *GeoEng 2000*, Melbourne. CD Rom: SNES 411.

- NLIC. 2003. Frequently asked questions (FAQ). *National landslide information center*: Webpage (landslides.usgs.gov).
- OAS. 1991. Ch 10: Landslide hazard assessment. *Primer on natural hazard management in integrated regional development*. Organization of American States.
- Omar, H. 2002. Development of risk assessment and expert systems for cut slopes. PhD thesis, University Putra Malaysia.
- PLUS. 2003. Slope ranking criteria. *Private communication*.
- Soeters, R. & van Westen, C.J. 1996. Slope instability recognition, analysis and zonation. In Turner, A.K. & Schuster, R.L. (eds.), *Landslides: Investigation and mitigation* Ch8:129–177. Transportation Research Board Special Report 247.
- Schuster, R.L. 1991. Landslide hazard management-experience in the United States. *Slope stability engineering*. London: Thomas Telford.
- Varnes, D.J. 1984. Landslide hazard zonation: A review of principles and practice 63. Paris: *UNESCO Press*.
- Wong, C.K.M. & Lee, C.K.T. 1999. Applications of quantitative landslide risk assessment in Hong Kong. In Yagi, Yamagani & Jiang (eds.), *Slope stability engineering*. Rotterdam: Balkema.
- Yin, K.L. & Yan, T.Z. 1988. Statistical prediction method for slope instability for Metamorphosed Rocks. *5th International symposium on landslides, Lausanne, Switzerland*. 2:1269–1272.



# CHAPTER 7

## Guidelines for development on hill-sites

Gue See-Sew & Tan Yean-Chin  
*Gue & Partners Sdn Bhd, Kuala Lumpur, Malaysia*

In Malaysia, there has been a tremendous increase in construction of residential buildings on hill-sites over the last 15 years especially due to depleting flat land and other influencing factors like beautiful scenery, fresh air, exclusiveness, etc. Often hill-site development is related to landslides, and safety of buildings on hill-sites is often a topic of discussion among engineers and the public. The truth is hill-site development can be safe with proper planning, design, construction and maintenance. This chapter presents brief guidelines on the engineering aspects of hill-site development. A simplified classification of landslide risk for hill-site development and recommendations by The Institution of Engineers, Malaysia (IEM) will also be discussed in this chapter together with the current legislation related to hill-site development in Malaysia.

### 7.1 INTRODUCTION

Safety of buildings and slopes on hill-sites is often a topic of discussion among engineers and the public. The discussions intensify each time a landslide is highlighted by media and this usually happens during the monsoon seasons. The collapse of Block 1 of Highland Towers in 1993, landslides at Bukit Antarabangsa in 1999, and the recent tragic landslide at Taman Hillview in November 2002 have worried the public particularly those who are staying on a hill-site or planning to purchase a unit on one.

Hill-site development is safe with proper planning, design, construction and maintenance. Engineers with good engineering expertise on soil/rock slopes and foundation designs are usually engaged to design for a hill-site development to safeguard the safety of the public from landslide hazards.

This chapter summarises some of the statute related to hill-site development and presents brief guidelines on the engineering aspects of hill-site development for general engineers.

## 7.2 POSITION PAPER ON MITIGATING THE RISK OF LANDSLIDE ON HILL-SITE DEVELOPMENT

With the recent awareness of the difficulty and risks involved in building on hill-sites, a more systematic control of hill-site developments is taking shape through the public and private sectors. One is the position paper titled 'Mitigating the Risk of Landslide on Hill-Site Development' (IEM 2000) prepared by The Institution of Engineers, Malaysia.

In the IEM position paper, it is proposed that the slopes for hill-site developments be classified into three classes and the necessary requirements are as follows:

- *Class 1 Development (Low Risk)*: Existing Legislation Procedures can still be applied.
- *Class 2 Development (Medium Risk)*: Submission of geotechnical report prepared by professional engineer to the authority is mandatory. The taskforce viewed a professional engineer for hill-site development as those with the relevant expertise and experience in analysis, design and supervision of construction of the slopes, retaining structures and foundations on hill-site.
- *Class 3 Development (Higher Risk)*: Other than submission of geotechnical report, the developer shall also engage an 'Accredited Checker' (AC) in the consulting team. In the original proposal by the taskforce, the AC shall have at least 10 years relevant experience on hill-site development and have published at least five (5) technical papers on geotechnical works in local or international conferences, seminars or journals.

The general risk classification is based on the geometry of the slopes such as height and angle for simplicity of implementation by non-technical personnel in our local authorities, although under actual conditions are many other factors that also affect the stability of the slopes such as geological features, engineering properties of the soil/rock, groundwater regime, etc. In order to facilitate the implementation of the classification, simple geometry has been selected as the basis for risk classification. Table 7.1 summarizes the details of the classification and Figure 7.1 shows the geometries of slopes referred for classification (IEM 2000a, Gue & Tan 2002).

Table 7.1. Classification of risk of landslide on hill-site development (after IEM 2000).

Class	Description
1 (Low risk)	For slopes either natural or man made, in the site or adjacent to the site not belonging to Class 2 or Class 3.
2 (Medium risk)	For slopes either natural or man made, in the site or adjacent to the site where: <ul style="list-style-type: none"> <li>• <math>6\text{m} \leq H_L \leq 15\text{m}</math> and <math>\alpha_G \geq 27^\circ</math> or</li> <li>• <math>6\text{m} \leq H_L \leq 15\text{m}</math> and <math>\alpha_L \geq 30^\circ</math> with <math>H_L \geq 3</math> m or</li> <li>• <math>H_L \leq 6\text{m}</math> and <math>\alpha_L \geq 34^\circ</math> with <math>H_L \geq 3</math> m or</li> <li>• <math>H_L \geq 15</math> m and <math>19^\circ \leq \alpha_G \leq 27^\circ</math> or <math>27^\circ \leq \alpha_L \leq 30^\circ</math> with <math>H_L \geq 3</math> m</li> </ul>

3 (Higher risk) Excluding bungalow (detached unit) not higher than 2-storey.  
 For slopes either natural or man made, in the site or adjacent to the site where:

- $H_T \geq 15\text{m}$  and  $\alpha_G \geq 27^\circ$  or
- $H_T \geq 15\text{m}$  and  $\alpha_L \geq 30^\circ$  with  $H_L \geq 3\text{m}$

$H_T$  = Total height of slopes

= Total height of natural slopes & man made slopes at site and immediately adjacent to the site which has potential influence on the site. It is the difference between the Lowest Level and the Highest Level at the site including adjacent site.

$H_L$  = Height of Localised Slope which Angle of Slope,  $\alpha_L$  is measured.

$\alpha_G$  = Global Angle of Slopes (Slopes contributing to  $H_T$ ).

$\alpha_L$  = Localise Angle of Slopes either single and multiple height intervals.

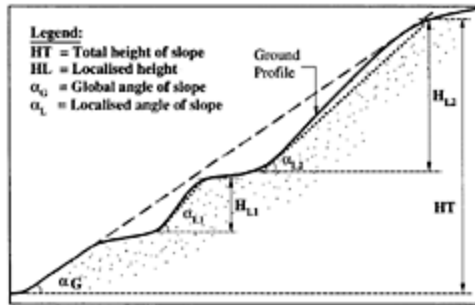

Figure 7.1. Geometries of slope (after IEM 2000).

From the review of several case histories of landslides in Malaysia, IEM (2000a) summarises the causes of the failures as follows:

- Design—inadequate subsurface investigation and lack of understanding of analysis and design.
- Construction—lack of quality assurance and quality control by contractors.
- Site supervision and maintenance—lack of proper site supervision by consulting engineers during construction and lack of maintenance after construction.
- Communication—lack of communication amongst various parties during construction.

The IEM position paper also proposes that a new federal department called ‘Hill-Site Engineering Agency’ be formed under the Ministry of Housing and Local Government to assist local authorities in respect to hill-site development. The Agency is to assist local authorities to regulate and approve all hill-site developments. The Agency could engage or outsource, whenever necessary, a panel of consultants to assist and expedite implementation. For existing hill-site development, the Agency should advise the local government to issue ‘Dangerous Hill-Side Order’ to owners of doubtful and unstable slopes so that proper remedial and maintenance works can be carried out to stabilize unstable slopes and prevent loss of lives and properties.

## 7.3 STATUTE RELATED TO HILL-SITE DEVELOPMENT IN MALAYSIA

### *Definition of hill-site in Malaysia*

There is no legal definition of Hill-Site development. Some agencies have proposed various classification systems to suit their own usage. The most common ones are based on altitude and/or slope gradient of the original topography before development. According to the Ministry of Housing and Local Governments of Malaysia (KPKT 1997), hill-sites will be classified as high risk if the lands have natural or original gradient of the slopes of 25 degrees and steeper.

In the EPU (2002) report prepared by WWF, it was stated that a consistent classification of highlands should be adopted throughout the country. Hence it gives the proposed definition based on altitude as follows:

- 0m-150m=Lowland
- 150 m-300 m=Hill Land
- 300 m-1000 m=Highland
- Above 1000m=Mountain

### *Planning Stage*

In the planning stage, Section 22 of The Town & Country Planning Act 1976 as amended in 2001 has widened the statutory requirements in granting planning approval or development order (DO). This section allows local authorities to regulate hill-site developments (defined as hill tops or hill slopes in the Act) by imposing a list of conditions to ensure sustainability, environmentally friendly and of course, public safety. The Act also states that planning approval may be subjected to certain conditions, namely the prohibition of damage to the land, natural topography and landscape, prohibition of the removal or alteration of any natural features of the land and, the prohibition of the felling of certain trees.

In the stage of planning permission, many local authorities also require earthwork and building plans to be submitted together with the application of DO. Recently, the State of Selangor and Penang have imposed the requirements of a Geotechnical Report as well as an Independent Geotechnical Report submitted by separate geotechnical engineers for areas which local authority is of the opinion that the proposed development site falls under the category of high risk.

Section 70 of The Street, Drainage & Building Act (Act133) 1974 (amendments 1994) also gives local authorities the power to impose the additional condition. Under this Act, local authorities can give written directions to the person submitting a plan and specification in respect of compliance with 'This or Other Act' which would include compliance with the Town & Country Act, Land Conservation Act and Environmental Legislation.

On the environmental aspects, The Environmental Quality Act 1974 gives the Minister the power to order and prescribe conditions on any activity which may have significant environmental impact. The following two prescribed activities under The Environment Quality (Prescribed Activities) (EIA) Order 1987 are relevant to hill-site development:

- Conversion of hill forest land to other land-use covering an area of 50 hectares or more (Paragraph 6: Forestry)
- Hillstation resort or hotel development covering an area of 50 hectares or more (Paragraph 17:Resort and Recreational Development)

Environmental Impact Assessment (EIA) Report should be carried out according to prescribed guidelines, particularly in relation to assessment of the impact or likely impact of such development on the environment and proposed measures to prevent, reduce or control the adverse impact on the environment are being incorporated (534A of EQA).

In some states, The Land Conservation Act 1960 has been applied to prescribe certain areas as hill-land by notification in gazette (S.3). For example lands in Penang that are generally above 1,000 ft (300 m) have been prescribed as hill land and therefore development is not allowed (S.6). The technical definition for the gazette is not provided and the classification is unclear and merely based on altitude.

### *Design and construction stage*

Section 70 of The Street, Drainage & Building Act (Act133) 1974 (amendments 1994), requires submission of infrastructure and building plans before construction is allowed. Earthwork precedes building construction and it is a common practice to get infrastructure plans including earthwork be approved first while preparation for actual building plans are in progress. This allows the developer to reduce the holding time and save on cost.

The earthwork plans should also include detailed mitigation plans to control the adverse impact on the environment especially erosion, siltation and additional runoff due to the proposed site clearance.

On the safety of earthworks or slope stability aspects, earthwork plans should clearly indicate the cut and fill slopes with the design slope gradients and surface and subsurface drainage details, retaining systems and strengthening measures such as soil nails, rock bolts and etc, if required.

The design of slopes has to consider not only the safety of the slopes within the development site but also within the vicinity which may foreseeably affect the proposed building, if the slope fails. This 'Duties At Common Law' has been reaffirmed by the decision of the High Court and Court of Appeal in the Highland Towers case.

Duties of care to the neighbours in particular those located downslope such that their acts or omissions do not destabilise their neighbour's properties.

## 7.4 PLANNING, ANALYSIS AND DESIGN FOR HILL-SITE DEVELOPMENT

### *Planning of hill-site development*

The planning of hill-site development can be divided into four major sections as follows:

- Desk Study
- Site Reconnaissance
- Subsurface Investigation
- Planning of Layout

### *Desk study*

Desk study includes reviewing of geological maps, memoirs, topographic maps and aerial photographs of the site and adjacent areas so that the engineers are aware of the geology of the site, geomorphology features, previous and present land use, current development, construction activities, problem areas like previous slope failure, etc.

### *Site reconnaissance*

Site reconnaissance is required to confirm the information acquired from the desk study and also to obtain additional information from the site. For hillside development, it is also very important to locate and study the landslip features to identify previous landslides or collapses that can act as an indicator of the stability of the existing slopes.

### *Subsurface investigation*

Subsurface investigation (S.I.) for hill-site development should be properly planned to obtain representative subsurface condition of the whole site such as general depth of soft soil, hard stratum, depth of bedrock, geological weak zones, clay seams or layers, and groundwater regime. The planning of exploratory boreholes shall take into consideration the terrain instead of following a general grid pattern. Usually S.I. can be carried out in two or more stages. Preliminary S.I. usually consists of boreholes and sometimes also includes geophysical survey for a larger area with varying thickness of overburdened subsoil.

The general information on the subsurface profile and properties will be useful when planning the cut and fill and formation of the platform because the depths of hard stratum and bedrock will have major influence on the cost and construction time for earthworks.

Once the preliminary layout of the hill-site development is confirmed, the detailed S.I. should be carried out to obtain the necessary information for detailed geotechnical designs. In the detailed S.I., field tests can be carried out at the following locations:

- Areas of major cut and fill
- Retaining walls
- Buildings or structures with heavy loading

For details on the planning of subsurface investigation and interpretation of test results for geotechnical design, reference can be made to Gue & Tan (2000a) and Gue (1995).

### *Planning of the layout for roads network and platforms*

Different from normal flat ground development, the planning of platform and roads network for hill-site development shall be geotechnical engineering driven with close coordination among developers, planners, architects, and civil & structural engineers. With this, a terrain friendly (less disturbance to the existing vegetated slopes), safe, ease of construction and cost effective development can be achieved. The planning of platform layout for hill-site development shall try to suit the natural contour and minimise cut and fill. Although retaining walls or soil nailing are generally more costly than normal earthwork solution, with proper planning, the use of these retaining systems at critical areas will be effective to reduce significant earthworks that may be more expensive as shown in Figure 7.2.

*Buildings on slopes*

It is a good practice to construct buildings with extended columns above the stable slopes instead of filling a platform on slopes as shown in Figure 7.3. This is to reduce the load acting on the slopes that could reduce the stability of slopes.

If a flat platform is preferred, then it is very important to orientate the building layout to minimise potential differential settlement especially if buildings are on filled ground. This can be achieved by arranging the longitudinal axis of the buildings parallel to the contour lines of the original topography, in which the building is underlain by a fill of more uniform thickness and therefore with less differential settlement. Figure 7.4 shows two different arrangements of buildings on a filled ground. The designer if possible shall refrain from arranging a long building perpendicular to the contour. Care should be taken to eliminate excessive long term settlement.

When piles are used to support buildings on a fill, the design engineer should evaluate negative skin friction (down drag) acting on the piles if the ground is going to settle with time. Slip coating of the piles with bitumen coating or surcharging of the fill to eliminate future settlement are options to eliminate the negative skin friction. However, the slip coating option is more complex and costly. Other more cost effective options include the use of temporary surcharging, floating piles system and rearrangement of layout to reduce differential settlement.

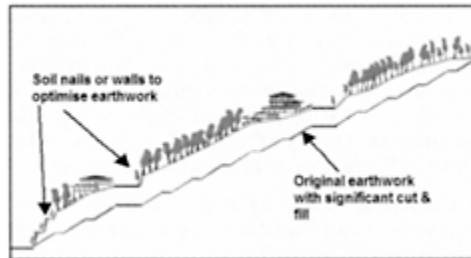

Figure 7.2. Method to optimise earthworks.

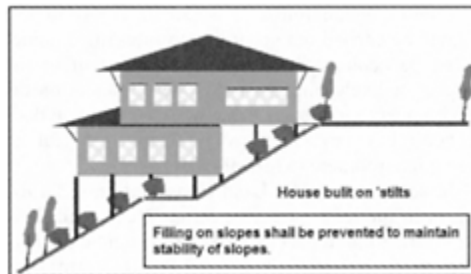

Figure 7.3. Typical building on cut slopes.

### *Analysis and design of slopes*

Although local geology and rainfall characteristics differ in different countries, generally the phenomenon of slope failure occurs in much the same way throughout the world with the fundamental causes not differing greatly with geological and geographical locations. Therefore, the same methods of assessment, analysis, design and also remedial measures can be applied. The only difference is that in tropical areas, the climate is both hot and wet causing deep weathering of the parent rocks and the slopes are of weaker materials.

For the design of the slopes, correct information on soil properties, groundwater regime, geology of the site, selection, and methodology for analysis are important factors that require special attention from the design engineer. For a detailed analysis of soil slopes, reference can be made to Tan & Chow (2004) and Gue & Tan (2000a).

### *Factor of safety for slopes*

For hill-site development in Malaysia, the Factor of Safety (FOS) against slope failure recommended by Geotechnical Manual for Slopes (GCO 1991) of Hong Kong is usually adopted with minor modifications to suit local conditions. When selecting the FOS to be adopted in the stability analysis, the two main factors to be considered are:

- (a) Risk-to-life or consequence to life (e.g. casualties)
- (b) Economic risk or consequence (e.g. damage to properties or services)

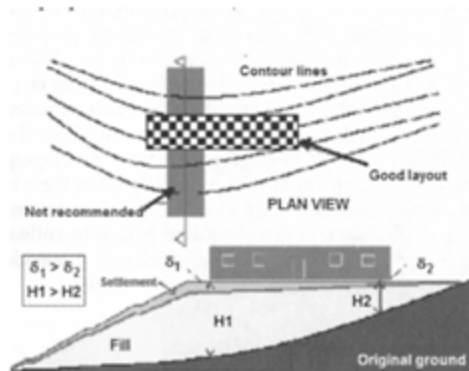

Figure 7.4. Different layout of building on filled ground.

There are three levels of risk in each factor (negligible, low and high) as defined in detail by GCO (1991). The engineer has to use his judgement when deciding the seriousness of the consequence for both loss of life and economic loss. For guidance, reference can be made to Tables 7.2 and 7.3 that list the typical examples of slope failures in each risk-to-life and economic risk categories respectively after GCO (1991).

Generally the slopes are divided into three categories namely:

- New Slopes
- Existing Slopes
- Natural Slopes



For new slopes, the recommended FOS for slopes with groundwater conditions resulting from a ten-year return period, rainfall or representative groundwater conditions are listed in Table 7.4 for different levels of risk. In addition, slopes of high risk-to-life category should have FOS of 1.1 for the predicted worst groundwater conditions using moderately conservative strength parameters (characteristics values).

Table 7.2. Typical examples of slope failures in each risk-to-Life category (modified from GCO 1991).

Examples of failure affecting the following:	Risk-to-life
1. Country parks and lightly used open-air recreation areas.	Negligible
2. Roads with low traffic density.	Negligible
3. Storage compounds (non-dangerous goods).	Negligible
4. Densely used open spaces and recreational facilities (e.g. sitting-out areas, play-grounds, car parks).	Low
5. Roads with high vehicular or pedestrian traffic density.	Low
6. Public waiting areas (e.g. railway platforms, bus stops, petrol station).	Low
7. Occupied buildings (e.g. residential,	High
8. educational, commercial, industrial). Buildings storing dangerous goods.	High

Table 7.3. Typical examples of slope failures in each economic risk category (modified from GCO 1991).

Examples of failure affecting the following:	Risk-to-life
1. Country parks.	Negligible
2. Rural, feeder, district distributor and local distributor roads which are not sole accesses.	Negligible
3. Open-air car parks.	Negligible
4. Rural or primary distributor roads which are not sole accesses.	Low
5. Essential services which could cause loss of that service for a temporary period (e.g. power, water and gas mains).	Low
6. Rural or urban trunk roads or roads of strategic importance.	High
7. Essential services, which could cause loss of that service for an extended period.	High
8. Buildings, which could cause excessive structural damage.	High

An existing slope should be analyzed to check for its stability and to determine the extent of any remedial or preventive works required. If the engineer has the opportunity to examine the geology and subsoil conditions of the slope closely and can obtain more realistic information on the groundwater, the FOS for existing slopes recommended in Table 7.5 may be used. Otherwise, if substantial modification to the existing slopes is required, the recommended FOS in Table 7.4 shall be adopted.

Table 7.4. Recommended factor of safety for new slopes.

Economic risk	Risk-to-life		
	Negligible	Low	High
Negligible	>1.0	1.2	1.4
Low	1.2	1.2	1.4
High	1.4	1.4	1.4

Note:

1. The FOS above is based on Ten-Year Return Period Rainfall or Representative Groundwater Conditions.
2. A slope in the high risk-to-life category should have a FOS of 1.1 for the predicted worst groundwater conditions.
3. The FOS listed are recommended values. Higher or lower FOS must be warranted in particular situations in respect to both risk-to-life and economic risk.

Table 7.5. Recommended FOS for existing slopes.

FOS against loss of life for a ten-year return period rainfall		
<i>Negligible</i>	<i>Low</i>	<i>High</i>
>1.0	1.1	1.2

Note:

1. These FOS are minimum values recommended only where rigorous geological and geotechnical studies have been carried out, where the slope has been standing for considerable time, and where the loading conditions, the ground water regime and the basic form of the modified slope remain substantially the same as those of the existing slope.
2. Should the back-analysis approach be adopted for the design of remedial or preventive works, it may be assumed that the existing slope had a minimum FOS of 1.0 for the worst known loading and groundwater conditions.
3. For a failed or distressed slope, the causes of the failure or distress must be specifically identified and taken into account in the design of the remedial works.

It is very important to be aware that not all natural slopes are safe. It is very common for natural slopes to fail during a monsoon though there may not be any activity like clearing of trees or development around it. Therefore the stability of the natural slopes in or adjacent to the site should be evaluated. Usually it is not advisable to disturb the natural slopes and

vegetation just to achieve marginal improvement in stability unless the slope does not have adequate FOS. It is important not to locate buildings on areas that could be affected by landslide of natural slopes, otherwise the recommended FOS in Table 7.4 need to be used for natural slopes.

### *Design of cut slopes*

The vertical interval of slopes between intermediate berms is usually about 5 m to 6 m in Malaysia. GCO (1991) recommends that the vertical interval of slopes should not be more than 7.5m. The typical slope gradient is normally 1V: 1.75 H to 1V: 1.5 H depending on the results of analysis and design based on moderately conservative strength parameters and representative groundwater level. The berms must be at least 1.5m wide for easy maintenance. The purpose of berms with drains is to reduce the volume and velocity of runoff on the slope surface and the consequent reduction of erosion potential and infiltration. Cut slope should be designed to the recommended FOS in Table 7.2 taking into considerations representative geotechnical parameters, geological features (e.g. clay seams) and the groundwater regime.

### *Design of fill slopes*

As in the case of cut slopes, berms of 1.5 m wide at 5 m to 6 m vertical slope interval are commonly used for fill slopes in Malaysia. Usually the fill slope is at one vertical to two horizontal angles (1 V:2H) depending on the subsoil conditions and the material used for filling.

Before placing of fill, the vegetation, topsoil and any other unsuitable material should be properly removed. The foundation should also be benched to key the fill into an existing slope. Free-draining layer conforming to the filter criteria is normally required between the fill and natural ground to eliminate the possibility of high pore pressures from developing and causing slope instability especially when there is an existing surface stream or creek. Sufficient numbers of discharge drains should be placed to collect the water in the filter layer and discharge it outside the limits of the fill and away from the slopes.

### *Surface protection and drainage*

Surface drainage and protection are necessary to maintain the stability of the designed slopes through reduction of infiltration and erosion caused by heavy rain especially during monsoon seasons. Runoff from both the slopes and the catchment area upslope should be effectively cut off, collected and led to convenient points of discharge away from slopes.

When designing surface drainage on steep slopes, it is important to make sure the drains have sufficient capacity to carry the runoff. General guidelines for design of permanent surface drainage is based upon a hundred-year return period rainfall, and temporary drainage is based upon a ten-year return period.

For proper slope drainage, runoff should be channelled by the most direct route away from vulnerable areas of the slope, particularly runoff from behind the top of the slope. Cast-in-situ reinforced concrete berm drains instead of precast drain should be constructed

at all the berms. The berm drains should be suitably reinforced to prevent them from cracking. Cracked berm drains will induce water seeping into the slopes thus reducing the factor of safety of slopes against slip failure.

For large slopes, several stepped channels (e.g. cascading drains) should be employed instead of concentrating into one or two channels only. Since the flow in stepped channels is turbulent, sufficient freeboard must be allowed for splashing and aeration, or energy breakers could be provided. Special attention should also be given to the design of the junctions (e.g. catchpit or sump) of channels due to inevitable turbulence, splashing and vulnerability to blockage by debris.

Surface protection should be provided to slopes formed in materials susceptible to rapid surface erosion or to weakening by infiltration. The most common surface protection used in Malaysia is close turfing or hydro-seeding (slope vegetation). Establishment of vegetation on a slope is governed by several factors such as steepness and material composition of the slopes and weather. The steeper the slope, the greater the effort required to establish vegetation. Generally cut slopes can be regarded as relatively infertile and appropriate fertilisers should be added at the time of planting. If turfing is carried out in the dry season, frequent watering is required to enable the growth of the grass on slopes.

If slope vegetation cannot be carried out or is not suitable for the slope, rigid protection measures would be required. The most common rigid protection measures used in Malaysia is sprayed concrete (shotcrete and gunite) reinforced with BRC and with proper drainage weepholes.

## 7.5 CONSTRUCTION CONTROL

It is very important for the consultant to properly supervise the construction of a hill-site development. The personnel supervising hill-site development especially on the formation of cut and fill slopes, should have sufficient knowledge and experience in geotechnical engineering to identify any irregularities of the subsurface condition (e.g. soil types, surface drainage, groundwater, weak plane such as clay seam etc.) that might be different from that envisaged and adopted in the design. Close coordination and communication between design engineer(s) in the office and supervising engineer(s) are necessary to ensure modification of the design to suit the change of site condition. This should be carried out effectively during construction to prevent failure and unnecessary remedial works during the service life of the project. Site staff should keep detailed records of the progress and the conditions encountered when carrying out the work in particular if irregularities like clay seams and significant seepage of groundwater are observed. Sufficient photographs of the site before, during and after construction should be taken. These photographs should be supplemented by information like date, weather conditions or irregularities of the subsoil conditions observed during excavation.

Whenever possible, construction programmes should be arranged such that the fill is placed during the dry season, when the moisture content of the fill can be controlled more easily. When filling, tipping should not be allowed and all fill should be placed in layers not exceeding 300 mm to 450 mm thick depending on the type of compacting plants used (unless compaction trials prove to be thicker, loose thickness is achievable) in loose form per layer and uniformly compacted in near-horizontal layer to achieve the required degree

of compaction before the next layer is applied. The degree of compaction for the fill to be placed on slopes is usually at least 90% to 95% of British Standard maximum dry density (Standard Proctor) depending on the height of the slope and the strength required.

Cutting of slopes is usually carried out from topdown followed by works like drains and turfing. When carrying out excavation of the cut slopes, care must be taken to avoid overcutting and loosening of the finished surface which may lead to severe surface erosion. Minor trimming should be carried out either with light machinery or by hand as appropriate. It is also a good practice to first construct the interceptor drains or berm drains with proper permanent or temporary outlets and suitable dissipators before bulk excavation is carried out or before continuing to excavate the next bench.

For all exposed slopes, slope protection such as turfing or hydroseeding should be carried out within a short period (not more than 14 days and 7 days during the dry and wet seasons respectively) after the bulk excavation or filling for each berm. All cut slopes should be graded to form suitable horizontal groves (not vertical groves) using a suitable motor grader before hydroseeding. This is to prevent gullies from forming on the cut slopes by running water before the full growth of the vegetation and also to enhance the growth of vegetation.

## 7.6 MAINTENANCE OF SLOPES

Although lack of maintenance of slopes and retaining walls are not a direct cause of failure, failure to maintain slopes, particularly after erosion may propagate and trigger landslides. Therefore regular inspection and maintenance of the slopes are necessary.

Awareness alone is not sufficient; engineers and personnel involved in slope maintenance should also know how to carry out their working properly, they need a set of standards of good practice slope maintenance to follow. A good guideline from GEO (1995) of Hong Kong for engineers and GEO (1996) for layman should be referred.

Geoguide-5 (1995) recommends maintenance inspections be sub-divided into three categories:

- a) Routine Maintenance Inspections, which can be carried out adequately by any responsible person with no professional geotechnical knowledge (layman).
- b) Engineer Inspections for Maintenance, which should be carried out by a professionally qualified and experienced geotechnical engineer.
- c) Regular Monitoring of Special Measures, which should be carried out by a firm with special expertise in the particular type of monitoring service required. Such monitoring is only necessary where the long term stability of the slope or retaining wall relies on specific measures which are liable to become less effective or deteriorate with time.

Since Malaysia has at least two monsoon seasons, Routine Maintenance Inspections (RTI) by layman should be carried out at least twice a year for slopes with negligible or low risk-to-life. For slopes with high risk-to-life, more frequent RTI is required (once a month). In addition, it is a good practice to inspect all the drainage channels to clear any blockage by siltation or vegetation growth and repair all cracked drains before the monsoon. Inspection should also be carried out after every heavy rainstorm.

Category B Engineer Inspection for Maintenance should be undertaken to prevent slope failure when the Routine Maintenance Inspection by layman observed something unusual or abnormal, such as occurrence of cracks, settling ground, bulges or distortions or wall or settlement of the crest platform. Geoguide-5 (1995) recommends, as an absolute minimum, that an Engineer Inspection for Maintenance should be conducted once every five years or more as requested by those who carry out the Routine Maintenance Inspections. More frequent inspections may be desirable for slopes and retaining walls in the high risk-to-life category.



Figure 7.5. Rills and gullies on slopes.



Figure 7.6. Localised slip failures and erosions on slopes.

Slope maintenance is also an important factor. Poorly maintained slopes can lead to slope failure. These may include, amongst others, damaged/cracked drains, inadequate surface erosion control and clogged drains. Eventually, erosion of the slopes allow the formation of rills and gullies (Figure 7.5) or may cause localised landslips (Figure 7.6) which will may propagate with time into landslides if erosion control is ignored.

## 7.7 CONCLUSION

For safe hill-site development, geotechnical input by the engineers with relevant geotechnical experience during planning, design, construction and maintenance is necessary.

It is also important for the consultant to send personnel with knowledge on geotechnical engineering to supervise hill-site construction so that any irregularities of the subsoil condition from that adopted in the design can be identified and rectified. Close coordination and communication between design engineer(s) in the office and supervising engineer(s)

are necessary so that modification of the design to suit the site condition can be carried out effectively during construction to prevent failure and unnecessary remedial works in the future.

Finally, even with correct design and proper construction, lack of maintenance of slopes and retaining walls can also trigger landslides. Owners and engineers should regularly inspect and maintain their slopes.

## REFERENCES

- EPU 2002. Act 133: Street, Drainage and Building Act, 1974 of Malaysia Economic Planning Unit (EPU) of Prime Minister's Department of Malaysia. Study for the sustainable development of the highlands of Peninsular Malaysia. Report prepared by WWF Malaysia.
- GCO. 1988. Guide to rock and soil descriptions: Geoguide 3. Geotechnical Control Office, Hong Kong: 295.
- GCO. 1991. Geotechnical manual for slopes (2nd ed.). Geotechnical Control Office: 301.
- GEO. 1995. Guide to slope maintenance: Geoguide 5. Geotechnical Engineering Office, Hong Kong: 84.
- GEO. 1996. Layman's guide to slope maintenance. Geotechnical Engineering Office, Hong Kong: 24.
- Gue, S.S. & Tan, Y.C. 2003. The engineering aspects of hillside development. *Property seminar 2003 on hillside development—Issues and challenges, Kuala Lumpur*.
- Gue, S.S. & Fong, C.C. 2003. Slope safety: Factors and common misconceptions. *Buletin Injenieur* 19.
- Gue, S.S. & Tan, Y.C. 2002. Mitigating the risk of landslide on hill-site development in Malaysia. Special lecture, Huat et al. (eds) *2nd World engineering congress, Kuching, Sarawak, Malaysia*.
- Gue, S.S. & Tan, Y.C. 2000a. Hill-site development Planning, design, construction & maintenance considerations. *Seminar on geotechnical engineering*, The Institution of Engineers, Malaysia, Penang, Malaysia.
- Gue, S.S. & Tan, Y.C. 2000b. Subsurface investigation and interpretation of test results for geotechnical design. *Seminar on Geotechnical Engineering*. The Institution of Engineers, Malaysia.
- Gue, S.S. 1999. (Interview). Face to face with the man who knows landslides. *The Edge Capital*, November 1999.
- Gue, S.S. 1995. Geotechnical assessment for hillside development. *Proc. of dialogue session on geological and geotechnical considerations in civil works*. Geological Survey Department Malaysia, Kuala Lumpur: 27–34.
- Institution of Engineers, Malaysia. 2000. Policies and procedures for mitigating the risk of landslide on hill-site development. *The Institution of Engineers, Malaysia*. Jabatan Perancangan Bandar dan Desa Selangor Darul Ehsan. 1997. Garis panduan perancangan pembangunan kawasan bukit. Malaysia.
- Kementerian Perumahan dan Kerajaan Tempatan (KPKT) 1997. Garis panduan pembangunan di kawasan bukit. Malaysia.
- Tan, Y.C. & Chow, C.M. 2004. Slope stability and stabilization, Huat et al.(ed). *Tropical residual soil engineering*, Balkema (in press).
- Uniform Building By-laws 1984 of Malaysia.





## CHAPTER 8

# Characterization of tropical soils in the design of material as natural foundation and fill

Ting Wen Hui

*Principal, Zaidun- Leeng Sdn Bhd, Malaysia*

R.Nithiaraj

*Associate, Zaidun-Leeng Sdn Bhd, Malaysia*

Publications related to geotechnical properties of residual tropical soils in Malaysia are reviewed in this chapter. It is observed that the range in geotechnical values, though large, in general exhibit increasing or decreasing trends with depth for respective weathering grades. To cater to the inherent variation in behavior with weathering grades, in the characterization process, lithology and weathering profiles within the project site should be established prior to association with the respective geotechnical parameters. Relevant lab/field tests and empirical methods to assess geotechnical parameters for design implementation are also briefly described. In light of difficulties in characterization of the strength parameters of weathered formation, a method that may be used as a basis in the preliminary determination of suitable strength parameters is presented.

### 8.1 INTRODUCTION

Population and economic growth have led to the present trend of large townships, high standard expressway and very ambitious recreational theme parks. As residual soils form the largest soil group in Malaysia, these projects more often than not involve earthworks in weathered rock formation. Residual soils by nature are heterogenous with depth and extent. This chapter reviews observations in publications on residual soils and outlines the process in the characterization of tropical soils for the design of material as natural foundation and fill.

### 8.2 GEOTECHNICAL ASPECTS OF SOIL RESIDUAL MATERIAL USED FOR LAND DEVELOPMENT

Aspects of land development where geotechnical considerations are required are as follows:

- i) Adequate stability of formed slopes at edges of fills e.g. roads/expressways, platforms for infrastructure development etc.
- ii) Adequate foundation support (i.e. bearing capacity and settlement) of formed platform for infrastructure and structure facilities i.e. sewer pipes, water pipes, drains, roads etc.

### 8.3 CONSIDERATIONS WITH RESIDUAL SOIL AS NATURAL FOUNDATION MATERIAL

Common problems associated with residual soil as a natural foundation or material as fill is heterogeneity of the material due to variation in the parent geology and variation in weathering profile with depth and extent. As a result, material properties are also variable i.e.:

- i) grading,
- ii) index properties, and
- iii) mineral compositions that react and degrade with time upon exposure with the atmosphere.

With the variation in material properties, the affected engineering properties are

- i) strength,
- ii) stiffness and compressibility, and
- iii) permeability.

### 8.4 CONSIDERATIONS WITH RESIDUAL SOIL AS CONSTRUCTION FILL MATERIAL

#### *Material type*

Standard specifications on earthworks broadly identify material type unsuitable for use as construction fill material. Material other than unsuitable material are deemed suitable for use as construction fill material.

The definition of 'Unsuitable Material' in most standard earthworks specifications is as follows:

- i) Running silt, peat, logs, stump, perishable or toxic material, slurry or mud or
- ii) Any material consisting of highly organic clay and silt;
- iii) Any material which is clay having a liquid limit exceeding 80% and/or a plasticity index exceeding 55%;
- iv) Any material which is susceptible to spontaneous combustion;
- v) Any material which has a loss of weight greater than 2.5% on ignition;
- vi) Any material containing large amounts of roots, grass and other vegetable matter.

#### *Compaction requirements*

For site quality control of engineered fill, performance requirements are in general related to a pre-selected range in percentage of maximum dry density in a lab controlled compaction test. The process to check adequacy is briefly summarized below:

- i) Identify location of suitable borrow source material i.e. assessed as not unsuitable as per earthworks specifications, close proximity to the project site, etc.
- ii) Obtain sample and perform laboratory compaction tests to obtain Maximum Dry Density (MDD) and Optimum Moisture Content (OMC). It is noted that compactive effort requirements (i.e. Modified or Standard Proctor) for the test may differ based upon proposed land use i.e. dam, airport runway, expressway, recreation park, golf course etc.
- iii) Set minimum performance requirements for adequacy e.g. greater than 90% MDD and corresponding range in moisture content.
- iv) Carry out field trials to determine optimum layer thickness appropriate to field compactive effort (i.e. weight of compaction plant and number of passes) required to satisfy dry density requirements based on (ii) and (iii) above.
- v) Perform Field Density tests to check compaction adequacy based against set performance criteria from lab tests as per item (iii) above. The Core Cutter or Sand Replacement methods are common field density tests performed.

## 8.5 REVIEW OF PUBLICATIONS

### *Mineralogy*

West & Dumbleton (1970) as part of their study on the mineralogy of tropical weathering of some Malaysian soils have reported that hydrolysis followed by differential solution did account for the formation of residual soils that were studied in Malaysia. It was reported that soils formed of granite origin contained relatively well ordered kaolinite, illite and iron oxide in the form of goethite or hermatite. Feldspar and abundant quartz were inherited from the parent rock, but the feldspar and the illite disappeared under more severe weathering. For soil formed of shale origin, it was reported that they contained illite, kaolinite and iron oxide in the form of goethite. Inherited quartz was also present. Soils formed of mixed shale and sandstone origin was reported to contain more inherited quartz, but lacked illite.

### *Engineering properties*

#### *Residual soil of igneous rock origin*

Ledgerwood (1963) reports that residual soils of granite origin range from plastic sandy silt soils at the surface to a gravelly silty sand soils adjacent to the unweathered rock. In some occurrences, the upper layers were noted to be absent, leaving only the coarse grained gravelly sand.

The use of aerial photographs to describe residual soils of granite origin according to the landforms was presented by Beavan (1967). In the high steep hills, the residual soil was very thick particularly on spurs and ridge tops. The depth of weathering in these steep hills was much deeper inspite of the frequent occurrence of core boulders. In the area of low hills, the residual soils were soft in consistency. The typical profile consists of yellow sandy clay over a yellow mottled red silty clay containing grains of quartz. The clay content

was generally found to decrease with depth to give clayey silt. These soils were relatively porous of low density with the absence of laterite.

From their study on the mineralogy and plasticity of granite residual soils up to 4m depth from sites in Johore and Negeri Sembilan, West & Dumbleton (1970) reported that soil from both sites plotted above the A-line with the higher plasticity exhibited by the samples on the gentler slopes of Negeri Sembilan.

Ting & Ooi (1972) described the properties of granite residual soil in Sungei Besi, Kuala Lumpur to be of two distinct groups. The soil was classified as sandy clay (29–56% for clay content and 38–64% for sand content), but was further divided into two groups based on the percentage of sand fraction. Group A had a lower sand content whilst Group B had a higher sand content. The range in index properties measured was 20–30% for natural moisture content, 0.55–0.72 for void ratio and 2.62–2.64 for specific gravity. The samples from both groups plotted above the A-Line with the higher plasticity exhibited by Group A. The average activity of the soils tested was 1.1. The samples tested were acidic with a pH value of 5. Consolidation tests on the samples revealed that the samples at the shallower depths were over consolidated ( $OCR=4.5$ ). The compressibility characteristics of the tested samples and their range showed a compression index of 0.004–0.009  $cm^2/kg$ , coefficient of consolidation of 1–15  $cm^2/min$  and coefficient of permeability of  $5 \times 10^{-6}$  to  $5 \times 10^{-7} cm/s$ . The range of total stress parameters reported from undrained triaxial tests were  $c=68-94$  kPa and  $\phi = 3-5^\circ$ . The range of effective stress parameters reported from drained triaxial tests were  $c'=21-77$  kPa and  $\phi' = 17-30$ .

Some properties of granite residual soils along the Federal Highway in Kuala Lumpur were reported by Chan & Chin (1972). The residual soil was classified as sandy silty clay varying in consistency from firm to hard up to a depth 35m. The range of size distribution of particles reported was 35–53% for clay/silt, 28–40% for sand and 9–25% for gravel. The ranges in index properties measured were 33–50% for liquid limit, 12–16% for plasticity index, 24–31% for natural moisture content and 2.64–2.72 for specific gravity. The range in coefficient of permeability was  $1.4 \times 10^{-6}$  to  $7.8 \times 10^{-6} cm/s$ . The range of total stress parameters reported were  $c=15-32$  kPa and  $\phi = 1-11$ .

Komoo (1985, 1989) reported some properties of granite residual soil along the Karak Highway in Selangor, Petaling Jaya and Cheras. The classification and index properties described along Karak Highway were <15% for clay, <20% for silt, <60% for sand, 15–25% for natural moisture content, 20–60% for liquid limit, 4–20% for plasticity index and 0.5–0.9 for natural void ratio. In Petaling Jaya, the results reported were 40–50% for silt/clay, 25–40% for sand and <20% for gravel whilst that at Cheras were, 20–40% for silt/clay, 30–60% for sand and <25% for gravel. The variation in index properties reported for Petaling Jaya and Cheras areas were 12–99% for water content, 27–78% for liquid limit and 2–32% for plasticity index.

Mun (1985) reported on residual soils of granite origin as follows:

- i) In a borrow site, the particle size distribution shows greater silt content and lower clay content with depth.
- ii) The higher silt content material was difficult to handle and compact.
- iii) The higher sand content material recorded higher field density and higher modulus for the same compactive effort.

As part of the soil investigation along the North South Expressway, Singh & Ismail (1993) presented the properties of granite residual soil between Bukit Lanjan and Damansara. The area investigated was described as undulating and mountainous. The data reported were from depths up to 35 m and represented samples from weathering grades IV, V and VI. The ranges in particles size distribution reported were <20% for clay, 15–20% for silt, 40% for sand and 30% for gravel. The ranges in index properties were 20–55% for liquid limit, 5–30% for plasticity index, 10–30% for natural moisture content, 2.6–2.7 for specific gravity, 0.5–0.9 for natural void ratio and 18–22 kN/m<sup>2</sup> for bulk density. The samples from all three weathering grades plotted along and below A-Line with the higher plasticity exhibited by the higher weathering grades. The range of effective stress parameters reported from undrained triaxial tests with pore pressure measurements were  $c' < 20$  kPa and  $\phi' = 30\text{--}35^\circ$ .

#### *Residual soils of sedimentary rock origin*

The properties of mudstone residual soil from investigations for the deep cuttings for the Muda Irrigation Project, Kedah were described by Taylor & James (1967). The soil was classified as silty and at some locations as sandy silty clays with intermediate plasticity and activity seldom exceeding unity. The effective stress parameters reported from consolidated drained tests were  $c' = 3.5$  kPa and  $\phi' = 27\text{--}28$ . The  $\phi'$  was reported to vary linearly with plasticity index for this site.

The use of aerial photographs to describe residual soils of sedimentary origin according to the landforms was presented by Beavan (1967). In the high steep hills, the residual soil was thin and formed from hard quartzite. In the steep hills present in the lowlands, the rock type was sandstone. In the area of low hills, ridged landform was associated with sandstone whilst rounded landform was associated with shale. The soil profile for the top 5 m in shale was described as yellow medium clay over red heavy clay, with the depth of yellow soil reported to increase downslope. A gravel layer of iron-hardened rock fragment was often detected between the two layers. The plasticity index was reported to increase with depth. The samples from both clays plotted above the A-Line with the higher plasticity exhibited by the lower red clay.

Philip & Robinson (1967) reported some properties of residual soil from shale and sandstone origin in the 1000 km<sup>2</sup> Jengka Triangle agricultural land development scheme, Pahang. The topography was described as rolling with the range in slope angles between 0 and 12°. The particle size distribution tests on samples to depths of 3.5 m were reported to reflect two broad groups. Group 1 was classified as high plastic clays with liquid limit of 80–100% and plastic limit of 35–50% whilst Group 2 was classified as low plastic silt with liquid limit of <30% and plastic limit of <20%.

A study on the mineralogy and plasticity of shale residual soils was reported by West & Dumbleton (1970) from sites in Kedah and Johore and shale interbedded with sandstone residual soils from a site in Selangor. The depth of study was up to 6 m. The samples from sites in Kedah and Johore were described as silty clay overlaying black silt and contained illite, kaolinite and quartz. The sample from Selangor was described as clay and contained kaolinite, goethite and abundant quartz. The samples from Kedah and Johore plotted along and below the A-Line whilst the samples from Selangor plotted along and above A-Line.

Komoo (1985) reported some properties of shale interbedded with sandstone residual soils in Bandar Baru Bangi, Selangor. The particle size distributions reported were 10–50% for clay, 20–40% for silt and 30–70% for sand. The ranges of index properties measured were 18–22% for natural moisture content, 25–40% for liquid limit, 4–10% for plasticity index. The natural void ratio was reported to vary between 0.5 and 0.6.

Mun (1985) reported that residual soils of sedimentary origin in a borrow site had highly complex deposition patterns due to close interbedding of shale and sandstone. In following, the particle size distribution is highly variable with depth.

Wong & Singh (1996) reported properties for Kenny Hill Formation (i.e. sequence of interbedded sandstone, siltstone and shale/mudstone) countered at eight sites along the Putra LRT line between Kuala Lumpur and Petaling Jaya. At most of the test sites, phyllite was reported more dominant than sandstone due to mild regional metamorphism with SPT 'N' blowcount range between 50 and 150 blows/ft. The range in effective stress parameters reported were  $c'=0$  to 12 kPa and  $\phi' = 23\text{--}39^\circ$ . Higher  $\phi'$  values were noted associated with samples with greater sand content. Reported relationships with interpreted data were  $c_u/N=4$  kPa and  $E_{pm}/N=0.6$  MPa where  $c_u$ =undrained shear strength,  $N$ =Standard Penetration Test Blowcount and  $E_{pm}$ =initial modulus values of the pressure-radial expansion curve.

#### *Residual soils of metamorphic rock origin*

From a study of over 400 cut slopes throughout the Peninsular, Bulman (1967) described the engineering behavior of some cut slopes encountered in weathered quartzite, phyllite and schist. It was reported that the weathered rocks can be distinguished into three main types. Type 1 was described as 'Firm' schist's and phyllite's interbedded with sandstone's and quartzite's; the arenaceous beds comprising of more than 20% by volume of the whole. Type 2 was described as 'Firm' schist's and phyllite's interbedded with sandstone's and quartzite's; the arenaceous beds comprising less than 20% by volume of the whole. Type 3, described as 'Soft' schist's and phyllite's was characteristically pale gray or white and found in low hills with heights less than 15m. Type 3 was reported to be the of least stable and when freshly exposed was described as having a consistency of a firm clayey silt but on exposure lost its cohesion and degenerated into a soft cohesionless silt. It was further reported that the silt content in Type 3 was greater than about 60% and was thought to have a connection with slope stability as was indicated from an unpublished study by Clare & Newill (1965) as reported in Bulman (1967).

Komoo (1989) presented classification and index properties for schist residual soils in Jalan Gurney, Kuala Lumpur as 75–90% for silt/clay, 10–20% for sand, <5% for gravel, 10–48% for natural water content, 25–90% for liquid limit and 18–38% for plastic index.

Ting et al. (1990) reported properties for metasediments along the North-South Expressway between Seremban and Ayer Keroh. The metasediments comprised quartz mica schist, quartzite/phyllite and graphitic schist. The range of particle size distribution reported was 3–31% for clay, 27–68% for silt, 21–57% for sand and < 16% for gravel. The ranges in index properties were 39–95% for liquid limit, 11–41% for plasticity index, 8–43% for natural moisture content and 16–20kN/m<sup>3</sup> for bulk density. The range in total stress parameters reported were  $c=56\text{--}150$  kPa and  $\phi = 0\text{--}37^\circ$ . The range in effective stress parameters reported were  $c'=10\text{--}50$  kPa and  $\phi' = 21\text{--}37^\circ$ .

Singh & Ho (1990) reported direct shear box test results conducted on residual soils of quartzite and phyllite along the North-South Expressway between Gopeng and Tapah. The samples tested were obtained at depths between 11 and 20m and described as clayey silt of firm to stiff consistency. The samples were also reported to represent weathering grade V. The range in bulk density varied between 16 and 17kN/m<sup>3</sup> and that of moisture content between 43 and 52%. The samples were prepared such that shearing was along the foliation's present. The range of effective stress parameters reported were  $c' = 30-136$  kPa and  $\phi' = 14-28^\circ$ .

*Summary*

Studies on weathering profiles have indicated that the thickness can vary considerably for the same lithology in different locations. It has been explained by the Geological Society Working Party (1990) that the immediate slope and surrounding relief have an influence on the depth of weathering as they influence the drainage and a consequence the rate of leaching. Some studies on landform have also associated topography with lithology (Table 8.1). It has been reported that the more resistant sandstone, quartzite and granite are usually found in the high relief locations (>300m) whilst the less resistance phyllite, slate and shale are found in low hills (20-70 m). From published information in Malaysia, the maximum thickness of weathering grades V and VI reported in all geological types can be up to 35 m.

Table 8.1. Description of major landform units in Peninsular Malaysia (Beavan 1967).

Geology	Mountains, generally over 1000ft	Steep hills, generally 300-1000ft	Low hills crest to valley height of 50-200 ft	Plains, low lying flat areas
Granite	Long steep slopes >250 and continuous lateral extent	Steep slopes often considerable height, but broken into individual hills	Flat crests and gentle slopes with sharp transition to gullies. Higher areas may have core stones on crest.	
Basalt			Convex upper slopes with concave foot slopes	
Limestone		Isolated hills with steep rocky slopes	Small rounded hills up to 600 ft across and 100 ft high	
Sedimentary: sandstones and shales	(a) High plateaus of relatively flat areas: usually bounded in part by cliff	Similar to mountainous region but lower height and smaller areas	(a) Ridged valley divides. Probably marked with sandstone outcrops.	

	(b) Long ridges marking outcrop of resistant strata	(b) Rounded hills, usually with greater distance between valleys. Shale predominates.
Alluvium		<p>Old alluvium can produce similar topography to granite and shale areas</p> <p>(a) Coastal sand complex elevated sand ridges separated by sandy or clayey depressions which may be marshy</p> <p>(b) Alluvial plain areas bordering rivers showing relict drainage features. Soils may be mineral or organic.</p>

The general range in classification and index properties for the granite residual soils reported in past publications at tested locations were 15–22kN/m<sup>3</sup> for bulk density, 3–43% for moisture content, 20–60% for liquid limit, 4–30% for plasticity index, 15–60% for clay/silt, 40–60% for sand/gravel and 0.5–1.4 for void ratio. The effective stress parameters ranged between  $c'=7-77$  kPa and  $\phi' = 17-40^\circ$ . A summary is tabulated in Table 8.2.

The corresponding general range in classification and index properties for residual soils of metamorphic and sedimentary origin reported in past publications at tested locations were 14–22kN/m<sup>3</sup> for bulk density, 1–57% for moisture content, 25–95% for liquid limit, 0–41% for plasticity index, 30–90% for clay/silt, 10–70% for sand/gravel and 0.4–1.6 for void ratio. The effective stress parameters ranged between  $c'=0-136$  kPa and  $\phi' = 17-40^\circ$ . A summary is tabulated in Table 8.3.

The ranges reported for the respective properties are large and probably indicative of the heterogeneity resulted from weathering. However as noted by Komoo (1985), the variation of index properties with depth for the various weathering grades exhibited increasing or decreasing trends and were indicative of the relative engineering behavior within a weathered profile (Figures 8.1, 8.2 & 8.3).

The effective stress parameters reported for the different lithologies do show a wide range of values. A possible explanation can be attributed to the wide range in particle size distribution. Irfan & Tang (1992) performed a study on the effect of coarse inclusion content on the effective stress parameters and found that beyond a particular coarse inclusion content, the behavior of the samples tended to be cohesionless. In a study on residual



granitic and metasedimentary soils in Kampar, Ramanathan (1995) observed that the clay size fraction percentage decreased with decreasing weathering grades (Figures 8.4 & 8.5).

Table 8.2. Summary of geotechnical parameters for residual soils of granite origin at selected locations.

Source	Location	Bulk density (kN/m <sup>3</sup> )	Moisture content (%)	Liquid limit (%)	Plasticity index (%)	Clay (%)	Silt (%)	Sand (%)	Gravel (%)	Specific gravity	Void ratio	Consolidated undrained triaxial test			
												c (kN/m <sup>2</sup> )	$\phi'$ (degrees)	c' (kN/m <sup>2</sup> )	$\phi'$ (degrees)
Ting & Ooi (1972)	Sg. Besi Kuala Lumpur		20-30			29-56		38-64		2.62-2.64	0.55-0.74	68-94	3-5	21-77	17-30
Chan & Chin (1972)	Federal H'Way Kuala Lumpur		24-31	33-50	12-16	35-53		28-40	9-25	2.64-2.72		15-32	1-11		
Komoo (1985)	Karak H'way Selangor		15-25	20-60	4-20	<15	<20	>60			0.5-0.9				
Komoo (1989)	Petal-ing Jaya Selangor					40-50		25-40	<20						
Komoo (1989)	Cheras Selangor		12-99	27-78	2-32	20-40		30-60	<25						





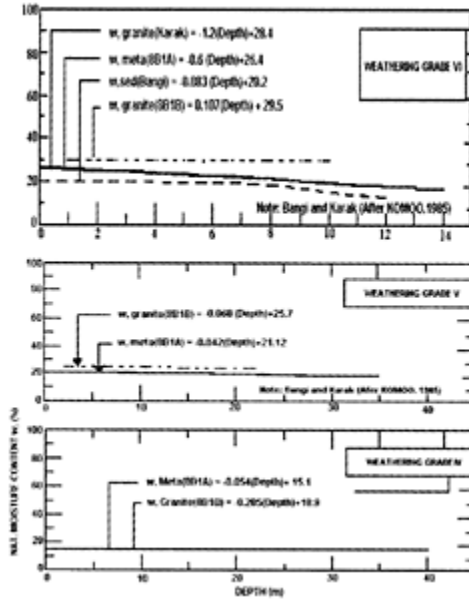

Figure 8. 1 Variation of natural moisture content with dept h for va rious geology.

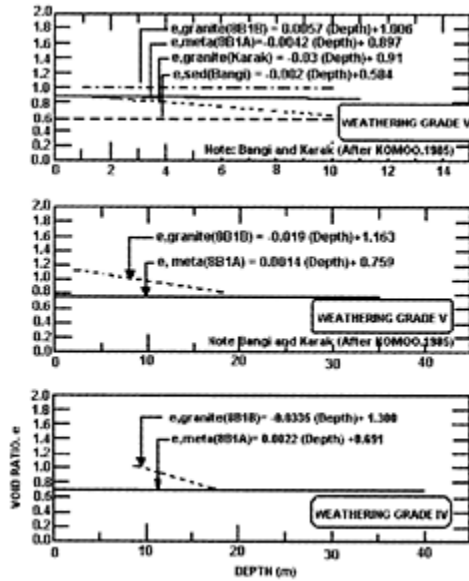

Figure 8.2. Variation of void ratio with depth for various geology.

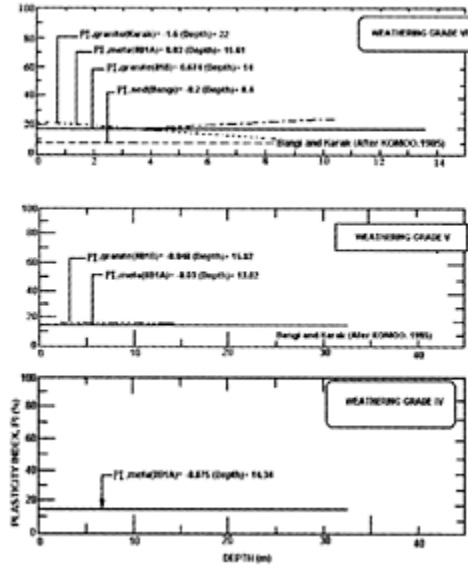

Figure 8.3. Variation of plasticity index with depth for various geology.

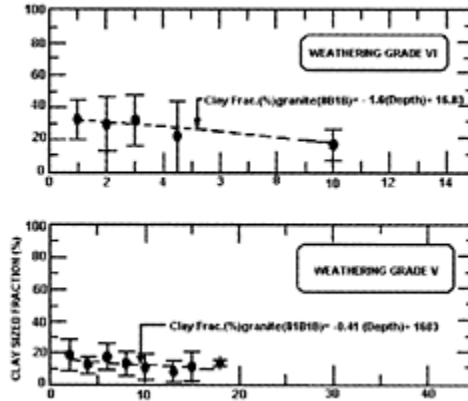

Figure 8.4. Variation of clay sized fraction with depth for weathered granite.

### 8.6 CHARACTERIZATION OF TROPICAL SOILS

For design purpose, the relevant engineering properties of interest are strength and stiffness/compressibility profile, and in some cases the permeability. In their natural state, residual tropical soils exhibit different behavior partly due to grading, index properties, mineral composition, structure and bonding inherited from the parent rock. In the case of excavated

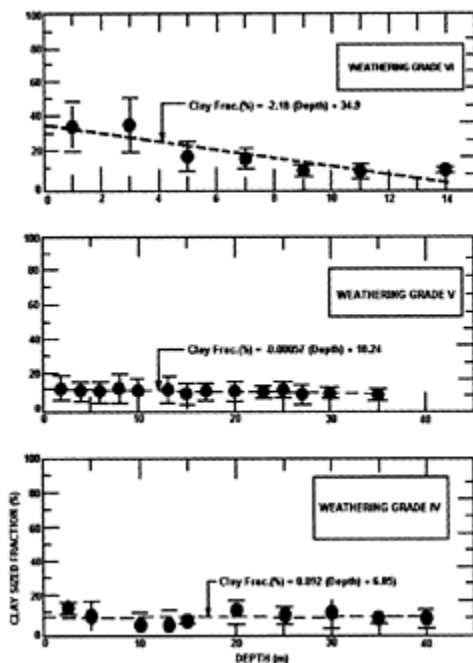

Figure 8.5. Variation of clay sized fraction with depth for weathered schist.

material for use as fill, the effects of structure and bonding may be less pronounced. The preceding sections outline process and tests methods used in the characterization of residual tropical soils as natural foundations and engineered fills.

### Characterization as natural foundation

Of engineering interest as a natural foundation are properties related to assess safe bearing capacity and settlement. In view of the inherent variation in behavior with lithology and weathering profiles for reasons as described in the sections herein before, weathering profiles within the project site are required to be established prior to association with the respective geotechnical parameters. Deep boreholes distributed geographically and topographically with an Engineering Geologist/Geologist to log retrieved samples are recommended. Preparation of a project specific Surface Geology Map can also be of assistance. Methods and tests to obtain geotechnical parameters are briefly outlined below.

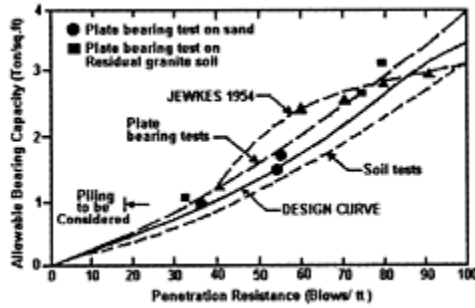

Figure 8.6. Allowable bearing capacity versus JKR dynamic cone penetration resistance (Ooi & Ting 1975).

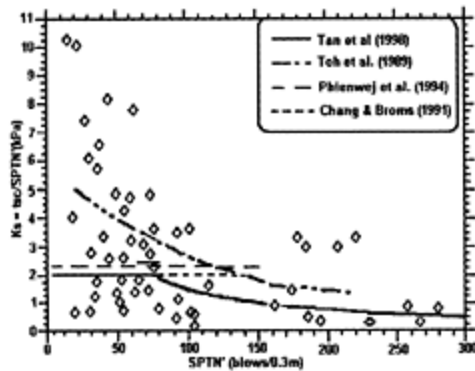

Figure 8.7. Variation of  $K_s$  with SPT ‘N’ (Tan et al. 1998).

For slope bodies, the empirical approach of Bulman (1967) is relevant. With this scheme, typical slope angles may be recommended based on observations of similar slopes. A deviation from the general scheme would be investigated as a localized problem to be dealt with on a case-to-case basis for the given site during the slope formation construction process.

For shallow foundations such as footings, design curve on allowable bearing capacity from studies carried out with JKR probe by Ooi & Ting (1975) is available and reproduced in Figure 8.6.

For pile foundations such as bored piles, design parameters investigation was carried out by Toh et al. (1989) for weathered sedimentary formations. Recent studies such as that conducted by Tan et al. (1998) is available. Design curve relating shaft resistance factor with SPT ‘N’ value is reproduced in Figure 8.7. Pile base resistance factor from their studies was small relative to previous published values and attributed to unpredictable base response due to existence of soft toe. For design purpose, however, the potential total capacity should also be estimated, and a final evaluation made.

*Laboratory test*

The engineering properties required for the assessment of bearing capacities based upon engineering expressions developed by respected experts i.e. Vesic, Meyerhof, Terzaghi etc are related to undrained and drained strength parameters i.e.  $c$ ,  $\phi$ ,  $c'$ ,  $\phi'$ .

These strength parameters may be obtained via strength envelopes determined from tri-axial tests carried out on undisturbed samples. The portion of the envelope used for design purposes must reflect that for the desired design stress range. Samples selected for testing should be sufficient to cover the full weathering profile for the different lithologies.

*Field test*

Direct measurements on settlement and bearing capacity may be carried out via plate bearing tests or pressuremeter tests conducted in boreholes at the required depths.

*Characterization as fill material*

Fill material may be either engineered i.e. manner of deposition and compaction is controlled/checked or non-engineered i.e. loosely dumped. Engineered fill embankments that are very high (i.e. >20 m) are prone to collapse type settlements upon saturation and require evaluation (Ting 1979, Ting & Chan 1991). Non-engineered fills do not lend themselves to be characterized as the material type and manner of deposition can be variable in extent as well as depth. Methods and tests to obtain geotechnical parameters are briefly outlined below.

The standard of improvement required for engineered fill commensurates with the desired performance (Ting 1999) of the end product in providing a flood free surface, support of infrastructure or in more demanding circumstances in the support of superstructures (Ting & Chan 1991). As an example, for applications such as in drainage and irrigation bunds, conditioning of the in-situ wet fill by drying out may be adequate for the performance required of low embankment and of imperviousness.

The quality of source of fill in the local context is a function of the content of granular material in terms of size and quantum (Ting & Ooi 1976, Ting et al. 1982). For clayey material at source, the natural moisture content is relevant.

The required compaction characteristics (maximum dry density and optimum moisture contents) are usually a function of the granular content and the moisture content. Disturbed samples obtained from source may be re-constituted, based on results of compaction tests, and be tested for shear strength.



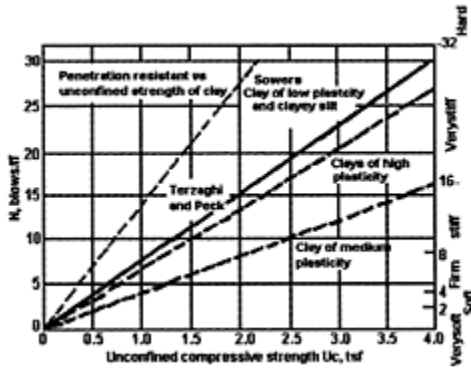

Figure 8.8. Correlations of SPT N values with  $U_c$  for cohesive soils of varying plasticities. Source=NAVFAC Manual DM 7 (1971) as reported in Hunt (1984).

In appropriate sampling from source, an understanding of the geology of the deposits is essential.

*Laboratory test*

Strength and compressibility parameters may be assessed from triaxial and consolidation tests results carried out on extruded samples that have been reconstituted to specify compaction requirements i.e. proctor test requirements. Collapsed type settlement may be estimated by repeating the consolidation test on saturated samples for each load increment.

*Field test*

As in the above section, plate bearing tests or pressuremeter tests carried out in boreholes are applicable for the assessment of bearing capacity and settlement.

*Empirical methods*

For initial reference to assess engineering properties of engineered fill, the chart and table in NAVFAC (1971) manual publication reproduced in Figure 8.8 and Table 8.4 may be of assistance. Ramanathan (1995) reported that correlations between strength parameters and SPT ‘N’ values carried out on residual soils of granite and metasedimentary origin at Kampar are shown to exhibit good linear relationships (Figures 8.9, 8.10, 8.11 & 8.12).

Nithiaraj et al. (1996) have described a method for the selection of strengths for stability analyses.

Table 8.4. Typical properties of compacted soils. (Source: NAVFAC Manual DM 7 (1971) as reported in Hunt 1984).

Group symbol	Soil type	Range of maximum dry unit weight, pcf	Range of optimum moisture, %	Typical value of compresion			Typical strength characteristics					Range of CBR values	Range of subgrade modulus, $k_v$ , lb/in <sup>3</sup>	
				Percent of original height			Cohesion (saturated) psf	Effective stress erve	Typical coefficient of permeability, ft/min	Cohesion (as compacted) psf	Effective stress erve			Typical coefficient of permeability, ft/min
				At 1.4 tsf(20psi)	At 3.6 tsf (50psi)	At 10.0 tsf (150psi)								
GW	Well-graded clean gravels, gravel-sand mixtures	125-135	11-8	0.3	0.6	0	0	0	>38	>0.79	$5 \times 10^{-2}$	40-80	300-500	
GP	Poorly graded clean gravels, gravel-sand mix	115-125	14-11	0.4	0.9	0	0	0	>37	>0.74	10-1	30-60	250-400	

GM	Silty gravels, poorly graded gravel-sand silt	120-135	12-8	0.5	1.1	-	-	>34	>0.67	$>10^{-6}$	20-60	100-400
GC	Clayey gravels, poorly graded gravel-sand-clay	115-130	14-9	0.7	1.6	-	-	>31	>0.60	$>10^{-7}$	20-40	100-300
SW	Well graded clean sands, gravelly sands	110-130	16-9	0.6	1.2	0	0	38	0.79	$>10^{-3}$	20-40	200-300
SP	Poorly-graded clean sand, sand-gravel mix	100-120	21-12	0.8	1.4	0	0	37	0.74	$>10^{-3}$	10-40	200-300
SM	Silty sands, poorly graded sand-silt mix	110-125	16-11	0.8	1.6	1050	420	34	0.67	$5 \times 10^{-5}$	10-40	100-300

SM-SC	Sand-silt clay mix with slightly plastic fines	110-130	15-11	0.8	1.4	1050	300	33	$0.66 \times 10^{-6}$	-	
SC	Clayey sands, poorly graded sand-clay mix	105-125	19-11	1.1	22	1550	230	31	$0.60 \times 10^{-7}$	5-20	100-300
ML	Inorganic silts and clayey silts, elastic silts	95-120	24-12	0.9	1.7	1400	190	32	$0.62 \times 10^{-5}$	15 or less	100-200
ML-CL	Mixture of inorganic silt and clay	100-120	22-12	1.0	22	1350	460	32	$0.62 \times 10^{-7}$	-	

CL	Inorganic clay of low to medium plasticity	95-120	24-12	1.3	25	1800	270	28	0.54	$10^{-7}$	15 or less	50-200
OL	Organic silts and silt-clays, low plasticity	80-100	33-21	-	-	-	-	-	-	-	5 or less	50-100
MH	Inorganic clayey silts, elastic silts	70-95	40-24	20	3.8	1500	420	25	0.47	$5 \times 10^{-7}$	10 or less	50-100
CH	Inorganic clayey of high plasticity	75-105	36-19	26	3.9	2150	230	19	0.35	$10^{-7}$	15 or less	50-150

From NAVFAC Manual DM 7 (1971). All properties are for condition of 'Standard Proctor' maximum density, except values of k and CBR which are for 'modified Proctor' maximum density. Typical strength characteristics are for effective strength envelopes and obtained from USER data. Compression values are for vertical loading with complete lateral confinement. '-' indicates that insufficient data is available for an estimate.

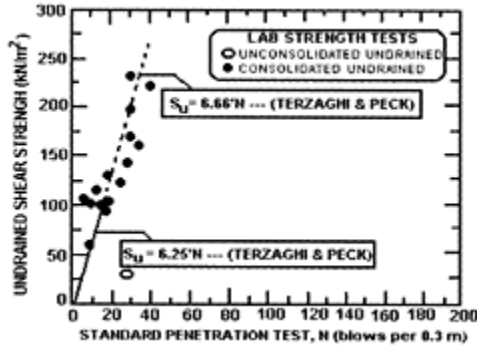

Figure 8.9. Variation of undrained shear strength with SPT ‘N’ for weathered schist in grade v zone.

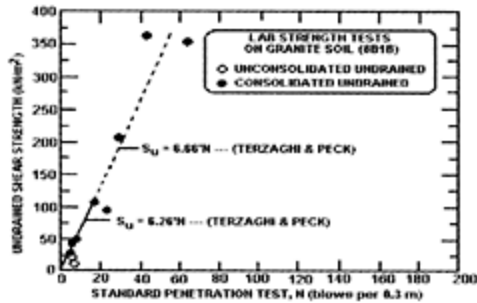

Figure 8.10. Variation of undrained shear strength with SPT ‘N’ for weathered granite in grade v zone.

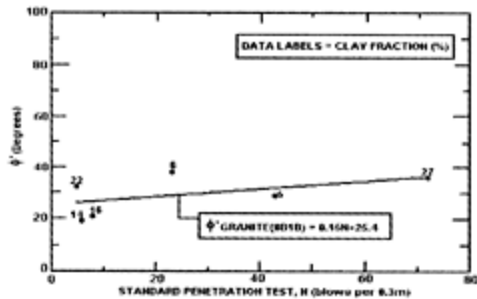

Figure 8.11. Variation  $\phi'$  of with SPT ‘N’ for weathered granite.

The findings of the chapter may be summarized in the following figures i.e. Figure 8.12 and Figure 8.13. For similar formations, given ‘N’,  $\phi'$  may be deduced from Figure 8.12. The value of  $c'$  may then be deduced from Figure 8.13 and the effective strength parameters are then available for design. The described method may be used as a basis in the preliminary determination of suitable design strength parameters.

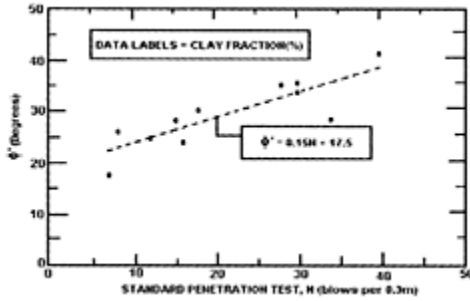

Figure 8.12. Variation of  $\phi'$  with SPT 'N' for weathered schist.

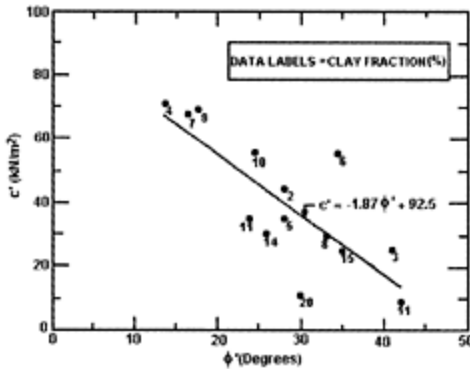

Figure 8.13. Variation of  $c'$  with  $\phi'$  for weathered schist.

### 8.7 CONCLUSION

From review of published literature on tropical residual soils in Malaysia, it is observed that the range in values of geotechnical properties though large in general, exhibit increasing or decreasing trends with depth for respective weathering grades. To cater to the inherent variation in behavior with weathering grades in the characterization process, lithologies and weathering profiles within the project site should be established prior to association with the respective geotechnical parameters. Project specific Geological Surface Mapping and Logging of Deep Boreholes distributed geographically and topographically for the project site by a qualified Engineering Geologist/ Geologist samples is recommended.

Some salient trends observed from past publications on tropical residual soils are:

- i) Bulk density increased and plasticity index decreased with decreasing weathering grades.
- ii) The observed trends in index properties differed for different geological origin.
- iii) The observed trends in index properties differed for the same geological origin at different sites.

- iv) For a particular weathering grade, the range in values for an index property can be fairly wide. However the observed trend does allow a preliminary assessment of the relative engineering behavior between the different weathering grades.

Empirical methods for natural foundation (slopes and pile support) and fill, used as a basis in the preliminary determination of suitable design strength parameters have been described; particularly in the face of the difficulties in characterization of the strength of the weathered formation.

Swamy & Saxena (2003) concur with Nithiaraj et al. (1996) that weathered formations require an empirical approach for characterization.

## REFERENCES

- Beavan, P.J. 1967. An engineering materials survey illustrated by work in Malaysia. *Proceedings of the Southeast Asian regional conference on soil engineering, Bangkok.*
- Bulman, J.N. 1967. A survey of road cuttings in western Malaysia. *Proceedings of the Southeast Asian regional conference on soil engineering, Bangkok.*
- Chan, S.F. & Chin, F.K. 1972. Engineering characterization of the soils along Federal Highway in Kuala Lumpur. *Proceedings of the third Southeast Asian conference in soil engineering, Hong Kong.*
- Geological Society Working Party. 1990. Tropical residual soils, geological society engineering group working party report. *Quarterly Journal of Engineering Geology.* 13 (1).
- Hunt, R.E. 1984. *Geotechnical engineering investigation manual.*
- Irfan, T.Y. & Tang, K.Y. 1992. Effect of coarse fractions on the shear strength of colluvium. Geotechnical engineering office, Hong Kong Publication.
- Komoo, I. 1985. Engineering properties of weathered rock profiles in Peninsular Malaysia. *Proceedings of the eighth Southeast Asian conference geotechnical conference, Kuala Lumpur.*
- Komoo, I. 1989. Engineering geology of Kuala Lumpur, Malaysia. *Proceedings of the international conference on engineering geology in tropical terrains, Bangi, Malaysia.*
- Ledgerwood, D.E. 1963. Some notes on the humid tropical weathering of granite and associated rocks in the Cameron Highlands area, Federation of Malaya, Professional Paper E63. Director of Geological Survey, Malaysia, Kuala Lumpur.
- Mun, K.P. 1985. Sampling and testing of residual soils in Malaysia. Technical committee on sampling and testing of residual soils, ISSMFE.
- NAVFAC Manual DM 7 1971. Graph of SPT 'N' vs  $U_c$  for cohesive soils of varying plasticities and table on typical properties of compacted soils. As reported in *Geotechnical engineering investigation manual, Roy E Hunt, 1984.*
- Ooi, T.A. & Ting, W.H. 1975. The use of a light dynamic cone penetrometer in Malaysia. *Proc. 4th S.E. Asian conference soil eng. Kuala Lumpur.*
- Philip, N. & Robinson, P.J.M. 1967. Reconnaissance assessment of soils characteristics for a regional highway system in Malaysia. *Proceedings of the Southeast Asian regional conference on soil engineering, Bangkok.*
- Ramanathan, N. 1995. Geotechnical parameters and slope stability of a section of an expressway in Kampar, Malaysia. AIT, Thailand M.Eng Thesis.
- Ramanathan, N., Ting, W.H. & Balasubramaniam, A.S. 1996. Strength parameters of residual soils and application to stability analysis of anchored slopes. *Geotechnical Engineering, Dec 1996, SEAGS, Thailand.* 27 (2).
- Singh, M. & Ho, H.S. 1990. Strength testing of residual soils. *Seminar on geotechnical aspects of the north south expressway, Kuala Lumpur.*



- Singh, M., Ismail, P. 1993. Site investigation works related to engineering geology for urban geology. Forum on urban geology and geotechnical engineering in construction, Petaling Jaya, Malaysia.
- Swamy, A.S.R. & Saxena, K.R. 2003. In situ characterization of coarse-grained weathered soils. *In situ characterization of soils*. Rotterdam: A.A.Balkema.
- Tan, Y.C., Chen, C.S. & Liew, S.S. 1998. Load transfer behavior of cast-in place bored piles in tropical residual soils of Malaysia. *Proc. 13th S.E. Asian geotechnical conference, Taipei*.
- Taylor, R.G. & James, P.M. 1967. Geotechnical aspects of the Muda irrigation project. *Proceedings of the Southeast Asian regional conference on soil engineering, Bangkok*.
- Ting, W.H. 1979. Consolidation of a partially saturated residual soil. *Proc. 6th Asian conf. on SM & Fn Engr. 1979, Singapore*. 1.
- Ting, W.H. 1999. A Survey of embankment construction practice and future developments. *Year 2000, Geotechnics, AIT*.
- Ting, W.H. & Ooi, T.A. 1972. Some properties of a Malaysian residual granite soil. *Third Southeast Asian conference on soil engineering*.
- Ting, W.H. & Ooi, T.A. 1976. Behaviour of a Malaysian residual granite soil as a sand-silt-clay composite soil. *Geotechnical Engineering, J of SEA Soc. of Soil Eng., December 1976*. VII (2): 67-79.
- Ting, W.H. & Chan, S.F. 1991. Improvement of fill by compaction for building purposes. *4th Asian regional conference on soil mechanics & foundation engineering, 9-13 Dec. 1991, Bangkok, Thailand*. 1.
- Ting, W.H., Garib, Z. & Ramanathan, N. 1990. Study on the stability of slopes along the Seremban-Ayer Keroh Expressway. *Seminar on geotechnical aspects of the north south expressway, Kuala Lumpur*.
- Ting, W.H., Mun, K.P. & Toh, C.T. 1982. Characteristics of a composite residual granite soil. *Proc. of 7th SEA geot. conf., Hong Kong*.
- Toh, C.T., Ooi, T.A., Chiu, H.K., Chee, S.K. & Ting, W.H. 1989. Design parameters for bored piles in a weathered sedimentary formation. *Proc. of the 12th int. conf. on soil mech. & found. Eng. Rio de Janeiro, August 1989*.
- West, G. & Dumbleton, M.J. 1970. The mineralogy of tropical weathering illustrated by some West Malaysian soils. *Quarterly Journal of Engineering Geology* (3).
- Wong, J. & Singh, M. 1996. Some engineering properties of weathered Kenny Hill formation in Kuala Lumpur. *Proceedings of the twelfth Southeast Asian geotechnical conference, Kuala Lumpur*.

## CHAPTER 9

# Stabilization of tropical residual soils

Bambang I.Siswosoebrotho

*Bandung Institute of Technology, Indonesia*

Mustaque Hossain

*Kansas State University, U.S.*

Asmidar Alias & Bujang B.K.Huat

*University Putra Malaysia*

Soil stabilization is the alteration of one or more soil properties, by mechanical or chemical means, to improve the engineering properties of soil. Stabilization can be achieved through mechanical or chemical means. In chemical stabilization, a number of stabilizers, such as, portland cement, lime, fly ash, foamed asphalt chemical compounds or liquid stabilizer, or a combination of some of these, have been successfully used in the past. Existing work indicates that most of these stabilizers could be used for tropical residual soils in road construction.

### 9.1 INTRODUCTION

In most tropical countries, the road network consists of paved and unpaved roads. While some unpaved roads are gravel-surfaced, the majority are earth roads. Due to lack of suitable road construction materials, these earth roads that require minimum engineering, are quite economical choice to provide transportation for 20–30 vehicles per day (Fookes 1997). However, certain residual soils, such as those containing smectite or halloysite clays, may be unsuitable for road construction material, either because of inadequate strength or excessive volume change with varying moisture content, or because of loss of strength on wetting (Simmons & Blight 1997). These also tend to have high plasticity and low strength. Thus they need to be ‘stabilized’ when used in earth roads as well as in the subgrade or subbase of paved or gravel-surfaced roads.

Soil stabilization is the alteration of one or more soil properties, by mechanical or chemical means, to improve the engineering properties of soil. Stabilization is being used for a variety of engineering works, the most common application being in the construction of roads and airfield pavement, where the main objective is to increase the strength or stability of soil and to reduce the construction cost by making best use of local available materials.

In pavements, soil is stabilized to have a better subgrade or sub-base in terms of strength and durability. For earth roads, such stabilization results in improved traffic-ability of the road.

## 9.2 BENEFITS OF STABILIZATION

According to TRL (1993) stabilization can enhance the properties of road materials and pavement layers in the following ways:

- i) A substantial proportion of their strength is retained when they become saturated with water.
- ii) Surface deflections are reduced i.e. the bearing capacity is improved.
- iii) Resistance to erosion is increased.
- iv) Materials in the supporting layer cannot contaminate the stabilized layer.
- v) The effective elastic modulus of granular layers constructed above stabilized layers are increased.
- vi) Lime-stabilized material is suitable for use as a capping layer or working platform when the in-situ material is excessively wet or weak and removal is not economical.

In addition to above, the permeability and water absorption of the stabilized layers are also decreased.

## 9.3 METHODS OF STABILIZATION

There are numerous methods by which soils can be stabilized. The method of soil stabilization to be selected depends on the desired properties and conditions at the construction site. Some of the soil stabilization methods that have been used for improvement of highway sub-grade and sub-bases can be grouped into three broad categories:

- a) Mechanical stabilization
- b) Geosynthetic soil stabilization
- c) Chemical admixture stabilization

Mechanical stabilization is a process of mixing two or more soils with different gradations to produce a new soil with desirable engineering characteristics and then compacting the mixture to the required density using conventional methods. The particle size distribution and composition are the important factors governing the engineering behavior of a soil and significant changes in the properties can be made by addition or removal of suitable soil fractions. The soils may be mixed at the construction site, or at a central plant, or at a borrow area. Adequate mixing and compaction are required for successful mechanical stabilization. Compaction has a great effect on soil properties, such as strength and stress-strain characteristics, permeability, compression, swelling and water absorption. The properties of a soil under compaction depend upon the water content, amount and type of compaction.

Geosynthetics is a broad term that includes tough geotextiles fabrics, geogrids, geowebbs, and geocells. These are manufactured from strong and durable polymers. Geosynthetics have been used to improve highway sub-grade for the last two decades.

Chemical soil stabilization always involves treatment of the soil with some kind of chemical compound, which when added to the soil, would result in ‘chemical reaction’. The chemical reaction modifies/ enhances the physical and engineering properties of a soil, such as, volume stability and strength. When applied in road construction for stabilizing sub-grade materials, the chemical stabilization produces new materials which resist traffic loading and detrimental weather effects. The chemical admixture may be Portland cement, lime, fly ash, rice husk ash, chemical compound or liquid stabilizer etc.

The degree of improvement of in-situ soil may differ within a particular method and also between the methods. The reason behind is that soils exist in a broad range of types and different soils react differently to a stabilizer. Figure 9.1 shows the feasibility of different stabilization techniques related to soil type.



Figure 9.1. Soil stabilization techniques with respect to soil type (Mitchell 1976).

TRL (1993) recommends selection of stabilizer in Overseas Road Note (ORN) 31 based on plasticity and particle size distribution following the criteria developed by NAASRA (1986). Table 9.1 shows the NAASRA criteria. Although ORN 31 recommends stabilization based on the above criteria, the Public Works of Department of Malaysia (JKR 1985) recommends stabilization whenever CBR is less than 20%. No gradation is specified to maximize use of suitable local materials including sand and laterite (JKR 1985). Gradation is only required for crushed aggregates. Portland Cement is the recommended stabilizer.

The US Army (1997) suggests subgrade stabilization according to the guidelines shown in Table 9.2. To determine the stabilizing agent(s) most suited to a particular soil, the gradation triangle in Figure 9.2 is used.

### Mechanical stabilization

Mechanical stabilization relies on physical processes to stabilize the soil. Through compaction it produces an interlocking of soil-aggregate particles. The grading of the soil-

aggregate mixture must be such that a dense mass is produced when it is compacted. Mechanical stabilization can be accomplished through uniformly mixing the material, and then by compacting the mixture. As an alternative, additional fines or aggregates may be blended before compaction to form a uniform, well-graded, dense soil-aggregate mixture after compaction (US Army 1997). There are three essential elements for obtaining a properly stabilized soil mixture:

Table 9.1. Guidelines for selection of stabilizers (NAASRA 1986).

Type of Stabilization	Soil properties					
	More than 25% passing the 0.075 mm sieve			Less than 25% passing the 0.075 mm sieve		
	PI≤10	10<PI≤20	PI>20	PI<6	PP**≤60	PI>10
Portland cement	Yes	Yes	*	Yes	Yes	Yes
Lime	*	Yes	Yes	No	*	Yes
Lime-Pozzolan	Yes	*	No	Yes	Yes	*

\* Marginally effective.

\*\* Plasticity product.

Table 9.2. Subgrade stabilization method most suitable for specific applications (US Army 1997).

Purpose	Soil type	Method/Additive
Improves load-carrying and stress-distribution characteristics	Fine-grained	Mechanical, asphalt & cement
	Coarse-grained	Mechanical, asphalt & cement
	Clays of low PI	Asphalt, cement & lime
	Clays of high PI	Lime
Improves water-proofing and runoff Controls shrinkage and soil	Clays of low PI	Asphalt, cement & lime
	Clays of high PI	Lime

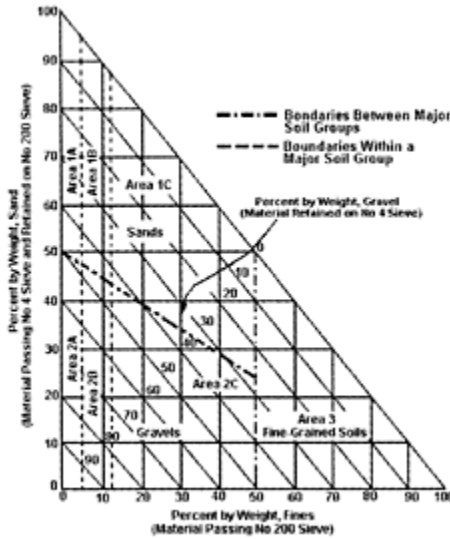

Figure 9.2. Gradation triangle for selecting a suitable stabilizer (US Army 1997).

- i) Proper gradation
- ii) A satisfactory binder soil
- iii) Proper control of the mixture content

To obtain uniform bearing capacity, uniform mixture and blending of all materials is essential. The mixture will normally be compacted at or near optimum moisture content. The primary role of the fraction in the blend retained on 0.075mm sieve is to produce internal friction. Satisfactory materials include crushed stone, crushed and uncrushed gravel, sand and crushed slag. Many other locally available materials have been successfully used, including disintegrated granite, talus rock, lime rock, tuff, shell, cinders, etc. (US Army 1997). In the soil-aggregate mixture, the portion that passes 0.075 mm sieve works as filler and supplies cohesion. This aids in the retention of stability during dry weather. The swelling of clay material serves somewhat to retard the penetration of moisture during wet weather. The nature and amount of this finer material must be carefully controlled. Too much fines may result in unacceptable volume change and other undesirable properties due to change in moisture content. The properties of the soil binder are usually governed by the plasticity characteristics. There is no fixed proportion for the soil aggregate mixtures. The mixture should meet the prevailing requirements for the subbase course. Typical gradation requirements for subbase by ORN 31 are shown in Table 9.3 (TRL 1993). Table 9.4 shows the recommended plasticity characteristics for granular subbases for tropical climates.

The Public Works Department (JKR 1985) Malaysia requires the pavement subbase consisting of sand, laterites, etc. to have a minimum California Bearing Ratio (CBR) of 20. Laterites form from the parent rock by excessive accumulation of iron, and leaching of other constituents of the parent material, such as, quartz. JKR (1985) requires that even though laterites can be used in the subbase, the plasticity index should not be greater than 6.

Table 9.3. Typical particle size distribution for subbases (TRL 1993).

BS sieve size (mm)	Percentage by mass of total aggregate passing test sieve
50	100
37.5	80–100
20	60–100
5	30–100
1.18	17–75
0.30	9–50
0.075	5–25

Table 9.4. Recommended plasticity characteristics for granular subbases (TRL 1993).

Climate	Liquid limit	Plasticity index	Linear shrinkage
Moist tropical and wet tropical	<25	<6	<3
Seasonally wet tropical	<45	<12	<6

Table 9.5. Standard gradation limit for subbases (JKR 1985).

BS sieve size (mm)	Percentage by mass of total aggregate passing test sieve
50	100
37.5	80–100
20	60–100
5	30–100
1.18	17–75
0.30	9–50
0.075	5–25

The gradation requirements are shown in Table 9.5. Note that they are similar to the particle size distribution for subbase of TRL (1993), shown in Table 9.3. For sand, laterites, etc. nominal size shall not be greater than one-third of the compacted layer thickness (JKR 1985).

Although ORN 31 and JKR Pavement Design Guide both permit use of tropical residual soil in road construction, performance data on the roads constructed with a mixture of residual soils and aggregate mixture is almost lacking. De Rezende & Carvalho (2003) have described the work by Nogami & Villibor (1995) in Brazil where low-cost pavements

with laterite soils were studied. De Rezende & Carvalho (2003) studied stabilization of laterites with a mixture of 80% crushed rocks (9.5 mm nominal size) and 20% fine soil. The CBR of this material was 8. This method of stabilization produced the best structural behavior when compared to other methods, such as lime stabilization and no treatment.

### *Chemical admixture stabilization*

Since the early forties, stabilization of soil with admixtures, such as cement, lime, bitumen, fly ash, etc. have been successfully experimented and used extensively for road and airport foundations in Australia, U.S., Europe, India, Africa and many other parts of the world. Addition of inorganic chemical stabilizers like cement and lime have a two-fold effect on soil—acceleration of flocculation and promotion of chemical bonding. Due to flocculation, the clay particles are electrically attracted and aggregated with each other. This results in an increase in the effective size of the clay aggregations. Ingles (1968) asserted that such aggregation converts clay into the mechanical equivalent of a fine silt. Also, a strong chemical bonding force develops between the individual particles in such aggregations. The chemical bonding depends upon the type of stabilizer employed.

### *Portland cement stabilization*

Soil stabilized with cement is known as soil cement. The cementing action is believed to be the result of chemical reactions of cement with the silicious soil during hydration. The binding action of individual particles through cement may be possible only in coarse-grained soils. In fine grained, cohesive soils, only some of the particles can be expected to have cement bonds, and the rest will be bonded through natural cohesion. The important factors affecting soilcement are: nature of soil, cement content, conditions of mixing, compaction and curing, and admixtures (Bergado 1996).

Ordinary Portland Cement (ASTM Type I) has been extensively used to stabilize a wide variety of soils, including granular materials, silts, and clays. Addition of cement to the soil decreases compressibility and swell potential, and increases the strength and durability of the soil (Schaefer et al. 1997). Since 1915, more than 160,000 km of equivalent 8 meter wide pavement bases have been built using soilcement (Little et al. 2000).

When water is added to neat cement, the major hydration products are basic calcium silicate hydrates, calcium aluminate hydrates and hydrated lime. The silicate hydrates constitute



Figure 9.3. Cementation effect around the contact points of coarse grains (Kezdi 1979).



the major cementitious compounds, while the lime is deposited as a separate crystalline solid phase. The silicate hydrate products are also responsible for strength gain of soil-cement mix. The interaction between cement and soil differs somewhat for two principal types of soil, granular and cohesive. In granular soils, the cementation effect is similar to that in concrete, the only difference being that the cement paste does not fill the voids of the additives, so that the latter is only cemented at contact points (Figure 9.3). In this case, no continuous matrix is formed and the fracture type depends on whether the interparticle bond or the natural strength of the particles themselves is sufficiently strong. The better graded the grain distribution of a soil, the smaller the voids and the greater the number, and the larger the interparticle contact surfaces, the stronger the effect of cementation (Kezdi 1979).

In fine-grained soils, the hydration of cement creates rather strong bonds between the various mineral substances and forms a matrix which efficiently encloses the non-bonded soil particles. This matrix develops a cellular structure on whose strength that of the entire construction depends. This happens due to the fact that the strength of the clay particles within the matrix is rather low. Since this matrix pins the particles, the cement reduces plasticity and increases shear strength. The chemical surface effect of the cement reduces the water affinity of the clay and in turn, the water-retention capacity of the clay. Together with a strength increase, this results in the enclosure of the larger unstabilized grains which therefore cannot expand and will have improved durability. The cement-clay interaction is significantly affected by the interaction of lime, produced during hydration of Portland cement and the clay minerals. The interaction can be classified into two groups: rapid rate (ion exchange and flocculation) and slow processes (carbonation, pozzolanic reaction and production of new substances). The whole process can be divided into a primary and a secondary process.

The primary process includes hydrolysis and hydration of cement. In this process, hydration products appear and the pH value of water increases. The calcium hydroxide produced in this period can react much more strongly than ordinary lime (Herzog & Mitchell 1963). Clay is important in the secondary processes. The calcium ions produced during cement hydration combine with pozzolans present in clay to form more calcium silicate hydrate and calcium aluminum hydrate in a pozzolanic reaction (Little 1995). This increases the intensity of flocculation that had been initiated by the increased total electrolyte content due to cement addition. Calcium hydroxide then attacks the clay particles and the amorphous compound parts. Then the silicates and aluminates dissolved in the pore water, whose pH has been raised due to dissociation of calcium hydroxide, will mix with the calcium ions and additional cementing material is precipitated (Bergado 1996). The calcium hydroxide consumed during secondary processes is partly replaced by the lime produced by cement hydration. During secondary processes, cementitious substances are formed over the surface of clay particles or in their immediate vicinity, causing flocculated clay grains to be bonded at the contact points. Still stronger bonds may be created between the hydrating cement paste and the clay particles coating the cement grains (Herzog & Mitchell 1963; Kezdi 1979). Pozzolanic reaction can continue for months or even years after mixing, resulting in an increase in the strength of cement-stabilized clay with the increase in curing time (Bergado 1996). Pozzolanic reaction will continue as long as the calcium is available and as long as the pH maintains the solubility of silica and alumina of the soil (Little 1995).

Thus, pozzolanic reactions result in long-term strength development of cement-stabilized clay. The cementation strength of primary cementitious products is much stronger than that of secondary cementitious products (Bergado 1996).

Portland cement stabilization for tropical residual soils does not appear to be very common although cement stabilization will not depend on the mineralogy of the soil (Rollings & Rollings 1996). The suitability of soils for cement stabilization is governed by two factors (Bell 1993):

- i) Whether the soil and cement can be mixed uniformly; and
- ii) Whether the soil-cement will harden adequately after mixing and compacting.

Also, cement stabilization is generally not economical for clays with plastic limits greater than 20% or liquid limits in excess of about 45% to 50% (Lancaster-Jones et al. 1978). High amounts of cement is required to stabilize heavy clays. Heavy clays cause problems in pulverizing, mixing and compacting soil-cement. It is also very difficult to mix dry cement with heavy clays. These clays are generally treated with lime, before they are mixed with cement, to reduce the plasticity and to make the clay workable for cement stabilization. Thus some residual soils will be excluded from this type of stabilization. However, Fookes (1997) has suggested using 5% (by weight) of Portland cement for about a tenfold increase in strength. However, JKR of Malaysia recommends 2 to 4% (by weight) for stabilizing laterite for pavement sub-base construction (JKR 1985).

Wibawa & Rahardjo (2001) conducted a study to find the effect of cement on the swell pressure and free swell of a swelling soil from Cikarang, West Java, Indonesia. According to USCS, the soils were classified as CH, inorganic clay of high plasticity. The soil was treated with 5% ordinary Portland cement. Soil-cement mixture was compacted immediately after mixing. Soil specimens for free swell tests were prepared from compacted specimens. Free swell tests were conducted using an oedometer. Initial surcharge of 10 kN/m<sup>2</sup> was used. The results, shown in Figures 9.4 and 9.5, indicate that the addition of cement reduced the swelling pressure and free swell of the soil. The swelling pressure of the untreated soil ranged from 17.5 kPa to 55 kPa at different water contents. The swelling pressure for the cement-treated soil ranged from 10.2 kPa to 18 kPa. Free swell of the untreated

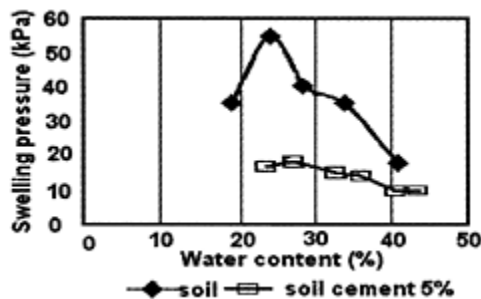

Figure 9.4. Effect of cement on swelling pressure (Wibawa & Rahardjo 2001).

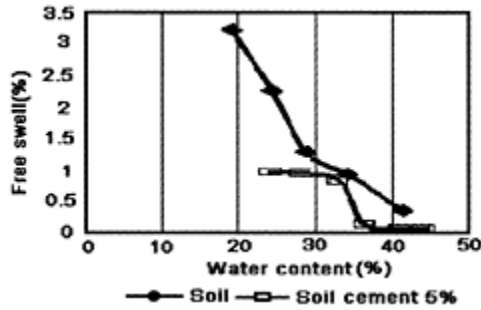

Figure 9.5. Effect of cement on free swell (%) (Wibawa & Rahardjo 2001).

0.95%. Ola (1974) experimentally showed that less than 50% of the cement requirement for a temperate zone soil is required for efficient stabilization of a lateritic soil. This happened because the lateritic soils existed at a higher shearing strength level than its temperate zone counterpart.

### *Lime stabilization*

Lime has been used as a soil-stabilizing agent since Roman times (Lancaster-Jones et al. 1978). Presently, this technique is used in highways, railroads, airports, retaining walls and lime columns. Lime may be used alone, or in combination with cement, bitumen or fly ash. The benefits of lime stabilization are similar to those of cement stabilization. However, it is possible that there will be an increase in permeability. Usually, this is of lesser significance for the subgrade.

Lime is produced by calcining limestone or dolomitic limestone. Lime is available in various forms. However, the most commonly used forms of lime for soil stabilization are quicklime and hydrated lime. Quicklime ( $\text{CaO}$ ) is produced by calcining limestone ( $\text{CaCO}_3$ ) at an elevated temperature (about  $1315^\circ\text{C}$ ). Hydrated lime is produced by treating quicklime ( $\text{CaO}$ ) with sufficient water ( $\text{H}_2\text{O}$ ) to satisfy its chemical affinity to water. Quick lime is a more granular substance and is more caustic and quicklime is much cheaper and most effective but it is dangerous to the health of the laborers. Additional safety procedures must be followed when using quick lime. Hydrated lime is a fine powder and is less caustic when compared to the quick lime (Little 1995).

Two phases of stabilization occur in a lime-soil system. The first involves the practically immediate reaction of cation exchange and flocculation-agglomeration. Although the exact mechanisms of lime-soil stabilization are not totally agreed upon, general agreement does exist that four basic reactions do occur to some level (Little 1995):

- i) cation exchange,
- ii) flocculation and agglomeration,
- iii) pozzolanic reaction, and
- iv) carbonation.

Lime and moist soil (clay) results in friable and silty-like and when added to a soil, lime produces calcium ions ( $\text{Ca}^{2+}$ ) that tends to replace the weaker ions like sodium ions ( $\text{Na}^+$ ) or potassium ions ( $\text{K}^+$ ) on the surface of the clay particles (Lancaster-Jones 1978). This process is known as the cation exchange process. In the surface of clay particles : calcium ions replacing sodium and hydrogen ions with general order of replaceability:  $\text{Na}^+ < \text{K}^+ < \text{Ca}^{++} < \text{Mg}^{++}$  (monovalent cations replaced by multivalent cations). Addition of lime ( $\text{Ca}(\text{OH})_2$ -alkali) will also raise pH of the soil, which in turn, increases the cation exchange capacity. As explained earlier, cation exchange process results in the flocculation and agglomeration of clay particles. The rise in pH of the pore water increases the solubility, and reactivity of silica and alumina (pozzolans) present in clay particles (Bergado 1996, Herzog & Mitchel 1963). Lime also provides free calcium that combines with pozzolans present in clay to form more calcium silicates hydrate and calcium aluminate hydrates. This reaction is called pozzolanic reaction (Little 1995).

Some researchers have explained that the immediate textural changes, plasticity changes and shortterm strength gains which were traditionally thought to be the result of cation exchange are actually artifacts of the crowding of calcium hydroxide molecules along the surface of the clay. This crowding results in an attack on the clay mineral surface and the formation of calcium-aluminate and calcium silicate minerals, which help bond the mineral surfaces together- reducing plasticity and affecting the textural change. This is essentially a 'pozzolanic effect' (Little 1995). Eades and Grim, as reported by Little (1995), found out that the amount of lime necessary to initiate and 'drive' lime-soil reactions that are responsible for long-term compressive strength gain and pozzolanic reactivity is soil dependent and varies considerably from soil to soil.

The extent to which the pozzolanic reaction happens is primarily influenced by soil properties. With some soils, the reaction is inhibited and cementing agents are not formed. Robnett & Thompson (1970) has proposed that those soils react with lime to produce a substantial increase in unconfined compressive strength (greater than 345 kPa) following 28 days of curing at 22°C are 'reactive' and those that display less than 345 kPa strength increase are 'non-reactive'. It is to be noted that a number of factors influence lime-soil pozzolanic reactions. The major factors are: (i) organic carbon, and (ii) sulfates. The other factors are: (i) clay content, (ii) clay mineralogy, (iii) weathering, (iv) pedology, and (v) geographical and climatic effects.

The mechanisms of lime stabilization require the presence of clay minerals to provide alumina and silica to support pozzolanic reactions for long-term strength gain. Thus, clays or soils with sufficient clay fines to interact with lime are suitable for lime stabilization (Rollings & Rollings 1996). Lime stabilization is more suitable for soils with high clay content and less suitable for granular soils. Soils with plasticity index greater than 10% and with greater than 25% of soil passing 0.075 mm sieve are more suitable for lime stabilization (Little 1995). Lime reacts with most of the soils having a plasticity index ranging from 10% to 50%. Soils with plasticity index less than 10% are generally treated with pozzolan like fly ash to enhance the reaction with lime (Bell 1993). Organic matter absorbs calcium ions that are necessary for cation exchange process and pozzolanic reactions. Generally, the presence of organic matter in excess of 1% will interfere with pozzolanic reaction (Little 1995).

The flocculation and agglomeration of clay particles, with the addition of lime, results in an increase in percentage of coarse particles and a decrease in the clay content. This will result in the reduction of plasticity and change in texture of the soil. Reduction in plasticity will result in improved workability (reduced stickiness), reduction in swell and shrink potential, and reduction in strength loss in the presence of moisture (Rollings & Rollings 1996). The changes in the plasticity and swell potential of the lime-treated soils can be determined by conducting various laboratory tests.

The amount of lime required may be based on the unconfined compressive strength or the CBR test criteria. The optimum lime content for stabilization is the minimum amount that can produce desired change in the engineering properties of the soil for the time required. Lime content of 3–4% for silty clays and 3–8% for heavy and very heavy clays are required for stabilization (Ingles & Metcalf 1972). However, the Eades and Grim procedure is the most commonly used design method for determining the amount of lime required for stabilization. This procedure is available in ASTM specification D6276–99a (Standard Test Method for using pH to Estimate the Soil-Lime Proportion Requirement for Soil Stabilization). The method is based on the philosophy of adding lime required to satisfy the cation exchange capacity of the soil and satisfy initial and short-term reactions and to provide enough lime for the long-term pozzolanic reactions. This test is a good test for a starting point to determine optimum lime content required for soil stabilization that would satisfy strength requirements. ONR 31 recommends that lime content be selected according to British Standard 1924 (TRL 1993). For tropical countries, sample temperature is to be maintained at 25°C.

Experience has shown that lime will react with medium, moderately fine and fine-grained soils (CH, CL, MH, SC, SM, SW-SC, SP-SC, GP-GC or GM-GC) to produce decreased plasticity, increased workability, reduced swell and increased strength. The key to a pozzolanic reaction resulting in long term strength is the presence of reactive clay to supply the pozzolans. Lime has also been found to be an effective stabilizer for sandy/silty soils with clay content as low as 7% and a plasticity index as low as 10 (Little 1995). However, Little (1995) has proposed that lime be considered in soil stabilization when the plasticity index is greater than 10 and with more than 25% material passing 0.075 mm sieve (US No. 200).

The strength requirements of lime-stabilized materials vary from agency to agency. ONR 31 requires that the lime-stabilized material have an unconfined compressive strength of 0.75 to 1.5 MPa when tests are conducted on 150 mm cubes that have been moist cured for 7 days and soaked for 7 days at 25°C. Alternatively, a minimum CBR of 70 under similar curing and conditioning as before is required (TRL 1993). The US Navy requires an unconfined compressive strength of 1.05 MPa after 28 days of curing (US Army 1997).

Nicholson et al. (1994) conducted a study using lime to improve tropical Hawaiian soils—two highly plastic ‘adobe’ clays from Manoa and Palolo Valleys, a plastic clay from Kapolei, a silty-clay from Kailua, and a silty-clay soil from Kaneohe consisting of moderate to highly weathered saprolite. The Manoa and Palolo clays were classified as CH soil according to the Unified Soil Classification Soil (USCS), and had a high-percentage of high-activity smectite clays. These soils had low CBR values, high plasticity (>50), high Liquid Limits (>100) and high natural water contents (200 to 300%). The Kapolei silty clay (CH) contained a large amount of histosols. It had relatively low CBR, poor workability

and a steep compaction curve that made it difficult to compact to a high density in the field. The Kailua silty clay (MH) belonged to the oxisols and exhibited high plasticity, low CBR and moderately high swell potential. The Kaneohe soil (MH) contained a significant percentage of halloysite, had low CBR and high natural moisture content (55–75%).

The Hawaiian soils were mixed with 3%, 5%, and 7% lime. The soil-lime mixtures were then cured for 24 hours. The cured mixtures were then air-dried and Atterberg limit tests were conducted. The results, shown in Figure 9.6, indicate that the addition of lime decreased the plasticity index of these soils. Addition of 5% and 7% lime converted Kapolei and Kaneohe silty-clay soils to non-plastic soils. Free swell test was also conducted on lime-treated soils. The specimens for free swell test were prepared by compacting the soil-lime mixtures to 90% of modified Proctor density at optimum moisture content. Swell tests were conducted on the specimens after approximately four days of curing. The results of these tests, shown in Figure 9.7, indicate that lime addition almost eliminated the free swell measured.

Nicholson et al. (1998) also described the lime stabilization of two soils from the Island of O'ahu in Hawaii treated with 5% hydrated lime ( $\text{Ca}(\text{OH})_2$ ). These soils, obtained from roadway construction sites in Halawa Valley and Aikahi, were fine-grained soils with moderate to high plasticity. Based on sieve analyses and Atterberg limit tests, the soils from Halawa and Aikahi were designated USCS classifications of MH and CH, respectively.

The Halawa soil is a mottled-brown deposit derived from weathered basalt. The mineral content of the Halawa soil was found to be predominantly halloysite with some gibbsite, goethite, anatase, and quartz. While the Halawa soil classifies as MH, the mineralogy shows it to be predominantly clay. This is not uncommon for tropical soils where high plasticity MH soils are abundant. The sample obtained from Aikahi is dark, greenish-grey, highly plastic clay whose principle constituents are smectite and halloysite as indicated by X-ray diffraction (Nicholson et al. 1998).

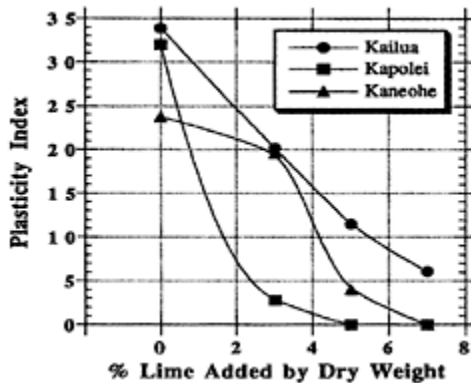

Figure 9.6. Effect of lime on plasticity index of the soils (Nicholson et al. 1994).

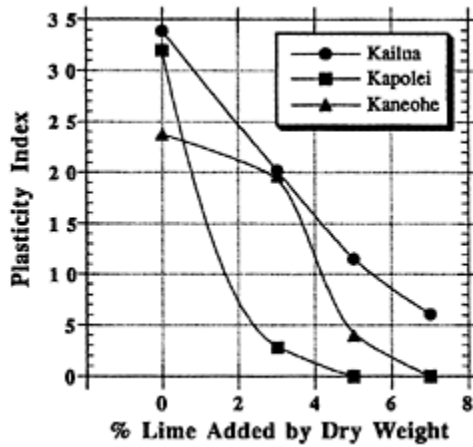

Figure 9.7. Effect of lime on percent swell of the soils (Nicholson et al. 1994).

Tests were done to determine the Unified Soil Classification System (USCS) classification as well as the before and after-stabilization properties of the soil when compacted to levels typical for roadway applications. The classification phase of the testing program was conducted on original (untreated) soil and consisted of grain size analyses, Atterberg limits, X-ray diffraction, and pH analyses. The pH tests were performed to identify the amount of lime additive that was needed to raise the pH of the soil mixture to the lime retention point of 11.3, at which the efficiency of the soil-lime reaction is maximized. Comparisons of Atterberg test results were performed on the soils before and after treatment to determine any changes in the plasticity of the soil. The second phase of the test program included swell and unconsolidated-undrained (UU) triaxial compression tests for determination of relative strength and strength increase of the soil following the addition of stabilizing agent. Moisture-density relationships for each soil were determined by the modified Proctor compaction test prior to performing the strength tests to determine the maximum dry density (MDD) and optimum moisture content (OMC). Free swell tests were also performed to determine the effects of stabilization on volumetric changes due to moisture fluctuations.

Table 9.6 shows the test results obtained. Lime was very effective in reducing the swell of the Halawa clay, but not plasticity. However, for Aikahi clay, it reduced the swell by almost 50% and the plasticity index by about 61%. The strength gains were 64.5% and 12.5% for the Halawa and the Aikahi clays, respectively. Thus the results of this stabilization effort can be concluded as mixed.

De Rezende & Carvalho (2003) described the results of a study on three test sections on two highways in Brazil where lateritic clay soils were stabilized with 2, 3 and 6% moisturized calcite lime. The results, shown in Table 9.7, show that lime was not effective in reducing plasticity but was very effective in increasing the strength of the soils (CBR). The increases in LL, PL and OMC after lime treatment were thought to be due to the oxides and hydroxides of iron and aluminum present in the soils (De Rezende & Carvalho 2003).

Table 9.6. Test results for Hawaiian soils treated with or without lime (Nicholson et al. 1998).

Soil	Description	Gradation	UCSC	LL	PL	PI	MDD (kN/m <sup>3</sup> )	OMC (%)	Swell (%)	UU (kPa)
Halawa clay	Untreated	19% Gravel 24% Sand 57% Silt/ Clay	MH	91	61	30	12.9	35	4.3	380
	5% lime	–	MH	91	62	28	–	–	0.5	625
Aikahi clay	Untreated	>90% passing 0.075 mm sieve	CH	146	41	105	13.7	33.5	47	160
	5%	–	MH	82	41	41	–	–	25	180

Table 9.7. Test results for Brazilian soils treated with or without lime (De Rezende &amp; Carvalho 2003).

Property	Experimental Highway 1		Experimental Highway 2		
	Untreated soil	Soil+2% lime	Untreated soil	Soil+3% lime	Soil+6% lime
Gravel (%)	0.6	0.3	0	0	0
Sand (%)	3.1	10.1	18.4	11.2	18.8
Silt & Clay (%)	96.3	89.6	81.6	88.8	81.2
Unit weight (g/cc)	2.78	–	2.66	–	–
LL (%)	45	52	52	52	54
PL (%)	31	37	41	38	41
PI (%)	14	15	11	14	13
USCS	MH	MH	MH	MH	MH
Brazil Tropical Soil Class	LG*	–	LG*	–	–
MDD**(kN/m <sup>3</sup> )	16	16.2	14.7	14.2	14.2
OMC (%)**	23.7	23.7	29.5	28.5	28.4
Swell (%)**	0	0.06	0.01	0.06	0.05
CBR (%)**	23	90	18	37	52

\* Lateritic clay.

\*\* Intermediate energy.



*Fly ash*

Fly ash is a pozzolan, that is, finely divided siliceous or siliceous and aluminous material which, when mixed with lime and water, forms cementitious compounds. The mechanical and chemical characteristics of fly ash are highly dependent on the type and source of coal burned and the coal burning technique. Figure 9.8 shows a schematic of the fly ash production process.

Fly ash is classified by the American Society of Testing and Materials (ASTM) into two classes—F and C. Both classes can be used as stabilizers for soil. Class F materials are generally of low calcium (less than 10% CaO) fly ashes with carbon content less than 5%, but some may contain carbon as high as 10%. Class F materials are not cementitious by themselves and usually used with Portland cement or lime. Class C materials are often of high-calcium (10% to 30% CaO) fly ashes with carbon contents less than 2%. Many Class C fly ashes can be cementitious by themselves, and when exposed to water will hydrate and harden in less than 45 minutes. The difference in classes result from burning different coals. Class C results from burning subbituminous and lignite coals.

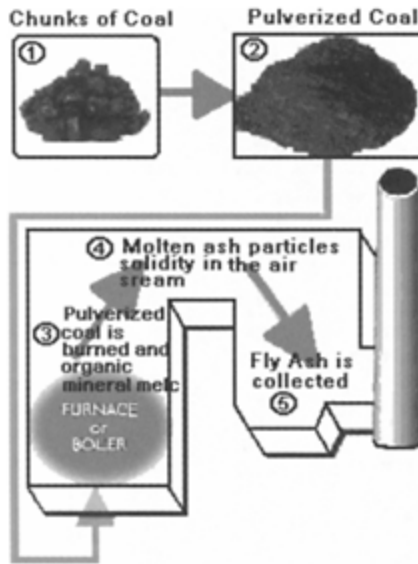

Figure 9.8. Schematic of the fly ash production process (SEFA 2002).

The mechanism of soil-Class F fly ash stabilization is a classic ‘pozzolanic’ reaction. The mechanism of soil-Class C fly ash reaction is very similar to the soil-lime reaction. However, since some cementitious materials (calcium silicate hydrate) are also produced, part of the reaction would follow the mechanics described in soil-Portland cement reaction.

Addition of Class C fly ash to clayey soils immediately causes the flocculation and agglomeration of clay particles due to ion exchange at the surfaces of the soil particles. As stated earlier, Class C fly ash contains enough lime that reacts with the pozzolans to form cementitious compounds, which results in the bonding of soil particles. The calcium ions

( $\text{Ca}^{2+}$ ) replace monovalent ions on the clay surface (cation exchange) and promote flocculation of clay particles. This results in the decrease in surface area and water affinity, which implies a reduction in swell potential (Cokca 2001). The cation exchange reaction also results in increased interparticle attraction that, in turn, results in a decrease in plasticity of treated soils (Nalbantoglu & Guebilmmez 2002). Due to low calcium ion concentration in fly ash, the reduction in Atterberg limits of soils is generally smaller compared to that due to lime. The reduction in swell potential by the addition of fly ash is comparable with that observed for lime treatment (Ferguson & Avent 1993).

Nalbantoglu & Guebilmmez (2002) also showed that the addition of fly ash reduced the volume change potential of foundation soils. In that study, highly plastic clay (CH) with a plasticity index of 45.6% was evaluated. Addition of 15% Class C fly ash to this soil converted it into a silt with high plasticity (MH) as shown in Figure 9.9. However, addition of 25% Class C fly ash resulted in a silt with low plasticity (ML).

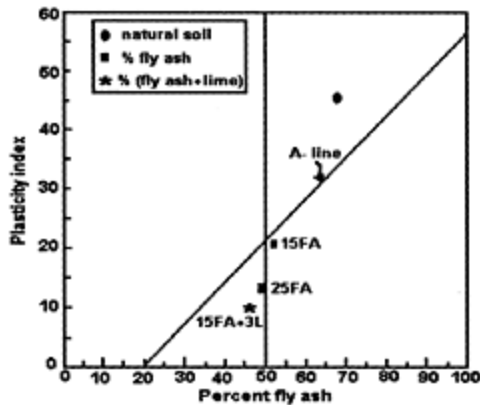

Figure 9.9. Plasticity of treated and untreated soils (Nalbantoglu & Guebilmmez 2002).

Swell tests were also conducted to evaluate the effect of fly ash on swell potential of the soil. The results of these tests showed that with a curing period of 30 days, the swell potential of 15% and 25% fly ash-treated soils decreased almost to zero as shown in Figure 9.10.

Nicholson et al. (1994) in Hawaii found that the addition of 15% and 25% of fly ash (with more than 20% lime content) by weight decreased the plasticity of CH clays by more than 50% as indicated by Figure 9.11. The results of swell tests are shown in Figure 9.12. The fly ash greatly reduced the swell for the smectite clays. However, the increase in CBR of only fly ash treated soils was marginal. When only 3% lime was added to the 15% fly ash and soil mixture, strength increase was dramatic. The unconfined compressive strength of fly ash-treated soil was higher in the long run (after 7 to 28 days) as indicated by the results in Table 9.8. The fly ash used in that study was actually a blend of fly ash and bottom ash

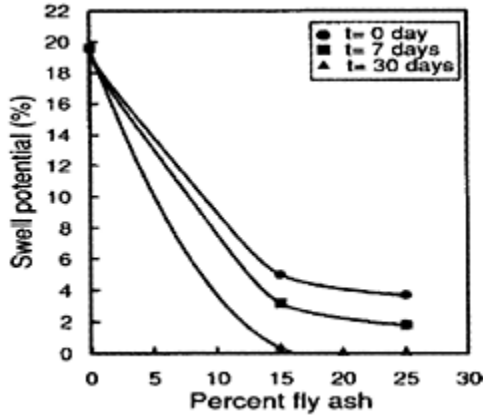

Figure 9.10. Effect of fly ash on swell potential of the soil (Nalbantoglu & Guebilmez 2002).

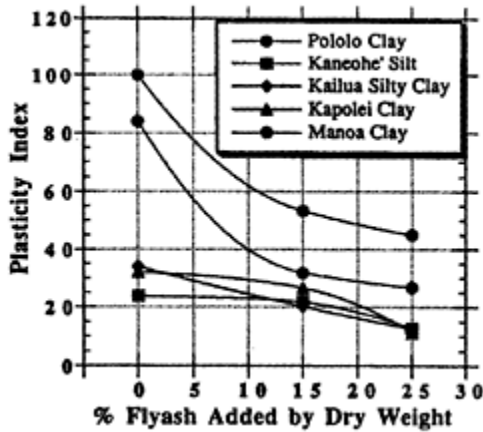

Figure 9.11. Variation of plasticity index with varied amounts of fly ash (Nicholson et al. 1994).

mixed as 75:25 (by weight) representing the approximate proportions actually generated from the coal burning process in that particular power plant in Hawaii. The study concluded that fly ash may become an accepted admixture for tropical soils.

Siswosoebrotho et al. (2003b) also reported the use of fly ash in improving properties of road material without incurring an acceptable loss in performance, including partial replacement by fly ash. An investigation was carried out on examining the use of fly ash mixed with granite as a suitable material for constructing access roads into the oil field explorations taking place in Riau Province, Sumatera, Indonesia and trying to find an optimum mix design for a range of granite/fly ash mixture. From the range of combinations of fly ash content tried, it was found that a mix of granite +5% fly ash content produced the highest value of dry density compared with using granite alone of the other granite—fly ash

mixes. The mixture with 5% fly ash content gave the highest dry density; in this case the fly ash just filled air voids but, where the fly ash content exceeded 5%, the fly ash not only filled the air voids, but also replaced a part of the granite, the dry density thereby decreasing since the specific gravity of fly ash is less than that of the granite (Figure 9.13).

Further addition of fly ash resulted in decreasing the dry density, although not significantly until the fly ash content started to exceed 10% with corresponding changes in optimum water content. In the mixtures

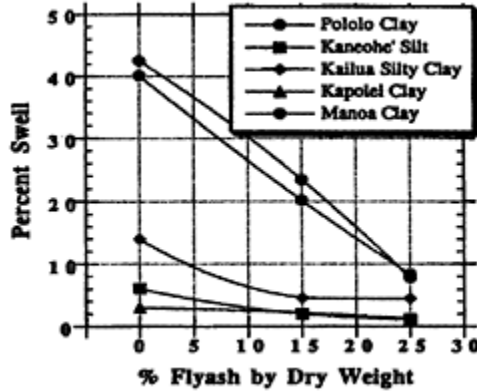

Figure 9.12. Variation of free swell with varied amounts of fly ash (Nicholson et al. 1994).

exceeding 5–10% fly ash content, the decreases in the dry density caused by introducing fly ash reflected the condition of not only filling the air voids, but also the replacement of part of the granite, the dry density decreasing since the specific gravity of fly ash is less than that of the granite.

It was also found that soaking affected the strength of materials, both for the granite alone and in the mixes with various PFA contents and curing time influenced the strength of the mixtures; this being caused by pozzolanic reactions taking place in the PFA. Furthermore, the combination of granite +15% PFA was found to provide the strongest mix, and granite +50% PFA, the weakest mixture after curing time of 14 days (Figure 9.14).

### *Bituminous Stabilization*

Stabilization with various bituminous materials such as cut backs, asphalt emulsion, etc. is very satisfactory for coarse-grained or granular materials (Yoder & Witczak 1979). Use with plastic soils, however, is sometimes limited due to mixing and construction difficulties unless the soil is pretreated with lime or cement. Currently, the foamed bitumen is being touted as an effective stabilizer.

The use of foamed bitumen as a stabilizing agent is not a new idea. In 1956, Dr. Ladis H. Csanyi, Professor at the Engineering Experiment Station of Iowa State University, investigated the possibility of using the foamed asphalt as a binder for soil stabilization (Csanyi 1957). Foaming of the asphalt reduces its viscosity considerably and has shown to increase adhesion properties making it well suited for mixing with cold and moist soil and aggregates.

Table 9.8. Unconfined compressive strength (kPa) of Hawaiian soils treated with and without lime and fly ash (Nicholson et al. 2002).

	Paloto				Kaneohe				Mance						
% Ash	0	15	25	15	0	15	25	15	0	0	0	0	15	25	15
% Lime	0	0	0	3	0	0	3	3	5	7	0	0	0	0	3
1-Day	347	200	98	358	517	245	209	862	352	400	414	349	120	203	332
7-Day		349	289	388		302	249	861	461	517	1117		307	259	395
28-Day		651	395	470		397	299	1676	862	1082	1862		599	350	484

	Kapolei				Kailua									
% Ash	0	15	25	15	0	15	25	15						
% Lime	0	0	0	3	3	5	7	0	0	0	3	3	5	7
1-Day	444	523	962	885	272	173	184	433	451	195	572	291	332	330
7-Day		914	1368	1599	433	465	839		500	396	951	323	417	753
28-Day		1134	1993	1951	1143	1276	2306		659	520	1238	577	728	1110

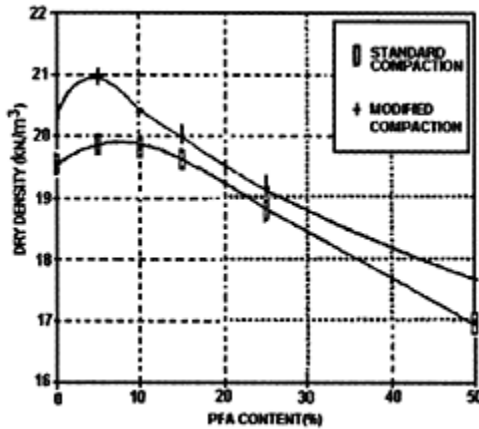

Figure 9.13. The relationship of fly ash content on the maximum dry density (Siswosoebrotho et al. 2003b).

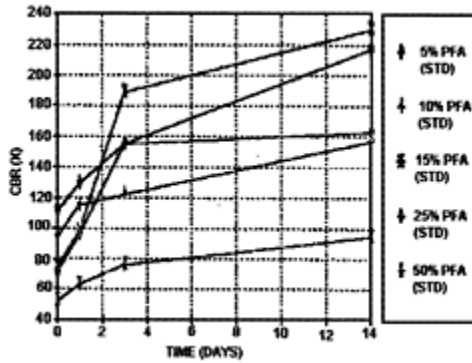

Figure 9.14. Influence of curing time on the CBR strength of granite mixed with PFA as a function of PFA content for standard compaction (Siswosoebrotho et al. 2003b).

No chemical reaction is involved only the physical properties of the asphalt are temporarily altered. When the cold water comes into contact with the hot asphalt, it turns into steam and in turn, gets trapped in the asphalt as thousands of tiny steam bubbles. After a few minutes, the asphalt will regain its original properties once the steam evaporates. Figure 9.15 shows the schematic of the asphalt foaming process.

The first reported use of foamed asphalt dates back to 1957 on an Iowa county road. Several other field applications were also reported including projects in Arizona (1960) and in Nipawin, Canada (1960–1962). However, the original process consisted of injecting high-pressure steam, at controlled pressure and temperature, into a heated penetration grade asphalt cement. This required special equipment on the job site such as a boiler and was not very practical.

In 1968, Mobil Oil Australia modified the original process by adding cold water rather than steam, into a stream of hot asphalt in a low-pressure system (Lancaster et al. 1994). This made the process much more practical and economical. The foam was created within an expansion chamber after which it was dispersed through a series of nozzles, onto the aggregate or mass. However, the nozzles were prone to blockage and the manufacturer could not soil mass control the foam characteristics. Recently, Wirtgen GmbH of Germany, Soter of Canada, and CMI of Oklahoma City, USA have developed new equipment for producing foamed asphalt. The foamed asphalt can be used for stabilization of subgrade soil.

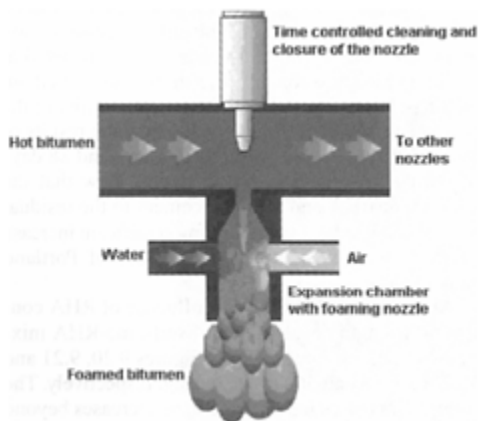

Figure 9.15. Schematic of the foamed asphalt production (Wirtgen 1998).

### *Chemical compounds*

Over the last two decades, there has been an emphasis on marketing some chemical compounds or liquid stabilizer for soil stabilization. Lignosulfonate additives, mostly by-products of the paper industry, have been marketed as a binder for subgrade materials. As a dispersing agent, they can make a clayey soil less permeable and reduce moisture evaporation (Ground Stabilization Services 2002). Currently some multienzymic products are being offered for soil stabilization (EMC Squared System 2002). Other compounds are also available. Examples are: CBR PLUS 2002, Earthzyme 2002, Liquid 2002, Consolid (C-444), Conservex (CX).

## 9.4 COMPACTION OF TROPICAL RESIDUAL SOILS

As seen earlier, tropical residual soils are widely used as paving materials. Compaction of untreated and stabilized soil is an integral process of pavement construction. However, some aspects of compaction of residual soils are unique and must be considered in the process. First of all, drying the soil from its in-situ moisture content may change both its index and compaction properties. Thus the soil samples have to be handled and tested with great care in order to have the compaction test results meaningful. Simmons & Blight (1997) referred to Gidigas (1974) who showed the influence of sample preparation and laboratory procedure on the compaction characteristics of a laterite soil in Ghana (Figure 9.16). Both OMC and MDD of this soil were affected by air- or oven-drying of the soil prior to compaction. The compaction characteristics of residual soils may very much depending on the method of applying the compaction energy. It is quite possible that the laboratory compaction curves may

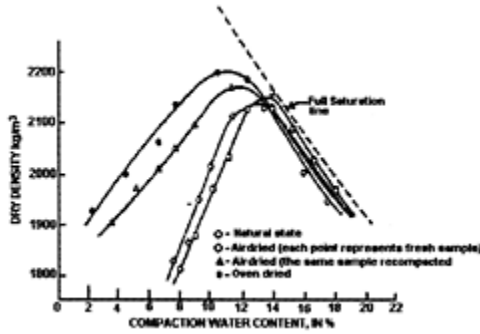

Figure 9.16. Influence of sample preparation process and laboratory procedure on compaction characteristics of laterite soil (Simmons & Blight 1997).

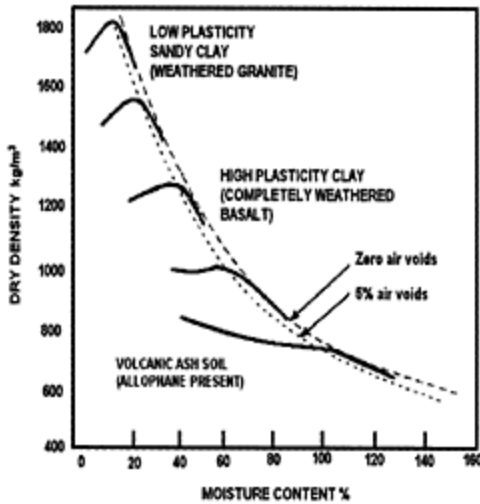

Figure 9.17. Typical compaction curves for different residual soils (Simmons & Blight 1997).

not be duplicated in the field. Compaction may result often in a progressive break-down of the particles in a residual soil (Simmons & Blight 1997). Figure 9.17 illustrates the compaction curves for a wide range of residual soils subjected to the same method of compaction and the same compactive effort. All curves show classical moisture-density relationships i.e. a maximum dry density exists at certain moisture content (optimum). However, very low densities and abnormally high in-situ moisture contents may be associated with volcanic soils. All soils exhibit the following common characteristics (Simmons & Blight 1997):

- i) High strength and void contents in the moisture content regime dry of optimum.
- ii) A rapid reduction of strength in the moisture content regime wet of optimum, where the curve follows a line of minimum air voids.



- iii) A range of moisture contents around the optimum condition, where the acceptability of the compacted soil can be measured by a variety of methods. In-situ strength is often the most appropriate compaction control parameter for residual soils.

The optimum moisture condition for field compaction is best determined for any compaction equipment by a process of field trials (Simmons & Blight 1997). Another factor to be considered is the process of moisture conditioning. Uniform distribution of moisture should be ensured. In high rainfall areas in the tropics, it may be necessary to dry the soil in order to operate the compaction equipment. The air-drying must be aided by ploughing or tilling to turn the wetter soil to the surface and expose it to sun and wind. However, stabilization by lime or fly ash expedites this drying.

There are a number of problems that may result if uniform mixing of soil and water is not accomplished. They include: (a) inclusion of dry soil clods in a wet matrix, resulting in large voids in the compacted mass; (b) shearing due to distortion of over-wet fill under the action of the compaction equipment, resulting in loss of shear strength of the compacted mass; (c) debonding between compacted layers, resulting in loss of strength in a horizontal direction. This, however, can be avoided by scarification immediately prior to the next lift of loose soil; and (d) poor support of the construction equipment and/or pounding of water (Simmons & Blight 1997).

Thus, more attention should be paid to the compaction of tropical residual soils. Otherwise premature rutting on newly paved highway is quite possible due to inadequate compaction of subsurface layers.

## 9.5 REGIONAL RESEARCH IN RESIDUAL SOIL STABILIZATION

Ali (1990) has studied the behavior of residual soil stabilized with chemical stabilizers in Malaysia. The researcher studied the effect of residual soil treated with Portland cement, lime and rice husk ash (RHA). Soil samples were taken from a hillside at Kampong Penchala, near Kuala Lumpur. The soil was classified as A-7-5 according to the AASHTO classification and as SC (sandy clay) according to the Unified Soil Classification System. The RHA was burned under controlled condition to produce pozzolanic RHA. Residual soils were mixed with different proportions (by dry weight of soil) of RHA and stabilizer (cement/ lime). The specimens for the unconfined compression and California bearing ratio tests were compacted at optimum moisture content. The study also carried out wetting-and-drying tests to check the durability of the specimens. Figures 9.18 and 9.19 show the results of the unconfined compression tests after 7 and 28 days of curing, respectively. These results show that the addition of RHA and Portland cement to the residual granite soil would not produce any significant increase in strength when compared to the use of Portland cement alone.

Ali (1990) also studied the influence of RHA content on strength development of soil-lime-RHA mixtures. The results are shown in Figures 9.20, 9.21 and 9.22 for 7, 28 and 56 days of curing, respectively. The strength increases initially and then decreases beyond certain value of RHA content. This indicates that there is an optimum strength that can be achieved for a particular percentage of lime and RHA in each sample.

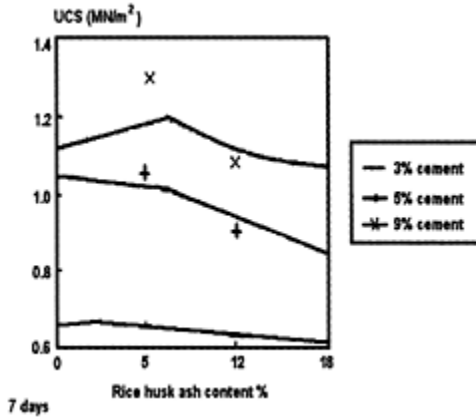

Figure 9.18. Variation of unconfined strength of soil with cement—RHA contents for 7 days curing period (Ali 1990).

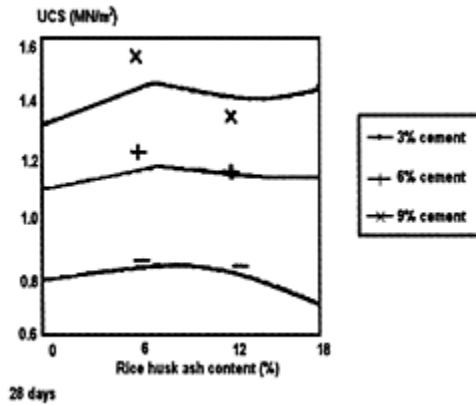

Figure 9.19. Variation of unconfined strength of soil with cement—RHA contents for 28 days curing period (Ali 1990).

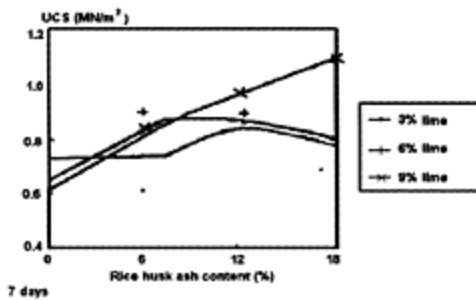

Figure 9.20. Variation of unconfined strength of soil with lime—RHA contents for 7 days curing period (Ali 1990).

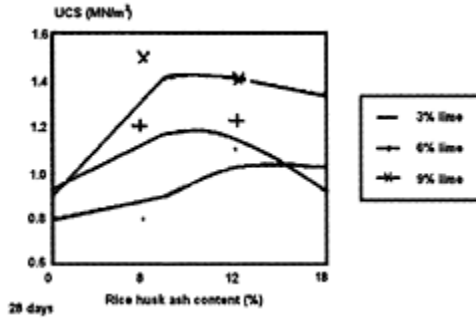

Figure 9.21. Variation of unconfined strength of soil with lime—RHA contents for 28 days curing period (Ali 1990).

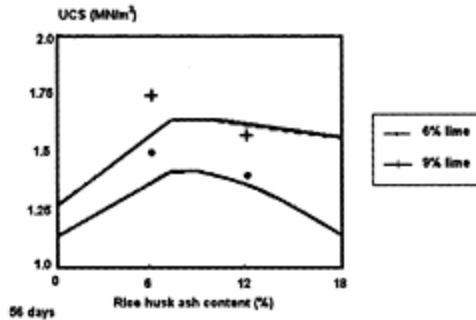

Figure 9.22. Variation of unconfined strength of soil with cement—RHA contents for 56 days curing period (Ali 1990).

Further addition of rice-husk after reaching this optimum point will only decrease the unconfined compressive strength.

The study also concluded that the addition of RHA alone to the tropical soil slightly decreased the plastic limit and linear shrinkage. Absorption of moisture caused the decrease in the unconfined strength of the stabilized soil but it was then followed by a slow gain in strength due to the curing effect.

Siswosoebrotho et al. (2003a) studied stabilized lateritic soil for use as a road base material in Indonesia. Lateritic soil that developed in a tropical forest of warm to temperated climate is soil rich in secondary oxides of iron, aluminium or both. The soil is one of residual soil or end product of weathering. Soil samples were taken from the province of Lampung in Indonesia and were classified as A-7-5 and CH according to the AASTHO and USCS classification systems, respectively. The samples were then tested based on the ASTM and AASHTO standards to find out the physical characteristics, compaction, and strength in terms of the California Bearing Ratio (CBR) and Unconfined Compressive Strength (UCS). Material used as stabilization agents were Type-1 Portland cement and hydrated lime,  $\text{Ca}(\text{OH})_2$ . The stabilizers were used at proportions of 2, 4, 6, 8 and 10% by

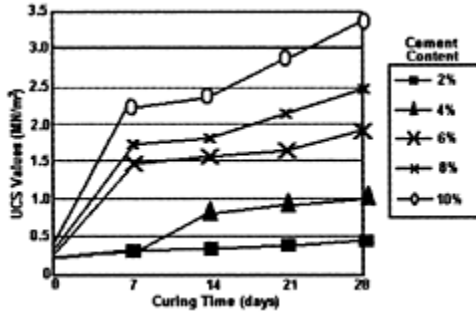

Figure 9.23. The relationship between UCS values and curing time at various cement content (Siswosoebrotho et al. 2003).

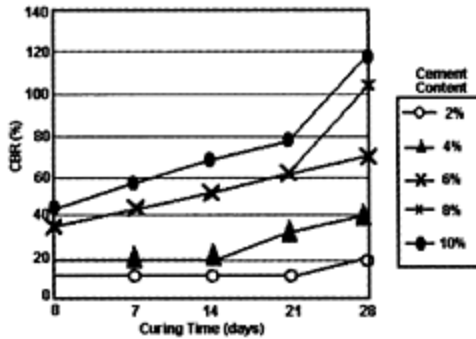

Figure 9.24. The relationship between CBR values and curing time at various cement content (Siswosoebrotho et al. 2003).

weight of dry soil. Curing was done for time periods of 0, 7, 14, 21 and 28 days. Figure 9.23 shows the relationship between the UCS values and curing time for various cement contents. Figure 9.24 shows the relationship between the CBR values and the curing time for various cement contents. Addition of Portland cement improved the soil characteristics as indicated by the decrease in the plasticity index, liquid limit and plastic limit. The UCS and CBR results showed significant increase as the percentage of Portland cement and curing period increased.

Siswosoebrotho et al. (2003a) found that the addition of 6 to 10% Portland cement produced hard soilcement mixtures. The UCS values obtained met the standard strength specifications for the sub-base and base layers.

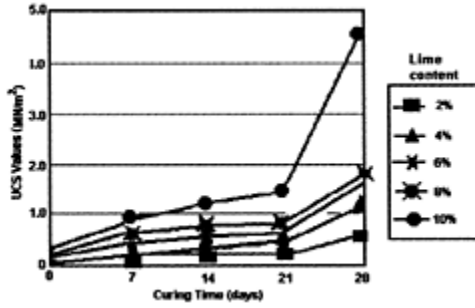

Figure 9.25. The improvement of UCS values at various lime content and curing time (Siswosoebrotho et al. 2003a).

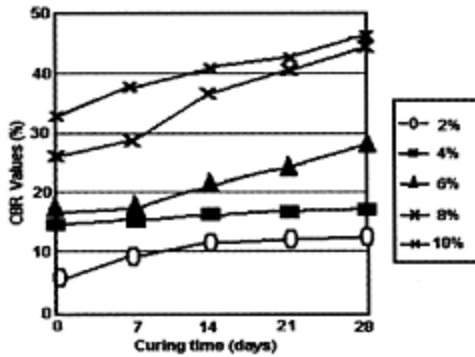

Figure 9.26. The improvement of CBR values at various lime content and curing time (Siswosoebrotho et al. 2003a).

Siswosoebrotho et al. (2003a) also investigated the effect of lime stabilization of residual soils in Indonesia. Figure 9.25 and 9.26 show the UCS and CBR values for various lime contents and curing time, respectively. These results show that strength increased by increasing lime content. The UCS and CBR values obtained only met the standard specifications for the sub-base material at 8% lime content.

In Malaysia research on residual soil stabilized with lime had been carried out by Huat & Muhammad (1997). The study used a local residual soil located at Serdang, typically known as Serdang series that form from sandstones, quartzites or conglomerates. The texture of this soil is commonly sandy clay and the colour is typically yellowish to reddish brown. The soil was then tested for unconfined compressive and durability after mixing with 2%, 5% and 8% of lime by weight of dry soil. Strength and durability tests were carried out for all samples compacted at optimum water content. The samples were then cured for 7, 14 and 28 days before compression tests. The Atterberg limit test results showed that the liquid limits decreased with an increase in lime content, while the plastic limit increased. This consequently led to a decrease in the plasticity index of the treated soil. Figure 9.27 shows the unconfined compressive strength test results.

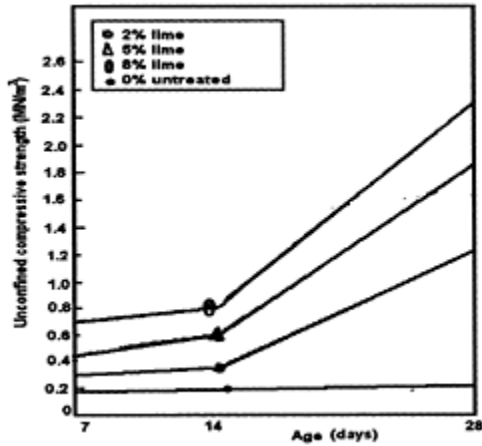

Figure 9.27. Unconfined compressive strength test results (Huat & Muhammad 1997).

The results showed that lime is suitable to be used for stabilizing local residual soil containing a high percentage of active clay minerals. Huat & Muhammad (1997) also observed that both maximum dry density and compressive strength of the soil increased with increasing lime contents.

Siswosoebrotho & Satrio (2000) investigated the role of new form of lime called 'Argojati' lime for soil stabilization in Bandung, Indonesia and compared the properties with soil stabilized with standard lime. Argojati lime is lime that has been further developed by including an additive material. Apart from portlandite and calcite, gypsum, pyrite and illite was added in argojati lime (Table 9.9). The chemical analysis of the soil sample used that is the Ujung Berung soil is shown in Table 9.10.

The addition of standard and Argojati lime to the soil classified as A-7-5 or CH, resulted in a progressive reduction in plasticity index (PI) and specific gravity ( $G_s$ ). However, the reduction of PI and  $G_s$  was more significant for soil mixed with standard lime.

Compaction characteristics of standard lime-soil mixtures showed that the maximum dry density (MDD) decreased and the optimum moisture content (OMC) increased with increase in standard lime content. In the lime-soil with Argojati lime, the addition of 2% lime caused OMC to increase and MDD to decrease; further addition of lime caused a progressive reduction in OMC and an increase in MDD.

Table 9.9. Chemical analysis and mineral composition of standard lime and Argojati lime.

Type of analysis	Standard lime analysis result (%)	Argojati lime analysis results (%)
Chemical composition		
SiO <sub>2</sub>	0.29	1.39
Al <sub>2</sub> O <sub>3</sub>	0.39	1.67

Fe <sub>2</sub> O <sub>3</sub>	0.21	1.57
CaO	69.47	60.83
MgO	2.64	3.22
SO <sub>2</sub>	0.04	4.20
H <sub>2</sub> O	1.04	2.33
Mineral composition	Portlandite CaO(OH) <sub>2</sub> Calcite CaCO <sub>3</sub>	Portlandite Ca(OH) <sub>2</sub> Calcite CaCO <sub>3</sub> Gypsum CaSO <sub>4</sub> .2H <sub>2</sub> O Illite (OH) <sub>4</sub> K <sub>y</sub> (Si <sub>8-y</sub> .Al <sub>y</sub> ) (Al <sub>4</sub> .Mg <sub>6</sub> .Fe <sub>6</sub> ) O <sub>20</sub> * Pyrite FeS <sub>2</sub>

\* y is value from 1.0 to 1.5.

Table 9.10. Chemical analysis and mineral composition of Ujung Berung soil (Siswosoebrotho & Satrio 2000).

Type of analysis	Analysis results (%)
Chemical composition	
SiO <sub>2</sub>	43.52
Al <sub>2</sub> O <sub>3</sub>	25.12
Fe <sub>2</sub> O <sub>3</sub>	11.86
CaO	1.86
MgO	0.6
K <sub>2</sub> O	0.1
SO <sub>3</sub>	0.02
H <sub>2</sub> O	3.74
Mineral composition	Kaolinite (OH) <sub>8</sub> Al <sub>4</sub> Si <sub>4</sub> O <sub>10</sub> Plagioclase CaAl <sub>2</sub> Si <sub>2</sub> O <sub>8</sub> Quartz SiO <sub>2</sub>

Generally, an increase in the content of both standard and Argojati lime increased the unconfined compression strength (UCS) (Figure 9.28). The lime soil mixtures cured for 1, 3 and 7 days and at each percentage of lime, the UCS increased with increase in curing

time. The UCS of Argojati lime soil was higher than that of soil treated with standard lime at all lime contents and curing periods.

The immersion effect indicated that the Argojati lime-soil is better able to resist water absorption than samples made with standard lime. However, neither type of lime can be considered satisfactory in terms of resistance to water damage. On the basis of the SNI specification, soil mixed with 5% standard lime or 2% Argojati lime meets the requirement for sub-base material; none of the mixtures investigated satisfy the roadbase strength requirements (Figure 9.29).

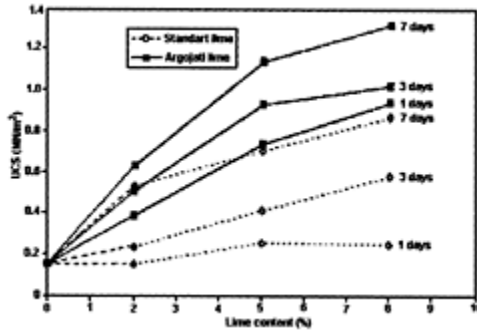

Figure 9.28. Effect of lime content on strength at room temperature (25°C) for different curing times (Siswosoebrotho & Satrio 2000).

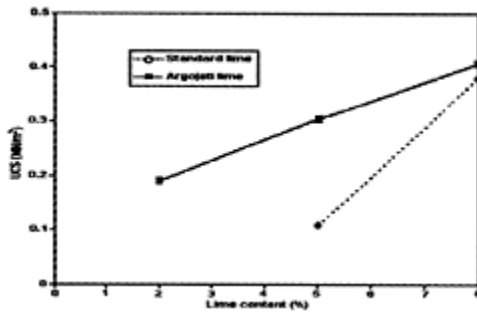

Figure 9.29. Effect of water immersion on strength for different lime contents (with 6 days curing and 1 day immersion) (Siswosoebrotho and Satrio 2000).

Related to the use of chemical compound on liquid stabilizer a soil stabilizer agent, Siswosoebrotho & Sinurat (2001) investigated the use of 2-component consolid system into the soils, namely Consolid-444 (444) and Conservex (CX). Three types of soils were investigated namely soil-A (classified as CH/A-7, having a soaked CBR value of 4.8%); soil-B (classified as SC/A-4, having a soaked CBR of 6.4%) and soil-C (classified as SM/A-3 having a soaked CBR of 34.9%). Table 9.11 shows the physical properties of the untreated soil. The amounts of the additives investigated covered the range of 400 to 800 cc per m3 of soil. The parameter used to characterize strength was CBR value; an attempt to use the



unconfined compressive strength test (UCS) was unsuccessful but the influence of curing time on strength development was investigated.

Table 9.11. Physical properties of untreated Soil A, Soil B and Soil C.

Properties test	Soil A (Tanjung Seri-West Java)	Soil B (Semen Api-Palembang)	Soil C (Pasir Merah-Palembang)
Specific gravity	2.68	2.67	2.78
Liquid limit, %	96.05	30.39	–
Plastic limit, %	45.50	21.92	–
Plasticity index,%	50.55	6.47	Non plastic
Grain analysis			
% passing 4	100.00	100.00	100.00
% passing 10	100.00	100.00	100.00
% passing 20	99.90	72.58	96.87
% passing 40	99.80	49.78	88.76
% passing 80	99.34	39.48	4.44
% passing 100	99.24	38.42	25.48
% passing 200	98.66	36.12	16.64
Classification			
USCS	CH	SC	SM
AASTHO	A-7	A-4	A-3

The test programme was devised to determine the amount of C-444 that needed to be added to soil compacted to standard maximum dry density in order to optimize the amount of CX added to the soil prepared at optimum C-444 content as shown in Table 9.12. The optimum amounts of C-444 were determined to be 550 cc/m<sup>3</sup> for soil A and 650 cc/m<sup>3</sup> for soils B and C. The optimum amount of CX was determined to be 10 litre/m<sup>3</sup> for all soil types; amounts in excess of this resulted in a reduction in soil strength. Addition of the optimum amount of C-444 to soils A, B and C increased CBR value by 166%, 33% and 7%, respectively. Addition of CX to soil A treated with C-444 further increased CBR value by 30% (Table 9.13). Addition of Consolid C-444 did not improve significantly the resistance to water of any of the soils investigated; a significant improvement however was observed when CX

was added. From considerations of strength improvement alone, only soil A appears to be a viable candidate for stabilization with the consolid system. Figure 9.30 shows the samples being soaked for the durability test.

Siswosoebrotho & Paransa (2002) studied the influence of the amount and plasticity of fines on the characteristics of Consolid-Treated Granular Materials. The Consolid C-444 was used together with the Conservex CX as an additive applied to materials which have fines content and plasticity index greater than the specified values for sub base or road-base layers. Eight mixtures with varying amounts of fines and having high plasticity indexes were prepared by mixing Galunggung coarse sand and Tanjungsari heavy clay soil (Figures 9.31 and 9.32).

Table 9.12. Summary of CBR test results for soils A, B and C treated with Consolid 444 content of 400, 550, 650 and 800cc/m<sup>3</sup> of soil, curing time 7 days.

Soil	Content of consolid 444 (cc/m <sup>3</sup> of soil)	CBR (%)				
		Sample 1	Sample 2	Sample 3	Sample 4	Average
A	400	10.25	12.71	11.96	12.71	11.64
	550	12.33	13.26	13.09		12.86**
	650	11.39	12.33	10.82		11.51
	800	11.20	10.06	11.58		10.94
B	400	8.10	8.60	8.35	9.74	8.35
	550	8.48	8.86	9.36		8.90
	650	9.11	8.73	9.36		9.24**
	800	8.60	9.36	9.11		9.02
C	400	35.42	36.56	38.71	37.07	36.90
	550	36.69	37.07	37.32		37.03
	650	37.95	37.45	36.56		37.26**
	800	35.04	36.06	38.21		36.44

\* Additional tests.

\*\* Optimum Consolid 444 content.

Table 9.13. Comparison of CBR values of untreated and treated soils A, B and C (at Optimum C-444 & Optimum C-444+CX).

Soil type	CBR (%)								
	Untreated	Treated							
		Optimum Consoild 444				Optimum Consoild 444+Conservex			
	1 day	3 days	7 days	14 days	1 day	3 days	7 days	14 days	
A	4.84	11.01	11.48	12.88	13.09	13.85	15.75	16.37	16.32
B	6.96	7.08	7.97	9.24	9.11	8.73	8.98	8.86	9.24
C	34.96	34.92	36.56	37.26	38.90	38.84	39.72	41.97	42.19

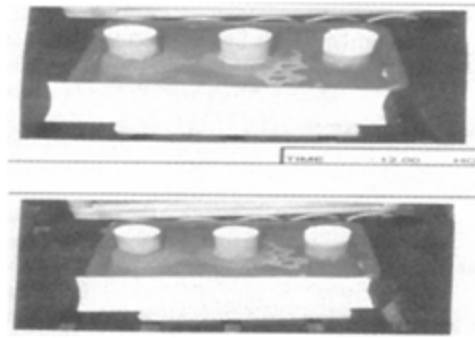

Figure 9.30. Durability test for the mixture soils.

CBR tests were carried out on samples compacted in a 6-inch mold in accordance with AASHTO Designation T180-90, method D. The tests were performed on treated, uncured mixtures and on mixtures

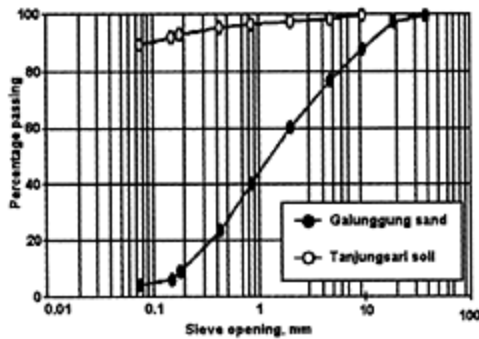

Figure 9.31. The gradation of original soil.

treated with varying amounts of C-444 and C-444+CX and cured for different periods. The tests results indicate that the addition of C-444 additive increases significantly the CBR value of all mixtures investigated, in particular those having fines content of 20% or more.

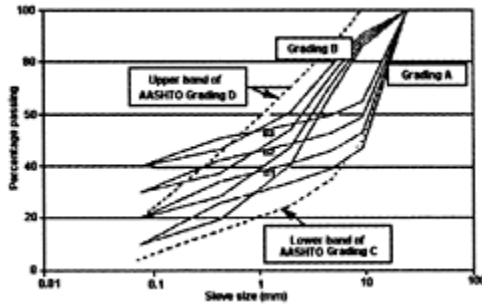

Figure 9.32. The eight types of gradation used in the investigation (Siswosoebrotho & Paransa 2002).

The addition of CX additive in mixtures containing C-444 is particularly effective in increasing the CBR value of mixtures with 10% fines. The addition of the additive reduces significantly the permeability of the mixture investigated. From a strength point of view, the use of C-444 plus CX upgrades the mixtures with 20% fines from subbase to road-base quality material.

Biocatalyst Stabilizer (EMC Squared) was also studied by Siswosoebrotho & Sunaryono (2003) for soil stabilization especially on the strength and compaction characteristics of some Java Island soils collected from three places i.e. Cepu, Cikalong Purwakarta and Pasir Impun Bandung, Indonesia.

Tests on untreated soil included classification, standard compaction and CBR, while tests on the treated soil include in addition to the above investigation of the influence of curing time on strength development. EMC Squared is a biocatalyst formulation designed to economically improve the cementation and stability of compacted earth material. Tests on material treated with EMC Squared were made on samples prepared at optimum moisture content. Three different dilution ratios (parts by volume of EMC Squared to parts by volume of water) were investigated, e.g. 1:30, 1:60 and 1:90.

The Cepu soil is classified as CH (USCS) or A-7-5 (AASHTO), Cikalong Purwakarta soil as MH (USCS) or A-5 (AASHTO) and Bandung soil as MV (USCS) or A-5 (AASHTO) as shown in Figure 9.33. According to the USCS, Cepu, Purwakarta and Bandung soils are classified as fine-grained soils (more than 50% passing sieve #200) and silty clays (LL more than 50%). The PI value of Cepu clay was in the range of 52% to 55%, whereas that of Purwakarta soil was around 96%. Montmorillonite clay content of Cepu soil was found to be 53.7% of its weight by the X-ray diffraction method. Montmorillonite is the clay mineral that presents the most expansive soil problems.

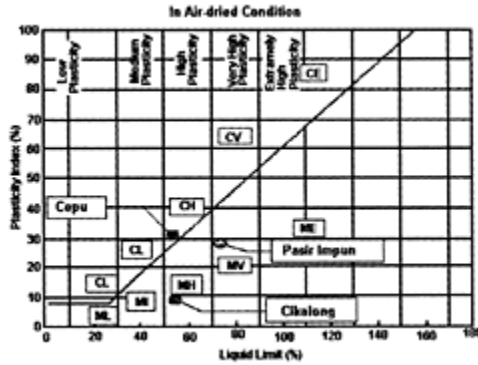

Figure 9.33. Position of Cepu, Cikalong (Purwakarta) and Pasir Impun (Bandung) samples relative to the A-line of the Casagrande chart (Siswosoebrotho & Sunaryono 2003).

In summary, the soils investigated may be described as fine grained, silty clay. Cepu soil is classified as CH (high plasticity), Purwakarta soil as MH and Bandung soil as MV. Cepu soil is relatively expansive, the Bandung and Purwakarta soils appear to have low swelling potential. The application of EMC Squared was found to affect the compacted density of the soils; the density obtained however does not vary significantly with dilution ratio.

Results show that Bandung and Purwakarta soils have similar compaction characteristics, i.e. OMC of around 40% and MDD approximately 1250 kg/m<sup>3</sup>. These characteristics are consistent with typical halloysites and allophone clay characteristic i.e. low density and high water content (Wesley 1973). Cepu soil, classified as CH (high plasticity), has a lower OMC than Cikalong and Pasir Impun Bandung soils, but has a higher MDD. Bandung and Purwakarta soils have relatively high (untreated) strength (CBR) values i.e. 7.51% and 6.53%, respectively. Both soils exhibit little swelling after four days of soaking. Cepu soil (high plasticity) shows a relatively low (untreated) CBR (3.92%) and has a swelling of 2.11%.

The addition of EMC Squared, in the amounts investigated, shows an increase in the CBR values, and a reduction of the swell potential of the soils studied (Table 9.14). In the case of Cepu soil, there is a generally consistent trend for CBR to increase with increase in concentration of EMC Squared i.e. with reduction in dilution ratio. The most significant effect of EMC Squared was found at a dilution ratio of 1:30 where a CBR value of 6.40% was obtained. This represents an increase of 63% on the untreated CBR value.

A different trend was found with the application of EMC Squared on Purwakarta soil where increasing the concentration of EMC Squared did not necessarily result in a higher CBR. For the three dilution ratios studied, it was observed that a dilution ratio of 1:60 produced the highest CBR value i.e. 13.85%. This value represents an increase of 112% on the value determined for untreated samples. In the case of Bandung soil, the lower the concentration of EMC Squared, the higher the CBR value obtained. The greatest effect was found at a dilution ratio of 1:90, i.e. CBR 10.82%. This value shows an increase of 44% compared with the untreated sample. In summary, there is no consistent trend for strength to increase with increased concentration of EMC Squared.

Table 9.14. Maximum effect of EMC squared on Java island soils (Siswosoebrotho &amp; Sunaryono 2003).

Samples	Untreated sample (%)	Treated samples (%)	% Increase/ Decrease (%)	Remarks
Comparison of CBR values				
Cepu	3.92	6.40	63	T.1-CT.3
Purwakarta	6.53	13.85	112	T.2-CT.3
Bandung	7.51	10.82	44	T.3-CT.3
Comparison of swelling values				
Cepu	2.11	0.24	88	T.1-CT.3
Purwakarta	0.21	0.17	19	T.1-CT.1
Bandung	0.79	0.44	44	T.1-CT.1

Note: T.1, T.2, T.3: Dilution Ratio of 1:30, 1:60, 1:90 CT.1, CT.2, CT.3: Curing Time of 1 day, 2 days, 3 days

In general, the strength of treated samples increased with curing time. The application of EMC Squared was found to be effective in reducing the swell of soil soaked for 96 hours in the CBR mould under surcharge.

Soil type appears to influence the effect of EMC Squared on strength and swelling characteristics; in general both of these properties improved with increase in curing time.

Wong (2003) who studied the effect of an acrylic polymer on the properties of soil-cement, showed that the unconfined compressive strength increase with the addition of cement. Residual sandy clay of the Serdang series is used in this study. The mix composition of 8% cement with 10% polymer achieved more than 2.9MN/m<sup>2</sup> which has fulfilled the JKR (1985) requirement for road base. The X-ray fluorescence analysis showed the agglomeration of quartz minerals and the progressive reduction in the pore sizes when the polymer was added to the cementmix soil. Figure 9.34 shows the variation of unconfined compressive strength of the soil cementpolymer mix.

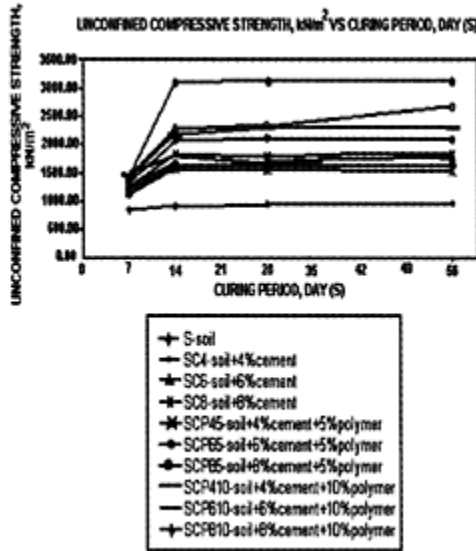

Figure 9.34. Variation of unconfined compressive strength of the laterite Serdang series soil with cement-polymer.

### 9.6 SUMMARY

Soil stabilization is the alteration of one or more soil properties, by mechanical or chemical means, to improve the engineering properties of soil. Stabilization can be achieved through mechanical or chemical means. In chemical stabilization, a number of stabilizers, such as, Portland cement, lime, fly ash, chemical compounds or liquid stabilizers, foamed asphalt or a combination of some of these, have been successfully used in the past. Existing work indicates that most of these stabilizers could be used for tropical residual soils in road construction. The guidelines developed for other soils can be used to achieve stabilization of tropical residual soils. This has been proven in research work in the South-East Asia region. However, local experience is essential for successful application of stabilization for road construction. During application of subgrade stabilization, some aspects of compaction of tropical residual soils such as handling, moisture conditioning etc. that are unique must be considered in the process.

### REFERENCES

Ali, F. 1990. Improvement of a residual soil. *Proceedings of the tenth Southeast Asian geotechnical conference, Taipei, Republic of China, April 16–20*:1–8.

Bell, F.G. 1993. *Engineering treatment of soils*. First edition, London, New York: E & FN Spon.,

Bergado, D.T. 1996. Soil compaction and soil stabilization by admixtures. *Proceeding of the seminar on ground improvement application to Indonesian soft soils, Jakarta, August*: 23–26.

- CBR PLUS Liquid Stabilizer. CBR PLUS North America, Inc. <http://www.cbrplus.com/>. Accessed July 3, 2002.
- Cokca, E. 2001. Use of class C fly ashes for the stabilization of an expansive soil. *Journal of Geotechnical and Geoenvironmental Engineering*, July 2001, ASCE. 127(7).
- Csanyi L.H. 1957. Foamed asphalt in bituminous paving mixtures. Highway research records No. 160, National Research Council, Washington, DC, 1957:108–122.
- De Rezende, L.R. & Carvalho, J.C. 2003. Use of locally available soils on subbase and base layers of flexible pavements. In Transportation Research Record No. 1819, *Journal of the Transportation Research Board, National Research Council, Washington, D.C.*: 110–121.
- Earthzyme Solutions. Cypher Intl. Ltd. <http://www.%20cypherltd.com/>. Accessed July 3, 2002.
- Fookes, P.G. 1997. Tropical residual soils. A geological society engineering group working party revised report, The Geological society, London, United Kingdom: 146–147.
- Ferguson, P.J. & Avent, J. 1993. Lime-fly ash aggregate base course with class C fly ash. Final report no. MDOT-RD-93–97, Mississippi Department of Transportation.
- Ground stabilisation services. Enzyme stabilization of marginal soils in Nepal. <http://www.ground-stabilisation.%20com/>. Accessed on Jul 1, 2002.
- Herzog, A. & Mitchell, J.K. 1963. Reactions accompanying stabilization of clay with cement. Highway research record, Transportation Research Board, Washington, DC.
- Huat, B.B.K. & Muhammad, M.M. 1997. Effect of lime admixture on geotechnical properties of tropical residual soil. *International conference on ground improvement technique, Macau*.
- Indonesian National Standard, SNI 03–3439. 1994. Construction method on lime stabilization for road construction, National Standardization Board.
- Indonesian National Standard, SNI 03–3440. 1994. Construction method on cement stabilization for road construction, National Standardization Board.
- Ingles, O.G. 1968. Soil chemistry relevant to the engineering behavior of soils. Soil mechanics selected topics. Edited by I.K.Lee.
- Ingles, O.G. & J.B. Metcalf. 1972. *Soil stabilization: principles and practice*. Sydney: Butterworths.
- Jabatan Kerja Raya (JKR). 1985. Pavement design guide. Kuala Lumpur.
- Kézdi, Árpád. 1979. *Stabilized earth roads*. Developments in geotechnical engineering 19. Amsterdam: Elsevier Scientific Publishing Company.
- Kosmatka et al. 2002. *Design and control of concrete mixtures*. 14th Edition, Engineering bulletin No. 001, Portland Cement Association, Skokie, Illinois.
- Lancaster, J., McArthur, L. & Warwick, R. 1994. VICROADS experience with foamed bitumen stabilisation. *In the Proceedings of the 17th ARRB Conference held in Gold Coast, Queensland, 15–19 August*, 17(3): 193–211.
- Lancaster-Jones, P.F.F., McKeand, E. & Bell, F.G. 1978. Ground treatment, Foundation engineering in difficult ground. London, Boston: Newnes-Butterworth.
- Little, D.N., Males, E.H., Prusinski, J.R. & Stewart, B. 2000. Cementitious stabilization, Transportation in the New Millennium Transportation Research Board, Washington, DC.
- Little, D.N. 1995. *Stabilization of pavement subgrades and base courses with lime*. Dubuque, Iowa: Kendall/Hunt Publishing Company.
- Liquid Base Stabilizer. Enviroseal Corporation. Accessed July 3, 2002.
- Mitchell, J.K. 1976. Introduction; Survey of soil improvements. Continuing education, The University of California, Berkeley, 1976.
- NAASRA 1986. Guide to stabilisation in roadworks. National Association of Australian State Road Authorities, Sydney.
- Nalbantoglu, Z. & Gucbilmez, E. 2002. Utilization of an industrial waste in calcareous expansive clay stabilization. *Geotechnical Testing Journal*. GTJODJ. 25(1):78–84.



- Nicholson, P.G., Jeffrey K. Kalani, & Mingxun Ding 1998. Transportation research board, 77th annual meeting preprint CD-ROM, Transportation Research Board, Washington, D.C.
- Nicholson, P.G., Kashyap, V & Fuji, C.F. 1994. Lime and fly ash admixture improvement of tropical Hawaiian Soils. Transportation research record, Transportation Research Board, Washington, D.C, Issue: 1440:71–78.
- Ola, S.A. 1974. Need for stimated cement requirements for stabilizing lateric soils. *Journal of the Transportation Engineering Division, The American Society of Civil Engineering* 100(2): 379–388.
- Robnett, Q.L. & Thompson, M.R. 1970. Concept for developing stabilization recommendations for the soils of an area. Highway research record No. 315, Highway Research Board, Washington, D.C.
- Rollings, M.R., & Rollings, R.S. 1996. *Geotechnical materials in construction*. New York: McGraw-Hill.
- Schaefer, V.R., Abramson, L.W., Drumheller, J.C., Hussin, J.D. & Sharp, K.D. 1997. Ground improvement ground reinforcement ground treatment: Developments 1987–1997, Geotechnical special publication ASCE, New York (69).
- SEFA 2002. <http://www.sefagroup.com/>. Accessed on August 27.
- Simmons, J.V. & Blight, G.E. 1997. *Compaction. in mechanics of residual soils*. G.E. Blight, Chapter 9. Rotterdam: Balkema. 65–77.
- Siswosoebrotho, B.I., Notodisuryo, P.W. & Moerdika, O.V. 2003a. Stabilisation of lateritic soil as road base material. *Proceedings of the 2nd international conference on advances in soft soil engineering and technology*, Huat et al (ed) Putrajaya, Malaysia, July 2–4: 807–818.
- Siswosoebrotho, B.I., Younger, J.S. & Erwanto, T. 2003b. Compaction and CBR strength characteristics of Karimun Island granite mixed with Suralaya pulverized fuel ash, *Proceeding the 5th International conference of eastern asia society for transportation studies, Fukuoka, Japan, October 29–November 1*:302.
- Siswosoebrotho, B.I. & Sunaryono, S. 2003. Influence of biocatalyst stabilizer (EMC Squared) on strength and characteristics of some Java island soils. *Proceeding of the international conference on civil engineering, Department of civil engineering Brawijaya University, Batu, Malang, Indonesia, October 1–3*.
- Siswosoebrotho, B.I. & Paransa, Y. 2002. The influence of the amount and plasticity of fines on the characteristics of consolid treated granular materials, *The international conference on advance structure and construction management, APEC, Bali, Indonesia, March*.
- Siswosoebrotho, B.I. & Sinurat, H. 2001. Consolid system in soil stabilization, *Proceeding the 4th conference of the eastern asia society for transportation studies, Fukuoka, Japan, October 29–November 1*.
- Siswosoebrotho, B.I. & Satrio, B. 2000. Argojati lime in soil stabilization from Ujung Berung Bandung. *Proceeding of the national conference on road engineering, Jakarta, Indonesia*.
- The EMC Squared System. Soil stabilization product company, Inc. <http://www.sspco.org/>. Accessed July 3, 2002.
- TRL 1993. A guide to the design of bitumen-surfaced roads in tropical and sub-tropical countries. Overseas road note 31, 4th edition, Transport road research laboratory, Crowthorne, London, United Kingdom.
- US Army 1997. Field manual-410: Military soils engineering—Chapter 9: Soil stabilization for roads and airfields. Department of the Army, Washington, D.C. June.
- Wesley, L.D. 1973. Some basic engineering Properties of halloysites and allophane clays in Java, Indonesia.

- Wibawa, B. & H.Rahardjo 2001. Stabilization of a compacted swelling clayey soil, *Clay science for engineering, proceedings of the international symposium on suction, swelling, permeability and structure of clays, Shizuoka, Japan, 11–13 January 2001*, edited by K.Adachi, M.Fukue. Rotterdam: A.A.Balkema. 125–130.
- Wirtgen GmbH, Wirtgen, 1998. Cold recycling manual, Windhagen, Germany, ISBN 3–00–003577-X.
- Wong, K.H. 2003. Assesment of an acrylic polymer on the properties of soil-cement (unpublished master thesis). Universiti Putra Malaysia.
- Yoder, E.J. & Witzcak, M.W. 1975. *Principles of pavement design*. 2nd edition. New York: John Wiley & Sons.



## CHAPTER 10

# Slope stability and stabilization

Tan Yean-Chin & Chow Chee-Meng  
*Gue & Partners Sdn Bhd, Kuala Lumpur, Malaysia*

Tropical residual soils are derived from in situ weathering and decomposition of rock and have characteristics that are quite different from those of transported soils. Some methods commonly adopted in Malaysia for slope stabilization work are discussed, highlighting good practices and relevant design guidelines. Some aspects on measurement of strength parameters and groundwater profile assessment together with a discussion on stability analysis are also presented.

### 10.1 CHARACTERISTICS OF TROPICAL RESIDUAL SOIL SLOPE

Residual soils are derived from in situ weathering and decomposition of rock and remain at their original location. The stratigraphy may be a continuous gradation from the fresh, sound unweathered parent rock through weathered soft rock and hard soil to highly weathered material containing secondary deposits of iron, alumina, silica or calcium salts with its original rock texture completely destroyed (Blight 1997a). Based on the above definition, it is clear that residual soils would have characteristics that are quite different from those of transported soils. The same also applies with respect to the behavior of a residual soil slope as compared to a transported soil slope. Figure 10.1 illustrates the typical weathering profile for a residual soils showing gradual changes of gradation from sound unweathered rock (Grade I) to highly weathered (decomposed) material (Grade VI).

The weathering process leading to the formation of residual soils is highly complex and weathering sequence such as those proposed by van der Merwe (1965) cannot be used as a general guide to relate the properties of residual soils to its parent rock. The weathering process is influenced by climate and drainage conditions and any changes to the two factors may arrest or reverse certain stages of weathering. It has also been demonstrated extensively in the literature that behavior of residual soils in different regions of the world (or even within the same region) shows distinct differences in characteristics. However, Blight (1997a), based on the works of Vargas & Pichler (1957), Ruxton & Berry (1957) and Little (1969) summarised that a residual soils will typically consist of three zones (Figure 10.1):

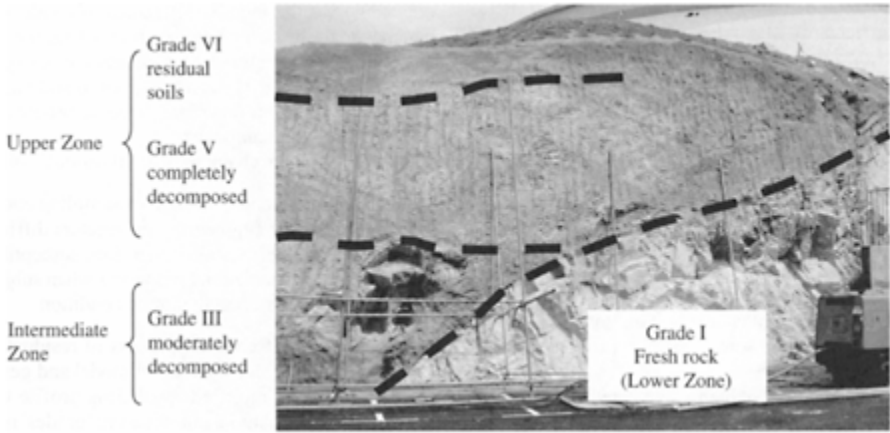

Figure 10.1. Typical weathering profile of residual soils.

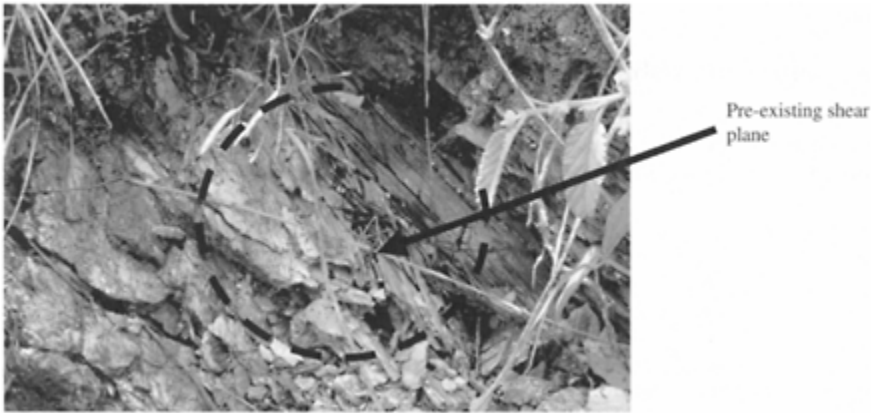

Figure 10.2. Structural features in residual soil slope.



Figure 10.3. Possible 'platy' soil materials from a residual soil slope.

## a) Upper zone

This zone consists of highly weathered (or decomposed) and leached soils often reworked by burrowing animals and insects or cultivation, and intersected by root channels. This zone is also possibly subjected to some transport processes.

## b) Intermediate zone

This zone consists of highly weathered to moderately weathered material (50% to 90% rock) but exhibits some features of the structure of the parent rock and may contain some core stones (or boulders).

## c) Lower zone

This zone consists of fresh rock and slightly weathered material.

Sometimes, behavior of a residual soil slope is governed more by its structural features such as relict jointing, bedding or slickensiding which it has inherited from the parent rock. The influence of such structural features cannot be ignored in the analysis of slope stability and stabilization involving residual soils. For example, a slope with pre-existing shear plane which dips in the direction of the slope ('daylighting') as shown in Figures 10.2 and 10.3 will definitely have a lower factor of safety compared to a slope without such structural feature or one in which the direction of dip is in the opposite direction. In addition, Blight (1997a) also highlighted the difficulties of determining the relevant engineering properties of residual soils. This is due to the weathering characteristics of residual soils which tend to form soil which consists of aggregates or crystals bonded together by a combination of capillary forces and bonding. These aggregates of soil particles can be easily broken down and become progressively finer if the soil is manipulated.

In brief, the main characteristics of residual soils are:

- a) Very heterogeneous; this makes sampling and testing for relevant engineering parameters difficult.
- b) Usually high permeability, therefore susceptible to rapid changes in material properties when subjected to changes of external hydraulic condition.

In general, the formation process of residual soils is complex and is very difficult to model and generalize. Therefore, a simplified weathering profile which differentiates the material into different 'grades' is used to describe the degree of weathering and the extent to which the original structure of the rock mass is

Table 10.1. Material grade classification system modified from GCO (1988).

Descriptive term	Grade	General characteristics
Residual soils	VI	Original rock texture completely destroyed Can be crumbled by hand and finger pressure
Completely decomposed	V	Rock wholly decomposed but rock texture preserved No rebound from N Schmidt Hammer Can be crumbled by hand and finger Easily indented by point of geological pick Slakes when immersed in water Completely discoloured compared with fresh rock

Highly decomposed	IV	Rock weakened and can be broken by hand into pieces Positive N Schmidt rebound value up to 25 Makes dull sound when struck by hammer Geological pick cannot be pushed into surface Does not slake readily in water Hand penetrometer strength index greater than 250 kPa Individual grains may be plucked from surface Completely discoloured compared with fresh rock
-------------------	----	---

Table 10.2. Comparison of residual soils and transported soils with respect to various special features that affect strength (from Brenner et al. 1997).

Factors affecting strength	Effect on residual soils	Effect on transported soils
Stress history	Usually not important.	Very important, modifies initial grain packing, causes overconsolidation effect.
Grain/Particle strength	Very variable, varying mineralogy and many weak grains are possible.	More uniform; few weak grains because weak particles become eliminated during transport.
Bonding	Important component of strength mostly due to residual bonds or cementing; causes cohesion intercept and results in a yield stress; can be destroyed by disturbance.	Occurs with geologically aged deposits, produces cohesion intercept and yield stress, can be destroyed by disturbance.

destroyed varying with depth from the ground surface. The weathering profile is important for slope stability analysis in residual soils because it usually controls:

- a) The potential failure surface and mode of failure.
- b) The groundwater hydrology, and therefore the critical pore pressure distribution in the slope.
- c) The erosion characteristics of the soil materials.

The Geotechnical Engineering Office, GEO (formerly Geotechnical Control Office, GCO) of Hong Kong, has adopted a system for granites in which a profile is logged according to six rock material ‘grades’ given by GCO (1988). Table 10.1 presents the modified grades classification based on the above reference for ease of classification. For geotechnical design of slopes, materials of Grade I to III are usually treated as ‘rock’ and materials of Grades IV to VI (upper zone) as ‘soil’.

It is also important to be aware of the contribution of capillary forces, bonding and structural features on the shear strength of residual soils. Therefore, proper determination of relevant engineering properties for residual soil slope is essential in order to produce design that is safe but not over-conservative.

## 10.2 MEASUREMENT OF STRENGTH PARAMETERS AND GROUNDWATER PROFILE FOR ASSESSMENT OF SLOPE STABILITY STABILIT

### *Stress-strain and shear strength characteristics of residual soils*

The special features encountered in residual soils that are mainly responsible for the difference in stress-strain and strength behavior in comparison with transported soils are listed in Table 10.2.

One of the significant characteristics of residual soils is the existence of bonds between particles. These bonds are a component of strength (can be reflected as apparent cohesion,  $c'$ ) and initial stiffness that is independent of effective stress and void ratio/density. The bonding also contributes to 'apparent' overconsolidated behavior of the soils.

Vaughan (1988) highlighted some of the possible causes of the development of bonds as:

- a) Cementation through the deposition of carbonates, hydroxides, organic matter, etc.
- b) Solution and re-precipitation of cementing agents, such as silicates.
- c) Cold welding at particle contacts subjected to high pressure.
- d) Growth of bonds during chemical alteration of minerals.

In engineering applications, these bonds are purposely omitted (on the conservative side) because it is easily destroyed and not reliable for design. In addition, these bonds also contribute to the peak strength of the soil. These bonds affect residual soils in a way which is similar to dense sand. In dense sand which tends to dilate during shearing, Bolton (1986) shows that in plane strain, the contribution of dilation to peak strength is closely represented by the expression:

$$\phi'_{peak} = \phi'_{cr} + 0.8\psi_{max} \quad (10.1)$$

where  $\phi'_{peak}$  = peak strength;  $\phi'_{cr}$  = critical state strength; and  $\psi_{max}$  = maximum angle of dilation.

Such findings have led to recommendations of using critical state strength instead of peak strength in the design of cut slopes as summarized by Skempton (1977):

- a) The shear strength parameters of clay relevant to first-time slides is the 'fully-softened' value (critical state) and also by the lower limit of strength measured on structural discontinuities (joints and fissures).
- b) The peak strength is considerably higher; so some progressive failure mechanism appears to be involved.
- c) The residual strength is much smaller than the 'fully-softened' value (critical state) and corresponds to the strength mobilized after a slip has occurred, with large displacements of the order of 1 or 2m.



- d) It is a characteristic of first-time slide in clay slopes to occur many years after a cutting has been excavated. The principal reason for this delay is the very slow rate of pore-pressure equilibration; a process which in typical cuttings is not completed, for practical purposes until 40 or 50 years after excavation.

In addition, Powrie (1997) also highlighted the potential danger of using peak strength:

- a) It can lead to the overestimation of the actual peak strength at either low or high effective stresses, depending on where the 'best fit' straight line is drawn.
- b) The designer cannot guarantee that the peak strength will be uniformly mobilized everywhere it is needed at the same time. It is much more likely that only some soil elements will reach their peak strength first. If any extra strain is imposed on these elements, they will fail in a brittle manner as their strength falls towards the critical value. In doing so, they will shed load to their neighbors, which will then also become overstressed and fail in a brittle manner. In this way, a progressive collapse can occur, which—like the propagation of crack through glass—is sudden and catastrophic. Experience also suggests that progressive failure is particularly important with slopes.
- c) Many of the design procedures used in geotechnical engineering assume that the soil can be relied on to behave in a ductile manner. When a ductile material fails, it will undergo continued deformation at constant load. This is in contrast to a brittle material, which at failure breaks and loses its load carrying capacity entirely. At the critical state, the behavior of the soil is ductile: the definition of the critical state is that unlimited shear strain can be applied without further changes in stress or specific volume. Between the peak strength and the critical state, however, the behavior of the soil is essentially brittle.

The main purpose of discussing the effects of bonds, peak strength and critical state strength on the stability of residual soil slopes is to highlight recent advances in the understanding of slope stability. It must be understood however, that most of the current procedures and standards commonly used by practising engineers on the subject of slope (e.g. GEO 2000) is based on statistical analysis of data using peak strength. These procedures and standards have generally produced acceptable designs if used correctly and if critical state strength is used based on these procedures and standards, the designs will be too conservative and uneconomical (Gue 2003, Powrie 1997). Therefore, the following sections shall discuss the measurement of shear strength in residual soils for stability analysis using existing procedures and standards on the basis of peak strength. The designer must be aware though on the pitfalls and limitations of these approaches as discussed above in order to exercise better engineering judgment.

### *Measurement of shear strength in residual soils*

For cut slope, effective stress (drained or long-term condition) is normally more critical than total stress (undrained condition). Therefore, effective stress strength parameters,  $c'$  and  $\phi'$ , determined from testing of representative samples of matrix materials are used in analysis. The most common approach to measure shear strength of residual soils is through

a large number of small scale in situ (field) and laboratory tests. In situ tests include the standard penetration tests (SPT), cone penetrometer tests (CPT or CPTU), vane shear tests and pressuremeter tests. Laboratory tests commonly used are shear box tests, consolidated undrained triaxial compression tests with pore water pressure measurements (CIU) and consolidated drained triaxial compression tests (CID) carried out on undisturbed soils (from Mazier sampler without trimming and without side drains). Shear box tests with the direction of shearing in specified orientation are sometimes carried out to explore the effects of anisotropy and shear strength in structural discontinuities. In this chapter, only laboratory tests will be discussed.

Figures 10.4 and 10.5 show the systems of stresses applied in the direct shear box tests and the triaxial tests respectively. Both laboratory tests have their advantages and disadvantages, but certain field conditions may be simulated well by one type than by the other. The main features of these two types of tests are summarized in Table 10.3.

For the laboratory tests, the soil samples should be tested at stresses comparable to those in the field, and should be saturated. It is appropriate to measure strength parameters on saturated soil samples because residual soils are usually of high permeability (usually  $10^{-4}$  to  $10^{-6}$  m/sec), rainwater can infiltrates with ease into it and it is likely that saturation conditions will be approached at shallow depths in the field during the life of a slope. To date it is not advisable to include soil suction (negative pore pressure) in design of long-term slopes in view of many factors that can cause the loss of suction. It is also important to realize that stiff materials like residual soils usually contain discontinuities which the small scale strength tests may miss in the sampling process and overestimate the soil shear strength. On the other hand, if there are corestones and other large sized particles present in the residual soil mass, the effect of this material cannot be quantitatively determined and the small scale laboratory tests carried out on the 'matrix' material of residual soils will usually underestimate the overall shear strength of the in situ material mass. Therefore, special care is to be taken in the selection of representative soil strength for stability analysis.

#### *Direct shear box test*

The soil parameters that can be obtained from a direct shear box test are:

- a) The angle of friction (peak, critical state and residual).
- b) The cohesion intercept (peak, critical state and residual) *\*Note: to use with care.*
- c) The volume change response of the soil due to shearing which can be either dilatant or contractive.

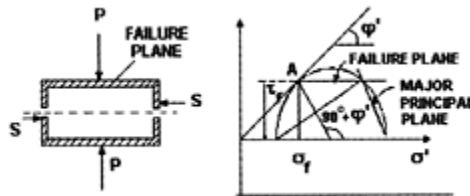

Figure 10.4. Stress system applied in direct shear and failure envelope through point A and Mohr's circle (from Brenner et al. 1997).

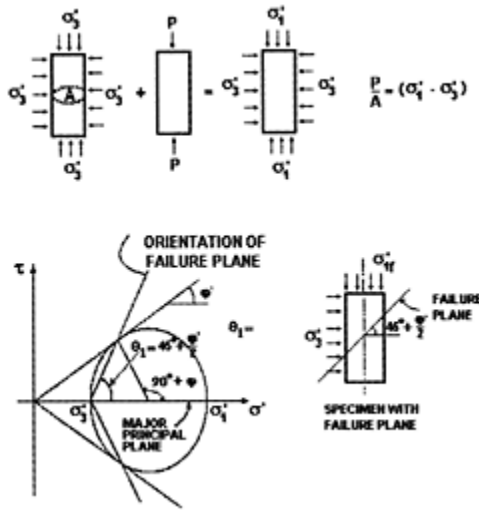

Figure 10.5. Stress system applied in triaxial compression test, Mohr's circle and orientation of failure plane (from Brenner et al. 1997).

In the direct shear box test, the following variables have to be determined first before commencement of a test:

- a) Minimum size of shear box
- b) Thickness of soil specimen
- c) Drainage condition
- d) Consolidation and saturation status
- e) Shearing rate and displacement allocated
- f) Stress level (normal stress).

Shear boxes can either be square (60 mm, 100 mm, 300 mm or more) or circular (50 mm and 75 mm) with the thickness of the sample not more than half of its size. The direct shear box tests can be carried out via Stress-Controlled (increasing the shear stress in increments and measuring the displacement) or Strain-Controlled (shear by a certain displacement rate and measuring the resulting stress). Usually Strain-Controlled test is used because it is easier to perform and allows peak, critical state and residual shear strength of the soil to be determined.

Table 10.3. Comparison of direct shear box test and triaxial test (from Brenner et al. 1997).

Direct shear box test	Triaxial test
<i>Advantages</i>	
1. Relatively simple and quick to perform.	1. Enables the control of drainage and the measurement of pore pressures.
2. Enables relatively large strains to be applied and thus the determination of the residual strength.	2. Stress conditions in the sample remain more or less constant and are more uniform than in direct shear test. They are controllable during the test and their magnitude is known with fair accuracy.
3. Less time is required for specimen drainage (especially for clayey soils), because drainage path length is small.	3. Volume changes during shearing can be determined.
4. Enables shearing along a predetermined direction. (e.g. plane of weakness, such as relict bedding)	
<i>Disadvantages/Limitations</i>	
1. Drainage conditions during test, especially for less previous soils, are difficult to control.	1. Influence of value of intermediate principal stress, $\sigma_2$ cannot be evaluated independently. In certain practical problems which approximate the conditions of plane strain, $\sigma_2$ , may be higher than $\sigma_3$ . This will influence $c'$ and $\phi'$ .
2. Pore pressures cannot be measured.	2. Principal stress directions remain fixed, conditions where the principal stresses change continuously cannot be simulated easily.
3. Stress conditions during the test are indeterminate and a stress path cannot be established; the stresses within the soil specimen are non-uniform. Only one point can be plotted in a diagram of shear stress, $\tau$ versus normal stress, $\sigma$ , representing the average shear stress on the horizontal failure plane. Mohr's stress circle can only be drawn by assuming that the horizontal plane through the shear box is the theoretical failure plane. During straining, the direction of principal stresses rotates.	3. Influence of end restraint (end caps) causes non-uniform stresses, pore pressures and strains in the test specimens and barrel shape deformation.
4. Shear stress over failure surface is not uniform and progressive failure may develop.	
5. Saturation of fine-grained specimens (e.g. by back-pres-suring) is not possible. The area of the shearing surfaces changes continuously.	

The following direct shear tests categories are possible: unconsolidated undrained (UU), consolidated undrained (CU) and consolidated drained (CD). For the UU and CU tests, the shearing rate has to be as rapid as possible to maintain the ‘undrained’ condition and total stress parameters can be obtained.

The shearing rate has to be extremely slow especially for soil with low permeability in the CD type of direct shear tests. Usually, tests for which drainage is allowed is performed with the soil specimen fully immersed in water to eliminate the effects of capillary moisture stresses. Gibson & Henkel (1954) and Head (1982a) recommend a time to failure,  $t_p$  for drained direct shear tests to be  $12.7t_{100}$ , where  $t_{100}$  is the time to 100% primary consolidation and can be obtained by extrapolating the linear portion of the square root of time plot of the consolidation phase of the test. The maximum permissible shearing rate in a drained direct shear test can be estimated to be less than  $\delta_f/t_p$  where  $\delta_f$  is the horizontal displacement of the shear box at peak strength. This value is however, not known prior to testing and has to be estimated or based on experience on similar materials.

In deciding on the normal pressures to be applied, usually the soil samples should be tested at stresses comparable to those in the field. With coarse-grained soils (cohesionless soils), the test results usually pass through the origin but for soils with bonded structure, there will usually be an apparent cohesion intercept. For details of carrying out direct shear box test, reference can be made to Head (1982a).

#### *Triaxial test*

The soil parameters that can be obtained from a triaxial test are:

- a) The angle of friction (peak, critical state and residual).
- b) The cohesion intercept (peak, critical state and residual) *\*Note: to use with care.*
- c) The pore water pressure response due to shearing (in undrained tests).
- d) Initial tangent and secant moduli (unloading and reloading).
- e) Consolidation characteristics and permeability.

In normal practice, the following tests are routinely carried out where practical:

- a) Isotropically Consolidated Undrained Compression Test (CIU) with pore pressure measurement. In this test, drainage is permitted during the isotropic consolidation under consolidation stress,  $\sigma_3$ . After the soil sample is fully consolidated, the sample is sheared through application of the deviator stress ( $\sigma_1 - \sigma_3$ ) without permitting drainage (undrained). CIU tests are one of the most commonly used laboratory tests to obtain effective stress strength parameters,  $c' - \phi'$  for analysis of cut slope. (*Note: In the triaxial test,  $\sigma_2 = \sigma_3$* )
- b) Isotropically Consolidated Drained Compression Test (CID) with pore pressure measurement. Similar to CIU, drainage is permitted during isotropic consolidation under consolidation stress,  $\sigma_3$ . Full drainage during shearing is permitted so that no excess pore water pressure is generated. Although CID tests are technically superior, they are not often used due to the long duration required during shearing to obtain the effective stress strength parameters,  $c' - \phi'$  for analysis of cut slope.

For triaxial testing of residual soils, the specimen diameter should be about 75 mm. Therefore, the use of Mazier samples without trimming is suitable. Specimens with smaller diameters are not considered representative because of the scale effect relating to fissures and joints in the soil. The ratio of specimen length to diameter must be at least 2 to 1.

In triaxial tests, multi-stage tests should not be used as these tests will usually produce misleadingly high apparent cohesion,  $c'$ . The multi-stage test will also give misleading results as the second test will be significantly affected by the failure surface formed in the first test (GEO 2000). Sometimes high  $c'$  obtained from testing is often due to the rate of strain or time of shearing to failure being too short. The rate of strain should be estimated from the results during consolidation as discussed earlier. Side drains should not be used as this has shown to produce inconsistency in the sample (Tschebotarioff 1950, GEO 2000). Further details on the laboratory triaxial tests can be obtained from Head (1982b).

*Interpretation of effective shear strength from laboratory tests*

The shear strength of the soil in normal practice is usually represented graphically on a Mohr diagram. The  $c'$  and  $\phi'$  parameters are not intrinsic soil properties, but are merely coefficients in the simplified design model and should only be assumed to be constant within the range of stresses for which they are evaluated.

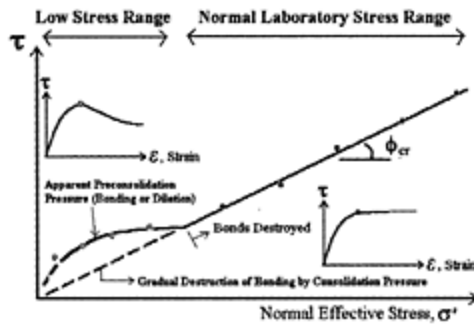

Figure 10.6. Effect of bonding on the apparent cohesion intercept of drained strength (effective stress) failure envelope (from Brenner et al. 1997).

For simplicity of analysis, it is conventional to use a linear Mohr-Coulomb failure envelope ( $c' - \phi'$  soil strength model) for the concerned stress range as expressed in the equation below:

$$\tau_f = c' + \sigma_{nf}' \tan \phi' \tag{10.2}$$

where

- $\tau_f$  = shear strength of soil (kPa)
- $\sigma_{nf}'$  = effective normal stress at failure (kPa)
- $\phi'$  = effective angle of friction (degree)
- $c'$  = apparent cohesion (kPa).

Figure 10.6 shows typical bonding and dilatant characteristics of residual soil at low stress range (low confining and consolidation pressure) which exhibits a peak shear envelope in terms of effective stress which has an apparent cohesion intercept,  $c'$  if a linear Mohr-Coulomb  $c' - \phi'$  line is used. As the consolidation pressure in the laboratory test prior to shearing increases, the bonds are destroyed and the residual soil will likely to behave like normally consolidated or lightly consolidated transported soil. The critical state friction angle is represented as  $\phi'_{cr}$ .

Figure 10.7 illustrates a typical stress-strain curve for residual soils. A sample is isotropically consolidated (Point A), then sheared to reach the peak strength (Point B) at low stress range and shearing continued until the critical state strength (Point C). Normally the peak strength is obtained at relatively small strain and after continued shearing, the critical state strength,  $\phi'_{cr}$  is obtained at a larger strain. The critical state usually occurs in the 10% to 30% strain range where the soil sample continues to shear at constant volume and constant effective stress. The critical state strength is also called the ultimate strength (Atkinson & Bransby 1978) or the fully-softened strength (Skempton 1970). The critical state strength is different from residual strength (Skempton 1964, 1985) which is lower and occurs after very large movement on the slip/failure surface. The residual strength is also associated with highly polished slip surfaces in which the soil particles have become aligned in directions parallel with the direction of sliding and is relevant only after displacements in the order of several metres (Crabb & Atkinson 1991).

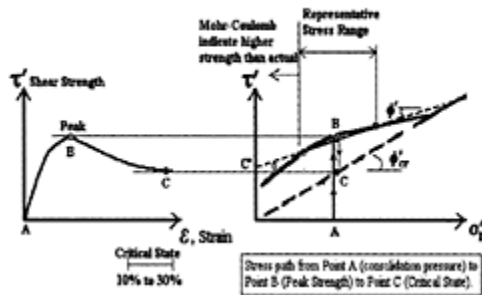

Figure 10.7. Typical shearing characteristics of residual soils during drained shear tests and the tangent method in selection of shear strength envelope.

As shown in Figure 10.7, the critical state strength falls on a straight line through the origin. The conventional interpretation of peak failure strength is the Mohr-Coulomb envelope ( $c' - \phi'$ ) at the stress range concerned using the tangent method. It should be noted that  $\phi'$  is different from  $\phi'_{cr}$  (critical state); and  $c'$  is simply the intercept of the peak failure envelope on the shear stress axis,  $\tau'$ . It is important to realise that  $c'$  does not imply that at zero effective stress, the strength is  $c'$  (kPa). Therefore, at low effective confining stress (outside representative stress range), Mohr-Coulomb failure envelope ( $c' - \phi'$ ) might overestimate the strength of the soil. Therefore, the in situ stress range and the stress path followed (see details in the next section) must be correctly determined in order to obtain  $c' - \phi'$  shear strength envelope that is representative of the field condition.

Another method of determining the shear strength envelope is through the secant method for the stress range concerned as shown in Figure 10.8. In this method, generally the  $c'$  is taken as zero unless there are sufficient test results to obtain the representative  $c'$ . Usually  $c'$  should not exceed 10 kPa. This method will yield a more conservative (lower) peak strength value compared to the tangent method at the low stress range and both will yield the same results at high stress range. Therefore, if the stress range at site during design cannot be confirmed, then the secant method shall be used instead of the tangent method.

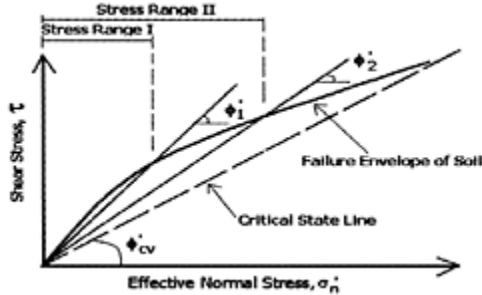

Figure 10.8. Secant method in the selection of shear strength envelope.

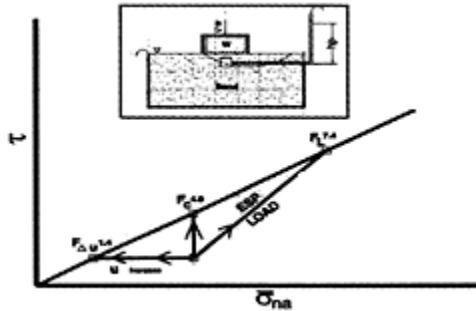

Figure 10.9. Stress path to failure (from Lambe & Silva 1998).

### *Influence of stress path on shear strength*

In analysis of geotechnical problems including slope stability, Stress Path Method is the most rational and useful method because it uses laboratory and field data to obtain the stress path of average stresses in a field situation for a past, present and future conditions (Lambe & Silva 1998). In general, the effective stress path for the field situation must be determined first and then tests (usually laboratory tests) are performed along the field effective stress path with the specimens at the field conditions; water content, degree of saturation, stress state, pore pressure, geometry, etc.

Figure 10.9 demonstrates the stress path to failure due to three different conditions (Lambe & Silva 1998). Increasing the weight ( $W$ ) will give the loading effective stress



path with a strength of  $F_L$ . On the other hand, building up the pore water pressure in the subsoil will result in failure along the horizontal stress path to  $F_{\Delta U}$ . In assessing the stability of the weight ( $W$ ), a limit equilibrium computer program (e.g. slope stability program) will use a stress path corresponding to a constant  $\sigma'_v$  to failure along the vertical effective stress path to failure at  $F_C$ . This simple demonstration indicates that different shear strengths are obtained for different stress paths followed ( $F_L > F_C > F_{\Delta U}$ ) and thus yield different factors of safety (FOS). It is very important to note that the vertical stress path (usually used in limit equilibrium computer program,  $F_C$ ) does not properly model the other two mechanisms that could occur in the field.

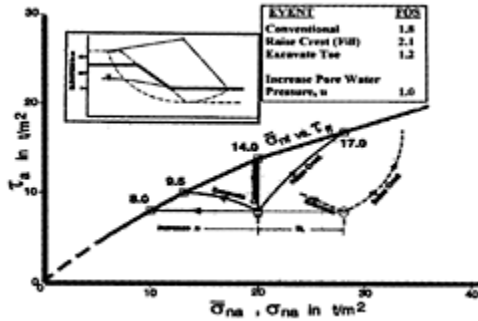

Figure 10.10. Example on effect of stress path on factor of safety from stability analysis (from Lambe & Silva 1998).

Figure 10.10 shows another example of three different stress paths to failure (for one element of soil):

- Raising the crest through filling on top of the slope will yield FOS of 2.1.
- Excavating the toe of the slope will yield FOS of 1.2.
- Conventional vertical stress path (limit equilibrium analysis assumption) will yield FOS of 1.8.

From the two examples shown (Figures 10.9 and 10.10), three important points have been illustrated:

- The factor of safety (FOS) for slopes depends on the stress path to failure
- The most dangerous situation occurs when pore water pressure builds up (e.g. rising of groundwater). Therefore, it is very important and critical in slope stability analysis to have a representative groundwater and pore water pressure in the subsoil
- Conventional procedure of assuming a vertical stress path to failure does not represent the actual field stress path to failure of slope.

As a summary, it is important to recognise the significance of stress path effect in stability analysis to yield the correct factor of safety.

### Groundwater and pore water pressure

The hydrological effects of rainfall on a permeable slope are shown in Figure 10.11. Some of the rainwater runs off the slope and may cause surface erosion if there is inadequate surface protection. In view of the high soil permeability, much of the water will infiltrate into the subsoil. This causes the water level in the slope to rise or it may cause a perched water table to be formed at some less permeable boundary, usually dictated by the weathering profile. Above the water table, the degree of saturation of the soil increases and thus reduces the soil suction (i.e. negative pore pressure).

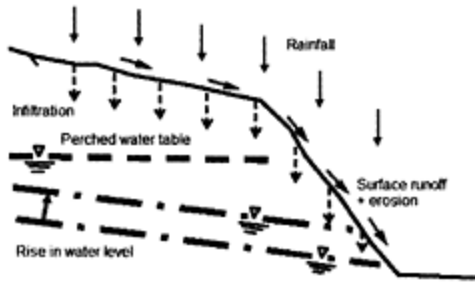

Figure 10.11. Effect of rainfall on permeable slope (after Brand 1995).

Failure in residual soils cut slopes might be caused by ‘wetting-up’ process which causes a decrease in soil suction and hence, decreases the soil strength. There is also evidence suggesting that transient rises in groundwater table are responsible for some rain-induced landslides (Premchitt et al. 1985). Lambe & Silva (1998) also reported that over the 60 slope failures they investigated, three-quarters of these failures were due to an increase in pore water pressure.

Slopes should be designed for the representative groundwater level through observation and estimation. However, to predict pore water pressure or groundwater level in cut slopes is one of the most difficult tasks because there are many unknown variables that require long-term monitoring (especially high cut slopes with catchments behind them) and are usually not available during design stage. Therefore, sensitivity analysis on the effect of water levels to the stability of slopes in the high risk-to-life and high economic risk category (GEO 2000) should be carried out and this requires prediction of the worst groundwater conditions.

Transient perched water tables might be formed at the interface of layers of differing permeability. Therefore an examination of the material profiles within a slope and the catchments above the slope must be carried out. Sometimes leakage from services, such as sewers, drains or water mains can cause rising of groundwater level. Services on hill-sites should be properly protected from leakage to prevent contributing to the failure of the slopes. In some cases, subsurface drainage (e.g. horizontal drains, vertical wells, etc.) can be used to reduce the groundwater levels and thus increases the factor of safety against failure on any potential slip surface which passes below the water table. If subsurface drainage system is employed, regular maintenance is required to prevent reduction in efficiency caused by siltation, deterioration of seals or growth of vegetation blocking the water outlet.

## 10.3 DESIGN AND STABILIZATION OF RESIDUAL SOIL SLOPES

*Analysis of stability*

There are generally two types of failure mechanisms:

- a) Planar slide
- b) Rotational slip or sliding block.

If the residual soil mantle is shallow in comparison with the length of the slope, a planar slide may result (Blight 1997b). The slip surface is commonly between the transition zones of soil (Grade IV to VI) with rock and the thickness of the sliding mass is usually roughly constant. Skempton (1957) presented a simple method of stability analysis for planar slide failure mechanism as illustrated in Figure 10.12. With reference to Figure 10.12, the factor of safety (FOS) with respect to planar slide failure is given as:

$$\text{FOS} = \frac{c' + (\gamma - m \cdot \gamma_w) z \cos^2 \beta \cdot \tan \phi'}{\gamma z \sin \beta \cos \beta} \quad (10.3)$$

In addition, Skempton (1957) also demonstrated the possibility of slope failure occurring in a relatively gentle gradient due to the effect of rising groundwater level:

For  $c'=0$  (critical state), the critical slope is given by the expression:

$$\tan \beta_c = \frac{\gamma' - m \cdot \gamma_w}{\gamma} \tan \phi' \quad (10.4)$$

If, in addition,  $m=1$  (i.e. groundwater level coincides with ground surface), then

$$\tan \beta_c = \frac{\gamma'}{\gamma} \tan \phi' \quad (10.5)$$

where  $\gamma'$  is the submerged density of the soil. Assuming that  $\gamma=18 \text{ kN/m}^3$  and  $\phi' = 20^\circ$  and  $c'=0$ , the critical slope of clay in accordance to the above equation is approximately  $9^\circ$ . When the groundwater level is below the surface, the maximum stable slope will be greater than this value. For example if  $m=1/2$ , then  $\beta_c=14.7^\circ$ . This demonstrates the significant influence of groundwater level in stability of slope.

The second typical failure mechanisms is the rotational slip or sliding block which occurs when the residual soil mantle is deep (Blight 1997b). Stability analysis for such failure mechanisms can be carried out using conventional methods such as Modified Bishop, Morgenstern-Price, Janbu, Spencer and Sliding Block method, which are readily available in commercial software. Generally, different analysis methods make different assumptions with regard to the interslice forces and the failure mechanism. For a detailed discussion on the various types of methods of analysis, reference can be made to Fredlund & Krahn (1977).

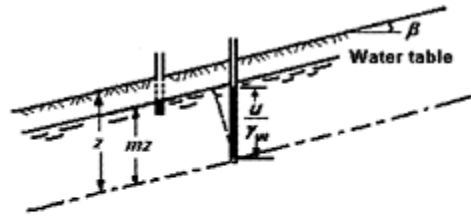

For limiting equilibrium:

$$\gamma z \sin \beta \cos \beta = c' + (\gamma - m\gamma_w) z \cos^2 \beta \tan \phi'$$

If  $c' = 0$ :

$$\tan \beta = \frac{\gamma - m\gamma_w}{\gamma} \tan \phi'$$

Figure 10.12. Stability analysis for planar slide failure mechanism (from Skempton 1957).

As a summary, for stability analysis in residual soil slopes, it is important to carry out analyses for different modes of failure if the designer is unsure of the likely failure mechanism in the field, i.e.:

- a) Planar slide
- b) Rotational slip (circular)
- c) Sliding block (wedge).

### *Methodologies for stabilization of slopes*

In the following sections, different methodologies for stabilization of slopes will be presented, i.e.:

- a) Regrading of slope profile
- b) Rock berms (toe counterweight)
- c) Reinforced soil wall
- d) Soil nailing.

These methods are by no means exhaustive and other methods such as contiguous bored pile, micropile, sheet pile, etc. can also be used as slope stabilization measures. The four methods above only represent some methods normally used in Malaysia.

The general concept of the stabilization measures shall be presented together with some recommendations on design and good practices. For stabilization work, it is important to bear in mind that the repair work itself may sometimes lead to larger failures, especially during removal of failed material. Therefore, proper caution must be exercised when carrying out stabilization work and work shall be carried out as fast as possible to place material back at the toe of the failure. Removal of failed materials shall not be more than 15 to 30 linear metres (if practical) of the failed material and stabilization work should then be carried out immediately. The minimum distance for machineries operation, site constraints, etc. often governs the practical limits for the removal of the failed material.

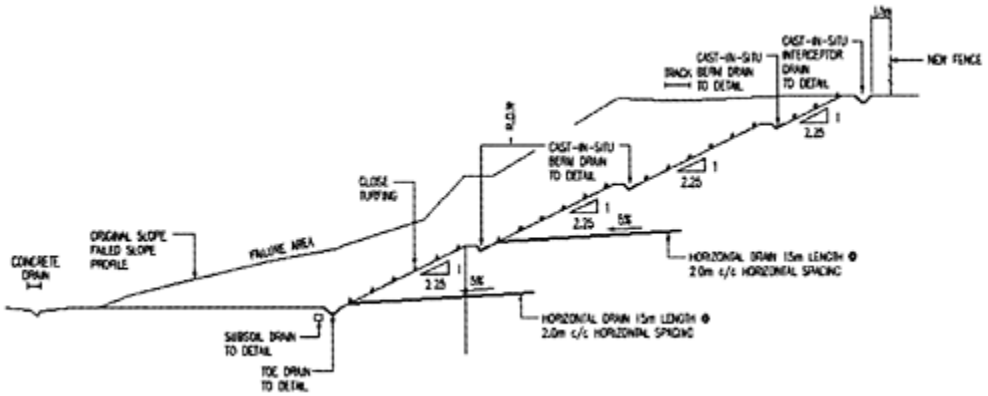

Figure 10.13. Regrading of slope profile.

#### 10.4 REGRADING OF SLOPE PROFILE

This is the easiest and cheapest method conventionally adopted for stabilizing slopes. Typically, the slope is regraded to a gentler gradient either by trimming or placing of soil/rock onto the existing slope. The regraded slope profile shall be chosen based on the required factor of safety. Important considerations in adopting this method include:

- a) Failed materials within the failed slope shall be removed prior to placing of soil/rock. If trimming is carried out, the trimming work shall extend beyond the failure plane. This is because the strength of the soil within the failure plane will tend to soften to a value which is significantly lower than the representative soil strength and for repeated failures, this value is close to the residual strength (Skempton 1985).
- b) The slope shall be benched prior to placement of fills.
- c) Any structural features on the slope shall be identified. If the failure of the slope is influenced by such features, the required slope profile will be governed by the structural features, e.g. angle of the bedding plane. This may result in a significantly gentler slope profile required for stability as compared to conventional analysis using slope stability methods for homogeneous soils.

A typical schematic sketch illustrating the concept of regrading of slope profile is shown in Figure 10.13.

#### 10.5 ROCK BERMS (TOE COUNTERWEIGHT)

Rock berm (toe counterweight) stabilizes the slope by providing a counterweight in the toe area of the slope. This method is effective in stabilizing slopes which failed due to inadequate lateral resistance or deep rotational failures. This method is also used to repair small slips where the toe area of the slope may be over steepened as a result of erosion or poor construction (FHWA 1988).

The design of rock berms shall take into consideration the location of the berms, i.e.:

- a) The berms shall be placed in a manner that would contribute to the stabilizing force (NOT destabilizing).
- b) The berms shall extend beyond the toe area of the failure.

Sometimes, rock berms are adopted together with regrading of slope profile to increase the factor of safety of the slope as shown in Figure 10.14. Geotextile fabric or filter aggregate is placed against the excavated slope before placing the rock or backfill to serve as drainage and separator.

## 10.6 REINFORCED SOIL WALL

Reinforced soil wall consists of a composite material of frictional soils and reinforcing strips that enable the gravity forces on a wall to be resisted by tensile forces generated in the strip and hence transferred by friction to the soil (Puller 1996). For the design of reinforced soil walls, the following criteria have to be satisfied:

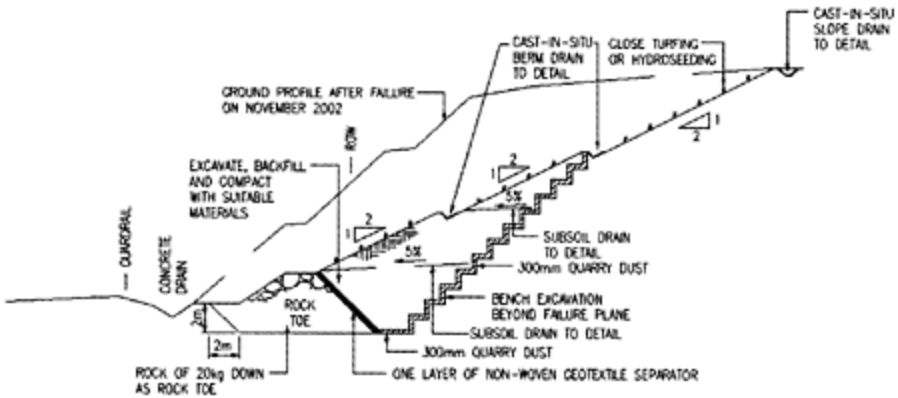

Figure 10.14. Rock berms (toe counterweight).

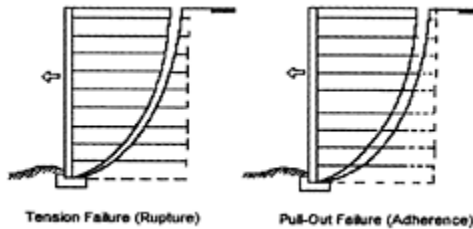

Figure 10.15. Internal stability (from Clayton et al. 1993).

- a) Internal stability (Figure 10.15)
  - a. Tension failure of reinforcement strips
  - b. Pull-out failure of reinforcement strips

b) External stability (Figure 10.16)

- a. Sliding failure
  - b. Overturning failure
  - c. Bearing and tilt failure
  - d. Slip failure
- c) Settlement of the wall is within acceptable limits in accordance to its intended function (serviceability limit state).

To satisfy the above criteria, design of reinforced soil walls involves determining:

- a) Reinforcement length and lateral/vertical spacing of reinforcement, and
- b) Embedment depth of the wall.

Various codes of practice and design manuals such as listed below are available for design of reinforced soil walls:

- a) British Standard BS8006:1995, Code of Practice for Strengthened/Reinforced Soils and Other Fills
- b) U.S. Department of Transportation, Federal Highway Administration (FHWA 2001); Mechanically Stabilized Earth Walls and Reinforced Soil Slopes Design and Construction Guidelines.

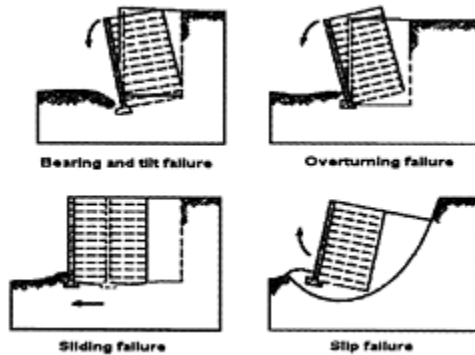

Figure 10.16. External stability (from Das 1999).

In this chapter, only the recommended design approach by BS8006 is discussed and some of the important recommendations by BS8006 are summarised in the following sections (Fong 2003).

### *Reinforcement length*

BS8006 recommends that:

- a) The minimum reinforcement length is  $0.7 * H$  for normal retaining structures where  $H$  is the maximum height of the wall or higher than the wall if there is a sloping back-fill.

- b) For abutments (bridges), the minimum length shall be (whichever is longer):  
 a.  $0.6 * H + 2$  metres  
 b. 7.0 metres

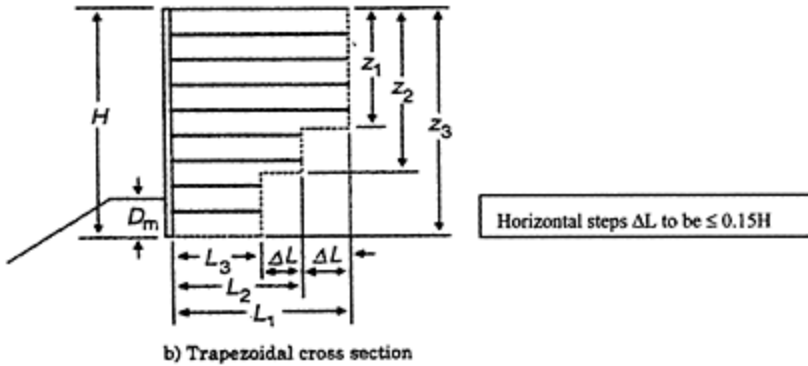
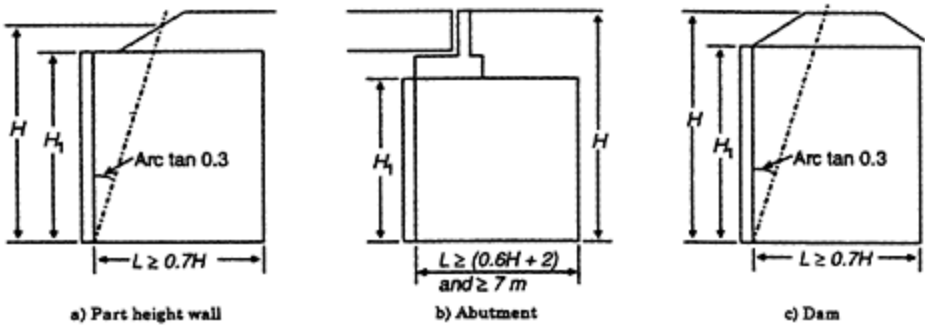

Figure 10.17. BS8006 criteria on reinforcement length (from BS8006 1995).

- c) If the reinforcement length is to be stepped, the maximum difference between the steps shall be less than  $0.15 * H$ .

Figure 10.17 illustrates the definition of the above criteria as recommended by BS8006.

### Reinforcement spacing

In Malaysia, the vertical and lateral spacing is generally 0.75 m as most common reinforced soil wall specialist contractors use 1.5 m × 1.5 m concrete face panel with two anchor points per panel per level.



*Reinforcement type*

BS8006 differentiates reinforcement into two types:

## a) Extensible reinforcement

Reinforcement that sustains design loads at strains greater than 1% (e.g. geosynthetics).

## b) Inextensible reinforcement

Reinforcement that sustains design loads at strains less or equal to 1% (e.g. metallic reinforcement).

*Embedded depth*

The minimum depth is governed by the mechanical height of the wall and also the factored bearing pressure. The recommendations by BS8006 are summarised in Table 10.4.

*External stability*

External stability checks for reinforced soil wall can be carried out using conventional analysis methods used for a gravity retaining wall. BS8006 recommendations on external loads and partial safety factors should be taken into consideration when carrying out the external stability checks.

*Internal stability*

BS8006 provides internal stability checks using two methods:

## a) Coherent gravity method (Figure 10.19)

## b) Tie back wedge method (Figure 10.20)

The tie back wedge method is based on the principles currently employed for classical or anchored retaining walls. Meanwhile, the coherent gravity method is based on the monitored behavior of structures using inextensible reinforcements and has evolved over a number of years from observations on a large number of structures, supported by theoretical analysis.

Table 10.4. Minimum embedment depth (from Table 20, BS8006 1995).

Slope of the ground at toe, $\beta_s$		Minimum embedment, $D_m$ (m)	Minimum embedment, $D_m/q_r$ ( $m^3/kN$ )
$\beta_s=0$	Walls	H/20	$1.35 \times 10^{-3}$
$\beta_s=0$	Abutments	H/10	$2.7 \times 10^{-3}$
$\beta_s=18^\circ$ (cot $\beta_s=3/1$ )	Walls	H/10	$2.7 \times 10^{-3}$

$\beta_s=27^\circ$ (cot $\beta_s=2/1$ )	Walls	H/7	$4.0 \times 10^{-3}$
$\beta_s=34^\circ$ (cot $\beta_s=3/2$ )	Walls	H/5	$5.9 \times 10^{-3}$

Note:

1.  $q_r$ —factored bearing pressure
2. For definition of notation, refer to Figure 10.18.

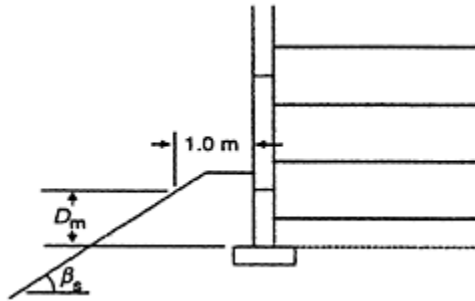

Figure 10.18. Definition of embedment depth,  $D_m$  (from BS8006 1995).

Coherent Gravity method should only be used for inextensible reinforcements and for simple wall geometry. For complex wall geometry, curved walls or multi-tiered wall, comparison should also be made using the Tie Back Wedge method and the design which gives longer reinforcement length or closer reinforcement spacing is to be adopted (i.e. whichever is more conservative).

The Tie Back Wedge method is used for extensible reinforcements and complex wall geometries where the failure plane is not planar (e.g. wall at corners or wall with curved geometries).

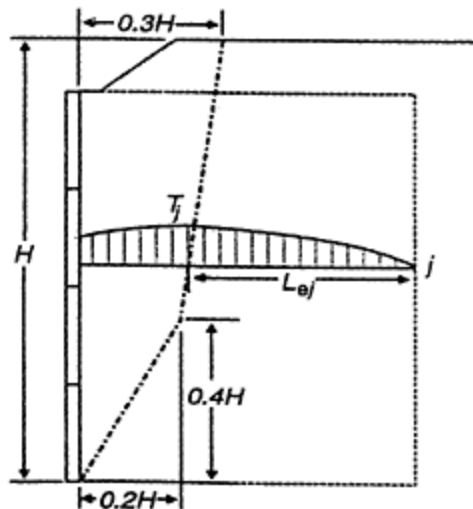

Figure 10.19. Coherent gravity method (from BS8006 1995).

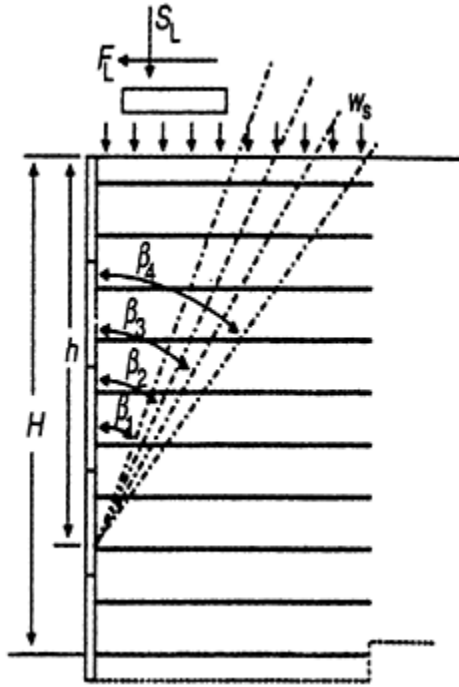

Figure 10.20. Tie back wedge method (from BS8006 1995).

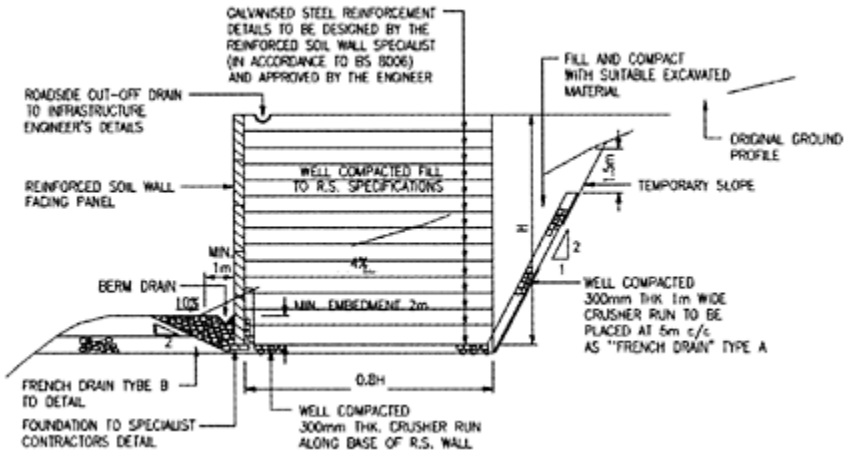

Figure 10.21. Typical details of reinforced soil wall.

### Settlement

Settlement of the wall, especially differential settlement should be assessed to ensure that the long-term settlement of the wall is within tolerable limits so as not to cause distress to the wall or impair its functionality. For walls with reinforced concrete panels and metallic reinforcements, the maximum differential settlement is limited to 1% or  $\Delta/L=1/100$ .

Typical section of a reinforced soil wall is as shown in Figure 10.21.

## 10.7 SOIL NAILING

Stabilization of slopes using soil nailing has the distinct advantage of strengthening the slope without causing further disturbance to the existing slope. Therefore, this method is very popular for strengthening work involving distressed slopes. The basic concept of soil nailing is to reinforce and strengthen the existing ground by installing closely-spaced steel bars, called 'nails', into a slope as construction proceeds from 'top-down'. This process creates a reinforced section that is in itself stable and able to retain the ground behind it. The reinforcements are passive and develop their reinforcing action through nail-ground interactions as the ground deforms during and following construction.

Various codes of practice and design manuals such as listed below are available for design of soil nailing:

- a) British Standard BS8006:1995, Code of Practice for Strengthened/Reinforced Soils and Other Fills.
- b) U.S. Department of Transportation, Federal Highway Administration (FHWA 1998), Manual for Design & Construction Monitoring of Soil Nail Walls.

While BS8006 provides some guidelines for the design of soil nailing, it is not as comprehensive and user-friendly compared to the recommendations of FHWA's manual. FHWA's manual provides a very comprehensive and systematic design approach and major steps involved in the design using Service Load Approach (SLD) are summarized as follows:

### *Step 1: Set up critical design cross-section(s) and select a trial design*

This step involves selecting a trial design for the design geometry and loading conditions. The ultimate soil strength properties for the various subsurface layers and design water table location should also be determined. Table 10.5 provides some guidance on the required input such as the design geometry and relevant soil parameters. Subsequently, a proposed trial design nail pattern, including nail lengths, tendon sizes, and trial vertical and horizontal nail spacing, should be determined.

### *Step 2: Compute the allowable nail head load*

The allowable nail head load for the trial construction facing and connector design is evaluated based on the nominal nail head strength for each potential failure mode of the facing and connection system, i.e. flexural and punching shear failure. The flexural and punching strength of the facing is evaluated as follows in accordance to the recommendations of FHWA (1998):

*Flexural strength of the facing:*

Critical nominal nail head strength,  $T_{FN}$ .

$$T_{FN} = C_F (m_{v,NEG} + m_{v,POS}) (8 S_H / S_V) \tag{10.6}$$

Table 10.5. Input required for soil nail design.

		Remarks
Soil properties	Bulk density, $\gamma$	–
	Ultimate friction angle, $\phi_{ult}$	–
Wall geometry	Ultimate soil cohesion, $c_{ult}$	–
	Wall height, $H$	–
	Wall inclination, $\alpha$	–
	Height of upper cantilever, $C$	–
	Height of lower cantilever, $B$	–
	Backslope angle, $\beta$	$\beta \geq \phi_{ult}$
	Soil-to-wall interface friction angle, $\delta$	Typically 2/3 $\phi_w$
	Nail inclination, $\eta$	Typically 15°
	Vertical spacing of nail, $S_V$	Typically 1.5m to 2.5m
	Horizontal spacing of nail, $S_H$	Typically 1.5 m to 2.5 m
Nail and shotcrete properties	Characteristic strength of nail, $F_y$	Typically 460 N/mm <sup>2</sup>
	Nail size/diameter	Minimum $\phi$ 20 mm
	Ultimate bond stress, $Q_u$ (kN/m)	Tables 10.6 & 10.7
	Values given in Tables 10.6 & 10.7 in kN/m <sup>2</sup>	
	Multiply with perimeter of grout column ( $\pi x D_{GC}$ ) to obtain value in kN/m	
	Shotcrete strength	–
	Thickness of shotcrete	–
	Depth/Width of steel plate	Minimum plate width 200 mm
	Thickness of steel plate	Minimum plate thickness 19mm

	Reinforcement for shotcrete	Use BRC reinforcement
	Waler bars	Typically 2T12
	Concrete cover	Typically 50–75 mm
	Diameter of grout column, $D_{GC}$	Typically 125 mm
Factors of safety	Soil strength	Table 10.10
	Nail tendon tensile strength, $\alpha_N$	Table 10.10
	Ground-grout pullout resistance, $\alpha_Q$	Table 10.10
	Facing flexure pressure, $C_F$	Table 10.8
	Facing shear pressure, $C_s$	Table 10.8
	Nail head strength facing flexure/ punching shear, $\alpha_F$	Table 10.9
	Nail head service load, $F_F$	Section 2.4.5 (FHWA 1998) Typically 0.5
	Bearing capacity	Typically 2.5

$m_{V,NEG}$  = vertical unit moment resistance at the nail head

$m_{V,POS}$  = vertical unit moment resistance at mid span locations

$S_H$  = horizontal nail spacings

$S_V$  = vertical nail spacings

$C_F$  = pressure factor for facing flexure (Table 10.8)

Vertical nominal unit moment

$$m_v = (A_s F_y / b) [d - (A_s F_y / 1.7 f' c b)] \quad (10.7)$$

$A_s$  = area of tension reinforcement in facing panel width 'b'

$b$  = width of unit facing panel (equal to  $S_H$ )

$d$  = distance from extreme compressive fiber to centroid of tension reinforcement

$f'c$  = concrete compressive strength

$F_y$  = tensile yield stress of reinforcement

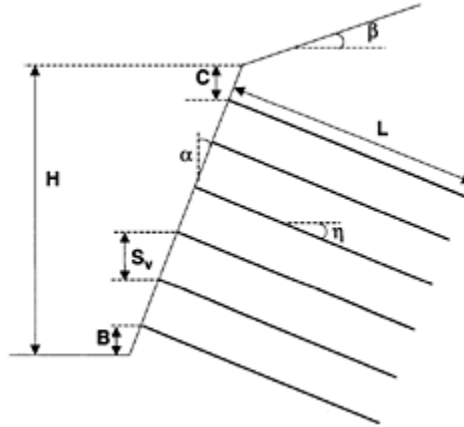

Figure 10.22. Definition of notation used in Table 10.5.

Table 10.6. Suggested ultimate bond stress—rock (from Table 3.2 and 3.3, FHWA 1998).

Construction method	Soil type	Suggested unit ultimate bond stress kN/m <sup>2</sup> (psi)	
Open hole	Cohesionless soils	Non-plastic silt	20–30 (3.0–4.5)
		Medium dense sand and silty sand/sandy silt	50–75 (7.0–11.0)
		Dense silty sand and gravel	80–100 (11.5–14.5)
		Very dense silty sand and gravel	120–240 (17.5–34.5)
		Loess	25–75 (3.5–11.0)
	Cohesive soils	Stiff clay	40–60 (6.0–8.5)
		Stiff clayey silt	40–100 (6.0–14.5)
		Stiff sandy clay	100–200 (16.5–29.0)

Note: In Malaysia, the ultimate bond stress is usually obtained based on correlations with SPT ‘N’ values and typically ranges from 3N to 5N.

Table 10.7. Suggested ultimate bond stress—rock (from Table 3.4, FHWA 1998).

Construction method	Soil type	Unit ultimate bond stress kN/m <sup>2</sup> (psi)
Open hole	Marl/Limestone	300–400 (43.5–58.0)
	Phillite	100–300 (14.5–43.5)
	Chalk	500–600 (72.0–86.5)
	Soft Dolomite	400–600 (58.0–86.5)
	Fissured Dolomite	600–1000 (86.5–144.5)
	Weathered Sandstone	200–300 (29.0–43.5)
	Weathered Shale	100–150 (14.5–21.5)
	Weathered Schist	100–175 (14.5–25.5)
	Basalt	500–600 (72.0–86.5)

Table 10.8. Recommended value for design—facing pressure factors (from Table 4.2, FHWA 1998).

Nominal facing thickness (mm)	Temporary facings		Permanent facings	
	Flexure pressure factor $C_F$	Shear pressure factor $C_s$	Flexure pressure factor $C_F$	Shear pressure factor $C_s$
100	2.0	2.5	1.0	1.0
150	1.5	2.0	1.0	1.0
200	1.0	1.0	1.0	1.0

*Punching shear strength of the facing:*

Nominal internal punching shear strength of the facing,  $V_N$

$$D'_c = \frac{V_N}{b_{PL} + h_C} = 0.33 (f'_c \text{ (MPa)})^{1/2} (\pi) (D'_c) (h_c) \quad (10.8)$$

Nominal nail head strength,  $T_{FN}$

$$T_{FN} = V_N \{1/1 - [C_s(A_C - A_{GC}) / (S_V S_H - A_G C)]\} \quad (10.9)$$

$C_s$  = pressure factor for punching shear (Table 10.8)

$A_C$ ,  $A_{GC}$ —refer Figure 10.23.

The allowable nail head load is then the lowest calculated value for the two different failure modes.



*Step 3: Minimum allowable nail head service load check*

This empirical check is performed to ensure that the computed allowable nail head load exceeds the estimated nail head service load that may actually be developed as a result of soil-structure interaction. The nail head service load actually developed can be estimated by using the following empirical equation:

$$t_f = F_f K_A \gamma H S_H S_V \tag{10.10}$$

- $F_f$  = empirical factor (=0.5)
- $K_A$  = coefficient of active earth pressure
- $\gamma$  = bulk density of soil
- $H$  = height of soil nail wall
- $S_H$  = horizontal spacing of soil nails
- $S_V$  = vertical spacing of soil nails

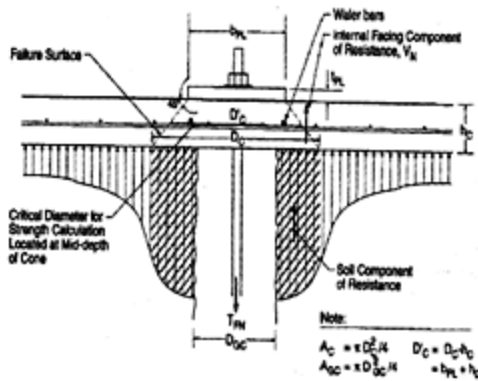

Figure 10.23. Bearing plate connection details (from FHWA 1998).

*Step 4: Define the allowable nail load support diagrams*

This step involves the determination of the allowable nail load support diagrams. The allowable nail load support diagrams are useful for subsequent limit equilibrium analysis. The allowable nail load support diagrams are governed by:

- a) Allowable Pullout Resistance,  $Q$  (Ground-Grout Bond)  
 $Q = \alpha Q_u$  Ultimate Pullout Resistance,  $Q_u$
- b) Allowable Nail Tendon Tensile Load,  $TN$   
 $TN = \alpha N_x$  Tendon Yield Strength,  $TNN$
- c) Allowable Nail Head Load,  $TF$   
 $TF = \alpha F_x$  Nominal Nail Head Strength,  $TFN$  where  $\alpha Q$ ,  $\alpha N$ ,  $\alpha F$  = strength factor (Table 10.10).

Next, the allowable nail load support diagrams shall be constructed according to Figure 10.24.

*Step 5: Select trial nail spacing and lengths*

Performance monitoring results carried out by FHWA have indicated that satisfaction of the strength limit state requirements will not in itself ensure an appropriate design. Additional constraints are required to provide for an appropriate nail layout. The following empirical constraints on the design analysis nail pattern are therefore recommended for use when performing the limiting equilibrium analysis:

Table 10.9. Nail head strength factors—SLD (from Table 4.4, FHWA 1998).

Failure mode	Nail head strength factor (Group I)	Nail head strength factor (Group IV)	Nail head strength factor (Group VII) (Seismic)
Facing flexure	0.67	$1.25(0.67)=0.83$	$1.33(0.67)=0.89$
Facing punching shear	0.67	$1.25(0.67)=0.83$	$1.33(0.67)=0.89$
Headed stud			
Tensile			
Fracture			
ASTM A307 Bolt material	0.50	$1.25(0.50)=0.63$	$1.33(0.50)=0.67$
ASTM A325 Bolt material	0.59	$1.25(0.59)=0.74$	$1.33(0.59)=0.78$

Table 10.10. Strength factors and factors of safety (from Table 4.5, FHWA 1998).

Element	Strength factor (Group I) $\alpha$	Strength factor (Group IV)	Strength factor (Group VII) (Seismic)
Nail head strength	$\alpha_F$ =Table 12.9	see Table 12.9	see Table 12.9
Nail tendon tensile strength	$\alpha_N$ =0.55	$1.25(0.55)=0.69$	$1.33(0.55)=0.73$

Ground-grout pullout resistance	$\alpha_Q=0.50$	$1.25(0.55)=0.63$	$1.33(0.50)=0.67$
Soil	$F=1.35$ (1.50*)	$1.08$ (1.20*)	$1.01$ (1.13*)
Soil-temporary construction condition†	$F=1.20$ (1.35*)	NA	NA

Note:

- a) Group I: General loading conditions
- b) Group IV: Rib shortening, shrinkage and temperature effects taken into consideration
- c) Group VII: Earthquake (seismic) effects (Not applicable in Malaysia)
- d) \*Soil Factors of safety for critical structures
- e) † Refers to temporary condition existing following cut excavation but before nail installation. Does not refer to ‘temporary’ versus ‘permanent’ wall.

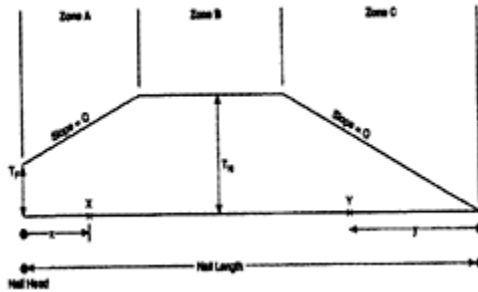

Figure 10.24. Allowable nail load support diagram (from FHWA 1998).

- a) Nails with heads located in the upper half of the wall height should be of uniform length.
- b) Nails with heads located in the lower half of the wall height shall be considered to have a shorter length in design even though the actual soil nails installed are longer due to incompatibility of strain mobilized compared to the nails at the upper half. This precautionary measure is in accordance with the recommendations given by Figure 10.25. However, further refinement in the nail lengths can also be carried out if more detailed analyses are being carried out, e.g. using finite element method (FEM) to verify the actual distribution of loads within the nails.

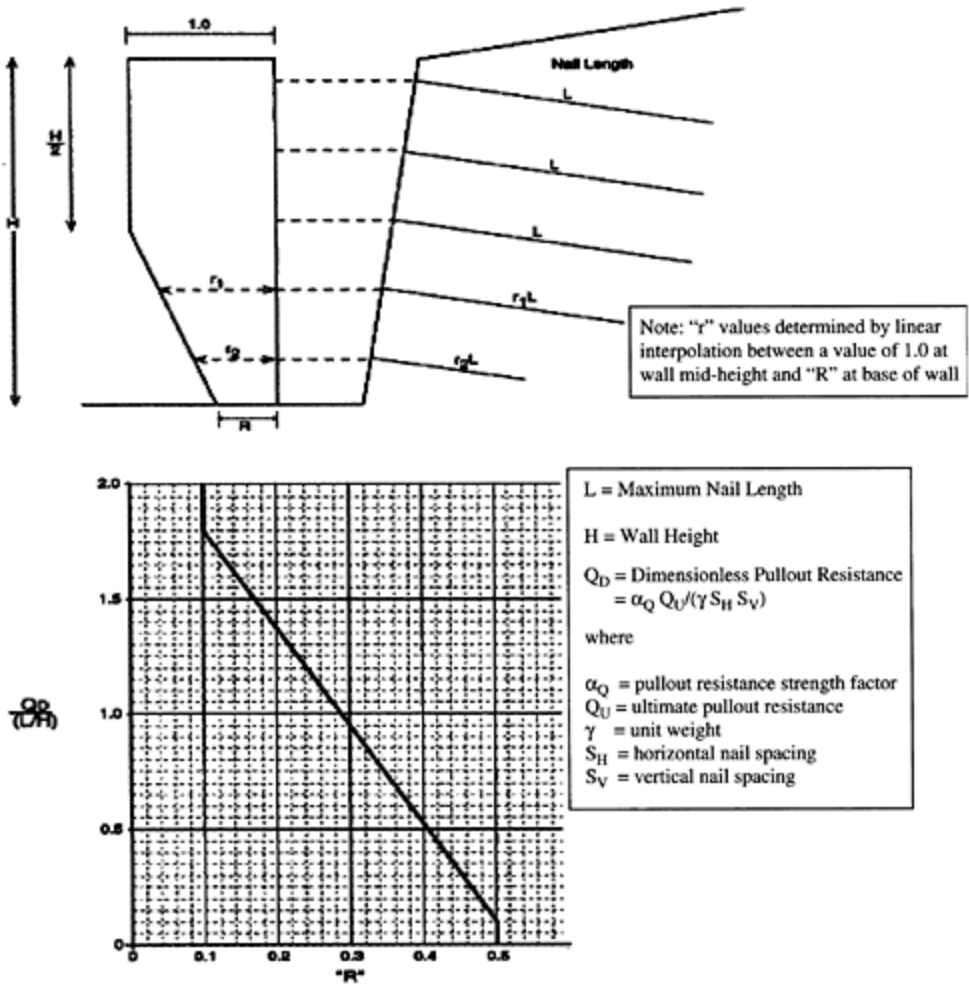

Figure 10.25. Nail length distribution assumed for design (from FHWA 1998).

The above provision ensures that adequate nail reinforcement (length and strength) is installed in the upper part of the wall. This is due to the fact that the top-down method of construction of soil nail walls generally results in the nails in the upper part of the wall being more significant than the nails in the lower part of the wall in developing resisting loads and controlling displacements. If the strength limit state calculation overstates the contribution from the lower nails, then this can have the effect of indicating shorter nails and/or smaller tendon sizes in the upper part of the wall, which is undesirable since this could result in less satisfactory in-service performance. The above step is essential where movement sensitive structures are situated close to the soil nail wall. However, for stabilization work in which movement is not an important criterion, e.g. slopes where there is no nearby buildings or facilities, the above steps may be ignored.

*Step 6: Define the ultimate soil strengths*

The representative soil strengths shall be obtained using conventional laboratory tests, empirical correlations, etc. The limit equilibrium analysis shall be carried out using the representative soil strengths (NOT factored strengths).

*Step 7: Calculate the factor of safety*

The Factor of Safety (FOS) for the soil nail wall shall be determined using the ‘slip surface’ method (e.g. Bishop’s circular). This can be carried out using commercially available software to perform the analysis. The stability analysis shall be carried out iteratively until convergence, i.e. the nail loads corresponding to the slip surface are obtained. The required factor of safety (FOS) for the soil nail wall shall be based on recommended values for conventional retaining wall or slope stability analyses (e.g. 1.4 for slopes in the high risk-to-life and economic risk as recommended by GEO (2000)).

*Step 8: External stability check*

The potential failure modes that require consideration with the slip surface method include:

- a) Overall slope failure external to the nailed mass (both ‘circular’ and ‘sliding block’ analysis are to be carried out outside the nailed mass). This is especially important for residual soil slopes which often exhibit specific slip surfaces, defined by relict structure, with shear strength characteristics that are significantly lower than those applied to the ground mass in general. Therefore, for residual soil slopes, the analyses must consider both general and non-structurally controlled slip surfaces in association with the strength of the ground mass, together with specific structurally controlled slip surfaces in association with the strength characteristics of the relict joint surfaces themselves. The soil nail reinforcement must then be configured to support the most critical condition of these two conditions.
- b) Foundation bearing capacity failure beneath the laterally loaded soil nail ‘gravity’ wall. As bearing capacity seldom controls the design, therefore, a rough bearing capacity check is adequate to insure global stability.

*Step 9: Check the upper cantilever*

The upper cantilever section of a soil nail wall facing, above the top row of nails, will be subjected to earth pressures that arise from the self-weight of the adjacent soil and any surface loadings acting upon the adjacent soil. Because the upper cantilever is not able to redistribute load by soil arching to adjacent spans, as can the remainder of the wall facing below the top nail row, the strength limit state of the cantilever must be checked for moment and shear at its base, as described in Figure 10.26.

For the cantilever at the bottom of the wall, the method of construction (top-down) tends to result in minimal to zero loads on this cantilever section during construction. There is

also the potential for any long-term loading at this location to arch across this portion of the facing to the base of the excavation. It is therefore recommended by FHWA (1998) that no formal design of the facing be required for the bottom cantilever. It is also recommended, however, that the distance between the base of the wall and the bottom row of nails not exceed two-thirds of the average vertical nail spacing.

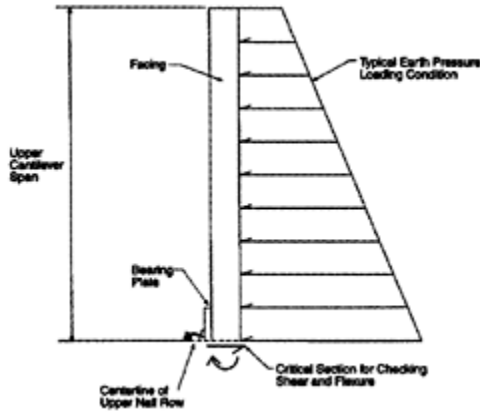

Figure 10.26. Upper cantilever design checks (from FHWA 1998).

### *Step 10: Check the facing reinforcement details*

Check waler reinforcement requirements, minimum reinforcement ratios, minimum cover requirements, and reinforcement anchorage and lap length as per normal recommended procedures for structural concrete design.

It is recommended that waler reinforcement (usually 2T12) to be placed continuously along each nail row and located behind the face bearing plate at each nail head (i.e. between the face bearing plate and the back of the shotcrete facing). The main purpose of the waler reinforcement is to provide additional ductility in the event of a punching shear failure, through dowel action of the waler bars contained within the punching cone.

### *Step 11: Serviceability checks*

Check the wall function as related to excess deformation and cracking (i.e. check the service limit states). The following issues should be considered:

- a) Service deflections and crack widths of the facing.
- b) Overall displacements associated with wall construction.

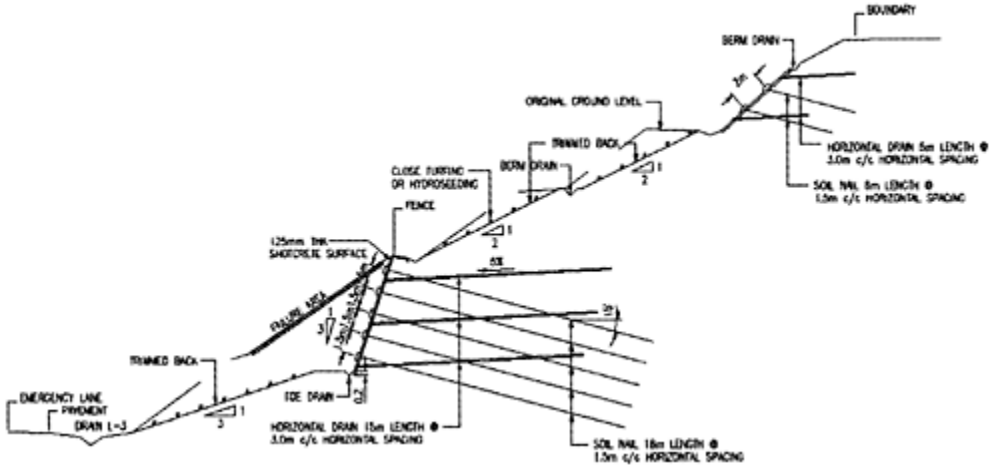

Figure 10.27. Typical details of soil nail wall.

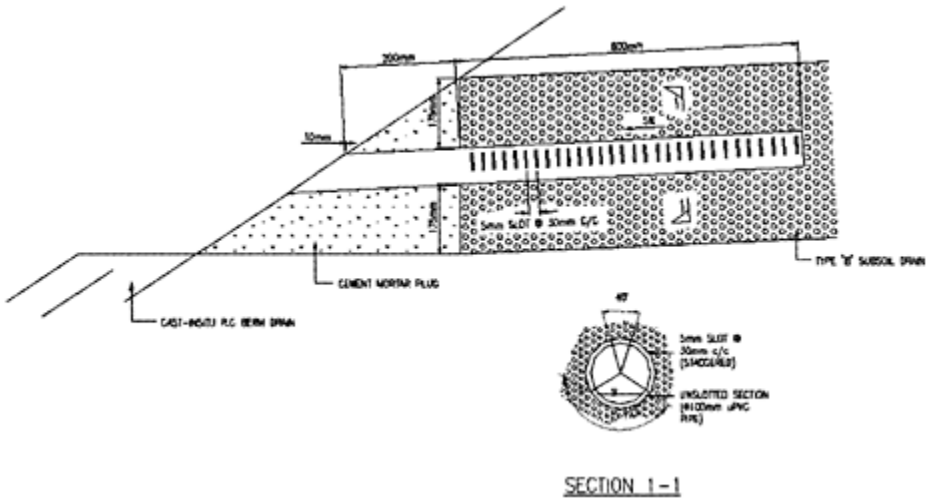

Figure 10.28. Weepholes.

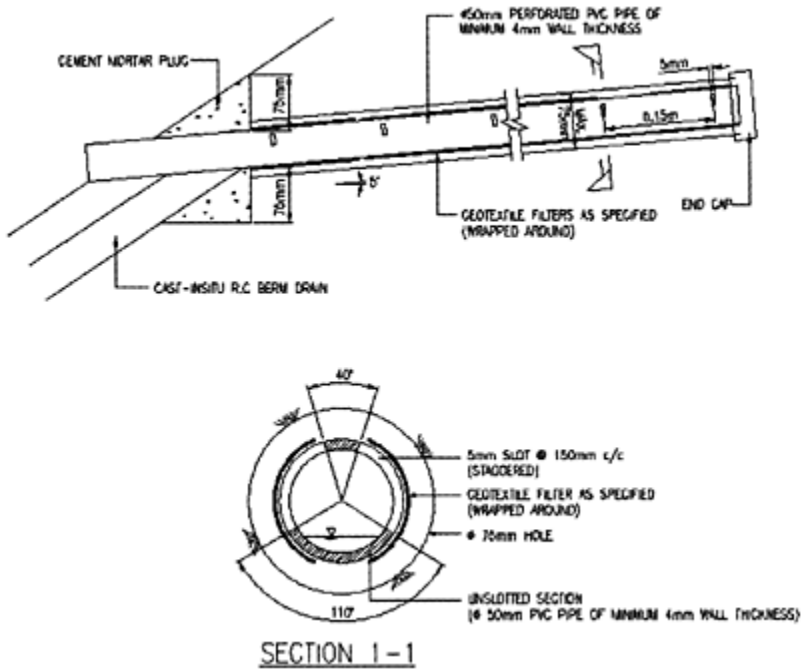

Figure 10.29. Horizontal drain.

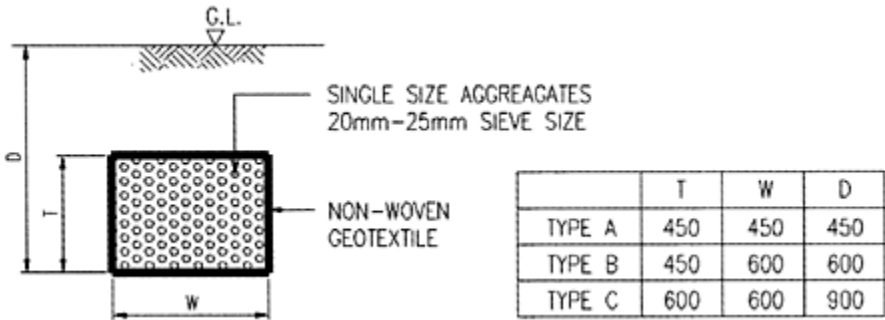

Figure 10.30. Subsoil drain.

- c) Facing vertical expansion and contraction joints. Typical section of a soil nail wall is as shown in Figure 10.27.

## 10.8 CONTROL OF DRAINAGE AND SEEPAGE

As discussed in the earlier sections, water is one of the main contributors to slope failure in residual soils. Therefore, slope stabilization measures are usually implemented together



with methods to control drainage and seepage. A variety of surface and subsurface drainage may be used to control drainage and seepage as listed below:

- a) Surface water drainage measures
  - i. Surface ditches
  - ii. Divert surface waters
  - iii. Seal joints, cracks, fissures
  - iv. Regrade slope to eliminate ponding
  - v. Shotcrete surface of slope
  - vi. Hydroseeding/Turfing

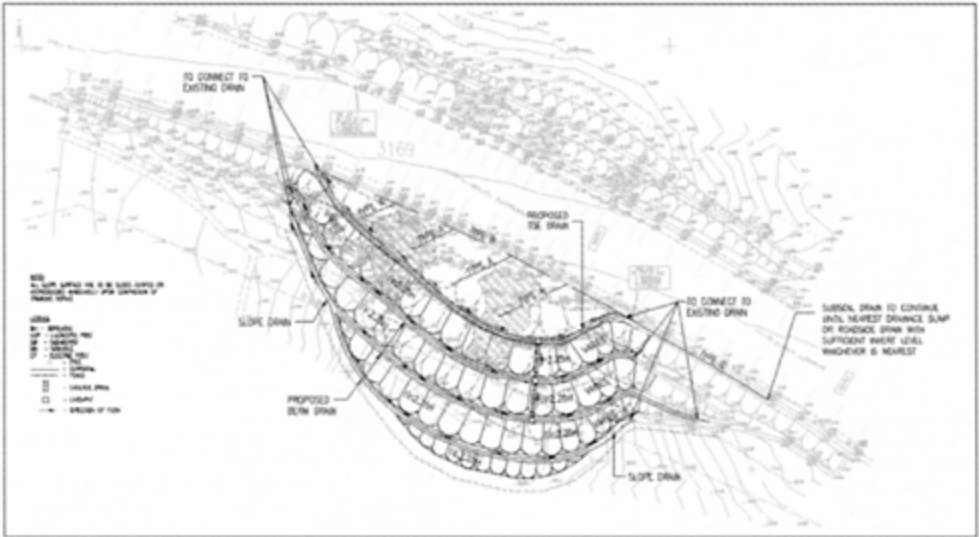

Figure 10.31. Typical drainage layout for slope rehabilitation.

- b) Subsurface drainage measures
  - i. Horizontal drains
  - ii. Weepholes
  - iii. Subsoil drains
  - iv. Drainage blankets
  - v. Cut-off walls
  - vi. Vertical well points
  - vii. Seepage tunnels

Drainage is important to intercept groundwater seepage before it enters the slope zone and drains away the water that might infiltrate the slope from rainfall. For subsurface drainage, the drainage blanket should be protected from clogging by enclosing it with a proper geotextile filter, or by designing the granular blanket as a filter.

Some typical drawings showing some of the drainage measures commonly adopted are shown in Figures 10.28, 10.29, 10.30 and 10.31 respectively.

## 10.9 CONCLUSION

Residual soils exhibit characteristics that are quite different from those of transported soils, i.e.:

- a) Very heterogeneous, which makes sampling and testing for relevant engineering parameters difficult.
- b) Usually high permeability, therefore susceptible to rapid changes in material properties when subjected to changes of external hydraulic condition.

Residual soils also often exhibit structural features such as relict jointing, bedding or slickensiding which it has inherited from the parent rock.

As such, slope stability and stabilization in residual soils is often not a straightforward task and it poses great challenges to geotechnical engineers all around the world. Therefore, proper understanding of the behavior of residual soils is essential and geotechnical engineers should realize the difference in stress-strain behavior between residual soils and transported soils and its influence on shear strength.

Stability analysis for residual soil slopes are governed by the likely mode of failure and there are generally three types of possible failure mechanisms:

- a) Planar slide
- b) Rotational slip (circular)
- c) Sliding block (wedge).

Common methods of stabilization for transported soil slopes can also be adopted for residual soil slopes. However, for residual soil slopes, the influence of structural features shall be properly identified and stabilization measures shall be modified to cater for the most critical conditions. Four different types of stabilization measures are presented, i.e.:

- a) Regrading of slope profile
- b) Rock berms (toe counterweight)
- c) Reinforced soil wall
- d) Soil nailing.

Finally, drainage measures to control surface runoff and seepage are presented. Drainage measures are usually implemented together with the stabilization measures to effectively stabilize the slope during its intended service.

## REFERENCES

- Atkinson, J.H. & Bransby, P.L. 1978. *The mechanics of soils*. London: McGraw Hill.
- Blight, G.E. 1997a. Origin and formation of residual soils. In G.E.Blight (ed.), *Mechanics of residual soils*, Rotterdam: A.A.Balkema.
- Blight, G.E. 1997b. Case histories of shear strength—Controlled aspects of residual soils. In G.E.Blight (ed.), *Mechanics of residual soils*, Rotterdam: A.A.Balkema.
- Bolton, M.D. 1986. The strength and dilatancy of sands. *Geotechnique* 36(1):65–78.
- British Standard Institution, BS8006:1995: *Code of practice for strengthened/reinforced soils and other fills*.

- Brand, E.W. 1995. Slope stability and landslides under tropical conditions—A review. *Symposium on hillside development*. Kuala Lumpur, Malaysia.
- Brenner, R.P., Garga, V.K. & Blight, G.E. 1997. Shear strength behavior and the measurement of shear strength in residual soils. In G.E.Blight (ed.), *Mechanics of residual soils*. Rotterdam: A.A.Balkema.
- Clayton, C.R.I., Milititsky, J. & Woods, R.I. 1993. *Earth pressure and earth-retaining structures*. Second edition. Glasgow, U.K: Blackie academic & professional.
- Crabb, G.I. & Atkinson, J.H. 1991. Determination of soil strength parameters for the analysis of highway slope failures. *Slope stability engineering*. London: Thomas Telford.
- Das, B.M. 1999. *Principles of foundation engineering*. Pacific Grove, USA: PWS Publishing.
- Fong, C.C. 2003. Design of reinforced soil wall. Gue & Partners training module (In-house publication).
- FHWA. 1988. *Highway slope maintenance and slide restoration workshop: Participant manual*. Federal Highway Administration, US Department of Transportation, USA.
- FHWA. 1998. *Manual for design & construction monitoring of soil nail walls*. Federal Highway Administration, US Department of Transportation, USA.
- FHWA. 2001. *Mechanically stabilized earth walls and reinforced soil slopes design & construction guidelines*. Federal Highway Administration, US Department of Transportation, USA.
- Fredlund, D.G. & Krahn, J. 1977. Comparison of slope stability methods of analysis. *Can. Geotech. Journal* 14: 429–439.
- GCO. 1988. *Guide to rock and soil descriptions: Geoguide 3*. Geotechnical Control Office, Hong Kong.
- GEO. 2000. *Geotechnical manual for slopes*. Geotechnical Engineering Office, Hong Kong.
- Gibson, R.E. & Henkel, D.J. 1954. Influence of duration of tests at constant rate of strain on measured 'drained' strength. *Geotechnique*. 4(1):6–15.
- Gue, S.S. 2003. Private Communication.
- Head, K.H. 1982a. *Manual of soil laboratory testing, volume 2: Permeability, shear strength and compressibility tests*. London: ELE International Ltd. Pentech Press.
- Head, K.H. 1982b. *Manual of soil laboratory testing, volume 3: Effective stress tests*. London: ELE International Ltd. Pentech Press.
- Lambe, T.W. & Silva, F. 1988. The determination of soil strength for stability analysis. *Proc. 13th Southeast Asian Geot. Conf., Taipei*, 1.
- Little, A.L. 1969. The engineering classification of residual tropical soils. *Proc. Spec. Session on Eng. Props. Lateric soils. 7th Int. Conf. Soil Mech. & Found. Eng., Mexico City*: 1–10.
- Puller, M. 1996. *Deep excavations: A practical manual*. London: Thomas Telford.
- Powrie, W. 1997. *Soil mechanics: Concepts and applications*. London: E&FN Spon.
- Premchitt, J., Brand, E.W. & Phillipson, H.B. 1985. Landslides caused by rapid groundwater changes. In J.C.Cripps et al. (eds.). *Groundwater in engineering geology*, Geol. Soc., London: 87–97.
- Ruxton, G.P. & Berry, L. 1957. Weathering of granite and association erosional features in Hong Kong. *Bulletin Geol Soc. Amer.* 68:1263–1292.
- Skempton, A.W. 1957. Stability of natural slopes in London clay. *Proc. 4th Int. Conf. Soil Mech.*, London. 2:378–381.
- Skempton, A.W. 1964. Long term stability of clay slopes. *Geotechnique* 14:77–101.
- Skempton, A.W. 1970. First time slides in overconsolidated clay. *Geotechnique* 20:320–324.
- Skempton, A.W. 1977. Slope stability of cuttings in brown London clay. *Proc. 9th Int. Conf. Soil Mech., Tokyo* 3: 261–270.
- Skempton, A.W. 1985. Residual strength of clays in landslides, folded strata and the laboratory. *Geotechnique* 35(1):3–18.

- Tan, Y.C. & Gue, S.S. 2001. The determination of shear strength in residual soils for slope stability analysis. *Seminar cerun kebangsaan, Cameron Highlands, Malaysia*.
- Tschebotarioff, G.P. 1950. Discussion on effect of driving piles into soft clays by Cummings, A.E., Kerkhoff, G.O. & Peck, R.B. *Transactions, ASCE* 115:296–301.
- Van der Merwe, D.H. 1965. The soils and their engineering properties of an area between Pretoria North and Brits, Transvaal. DSc Thesis, University of Pretoria.
- Vargas, M. & Pichler, E. 1957. Residual soil and rock slides in Santos, Brazil. *Proc. 4th Int. Conf. for Soil Mechanic. & Found. Eng., London* II:394–398.
- Vaughan, P.R. 1988. Characterising the mechanical properties of in situ residual soil. *Proc. 2nd Int. Conf. Geomechanics in Tropical Soils, Singapore* 2:469–487.

## CHAPTER 11

# Soil erosion and sedimentation assessment, control and management plan for the tropical region

Roslan Zainal Abidin

*National Soil Erosion Research Centre, MARA University of Technology, Shah Alam,  
Selangor, Malaysia*

Tew Kia Hui

*VT Soil Erosion Research & Consultancy, Sg. Buloh, Selangor, Malaysia*

Soil erosion and sedimentation have lately become very serious problems in the tropical region as activities such as deforestation, intensification of agriculture, and urbanisation have proceeded at variable and often rapid rates over the last couple of decades. This problem will certainly persist and worsen unless proper planning and management of land utilization is adopted at the early stage of any proposed land development. The fact that soil erosion and sedimentation continue to be an environmental problem of significant proportions in the tropical region suggests that more definitive guidelines and stringent monitoring and enforcement of land development are required. Therefore, this paper will focus on soil erosion assessment, control and management plan for the tropical region to identify the risk locations as well as the level of risk involved to better provide site-specific mitigation measures even before the construction period. With the application of soil erosion and sedimentation assessment as well as an in-depth understanding of the Best Management Practices on erosion and sediment control, it would be beneficial to the knowledge-based community in moving a step closer towards a better understanding of soil erosion and sedimentation issues to ensure a more sound and sustainable development in future.

### 11.1 INTRODUCTION

Land use and cover change in the tropical region, including the South-East Asia, has been a high profile issue of late because of concerns about soil losses due to deforestation, intensification of agriculture, and urbanisation, which often encroaches on hillside and highland areas. Although these activities form an integral part of the socio-economic advancement

in this region, their success is indeed limited, if insufficient attention is paid to the adverse effects of land development, particularly on soil erosion issues and subsequently sedimentation of waterways.

In the engineering perspective, soil erosion is defined as a general destruction of soil structure by the action of water and wind (Beasley 1972). It is essentially the smoothing process with soil particles being carried away, rolled and washed down by the force of gravity (Morgan 1993). Rainfall is the prime agent of soil erosion, whereby the rain's runoff will scour away, loosen and break soil particles and then carry them away, thus leaving behind an altered bare earth surface (Wischmeier & Smith 1978). In the case of a slope, an altered bare surface of the slope with the formation of sheet, rill and gully erosion features will cause instability of the slope. This situation will gradually cause slope failure or landslide as is commonly known. The soil erosion phenomenon is basically the function of the erosivity of the rainfall and the erodibility of the soil. In other words, when the rainfall acts upon the earth surface, the amount of the soil erosion loss will basically depend upon the combination of the strength and the magnitude of the rainfall to cause the erosion process and the ability of the soil to withstand the rain itself (Hudson 1979).

Sedimentation, on the other hand, is a consequence of soil erosion, and is the deposition of eroded soil particles to a low-lying area, which in this case is the river. Sedimentation therefore depends on the rate of erosion, while its delivery to another area will depend on the proximity, landform and availability of obstruction along its path, such as trees and buffers.

The soil erosion and sedimentation related problems could be identified and minimized if the knowledge of the soil erosion prone areas are identified and mapped. This would require an understanding of the assessment as well as the basic parameters that influence soil erosion losses. However, it must be noted that this assessment would need to be in line with the current environmental guidelines and requirements, if it were to function as an effective environmental planning tool.

## 11.2 ENVIRONMENTAL GUIDELINES AND REQUIREMENTS ON SOIL EROSION AND SEDIMENTATION ASSESSMENT

In an attempt to contain the environmental problems including soil erosion issues and subsequently sedimentation of waterways, the various governments had introduced specific legislation to govern and control land development, though it might vary slightly from country to country.

A typical example is that the Malaysian Federal Government had introduced legislation enabling local authorities to exert greater control over the layout and management of construction sites. The Environmental Quality Act (1974) was introduced into Malaysian Law as a comprehensive piece of legislation to provide a common legal basis for co-ordinating all activities relating to environmental control. Amendments to the Environmental Quality (Amendment) Act 1985 require any person or agency intending to carry out a 'prescribed activity' to submit a report on its potential effects on the environment to the Director General, Department of Environment (DOE), for approval.

The Environmental Quality (Prescribed Activities) (Environmental Impact Assessment, EIA) Order 1987 was gazetted in November 1987 and came into force on 1 April 1988.

This Order lists the nineteen (19) ‘prescribed activities’ for which an EIA is mandatory out of a total of twenty six (26) activities accounted for by Department of Environment (DOE) in their generic and specific guidelines. Of the 26 activities listed, the following are considered to be relevant to the ‘*Urban Stormwater Management Manual for Malaysia*’.

Activity	7	Housing ( <i>Prescribed</i> )
Activity	8	Industry ( <i>Prescribed</i> )
Activity	9	Infrastructure ( <i>Prescribed</i> )
Activity	16	Transportation ( <i>Prescribed</i> )
Activity	17	Resort and Recreational Development ( <i>Prescribed</i> )
Activity	20	Land Conversion for Golf Course
Activity	21	Hill Slope Development
Activity	22	Development of Ecologically Sensitive Areas

Section 34A(2) of the 1985 Amendment Act specifies that where an EIA is required under the legislation, it shall follow the guidelines prescribed by the Director General of DOE. The procedures for preparing an EIA are set out in the Handbook of EIA Guidelines.

The fundamental objective of an EIA is to ensure that full consideration is given to its potential effects so that wherever possible, these can be mitigated by careful design, construction and operation.

Under the National Development Plan and in the Second Outline Perspective Plan (OPP2) as well as in the Sixth Malaysia Plan 1991–1995, emphasis is given to enhancement of the environment and eco-logy by proper planning and assessment to ensure a sustainable development of the country.

It must be stressed that the onset of the construction activities are fundamental to a nation’s development, and the beneficiaries of such infrastructural projects are the nation’s citizens—directly through increased infrastructure, mobility and access, and indirectly through an enhanced economic prosperity. Therefore, the Government of Malaysia, for example, is committed to environmental protection as set out in:

- Sixth Malaysia Plan 1991–1995
- Second Outline Perspective Plan 1991–2000
- Langkawi Declaration, October 1989
- Kuala Lumpur Accord on the Environment and Development, June 1990
- Kuala Lumpur Declaration on Environment and Development, April 1992
- Rio Declaration on the Environment and Development, June 1992

By adhering to these guidelines and other related statutory compliance requirements with respect to erosion and sediment control in the tropical region, it is also hoped that planners and project proponents will be able to identify potential erosion and sedimentation risk areas in their construction sites, especially in hillslope areas where erosion risk is greater. This will be based on an understanding of the processes, which underline the causes and

the effects of erosion and sedimentation. One would then be able to plan the Best Management Practices (BMP) for erosion and sediment control in a more effective way.

### *Environmental Impact Assessment (EIA)*

The EIA, although the term may vary from country to country, shall follow the guidelines prescribed by the Director General/Head of the nation's Department of Environment. However, to successfully undertake an EIA, it is necessary to determine just what the issues are: (i) to identify precisely who or what could be affected and how, and (ii) to describe the project activities with the potential to adversely affect the environment. Coming to grips with the issues is a fundamental requirement of an EIA.

Environmental impacts touching on key issues of soil erosion and sedimentation are results of actions and activities, associated with planning, constructing, operating and managing of the construction activities. The EIA guidelines would then subdivide the project activities within three phases—*pre-construction, construction and post construction*.

Although the activities may be different, in many instances of erosion and sedimentation impacts on the environment may be similar. Accordingly, when evaluating and describing the existing environment and the impact on environment from the project, it is the issues, which need to be highlighted.

### *Environmental Management Plan (EMP)*

Within the ISO 14000 Series, there are provisions for the design of an Environmental Management Plan (EMP), which, among other measures includes provisions for the management of soil erosion and sedimentation during site clearing and earthworks. The components pertaining to erosion and sedimentation can be segregated out to form an *Erosion and Sediment Control Plan (ESCP)*, which specifically aims to control erosion and siltation during the stages from land clearing to project completion.

An integral part of an EMP is also an ESCP. Therefore, the DOE generally requires an ESCP at the submission stage of an EIA to enable it to assess the adequacy of the proposed mitigation measures for the control of erosion and sedimentation during earthworks and construction on-site. An ESCP can also be incorporated in the EMP if it is not already done in the EIA submitted earlier.

Systematic environmental site checks for compliance with standards carried out subsequently by DOE during construction and operation of a project are often based on comparative audits of information obtained during field surveys with the baseline information given in the EIA or in the ESCP and EMP. Thus, a well-documented ESCP is basic and meaningful for any project development.

### *Erosion and Sediment Control Plan (ESCP)*

The Erosion and Sediment Control Plan (ESCP) is the main document submitted to the DOE for the control of erosion and sedimentation, forming a component of a section in an EIA, outlining measures designed to mitigate environmental impacts.



An ESCP should provide for temporary measures that can be adopted during the development phase and for mitigation measures that will remain in place once development is completed and is prepared by the project proponent or the proponent's consultants. A copy of this Plan is normally made available at the work site at all times as a reference.

In preparing ESCP, the areas within the development project site susceptible to erosion and sedimentation should be clearly defined and factors causing erosion be identified. Factors, such as, rainfall characteristics should be determined, the susceptibility of the soil types present ascertained, the distribution of steep slopes mapped, the theoretical potential erosion values for the area determined and the susceptibility of the area to landslides evaluated. This will enable site hazard maps to be prepared, which will help determine site layout and give an indication of the types of preventive measures required during and following development. It will also enable works to be scheduled to avoid likely periods of heavy storm rainfall.

An effective ESCP aims to prevent controllable erosion and to minimize the adverse effects of sediment transport from on-site to off-site areas. In general, an ESCP for a development project serves to provide:

- Clear interpretation of the development's impact on the environment, which in turn will improve the quality of evaluation and interpretation by the government authorities who are responsible for commenting, approving and monitoring the project;
- Clear interpretation of proposed action erosion and sediment control measures, thus improving the quality of construction tender pricing;
- A saving of time and costs because both the developer and approving authority agree on the implementation of the plan;
- Clear interpretation of proposed erosion and sediment control measures by the project proponent, thus improving the efficiency and cost effectiveness of the control techniques; and
- The incorporation of a standard ESCP into engineering construction documentation is strongly recommended.

The first and main principle of ESCP preparation is to ensure that erosion and sediment control measures are fully integrated into the development sequence. Erosion and sediment control can only be effective if construction and control practices were jointly planned during the planning and feasibility stages and implemented simultaneously throughout the construction stage.

The second principle is that an ESCP should form part of the engineering documents for a contractor and be part of the final engineering design drawings for documentation in the Schedule of Rates or Bill of Quantities.

The third principle is to ensure that all control structures are maintained at all stages of the development, such as during earthwork preparation, foundation and construction works. Well-maintained control structures may not overcome all erosional problems, but will ensure that the extent of the problems is significantly reduced.

The fourth principle is to ensure that there is a system of continuous measurement of the parameters identified in the ESCP to control erosion throughout the construction of the project.

The fifth principle is to prepare an emergency plan for immediate implementation if any of the erosion and sediment control measures fail due to unforeseen circumstances, such as severe rainstorms overtopping or breaching sediment basins.

### 11.3 SOIL EROSION FEATURES AND IMPACTS

The successive stages of soil erosion and extent to which the tropical region is affected at each stage vary greatly. The onset of erosion is usually insidious and its early harmful consequences are usually ignored. Only when it has become epidemic in proportion, the need for adequate control measures is realized. One of the earlier symptoms is the loss of soil fertility through deterioration in the physical properties of the soil. The ultimate result is complete devastation of the land (RRIM 1980).

In the tropical region, where the amount and intensity of rainfall are high, water erosion is a major problem. Soil erosion by water takes place by the detachment of individual particles from the soil mass and their transportation down slope through the action of raindrops and the surface runoff. Its rate of progress is dependent on such factors as slope, soil type, density of vegetative cover, and the amount and intensity of rainfall (Roslan & Tew 1999). Improper methods of cultivation, overgrazing and burning tend to intensify soil erosion. The principal types of water erosion features are *sheet erosion, rill erosion and gully erosion*.

#### *Soil erosion features*

##### *Sheet erosion*

This is the most widespread and probably the most damaging form of erosion by water. Essentially, it refers to the uniform removal of a thin layer, or 'sheet' of soil from a given area of land. Normally, the soil is detached by the impact of falling raindrops and then removed by surface runoff. As sheet erosion occurs on smooth soil surface and uniform slope, it usually goes unnoticed as only a few millimetres of soil are removed during each rainy season. The initial change takes place very slowly and the only obvious feature is the transformation of the soil from a dark to a lighter colour as the organic rich topsoil is removed and the subsoil is exposed.

Besides the removal of soil, sheet erosion also results in soil compaction and the formation of an impervious layer, 2 to 6cm below the soil surface (Bennet 1947). This is caused by the plugging up of soil pores by fine particles from the disintegrated soil aggregates. The impervious layer seals the soil surface against filtration of water, thereby causing more of the rain water to flow off the land as surface runoff, and in the process, erosion of the land is accelerated.

##### *Rill erosion*

Under natural conditions soil surface is always irregular, particularly at cultivated fields within the tropical region. There tend to be low places and high places, irregularities between soil clods and aggregates, and furrows caused by tillage implements. Consequently, as the

rainwater accumulates it concentrates in depressions and then flows along the irregularities, causing the formation of rills. The numbers of rills in a given area can vary widely, depending mainly on the irregularity of the soil surface and the amount and velocity of runoff. They also vary in size from minute channels to a size that is easily observable.

Detachment and transportation of soil particles are greater in rill erosion than in sheet erosion. This is due to acceleration of the moving water as it concentrates and moves in rills. Detachment of soil particles is primarily initiated by the energy of the flowing water, and not by the raindrop impact as in sheet erosion. The amount of soil particles detached by moving water is proportional to the square of its velocity and its transporting power varies as the fifth power of its velocity. Rill erosion is most severe where intense rainstorm occurs on soil with high runoff characteristics and where topsoil erodes easily. The important characteristic of this type of soil is that soil erodes downwards and may extend into the subsoil, leading to gully erosion in a short time.

#### *Gully erosion*

Gullies are among the most spectacular and advanced form of erosion; without them the more insidious and widely present sheet erosion may pass unnoticed for much longer. Besides the formation of the ugly scars on the landscape, gully erosion would also reduce the economic value of the land, damage installations and completely devastate the agricultural potential of the land. Agricultural land deserted on account of gullies would also restrict free movement of farm machinery.

Gullies are developed from rills, which are allowed to go unchecked. They can also be started by tracks made up and down hill by the movement of machinery or livestock. The rate and extent of gully development is closely related to the amount and velocity of runoff water. Furthermore, it is also affected by soil characteristics and slope of the channel. There is a wide range of gully sizes, depending on where the gullies are located, their age and the many conditions contributing to their development. They may be narrow and only 1 m deep or may range enormously from 12 m to 15m deep and 30 m to 40 m wide.

The cross sections of gullies are either a V or a U shaped. The V-shaped form often occurs where the subsoil is resistant to rapid cutting because of fine soil texture or compactness. The U-shaped gullies are often found in areas where both the surface soil and subsoil are easily eroded. It is not uncommon to find both V and U shapes in the same gully.

#### *Soil erosion impacts*

The serious consequences of soil erosion and subsequently sedimentation are well-known. Currently, the efficiency of mitigation measures in reducing the impact of soil erosion and sedimentation on the environment and receiving waters is little known.

On-site and off-site effects of soil erosion, sediment transport, siltation and deposition, which are detrimental to the environment surrounding the construction sites are listed in Table 11.1.

### 11.4 SOIL EROSION ASSESSMENT

Soil erosion has to be tackled at source in order to ensure minimum impacts of eroded soil, which would subsequently lead to sedimentation of watercourses. Consideration of

the various factors influencing soil erosion, and subsequently sedimentation, is vital for identifying the risk areas as well as achieving optimum management of the river system in the vicinity of the affected area.

### *Universal Soil Loss Equation (USLE)*

Empirical equations have been already used extensively in the United States to estimate soil loss from a cropped field under specific combinations of soil slope, cropping system and management. These soil-loss equations undergo continuous modifications with the availability of more research data (Harper 1987). At present, a new equation has been developed which has universal application. The Universal Soil Loss Equation (USLE) improves localized soil-loss prediction without drastically changing basic concepts and application procedure of the older equations. It reflects the influence of all the major factors known to affect rainfall erosion.

$$A = RKLSCP \quad (11.1)$$

where

- A*=Average Annual Soil Erosion Loss (t/ha/yr)
- R*=Rainfall Erosivity Factor (MJ.mm/(ha.hr.yr))
- K*=Soil Erodibility Factor (t.ha.hr/(ha.MJ.mm))
- L*=Slope Length Factor
- S*=Slope Steepness Factor
- C*=Cover and Management Factor
- P*=Conservation Practice Factor

Table 11.1. 'On-site' and 'off-site' soil erosion impacts.

Locations	Effects
On-site	<ul style="list-style-type: none"> <li>• Loss of value, productivity and services from affected land</li> <li>• Undermining of roads and utilities</li> <li>• Sediment and mud on roads with associated traffic problems and road safety issues</li> <li>• Clogged drains and increased incidence of flooding</li> <li>• Sedimentation and bank damage on construction sites</li> <li>• Increased down-time on construction and building sites after storm events</li> <li>• Unsightly appearance of construction works</li> <li>• Sedimentation and accelerated loss of capacity in sediment basins</li> <li>• High cost of reconstruction and maintenance</li> </ul>

- Off-site
- Sedimentation in nearby reservoirs and other storage structures, with resulting loss of water storage capacity
  - Instability of stream channels nearby caused by increased runoff and sediment loads
  - Siltation and sedimentation of rivers causing a reduction in channel capacity
  - leading to greater frequency of floods Proliferation of exotic weeds within water-courses due to high nutrients content of silt and sediments
  - Smothering of aquatic and marine flora and fauna: high turbidity in rivers excluding light penetration affecting fish life
  - Land degradation caused by gully erosion and sediment deposition
  - Increased pollution of rivers and streams
  - Loss of navigable reaches of a river or water course
  - Adverse ecological effects of high sediment loads, deposition and dredging and de-silting of waterways
  - Decline or total loss of recreational and commercial fishing, particularly as a result of increased turbidity due to sediment load
- 

(U.S. Agriculture Research Service 1961) These factors are described in more detail below.

*(a) Rainfall Erosivity Factor, R*

The Rainfall Erosivity Factor,  $R$  for a given rainfall period is a numerical value which indicates the erosivity of the rain expressed in the index  $EI_{30}$ . The factor  $E$  is the total energy for a rainfall and  $I_{30}$  is the rainfall's maximum 30-minute intensity. The variable  $EI_{30}$  is the product of total energy for a rain event and the rainfall's maximum 30-minute intensity. Several equations are available for describing the erosivity of rainfall.

*(b) Soil Erodibility Factor, K*

The Soil Erodibility Factor,  $K$  is the rate of soil loss per unit of rainfall erosivity factor  $R$  or  $EI_{30}$  for a specified soil that is measured on a unit plot, which is a 22.1 m length of uniform 9% slope continuously in clean tilled fallow. Therefore,  $K$  has units of mass per area per erosivity unit. There are many factors, which affect erodibility of soil such as the physical features of the soil, the topographic features and the management of the land. The  $K$  factor could be calculated using a nomograph. A typical Malaysian nomograph for calculation of Soil Erodibility Factor,  $K$  is as shown in Figure 11.1.

*(c) Slope Length And Steepness Factor, LS*

The Slope Length Factor,  $L$  is the ratio of soil loss from the field slope length to that from a 22.1 m length under identical conditions. In the case of a longer slope, there is a greater build up of the amount of surface runoff and velocity. This will lead to scour erosion, which

would not occur on a shorter length of slope. The Slope Steepness Factor,  $S$  is the ratio of soil loss from the field slope gradient to that from a 9% slope under identical conditions. Evaluation of the Slope Steepness Factor is done most easily on standard plots with a fallow surface.

In the USLE, a combined factor is used for slope length and steepness. The standard conditions are 9% slope and length of 22.1 m, so that at this point on the graph, the ratio becomes unity (Figure 11.2). By entering the graph for other values of slope steepness and length, the  $LS$  ratio that is to be applied in the USLE can be obtained.

(d) Cover Management Factor,  $C$

The Cover Management Factor,  $C$  is a ratio, which compares the soil loss from an area with specified cover and management to that from a field under a standard cultivated continuous fallow. The factor  $C$  also depends upon the period of time within which weather effects would have varying influences. Therefore, there are clearly major interactions between crop management and climate. Usually, the annual value of the factor  $C$  is multiplied by the annual value of the rainfall factor  $R$ . However, it is equally possible to divide the growing season into periods and multiply  $C$  and  $R$ -values for each period in which the products are used to obtain the annual combined effects of factors  $C$  and  $R$ . Land use management factors, which include the factor  $C$  and the Conservation Practice Factor,  $P$  of the USLE, may change from year to year as land use changes.

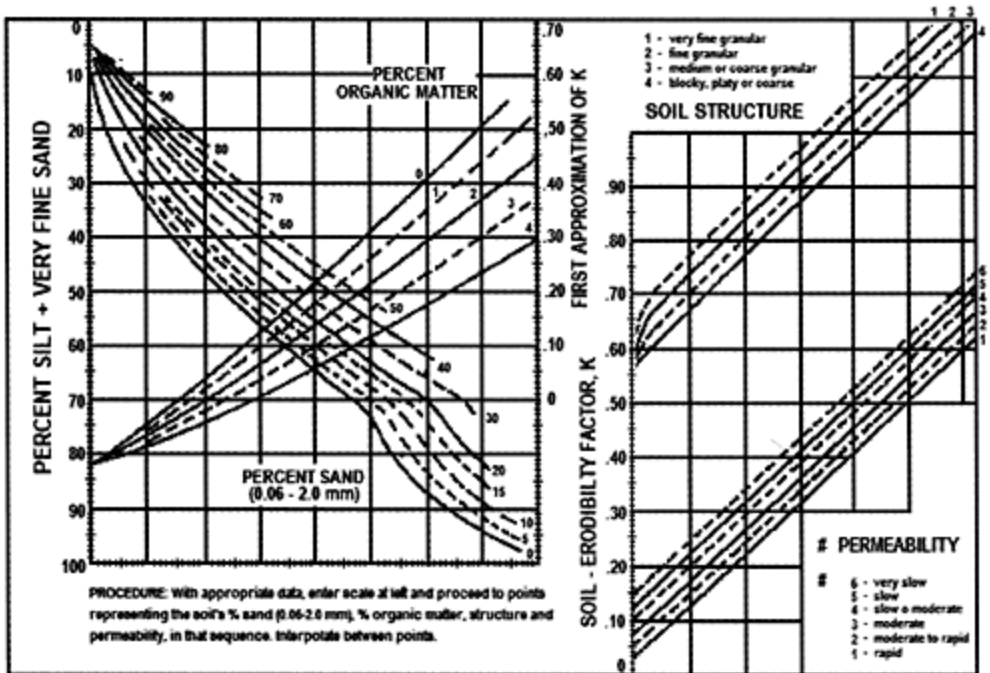

Figure 11.1. Malaysian soil erodibility nomograph for calculation of soil erodibility factor,  $K$  (Tew 1999).

*(e) Conservation Practice Factor, P*

The Conservation Practice Factor,  $P$  is the ratio of soil loss for a given practice to that where there is no conservation practice with farming up and down the slope. The factor  $P$  of the USLE is a dimensionless supporting erosion control, which has a specific value for slope groups from 1.1 to 24% as shown in Table 11.2.

It can be expressed as a ratio of the soil loss with practices, such as contouring, strip cropping or terracing to that with farming up and down the slope. The effects of conservation practices are not likely to vary from one country to another. The practices themselves may be different and there may be different designs and construction methods for mechanical protection works.

*'ROM' Scale, EIROM*

Several studies related to soil erosion issues in Malaysia were carried out earlier by various government agencies such as Department of Irrigation and Drainage, Department of Agriculture and Public Works Department as well as institutions of higher learning.

Nevertheless, till to-date, there is no research being done on establishing the soil erosion scale based on soil grading characteristics. In earlier studies, researchers had successfully and clearly identified the relationship between soil erosion features and its erodibility index.

However, new studies found that the soil erosion scale can be established by linking the various soil erosion tragedy occurrence in Malaysia based on soil grading characteristics as used in the Bouyancos Equation. Samples from each soil erosion occurrence were taken and their grading characteristics identified. Using the Bouyancos Equation, the value of Erodibility Index ( $EI$ ) can be obtained and from the  $EI$  value, a new equation, which is modified from the original Bouyancos Equation, was developed successfully.

Table 11.2. Conservation practice factor ( $P$ ) for contouring and terracing (Wischmeier & Smith 1978).

Slope (%)	Conservation practice ( $P$ ) values	
	Contouring	Terracing (Strip contour-cropping)
1.1–2.0	0.60	0.30
2.1–7.0	0.50	0.25
7.1–12.0	0.60	0.30
12.1–18.0	0.80	0.40
18.1–24.0	0.90	0.45

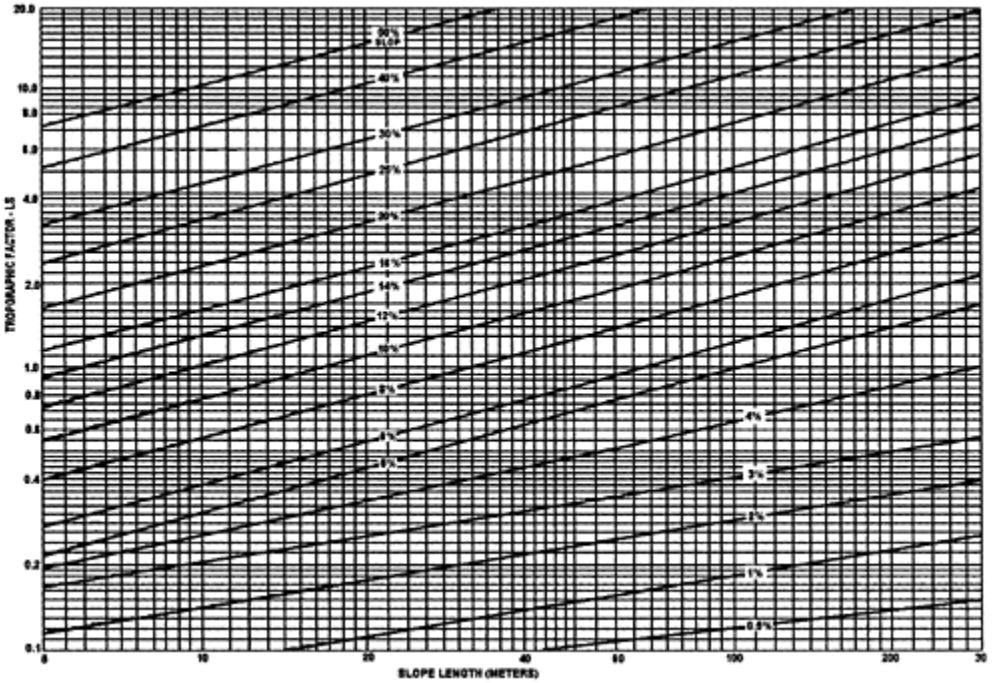

Figure 11.2. Combined slope length-steepness factor, *LS* (Wischmeier & Smith 1978).

$$EI_{ROM} = \frac{\%SAND + \%SILT}{2(\%CLAY)}$$

'ROM' SCALE	DEGREE OF SOIL EROSION
<1.5	LOW
1.5-4.0	MODERATE
4.0-8.0	HIGH
>8.0	CRITICAL

Figure 11.3. 'ROM' Scale for measurement of soil erosion tragedy (Roslan & Mazidah 2002).

This new equation is named 'ROM' Equation (after Roslan & Mazidah 2002/ The equation is then used to acquire the new value of *EI<sub>ROM</sub>*, thus leading to the establishment of the 'ROM' Scale, which indicates the degree of any soil erosion tragedy. Figure 11.3 shows the 'ROM' Scale equation as well as the degree of soil erosion tragedy based on this equation.



## 11.5 SOIL EROSION ASSESSMENT REPORT (SEAR)

*General principles*

The Soil Erosion Assessment Report (SEAR) is a specific document submitted to the various Local Authorities for any proposed new development (name of report might vary from country to country), which would include the assessment of factors influencing soil erosion, mapping of factors involved, environmental monitoring programme on erosion and sediment control and also recommendations of mitigation measures to be taken to minimize the impacts of soil erosion and sedimentation on-site. It is aimed at providing a better understanding on the impacts of soil erosion and sedimentation before, during and after the construction period in which amendments to the Earthworks Plan would be required based on the outcome and findings of this report before it could be approved by the relevant authorities.

This report would also incorporate the Erosion and Sediment Control Plan (ESCP) and Environmental Monitoring Programme, which is important to address specific issues and denote the locations of erosion and sediment control measures on plan as well as the proposed monitoring stations.

*Data acquisition*

The acquisition of data needed to carry out this assessment report would include:

- *Rainfall data*—information on daily rainfall recorded by rainfall stations nearest to the project area for a period of at least five years;
- *Soil data*—specific information on the soil composition would be required as this could be done using a hand-auger to a depth of 1 meter. Alternatively, information could be acquired from the Soil Investigation Report;
- *Slope length and steepness data*—this could be obtained from the Survey Plan that was carried out and the slope being analysed using the Geographical Information Systems (GIS); and
- *Land use data*—for modelling purposes, the land use for conditions before, during and after construction would be required. The existing land use could be obtained from the Survey Plan, but if for a large area, then this information would need to be obtained from satellite imagery/aerial photographs. During construction stage, the land use would be based on the Earthworks Plan with the indication of the earthworks area. After construction, the proposed Layout Plan would be used as a reference to estimate the land use during that time.

Therefore, the following data/plans are required:

- Daily Rainfall Data (at least 5 years)
- Soil Sampling/Soil Investigation Report
- Earthworks Plan
- Layout Plan
- Survey Plan
- Silt Trap/Sediment Basin Details Plan.

### *Methodologies adopted*

The methodologies adopted for the Soil Erosion Assessment Report for a project area are as follows:

- i) Analysing 'Survey and Earthworks Plan' to determine the elevation (before and after construction)
- ii) Analysing rainfall data to determine the Rainfall Erosivity,  $R$
- iii) Analysing summary of laboratory results acquired from 'Soil Investigation' to determine the Soil Erodibility Factor,  $K$
- iv) Using elevation information to produce the Slope Length and Steepness Factor,  $LS$  (before and after construction)
- v) Using site observation information and 'Survey, Earthworks and Layout Plan' to determine the Cover Management/Land Use Factor,  $CP$  (before, during and after construction)
- vi) Gathering of all the information from the respective maps to produce Soil Erosion Loss,  $A$  (before, during and after construction) to identify the risk areas involved.

### *Result analysis*

Result analysis on each of the factors influencing erosion need to be carried out in the assessment report. This would include analysis on:

- i) *Rainfall Erosivity Factor,  $R$* . The areas with higher rainfall erosivity denote implication of higher erosion risk based on this factor.
- ii) *Soil Erodibility Factor,  $K$* . According to international standards, if the  $K$  factor value is above 0.10 then the area would be considered highly erodible and erosion risk is higher too.
- iii) *Slope Length and Steepness Factor,  $LS$* . The steeper and longer slope areas will show higher  $LS$  factor. Therefore, this would increase the erosion rate in the area.
- iv) *Cover Management Factor,  $CP$* . The  $CP$  factor would increase if the area is left barren and this would certainly increase the erosion rates. The estimated  $CP$  value for an area is as shown in Table 11.3.
- v) *Soil Erosion Loss,  $A$* . The soil erosion loss would very much depend on all the factors that influence erosion. Areas having erosion losses of more than 150 t/ha/yr would be considered as having critical erosion risk as shown in Table 11.4. Therefore, mitigation measures would need to be proposed for erosion and sediment control for these areas to ensure minimum impact on the surrounding environment.

### *Environmental monitoring programme on erosion and sediment control*

The Soil Erosion Assessment Report would need to detail out the environmental monitoring programme as the soil erosion and sedimentation issues would need to be tackled at source especially during the construction phase which involves earthworks activities. Activities within the project area such as construction of roads, structures, drains and veg-

etation clearing would cause erosion. If soil erosion during this stage is not contained, sediment will be transported out of the site especially during rainy seasons. Therefore, daily routines in erosion monitoring are required.

### *Frequency*

Soil erosion within the site should be monitored by the Site Manager and on-site workers assigned to the task. If erosion problems arise that are not contained by the installed mitigation measures, the Project Manager should be notified immediately. Sediment build-up on the silt traps should be monitored weekly and reported to the Project Manager. Evaluation of the contractor's compliance with recommended mitigation measures and adherence to applicable guidelines in relation to the earthworks practice should be undertaken every two months.

Table 11.3. Cropping and management practices factor, CP (Roslan & Tew 1996).

Land cover	CP Factor
Water body	0.000
Bareland*	1.000
Horticultural	0.250
Permanent cropland	0.150
Cropland	0.200
Rangeland	0.229
Grassland	0.015
Forest	0.010
Swamps	0.001
Residential	0.003
Impervious	0.005
Commercial	0.008
Construction	1.000

\* incl. mining areas and newly cleared land.

Table 11.4. Classification for soil erosion risk (Roslan &amp; Tew 1995).

Soil erosion loss range (t/ha/yr)	Classification (Risk)
<50	Low
50–100	Moderate
101–150	High
>150	Critical

### *Methodology*

#### *Sediment transport within the project site:*

Permanent reference poles with vertical measurement scales and clearly visible reference numbers should be placed at the silt traps/sediment basins proposed within the site. The Site Manager or staff assigned to the task should take photographs of the submerged sections of the reference poles each week using a digital camera, and submit the photographs via email to the Project Manager which allow him/her direct, visual assessment of the sediment transport within the project area.

#### *Monitoring of implementation of mitigation measures and earthworks practices:*

The Consultant is to perform monthly field surveys to oversee that all proposed mitigation measures for soil erosion and sedimentation are in fact installed, maintained, and operational.

#### *Monitoring stations*

Proposed site for monitoring of soil erosion and sedimentation would need to be identified. The Project Manager should be notified on a regular basis the performance of each of these stations and instruct the on-site staff to carry out maintenance works when necessary.

#### *Amendments to earthworks plan*

As the earlier Earthworks Plan designed by the consultant would be based on an assumption on the best location of the erosion and sediment control measures on-site, this would need to be confirmed based on the outcome of the Soil Erosion Assessment Report. For example, if the location of earth drains does not tally with the areas identified as high-risk areas, then amendments are required to be made to the Earthworks Plan, whereby the earth drain location would be adjusted in order to channel silt out of the risk areas identified.

*Development of the Erosion and Sediment Control Plan (ESCP)*

Based on the outcome of risk areas identified in the Soil Erosion Assessment Report, the placement of erosion and sediment control measures on-site such as the temporary check dams, earth drains, silt traps, sediment basins and turfing areas could be formulated. Staging of construction activities could also be planned to ensure minimum impacts of erosion and sedimentation on-site.

*Enforcement usage*

The Soil Erosion Assessment Report could be used as an enforcement document whereby any proposal of mitigation measures specified in the report should be implemented on-site. The number of earth drains/silt traps/sediment basins and other erosion and sediment control measures should be in accordance to the specifications on the amended Earthworks Plan. Therefore, records of non-compliance should be noted down each time the inspection is carried out so as to ensure relevant action against errant contractors or developers who fail to comply with the approval conditions of the report by the local authorities.

11.6 INCORPORATING BEST MANAGEMENT PRACTICES FOR EROSION CONTROL

Specific Best Management Practices (BMP) should be incorporated for common construction activities that result in erosion of construction sites and the generation of sediment, which impacts waterways and off-site property.

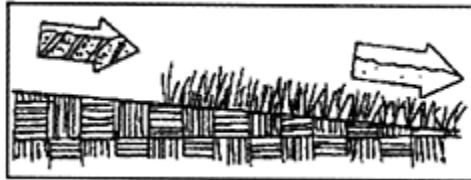

Figure 11.4. Seeding and planting.

*Site planning considerations*

*Scheduling*

This is defined as sequencing the construction project to reduce the amount and duration of soil exposed to erosion by wind, rain, runoff, and vehicle tracking. Proper sequencing of construction activities should be incorporated into the schedule of every construction project. Use of other more costly yet less effective, erosion and sedimentation controls may often be reduced through proper construction sequencing.

The approach would be to integrate into existing land contours as far as practicable; this would mean incorporating existing natural areas, avoiding rainy periods, practising erosion and sediment control all year round, minimizing the extent of soil exposed at any one time and also carrying out trenching operations. This procedure may increase other construction costs due to reduced economies of scale in performing site grading. The cost-effectiveness of scheduling techniques should be compared with other, less effective erosion and sediment controls to achieve a cost-effective balance.

### *Preservation of existing vegetation*

Carefully planned preservation of existing vegetation minimizes the potential of removing or injuring existing trees, shrubs, and/or grasses that serve as erosion controls.

Corridors of vegetation act as buffer zones to separate disturbed land from an adjacent watercourse, protected forest, or other sensitive areas. Leaving a clearly marked buffer zone around these unique areas will help to preserve them as well as take advantage of their natural erosion prevention and trapping characteristics.

The inspection and maintenance requirements for protection of vegetation are low and there is little cost associated with preserving existing vegetation if properly planned during the project design. Aesthetic benefits may also enhance property values.

### *Vegetative stabilization*

#### *Seeding and planting*

Seeding of grasses and planting of trees, shrubs and ground covers provide long-term stabilization of soil (Figure 11.4). Grasses may also be planted for temporary stabilization. It is appropriate for site stabilization both during and after construction, any graded or cleared areas where construction activities have ceased, open space cut and fill areas, steep slopes, spoil stockpiles, vegetated swales, landscape corridors and streams banks. Shrubs and trees must be adequately watered, fertilized, and pruned if needed. Grasses may need to be watered and mowed too.

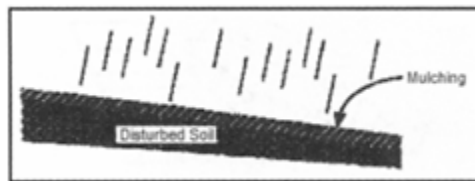

Figure 11.5. Mulching.

However, permanent and temporary vegetation may not be appropriate in dry periods without irrigation. Fertilizer requirements may have the potential to create stormwater pollution if improperly applied.

*Mulching*

Mulching (Figure 11.5) is a temporary ground covering that protects the soil from rainfall impacts, increases infiltration, conserves moisture around trees, shrubs, and seedlings, prevents compaction and cracking of soil, and aids the growth of seedlings and plantings by holding the seeds, fertilizers, and topsoil in place until growth occurs.

Mulching can be used either to temporarily or permanently stabilize cleared or freshly seeded areas. Types of mulches include organic materials, straw, wood chips, bark or other wood fibres, decomposed granite, and gravel. A variety of mats of organic or inorganic materials and chemical stabilization may be used with mulches.

Mulching prevents erosion by protecting the soil surface and fostering growth of new seedlings that do not stabilize by themselves. Organic mulch materials such as straw, wood chips, bark, and wood fibre are most effective where re-vegetation will be provided by reseeded. The choice of mulch should be based on the size of the area, site slopes, surface conditions (such as hardness and moisture), weed growth, and availability of mulch materials.

However, the limitation is that organic mulches are not permanent erosion control measures. Mulches tend to lower the soil surface temperature, and may delay germination of some seeds.

*Physical stabilization**Geotextiles and mats*

Mattings (Figure 11.6) made of natural or synthetic material, which are used to temporarily or permanently stabilize soil. Mattings reduce erosion from rainfall impact, hold soil in place, absorb and hold moisture near the soil surface. Additionally, mattings may be used alone or with mulch during the establishment of protective cover on critical slopes.

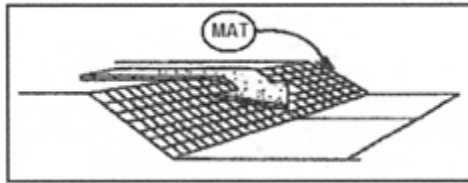

Figure 11.6. Mat.

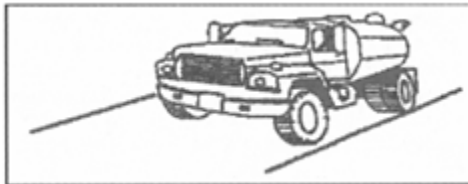

Figure 11.7. Dust control.

Typically suited for permanent site stabilization, but may be used for temporary or permanent stabilization of highly erosive soils. Matting may be applied to disturbed soils and where existing vegetation has been removed.

Mattings, on the other hand, are more costly than other BMP practices, limiting their use to areas where other BMP are ineffective (e.g. channels, steep slopes). It also may delay seed germination, due to reduction in soil temperature.

#### *Dust control*

Dust control (Figure 11.7) measures are used to stabilize soil from wind erosion, and reduce dust generated by construction activities. Suitable to be applied for clearing and grading activities, construction vehicle traffic on unpaved roads, drilling and blasting activities, sediment tracking onto paved roads, soil and debris storage stockpiles, batch drop from front end loaders and areas with unstabilized soil. Final grading/site stabilization usually is sufficient to control post-construction dust sources.

Installation costs for water/chemical dust suppression are low, but annual costs may be quite high since these measures are effective for only a few hours to few days.

The limitation includes watering which prevents dust only for a short period and should be applied daily (or more often) to be effective and over watering may cause erosion.

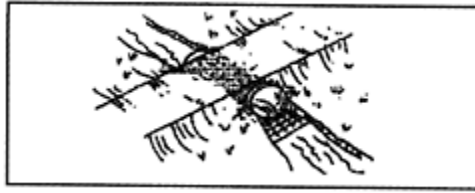

Figure 11.8. Temporary waterway crossing.

#### *Temporary waterway crossing*

A temporary access waterway crossing (Figure 11.8) is a temporary culvert, ford, or bridge placed across a waterway to provide access for construction purposes for a period of less than one year. Temporary access crossings are not intended to be used by the general public.

The purpose of a temporary crossing is to provide a safe, erosion-free access point across a waterway for construction equipment. An engineer should establish minimum standards and specifications for the design, construction, maintenance, and removal of the structure. Crossings may be necessary to prevent construction equipment from causing erosion of the waterway and tracking of pollutants into the waterway.

However, the temporary waterway crossings may be an expensive measure for a temporary improvement and requires other BMP to minimize soil disturbance during installation and removal.



*Construction road stabilization*

Access roads, subdivision roads, parking areas, and other on-site vehicle transportation routes should be stabilized immediately after grading and frequently maintained to prevent erosion and control dust.

Areas which are graded for construction vehicle transport and parking purposes are especially susceptible to erosion and dust. The exposed soil surface is continually disturbed, leaving no opportunity for vegetative stabilization. Such areas also tend to collect and transport surface runoff. During wet weather, they often become muddy quagmires, which generate significant quantities of sediment that may pollute nearby streams or be transported off-site on the wheels of construction vehicles. Dirt roads can become so unstable during wet weather that they are virtually unusable.

Efficient construction road stabilization not only reduces on-site erosion, but significantly speeds up on-site work, avoids instances of immobilized equipment and delivery vehicles, and generally improves site efficiency and working conditions during adverse weather. The roadway, however, must be removed or paved when construction is complete. Certain chemical stabilization methods may cause stormwater or soil pollution and should not be used.

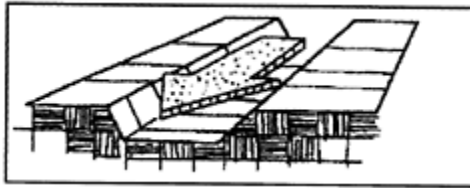

Figure 11.9. Diversion channel.

*Construction access stabilization*

A stabilized construction access is a stabilized pad of aggregate underlain with filter cloth located at any point where traffic will be entering or leaving a construction site from or to a public right-of-way, street, alley, footpath, or parking area. Stabilizing the site entrance significantly reduces the amount of sediment (dust and mud) tracked off-site, especially if a wash rack is incorporated for removing caked-on sediment.

Applications include all points of construction entry and exit from the site and unpaved areas where sediment tracking occurs from the site onto paved roads. This access should be used in conjunction with street sweeping on the adjacent public right-of-way and it requires periodic top dressing with additional stones.

*Diversion of run off**Earth bank*

A temporary earth bank is a temporary berm or ridge of compacted soil used to divert runoff or channel water to a desired location, thereby reducing the potential for erosion

and off-site sedimentation. Earth banks may also be used to divert runoff from off-site and from undisturbed areas away from disturbed areas, and to divert sheet flows away from unprotected slopes.

An earth bank does not in itself control erosion or remove sediment from runoff, but it prevents erosion by directing runoff to an erosion control device such as a sediment trap or basin or directing runoff away from an erodible area. Temporary earth banks should not adversely impact adjacent properties and must conform to any local floodplain management regulations.

Earth banks are typically used to divert concentrated runoff through disturbed areas into another BMP (e.g. a sediment trap or basin), to divert runoff away from disturbed or unstable slopes, to divert runoff from offsite and undisturbed areas around disturbed areas, and as a containment for construction materials and wastes. The on-site banks should remain in place until the disturbed areas are permanently stabilized and must safely convey anticipated flood flows.

#### *Diversion channel*

Temporary diversion channels (Figure 11.9) may be used to divert offsite runoff around the construction site, divert runoff from stabilized areas around disturbed areas, and direct runoff into sediment traps or basins. Diversion channels should be installed when the site is initially graded and remain in place until permanent BMPs are installed and/or slopes are stabilized.

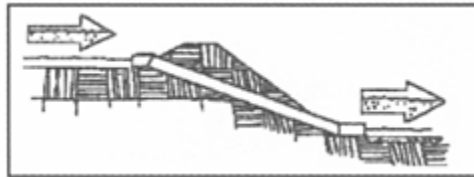

Figure 11.10. Slope drain.



Figure 11.11. Drainage outlet protection.

Such channels are appropriate for diverting any upslope runoff around unstabilized or disturbed areas of the construction site in order to prevent slope failures, prevent damage to adjacent property, prevent erosion and sediments into waterways, increase the potential for infiltration and divert sediment-laden runoff into trapping devices. However, it must conform to local floodplain management requirements.

*Slope drain*

A slope drain (Figure 11.10) is a temporary pipe or lined channel to drain the top of a slope to a stable discharge point at the bottom of a slope without causing erosion. It is typically used in combination with an earth bank or diversion channel at the top of the slope.

A slope drain is effective because it prevents runoff from flowing directly down a slope by confining all of the runoff into a channel or enclosed pipe. However, the maximum drainage area per slope drain is two hectares. Larger areas would require a paved chute, rock lined channel, or additional pipes. Another limitation is that the clogged slope drains will force water around the pipe and cause slope erosion; failure of this slope drain can result in flooding and severe erosion.

*Flow velocity reduction**Drainage outlet protection*

Drainage outlet protection (Figure 11.11) is a physical device composed of rock, grouted riprap, or concrete rubble which is placed at the outlet of a culvert, conduit, or channel to prevent scour of the soil caused by high flow velocities, and to absorb flow energy to produce non-erosive velocities.

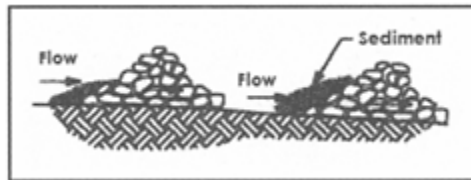

Figure 11.12. Check dam.

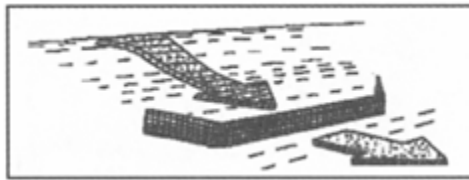

Figure 11.13. Sediment fence.

Rock outlet protection is effective when the rock is sized and placed properly. When this is accomplished, rock outlets do much to limit erosion at pipe outlets. Rock size should be increased for high velocity flows. The best results are obtained when sound, durable, angular rock is used.

However, large storms often wash away rock outlet protection and leave the area susceptible to erosion. Sediment captured also by the rock outlet protection will be difficult to remove without removing the rock.

*Check dam*

A check dam (Figure 11.12) is a small temporary dam constructed across a diversion channel or swale. Check dams reduce the velocity of concentrated stormwater flows, therefore reducing erosion of the diversion channel or swale and promoting sedimentation behind the dam. If properly anchored, brush or rock filter berms may be used for check dams.

A check dam is primarily used in small channels in steep terrain where velocities exceed 0.6 m/s in preventing erosion by reducing the velocity of channel flow in small intermittent channels and temporary swales. Check dam is to be used only in small open channels which drain an area of four hectares or less and not to be used in streams, or in lined or vegetated channels.

*Sediment trapping/filtering**Sediment fence*

A sediment fence (Figure 11.13) is a temporary sediment barrier consisting of filter fabric stretched across and attached to supporting posts, entrenched, and depending upon the strength of the fabric used, backed by a wire fence for support. Sediment fences trap sediment by intercepting and detaining small amounts of sediment from disturbed areas during construction operations in order to promote sedimentation behind the fence and decreasing the velocity of low flows (up to 151/s) in swales and small diversion channels.



Figure 11.14. Sand bag barrier.

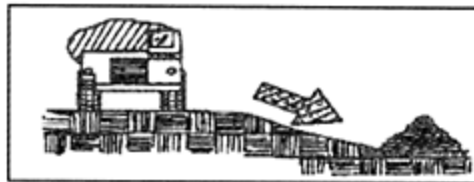

Figure 11.15. Rock filter.

Sediment fences are generally effective in locations where the flow is concentrated and are only applicable for sheet overland flows and not to be used in streams, channels, or any place where the flow is concentrated and in locations where ponded water may cause flooding.

*Sand bag barrier*

Stacking sand bags (Figure 11.14) along a level contour creates a barrier, which detains sediment-laden water by ponding upstream of the barrier. Water, thereby promoting sedimentation. Sand bags provide a semi-permeable barrier in potentially wet areas and are more permanent than sediment fences. They also allow for easy on-site relocation to meet changing needs during construction.

Sand bag barriers are most costly, but typically more durable, having a longer useful life than other barriers and may be used in drainage areas up to two hectares.

*Brush or rock filter*

A rock filter berm (Figure 11.15) is made of 20 to 75 mm diameter rock placed along a level contour where sheet flow may be detained and ponded to promote sedimentation. A brush barrier is composed of brush (usually obtained during the site clearing) wrapped in filter cloth and anchored to the toe of the slope. If properly anchored, brush or rock filters may be used as a check dam for sediment trapping and velocity reduction.

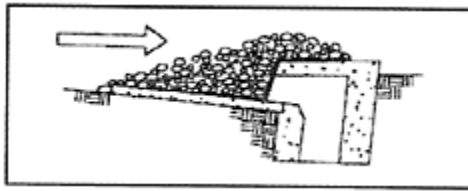

Figure 11.16. Drainage inlet protection.

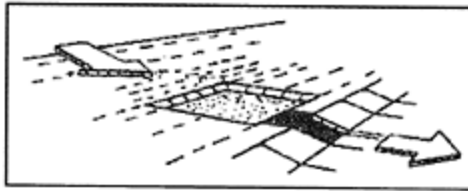

Figure 11.17. Sediment traps.

Rock filter berms should only be applied to drainage area not exceeding two hectares but if there is insufficient storage space, runoff will pond at upstream of the filter, possibly causing flooding in the area.

*Drainage inlet protection*

Drainage inlet protection (Figure 11.16) consists of a sediment filter or an impounding area around or upstream of a stormwater drain, drop inlet, or kerb inlet which prevents excessive sediment from entering stormwater drainage systems prior to permanent stabilization.

All on-site stormwater inlets receiving sedimentladen runoff should be protected, either by covering the inlet or promoting sedimentation upstream of the inlet. Off-site inlets should be protected in areas where construction activity tracks sediment onto paved areas or where inlets receive runoff from disturbed areas.

Drainage inlet protection is recommended only for drainage areas smaller than 0.4 hectares unless a sediment trap first intercepts the runoff. However, ponding will occur at a protected inlet, with possible short-term flooding.

### *Sediment traps*

A sediment trap (Figure 11.17) is a small temporary ponding area, usually with a gravel outlet, formed by excavation and/or construction of an earth embankment. Its purpose is to collect and store sediment from sites cleared and/or graded during construction. It is intended for use on small catchment areas with no unusual drainage features, where construction will be completed in a reasonably short period of time. It should help in removing coarse sediment from runoff. The trap is a temporary measure with a design life of approximately six months, and is to be maintained until the site area is permanently protected against erosion by vegetation and/or structures.



Figure 11.18. Sediment basins.

Intended for use in any disturbed area less than two hectares, the sediment traps only remove coarse sediment (medium silt size and larger).

### *Sediment basins*

A sediment basin (Figure 11.18) is a structure formed by excavation and/or construction of an embankment across a waterway or other suitable locations to collect and store sediment from sites cleared and/or graded during construction for extended periods of time before re-establishment of permanent vegetation and/or construction of permanent drainage structures. It is intended to trap sediment before it leaves the construction site. The basin is a temporary measure (with a design life of 12 to 18 months) and is to be maintained until the site area is permanently protected against erosion or a permanent detention basin or water quality control structure is constructed.

Sediment basins are suitable for nearly all types of construction projects. Wherever possible, sediment basins should be constructed before clearing and grading work begins and is applied at the outlet of all disturbed catchment areas greater than two hectares or at the outlet of smaller disturbed catchment areas, as necessary.

However, sites with very fine sediment (fine silt and clay) may require longer detention times for effective sediment removal. Basins in excess of certain depth and storage volume criteria must also meet State and/ or Federal dam safety criteria.

Example of calculation for sizing of a dry sediment basin is included in Appendix 11.1.

## 11.7 CONCLUSION

Soil erosion arising out of land development activities in the tropical region, where the amount and intensity of rainfall are high, has posed a persistent threat to the environment, and in cases of prolonged and uncontrolled erosion, leading to untoward incidences such as landslides and mudslides. It has also led to the cumulative effects of sedimentation as well as the shallowing of riverbeds and waterways, thus prompting flash and regular floods in low-lying areas.

Fully aware of the impacts of soil erosion, the respective governments have initiated a number of measures to minimize and control soil erosion resulting from land development projects such as the mandatory requirements of the EIA, EMP, ESCP and SEAR (or equivalent), which have now been formally documented as guidelines for construction activities. These guidelines also specify the proposal of specific mitigation measures imposed for the control of soil erosion during the pre-construction, construction and post construction phases. With the outlining of the Best Management Practices (BMPs) on erosion and sediment control to better manage and mitigate the issues, proper enforcement and implementation of these requirements could effectively prevent or minimize the dangers and impacts posed by soil erosion and subsequently sedimentation.

Last but not least, mutual responsibilities and commitment by both the approving authorities and the respective project proponents should also be emphasized in order to ensure that soil erosion and sedimentation arising from the land development activities could be effectively controlled and minimized for the benefit and interest of all parties concerned and the general public at large.

## REFERENCES

- Beasley, R.P. 1972. *Erosion and sediment pollution Control*. Iowa: Iowa State Univ. Press.
- Bennet, H.H. 1947. *Elements of soil conservation*. New York: McGraw-Hill.
- Department of Environment 1996. *Guidelines for prevention and control of soil erosion and siltation in Malaysia*. Kuala Lumpur.
- DID (Department of Irrigation and Drainage) Malaysia 2000. *Urban stormwater management manual for Malaysia*. Kuala Lumpur.
- Harper, D. 1987. Improving the accuracy of the universal soil loss equation in Thailand. *Fifth international soil conservation conference*. Bangkok.
- Hudson, N.W. 1979. *Soil conservation*. Cornell: Cornell Univ. Press.
- Morgan, R.P.C. 1993. *Soil erosion and conservation*. New York: Longman Scientific & Technical.
- Roslan, Z.A. 1994. Erosion risk assessment, *Sarawak water resources-towards sustainable national growth*. Kuching.
- Roslan, Z.A. & Mazidah, M. 2002. Establishment of soil erosion scale with regard to soil grading characteristics. (Ed) Huat et al. *World engineering congress*, Kuching.

- Roslan, Z.A. & Tew, K.H. 1995. Erosion study in Cameron Highlands, *Malaysian science and technology congress, Perdanasiswa, Universiti Malaya, Kuala Lumpur*.
- Roslan, Z.A. & Tew, K.H. 1996. Determination of the land use management factors of the USLE in reducing soil erosion loss, *Tenth congress of the Asia and Pacific Division (APD) of the international association for hydraulic research (IAHR), Langkawi*.
- Roslan Z.A. & Tew, K.H. 1999. *Compilation of presented research papers on soil Erosion issues in Malaysia—2nd edition*. Subang Jaya: VT Soil Erosion Research & Consultancy.
- RRIM (Rubber Research Institute of Malaysia). 1980. *Soil erosion and conservation in Peninsular Malaysia*, Kuala Lumpur.
- Tew, K.H. 1999. *Production of Malaysian soil erodibility nomograph in relation to soil erosions issues*. Subang Jaya: VT Soil Erosion Research & Consultancy.
- U.S. Agricultural Research Service 1961. *An universal equation for predicting rainfall-erosion losses*. Washington, D.C. ARS 22-66.
- Wischmeier, W.H. & Smith, D.D. 1978. Predicting rainfall erosion losses—a guide to conservation planning, USDA, *Agriculture Handbook No. 537*.

## APPENDIX 11.1

### Problem

To determine the size of a dry sediment basin and outlet structures required for the Selangor Estate development as shown in the Figure 11.19. The catchment area for the development is 6 hectares and the following assumptions are made for the sizing of the basin:

- Adopted basin type is an earth embankment and perforated outlet
- Most of the surface soil type is sandy loam
- Overland sheet flow to the basin will pass over two segments, i.e. Segment A & B with soil types of bare sand and bare clay respectively,
- Segment A:  $L_A=110$  m &  $SA=0.64\%$
- Segment B:  $L_B=150$  &  $SB=0.80\%$
- As the construction period will be less than 2 years, the design storm is 3 month ARI
- Given  $n=0.01$  (bare sand) &  $n=0.02$  (bare clay)
- C value=0.84
- $10I60=83.2$  mm/h,  $10I30=129.2$  mm/h, and  $F=1.28$
- Trial dimensions:  $B=5.0$ m,  $H_p=0.5$ m and  $C_{sp}=1.65$

Equations for sizing of dry sediment basin:

$$t_o = \frac{107 n L^{0.33}}{S^{0.2}} \quad (11.2)$$

$$t_{total} = t_A(L_A) + t_B(L_A + L_B) - t_B(L_A) \quad (11.3)$$

$$L_1 = \frac{V_1}{W_1 + y_1} \quad (11.4)$$

$$W_2 = W_1 - 2 \times \frac{d_1}{2} \times Z \quad (11.5)$$



$$L_2 = L_1 - 2 \times \frac{d_1}{2} \times Z \quad (11.6)$$

$$V_2 = Z^2 y_2^3 - Z y_2^2 (W_2 + L_2) + y_2 (W_2 L_2) \quad (11.7)$$

$$A_{\text{total}} = \frac{2 A_{\text{cr}}}{t C_d \sqrt{2g}} \sqrt{y} \quad (11.8)$$

$$Q_1 = \frac{C_d I_r A}{360} \quad (11.9)$$

$$Q_{\text{riser}} = C_0 A_0 \sqrt{2gH_0} \quad (11.10)$$

$$Q_{\text{spillway}} = C_{\text{sp}} B H_p^{1.5} \quad (11.11)$$

### Solution

Step (1): Determine overland flow time of concentration (minutes).

From Equation (11.2), 
$$t_o = \frac{107 n L^{0.333}}{S^{0.2}}$$

From Equation (11.3),

$$t_{\text{total}} = t_A(L_A) + t_B(L_A + L_B) - t_B(L_A)$$

For segment A;  $n=0.01$  (for bare sand)

$$t_A(L_A) = \frac{107 \times 0.01 \times 110^{0.333}}{0.64^{0.2}} = 5.6 \text{ minutes}$$

For segment B;  $n=0.02$  (for bare clay)

$$t_B(L_A + L_B) = \frac{107 \times 0.02 \times 260^{0.333}}{0.80^{0.2}} = 14.3 \text{ minutes}$$

$$t_B(L_A) = \frac{107 \times 0.02 \times 110^{0.333}}{0.80^{0.2}} = 10.7 \text{ minutes}$$

$$t_{\text{total}} = 5.6 + 14.3 - 10.7 = 9.2 \text{ minutes}$$

Adopted time of concentration = 10 minutes.

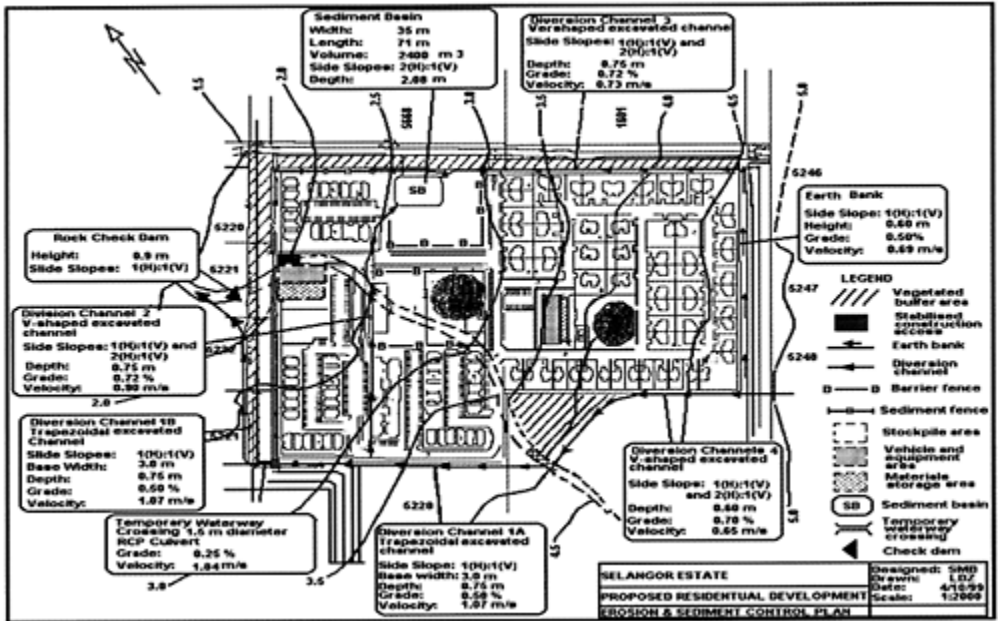

Figure 11.19. Worked example: Sizing of a dry sediment basin.

*Step (2): Sizing of sediment basin*

From Table 11.5, the predominant soil type is categorised as type C.

From Table 11.6 for a 3-month ARI, the required surface area is 333 m<sup>2</sup>/ha and the required total volume is 400 m<sup>3</sup>/ha.

The surface area required for the site=333×6.0= 1988<sup>2</sup>.

(Note: This is the average surface area for the settling zone volume, i.e. at mid-depth)

The total basin volume required for the site=400× 6.0=2400 m<sup>3</sup>.

*(a) Settling zone:*

From Table 11.6, the required settling zone  $V_1 = 1200\text{m}^3$  (half the total volume) and the settling zone depth  $y_1 = 0.6\text{m}$ .

Try a settling zone average width,  $W_1 = 30\text{m}$ .

Table 11.5. Sediment basin types and design considerations (DID Malaysia 2000).

Soil description	Soil type	Basin type	Design considerations
Coarse-grained sand, sandy loam; less than 33% < 0.02mm	C	Dry	Settling velocity, sediment storage
Fine-grained loam, clay: more than 33% < 0.02mm storage	F	Wet	Storm impoundment, sediment storage
Dispersible fine-grained clays as per type F, more than 10% of dispersible material	D	Wet	Storm impoundment, sediment storage, assisted flocculation

Table 11.6. Dry Sediment Basin Sizing Guidelines (DID Malaysia 2000).

Parameter	Design storm	Time of concentration of basin catchment (minutes)				
		10	20	30	45	60
Surface area (m <sup>2</sup> /ha)	3-month ARI	333	250	200	158	121
	6-month ARI	n/a	500	400	300	250
Total volume (m <sup>2</sup> /ha)	3-month ARI	400	300	240	190	145
	6-month ARI	n/a	600	480	360	300

Required settling zone average length from Equation (11.4),

$$L_1 = \frac{V_1}{W_1 + y_1} = \frac{1200}{30 \times 0.6} = 66.7 \text{ m, say } 67 \text{ m}$$

Avg. surface area =  $67 \times 30 = 2010 \text{ m}^2 > 1998 \text{ m}^2$ ;

OK

Check settling zone dimensions.

(Note: Basin length to settling depth ratio should be less than 200:1 and basin length to width ratio should be greater than 2:1)

$$\frac{L_1}{y_1} \text{ ratio} = \frac{67}{0.60} = 111.7 < 200; \text{ OK}$$

$$\frac{L_1}{W_1} \text{ ratio} = \frac{67}{30} = 2.23 > 2; \text{ OK}$$

(b) *Sediment storage zone:*

The required sediment storage zone volume is half the total volume,  $V_2 = 1200 \text{ m}^3$ .

For a side slope  $Z=2(H):1(V)$ , the dimensions at the top of the sediment storage zone based on Equation (11.5) and Equation (11.6) are

$$W_2 = W_1 - 2 \times \frac{d_1}{2} \times Z = 30 - 2 \times 0.3 \times 2 = 28.8 \text{ m}$$

$$L_2 = L_1 - 2 \times \frac{d_1}{2} \times Z = 67 - 2 \times 0.3 \times 2 = 65.8 \text{ m}$$

The required depth for the sediment storage zone, which must be at least 0.3 m, can be calculated from the following relationship as denoted in Equation (11.7).

$$V_2 = Z^2 y_2^3 - Z y_2^2 (W_2 + L_2) + y_2 (W_2 L_2)$$

which gives,

$$1200 = 4y_2^3 - 189.2y_2^2 + 1895y_2$$

Use trial and error to find  $y_2$ .

$$\text{For } y_2=0.8\text{m, } V_2=1397 \text{ m}^3$$

$$\text{For } y_2=0.7\text{m, } V_2=1235 \text{ m}^3$$

$$\text{For } y_2=0.68\text{m, } V_2=1202 \text{ m}^3 \quad y_2 > 0.3 \text{ m,}$$

$$V_2 > 1200 \text{ m}^3; \text{ OK}$$

(c) Overall Basin Dimensions:

At top water level:

$$W_{\text{TWL}} = W_1 + 2 \times Z \times \frac{y_1}{2} = 31.12 \text{ m} \quad \text{say, 31 m}$$

$$L_{\text{TWL}} = L_1 + 2 \times Z \times \frac{y_1}{2} = 68.2 \text{ m} \quad \text{say, 68 m}$$

Base:

$$W_B = W_1 + 2 \times Z \times \left( \frac{y_1}{2} + y_2 \right) = 26.1 \text{ m} \quad \text{say, 26 m}$$

$$L_B = L_1 + 2 \times Z \times \left( \frac{y_1}{2} + y_2 \right) = 63.1 \text{ m} \quad \text{say, 63 m}$$

Depth: Settling Zone,  $y_1=0.06\text{m}$

Sediment Storage Zone,  $=0.68 \text{ m}$

Side Slope  $Z=2(\text{H}):1(\text{V})$

*Step (3): Sizing of outlet pipe*

Outlet riser: 900 mm diameter perforated MS pipe. The pipe is to be provided with sufficient small orifice openings to ensure that the basin will completely drain within 24 hours after filling.

An estimate of the total area of orifice openings required can be obtained by using the average surface area and total depth of the basin,

Average surface area,

$$A_{av} = \frac{(31 \times 68) + (26 \times 63)}{2} = 1873 \text{ m}^2$$

Orifice area from Equation (11.8)

$$\begin{aligned} A_{total} &= \frac{2 A_{av}}{t C_d \sqrt{2g}} \sqrt{y} \\ &= \frac{2 \times 1873}{(24 \times 60 \times 60) \times 0.6 \times \sqrt{2 \times 9.81}} \sqrt{1.28} \\ &= 0.082 \text{ m}^2 \end{aligned}$$

Using an orifice size of 50 mm, the area of each orifice is  $A_0 = 1.96 \times 10^{-3} \text{ m}^2$ .

$$\text{Total number of orifices required} = \frac{0.082}{1.96 \times 10^{-3}} = 42$$

At height increments of 200 mm, starting at the bottom of the pipe, put six rows of  $7 \times 50 \text{ mm}$  orifices evenly spaced around the pipe.

#### *Step (4): Sizing of emergency spillway*

The emergency spillway must be designed for a 10-year ARI flood. The sill level must be set a minimum 300 mm above the basin top water level. To simplify the calculations, the following assumptions are made:

- assume riser pipe flow is orifice flow through the top of the pipe only
- riser pipe head is 300 mm, i.e. the height between the top of the pipe and the spillway crest level

$$Q_{spillway} = Q_{10} - Q_{riser}$$

From Equation (11.9),

$$Q_i = \frac{C_i I_i A}{360}$$

The 10-year ARI rainfall intensity for Kuala Lumpur is for a 10-minute duration.

$^{10}I_{60} = 83.2 \text{ mm/h}$ ,  $^{10}I_{30} = 129.2 \text{ mm/h}$ , and  $F = 1.28$ . Therefore,

$$^{10}I_{10} = \frac{[64.6 - 1.28(83.2 - 64.6)]}{(10/60)} = 245 \text{ mm/hr}$$

For  $C = 0.84$  (given),

$$Q_{10} = \frac{C \cdot ^{10}I_{10} \cdot A}{360} = \frac{0.84 \times 245 \times 6.0}{360} = 3.43 \text{ m}^3/\text{s}$$

From Equation (11.10) for orifice flow and assuming an orifice discharge coefficient of 0.06, the discharge at the riser is,

$$\begin{aligned} Q_{\text{riser}} &= C_o A_o \sqrt{2gH_o} = 0.6 \times \frac{\pi(0.9)^2}{4} \times \sqrt{2 \times 9.81 \times 0.3} \\ &= 0.93 \text{ m}^3/\text{s} \end{aligned}$$

Therefore, allowing for the riser pipe flow the required spillway capacity is

$$Q_{\text{spillway}} = 3.43 - 0.93 = 2.50 \text{ m}^3/\text{s}$$

$$\text{From Equation (11.11), } Q_{\text{spillway}} = C_{sp} B H_p^{1.5}$$

Trial dimensions:  $B=5.0\text{m}$ ,  $H_p=0.5\text{m}$  and  $C_{sp} = 1.65$  (given),

$$\begin{aligned} Q_{\text{spillway}} &= 1.65 \times 5.0 \times 0.5^{1.5} \\ &= 2.74 \text{ m}^3/\text{s} > 2.50 \text{ m}^3/\text{s}; \text{ OK} \end{aligned}$$

Therefore, the design is adopted and the total basin depth including the spillway is,

$$0.6 + 0.68 + 0.3 + 0.5 = 2.08\text{m}.$$



## CHAPTER 12

# Geoenvironmental aspects of tropical residual soils

Mohd Raihan Taha

*University Kebangsaan Malaysia*

Kamaruddin Ahmad

*University Teknologi Malaysia*

Azlan Abdul Aziz

*University Putra Malaysia*

Zamri Chik

*University Kebangsaan Malaysia*

Domestic, chemical and industrial waste has become a major issue in all aspects of current development. Its generation will gradually increase despite all waste minimisation efforts and therefore its management will get tougher year by year. In general, waste will eventually be exposed to soil no matter what disposal or containment measures are taken. It is then that the services of geoenvironmental engineers are called upon, as they are the persons most qualified to advise the respective parties on the engineering aspects of soils and its interaction and fate with chemicals/waste. Thus, an understanding of soil-chemical/waste interaction is important so that geotechnical and geoenvironmental structures could be constructed safely and reliably. In addition it is also crucial to evaluate the performance of existing structures upon waste or chemical attack and also to decontaminate soils to disarm its toxicological effects and prevent further migration of contamination. It is also now necessary to evaluate how the services of a geoenvironmental engineer are related to sustainability since it is currently one of the main objectives of development. The information provided in this chapter serves to highlight some of the various aspects of geoenvironmental technology and issues for basic understanding and appraisal of the subject particularly on tropical residual soils.

### 12.1 INTRODUCTION

Geoenvironmental engineering or environmental geotechnics is a subject matter that deals mainly with soils and its interaction with chemicals or waste. Its importance grew rapidly



within the last two decades due to pressure from waste management industries. Intensive growth in industrialization and development has resulted in the generation of waste that has multiplied many folds over the past few years. However, waste disposal technology, sites and matters related to engineered landfills could not be reciprocally advanced economically. Many important components of disposal sites or landfills such as liners and caps are soil related and require the services of geoenvironmental engineers. In addition there are many avenues in which contamination of land could occur and also need the services of geoenvironmental engineers for its characterization, protection, cleanup and litigation. Soil contamination may originate from unengineered disposal of waste, underground storage tanks, mining activities, accidents, and seepage from old dumpsites, cemeteries and salt intrusion from the sea (Taha 2000). Thus the relevance of knowledge related to geoenvironment is highly justified.

Much has been learnt of soil contamination problems from the Love Canal and the famed Woburn (from which a book and a Hollywood film 'A Civil Action' is based on) incidents in the USA. They depicted serious health related matters when people lived on or near contaminated sites. Similarly a court case in Malaysia, i.e. Woon Tan Kan & 7 YL vs. Asian Rare Earth Materials Sdn Bhd (Buang 1993) served to notice that problems and civic awareness are gaining ground in this part of the world. In another legal battle, the authors were involved in a court case whereby a company sued another which was located upstream in an industrial estate. The plaintiff submitted to the court that wastewater flowing out of the premise of the defendant had infiltrated their ground causing significant reduction in the carrying capacity of the piles of their building structure. They claimed that as a result the building suffered from serious cracking throughout its entire structure. This case warrants the services of engineers particularly those specialised in soils and its interaction and fate with chemicals/waste for both the plaintiff and the defendant. Thus engineers need to be knowledgeable and updated in this matter to better serve the public in an informed and professional manner.

Other than humans, other forms of life such as animals and plants are also affected from soil contamination. Plants can suck up contaminants, then in turn being eaten up by goats and cows and contamination can easily move further up the food chain, again endangering human health. In addition, structures such as concrete and steel can deteriorate when attacked by chemicals reducing its structural carrying capacity. These construction materials are of interest to geotechnical engineers as these are the main materials forming the structures of foundations, i.e. piles, pad and mat foundation, pile caps etc. Soils could also lose its cohesion when exposed to many organics resulting in lost of adhesion and strength so much relied on for stability.

Much of the current practices in conventional geotechnical engineering has relied mainly on experience with clay i.e. a sedimentary soil, which has been intensively and thoroughly studied. However, tropical residual soils are different in many aspects that lead to differences in general properties and behavior. For example, their formation sequence itself is already very different as schematically shown in Figure 12.1. Residual soils are formed from in-situ weathering of solid rocks. In time, weaker particle bonding should be expected as the residual soil becomes weathered in contrast to the time evolution of clays. The word weathering is a strong component of the qualitative soil behavior as put forward by Lutenecker (1992), i.e.

*BEHAVIOR=COMPOSITION+WEATHERING*

The ‘compositional’ aspects have been much covered in traditional soil mechanics and can be quantitatively described. However, this cannot be easily said of ‘weathering’ which plays a marked role in the case of residual soils (Taha et al. 2000a).

The limited information supplied in this chapter will highlight some of these differences in order to provide further understanding of the general behavior of residual soils with regard to geoenvironmental engineering.

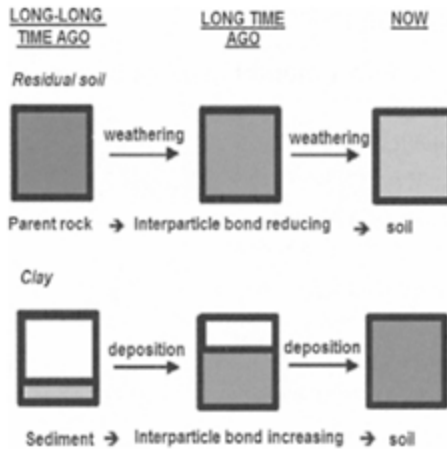

Figure 12.1. Formation of residual soil and clay.

## 12.2 TYPES OF CONTAMINATIONS

Before the various aspects of geoenvironmental engineering are discussed in greater detail, it is crucial to know the types and basic properties of some common contaminants or chemicals. There are basically two types of priority pollutants, i.e. organic compounds and inorganic species (mainly metallic elements). All of these chemicals are either toxic/mutagenic (causing slow or immediate death, for example by stopping oxygen intake such as cyanide), carcinogenic (causing cancer, such as benzene and DDT) or both. The organics include volatiles, base neutral extractables, acid extractables, and pesticides (Domenico & Schwartz 1990). Table 12.1 lists some examples of these groups of chemicals. Benzenes and phenols are amongst the widely used chemicals in the world and are thus commonly found in wastes. The use of DDD, DDE and DDT as pesticide control is still common in many parts of the tropical countries although it has been banned from use in most developed nations in the late 1970s. Examples of inorganics include arsenic, asbestos, chromium, copper, cyanide, lead, mercury, nickel, silver, thallium, zinc, etc. Table 12.2 lists some common chemical groups found in literatures and defined for familiarisation of the terminology used.

Other groups of chemicals that are injurious to health are radioactive contaminants/waste (confined mainly to countries which derive their energy from nuclear power stations) and agriculture nutrients or fertilizers such nitrates (other sources of similar contaminants are seepage from septic tanks, irrigated waste water, and sewage treatment plants effluents).

In most countries, MSW (municipal solid waste) or domestic waste is a major problem. These include food waste, packaging (paper and plastics), yard waste, construction waste, etc. In addition to its disposal problems, the most challenging aspect about MSW is to estimate its properties such as density, strength, deformation, etc. These characteristics are required for the design of landfills and have been quantified in many publications. For example, the shear strength parameters vary widely i.e. friction angles ( $\phi'$ ) ranging from  $10^\circ$  to  $53^\circ$  and the cohesion intercepts of 0 to 67 kPa (Kavazanjian et al. 1995, Knochenmus et al. 1998). Kavazanjian et al. (1995) suggested a bilinear strength envelopewith  $\phi' = 0$  and  $c' = 24$  kPa

Table 12.1. Examples of organics priority pollutants according to the United States EPA.

Priority pollutants	Examples
Volatiles	Acrolein, benzene, carbon tetrachloride, chlorobenzene, chloroform, chloromethane, ethylbenzene, methylene chloride, toluene, trichloroethene (TCE), vinyl chloride
Base neutral extractables	Acenaphthene, benzo[a] anthracene, benzo[b]fluoranthene, butyl benzyl phthalate, chrysene, 1,2-dicholobenzene, 2,4-dinitrotoluene, flourene, hexachlorobutadiene, naphthalene, 1,2,4-trichlorobenzene
Acid extractables	2-chlorophenol, 2,4-dicholophenol, 2,4-dimethylphenol, 4,6-dinitro-ocresol, 2-nitrophenol, pentachlorophenol, phenol, total phenols
Pesticides	Aldrin, 4,4'-DDD, 4,4'-DDE, 4,4'-DDT, dieldrin, endosulfan sulfate, endrin, heptachlor, PCB-1016 <sup>a</sup> , PCB-1221 <sup>a</sup> , PCB-1232 <sup>a</sup> , toxaphene

for normal stress below 37 kPa, and  $\phi' = 33^\circ$  and  $c' = 0$  for normal stress greater than 37 kPa. Villar & Carvalho (2002) observed that friction and cohesion were mobilised at large strain values and degree of saturation has no influence on the shear strength parameters. Other than testing parametric properties mainly depend on culture (eating ters such as strain rates and tests types, in general, the habits, contents, packaging, education, etc), and rainfall. For example when staple foods are rice and nootropical climates where rainfall is intensive, moisture dles, domestic waste will have higher moisture. In and generated leachate will be additionally elevated. Thus, its strength is possibly lower than that published elsewhere. In countries where systematic waste management is still in its infancy, the presence of industrial or chemical wastes is not uncommon. Age of waste is also a dependent variable.

Table 12.2. Some common chemicals/chemical groups used in literatures.

Chemicals abbreviation	Examples and brief information
BTEX	Benzene, Toluene, Ethylbenzene, Xylene. These chemicals are ingredients of gasoline, diesel, jet fuel, etc.
NAPL	Non-Aqueous Phase Liquids. These are chemicals that are not soluble in water. It consists of LNAPL, i.e. light NAPL (lighter than water) and DNAPL, i.e. dense NAPL (denser than water). BTEX are basically LNAPL. MTBE which is a gasoline additive has low solubility in water but exceeds most standards. DNAPL is most problematic since it seeps and stays deep underground avoiding detection and making clean-up efforts difficult. Common examples are TCE, PCB, etc. which are contained in chlorinated solvents, degreasing agents, industrial cleaners, coal tars, etc.
PAH	Polycyclic-Aromatic Hydrocarbons. Chemicals with a benzene ring as the base of its chemical structure is called aromatics. When more than one benzene ring is involved, the term polycyclic is invoked. DDD, DDE, DDT and PCBs are some examples.
TPH	Large family of several hundreds of chemical compounds that originally come from crude oil. Some chemicals that may be found in TPH are hexane, jet fuels, mineral oils, benzene, toluene, xylenes, naphthalene, and fluorene, as well as other petroleum products and gasoline components.

Settlement of MSW is another behavior of utmost interest to geoenvironmental engineers. It is generally known that MSW exhibits pronounced secondary compression and behaved similarly as fibrous peat. Manassero et al. (1996) state that the compression of waste is governed by (a) physical compression, i.e. mechanical distortion, bending, crushing, and reorientation of waste components; (b) ravelling settlements due to migration of small particles into voids of large particles; (c) viscous behavior and consolidation phenomena involving both solid skeleton and single particles components; (d) decomposition settlement due to the biodegradation of organic components; and (e) collapse components due to physicochemical changes such as corrosion, oxidation, and degradation of inorganic components.

Mine waste have generated problems related to acidity, heavy metals and contaminated sediments as a result of extraction and benefaction of metallic ores, phosphate, uranium, oil shale, coal, etc. Industrial waste, e.g. phosphogypsum (waste from the production of sulphuric acid), and combustion fly/bottom ash are abundant in many countries in the form of waste piles, dams and even mountains. In tropical countries where there are rice and palm oil industries, similar waste heaps are available. There are efforts to turn these wastes into construction materials especially for road building but detailed studies on the engineering, environmental, economic and social benefits have not been conclusive and attractive.

## 12.3 SOIL-WATER INTERACTION

The soil or clay-water interaction is of paramount importance in geotechnical and geoenvironmental engineering. The effective stress principle and soil plasticity are amongst behavior most influenced by soil-water interaction. Understanding this basic phenomenon will provide the background necessary for the study of soil behavior with and without contamination. It is also important to know the chemical structure of water in order to understand and appreciate the behavior as discussed especially at the soil/clay-water interface.

The oxygen and two hydrogen atoms of a water molecule are arranged in a V-shape configuration with an angle of  $105^\circ$  between the two arms of the hydrogen atoms (Figure 12.2). Water is essentially neutral but a polar molecule with distinct dipole moment as depicted by the separation of the centres of its positive ( $H^+$ ) and negative  $O^{2-}$  charges. Polarity is actually the uneven distribution of charge within the molecule (due to its dipole characteristics and its unsymmetrical structure). Of interest is also the hydrogen bonding (H-bonding) which is the attraction of the hydrogen atom of a water molecule to the oxygen atom of another. It not only operates in water but also when nitrogen and fluorine atoms are present. These properties (polarity, H-bonding, etc.) result in bonding of water molecules to charged sites on soil surfaces and to charged materials such as cations and anions. All these bondings/attractions eventually give rise to adhesion and cohesion of the soil.

The soil-water interaction is actually a nanoscale ( $10^{-9}m$ ) phenomenon which has been understood by geotechnical engineers for many years now. On this note it must be emphasised that geotechnical engineers are one of the first groups of technologists who have reaped the benefits of nanotechnology which is the current buzzword in science and engineering.

In general there are five types of water on and surrounding the soil (Figure 12.3). These include water of hydration, adsorbed, hygroscopic water, capillary water, and gravity water. Water of hydration is chemically bound water held on and in the soil particle surface which in most practical cases could not be oven dried. Adsorbed water is held by electrical forces and has viscosity higher than surrounding water layers. Hygroscopic water is the water held at 98% relative humidity. The capillary water is held by surface tension and the gravity water has the ability to flow under its own weight. The definition of water content in soil mechanics excludes the contribution of water of hydration.

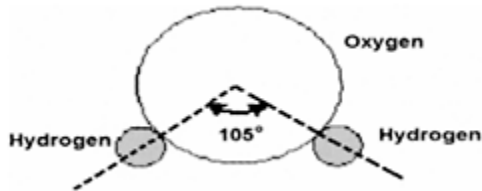

Figure 12.2. Dipolar structure of water.

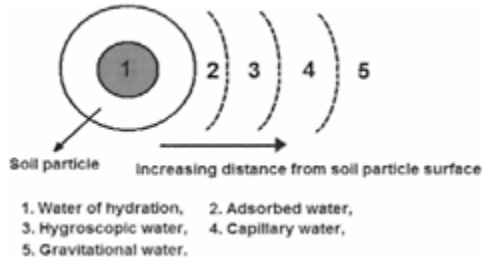

Figure 12.3. Water types on and surrounding a soil particle (adapted from Vermuelen 2003).

The adsorbed water section is the soil-water interaction (specifically clay-water interaction) which is of utmost interest in geoenvironmental engineering. It will be shown later that the diffuse double layer plays significant roles in controlling the behavior of soil including plasticity, fabric development, shrinkage, strength, and hydraulic conductivity. Thus it is possible to manipulate soils to our advantage by understanding this nano level phenomenon.

When clay is mixed with water, cations available in the water will be the dominant ions at the particles-water interface. This is particularly due to attraction by the negatively charged clay surface. As distance from the particle surface increases, the concentration of cations decreases and the concentration of anions increases. When the concentration of both the cations and the anions are the same, the state of free water is achieved. This is water type 3 and beyond (Figure 12.3). The negative charge on the clay surface and the balancing cations surrounding it (in the adsorbed water layer) is called the diffuse double layer. This layer and the corresponding cations and anions distribution as described above are shown in Figure 12.4.

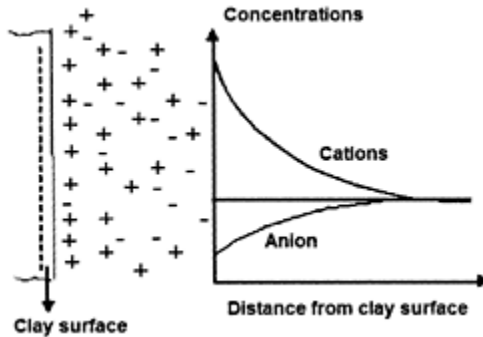

Figure 12.4. Diffuse double layer and charge distribution adjacent to clay surface.

The ‘thickness’ of the double layer can be estimated by the Gouy-Chapman relationship, in which

$$t_d = \sqrt{\frac{\epsilon K T}{8 \pi \eta e^3 v}} \quad (12.1)$$

where  $t_d$  is the thickness of the double layer,  $\epsilon$  is the dielectric constant,  $K$  is the Boltzman constant,  $T$  is the absolute temperature,  $e$  is the electronic charge,  $\eta$  is the concentration of chemicals,  $v$  is the valence of ions involved. The interpenetration of the diffuse double layer results in repulsion. Since  $\epsilon$ ,  $K$ ,  $e$  and are constants, the double layer thickness only depends namely on the dielectric constant, concentration and the valence. Consequently these are the main parameters that govern the behavior of soil in a waste or chemical environment as we shall analyse in the next section. In nonpolar fluids such as the heptane, benzene, and trimethylamine ( $\epsilon$  respectively having values of 1.9, 2.3, and 2.5) the diffuse double layer will not fully develop. Its thickness in these fluids will only be approximately 15% of that in water ( $\epsilon=80.4$ ). The van der Walls attractive force is the only major physico-chemical factor involved for these organic fluids (Chen et al. 2000). This force (i.e. van der Walls) together with polarity, H-bonds and electrostatic forces (due to electrically charged clay particles) are also of much concern to engineers since they are greatly influenced by applied stresses and by changes in the nature of the soil-water system (Lambe 1958).

## 12.4 FUNDAMENTALS OF CLAY MINEROGLOGY

The study on clay minerals is fundamental as this is the portion of the grain size distribution that controls the engineering behavior of soils. Furthermore clays are much used (and studied) for applications as the main barrier materials for containment structures i.e. landfills (liners and caps) and cut-off walls. A high proportion of clay has been observed in many tropical residual soils.

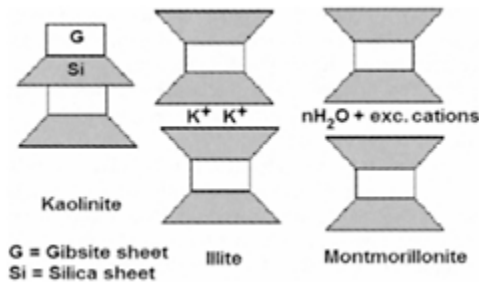

Figure 12.5. Schematic structure of the three main clay minerals i.e. kaolinite, illite, and montmorillonite.

Clay in geoenvironmental (and geotechnical) engineering is generally defined as particles of less than 2  $\mu\text{m}$  in size and must also have plastic properties when mixed with water which give rise to its plasticity characteristics. The latter part of the definition is required to distinguish it from silts and other fine metallic particles from industrial machining processes which meets the size definition but does not have plasticity.

Details of clay mineralogy have been described for example in Grimm (1968) and Mitchell (1993). The two basic building blocks are the silica tetrahedron and the alumina (gibbsite) octahedron. The silica tetrahedron is basically stable but the octahedron may also consist of magnesium (brucite). Combining these blocks in various ways led to the three most common minerals i.e. kaolinite, illite and montmorillonite (Figure 12.5).

It is shown in Figure 12.5 that kaolinite is a two-layer sheet or a one-to-one (1:1) mineral, whereas illite and montmorillonite are 2:1 minerals. The difference between illite and montmorillonite is the existence interlayer potassium in the case of illite and for montmorillonite the interlayer consists of water and exchangeable cations. As such montmorillonite minerals swell extensively upon contact with water and have been identified as the major cause of problems related to swelling soils.

The change from magnesium to aluminium in the octahedral sheet is the result of isomorphous substitution, i.e. the substitution of one kind of ion with another without changing its crystal structure. This phenomenon is also related to ion exchange mechanisms. The replacing power of some cations in soil/clay minerals is in the following order (Oweis & Khera 1998):

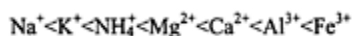

It can be seen that higher valence ion replaces lower valence ions. In addition, ions with higher concentrations can replace their higher valence counterparts. When valence and the concentrations are the same, then ions with lower ionic radius will replace ions of larger ionic radius.

Another important characteristics of clay minerals, also much related to ion exchange is the ability to adsorb external cations. This property is known as the cation exchange capacity (CEC). The SI unit of CEC is mmol-charge/100 g of dry soil although the old unit of meq/100g of dry soil continue to be extensively used. However, the use of these units interchangeably requires no correction. Its testing may follow procedures developed by Bascomb (1964). The range of values for kaolinite, illite and montmorillonite are 3–15, 10–40, and 80–150, respectively. Residual soils have mainly low CEC range of 2 to 8 depicting the dominating presence of kaolinite and lack of any swelling problems (Taha & Debnath 1999, Zain et al. 2001).

In terms of particle shape and surface charge, it is generally accepted that clay particles are platy in shape and their surface is negatively charged primarily due to isomorphous substitution. With regard to some engineering characteristics, the specific surface, CEC, the swelling potential, liquid limit, and activity (plasticity index divided by percent clay) are lowest in kaolinite followed by illite and montmorillonite. In terms of strength, hydraulic conductivity, and resistance to chemical attack, the order reverses.

The kaolinite and illite minerals are stable with zero charge deficiency. However, for montmorillonite the charge deficiency is balanced by externally adsorbed sodium or calcium ions. This results in high CEC and giving rise to two types of montmorillonite, i.e. sodium or calcium montmorillonites (these products are commonly referred to as sodium [Na] or calcium [Ca]-bentonites).

The term clay fabric and structure are also commonly now used in the literature. Fabric refers to the arrangement of particle groups and pore spaces in a soil. Structure includes



fabric, composition, and interparticle forces and play marked role in determining the behavior of soils. Its importance was described by Lambe (1958): ‘The engineer must, therefore, consider structure in order to understand the fundamentals of soil behavior. He needs an understanding of structure especially if he tries to predict the effects on soil properties of time, pressure and changes in environmental conditions’.

When repulsive forces dominate in the soil-water matrix in which monovalent cations are available in the pore fluid and systems of high pH, a thick diffuse double layer and dispersed structure (Figure 12.6) will result. Increasing ionic concentration and availability of high valence ions will compress the diffuse double layer and the dominant attractive forces will produce a ‘card-house’ flocculative structure (Figure 12.7). Sridharan et al. (1988) mentioned that a low soil pH also promotes this positive edge (develop at the broken edges) to negative edge face flocculation. Dispersive structure is most desirable where a very low hydraulic conductivity is required for example in the case of containment systems (e.g. landfills and barrier walls). Here, a greater portion of the soil water is adsorbed on the clay mineral making the water harder to move, and the soil less permeable. There are also fewer gaps containing free water as found with a flocculated structure.

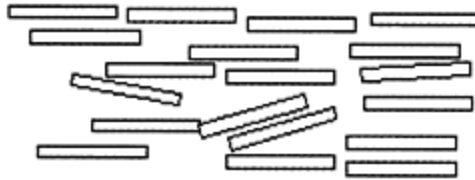

Figure 12.6. Dispersed soil structure.



Figure 12.7. Flocculative soil structure.

There will also be an environment in which the soil mineral will have no charge. This zero point charge (ZPC) has a similar meaning to isoelectric point. At high pH values soil mineral normally carries a negative charge which decreases as the pH drops. When pH is continuously decreased, a point will be reached when the charge becomes zero. The pH at which this occurs is the ZPC (Mohamed & Antia 1998). ZPC is also an important parameter for characterising adsorption (Hemsi et al. 2002).

## 12.5 EFFECTS OF CHEMICALS/WASTE ON THE PROPERTIES OF SOILS

The water used in soil mix is fundamental in determining the soil properties. From the understanding of the influence of chemicals/waste on soils it is important to check the pH or at least have some 'feeling' of the quality of water when used in any soil testing. For example, carbon dioxide has been used in the past to enhance saturation of soil samples for triaxial testing. At present this is no longer allowed as the carbon dioxide provides a different chemical environment in the soil samples. Residual soils are naturally quite acidic (pH between 4 and 6) and are more prone to change under different chemical conditions. Again when soil is mentioned, it is the clay particles which are referred to and in some residual soils such as the granite residual soil the clay content is almost 50% (Taha & Debnath 1999). It is recommended that when conducting any tests involving mixing of water to the soils in question such as Atterberg limits (most important), compaction, strength, etc., the pH of water used must be checked. Water beyond the pH limits of 6.5 to 7.5 should not be used in any testing.

From the Gouy-Chapman relationship, it is possible to evaluate the change in soil behavior due to variations in chemical concentration. When chemical concentration increases (while maintaining other factors) the double layer thickness decreases theoretically resulting in reduced repulsive forces and increase in attraction. This will result in flocculative soil structure resulting in an increase in voids eventually causing more compression/settlement and an increase in hydraulic conductivity. Similarly, Yong & Warkentin (1966) observed that saturation of kaolinite with divalent and trivalent cations favours electrostatic attraction between the negative and positive edges of clay faces leading to a flocculated structure. These are undesirable effects in landfills in which their integrity related flow or transport of contaminants in liners and caps is controlled by their hydraulic conductivity.

Pore fluid interaction in waste/chemical environment also permits the replacement of the diffuse double layer water and cations on the particle surface with organic cations in water soluble organics. These organics have lower dielectric constant than water. As a result the diffuse double layer will not be fully developed as mentioned in section 12.3. The particles will lose their cohesion and behave like silt. Thus foundations especially with design incorporating cohesion factors will be unsafe. This pore fluid interaction is actually reversible and cyclic, i.e. organic cations can flow in and out causing clay layers to swell and shrink. Changes in strength and hydraulic conductivity of soil will take place actively in this environment which is very difficult to predict quantitatively.

The use of bentonites is also common for waste containment. Following the ion exchange rule, sodium ions (when using Na-bentonite) can be replaced by many other ions. This change will result in a compressed double layer and an increase in hydraulic conductivity. Thus in terms of resistance to chemical attack, Ca-bentonite is superior.

## 12.6 HYDRAULIC CONDUCTIVITY

Hydraulic conductivity,  $k$ , is a parameter much discussed in geoenvironmental engineering since it governs the flow of contaminants and also serves as a basic requirement by which a containment structure is accepted or not. In order to estimate the hydraulic conductivity,

the Hazen's formula is still widely used due to its simplistic relationship with the grain size distribution parameter, i.e.

$$k = C_H D_{10}^2 \quad (12.2)$$

in which  $D_{10}$  is the effective grain size (in cm for measurement of  $k$  in cm/s) or size for 10% passing of the grain size distribution. The parameter  $C_H$  is known to be the weakest aspect of this formula. Although the value usually assumed is 100, however collection from many references have yielded a range from 1 to 1000 (Carrier 2003). In addition it has many limitations which include effective grain size of between 0.01cm and 0.3cm, water temperature of 10°C, and condition of loose sands. As such Carrier (2003) also recommends that Hazen's formula be retired and Kozeny-Carman's formula be extensively used:

$$k = \frac{\gamma}{\mu} \frac{1}{C_{KC}} \frac{1}{S_o^2} \frac{e^3}{1+e} \quad (12.3)$$

In this formula  $\gamma$  and  $\mu$  are unit weight and viscosity of water/permeant, respectively,  $C_{KC}$  is the Kozeny-Carman empirical coefficient (usually taken to be equal to 5),  $S_o$  is the specific surface area per volume of particles (1/cm), and  $e$  is the void ratio. After considering the unit weight and viscosity of water at 20°C and an estimation of  $S_o$ , Equation (12.3) becomes:

$$k = 1.99 \cdot 10^4 \frac{100\%}{\left\{ \sum \left( \frac{f_i}{D_{li}^{0.404} \times D_{si}^{0.595}} \right) \right\}} \frac{1}{SF^2} \frac{e^3}{1+e} \quad (12.4)$$

In Equation (12.4), as reported by Carrier (2003),  $f_i$  is the fraction of particles between two sieve size,  $D_{li}$  is the size of the larger sieve (larger particle size),  $D_{si}$  is the size of the smaller sieve (smaller particle size), and  $SF$  is the shape factor: spherical—6.0, rounded—6.1, worn—6.4, sharp—7.4, and angular—7.7 (Fair & Hatch 1933). Loudon (1952) suggested the following values: rounded—6.6, medium angularity—7.5, and angular—8.4. Although Equation (12.4) is much more complex than that of Hazen, advancement in computers and softwares/spreadsheets have facilitated its ease of computation.

It must be emphasised that the Kozeny-Carman formula is not appropriate for clayey soils although it will work for nonplastic silts. Carrier & Beckman (1984) provided a useful relationship between index tests and the permeability of remoulded clay (in m/s) such that:

$$k = \frac{0.0174 \left\{ \frac{e - 0.027[(PL) - 0.242(PI)]}{PI} \right\}^{4.29}}{1+e} \quad (12.5)$$

However, Benson & Trast (1995) based on their study of thirteen compacted clays mentioned that hydraulic conductivity was not uniquely related to any of the compositional variables suggesting that a single index property is not sufficient to estimate hydraulic conductivity.

Laboratory testing for hydraulic conductivity is detailed in British Standards, ASTM, journals, textbooks and conference proceedings, etc. It covers various methods and of particular interest are types of permeameters, i.e. rigid wall (e.g. compaction permeameters) or flexible wall (e.g. rubber membranes such as that used in triaxial tests). With the use of the flexible wall apparatus (rubber membrane holding the specimen as in triaxial tests), the membrane will deform according to the shape of the particles (Figure 12.8). This reduces problems associated with preferential flow along the walls of a rigid wall permeameter (Abdul Aziz 2002). Side leakage can also be minimised using double ring permeameters. The effects of leachate and other toxic liquids on hydraulic conductivity should be assessed with the baseline hydraulic conductivity of 0.01N CaSO<sub>4</sub> solution.

Field measurements of hydraulic conductivity usually employ pumping tests from boreholes. For landfills soil liners, hydraulic conductivity measurements can be performed using the sealed double ring infiltrometer (SDRI) and the borehole permeability tests. Because the SDRI (ASTM D 5093) type of testing is highly specialized and costly in both equipment and the time involved it is difficult to convince project proponents of its use.

Another point of interest is the field versus laboratory measurements of hydraulic conductivity. Daniel (1984) observed that the actual hydraulic conductivity (field) for clay liners were between 10 to 1000 times larger than laboratory measurements. The main reason was difficulty of obtaining representative samples. The compaction moisture content, method of compaction, compactive effort, size of clods, degree of hydration of clods, distribution of desiccation cracks, fissures, slickensides, and other hydraulic effects do not match conditions in the field. Daniel (1984) also mentioned that field tests produced much better results because the tests permeated larger and more representative samples.

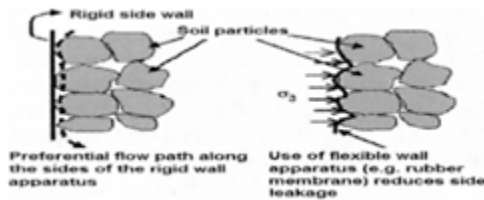

Figure 12.8. Side leakage problems in rigid walls (left) and improvement using flexible wall apparatus (right).

Estimation of in-situ hydraulic conductivity of residual soils at landfill sites around the Kuala Lumpur region in Malaysia yields between 10–6 to 10–4cm/s (Ibrahim 1999). These low hydraulic conductivity values may be the primary reason for the low extent of soil pollution around the above landfill sites (Abdul Latiff 1999). Hydraulic conductivities of compacted residual soils for liner applications are discussed in section 12.9.

## 12.7 ADSORPTION

Adsorption is a phenomenon whereby a solute attaches itself onto the surface of the solid materials. It may be either physical or chemical (chemisorption) depending on the type of forces involved. In physical adsorption, the electron cloud of the substance adsorbed inter-

acts as a whole with the adsorbent. On the other hand, in chemisorption, electron transfer and sharing of electrons takes place between the adsorbate and the adsorbent. In general, adsorption has a far reaching industrial applications worldwide. With respect to geoenvironmental applications, adsorption is used to assess the migrational characteristics of the solute in soil. The more it is adsorbed, the lesser its migrates and pollution to surrounding areas will be less extensive. An important parameter which is used in contaminant transport models, the partition coefficient ( $K_d$ ), may be directly obtained from adsorption studies. In addition, the attenuation characteristics (ability to retain contaminants) of a soil for a potential liner material can also be derived from the study on adsorption. Another term absorption is used when the contaminants or chemicals is adsorbed into the particle body through fine cracks.

The results of the batch adsorption tests are usually analysed with respect to the adsorption isotherms. The parameters used are the amount of contaminant/ solute adsorbed,  $q$ , and the equilibrium concentration,  $C_e$ . When the relationship between  $q$  and  $C_e$  can be approximated by a straight line, a linear adsorption isotherm is established. Thus:

$$q = K_d C_e \quad (12.6)$$

in which  $K_d$  is the partition or distribution coefficient. In soil science literature (e.g. McBride 2000), this isotherm is classified as a C-type isotherm indicating constant partitioning. This suggests a constant relative affinity of the solute molecules for the soil and is usually observed at the low range adsorption. Thus, a linear relationship (Equation 12.1) is normally true in low concentration systems. Usually a curved relationship is obtained and one of the isotherms that may be used to fit data from adsorption tests is the Freundlich adsorption isotherm (Freundlich 1926) which may be written as

$$q = K_F C_e^{1/n} \quad (12.7)$$

where  $K_F$  is the Freundlich adsorption constant which is a measure of the sorption capacity or extent of the soil, and  $n$  is an empirical constant. The linear adsorption isotherm is a special case of the Freundlich's isotherm with  $n=1$ . The values of  $n < 1$  is also usually termed as unfavourable sorption since there are greater amounts of solute in the solution than adsorbed. Likewise, a system with  $n > 1$  is said to be favourable sorption. This isotherm with high  $n$  value is classified as the L-type isotherm reflecting a relatively high affinity between the solute and the soil and is usually indicative of chemisorption. Equation (12.7) has no theoretical basis and is empirical in nature. The linear form of Equation (12.7) is

$$\ln q = \ln K_F + \frac{1}{n} C_e \quad (12.8)$$

From a plot of  $\ln q$  vs  $\ln C_e$  the values  $K_F$  (the intercept) and  $n$  (inverse slope) can be determined.

Another useful isotherm is the Langmuir adsorption isotherm (Langmuir 1918) which is based on the concept that solid surfaces have finite adsorption sites. When all the adsorption sites are filled, the surface will no longer be able to adsorb solute from solution. Therefore, this isotherm offers an advantage over the other previously discussed isotherms in that it puts a cap on the amount of chemical species the soil can adsorb. Thus, the maximum

amount of solute adsorbed in a particular soil-chemical interaction system can be estimated. Analytically, the isotherm (also an L-type) may be written as

$$q = \frac{\alpha \beta C_e}{1 + \alpha C_e} \quad (12.9)$$

where  $\alpha$  is an adsorption constant related to the binding energy or the ‘affinity’ parameter (Veith & Sposito 1977) and  $\beta$  is the maximum amount of solute that can be adsorbed by the soil. These parameters can be easily obtained from its linearised form

$$\frac{1}{q} = \frac{1}{\alpha \beta C_e} + \frac{1}{\beta} \quad (12.10)$$

A plot of  $1/q$  vs  $1/C_e$  can be used to obtain the isotherm parameters.

There are a number of other adsorption isotherms, such as BET, Gibbs equation, Fowler-Frumkin’s equation, Hill-de Boer, Volmer, Temkin, etc. These, however, are mainly applied to adsorption of gases on to adsorbent materials. Details can be found in Ponec et al. (1974).

As mentioned earlier,  $K_d$  is one of the most fundamental parameters for contaminant transport processes in soil. Another established method for obtaining this parameter for organic contaminants is through the use of the hydrophobic theory advanced by Karickhoff et al. (1979) who proposes that

$$K_d = K_{oc} f_{oc} \quad (12.11)$$

in which  $f_{oc}$  is the fraction of organic compound and  $K_{oc}$  is the partition coefficient of a hydrophobic compound between soil and water.  $K_{oc}$  is usually related to  $K_{ow}$  (octanol-water partition constant) which is known for many compounds or estimated from solubility tables. However, this approach is only applicable to hydrophobic compounds with  $f_{oc}$  greater than 1%.

Taha et al. (2003b) studied interaction of phenol and granite residual soil in batch adsorption test. Basically the procedure consists of shaking 12 grams of air dried soils with a series of phenol solutions of different concentrations for 24 hours. The mixture is then allowed to equilibrate for 2 weeks before the final fluid concentrations are analysed. The amount of phenol adsorbed,  $q$ , is then calculated using the following equation:

$$q = (C_o - C_e) \frac{V}{M} \quad (12.12)$$

where  $C_o$  is the initial concentration,  $C_e$  is the final or equilibrium concentration,  $V$  is the volume of solution (fixed at 60 mL in this study), and  $M$  is the mass of soil used (12 g). The results are plotted and shown in Figure 12.9. The results for kaolinite are also plotted for comparison. The figure illustrates that a straight-line approximation for the adsorption isotherm is only possible for low concentration values. Thus, the use of  $K_d$  in the general contaminant transport equation (discussed in the next section) will lead to an increase in adsorption and reducing migration. This will lead to underestimating transport of contaminants and yield unsafe estimates of the pollution extent. Quantitatively, the  $K_d$  values for initial slopes were 10.48 L/kg and 1.18L/kg, respectively for the granite residual soil and

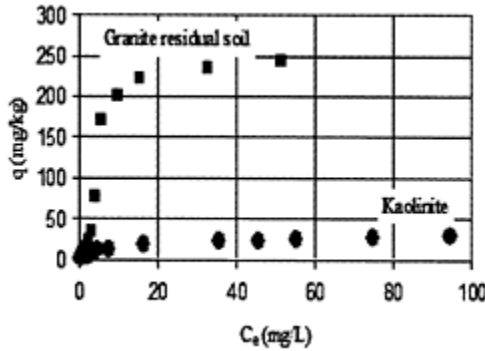

Figure 12.9. A linear adsorption isotherm for phenol-soil interaction.

kaolinite. The maximum adsorption capacities were approximately 238mg/kg and 23 mg/kg for the granite residual soil and kaolinite, respectively showing much greater adsorption capacity of the granite residual soil over the commercial kaolinite. This is possibly another reason for the low extent of contamination of soil around landfill sites in Kuala Lumpur, Malaysia (as mentioned in section 12.5).

### 12.8 CONTAMINANT TRANSPORT

Contaminant transport equations are used to model the flow or transport of contaminants in the soil. Leaking of contaminants from tanks or landfills and movements of contaminants from dumpsites are amongst the situations that these models are likely to be applied to estimate the spatial and temporal distributions of the contaminant plume.

The general advective-dispersive transport equation for contaminants (non NAPLs) in saturated soils are based on Darcy & Fick’s (1st and 2nd) law and usually given by:

$$R \frac{\partial c}{\partial t} = D \frac{\partial^2 c}{\partial t^2} - v_s \frac{\partial c}{\partial t} - \lambda c \tag{12.13}$$

in which

$$R = 1 + \rho_d \frac{K_d}{n} \tag{12.14}$$

where  $R$  is the retardation factor,  $D$  is the hydrodynamic diffusion-dispersion coefficient,  $v_s$  is the seepage velocity which is related to the hydraulic conductivity through Darcy’s law,  $\lambda$  is the first order decay constant,  $c$  is the concentration and  $t$  is the time related to the transport process. From Equation (12.13),  $R$  is the factor to take care of adsorption and only involves linear adsorption process.  $D$  is taken as the combined effect of mechanical dispersion (as a result of velocity difference in the soil system), and diffusion (movement due to concentration gradient) and is given as:

$$D = D_m + D_o \tag{12.15}$$

$$= \alpha v_s + \tau D_o \tag{12.16}$$

where  $D_m$  is the mechanical dispersion coefficient,  $\alpha$  is the dispersivity (longitudinal),  $D_o^*$  is the effective molecular diffusion coefficient,  $D_o$  is the molecular diffusion coefficient, and  $\tau$  is tortuosity. The longitudinal dispersivity ( $\alpha$ ) is scale dependant and shown in Table 12.3.

The molecular diffusion coefficient ( $D_o$ ), also called the self diffusion coefficient, has been much studied by chemists in the past and some values for typical ions at 25°C are provided in Table 12.4. These values reduce to about one half at 0°C.

The tortuosity factor ( $\tau$ ) is related to the fact that when ions travel in the soil, they do not pass through a straight line but follow irregular and winding (tortuous) paths. It varies with moisture content because as soil becomes drier the diffusive pathways become more tortuous. In free liquid  $\tau = 1$ , and in saturated soil  $\tau = 0.4$  (Mohamed & Antia 1998).

van Genuchten & Alves (1982) have compiled a host of solutions for various initial and boundary conditions. For example, the simplest case involves a surface of an infinitely deep stratum subjected to constant concentration,  $c_o$ , such that (Oweis & Khera 1998):

$$\begin{aligned} c(0, t) &= c_o \quad t \geq 0 \\ c(z, 0) &= 0 \quad z > 0 \\ c(a, t) &= c_o \quad t \geq 0 \end{aligned} \tag{12.17}$$

The solution for Equation 12.13 with the initial and boundary conditions prescribed in Equation 12.17 is given as

$$c(z, t) = \frac{c_o}{2} \left[ \operatorname{erfc} \left\{ \frac{zR - v_s t}{2\sqrt{DRt}} \right\} + \exp \left( \frac{v_s z}{D} \right) \operatorname{erfc} \left\{ \frac{zR - v_s t}{2\sqrt{DRt}} \right\} \right] \tag{12.18}$$

where  $\operatorname{erfc}(z)$  is the complementary error function, i.e.  $\operatorname{erfc}(z) = (1 - \operatorname{erfc}[z])$  which is tabulated in many mathematical texts. The exponential term ( $v_s z/D$ ) is also known as the Peclet number. This term is the ratio of the advective to the diffusive transport. Dispersive transport becomes more important as the Peclet number becomes smaller. Laboratory study of contaminant transport and verification of the transport parameters are usually conducted using column leaching apparatus.

Table 12.3. Typical values of the longitudinal dispersivity,  $\alpha$  (Gilham & Cherry 1982).

Type of test	$\alpha(m)$
Laboratory	0.0001–0.01
Natural gradient tracer	0.01–2.0
Single well	0.03–3.0
Radial and 2 wells	0.05–15.0



Table 12.4. Molecular diffusion coefficient ( $D_o$ ) of some selected ions at 25°C (Robinson & Stokes 1965).

Cations	$D_o \times 10^{-10}$ m <sup>2</sup> /sec	Anions	$D_o \times 10^{-10}$ m <sup>2</sup> /sec
H <sup>+</sup>	93.1	OH <sup>-</sup>	52.7
Li <sup>+</sup>	10.3	F <sup>-</sup>	14.6
Na <sup>+</sup>	13.3	Cl <sup>-</sup>	20.3
K <sup>+</sup>	19.6	Br <sup>-</sup>	20.1
Mg <sup>2+</sup>	7.05	I	20.0
Zn <sup>2+</sup>	7.15	SO <sub>4</sub> <sup>-2</sup>	10.7
Pb <sup>2+</sup>	9.45	NO <sub>2</sub> <sup>-</sup>	19.1
Cr <sup>3+</sup>	5.94	NO <sub>3</sub> <sup>-</sup>	19.0
Fe <sup>3+</sup>	6.07	CO <sub>3</sub> <sup>-2</sup>	9.55
Al <sup>3+</sup>	5.59		

For multiphase flow (air/water or unsaturated low, and water/*NAPL*) the problem is more complex and beyond the scope of this discussion. Currently modelling is normally done with the aid of many commercial softwares of unlimited capabilities available in the market.

## 12.9 SOIL LINERS

Landfill is a relatively new class of geotechnical structure that demands the expertise and services of a geoenvironmental engineer for its proper construction and operation. The use of an engineered landfill with proper systems for waste disposal especially in developing countries is still in its infancy. The costs to build such facilities are exorbitant and are not within the means of many local authorities or governments. However, landfilling is still the cheapest disposal method available. One of the main elements of a landfill is the impervious liner. Some typical liner sections are given in Figure 12.10.

In most guidelines, to satisfy breakthrough criteria, the compacted clay layer should have a maximum hydraulic conductivity of  $1 \times 10^{-7}$  cm/s. This figure was derived from studies with kaolinite and thus this design can only be possible if a similar clay is available on site. Benson et al. (1994) performed extensive studies to evaluate indicators related to basic soil parameters to achieve this hydraulic conductivity requirement. The soil characteristics include particle size distribution and Atterberg limits and 5 conditions were established:

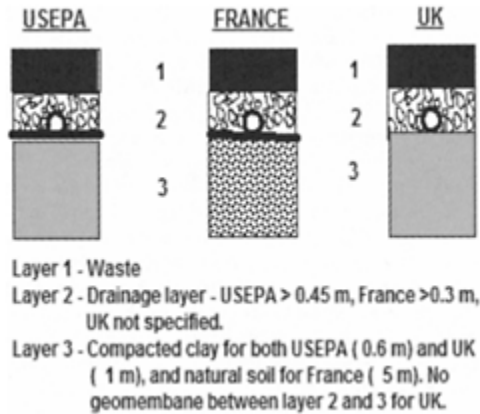

Figure 12.10. Bottom lining requirement of three selected systems (modified after Manasero et al. 1998).

- $%F$  (particles passing  $74 \mu\text{m}$ )  $\geq 30\%$
- $%C$  (particles passing  $2 \mu\text{m}$ )  $\geq 15\%$
- $LL$  (liquid limit)  $\geq 20$
- $PI$  (plasticity index)  $\geq 5$
- $A$  (activity= $PI/\%C$ )  $\geq 0.3$

Studies by Taha et al. (2003 a) on a granite residual soil have shown the following grain size analysis and Atterberg limits for liner purposes:

- $%F=35\%$  ( $>30\%$ )
- $%C=49\%$  ( $>15\%$ )
- $LL=67.8$  ( $>20$ )
- $PI=31$  ( $>5$ )
- $A=0.63$  ( $>0.3$ )

In the Casagrande's plasticity chart, the residual soil can be grouped under CH (high plasticity). Using Casagrande's procedure (Holtz & Kovacs 1981), the shrinkage limit ( $SL$ ) is approximately 20%.

It can be observed that the classifications and Atterberg limits test results showed that the granite residual soil meets the requirements suggested by Benson et al. (1994). In addition, it is also an advantage to have soils in the CH group because it is easier to achieve the required hydraulic conductivity. In terms of shrinkage, the soil has little to moderate likelihood of volume change based on the guideline provided by Lutton et al. (1979).

There are also other recommended approaches that are worth exploring in order to fully evaluate the potential of the soil for use as clay liners. For example, U.S. Bureau of Reclamation (1974) recommends a limit on the  $PI$  of 25 and 45 on the  $LL$ . One reason for limiting the  $PI$  is that highly plastic soils usually contain clods (chunk of clay) that are difficult to break and to achieve proper compaction. Thus the presence of clods can significantly increase the hydraulic conductivity of the soil (Daniel 1984). The limitation on the liquid

limit is to limit its swell potential. Based on these recommendations, the residual soil being studied will be difficult to work with in the field because it becomes highly viscous when moistened and could stick on to the wheels of rollers. It is also expected that the residual soil clods will be too hard when dry and there is high possibility of cracking due to shrinkage. These problems could be partly solved by using smooth drum rollers (for final compaction of each layers) and covering the soil immediately after compaction is completed.

In order to evaluate its hydraulic conductivity, a series of compaction tests was conducted using the low, standard Proctor and modified Proctor energies (Daniel & Benson 1990). The low compaction energy uses the same mould, hammer and procedure as the Standard Proctor test. The only variation is the number of hammer blows. In the low energy tests only 15 hammer blows were applied. The basic concept is to test soil over a range of compactive effort expected in the field. Table 12.5 shows the results of the maximum dry density and its corresponding optimum moisture contents.

From the compaction test data, the hydraulic conductivity was determined at its optimum moisture contents. The laboratory tests results are shown in Table 12.6.

The results showed that compacting the specimens even using the lowest energy (at its optimum moisture content) could achieve the required hydraulic conductivity. Obviously if compaction was done within about 2% wet of optimum, a lower hydraulic conductivity will be achieved. Thus from hydraulic conductivity standpoint, the requirement can be easily met using this granite residual soil. A zone of acceptable limits in the dry density vs. moisture content curve based on hydraulic conductivity, strength, and shrinkage criteria for compaction of liner material can be obtained through a procedure recommended by Daniel & Wu (1993).

Table 12.5. The maximum dry densities and optimum moisture contents in respective to their compaction energies.

Compaction energy	Max. dry density $\gamma_{dmax}$ (kN/m <sup>3</sup> )	Opt. moisture content, $w_{opt}$ (%)
Low (reduced)	13.95	27.8
Standard	14.45	26.6
Modified	16.40	20.8

Table 12.6. Results of the hydraulic conductivity tests.

Compaction energy	Hydraulic conductivity ( $\times 10^{-7}$ cm/s)
Low (reduced)	1.09
Standard	0.179
Modified	0.029

Geosynthetic clay liner (GCL) has been employed as substitute for a conventional compacted clay liner and cover. It consists mainly of a geosynthetic and dry bentonite. Its

main advantages are its limited thickness, good compliance with differential settlements of underlying soil or waste, easy placement and relatively low cost. However its limited thickness can lead to vulnerability to mechanical accidents, limited sorption, and increase in diffuse transport. In addition, when mixed with some types of leachate, bentonite will show limited swelling thus reducing its efficiency as a barrier material (Manassero et al. 1998).

## 12.10 BARRIER/CUTOFF WALLS

These structures are used for separation of 'green' and 'brown' land/fields where it could find useful applications in unengineered containment systems. It is usually made of bentonite slurry and backfill materials to prevent the flow of leachate/chemicals out of containment or contaminated areas. The thixotropic gain in strength of a suspension is called gelation. Three to seven percent of Na-bentonite suspension is adequate to stabilize a trench and provide the necessary gel strength (Oweis & Khera 1998). In order to minimise clay-contaminant interaction, the use of Ca-bentonite is recommended as sodium ions can be easily replaced by other ions as explained in section 12.3. In addition, a strict control of pH is required for Na-bentonites since the water uptake and swelling pressure varies significantly with pH. Hermanns et al. (1987) found that a pH value of between 7 and 8 is required for maximum swelling pressure; any pH lower or higher than this will significantly decrease water uptake capacity thus reducing the swelling pressure for wall stability. Ca-bentonites do not suffer this property and its water uptake capacity does not change with pH albeit much lower water uptake than Na-bentonites. Thus the use of Ca-bentonite will result in lower CEC and minimise the effect of chemical attack. However using this mineral will require about three to four times the amount of Na-bentonite to achieve the type of swelling pressure for stability of the walls. This is the result of a compressed diffuse-double layer in the case of Ca-bentonite rendering more attraction and less repulsion (which produces the swelling pressure). A blend of Na and Ca minerals is therefore necessary to produce barriers which can protect itself against chemical attack, and provide wall or trench stability in a cost effective manner.

Reactive permeable barriers have also been used. This barrier intercepts a contaminant plume, provide a preferential flow path through a reactive media, and transforms the contaminants into an environmentally acceptable form for discharge. The reactive media consists of iron and other zero-valent or zero-oxidation-state metals which have been long recognised to change chemical forms of organics and inorganics. Several forms of these chemicals are inexpensively available. However its use will elevate levels of  $\text{Fe}^{2+}$  and pH in the groundwater.

## 12.11 SOIL REMEDIATION

The general or traditional categories of site remediation/ soil treatment/soil clean-up processes may be classified as thermal, physical, chemical, biological, and electrical (Table 12.7). In addition, there are volume reduction techniques to reduce the volume of soil to be treated/cleaned, and source control measures to retard/stop migration of contaminants. Generally, clean-up methods have proved to be expensive, imperfect, time consuming, and uncertain in their future effects (ISSMGE Technical Committee TC 5 1997). Thus, pol-

lution prevention is required to preserve the environment and avoid using-up significant amount of resources (time and money) in the future for soil remediation projects.

Table 12.7. Some examples of soil clean-up technologies.

Classification	Techniques
Thermal	Incineration, pyrolysis, radio frequency, electrical resistance heating, plasma, in-situ vitrification, hot water injection, steam enhanced extraction.
Physical	Groundwater pumping-and treatment, high pressure soil washing, vacuum extraction, vapour extraction, water flooding and pumping, hydrofracturing, pneumatic fracturing, explosive blasting.
Chemical	Soil washing with chemicals, pump and treatment with chemicals, chemical extraction, mixing (stabilizing) and solidifying.
Biological	Bioremediation reactors, phytoremediation, bioventing, bioslurping, composting, vegetative, constructed wetlands, biofarming lagoons.
Electrical	Electrokinetics (including electroosmosis and electromigration), electroacoustics.

There are a host of items/reasons that make up the decision making process in choosing a particular technique for a contaminated site in question. These include the type of contaminants, its fate in the environment, the type of environment to deal with and process limitations. The role of clean-up objectives is also significant especially when questions related to project economics appear from the financier.

It must be mentioned that the process called ‘natural attenuation’ is possibly the combination of different techniques mentioned above although many believe that it is a form of bioremediation. In this process, the extent and concentration of contaminants decrease in the absence of any remedial efforts. It may also be the reason why many groundwater contaminant plumes did not extend to the limits predicted by mathematical models. This ‘do-nothing’ approach has been accepted by USEPA, mostly on fuel hydrocarbons at military installations. Other terms used to describe this process include ‘intrinsic remediation’, ‘intrinsic bioremediation’, ‘passive bioremediation’, ‘natural recovery’ and ‘natural assimilator’ (EPA 1997).

With regard to tropical residual soils, not many remediation works have been done in this soil formation. However, there are lessons that can be learnt from its natural soil profile and properties from laboratory and field observations. The residual soil profile is typically dry with deep ground water levels (Taha et al. 2000b). Thus soil remediation which relies upon full saturation such as groundwater pumping and electrokinetic remediation may prove to be problematic in the dry season. Although the soil gets easily saturated upon raining, it gets dried out just as easily due to consistently warm weather all year round. Electrokinetic testing on a granite residual soil also showed reversal of flow than generally understood and observed. Kassim et al. (2003) mentioned of net flow from cathode to anode for systems with water at both electrodes and water at the anode and phosphoric acid at the cathode. Thus flow for anionic species will be greatly enhanced for residual soils. Traditionally in kaolinite the migration of cations will be aided since the flow is from anode to cathode.

The fact that the pH of tropical residual soils are in the acidic range also warrants some restrictions and further research into its performance in soil remediation and stabilisation. For example, in soil solidification process, a high pH environment (alkaline condition) is required for calcium ions to react with clay minerals to form cementitious materials. This is probably one of the reasons why soil grouting is not so successful in residual soils. Low pHs also caused many contaminants to remain in ionic form and are thus soluble and easily leached in water. TCLP (Toxicity Characteristic Leaching Procedure) for solidified contaminated soil will usually fail in such a case.

The potential use of plants for soil clean up, i.e. phytoremediation, in tropical regions was discussed by Andrade et al. (2002). In addition to its low cost compared to other remediation methods, they mentioned that sunlight and temperature benefit the cultivation of plants practically all year round. Moreover the tropical regions have enormous plant and microorganic biodiversity. It is estimated that from approximately 250,000 species of superior plants known today, about 70% grow in the tropics and subtropics. It was also established that nutrient recycling efficiency is high in the tropics due to these factors. Recycling of carbon and nitrogen takes about 12 years compared to about 60 to 100 years in temperate forest. Thus, these factors (cost, climate, biodiversity, etc.) must be fully tapped for efficient and optimum use of soil remediation projects in the tropics.

## 12.12 FOUNDATIONS AND SPREAD OF CONTAMINATION

In many cases engineers work on expansion projects on contaminated land. In residual soils, beyond three or four stories high, the use of pile foundations is customary. However, on such sites, potential environmental problems may arise due to puncturing of soil layers. Construction on former dumpsites poses a similar problem. Waste refuse are so soft to carry any surface loads and piles are employed to carry the forces down beyond the landfill deposits. Penetrating the soil below the landfill could create a preferential flow path of contaminants or leachate aiding its spatial movements to surrounding soils and water catchment systems.

The above problems were studied and documented by Boutwell et al. (2001) who studied problems on clay. However, the nature and the seriousness of the problem also apply to residual soils and other types of formations. In essence, there are four mechanisms by which contaminants can be transferred/accelerated through piling works:

- a) Self transfer. This due to the contamination/ chemicals from the pile itself such as creosoted timber. Creosote contains over 200 chemicals, mostly toxic organics in its constituents. The spread of contaminants will occur over a long term as long as there is creosote in the timber (Figure 12.11).
- b) Direct transfer (Figure 12.12). Soil plug formed at the tip of the pile in the contaminated zone will be carried and released to the groundwater as the pile is pushed or rammed downwards.
- c) Conduit formation (Figure 12.13). Pile installation will create an annular zone or zones of higher permeability near the pile surface. This disturbance will take some time to come back to its original state depending upon how quick the generated excess pore water could dissipate. Thus the flow of contaminants may accelerate in this zone.

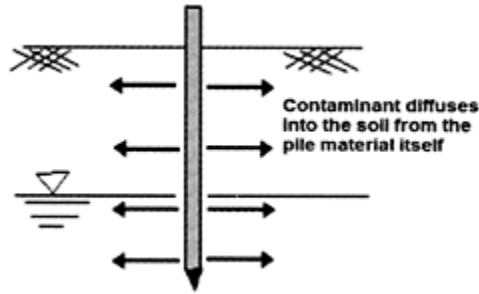

Figure 12.11. Self transfer of contaminants from pile material.

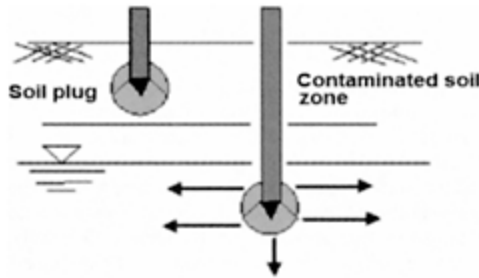

Figure 12.12. Direct transfer of contaminants by virtue of soil plug at tip of the pile.

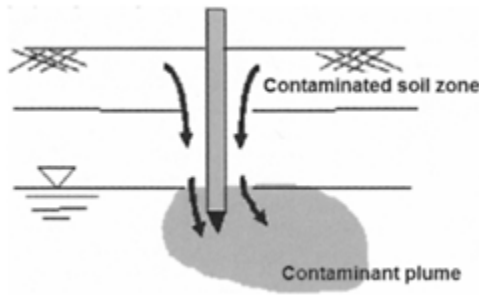

Figure 12.13. Flow at pile/soil interface.

- d) Wicking (Figure 12.14). If piles are made of material more permeable than the soil, such as in the case of sand or stone columns, contaminants can move freely to surrounding zones through them. As long as the pile exists, the spread of contamination will continue to occur and it is a long-term problem.

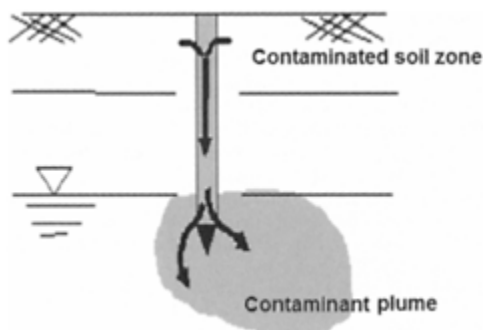

Figure 12.14. Wicking problem, i.e. flow through pile.

### 12.13 CONTRIBUTIONS TO SUSTAINABLE DEVELOPMENT

Arguably the various aspects of geoenvironmental engineering are where the concept of sustainable development can be much practised. Geoenvironmental engineering strives to mainly protect the environment so that future generations could live in a harmonious environment like us. This forms the cornerstone of sustainable development as defined by Bruntland (1987): ‘Sustainable development meets the need of the present without compromising the ability of future generations to meet their own needs’. There are number of model frameworks on how these can be achieved. The two frameworks shown in Figures 12.15 and 12.16 encompass most of the definitions and goals of sustainable development. Considerations for engineering, economic and social harmony must be made for any developments/projects (Figure 12.15). In this regard the engineering aspects must include environmental/ecosystem analysis. In the economical aspects, efficiency must be combined with equity so that any wealth or prosperity generated is evenly distributed to combat poverty which is one of the main deterrents to sustainable development. The social aspects should not only include regular human physical concerns but must also consider peace and harmony in achieving sustainability.

The approach shown in Figure 12.16 is frequently use by biologists or scientists to highlight the importance of ecosystem and biodiversity. Sustainable development is most likely to be achieved when due considerations of all aspects mentioned ideally fall within the hatched zone. The traditional concept by which the heaviest factor, by far, was based on economic considerations is not and has never been sustainable in most cases.

In geoenvironmental engineering, the practice of the concepts related to sustainable development has been in place for quite sometime. This holistic approach was used in the siting of landfills. The engineering and ecological factors such as geology, climate, distance from wells, flood plains, forest, wildlife, etc. were considered along with the social (e.g. proximity to residence, archaeological and historical sites, land use, public safety and health, etc.) and economic (access to highway, cost of development, operation, and maintenance, effect on property value, distance to waste generation systems, etc.) factors in choosing the most suitable sites for landfill development.



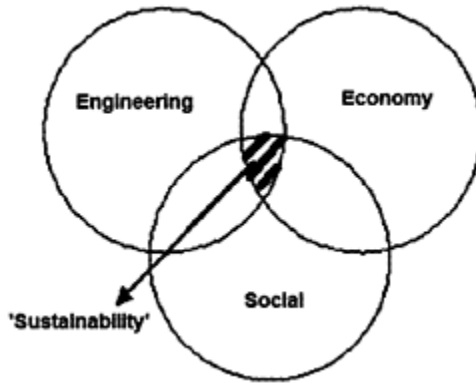

Figure 12.15. The Engineering-Economy-Social framework for achieving sustainable development.

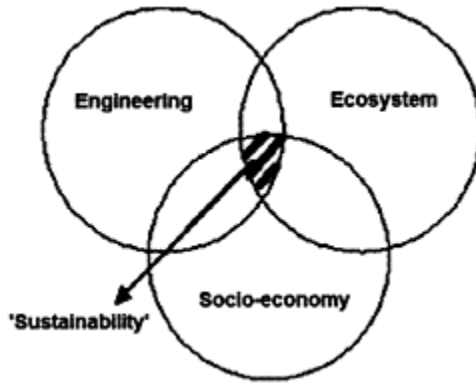

Figure 12.16. The Engineering-Ecosystem-Socio-economic framework for achieving sustainable development.

## 12.14 CONCLUSION

Geoenvironmental engineering serves to complement the traditional geotechnics due to pressures imposed by waste management industries. The complexity of the problems can be inferred from the complexity of soil-waste/chemical interactions. Thus the fundamentals of soil behavior and its interaction with waste or chemicals are very important in understanding basic concepts of geoenvironmental engineering. In addition to these, some practical problems such as matters related to clay liners, contaminant transport and transfer, and issues related to sustainability in tropical residual soils are outlined in the chapter. Also in a majority of cases, these have been compared to the general behavior of clay where much studies have been done. It is evident that matters related to soil contamination or pollution is complex and must therefore be reduced or eliminated. Failure in doing so will result in a

heavy price, both tangible and intangible. Society needs to pay either now or in future for soil remediation and stabilization efforts.

## ACKNOWLEDGEMENTS

Much of the studies undertaken by the authors which have been referenced in this chapter were largely sponsored through the various IRPA grants provided by the Ministry of Science, Technology and Environment (MOSTE), Malaysia. The authors gratefully acknowledge these contributions. However, opinions provided in this chapter are solely the responsibility of the authors and do not necessarily reflect the views of the sponsoring agency.

## REFERENCES

- Abdul Aziz, A. 2002. A prototype triaxial permeameter for the filtration of a soil/geotextile system. *Proc. 2nd Intl. conference on geotechnical and geoenvironmental engineering in arid lands, Riyadh*. Lisse: Swets & Zeitlinger. 101–108.
- Abdul Latiff, P. 1999. Chemical pollutants distribution in soil samples from the landfill sites. *Proc. workshop on disposal of solid waste through sanitary landfill-mechanisms. Processes, potential impacts and postclosure management, Universiti Putra Malaysia*: 237–250.
- Andrade, J.C.M., Mahler, C.F. & Oliviera, J.A. 2002. Soil phytoremediation. *Proc. 4th Intl congress on environmental geotechnics, Rio de Janeiro*. Lisse. 2: Swets & Zeitlinger 875–880.
- EPA 1997. Use of monitored natural attenuation at Superfund, *RCRA corrective action, and underground storage tank sites*, OWSER Directive 9200. 4–17, Nov.
- Benson, C.H. & Trast, J.M. 1995. Hydraulic conductivity of thirteen compacted clays, *Clays and Clay Minerals, The Clay Mineral Society* 43(6):669–681.
- Benson, C.H., Zhai, H. & Wang, X. 1994. Estimating hydraulic conductivity of clay liners. *J. of Geot. Eng. Div. ASCE* 120(2):366–387.
- Bruntland, G.H. 1987. *Our common future*. Oxford University Press.
- Buang, S. 1993. *The law of negligence in Malaysia*. Ampang Jaya, Selangor: Central Law Book Corp.
- Carrier, W.D. 2003. Goodbye, Hazen; Hello, Kozeny-Carman, technical notes, *J. of Geotechnical and Geoenvironmental engineering*, ASCE 129(11):1054–1056.
- Carrier, W.D. & Beckman, J.F. 1984. Correlations between index tests and the properties of remoulded clays. *Geotechnique* 34(2):211–228.
- Chen, J., Anandarajah, A. & Inyang, H. 2000. Pore fluid properties and compressibility of kaolinite, *J. of Geotechnical and Geoenvironmental Engineering*, ASCE 126(9):798–807.
- Daniel, D.E. 1984. Predicting hydraulic conductivity of clay liners. *J. of Geot. Eng. Div., ASCE* 110(2):285–300.
- Daniel, D.E., 1987. Earthen liners for waste disposal facilities. *Geotechnical practice for waste disposal*. GSP 13, ASCE, New York: 21–39.
- Daniel, D.E. & Benson, C.H. 1990. Water content-density criteria for compacted soil liners, *J. of Geot. Eng. Div., ASCE* 116(12):1811–1830.
- Daniel, D.E. & Wu, Y.K. 1993. Compacted clay liners and cover for arid sites, *J. of Geot. Eng. Div., ASCE* 119(2): 223–237.
- Domenico, P.A. & Schwartz, F.W. 1990. *Physical and chemical hydrogeology*. New York: John Wiley and Sons.

- Fair, G.M. & Hatch, L.P. 1933. Fundamental factors governing the stream-line flow of water through sand. *J. Am. Water Works Assoc.* 25:1551–1565.
- Freundlich, H. 1926. *Colloid and capillary chemistry*. London: Methuen.
- Gillham, R.W. & Cherry, J.A. 1982. Contaminant migration in saturated unconsolidated geological deposits. *Special paper 189*, Geological society of America, Boulder, CO: 31–62.
- Grimm, R.E. 1968. *Clay mineralogy*. New York: McGraw-Hill, Inc.
- Hemsi, P.S., Boscov, M.E. & Shackelford, C.D. 2002. Points of zero charge and adsorption for a Brazilian residual soil, *Proc. 4th Intl congress on environmental geotechnics, Rio de Janeiro, Swets & Zeitlinger, Lisse*. 1:105–111.
- Hermanns, R., Meseck, H. & Reuter, E. 1987. Sind dichtwandmassen beständig gegenüber den sicklerwassern aus altlasten? *Mitteilung des Instituts für Grundbau und Bodenmechanik, TU Braunschweig, Heft Nr. 23*, Meseck H., ed., Dichtwände und Dichtsohlen, Braunschweig, Federal Republic of Germany: 113–154.
- Holtz, R.D. & Kovacs, W.D. 1981. *An introduction to geotechnical engineering*, Englewood Cliffs: Prentice-Hall.
- Ibrahim, S. 1999. The influence of hydro-geological characteristics of earth materials surrounding and underlying municipal landfill sites on the risks of groundwater and surface water pollution in the Federal Territory of Kuala Lumpur, *Proc. workshop on disposal of solid waste through sanitary landfill-mechanisms, processes, potential impacts and postclosure management*, Universiti Putra Malaysia: 127–152.
- ISSMGE Technical Committee TC 5 1997. Environmental geotechnics, *Report of the international soc. for soil mechanics and geotechnical engineering technical committee TC 5*, Ruhr-Universität Bochum, Germany. <http://www.gub.ruhr-uni-bochum.de/tc5/sc503.htm>.
- Karickhoff, S.W., Brown, D.S. & Scott, T.A. 1979. Sorption of hydrophobic pollutants on natural sediments. *Water research* 13:241–248.
- Kassim, K.A., Taha, M.R. & Ahmad, K. 2003. Electrokinetic testings on tropical residual soil. *Proc. 2nd Intl. conf. on advances in soft soil engineering and technology (ASSET 2)*, Huat et al. (ed) Putrajaya, Malaysia, July 2–4: 833–844.
- Kavazanjian, E., Matasovic, N., Bonaparte, R. & Schmertmeyer, G.R. 1995. Evaluation of MSW properties for seismic analysis. *Geoenvironment 2000*, Geotechnical special publication ASCE 2(46):1126–1142.
- Knochenmus, G., Wojnarowicz, M. & van Impe, W.F. 1998. Stability of municipal solid waste. *Proc. 3rd Intl congress on environmental geotechnics, Lisbon, Portugal Balkema, Rotterdam*: 977–1000.
- Lambe, T.W. 1958. The structure of compacted clay. *J. of the soil mechanics and foundations division*, ASCE 84 (SM 2):1654–1654–34.
- Langmuir, I. 1918. The adsorption of gasses on plane surfaces of glass, mica and platinum. *J. Am. Chem. Soc.* 40: 1361–1382.
- Loudon, A.G. 1952. The computation of permeability from simple soil tests. *Geotechnique* 3:165–183.
- Lutenegger, A.J. 1992. Applications and limitations of in situ tests in structured soils. *US-Brazil NSF workshop on applicability of classical soil mechanics principles to structured soils*, National Science Foundation, USA : 5–36.
- Lutton, R.J., Regan, G.L. & Jones, L.W. 1979. *Design and construction of covers for solid waste landfills*. EPA-600/2–79–165, U.S. Environmental protection agency, Cincinnati.
- McBride, M.B. 2000. Chemisorption and precipitation reactions. *Handbook of soil science*, Sumner, M.E. (Ed.-in-Chief). Boca Raton: CRC Press B-265-B302.
- Mitchell, J.K. 1993. *Fundamental of soil behaviour*. New York: John Wiley & Sons, Inc.
- Mohamed, A.M.O. & Antia, H.E. 1998. *Geoenvironmental engineering*. Amsterdam: Elsevier.

- Manassero, M., Parker, R., Pasqualini, E., Szabo, I., Almeida, M.S.S., Bouazza, A., Daniel, D.E., & Rowe, R.K. 1998. Controlled landfill design (Geotechnical aspects). *Proc. 3rd intl. congress on environmental geotechnics*, Lisbon, Portugal, Rotterdam: Balkema, 1001–1038.
- Manassero, M., van Impe, W.F. & Bouazza, A.M. 1996. Waste disposal and containment. *Proc. 2nd Intl. congress on environmental geotechnics, Osaka, Japan*. Rotterdam: Balkema 3:1425–1474.
- Oweis, I.S. & Khera, R.P. 1998. *Geotechnology of waste management*. Boston: PWS/ITP Pub. Co.
- Ponec, V, Knor, Z. & Cerny, S. 1974. *Adsorption on solids*, London: Butterworths. 693.
- Robinson, R.W. & Stokes, R.H. 1965. *Electrolytes solutions*, 2nd edition. New York: Butterworth Publishers.
- Sridharan, A., Rao, S.M. & Murthy, N.S. 1988. Liquid limit of kaolinitic soils. *Geotechnique* 38(2):191–198.
- Sima, N. & Harsulescu, A. 1979. The use of bentonites for sealing of earth dams. *Bulletin of Intl assoc of engineering geologists* 20:222–226.
- Taha, M.R. 2000. Remediation techniques for contaminated soils. Invited Paper, *KIG forum 2000*, Kansai branch of the Japanese Geotechnical Society and International Institute for Advanced Studies. Kyoto.: 71–82.
- Taha, M.R. & Debnath, D.K. 1999. Interaction of cyanide with residual soil and kaolinite in batch adsorption test. *Journal Inst. engineers Malaysia* 60(3):49–58.
- Taha, M.R, Hossain, M.K. & Mofiz, S.A. 2000a. Drained and undrained behaviour of saturated granite residual soil, *Journal Inst. of Engineers, Malaysia* 61(3):47–58.
- Taha, M.R., Hossain, M.K. & Mofiz, S.A. 2000b. Effect of matric suction on the shear strength of unsaturated granite residual soil, *Journal Inst. of Engineers, Malaysia* 61 (2): 27–40.
- Taha, M.R., Kabir, H. & Desa, H. 2003a. Basic testing of a residual soil for use as landfill liner material. *Proc. 13th regional African conference on soil mechanics and geotechnical engineering*. Casablanca: Megamix: 347–354.
- Taha, M.R., Leng, T.O., Mohamed, A.B. & Kadhum, A.A.H. 2003b. Batch adsorption tests of phenols in soils, *Bull eng. geol. & env.*, (62), Berlin: Springer-Verlag: 251–257.
- U.S. Bureau of Reclamation, 1974. *Earth manual*, U.S. Government Printing Office, Washington, D.C.
- van Genuchten, M. Th. & Alves, W.J. 1982. *Analytical solutions of the one dimensional convective dispersive solute transport equations*. Technical bulletin 1661, U.S. department of Agriculture, Washington, D.C.
- Veith, J.A. & Sposito, G. 1977. On the use of the Langmuir equation in the interpretation of adsorption phenomena. *J. Am. Soil Sci. Soc.* 41:697–702.
- Vermeulen, N.J. 2003. The water content of soils. Inaugural Lecture. *Proc. 13th regional African conference on soil mechanics and geotechnical engineering*. Casablanca: Megamix: 347–354.
- Villar, O.M. & Carvalho, M.F. 2002. Shear strength properties of municipal solid waste, *Proc. 4th intl congress on environmental geotechnics, Rio de Janeiro*. Lisse: Swets & Zeitlinger. 1:59–64.
- Yong, R. & Warkentin, B.P. 1966. *Introduction to soil behaviour*. New York: Macmillan.
- Zain, S.M., Basri, H., Suja, F. & Jaafar, O. 2001. Land application technique for the treatment and disposal of sewage sludge, *Proc. conf. on water & wastewater management for developing countries*, Skudai, Universiti Teknologi Malaysia: 401–407.



## CHAPTER 13

# Development and application of a spatial database for residual soils

A.R.Mahmud, A.R.Mohamed Shariff & S.B.Mansor  
*Faculty of Engineering, University Putra Malaysia*

The creation of a spatial database is the starting point for any GIS application. This chapter discusses the application and development of a spatial database for residual soils. It includes data acquisition, relational databases, data types, data structuring, and the usage of lookup tables. Spatial modeling, analysis, queries and visualization are discussed generally. Discussion on planning and implementation of spatial data sharing by the government is also included.

### 13.1 INTRODUCTION

Digital mapping is not new in Malaysia. The country already has several types of geographic databases in digital form such as topographic mapping, geological maps, landcover classification, landuse map and traffic network. These maps have been widely used in many Geographical Information System (GIS) applications. Users have created vast amount of data for spatial and non-spatial databases for producing maps and reports. Data are collected and segregated into several tables based on certain data classification. The database is developed and structured to simplify the analysis and the output. As an example, in the process of creating soil maps, information on agronomic and environmental parameters are needed. Therefore, information such as pH, organic carbon content, clay mineralogy, soil depth, soil and terrain suitability for specific crop production, soil moisture storage capacity and soil drainage needs to be collected. Based on this information, users may apply their model and create several forms of maps.

### 13.2 WHY GIS

The popularity of GIS is due to the ability of the system to tie the databases and their location on the earth. Each point on a GIS map has its own 'address' and therefore it can store an unlimited amount of spatial information about that point (Hanna & Culpepper 1998).

GIS can be defined as a system for capturing, storing, checking, integrating, manipulating, analyzing, and displaying data which are spatially referenced to the earth. In simpler terms it can be said to be a computer-based approach to interpreting maps and images and applying them to solving problems. The use of computers to store, process, manipulate, interpret, and display GIS information has allowed modern GIS to be distinguished from the more conventional (traditional) methods of using maps and correlative data.

Advances in database management (DBMS) take their value far beyond simple retrieval of data and generation of statistics. Users may give several instructions to the databases that will allow for examination of a specific set of conditions not immediately obvious to the user. Apart from that, the user may also see the analyzed data in 3D view from any angle.

Residual soil type mapping can be created using the information recorded from the soil databases. Information on environmental factors such as landform, parent material, and land cover are therefore required. Carré & Girard (2002) used fuzzy logic and environmental criteria to interpolate soil types in describing the soil types of a particular region. Predictions about the occurrences and relative locations of soil types were mapped spatially using GIS. Similarly this method may be applied to determine residual soils to reflect the character of the underlying bedrock.

Kollias et al. (1999) collected information on boring within a study area, and used this data to interpolate a soil map. In particular, ARC/INFO GIS were used to store detailed soil information for every point in developing the 'fuzzy soil maps', which enabled the representation of the spatial variation of the region and to determine the geographical location of the areas of uncertainty. This method for producing soil maps is believed to be less costly and time consuming than traditional methods, and produces more flexible results than classical soil maps.

### 13.3 DATABASE

A database is a model of reality in the sense that the database represents a selected set or approximation of phenomena. The portion of the earth and its attributes are considered the selected phenomena. The relevant information are sorted and classified and recorded in digital and tabular form. Digital representation might be for some past, present or future time periods (or may contain some combinations of several time periods in an organized fashion).

#### *Spatial database*

A spatial database is a collection of spatially referenced data that acts as a model of reality. It may be in the form of a vector having values of geographic locations (the easting, northing and height from a referenced datum or the latitude and longitude), raster or hybrid. Or for that matter, it would be a system employed to capture, store, edit, update, retrieve, analyse and display the objects in 2D or 3D viewing. The spatial data can be referred to as geographical features which are represented in the form of points, linear or polygons.

### *Database elements*

The basic elements of reality modeled in a GIS database feature three identities. The first is known as 'entity' which is the element in reality. The second is the 'object' which is the element as it is represented in the database. A third identity that is important in cartographic applications is the 'symbol' that is used to depict the object or entity as a feature on a map or other graphic displays.

### *Relational databases*

Major types of database are hierarchical, network, relational and object-oriented. The most common usage in GIS is relational. In relational database systems all data are kept in tables. The data is stored in rows and columns, and in separate tables which are related to each other (Burrough 1986). Hence, there can be many tables, each with rows and columns, and within each table there is a column defined as key. The key column is used to relate the data to their locations on the maps. As a result, the tables can be joined or separated, or pieces of the data can be selected and manipulated (Huxhold 1991). Every single bit of the information (every line) in the tables is called records. Relational systems that are employed are useful because they allow us to collect data in reasonably simple tables, keeping the organizational tasks equally simple (Demers 2000).

With the Relational Database format, the following functions can be implemented:

- Sort—to sort all records according to one attribute
- Select—to select all records (rows) given certain attributes
- Join—used to put two tables together if attributes relate to common objects
- Logical operators—used to create new tables using and, or, >, <, or=operators.

### *Data types*

Data types refer to the types and format of data to be stored in databases. In doing this, the fields must be explicitly defined before use. Common data types differ in how data is stored, and how it is to be used in the analysis. Examples of important data types to be considered are the following:

- Character data—Any string of alphanumeric characters
- Integer data—Stored as a string of integers
- Binary integer—An integer stored in binary format
- Number—A string of characters that make a decimal number
- Binary floating point—A decimal number stored in binary format
- Date—A formatted date

### *Data structuring*

Data structuring refers to how data is segregated and stored in the database. It can be defined as 'a representation of the data model often expressed in terms of diagrams, lists and arrays designed to reflect the recording of the data in computer code' (Peuquet 1984).



In the spatial environment, it can be defined as ‘the logical and physical means by which a map feature or an attribute is digitally encoded’ (Clarke 1996).

*Lookup tables*

A lookup table is a special table that keeps the information of the coding of the records in the main tables. When a relation is needed to find the meaning of the records, it will do the ‘many-to-one’ relation searching. It can be easily implemented if the database is in the form of RDBMS. Look up table create a temporary reclassification of data and may be used to separate numeric data into class intervals. For an example, the Figure 13.1 shows how the table of main.dat file is linked to the lookup tables (material.lut, colour.lut and symbol.lut), again as example, the main.dat is linked to material.lut through the column ‘material’ and ‘mcode’. The same file is linked to another table ‘symbol.lut’. The table is created as a reference for displaying the right symbol for the recorded material.

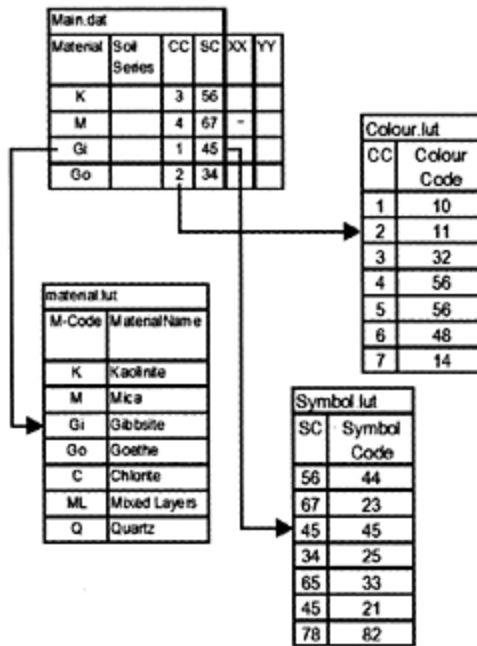

Figure 13.1. Files linkages in RDBMS.

13.4 DATA FOR GIS

There is always demand from various parties to have readily available digital maps. In the context of Malaysia, the need for spatial data in digital format has resulted in individual agencies collecting their own spatial data. The systems that are developed individually contain highly valuable information for the land information user community. If coordina-

tion is not carried out at a centralized level, these stand alone systems will result in an array of disconnected islands of information systems. The user community will thus not be able to gain the full advantage of the existing datasets within a particular country.

Several initiatives in spatial data sharing have been implemented, for example the National Spatial Data Infrastructure (NSDI) in the USA. In Malaysia, the equivalent of the NSDI is the National Infrastructure for Land Information System (NaLIS) set up in 2001 and renamed as Malaysian Centre For Geospatial Data Infrastructure (MaCGDI) in 2002). MaCGDI enables not only the 11 land related agencies in Malaysia to communicate and share spatial data but allows land information users to access the spatial data from a central clearinghouse. The objectives of MaCGDI are to support the sharing of information among producers and users of land data in order to:

- Enable on-line access to land data residing in land related agencies.
- Avoid wasteful duplication of efforts in the collection and production of land data.
- Ensure the accuracy, timeliness, correctness and consistency of land information used in planning for development and management of land resources.

The implementation of MaCGDI has led to the cooperation among Federal, State and Local Authorities in the development and usage of land information in such areas as transportation, community development, agriculture, industry, environmental management and information technology. It avoids wasteful duplication, and promotes effective economic management of resources by these authorities.

### *Data acquisition*

Data acquisition or data input of spatial data into digital format is known to be the most expensive component in any GIS setup and procedures are time consuming in GIS. The data sources for data acquisition should be carefully selected for specific purposes. Figure 13.2 shows an example of data sources and output in a GIS database. Data collection may take place directly in the field especially the agronomic and environmental factors. However the following data sources (Figure 13.3) are widely used for the base spatial basemap:

- Analog maps—Soil maps, topographic maps with contours and other terrain features and thematic maps with respect to defined object classes are digitized or can be purchased from the authority.
- Aerial photographs—are the images taken from aircraft; it can be also taken from a model aircraft using digital camera.
- Satellite imagery—images captured by satellite, upon undergoing image processing, soil type classification, land cover, land use classification, digital elevation model (DEM), and highway network can be sort to different layers.
- Field measurement with GPS/Total Station—will give a very accurate reading but is too expensive to cover wide areas.
- Reports and publications—existing reports such as the soil investigation documents.

Satellite images, analog maps and aerial photographs are important sources of data for the development of a GIS database for soil management and the monitoring and identification

of soil erosion. As an example, Honda et al. (1996) used Landsat data for the analysis of the changes in the forest cover of the Ratu watershed in the Central Siwalik area of Nepal. They then applied topographical parameters in an improved model to estimate the probable annual soil loss.

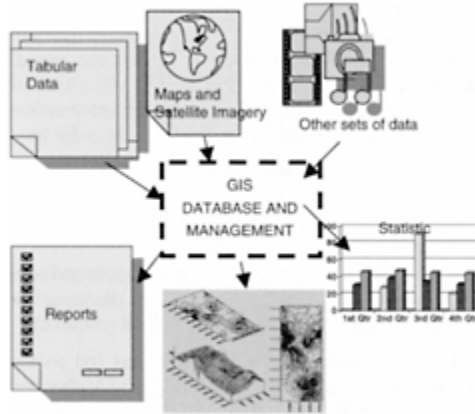

Figure 13.2. Data and output from GIS database.

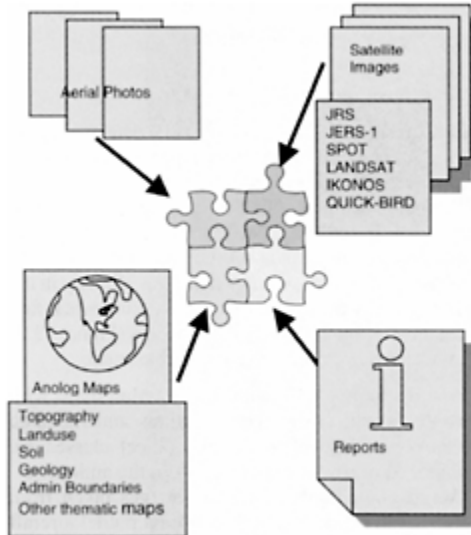

Figure 13.3. Summarizes major spatial data sources for GIS.

Another relevant satellite data which might be useful would be ASTER (Advanced Spaceborne Thermal Emission and Reflection Radiometer) data format. ASTER is an imaging instrument that is flying on the NASA's Terra satellite launched in December 1999. ASTER acquires 14 spectral bands and can be used to obtain detailed maps of land surface temperature, emissivity, reflectance and elevation.

The ASTER data format covers 60×60 km and will take 600 scenes daily. The recorded data exceeds the specified signal to noise ratios (Yamaguchi et al. 2001). ASTER data has been used to map silicate and carbonate rocks (Hewson et al. 2001) and has been used to carry out volcanic studies, urban studies, lithologic mapping, and monitoring of coastal environments (Yamaguchi et al. 2001).

### *Soil data sources*

Spatial location at sampling points during the soil data investigation in particular i.e. the entity of the database location can simply be obtained from site surveying. It can be done directly from measurements on ground (such as using Total Station) or from the use of satellite observation using the Global Positioning System (GPS) technology. Thus, the coordinate of the sampling locations can be determined. The locations of the sampling points will be the entities to be shown graphically for determining the distribution or the extent of the residual soils boundary. Detailed information such as particle size, moisture content, plasticity and density will be the textual information or the attributes of those entities. This sort of information may be kept in different sets of tables for easy retrieval and analysis.

In designing the database, one of the first aspects to be considered is the soil forming factors. As such one should be looking into soil formation and classification. These factors would be the main database file. Among the soil forming factors are the parent material, climate, topography, biological factors and time. Information on these factors is tabulated and becomes the attributes to the geographic features. The data would be attributes to the point or polygon features in the GIS spatial database.

## 13.5 SPATIAL MODELLING, ANALYSIS AND QUERIES

### *Spatial data model*

In this specific discussion, spatial data model may refer to ‘where it is’ and ‘what is present’ at a certain location. The ‘where it is’ refers to the spatial data while the ‘what is present’ refers to the attribute data of the geographic features. Alternatively, the spatial data model may refer to a prediction of a phenomenon that may exist at certain locations. In this case, developing a spatial data model requires several sets of formulation. It is the process of manipulating and analyzing spatial or geographical data to generate useful information for solving complex problems.

### *Spatial analysis*

Generally there are three phases used in normal spatial data analyses. The first phase is the input to the soil type database. The second phase involves the methodology and techniques that can be categorised into two important outputs known as textual and graphical analyses. Under the textual analysis, various statistical outputs can be obtained. These can be in the form of cross tabulation, graphs and prediction models. In the graphical output, analysis can be done based on the drawn location and distribution of the residual soil locations.

The third phase is the action to be undertaken to the site location. A proper spatial modelling needs to be formulated. This should be in accordance to the application or activities to be constructed at the site.

One of the methods to create residual mapping is to extract information by interpolating borehole information of the area. However, when boreholes are scarce, or the terrain is very heterogeneous, this is not a good solution. In such situations, analysis could be made from geomorphologic information and an engineering geological data base. The analyses can be done by logical reasoning whereby the logical operations provided in the GIS function can be applied.

### *Spatial queries*

Spatial queries refer to the location and attributes of the geographic features. It could be as simple as ‘what type of material within this boundary’ or ‘show the area of sandy silt’. GIS are able to support two retrieval mode base on the attribute base on the location. More complex queries would involve displaying certain features with different sets of colors or symbols based on certain set of criteria. The process will involve logical operators such as ‘greater than’, ‘less than’, ‘equal’, etc. Most GIS systems will allow ad hoc queries directly from the available functions. However, complex queries may require several steps that need extra programming script to be included to the system.

## 13.6 VISUALIZATION OF RESIDUAL SOILS

Layers of residual soils generated from a set of sampling points and cross-sections can be visualized in 2D and 3D view. A case study on a development site at Jalan Puchong in Selangor, Malaysia (Figure 13.4) covering an area of 13598 meter square was undertaken. The spatial data consisting of topographic maps, spots heights, cross-sections and nine boreholes were used to identify layers of soils. The boreholes of the previous soil investigation (May 1999) and a recent soil investigation (September 2003) were reviewed, interpreted and tabulated to form attribute tables in the form of a relational database format.

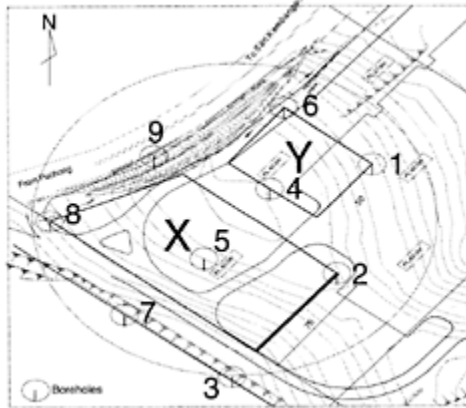

Figure 13.4. Locations of boreholes in the study area.

Table 13.1. Soil profile data.

Borehole number	Depth from surface (meter)					
	1	2	3	4	5	6
BH1	SS	SS	SS	SS	HWR	HWR
BH2	SS	HSS	HCS	HWR	HWR	HWR
BH3	SS	SSS	SSS	SSS	HSS	HWR
BH4	SS	HSS	HSS	HWR	HWR	HWR
BH5	SS	HSS	HSS	HWR	HWR	HWR
BH6	SS	HSS	HSS	HWR	HWR	HWR
BH7	SS	HSS	HSS	HWR	HWR	HWR
BH8	SS	HSS	HSS	HWR	HWR	HWR
BH9	SS	CS	CS	HWR	HWR	HWR

SS=Sandy Silt, CS=Clay Silt, HCS=Hard Clay Silt,  
HSS=Hard Sandy Silt, SSS=Stiff Sandy Silt,  
SCS=Stiff Clayey Silt, HWR=Highly Weathered Rock.

Table 13.1 shows the profile of the soil at the nine boreholes covering the study area. The information from soil investigation was then used to develop the model of the profile before development takes place. Table 13.2 describes the depth of the hard clay from the original ground surface.

Having stored the spatial data and the attributes into the system, the visualization of the soil profiles are then able to be presented graphically in 2D and 3D viewing. Figure 13.5 and Figure 13.6 show the layers generated and viewed from a different perspective for site X and Y respectively. Both models were 'clipped' using the boundaries as shown in Figure 13.4 to the surrounding area of investigation. The surface area covered and the volume of each type of soil can easily be calculated. Several studies can also be done to determine the slope assessment and surface examination. Other applications such as studying the runoff would also be possible.

Table 13.2. Level of highly weathered rock.

Ground level	Interpreted depth of hard clayey	Contour of hard clayey
40	7.6	32.4
42	7.4	34.6
44	7.2	36.8
46	7.0	39.0

48	6.8	41.2
50	6.6	43.4
52	6.4	45.6
54	6.2	47.8
56	6.0	50.0
58	5.8	52.2
60	5.6	54.4
62	5.4	56.6
64	5.2	58.8

---

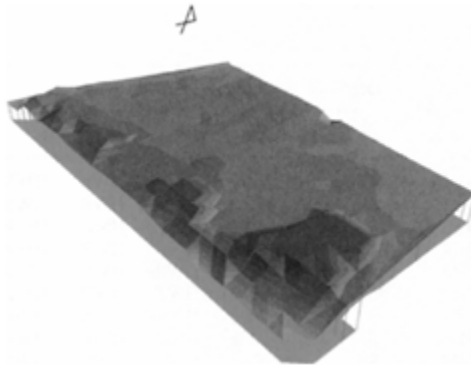

Figure 13.5. Profile of residual soil at site X.

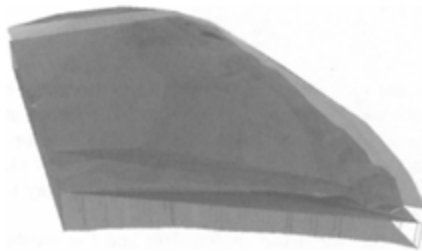

Figure 13.6. Profile of residual soils at site Y.

### 13.7 CONCLUSION

GIS can provide spatial information beyond the traditional methods as spatial data can easily be manipulated and maps can be visualized in 2D and 3D mode. The attributes of

the geographical features, in this case the environmental factors such as landform, parent material, slope, land cover and time factor can be used to predict and create maps of residual soils.

## REFERENCES

- Burrough, P.A. 1986. Principle of geographical information systems for land resources assesment. Oxford: Clarendun Press.
- Carré, F. & Girard, M.C. 2002. Quantitative mapping of soil types based on regression kriging of taxonomic distances with landform and land cover attributes. *Geoderma* 110(3–4): 241–263.
- Clarke, K.C. 1996. *Getting started with geographic information systems*. Prentice Hall, Inc.
- Demers, M.N. 2000. *Fundamentals of geographic information systems*. John Wiley & Sons, Inc.
- Hanna, K.C. & Culpepper, R.B. 1998. *GIS in site design*. John Wiley & Sons, Inc.
- Hewson, R.D., Cudahy, T.J. & Huntington, J.F. 2001. Geologic and alteration mapping at Mt Fitton, South Australia, using ASTER satellite-borne data.
- Honda, K., Samarakon, L., Ishibashi, A., Mabuchi, Y. & Miyajima, S. 1996. Remote sensing and GIS technologies for denudation estimation in a siwalik watershed of Nepal. *Proceedings of ACRS* 1996.
- Huxhold, W.E. 1991. *An introduction to urban geographic information systems*. New York: Oxford University Press.
- Kollias, V.J., Kalivas, D.P. & Yassoglou, N.J. 1999. Mapping the soil resources of a recent alluvial plain in Greece using fuzzy sets in a GIS environment. *European Journal of Soil Science* 50(2): 261–73.
- Pasco International Inc. Tokyo. Proposal on the establishment of national common database and Geo-spatial information system for overall development of Malaysia.
- Peuquet, D.J. 1984. A conceptual framework and comparison of spatial data models. *Cartographica* 21(4): 66–113.
- Yamaguchi, Y, Fujisada, H., Kahle, A.B., Tsu, H., Kato, M., Watanabe, H., Sato, I. & Kudoh, M. 2001. ASTER instrument performance, operational status and application to earth sciences. *IEEE Trans. Geosci. Remote Sens.*



# CHAPTER 14

## Country case study: engineering geology of tropical residual soils in Malaysia

B.K.Tan

*Universiti Kebangsaan Malaysia, Bangi, Malaysia*

This chapter discusses the engineering geology of tropical residual soils in Malaysia. The formation of tropical residual soils and factors affecting soil formation are briefly reviewed. This is then followed by a discussion on weathering profiles. The distribution of tropical residual soils in Malaysia in relation to rock types is illustrated followed by their physico-chemical properties. The chapter ends with a discussion on their engineering significance and how tropical residual soils affect slope stability, dam foundations, etc. drawing on local case histories as illustrations.

### 14.1 INTRODUCTION

Tropical residual soils are widespread in Malaysia, and feature prominently in engineering construction work such as highway cut-slopes, urban developments, dam site excavations, etc. They are also widely used as construction fill materials for highway embankments, earth dams, fill platforms for housing, etc. Given the humid tropical climate that prevails in Malaysia which is characterized by high temperatures and heavy rainfalls, the formation of tropical residual soils is intense with a predominance of chemical weathering of rocks over other processes of weathering, thus resulting in deep weathering profiles and soil mantles often exceeding 30m. The types and properties of the tropical residual soils encountered at each individual construction site depend, of course, on the bedrock or parent material at the site, among other factors. While tropical residual soils are generally good engineering materials, some soils may be problematic. Case histories are presented as illustrations.

### 14.2 FORMATION OF TROPICAL RESIDUAL SOILS

By definition, residual soils (or eluvium) are soils which are derived from the weathering of rocks, formed in-situ and which have not been subjected to any movement or transportation (in contrast to transported soils such as alluvium, colluvium, etc.).

Tropical residual soils are residual soils formed in the tropical areas (in contrast to the temperate regions), generally defined as the regions or climatic zones enclosed between the latitudes 20° North (Tropic of Cancer) and 20° South (Tropic of Capricorn) of the Equator, which includes Malaysia.

Specifically in Malaysia, chemical weathering of the rocks is intense. Chemical weathering involves decomposition of the rock, namely the breakdown of minerals in the rock by various chemical processes such as oxidation, hydrolysis, hydration, carbonation, etc. The products of chemical weathering are new, secondary minerals such as clay minerals and iron oxides/hydroxides (gibbsite, goethite, etc.) which then remain as part of the soil constituents.

Fookes et al. (1971) discussed the effects of different climatic regimes vis-à-vis the different processes of weathering. For example, in cold and dry climatic regimes, physical weathering involving disintegration or physical breakdown of the rocks predominates. In hot and wet climates, as in tropical and equatorial climates, chemical weathering involving decomposition or chemical breakdown of minerals predominates. Additional effects are attributed to biological factors or organisms in the soils, which again are more active in hot and wet tropical climates.

The rock type or parent material is one of the main geological factors controlling the formation and properties of the tropical residual soils. All three major classes of rocks, namely igneous, sedimentary and metamorphic rocks would be subjected to weathering resulting in the production of tropical residual soils. The original mineralogical compositions of the parent rock, its texture and rock mass structures influence the final products and depths of weathering. For example, granites produce predominantly sandy soils, while basalts produce silty and clayey soils. Shales and schists would produce mostly silty soils. Granites produce kaolinitic clays, while shales and schists produce mostly illitic clay minerals.

Topography and drainage are geomorphic factors which can also affect the processes of chemical weathering and hence the products of weathering. Thus for example, the tops or upper portions of hills or slopes would generally contain thicker residual soil mantles compared to the base or valleys. Well-drained soils produce kaolinite as the predominant clay mineral compared to montmorillonite in poorly drained soils. The leaching of soils and the deposition or precipitation of various ions in the soils also depends very much on topography and drainage conditions at a particular site, in addition to soil and pore fluids chemistry.

### 14.3 WEATHERING PROFILES

A prerequisite for engineering in tropical residual soils is the weathering profiles, just as the soil strata or soil profiles at a particular site are prerequisites in soft soil engineering. Since the weathering processes, in particular chemical weathering of the rock, proceed from the ground surface downwards, the weathering profiles by-and-large show stratification roughly parallel or sub-parallel to the ground surface. Thus, the weathering profiles would be sub-horizontal if the original ground surface is horizontal or sloping in parallel with sloping grounds.

Numerous schemes for weathering profiles have been proposed by various researchers in the past, both locally and overseas. For practical engineering usage, however, the

author still prefers the old, simple scheme proposed by Little (1969) illustrated in Figure 14.1. This scheme is easy to use in the field, and clearly defines weathering grades of I-III as rock or bedrock (rock mechanics applies), and grades IV-VI as soils (soil behavior in accordance with principles of soil mechanics). This scheme was derived from work done on granites (igneous rocks)—however, it can also be applied to sedimentary and metasedimentary rocks with some care or experience.

For practical engineering purposes, the tropical residual soils would encompass the entire range of grades IV to VI materials. Note that in Little's (1969) classification, grade VI is designated as 'Residual Soil, RS', not to be confused with tropical residual soils as used here for the entire range of grades IV to VI materials. What the scheme does show clearly is that the different grades of IV, V and VI can and do show significant differences in soil composition and engineering properties. Thus, for example, in cut-slopes, these different grades can have different slope angles and would require different soil stabilization measures.

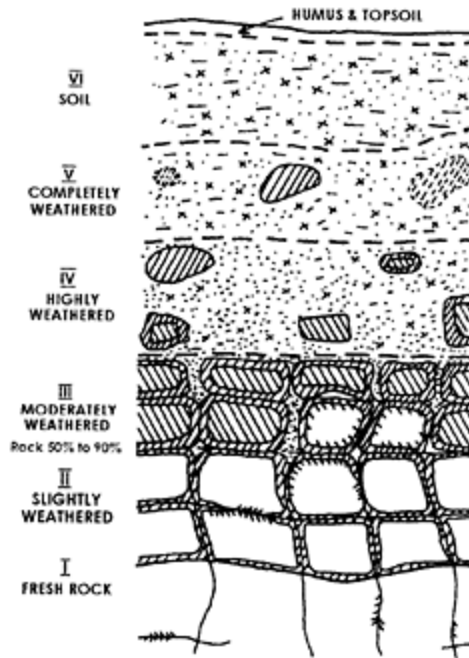

Figure 14.1. Weathering profile (Little 1969).

The thickness of the various weathering zones differs from site to site, and also depends on the various parent bedrock or rock types, and can only be determined from bore holes and upon excavations. Some generalizations, however, are possible from previous experience. Granitic soil profiles often extend up to or in excess of 30 m, at times even 50 m; while residual soils of sedimentary/metasedimentary rocks such as shales and schists are often thinner, say ~10m only.

#### 14.4 DISTRIBUTION OF TROPICAL RESIDUAL SOILS IN MALAYSIA

As residual soils are derived from the weathering of the parent bedrock in-situ, the distribution of tropical residual soils is therefore closely related to the distribution of the various rock types in the country. This in effect means that the geologic map showing the various rock formations in the country is a good guide to the distribution of the various types of tropical residual soils in the country.

Figure 14.2 shows the distribution of the three major 'classes' of tropical residual soils in Peninsular Malaysia, correlated with or based on the distribution of igneous, sedimentary and metasedimentary (metamorphic) rock formations. Note that this is at best a very rough or broad, preliminary guide since the very small scale of the geologic map (1:2,000,000) means that site variations or details are lost in the map. Also, sedimentary and metasedimentary rocks are lumped together in Figure 14.2 when in actual fact, they represent a host of different rock types with very contrasting characteristics and which can produce very different residual soils (eg. sandstone versus shale versus limestone; quartzite versus schist, etc.). Similarly, igneous rocks can span from granites to basalts, which produce entirely different residual soils, for instance sandy versus silty/clayey soils respectively.

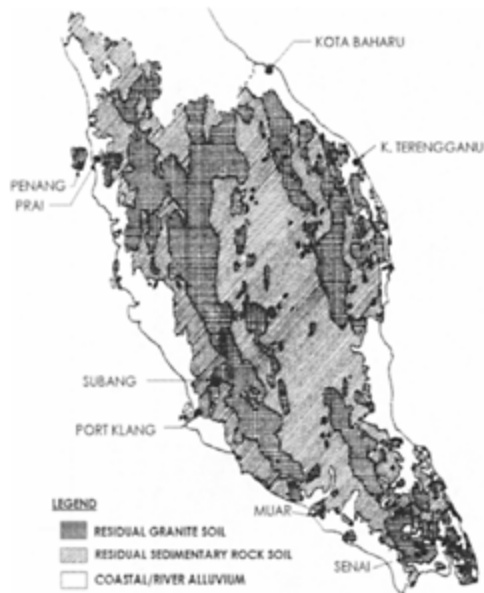

Figure 14.2. Distribution of tropical residual soils in Peninsular Malaysia (Ooi 1982).

For engineering works therefore, larger scale geologic maps e.g. 1:25,000 or 1 inch=1 mile (1:36,630) showing more details would be preferable. This should be followed by detailed site mapping and site investigations, including bore holes. As the geology or lithology varies laterally and vertically, so also the various residual soils, in particular the sedimentary and metasedimentary rock formations and their associated residual soils.

It is worthy of note that precisely because of the intensive and pervasive nature of chemical weathering in the humid tropics, almost all rock formations are overlain by a thick layer of residual soils, thus hiding the actual bedrock from direct surface observation. This results in the geological mapping of various rock formations in the tropical areas (e.g. Malaysia) often being based on 'soil mapping', or on the ability to recognize or differentiate various types of residual soils to infer their parent bedrock. Another implication is that based on the geologic maps, which show various rock formations in colours, one generally cannot expect to see rock on the surface at a particular site—in general, the rock/bedrock will only be encountered at some depths (say tens of meters).

#### 14.5 PHYSICO-CHEMICAL PROPERTIES OF TROPICAL RESIDUAL SOILS IN MALAYSIA

The behavior of a soil mass is dependent on three fundamental properties of the soil, namely its physical properties, chemical properties, and composition of the soil.

Systematic studies have been conducted in the local universities in the recent past on the physicochemical properties of some tropical residual soils in Malaysia (Tan 1990, 1995a, Tan & Anizan 1998). Several student theses have also dealt with the physico-chemical properties of various tropical residual soils in Peninsular Malaysia. This section summarizes some of the major results of these studies. Details can also be obtained from several studies: (Tan 1995b, 1996, 2000, Tan & Ong 1993, Tan & Tai 1999, Tan & Zulhaimi 2000, Tan & Azwari 2001, Tan & Yew 2002).

While Table 14.1 summarizes the physical properties of the tropical residual soils in Peninsular Malaysia, Table 14.2 summarizes the chemical properties of the residual soils. Some brief comments on the physico-chemical properties of these residual soils are given in the following sections.

##### *Granitic soils*

Granitic soils occur widely in Peninsular Malaysia since granites underlie many of the hills and mountain ranges in the Peninsula. Granitic soils are thus widely encountered and are also used in construction, especially in hilly terrain such as in highway and dam construction.

Granitic soils are generally sandy (high sand content), have a lower water content and lower liquid limits compared to basaltic or gabbroic soils. The more well-graded nature of the granitic soils produces higher compacted densities.

##### *Basaltic/andesitic soils*

Basaltic and andesitic soils are not as widespread as granitic soils, and occur only in sporadic patches in Peninsular Malaysia. They are more widespread in East Malaysia, such as in the Tawau area.

Table 14.1. Physical properties of tropical residual soils in Peninsular Malaysia.

Property	Granite				Basalt				Schist			
	JBG	SL	SEG	KTN	Andesite	Gabbro	QS	GS	Shale	Serpentinit		
G <sub>s</sub>	2.49–2.61	2.41–2.56	2.54–2.98	2.62–2.86	2.67–2.99	2.21–2.67	2.35–2.74	2.48–2.76	2.49–2.67	2.77–3.65		
W <sub>0</sub> %	12.0–25.7	27.8–41.6	11.7–40.6	17.3–54.2	16.3–50.6	37.9–57.0	1.20–29.1	4.3–35.8	9.4–41.5	26.1–69.0		
LL%	55.0–91.0	58.0–87.0	50.0–84.0	31.0–85.0	57.5–99.0	72.0–96.0	26.0–64.0	26.0–79.0	30.0–81.0	37.0–96.0		
PL%	33.0–50.0	31.0–45.0	29.0–44.0	26.0–52.0	42.1–85.1	36.0–52.0	21.0–44.0	18.0–45.0	22.0–42.0	30.9–70.0		
PI%	22.0–44.0	26.0–42.0	21.0–40.0	4.0–36.0	8.9–45.7	36.0–45.0	4.0–22.0	4.0–37.0	8.0–39.0	6.1–47.9		
G%	0	0	0–67	0–55	0–38	0	0–10	0–25	0	0–6		
S%	39.0–76.0	40.0–52.0	4.0–56.0	4.0–48.0	3.0–51.0	0–9.0	3.0–84.0	1.0–49.0	26.0–72.0	1.0–65.0		
M%	8.0–37.0	29.0–45.0	4.0–61.0	16.0–66.0	15.0–53.0	37.0–69.0	15.0–82.0	38.0–98.0	26.0–51.0	7.0–69.0		
C%	5–37	15–23	5–64	0–63	18–79	28–60	0–42	0–47	2–25	21–72		
ρ <sub>d</sub> <sub>max</sub> (g/cm <sup>3</sup> )	1.45–1.58	1.41–1.55	1.26–1.80	1.22–1.60	1.15–1.96	1.27–1.39	1.39–1.76	1.33–1.62	1.42–1.76	1.24–1.71		
W <sub>opt</sub> %	23.4–29.0	20.0–32.0	20.0–44.0	29.0–47.5	14.5–47.5	24.0–32.0	13.3–21.2	17.1–30.2	16.0–29.0	22.0–41.0		
Class (fines)	MH	MH	MH	ML-MH	MH	MH	CL-ML/ MH	MH-ML	MH/CL	ML/ MH-CH		

JBG=Johor Baru Granite; SL=Second Link (Highway); SEG=Segamat; KTN=Kuantan; QS=Quartz-mica Schist; GS=Graphitic Schist.

Table 14.2. Chemical properties of tropical residual soils in Peninsular Malaysia (pore fluids chemistry).

Property	Granite					Schist				
	JBG	SL	SEG	KTN	Andesite	Gabbro	QS	GS	Shale	Serpentinite
pH	4.33–6.53	5.01–5.70	6.09–7.13	5.94–6.94	5.68–6.30	3.80–6.70	6.50–6.80	4.50–6.80	5.40–6.50	5.21–5.80
Conduct.	105.8–267.0	89.7–123.0	83.0–552.0	50.0–229.0	57.0–247.0	92.9–810.0	20.0–300.0	100.00–2400.00	81.80–180.00	20.00–224.00
(uS/cm) Na	1.11–15.60	6.30–8.00	7.30–21.50	2.06–21.50	4.06–8.90	5.30–6.90	11.00–57.00	13.50–78.60	5.30–13.60	0.08–8.23
K	0.80–4.60	0.50–1.10	1.23–7.39	1.25–4.31	0.05–11.17	0.36–0.89	0.20–3.30	0.30–13.20	0.70–5.00	0–7.31
Mg	0.01–0.07	0.05–0.16	0.08–6.77	0.05–0.68	0.04–1.56	0.06–0.09	0–1.90	0–18.40	0.02–0.23	0.07–3.57
Ca	0.20–0.66	0.40–0.60	0.40–7.23	0–3.73	0–3.68	0.10–0.80	0.60–6.60	0.20–4.50	0.40–2.47	0.67–3.97
Cl	9.75–20.00	9.00–51.25	3.80–45.80	0	4.50–41.5	9.00–17.50	0–58.0	0–50.0	6.50–38.00	2.50–117.50
SO <sub>4</sub>	10.71–42.00	5.00–30.00	20.00–50.00	35.00–122.0	5.00–35.00	1.00–27.50	1.00–13.50	1.00–130.00	5.00–15.00	12.50
(Na+K)/ (Mg+Ca)	2.00–30.00	11.00–15.00	1.00–19.00	3.00–17.00	3.40–113.00	7.00–82.00	2.00–17.00	4.00–28.00	7.00–19.00	0.04–3.00

Ionic concentrations in ppm.

Note the striking similarities between basaltic and andesitic soils which is not surprising since the two rock types are quite similar in texture (fine-grained volcanic rocks) and mineralogical composition. Basaltic and andesitic soils generally have a higher water content due to a higher fines content compared to granitic soils. Liquid limits are thus also higher. Due to a higher fines content and as they are not as well-graded, basaltic and andesitic soils produce lower compacted densities.

### *Gabbroic soils*

Gabbroic soils occur locally in some parts of South Johor, and have been the subject of studies in relation to some incidents of highway cut-slope failure recently.

The properties of gabbroic soils are similar to basaltic soils since the parent rocks are basic rocks similar in mineralogical composition and vary only in grain size, one being the fine-grained volcanic equivalent (basalt) of the other (gabbro). Gabbroic soils have high fines content, high liquid limits and also produce low compacted densities as in basaltic soils (compared to granitic soils).

### *Residual soils of carbonaceous shales*

Shales represent soft sedimentary rocks often associated with various engineering problems, one of which is the inherent slaking characteristic of shales. Black, carbonaceous shales are even more problematic since, in addition to slaking, they often contain pyrite ( $\text{FeS}_2$ ) which can cause further deterioration in the shear strength of the black shales and associated residual soils.

Shales and schists show comparable low water content. They also have low liquid limits as they are mostly silty soils and produce low compacted densities.

### *Residual soils of graphitic schists*

As in carbonaceous shales, graphitic schists also often contain pyrite which causes deterioration of shear strength of the residual soils with time. They have been the subject of numerous studies/investigations of slope failures along major highways in Peninsular Malaysia (Tan 1992). Highway cut-slopes in graphitic schist soils have invariably failed at slopes of 1V: 1H, 1V: 2H and even 1V: 3H.

As graphitic schist soils have high carbon/graphite content, they have lower compacted densities compared to quartz-mica schist soils. The main chemical characteristic of the graphitic schist soils is the acidity (pH as low as  $\sim 4$ ) of the pore fluids due to oxidation and hydrolysis of the pyrite in the soils producing sulphuric acid as one of the by-products of the chemical reactions. The pore fluids of graphitic schist soils thus show the highest dissolved ions, with consequently high electrical conductivity values and acidity. It is the chemical properties of the graphitic schist soils that contribute to the deterioration in shear strength (loss of cohesion, reduction in friction angle,  $\phi$ ) of these soils resulting in the frequent occurrences of cut-slope failures involving these soils.



*Residual soils of quartz-mica schists*

Though not as problematic as the graphitic schists, quartz-mica schists also produce silty soils with foliations which are also subject to slope failures.

Again, quartz-mica schists produce mostly silty soils, though there can be some sand due to the presence of quartz layers and quartz veins.

*Residual soils of serpentinite*

Serpentinite is an example of an ultramafic rock, and occurs only in very limited places in Peninsular Malaysia. It is recognizable on site by its dark brown to red colour due to the very high Fe contents in the soils, products of the weathering of the ultramafic rock.

*Slumped zone associated with limestone bedrock*

Residual soils formed by the solutioning of limestone bedrock are collectively called 'terra rossa' or residual red clays, and represent the remnants of insoluble residues or impurities in the limestone, now overlying the limestone bedrock. Laterization or the accumulation of iron oxides in the residues impart a reddish colour to the soils, hence the term 'terra rossa'. However, 'terra rossa' does not appear to be common in Malaysia, or at least, not much encounters with these soils have been reported in relation to major engineering works.

What is more important or interesting, since it is often related to foundation work in the Kuala Lumpur area, is the very weak soil or slumped zone associated with limestone bedrock. This slumped zone is located immediately above the limestone bedrock surface, and is recognized by its very low S.P.T. N values of  $\sim 0$  (Figure 14.3). Its origin and characteristics have been discussed previously (Tan 1988, Tan & Ch'ng 1986, Ting 1985). The slumped zone has been encountered in numerous high rise building sites in Kuala Lumpur including in the KLCC or Petronas Twin Towers site (Hamdan & Tarique 1995). Typically for the Kuala Lumpur area, the slumped zone comprises collapsed materials of the Kenny Hill formation that overlies the Kuala Lumpur limestone. The thickness of this slumped zone can vary from several meters to tens of meters. The slumped zone can also occur at great depths, say  $\sim 100$  m from the ground surface. Note that over-lying the slumped zone, materials representing the original, undisturbed residual soils of the Kenny Hill formation can have high S.P.T. N values of, say 30–50, or even  $>50$ , i.e. stiff to hard materials. The slumped zone thus represents a hidden danger or soft 'bottom' that can pose problems if undetected earlier during site investigation.

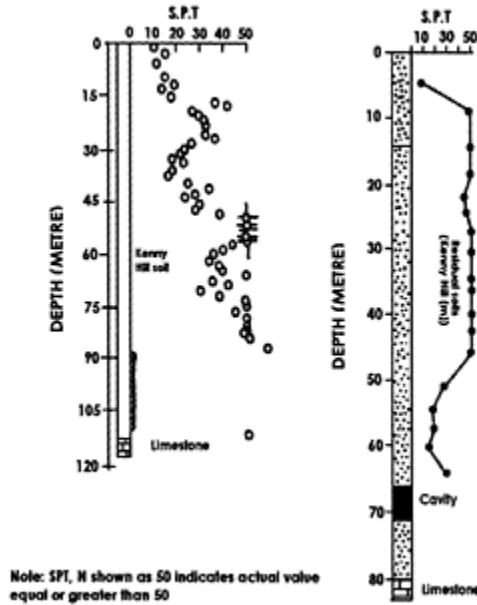

Figure 14.3. Slumped zone with very low S.P.T. N values of  $\sim 0$ .

## 14.6 CLAY MINERALOGY

Clay mineralogy is seldom studied or investigated by soil engineers in Malaysia. Just about the only major study on clay mineralogy relating to engineering projects was the one on soft clays/marine clays associated with some parts of the North-South Expressway (Ramli Mohamad 1992). There might also have been other minor studies on clay mineralogy of soft/marine clays for some other coastal engineering projects such as airports and harbors, but little or none on residual soils. This dearth of studies on clay mineralogy of residual soils is perhaps due to the fact that residual soils are less problematic compared to the soft/marine clays.

Some studies on clay mineralogy of various tropical residual soils have been conducted by students in local universities (Tai 1999, Zulkhaimi 2000, Azwari 2001, Yew 2002). It would appear that kaolinite and illite are the two predominant clay minerals in tropical residual soils in Peninsular Malaysia. Montmorillonite or smectite swelling clays have not been encountered in the residual soils studied. Whether kaolinite or illite forms the dominant clay mineral in a particular residual soil depends on the soil type/parent rock as well as other factors affecting the chemical weathering processes (drainage, pore fluids chemistry, etc.). In general, however, one can say that granitic, basaltic, andesitic and gabbroic soils produce mostly kaolinite clays, while shales and schists produce more illites. For the shales and schist soils, some randomly interstratified clays (e.g. illite-montmorillonite) and chlorite have also been reported (Raj 1987, 1995). In the chemical weathering and reduction of primary minerals to clay minerals, the ultimate, most stable clay mineral to remain in

the soil is kaolinite. Hence, under prolonged and advanced stage of weathering, kaolinite would be the penultimate clay mineral to remain in the residual soil.

Among other things, the study of clay mineralogy in tropical residual soils is relevant to the understanding of the fundamental behavior of the soils and their physico-chemical properties such as the cation exchange capacity, adsorption capability, dispersivity, swelling, etc. For example, high cation exchange capacity, high adsorption capability, and high dispersivity of soils are often attributed to the smectite/montmorillonite swelling clays.

## 14.7 ENGINEERING SIGNIFICANCE AND APPLICATIONS

The engineering significance and applications of tropical residual soils covering the range of weathering grades IV to VI materials (soils) are discussed in the following sections. A more detailed discussion covering the entire weathering profile of grades I to VI materials (rocks and soils) has been presented in an earlier paper (Tan 1995c).

### *Slopes*

Of engineering significance and application in relation to tropical residual soils and weathering profiles is in the cutting of slopes, such as along major highways. Since materials of different weathering grades can have different properties, e.g. shear strength, the stable cut-slope angle may differ from grade IV to grade VI. Also, different residual soils derived from different parent materials may have widely contrasting properties, e.g. granitic soils versus residual soils of graphitic schists. As mentioned previously, while most tropical residual soils are stiff to hard materials and can thus stand at relatively steep slopes ( $45^\circ$ ), the graphitic schist soils have been known to fail even at very gentle slopes of 1V: 3H. Cementation of soil particles as a result of the deposition of secondary iron oxides and hydroxides from chemical weathering enhances the shear strengths of the soils. While turfing and hydroseeding works very well in grades V and VI materials (more silty and clayey soils), problems may arise in the more sandy grade IV materials of granitic soils.

### *Excavation*

Soil excavation would generally be non-problematic. However, because of secondary deposits of iron oxides/hydroxides resulting in layers of iron concretions or hardpans, a very hard layer of 'soil' can result defying conventional soil excavation works. Typical examples of iron concretions or hardpans are encountered in the Air Keroh area in Malacca, where numerous boulders of hardpans are left in excavation sites in schists (both graphitic and quartz-mica schists).

### *General foundation and foundation in limestone*

Tropical residual soils are generally good bearing strata with high bearing capacities. The strength or stiffness of a tropical residual soil also generally increases with depth, e.g. S.P.T. N value increases with depth. Numerous bore hole data in various tropical residual soils attest to this trend of increasing hardness/strength with depth.

The exception to the rule is the slumped zone associated with limestone bedrock, which can have zero S.P.T. N values. This slumped zone can, moreover, underlie stiff to hard residual soils of the Kenny Hill formation in the Kuala Lumpur area, hence a potential danger to foundation works.

### *Dam foundation*

Due to the extensive occurrence of tropical residual soils, many dam foundations will encounter these materials, in addition to alluvial deposits along riverbeds and river valleys. Depending on the types and sizes of the dams, some parts of the dam foundations may rest on weathered rocks or on residual soils. Permeabilities of the residual soils and weathered rocks, grouting requirements of the dam foundations, etc. are some of the relevant areas of concern. Since tropical residual soils are generally silty to clayey and of stiff to hard consistencies, their permeabilities are generally low, say  $<10^{-7}$  m/sec, in which case foundation grouting may not be necessary. However, the more sandy layers, such as the sandy grade IV zone of granitic soils, and interbedded sandstone beds in sedimentary formations, would have much higher intrinsic permeabilities of  $>10^{-5}$  m/sec which would require grouting. Also, highly faulted, sheared or jointed rock formations, irrespective of grain size, would introduce much secondary porosities and conduits which will greatly increase the permeabilities and hence the need for grouting of the dam foundations.

### *Construction material*

Tropical residual soils in general make good construction materials for a host of engineering projects. Materials for the clay core of an earth dam or rockfill dam are often sourced from the grade VI, clay-rich zone of the granitic weathering profiles. More sandy soils can be obtained from the grade IV zone of the granitic weathering profiles.

In engineered fills for housing platforms and highway embankments, various types of tropical residual soils ranging from granitic to shales to schists soils have been used successfully in the past. However, Toh (2003) has demonstrated that the success or otherwise of the use of compacted/engineered fills can be affected by a combination of geological factors such as lithologies and weathering grades, among other things. For example, the compaction of tropical residual soils derived from interbedded sandstone-shale formations can have poor results due to the presence of the harder sandstone cobbles and boulders mixed in the residual soils.

### *Tunnelling*

In so far as tunnelling in rocks is concerned, the presence of significant bands of highly weathered materials (soils) along fault zones or shear zones in the rock mass is a potential tunnelling problem which can be catastrophic if not detected prior to tunnelling and encountered without warning. Flow of soils and water can enter the tunnel in such a situation, leading to flooding and even collapse of the tunnel. An interesting case study of such

a problem in Cameron Highlands, Pahang, has been documented by Newbery (1971). In this case study, the tunnel had to be diverted from its original alignment due to this sudden flow of granitic soils/water into the tunnel when a fault zone was intersected by the tunnelling works.

## 14.8 CONCLUSIONS

This chapter discusses the engineering geology of tropical residual soils in Malaysia, drawing on some case studies with engineering significance and applications to serve as illustrations. Some results of studies on the physico-chemical properties of various tropical residual soils in Peninsular Malaysia are also provided.

## ACKNOWLEDGEMENTS

The author acknowledges the symposium organizers and Universiti Putra Malaysia (UPM) for the invitation to present this chapter. Thanks are also due to Miss Tan Sze Yuen of UPM for her efforts in compiling reference materials related to the formation of soils and weathering, some of which have been incorporated in this chapter.

## REFERENCES

- Azwari Huslan Mohd 2001. Sifat fiziko-kimia dan mineralogi lempung tanah baki sekitar bandar Yong Peng, Johor. B.Sc. Hons. Thesis, Geology Programme. FST, Selangor: UKM.
- Fookes, P.G., Dearman, W.R. & Franklin, J.A. 1971. Some engineering aspects of rock weathering. *Quarterly Journal of Engineering Geology* 4:139–185.
- Hamdan Mohamad & Tarique Azam. 1995. The Petronas Towers, the tallest building in the world. *Journal Institution of Engineers Malaysia* 56(1):119–134.
- Little, A.L. 1969. The engineering classification of residual tropical soils. *Proc. specialty session on the engineering properties of Lateritic Soil, vol. 1, 7th Int. conf. soil mechanics & foundation engineering, Mexico City* 1:1–10.
- Newbery, J. 1971. Engineering geology in the investigation and construction of the Batang Padang hydro-electric scheme, Malaysia. *Quarterly Journal of Engineering Geology* 3(1071):151–181.
- Ooi, T.A. 1982. Malaysian soils and associated problems. Chapter 2, Geotechnical engineering course, 22 March–2 April, 1982, Univ. Malaya, Kuala Lumpur.
- Raj, J.K. 1987. Clay minerals in weathered shales of red beds along the Paloh-Kluang bypass highway. *Newsletter, Geological Society of Malaysia* 13(5):213–219.
- Raj, J.K. 1995. Clay minerals in the weathering profile of a graphitic-quartz-muscovite schist in the Kajang area, Selangor. *Newsletter, Geological Society of Malaysia* 21(1):1–8.
- Ramli Mohamad. 1992. Engineering the North-South Expressway on soft ground. *Proc. Int. conf. on geotechnical engineering '92 (GEOTROPIKA '92), 21–23 April, 1992, Johor Bahru*: 337–356.
- Tai, T.O. 1999. Sifat fiziko-kimia dan mineralogi tanah sekitar Kota Melaka. B.Sc. Hons. Thesis, Geology Dept., FST. Selangor: UKM.
- Tan, B.K. 1988. A short note on the occurrence of a soft soil zone above limestone bedrock. *Proc. Int. conf. on calcareous sediments, Perth, March 15–18, 1988* 1:35–39.
- Tan, B.K. 1990. Kajian ciri tanah & batuan serta kestabilan cerun di kawasan perbandaran Pulau Pinang. Final report, research project no. 81/87, July 1990, UKM.

- Tan, B.K. 1992. A survey of slope failures along the Senawang—Air Keroh Highway, Negeri Sembilan/Melaka, Malaysia. *Proc. 6th Int. symposium on landslides, 10–14 Feb 1992, Christchurch*: 1423–1427.
- Tan, B.K. 1995a. Sifat kejuruteraan bahan basalt dan granit di kawasan sekitar Kuantan, Pahang. Final Report, Research Project no. 59/93, Dec 1995, UKM.
- Tan, B.K. 1995b. Physico-chemical properties of granitic versus basaltic soils of Kuantan, Pahang. *Proc. forum on soil & rock properties, Geological Society of Malaysia, Kuala Lumpur*: 4.1–4.13.
- Tan, B.K. 1995c. Some experiences on weathering of rocks and its engineering significance in Malaysia. IKRAM geotechnical meeting '95, Comparative geotechnical engineering practice, 7–9 June 1995, Penang 2(6):22. (Invited Lecture).
- Tan, B.K. 1996. Physico-chemical properties of some granitic soils from Peninsular Malaysia. *Proc. 12th SE Asian geotechnical conf., 6–10 May 1996, Kuala Lumpur* 1:595–600.
- Tan, B.K. 2000. Physico-chemical properties of some residual soils in Peninsular Malaysia. *Proc. GeoEng 2000, Melbourne*.
- Tan, B.K. & Anizan Isahak. 1998. Sifat fiziko-kimia dan mineralogi lempung beberapa jenis tanah di Negeri Johor. Final report, research project no. S/7/96, UKM, Sept. 1998.
- Tan, B.K. & Azwari Huslan Mohd. 2001. Physico-chemical properties of carbonaceous shale soils in the Yong Peng area, Johor. *Proc. Geological Society of Malaysia annual Geological Conf, Pulau Pangkor*: 229–232.
- Tan, B.K. & Ch'ng, S.C. 1986. Zon tanah lemah di atas batu kapur dasar. *Newsletter, Geological Society of Malaysia* 12(2): 51–57.
- Tan, B.K. & Ong, C.Y. 1993. Physico-chemical properties of granitic soils along the Ipoh-Ct. Jering Expressway, Perak, Malaysia. *Proc. 11th SE Asian geotechnical conf, Singapore*: 217–222.
- Tan, B.K. & Tai, T.O. 1999. Physico-chemical properties of graphitic schist soils from Malacca, Peninsular Malaysia. *Proc. 2nd Asian symp. on engineering geology & environment, Bangi*: 2–8 to 2–10 (Extended Abstract).
- Tan, B.K. & Yew, C.K. 2002. Physico-chemical properties of andesitic soils in the Kg. Awah area, Pahang. *Bulletin no. 45, Geological Society of Malaysia annual geological conf, Kota Bharu*: 31–35.
- Tan, B.K. & Zulhaimi Abdul Rahman. 2000. Physico-chemical properties of graphitic schist soils in the Rawang area, Selangor. *Proc. Geological Society of Malaysia annual geological conf, Pulau Pinang*: 283–286.
- Ting, W.H. 1985. Foundation in limestone areas of Malaysia. Special lecture, *Proc. 8th S.E. Asian geotechnical conf, Kuala Lumpur* 2:124–136.
- Toh, C.T. 2003. Compression of residual soils and weak rock fills. Forum on building on engineered fill. *Institution of Engineers, Malaysia, Petaling Jaya*.
- Yew, C.K. 2002. Sifat fiziko-kimia dan mineralogi lempung tanah baki sekitar kawasan Kg. Awah, Pahang. B.Sc. Hons. Thesis, Geology Programme, FST. Selangor: UKM.
- Zulhaimi Abdul Rahman. 2002. Sifat fiziko-kimia dan mineralogi lempung tanah baki sekitar bandar Rawang, Selangor Darul Ehsan. B.Sc. Hons. Thesis, Geology Programme, FST. Selangor: UKM.

## Author Index

Abidin R.Z. 193  
Ahmad K. 213  
Ali F.H. 57  
Alias A. 21, 145  
Aziz A.A. 213  
  
Bambang I. Siswosoebrotho 145  
Bujang B.K. Huat 1, 21, 37, 145  
  
Chee-Meng C. 169  
Chik Z. 213  
  
Hossain M. 145  
Hui T.K. 193  
Hui T.W. 131  
Hussein A.N. 103  
  
Jamaludin S. 21, 37, 103  
  
Maail S. 37  
Mahmud A.R. 231  
Mansor S.B. 231  
Mohamed Shariff A.R. 231  
  
Nithiaraj R. 131  
  
Omar H. 103  
  
Rahardjo H. 57  
  
See-Sew G. 121  
Shaw-Shong L. 73  
Singh H. 1  
  
Taha M.R. 213  
Tan B.K. 237  
  
Yean-Chin T. 121,169