

Advances in Polymer Science 274

Richard Hoogenboom  
Ulrich S. Schubert  
Frank Wiesbrock *Editors*

# Microwave- assisted Polymer Synthesis

 Springer

**Editorial Board:**

- A. Abe, Yokohama, Kanagawa, Japan
- A.-C. Albertsson, Stockholm, Sweden
- G.W. Coates, Ithaca, NY, USA
- J. Genzer, Raleigh, NC, USA
- S. Kobayashi, Kyoto, Japan
- K.-S. Lee, Daejeon, South Korea
- L. Leibler, Paris, France
- T.E. Long, Blacksburg, VA, USA
- M. Möller, Aachen, Germany
- O. Okay, Istanbul, Turkey
- V. Percec, Philadelphia, PA, USA
- B.Z. Tang, Hong Kong, China
- E.M. Terentjev, Cambridge, UK
- P. Theato, Hamburg, Germany
- M.J. Vicent, Valencia, Spain
- B. Voit, Dresden, Germany
- U. Wiesner, Ithaca, NY, USA
- X. Zhang, Beijing, China

## **Aims and Scope**

The series *Advances in Polymer Science* presents critical reviews of the present and future trends in polymer and biopolymer science. It covers all areas of research in polymer and biopolymer science including chemistry, physical chemistry, physics, material science.

The thematic volumes are addressed to scientists, whether at universities or in industry, who wish to keep abreast of the important advances in the covered topics.

*Advances in Polymer Science* enjoys a longstanding tradition and good reputation in its community. Each volume is dedicated to a current topic, and each review critically surveys one aspect of that topic, to place it within the context of the volume. The volumes typically summarize the significant developments of the last 5 to 10 years and discuss them critically, presenting selected examples, explaining and illustrating the important principles, and bringing together many important references of primary literature. On that basis, future research directions in the area can be discussed. *Advances in Polymer Science* volumes thus are important references for every polymer scientist, as well as for other scientists interested in polymer science - as an introduction to a neighboring field, or as a compilation of detailed information for the specialist.

Review articles for the individual volumes are invited by the volume editors. Single contributions can be specially commissioned.

Readership: Polymer scientists, or scientists in related fields interested in polymer and biopolymer science, at universities or in industry, graduate students.

Special offer:

For all clients with a standing order we offer the electronic form of *Advances in Polymer Science* free of charge.

More information about this series at <http://www.springer.com/series/12>

Richard Hoogenboom · Ulrich S. Schubert ·  
Frank Wiesbrock  
Editors

# Microwave-assisted Polymer Synthesis

With contributions by

D.S. Achilias · S. Bednarz · D. Bogdal · C. Englert ·  
L. Fang · M. Fimberger · B. Grassl · G. Han · S. Hoepfener ·  
R. Hoogenboom · N.E. Leadbeater · K.P. Luef ·  
S. Mallakpour · K. Matras-Postolek · S. Reynaud ·  
U.S. Schubert · A.M. Schwenke · C. Weber · F. Wiesbrock ·  
A. Zadehnazari · H. Zhang

 Springer

*Editors*

Richard Hoogenboom  
Department of Organic Chemistry  
Supramolecular Chemistry group  
Ghent University  
Ghent, Belgium

Ulrich S. Schubert  
Institute for Organic and Macromolecular  
Chemistry  
Friedrich Schiller University Jena  
Jena, Germany

Frank Wiesbrock  
Polymer Competence Center  
Leoben GmbH  
Leoben, Austria

ISSN 0065-3195

Advances in Polymer Science

ISBN 978-3-319-42239-8

DOI 10.1007/978-3-319-42241-1

ISSN 1436-5030 (electronic)

ISBN 978-3-319-42241-1 (eBook)

Library of Congress Control Number: 2016949740

© Springer International Publishing Switzerland 2016

This work is subject to copyright. All rights are reserved by the Publisher, whether the whole or part of the material is concerned, specifically the rights of translation, reprinting, reuse of illustrations, recitation, broadcasting, reproduction on microfilms or in any other physical way, and transmission or information storage and retrieval, electronic adaptation, computer software, or by similar or dissimilar methodology now known or hereafter developed.

The use of general descriptive names, registered names, trademarks, service marks, etc. in this publication does not imply, even in the absence of a specific statement, that such names are exempt from the relevant protective laws and regulations and therefore free for general use.

The publisher, the authors and the editors are safe to assume that the advice and information in this book are believed to be true and accurate at the date of publication. Neither the publisher nor the authors or the editors give a warranty, express or implied, with respect to the material contained herein or for any errors or omissions that may have been made.

Printed on acid-free paper

This Springer imprint is published by Springer Nature  
The registered company is Springer International Publishing AG Switzerland

# Editorial

Microwave-assisted chemistry has become a major research field in recent decades. The term '*microwave-assisted chemistry*' generally refers to the application of microwave irradiation in chemical reactions, enabling the creation of new and efficient protocols for syntheses. The interaction of microwaves with molecules that contain mobile electric charges, such as polar or ionic groups, produces a source of heating that has certain benefits compared with conventional heating methods: It provides very fast and efficient direct heating of molecules, sometimes in combination with *targeted/selective heating* of sample compounds. Additionally, *autoclave conditions* can be obtained by the design of dedicated microwave reactors enabling the use of closed vessels within the setup. Hence, accelerated kinetics resulting in *increased reaction rates and higher yields* can be obtained by overcoming the limitation of reaction temperature to the boiling temperature of the solvent.

In the field of polymer synthesis, the *precise reproducibility of reaction parameters* is an important criterion for quality control. Correspondingly, alteration of process parameters during the polymerization reaction can lead to undesired changes in material properties such as monomer consumption, molar mass distribution, polymer composition and geometry, morphology, mechanical strength, and/or designed functionalization. The performance of microwave-assisted polymerizations in *state-of-the-art laboratory reactors* ensures accurate control and monitoring of the targeted reaction parameters. Hence, microwave-assisted reactions have found broad acceptance in various areas of polymer syntheses, including step-growth polymerizations, free-radical and controlled-radical polymerizations, and ring-opening polymerizations. The use of microwave irradiation has stimulated *ever-increasing research activities in these fields*, as evidenced by a continuous increase in the number of publications and recent achievements in the fields of polymer modification and composite synthesis. Last, but not least, recent advances in the design of microwave reactors have enabled *efficient process scale-up* and accelerated polymer degradation.

This volume of *Advances in Polymer Science* consists of ten chapters that summarize the state-of-the-art in application of microwave irradiation. Starting with the general concepts of microwave-assisted synthesis (Chap. 1 by Nicholas E. Leadbeater), progress in the fields of step-growth polymerization (Chap. 2 by Shadpour Mallakpour), free-radical polymerization (Chap. 3 by Huiqi Zhang), and controlled-radical polymerization (Chap. 4 by Bruno Grassl) are discussed. Subsequently, the most recent developments in the area of ring-opening polymerization in general (Chap. 5 by Frank Wiesbrock) and of cationic ring-opening polymerizations of 2-oxazolines in particular (Chap. 6 by Ulrich S. Schubert, Richard Hoogenboom, and Frank Wiesbrock) have been summarized. Following this, post-polymerization modification reactions (Chap. 7 by Ulrich S. Schubert) and the synthesis of hybrid materials and composites (Chap. 8 by Dariusz Bogdal) are presented. The concluding two chapters focus on new perspectives for up-scaling of microwave-assisted polymerizations (Chap. 9 by Richard Hoogenboom) and the use of microwave irradiation for polymer degradation (Chap. 10 by Dimitris S. Achilias).

We hope that the articles in this volume will be a substantial source of information and inspiration for current and future research on the topic of microwave-assisted polymer synthesis. In conclusion, we would like to cordially acknowledge all contributors for their outstanding contributions to this compilation. Enjoy reading!

Leoben, Austria  
Ghent, Belgium  
Jena, Germany  
May 2016

Frank Wiesbrock  
Richard Hoogenboom  
Ulrich S. Schubert

# Contents

<b>Microwave-Assisted Synthesis: General Concepts</b> . . . . .	1
Nicholas E. Leadbeater	
<b>Microwave-Assisted Step-Growth Polymerizations (From Polycondensation to C–C Coupling)</b> . . . . .	45
Shadpour Mallakpour and Amin Zadehnazari	
<b>Microwave-Assisted Free Radical Polymerizations</b> . . . . .	87
Liangjing Fang, Guang Han, and Huiqi Zhang	
<b>Microwave-Assisted Controlled Radical Polymerization</b> . . . . .	131
Stéphanie Reynaud and Bruno Grassl	
<b>Microwave-Assisted Synthesis of Polyesters and Polyamides by Ring-Opening Polymerization</b> . . . . .	149
Martin Fimberger and Frank Wiesbrock	
<b>Microwave-Assisted Cationic Ring-Opening Polymerization of 2-Oxazolines</b> . . . . .	183
Klaus P. Luef, Richard Hoogenboom, Ulrich S. Schubert, and Frank Wiesbrock	
<b>Microwave-Assisted Polymer Modifications</b> . . . . .	209
Christoph Englert, Almut M. Schwenke, Stephanie Hoepfener, Christine Weber, and Ulrich S. Schubert	
<b>Microwave-Assisted Synthesis of Hybrid Polymer Materials and Composites</b> . . . . .	241
Dariusz Bogdal, Szczepan Bednarz, and Katarzyna Matras-Postolek	



<b>Upscaling Microwave-Assisted Polymerizations . . . . .</b>	<b>295</b>
Richard Hoogenboom	
<b>Polymer Degradation Under Microwave Irradiation . . . . .</b>	<b>309</b>
Dimitris S. Achilias	
<b>Index . . . . .</b>	<b>347</b>

# Microwave-Assisted Synthesis: General Concepts

Nicholas E. Leadbeater

**Abstract** Microwave heating is proving to be a valuable technique in preparative chemistry. Using a modern scientific microwave apparatus it is possible to access elevated temperatures in an easy, safe and reproducible way. By using microwave heating, reaction times can often be decreased, product yields increased and purity enhanced as compared with conventional heating methods. The origins of the rate enhancements observed have been a topic of considerable debate over the years. It is now accepted, however, that microwave heating is just that – heating. As well as giving an overview of the physical chemistry concepts behind microwave heating, this chapter explores the key tenets of microwave-assisted organic chemistry in the context of particular classes of reaction. The chapter discusses topics such as metal catalysis, cycloaddition and condensation reactions, use of gases as reagents, combinatorial chemistry and reaction scale-up.

**Keywords** Combinatorial chemistry · Continuous-flow · Cycloaddition · Metal catalysis · Microwave heating · Organocatalysis · Rearrangement · Scale-up

## Contents

1	Introduction .....	2
2	Frequently Used Terms .....	3
2.1	Specific Microwave Effects .....	3
2.2	Nonthermal Microwave Effects .....	3
2.3	Multimode Microwave Unit .....	4
2.4	Monomode Microwave Unit .....	4
2.5	Simultaneous Cooling .....	4
2.6	Microwave-Assisted Continuous-Flow Organic Synthesis .....	4
2.7	Heating Aids .....	5

---

N.E. Leadbeater (✉)  
Department of Chemistry, University of Connecticut, 55 North Eagleville Road, Storrs,  
CT 06269-3060, USA  
e-mail: [nicholas.leadbeater@uconn.edu](mailto:nicholas.leadbeater@uconn.edu)

3	Physical Chemistry Concepts .....	5
4	Equipment .....	6
5	Microwave Effects .....	8
	5.1 Introduction .....	8
	5.2 Specific Microwave Effects .....	8
	5.3 Nonthermal Microwave Effects .....	9
6	Safety .....	9
7	Metal-Catalyzed Reactions .....	10
	7.1 Coupling Reactions .....	10
	7.2 Alkene Metathesis .....	11
	7.3 Functionalization of Unactivated Carbon–Hydrogen Bonds .....	12
	7.4 Selected Additional Examples .....	14
8	Cycloaddition and Rearrangement Reactions .....	15
	8.1 Diels–Alder Cycloaddition Reactions .....	15
	8.2 Claisen Rearrangements .....	16
	8.3 The Use of Heating Aids .....	16
9	Carbonyl Chemistry .....	17
	9.1 Condensation Reactions .....	17
	9.2 Multicomponent Reactions .....	19
	9.3 Solvent-Free Reactions .....	20
10	Organocatalysis .....	21
11	Reactions Involving Gases as Reagents .....	22
12	Use of Microwave Heating in Combinatorial Chemistry .....	24
	12.1 Introduction .....	24
	12.2 Parallel Processing .....	24
	12.3 Solid-Phase Organic Synthesis .....	25
13	Microwave-Assisted, Continuous-Flow Organic Synthesis .....	27
14	Scale-Up of Reactions Using Microwave Heating .....	28
	14.1 Introduction .....	28
	14.2 Open-Vessel Batch Processing .....	29
	14.3 Sealed-Vessel Batch Processing .....	30
	14.4 Continuous-Flow Processing .....	31
15	Summary .....	32
	References .....	33

## Abbreviations

GHz	Gigahertz
MW	Microwave
ppb	Parts per billion
ppm	Parts per million
UV	Ultraviolet

## 1 Introduction

Microwave heating is a valuable technique in the preparative chemist's toolkit. This is because, using a modern scientific microwave apparatus, it is possible to access elevated temperatures in an easy, safe and reproducible way (for books on the

application of microwave heating to organic chemistry, see [1–3]). Research articles, now numbering into the thousands, have shown that by using microwave heating the reaction times can be decreased, product yields increased and purity enhanced as compared with conventional heating methods. The origins of the rate enhancements observed have been a topic of considerable debate over the years. It is now accepted that heating is just that – heating. From a preparative chemistry standpoint, the use of microwave heating is not limited to organic synthesis. It has found application in materials chemistry (for a review, see [4]), the preparation of inorganic and organometallic compounds (for a review, see [5]) as well as in the biosciences [6, 7]. In the field of polymer chemistry, post-synthesis modification of organic polymers benefits greatly from microwave heating (for reviews, see [8–13]). Radical as well as step-growth and ring-opening polymerizations have all been studied. In addition, the field has broadened to the fabrication of polymer/metal composites as well as biobased materials.

To review each individual reaction performed using microwave heating is beyond the scope of this chapter and also not particularly useful. Instead, the aim here is to present some of the broad areas in which microwave heating has proven a valuable tool and to direct the reader to reviews of these topics for more detailed information. After an overview of some frequently used terms in microwave chemistry and a brief discussion of the physical chemistry concepts, attention will focus primarily on classes of reaction used widely as part of the synthetic organic chemist's toolkit.

## 2 Frequently Used Terms

There are certain terms that are used frequently in the literature for reactions performed using microwave heating. They are summarized here and discussed at various junctures in the chapter.

### 2.1 *Specific Microwave Effects*

Specific microwave effects are macroscopic heating events that occur slightly differently under microwave irradiation than when using conventional (convection) heating methods. They are often difficult (but not impossible) to reproduce without the use of microwave irradiation (see Sect. 5.2).

### 2.2 *Nonthermal Microwave Effects*

Nonthermal microwave effects are effects resulting from direct interaction of the electric component of the microwave irradiation with specific molecules in a reaction medium, leading to orientation effects of dipolar molecules or

intermediates and hence a change in the pre-exponential factor or the activation energy. Additionally, in the case of polar reaction mechanisms where the relative polarity of the reaction is enhanced from the ground state to the transition state, acceleration due to an increase in microwave absorbance of the intermediate could occur. When nonthermal microwave effects are discussed, they are generally invoked as a result of inaccurate comparison of the outcome of microwave and conventionally heated experiments (see Sect. 5.3).

### **2.3 *Multimode Microwave Unit***

A multimode microwave unit is a type of microwave apparatus including household microwave ovens. When microwaves come in to the cavity (heating chamber), they move around and bounce off the walls. As they do so, they generate pockets (called modes) of high energy and low energy as the waves either reinforce or cancel each other out. As a result, the microwave field in the cavity is not uniform. There will instead be hot spots and cold spots, corresponding to the pockets of high and low energy respectively (see Sect. 4).

### **2.4 *Monomode Microwave Unit***

A monomode microwave unit is an apparatus for small-scale synthesis. The cavity of a monomode microwave system is the width of just one wave (mode) and it is possible to heat volumes as small as 0.2 mL effectively. The upper limit of monomode units is determined by the size of the microwave cavity and is usually in the region of 100 mL (see Sect. 4).

### **2.5 *Simultaneous Cooling***

Simultaneous cooling signifies cooling the walls of a reaction vessel with compressed air or a cryogenic fluid while at the same time irradiating the vessel contents with microwave irradiation. The objective is to keep the bulk reaction temperature relatively low while maximizing the applied microwave power. This technique has been found to open the door to the possibility of data misinterpretation, especially with regard to accurate temperature monitoring (see Sect. 10).

### **2.6 *Microwave-Assisted Continuous-Flow Organic Synthesis***

Microwave-assisted continuous-flow organic synthesis is centered around the use of microcapillary reactors. By coating the inside of the capillaries with metal, it is possible not only to use them to perform heterogeneous catalysis but also simply to heat reaction mixtures very effectively (see Sect. 13).

## 2.7 Heating Aids

Heating aids (also known as passive heating elements) are microwave absorbing materials added to a reaction vessel to allow for effective heating of nonpolar reaction mixtures. Heating aids include some ionic liquids as well as solids such as graphite and silicon carbide (see Sect. 8.3).

## 3 Physical Chemistry Concepts

The microwave region of the electromagnetic spectrum is classified as that between 0.3 and 300 GHz, corresponding to wavelengths of 1 m to 1 mm. Because applications such as wireless devices and air traffic control operate in this range, regulatory agencies allow equipment for industrial, scientific and medical (ISM) use to operate at only five specific frequencies. Household microwave ovens and scientific microwave units typically operate at 2.45 GHz (12.25 cm wavelength), with few exceptions (for reviews, see [14]).

Microwave heating is based upon the ability of a particular substance to absorb microwave energy and convert the electromagnetic energy to heat. Molecules with a dipole moment attempt to align themselves with the oscillating electric field of the microwave irradiation, leading to rotation. One molecule excited rotationally by incident irradiation can strike a second, converting rotational energy into translational energy. Under microwave irradiation, a large number of molecules are being rotationally excited and, as they strike other molecules, rotational energy is converted into translational energy (i.e. kinetic energy) and, as a consequence, heating is observed (Fig. 1).

Because microwave heating is dependent upon the dipole moment of a molecule, polar solvents such as dimethylsulfoxide, dimethylformamide, ethanol and water better convert microwave irradiation into heat as compared with nonpolar solvents such as toluene or hexane. That said, a number of other factors also contribute to how rapidly a substance heats upon microwave irradiation. Attributes such as specific heat capacity and heat of vaporization, as well as the depth to which microwave irradiation can penetrate into the sample, can sometimes have a larger impact upon heating rate than its respective dielectric loss. In addition, all these parameters change as a function of temperature, and heat of vaporization changes as a function of pressure. Room temperature water, for instance, is most microwave absorbent at approximately 18 GHz, but as temperature increases, so does the optimum frequency at which water converts microwave irradiation to heat. Generally, however, when synthetic chemists speak of “good” or “bad” microwave absorbers, implied is a 2.45 GHz irradiation source, a small depth-of-field (1–10 cm) and synthetically relevant temperatures (50–150°C).

Due to the ease with which reactions can be performed under sealed vessel (autoclave) conditions, microwave heating opens access to a process window that is

**Fig. 1** Molecule *a* has been rotationally excited by microwave irradiation and is approached by a second molecule *b* (1, 2). Upon impact (3), the rotational energy of *a* is converted to translational movement of *b*. In 4, notice the increase in translational vector magnitude, the consequence of which leads in an increase in molecular collisions (kinetic energy)

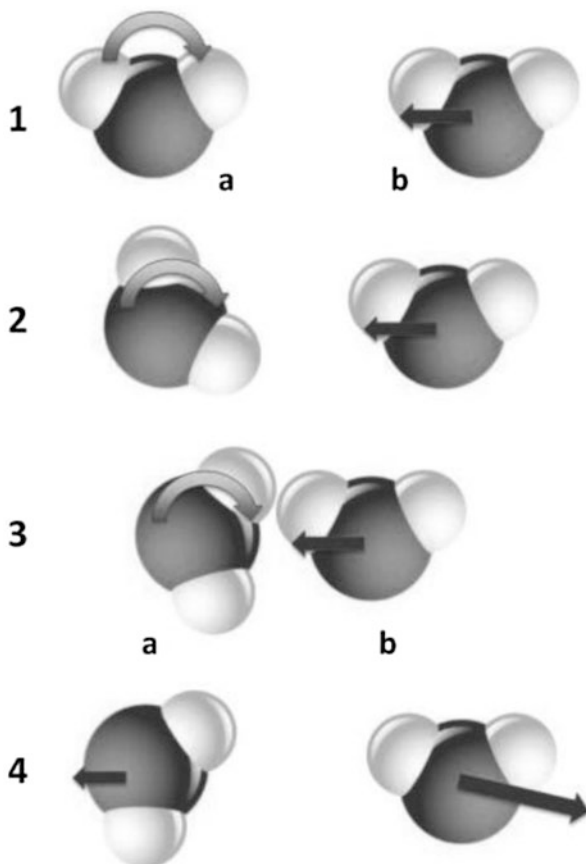

otherwise difficult to access (although not impossible). Nearly any solvent the bench chemist selects becomes a viable option. Ethanol or acetonitrile can replace *N*-methyl pyrrolidinone (NMP); ethyl acetate or methyl ethyl ketone can serve as an alternative to xylenes; and even dichloromethane (b.p. 40°C at 1 atm) can be heated to 160°C within the typical pressure limitations of most commercially available scientific microwave units.

## 4 Equipment

There are two major types of microwave apparatus (Figs. 2 and 3). The larger of these is termed a “multimode” unit; household microwave ovens are an example of this category. When the microwaves come in to the cavity (heating chamber), they will move around and bounce off the walls. As they do so, they will generate pockets (called modes) of high energy and low energy as the waves either reinforce

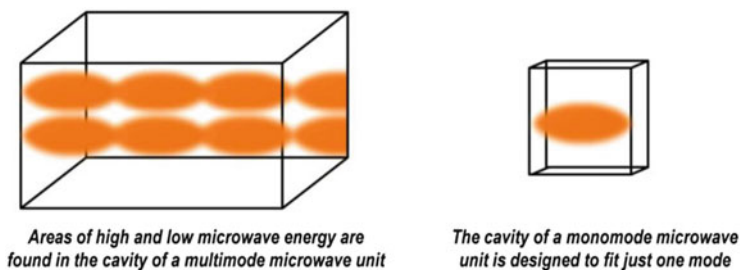

**Fig. 2** Differences between multimode (*left*) and monomode (*right*) microwave units



**Fig. 3** A (larger) multimode (*left*) and a (smaller) monomode (*right*) scientific microwave unit (Reproduced with permission from CEM Corporation)

or cancel each other out. As a result, the microwave field in the cavity is not uniform. There will instead be hot spots and cold spots, corresponding to the pockets of high and low energy respectively. This is why domestic microwave ovens (and their scientific cousins) often have turntables installed. The turntable allows for movement of food (or reaction vessels) around the cavity and equalizes the microwave energy that the sample is exposed to. A number of reaction vessels can be heated at the same time by loading them onto a turntable.

When performing reactions on a small scale it is difficult to heat the mixture effectively in a multimode microwave unit. To overcome this, single-mode (also called monomode) units have been developed. The cavity of a monomode microwave system is the width of just one wave (mode) and it is possible to heat volumes as small as 0.2 mL effectively. The upper limit of monomode units is determined by the size of the cavity but is usually in the region of 100 mL.

There are a range of peripheral tools that are available for interfacing with both monomode and multimode scientific microwave units. They range from devices to increase throughput to those that allow for novel applications of microwave irradiation, thus opening new avenues for fundamental research.

Using a scientific microwave apparatus it is possible not only to perform reactions using sealed vessels but also using standard reflux glassware. Clearly, operating in this so-called “open-vessel” mode means that the maximum temperature reached is that of reflux, negating one of the main advantages of microwave



heating; namely accessing high temperatures and short reaction times. That said, there are several classes of reaction that benefit from it, including those that lead to the formation of a gaseous byproduct or those that are facilitated by removal of a product or byproduct during the course of the reaction.

## 5 Microwave Effects

### 5.1 Introduction

Microwave heating *can* be different to “conventional”, solely convection-based, heating. Numerous attempts have been made to evaluate the differences between microwave versus conventional heating, either real or perceived. For the most part, these differences have been divided into two categories: “specific” microwave effects and “nonthermal” microwave effects.

### 5.2 Specific Microwave Effects

Specific microwave effects encompass macroscopic heating events that occur slightly differently under microwave irradiation than when using conventional (convection) heating methods. Specific microwave effects are often difficult (but not impossible) to reproduce without the use of microwave irradiation. The first specific microwave effect has already been addressed: substrates that better convert incident microwave irradiation into heat, allow the bulk to be heated faster. For example, heating 2 mL of water to 100°C from room temperature will take considerably less time than heating 2 mL of toluene across the same temperature range and utilizing the same applied microwave power at 2.45 GHz.

The next specific effect of microwave irradiation is that of inverted temperature gradients. Conventional heating must heat reactions from the outside in, and the walls of the reaction vessel are generally the hottest part of the reaction, especially during the initial ramp to the desired temperature. Microwave heating, on the other hand, can lead to inversion of this gradient because heat is generated across the entire reaction volume and a larger cross-section of the reaction may reach the ideal reaction temperature sooner than it would have with conventional heating. However, efficient stirring and controlled heating can generally mitigate temperature gradients in both microwave and conventionally heated reactions.

A third example of specific microwave effects is the phenomenon of macroscopic superheating [15]. Solvents will only boil when they are in contact with their own vapor and, if this is not the case, they can be heated to above their normal (atmospheric) boiling point without the onset of boiling [16]. Without nucleation sites, solvents are only in contact with their own vapor at the top of the vessel, thus boiling (and hence release of heat) is limited to this relatively small interface. Using microwave irradiation, solvents have been held well above their boiling points for extended periods of time.

The final example of a specific microwave effect is the ability to heat very microwave absorbant substrates and/or catalysts selectively under heterogeneous reaction conditions. An example is in the synthesis of CdSe and CdTe nanomaterials using the nonpolar hydrocarbons heptane, octane and decane as solvents [17, 18]. The precursor substrates are purported to absorb the microwave irradiation selectively, leading to more uniform morphology in the resulting nanomaterials as compared to conventional heating methods. Selective heating at the point of reaction is, however, the exception rather than the rule, existing in only very specific instances.

### 5.3 *Nonthermal Microwave Effects*

Numerous attempts have been made over the past 20 years to rationalize *perceived* enhancements in reaction rates that could not be explained according to typical models (e.g. the Arrhenius equation) (for reviews, see [19, 20]). Reactions were often performed side-by-side, one in a microwave unit and one in an oil bath, and these reactions were purportedly carried out at identical temperatures, with increased yields or decreased reaction times almost exclusively reported when using microwave as opposed to conventional heating. However, when meticulous attention is paid to reaction set-up and accurate temperature monitoring, the playing field again becomes level. Some examples of reactions in which nonthermal microwave effects have been invoked are discussed at different points throughout this chapter.

## 6 Safety

Household microwave ovens are not suitable for chemistry and should be relegated to where they belong; the kitchen. All scientific microwave apparatus is built with safety in mind and comes with temperature, pressure and microwave power measurement devices. This said, attention to safety is still essential. Elevated pressure in sealed systems poses a significant hazard. If gases or other volatile components are produced stoichiometrically during the course of a reaction this will add to the internal pressure. Efficient stirring is very important and an additional precaution related to magnetic stirrer bars when used in vessels that are placed into a microwave field is that they should not be one quarter of the wavelength of the radiation in length (i.e. ~3 cm), otherwise they can function as an antenna and may lead to destruction of the stirring bar and even rupture of the vessel.

When performing a reaction on a small scale using a monomode microwave unit, a temptation is to heat the reaction mixture with the full microwave power available. However, this can sometimes lead to uncontrollable temperature and pressure rises and, as a result, vessel failure. Although reactions performed using microwave heating can potentially be scaled directly in a linear manner, it is important to take a

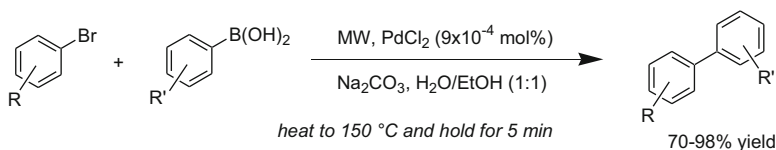

R = 4-Me, 4-OMe, 4-COMe

R' = 2-Me, 4-OMe, 4-COMe, 4-NHAc

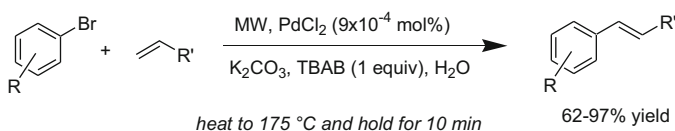

R = H, 2-Me, 4-Me, 4-OMe, 4-COMe, 4-Cl

R' = Ph, CO<sub>2</sub>H

TBAB = Tetrabutylammonium bromide

**Scheme 1** Suzuki and Heck coupling reactions performed using ultralow catalyst loadings

gradual approach; test reactions at intermediate scales being a wise precaution. This is particularly important when performing chemistry using concentrated or solvent-free protocols.

## 7 Metal-Catalyzed Reactions

### 7.1 Coupling Reactions

Because many metal-catalyzed coupling reactions require heating, often for extended times, microwave heating has found significant application [21]. Palladium catalysts have perhaps been the subject of the most attention [22, 23]. In a number of cases, simple palladium salts have been used as catalysts. Under the reaction conditions used, highly catalytically active nanoparticulate palladium is formed and reactions such as the Suzuki [24] and Heck [25] couplings can be performed using catalyst loadings of as low as 50 ppb to 10 ppm (Scheme 1). Reactions can be complete after 5 min heating at 150°C.

Microwave-assisted cross-coupling reactions have also found application in the preparation of organic materials. For example, polythiophenes can be synthesized by sequential borylation/Suzuki coupling protocols (Scheme 2) [26, 27]. Quinque- and sexithiophenes can be prepared this way. Longer oligomers can be synthesized by a similar methodology but incorporating both microwave heating and ultrasound irradiation, another modern processing tool (for a review, see [28]). Suzuki coupling and borylation reactions are performed using microwave heating, with selective bromination of thiophene rings being achieved under ultrasound irradiation [29].

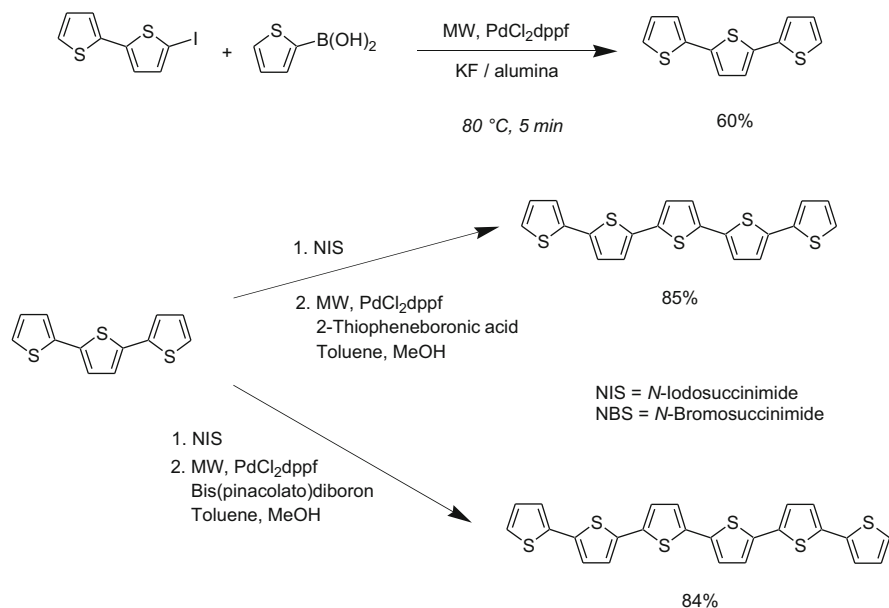

**Scheme 2** Microwave-assisted synthesis of polythiophenes

The application of microwave heating is by no means limited to carbon–carbon cross-coupling reactions. It has been used for C–N, C–O, C–P and C–S couplings with success [30]. Also, a wide range of heterogeneous catalysts have been used for cross-coupling reactions employing microwave heating [31]. Although claims have been made that it is possible to superheat supported catalysts when using microwave heating, experimental evidence for this is lacking in all but a few extreme cases [17]. Even though the supported catalyst may in some cases be the most microwave absorbing component of the reaction mixture, the dissipation of heat is rapid, especially if the reaction mixture is stirred [32]. Therefore, any temperature gradient between the catalyst and bulk reaction medium is most probably small. That being said, heterogeneous catalysis and microwave heating do form a valuable partnership [33, 34].

## 7.2 Alkene Metathesis

Among the numerous different classes of reaction, ring-closing metathesis (RCM) using ruthenium-based catalysts has perhaps seen the most attention, with reactions reported to be completed within minutes or even seconds at elevated temperatures, instead of hours at room temperature (for a review, see [35]). Early reports suggested that the rate enhancements observed were as a result of the direct

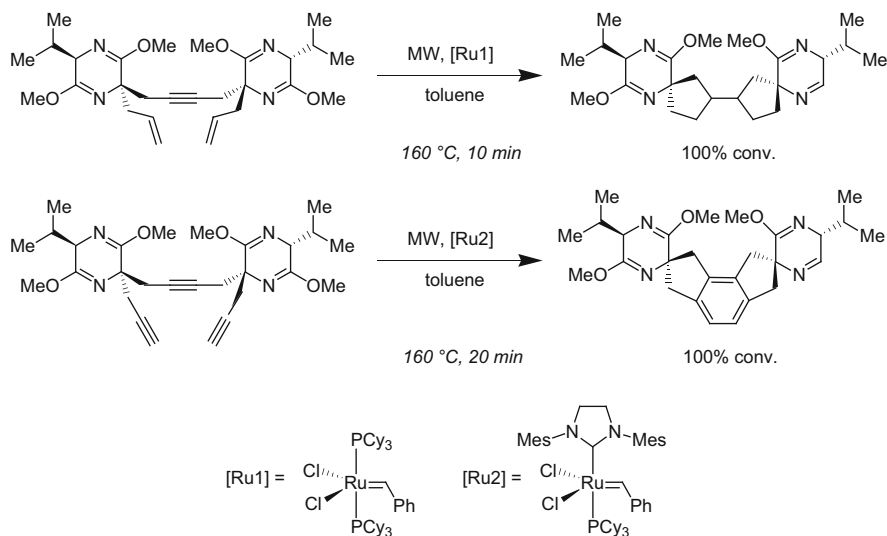

**Scheme 3** Domino dienyne and triyne ring-closing metathesis

activation of the catalyst and/or the alkene [36–38] but performing the reaction using microwave and conventional heating under strictly isothermal conditions shows no evidence for such effects [39].

The use of microwave heating for metathesis is not limited to alkenes; for example, alkyne and ene-yne metathesis have also benefitted (see [40, 41]). One particularly interesting case is the domino dienyne and triyne ring-closing metathesis of suitably functionalized substrates (Scheme 3) [42]. Performing the reaction conventionally at 95 °C in toluene requires multiple additions of fresh catalyst over the course of 9 h in order to obtain a good yield of the products. Using microwave heating, one dose of catalyst followed by 10 min at 160 °C is sufficient to obtain complete conversion.

### 7.3 Functionalization of Unactivated Carbon–Hydrogen Bonds

The selective functionalization of unactivated carbon–hydrogen bonds has proven to be one of the most challenging transformations for synthetic chemists to accomplish [43, 44]. Employing microwave heating, rhodium catalysis has been used for the direct coupling of heterocycles with aryl bromides and iodides [45–47]. In a similar vein, electron-deficient nitrogen heterocycles can be coupled with iodoarenes without the addition of a transition metal catalyst, the reaction being promoted by potassium *tert*-butoxide (KO<sup>t</sup>Bu; Scheme 4) [48]. There is evidence

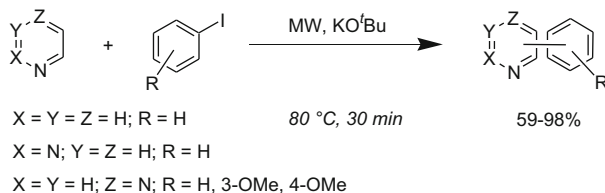

**Scheme 4** Potassium *tert*-butoxide-promoted coupling of electron-deficient nitrogen heterocycles and aryl iodides

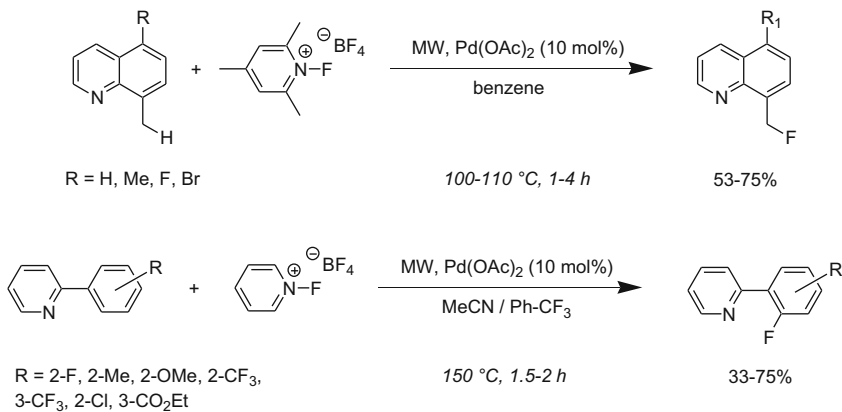

**Scheme 5** Palladium-catalyzed fluorination of C–H bonds

for a radical mechanism in this and subsequent similar couplings reported in the literature; the combination of a strong base and an amine ligand initiating a single electron transfer to an aryl–halide bond at high temperatures. That said, care needs to be taken when defining a reaction as truly transition-metal-free. This is especially the case when reactions are performed at elevated temperatures because very low loadings of metal can effect remarkably fast catalysis. A number of previous “transition-metal-free” couplings have later been found to contain adventitious metal as contaminants in reagents that subsequently act as a catalyst [49].

Microwave heating can also be used in conjunction with iridium (see, for example [50]), palladium (see, for example [51]) and copper (see, for example [52]) catalysis to form C–H bond-activated products. With the increasing interest in the incorporation of fluorine into molecules (see, for example [53]), the Pd-catalyzed fluorination of C–H bonds is a noteworthy example [54]. The reaction involves the use of electrophilic *N*-fluoropyridinium reagents. Heating in the presence of catalytic palladium acetate allows for the fluorination of C–H bonds in a variety of substituted 2-arylpyridine and 8-methylquinoline derivatives (Scheme 5).

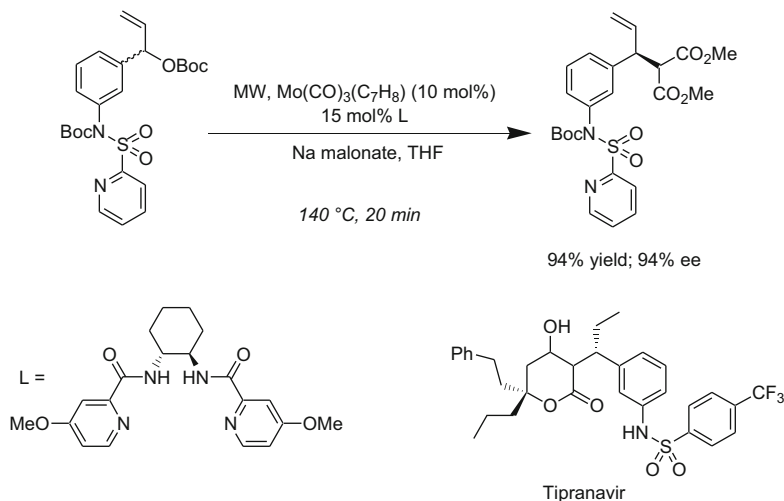

**Scheme 6** Molybdenum-catalyzed double dynamic kinetic asymmetric transformation in the synthesis of Tipranavir

#### 7.4 Selected Additional Examples

Microwave heating has, of course, found application in a range of other metal-catalyzed processes that require heat. Gold catalysis, a topic of much current interest (for an introduction, see [55]), can benefit from microwave heating; hydroaminations [56], hydroarylations [57] and intramolecular [4+2] cycloadditions [58] being examples. Click reactions such as the Huisgen 1,3-dipolar cycloaddition of azides and alkynes, along with its copper-catalyzed analog can all benefit from microwave heating (for reviews, see [59, 60]). Microwave-assisted copper-catalyzed click chemistry is not limited to organic chemistry. Application has been found in supramolecular [61–65], oligonucleotide [66–68], carbohydrate [69–73] and polymer chemistry [74, 75], to mention a few.

A common misconception is that microwave heating is not suitable for enantioselective reactions. This is definitely not the case. Metal-catalyzed asymmetric allylic alkylation reactions can be performed in high yield and enantioselectivity (see, for example [76, 77]). They are generally run at 145–220°C for between 30 s and 20 min. The same reactions often take a day or more at room temperature. This chemistry has been used as a key step in the synthesis of Tipranavir, an orally bioavailable HIV inhibitor (Scheme 6) [78].

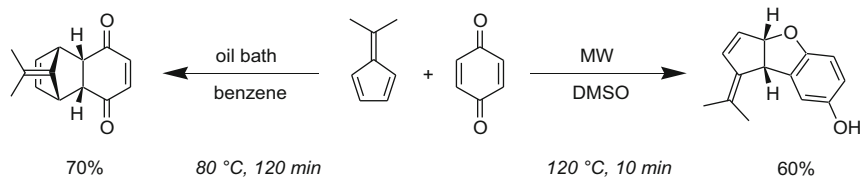

**Scheme 7** Diels–Alder reaction of 6,6-dimethylfulvene with benzoquinone

## 8 Cycloaddition and Rearrangement Reactions

### 8.1 Diels–Alder Cycloaddition Reactions

Cycloaddition reactions are often performed at high temperatures. A glance at the literature shows that these reactions are now frequently carried out using microwave heating and thus they have been the subject of a wide array of research articles in the field (for a review, see [79]). The application of microwave heating to the Diels–Alder [4+2] cycloaddition goes back to one of the two initial papers on microwave-assisted organic synthesis published in 1986 [80]. There, and in a subsequent report [81], five Diels–Alder reactions were performed in sealed tubes using a domestic microwave oven. In each case, the reaction time was decreased and the yield increased over the conventional approach. The microwave reactions were performed at higher temperatures than the conventional comparisons, as well as being run in sealed tubes rather than reflux, these factors explaining the rate acceleration seen. These early reports sparked other work in the area and it was not long before the topic of nonthermal microwave effects raised its head. In one example, cyclic dienes were reacted with acetylenic dienophiles under solvent-free conditions [82]. Comparing experimental results obtained with microwave and conventional heating, and taking into account some computational chemistry studies, the conclusion was drawn that nonthermal microwave effects were at play. However, a reassessment of the work shows that differences in yield and regiochemical outcome between conventional and microwave heating come down to inaccurate temperature measurement [83, 84]. When microwave and oil-bath experiments were both performed using in-situ temperature measurement by means of a fiber-optic probe, identical results were obtained. A more egregious example of a purported nonthermal microwave effect is the case of the reaction of 6,6-dimethylfulvene with alkenes and alkynes (Scheme 7) [85]. When using microwave heating, the reactions were performed at 120–150 °C in dimethylsulfoxide as the solvent. Conventionally heated examples were run at 80 °C in benzene and different products obtained. This is clearly not a fair comparison of the two heating methods; different solvents and different temperatures and different reaction times being used. The reaction has more recently been assessed computationally and, not surprisingly, thermal effects alone were deemed responsible for the differences in regioselectivity or product yield [86].



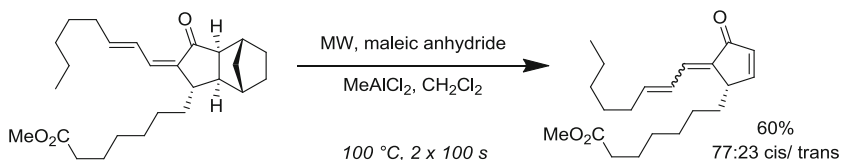

**Scheme 8** Lewis acid-catalyzed retro-Diels–Alder reaction

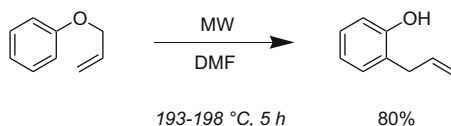

**Scheme 9** Claisen rearrangement of allyl phenyl ether to 2-allyl phenol

Hetero-Diels–Alder cycloadditions can also benefit from microwave heating (for examples, see [87, 88]) as can retro-Diels–Alder reactions (for examples, see [89, 90]). In the case of the latter, the Lewis acid-catalyzed unmasking of cyclopentenone building blocks can be used to prepare precursors to arachidonic acid derivatives, maleic anhydride being used as a trap for the cyclopentadiene byproduct (Scheme 8) [91, 92].

From a materials chemistry perspective, single-walled nanotubes (SWNTs) and fullerenes such as C<sub>60</sub> can be derivatized by means of Diels–Alder and hetero-Diels–Alder reactions (for a review, see [93]). The relatively low-lying LUMO (lowest unoccupied molecular orbital) of C<sub>60</sub> makes it behave as an electron-deficient alkene and it reacts relatively rapidly under the high temperature conditions. Nanotubes react similarly, albeit significantly slower.

## 8.2 Claisen Rearrangements

As with the Diels–Alder reaction, the application of microwave heating for the Claisen rearrangement goes back to the first reports in organic chemistry, allyl phenyl ether being converted to 2-allyl phenol in 80% yield after 5 h at around 200 °C (Scheme 9) (for a review, see [94]). This same reaction has been studied using a range of different microwave equipment, serving as a good example of a high-temperature transformation. Microwave heating has also seen significant application in the aza-Claisen rearrangement (for a review, see [95]).

## 8.3 The Use of Heating Aids

Given that many cycloadditions and rearrangements require elevated temperatures, that the reagents are often nonpolar and that the transformations are traditionally performed in nonpolar solvents, heating the reaction mixture using microwave

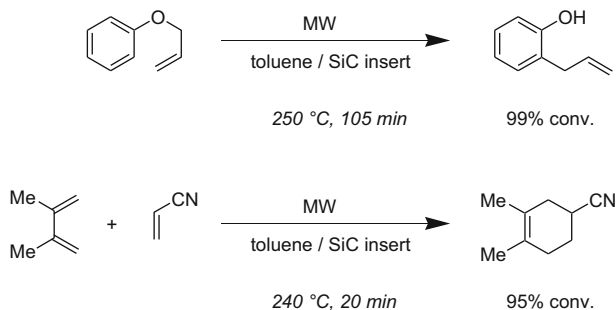

**Scheme 10** Silicon carbide heating aids in cycloaddition and rearrangement reactions

irradiation can sometimes be a challenge. To overcome this, highly microwave-absorbing heating aids have been used. This indirect heating of the reaction mixture allows elevated temperatures to be reached quickly and effectively. Clearly, the heating aid must not react chemically with the reagents. One class of compounds that has been used is ionic liquids because many are immiscible with common organic solvents and they heat very rapidly upon microwave irradiation (for reviews, see [96, 97]). Silicon carbide (SiC) heating elements can also be used effectively (for a review, see [98]). This material is highly microwave absorbing, chemically inert and has a very high thermal conductivity and melting point. Small SiC cylinders can be added to reaction mixtures without compromising the ability to stir the vessel contents. The Claisen rearrangement of allyl phenyl ether and the Diels–Alder reaction of 1,3-dimethylbutadiene and acrylonitrile can both be performed effectively using this approach (Scheme 10) [99]. Rather than use a cylinder of SiC as a heating aid, the entire microwave vessel can be made of silicon carbide [100]. This albeit costly option does allow for interesting comparisons between microwave and conventional heating to be made [101]. Silicon carbide can additionally be used as a material for manufacturing well-plates with application in combinatorial chemistry (for a review, see [102]).

## 9 Carbonyl Chemistry

### 9.1 Condensation Reactions

Condensation reactions often require heat and have been performed extensively using microwave irradiation. Examples include Knoevenagel (see, for example [103, 104]), aldol (for examples, see [105, 106]) and Dieckmann (for examples, see [107, 108]) condensations. Broadening the topic somewhat, esterification and transesterification reactions have been performed extensively using microwave heating (for examples, see [109, 110]). As well as being a tool for preparation of simple esters, the technology has been used for the acid- (for examples, see [111, 112]) or base-catalyzed [113] (for other examples, see [114, 115]) preparation

of biodiesel, a biorenewable fuel formed as the product of the transesterification of vegetable oil and methanol. The base-catalyzed reaction is very rapid and, by working in continuous-flow mode, it is possible to produce up to 7 L of biodiesel per minute with a modestly sized microwave unit [116]. When using butanol instead of methanol as a reagent, the reaction can be performed in the absence of a catalyst by operating in a sealed vessel at 310°C for 4 h [117]. To reach this temperature, six silicon carbide inserts are used as heating aids and the reaction has to be performed in a thick-walled quartz vessel capable of withstanding the 80 bar autogenic pressure involved. The same reaction can be performed more rapidly and at ambient pressure by using an acid catalyst [118].

These condensation reactions involve loss of a small molecule, often water. In addition, many of the reactions are reversible in nature, an equilibrium being established in solution. This can pose a problem when using a sealed tube to perform the reaction. Although elevated temperatures can be achieved under these conditions, removal of the water as it is formed is not possible unless a drying agent is added. The obvious choice is molecular sieves. However, literature suggests that they cannot be used efficiently as water scavengers under standard sealed-vessel microwave heating conditions [119]. The reasons for this are not so much associated with the fact that these zeolite materials are strong microwave absorbers but more because their ability to remove water is at its maximum at room temperature. The issues associated with operating in sealed-vessel mode can be overcome by using an open-flask approach in conjunction with a Dean–Stark trap or reactive distillation (for an example, see [120]). Take, for example, the esterification of acetic acid with butanol [121]. Using a 1:1 molar ratio of the reagents and sulfuric acid (1 wt%) as catalyst, the reaction mixture is heated until water starts to accumulate in the Dean–Stark trap and then held at this temperature (103°C) until water stops being generated. Looking at the case of the acid-catalyzed reaction of diethyl adipate with butanol, the reaction could be driven towards completion by removing the ethanol byproduct [121]. Working with a 2:1 molar ratio of butanol to diethyl adipate, the reaction mixture is first heated to 105°C, holding it at this temperature for 10 min. The temperature is then raised to 115°C and held for another 10 min. By this time all the ethanol produced in the reaction is removed. The temperature is then raised one more time, to 145°C, to strip off any butanol remaining in the reaction mixture, leaving the dibutyl adipate product in the reaction vessel (Scheme 11).

Clearly, operating in open-vessel mode means that the maximum temperature reached is that of reflux, negating one of the main advantages of microwave heating; namely, accessing high temperatures and short reaction times. However, the examples shown here demonstrate that performing a distillation from a scientific microwave allows an exquisite level of control not easy to duplicate in an oil or sand bath (for an example, see [122]). As well as in preparative chemistry, this has been leveraged in the field of natural products, flavors and fragrances, being used extensively as a tool for extraction of essential oils from plants and fruits (for reviews, see [123, 124]).

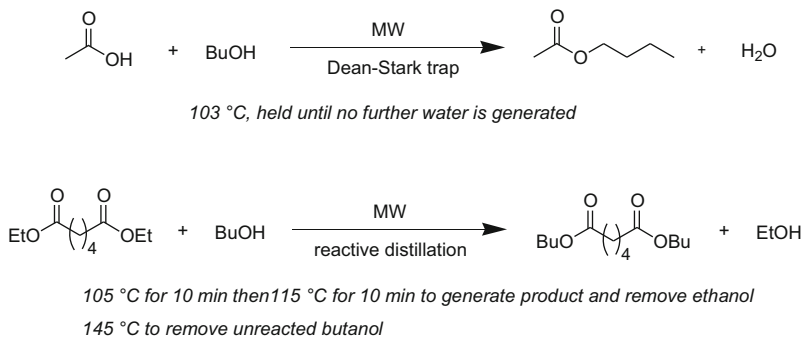

**Scheme 11** Application of a Dean–Stark trap or reactive distillation

## 9.2 Multicomponent Reactions

Multicomponent reactions (MCRs), defined as one-pot processes in which at least three easily accessible starting materials react to give a single reaction product, are of tremendous use for the introduction of many points of structural diversity into heterocyclic compounds in a single synthetic step. Combining these features with the short reaction times possible when using microwave heating provides a rapid and efficient route to libraries of heterocycles (for reviews, see [125–127]). Microwave heating has found application in synthetic routes to a wide array of nitrogen-, oxygen- and sulfur-containing, five- and six-membered partially unsaturated or fully aromatic heterocyclic rings by means of MCRs involving carbonyl compounds [128, 129].

Given the number of variables involved in multicomponent reactions (including reagent stoichiometry, catalyst, solvent, temperature and time), optimization can be a labor-intensive process. A “design of experiments” (DoE) approach can be used to accelerate this (for a review, see [130]). Simple experimental designs and statistical tools for data analysis can provide a great deal of information about a reaction after only a few experiments. Instead of having to optimize each parameter individually, a DoE approach involves performing a set of key reactions, statistical analysis of which can give a valuable insight into which parameters are most important. This is followed by an optimization component where the best settings for the important variables are determined, again by performing a discrete set of reactions and analyzing the data using statistical methods. As most synthetic chemists are not by training statisticians, there is an array of commercially available software packages available to help. A DoE approach has been combined with microwave heating for optimizing both the Biginelli [131] and Ugi [132] reactions, among others. In the synthesis of the mitotic kinesin Eg5 inhibitor monastrol by the Lewis-acid catalyzed Biginelli reaction of ethyl acetoacetate, 3-hydroxybenzaldehyde and thiourea, a series of 29 experiments was all that was needed in order both to identify catalyst loading, temperature and concentration as the key parameters and then to determine the optimal conditions for the reaction (Scheme 12) [131].

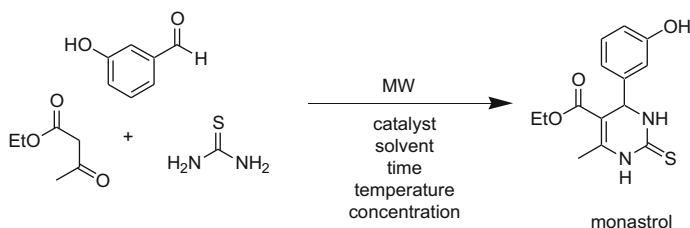

**Scheme 12** Design of experiments approach to the Biginelli reaction

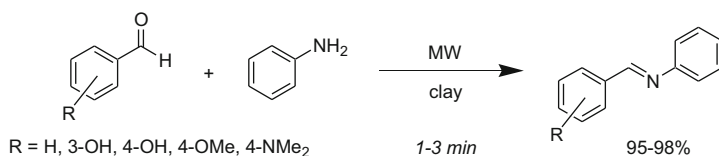

**Scheme 13** Solid-supported solvent-free synthesis of imines

### 9.3 Solvent-Free Reactions

With the increasing drive towards cleaner, greener processing, performing reactions in the absence of a solvent is receiving increasing attention [133]. A wide range of synthetic transformations has been performed solvent-free using microwave heating and those involving carbonyl compounds predominate (for a review, see [134]). In the early days when domestic microwave ovens were the only equipment available, performing reactions in the absence of an organic solvent was particularly attractive since it reduced the risk of an accident. One technique used extensively then, and still now, is to adsorb the starting materials on to a solid support and irradiate this with microwave energy (for a review, see [135]). The support can either be inert or else an acidic or basic material, offering the capability to catalyze the reaction (for a review, see [136]). For example, the reaction of aromatic aldehydes with aniline to yield imines can be achieved in 1–3 min of microwave heating after adsorbing the reagents on a clay support (Scheme 13) [137]. MCRs can also be performed using this approach, the Hantzsch [138] and Ugi [139] reactions being examples.

An interesting way to perform and monitor these solid-supported solvent-free reactions is to use a thin-layer chromatography (TLC) plate [140]. Reagents are co-spotted onto the plate, which is then placed into the microwave cavity, irradiated, allowed to cool and then eluted and visualized to assay the extent of reaction. Several TLC plates can be irradiated at the same time, each with a different stoichiometry of reagents, or else different reagents. This process allows for more rapid optimization of reactions and also for the synthesis of a library of examples.

Another method for performing solvent-free synthesis is simply to heat the reagents in a reaction vessel. This has been used on a number of occasions

(see, for example [141, 142]). Because many reactions involving carbonyl compounds are actually exothermic, one approach has been to use a short burst of irradiation initially and then turn the microwave off for the remainder of the synthesis. This has been used for the Biginelli reaction, as well as the Pechmann synthesis of coumarins [143]. The issue with this approach is that it is essentially uncontrollable and is certainly not scalable.

## 10 Organocatalysis

Defined as an organic molecule that does not contain a metal and that in substoichiometric amounts accelerates a reaction, organocatalysts are often natural products; examples include L-proline and Cinchona alkaloids (for background, see [144]). As well as yield, enantioselectivity is often a key metric in organocatalysis. By virtue of the focus on selectivity, most organocatalyzed reactions are performed at room temperature or lower. As a consequence, the kinetics are often slow, meaning that reactions can take a long time to reach completion. There is therefore a dichotomy when it comes to application of microwave heating to these transformations. Although it may reduce the reaction time, this may be at the cost of selectivity. As a result, there are not many examples in the literature (for a review, see [145]). Transformations that have been studied include the Mannich reaction [146, 147], aldol condensation [148], Michael addition [149], Diels–Alder cycloaddition [148], Baylis–Hillman reaction [150] and anomerization [151]. Unfortunately, significant issues arise in many cases related to temperature measurement by virtue of the fact that they are performed in conjunction with simultaneous cooling of the reaction mixture.

Although it has seen limited practical application in synthesis, the subject of simultaneously cooling while heating reactions with microwave energy deserves further discussion here. Monomode units use compressed air to cool reaction vessels upon completion, but this function also allows for simultaneous cooling during sample irradiation [152]. The role of simultaneous cooling is to keep the bulk reaction temperature relatively low while maximizing the applied microwave power. In addition to air cooling, it is also possible to pump microwave-transparent cryogenic fluid around a specially designed microwave vessel while a reaction is being irradiated with microwave energy. The fluid can be cooled to temperatures as low as  $-60^{\circ}\text{C}$ , allowing maximum microwave irradiation while keeping the solution relatively cool.

Cooling of reactions while simultaneously heating with microwave irradiation has been found to open the door to the possibility of data misinterpretation, especially with regard to accurate temperature monitoring. A significant temperature gradient can be established across the reaction vessel. In addition, if using the built-in infrared sensor on the microwave unit for temperature measurement when applying simultaneous cooling, issues arise concerning accuracy. Using external temperature measurement it is possible to, in effect, ‘trick’ the temperature sensor

by blowing air over it; the temperature read being significantly lower than the actual bulk temperature in the reaction vessel. Therefore, a difference in reactivity could be attributed simply to a difference in reaction temperature.

When reassessed using fiber-optic probes placed inside the reaction mixture, many of the purported rate accelerations observed when using microwave heating for organocatalysis were found to be artifacts of inaccurate temperature measurement [153].

## 11 Reactions Involving Gases as Reagents

Scientific microwave units are, in essence, modern autoclaves. They are designed with safety in mind and reaction vessels can hold at least moderate pressures (generally up to 30 bar). They are therefore ideal to interface with gas-loading accessories capable of introducing an atmosphere of reactive gas into a vessel while in the microwave cavity (for reviews, see [154, 155]).

A number of commercially available scientific microwave units have the capability to load gas into the reaction vessel safely, controllably and reproducibly; a general schematic representation is shown in Fig. 4. Hydrogen gas has been one of the most widely used gaseous reagents in microwave-assisted reactions using this equipment and examples include hydrogenation of alkenes (see, for example [156]), debenzilation [157] and dearomatization of pyridine derivatives to form saturated piperidines [158]. Ethene can be used as a dienophile in Diels–Alder reactions using substituted 2(1H)-pyrazinones as dienes [159]. When working at the elevated temperatures needed, the overpressure of ethene helps prevent the competing retro-Diels–Alder reaction to regenerate starting materials. In another example, by careful optimization of the catalyst system it is possible to perform Heck reactions between ethene and aryl halides to generate styrenes [160].

In the case of carbonylation reactions, molybdenum hexacarbonyl,  $\text{Mo}(\text{CO})_6$ , can be used as a carbon monoxide source. The organometallic complex starts to dissociate at temperatures around  $150^\circ\text{C}$  and a range of palladium-catalyzed carbonylation reactions have been performed, the most common of which are three-component couplings involving carbon monoxide, an aryl-, benzyl- or vinyl halide (or pseudohalide) and a suitable nucleophile (for a review, see [161]). Although using  $\text{Mo}(\text{CO})_6$  as a carbon monoxide surrogate does have some advantages, including the fact that it is a solid and is easily used on a small scale, its use results in metal waste; this being a particular problem if the reaction is to be scaled up. Using carbon monoxide gas in palladium-catalyzed hydroxy- [162], alkoxy- [163] and amino-carbonylation [164–166] reactions is an alternative. That said, there are a number of disadvantages to using a significant excess of CO. From a practical standpoint, because it is highly toxic, extreme care must be taken when venting a vessel at the end of the reaction. By controlled loading of the reaction vessel, alkoxy-carbonylation reactions can be performed effectively using a near-

**Fig. 4** Representation of a gas-loading accessory

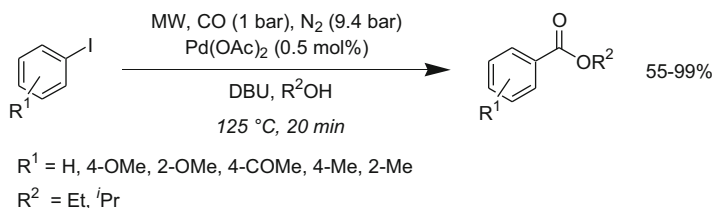
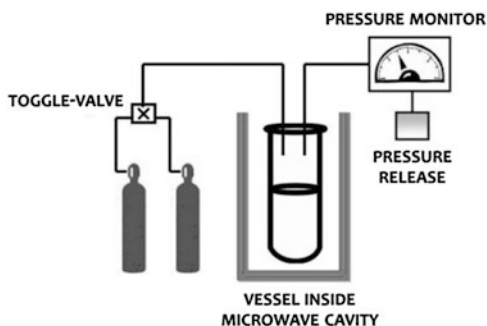

**Scheme 14** Palladium-catalyzed alkoxyacylation reactions using a near-stoichiometric quantity of carbon monoxide

stoichiometric quantity of carbon monoxide (Scheme 14) [167]. Key to the success of the reaction is an additional load of nitrogen gas.

Rhodium-catalyzed hydroformylation reactions can be performed using syngas (1:1 mix of CO and H<sub>2</sub>). Loading with 3 bar of gas and using an ionic liquid as the solvent, a range of substrates can be hydroformylated in 4–6 min at 110°C [168]. Molecular oxygen can be employed in palladium-catalyzed oxidative Heck reactions [169].

Another use of oxygen brings together a range of techniques. By performing simultaneous microwave heating and UV irradiation, 1,4-dihydropyridines (DHPs) can be converted to pyridines using singlet oxygen as the oxidant, offering a cleaner, greener alternative to stoichiometric metal oxidants (Fig. 5) [170]. The electrodeless discharge lamps (EDLs) used in this methodology had their genesis in a series of experiments focused around the observation that a high-frequency electromagnetic field can trigger gas discharge leading to the emission of electromagnetic radiation (for a review, see [171]). Using these EDLs, it is possible to place the lamp directly into a microwave vessel and run a reaction under simultaneous UV and microwave irradiation. Because a range of filling gases can be placed into EDLs, the emission wavelength can be varied. In the field of environmental chemistry, increased efficiency is seen when using microwave irradiation in the photocatalytic degradation of various substrates (for a review, see [172]). The technique has seen some, but limited, application in synthetic chemistry (for a review see [173]).



**Fig. 5** Electrodeless discharge lamp inside the reaction vessel used for performing microwave irradiation in conjunction with UV irradiation (*left*) and the vessel assembly in use (*right*)

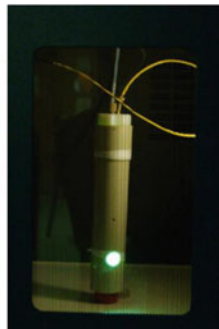

## 12 Use of Microwave Heating in Combinatorial Chemistry

### 12.1 Introduction

The preparation of a large number of different but often structurally related molecules or materials is the essence of combinatorial chemistry. Key to success is the ability to access these compounds rapidly and, as a result, microwave heating can play an important role (for a review, see [174]), [175]. Although automated sequential processing of reactions is an option, it is far more efficient to use parallel processing, running more than one reaction at a time. To do this, multimode microwave units are generally used, in conjunction with well-plates or modules capable of holding multiple reaction vessels. Also intimately linked to combinatorial chemistry is the use of solid-phase synthesis techniques. These topics have been the subject of considerable attention, often driven by the desire to prepare libraries of small molecules for biological screening with drug discovery in mind [176].

### 12.2 Parallel Processing

To perform multiple reactions concurrently using microwave heating, one of two approaches can be taken. The first is to use a carousel into which reaction vessels can be loaded. Depending on the equipment used, it is possible to monitor the temperature of either one reaction vessel or a number of vessels simultaneously. However, one vessel is usually designated the “control” and the microwave unit programmed to heat this to the requisite temperature. If all the reaction mixtures comprise components that are of roughly the same microwave absorptivity, temperature variation between vessels is often not a significant issue. This is especially the case when all the reactions are performed in the same strongly absorbing solvent. However, when there is a significant difference in microwave absorptivity across the reaction vessels, then there can be considerable discrepancy in the temperature that the contents of each tube reaches, which affects the yield of the products.



**Fig. 6** A 48-position (*left*) and a 24-position (*right*) silicon carbide plate capable of holding standard glass vials

Another approach is to use a well-plate, each reaction being performed in an individual well. This can be advantageous because reactions can be performed on small scales and a large number can be performed in each run, using for example a 96-well plate. In addition, the well-plates used can be interfaced with equipment for product purification and high-throughput screening. Early attempts at using these plates in conjunction with microwave heating were fraught with difficulties (for a review, see [177]). The best option is to use plates made from silicon carbide (for a review, see [102]). As already discussed, SiC has a number of attractive features when it comes to microwave heating. In particular, it is highly microwave absorbing and also chemically inert. This means that reaction mixtures can be placed directly into wells in a silicon carbide plate [178], or alternatively in vials that themselves are placed into SiC blocks (Fig. 6) [179, 180]. Using these accessories, it is possible to perform up to 192 reactions at one time in parallel. It is the silicon carbide that absorbs essentially all the microwave irradiation and the plates heat very uniformly [181]. The microwave absorptivity of the individual reaction mixtures is no longer a factor because the reaction mixtures are heated by the plate itself.

The silicon carbide plates have been used for a range of synthetic chemistry, an example being the preparation of a library of 24 biaryls by Suzuki coupling reactions [182]. Silicon carbide plates have also been used in analytical and biological chemistry for applications such as sample extraction [183], forced degradation [184] and protein hydrolysis [185].

### **12.3 Solid-Phase Organic Synthesis**

Solid-supported synthesis offers operational advantages such as ease of product isolation from reaction mixtures and applicability to automation. A drawback, however, is that reactions can be slow when using a solid-phase approach. For that reason, and others, microwave heating can be a beneficial tool (for reviews, see [186, 187]). A common misconception is that the polystyrene resins used as supports limit the user to reaction conditions below 130–140°C. For 20–30 min, these resins can tolerate heating to temperatures up to 200°C [188]. A wide range of

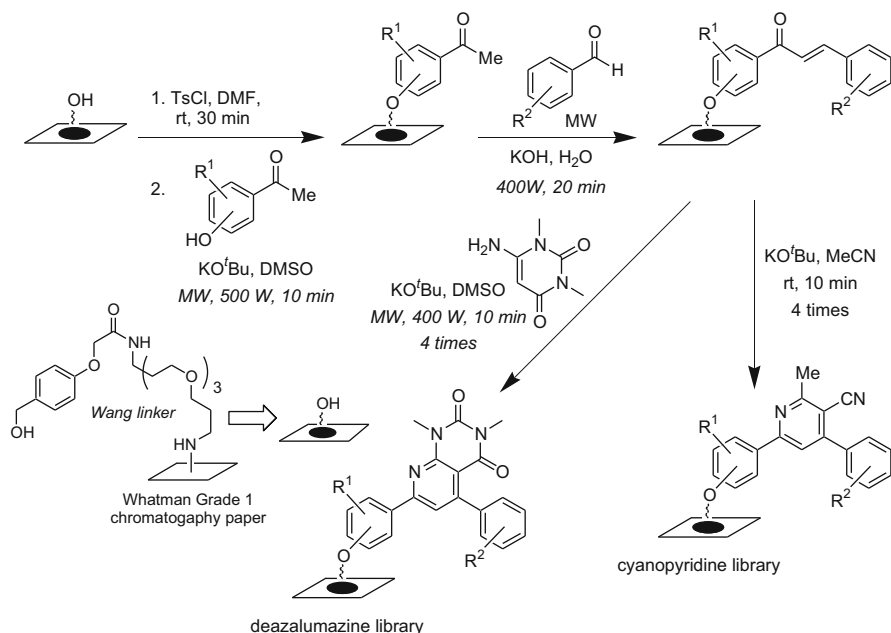

**Scheme 15** Spatially addressed synthesis of cyanopyridine and azalumazine dye libraries

synthetic transformations can be performed on a solid-support using microwave heating. Examples include metal-catalyzed couplings (for examples, see [189, 190]), multicomponent reactions (for examples, see [191, 192]), rearrangements (for examples, see [193, 194]) and cycloadditions (for a review, see [195]) as well as peptide synthesis.

The support used need not be a polymer. Planar supports such as cellulose are also a possibility and a range of reactions can be performed using microwave heating [196]. One example is in the discovery of fluorescent cyanopyridine and deazalumazine dyes (Scheme 15) [197]. Standard chromatography paper derivatized with an acid-cleavable linker can be used as the solid-support system and spatially addressed synthesis of the heterocycles can be performed by means of condensation reactions. Practically speaking, the appropriate reagent(s) are applied to each spot on the paper, which is then placed into the microwave and irradiated for 10 min. The spot and heat process is then repeated a number of times.

Simple visual inspection of the arrays under irradiation from a handheld UV lamp (at 254 nm) provides a straightforward primary screen to determine if the compounds are fluorescent (Fig. 7). In some cases, this visual assay also facilitates qualitative SAR to be derived across the entire macroarray. The individual compounds can also be cleaved off the paper support by punched out each spot from the macroarray with a desktop hole-punch and placing them in individual vials, followed by treatment with trifluoroacetic acid.

**Fig. 7** UV assay of small molecule macroarrays of cyanopyridines and deazalumazines prepared via spatially addressed synthesis on planar cellulose supports (Reproduced from Ref [197], with permission from American Chemical Society)

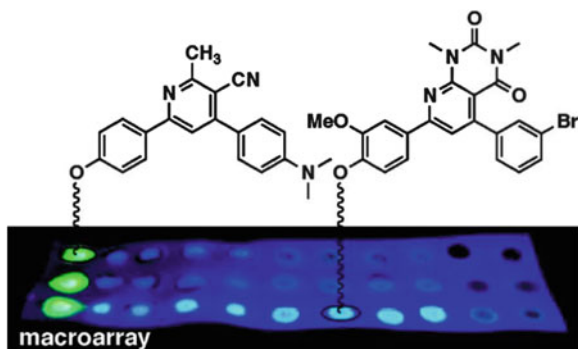

### 13 Microwave-Assisted, Continuous-Flow Organic Synthesis

So far, attention has been focused on performing reactions in batch mode. However, continuous-flow processing has a number of attractive features, including aspects of enhanced safety and efficient mixing of reagents (for reviews, see [198, 199]). It has been used as a tool for highly effective smaller scale synthesis and sequential parallel synthesis, a technique dubbed “MACOS”, microwave-assisted continuous-flow organic synthesis (for a review see [200]). Much of this work is centered on the use of microcapillary reactors.

There are two designs for the construction of microcapillary reactors (Fig. 8). One is used for small-scale synthesis and has three inlet ports that merge into one outlet, allowing separate reagent streams to flow into the capillary where they mix and react [201]. The other type of microcapillary reactor is used for sequential parallel synthesis and comprises four pairs of two inlet ports that merge into four different outlets [202]. Both capillary reactors fit into the cavity of a monomode microwave unit. The capillaries are generally of around 200–1,200  $\mu\text{m}$  diameter and flow rates vary from 10 to 60  $\mu\text{L}/\text{min}$ .

A wide range of synthetic transformations have been performed using microcapillary reactors. Examples range from nucleophilic aromatic substitutions to metal-catalyzed couplings and alkene metathesis [200]. Compound libraries can also be effectively generated. Suzuki couplings and  $\text{S}_{\text{N}}\text{Ar}$  reactions lead to libraries of biaryls and anilines, respectively [200].

By coating the inside of a capillary with palladium, Suzuki and Heck couplings can be effectively performed [203]. Reactions are run at around 200°C and are complete in a residence time of the order of seconds. These same palladium-coated capillaries can be used for performing Diels–Alder reactions (Scheme 16) [204]. The metal film serves two roles. Due to its high microwave absorptivity, the metal film helps to effectively heat the mixture but it also serves as a catalyst for the reaction, feasibly coordinating the dieneophile.

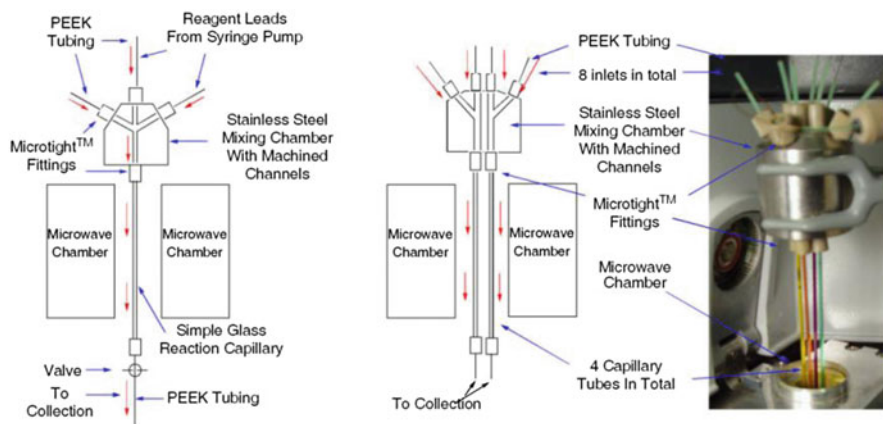

**Fig. 8** Microcapillary reactors used in conjunction with microwave heating (Reproduced with permission from Professor Michael Organ, York University Canada)

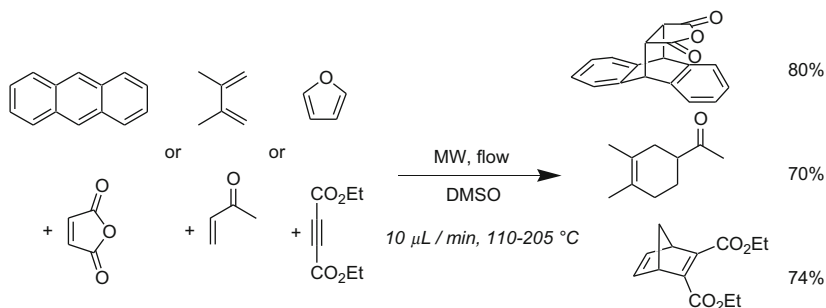

**Scheme 16** Synthesis of lactams in flow via in-situ generation of organic azides

## 14 Scale-Up of Reactions Using Microwave Heating

### 14.1 Introduction

For microwave heating to be a technology that continues to be useful from an industrial standpoint, the methods developed on a small scale need to be scaled up to make more significant quantities of material. Although the use of microwave heating for performing reactions on the millimolar scale in sealed vessels is straightforward, there are a number of potential issues associated with scale-up. These range from accessing suitable equipment through to safety considerations when working on scale. Manufacturers of microwave equipment have, for the most part, developed equipment to meet scale-up needs using three main approaches: (1) open-vessel batch, (2) sealed-vessel batch and (3) continuous-flow processing (for reviews, see [205–207]).

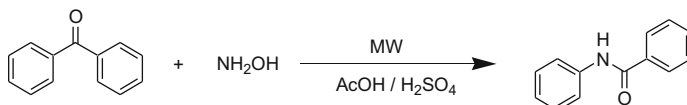

sealed vessel (10 mmol): heat to 140 °C and hold for 20 min - 74 % yield

open vessel (1 mol): heat to reflux (120 °C) and hold for 20 min - 90 % yield

**Scheme 17** Scale-up of the Beckmann rearrangement using an open-vessel approach

Also, when using microwave heating for scale-up of synthetic chemistry, the issue of energy efficiency has to be considered. Transitioning from conventional heating approaches to microwave heating often involves moving away from a laboratory infrastructure that has been designed over the years to maximize efficiency. A number of energy assessments have been performed, comparing microwave and conventional heating across a range of scales (for a review, see [208]). Small monomode microwave units are undoubtedly not energy efficient (for studies, see [209, 210]). In many cases, the microwave field is simply too dense in a monomode cavity to be completely absorbed by the reaction mixture [211]. Moving up in scale, multimode microwave systems appear to be more energy efficient than their monomode cousins and sometimes more so than conventional heating methods. Indeed, the most efficient microwave equipment operating under optimal conditions can be significantly more energy efficient than conventional pilot scale reactors, even up to 40 L [212].

## 14.2 Open-Vessel Batch Processing

When working on a larger scale, performing reactions in standard laboratory glassware at atmospheric pressure can offer operational advantages over a sealed-vessel approach. However, as discussed earlier (see Sect. 4), this eliminates one of the greatest attributes of microwave heating; namely the ability to heat reactions to well above the normal boiling points of solvents in a safe and effective manner. As a result, open-vessel approaches to scale-up have seen somewhat limited application [213–215]. The Beckmann rearrangement (acid-catalyzed conversion of ketoximes to N-substituted amides) proves very amenable to translation from small-scale sealed-vessel processing to a larger open-vessel approach (Scheme 17) [121].

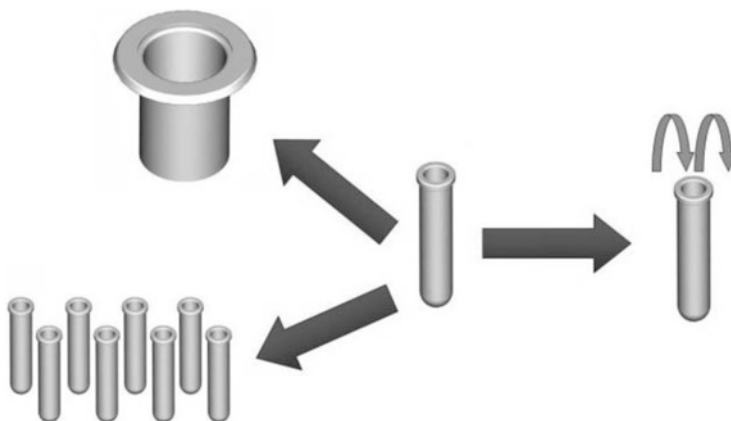

Fig. 9 Three approaches to scale-up using sealed-vessel processing

### 14.3 Sealed-Vessel Batch Processing

A sealed-vessel batch approach represents an attractive choice in the scale-up of reactions performed using microwave heating. The primary advantage is that most small-scale reactions are developed under sealed-vessel conditions, thus scale-up is potentially straightforward with little or no re-optimization needed. Disadvantages to this approach are the limits of reaction volume that can be irradiated as well as the safety requirements when working with larger vessels under pressure. There are three options available for sealed-vessel processing (Fig. 9), namely, (1) use of multiple smaller reaction vessels, (2) an automated stop-flow approach and (3) use of one larger vessel.

When using multiple vessels processed in a carousel, it is generally possible to scale reactions without re-optimization of conditions developed on small-scale equipment (for examples, see [216, 217]). An example is the synthesis of *N*-aryl functionalized  $\beta$ -amino esters using a Michael addition protocol (Scheme 18). Optimized on the 13 mmol scale, it can be scaled to 2.8 mol by placing 20 mL (0.14 mol) of reaction mixture into each of 20 vessels, thus processing a total substrate volume of 0.4 L [121].

A drawback to using multiple sealed reaction vessels is that the loading and sealing of the tubes prior to heating, and then the opening and emptying afterwards, are all time-consuming processes. In an attempt to overcome this, a stop-flow route can be used for modest scale-up [121] (see, for example [218, 219]). Having optimized reaction conditions on a small scale, it is possible in principle to move directly to a stop-flow method using the same equipment. Reagents are loaded in and products pumped out by means of a number of polytetrafluoroethylene (PTFE) lines [220]. A stop-flow approach has been used in a step of the synthesis of citalopram [221]. The key palladium-catalyzed cyanation is performed on 12 g of

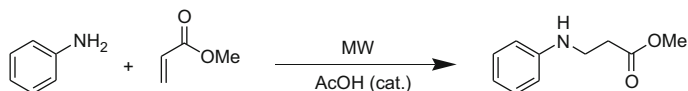

sealed vessel (13 mmol): heat to 200 °C and hold until a total time of 20 min has elapsed - 81 % yield

sealed vessel (2.8 mol): irradiate for 20 min (maximum temperature reached is 198 °C) - 78 % yield

**Scheme 18** Scale-up using multiple sealed vessels

starting material per batch. When the time for addition and removal of material is factored in, the total cycle time is around 10 min per batch, allowing for the preparation of 150 g in less than 2 h.

A single, larger reaction vessel for scale-up avoids the issues encountered both with using multiple, smaller vessels and stop-flow processing. However, a number of new potential problems arise. First, the equipment used must be designed with additional safety measures in mind if larger volumes are going to be heated to elevated temperatures and pressures. Second, significant changes in engineering are required in order to obtain heating profiles that in any way mirror those of smaller microwave units. Associated with this is the requirement for highly effective stirring to overcome any issues with the limited penetration of microwave irradiation into the sample. Third, although it may be possible to heat a reaction mixture effectively using microwave irradiation, it is also important that the contents of the vessel be cooled back to ambient temperature in a timely manner. The increased safety measures needed to withhold a potential vessel failure at elevated temperature and pressure generally mean that thick-walled vessels and microwave cavities are used. As a result, cooling can be very slow. This can be overcome by use of adiabatic cooling, the contents of the reaction vessel being ejected into a holding tank. Using this, the temperature of the mixture can be reduced rapidly to the boiling point of the solvent used.

A number of reactions have been scaled up using a single sealed-vessel approach, most in the 0.1–1 L range (for an example, see [222]). Equipment is also available capable of processing from 2 to 12 L at a time [223]. This can feasibly help bridge the gap between a small-scale protocol and larger kilo- or pilot-plant scale. Reactions using gaseous reagents can also be scaled up in a single sealed-vessel approach [224].

## 14.4 Continuous-Flow Processing

There are a number of reasons to adopt a continuous-flow approach for scale-up. Reactions are actually “scaled-out” rather than scaled up. Maximum throughput is only a matter of run time and the total number of units operating in parallel. Drawbacks to this approach are that reaction mixtures are generally required to



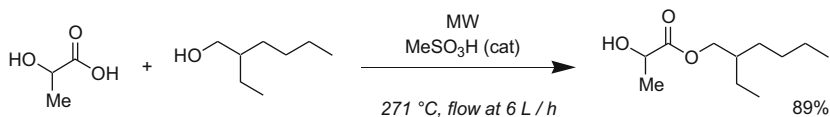

**Scheme 19** Scale-up of an esterification reaction using continuous-flow processing

be homogeneous before, during and until out of the microwave apparatus. A consequence of this is that extensive re-optimization may need to be undertaken in order to develop appropriate homogeneous reaction conditions and suitable residence times. In addition, significant temperature gradients can be observed when using flow approaches and the tubing diameter needs to be carefully assessed to ensure adequate penetration of the microwave irradiation across the entire cross-section. Despite these drawbacks, a number of synthetic transformations have been successfully scaled up using continuous-flow processing [121, 225]. The esterification of lactic acid is an example at the higher throughput end [226]. Using methanesulfonic acid as a catalyst, the reaction can be performed at a flow rate of 6 L/min with a residence time in the microwave cavity of 28 s (Scheme 19).

There is a clear parallel between microwave irradiation and conventionally heated continuous-flow processing. Both technologies offer the ability to heat reaction mixtures rapidly, safely and (in most cases) easily. It therefore comes as no surprise that synthetic methods developed on a small scale in batch using microwave heating can be scaled up using conventionally heated flow reactors (for an example, see [227]). When using micro- and meso-flow reactors, the rapid heat transfer that is possible means that comparable heating rates can often be obtained regardless of whether the thermal energy comes from a conventional or microwave source.

## 15 Summary

This chapter has just scratched the surface of the many synthetic transformations that can be performed using microwave heating. Using a scientific microwave apparatus, chemists find that they can perform chemical reactions quickly, easily and safely. Indeed, for many, the microwave is the go-to appliance whenever they need to perform a reaction that requires heat and it been dubbed “the Bunsen burner of the twenty-first century” [228].

Microwave heating goes beyond being a useful tool for routine laboratory work to affording the bench chemist an opportunity to carry out exciting new chemistry. As stressed several times in the chapter, microwave heating is just that – heating. It gives chemists easy access to elevated temperature/pressure conditions. Accurate temperature measurement is essential when making comparisons with conventional methods. It is becoming more and more apparent that, when using identical

conditions, the same reactions can be performed with the same outcome and the same product yield using either microwave or conventional heating.

To be able to monitor a reaction in real-time is highly advantageous when using microwave heating. A consequence of working at high temperatures is that reaction times can often be on the order of minutes instead of hours and there may be a narrow time window in which product yield is maximized and the onset of decomposition has not started. To address this, chemists have developed a number of tools for reaction monitoring (for a review, see [229]). These include interfacing a digital camera with a scientific microwave unit (see, for example [230]) or using in-situ analytical tools such as infrared [231], Raman (see, for example [232]) or UV-visible spectroscopy [233].

As mentioned at various junctures along the way, microwave heating is not an “organic chemistry” technique. Its application is far broader than that. Other disciplines are seeing the benefits that a microwave unit can add to the laboratory setting and exciting new developments lie ahead.

## References

1. de la Hoz A, Loupy A (eds) (2012) *Microwaves in organic synthesis*, 3rd edn. Wiley-VCH, Weinheim
2. Kappe CO, Stadler A, Dallinger D (2012) *Microwaves in organic and medicinal chemistry*, 2nd edn. Wiley-VCH, Weinheim
3. Leadbeater NE (ed) (2010) *Microwave heating as a tool for sustainable chemistry*. CRC, Boca Raton
4. Bilecka I, Niederberger M (2010) Microwave chemistry for inorganic nanomaterials synthesis. *Nanoscale* 2:1358–1374
5. Powell GL (2010) Microwave heating as a tool for inorganic and organometallic synthesis. In: Leadbeater NE (ed) *Microwave heating as a tool for sustainable chemistry*. CRC, Boca Raton
6. Vanier GS (2010) Microwave heating as a tool for the biosciences in microwave heating. In: Leadbeater NE (ed) *Microwave heating as a tool for sustainable chemistry*. CRC, Boca Raton
7. Sandoval WN, Pham VC, Lill JR (2008) Recent developments in microwave-assisted protein chemistries – can this be integrated into the drug discovery and validation process? *Drug Discov Today* 13(23–24):1075–1081
8. Bogdal D, Prociak A (2007) *Microwave-enhanced polymer chemistry and technology*. Blackwell, Oxford
9. Ebner C, Bodner T, Stelzer F, Wiesbrock F (2011) One decade of microwave-assisted polymerizations: Quo vadis? *Macromol Rapid Commun* 32:254–288
10. Iannelli M (2010) Microwave heating as a tool for sustainable polymer chemistry. In: Leadbeater NE (ed) *Microwave heating as a tool for sustainable chemistry*. CRC, Boca Raton
11. Sosnik A, Gotelli G, Abraham GA (2011) *Prog Polym Sci* 36:1050–1078
12. Hoogenboom R, Schubert US (2007) Microwave-assisted polymer synthesis: recent developments in a rapidly expanding field of research. *Macromol Rapid Comm* 28:368–386
13. Galbrecht F, Bünnagel TW, Scherf U, Farrell T (2007) Microwave-assisted preparation of semiconducting polymers. *Macromol Rapid Comm* 28:387–394
14. Horikoshi S, Serpone N (2012) Microwave frequency effects in organic synthesis. In: de la Hoz A, Loupy A (eds) *Microwaves in organic synthesis*, 3rd edn. Wiley-VCH, Weinheim

15. Saillard R, Poux M, Berlan J, Audhuy-Peaudecerf M (1995) Microwave heating of organic solvents: thermal effects and field modelling. *Tetrahedron* 51:4033–4042
16. Lienhard JH IV, Lienhard JHV (2008) A heat transfer textbook, 3rd edn. Phlogiston, Cambridge
17. Washington AL, Strouse GF (2009) Selective microwave absorption by trioctyl phosphine selenide: does it play a role in producing multiple sized quantum dots in a single reaction? *Chem Mat* 21:2770–2776
18. Washington AL, Strouse GF (2008) Microwave synthesis of CdSe and CdTe nanocrystals in nonabsorbing alkanes. *J Am Chem Soc* 130:8916–8922
19. Perreux L, Loupy A (2012) Nonthermal effects of microwaves in organic synthesis. In: de la Hoz A, Loupy A (eds) *Microwaves in organic synthesis*, 3rd edn. Wiley-VCH, Weinheim
20. de la Hoz A, Diaz-Ortiz A, Moreno A (2005) Microwaves in organic synthesis. Thermal and non-thermal microwave effects. *Chem Soc Rev* 34:164–178
21. Russo F, Odell LR, Olofsson K, Nilsson P, Larhed M (2012) Microwave-heated transition metal-catalyzed coupling reactions. In: de la Hoz A, Loupy A (eds) *Microwaves in organic synthesis*, 3rd edn. Wiley-VCH, Weinheim
22. Mehta VP, Van der Eycken E (2011) Microwave-assisted C–C bond forming cross-coupling reactions: an overview. *Chem Soc Rev* 40:4925–4936
23. Singh BK, Kaval N, Tomar S, Van der Eycken E, Parmar VS (2008) Transition metal-catalyzed carbon–carbon bond formation Suzuki, Heck, and Sonogashira reactions using microwave and microtechnology. *Org Process Res Dev* 12:468–474
24. Arvela RK, Leadbeater NE, Sangi MS, Williams VA, Granados P, Singer RD (2005) A reassessment of the transition-metal free Suzuki-type coupling methodology. *J Org Chem* 70:161–168
25. Arvela RK, Leadbeater NE (2005) Microwave-promoted Heck coupling using ultralow metal catalyst concentrations. *J Org Chem* 70:1786–1790
26. Melucci M, Barbarella G, Sotgiu G (2002) Solvent-free, microwave-assisted synthesis of thiophene oligomers via suzuki coupling. *J Org Chem* 67:8877–8884
27. Melucci M, Barbarella G, Zambianchi M, Di Pietro P, Bongini A (2004) Solution-phase microwave-assisted synthesis of unsubstituted and modified alpha-quinque- and sexithiophenes. *J Org Chem* 69:4821–4828
28. Cravotto G, Cintas P (2012) The combined use of microwaves and ultrasound: methods and practice. In: de la Hoz A, Loupy A (eds) *Microwaves in organic synthesis*, 3rd edn. Wiley-VCH, Weinheim
29. Di Maria F, Olivelli P, Gazzano M, Zanelli A, Biasiucci M, Gigli G, Gentili D, D'Angelo P, Cavallini M, Barbarella G (2011) A successful chemical strategy to induce oligothiophene self-assembly into fibers with tunable shape and function. *J Am Chem Soc* 133:8654–8661
30. Stockland RA (2010) Microwave heating as a tool for organic synthesis. In: Leadbeater NE (ed) *Microwave heating as a tool for sustainable chemistry*. CRC, Boca Raton
31. Luque R, Balu AM, Macquarrie DJ (2012) Microwave-assisted heterogeneously catalyzed processes. In: de la Hoz A, Loupy A (eds) *Microwaves in organic synthesis*, 3rd edn. Wiley-VCH, Weinheim
32. Irfan M, Fuchs M, Glasnov TN, Kappe CO (2009) Microwave-assisted cross-coupling and hydrogenation chemistry by using heterogeneous transition-metal catalysts: an evaluation of the role of selective catalyst heating. *Chem Eur J* 15:11608–11618
33. Bag S, Dasgupta S, Török B (2011) Microwave-assisted heterogeneous catalysis: an environmentally benign tool for contemporary organic synthesis. *Curr Org Synth* 8:237–261
34. Desai B, Kappe CO (2004) Microwave-assisted synthesis involving immobilized catalysts. *Top Curr Chem* 242:177–208
35. Coquerel Y, Rodriguez J (2008) Microwave-assisted olefin metathesis. *Eur J Org Chem* 1125–1132

36. Grigg R, Martin W, Morris J, Sridharan V (2003) Synthesis of  $\Delta^3$ -pyrrolines and  $\Delta^3$ -tetrahydropyridines via microwave-accelerated ring-closing metathesis. *Tetrahedron Lett* 44:4899–4901
37. Thanh GV, Loupy A (2003) Microwave-assisted ruthenium-catalyzed olefin metathesis under solvent-free conditions. *Tetrahedron Lett* 44:9091–9094
38. Mayo KG, Nearhoof EH, Kiddle JJ (2002) Microwave-accelerated ruthenium-catalyzed olefin metathesis. *Org Lett* 4:1567–1570
39. Garbacia S, Desai B, Lavastre O, Kappe CO (2003) Microwave-assisted ring-closing metathesis revisited. on the question of the nonthermal microwave effect. *J Org Chem* 68:9136–9139
40. Debleds O, Campagne JM (2008) 1,5-Enyne metathesis. *J Am Chem Soc* 130:1562–1563
41. Comer E, Rohan E, Deng L, Porco JA (2007) An approach to skeletal diversity using functional group pairing of multifunctional scaffolds. *Org Lett* 9:2123–2126
42. Efskind J, Undheim K (2003) High temperature microwave-accelerated ruthenium-catalysed domino RCM reactions. *Tetrahedron Lett* 44:2837–2839
43. Gütekunst WR, Baran PS (2011) C–H functionalization logic in total synthesis. *Chem Soc Rev* 40:1976–1991
44. Collet F, Lescot C, Dauban P (2011) Catalytic C–H amination: the stereoselectivity issue. *Chem Soc Rev* 40:1926–1936
45. Lewis JC, Berman AM, Bergman RG, Ellman JA (2008) Rh(I)-catalyzed arylation of heterocycles via C–H bond activation: expanded scope through mechanistic insight. *J Am Chem Soc* 130:2493–2500
46. Lewis JC, Wu JY, Bergman RG, Ellman JA (2006) Microwave-promoted rhodium-catalyzed arylation of heterocycles through C–H bond activation. *Angew Chem Int Ed* 45:1589–1591
47. Yanagisawa S, Sudo T, Noyori R, Itami K (2006) Direct C–H arylation of (Hetero)arenes with aryl iodides via rhodium catalysis. *J Am Chem Soc* 128:11748–11749
48. Yanagisawa S, Ueda K, Taniguchi T, Itami K (2008) Potassium t-butoxide alone can promote the biaryl coupling of electron-deficient nitrogen heterocycles and haloarenes. *Org Lett* 10:4673–4676
49. Leadbeater NE (2010) Cross coupling: when is free really free? *Nature Chem* 2:1007–1009
50. Tajuddin H, Shukla L, Maxwell AC, Marder TB, Steel PG (2010) “One-pot” tandem C–H borylation/1,4-conjugate addition/reduction sequence. *Org Lett* 12:5700–5703
51. Baghbanzadeh M, Pilger C, Kappe CO (2011) Palladium-catalyzed direct arylation of heteroaromatic compounds: improved conditions utilizing controlled microwave heating. *J Org Chem* 76:8138–8142
52. Johansen MB, Kerr MA (2010) Direct functionalization of indoles: copper-catalyzed malonyl carbenoid insertions. *Org Lett* 12:4956–4959
53. Filler R, Saha R (2009) Fluorine in medicinal chemistry: a century of progress and a 60-year retrospective of selected highlights. *Future Med Chem* 1:777–791
54. Hull KL, Anani WQ, Sanford MS (2006) Palladium-catalyzed fluorination of carbon–hydrogen bonds. *J Am Chem Soc* 128:7134–7135
55. Hashmi AS, Toste FD (eds) (2012) *Modern gold catalyzed synthesis*. Wiley-VCH, Weinheim
56. Liu XY, Li CH, Che CM (2006) Phosphine gold(I)-catalyzed hydroamination of alkenes under thermal and microwave-assisted conditions. *Org Lett* 8:2707–2710
57. Wang MZ, Wong MK, Che CM (2008) Gold(I)-catalyzed intermolecular hydroarylation of alkenes with indoles under thermal and microwave-assisted conditions. *Chem Eur J* 14:8353–8364
58. Nieto-Oberhuber C, Pérez-Galán P, Herrero-Gómez E, Lauterbach T, Rodríguez C, López S, Bour C, Rosellón A, Cárdenas DJ, Echavarren AM (2008) Gold(I)-catalyzed intramolecular [4+2] cycloadditions of arylalkynes or 1,3-enynes with alkenes: scope and mechanism. *J Am Chem Soc* 130:269–279
59. Barge A, Tagliapietra S, Binello A, Cravotto G (2011) Click chemistry under microwave or ultrasound irradiation. *Curr Org Chem* 15:189–203

60. Kappe CO, Van der Eycken E (2010) Click chemistry under non-classical reaction conditions. *Chem Soc Rev* 39:1280–1290
61. Munteanu M, Choi S, Ritter H (2008) Cyclodextrin methacrylate via microwave-assisted click reaction. *Macromolecules* 41:9619–9623
62. Hoogenboom R, Moore BC, Schubert US (2006) Synthesis of star-shaped poly(*ε*-caprolactone) via ‘click’ chemistry and ‘supramolecular click’ chemistry. *Chem Commun* 2006(38):4010–4012
63. Song Y, Kohlmeir EK, Meade TJ (2008) Synthesis of multimeric MR contrast agents for cellular imaging. *J Am Chem Soc* 130:6662–6663
64. Fazio MA, Lee OP, Schuster DI (2008) First triazole-linked porphyrin – fullerene dyads. *Org Lett* 10:4979–4982
65. Ortega-Muñoz M, Morales-Sanfrutos J, Perez-Balderas F, Giron-Gonzalez D, Sevillano-Tripero N, Salto-Gonzalez R, Santoyo-Gonzalez F (2007) Click multivalent neoglycoconjugates as synthetic activators in cell adhesion and stimulation of monocyte/macrophage cell lines. *Org Biomol Chem* 5:2291–2301
66. Bouillon C, Meyer A, Vidal S, Jochum A, Chevotot Y, Cloarec J-P, Praly J-P, Vasseur J-J, Morvan F (2006) Microwave assisted “Click” chemistry for the synthesis of multiple labeled-carbohydrate oligonucleotides on solid support. *J Org Chem* 71:4700–4702
67. Géci V, Filichev V, Pedersen EB (2007) Stabilization of parallel triplexes by twisted intercalating nucleic acids (TINAs) incorporating 1,2,3-triazole units and prepared by microwave-accelerated click chemistry. *Chem Eur J* 13:6379–6386
68. Lucas R, Zerrouki R, Granet R, Krausz P, Champaviret Y (2008) A rapid efficient microwave-assisted synthesis of a 3',5'-pentathymidine by copper(I)-catalyzed [3+2] cycloaddition. *Tetrahedron* 64:5467–5471
69. Pietrzik N, Schips C, Ziegler T (2008) Efficient synthesis of glycosylated asparaginic acid building blocks via click chemistry. *Synthesis* 2008(4):519–526
70. Broggi J, Diez-González S, Petersen J, Berteina-Raboin S, Nolan SP, Agrofoglio LA (2008) Study of copper(I) catalysts for the synthesis of carbanucleosides via azide-alkyne 1,3-dipolar cycloaddition. *Synthesis* 2008(1):141–148
71. Pradere U, Roy V, McBrayer TR, Schinazi RF, Agrofoglio LA (2008) Preparation of ribavirin analogues by copper- and ruthenium-catalyzed azide-alkyne 1,3-dipolar cycloaddition. *Tetrahedron* 64:9044–9051
72. Cheshev P, Marra A, Dondoni A (2006) First synthesis of 1,2,3-triazolo-linked (1,6)- $\alpha$ -D-oligomannoses (triazolomannoses) by iterative Cu(I)-catalyzed alkyne–azide cycloaddition. *Org Biomol Chem* 4:3225–3227
73. Joosten JAF, Tholen NTH, Maate FAE, Brouwer AJ, van Esse GW, Rijkers DTS, Liskamp RMJ, Pieters RJ (2005) High-yielding microwave-assisted synthesis of triazole-linked glycodendrimers by copper-catalyzed [3+2] cycloaddition. *Eur J Org Chem* 3182–3185
74. Poon CK, Chapman R, Jolliffe KA, Perrier S (2012) Pushing the limits of copper mediated azide–alkyne cycloaddition (CuAAC) to conjugate polymeric chains to cyclic peptides. *Polym Chem* 3:1820–1826
75. van Dijk M, Nolle ML, Weijers P, Dechesne AC, van Nostrum CF, Hennink WE, Rijkers DTS, Liskamp RMJ (2008) Synthesis and characterization of biodegradable peptide-based polymers prepared by microwave-assisted click chemistry. *Biomacromol* 9:2834–2843
76. Braga AL, Vargas LF, Sehnem JA, Wessjohann LA (2006) Microwave-mediated palladium-catalyzed asymmetric allylic alkylation using chiral-seleno amides. *Eur J Org Chem* 2006(22):4993–4997
77. Yeager AR, Min GK, Porco JA, Schaus SE (2006) Exploring skeletal diversity via ring contraction of glycal-derived scaffolds. *Org Lett* 8:5065–5068
78. Trost BM, Andersen NG (2002) Utilization of molybdenum- and palladium-catalyzed dynamic kinetic asymmetric transformations for the preparation of tertiary and quaternary stereogenic centers: a concise synthesis of tipranavir. *J Am Chem Soc* 124:14320–14321

79. Appukkuttan P, Mehta VP, Van der Eycken E (2010) Microwave-assisted cycloaddition reactions. *Chem Soc Rev* 39:1467–1477
80. Giguere RJ, Bray TL, Duncan SM, Majetich G (1986) Application of commercial microwave ovens to organic synthesis. *Tetrahedron Lett* 27:4945–4948
81. Majetich G, Hicks R (1995) The use of microwave heating to promote organic reactions. *J Microw Power Electromagn Energy* 30:27–45
82. Loupy A, Maurel F, Sabatie-Gogova A (2004) Improvements in Diels–Alder cycloadditions with some acetylenic compounds under solvent-free microwave-assisted conditions: experimental results and theoretical approaches. *Tetrahedron* 60:1683–1691
83. Herrero MA, Kremsner JM, Kappe CO (2008) Nonthermal microwave effects revisited: on the importance of internal temperature monitoring and agitation in microwave chemistry. *J Org Chem* 73:36–47
84. Leadbeater NE, Pillsbury SJ, Shanahan E, Williams VA (2005) An assessment of the technique of simultaneous cooling in conjunction with microwave heating for organic synthesis. *Tetrahedron* 61:3565–3585
85. Hong BC, Shr YJ, Liao JH (2002) Unprecedented microwave effects on the cycloaddition of fulvenes. A new approach to the construction of polycyclic ring systems. *Org Lett* 4:663–666
86. de Cózar A, Millán MC, Cebrián C, Prieto P, Díaz-Ortiz A, de la Hoz A, Cossío FP (2010) Computational calculations in microwave-assisted organic synthesis (MAOS). Application to cycloaddition reactions. *Org Biomol Chem* 8:1000–1009
87. Ghoshal A, Sarkar AR, Kumaran RS, Hegde S, Manickam G, Jayashankaran J (2012) A facile stereoselective synthesis of julolidine hybrid analogs via domino knoevenagel intramolecular hetero Diels–Alder reaction. *Tetrahedron Lett* 53:1748–1752
88. Long S, Monari M, Panunzio M, Bandini E, D'Aurizio A, Venturini A (2011) Hetero-Diels–Alder (HDA) strategy for the preparation of 6-aryl- and heteroaryl-substituted piperidin-2-one scaffolds: experimental and theoretical studies. *Eur J Org Chem* 6218–6225
89. Fordyce EAF, Morrison AJ, Sharp RD, Paton RM (2010) Microwave-induced generation and reactions of nitrile sulfides: an improved method for the synthesis of isothiazoles and 1,2,4-thiadiazoles. *Tetrahedron* 66:7192–7197
90. Kranjc K, Kocevar M (2008) Ethyl vinyl ether as a synthetic equivalent of acetylene in a DABCO-catalyzed microwave-assisted Diels–Alder-elimination reaction sequence starting from 2H-Pyran-2-ones. *Synlett* 2008(17):2613–2616
91. Iqbal M, Li Y, Evans P (2004) Synthesis of  $\Delta^{12,14}$ -15-deoxy-PG-J<sub>1</sub> methyl ester and epi- $\Delta^{12,15}$ -deoxy-PG-J<sub>1</sub>. *Tetrahedron* 60:2531–2538
92. Eddolls JP, Iqbal M, Roberts SM, Santoro MG (2004) Preparation of optically pure cross-conjugated cyclopentadienones. *Tetrahedron* 60:2539–2550
93. Langa F, de la Cruz P (2012) Application of microwave irradiation in carbon nanostructures. In: de la Hoz A, Loupy A (eds) *Microwaves in organic synthesis*, 3rd edn. Wiley-VCH, Weinheim
94. Tymoshenko DO (2008) Microwave-assisted Claisen and aza-Claisen rearrangements. *Mini Rev Org Chem* 5:85–95
95. Majumdar KC, Bhattacharyya T, Chattopadhyay B, Sinha B (2009) Recent advances in the aza-Claisen rearrangement. *Synthesis* 2009(13):2117–2142
96. Besson T, Kappe CO (2012) Microwave susceptors. In: de la Hoz A, Loupy A (eds) *Microwaves in organic synthesis*, 3rd edn. Wiley-VCH, Weinheim
97. Martínez-Palou R (2010) Microwave-assisted synthesis using ionic liquids. *Mol Divers* 14:3–35
98. Kremsner JM, Kappe CO (2009) Silicon Carbide. In: Paquette LA (ed) *Encyclopedia of reagents for organic synthesis II*. Wiley, Chichester
99. Kremsner JM, Kappe CO (2006) Silicon carbide passive heating elements in microwave-assisted organic synthesis. *J Org Chem* 71:4651–4658

100. Gutmann B, Obermayer D, Reichart B, Prekodravac B, Irfan M, Kremsner JM, Kappe CO (2010) Sintered silicon carbide: a new ceramic vessel material for microwave chemistry in single-mode reactors. *Chem Eur J* 40:12182–12194
101. Obermayer D, Gutmann B, Kappe CO (2009) Microwave chemistry in silicon carbide reaction vials: separating thermal from nonthermal effects. *Angew Chem Int Ed* 48:8321–8324
102. Kappe CO, Damm M (2012) Parallel microwave chemistry in silicon carbide microtiter platforms: a review. *Mol Divers* 16:5–25
103. Deshpande SJ, Leger PR, Sieck SR (2012) *Tetrahedron Lett* 53:1772–1775
104. Ghosh S, Das J, Chattopadhyay S (2011) *Tetrahedron Lett* 52:2869–2872
105. Staderini M, Cabezas N, Bolognesi ML, Menendez JC (2011) A general protocol for the solvent- and catalyst-free synthesis of 2-styrylquinolines under focused microwave irradiation. *Synlett* 2011(17): 2577–2579
106. Sharma LK, Kim KB, Elliott GI (2011) A selective solvent-free self-condensation of carbonyl compounds utilizing microwave irradiation. *Green Chem* 13:1546–1549
107. Zhou Z-Z, Deng Y-H, Jiang Z-H, Chen W-H (2010) Microwave-assisted Dieckmann reaction: efficient one-step synthesis of 2-arylbenzofuran-3-ols. *Adv Synth Catal* 352:1909–1913
108. Yougnia R, Rochais C, de Oliveira Santos JS, Dallemagne P, Rault S (2010) One-pot synthesis of novel poly-substituted phenanthrenes. *Tetrahedron* 66:2803–2808
109. Altman E, Stefanidis GD, van Gerven T, Stankiewicz A (2012) Microwave-promoted synthesis of n-propyl propionate using homogeneous zinc triflate catalyst. *Ind Eng Chem Res* 51:1612–1619
110. Devine WG, Leadbeater NE, Jacob LA (2008) Titanium-catalyzed esterification and transesterification reactions facilitated using microwave heating. *Future Med Chem* 2:225–230
111. Melo Júnior AR, Albuquerque CER, Carneiro JSA, Dariva C, Fortuny M, Santos AF, Egues SMS, Ramos ALD (2010) Solid-acid-catalyzed esterification of oleic acid assisted by microwave heating. *Ind Eng Chem Res* 49:12135–12139
112. Zhang S, Zu Y-G, Fu Y-J, Luo M, Zhang D-Y, Efferth T (2010) Microwave-assisted transesterification of yellow horn oil to biodiesel using a heteropolyacid solid catalyst. *Bioresource Technol* 101:931–936
113. Leadbeater NE, Stencil LM (2006) Fast, easy preparation of biodiesel using microwave heating. *Energy Fuels* 20:2281–2283
114. Chen K-S, Lin Y-C, Hsu K-H, Wang H-K (2012) Improving biodiesel yields from waste cooking oil by using sodium methoxide and a microwave heating system. *Energy* 38:151–156
115. Koberg M, Abu-Much R, Gedanken A (2011) Optimization of biodiesel production from soybean and wastes of cooked oil: combining dielectric microwave irradiation and a SrO catalyst. *Bioresource Technol* 102:1073–1078
116. Barnard TM, Leadbeater NE, Boucher MB, Stencil LM, Wilhite BA (2007) Continuous-flow preparation of biodiesel using microwave heating. *Energy Fuels* 21:1777–1781
117. Geuens J, Kremsner JM, Nebel BA, Schober S, Dommissie RA, Mittelbach M, Tavernier S, Kappe CO, Maes BUW (2008) Microwave-assisted catalyst-free transesterification of triglycerides with 1-butanol under supercritical conditions. *Energy Fuels* 22:643–645
118. Leadbeater NE, Barnard TM, Stencil LM (2008) Batch and continuous-flow preparation of biodiesel derived from butanol and facilitated by microwave heating. *Energy Fuels* 22:2005–2008
119. Baghbanzadeh M, Kappe CO (2009) Can molecular sieves be used as water scavengers in microwave chemistry? *Aust J Chem* 62:244–249
120. Altman E, Stefanidis GD, van Gerven T, Stankiewicz A (2010) Process intensification of reactive distillation for the synthesis of n-propyl propionate: the effects of microwave radiation on molecular separation and esterification reaction. *Ind Eng Chem Res* 49:10287–10296

121. Bowman MD, Holcomb JL, Kormos CM, Leadbeater NE, Williams VA (2008) Approaches for scale-up of microwave-promoted reactions. *Org Process Res Dev* 12:41–57
122. Guerrero-Sanchez C, Lobert M, Hoogenboom R, Schubert US (2007) Microwave-assisted homogeneous polymerizations in water-soluble ionic liquids: an alternative and green approach for polymer synthesis. *Macromol Rapid Commun* 28:456–464
123. Chemat F, Lucchesi M-E (2006) Microwave-assisted extraction of essential oils. In: Loupy A (ed) *Microwaves in organic synthesis*, 2nd edn. Wiley-VCH, Weinheim
124. Raynie DE (2010) Modern extraction techniques. *Anal Chem* 82:4911–4916
125. Chebanov VA, Desenko SM (2012) Multicomponent heterocyclization reactions with controlled selectivity. *Chem Heterocycl Compd* 48:566–583
126. Eckert H (2012) Diversity oriented syntheses of conventional heterocycles by smart multi component reactions (MCRs) of the last decade. *Molecules* 17:1074–1102
127. Kruihof A, Ruijter E, Orru RVA (2011) Microwave-assisted multicomponent synthesis of heterocycles. *Curr Org Chem* 15:204–236
128. Bazureau JP, Paquin L, Carrié D, L'Helgoual'ch JM, Guihéneuf S, Coulibaly KW, Burgy G, Komaty S, Limanton E (2012) Microwaves in heterocyclic chemistry. In: de la Hoz A, Loupy A (eds) *Microwaves in organic synthesis*, 3rd edn. Wiley-VCH, Weinheim
129. Van der Eycken E, Kappe CO (eds) (2006) *Microwave-assisted synthesis of heterocycles. Topics in heterocyclic chemistry, vol 1.* Springer, Berlin
130. Moore KW, Pechen A, Feng X-J, Dominy J, Beltrani VJ, Rabitz H (2011) Why is chemical synthesis and property optimization easier than expected? *Phys Chem Chem Phys* 13:10048–10070
131. Glasnov TN, Tye H, Kappe CO (2008) Integration of high speed microwave chemistry and a statistical 'design of experiment' approach for the synthesis of the mitotic kinesin Eg5 inhibitor monastrol. *Tetrahedron* 64:2035–2041
132. Tye H, Whittaker M (2004) Use of a design of experiments approach for the optimisation of a microwave assisted Ugi reaction. *Org Biomol Chem* 2:813–815
133. Tanaka K, Kaupp G (2009) *Solvent-free organic synthesis.* Wiley-VCH, Weinheim
134. Baig RBN, Varma RS (2012) Alternative energy input: mechanochemical, microwave and ultrasound-assisted organic synthesis. *Chem Soc Rev* 41:1559–1584
135. Polshettiwar V, Varma RS (2008) Microwave-assisted organic synthesis and transformations using benign reaction media. *Acc Chem Res* 41:629–639
136. Varma RS, Baig RBN (2012) Organic synthesis using microwaves and supported reagents. In: de la Hoz A, Loupy A (eds) *Microwaves in organic synthesis*, 3rd edn. Wiley-VCH, Weinheim
137. Varma RS, Dahiya R, Kumar S (1997) Clay catalyzed synthesis of imines and enamines under solvent-free conditions using microwave irradiation. *Tetrahedron Lett* 38:2039–2042
138. Cotterill IC, Usyatinsky AY, Arnold JM, Clark DS, Dordick JS, Michels PC, Khmel'nitsky YL (1998) Microwave assisted combinatorial chemistry synthesis of substituted pyridines. *Tetrahedron Lett* 39:1117–1120
139. Varma RS, Kumar D (1999) Microwave-accelerated three-component condensation reaction on clay: solvent-free synthesis of imidazo[1,2-a] annulated pyridines, pyrazines and pyrimidines. *Tetrahedron Lett* 40:7665–7669
140. Williams L (2000) Thin layer chromatography as a tool for reaction optimisation in microwave assisted synthesis. *Chem Commun* 2000(6):435–436
141. Collados JF, Toledano E, Guijarro D, Yus M (2012) Microwave-assisted solvent-free synthesis of enantiomerically pure *N*-(*tert*-butylsulfinyl)imines. *J Org Chem* 77:5744–5750
142. Yin G, Liu Q, Ma J, Shi N (2012) Solvent- and catalyst-free synthesis of new hydroxylated trisubstituted pyridines under microwave irradiation. *Green Chem* 14:1796–1798
143. Manhas MS, Ganguly SN, Mukherjee S, Jain AK, Bose AK (2006) Microwave initiated reactions: pechmann coumarin synthesis, biginelli reaction, and acylation. *Tetrahedron Lett* 47:2423–2425



144. List B (ed) (2012) *Asymmetric organocatalysis*. Topics in current chemistry, vol 291. Springer, Berlin
145. Bruckmann A, Krebs A, Bolm C (2010) Organocatalytic reactions: effects of ball milling, microwave and ultrasound irradiation. *Green Chem* 10:1131–1141
146. Westermann B, Neuhaus C (2005) Dihydroxyacetone in amino acid catalyzed Mannich-type reactions. *Angew Chem Int Ed* 44:4077–4079
147. Rodríguez B, Bolm C (2006) Thermal effects in the organocatalytic asymmetric Mannich reaction. *J Org Chem* 71:2888–2891
148. Mossé S, Alexakis A (2006) Organocatalyzed asymmetric reactions via microwave activation. *Org Lett* 8:3577–3580
149. Hagiwara H, Inotsume S, Fukushima M, Hoshi T, Suzuki T (2006) Heterogeneous amine catalyst grafted on amorphous silica: an effective organocatalyst for microwave-promoted Michael reaction of 1,3-dicarbonyl compounds in water. *Chem Lett* 35:926–927
150. Octavio R, de Souza MA, Vasconcellos MLAA (2003) The use of DMAP as catalyst in the Baylis–Hillman reaction between methyl acrylate and aromatic aldehydes. *Synth Commun* 33:1383–1389
151. Massi A, Nuzzi A, Dondoni A (2007) Microwave-assisted organocatalytic anomerization of  $\alpha$ -C-glycosylmethyl aldehydes and ketones. *J Org Chem* 72:10279–10282
152. Hayes BL, Collins MJ Jr (2004) Reaction and temperature control for high power microwave-assisted chemistry techniques. US Patent 6,744,024 B1
153. Hosseini M, Stiasni N, Barbieri V, Kappe CO (2007) Microwave-assisted asymmetric organocatalysis. a probe for nonthermal microwave effects and the concept of simultaneous cooling. *J Org Chem* 72:1417–1424
154. Stolle A, Scholz P, Ondruschka B (2012) Gaseous reactants in microwave-assisted synthesis in microwaves in organic synthesis. In: de la Hoz A, Loupy A (eds) *Microwaves in organic synthesis*, vol 1 (3rd edn). Wiley-VCH, Weinheim, doi: 10.1002/9783527651313.ch11
155. Petricci E, Taddei M (2008) Microwave assisted reactions with gas reagents. *Chem Today* 26:18–22
156. Vanier GS (2007) Simple and efficient microwave-assisted hydrogenation reactions at moderate temperature and pressure. *Synlett* 2007(1):131–135
157. Kennedy DP, Kormos CM, Burdette SC (2009) FerriBRIGHT: a rationally designed fluorescent probe for redox active metals. *J Am Chem Soc* 131:8578–8586
158. Piras L, Genesio E, Ghiron C, Taddei M (2008) Microwave-assisted hydrogenation of pyridines. *Synlett* 2008(8):1125–1128
159. Kaval N, Dehaen W, Kappe CO, Van der Eycken E (2004) The effect of pressure on microwave-enhanced Diels–Alder reactions. A case study. *Org Biomol Chem* 2:154–156
160. Kormos CM, Leadbeater NE (2008) Preparation of nonsymmetrically substituted stilbenes in a one-pot two-step Heck strategy using ethene as a reagent. *J Org Chem* 73:3854–3858
161. Odell R, Russo F, Larhed M (2012) Molybdenum hexacarbonyl mediated CO gas-free carbonylative reactions. *Synlett* 23(5):685–698
162. Kormos CM, Leadbeater NE (2006) Microwave-promoted hydroxycarbonylation in water using gaseous carbon monoxide and pre-pressurized reaction vessels. *Synlett* 2006(11):1663–1666
163. Kormos CM, Leadbeater NE (2007) Alkoxy carbonylation of aryl iodides using gaseous carbon monoxide and pre-pressurized reaction vessels in conjunction with microwave heating. *Org Biomol Chem* 65–68
164. Pizzetti M, Russo A, Petricci E (2011) Microwave-assisted aminocarbonylation of ynamides by using catalytic  $[\text{Fe}_3(\text{CO})_{12}]$  at low pressures of carbon monoxide. *Chem Eur J* 17:4523–4528
165. Salvadori J, Balducci E, Zaza S, Petricci E, Taddei M (2010) Microwave-assisted carbonylation and cyclocarbonylation of aryl iodides under ligand free heterogeneous catalysis. *J Org Chem* 75:1841–1847

166. Cardullo F, Donati D, Merlo G, Paio A, Petricci E, Taddei M (2009) Microwave-assisted aminocarbonylation of aryl bromides at low carbon monoxide pressure. *Synlett* 2009 (1):47–50
167. Kormos CM, Leadbeater NE (2007) Alkoxy carbonylation reactions performed using near-stoichiometric quantities of CO. *Synlett* 2007(13):2006–2010
168. Petricci E, Mann A, Schoenfelder A, Taddei M (2006) Microwaves make hydroformylation a rapid and easy process. *Org Lett* 8:3725–3727
169. Andappan MMS, Nilsson P, von Schenck H, Larhed M (2004) Dioxygen-promoted regioselective oxidative Heck arylations of electron-rich olefins with arylboronic acids. *J Org Chem* 69:5212–5218
170. Kormos CM, Hull RM, Leadbeater NE (2009) Microwave heating in conjunction with UV irradiation: a tool for the oxidation of 1,4-dihydropyridines to pyridines. *Aust J Chem* 62:51–57
171. Církva V (2012) Microwaves in photochemistry and photocatalysis. In: de la Hoz A, Loupy A (eds) *Microwaves in organic synthesis*, 3rd edn. Wiley-VCH, Weinheim
172. Serpone N, Horikoshi S, Emeline AV (2010) Microwaves in advanced oxidation processes for environmental applications. A brief review. *J Photochem Photobiol C* 11:114–131
173. Církva V, Relich S (2011) Microwave photochemistry. Applications in organic synthesis. *Mini Rev Org Chem* 8:282–293
174. Matloobi M, Kappe CO (2007) Microwave synthesis in high-throughput environments. Moving from automated sequential to microtiter plate formats. *Chem Today* 25:26–31
175. Blackwell HE (2003) Out of the oil bath and into the oven – microwave-assisted combinatorial chemistry heats up. *Org Biomol Chem* 1:1251–1255
176. Kappe CO, Dallinger D (2006) The impact of microwave synthesis on drug discovery. *Nat Rev Drug Discov* 5:51–63
177. Kappe CO, Matloobi M (2007) Parallel processing of microwave-assisted organic transformations. *Comb Chem High T Scr* 10:735–750
178. Kremsner JM, Stadler A, Kappe CO (2007) High-throughput microwave-assisted organic synthesis: moving from automated sequential to parallel library-generation formats in silicon carbide microtiter plates. *J Comb Chem* 9:285–291
179. Damm M, Kappe CO (2009) High-throughput experimentation platform: parallel microwave chemistry in HPLC/GC vials. *J Comb Chem* 11:460–468
180. Treu M, Karner T, Kousek R, Berger HDB, Stadler A (2008) Microwave-assisted parallel synthesis of fused heterocycles in a novel parallel multimode reactor. *J Comb Chem* 10:863–868
181. Damm M, Kappe CO (2009) Parallel microwave chemistry in silicon carbide reactor platforms: an in-depth investigation into heating characteristics. *Mol Divers* 13:529–543
182. Stencel LM, Kormos CM, Avery KB, Leadbeater NE (2009) Assessment and use of two silicon carbide multi-well plates for library synthesis and proteolytic digests using microwave heating. *Org Biomol Chem* 7:2452–2457
183. Damm M, Kappe CO (2011) A high-throughput platform for low-volume high-temperature/pressure sealed vessel solvent extractions. *Anal Chim Acta* 707:76–83
184. Prekodravac B, Damm M, Kappe CO (2011) Microwave-assisted forced degradation using high-throughput microtiter platforms. *J Pharm Biomed Anal* 56:867–873
185. Damm M, Holzer M, Radspieler G, Marsche G, Kappe CO (2010) Microwave-assisted high-throughput acid hydrolysis in silicon carbide microtiter platforms – a rapid and low volume sample preparation technique for total amino acid analysis in proteins and peptides. *J Chromatogr A* 1217:7826–7832
186. O'Neill JC, Blackwell HE (2007) Solid-phase and microwave-assisted syntheses of 2,5-diketopiperazines: small molecules with great potential. *Comb Chem High T Scr* 10:857–876
187. Dai WM, Shi J (2007) Diversity-oriented synthesis and solid-phase organic synthesis under controlled microwave heating. *Comb Chem High T Scr* 10:837–856

188. Pérez R, Beryozkina T, Zbruyev OI, Haas W, Kappe CO (2002) Traceless solid-phase synthesis of bicyclic dihydropyrimidones using multidirectional cyclization cleavage. *J Comb Chem* 4:501–510
189. Cerezo V, Amblard M, Martínez J, Verdié P, Planas M, Feliu L (2008) Solid-phase synthesis of 5-arylhistidines via a microwave-assisted Suzuki–Miyaura cross-coupling. *Tetrahedron* 64:10538–10545
190. Tsukamoto H, Suzuki R, Kondo Y (2006) Revisiting benzenesulfonyl linker for the deoxygenation and multifunctionalization of phenols. *J Comb Chem* 8:289–292
191. Tullberg M, Luthman K, Grøtli M (2006) Microwave assisted solid-phase synthesis of 2,5-diketopiperazines: solvent and resin dependence. *J Comb Chem* 8:915–922
192. Henkel B (2004) Synthesis of imidazole-4-carboxylic acids via solid-phase bound 3-*N*, *N*-(Dimethylamino)-2-isocyanoacrylate. *Tetrahedron Lett* 45:2219–2221
193. Schobert R, Jagusch C (2003) Solid-phase domino syntheses of functionalized tetronates with  $\text{Ph}_3\text{P}=\text{C}=\text{O}$ . *Tetrahedron Lett* 44:6449–6451
194. Kumar HMS, Anjaneyulu S, Reddy BVS (2000) Microwave-assisted rapid Claisen rearrangements on solid phase. *Synlett* 2000(8):1129–1130
195. Feliu L, Vera-Luque P, Albericio F, Álvarez M (2007) Advances in solid-phase cycloadditions for heterocyclic synthesis. *J Comb Chem* 9:521–565
196. Blackwell HE (2006) Hitting the SPOT: small molecule macroarrays advance combinatorial synthesis. *Curr Opin Chem Biol* 10:203–212
197. Bowman MD, Jacobson MM, Blackwell HE (2006) Discovery of fluorescent cyanopyridine and deazalumazine dyes using small molecule macroarrays. *Org Lett* 8:1645–1648
198. Wiles C, Watts P (2011) Recent advances in micro reaction technology. *Chem Comm* 47:6512–6535
199. Wegner J, Ceylan S, Kirschning A (2011) Ten key issues in modern flow chemistry. *Chem Comm* 47:4583–4592
200. Alcázar J, AdeM M (2012) Microwave-assisted continuous flow organic synthesis (MACOS). In: de la Hoz A, Loupy A (eds) *Microwaves in organic synthesis*, 3rd edn. Wiley-VCH, Weinheim
201. Comer E, Organ MG (2005) A microreactor for microwave-assisted capillary (continuous flow) organic synthesis. *J Am Chem Soc* 127:8160–8167
202. Comer E, Organ MG (2005) A microcapillary system for simultaneous, parallel microwave-assisted synthesis. *Chem Eur J* 11:7223–7227
203. Shore G, Morin S, Organ MG (2006) Catalysis in capillaries by Pd thin films using microwave-assisted continuous flow organic synthesis (MACOS). *Angew Chem Int Ed* 45:2761–2766
204. Shore G, Organ MG (2008) Diels–Alder cycloadditions by microwave-assisted, continuous flow organic synthesis (MACOS): the role of metal films in the flow tube. *Chem Commun* 2008(7):838–840
205. Moseley JD (2010) Microwave heating as a tool for process chemistry. In: Leadbeater NE (ed) *Microwave heating as a tool for sustainable chemistry*. CRC, Boca Raton
206. Leonelli C, Mason TJ (2010) Microwave and ultrasonic processing: now a realistic option for industry. *Chem Eng Process* 49:885–900
207. Strauss CR (2009) On scale up of organic reactions in closed vessel microwave systems. *Org Process Res Dev* 13:915–923
208. Moseley JD, Kappe CO (2011) A critical assessment of the greenness and energy efficiency of microwave-assisted organic synthesis. *Green Chem* 13:794–806
209. Devine WG, Leadbeater NE (2011) Probing the energy efficiency of microwave heating and continuous-flow conventional heating as tools for organic chemistry. *ARKIVOC* 2011(5):127–143. doi:10.3998/ark.5550190.0012.512
210. Hoogenboom R, Wilms TFA, Erdmenger T, Schubert US (2009) Microwave-assisted chemistry: a closer look at heating efficiency. *Aust J Chem* 62:236–243

211. Robinson J, Kingman S, Irvine D, Licence P, Smith A, Dimitrakis G, Obermayer D, Kappe CO (2010) Understanding microwave heating effects in single mode type cavities – theory and experiment. *Phys Chem Chem Phys* 12:4750–4758
212. Godwin DR, Lawton SJ, Moseley JD, Welham MJ, Weston NP (2010) Energy efficiency of conventionally-heated pilot plant reactors compared with microwave reactors. *Energy Fuels* 24:5446–5453
213. Barnard TM, Vanier GS, Collins MJ (2006) Scale-up of the green synthesis of azacycloalkanes and isoindolines under microwave irradiation. *Org Process Res Dev* 10:1223–1237
214. Leadbeater NE, Williams VA, Barnard TM, Collins MJ (2006) Open-vessel microwave-promoted Suzuki reactions using low levels of palladium catalyst: optimization and scale-up. *Org Process Res Dev* 10:833–837
215. Leadbeater NE, Williams VA, Barnard TM, Collins MJ (2006) Solvent-free, open-vessel microwave-promoted Heck couplings: from the mmol to the mol scale. *Synlett* 2006 (18):2953–2958
216. Alcázar J, Diels G, Schoentjes B (2004) Reproducibility across microwave instruments: first example of genuine parallel scale up of compounds under microwave irradiation. *QSAR Comb Sci* 23:906–910
217. Stadler A, Yousefi BH, Dallinger D, Walla P, Van der Eycken E, Kaval N, Kappe CO (2003) Scalability of microwave-assisted organic synthesis. from single-mode to multimode parallel batch reactors. *Org Process Res Dev* 7:707–716
218. Marafie JA, Moseley JD (2010) The application of stop-flow microwave technology to scaling-out  $S_NAr$  reactions using a soluble organic base. *Org Biomol Chem* 8:2219–2227
219. Loones KTJ, Maes BUW, Rombouts G, Hostyn S, Diels G (2005) Microwave-assisted organic synthesis: scale-up of palladium-catalyzed aminations using single-mode and multi-mode microwave equipment. *Tetrahedron* 61:10338–10348
220. Arvela RK, Leadbeater NE, Collins MJ (2005) Automated batch scale-up of microwave-promoted Suzuki and Heck coupling reactions in water using ultra-low metal catalyst concentrations. *Tetrahedron* 61:9349
221. Pitts MR, McCormack P, Whittall J (2006) Optimisation and scale-up of microwave assisted cyanation. *Tetrahedron* 62:4705–4708
222. Dallinger D, Lehmann H, Moseley JD, Stadler A, Kappe CO (2011) Scale-up of microwave-assisted reactions in a multimode bench-top reactor. *Org Process Res Dev* 15:841–854
223. Schmink JR, Kormos CM, Devine WG, Leadbeater NE (2010) Exploring the scope for scale-up of organic chemistry using a large batch microwave reactor. *Org Process Res Dev* 14:205–214
224. Iannelli M, Bergamelli F, Kormos CM, Paravisi S, Leadbeater NE (2009) Application of a batch microwave unit for scale-up of alkoxycarbonylation reactions using a near-stoichiometric loading of carbon monoxide. *Org Process Res Dev* 13:634–637
225. Wagner RW, Brownell JH (2012) Combining microwaves with continuous flow. *Specialty Chemicals Magazine*, November 2012, pp. 24–26
226. Morschhäuser R, Krull M, Kayser C, Boberski C, Bierbaum R, Püschner PA, Glasnov TN, Kappe CO (2012) Microwave-assisted continuous flow synthesis on industrial scale. *Green Process Synth* 1:281–290
227. Glasnov TN, Kappe CO (2011) The microwave-to-flow paradigm: translating high-temperature batch microwave chemistry to scalable continuous-flow processes. *Chem Eur J* 17:11956–11968
228. Bose AK, Banik BK, Lavlinskia N, Jayaraman M, Manhas MS (1997) MORE chemistry in a microwave. *Chemtech* 27:18–24
229. Leadbeater NE, Schmink JR, Hamlin TA (2012) Tools for monitoring reactions performed using microwave heating. In: de la Hoz A, Loupy A (eds) *Microwaves in organic synthesis*, 3rd edn. Wiley-VCH, Weinheim

230. Bowman MD, Leadbeater NE, Barnard TM (2008) Watching microwave-promoted chemistry: reaction monitoring using a digital camera interfaced with a scientific microwave apparatus. *Tetrahedron Lett* 49:195–198
231. Leadbeater NE (2010) In situ reaction monitoring of microwave-mediated reactions using IR spectroscopy. *Chem Commun* 46:6693–6695
232. Leadbeater NE, Schmink JR (2008) Use of Raman spectroscopy as a tool for in situ monitoring of microwave-promoted reactions. *Nat Protoc* 3:1–7
233. Heller E, Klöckner J, Lautenschläger W, Holzgrabe U (2010) Online monitoring of microwave-enhanced reactions by UV/Vis spectroscopy. *Eur J Org Chem* 5:3569–3573

# Microwave-Assisted Step-Growth Polymerizations (From Polycondensation to C–C Coupling)

Shadpour Mallakpour and Amin Zadehnazari

**Abstract** The use of microwave irradiation has become a widespread and convenient method for heating food and beverages in modern society due to the energy efficient and volumetric heating observed with microwave irradiation. The application of microwave or dielectric heating in chemistry has been limited, however, with most applications occurring in organic chemistry. This new technology provides novel approaches for enhancing the material properties. The technique offers a simple, clean, fast, efficient, and economic method for the synthesis of a large number of organic molecules, which provided the momentum for many chemists to switch from traditional heating method to microwave-assisted chemistry. In recent years, the use of microwave irradiation has become a common heat source in organic chemistry. Inspired by this enormous success, chemists are also increasingly studying microwave irradiation for polymerization reactions. Polymer technology forms one of the largest areas of application of microwave technology, and the methods and procedures used therein are among the most developed in chemistry. The main areas in which the use of this energy has been explored in recent years are step-growth polymerizations, ring-opening polymerizations, and radical polymerizations. Its specific heating method attracts extensive interest because of rapid heating, suppressed side reactions, energy saving, direct heating, decreased environmental pollution, and safe operation. In the present chapter, an overview

---

S. Mallakpour (✉)

Organic Polymer Chemistry Research Laboratory, Department of Chemistry,  
Isfahan University of Technology, Isfahan 84156-83111, Iran

Nanotechnology and Advanced Materials Institute, Isfahan University of Technology,  
Isfahan 84156-83111, Iran

e-mail: [mallak@cc.iut.ac.ir](mailto:mallak@cc.iut.ac.ir); [mallak777@yahoo.com](mailto:mallak777@yahoo.com); [mallakpour84@alumni.ufl.edu](mailto:mallakpour84@alumni.ufl.edu)

A. Zadehnazari

Organic Polymer Chemistry Research Laboratory, Department of Chemistry,  
Isfahan University of Technology, Isfahan 84156-83111, Iran

will be given of recent applications of microwave technology in well-known step-growth polymerization reactions. A comparison with the conventional methods demonstrates the advantages of microwaves in synthetic condensation polymerization chemistry.

**Keywords** Application · Microwave irradiation · Step-growth polymerization · Synthesis

## Contents

1	Introduction .....	47
2	Step-Growth Polymerization .....	49
2.1	Poly(amide)s .....	50
2.2	Poly(imide)s .....	56
2.3	Poly(ether)s .....	59
2.4	Poly(ester)s .....	63
2.5	Poly(urea)s .....	65
2.6	Poly(amide-imide)s .....	67
2.7	Poly(amide-ester)s, Poly(ester-imide)s, Poly(ether-imide)s, and Poly(ether-ester)s .....	73
2.8	Poly(amide-imide-urethane)s and Poly (amide-ether-urethane)s .....	75
2.9	Polymerizations via C–C Coupling Reactions .....	76
3	Conclusions .....	78
	References .....	79

## Abbreviations

BCMO	3,3-Bis(chloromethyl)oxetane
DAI	Diphenylamino-isosorbide
DBTDL	Dibutyltin dilaurate
DDS	4,4'-Diaminodiphenylsulfone
DMAc	<i>N,N</i> -Dimethylacetamide
DMF	<i>N,N</i> -Dimethylformamide
DSC	Differential scanning calorimetry
HMDI	Hexamethylene diisocyanate
IL	Ionic liquid
IPDI	Isophorone diisocyanate
MALDI-TOF MS	Matrix-assisted laser desorption/ionization time-of-flight mass spectrometry
MDI	4,4'-Diphenylmethane diisocyanate
$M_n$	Number-average molecular weight
MPU	4-(4-Methoxyphenyl)urazole
$M_w$	Weight-average molecular weight
NMP	<i>N</i> -Methyl-2-pyrrolidone
NMR	Nuclear magnetic resonance
PA	Poly(amide)

PAI	Poly(amide-imide)
PEA	Poly(ester-amide)
PEG	Poly(ethylene glycol)
PEI	Poly(ester-imide)
PHU	4-Phenylurazole
PI	Poly(imide)
PPV	Poly(phenylene vinylene)
PTC	Phase-transfer catalysis
Py	Pyridine
$T_g$	Glass transition temperature
TGA	Thermogravimetric analysis
TPP	Triphenyl phosphite

## 1 Introduction

In the electromagnetic spectrum, the microwave region is broadly defined as the region with wavelengths ranging from 1 m down to 1 mm. This corresponds to frequencies of between 0.3 and 300 GHz. Because applications such as wireless devices (2.40–5.00 GHz; USA), satellite radio (2.30 GHz), and air traffic control operate in this range, regulatory agencies allow equipment for industrial, scientific, and medical use to operate at only five specific frequencies: 25.12, 5.80, 2.45, 0.91, and 0.43 GHz. Domestic microwave ovens operate at 2.45 GHz (12.25 cm wavelength), and this same frequency has also been widely adopted by companies manufacturing scientific microwave apparatus for use in preparative chemistry, with only a few exceptions [1]. The first announcement of a microwave oven was probably a magazine article about a newly developed Radarange for airline use. This device, it was claimed, could bake biscuits in 29 s, cook hamburgers in 35 s, and grill frankfurters in 10 s. The first commercial microwave oven was developed by Percy Spencer, of a company called Raytheon, in 1952. There is a legend that Spencer, who studied high-power microwave sources for radar applications, observed a melting of a chocolate bar in his pocket. Another story says that Spencer had some popping corn in his pocket that began to pop as he was standing alongside a live microwave source. This idea led to the microwave oven in 1961 and the generation of the mass market. The widespread domestic use of microwave ovens occurred during the 1970s and 1980s as a result of Japanese technology transfer and global marketing [2]. Microwave heating is based on the ability of a particular substance such as a solvent or substrate to absorb microwave energy and effectively convert the electromagnetic energy to heat (kinetic energy). Molecules with a dipole moment attempt to align themselves with the oscillating electric field of the microwave irradiation, leading to rotation. In the gas phase, these molecular rotations are energetically discrete events and can be observed using microwave spectroscopy [3]. In the liquid and solid phases, these once-quantized rotational events coalesce into a broad continuum as rotations are rapidly quenched both by collisions and translational movement. Molecules in the liquid or gas phase begin



to be rotationally sympathetic to incident electromagnetic irradiation when the frequency approaches  $10^6$  Hz [4]. On the other hand, above a frequency around  $10^{12}$  Hz (infrared region), even small molecules cannot absorb an appreciable amount of rotational energy before the field changes direction. The optimal frequency at which a molecule turns incident electromagnetic radiation into kinetic energy is a function of many component parts, including the permanent dipole moment, the size of the molecule, and temperature. However, for most small molecules, the relaxation process is most efficient in the microwave region (0.30–300 GHz) of the electromagnetic spectrum. Most good dielectric materials are solid and examples include ceramics, mica, glass, plastics, and the oxides of various metals, but some liquids and gases can serve as good dielectric materials as well. For example, deionized water is a moderately good dielectric; however, it consists of polar molecules that can couple efficiently with microwaves leading to heat generation due to polarization losses. Such substances that are counted among dielectrics but exhibit some polarization losses that result in the dielectric heating are also called dielectric loss materials. On the other hand, *n*-hexane, being a symmetrical molecule, does not possess a dipole moment and does not absorb microwaves. To apply microwaves to carry out chemical processes, it is most important to have at least one component that is polarizable and whose dipoles can reorient (couple) rapidly in response to the changing electric field of microwave radiation. Providentially, a number of organic molecules and solvents fulfill these necessities and are good candidates for microwave applications. Since the first published reports by the groups of Gedye and Giguere/Majetich in 1986 [5, 6] on the use of microwave irradiation to carry out organic transformations, more than 3,500 articles have been published in this fast-moving and exciting field, today generally referred to as microwave-assisted organic synthesis [7–10]. In many of the published examples, microwave irradiation has been shown to dramatically reduce reaction times, increase product yields, and improve product purities by reducing unwanted side reactions compared to conventional heating methods [10]. The advantages of this enabling technology have also been exploited in the context of multistep synthesis [11, 12] and medicinal chemistry/drug discovery [13–18], and have additionally penetrated related fields such as polymer synthesis [19–25], material sciences [26–30], nanotechnology [31–33], and biochemical processes [34–37]. The use of microwave irradiation in chemistry has thus become such a popular technique in the scientific community that it might be assumed that, in a few years, most chemists will probably use microwave energy to heat chemical reactions on a laboratory scale. The statement that, in principle, any chemical reaction that requires heat can be performed under microwave irradiation has today been commonly accepted as a fact by the scientific community. The use of microwave irradiation in polymer chemistry is an emerging field of research. The number of publications in this field is rapidly increasing and the number of research groups working on this topic is also expanding incessantly. Reported studies have already demonstrated that polymerizations can also be accelerated when using microwave heating and that the molecular weight distributions can be improved due to the homogeneous heating [19–25]. Step-growth polymerization was one of the first polymerizations to be studied using microwave heating technology and

numerous examples have been summarized in review articles and books [22, 24, 25, 38, 39]. Conventional polycondensation reactions involve, in many cases, the use of harsh conditions such as high temperatures and long reaction times, but they can be performed with great success with the assistance of microwave energy. Some more recent review articles show an overview on the potentials of microwave-assisted reactions for synthesis of polymers. Schubert et al. [21] reviewed microwave-assisted polymer synthesis, including step-growth, free and controlled radical, as well as ring-opening polymerizations. Microwave-assisted polymerizations, with an emphasis on microwave-assisted ring-opening polymerization, covering both homopolymerization and copolymerization of cyclic monomers, are also reviewed by Gong et al. and the advantages of microwave-assisted ring-opening polymerization over conventional polymerization discussed [22].

The objective of this contribution is to explain useful details concerning the application of microwave irradiation to step-growth polymerization chemistry. Research in this area has shown the potential advantages of microwaves to not only drive the polymerization reaction but also to perform them on a reduced time scale. Specific examples of condensation polymerizations are described to show that various types of polymers can be prepared under microwave irradiation. In addition, polymerization via C–C coupling reactions under microwave irradiation resulting in conjugated polymers is becoming more popular and will be discussed as well. Because the effects of microwave irradiation on chemical reactions are generally evaluated by comparing the time needed to obtain a desired yield of final products with respect to conventional thermal heating, for this purpose, in some cases, the syntheses run under microwave conditions are compared with conventional heating methods.

## 2 Step-Growth Polymerization

Step-growth polymerizations continue to receive intense academic and industrial attention for the preparation of polymeric materials used in a vast array of applications. Polycondensation is a special type of step-growth polymerization in which the reaction between monomers and the growing polymer chain end group releases a small molecule such as water, alcohol, or hydrochloric acid. This reversible reaction will reach equilibrium and halt unless the small molecular byproduct is removed. Polymers that contain heteroatoms in the main chain, such as polyamides (PA)s and poly(imide)s (PI)s, are typically synthesized by this mechanism. A number of polymers obtained in step-growth polymerization reactions can be classified as so-called functionally terminated thermoplastics, which combine the toughness of thermoplastics and the resistance of thermosets. Most recently, step-growth polymerizations have been amongst the most extensively investigated polymerization reactions under microwave irradiation. The challenge in the microwave synthesis and processing of these polymers is that temperature during the reactions and processing is often very close to the thermal degradation temperature, making temperature control crucial.

## 2.1 Poly(amide)s

Synthesis of aliphatic PAs under microwave irradiation was reported in a series of papers [40–44]. PAs were prepared from either  $\omega$ -amino acids or diamines together with dicarboxylic acids (i.e., the nylon salt type of monomers) in the presence of a small amount of a polar organic medium. The reactions were carried out in a modified domestic microwave oven with a small hole on the top of the oven so that nitrogen could be introduced into a 30-mL wide-mouth vial adapted as a reaction vessel. In a typical experiment, a monomer or its salt (2.00 g) in a polar high-boiling solvent (1.00–2.00 mL) that acted as a microwave absorber was irradiated under nitrogen atmosphere. The microwave-assisted polycondensation proceeded rapidly and was completed within 5 min for the PAs with inherent viscosity of around 0.24–0.63 dL g<sup>-1</sup>. Inherent viscosity of the polymer was measured by using an Ostwald viscometer at a concentration of 0.5 g dL<sup>-1</sup> in concentrated sulfuric acid at 30°C.

Large temperature differences were observed between the final temperature of the solvent alone and the final temperature of the polymerization mixtures. However, the temperature measurements were performed by means of a thermocouple that was immersed in the reaction mixtures just after removal of the reaction vessels from the microwave cavity. This phenomenon was explained by the participation of the polar amino acid monomer dissolved in the solvent to generate additional heat during the polymerization under microwave irradiation. When water, which possesses the highest dielectric constants, was used as a solvent, a PA with an inherent viscosity of 0.35 dL g<sup>-1</sup> was obtained. In general, the use of solvents possessing both a high dielectric constant and boiling point, attaining high final polymerization temperature, led to the formation of a PA characterized by viscosities higher than 0.50 dL g<sup>-1</sup>. Suitable solvents were found to be sulfolane and amide-type solvents such as *N*-cyclohexyl-2-pyrrolidone and 1,3-dimethylimidazolidone. Hydroxyl-containing solvents possessing a high dielectric constant like glycol, and those with low polarity, such as benzyl alcohol, *m*-cresol, and *o*-chlorophenol, were also effective in producing a PA with the viscosity values of approximately 0.5 dL g<sup>-1</sup> or higher. Thus, the solvents played an important role as primary microwave absorbers for the microwave-assisted polycondensations [39]. The same experimental procedure was applied and similar observations were made for the polymerization of diamines with dicarboxylic acids (i.e., the nylon-type salt monomers). Moreover, for the salt monomers, the rate of polycondensation under various conditions was in the following order: microwave-induced polycondensation > solid-state thermal polymerization > high-pressure thermal polycondensation [40]. For some series of diamines and dicarboxylic acids, the polycondensation reactions were run under periodic and continuous microwave irradiation [44]. Eventually, it was found that the polycondensation under periodic microwave irradiation yielded PAs with a higher inherent viscosity and allowed for easier temperature control in comparison with continuous irradiation. In a similar way, the synthesis of aromatic PAs from aromatic diamines [*m*-phenylenediamine, *p*-phenylenediamine,

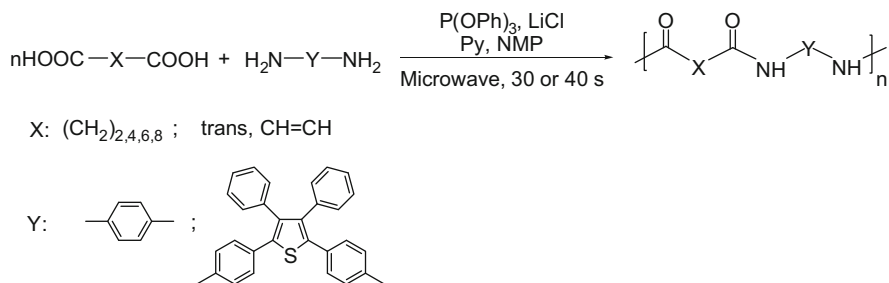

**Scheme 1** Synthesis of poly(amide)s from linear nonaromatic dicarboxylic acids (i.e., adipic, suberic, sebacic, and fumaric acid) and aromatic diamines [46]

bis(4-aminophenyl) methane, and bis(4-aminophenyl)ether] and dicarboxylic acids such as isophthalic and terephthalic was performed in a household microwave oven by Hong et al. [45]. The polycondensation was carried out in an *N*-methyl-2-pyrrolidone (NMP) solution in the presence of triphenyl phosphite (TPP), pyridine, and lithium chloride as condensing agents to produce a series of PAs with moderate inherent viscosities of 0.21–0.92 dL g<sup>-1</sup> within 30–50 s. However, no marked differences in molecular weight distribution and inherent viscosities were found between the PAs produced by conventional (60 s, 220°C) and microwave methods. The synthesis of PAs from linear nonaromatic dicarboxylic acids (i.e., adipic, suberic, sebacic, and fumaric acid) and aromatic diamines such as *p*-phenylenediamine or 2,5-bis(4-aminophenyl)-3,4-diphenylthiophene (Scheme 1) under microwave conditions was presented by Pourjavadi et al. [46]. The reactions were carried out in a 50-mL high density polyethylene (HDPE) screw-capped cylinder vessel, in which aromatic acid (1.25 mmol) with aliphatic diamine (1.25 mmol) in a NMP (3 mL) solution were irradiated in a domestic microwave oven (30–40 s) in the presence of TPP (3.12 mmol), pyridine (0.75 mL), and lithium chloride (3.12 mL). The PAs with inherent viscosity in the range of 0.10–0.80 dL g<sup>-1</sup> were obtained in medium to high yield (60–100%). Temperature was not measured during these microwave experiments. The PAs were characterized by thermal methods [thermogravimetric analysis (TGA), differential scanning calorimetry (DSC)]. However, no comparison with the polymers prepared by a conventional method was made.

More recently, the synthesis of PAs containing isosorbide units under microwave irradiation was described by Caouthar et al. [47]. The polycondensation of isosorbide-derived diamine with different derivatives of diacyl chlorides in the presence of a small amount of NMP is shown in Scheme 2.

The molecular weight of polymers under microwave and interfacial polymerization or the Higashi process was compared. Thus, it was found that the molecular weight of polymers obtained under microwave heating was much higher than under conventional conditions. The polymers were obtained with inherent viscosities between 0.22 and 0.73 dL g<sup>-1</sup>, corresponding to molecular weights up to 140,000 g mol<sup>-1</sup>. With interfacial polymerization or the Higashi method, lower molecular weight polymers were acquired with inherent viscosities in the range of

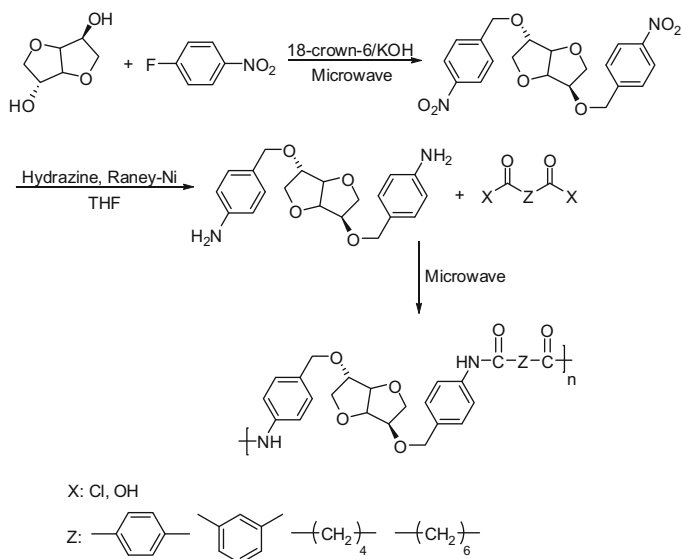

**Scheme 2** Reaction of isosorbide with *p*-fluoronitrobenzene and further reduction of the dinitro derivative into the diamino derivative and polymerization of acid dichlorides and the diamino derivative of isosorbide [47]

0.04–0.36 dL g<sup>-1</sup>. In another study by Caouthar's research group [48], a series of optically active PAs were prepared from the polycondensation reaction of an optically active isosorbide-derived diacyl chloride with two aromatic diamines, diphenylamino-isosorbide (DAI) and 4,4'-diaminodiphenylsulfone (DDS), in NMP under microwave irradiation and interfacial polymerization from an isosorbide-derived diamine with different diacyl chlorides. The polymers were obtained in 52% and 70% yields with inherent viscosities of 0.11 and 0.92 dL g<sup>-1</sup> after 30 and 6 min of reaction time for diamines of DAI and DDS, respectively, whereas the polymerization reaction using the interfacial technique was unsuccessful. The synthesis of chiral PAs from the polycondensation reaction of chiral 5-(4-methyl-2-phthalimidyl-pentanoylamino)isophthalic acid, (2*S*)-5-(3-phenyl-2-phthalimidylpropanoylamino)isophthalic acid and 5-(3-methyl-2-phthalimidylpentanoylamino)isophthalic acid with several aromatic and aliphatic diisocyanates such as 4,4'-diphenylmethane diisocyanate (MDI), toluylene-2,4-diisocyanate (TDI), isophorone diisocyanate (IPDI), and hexamethylene diisocyanate (HMDI) under microwave irradiation as well as using conventional techniques was investigated by Mallakpour et al. (Scheme 3) [49–51]. Amalgamation of the bulky side chain in the PAs cause an increase in the solubility while maintaining good thermal stability. Microwave-assisted step-growth polymerization reactions preceded rapidly compared to conventional solution polycondensation and were completed within a short period of time. The reactions were carried out in the presence of a small amount of dibutyltin dilaurate (DBTDL), pyridine, or triethylamine (TEA) as catalysts or without catalyst. The use of such an

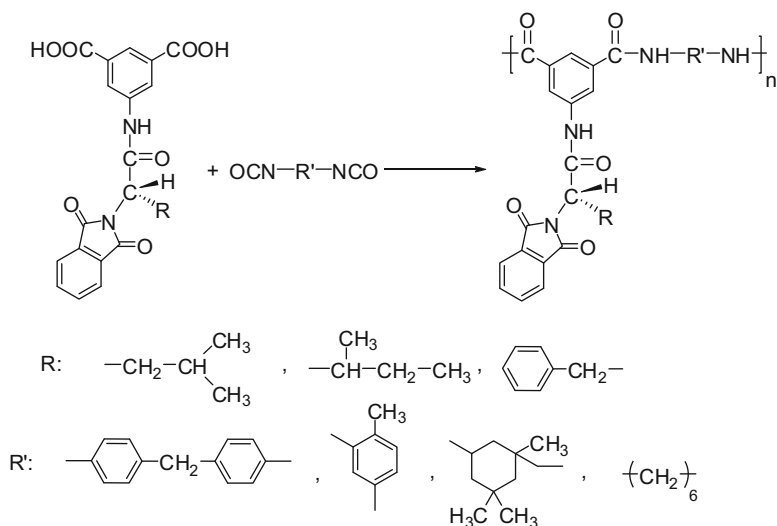

**Scheme 3** Synthesis of optically active and thermally stable poly(amide)s [49–51]

organic medium was necessary to induce effective homogeneous heating of the monomers. Mallakpour et al. obtained comparable results from the point of view of yield and inherent viscosity of the polymers, with lower reaction time by several orders of magnitude under microwave conditions, and the procedure was straightforward. The polymerization reactions were also carried out in the presence of tetrabutylammonium bromide (TBAB) as a molten salt ionic liquid (IL) or using a traditional solvent like NMP under microwave irradiation as well as conventional heating conditions [52–54].

In another study, Mallakpour et al. [55] synthesized novel optically active aromatic PAs from the reaction of a new diacid monomer, 5-[3-phenyl-2-(9,10-dihydro-9,10-ethanoanthracene-11,12-dicarboximido)propanoylamino]isophthalic acid, which was successfully synthesized starting from *cis*-9,10-dihydro-9,10-ethanoanthracene-11,12-dicarboxylic acid anhydride and *L*-phenylalanine, and different aromatic diamines, by both microwave-assisted and conventional heating polyamidation (Scheme 4). A highly effective, very fast microwave method was described for the synthesis of optically active aromatic PAs under microwave heating for only 3 min. Generally, better yields are obtained as well as faster and cleaner reactions when using microwave irradiation rather than conventional heating. All of these polymers having bulky anthracenic and amino acid functionality in the side chain showed excellent solubility and readily dissolved in various organic solvents. PAs were thermally stable, with 10% weight loss recorded at 385°C in the nitrogen atmosphere, char yields higher than 50% at 800°C, and glass transition temperature ( $T_g$ ) above 180°C.

Because of the importance of optically active materials and polymers based on amino acids, Mallakpour et al. [56] prepared a series of novel optically

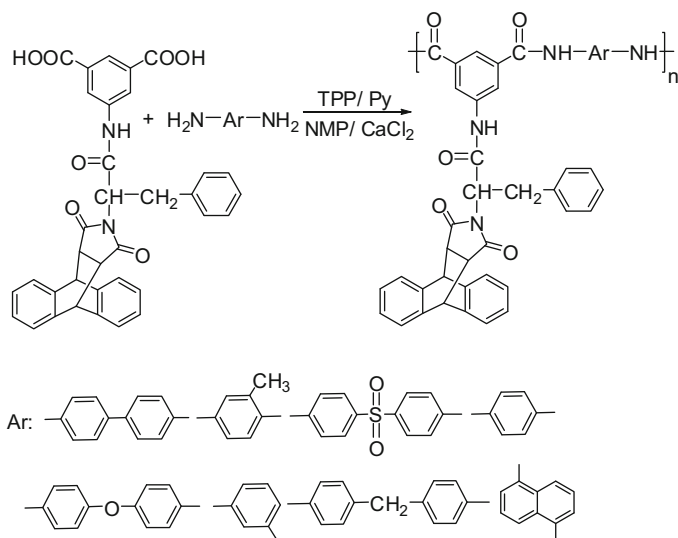

**Scheme 4** Polycondensation reactions of chiral monomer with aromatic diamines [55]

active PAs by direct polycondensation of chiral dicarboxylic acid, containing a rigid naphthalimide and flexible S-valine pendant group, 5-[3-methyl-2-(1,8-naphthalimidyl)-butanoylamino]isophthalic acid, with different diisocyanates. Both microwave heating, in the presence of a small amount of ILs that act as a primary microwave absorber, as well as conventional heating methods were used (Scheme 5). Incorporation of the naphthalimide group into the polymer side chain as well as combination of the aromatic backbone and aliphatic pendant group in the presence of several functional groups remarkably increased the solubility while maintaining good thermal stability of the new polymers. The choice of 1,8-naphthalenedicarboxylic anhydride was due to the many derivatives of 1,8-naphthalic anhydride that exhibit strong fluorescence emission and serve for this reason as fluorescent dyes and fluorescent whitening agents. The authors reported for the first time an electrochemical oxidation method based on the adsorptive stripping cyclic voltammetry technique on the multiwalled carbon nanotube-modified glassy carbon electrode for the investigation of electrochemical stability of the resulting polymers in aqueous solution at various pH values. The resulting polymers have many potential applications as photoactive materials for use in solar energy collectors as electro-optically sensitive materials and for laser activity.

In recent years, Mallakpour and coworkers [57] reported on the synthesis and characterization of a new class of fully aromatic and optically active PAs containing phthalimide and L-leucine pendant groups by condensation polymerization of a bulky diacid, (2S)-5-[4-(4-methyl-2-phthalimidyl)pentanoyl-amino]benzoylamino] isophthalic acid, and several diisocyanates (Scheme 6). Polymerization reactions were performed in 240 s under microwave irradiation in the

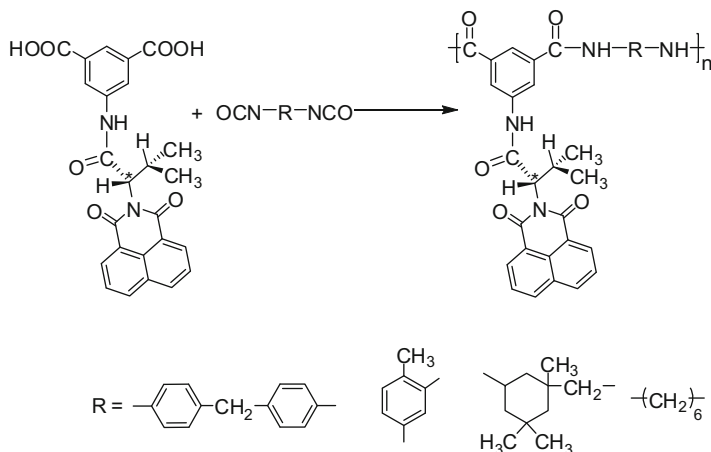

**Scheme 5** Synthesis of optically active flame retardant poly(amide)s [56]

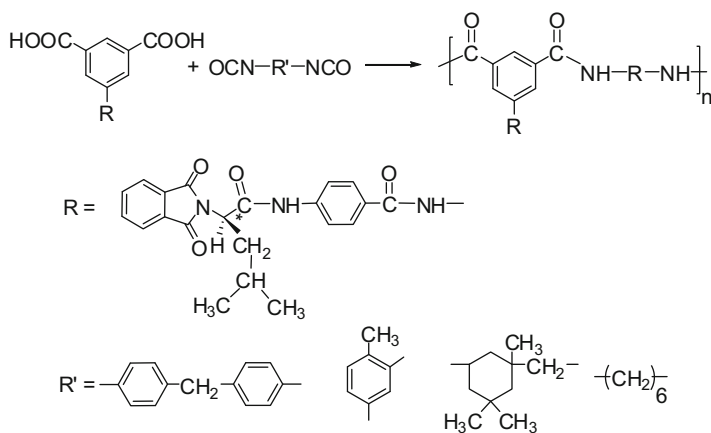

**Scheme 6** Synthesis of optically active poly(amide)s containing phthalimide and L-leucine pendant groups [57]

presence of DBTDL as a catalyst and without catalyst in molten TBAB as a green medium and were compared with polymerization in NMP as a common organic solvent. The resulting polymers were obtained in good yields and inherent viscosities ranged between 0.26 and 0.96 dL g<sup>-1</sup>. The resulting aromatic PAs were soluble in various organic solvents and had good thermal stability.

An optimization of the Yamazaki–Higashi method for direct polyamidation of aromatic diacids and aromatic diamines was reported by Carretero et al. [58]. As a model reaction, the polycondensation between 4,4'-oxydianiline and isophthalic acid was studied in the presence of a phosphorylation agent under microwave irradiation. It was shown that optimal results can be attained by using a great excess



of pyridine as catalyst (pyridine-to-monomer ratio of 7), at moderate radiation intensity (200 W), and up to 25% (w/v) monomer concentration. Although the inherent viscosity achieved by microwave and by conventional heating was comparable, an exceptional reaction rate under microwave irradiation yielded a PA inherent viscosity of around  $1.00 \text{ dL g}^{-1}$  in only a few minutes.

## 2.2 Poly(imide)s

As poly(imide)s (PIs) possess many desirable attributes, this class of materials has found applications in many technologies. They have inherently strong mechanical properties, good chemical resistance, low dielectric constants, and high thermal stability. The high processing temperature of these materials requires dopant molecules to have high thermal decomposition temperatures. Currently, high performance PIs are being widely used for several primary applications in the electronics area, including: (1) fabrication aids such as photoresists, planarization layers and in implant masks; (2) passivation overcoats and interlevel insulators; (3) adhesives and underfill materials for micro BGA ( $\mu$ BGA) packaging and flip chip technology; and (4) substrate components. Some other applications include aerospace, automotive, and general engineering. In the aerospace and automotive industry they are used in structural composites and as high temperature adhesives. General engineering applications include high temperature bearings and seals [59, 60].

A large number of the presented PIs contain the pyromellitoyl unit in their polymer chains. The incorporation of this unit into the polymers chain increased the thermal stability. Imai et al. [61] investigated the step-growth polymerization of aliphatic diamines  $\text{H}_2\text{N}-(\text{CH}_2)_x-\text{NH}_2$  ( $x = 6-12$ ) with both pyromellitic acid and its diethyl ester (Scheme 7). The reactions were performed in solution in a domestic microwave oven. Among the investigated solvents, all of them with high boiling points and high dielectric constants, 1,3-dimethyl-2-imidazolidone (DMI) proved to be best suited as primary microwave absorber and solvent for the monomers and polymers. PIs with inherent viscosities of  $0.7 \text{ dL g}^{-1}$  (for  $x = 12$ ) were obtained within 2 min from pyromellitic acid as starting material. Especially for pyromellitic acid diethyl ester as monomer, the microwave-assisted polymerization proved its virtues by producing a series of PIs with inherent viscosities of up to  $1.60 \text{ dL g}^{-1}$ . For the reaction of dodecamethylene diamine with pyromellitic acid, a direct comparison between microwave irradiation and conventional heating was made in control experiments. The solution polymerization in the microwave was shown to proceed much faster than the corresponding solid-state synthesis under conventional heating during the initial 5 min. After these 5 min, and with concomitant inherent viscosities of around  $1.00 \text{ dL g}^{-1}$ , the inherent viscosities of the polymers that were prepared in the microwave oven only slightly increased with prolonged irradiation times, whereas those from the polymers synthesized with conventional heating still increased to values of up to  $2.00 \text{ dL g}^{-1}$ . No explanation was provided for these observations; instead, Imai's group emphasized the microwave's superiority to conventional heating during the first 5 min.

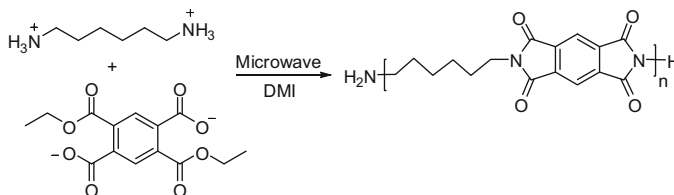

**Scheme 7** Poly(imide) synthesis from the reaction of hexamethylene diamine with pyromellitic acid diethylester under microwave irradiation [61]

Another series of PIs, having third-order nonlinear optical properties, were prepared by Lu et al. [62] from sodium tetrazodiphenyl naphthionate and pyromellitic dianhydride under microwave irradiation as well as oil-bath heating in *N,N*-dimethylformamide (DMF) as solvent by a two-step method (Scheme 8). Using microwave heating, the imidization time was reduced from hours to minutes and, due to the fast heating rate, the degree of imidization was noticeably increased. This same group [63] introduced PIs containing the pyromellitoyl unit via a two-step pathway. In the first step, reaction of benzoguanamine and TDI generated a poly(urea). Subsequent polyimidation of the resulting poly(urea) and pyromellitic dianhydride in the solid phase gave the PI (Scheme 9). Lu et al. found that the degree of imidization under microwave irradiation reached a maximum value in 8 min whereas by conventional heating it reached its highest value in 5 h.

Yi et al. [64] reported on the copolycondensation of 3,3',4,4'-benzophenonetetracarboxylic dianhydride, 4,4'-diaminodiphenylmethane, and 4,4'-oxydianiline in DMF under microwave irradiation as well as conventional heating via a two-step procedure (Scheme 10). In the first step, a certain amount of 4,4'-diaminodiphenylmethane and 4,4'-oxydianiline was dissolved in DMF. The reaction vessel, containing a mixture of a reactant and a solvent, was placed on the centre of the turntable in the domestic microwave oven, and then nitrogen gas was introduced from the top of the reaction vessel through a thin Teflon tube to minimize the danger of fire in the reaction system. Then, a certain amount of 3,3',4,4'-benzophenonetetracarboxylic dianhydride was dropped into the reaction vessel. The reaction system was irradiated with microwaves for a prescribed time at a low temperature. The polymerizations were carried out at different microwave irradiation times for which 2 h was found best for the preparation of poly(amic acid) (PAA) with highest yield and inherent viscosity. The polyimidation was achieved by dehydration under 1 h of continuous microwave radiation. Compared with the conventional solution polycondensation method, the results showed that the polymers obtained via microwave-assisted polymerization had superior inherent viscosities and yields in a much shorter reaction time.

More recently, Xu et al. [65] used a microwave-assisted polycondensation method for the synthesis of PAA and PI using pyromellitic dianhydride and 3,3',4,4'-benzophenonetetracarboxylic dianhydride and 4,4'-oxydianiline under microwave irradiation in DMF as solvent. The polymerization reaction under microwave irradiation resulted in an increase of the reaction rate as well as higher yield and inherent viscosity.

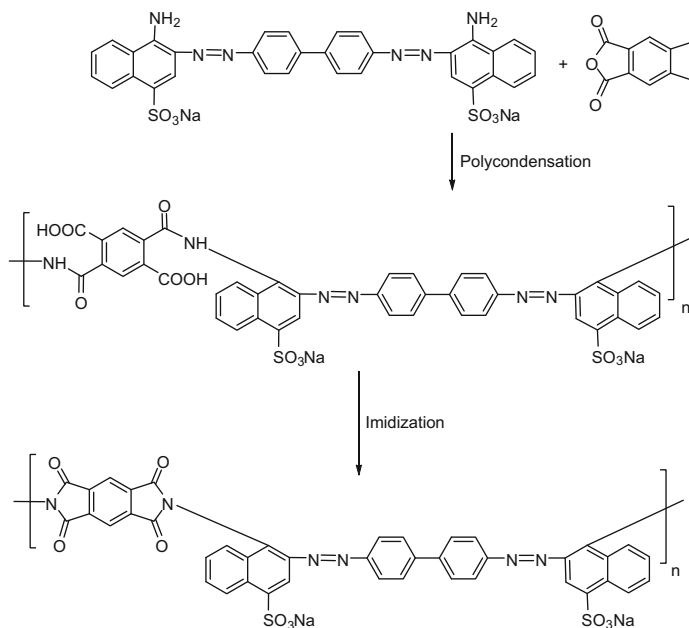

**Scheme 8** Synthesis of poly(imide)s by the reaction of sodium tetrazodiphenyl naphthionate and pyromellitic dianhydride [62].

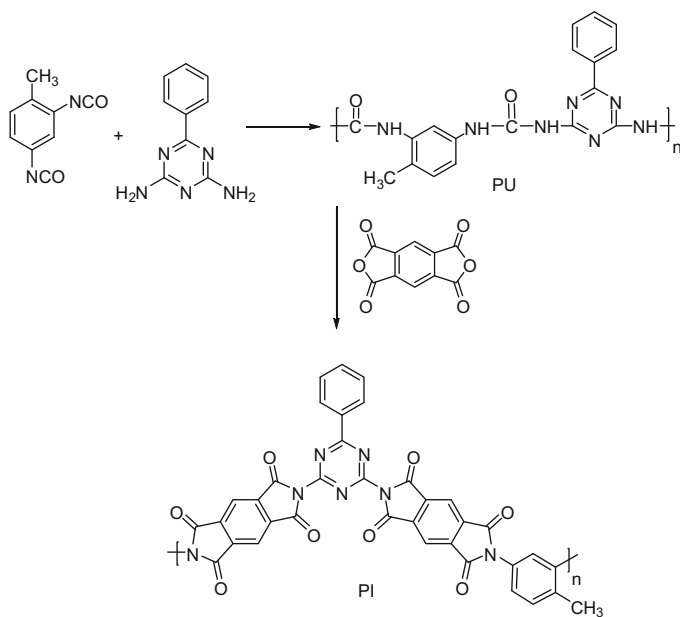

**Scheme 9** Synthesis of poly(imide) (PI) containing the pyromellitoyl unit . PU poly(urea) [63]

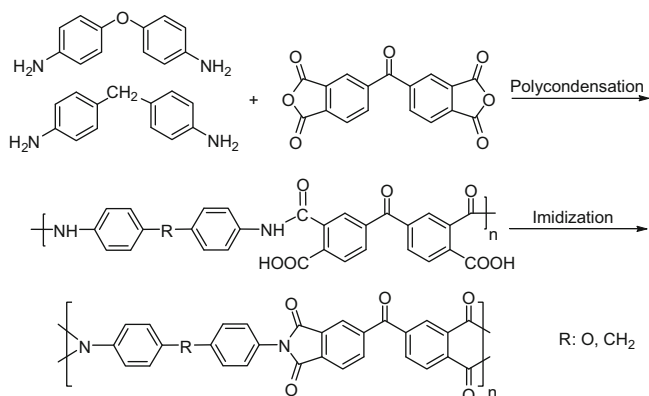

**Scheme 10** Copolycondensation of 3,3',4,4'-benzophenonetetracarboxylic dianhydride, 4,4'-diaminodiphenylmethane, and 4,4'-oxydianiline under microwave irradiation [64]

In a study by Ritter and coworkers [66], linear and cyclic PIs were synthesized via bulk polymerization under microwave irradiation. The AB-type monomer 3-aminophthalic anhydride (Scheme 11, structure 2) used was obtained by means of a one-pot microwave-assisted heterogeneous catalytic transfer hydrogenation of the corresponding nitrophthalic acid (Scheme 11, structure 1). The resulting bifunctional monomer (Scheme 11, structure 2) could easily be purified and is unreactive at room temperature. However, it has the possibility to form high-molecular-mass polymers at elevated temperatures and thereby fulfills the requirements of an AB-type monomer. Matrix-assisted laser desorption/ionization time-of-flight mass spectrometry (MALDI-TOF MS) measurements of the polymers (Scheme 11, structure 3), prepared under microwave heating, indicate the formation of a polymer homolog series of linear and ring-shaped molecules.

### 2.3 Poly(ether)s

Hurduc et al. [67] investigated the synthesis of a poly(ether) by phase-transfer catalysis (PTC) under microwave irradiation for the reaction of 3,3-bis(chloromethyl)oxetane (BCMO) and various bisphenols (i.e., bisphenol A, 4,4'-dihydroxyazobenzene, 4,4'-dihydroxybiphenyl, 4,4'-dihydroxybenzophenone, and 4,4'-thiodiphenyl) (Scheme 12). In a typical reaction, a mixture of bisphenol (1.30 mmol), water (5.00 mL), NaOH (3.00 g), nitrobenzene (5 mL), BCMO (1.30 mmol), and TBAB (0.20 mmol) was placed in a 50-mL flask and irradiated for 1.5 h in a microwave waveguide (60 W) while temperature (95–100°C) was monitored by a thermovision infrared camera. Under conventional conditions, the reaction was carried out for 5 h at 90°C. It was found that for semicrystalline polymers, the yields were higher under microwave conditions, whereas in the case of amorphous polymer, the yields were approximately equal in shorter reaction times.

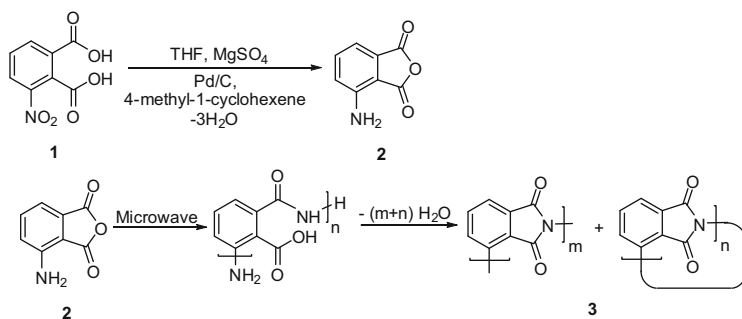

**Scheme 11** One-pot synthesis of 3-aminophthalic anhydride (2) via microwave-assisted transfer hydrogenation of nitrophthalic acid (1) and formation of poly(3-phthalimide) (3) under microwave heating [66]

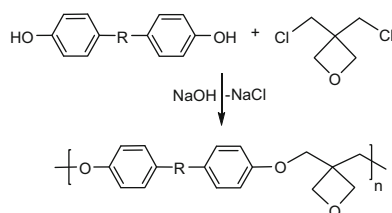

**Scheme 12** Synthesis of poly(ether)s by phase-transfer catalysis (PTC) reactions [67]

Moreover, this same group [68] studied the modification of oxetane-based polymers with 4-(2-aminoethyl)-morpholine (Scheme 13) under microwave irradiation. In a typical experiment, 0.1 g of the polymer with 0.10–0.40 g of 4-(2-aminoethyl) morpholine in a DMF solution (10 mL) was exposed to microwave irradiation for 1–3 h in a stereo-mode applicator while the temperature was monitored with use of a thermovision camera. The highest degree of conversion under microwave irradiation reached 27%, whereas in several syntheses under conventional conditions, the conversions of oxetane rings were always lower and achieved a maximum value of 18%.

Alimi et al. [69] investigated microwave-assisted homopolycondensation of 1-chloro-4-methoxybenzene in alkaline dimethyl sulfoxide solution for producing poly(phenylene vinylene)-ether (PPV-ether) (Scheme 14). The mixture was exposed to 600 W microwaves for a few minutes until a temperature of 470 K was achieved and then stirred at room temperature for 6 h. This raw mixture was composed of three fractions: a yellow fraction of PPV-ether insoluble in all common organic solvents with 43% yield, a white fraction soluble in CHCl<sub>3</sub> with 52% yield, and a yellow-green fraction soluble in the CH<sub>2</sub>Cl<sub>2</sub> with 5% yield.

Chatti et al. [70, 71] reported on the synthesis of linear poly(ether)s from either isosorbide or isoidide and disubstituted alkyl bromides or methanesulfates by using microwave irradiation under solid–liquid PTC conditions (Scheme 15). Isosorbide

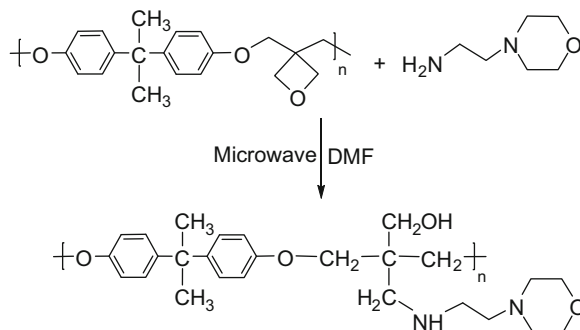

**Scheme 13** Modification of oxetane-based polymers under microwave irradiation [68]

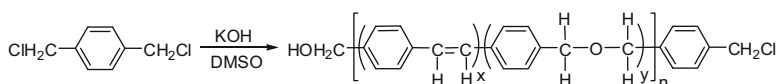

**Scheme 14** Microwave-assisted synthesis of poly(phenylene vinylene)-ether (PPV-ether) [69]

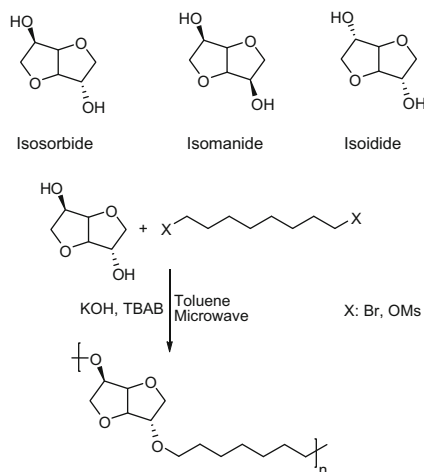

**Scheme 15** *Top*: Chemical structure of isosorbide (1,4-dianhydro-D-sorbitol), isomanide (1,4-dianhydro-D-mannitol), and isoidide (1,4-dianhydro-D-idoitol). *Below*: Synthetic scheme for linear poly(ether) synthesis from either isosorbide or isoidide and disubstituted alkyl bromides or methanesulfates [70–72]

and isoidide are byproducts of biomass obtained from the sugar industry through double dehydration of starch [72]. The reactions were carried out in a single-mode microwave reactor, Synthwave 402 (Prolabo), with temperature infrared detector, which was previously calibrated with an optical fiber detector introduced into a

reaction mixture. The reaction mixtures consisting of isosorbide or isoidide (5 mmol), alkyl dibromide/methanedisulfate (5 mmol), TBAB (1.25 mmol), and powdered KOH (12.50 mmol) were irradiated for 30 min to afford the poly(ether)s with 70–90% yield (Scheme 14). It was found that the use of a small amount of solvent was necessary to ensure good temperature control and a decrease in the viscosity of the reaction medium. In the case of isosorbide, the microwave-assisted synthesis proceeded more rapidly than with conventional heating and the reaction time was reduced to 30 min, with a yield of approximately 69–78%. Under conventional conditions, the poly(ether)s were obtained with 28–30% yield within 30 min. Similar yields of the poly(ether)s were obtained when the reaction time was extended to 24 h. These yields remained practically unchanged even though the synthesis was carried out for another 7 days. The analysis of properties of the synthesized poly(ether)s revealed that the structure of the products strictly depended on the activation mode (i.e., microwave or conventional activation). Under microwave conditions, the poly(ether)s were characterized by higher molecular weight and better homogeneity. For example, within 30 min of the reaction time under conventional heating, the poly(ether)s with higher molecular weight were not observed at all. Moreover, it was found that the mechanism of chain termination is different under microwave and conventional conditions. The poly(ether)s prepared with conventional heating had shorter chains with terminal hydroxyl ends, whereas under microwave irradiation the polymer chains were longer with terminal ethylenic ends. In fact, under microwave irradiation, terminal ethylenic ends were formed rapidly and set up a hindrance to further polymer growth. In contrast, under conventional conditions the terminations were essentially constituted by hydroxyl functions; however, further polymerization was prohibited as well.

Later, the same protocol was applied to the polycondensation of aliphatic diols of isosorbide with 1,8-dimesyloctane and other dibromo- and disulfonated alkylating agents [73]. In all cases, it was found that microwave-assisted polycondensations proceeded more efficiently compared with conventional heating (the reaction time was reduced from 24 h to 30 min: ratio 1:50). The polycondensation under microwave yielded 63% of poly(ether)s with relatively high average molecular weights [weight-average molecular weight ( $M_w$ ) up to 7,000 g mol<sup>-1</sup>]. The poly(ether)s were characterized by nuclear magnetic resonance (NMR) (<sup>1</sup>H, <sup>13</sup>C) and Fourier transform–infrared spectroscopy and SEC measurement and MALDI-TOF MS. It was demonstrated that the application of previously synthesized ethers of isosorbide was beneficial and allowed preparation of poly(ether)s in better yields than the poly(ether)s obtained in direct reactions of isosorbide and dibromo- or dimesylalkenes. Moreover, the molecular weights of the poly(ether)s were higher than of those prepared in the earlier work, whereas molecular weight distributions of new poly(ether)s were similar or lower. Such a microwave-assisted procedure can contribute to synthesis of alternating poly(ether)s and further modification of their properties.

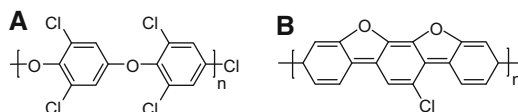

**Scheme 16** Chemical structure of poly(dichlorophenylene oxide) (A) and the conducting polymer (B) [74]

Poly(dichlorophenylene oxide) with a conducting polymer was obtained under microwave irradiation from 2,4,6-trichlorophenol (Scheme 16) [74]. Microwave-initiated polymerization was performed with a Pyrex vessel in which 2.5 g of 2,4,6-trichlorophenol was mixed with 0.5 g of NaOH and 1.00–2.00 mL of triple-distilled water. The reaction mixtures were irradiated in a domestic microwave oven for various time intervals of 1–7 min. The resulting polymers [i.e., poly(dichlorophenylene oxide)] (Scheme 16, A) and the conducting polymer (Scheme 16, B) ( $0.3 \text{ S cm}^{-2}$ ) were separated by precipitation from toluene. The optimum conditions for obtaining poly(dichlorophenylene oxide) or the conducting polymer were 70 W for 5 min and 100 W for 1 min, respectively. In turn, poly(alkylene hydrogen phosphonate)s were obtained by a transesterification of dimethyl hydrogen phosphate and poly(ethylene glycol) (PEG 400) under microwave irradiation (Scheme 17) [75]. The reactions were carried out in a round-bottomed vessel equipped with an upright condenser in which the mixture of 52.50 mmol of dimethyl hydrogen phosphate and 50 mmol of PEG-400 was irradiated in a single-mode microwave reactor for 55 min at 140–190°C. The temperature was monitored by an infrared sensor. It was found that microwave conditions avoid the undesirable thermal degradation of dimethyl hydrogen phosphate because of short reaction times. Although in comparing microwave and conventional conditions, poly(alkene hydrogen phosphonate)s with higher average molecular weights were obtained under conventional conditions, the reaction time was substantially reduced under microwave conditions from 9 h to 55 min for conventional and microwave conditions, respectively.

## 2.4 Poly(ester)s

Aliphatic poly(ester)s (PES)s are one of the most important classes of biodegradable materials. Convergence of functionality and biodegradability represents a major trend in modern materials, especially for biomedical applications and as environmentally friendly alternatives to nondegradable petrochemicals. However, the synthesis of functional (PES)s is still a formidable challenge. Most current methods are inefficient and require complex chemical processes [76]. Direct polycondensation of equimolar quantities of a dicarboxylic acid and a diol, which does not generate any undesirable wastes, is an ideal method for producing aliphatic (PES)s, the demand for which is set to increase considerably as a result of their



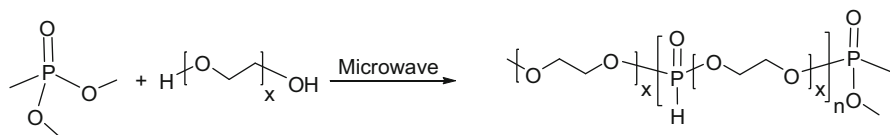

**Scheme 17** Synthetic route for poly(alkylene hydrogen phosphonate)s [75]

biocompatibility. There is a need for an effective system for producing aliphatic (PES)s under mild conditions with short reaction times. Takeuchi and coworkers [77] reported on a rapid, environmentally benign, solvent-free method for the synthesis of aliphatic (PES)s by direct polycondensation of equimolar quantities of a dicarboxylic acid and a diol through microwave irradiation (at a power of 200 W, 10 min) in the presence of tin(II) chloride as catalyst. The number-average molecular weight ( $M_n$ ) of the polymers that were obtained was relatively constant and the reaction time was extremely short (10 min) compared with existing systems, such as  $\text{Sc}(\text{OTf})_3$  ( $M_n = 2.09 \times 10^4$ ,  $4.0 \times 10^3$  Pa, 10 h) [78],  $\text{HfCl}_4(\text{THF})_2$ , (THF, tetrahydrofuran), ( $M_n = 3.40 \times 10^4$ , 24 h, *o*-xylene reflux) [79],  $\text{SnCl}_2$  ( $M_n = 1.64 \times 10^4$ , 16 h, dimethyl benzene reflux) [80]. The advantages of this microwave-assisted method, such as equimolar direct polycondensation, a short reaction time, and solvent-free conditions, permit the synthesis of aliphatic (PES)s in a rapid and ecofriendly manner under conditions that are mild compared with those used in conventional syntheses. In another study, Takeuchi et al. [81] reported on a microwave-assisted direct polycondensation of lactic acid by use of a binary catalyst of  $\text{SnCl}_2/p\text{-TsOH}$ , using a single-mode microwave synthesizer (2.45 GHz frequency and 300 W maximum power). They reported that microwave irradiation successfully accelerated the reaction and produced poly (lactic acid) (PLA) with a molecular weight higher than  $10,000 \text{ g mol}^{-1}$ . The reactions were performed with different catalysts like  $\text{SnCl}_2$ ,  $\text{Sn}(\text{Oct})_2$ ,  $\text{Bu}_2\text{SnCl}_2$ , 1,3-dichloro-1,1,3,3-tetrabutyl-distannoxane,  $\text{SnCl}_2/p\text{-toluene}$  sulfuric acid monohydrate (*p*-TsOH), *p*-TsOH, phosphoric acid, and sulfuric acid. Under optimized conditions, the  $\text{SnCl}_2/p\text{-TsOH}$  binary catalyst gave a white polymer with a molecular weight of  $16,000 \text{ g mol}^{-1}$  within 30 min of microwave irradiation at  $200^\circ\text{C}$ , and the reaction time can be reduced significantly compared to conventional polycondensation at the same temperature. An oligomer of lactic acid with  $M_w$  of  $1,800 \text{ g mol}^{-1}$  in 53.5% isolated yield under normal pressure was obtained after 30 min of microwave irradiation. In contrast, no polymer was obtained with a conventional heating system under the same conditions. PLAs with molecular weights of 6,400 and  $15,000 \text{ g mol}^{-1}$  were obtained after 60 and 300 min of microwave irradiation, respectively; polymers with molecular weights of 2,300 and  $8,600 \text{ g mol}^{-1}$  were produced at the same reaction times under conventional heating, respectively.

Recently, Nagahata et al. [82] studied direct polyesterification of succinic acid and butane-1,4-diol in the presence of 1,3-dichloro-1,1,3,3-tetrabutyl-distannoxane

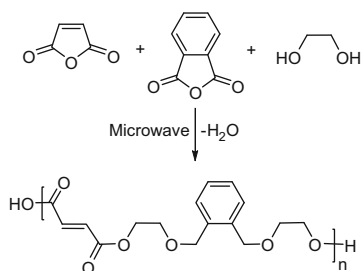

**Scheme 18** Polycondensation of acid anhydrides (i.e., maleic and phthalic anhydrides) with diols [83]

as a catalyst. Under optimum conditions, a reaction time of 20 min, poly(butylene succinate) with a  $M_w$  of  $2.35 \times 10^4 \text{ g mol}^{-1}$  was obtained. In comparison with the reactions conducted via conventional heating (5 h), microwave irradiation showed a tenfold increase in the rate of polymerization. Polycondensation reaction of acid anhydrides (i.e., maleic and phthalic anhydrides) with diols (i.e., ethylene glycol) under microwave irradiation was also described by Pielichowski et al. [83] for the synthesis of unsaturated (PES)s (Scheme 18). It was found that the reaction times for microwave and conventional protocols were comparable and depended on the rate of removing water from the reaction system.

The bulk polycondensation of DL-lactic acid to PLA under microwave irradiation was also studied by Keki et al. [84] (Scheme 19). The reactions were carried out in a domestic microwave oven, in which 5 g of lactic acid was placed in a 20-mL beaker and irradiated at 650 W. The reaction time was varied between 10, 20, and 30 min to afford PLA with 96%, 84%, and 63% yield, respectively. The yield of polycondensation decreased with increasing irradiation time, probably due to the loss of oligomers of lower polymerization degree during the polycondensation. Under conventional thermal conditions, the polymer was obtained in 94% yield after 24 h at 100°C. According to MALDI mass spectrometry analysis, only linear oligomers were formed. After 20 min of microwave irradiation, oligomers were obtained with nearly the same  $M_n$  as those produced upon conventional heating (i.e., 100°C, 24 h). Thus, the reaction time for preparing PLA could be considerably reduced. On increasing the reaction time under microwave conditions, a fraction of cyclic oligomers tended to appear as well as linear oligomers.

## 2.5 Poly(urea)s

Diamines are frequently used to react with diisocyanates, especially isocyanate prepolymers, to give poly(urea)s. The reaction has the advantages that no byproducts are produced and that it can be carried out at low temperatures. The synthesis of high molecular weight poly(urea)s and poly(thiourea)s via the reaction

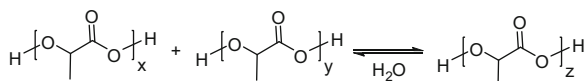

**Scheme 19** Polycondensation of DL-lactic acid to poly(lactic acid) under microwave irradiation [84]

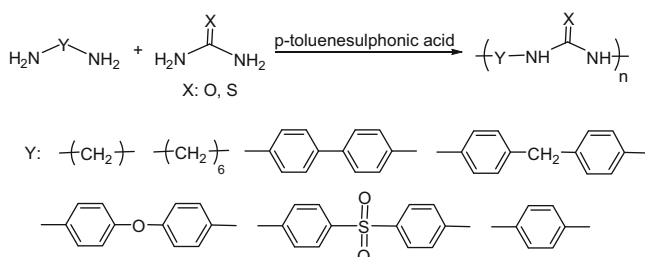

**Scheme 20** Synthesis of poly(urea)s and poly(thiourea)s under microwave irradiation [85]

of aromatic and aliphatic amines with urea and thioureas in the presence of a catalytic amount of *p*-toluenesulfonic acid was reported by Banihashemi et al. [85] using a microwave oven (for duration of 12 min) at 400 W (Scheme 20). The reactions were performed in different solvents such as dimethyl sulfoxide, *N,N*-dimethylacetamide (DMAc), chlorobenzene, dioxane, and toluene. DMAc was chosen as the most appropriate solvent owing to the greater solubility of the substrates, the higher rate of the reactions, and the excellent energy-transfer properties. In comparison with the conventional thermal method, microwave irradiation reduces the reaction time and simplifies the workup processes. Owing to partial degradation of the aliphatic polymers, increasing the reaction time up to 15 min led to polymers with lower viscosities.

Mallakpour et al. [86–88] reported on solution polycondensation reactions of 4-(4'-*N*-1,8-naphthalimidophenyl)-1,2,4-triazolidine-3,5-dione, 4-(4'-acetamidophenyl)-1,2,4-triazolidine-3,5-dione and 4-(4'-*t*-butylphenyl)-1,2,4-triazolidine-3,5-dione with HMDI, IPDI, and TDI in DMAc or NMP solution in the presence of pyridine, TEA, or DBTDL as a catalyst under microwave irradiation (Scheme 21). After irradiation times of 8–18 min, poly(urea)s with inherent viscosities of 0.06–0.30 dL g<sup>-1</sup> were obtained. In another study by Mallakpour and coworkers [89], 4-phenylurazole (PHU) and 4-(4-methoxyphenyl)urazole (MPU) were condensed with HMDI, IPDI, and TDI under solvent-free conditions using a domestic microwave oven (Scheme 21). Optimized experimental conditions allowed the preparation of high molecular weight poly(urea)s in yields up to 92% within 5 min of heating (no temperature measurement was reported). The materials are of potential use for the encapsulation of pharmaceuticals, inks, and dyes or for the modification of wool fibers by interfacial grafting techniques [90]. Conventional thermal synthesis, both solvent-free and also in DMAc solution, afforded polymers with comparable properties but only after 12 h at 120°C.

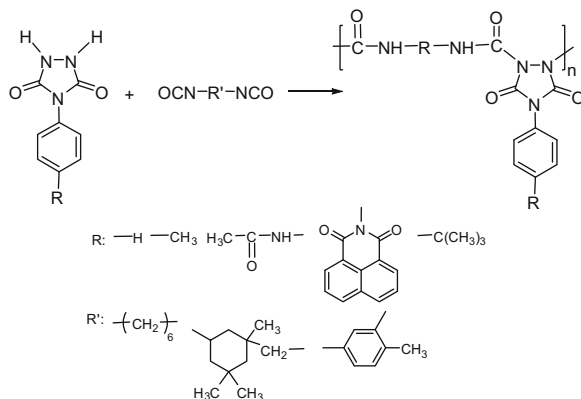

**Scheme 21** Polycondensation reactions of different urazole derivatives with various diisocyanates [86–89]

## 2.6 Poly(amide-imide)s

High performance polymers are thermally stable polymers that generally show excellent mechanical strength and stability. They have received widespread attention as replacements for metals or ceramics in the automotive, aerospace, and microelectronic industries [91]. Aromatic PIs as versatile high performance polymers have been investigated for a variety of applications (e.g., aerospace, microelectronics, optoelectronics, nanocomposites, separation membranes, finger-mounted tactile sensors, etc.) because of their excellent balance of thermal, mechanical, and electric insulation properties, and chemical resistance. However, the processing of these thermoplastic polymers has been greatly hindered because they lack softening or melting behavior at usual processing temperatures and they tend to degrade before or at the softening temperature [92, 93]. To overcome these drawbacks, modifications of the PI structure are often used, for example, introducing kinked and flexible bridging units, nonsymmetrical structures, or bulky substituents into the polymer backbones. In addition, various copolymers have been developed and reported, among them poly(amide-imide)s (PAIs), whose amide groups can improve the solubility [94]. PAIs have properties in between aromatic PAs and PIs. Thermal stability of PAIs is worse than that of PIs and better than PAs, but they are processable. The high thermal resistance of PAIs is due to heterocyclic imide-ring into polymer chains [95, 96]. PAs are used in a broad range of applications, from injection or compression molded parts and ingots to coatings, films, fibers, membranes, wire enamels, and adhesives [97, 98]. Synthesis and characterization of a number of optically active PAIs under microwave irradiation were investigated by Mallakpour's group [99–101]. The synthesis of PAIs from the polycondensation reaction of *N,N'*-(pyromellitoyl)-bis-*L*- $\alpha$ -amino diacid chlorides (prepared using amino acids such as *L*-leucine, *L*-isoleucine, and *L*-valine) with different aromatic diamines under

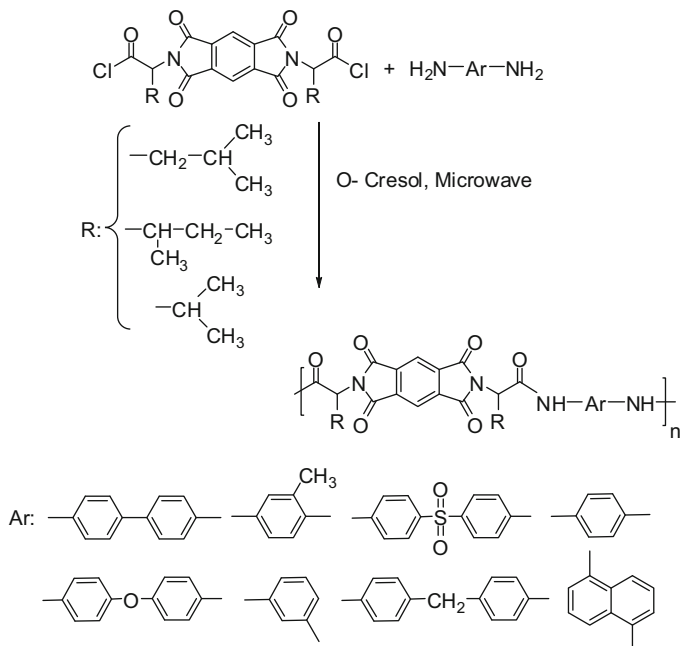

**Scheme 22** Synthesis of chiral poly(amide)s by reaction of different  $N,N'$ -(pyromellitoyl)-bis- $L$ - $\alpha$ -amino diacid chloride with aromatic diamines [99–101]

microwave heating in a porcelain dish was studied and the results compared with those polymers obtained by conventional heating (Scheme 22). The obtained aromatic PAIs were optically active and soluble in various organic solvents and have good thermal stability. Microwave-assisted step-growth polymerization reactions preceded rapidly compared to conventional solution polycondensation and it was completed within a short period of time. Several types of optically active PAIs were prepared by Mallakpour et al. [102–105] from polycondensation reaction of  $N,N'$ -(4,4'-carbonyldipthaloyl)-bis  $\alpha$ -amino diacid chlorides (prepared using amino acids such as  $L$ -phenylalanine,  $L$ -alanine and  $L$ -leucine) with several aromatic diamines in *o*-cresol or DMAc (Scheme 22). Polymerization reactions were carried out using microwave irradiation and conventional solution polycondensation. The microwave-assisted polycondensation proceeded rapidly, compared with the conventional melt polycondensation and solution polycondensation giving a series of PAIs with inherent viscosities of about 0.22–0.85 dL g<sup>-1</sup>. All aromatic PAIs were optically active and readily soluble in various organic solvents and had good thermal stability. The inherent viscosities obtained from microwave-assisted polycondensation reactions are much higher than those polymers obtained from solution polymerization. Furthermore, the above results demonstrate that microwave heating is an efficient method (shorter reaction time and high efficiency of energy) for the polycondensation reactions. Polymerization reaction of several diamines with 4,4'-(hexafluoroisopropylidene)- $N$ ,

**Scheme 23** Reaction of several optically active diacid chlorides with different aromatic diamines [102–119]

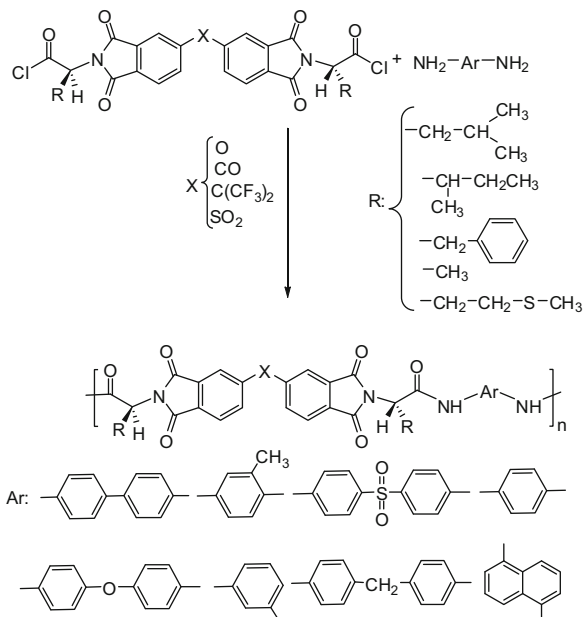

*N'*-bis-(phthaloylmethionine) diacid chloride and 4,4'-(hexafluoroisopropylidene)-bis-(phthaloylleucine) diacid chloride were performed in polar aprotic solvents by Mallakpour's group [106, 107] (Scheme 23). By applying different solution polycondensation methods, fluorine containing PAIs having inherent viscosities in a range of 0.09–0.45 dL g<sup>-1</sup> (molecular weight ranging 15,000–25,000 Da) were synthesized. These polymers exhibited a higher thermal stability than non-fluorine bearing polymers with comparable structures. The presence of both amide and chiral imide groups into the polymer backbone gives a good balance of properties with chiral centers; introducing two CF<sub>3</sub> groups into the monomer unit, gives a good solubility in comparison to the other PAIs.

Mallakpour's group have also reported direct polycondensation of 4,4'-(hexafluoroisopropylidene)-*N,N'*-bis(phthaloylleucine)-*p*-amidobenzoic acid) and *N,N'*-(4,4'-hexafluoroisopropylidenedipthaloyl)-bisoleucine with aromatic diamines in a medium consisting of TPP, NMP, pyridine, and CaCl<sub>2</sub> or via Vilsmeier adduct derived from tosyl chloride and DMF [108, 109] (Scheme 23). The resulting PAIs were obtained in high yield and were optically active and thermally stable. Furthermore, the resulting optically active PAIs contain amino acid linkages and could be biocompatible and biodegradable. The same group [110–114] studied the microwave-promoted as well as conventional heating polycondensation of *N,N'*-(4,4'-oxydipthaloyl)-bis-methionine diacid chloride or diacid chlorides containing amino acids of (S)-valine, L-isoleucine, or L-leucine with several aromatic diamines (Scheme 23). They also investigated a series of optically active PAIs via step-growth polymerization reactions of bis (*p*-amidobenzoic acid)-*N*-trimellitylimidoleucine monomer with different diisocyanates via direct step-growth polymerization under microwave irradiation, solution polymerization

under gradual heating, and reflux conditions in the presence of pyridine, DBTDL, and TEA as a catalyst and without a catalyst [115]. The optically active PAIs were obtained after a short time of 3 min in good yields (53–95%) and with inherent viscosities in the range of 0.17–0.61 dL g<sup>-1</sup>.

Synthesis of optically active PAIs by the reactions of chiral diacid chlorides containing 3,3',4,4'-diphenylsulfonetetracarboxylic dianhydride and  $\alpha$ -amino acids (*S*-valine, *L*-phenylalanine, *L*-leucine, or *L*-isoleucine) moieties with several aromatic diamines was reported by Mallakpour et al. [116–119] (Scheme 23). The polymerization reactions were carried out in the presence of a small amount of *o*-cresol and gave polymers with high yields and moderate inherent viscosities within 6 min with 100% of radiation power. In order to compare this method with conventional solution polycondensation, PAIs were also synthesized by both low and high temperature solution step-growth polymerization. Microwave-enhanced synthesis actually generates higher yields and purer products than conventional techniques. The polyamidation reactions of 4,4'-carbonyl-bis(phthaloylalanine) diacid chloride with six different derivatives of tetrahydropyrimidinone and tetrahydro-2-thioxopyrimidine compounds were discussed earlier in the work of Mallakpour and coworkers [120] in the presence of a small amount of *o*-cresol. Under microwave irradiation power of 900 W, a series of optically active and thermally stable PAIs were produced within 10 min with inherent viscosities in the range of about 0.25–0.45 dL g<sup>-1</sup> and high yields. The syntheses and characterization of optically active PAIs derived from diacid chloride containing epiclone and several amino acids (such as *L*-phenylalanine, *L*-isoleucine, *L*-methionine, *L*-valine, or *L*-leucine) with different aromatic diamines in the presence of a small amount of a polar organic medium such as NMP under microwave irradiation (Scheme 24) was studied by Mallakpour et al. [121–125]. To compare microwave irradiation polymerization with solution polymerization methods, PAIs were also synthesized by both low temperature and high temperature classical solution polymerization. The results of these methods were comparable with the microwave method. But, the microwave heating is a more efficient method for these step-growth polymerization reactions.

Recently, Mallakpour's group [126, 127] developed facile and rapid polycondensation reactions of 3,5-diamino-*N*-(3,4-dihydroxyphenethyl)benzamide with several *N,N'*-(pyromellitoyl)-bis-*L*- $\alpha$ -amino acids and *N*-trimellitylimido-*L*- $\alpha$ -amino acids, in the presence of a small amount of a molten salt, TBAB, and TPP as the activator using a domestic microwave oven (Scheme 25). The polycondensation reactions proceeded rapidly, and completed within 4 min, to produce a series of novel chiral, thermally stable, and nanostructured PAIs in high yield and inherent viscosities. It was shown that 3,5-diamino-*N*-(3,4-dihydroxyphenethyl) benzamide (Scheme 25, structure 4) is an interesting monomer that contains both hydroxyl groups as well as aromatic rings. A synergistic effect was observed with both microwave irradiation and molten salt to improve the thermal stability. Also, field emission scanning electron microscopy (FE-SEM) revealed that PAIs self-organized into nanopatterns. The average diameter of polymeric particles was in

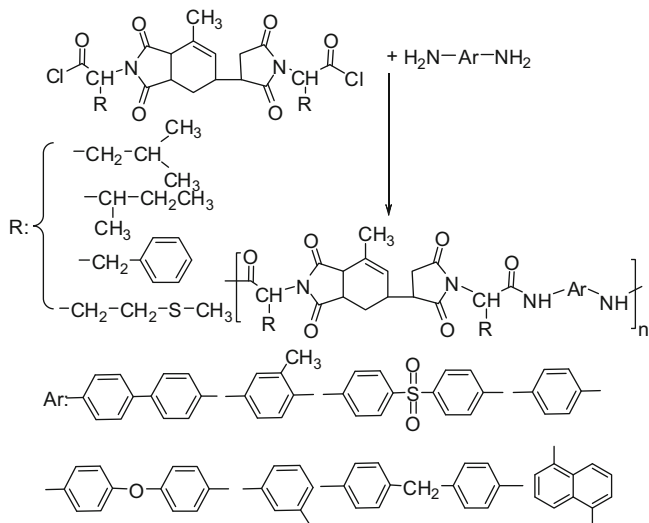

**Scheme 24** Synthesis of optically active poly(amide)s containing epiclone and several amino acids [121–125]

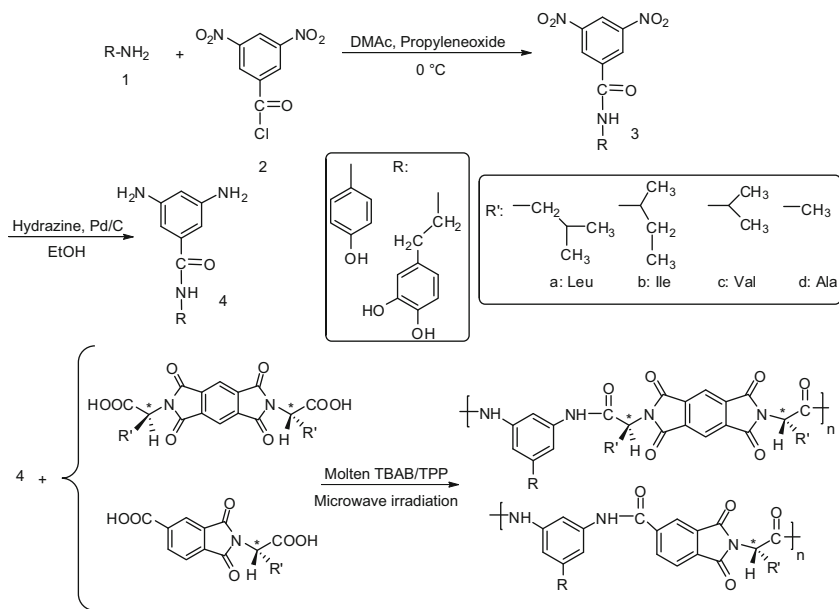

**Scheme 25** Polycondensation reactions of dopamine and *p*-amino phenol-containing diamines with different amino acid-containing diacids (1) *p*-amino phenol or dopamine (2) 3,5-dinitrobenzoylchloride (3) *N*-hydroxyphenyl-3,5-dinitro benzamide or *N*-(3,4-dihydroxyphenethyl)-3,5-dinitro benzamide (4) 3,5-diamino-*N*-(hydroxyphenyl)benzamide or 3,5-diamino-*N*-(3,4-dihydroxyphenethyl)benzamide [126–129]



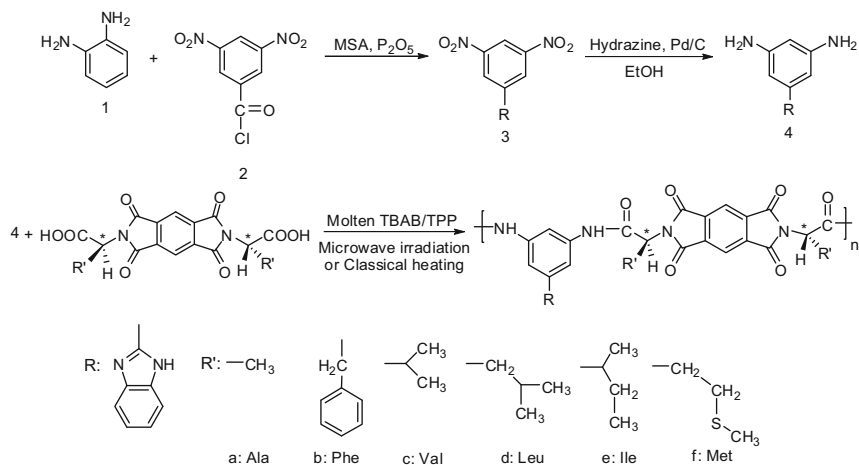

**Scheme 26** Preparation of nanostructure poly(amide)s containing benzimidazole (1) 1,2-phenylenediamine (2) 3,5-dinitrobenzoylchloride (3) 2-(3,5-dinitrophenyl)benzimidazole (4) 2-(3,5-diaminophenyl)benzimidazole [130]

the range of 46–65 nm and their shape was spherical. These properties could make these PAIs attractive for practical applications such as processable high-performance engineering plastics.

In a similar study, the same researchers [128, 129] investigated the polycondensation reactions of a hydroxyphenyl-containing diamine with different amino acid-based diacids in a microwave oven for 8 min at 50% of the power level (900 W) (Scheme 25). Optically active nanostructured PAIs were prepared with yields of 88–96% and inherent viscosities of 0.30–0.58 dL g<sup>-1</sup>. It was shown that the incorporation of hydroxyl pendant groups into the PAI structure can also improve the solubility of polymers. The polymer solutions are very stable and no gelation, phase separation, or precipitation was observed after storage for several weeks.

Different nanostructured PAIs containing benzimidazole and natural amino acids were also successfully synthesized by Mallakpour's research group [130] under green conditions using TBAB as molten IL (Scheme 26). The synthesis has been performed under conventional heating and microwave irradiation for 3 min at 90% of power level (810 W) to highlight the effect of microwave heating. Characterization of the resulting polymers demonstrates that the synthesis using microwave heating results in materials with properties equivalent to those obtained when using conventional heating routes. Beneficially, microwave-assisted polymerization allows a reduction in the reaction time, increased operational simplicity, energy saving and, in most cases, improved yields and inherent viscosities. In addition, in the case of IL-catalyzed polymerization, removal of some chemicals (e.g. NMP, CaCl<sub>2</sub>, and pyridine), which are essential in conventional methodologies, decreases the cost of the polymerization reaction.

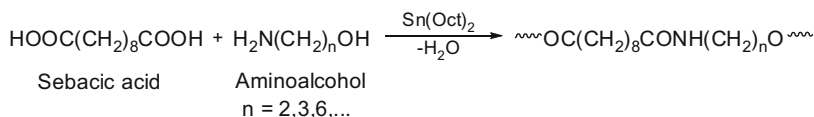

**Scheme 27** Synthesis of poly(amide-ester)s by reaction of sebacic acids and  $\omega$ -amino alcohols [131]

## 2.7 Poly(amide-ester)s, Poly(ester-imide)s, Poly(ether-imide)s, and Poly(ether-ester)s

Poly(ester-amide)s (PEAs) are emerging as promising materials for a wide range of biomedical applications due to their potential for both hydrolytic and enzymatic degradation as well as the ease with which their properties can be tuned by the choice of monomers. The architecture of the PEA polymers is a blend of PA and PES polymer character. This also leads to a blend of the characteristic behavior and properties of these two distinct polymers. The thermal properties of PEAs include higher melt transitions and increased thermal stability versus (PES)s. Synthesis of PEAs by polycondensation of sebacic acids and  $\omega$ -amino alcohols in the presence of stannous 2-ethyl hexanoate,  $\text{Sn}(\text{Oct})_2$ , as a catalyst under microwave irradiation was reported by Borriello et al. [131] (Scheme 27). A Teflon container was selected as synthetic reactor because of its transparency to microwave energy. A Teflon tube was connected to the Teflon reactor to provide a nitrogen blanket during the reactions. The polymerization temperature was measured and controlled by a grounded Omega K-type thermocouple, which was calibrated beforehand with a Luxtron optical fiber temperature probe. A low microwave input power, 50–70 W, was applied in these processes because of the high absorption of microwaves by the starting materials. Temperature control was achieved by changes in the applied electric field, which was programmed to maintain a set temperature by a pulse power on–off cycle. Polymerization reactions were also comparatively performed using conventional melt polycondensation; it was found that under microwave conditions, polymers with higher molecular weights and equivalents or higher yields were achieved in one third of the time required for a thermal process.

A series of optically active poly(ester-imide)s (PEIs) were prepared by Mallakpour et al. through a facile and rapid polycondensation reaction of chiral *N,N*-(pyromellitoyl)-bis-*L*-leucine diacid chloride and *N,N*-(pyromellitoyl)-bis-*L*-phenylalanine diacid chloride with several aromatic diols such as phenol phthalein, bisphenol-A, 4,4'-hydroquinone, 1,8-dihydroxyanthraquinone, 1,5-dihydroxy naphthalene, 4,4'-dihydroxy biphenyl, and 2,4-dihydroxyacetophenone using a domestic microwave oven in the presence of a small amount of a polar organic medium such as *o*-cresol [132, 133] (Scheme 28). The polymerization reactions proceeded rapidly and were completed within 10–20 min, producing a series of optically active PEIs with good yield and moderate inherent viscosity of 0.10–0.27 dL g<sup>-1</sup> and were compared with polymerization reactions under conventionally heated solution conditions but the resulting materials were soluble in methanol probably due to formation of

**Scheme 28** Polycondensation reaction of chiral  $N,N'$ -(pyromellitoyl)-bis- $L$ -amino acid chloride with several aromatic diols [132, 133]

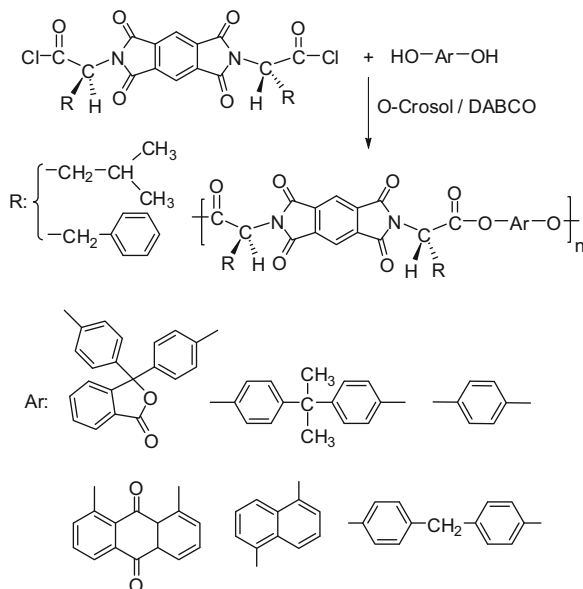

oligomers. Therefore, the microwave technique in this case was superior to the conventional solution method. These aromatic PEIs showed optical rotation and were readily soluble in various organic solvents and had good thermal stability.

Optically active PEIs containing benzophenone tetracarboxylic and  $L$ -phenylalanine or  $L$ -alanine moieties were synthesized from  $N,N'$ -(4,4'-carbonyldipthaloyl)-bisphenylalanine or  $L$ -alanine diacid chloride with several aromatic diols by low-temperature solution polycondensation in  $\text{CHCl}_3/\text{Et}_3\text{N}$  solution and under microwave irradiation in the presence of a small amount of a polar organic medium such as  $o$ -cresol [134, 135]. These PEIs showed optical rotation and were readily soluble in various organic solvents and had moderate thermal stability. Zhang et al. [136] studied the polycondensation reaction of disodium bisphenol-A with bis(chlorophthalimide)s with a domestic microwave oven in  $o$ -dichlorobenzene by PTC. PEIs with inherent viscosities between 0.55 and 0.92 dL  $\text{g}^{-1}$  were obtained within 25 min. The synthesis of poly(ether-ester)s based on diol-ether of isosorbide and adipoyl chloride or terephthaloyl chloride was investigated by Chatti et al. [137] (Scheme 29). The polymerizations were carried out in a monomode system with focused waves operating at 2.45 GHz. The polymerizations proceeded at least five times faster (compared with conventional heating) and the reactions were almost complete (yields up to approximately 95%) within 5 min. The comparison of the microwave-synthesized polymers with those synthesized via conventional heating using adipoyl chloride showed that a yield of 86% was achieved after 5 min at 150°C with  $M_w$  of 4,200  $\text{g mol}^{-1}$ ; under conventional heating, the polymer was obtained in 19% yield with  $M_w$  of 4,050  $\text{g mol}^{-1}$ .

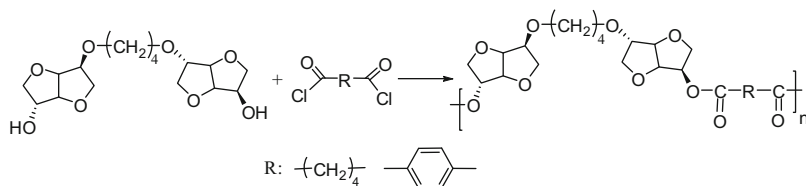

**Scheme 29** Synthesis of poly(ether-ester)s based on diol-ether of isosorbide and adipoyl chloride or terephthaloyl chloride [137].

## 2.8 Poly(*amide-imide-urethane*)s and Poly(*amide-ether-urethane*)s

A new class of optically active poly(*amide-imide-urethane*)s (PAIUs) was synthesized [138] via a two-step diisocyanate route under microwave irradiation [4 min of irradiation (2 + 2-min intervals of irradiation and grinding) at 100% power]. In these reactions, 4,4'-methylene-bis(4-phenylisocyanate) was reacted with bis(*p*-amido benzoic acid)-*N*-trimellitylimido-leucine and PEGs (such as PEG-400, PEG-600, PEG-1000, and PEG-2000) to furnish a series of new PAIUs. The effects of different reaction conditions, such as the method of preparation (polyol or acid chain extension), the prepolymerization step [NCO-terminated oligoamide or NCO-terminated poly(ether) polyol], the irradiation time and power, the reaction solvent, the soft-segment length, and the presence or absence of reaction catalysts (e.g., TEA, pyridine, and DBTDL), on the properties of the copolymers, including the solubility, viscosity, and thermal behavior, were investigated. A systematic study of PAIUs obtained under different reaction conditions has demonstrated a drastic influence of the reaction conditions on the polymer chain growth and microphase separation. The data obtained from this study suggest that microwave irradiation is an interesting alternative for preparing these kinds of PAIUs in competition with conventional heating methods. In a similar research [139], four different series of new optically active thermoplastic PAIUs with modified thermal stability were successfully synthesized by microwave-promoted reactions of different PEGs, MDI and a diacid chain extender. The synthetic procedure referred to as one-step method, is effective for the facile synthesis of multiblock copolymers. Systematic study of PAIUs obtained under different reaction conditions demonstrates a drastic effect of reaction conditions on the efficiency of polymer chain growth. The data obtained from this study suggest that microwave irradiation can be used effectively and easily for preparation of these kinds of PAIUs.

A series of new self-colored segmented polymeric dyes were synthesized via the reaction of an azo-based diacid with different diisocyanates and polyethylene glycol with molecular mass of 400 (PEG-400), under microwave irradiation via a diisocyanate route in NMP or NMP containing 4% w/w  $\text{CaCl}_2$  as a solvent in the presence of different catalysts (such as DBTDL or pyridine) or without catalyst by one-step as well as two-step methods [140]. The researchers investigated the effects

of different reaction conditions such as irradiation time, reaction catalysts, polymerization methods (one step versus two steps), reaction solvent, and changes in the structure of diisocyanates on the polymer chain growth as well as polymer properties.

## 2.9 Polymerizations via C–C Coupling Reactions

Microwave-assisted polymerizations by metal-catalyzed C–C coupling reactions have gained attention only very recently. The palladium-catalyzed cross-coupling reaction between organoboron compounds and organic halides or triflates provides a powerful and general methodology for the formation of carbon–carbon bonds. This reaction has been called the Suzuki coupling, Suzuki reaction, or Suzuki–Miyaura coupling [141]. Recently, many conjugated polymers were synthesized by this reaction under microwave irradiation as energy source. A novel microwave-assisted polycondensation protocol involving an in-situ activation/coupling scheme has been developed and applied to the preparation of lengthy poly(*m*-phenyleneethynylene)s without diyne defects via either AB' or A<sub>2</sub> + BB' approaches [142]. It was found that the microwave-assisted polymerization was comparable with thermal heating in toluene, which was ascribed to the low dipole moment of the solvent. When the solvent was changed to acetonitrile, the polymerization under microwave irradiation resulted in higher polymerization rates as well as polymers of higher molecular weight, whereby the microwave polymerizations were performed under different conditions. The synthesis of fully conjugated *p*-phenylene ladder polymers via microwave-assisted palladium-mediated “double” Suzuki and Stille-type reactions was recently demonstrated (Scheme 30) [143]. The polymerization reactions were run in a THF solution at 130°C in the presence of palladium catalyst with phosphine ligands and irradiated in a single-mode microwave reactor for 11 min. Compared to conventional thermal protocols, the reaction time was reduced from days to a couple of minutes, and molecular weight distributions [polydispersity index (PDI) was approximately 1.8] of the polymers were changed significantly. Subsequently, thiophene oligomers (up to six units) were also obtained under microwave conditions from 2-thiophene boronic acid and dibromo precursors with three thiophene units in the presence of a palladium catalyst and KF with KOH. The reactions were run in a single-mode microwave reactor at 70°C for 10 min [144]. Subsequently, an innovative heterogeneous procedure for the preparation of highly purified thiophene oligomers via microwave-assisted palladium catalysis by using silica- and chitosan-supported palladium complexes was reported [145]. This approach is very efficient and greener than the existing homogeneous methodology as it combines a very efficient reaction with improved catalyst separation. Thieryl iodides or activated bromides were employed as starting materials and KF as base. The microwave reaction was carried out in aqueous ethanol. The heterogeneous catalyst can be easily removed from the reaction mixture by filtration and reused in consecutive reactions (up to four times). Scherf et al. [146] investigated the Suzuki C–C coupling

**Scheme 30** Suzuki cross-coupling route to fully conjugated *para*-phenylene ladder polymers [143]

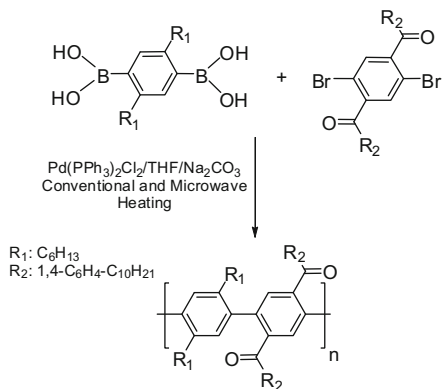

method under microwave irradiation to synthesize a series of ladder polyketones incorporating conjugated 1,5- and 2,6-naphthylene building blocks. A series of stepladder copolymers based on thiophene–phenylene–thiophene SL1–SL3 and thiophene–naphthylene–thiophene SL4 repeat units with varying lengths of the oligothiophene segment has been designed and synthesized via a microwave-assisted Stille-type cross-coupling reaction followed by a polymer-analogous cyclization reaction [147]. The chemical structure of the aforementioned polymers is shown in Scheme 31. The reaction was carried out by using a mixture consisting of equimolar amounts of the bis(trimethylstannyl) oligothiophene, 4',4''-didecyl-2,5-bis(5'-bromothiophen-2'-yl)terephthalophenone, potassium fluoride (10 equiv), 10 mol% PdCl<sub>2</sub>(dppf), toluene (2 mL), and dry DMF (1 mL) in a sealed 10-mL vial under glove-box conditions followed by irradiation with microwaves (300 W, 110°C) for 15 min. Microwave irradiation (at 200°C for 10 min) has also been employed to synthesize soluble polythiophenes via the Stille coupling, resulting in the preparation of a polythiophene with higher molecular weight ( $M_n > 15,000$ ) and a lower PDI ( $M_w/M_n \approx 2$ ) than those synthesized using conventional heating [148]. In another study [149], poly(ether sulfone) containing free carboxylic groups was synthesized by the condensation reaction of 4,4-bis(hydroxyphenyl)pentanoic acid and bis(4-chlorophenyl)sulfone. Thereupon, poly(ether sulfone) was condensed with 4-aminobenzoic acid and 1-naphthol under microwave irradiation and, as a comparison, under classical conditions in a preheated oil bath. In contrast to the classical procedure, the polymer-analogous amidation could be efficiently realized in apolar solvents using microwaves. Incorporation of bulky aromatic groups into the polymer structure caused an increased shear rate dependent viscosity compared to the parent polymer. Another palladium-catalyzed C–C coupling procedure, namely the Heck reaction, was studied by Ritter and coworkers for the formation of conjugated polymers under both microwave (monomode microwave reactor) and thermal heating [150]. They reported on the first microwave-assisted synthesis of poly(2,5-dibutoxy-1,4-phenylenevinylene) via Heck-polycondensation as an example of efficient heating. The facile synthesis of the higher lactones 1-oxa-2-oxocyclooctanone and 1-oxa-2-oxocyclononanone via the Baeyer–Villiger reaction offers an example of the microwave-accelerating effect.

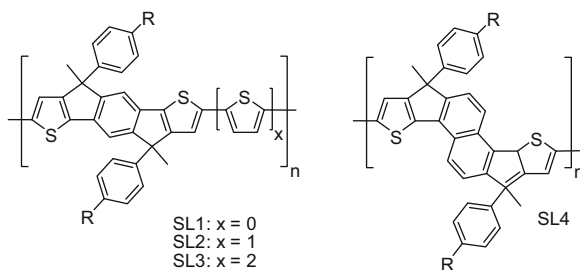

**Scheme 31** Structure of thiophene–phenylene–thiophene (SL1–SL3) and thiophene–naphthylene–thiophene (SL4)-based stepladder polymers [147]

In addition to palladium-catalyzed step-growth polymerization, nickel(0)-catalyzed polycondensation is also reported. Polyarylene-type polymer was prepared through the polymerization of 2,7-dibromo-9,9-dihexylfluorene under microwave irradiation [151]. In a typical experimental procedure, a catalyst stock solution was prepared consisting of bis(1,5-cyclooctadiene)nickel(0), 2,2'-bipyridine, and cyclooctadiene in toluene/DMF (1.15:1). Then, a monomer solution containing 2,7-dibromo-9,9-dihexylfluorene in toluene was prepared and added. The vial was sealed and irradiated in a single-mode microwave up to 250°C for 10 min. Eventually, polymers with  $M_n$  in the range of 5,000–10,000 g mol<sup>-1</sup> and PDI between 1.65 and 2.22 were obtained. Thereafter, poly(pyrazine-2,5-diyl) polymer was prepared through organometallic dehalogenative polycondensation of 2,5-dibromopyrazine [152]. The reaction was carried out by using a mixture of 2,5-dibromopyrazine, bis(1,5-cyclopentadiene)nickel(0), and 2,2'-bipyridyl that was irradiated in a single-mode microwave reactor for 10 min in either toluene or DMF solutions. Under microwave conditions, the polymer was obtained in 83–95% yield, while a similar yield under conventional conditions at 60°C was obtained after 2 days.

### 3 Conclusions

The use of microwave irradiation to accelerate polymerization reactions has provided new alternative procedures for the synthesis of polymers of interest by step-growth polymerization. The advantages that this methodology can offer over conventional conductive heating procedures, with the introduction of dedicated single-mode instruments, include accurate monitoring and control of reaction conditions, and thus reproducibility, the rapid optimization of procedures, the automation of multiple reactions with tailored variation in individual reaction parameters, changes in selectivity, improvements in product yield and purity, and the rapid generation of polymer libraries through considerable reduction in the reaction times of individual reaction events. The examples described in this chapter demonstrate that microwave-assisted synthesis can allow easy and rapid access to

various polymeric materials. These polymers have been synthesized by applying a variety of microwave systems, including domestic microwave ovens. This chapter is not intended to be exhaustive in its content, but rather to highlight significant examples where microwave irradiation has been either synthetically enabling or has provided a key advantage over conventional thermal methods. With so many advances in such a short time, it is with eager anticipation that we can expect many more developments in the microwave-assisted synthesis of polymers in the very near future.

**Acknowledgments** We wish to express our gratitude to the Research Affairs Division Isfahan University of Technology (IUT), Isfahan, for partial financial support. Further financial support from National Elite Foundation (NEF) and Center of Excellency in Sensors and Green Chemistry Research (IUT) is gratefully acknowledged.

## References

1. Leadbeater NE (ed) (2001) Microwave heating as a tool for sustainable chemistry. CRC, Boca Raton
2. Spencer PL (1952) Means for treating foodstuffs. US Patent 2,605,383
3. Hollas JM (2004) Modern spectroscopy. Wiley, Chichester
4. Gabriel G, Grant S, Grant EH et al (1998) Dielectric parameters relevant to microwave dielectric heating. *Chem Soc Rev* 27:213–223
5. Gedye R, Smith F, Westaway K et al (1986) The use of microwave ovens for rapid organic synthesis. *Tetrahedron Lett* 27:279–282
6. Giguere JR, Bray TL, Duncan SM et al (1986) Application of commercial microwave ovens to organic synthesis. *Tetrahedron Lett* 27:4945–4948
7. Loupy A (ed) (2002) Microwaves in organic synthesis. Wiley-VCH, Weinheim
8. Caddick S (1995) Microwave assisted organic reactions. *Tetrahedron* 51:10403–10432
9. Lidstrom P, Tierney J, Wathey B et al (2001) Microwave assisted organic synthesis—a review. *Tetrahedron* 57:9225–9283
10. Kappe CO (2001) Controlled microwave heating in modern organic synthesis. *Angew Chem Int Ed* 43:6250–6284
11. Baxendale IR, Ley SV, Nessi M et al (2002) Total synthesis of the amaryllidaceae alkaloid (+)-plicamine using solid-supported reagents. *Tetrahedron* 58:6285–6304
12. Artman DD, Grubbs AW, Williams RM et al (2007) Concise, asymmetric, stereocontrolled total synthesis of stephacidins A, B and notoamide B. *J Am Chem Soc* 129:6336–6342
13. Sen G, Pal S (2009) Microwave initiated synthesis of polyacrylamide grafted carboxymethylstarch (CMS-g-PAM): application as a novel matrix for sustained drug release. *Int J Biol Macromol* 45:48–55
14. Jacob A, Pratuangdejikul J, Buffet S et al (2009) In silico platform for xenobiotics ADME-T pharmacological properties modeling and prediction. Part II: the body in a Hilbertian space. *Drug Discov Today* 14:406–412
15. Wathey B, Tierney J, Lidstrom P et al (2002) The impact of microwave-assisted organic chemistry on drug discovery. *Drug Discov Today* 7:373–380
16. Aquino RP, Auriemma G, d'Amore M et al (2012) Piroxicam loaded alginate beads obtained by prilling/microwave tandem technique: Morphology and drug release. *Carbohydr Polym* 89:740–748
17. Mustafa DA, Kashemirov BA, McKenna CE (2011) Microwave-assisted synthesis of nitrogen-containing 1-hydroxymethylenebisphosphonate drugs. *Tetrahedron Lett* 52:2285–2287



18. Leonetti F, Capaldi C, Carotti A (2007) Microwave-assisted solid phase synthesis of Imatinib, a blockbuster anticancer drug. *Tetrahedron Lett* 48:3455–3458
19. Nicho ME, García-Escobar CH, Hernández-Martínez D et al (2012) Microwave-assisted solid phase synthesis of Imatinib, a blockbuster anticancer drug. *Mater Sci Eng B* 177:1441–1445
20. Wiesbrock F, Hoogenboom R, Schubert US (2004) Microwave-assisted polymer synthesis: state-of-the-art and future perspectives. *Macromol Rapid Commun* 25:1739–1764
21. Hoogenboom R, Schubert US (2007) Microwave-assisted polymer synthesis: recent developments in a rapidly expanding field of research. *Macromol Rapid Commun* 28:368–386
22. Zhang C, Liao L, Gong S (2007) Recent developments in microwave-assisted polymerization with a focus on ring-opening polymerization. *Green Chem* 9:303–314
23. Singh S, Chakraborty M, Murthy ZVP (2011) Microwave assisted synthesis of poly(ether sulfone) – an efficient synthetic route to control polymer chain structure. *J Macromol Sci Pure Appl Chem* 48:872–879
24. Mallakpour S, Rafiee Z (2008) Application of microwave-assisted reactions in step-growth polymerization: a review. *Iran Polym J* 17:907–935
25. Mallakpour S, Rafiee Z (2011) New developments in polymer science and technology using combination of ionic liquids and microwave irradiation. *Progress Sci J* 36:1754–1765
26. Marlow S, Marder SR (2003) Single-mode microwave synthesis in organic materials chemistry. *Adv Funct Mater* 13:517–518
27. Zhu YJ, Wang WW, Qi RJ et al (2004) Microwave-assisted synthesis of single-crystalline tellurium nanorods and nanowires in ionic liquids. *Angew Chem Int Ed* 43:1410–1414
28. Perelaer J, de Gans BJ, Schubert US (2006) Ink-jet printing and microwave sintering of conductive silver tracks. *Adv Mater* 18:2101–2104
29. Jhung SH, Jin T, Hwang YK et al (2007) Microwave effect in the fast synthesis of microporous materials: which stage between nucleation and crystal growth is accelerated by microwave irradiation? *Chem Eur J* 13:4410–4417
30. Millos CJ, Whittaker AG, Brechin EK (2007) Microwave heating – a new synthetic tool for cluster synthesis. *Polyhedron* 26:1927–1933
31. Tsuji M, Hashimoto M, Nishizawa Y et al (2005) Microwave-assisted synthesis of metallic nanostructures in solution. *Chem Eur J* 11:440–452
32. Tompsett GA, Conner WC, Yngvesson KS (2006) Microwave synthesis of nanoporous materials. *Chem Phys Chem* 7:296–319
33. Shi W, Yan Y, Yan X (2013) Microwave-assisted synthesis of nano-scale BiVO<sub>4</sub> photocatalysts and their excellent visible-light-driven photocatalytic activity for the degradation of ciprofloxacin. *Chem Eng J* 215–216:740–746
34. Collins JM, Leadbeater NE (2007) Microwave energy: a versatile tool for the biosciences. *Org Biomol Chem* 5:1141–1150
35. Lill JR, Ingle ES, Liu PS et al (2007) Microwave-assisted proteomics. *Mass Spectrom Rev* 26:657–671
36. Zafar F, Hassan Mir M, Kashif M et al (2011) Microwave assisted synthesis of bio based metallopolyurethaneamide. *J Inorg Organomet Polym Mater* 21:61–68
37. Narkhede HP, More UB, Dalal DS et al (2008) Solid-supported synthesis of bio-active carvacrol compounds using microwaves. *Synth Commun* 38:2413–2418
38. Cheng J, Zhou J, Li Y et al (2008) Improvement of coal water slurry property through coal physicochemical modifications by microwave irradiation and thermal heat. *Energy Fuels* 22:2422–2428
39. Lu H, Zhou J, Xiong S et al (2010) Effects of low-intensity microwave radiation on *Tribolium castaneum* physiological and biochemical characteristics and survival. *J Insect Physiol* 56:1356–1361
40. Imai Y (1996) Recent advances in synthesis of high-temperature aromatic polymers. *React Funct Polym* 30:3–15

41. Imai Y (1996) A new facile and rapid synthesis of polyamides and polyimides by microwave-assisted polycondensation. *ACS Symp Ser* 624:421–430
42. Imai Y, Nemoto H, Kakimoto MA (1996) A new facile and rapid synthesis of polyamides and polyimides by microwave-assisted polycondensation. *J Polym Sci Part A Polym Chem* 34:701–704
43. Imai Y, Nemoto H, Watanabe S et al (1996) A new facile and rapid synthesis of polyamides and polyimides by microwave-assisted polycondensation. *Polym J* 28:256–260
44. Watanabe S, Hayama K, Park KH et al (1993) New microwave-assisted rapid synthesis of polyamides from nylon salts. *Die Makromol Chem. Rapid Commun* 14:481–484
45. Hong PK, Watanabe S, Kakimoto MA et al (1993) Rapid synthesis of aromatic polyamides by microwave-assisted directed polycondensation of aromatic diamines with aromatic dicarboxylic acids. *Polym J* 25:209–213
46. Pourjavadi A, Zamanlu MR, Zohuriaan-Mehr MJ (1999) Microwave-induced synthesis of partially aromatic polyamides via the Yamazaki phosphorylation reaction. *Polym J* 269:54–60
47. Sundararajan S, Surianarayanan M, Sabdham K et al (2005) Synthesis and characterization of saturated and unsaturated polysulfide polymers and their thermal degradation processes investigated by flash pyrolysis-gas chromatography/mass spectrometry. *J Polym Sci Part A Polym Chem* 43:638–649
48. Caouthar A, Roger P, Tessier M et al (2007) Synthesis and characterization of new polyamides derived from di(4-cyanophenyl)isoborbidate. *Eur Polym J* 43:220–230
49. Mallakpour S, Dinari M (2008) Microwave step-growth polymerization of 5-(4-methyl-2-phthalimidylpentanoylamino)isophthalic acid with different diisocyanates. *Polym Adv Technol* 19:1334–1342
50. Mallakpour S, Taghavi M (2008) A facile, microwave-assisted synthesis of novel optically active polyamides derived from 5-(3-methyl-2-phthalimidylpentanoylamino) isophthalic acid and different diisocyanates. *Eur Polym J* 44:87–97
51. Mallakpour S, Sepehri S (2008) Preparation of new optically active polyamides containing a L-phenylalanine, phthalimide side-chain via the diisocyanate route by microwave energy: Comparison with conventional heating. *Des Monomers Polym* 11:535–546
52. Mallakpour S, Dinari M (2009) Soluble new optically active polyamides derived from 5-(4-methyl-2-phthalimidylpentanoylamino)isophthalic acid and different diisocyanates under microwave irradiation in molten ionic liquid. *J Appl Polym Sci* 112:244–253
53. Mallakpour S, Sepehri S (2008) Polycondensation of new optically active diacid with diisocyanates in the presence of tetrabutylammonium bromide as a green media under microwave heating. *React Funct Polym* 68:1459–1466
54. Mallakpour S, Taghavi M (2008) Efficient and rapid synthesis of optically active polyamides in the presence of tetrabutylammonium bromide as ionic liquids under microwave irradiation. *J Appl Polym Sci* 109:3603–3612
55. Mallakpour S, Rafiee Z (2009) Expedient synthesis of novel aromatic polyamides from 5-[3-phenyl-2-(9,10-dihydro-9,10-ethanoanthracene-11,12-dicarboximido) propanoylamino] iso-phthalic acid and various diamines using microwave-assisted polycondensation. *React Funct Polym* 69:252–258
56. Mallakpour S, Taghavi M (2008) Microwave heating coupled with ionic liquids: synthesis and properties of novel optically active polyamides, thermal degradation and electrochemical stability on multi-walled carbon nanotubes electrode. *Polymer* 49:3239–3249
57. Mallakpour S, Zadehnazari A (2009) Fast synthesis, using microwave induction heating in ionic liquid and characterization of optically active aromatic polyamides. *J Macromol Sci Part A Pure Appl Chem* 46:783–789
58. Carretero P, Sandin R, Mercier R et al (2009) Microwave-Induced synthesis of aromatic polyamides by the phosphorylation reaction. *Aust J Chem* 62:250–253
59. Mittal KL (ed) (2003) Polyimides and other high temperature polymers: synthesis, characterization and applications. VSP, Utrecht

60. Barikani M (2002) Polyimides derived from diisocyanates. *Iran Polym J* 11:1026–1065
61. Inal Y, Nemoto H, Kakimoto MA (1996) A new facile and rapid synthesis of aliphatic polypyromellitimides by microwave-assisted polycondensation of salt monomers composed of aliphatic diamines and pyromellitic acid. *J Polym Sci Part A Polym Chem* 34:701–704
62. Tang X, Lu J, Zhang Z et al (2003) Polycondensation of sodium tetrazodiphenyl naphthionate and pyromellitic dianhydride under microwave irradiation and the performance of the third-order nonlinear optics. *J Appl Polym Sci* 88:1121–1128
63. Lu JM, Ji SJ, Chen NY et al (2003) Third-order nonlinear optical properties of polyureas and polyimide synthesized by microwave irradiation. *J Appl Polym Sci* 89:2611–2617
64. Li Q, Xu Z, Yi C (2008) Preparation of poly(amic acid) and polyimide derived from 3,3',4,4'-benzophenonetetracarboxylic dianhydride with different diamines by microwave irradiation. *J Appl Polym Sci* 107:797–802
65. Li Q, Yang X, Chen W et al (2008) Preparation of poly(amic acid) and polyimide via microwave-assisted polycondensation of aromatic dianhydrides and diamines. *Macromol Symp* 261:148–156
66. Theis J, Ritter H (2008) Microwave-assisted synthesis and bulk polymerization of 3-aminophthalic anhydride as an AB-type monomer for the formation of linear and cyclic polyimides. *Polym Int* 61:1238–1244
67. Hurduc N, Abdelylah D, Buisine JM et al (1997) Microwave effects in the synthesis of polyethers by phase transfer catalysis. *Eur Polym J* 33:187–190
68. Hurduc N, Buisine JM, Decock P et al (1996) Influence of microwaves irradiation on modification of oxetane based polymers with 4-(2-amino-ethyl)morpholine. *Polym J* 28:550–552
69. Alimi K, Molinie P, Majdoub M et al (2001) Synthesis and characterization of copolymer derived from polyphenylene-vinylene potentially luminescent copolymers. *Eur Polym J* 37:781–787
70. Chatti S, Bortolussi M, Loupy A et al (2002) Efficient synthesis of polyethers from isosorbide by microwave-assisted phase transfer catalysis. *Eur Polym J* 38:1851–1861
71. Chatti S, Bortolussi M, Loupy A (2003) Synthesis of new polyethers derived from isosorbide under phase-transfer catalysis: reactivity and selectivity under microwaves and classical heating. *J Appl Polym Sci* 90:1255–1266
72. Flèche IG, Huchette IM (1986) Isosorbide. Preparation, properties and chemistry. *Starch* 38:26–30
73. Chatti S, Bortolussi M, Bogdal D et al (2004) Microwave-assisted polycondensation of aliphatic diols of isosorbide with aliphatic disulphonylestere via phase-transfer catalysis. *Eur Polym J* 40:561–577
74. Cakmak O, Bastukmen M, Kisakerek D (2004) Synthesis and characterization of conducting and non-conducting polymers of sodium 2,4,6-trichlorophenolate by microwave initiation. *Polymer* 45:5451–5458
75. Bezdushna E, Ritter H, Troev K (2005) Microwave-assisted single-step synthesis of poly(alkylene hydrogen phosphonate)s by transesterification of dimethyl hydrogen phosphonate with poly(ethylene glycol). *Macromol Rapid Commun* 26:471–476
76. Scheirs J, Long TE (eds) (2003) Modern polyesters: chemistry and technology of polyesters and copolyesters. Wiley, Chichester
77. Velamathi S, Nagahata R, Takeuchi K (2007) Extremely rapid synthesis of aliphatic polyesters by direct polycondensation of 1:1 mixtures of dicarboxylic acids and diols using microwaves. *Polym J* 39:841–844
78. Takasu A, Oishi Y, Iio Y et al (2003) Synthesis of aliphatic polyesters by direct polyesterification of dicarboxylic acids with diols under mild conditions catalyzed by reusable rare-earth triflate. *Macromolecules* 36:1772–1774
79. Ishihara K, Nakayama M, Ohara S et al (2002) Direct ester condensation from a 1:1 mixture of carboxylic acids and alcohols catalyzed by hafnium(IV) or zirconium(IV) salts. *Tetrahedron* 58:8179–8188

80. Zhu C, Zhang Z, Liu Q et al (2003) Synthesis and biodegradation of aliphatic polyesters from dicarboxylic acids and diols. *J Appl Polym Sci* 90:982–990
81. Nagahata R, Sano D, Suzuki H et al (2007) Microwave-assisted single-step synthesis of poly (lactic acid) by direct polycondensation of lactic acid. *Macromol Rapid Commun* 28:437–442
82. Velmathi S, Nagahata R, Sugiyama JI et al (2005) A rapid eco-friendly synthesis of poly (butylenes succinate) by a direct polyesterification under microwave irradiation. *Macromol Rapid Commun* 26:1163–1167
83. Pielichowski J, Bogdal D, Wolff E (2003) Microwave-assisted synthesis of unsaturated polyester resins (UPR). *Przem Chem* 82:8–9–938
84. Keki S, Bodnar I, Borda J et al (2001) Fast microwave-mediated bulk polycondensation of D, L-lactic Acid. *Macromol Rapid Commun* 22:1063–1065
85. Banihashemi A, Hazarkhani H, Abdolmaleki A (2004) Efficient and rapid synthesis of polyureas and polythioureas from the reaction of urea and thiourea with diamines under microwave irradiation. *J Polym Sci A Polym Chem* 42:2106–2111
86. Mallakpour S, Rafiee Z (2004) Microwave-assisted rapid polycondensation reaction of 4-(4'-acetamidophenyl)-1,2,4-triazolidine-3,5-dione with diisocyanates. *J Appl Polym Sci* 91:2103–2113
87. Mallakpour S, Rafiee Z (2003) Polymerization of 4-(4'-N-1,8-naphthalimidophenyl)-1,2,4-triazolidine-3,5-dione with diisocyanates. *J Appl Polym Sci* 90:2861–2869
88. Mallakpour S, Rezazadeh S (2004) Microwave-induced and high temperature solution polymerization of 4-(4'-t-butylphenyl)-1,2,4-triazolidine-3,5-dione with diisocyanates. *Iran Polym J* 13:29–38
89. Mallakpour S, Dinari M (2010) A green route for synthesis of different polyureas based on phenylurazole: rapid solid-state, microwave-assisted technique. *High Perform Polym* 22:314–327
90. Chantarasiri N, Choprayoon C, Thussanee MP et al (2004) Thermally stable metal-containing polyureas from hexadentate Schiff base metal complexes and diisocyanates. *Polym Degrad Stab* 86:505–513
91. Cassidy PE (1980) Thermally stable polymers: syntheses and properties. Dekker, New York
92. Park S, Kim K, Kim DM et al (2004) High temperature polyimide containing anthracene moiety and its structure, interface, and nonvolatile memory behavior. *ACS Appl Mater Interfaces* 3:765–773
93. Wang DH, Lee KM, Yu Z et al (2011) Photomechanical response of glassy azobenzene polyimide networks. *Macromolecules* 44:3840–3846
94. Behniafar H, Mohammadparast-delshaad S (2012) Novel ortho-linked and CF<sub>3</sub>-substituted poly(amide-imide)s: Optical and thermal behavior. *Polym Degrad Stab* 97:228–233
95. Thiruvasagam P, Vijayan M (2012) Synthesis of new diacid monomers and poly(amide-imide)s: study of structure–property relationship and applications. *J Polym Res* 19:9845–9853
96. Hsiao SH, Guo W, Lee WF et al (2011) Synthesis and characterization of electrochromic poly (amide-imide)s bearing methoxy-substituted triphenylamine units. *Mater Chem Phys* 130:1086–1093
97. Chen Y, Huang SP, Liu QL et al (2011) Influence of flexible oligo(tetrafluoroethene) segment on the sorption and diffusion of carbon dioxide in poly(amide-imide) membranes. *J Appl Polym Sci* 120:1859–1865
98. Hamciuc C, Carja LD, Hamciuc E et al (2011) Influence of flexible oligo(tetrafluoroethene) segment on the sorption and diffusion of carbon dioxide in poly(amide-imide) membranes. *High Perform Polym* 23:362–373
99. Mallakpour SE, Hajipour AR, Habibi S (2001) Facial synthesis of new optically active poly (amide-imide)s derived from *N, N'*-(pyromellitoyl)-bisleucine diacid chloride and aromatic diamines under microwave irradiation. *Eur Polym J* 37:2435–2442
100. Mallakpour S, Shahmohammadi MH (2004) Microwave-promoted rapid synthesis of new optically active poly(amide imide)s derived from *N, N'*-(pyromellitoyl)-bis-isoleucine diacid chloride and aromatic diamines. *J Appl Polym Sci* 92:951–959

101. Mallakpour S, Shahmohammadi MH (2005) Synthesis of new optically active poly(amide-imide)s derived from *N*, *N'*-(pyromellitoyl)-bis-*S*-valine diacid chloride and aromatic diamines under microwave irradiation and classical heating. Iran Polym J 14:473–483
102. Mallakpour SE, Hajipour AR, Zamanlou MR (2002) Novel optically active poly(amide-imide)s from *N,N'*-(4,4'-carbonyldipthaloyl)-bis-phenylalanine diacid chloride and aromatic diamines by microwave irradiation. Eur Polym J 38:475–485
103. Mallakpour SE, Hajipour AR, Faghihi K (2001) Microwave-assisted synthesis of optically active poly(amide-imide)s with benzophenone and *L*-alanine linkages. Eur Polym J 37:119–124
104. Mallakpour SE, Hajipour AR, Zamanlou MR (2001) Synthesis of optically active poly(amide-imide)s derived from *N,N'*-(4,4'-carbonyldipthaloyl)-bis-*L*-leucine diacid chloride and aromatic diamines by microwave radiation. J Polym Sci A Polym Chem 39:177–186
105. Mallakpour SE, Dabbagh AH, Faghihi K (2000) Synthesis of novel optically active poly(amide-imide)s with benzophenone and *L*-alanine moieties. Iran Polym J 9:41–48
106. Mallakpour S, Kowsari E (2006) Thermally stable and optically active poly(amideimide)s derived from 4,4'-(hexafluoroisopropylidene)-*N*, *N'*-bis-(phthaloylmethionine) diacid chloride and various aromatic diamines: synthesis and characterization. Polym Bull 57:169–178
107. Mallakpour SE, Hajipour AR, Khoee S (1999) Synthesis and characterization of novel optically active poly(amide-imide)s. Polym Int 48:1133–1140
108. Mallakpour S, Moghadam E (2006) Direct polyamidation of *N,N'*-(4,4'-hexafluoroisopropylidenedipthaloyl)-bis-isoleucine with different aromatic diamines via vilsmeier adduct derived from tosyl chloride and *N,N*-dimethylformamide. Polym Bull 56:339–347
109. Mallakpour SE, Hajipour AR, Khoee S (2002) Rapid synthesis of optically active poly(amide-imide)s by direct polycondensation of aromatic dicarboxylic acid with aromatic diamines. Eur Polym J 38:2011–2016
110. Mallakpour S, Kowsari E (2005) Synthesis and properties of novel soluble and thermally stable optically active poly(amide-imide)s from *N,N'*-(4,4'-oxydipthaloyl)-bisphenylalanine diacid chloride and aromatic diamines. Polym Bull 54:147–155
111. Mallakpour S, Kowsari E (2005) Ionic liquids as novel solvents and catalysts for the direct polycondensation of *N*, *N'*-(4,4'-oxydipthaloyl)-bisphenylalanine diacid with various aromatic diamines. J Polym Sci Part A Polym Chem 43:6545–6553
112. Mallakpour S, Kowsari E (2005) Soluble novel optically active poly(amide-imide)s derived from *N*, *N'*-(4,4'-oxydipthaloyl)-bisleucine diacid chloride and various aromatic diamines: synthesis and characterization. J Appl Polym Sci 96:435–442
113. Mallakpour S, Kowsari E (2006) Polycondensation reaction of *N,N'*-(4,4'-oxydipthaloyl)-bismethionine diacid chloride with aromatic diamines: synthesis and properties. J Appl Polym Sci 99:1038–1044
114. Mallakpour S, Kowsari E (2006) Preparation and characterization of new optically active poly(amide imide)s derived from *N,N'*-(4,4'-oxydipthaloyl)-bis-(*S*)-(-)-valine diacid chloride and aromatic diamines. Polym Eng Sci 46:558–565
115. Mallakpour S, Rafiemanzelat F (2004) Microwave assisted and classical heating polycondensation reaction of bis(*p*-amido benzoic acid)-*N*-trimellitylimidoleucine with diisocyanates as a new method for preparation of optically active poly(amide imide)s. J Appl Polym Sci 93:1647–1659
116. Mallakpour S, Kowsari E (2005) Preparation and characterization of new optically active poly(amide imide)s derived from *N,N'*-(4,4'-sulphonedipthaloyl)-bis-(*S*)-(+)-valine diacid chloride and aromatic diamines under microwave irradiation. Polym Bull 53:169–180
117. Mallakpour S, Kowsari E (2003) Synthesis and characterization of novel, optically active poly(amide imide)s from *N,N'*-(4,4'-sulfonyldipthaloyl)-bis-*L*-phenylalanine diacid chloride and aromatic diamines under microwave irradiation. J Appl Polym Sci 41:3974–3988
118. Mallakpour S, Kowsari E (2004) Microwave-assisted and conventional polycondensation reaction of optically active *N,N'*-(4,4'-sulphonyldipthaloyl)-bis-leucine diacid chloride with aromatic diamines. J Appl Polym Sci 91:2992–3000

119. Mallakpour S, Kowsari E (2005) Preparation and characterization of optically active and organosoluble poly(amide imide)s from polycondensation reaction of *N,N'*-(4,4'-sulphone-diphthaloyl)-bis-isoleucine diacid with aromatic diamines. *Polym Adv Technol* 16:466–472
120. Mallakpour SE, Hajipour AR, Faghihi K et al (2001) Novel optically active poly(amide imide)s with tetrahydropyrimidinone and tetrahydro-2-thioxopyrimidine moieties by microwave-assisted polycondensation. *J Appl Polym Sci* 80:2416–2421
121. Mallakpour S, Kowsari E (2004) Application of microwave irradiation for synthesis of novel optically active poly(amide imides) derived from diacid chloride containing epiclone and L-isoleucine with aromatic diamines. *J Appl Polym Sci* 93:2218–2229
122. Mallakpour SE, Hajipour AR, Zamanlou MR (2003) Microwave-assisted synthesis of optically active poly(amide imide)s derived from diacid chloride containing epiclone and L-leucine with aromatic diamines. *J Polym Sci Part A Polym Chem* 41:1077–1090
123. Mallakpour S, Kowsari E (2005) Synthesis and characterization of new optically active poly(amide-imide)s containing epiclone and L-methionine moieties in the main chain. *Polym Adv Technol* 16:732–737
124. Mallakpour S, Zamanlou MR (2004) Synthesis of new optically active poly(amide-imide)s containing EPICLON and L-phenylalanine in the main chain by microwave irradiation and classical heating. *J Appl Polym Sci* 91:3281–3291
125. Mallakpour S, Kowsari E (2005) Synthesis and properties of organosoluble and optically active poly(amide-imide)s based on epiclone and (S)-(+)-valine under microwave irradiation. *Iran Polym J* 14:81–90
126. Mallakpour S, Zadehnazari A (2012) New organosoluble, thermally stable, and nanostructured poly(amide-imide)s with dopamine pendant groups: microwave-assisted synthesis and characterization. *Int J Polym Anal Charact* 17:408–416
127. Mallakpour S, Zadehnazari A (2012) Synergic effects of molten ionic liquid and microwave irradiation in preparation of optically active nanostructured poly(amide-imide)s containing amino acid and dopamine moiety. *Polym Plast Technol Eng* 51:1090–1096
128. Mallakpour S, Zadehnazari A (2012) Simple and efficient microwave-assisted polycondensation for preparation of chiral poly(amide-imide) having pendant phenol moiety. *Polym Sci Ser B* 54:362–370
129. Mallakpour S, Zadehnazari A (2012) Microwave-assisted synthesis and morphological characterization of chiral poly(amide-imide) nanostructures in molten ionic liquid salt. *Adv Polym Technol* 32:21333. doi:[10.1002/adv.21333](https://doi.org/10.1002/adv.21333)
130. Mallakpour S, Dinari M (2012) Straightforward and green method for the synthesis of nanostructure poly(amide-imide)s-containing benzimidazole and amino acid moieties by microwave irradiation. *Polym Bull* 70:1049–1064. doi:[10.1007/s00289-012-0875-y](https://doi.org/10.1007/s00289-012-0875-y)
131. Borriello A, Nicolais L, Fang X et al (2007) Synthesis of poly(amide-ester)s by microwave methods. *J Appl Polym Sci* 103:1952–1958
132. Mallakpour SE, Hajipour AR, Habibi S (2002) Microwave-assisted synthesis of new optically active poly(ester-imide)s containing *N,N'*-(pyromellitoyl)-bisphenylalanine moieties. *J Appl Polym Sci* 86:2211–2216
133. Mallakpour S, Habibi S (2003) Microwave-promoted synthesis of new optically active poly(ester-imide)s derived from *N,N'*-(pyromellitoyl)-bis-L-leucine diacid chloride and aromatic diols. *Eur Polym J* 39:1823–1829
134. Mallakpour SE, Hajipour AR, Zamanlou MR (2002) New optically active poly(ester-imide)s derived from *N,N'*-(4,4'-carbonyldiphthaloyl)-bisphenylalanine diacid chloride. *J Appl Polym Sci* 85:315–320
135. Mallakpour SE, Hajipour AR, Faghihi K (2000) Synthesis of novel optically active poly(ester-imide)s with benzophenone linkages by microwave-assisted polycondensation. *Polym Int* 49:1383–1388
136. Gao C, Zhang S, Gao L et al (2004) Microwave-assisted synthesis of high-molecular-weight poly(ether imide)s by phase-transfer catalysis. *J Appl Polym Sci* 92:2415–2419

137. Chatti S, Bortolussi M, Bogdal D et al (2006) Synthesis and properties of new poly (ether-ester)s containing aliphatic diol based on isosorbide. Effects of the microwave-assisted polycondensation. *Eur Polym J* 42:410–424
138. Mallakpour S, Rafiemanzelat F (2005) New optically active Ppoly(amide-imide-urethane) thermoplastic elastomers derived from poly(ethylene glycol diols), 4,4'-methylene-bis (4-phenylisocyanate), and a diacid based on an amino acid by a two-step method under microwave irradiation. *J Appl Polym Sci* 93:1647–1659
139. Mallakpour S, Rafiemanzelat F (2005) Facile and rapid synthesis of novel optically active poly(amide-imide-urethane)s derived from bis(*p*-amido benzoic acid)-*N*-trimellitylimido-*L*-leucine and polyoxyethylene-MDI under microwave irradiation. *Iran Polym J* 14:909–919
140. Mallakpour S, Rafiemanzelat F, Faghihi K (2007) Synthesis and characterization of new self-colored thermally stable poly(amide-ether-urethane)s based on an azo dye and different diisocyanates. *Dyes Pigments* 74:713–722
141. Suzuki A (1999) Recent advances in the cross-coupling reactions of organoboron derivatives with organic electrophiles, 1995–1998. *J Organomet Chem* 576:147–168
142. Khan S, Hecht S (2004) Microwave-accelerated synthesis of lengthy and defect-free poly(*m*-phenyleneethylene) via AB' and A + BB' polycondensation routes. *Chem Commun* 2004 (3):300–301
143. Nehls BS, Asawapirom U, Fuldner S et al (2004) Semiconducting polymers via microwave-assisted Suzuki and Stille cross-coupling reactions. *Adv Funct Mater* 14:352–356
144. Melucci M, Barbarella G, Zambianchi M et al (2004) Solution-phase microwave-assisted synthesis of unsubstituted and modified  $\alpha$ -quinque- and sexithiophenes. *J Org Chem* 69:4821–4828
145. Alesi S, Di Maria F, Melucci M et al (2008) Microwave-assisted synthesis of oligothiophene semiconductors in aqueous media using silica and chitosan supported Pd catalysts. *Green Chem* 10:517–523
146. Nehls BS, Fuldner S, Preis E et al (2005) Microwave-assisted synthesis of 1,5- and 2,6-linked naphthylene-based ladder polymers. *Macromolecules* 38:687–694
147. Bunnagel TW, Nehls BS, Galbrecht F et al (2008) Microwave-assisted synthesis of 1,5- and 2,6-linked naphthylene-based ladder polymers. *J Polym Sci Part A Polym Chem* 46:7342–7353
148. Tierney S, Heeney M, McCulloch I (2005) Microwave-assisted synthesis of 1,5- and 2,6-linked naphthylene-based ladder polymers. *Synth Met* 148:195–198
149. Bezdushna E, Ritter H (2008) Microwave promoted polymer analogous amidation and esterification of poly(ether sulfone) bearing free carboxylic groups. *Macromol Rapid Commun* 29:1942–1947
150. Koopmans C, Iannelli M, Kerep P et al (2006) Microwave-assisted polymer chemistry: Heck-reaction, transesterification, Baeyer–Villiger oxidation, oxazoline polymerization, acrylamides, and porous materials. *Tetrahedron* 62:4709–4714
151. Carter KR (2002) Nickel(0)-mediated coupling polymerizations via microwave-assisted chemistry. *Macromolecules* 35:6757–6759
152. Yamamoto T, Fujiwara Y, Fukumoto H et al (2003) Preparation of a new poly(*p*-phenylene) type polymer, poly(pyrazine-2,5-diyl), with a coplanar structure. *Polymer* 44:4487–4490

# Microwave-Assisted Free Radical Polymerizations

Liangjing Fang, Guang Han, and Huiqi Zhang

**Abstract** Microwave irradiation has drawn rapidly increasing interest in the field of polymer science as an alternative heating method for polymer syntheses and modification, mainly because of its obvious advantages over conventional heating methods as the heating is non-contact, instantaneous and rapid, and highly specific. Many different kinds of microwave-assisted polymerizations have been developed in the past three decades, such as various microwave-assisted free radical polymerizations, step-growth polymerizations, and ring-opening polymerizations, which normally showed dramatically accelerated polymerization rates in comparison with those performed under conventional heating conditions. In this chapter, we provide a detailed overview of microwave-assisted conventional free radical polymerizations and their applications for the rapid and efficient preparation of a diverse range of polymer materials. The progress of both homogeneous (i.e., bulk polymerization and solution polymerization) and heterogeneous (including suspension polymerization, emulsion polymerization, dispersion polymerization, precipitation polymerization, and some other heterogeneous polymerizations) microwave-assisted conventional free radical polymerizations is presented. In addition, some important issues and perspectives in this research area are also discussed.

**Keywords** Conventional heating · Free radical polymerizations · Heterogeneous polymerization · Homogeneous polymerization · Microwave irradiation

---

These authors (Liangjing Fang and Guang Han) contributed equally to this work.

L. Fang, G. Han, and H. Zhang (✉)

Key Laboratory of Functional Polymer Materials, Ministry of Education, Nankai University, Tianjin 300071, P. R. China

Collaborative Innovation Center of Chemical Science and Engineering (Tianjin),  
Department of Chemistry, Nankai University, Tianjin 300071, P. R. China  
e-mail: [zhanghuiqi@nankai.edu.cn](mailto:zhanghuiqi@nankai.edu.cn)



## Contents

1	Introduction .....	88
2	Microwave-Assisted Free Radical Polymerizations .....	91
2.1	Homogeneous Free Radical Polymerizations .....	91
2.2	Heterogeneous Free Radical Polymerizations .....	102
3	Conclusions and Outlook .....	122
	References .....	123

## 1 Introduction

The past decades have witnessed considerable interest in the use of the radiation as an alternative to conventional thermal heating in the field of chemistry because this non-contact mode of heating can overcome some intrinsic disadvantages of conventional heating with regard to energy-saving, thus making it highly promising in industrial applications. However, traditional radiation sources like  $\gamma$ -radiation, electron beam, and UV light have their own limitations. UV light has poor penetration ability and cannot be used for thick samples, whereas  $\gamma$ -radiation is strongly penetrative and active but has inherent danger and liability problems. In addition, an electron beam in the megaelectron volt (MeV) region has ideal penetration ability but suffers from enormous start-up costs. These drawbacks have significantly limited their broad applications [1, 2].

In contrast to the above-mentioned radiation sources, microwave radiation (or irradiation) is an affordable and efficient heating source and has been widely utilized in many private households and chemical industries. Microwaves comprise electromagnetic radiation with a frequency between 300 GHz and 300 MHz (the corresponding wavelengths range from 1 mm to 1 m). Most microwave systems for domestic and synthetic purposes utilize an irradiation with a frequency of 2.45 GHz ( $\lambda = 0.122$  m) in order to avoid interference with telecommunications and radars. The mechanism of microwave-assisted heating is based on the dielectric character of microwaves, which can be selectively absorbed by polar molecules or ionic particles. The electric field of microwaves oscillates  $4.9 \times 10^9$  times per second and consequently drives polar molecules and ionic particles to continuous reorientation cycles, whereby heat is simultaneously generated because of the rotation, friction, and collision of the molecules [3, 4]. More importantly, this direct interaction of the electromagnetic irradiation with the particular molecules creates a very fast non-contact internal heating, which is almost uniform throughout the whole radiation process.

The popular use of microwave irradiation as a heating source in chemistry can be mainly attributed to the often observed enhanced reaction rates compared to those obtained with conventional heating. This enhancement is typically caused by a simple thermal/kinetic effect, which is a consequence of quickly achieved high temperature and high pressure conditions enabled by the use of sealed vials [5].

It is well known that according to the Van't Hoff rule, a reaction rate acceleration of a factor of 2–4 is generally predicted if the reaction temperature is increased by 10 K. In addition, the easily accessible high-pressure reaction conditions due to the use of sealed vials allows one to replace high-boiling solvents with low-boiling ones, thus simplifying product isolation and paving the way to environmentally benign industrial production. Furthermore, the direct and highly specific heating of particular polar or ionic molecules under microwave irradiation precludes the formation of by-products or the decomposition of the molecules close to the walls of the reaction vials. Therefore, the instantaneous and rapid heating, together with all the above-mentioned features, surely lead to less side reactions, cleaner products, and higher yields [6–8].

The first microwave-assisted organic syntheses were reported in 1986 [9, 10]. Ever since, these syntheses have received broad attention all over the world [11–15]. In comparison, there has been an obvious delay in the widespread use of microwave heating methods for polymer syntheses and modification. This might be caused by the polymer chemists' early awareness of the pronounced exothermic character of most polymerization reactions, which would make the reproducibility and safety of the potential experiments doubtful because of the insufficient temperature control in domestic microwave ovens.

With the advent of the new millennium, more and more commercial microwave synthesizers have been designed and manufactured to meet special laboratory needs (Fig. 1). In contrast to the common domestic microwave ovens, these microwave synthesizers are typically monomodal and allow the precise measurement and fast online monitoring of the temperature and pressure [17]. The irradiation power of such microwave synthesizers can thus self-regulate according to a predetermined heating profile or can be switched off automatically when the reaction parameters run out of control. In this way, the risks of hazardous explosions associated with the traditional domestic microwave ovens have been greatly minimized [18].

These technical improvements have attracted rapidly increasing interest in microwave-assisted polymerizations [16, 19–23], as indicated by the almost exponential increase in related publications (Fig. 2). So far, microwave irradiation has been applied in a number of polymerization systems, such as free radical polymerizations including both conventional free radical polymerization and controlled/"living" radical polymerization, step-growth polymerization, and ring-opening polymerization. Microwave-assisted step-growth polymerization has been widely utilized for the preparation of polyamides, polyimides, polyethers, and polyesters [24–27]. In addition, microwave-assisted ring-opening polymerization of cyclic monomers has proven to be efficient for obtaining in quite a short time poly(L-lactide)s, poly( $\epsilon$ -caprolactone)s, and poly(2-oxazoline)s with high molecular weights, which are highly useful in biomedical and pharmaceutical fields [28–30]. Some review papers on microwave-assisted step-growth polymerizations [31, 32] and ring-opening polymerizations [32–34] have been published to summarize the progress in these fields.

Controlled/"living" radical polymerizations have been intensively investigated in the field of polymer science in the past two decades due to their versatility in the

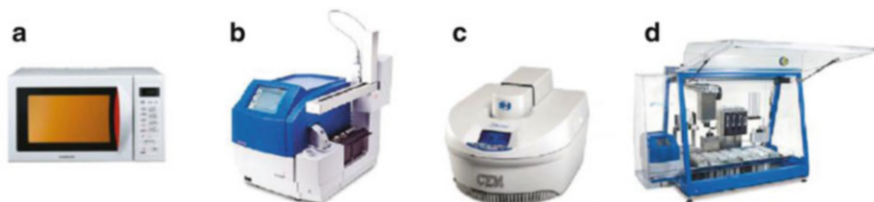

**Fig. 1** Selected examples of microwave reactors used for chemical reactions: (a) domestic microwave oven, (b) Initiator Eight (Biotage, Sweden), (c) CEM Discover (CEM), and (d) Chemspeed Swave automated microwave synthesizer (Chemspeed, Switzerland). Reprinted with permission from [16]. Copyright 2011 American Chemical Society

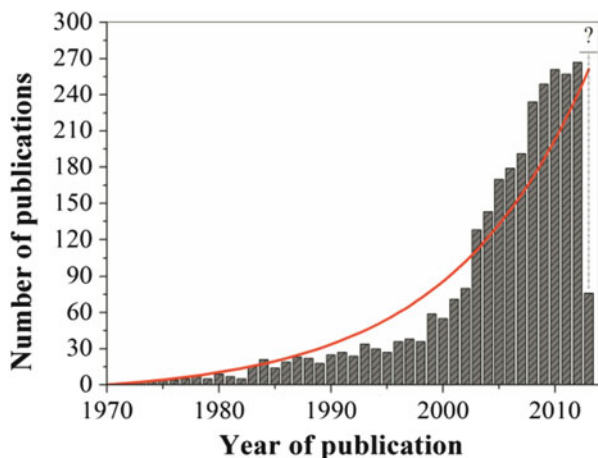

**Fig. 2** The number of publications (including books, journals, patents, preprints, and reviews) on microwave-assisted polymerizations per year, as obtained from the SciFinder database on April 28, 2013 using the keywords “microwave” and “polymerization”

preparation of well-defined polymers under mild reaction conditions. Microwave-assisted heating has also been successfully applied in different kinds of controlled/“living” radical polymerizations including atom transfer radical polymerization (ATRP) [35–37], nitroxide-mediated radical polymerization (NMP) [38–40], and reversible addition-fragmentation chain transfer (RAFT) polymerization [41–43]. Very recently, Kempe et al. have summarized the progress in microwave-assisted controlled radical polymerizations [16].

In this chapter, we aim to provide a detailed overview of microwave-assisted conventional free radical polymerizations including both homogeneous systems (i.e., bulk polymerization and solution polymerization) and heterogeneous systems (including suspension polymerization, emulsion polymerization, dispersion polymerization, precipitation polymerization, and some other heterogeneous polymerizations). Some important issues and perspectives on the future trends in this intriguing field are also discussed.

## 2 Microwave-Assisted Free Radical Polymerizations

The conventional free radical polymerization has been the most widely used polymerization approach for both the commercial and laboratory-scale production of high molecular weight polymers because of its applicability to a large number of monomers, mild polymerization conditions, and tolerance to many different solvents (such as water) and impurities. According to the polymerization conditions used, conventional free radical polymerization can be typically classified into homogeneous and heterogeneous systems. The former can be divided into homogeneous bulk and solution polymerizations, whereas heterogeneous systems mainly consist of suspension polymerization, emulsion polymerization, dispersion polymerization, and precipitation polymerization. In addition, some other free radical polymerizations such as surface-grafting polymerization from various substrates, simultaneous sol–gel reaction and free radical polymerization, and hydrogel-forming polymerization can also be included in the heterogeneous polymerization system. In this contribution, the research progress in various microwave-assisted conventional free radical polymerizations is reviewed in detail.

### 2.1 *Homogeneous Free Radical Polymerizations*

#### 2.1.1 Bulk Polymerization

Bulk polymerization here refers to the homogeneous polymerization of the monomer(s) in the absence of any solvent, which offers the simplest process with minimal contamination of the product. However, it is difficult to control the bulk polymerization because of the characteristics of radical chain polymerization (i.e., highly exothermic nature, high activation energies, and a tendency toward the gel effect). Normally, heat dissipation difficulties are encountered in the bulk polymerization system. So far, various monomers and conditions have been investigated in the case of microwave-assisted conventional free radical bulk polymerization, as summarized in Table 1 (entries 1–22) [44–65].

The first reported microwave-assisted free radical polymerization was a bulk polymerization system [44]. Although the intense use of microwave irradiation as a heating source in polymerization occurred well after the development of microwave-assisted organic syntheses, the first microwave-assisted free radical bulk polymerization had already been disclosed by Gourdenne et al. in 1979 and involved the crosslinking of an unsaturated polyester with styrene (St) under microwave irradiation [44]. Several years later, hydroxyethyl methacrylate (HEMA) proved to be polymerizable under microwave irradiation in bulk in the absence of any radical initiator [45]. The microwave-assisted bulk polymerization of HEMA was found to be significantly faster than the conventional thermal polymerization, although they turned out to have similar temperature profiles. Chia and coworkers

**Table 1** Microwave-assisted homogeneous free radical polymerizations

Entry	Monomer(s) (copolymer)	Microwave reactor	Temperature (power)	Polymerization time	Solvent	$M_n$ (kDa) <sup>a</sup>	$\bar{D}$ <sup>a</sup>	References
1	St+unsaturated polyester	N.P. <sup>b</sup>	N.P. <sup>b</sup>	N.P. <sup>b</sup>	Bulk	–	–	[44]
2	HEMA	N.P. <sup>b</sup>	N.P. <sup>b</sup>	N.P. <sup>b</sup>	Bulk	N.P. <sup>b</sup>	N.P. <sup>b</sup>	[45]
3	MMA	Self-assembled microwave circuit	200, 300, 500 W	45 min (200 W); 30 min (300 W); 20 min (500 W)	Bulk	N.P. <sup>b</sup>	N.P. <sup>b</sup>	[46]
4	St	Multimode microwave cavity	300, 500 W	50 min (300 W); 45 min (500 W)	Bulk	N.P. <sup>b</sup>	N.P. <sup>b</sup>	[47]
5	MA	Multimode microwave cavity	200, 300, 500 W	30 min	Bulk	N.P. <sup>b</sup>	N.P. <sup>b</sup>	[48]
6	VAc, St, MMA, AN	Samsung MW5630T	163, 196, 650, 687 W	<10 min (VAc); <20 min (St); <10 min (MMA); 1 min (AN)	Bulk	<68.3 (PVAc), <16.7 (PS), <57 (PMMA), N.P. <sup>b</sup> (PAN)	<4.9 (PVAc), <22.3 (PS), <3.1 (PMMA), N.P. <sup>b</sup> (PAN)	[49]
7	AM, EHA	Domestic micro- wave oven	<700 W	N.P. <sup>b</sup>	Bulk	N.P. <sup>b</sup>	N.P. <sup>b</sup>	[50]
8	N-Alkylacrylamide	Easy Tronic MO 201	350 W	30–150 s	Bulk	N.P. <sup>b</sup>	N.P. <sup>b</sup>	[51]

9	Diisopropyl fumarate	Zenith ZVP-2819	140, 210, 280 W	2–20 min	Bulk	<36	<2.0	[52]
10	Dialkyl fumarate	Zenith ZVP-2819	70, 140, 210, 280 W	2–20 min	Bulk	<23.53	<4.3	[53]
11	BrPMI	Domestic microwave oven	350 W	10 min	Bulk	N.P. <sup>b</sup>	N.P. <sup>b</sup>	[54]
12	MAH+MDE	Domestic microwave oven	45°C (700 W)	32 s	Bulk	N.P. <sup>b</sup>	N.P. <sup>b</sup>	[55]
13	MAH+AT	Domestic microwave oven	55 ± 1°C (270, 430 W)	<80 s	Bulk	N.P. <sup>b</sup>	N.P. <sup>b</sup>	[56]
14	DBTM+AT	Domestic microwave oven	44.0 ± 1.0°C (700 W)	<100 s	Bulk	N.P. <sup>b</sup>	N.P. <sup>b</sup>	[57]
15	DMAEMA+AT	Jianhua microwave KS2163	80–90°C	2–12 h	Bulk	N.P. <sup>b</sup>	N.P. <sup>b</sup>	[58]
16	(Meth)acrylic acid + (meth)acrylamide	CEM-Discover	140 W	30 min	Bulk	<3,620	<6.46	[59]
17	Acrylic acid +acrylimide+AM	CEM-Discover	100°C (<130 W)	30 min	Bulk	<37.2	<3.1	[60]
18	Methacrylic acid +methacrylimide	CEM-Discover	120°C (140 W)	30 min	Bulk	32	2.98	[61]
19	NPI	CEM-Discover	90°C (30 W)	50 min	Bulk	≈2.7	≈2	[62]
20	(Ethylene glycol) <sub>4</sub> diacrylate	Avanti domestic microwave oven	<1,300 W	<10 s	Bulk	–	–	[63]
21	MMA, St+MMA, St+BA, St+AcSt	CEM Discover Labmate	70°C	<15 min (MMA); <30 min (St+MMA);	Bulk	<163 (PMMA); <59.9 [poly (St-co-MMA)]; <123.4 [poly (St+MMA)];	<2.14 (PMMA), <1.48 [poly (St-co-MMA)], <1.83 [poly (St+MMA)];	[64]

(continued)

Table 1 (continued)

Entry	Monomer(s) (copolymer)	Microwave reactor	Temperature (power)	Polymerization time	Solvent	$M_n$ (kDa) <sup>a</sup>	$\bar{D}^a$	References
22	St	CEM Discover	60, 100°C (25, 300 W)	<20 min (St+BA); 15 min (St+AcSt)	Bulk	(St-co-BA); 109 [poly (St-co-AcSt)]	(St-co-BA), 2.16 [poly (St-co-AcSt)]	[65]
23	MMA	Domestic micro- wave oven	25–75°C (700 W)	<450 s	Chlorobenzene	<35	<2.2	[66]
24	AM	Kenstar (model no. MOW 9811)	<98°C (<800 W)	25, 50, 75, 100, 125 s	Water	N.P. <sup>b</sup>	N.P. <sup>b</sup>	[67]
25	St, St+MMA	CEM Discover	100°C (50, 150, 300 W)	45 min (St); 60 min (St+MMA)	DMF, toluene	<199 (PS); <184 [poly (St-co-MMA)]	<2.25 (PS); <2.39 [poly (St-co-MMA)]	[68]
26	St+MMA	CEM Discover	100°C (50, 150, 300 W)	60 min	DMF, toluene	<38.2	<2.39	[69]
27	PFS+NPI	CEM Discover	70 ± 1°C (150 W)	5–270 min	Anisole	<22	<2.09	[70]
28	N-Acryloyl-(S)- phenylalanine benzyl ester +DMA	CEM-Discover	100°C (250 W)	40 min	Dioxane	38.5	N.F. <sup>b</sup>	[71]
29	MMA	Biotope Emrys Liberator (small scale); CEM Dis- cover (large scale)	100°C (150 W)	20 min	Bulk/IL-1/IL2 (small scale); IL2 (large scale)	<26.4 (small scale); <23.7 (large scale)	<3.75 (small scale); <3.27 (large scale)	[72]

30	MMA, St, St+AN, MMA+NPI	MLS microPREP 1500	60, 80°C	<90 min (MMA); <420 min (St); <180 min (St+AN); <90 min (MMA +NPI)	[EMIM] EtSO <sub>4</sub> (M- MA, St, St +AN); [BMIM] BF <sub>4</sub> (MMA +NPI)	<750 (PMMA); <38.9 (PS); <300 [poly (St-co-AN)]; <250 [poly (MMA-co- NPI)]	<5.6 (PMMA); N. [73] P. <sup>b</sup> [PS, poly (St-co-AN), poly (MMA-co- NPI)]
31	BMA+DVB, St +DVB, BMA +EDMA	Domestic micro- wave oven	900 W	3, 5 min	[C <sub>6</sub> mim][BF <sub>4</sub> ]	–	– [74]
32	AM (with metal nanoparticle)	CEM Discover	125, 190°C	15, 45 min	Ethylene glycol	–	– [75]

*AcSt* 4-acetoxystyrene, *AM* acrylamide, *AN* acrylonitrile, *AT* allylthiourea, *BMA* butyl methacrylate, *BrPMI* *N*-*p*-bromophenylmaleimide, *DBTM* dibutyltin maleate, *DMA* *N,N*-dimethylaminoethyl acrylate, *DMAEMA* dimethylaminoethyl methacrylate, *DMF* dimethyl formamide, *DVB* divinylbenzene, *EDMA* ethylene dimethacrylate, *EHA* 2-ethylhexyl acrylate, *HEMA* hydroxyethyl methacrylate, *IL1* 1-butyl-3-methylimidazolium trifluoromethanesulfonate, *IL2* 1-butyl-3-methylimidazolium tetrafluoroborate, *MA* methyl acrylate, *MAH* maleic anhydride, *MDE* dibenzyl maleate, *MMA* methyl methacrylate, *NPI* *N*-phenylmaleimide, *PAN* poly(AN), *PFS* 2,3,4,5,6-pentafluorostyrene, *PMMA* poly(MMA), *PS* poly(St), *PVAc* poly(VAc), *St* styrene, *VAc* vinyl acetate  
<sup>a</sup>*M<sub>n</sub>* and *D* refer to the molecular weights and dispersities of the polymers, respectively, as determined by gel permeation chromatography  
<sup>b</sup>N.P. not presented



also observed an increase in reaction rates for the microwave-assisted free radical bulk homopolymerizations of methyl methacrylate (MMA), St, and methyl acrylate (MA) [46–48]. The percentage conversion profiles of the polymerizations were followed by Fourier transform infrared (FT-IR) spectroscopy at different microwave powers (200, 300, and 500 W). A sharp and large auto-acceleration at the gel effect was observed for the polymerization of St under microwave irradiation, which is in contrast to conventional heating. No clear explanation of this phenomenon was provided. The distinct auto-acceleration effect was also observed for the microwave-assisted polymerization of MMA, but not for MA. In addition, the authors also found that the limiting conversions decreased with an increase in the microwave power. Porto et al. systematically investigated the microwave-assisted free radical bulk polymerizations of a series of monomers including vinyl acetate (VAc), St, MMA, and acrylonitrile (AN) using a domestic microwave oven [49]. The polymerization rates proved to be dependent on the monomer structures as well as the power and time of the microwave irradiation, but independent of the periodic or continuous irradiation technique used. The polymerization of the highly absorbing AN could be realized even in the absence of the radical initiator azobisisobutyronitrile (AIBN) under high power microwave irradiation. Lu et al. reported the microwave-assisted free radical homopolymerizations of 2-ethylhexyl acrylate (EHA) and acrylamide (AM) in the presence of a carrier (i.e., aluminum oxide, silicon oxide, or magnesium oxide) [50]. The results revealed that the polymerization occurred according to a radical mechanism in the presence of aluminum oxide or silicon oxide, whereas it occurred according to a combination of radical and anionic polymerization mechanisms with superficial grafting in the presence of magnesium oxide.

The microwave-assisted free radical chain transfer bulk homopolymerizations (or telomerizations) of a series of *N*-alkylacrylamides including *N*-isopropylacrylamide (NIPAAm), *N,N*-dimethylacrylamide (NDMAM), and *N*-[3-(dimethylamino)propyl] acrylamide (N3DMAPAM), as well as the copolymerization of NIPAAm and NDMAM, were studied by Fischer et al. [51]. Polymerizations induced by microwave irradiation under solvent-free conditions or performed in superheated yet subcritical methanol (80–170°C) were compared with those carried out under standard reflux conditions (methanol reflux, ~65°C, ambient pressure) in terms of the yields and molecular weights of the resulting polymers. The polymerization rates in superheated methanol were found to be greatly increased in comparison with the standard reflux system, while the average molecular weights and yields of their products remained almost unchanged. When the microwave heating was applied to the bulk polymerization systems, the reaction rates could be further accelerated and the polymerization time could be reduced to the minute range (which was 1 h in the superheated polymerization system). A 30% drop in the average molecular weights of the polymers obtained under microwave irradiation was observed compared with those of the polymers obtained in the other two systems, which was ascribed to the higher polarity of the reaction mixtures under solvent-free conditions and the resultant higher chain transfer rate.

The microwave-assisted free radical bulk polymerization technique was also extended to some monomers with high steric hindrance. Cortizo and coworkers

reported the free radical bulk homopolymerizations of some dialkyl fumarates (alkyl group = isopropyl, cyclohexyl, 2-ethylhexyl, 2-phenylethyl) under microwave irradiation at different powers (70, 140, 210, and 280 W) using a domestic microwave oven [52, 53]. The effects of the monomer and initiator structures, initiator concentration, and microwave irradiation energy on the monomer conversions as well as the average molecular weights and dispersities ( $M_w/M_n$ ) of the resulting polymers were studied in detail. The results showed that microwave irradiation led to a significant enhancement in the polymerization rates in comparison with conventional heating. Naguib et al. described the free radical bulk homopolymerization of *N-p*-bromophenylmaleimide (BrPMI) with AIBN as the initiator, both with conventional heating and under microwave irradiation [54]. Although BrPMI could not be polymerized by conventional heating at 135°C, poly (BrPMI) was readily obtained under microwave irradiation (350 W) within 10 min.

In addition to the above-described microwave-assisted free radical bulk homopolymerization systems, many microwave-assisted free radical bulk copolymerizations were also reported. Lu et al. investigated a series of microwave-assisted solid-state copolymerizations of maleic anhydride (MAH) with dibenzyl maleate (MDE) [55] or allyl thiourea (AT) [56] as well as that of dibutyltin maleate (DBTM) with AT [57]. The experimental results showed that the targeted copolymers could be prepared under microwave irradiation in a domestic microwave oven in a short time [55–57]. The reactivity ratios were determined for the different combinations of monomers. In addition, the effects of the polymerization parameters on the polymer yields and viscosity were also studied. Later on, the same research group also reported the successful preparation of copolymers of *N,N*-dimethylaminoethyl methacrylate (DMAEMA) and AT in a domestic microwave oven [58]. Copper(II) was then coordinated to the copolymer by mixing the solution of the copolymer with blue vitriol under microwave irradiation. The resultant Cu-poly(DMAEMA-*co*-AT) proved to heterogeneously catalyze the polymerization of MMA at room temperature.

Ritter and coworkers reported very interesting microwave-assisted single-step synthesis of some (meth)acrylamides and their corresponding polymers directly from (meth)acrylic acid and different amines [59–61]. They found that (meth)acrylamides could be quickly (in 30 min) obtained in good yields directly from (meth)acrylic acid and the corresponding amines in a solvent-free environment by using microwave irradiation (140 W), whereas no products were formed under reflux in an oil bath even after 6 h of reaction time [59]. More interestingly, the addition of an initiator (AIBN) to the starting mixtures led to the in situ formation of copolymers of (meth)acrylic acid and (meth)acrylamide in a single step under microwave irradiation. They further investigated the microwave-assisted synthesis of chiral (meth)acrylamides directly from (meth)acrylic acid and (*R*)-1-phenylethylamine without any prior activation in bulk (Fig. 3) [60, 61]. The kinetic experimental results indicated that the reaction exhibited an exceptional selectivity for the desired AM monomers under microwave irradiation. Similarly, it was also very simple to obtain optically active copolymers consisting of both AM and imide structural units in a one-pot reaction under microwave irradiation

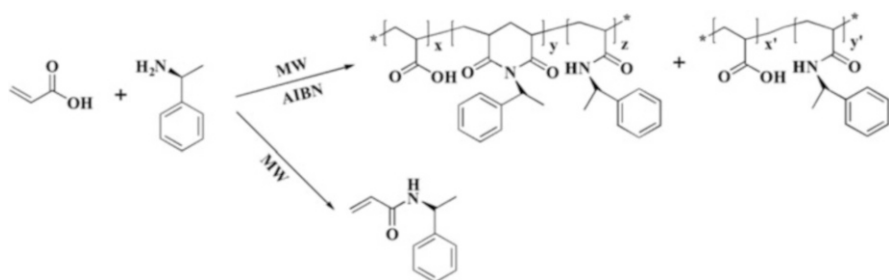
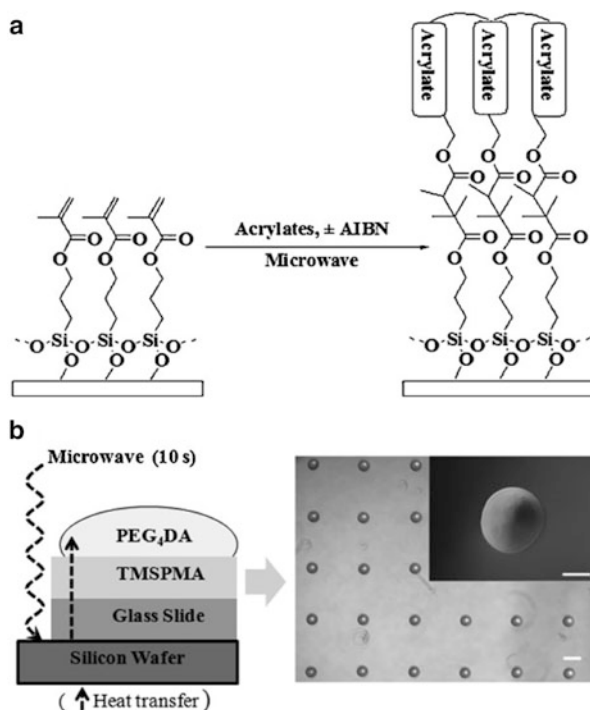

**Fig. 3** Condensation reaction between acrylic acid and (*R*)-1-phenylethylamine under microwave irradiation in the presence and absence of the radical initiator AIBN. Adapted with permission of Wiley-VCH from [60]

by adding AIBN to the starting reaction system. In addition, the same research group also reported the microwave-mediated direct synthesis of *N*-phenylmaleimide (NPI) from maleic anhydride and aniline [62]. The subsequent homopolymerization of this monomer in bulk (using AIBN as initiator) under microwave irradiation has also proven to be successful.

Microwave-assisted crosslinking bulk polymerization was also reported. Lee et al. developed a rapid and highly efficient approach for the fabrication of microstructures of poly(ethylene glycol) (PEG)-based (meth)acrylates by microwave-induced thermal crosslinking. PEG-based polymer microarrays and microwells were generated on 3-(trimethoxysilyl)propyl methacrylate (TMSPMA)-coated glass slides placed on top of a silicon wafer [63] (Fig. 4). In comparison with the conventional UV-irradiated polymerization and thermal curing technique, microwave-induced crosslinking polymerization has three main advantages: a very short reaction time (<10 s), no need for an additional radical source, and minimal oxygen inhibition in the presence of ambient oxygen. In addition, no thermal degradation was observed during the microwave-induced crosslinking. This approach is expected to be useful for providing various PEG-based microstructures for high-throughput screening assays, cell-based biosensors, and biomedical microdevices.

Very recently, a few important studies on the microwave-assisted bulk polymerizations have been carried out with the aim of checking whether there exists a particular “microwave effect”. Kwak et al. made critical evaluations of the microwave effect on the initiation, propagation, and termination during the free radical bulk polymerization of MMA and random bulk copolymerization of St with (meth)acrylates under both microwave heating and conventional heating conditions [64]. PMMAs with similar molecular weights, dispersities, and yields were obtained under precisely controlled temperature conditions, indicating very small changes in propagation rate constant. The decomposition rates of the initiator AIBN were essentially identical for microwave heating and conventional heating under well-controlled temperature conditions. Rate enhancement in the absence of precise temperature control was mostly due to the higher temperature of the reaction mixture than the apparent value indicated on the instrument display.



**Fig. 4** (a) Crosslinking polymerization of acrylates by microwave-induced heating. (b) Scheme of microwave-induced heating technique and phase contrast image of the crosslinked poly(ethylene glycol)<sub>4</sub> diacrylate (PEG<sub>4</sub>DA) after microwave-induced heating with 1% AIBN for 10 s in the presence of ambient oxygen. Scale bars: 100 µm (*top inset*) and 300 µm. Reprinted with permission of Wiley-VCH from [63]

Sugihara et al. also made an assessment of the influence of microwave irradiation on the free radical bulk polymerization of St by carefully conducting the experiments, and the results also demonstrated that there was no significant “microwave effect” on the polymerization rate [65].

### 2.1.2 Solution Polymerization

Solution polymerization here refers to the homogeneous polymerization of monomer(s) in a solvent that can also dissolve the formed polymer. The presence of a solvent in the solution polymerization can overcome many disadvantages of bulk polymerization. For example, the solvent can help transfer the heat produced during the polymerization process and its dilution effect allows easier stirring of the polymerization solution, which makes thermal control much easier in solution polymerization than in bulk polymerization. So far, many microwave-assisted homogeneous solution polymerizations have been investigated, including

microwave-assisted solution homopolymerization and copolymerization systems, as summarized in Table 1 (entries 23–32) [66–75].

Madras and Karmore investigated the kinetics of the simultaneous homopolymerization of MMA and the degradation of the formed poly(MMA) (PMMA) in chlorobenzene with different initiator and monomer concentrations under microwave irradiation [66]. The experimental results showed that the polymerization rates were enhanced by microwave radiation and that equilibrium between polymerization and degradation could be reached within 10 min for all the investigated systems. Recently, Singh et al. reported the efficient synthesis of poly(AM) (PAM) in water under microwave irradiation using a catalytic amount of potassium persulfate in a modified domestic microwave oven [67]. The polymerization process did not require any inert atmosphere and could be accomplished in approximately 2 min. The achieved maximum monomer conversion was 98.5% and the number average molecular weight ( $M_n$ ) of the obtained PAM samples ranged from  $4.11 \times 10^4$  to  $1.30 \times 10^5$ .

Stange and coworkers reported both the free radical homopolymerization of St and copolymerization of St with MMA in different solvents [toluene and *N,N*-dimethylformamide (DMF)] in the presence of different peroxide radical initiators with and without microwave heating [68, 69]. Significant solvent effects were observed for the studied polymerizations. Rather similar polymerization rates were obtained in toluene for both heating methods, whereas significant polymerization rate acceleration was observed in DMF under microwave irradiation in some cases. In the authors' opinion, the higher monomer conversions obtained in DMF under microwave irradiation probably originated from the much stronger microwave absorbing ability of the polar DMF, whereas the relatively poor microwave absorbing ability of toluene limited the heating efficiency of microwave irradiation, thus leading to no improvement in monomer conversions. Nevertheless, the specific microwave-induced selectivity of monomers and the change in reactivity ratio of the monomers were not observed in the copolymerization process.

Agarwal et al. described the copolymerization of 2,3,4,5,6-pentafluorostyrene (PFS) with NPI in anisole using both conventional heating and microwave heating [70]. The initial copolymerization rate under microwave irradiation was found to be about 14 times higher than that under conventional heating conditions. However, a lower maximum conversion was obtained in the former case, which was ascribed to an increased amount of diffusion-controlled termination reactions under microwave irradiation. In addition, the molecular weights of the polymers obtained with microwave heating proved to be lower than those of the polymers prepared with conventional heating, which could be due to the increased initiator efficiency under microwave irradiation. On the other hand, the dispersities of the polymers were higher in the microwave-assisted system, which was also attributed to the rapid and increased amounts of termination reactions. The novel copolymers possessed both high hydrophobicity and high glass transition temperatures. Buruiana et al. reported the microwave-assisted rapid synthesis of copolymers of *N*-acryloyl-(*S*)-phenylalanine benzyl ester and *N,N*-dimethylaminoethyl acrylate (DMA) in

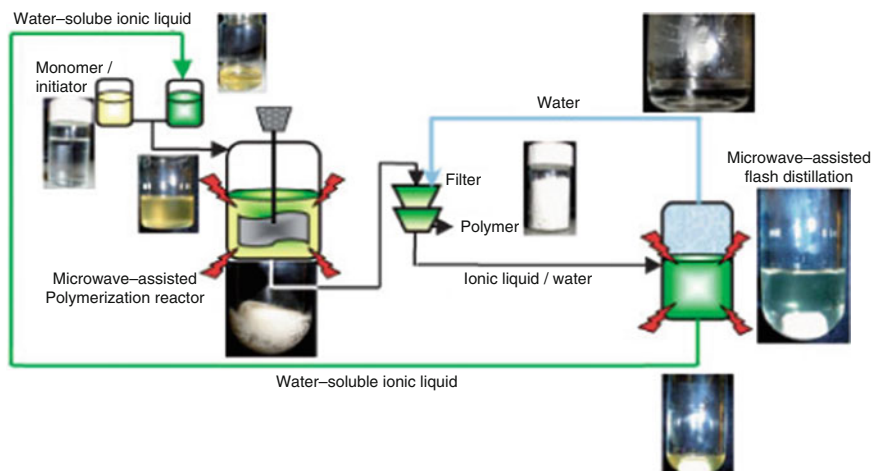

**Fig. 5** Conceptual green process for the continuous microwave-assisted synthesis of hydrophobic polymers in water-soluble ionic liquids. This process allow a reduction of emissions of volatile organic compounds into the environment and may allow for energy savings. Reprinted with permission of Wiley-VCH from [72]

dioxane with 1,1-azobis (cyclohexane-1-carbonitrile) as the initiator, whose subsequent quaternization with 4-chloromethylphenylcarbamoyloxy-methylstilbene led to a photoresponsive copolymer with a large fluorescence response towards monomethyl viologen, 4,4'-bipyridyl, 2,2'-bipyridyl, piperazine, and triethylamine in DMF solution [71].

Recently, microwave-assisted free radical solution polymerizations with ionic liquids as solvents have been described [72–74]. Ionic liquids interact very efficiently with microwaves through an ionic conduction mechanism and they can be rapidly heated at rates easily exceeding  $10^{\circ}\text{C/s}$  without any significant pressure build-up. Therefore, safety problems arising from overpressurization of heated sealed reaction vessels can be minimized [76, 77]. In addition, the excellent dissolution ability and very high boiling points of ionic liquids make them environmentally friendly solvents for microwave-assisted free radical polymerizations. Water-soluble ionic liquids were first used as reaction media in the homogeneous free radical polymerization of MMA by Schubert and coworkers [72]. The incorporation of ionic liquids into the polymerization provided a more efficient heating profile of the reaction mixtures under microwave irradiation. In addition, a convenient approach for the polymer isolation and recovery of the ionic liquids for further polymerization was demonstrated by taking advantage of the water solubility of the investigated ionic liquids (Fig. 5). Glück et al. investigated the free radical solution homopolymerizations of St and MMA and free radical solution copolymerizations of St with AN and MMA with NPI using both traditional solvents (DMF or methanol) and ionic liquid solvents ([EMIM]EtSO<sub>4</sub> or [BMIM]BF<sub>4</sub>) under microwave irradiation or conventional heating [73]. No differences were observed in the polymerization rates between microwave heating and conventional heating

when DMF or methanol was used as the solvent. The polymerization rates in ionic liquids were found to be higher than those in conventional solvents when the polymerizations were carried out with conventional heating. The overall polymerization rates in the microwave proved to be lower than those performed with conventional heating when ionic liquids were used as solvents, which was proposed to be due to the disturbance of the polar interactions between the ionic liquids and the monomer molecules or the polymer radicals by microwave irradiation, thus leading to a significant decrease in the propagation rate compared with conventional heating. On the other hand, there were no remarkable differences in the molecular weights of the polymers prepared using either heating method in either organic solvents or ionic liquid solvents, mainly because microwave heating had no influence on the viscosity of the reaction mixtures. More recently, Shih et al. described a rapid and efficient synthetic method for preparation of organic polymer-based monoliths in a room temperature ionic liquid medium via microwave-assisted vinylization and polymerization [74]. This novel approach took only 10 min to complete the whole process. The chromatographic performance of the obtained monolithic materials was found to be highly promising for chromatographic stationary phases and microreactors in proteomics or chemical syntheses.

The application of microwave-assisted simultaneous free radical solution polymerization and metal nanoparticle formation in the preparation of organic/inorganic hybrid materials has also been reported [75]. Zhu and Zhu described the convenient and efficient preparation of PAM-metal (silver, platinum, and copper) nanocomposites with metal nanoparticles homogeneously dispersed in the polymer matrix from the corresponding metal salt and AM in ethylene glycol under microwave irradiation [75]. This method was based on the single-step simultaneous formation of metal nanoparticles and polymerization of AM, leading to a homogeneous distribution of metal nanoparticles in the PAM matrix. In this study, ethylene glycol acted as a solvent, a reducing agent, and a microwave absorber at the same time, and there was no need for any additional initiator for the AM polymerization or surfactant for stabilizing metal nanoparticles in the whole process.

## 2.2 *Heterogeneous Free Radical Polymerizations*

### 2.2.1 **Suspension Polymerization**

Suspension polymerization is performed by suspending the monomer droplets (discontinuous phase) (50–500  $\mu\text{m}$  in diameter) in the continuous solvent phase through agitation and use of stabilizers. The initiators used in suspension polymerization are soluble in the monomer droplets, which makes each monomer droplet a miniature bulk polymerization system. The monomer droplets become dispersed solid polymer particles during the polymerization.

Some microwave-assisted suspension polymerization systems have been reported (entries 1–5 in Table 2) [78–82]. Liu et al. performed the free radical

**Table 2** Microwave-assisted heterogeneous free radical polymerizations

Entry	Monomer(s)	Microwave reactor type	Polymerization conditions			Particle diameter		References
			Temperature (power)	Time	Solvent	Microwave irradiation	Conventional heating	
<i>Suspension polymerization</i>								
1	BA	XO-50A	72.6–94.6°C (90–190 W)	<2.5 min	Water	N.P. <sup>a</sup>	N.P. <sup>a</sup>	[78]
2	MAA, AM, 4-VP, St	MAS-I	70°C	2 h	Water	80–250 μm <sup>b</sup>	N.P. <sup>a</sup>	[79]
3	4-VP+St	MAS-I	70°C	1 h	Water	70–180 μm <sup>b</sup>	N.P. <sup>a</sup>	[80]
4	AM+St	MAS-I	70°C	1 h	Water	80 μm <sup>b</sup>	N.P. <sup>a</sup>	[81]
5	MAA+St	MAS-I	70°C	1 h	Water	200 nm <sup>b</sup>	N.P. <sup>a</sup>	[82]
<i>Emulsion polymerization</i>								
6	St	Whirlpool-VIP20	~70°C (80 W)	~40 min	Water	~60 nm <sup>c</sup>	N.P. <sup>a</sup>	[83]
7	St	N.P. <sup>a</sup>	70 ± 4°C (800 W or 175 W)	140 s	Water	N.P. <sup>a</sup>	N.P. <sup>a</sup>	[84]
8	BA+St	Microwave oven (Korea Microwave Instrument Co.)	70°C (300 W)	3 h	Water	58 nm <sup>b</sup> ( $D_w^d$ ), 41 nm <sup>b</sup> ( $D_n^d$ )	62 nm <sup>b</sup> ( $D_w^d$ ), 35 nm <sup>b</sup> ( $D_n^d$ )	[85]
9	MMA, BA	Synthos 3000	70 or 80°C (1,400 W)	<40 min	Water	50–60 nm (PMMA) <sup>c</sup> , 110–120 nm (PBA) <sup>c</sup>	70–90 nm (PMMA) <sup>c</sup> , 120–130 nm (PBA) <sup>c</sup>	[86]
10	MMA	Self-designed microwave reaction apparatus	66 ± 2°C (30.2 W)	10–30 min	Water	N.P. <sup>a</sup>	N.P. <sup>a</sup>	[87]
11	St	Self-designed microwave reaction apparatus	72 ± 2°C (2–350 W)	40 min	Water	~70 nm <sup>c</sup>	N.P. <sup>a</sup>	[88]

(continued)



Table 2 (continued)

Entry	Monomer(s)	Polymerization conditions				Particle diameter		References
		Microwave reactor type	Temperature (power)	Time	Solvent	Microwave irradiation	Conventional heating	
12	St	MLS-Ethos 1600	75–90°C (1,000 W)	<16 min	Water	N.P. <sup>a</sup>	N.P. <sup>a</sup>	[89]
13	St	MLS-Ethos 1600	90°C (1,000 W)	70 s	Water	N.P. <sup>a</sup>	N.P. <sup>a</sup>	[90]
14	DFHMA+MMA+BA	XH-100A microwave oven	80°C (400 W)	2 h	Water	(71–103 nm <sup>b</sup> ), 58.5 nm <sup>c</sup>	81.2 nm <sup>c</sup>	[91]
15	St	Whirpool-VIP20	70 ± 2°C (80 W)	1 h	Water	20–90 nm <sup>c</sup>	N.P. <sup>a</sup>	[92]
16	MMA	Synthos 3000	80°C or pulsed irradiation (500 W or 1,400 W)	<15 min	Water	55–100 nm <sup>c</sup>	55–100 nm <sup>c</sup>	[93]
17	St	Whirpool-VIP20	~70°C (80 W)	1 h	Water	35–120 nm <sup>c</sup>	N.P. <sup>a</sup>	[94]
18	St	Whirpool-VIP20	63 ± 1°C (<900 W)	<8 h	Water and acetone	15–278 nm <sup>c</sup>	N.P. <sup>a</sup>	[95]
19	St+MMA (BMA, EA, or MAH)	N.P. <sup>a</sup>	<650 W	8 h	Water and acetone	20–280 nm <sup>c</sup>	N.P. <sup>a</sup>	[96]
20	AN	Kenstar domestic microwave oven	<100°C (<1,200 W)	30–360 s	Water	220–250 nm <sup>c</sup>	120–530 nm <sup>c</sup>	[97]
21	St+NIPAAm	SANLE-MP650D	70°C (130 W)	1 h	Water	100–130 nm <sup>c</sup>	N.P. <sup>a</sup>	[98]
22	St+NIPAAm	SANLE-MP650D	70°C (130 W)	1 h	Water	136–149 nm <sup>b</sup>	N.P. <sup>a</sup>	[99]
23	MMA	Whirpool T120	70°C (40 W)	2 h	Water, water/acetone	103–215 nm <sup>c</sup> (water), 45 nm <sup>c</sup> (water/acetone)	N.P. <sup>a</sup>	[100]
24	MMA	Initiator Eight (Biotage)	70°C (23 ± 2 W)	1 h	Acetone and water	<200 nm <sup>c</sup>	N.P. <sup>a</sup>	[101]
25	MMA	Modified microwave oven	~80°C (80 W)	1–5 h	Water	~220 nm <sup>c</sup>	165–200 nm <sup>c</sup>	[102]

26	BMA	Modified micro-wave oven	73 ± 2°C	1.5 h	Water	88–299.8 nm <sup>c</sup>	107.7 nm, 116.4 nm, 255.2 nm <sup>c</sup>	[103]	
27	MMA (with PNIPAAm-g-PEO as the seed emulsion)	Modified micro-wave oven	80°C (80 W)	1 h	Water	68–90 nm <sup>c</sup> (PMMA-coated PNIPAAm)	N.P. <sup>a</sup>	[104]	
28	St, MMA (in the presence of MWCNTs)	Domestic micro-wave oven (WP750L23-6 Galanz)	136 W (100°C)	25 min	Water	N.P. <sup>a</sup>	N.P. <sup>a</sup>	[105]	
<i>Dispersion polymerization</i>									
29	MMA	Self-designed microwave reaction apparatus	70°C (350, 840, 850 W)	<70 min	<i>n</i> -Heptane	134 ± 42 nm <sup>e</sup>	144 ± 23 nm <sup>e</sup>	[106]	
30	St	SANLE-MP650D	75°C (130 W)	1 h	Ethanol and water	(200–500 nm <sup>e</sup> ), 301 nm (PDI = 1.002) <sup>e</sup>	469 nm (PDI = 1.09) <sup>e</sup>	[107]	
31	EHMA+VBC+DVB	MARS multimode microwave reactor (CEM)	70°C (280 W)	4–5 h	Nonafluorobutyl ethyl ethers	1 μm <sup>b</sup>	1–2 μm <sup>b</sup>	[108]	
32	St	N.P. <sup>a</sup>	~70°C (400 W)	10–60 min	Ethanol	~1.1 μm <sup>b</sup>	N.P. <sup>a</sup>	[109]	
<i>Precipitation polymerization</i>									
33	St	Synthos 300 (water), Emrys Liberator (Biotage) (ethanol)	150–280°C (water) (<1,400 W) 150°C (ethanol) (150 or 300 W)	10 min (water), 1 h (ethanol)	Water or ethanol	N.P. <sup>a</sup>	N.P. <sup>a</sup>	[110]	

(continued)

Table 2 (continued)

Entry	Monomer(s)	Microwave reactor type	Polymerization conditions			Particle diameter		References
			Temperature (power)	Time	Solvent	Microwave irradiation	Conventional heating	
34	AM, MAA	MDS-2002AT	40–80°C	150 min	Acetonitrile, toluene, chloroform, etc.	50 $\mu\text{m}^b$	N.P. <sup>a</sup>	[111]
<i>Other heterogeneous polymerizations</i>								
35	NIPAAm+MBA	Panasonic NN-K542WF	75, 170, 340 W	15 min	PEO-600	–	–	[112]
36	NIPAAm+MBA	CEM Mars-5	70–90°C (<300 W)	5–30 min	Acetone	–	–	[113]
37	HEMA (grafting onto woolen fabrics)	National Corporation	<900 W	35 min	Water	–	–	[114]
38	AN (grafting onto guar gum)	Kenstar (model no. MOW 9811)	<97°C (<1,200 W)	0.33–1.66 min	Water	–	–	[115]
39	AM (grafting onto guar gum)	Kenstar (model no. MOW 9811)	<100°C (<1,200 W)	0.33–1.66 min	Water	–	–	[116]
40	AN (grafting onto chitosan)	Kenstar (model no. MOW 9811)	95°C (960 W)	1.5 min	5% aqueous formic acid	–	–	[117]
41	AM (grafting onto chitosan)	Kenstar (model no. MOW 9811)	<100°C (<1,200 W)	20–90 s	5% aqueous formic acid	–	–	[118]
42	MMA (grafting onto chitosan)	Kenstar (model no. MOW 9811)	<100°C (<1,200 W)	<2 min	5% aqueous formic acid	–	–	[119]
43	AN (grafting onto <i>Cassia siamea</i> seed gum)	Kenstar (model no. OM 20 ESP)	<100°C (<800 W)	30, 60, 90, 120 s	Water	–	–	[120]

44	MMA (grafting onto $\kappa$ -carrageenan)	LG kitchen microwave oven	<100°C	<250 s	Water	–	[121]
45	AM (grafting onto gellan gum)	Catalyst systems	480 W	1, 5 min	Water	–	[122]
46	Sodium acrylate+PEG diacrylate (grafting onto cornstarch)	Sanle WHLO7S-3	85–95°C (85, 100, 115 W)	8, 10, 12 min	Water	–	[123]
47	Sodium acrylate+AMPS (grafting onto starch)	N.P. <sup>a</sup>	540 W	3 min	Water	–	[124]
48	St, MMA, AM, acrylic acid, allyl alcohol (grafting onto MWCNTs)	Commercial microwave oven	600 W	<10 min	Water, THF, toluene	–	[125]
49	AM (grafting onto graphene sheets)	Midea household microwave oven	450 W	6 min	Water	–	[126]
50	St, MMA, HEA, DMAEMA, DMA (grafting onto silicon or glass substrates)	CEM Discover S	75–110°C (<260 W)	<20 min	Benzene, water	–	[127]
51	HEMA+BODIPY dye +MeTMS	Milestone General, Micro-SYNTH	Gradually controlled (30 W for 40 min, 100 W for 10 min and 300 W for 5 min)		Methanol/water	–	[128]
52	St+methacryloxypropyl silica nanoparticles	Galanz WP700L17	<700 W	10 min	Bulk	–	[129]

AM acrylamide, AMPS 2-acrylamido-2-methyl-propanosulfonic acid, AN acrylonitrile, BA butyl acrylate, BMA *n*-butyl methacrylate, BODIPY methacrylate-tethering boron dipyrromethene, DFHMA dodecafluorohexylmethacrylate, DMA *N,N*-dimethylaminoethyl acrylate, DMAEMA dimethylaminoethyl methacrylate, DMSO dimethyl sulfoxide, DVB divinylbenzene, EA ethyl acrylate, EHMA 2-ethylhexyl methacrylate, HEA 2-hydroxyethyl acrylate, HEMA hydroxyethyl methacrylate, MAA methacrylic acid, MAH maleic anhydride, MBA *N,N*'-methylenebisacrylamide, MeTMS methyltrimethoxysilane, MMA methyl methacrylate, MWCNT multiwalled carbon nanotube, NIPAAm *N*-isopropyl acrylamide, PEG poly(ethylene glycol), PEO poly(ethylene oxide), St styrene, VBC 2-ethylhexyl methacrylate vinylbenzyl chloride, 4-VP 4-vinylpyridine

<sup>a</sup>N.P. not presented

<sup>b</sup>Characterized by scanning electron microscopy

<sup>c</sup>Characterized by laser light scattering

<sup>d</sup> $D_v$  volume-average diameter,  $D_n$  number-average diameter

<sup>e</sup>Characterized by transmission electron microscopy

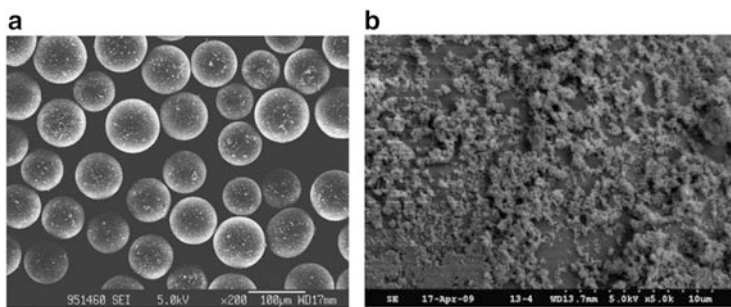

**Fig. 6** Scanning electron microscopy images of magnetic polymer beads prepared by microwave-assisted suspension polymerization. Magnification: (a) 200 $\times$  and (b) 5,000 $\times$ . Reprinted with permission of Elsevier from [80]

suspension polymerization of butyl acrylate (BA) in water with both microwave heating and conventional heating [78]. Monodispersed droplets of several hundred microns in diameter were produced by a coaxial capillary microreactor. The experimental results showed that microwave heating provided poly(BA) (i.e., PBA) with larger average molecular weights and higher dispersities due to the gradual temperature increase. In addition, significantly improved monomer conversions were obtained with microwave heating in comparison with conventional heating, although the reaction temperature with microwave heating was lower than that with conventional heating. This remarkable polymerization rate enhancement was ascribed by the authors to the nonthermal microwave effect.

Recently, microwave irradiation has also been applied in the preparation of magnetic molecularly imprinted polymer (MIP) particles via suspension polymerization [79–82]. Li and coworkers prepared a series of magnetic MIP particles for trace analysis or selective enrichment of the template molecules (atrazine, 24-epibrassinolide, and ractopamine) via microwave-assisted suspension polymerization [79–81]. The polymerization rates were dramatically enhanced with microwave heating in comparison with those obtained with conventional heating. The resultant MIP particles had narrow size distribution, spherical shape, and porous morphologies (Fig. 6) and exhibited good abilities of molecular recognition and magnetic separation. In addition, the imprinting efficiency of the magnetic MIP beads obtained under microwave irradiation was higher than those prepared by conventional heating [79]. Wang et al. reported the preparation of magnetic MIP particles for selective enrichment of 2-amino-4-nitrophenol (4-NAP) from aqueous solution via microwave-assisted suspension polymerization [82]. The microwave heating significantly shortened the polymerization time and the resultant particles had uniform morphology. These imprinted particles not only displayed excellent affinity and selectivity towards 4-NAP in aqueous solution, but also showed good superparamagnetic response to an external magnetic field.

### 2.2.2 Emulsion Polymerization

Emulsion polymerization is a unique polymerization process utilized for some radical polymerizations and involves the polymerization of monomers in the form of emulsions (including both oil-in-water emulsion and water-in-oil emulsion). A typical emulsion polymerization system consists of monomer(s), solvent, initiator, and surfactant (or emulsifier). The main difference between emulsion polymerization and suspension polymerization lies in the type and smaller size of the particles where polymerization occurs and the initiators used (whereas the initiators are soluble in monomer droplets in suspension polymerization, they are soluble in solvents instead of monomers in emulsion polymerization). Some different kinds of emulsion polymerization have been developed and can be classified in various ways: into normal emulsion and inverse emulsion polymerizations depending on the use of water or organic solvents; into classical emulsion, miniemulsion, and microemulsion polymerizations depending on the sizes of the monomer droplets formed in the beginning of emulsion polymerizations; or into surfactant-containing and surfactant-free emulsion polymerizations depending on the presence or absence of surfactants. So far, microwave irradiation has been widely utilized in the emulsion polymerization systems, as summarized in Table 2 (entries 6–28) [83–105].

Many microwave-assisted surfactant-containing emulsion polymerizations have been reported (Table 2, entries 6–16) [83–93]. Wu et al. described the preparation of PS nanoparticles with diameters down to 60 nm in the presence of an anionic surfactant (sodium dodecylsulfate; SDS) via microwave-assisted emulsion polymerization [83]. The experimental results showed that the microwave-assisted polymerization proceeded faster than the polymerization with water bath heating and provided narrowly distributed PS and PMMA nanoparticles. Correa et al. reported the preparation of PS via microwave-assisted surfactant-containing emulsion polymerization. A significant saving of energy and time was observed in the studied condition compared with conventional heating [84]. Jung et al. investigated the surfactant-containing emulsion copolymerization of BA and St under microwave irradiation with sodium lauryl sulfate as the surfactant [85]. The percentages of BA unit in the resulting copolymers increased compared with conventional heating polymerization at high feeding contents of BA. This was ascribed to the higher dipole moments of BA than St and the direct heating in the monomer droplets. More uniform spherical particles and higher monomer conversions were also obtained with microwave heating than with conventional heating. Costa et al. described the surfactant-containing emulsion polymerization of BA or MMA in the presence of anionic and nonionic emulsifiers under microwave irradiation in a commercial microwave reactor with well-controlled temperature and power [86]. The results showed that the microwave-assisted emulsion polymerizations of MMA were faster than the corresponding polymerizations with conventional heating, whereas the rates of microwave-assisted emulsion polymerizations of BA remained almost unchanged, which was attributed to the different aqueous phase solubility and dielectric parameters of the monomers. Meanwhile, smaller PMMA particles

were prepared under microwave irradiation than conventional heating. The authors ascribed this phenomenon to an increased decomposition rate of the initiator due to microwave irradiation. In addition, a pulsed irradiation strategy was also applied to the studied emulsion polymerization and the reaction showed a twofold increase in polymerization rate over continuous microwave irradiation at 80°C.

Zhu et al. reported the microwave-assisted surfactant-containing emulsion homopolymerizations of MMA [87] and St [88] under pulsed microwave irradiation (PMI) by using a self-designed pulsed microwave reaction apparatus. They investigated the effects of various parameters of PMI on the emulsion polymerizations in detail. Compared with conventional heating, microwave-assisted MMA emulsion polymerization rates increased by 131% and 163% when the initiator concentrations were 0.15 and 0.2 wt%, respectively. The molecular weights of the polymers obtained under microwave irradiation were 1.1–2.0 times larger than those obtained with conventional heating. Nevertheless, the glass transition temperatures ( $T_g$ ), molecular weight dispersities, and the regularity of the polymers obtained by using PMI and conventional heating were almost the same. Similar experimental results were also observed for the microwave-assisted polymerization of St. Based on the above results, the authors concluded that PMI had a significant nonthermal effect on the emulsion polymerization.

Holtze et al. described a new polymerization strategy combining the advantages of the confinement of the polymerization inside nanoreactors during miniemulsion polymerization (with SDS as the surfactant) with very rapid and efficient microwave heating [89]. Alternating short pulses of microwave heating (about 10 s) and longer intervals of cooling (at least 15 min) were applied for the studied polymerization system, which led to polymers with very high molecular weights on the order of  $10^7$  g/mol and high monomer conversion of up to 40% conversion after the first cycle. The above results were explained by the model of “surviving radicals”. In addition, microwave-specific effects such as coupling to dipolar moieties of the initiator could be excluded, and all experimental facts could be explained with common radical heterophase polymerization kinetics. Subsequently, the same group summarized the concept of “surviving radical polymerization” and presented their new results on the effects of radical-active additives and the development of a tube reactor for continuous microwave-assisted processing [90]. Later, Xiong et al. reported the preparation of fluorinated acrylate copolymer latexes by miniemulsion polymerization under microwave irradiation with SDS and polyoxyethylene alkylphenol ether (OP-10) as the mixed emulsifiers [91]. The particle sizes of the resulting latexes hardly changed during microwave-assisted polymerization, but they were smaller and more uniform than those prepared by conventional heating and had good centrifugal stability. Moreover, microwave-assisted miniemulsion polymerization had a higher reaction rate and higher conversion than that with conventional heating.

Wu and coworkers investigated both the microemulsion and emulsion polymerizations of St at 70°C with SDS as the surfactant and potassium persulfate as the initiator under microwave irradiation [92]. The influence of the initial emulsion composition (including the concentrations of SDS, potassium persulfate, and St) on

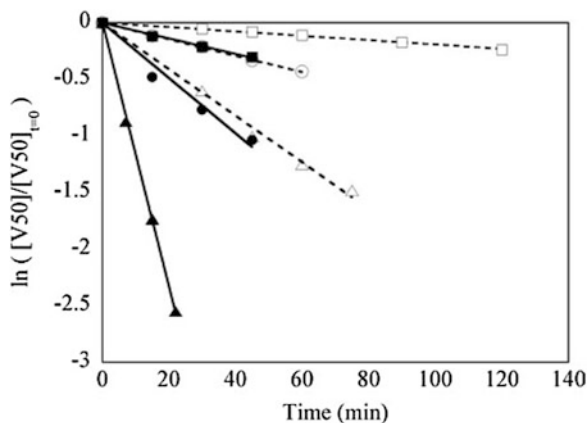
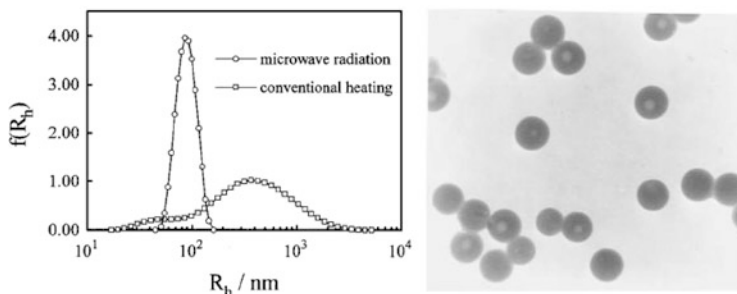

**Fig. 7** Variation in V50 concentration as a function of heating time. Conventional heating at 60 (open squares), 70 (open circles), and 80°C (open triangles). Microwave heating at 60 (filled squares), 70, (filled circles), and 80°C (filled triangles). Reprinted with permission of Wiley Blackwell from [93]

the final particle sizes led the authors to a simple modified structural model in which they considered the stabilization effects of both the surfactant and the ionic end groups generated from the initiator. The newly proposed model extended the application of the previous Wu plot from microemulsion polymerization to emulsion polymerization. Using this modified model, the authors were not only able to control the particle size but also to predict the monomer concentration dependence of the number of resultant latex particles and the effect of diluting the reaction mixture on the resultant particle size.

Many studies revealed that the acceleration of polymerization rates under microwave irradiation could be attributed to the higher decomposition rates of the used initiators. Costa et al. systematically investigated the decomposition of 2,2'-azobis (2-methylpropionamide) dihydrochloride (V50) under microwave irradiation and the microwave-assisted surfactant-containing emulsion polymerization of MMA (with V50 as the initiator) [93]. The decomposition rate of the initiator V50 proved to be improved under microwave irradiation in comparison with conventional heating (Fig. 7). The decomposition rate constants determined for the microwave-assisted reactions were about three to five times higher than those obtained from the conventional heating systems, just as observed for potassium persulfate previously [130]. These phenomena were ascribed to the generation of ionic radicals during the decomposition of these initiators, which provided specific heating by an ionic conduction mechanism under microwave irradiation. The rates of the studied microwave-assisted emulsion polymerization of MMA were faster than those with conventional heating, mainly due to the above-mentioned enhancements in initiator decomposition.





**Fig. 8** *Left*: Comparison of the typical hydrodynamic radius distributions,  $f(R_h)$ , of PS nanospheres prepared by microwave radiation and by conventional heating. *Right*: Electron microscopy image of surfactant-free PS nanoparticles prepared under microwave irradiation. Magnification, 50,000 $\times$ . Reprinted with permission from [94]. Copyright 1997 American Chemical Society

In addition to the above-described surfactant-containing emulsion polymerizations performed under microwave irradiation, many microwave-assisted surfactant-free systems have also been reported (Table 2, entries 17–28) [94–105]. Wu and coworkers described the microwave-assisted preparation of narrowly dispersed surfactant-free stable PS nanospheres in water by using a Whirlpool-VIP20 microwave reactor (Fig. 8) [94]. More than 98% of St was polymerized at 70°C within 40 min under microwave irradiation (80 W) whereas a polymerization time longer than 10 h was needed to reach the same monomer conversion with conventional heating. In addition, more uniform and smaller particles were generated with microwave heating than with conventional heating. The same research group also prepared narrowly dispersed stable PS nanoparticles with an averaged hydrodynamic radius  $\langle R_h \rangle$  down to 35 nm with good stability and reproducibility via surfactant-free emulsion polymerization in a water/acetone mixture (50/50 wt/wt) under microwave irradiation [95]. The microwave-assisted polymerization also proved to be faster than conventional heating polymerization because of the much faster decomposition rate of the initiator potassium persulfate. By considering both the roles of stabilization and destabilization of the initiator, they reformulated the Wu plot of  $\langle R_h \rangle \propto W_{\text{monomer}}/W_{\text{stabilizer}}$  into  $\langle R_h \rangle/[k_1(1 + k_2W_{\text{initiator}})] \propto W_{\text{monomer}}/W_{\text{initiator}}$ , which could be used to explain the effect of the Fleet ratio ( $W_{\text{monomer}}/W_{\text{initiator}}$ ) on the size of the resultant particles. You et al. described the preparation of stable PS nanospheres via the surfactant-free emulsion copolymerization of St with MMA, *n*-butyl methacrylate (BMA), ethyl acrylate (EA) and MAH as comonomers under microwave irradiation by using acetone-water as the solvent and potassium persulfate as the initiator [96]. The influences of the ratio of acetone to water in the solvent and comonomer concentration on the hydrodynamic radius of the copolymer nanoparticles were studied. Although nanoparticle latex could also be obtained by using conventional heating methods, the reaction proceeded more slowly and the particle size distribution was wider. In addition, the repeatability of the conventional heating method was found to be limited.

Recently, Biswal et al. reported the preparation of PAN latex by surfactant-free emulsion polymerization in the presence of Co(III) complex and ammonium persulfate with both microwave heating and conventional heating [97]. The polymerization under microwave irradiation took place much faster and the resulting polymer particle sizes (220–250 nm in diameter) were smaller and more uniform than with conventional heating (120–530 nm in diameter). Monodisperse thermoresponsive poly(St-co-NIPAAm) particles were prepared by Yi et al. via microwave-assisted surfactant-free emulsion polymerization [98]. The diameters of the resulting poly(St-co-NIPAAm) particles ranged from 100 to 130 nm and were smaller and more uniform than those prepared by using conventional heating. In addition, the diameters of the particles could be conveniently adjusted by varying the ratio of NIPAAm to St, temperature, and the concentration of potassium persulfate. Later, the same research group further investigated the self-assembly of these particles on clean glassware wafer substrates induced by capillary [99]. The results showed that these monodisperse particles could form ordered two-dimensional films arraying in hexagonal fashion and square fashion. With an increase in the NIPAAm contents in the copolymer particles, surface undulations or surface defective regions on the two-dimensional films gradually appeared.

Bao and Zhang prepared monodispersed PMMA spherical particles using microwave-assisted surfactant-free emulsion polymerization in a microwave reactor reconstructed from a Whirlpool T120 microwave oven, which could provide controlled temperature and power [100]. Microwave irradiation notably promoted the polymerization rate due to the acceleration of the initiator (potassium persulfate) decomposition by microwave irradiation, which was confirmed by a decrease in the activation energy of initiator decomposition from 128.3 kJ/mol for conventional heating to 106.0 kJ/mol for microwave heating. The average particle size of the prepared PMMA latex proved to be mainly controlled by the MMA concentration, which increased linearly from 103 to 215 nm when the MMA concentration increased from 0 to 0.3 mol/L and then remained almost constant at MMA concentrations of 0.3–1.0 mol/L. The potassium persulfate concentration had no effect on the average particle size, but the particle size dispersity was significantly reduced by a high potassium persulfate concentration. In addition, smaller PMMA nanoparticles with an average size of 45 and 67 nm could be obtained by using a mixed polymerization phase (water/acetone) and a redox initiation system, respectively.

An et al. reported the facile one-pot preparation of narrowly dispersed and crosslinked polymer nanoparticles with hydroxyl functional groups in the critical sub-50 nm range using microwave-assisted surfactant-free emulsion polymerization, which overcame several major challenges associated with the traditional surfactant-free emulsion polymerization [101]. This method could provide stable 20 nm nanoparticles with solids content up to 10%, which was in direct contrast to the >100 nm nanoparticles that could be prepared at only 5% solids content using traditional techniques (Fig. 9). In addition, the diameters of the nanoparticles could be readily adjusted by varying the solvent polarity (ratio of acetone to water), reaction temperature, and microwave power. In sharp contrast, polymer nanoparticles

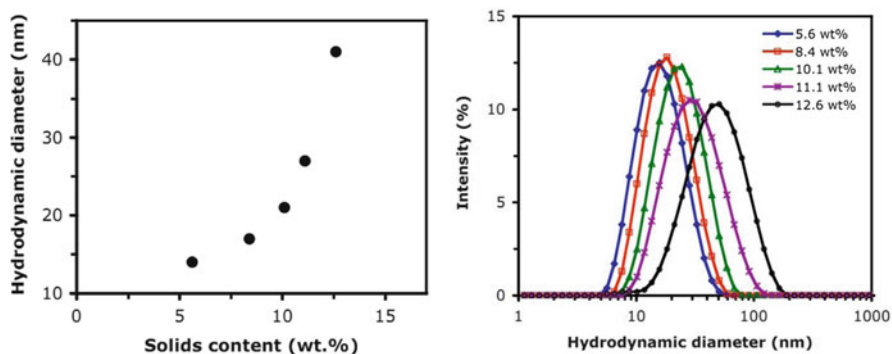

**Fig. 9** *Left:* Particle size as a function of solids content. *Right:* Dynamic light scattering results for size of nanoparticles prepared at different solids content in 40 wt% acetone/water under microwave power of  $50 \pm 3$  W at  $80^\circ\text{C}$  (*N,N'*-methylenebisacrylamide (MBA)/HEMA/MMA/potassium persulfate ratios were 1:1.6:30.7:1.6). Reprinted with permission from [101]. Copyright 2006 American Chemical Society

prepared under thermal heating conditions displayed no control for crosslinked nanoparticles, resulting in poorly defined systems.

As shown above, microwave-assisted surfactant-free emulsion polymerization can normally provide more uniform and smaller particles than surfactant-free emulsion polymerization with conventional heating. In this context, it is worth mentioning that a few microwave-assisted surfactant-free emulsion polymerizations provided polymer particles with similar sizes or slightly broader size distributions compared with the conventional heating system. Hu et al. synthesized rare earth-containing submicron-sized PMMA particles in water by microwave-assisted surfactant-free emulsion polymerization [102]. The polymerization rate under microwave irradiation was faster than that under conventional heating condition, whereas the final particle sizes obtained from these two methods were nearly the same. Meanwhile, surface enrichment of rare earth ions was found during the polymerization. He et al. investigated the surfactant-free emulsion polymerization of BMA in water at  $73 \pm 2^\circ\text{C}$  with potassium persulfate as the initiator under microwave irradiation [103]. The microwave-assisted polymerization was found to have a much higher reaction rate and produce smaller particles with a slightly broader size distribution compared with the polymerization under conventional heating conditions. The addition of ethanol into the polymerization system provided larger particles with a broad size distribution due to the improved compatibility of poly (BMA) (PBMA) with the reaction media.

Microwave-assisted core-shell emulsion polymerization was utilized for the rapid synthesis of temperature-sensitive PMMA-coated poly(NIPAAm) (PNIPAAm) particles by Zhao et al., which involved the first synthesis of PNIPAAm-*g*-PEO by surfactant-free emulsion polymerization with conventional heating and the subsequent preparation of PMMA-coated PNIPAAm using PNIPAAm-*g*-PEO as the seed emulsion under microwave irradiation [104]. In the second step, MMA

was added into an emulsion of PNIPAAm-*g*-PEO copolymer in several shots to keep the polymerization under the starvation condition and avoid the formation of PMMA particles by homogeneous nucleation. This, together with the very high rate of microwave-assisted polymerization of MMA, allowed MMA to polymerize and turn into PMMA very quickly, before its penetrating into PNIPAAm core, thus leading to the formation of PMMA coating on the PNIPAAm particles.

Wu et al. described the preparation of polymer-wrapped multiwalled carbon nanotubes (MWCNTs) via microwave-assisted in situ emulsion polymerization and studies on their optical limiting properties [105]. MWCNT/PS or PMMA composites were prepared by microwave-assisted emulsion polymerization with potassium persulfate as the initiator. In comparison with polymerization under conventional heating, microwave-assisted in situ emulsion polymerization showed obvious advantages in terms of the significant decrease in the reaction time and considerable improvement in yield under the same reaction conditions as that of conventional heating. The surface-modified MWCNTs could be dissolved in common organic solvents and exhibited much better optical limiting responses than pristine MWCNTs.

### 2.2.3 Dispersion Polymerization

Dispersion polymerization has been widely used for preparing uniform micron and submicron spherical particles. The process starts from a homogeneous mixture of monomer(s), solvent, initiator, and stabilizer, and becomes heterogeneous upon polymerization because the resulting polymers are insoluble in the solvent. The formed polymer particles are stabilized by the added steric stabilizers and dispersed homogeneously in the polymerization medium. The polymerization mainly occurs in the monomer-swollen droplet and a stable polymer latex is eventually produced.

Microwave-assisted dispersion polymerization has attracted much attention in recent years (entries 29–32 in Table 2) [106–109]. Albert et al. studied the thermal and microwave-assisted non-aqueous free radical dispersion polymerization of MMA with PS-*b*-poly(ethane-*alt*-propene) (SEP) as the dispersing agent, AIBN as the initiator, and *n*-heptane as the solvent [106]. A new microwave reactor was built to provide uniform heating and to control the reaction temperature. At identical MMA concentration and polymerization temperature (70°C), no special microwave effect on the monomer conversions, molecular weights, and particle sizes of PMMA was observed in comparison with conventional thermal free radical dispersion polymerization. Xu et al. reported the preparation of monodisperse PS microspheres with diameters of 200–500 nm via microwave-assisted dispersion polymerization with poly(*N*-vinylpyrrolidone) (PVP) as the stabilizer, AIBN as the radical initiator, and ethanol/water as the solvent [107]. Polymerization under microwave irradiation was found to take shorter time (1 h) to obtain stable dispersion than polymerization with conventional heating (24 h). In addition, the polymer microspheres prepared with microwave irradiation were more uniform and smaller than those prepared with conventional heating (Fig. 10), and the stability of the

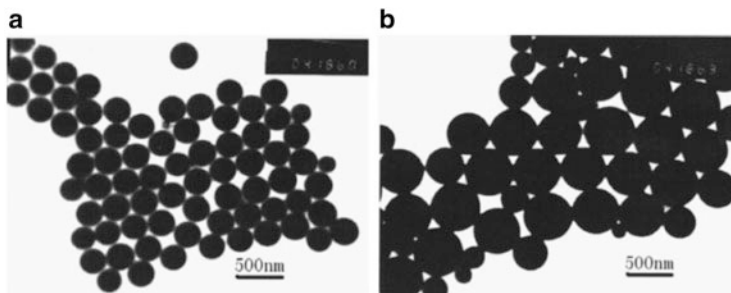

**Fig. 10** Transmission electron microscopy images of PS microspheres prepared by dispersion polymerization: (a) with microwave irradiation and (b) with conventional heating at 75°C. Reprinted with permission of Wiley Blackwell from [107]

polymer microspheres prepared with microwave irradiation was better than that of the microspheres prepared with conventional dispersion polymerization.

Karnati and Ford described the preparation of crosslinked copolymer microspheres by the copolymerization of 2-ethylhexyl methacrylate (EHMA), vinylbenzyl chloride, and divinylbenzene with nonafluorobutyl ethyl ether as the solvent via both microwave-assisted and conventional dispersion polymerizations. The subsequent modification of the copolymer particles by trimethylamine was also performed with both microwave heating and conventional heating to produce quaternary ammonium chloride-functionalized particles [108]. Microwave heating led to considerably faster polymerization and modification reactions in comparison with conventional heating; this was ascribed to the more rapid heating of the reaction mixtures in the former case. In addition, microwave heating provided stable dispersions of discrete polymer particles during both dispersion polymerization and modification processes, whereas only coagulated polymer particles were obtained during the above two processes under conventional heating conditions. Very recently, one-pot template-free synthesis of uniform monoporous PS microspheres via microwave-mediated dispersion polymerization was reported by Zhu et al. [109]. The morphologies and sizes of the polymer microspheres and the pores in their surfaces could be tuned by adjusting the polymerization parameters. Microwave irradiation was considered to play an indispensable role by accelerating the consumption of St, which resulted in the formation of such kinetically controlled monoporous polymer microspheres. In contrast, conventional polymerization favored the formation of thermodynamically controlled solid polymer microspheres.

## 2.2.4 Precipitation Polymerization

Precipitation polymerization is a highly versatile approach for the preparation of uniform micron or submicron polymer beads. It has received particular attention because of its easy operation and lack of need for any surfactant or stabilizer, which is the main difference between precipitation polymerization and dispersion

polymerization. The process starts from a homogeneous mixture of monomer(s), initiator, and optional solvents. During the polymerization, the growing polymer chains phase-separate from the continuous medium either by enthalpic precipitation or entropic precipitation (in cases where crosslinking prevents the polymer and solvent from freely mixing).

Microwave irradiation has also been applied in precipitation polymerization by some researchers (entries 33 and 34 in Table 2) [110, 111]. Erdmenger et al. investigated the microwave-assisted high temperature autoprecipitation polymerization of St in order to develop a fast and environmentally friendly approach for the production of PS [110]. The reaction systems containing different water/St or ethanol/St ratios were heated far beyond their boiling points at relatively high pressures under microwave irradiation. The molecular weights of the resulting PS could be adjusted by changing the ethanol-to-St ratio in cases where ethanol was used as the solvent, although the monomer conversions were rather low under the applied conditions. Moreover, the effect of a commercially available stable free nitroxide on the control of polymerization was also studied. The most attractive advantage of this polymerization process was the simple and straightforward purification steps required due to the precipitation of PS from the reaction solvent. Yuan et al. reported the preparation of molecularly imprinted polymer (MIP) microspheres for selective enrichment of podophyllotoxin (PPT) from traditional Chinese medicines via both microwave heating- and conventional heating-initiated precipitation polymerizations [111]. The microwave-assisted precipitation polymerization showed the obvious advantages of reducing the preparation time, increasing the imprinting efficiency, and improving the particle morphology of the MIPs compared with the precipitation polymerization under conventional heating. In addition, the obtained MIPs were successfully applied to the selective enrichment of PPT from three herb samples with satisfactory recovery.

### 2.2.5 Other Heterogeneous Polymerizations

In addition to the above typical microwave-assisted heterogeneous polymerizations, some other kinds of heterogeneous polymerizations have also been performed under microwave irradiation for the preparation of advanced functional polymers such as polymer hydrogels [112, 113], synthetic polymer-modified natural polymers [114–124], and other organic–inorganic hybrid materials [125–129] (entries 35–52 in Table 2).

Temperature-sensitive PNIPAAm hydrogels were prepared via microwave-assisted copolymerizations of NIPAAm and *N,N'*-methylenebisacrylamide (MBA) [112, 113]. Shi and Liu described the microwave-assisted preparation of a series of temperature-sensitive PNIPAAm hydrogels by the copolymerization of NIPAAm and MBA with poly(ethylene oxide-600) (PEO-600) as the reaction solvent, microwave-absorbing agent, and pore-forming agent [112]. PNIPAAm hydrogels were obtained in a yield of 98% within 1 min in a domestic microwave oven. The properties of the hydrogel (such as pore size, equilibrium swelling

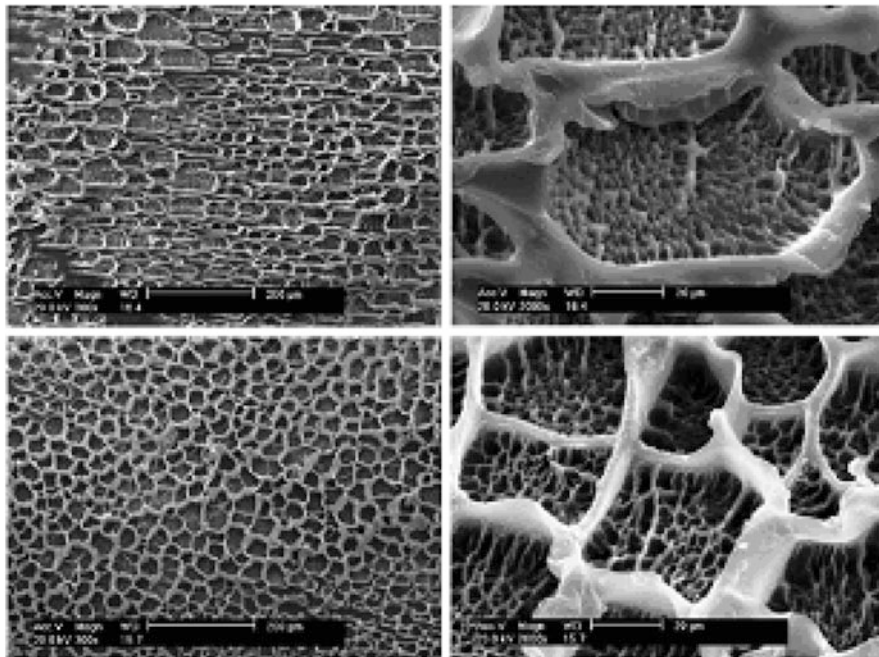

**Fig. 11** Scanning electron microscopy images of PNIPAAm hydrogels prepared by a conventional thermal method (*top*) and microwave-assisted heating (*bottom*) with PEO-600 as the pore-forming agent (magnification is 300 $\times$  for the *left images* and 2,000 $\times$  for the *right images*). Reprinted with permission of Elsevier from [113]

ratio, and swelling/deswelling rates) could be controlled to meet the different requirements for their potential applications by easily changing the feed weight ratios of monomer NIPAAm to PEO-600. Shortly after, Zhao et al. also prepared temperature-sensitive PNIPAAm hydrogels by the copolymerization of NIPAAm and MBA in acetone in a multimode microwave reactor [113]. The use of microwave irradiation greatly reduced the reaction time from several hours (required for synthesizing PNIPAAm hydrogels with conventional water-bath heating) to several minutes and obviously improved the yields of the PNIPAAm hydrogels up to 99%. In addition, the authors found that the hydrogels obtained under microwave irradiation had more porous structure and that their average pore sizes and specific surface areas were larger than those of the hydrogels obtained by using conventional water-bath heating methods (Fig. 11).

Microwave-assisted heterogeneous grafting polymerization was utilized to modify natural polymers with synthetic polymers [114–122]. The first such investigation was carried out by Xu et al., where poly(HEMA) (PHEMA) was grafted onto woolen fabrics in aqueous solution with ammonium persulfate as the catalyst under microwave irradiation [114]. Some grafting polymerization parameters were optimized, such as the reaction time, microwave intensity, and catalyst and monomer

concentrations. Microwave irradiation improved the grafted amounts of the polymer compared with conventional heating under the same reaction conditions, which was attributed to the microwave energy-absorbing ability of the monomer and catalyst as well as the more uniform temperature distribution and more rapidly increased temperature under microwave irradiation. In addition, the authors also suggested that some non-heating effect might be present for the grafting copolymerization by microwave.

Singh et al. reported the successful grafting of poly(AN) (i.e., PAN) and PAM onto guar gum in water with both conventional and microwave heating [115, 116]. The polymers could be efficiently grafted onto guar gum without using any initiator or catalyst in a very short reaction time (<2 min) under microwave irradiation, whereas a polymerization time of 80–90 min was required with conventional heating in the presence of the initiating system and no grafting was achieved in the absence of the initiating system with conventional heating. The authors also reported the grafting of PAN, PAM, and PMMA onto chitosan using both microwave and conventional heating methods [117–119]. Similar to the above works, the efficient grafting of polymers could be achieved in a very short time in the absence of any radical initiator or catalyst when applying microwave irradiation. Later on, Singh and Tripathi reported the grafting of PAN onto *Cassia siamea* seed gum under microwave irradiation without adding any radical initiator or catalyst [120].

Prasad et al. also used microwave irradiation as a heating source for the grafting of PMMA onto  $\kappa$ -carrageenan in the presence of a water-soluble initiator potassium persulfate in the aqueous medium [121]. The microwave irradiation conditions for obtaining maximum yields were optimized and successful grafting could be achieved in 2 min. Optical micrographs of the copolymer were studied to confirm the successful grafting. It is worth mentioning that the microwave-assisted grafting procedure could efficiently prevent thermal degradation of  $\kappa$ -carrageenan because of a good control over the copolymerization conditions. In a recent study, Vijan et al. performed the grafting of PAM onto gellan gum by microwave irradiation using ceric ammonium nitrate as the redox initiator (Fig. 12) [122]. The acute oral toxicity study of grafted gum was evaluated and tablets were prepared by incorporating the antidiabetic drug metformin hydrochloride into the grafted gum along with some excipients. The prepared tablet formulations showed release up to 8 h through in vitro studies.

Superabsorbents were also fabricated by microwave-assisted heterogeneous grafting polymerizations. Zheng et al. reported the grafting polymerization of sodium acrylate onto cornstarch with PEG diacrylate as the crosslinker in the presence of the initiator potassium persulfate under microwave irradiation [123]. Microwave irradiation was found to substantially accelerate the polymerization processes without the need to remove inhibitor or oxygen. Under the optimized experimental condition, microwave-assisted polymerization could produce a cornstarch-based superabsorbent with a swelling ratio of 520–620 g/g in distilled water and a solubility of 8.5–9.5 wt%. Another superabsorbent was prepared by Xu et al. by grafting copolymerization of sodium acrylate and 2-acrylamido-2-methylpropano-sulfonic acid (AMPS) onto starch [124]. The optimal mass fraction of the three



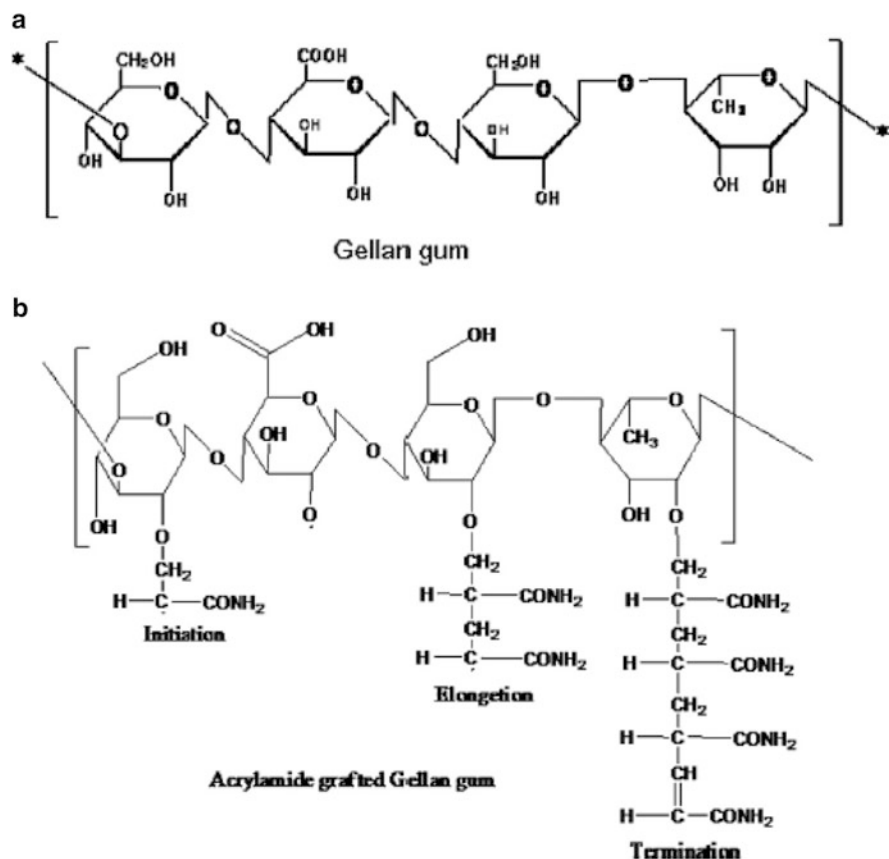

**Fig. 12** Structure of gellan gum (a) and PAM-grafted gellan gum (b). Reprinted with permission of Elsevier from [122]

components was determined (starch/acrylic acid/AMPS = 2:5:3) by studying the effect of AMPS on the performance of the copolymer. The swelling rate of the copolymer obtained under microwave irradiation proved to be faster than that of the copolymer prepared by using conventional heating. The maximum absorbing capacities of the resulting product in distilled water and a 0.9% sodium chloride solution were 450 and 53 g/g, respectively. Moreover, scanning electron microscopy (SEM) characterization of the surface morphology of the product obtained under microwave irradiation showed that they had many evenly distributed pores, whereas the corresponding product obtained with conventional heating contained limited and irregular pores, which was ascribed to the different drying modes of water on the surface and inside the products. The microwave heating caused quick evaporation of water, leading to pores in the product because of the resulting steam bubbles, whereas the temperature of the reaction was too low to create bubbles by the traditional method, thus resulting in fewer pores in the product obtained by conventional heating.

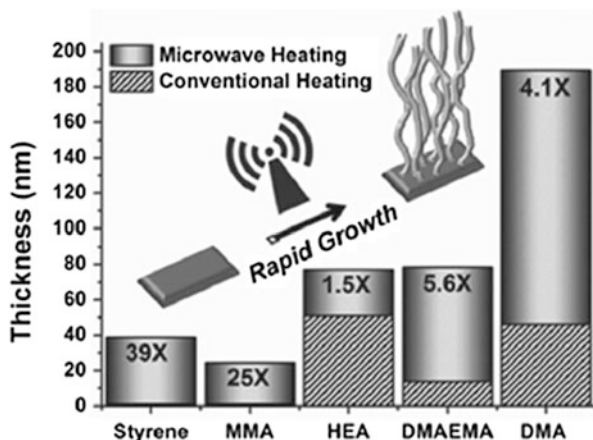

**Fig. 13** Comparison of brush thickness synthesized by microwave-assisted surface-initiated radical polymerization (SIP) and conventional SIP for different monomer types at the same effective solution temperature, reaction time, and concentration. Reprinted with permission of Wiley-VCH from [127]

Surface functionalization of carbon nanotubes (CNTs), graphene sheets (GS), and silicon or glass substrates was realized by using microwave-assisted heterogeneous grafting polymerization [125–127]. Hsin et al. successfully functionalized iron-filled multiwalled CNTs (Fe@MWCNTs) with various polymers in a rapid single-step process involving ultrasonication-assisted and microwave-induced radical polymerizations [125]. Both hydrophobic (PS and PMMA) and hydrophilic (PAM, polyacrylic acid, and polyallyl alcohol) polymer chains could be chemically grafted onto the surfaces of MWCNTs by the same process within ~10 min. This facile process is generally applicable for the functionalization of CNTs because the aggregation problem of CNTs encountered in most traditional functionalization processes can be overcome. Recently, Long et al. developed a facile and highly efficient approach for the synthesis of water-soluble graphene from graphene oxide involving pre-reduction, grafting, and post-reduction steps [126]. PAM chains were rapidly grafted onto the GS via free radical polymerization under sequential microwave irradiation, leading to substantially increased thickness of the sheets and improved water solubility of the GS. Guo et al. demonstrated the rapid synthesis of polymer brush surfaces on two-dimensional silicon or glass substrates via microwave-assisted surface-initiated radical polymerization (MW-SIP) [127]. MW-SIP enabled significant enhancements (up to 39-fold increase) in brush thickness at reduced reaction times compared with conventional thermal heating for a range of monomer types (i.e. AM, acrylates, methacrylates, and St) (Fig. 13). This “grafting from” strategy is expected to be applicable for a wide range of substrates, including membranes and nanoparticles.

Microwave-assisted simultaneous free radical polymerization and sol-gel condensation was reported for the preparation of organic/inorganic hybrid materials. Kajiwara et al. prepared polymer/silica hybrids with high luminescence by a facile and fast one-pot process through the combined use of sol-gel condensation and free radical copolymerization [128]. The sol-gel reaction of methyltrimethoxysilane (MeTMOS) was performed simultaneously with radical copolymerization of HEMA and methacrylate-tethering boron dipyrromethene (BODIPY) dye under microwave irradiation or conventional heating conditions. Transparent and homogeneous luminescent hybrids with high emission properties were obtained in a shorter time under microwave irradiation compared with conventional heating. When the molar ratio of BODIPY dye to HEMA was high, crystallization occurred in the hybrid obtained under conventional heating. However, a homogeneous polymer hybrid was obtained under microwave irradiation even at high concentrations of BODIPY dye, mainly because of the rapid occurrence of the polymerization of HEMA with the dye monomer and the sol-gel reaction under microwave irradiation before the crystallization of BODIPY dye. Liu and Su prepared a series of PS/silica nanocomposites with different contents of inorganic nanofillers by the in situ bulk free radical copolymerization of St with a macromonomer (i.e., methacryloxypropyl silica nanoparticles) under microwave irradiation [129]. The effects of the microwave power and initiator concentration on the St conversion and grafting efficiency were investigated. Compared with the previously reported methods, microwave-assisted polymerization was the fastest procedure and led to a relatively high grafting efficiency.

### 3 Conclusions and Outlook

This chapter presents a detailed summary of the research activity in the field of microwave-assisted conventional free radical polymerizations. The advantages of microwave irradiation such as non-contact heating, energy transfer instead of heat transfer, material-selective heating, rapid start-up and stopping of the heating, and reverse thermal effects (heating starts from the interior of the material body) make microwave irradiation a more efficient energy source than conventional heating. So far, very marked progress has been achieved in this field and many different microwave-assisted conventional free radical polymerizations have been realized for a wide range of monomers, including both homogeneous polymerizations (i.e., bulk polymerization and solution polymerization) and heterogeneous polymerizations (including suspension polymerization, emulsion polymerization, dispersion polymerization, precipitation polymerization, and some other heterogeneous polymerizations). In most cases, the polymerization rates were accelerated and the polymer yields were enhanced with the aid of microwave heating. In addition, many advanced functional polymer materials with improved properties were also efficiently prepared under microwave irradiation.

Despite tremendous progress made in this rapidly growing field, some issues still remain to be addressed. One such issue is the controversy on the effect of microwave irradiation as the acceleration source for polymerizations. Much of the debate has focused on whether the observed acceleration of the polymerization rates can be attributed to the thermal microwave effects arising from the rapid heating and high reaction temperatures attained with microwave dielectric heating or the so-called specific or nonthermal microwave effects. Although many recent carefully designed experiments have demonstrated that the effects reported for most microwave-irradiated polymerizations can be ascribed to the thermal microwave effects [35, 64, 65], the nonthermal and specific microwave effects are still being reported in the literature. More experiments are thus needed to definitely classify this issue. Another issue is how to scale up the microwave-assisted free radical polymerizations in order to make them suitable for industrial use. So far, microwave-assisted free radical polymerizations have been mainly performed at the small laboratory scale. However, some recent progress in the large-scale microwave-assisted polycondensation of lactic acid in batch mode has definitely confirmed the feasibility for scale-up of microwave-assisted polymerizations [131]. In addition, a continuous flow process might be a useful solution to this issue [132].

Based on the above overview, it can be concluded that the introduction of microwave heating into free radical polymerizations has definitely opened up a new field for the fast and efficient synthesis of various polymer materials under “green” conditions. The considerable advantages of microwave heating and the versatile characteristics of free radical polymerizations make microwave-assisted free radical polymerization a powerful synthetic tool for the polymer chemist. With the advent of many well-controlled and modestly priced commercial microwave synthesizers specially designed for polymerization purposes and the fast developments in this research field, we believe that microwave-assisted free radical polymerizations will definitely find broad application in addressing many of the challenges currently remaining in various research areas and may eventually become a popular tool for many polymer chemists and materials scientists, facilitating the effective design of their favorite products in the laboratory.

## References

1. Sakomoto I, Suzuki M, Kashiwagi M (1987) Current status and future electron beam systems in Japan. IAEA/UNDP/RCA Seminar on Radiation Engineering, JAERI, Takasaki, October 1987
2. Nablo SV (1985) The status of the industrial use of self-shielded electron processors. *J Ind Irradiat Tech* 3:41
3. Mingos DMP, Baghurst DR (1991) Applications of microwave dielectric heating effects to synthetic problems in chemistry. *Chem Soc Rev* 20:1
4. Gabriel C, Gabriel S, Grant EH, Halstead BSJ, Mingos DMP (1998) Dielectric parameters relevant to microwave dielectric heating. *Chem Soc Rev* 27:213
5. Hayes BL (2004) Recent advances in microwave-assisted synthesis. *Aldrichim Acta* 37:66

6. Stuerge D, Gonon K, Lallemand M (1993) Microwave heating as a new way to induce selectivity between competitive reactions. application to isometric ratio control in sulfonation of naphthalene. *Tetrahedron* 49:6229
7. Hoz ADL, Ortiz AD, Moreno A (2005) Microwave in organic synthesis. Thermal and non-thermal microwave effects. *Chem Soc Rev* 34:164
8. Hoz ADL, Ortiz AD, Moreno A (2004) Selectivity in organic synthesis under microwave irradiation. *Curr Org Chem* 8:903
9. Gedye R, Smith F, Westaway K, Ali H, Baldiseria L, Laberge L, Rousell J (1986) The use of microwave ovens for rapid organic synthesis. *Tetrahedron Lett* 27:279
10. Giguere RJ, Bray TL, Duncan SM, Majetich G (1986) Application of commercial microwave ovens to organic synthesis. *Tetrahedron Lett* 27:4945
11. Kappe CO (2004) Controlled microwave heating in modern organic synthesis. *Angew Chem Int Ed* 43:6250
12. Kappe CO, Stadler A (2005) *Microwaves in organic and medicinal chemistry*. Wiley-VCH, Weinheim
13. Kappe CO, Dallinger D, Murphree SS (2009) *Practical microwave synthesis for organic chemists – strategies, instruments, and protocols*. Wiley-VCH, Weinheim
14. Tierney JP, Lidstrom P (2004) *Microwave assisted organic chemistry*. Taylor & Francis, Abingdon
15. Hayes BL (2002) *Microwave synthesis: chemistry at the speed of light*. CEM, Matthews
16. Kempe K, Becer CR, Schubert US (2011) Microwave-assisted polymerizations: recent status and future perspectives. *Macromolecules* 44:5825
17. Barlow S, Marder SR (2003) Single-mode microwave synthesis in organic materials chemistry. *Adv Funct Mater* 13:517
18. Adam D (2003) Microwave chemistry: out of the kitchen. *Nature* 421:571
19. Bogdal D, Penczek P, Pielichowski J, Prociak A (2003) Microwave assisted synthesis, crosslinking, and processing of polymeric materials. *Adv Polym Sci* 163:193
20. Wiesbrock F, Hoogenboom R, Schubert US (2004) Microwave-assisted polymer synthesis: state-of-the-art and future perspectives. *Macromol Rapid Commun* 25:1739
21. Hoogenboom R, Schubert US (2007) Microwave-assisted polymer synthesis: recent developments in a rapidly expanding field of research. *Macromol Rapid Commun* 28:368
22. Sinnwell S, Ritter H (2007) Recent advances in microwave-assisted polymer synthesis. *Aust J Chem* 60:729
23. Ebner C, Bodner T, Stelzer F, Wiesbrock F (2011) One decade of microwave-assisted polymerizations: quo vadis? *Macromol Rapid Commun* 32:254
24. Mallon FK, Ray WH (1998) Enhancement of solid-state polymerization with microwave energy. *J Appl Polym Sci* 69:1203
25. Lu J, Ji S, Chen N, Sun Z, Zhu X, Shi W, Wang Z (2003) Third-order nonlinear optical properties of polyureas and polyimide synthesized by microwave irradiation. *J Appl Polym Sci* 89:2611
26. Alimi K, Molinie P, Majdoub M, Bernede JC, Fave JL, Bouchriha H, Ghedira M (2001) Synthesis and characterization of copolymer derived from poly-phenylene-vinylene potentially luminescent copolymers. *Eur Polym J* 37:781
27. Vogel BM, Mallapragada SK, Narasimhan B (2004) Rapid synthesis of polyanhydrides by microwave polymerization. *Macromol Rapid Commun* 25:330
28. Nagahata R, Sano D, Suzuki H, Takeuchi K (2007) Microwave-assisted single-step synthesis of poly(lactic acid) by direct polycondensation of lactic acid. *Macromol Rapid Commun* 28:437
29. Albert P, Warth H, Mülhaupt R, Janda R (1996) Comparison of thermal and microwave-activated polymerization of  $\epsilon$ -caprolactone with titanium tetrabutylate as catalyst. *Macromol Chem Phys* 197:1633

30. Wiesbrock F, Hoogenboom R, Leenen MAM, Meier MAR, Schubert US (2005) Investigation of the living cationic ring-opening polymerization of 2-methyl, 2-ethyl, 2-nonyl, and 2-phenyl-2-oxazoline in a single-mode microwave reactor. *Macromolecules* 38:5025
31. Mallakpour S, Rafiee Z (2008) Application of microwave-assisted reactions in step-growth polymerization: a review. *Iran Polym J* 17:907
32. Sosnik A, Gotelli G, Abraham GA (2011) Microwave-assisted polymer synthesis (MAPS) as a tool in biomaterials science: how new and how powerful. *Prog Polym Sci* 36:1050
33. Zhang C, Liao L, Gong S (2007) Recent developments in microwave-assisted polymerization with a focus on ring-opening polymerization. *Green Chem* 9:303
34. Bardts M, Gonsior N, Ritter H (2008) Polymer synthesis and modification by use of microwaves. *Macromol Chem Phys* 209:25
35. Zhang H, Schubert US (2004) Monomode microwave-assisted atom transfer radical polymerization. *Macromol Rapid Commun* 25:1225
36. Hou C, Guo Z, Liu J, Ying L, Geng D (2007) Atom transfer radical polymerization of acrylonitrile under microwave irradiation. *J Appl Polym Sci* 104:1382
37. Xu Z, Hu X, Li X, Yi C (2008) Monodispersed PEG-*b*-PSt nanoparticles prepared by atom transfer radical emulsion polymerization under microwave irradiation. *J Polym Sci A Polym Chem* 46:481
38. Li J, Zhu X, Zhu J, Cheng Z (2006) Microwave-assisted nitroxide-mediated radical polymerization of styrene. *Radiat Phys Chem* 75:253
39. Leenen M, Wiesbrock F, Hoogenboom R, Schubert US (2005) Microwave-assisted nitroxide-mediated polymerization of alkylacrylates. *e-Polymers* 5:741
40. Hernandez-Meza JJ, Jaramillo-Soto G, Garcia-Moran PR, Palacios-Alquisira J, Vivaldo-Lima E (2009) Modeling of polymerization kinetics and molecular weight development in the microwave-activated nitroxide-mediated radical polymerization of styrene. *Macromol React Eng* 3:101
41. Brown SL, Rayner CM, Graham S, Cooper A, Rannard S, Perrier S (2007) Ultra-fast microwave enhanced reversible addition-fragmentation chain transfer (RAFT) polymerization: monomers to polymers in minutes. *Chem Commun* 2007:2145
42. Roy D, Ullah A, Sumerlin BS (2009) Rapid block copolymer synthesis by microwave-assisted RAFT polymerization. *Macromolecules* 42:7701
43. An Z, Shi Q, Tang W, Tsung CK, Hawker CJ, Stucky GD (2007) Facile RAFT precipitation polymerization for the microwave-assisted synthesis of well-defined double hydrophilic block copolymers and nanostructured hydrogels. *J Am Chem Soc* 129:14493
44. Gourdenne A, Maassarant AH, Monchaux P (1979) Cross-linking of thermosetting resins by microwave heating: quantitative approach. *Polymer Prepr* 20:471
45. Teffal M, Gourdenne A (1983) Activation of radical polymerization by microwaves – I. Polymerization of 2-hydroxyethyl methacrylate. *Eur Polym J* 19:543
46. Jacob J, Chia LHL, Boey FYC (1995) Comparative study of methyl methacrylate cure by microwave radiation versus thermal energy. *Polym Test* 14:343
47. Chia LHL, Jacob J, Boey FYC (1996) The microwave radiation effect on the polymerization of styrene. *J Polym Sci A Polym Chem* 34:2087
48. Jacob J, Chia LHL, Boey FYC (1997) Microwave polymerization of poly(methyl acrylate): conversion studies at variable power. *J Appl Polym Sci* 63:787
49. Porto AF, Sadicoff BL, Amorim MCV, Mattos MCS (2002) Microwave-assisted free radical bulk-polyaddition reactions in a domestic microwave oven. *Polym Test* 21:145
50. Lu J, Ji S, Wu J, Guo F, Zhou H, Zhu X (2004) Study of microwave irradiation polymerization mechanism in the presence of carriers. *J Appl Polym Sci* 91:1519
51. Fischer F, Tabib R, Freitag R (2005) Chain transfer polymerization of poly-N-alkylacrylamides in superheated methanol and by microwave induction. *Eur Polym J* 41:403
52. Cortizo MS (2007) Polymerization of diisopropyl fumarate under microwave irradiation. *J Appl Polym Sci* 103:3785

53. Cortizo MS, Laurella S, Alessandrini JL (2007) Microwave-assisted radical polymerization of dialkyl fumarates. *Radiat Phys Chem* 76:1140
54. Naguib HF, Saad GR, Elsabeé MZ (2003) Copolymerization of bromophenylmaleimide with ethyl or butyl methacrylate. *Polym Int* 52:1217
55. Lu J, Zhu X, Zhu J, Yu J (1997) Microwave radiation solid-state copolymerization in binary maleic anhydride-dibenzyl maleate systems. *J Appl Polym Sci* 66:129
56. Lu J, Zhu X, Ji S, Zhu J, Chen Z (1998) Microwave radiation copolymerization in solid state of maleic anhydride and allylthiourea. *J Appl Polym Sci* 68:1563
57. Lu J, Jiang Q, Zhu X, Wang F (2001) Microwave radiation copolymerization of dibutyltin maleate and allyl thiourea. *J Appl Polym Sci* 79:312
58. Lu J, Wu J, Wang L, Yao S (2005) The synthesis of copolymer-Cu coordinates and its catalysis to methyl methacrylate. *J Appl Polym Sci* 97:2072
59. Goretzki C, Krlej A, Steffens C, Ritter H (2004) Green polymer chemistry: microwave-assisted single-step synthesis of various (meth)acrylamides and poly(meth)acrylamides directly from (meth)acrylic acid and amines. *Macromol Rapid Commun* 25:513
60. Iannelli M, Ritter H (2005) Microwave-assisted direct synthesis and polymerization of chiral acrylamide. *Macromol Chem Phys* 206:349
61. Iannelli M, Alupei V, Ritter H (2005) Selective microwave-accelerated synthesis and polymerization of chiral methacrylamide directly from methacrylic acid and (*R*)-1-phenyl-ethylamine. *Tetrahedron* 61:1509
62. Bezdushna E, Ritter H (2005) Microwave accelerated synthesis of *N*-phenylmaleimide in a single step and polymerization in bulk. *Macromol Rapid Commun* 26:1087
63. Lee SH, Lee WG, Chung BG, Park JH, Khademhosseini A (2009) Rapid formation of acrylated microstructures by microwave-induced thermal crosslinking. *Macromol Rapid Commun* 30:1382
64. Kwak Y, Mathers RT, Matyjaszewski K (2012) Critical evaluation of the microwave effect on radical (co)polymerizations. *Macromol Rapid Commun* 33:80
65. Sugihara Y, Semsarilar M, Perrier S, Zetterlund PB (2012) Assessment of the influence of microwave irradiation on conventional and RAFT radical polymerization of styrene. *Polym Chem* 3:2801
66. Madras G, Karmore V (2001) Evolution to similarity solutions for polymerization and depolymerization with microwave radiation. *Polym Int* 50:1324
67. Singh V, Tiwari A, Kumari P, Sharma AK (2007) Microwave accelerated synthesis and characterization of poly(acrylamide). *J Appl Polym Sci* 104:3702
68. Stange H, Ishaque M, Niessner N, Pepers M, Greiner A (2006) Microwave-assisted free radical polymerizations and copolymerizations of styrene and methyl methacrylate. *Macromol Rapid Commun* 27:156
69. Stange H, Greiner A (2007) Microwave-assisted free radical copolymerizations of styrene and methyl methacrylate. *Macromol Rapid Commun* 28:504
70. Agarwal S, Becker M, Tewes F (2005) Synthesis, characterization and properties evaluation of copolymers of 2,3,4,5,6-pentafluorostyrene and *N*-phenylmaleimide. *Polym Int* 54:1620
71. Buruiana EC, Zamfir M, Melinte V, Buruiana T (2010) Photo-polymers containing (*S*)-phenylalanine and stilbene pendants: synthesis and properties of ionic polyacrylates. *Des Monom Polym* 13:21
72. Guerrero-Sanchez C, Lobert M, Hoogenboom R, Schubert US (2007) Microwave-assisted homogeneous polymerizations in water-soluble ionic liquids: an alternative and green approach for polymer synthesis. *Macromol Rapid Commun* 28:456
73. Glück T, Woecht I, Schmalfuß A, Schmidt-Naake G (2009) Modification of the solvent influence on the free radical polymerization in ionic liquids by microwave irradiation. *Macromol Symp* 275–276:230
74. Shih YH, Singco B, Liu WL, Hsu CH, Huang HY (2011) A rapid synthetic method for organic polymer-based monoliths in a room temperature ionic liquid medium via microwave-assisted vinylization and polymerization. *Green Chem* 13:296

75. Zhu J, Zhu Y (2006) Microwave-assisted one-step synthesis of polyacrylamide-metal (M = Ag, Pt, Cu) nanocomposites in ethylene glycol. *J Phys Chem B* 110:8593
76. Dallinger D, Kappe CO (2007) Microwave-assisted synthesis in water as solvent. *Chem Rev* 107:2563
77. Mallakpour S, Rafiee Z (2011) New developments in polymer science and technology using combination of ionic liquids and microwave irradiation. *Prog Polym Sci* 36:1754
78. Liu Z, Lu Y, Yang B, Luo G (2013) Free radical polymerization of butyl acrylate in monodispersed droplets: comparison between two heating strategies. *J Appl Polym Sci* 127:628
79. Zhang Y, Liu R, Hu Y, Li G (2009) Microwave heating in preparation of magnetic molecularly imprinted polymer beads for trace triazines analysis in complicated samples. *Anal Chem* 81:967
80. Zhang Z, Zhang Y, Tan W, Li G, Hu Y (2010) Preparation of styrene-co-4-vinylpyridine magnetic polymer beads by microwave irradiation for analysis of trace 24-epibrassinolide in plant samples using high performance liquid chromatography. *J Chromatogr A* 1217:6455
81. Hu Y, Li Y, Liu R, Tan W, Li G (2011) Magnetic molecularly imprinted polymer beads prepared by microwave heating for selective enrichment of  $\beta$ -agonists in pork and pig liver samples. *Talanta* 84:462
82. Wang X, Mao H, Huang W, Guan W, Zou X, Pan J, Yan Y (2011) Preparation of magnetic imprinted polymer particles via microwave heating initiated polymerization for selective enrichment of 2-amino-4-nitrophenol from aqueous solution. *Chem Eng J* 178:85
83. Wu C, Gao J, Li M, Zhang W, Jiang M (2000) Formation, stabilization & application of polymeric nanoparticles. *Macromol Symp* 150:219
84. Correa R, Gonzalez G, Dougar V (1998) Emulsion polymerization in a microwave reactor. *Polymer* 39:1471
85. Jung HM, Yoo Y, Kim YS, Lee JH (2007) Microwave-irradiated copolymerization of styrene and butyl acrylate. *Macromol Symp* 249–250:521
86. Costa C, Santos AF, Fortuny M, Araújo PHH, Sayer C (2009) Kinetic advantages of using microwaves in the emulsion polymerization of MMA. *Mater Sci Eng C* 29:415
87. Zhu X, Chen J, Zhou N, Cheng Z, Lu J (2003) Emulsion polymerization of methyl methacrylate under pulsed microwave irradiation. *Eur Polym J* 39:1187
88. Zhu X, Chen J, Cheng Z, Lu J, Zhu J (2003) Emulsion polymerization of styrene under pulsed microwave irradiation. *J Appl Polym Sci* 89:28
89. Holtze C, Antonietti M, Tauer K (2006) Ultrafast conversion and molecular weight control through temperature programming in microwave-induced miniemulsion polymerization. *Macromolecules* 39:5720
90. Holtze C, Tauer K (2007) Surviving radicals: promises of a microwave effect on miniemulsion polymerization for technical processes. *Macromol Rapid Commun* 28:428
91. Xiong S, Guo X, Li L, Wu S, Chu P, Xu Z (2010) Preparation and characterization of fluorinated acrylate copolymer latexes by miniemulsion polymerization under microwave irradiation. *J Fluorine Chem* 131:417
92. Gao J, Wu C (2005) Modified structural model for predicting particle size in the microemulsion and emulsion polymerization of styrene under microwave irradiation. *Langmuir* 21:782
93. Costa C, Santos VHS, Araújo PHH, Sayer C, Santos AF, Dariva C, Fortuny M (2010) Rapid decomposition of a cationic azo-initiator under microwave irradiation. *J Appl Polym Sci* 118:1421
94. Zhang W, Gao J, Wu C (1997) Microwave preparation of narrowly distributed surfactant-free stable polystyrene nanospheres. *Macromolecules* 30:6388
95. Ngai T, Wu C (2005) Double roles of stabilization and destabilization of initiator potassium persulfate in surfactant-free emulsion polymerization of styrene under microwave irradiation. *Langmuir* 21:8520



96. You L, Wu H, Zhang W, Fu Z, Shen L (2001) Preparation and stabilization of emulsifier-free macromolecule nanoparticle latex particles. *Chin J Chem* 19:814
97. Biswal T, Samal R, Sahoo PK (2010) Co(III) complex mediated microwave-assisted synthesis of PAN. *J Appl Polym Sci* 117:1837
98. Yi C, Deng Z, Xu Z (2005) Monodisperse thermosensitive particles prepared by emulsifier-free emulsion polymerization with microwave irradiation. *Colloid Polym Sci* 283:1259
99. Deng Z, Hu X, Li L, Xu Z, Yi C (2006) Self-assembled poly(styrene-co-*N*-isopropylacrylamide) film induced by capillary force. *J Appl Polym Sci* 99:3514
100. Bao J, Zhang A (2004) Poly(methyl methacrylate) nanoparticles prepared through microwave emulsion polymerization. *J Appl Polym Sci* 93:2815
101. An Z, Tang W, Hawker CJ, Stucky GD (2006) One-step microwave preparation of well-defined and functionalized polymeric nanoparticles. *J Am Chem Soc* 128:15054
102. Hu J, Zhao H, Zhang Q, He W (2003) Synthesis and characterization of submicron PMMA particles containing rare earth ions on the surface. *J Appl Polym Sci* 89:1124
103. He W, Pan C, Lu T (2001) Soapless emulsion polymerization of butyl methacrylate through microwave heating. *J Appl Polym Sci* 80:2455
104. Zhao H, Chen H, Li Z, Su W, Zhang Q (2006) The synthesis of temperature-sensitive PMMA-coating PNIPAM particles via a rapid microwave-assisted polymerization. *Eur Polym J* 42:2192
105. Wu H, Qiu X, Cao W, Lin Y, Cai R, Qian S (2007) Polymer-wrapped multiwalled carbon nanotubes synthesized via microwave-assisted in situ emulsion polymerization and their optical limiting properties. *Carbon* 45:2866
106. Albert P, Hö lderle M, Mülhaupt R, Janda R (1996) Thermal and microwave-activated non-aqueous free-radical dispersion polymerization of methyl methacrylate in *n*-heptane. *Acta Polym* 47:74
107. Xu Z, Deng Z, Hu X, Li L, Yi C (2005) Monodisperse polystyrene microspheres prepared by dispersion polymerization with microwave irradiation. *J Polym Sci A Polym Chem* 43:2368
108. Karnati R, Ford WT (2008) Dispersion copolymerization of 2-ethylhexyl methacrylate and vinylbenzyl chloride and functional group conversions in a fluorinated solvent using microwave heating. *J Polym Sci A Polym Chem* 46:3813
109. Zhu M, Chen G, Li Y, Fan J, Zhu M, Tang Z (2011) One-step template-free synthesis of monoporous polymer microspheres with uniform sizes via microwave-mediated dispersion polymerization. *Nanoscale* 3:4608
110. Erdmenger T, Becer CR, Hoogenboom R, Schubert US (2009) Simplifying the free-radical polymerization of styrene: Microwave-assisted high-temperature auto polymerizations. *Aust J Chem* 62:58
111. Yuan Y, Wang Y, Huang M, Xu R, Zeng H, Nie C, Kong J (2011) Development and characterization of molecularly imprinted polymers for the selective enrichment of podophyllotoxin from traditional Chinese medicines. *Anal Chim Acta* 695:63
112. Shi S, Liu L (2006) Microwave-assisted preparation of temperature sensitive poly(*N*-isopropylacrylamide) hydrogels in poly(ethylene oxide)-600. *J Appl Polym Sci* 102:4177
113. Zhao Z, Li Z, Xia Q, Xi H, Lin Y (2008) Fast synthesis of temperature-sensitive PNIPAAm hydrogels by microwave irradiation. *Eur Polym J* 44:1217
114. Xu W, Bao J, Zhang J, Shi M (1998) Microwave irradiation graft copolymerization of hydroxyethyl methacrylate onto wool fabrics. *J Appl Polym Sci* 70:2343
115. Singh V, Tiwari A, Tripathi DN, Sanghi R (2004) Grafting of polyacrylonitrile onto guar gum under microwave irradiation. *J Appl Polym Sci* 92:1569
116. Singh V, Tiwari A, Tripathi DN, Sanghi R (2004) Microwave assisted synthesis of Guar-*g*-polyacrylamide. *Carbohydr Polym* 58:1
117. Singh V, Tripathi DN, Tiwari A, Sanghi R (2005) Microwave promoted synthesis of chitosan-graft-poly(acrylonitrile). *J Appl Polym Sci* 95:820

118. Singh V, Tiwari A, Tripathi DN, Sanghi R (2006) Microwave enhanced synthesis of chitosan-*graft*-polyacrylamide. *Polymer* 47:254
119. Singh V, Tripathi DN, Tiwari A, Sanghi R (2006) Microwave synthesized chitosan-*graft*-poly(methylmethacrylate): an efficient  $Zn^{2+}$  ion binder. *Carbohydr Polym* 65:35
120. Singh V, Tripathi DN (2006) Microwave promoted grafting of acrylonitrile onto cassia siamea seed gum. *J Appl Polym Sci* 101:2384
121. Prasad K, Meena R, Siddhanta AK (2006) Microwave-induced rapid one-pot synthesis of  $\kappa$ -carrageenan-*g*-PMMA copolymer by potassium persulphate initiating system. *J Appl Polym Sci* 101:161
122. Vijan V, Kaity S, Biswas S, Isaac J, Ghosh A (2012) Microwave-assisted synthesis and characterization of acrylamide grafted gellan, application in drug delivery. *Carbohydr Polym* 90:496
123. Zheng T, Wang P, Zhang Z, Zhao B (2005) Microwave irradiation copolymerization of superabsorbents from cornstarch and sodium acrylate. *J Appl Polym Sci* 95:264
124. Xu K, Zhang W, Yue Y, Wang P (2005) Swelling behaviors of a three-component copolymer (starch graft sodium acrylate and 2-acrylamido-2-methyl-propanosulfonic acid) synthesized by microwave polymerization. *J Appl Polym Sci* 98:1050
125. Hsin YL, Lai JY, Hwang KC, Lo SC, Chen FR, Kai JJ (2006) Rapid surface functionalization of iron-filled multi-walled carbon nanotubes. *Carbon* 44:3328
126. Long J, Fang M, Chen G (2011) Microwave-assisted rapid synthesis of water-soluble graphene. *J Mater Chem* 21:10421
127. Guo W, Hensarling RM, LeBlanc AL, Hoff EA, Baranek AD, Patton DL (2012) Rapid synthesis of polymer brush surfaces via microwave-assisted surface-initiated radical polymerization. *Macromol Rapid Commun* 33:863
128. Kajiwara Y, Nagai A, Chujo Y (2010) Microwave-assisted preparation of intense luminescent BODIPY-containing hybrids with high photostability and low leachability. *J Mater Chem* 20:2985
129. Liu P, Su Z (2005) Thermal stabilities of polystyrene/silica hybrid nanocomposites via microwave-assisted in situ polymerization. *Mater Chem Phys* 94:412
130. Costa C, Santos VHS, Araújo PHH, Sayer C, Santos AF, Fortuny M (2009) Microwave-assisted rapid decomposition of persulfate. *Eur Polym J* 45:2011
131. Nakamura T, Nagahata R, Kunii K, Soga H, Sugimoto S, Takeuchi K (2010) Large-scale polycondensation of lactic acid using microwave batch reactors. *Org Process Res Dev* 14:781
132. Loupy A (2006) *Microwaves in organic synthesis*, 2nd edn. Wiley-VCH, Weinheim

# Microwave-Assisted Controlled Radical Polymerization

Stéphanie Reynaud and Bruno Grassl

**Abstract** Use of microwave energy to heat and drive chemical reactions has been an increasingly popular theme in the scientific community. Historically, since the 1950s microwave energy has become an essential part of many technical applications in chemical and related industries, particularly in organic chemistry. However, microwave heating was not introduced to polymer chemistry until the mid-1980s. Regardless of the exact nature of the still-debated microwave effects, microwave synthesis has now truly matured and has moved from a laboratory curiosity to an established technique in both academia and industry. Among the polymerization techniques, controlled radical polymerizations (CRPs) are known to produce high-value products with controlled architecture and low dispersity. Original physicochemical properties and promising applications are reachable. This chapter provides, in a concise form, a current picture of three types of microwave-assisted controlled radical polymerization (RAFT, NMP, ATRP) with regard to the irradiation mode and the activation energy values.

**Keywords** Controlled radical polymerization • Irradiation mode • Microwave-assisted synthesis • Molecular weight control and distribution • Temperature control

## Contents

1	Introduction .....	132
2	Apparatus and General Conditions .....	133
3	Controlled Radical Polymerization .....	133
3.1	CMS and EMS .....	135
3.2	RAFT in CMS and EMS .....	136

3.3 NMP in CMS and EMS .....	138
3.4 ATRP in CMS and EMS .....	139
4 Discussion .....	140
5 Conclusion and Perspectives .....	144
References .....	145

## 1 Introduction

Conductive heating in a round-bottom flask or Schlenk flask has long been the method of choice for performing syntheses on the milligram to gram scale. Conventional heating through conduction and convection can only occur within an object or material or between two objects that are in direct or indirect contact with each other. Therefore, these direct heating methods expend energy to heat the target material itself. In 1986, Gedye [1] and Guidere [2] were among the first to describe the use of a microwave oven as an efficient tool for chemical synthesis. Microwaves couple directly with the molecules present within the reactive medium, leading to a rapid rise in temperature. The heating is only affected by the polarity and ionic conduction of the target chemicals. Thus, microwave irradiation can be used as an alternative method for organic synthesis, and it has been used successfully for polymerization. The first experiments on the microwave-assisted radical polymerization of styrene were conducted in 1993 [3]. Since then, a number of studies have been published on similar microwave-assisted syntheses.

Until the late 1990s, microwave-assisted chemistry was limited by the lack of temperature control in consumer microwave ovens. Reactions were difficult to control, and experiments were not reproducible. To improve safety and control, researchers developed more reliable equipment with the ability to control temperature [4] and pressure. In this study of microwave-assisted synthesis, we must include a discussion of the microwave effect. In the scientific world, the microwave effect is defined to include all positive contributions that enhance the properties of a reaction (by, for example, increasing the reaction rate and selectivity or reducing degradation). To evaluate the microwave effect, we must conduct a fair comparison between the reaction by microwave irradiation and by conventional heating. However, the heating rate achieved with microwaves cannot always be matched by conventional heating. Moreover, overheating is also observed in certain microwave-assisted reactions. For these reasons, the existence of the microwave effect is still a subject of debate, and the field appears to be divided into those who advocate the existence of nonthermal effects and those who claim that purely thermal effects provide sufficient explanation. This chapter focuses on microwave-assisted controlled radical polymerization (CRP). We describe the different modes of irradiation and, rather than debate the existence of a microwave effect, we describe the effects and consequences of microwave irradiation on polymerization processes.

## 2 Apparatus and General Conditions

Microwave heating is part of a family of electroheating techniques that utilize specific parts of the electromagnetic spectrum. “Microwave-assisted polymerization” can be considered an umbrella term for all polymerization reactions conducted within microwave devices. The high-performance microwave reactors specially designed for synthesis applications in research and development laboratories have unique properties that allow them to achieve conditions unattainable in conventional reaction vessels. In particular, they enable extremely rapid heat transfer, volumetric and selective heating, the use of compact equipment, rapid switching on and off, and a pollution-free environment because there are no products of combustion. Two types of microwave reactor are currently available for chemists: multimode and mono-mode (or single mode). In mono-mode reactors, the electromagnetic beam is focused on and situated in the center of the reaction vessel; therefore, the reactor cavity is designed for a dedicated vessel. This enables the reactive medium to be placed in the position of maximum electric field strength for optimum transfer of the electromagnetic energy. The cavity sizing takes into account the limitations of penetration depth ( $\delta_p$ ), which can limit the range to centimeters depending on the composition and physical properties of the reaction mixture; for example,  $\delta_p = 5.7$  cm in water at 95°C when operating at 2.45 GHz. In addition, the machines provide adjustable magnetic stirring and temperature control via an internal fiber-optic (FO) device (in situ reaction temperature) or external infrared (IR) sensor (ex situ reaction temperature). The reaction may also be performed at pressures up to dozens of bars. With efficient thermal management, side reactions and reaction hot spots can be minimized or suppressed, and the control of highly exothermic reactions can be improved.

Limiting the size of the reactor helps to improve the overall safety for the operator, particularly when handling potentially exothermic, toxic, or explosive reaction mixtures that would not be suitable for hazard assessment in conventional reactors. Additionally, it is advantageous that slow reactions can be intensified by increasing the temperature and pressure in the reactor cavity. Controlled radical polymerization has been readily achieved at 160°C [5] for acrylamide in the aqueous phase and for methylmethacrylate in toluene [6]. Styrene polymerization has even been conducted at temperatures above 200°C [7]. These advantages of microwave reactors have led to their use in a variety of applications in different areas of polymer chemistry [8–13].

## 3 Controlled Radical Polymerization

Controlled radical polymerization (CRP) is a well-known method for preparing (co) polymers with controlled functionalities, controlled topologies, and low molecular weights [14]. The CRP process requires conditions that allow for or create a

Reversible deactivation by coupling [22, 23], e.g., SFRP, NMP

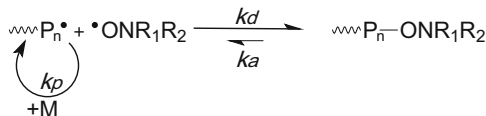

Reversible deactivation by atom transfer [15, 22-26], e.g., ATRP

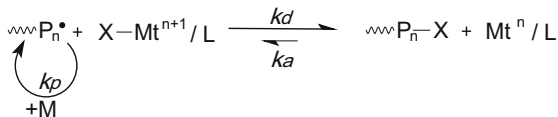

Degenerative transfer [10, 27-29], e.g., RAFT, MADIX

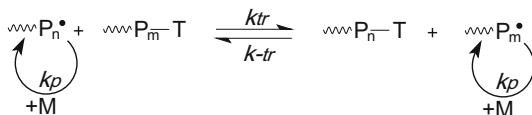

**Fig. 1** Reactions representing the dynamic equilibria required to control the three major types of CRP processes: reversible deactivation by coupling, reversible deactivation by atom transfer, and degenerative transfer

dynamic equilibrium between a low concentration of active propagating chains and a large number of dormant chains, which are unable to propagate or self-terminate. There are several CRP processes based on this fundamental understanding, and the techniques that have received the most attention include atom transfer radical polymerization (ATRP) [15]; stable free radical polymerization (SFRP), such as nitroxide-mediated polymerization (NMP) [16]; degenerative transfer (DT) processes, e.g., reversible addition fragmentation transfer (RAFT) [10, 17, 18] and macromolecular design via the interchange of xanthates (MADIX) [19, 20]. The dynamic equilibria required to control each of the three major CRP processes are summarized in Fig. 1. Unlike NMP and ATRP, RAFT polymerization allows utilization of a larger variety of monomers and different chain transfer agents without using transition metal catalysts [21].

Within the last few years, microwave-assisted synthesis has provided various examples of reaction acceleration, improved selectivity, and increased yield [30, 31]. Reviews of microwave-assisted polymerization have been provided since the early 2000s by such authors as Ritter and coworkers [8, 32], Schubert and coworkers [11–13, 33, 34], and others [9, 10, 35, 36].

Several of the reviews discuss results obtained by microwave-assisted CRP [8–13]. Although many studies report a rate enhancement by microwave CRP, the existence and nature of the microwave effect is still under debate. Of the available CRP methods, microwave-assisted RAFT is certainly the most documented. Nevertheless, the reported results cannot be easily compared because of differences in experimental conditions, including the reactive nature, the type of apparatus (modified domestic oven or multi-/mono-mode microwave synthesizer), and (for mono-modal reactors) the irradiation mode (fixed, pulsed, or dynamic power, with or without cooling). The temperature can also be controlled and

monitored by IR or FO probes that have access to the external or internal temperature.

In addition to an exhaustive review of microwave-assisted CRP, this chapter provides a comparison of studies conducted with microwave-assisted RAFT, NMP, and ATRP. These different types of studies can be compared if the parameters are restricted. We applied strict criteria to select bibliographic references according to their experimental processes. For example, we selected experiments conducted in mono-mode microwave synthesizers using both the conventional and enhanced microwave synthesis modes (CMS and EMS, respectively) if they used a CEM (Matthews, NC, USA) apparatus.

### 3.1 *CMS and EMS*

There are several discrepancies in the literature concerning the influence of microwave irradiation on CRP rates. Most of these differences are probably the result of differences in the application of the microwave equipment. For polymerizations in mono- or single-mode microwave synthesizers, significant rate enhancements are typically observed when there is simultaneous air cooling. By externally cooling the reaction vessel with compressed air while administering microwave irradiation, more of the energy can be directly applied to the reaction mixture. This method for performing microwave-assisted CRP reactions, referred to as “enhanced microwave synthesis” (EMS), has been examined by several authors who used the CEM Discover instrument. An alternative method without air cooling, referred to as “conventional microwave synthesis” CMS, has been used and compared with other methods in various studies. In CMS, the initial microwave power is high, which rapidly increases the bulk temperature to the targeted set point. However, upon reaching this temperature, the microwave power decreases or shuts off completely to maintain the targeted bulk temperature (TB) without exceeding it. When microwave irradiation is off, classical thermal chemistry dominates and the full advantages of microwave-accelerated synthesis are lost. With CMS, microwave irradiation is predominantly used to reach the desired TB more rapidly. Microwave enhancement of chemical reactions should only occur during the application of microwave energy. This source of energy directly activates the molecules in a chemical reaction; therefore, it is not desirable to suppress its application. EMS ensures that a high and constant level of microwave energy is applied with the help of simultaneous air cooling provided by compressed air throughout the reaction. As soon as the temperature reaches the set point, the power shuts off. The temperature drops rapidly as a result of the cooling, the power turns on again, and irradiation starts so that the temperature again reaches the set point.

To truly elucidate the power and potential effects of microwave-assisted heating in the field of CRP, microwave-assisted CRP studies carried out using the same instrument should be compared. In the following sections, we compare

microwave-assisted RAFT, NMP, and ATRP procedures performed using the same instrument with one of the two modes of irradiation described above (CMS or EMS). The activation energy ( $E_a$ ) of monomers and solvents (polar and apolar) obtained under conventional or microwave heating modes have been discussed. In most of the cases considered here, the components were placed in a 10 mL pressure-rated reaction tube that was specially designed for the mono-mode microwave CEM Discover instrument. The vial was capped under nitrogen and the reaction mixture magnetically stirred and heated within the microwave reactor at the desired temperature for a certain amount of time. After that, the mixture was allowed to cool down to room temperature with the help of air cooling or an ice bath. The microwave instrument was equipped with an IR temperature feedback system for ex situ temperature monitoring and/or an FO probe for in situ temperature control or monitoring. The instrument was operated at a maximum power of 300 W and maximum pressure of 17 bar.

### 3.2 RAFT in CMS and EMS

Assem et al. [37] studied the RAFT polymerization of a cyclopolymerizing monomer, diallyldimethylammonium chloride (DADMAC), in the presence of a trithiocarbonate agent in aqueous solution at 60°C under microwave irradiation (EMS, average power 20 W). The cyclization reactions occurring during DADMAC polymerization under microwave irradiation achieved higher conversions for each time interval compared with conventional heating. Rate enhancements as high as 520% were observed for some reactions. High molecular weight poly(DADMAC) chains with narrow polydispersities (approaching 1.05) have been obtained using microwave irradiation.

Brown et al. [38] demonstrated an enhanced rate of RAFT polymerization for the polar monomers vinyl acetate (VA) and methylacrylate (MA) and the nonpolar monomer styrene in bulk solution (EMS; VA, 70°C, average power 10 W; MA, 50°C, average power 40 W; styrene, 60°C, average power 150–300 W). As mentioned above, the differences in average power are related to the intrinsic properties of the monomers in terms of polarity. Rate enhancements as high as 500–1,300% were observed for some reactions.

The same authors [39] studied RAFT microwave-mediated polymerization of MA, methyl methacrylate (MMA), and styrene using CMS. In this mode, at comparable temperatures (50–70°C) and uniform power output (1–3 W), the microwave outperformed the oil bath in terms of polymerization rate for both MA and MMA, displaying rate enhancements of up to 152% and 254%, respectively, relative to conventional heating. Interestingly, the polymerization rate of styrene, a nonpolar monomer, does not appear to be enhanced by the use of microwave heating.

Roy et al. [40] studied the synthesis of well-defined homo- and block copolymers of acrylamido and acrylate monomers via RAFT polymerization in EMS and



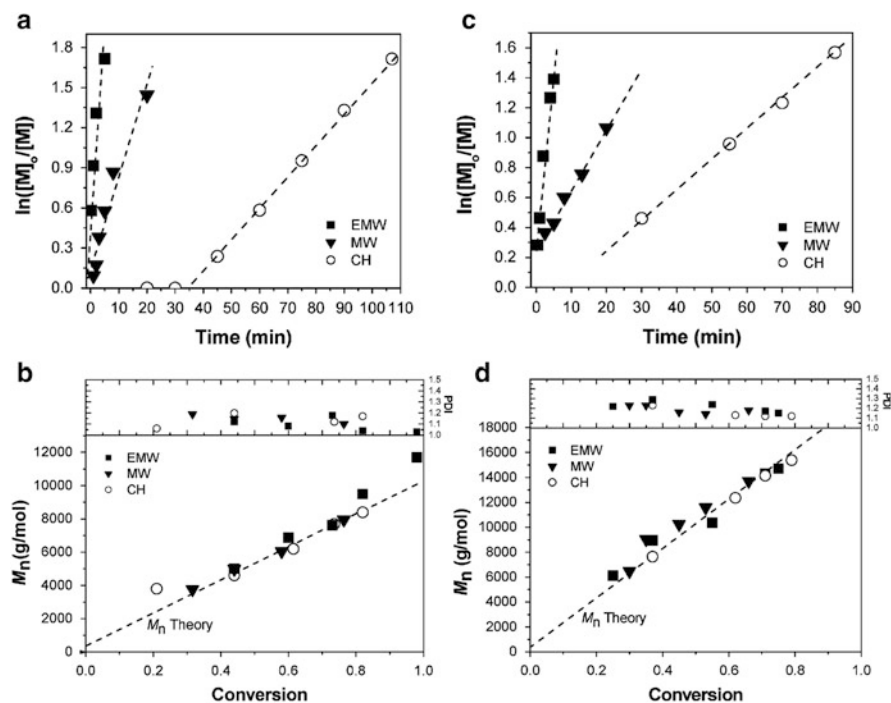

**Fig. 2** Pseudo-first-order kinetic plot (a, c) and number-average molecular weight versus conversion (b, d) for the RAFT polymerization of *N,N*-dimethylacrylamide (DMA) in benzene at different molar ratios of monomer to chain transfer agent (CTA) and initiator (I):  $[DMA]/[CTA]/[I] = 100/1/0.05$  (a, b) and  $[DMA]/[CTA]/[I] = 200/1/0.05$  (c, d). MW CMS, EMW EMS, CH conventional heating (see [40])

CMS devices and compared the results with those obtained using conventional heating, as illustrated in Fig. 2. The rates of polymerization were significantly higher than those observed under conventional heating conditions, with no negative effects on molecular weight control during homopolymerization. In all cases, narrow molecular weight distributions were observed, and the agreement between theoretical and experimental molecular weight values was excellent. Rates for the polymerization of *N,N*-dimethylacrylamide and *N*-isopropylacrylamide were increased by up to 1,650% and 1,300%, respectively, for EMS heating relative to conventional heating.

In a second study [41], well-defined homo- and block copolymers of vinyl esters were synthesized under microwave irradiation by RAFT/MADIX transfer polymerization via the interchange of xanthates, without the significant inhibition or retardation that is often observed with conventional heating. Poly(vinyl acetate) (PVAc) with number-average molecular weight ( $M_n$ ) of 1,000–10,000 g/mol was prepared in less than 15 min using microwave irradiation at an apparent temperature of 70°C in the presence of the commercially available chain transfer agent ethylxanthogenacetic acid. This result represents a 1,400% rate enhancement in

EMS mode. The polymerizations were well controlled, producing polymers with narrow molecular weight distributions and excellent agreement between the theoretical and observed molecular weights. Despite the high rates of polymerization, the resulting PVAc homopolymers retained a high number of thiocarbonylthio end group functionalities, which allowed the synthesis of block copolymers by chain extension with vinyl benzoate and vinyl pivalate. The rates of polymerization during addition of the second blocks were also high, and the resulting block copolymers were obtained in good yield with excellent control of molecular weight and distribution.

Although Sugihara et al. [7] did not strictly use EMS or CMS, their work is of interest because of the high temperature of their procedure. The authors used a fixed power mode set at 200 W for the RAFT polymerization of styrene without air cooling. The temperature profile was not controlled in this mode and increased to 200–250°C, a temperature not attained by conventional heating. The polymerization was not conducted at this temperature; nevertheless, RAFT polymerizations were conducted in an oil bath at 140°C. The polymerization rate was lower than for polymerization under microwave irradiation, although direct and objective comparisons cannot be made because of the broad range of temperatures observed in the case of the microwave.

### 3.3 *NMP in CMS and EMS*

Li et al. [42] studied the nitroxide-mediated radical bulk polymerization of styrene in EMS. When benzoyl peroxide (BPO) was used as an initiator in conjunction with OH-TEMPO, the polymerizations were well controlled in terms of kinetics. There was also a linear increase in the molecular weights with increasing conversion, and a narrow molecular weight distribution of 1.16–1.38. The polymerization temperature (125°C) and microwave output power (100 or 200 W) were accurately monitored during the polymerization. The irradiation power (100 or 200 W) had a considerable effect on the rate of polymerization, even though the temperature, monitored by an IR probe, remained constant (125°C). The polymerization rates of microwave-assisted reactions at an appropriate power value were faster than those obtained with conventional heating at the same polymerization temperature, with or without BPO.

Rigolini et al. [5] demonstrated that the combined use of microwave irradiation as a heating source and water as a solvent provides reasonably controlled (living) polymerization of acrylamide by NMP. For the reaction, a combination of a conventional hydrosoluble radical initiator (Vazo56) and a  $\beta$ -phosphonylated nitroxide (SG1) was employed. Microwave enhancement of the polymerization was dependent on the mode of irradiation (Fig. 3). No specific microwave effect was observed using CMS, yet there was a strong acceleration of the polymerization process (5,000%) without any loss of the controlled polymerization characteristics when using EMS with a fixed power value. In the EMS procedure, polyacrylamide

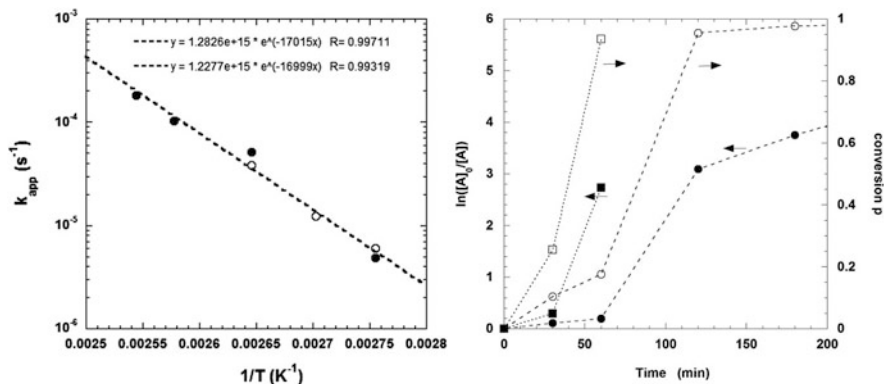

**Fig. 3** Left: Arrhenius plot of NMP of acrylamide under conventional heating (*closed symbols*) and CMS (*open symbols*). Right: Logarithmic monomer conversion (*closed symbols*) and conversion (*open symbols*) versus reaction time in EMS mode at 90°C and power of 150 W (*circles*) or 190 W (*squares*) (see [5])

(PAM) macroinitiator has been shown to reinitiate efficiently, even after 100% conversion of the first block.

### 3.4 ATRP in CMS and EMS

A few ATRP studies have been conducted using a CEM microwave. Such studies can be compared with the studies mentioned above or to each other. In one study, Buruiana et al. [43] described the microwave-assisted synthesis of modified L-phenylalanine-based copolyacrylates. The authors reported an increase in molecular weights and polymerization rate when using microwaves. However, no details on the microwave irradiation mode or reaction kinetics were provided, and thus, their study does not allow for a better understanding of the causes of microwave-assisted process efficiency.

Delfosse et al. [6] performed comparisons of ATRP under conventional heating and microwave irradiation. They studied the ATRP of MMA under microwave irradiation using both the temperature and irradiation mode (CMS and EMS) as parameters and compared their results with those obtained under conventional heating. A significant increase in the rate of living polymerization was obtained at temperatures above 100°C using CMS. At 120°C and 135°C, the slopes of the lines defined by  $\ln([M]_0/[M]) = f(t)$  revealed that the apparent rate constant ( $k_{app}$ ) for the microwave-assisted polymerization was 3.1- and 3.3-fold greater than  $k_{app}$  for a conventional heating process, respectively. As shown in Fig. 4, the kinetics obtained using simultaneous cooling (EMS) display an even more pronounced acceleration of the polymerization rate (by a factor of 2.5 relative to CMS polymerization at 120°C, or an increase by a factor of 7 compared with conventional

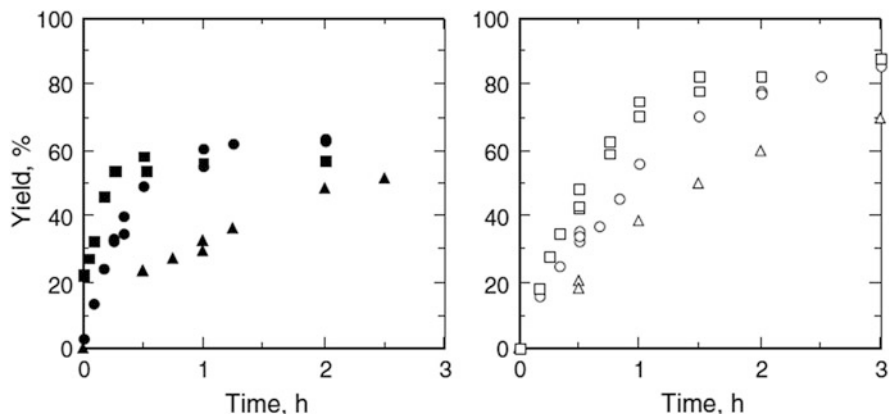

**Fig. 4** Comparison of the EMS (*closed symbols*) and CMS (*open symbols*) methods for the polymerization of MMA at 85°C (*triangles*), 110°C (*circles*), and 120°C (*squares*). Monomer conversion is obtained by the gravimetric method after purification of the polymer (see [6])

heating). However, the polymerization was no longer controlled, and termination reactions occurred, as evidenced by the failure to resume polymerization. The authors noted that temperature control and time needed to reach the target temperature are key factors that determine this behavior, especially when air cooling is used. These authors also suggested that the striking difference in reactivity could be due to the irradiation power needed to maintain the temperature of the reaction mixture (at 120°C, 25–35 W is necessary with CMS, whereas the EMS protocol requires 135–150 W).

Microwave-assisted ATRP has been used by other authors to synthesize block copolymers [44]. Those authors first describe the kinetics of the synthesis of the first polymer block. The kinetics for EMS with fixed power exhibited a surprising increase in the polymerization rate after 30–40% conversion. The polymerization rate at that point had increased by approximately 1,000% relative to conventional heating. As described previously [6], the polymerization remained under control even though the irradiation power was kept as high as 100 W during the reaction.

Similar results were previously observed for the microwave-assisted NMP of acrylamide [5]. The lack of temperature control with the IR probe and the increase in medium viscosity were suspected to be the causes of this interesting behavior.

## 4 Discussion

The EMS and CMS methods can provide rate enhancement compared with the same reactions performed using conventional heating. The increase in polymerization rate is often more pronounced with EMS than with CMS (Table 1).

**Table 1** Comparison of microwave-assisted RAFT, NMP, and ATRP reactions performed under the same conditions

Method	Monomer	Solvent	Temperature (°C)	Power (W)	Rate acceleration relative to conventional heating (%)	Refs.
<i>RAFT</i>						
EMS	Diallyldimethylammonium chloride (DADMAC)	Water	60	20	520	[37]
EMS	Vinylacetate (VA) Methylacrylate (MA) Styrene	Bulk	70	10	500–1,300	[38]
			50	40		
			60	150–300		
CMS	MA Methylmethacrylate (MMA) Styrene	Bulk	50 and 70	1–3	150	[39]
					250	
					No effect	
CMS	<i>N,N</i> -Dimethylacrylamide (DMA) <i>N</i> -Isopropylacrylamide (NIPAM)	Benzene	60		200–300	[40]
			70		300	
EMS	DMA NIPAM	Benzene	60		1,650	[40]
			70		1,300	
EMS	VA	Anisole	70	Not specified	1,400	[41]
CMS	Styrene	Bulk	25–250	200	Not specified	[7]
			Not controlled			
<i>NMP</i>						
EMS	Styrene	Bulk	125	100–200	Not calculated	[42]
EMS	Acrylamide (AM)	Water	80–105	10–300	5,000	[5]
CMS	AM	Water	90–105	<10	No effect	[5]
<i>ATRP</i>						
CMS	MMA	Bulk	85		No effect	[6]
			120		300	
EMS	MMA	Bulk	120	150	750	[6]
EMS	Styrene	Bulk	80–110	60–100	>1,000	[44]

The results summarized in Table 1, which were obtained with the same apparatus and irradiation mode, illustrate that rate enhancement can be obtained for any type of controlled radical polymerization process (RAFT, NMP, or ATRP) regardless of the monomer or solvent. The rate can be increased by more than 1,000% compared with conventional heating, without any loss of control of the polymerization (a linear increase in molecular weight is obtained with a narrow molecular weight distribution) and with a linear increase in the logarithmic conversion over time. Nevertheless, none of the reports describing these results mention or describe the existence of a microwave effect.

As mentioned earlier, the temperature can be monitored and/or controlled by an external IR probe or an internal FO probe. External IR sensors measure the outer surface temperature of the reaction vessel and do not necessarily reflect the actual reaction temperature inside a reaction mixture that is heated by dielectric heating inside a reaction vessel. When simultaneous cooling is used, the internal reaction temperature could be significantly higher than that recorded by an IR sensor on the outside of the vessel. The resulting errors in temperature measurement during microwave dielectric heating (which occur as a result of the viscosity and microwave absorptivity of organic solvents and polymers) can cause the stirring rate to be underestimated by up to 20%, according to published results [4, 45, 46] (Fig. 5).

We will next consider the activation energy values for CRP reported in the literature to determine whether kinetic effects are simply caused by poor control of the temperature during the microwave process. The results are summarized in Table 2.

Typical values for the overall activation energy,  $E_a$ , for CRP with conventional heating are within the range of 60–140 kJ/mol (see Table 2). If the measured temperature is only 80% of its true value, the  $E_a$  is underestimated. A 20% temperature increase in the 60–120°C range corresponds to a two- to threefold rate increase for  $E_a = 60$  kJ/mol and a 5- to 12-fold rate increase for  $E_a = 140$  kJ/mol. The activation energies for the ATRP of MMA and styrene were found to be 58 and 67–74 kJ/mol, respectively (see [52], Table 2). Delfosse et al. [6] and Marcasuzaa et al. [44] found acceleration rates of up to 700% and more than 1,000%, respectively (see Table 1), which would correspond to a real temperature of up to 170°C instead of the reported 80–120°C, according to the  $E_a$  (and considering that no microwave effect is observed). Similar behavior has been observed for the polymerization of acrylamide; an increase in the polymerization rate of up to 5,000% was found for NMP using EMS ([5] in Table 1). Considering the  $E_a$  of 140 kJ/mol, we find that the real reaction temperature should be at least 140°C rather than 105°C, as reported by Rigolini et al. [5]. This difference exceeds the 20% deviation previously defined. The same conclusion could easily be reached on the basis of results obtained for RAFT with an intermediate average  $E_a$  of approximately 100 kJ/mol.

A comparison of the results listed above clearly demonstrates that an underestimation of the temperature might not be solely sufficient to explain the kinetic

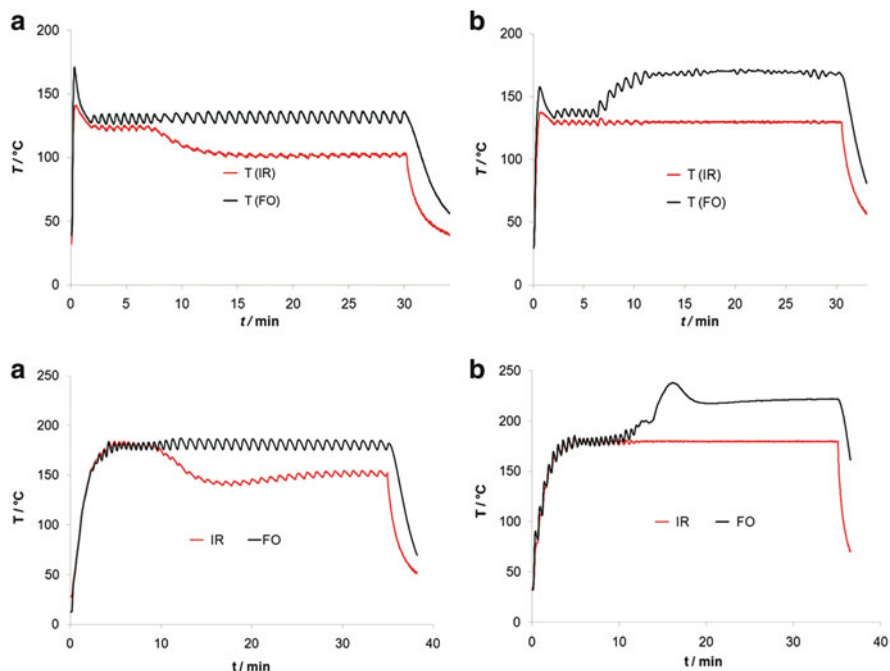

**Fig. 5** Overlay of fiber-optic (FO) and infrared (IR) temperature profiles recorded during microwave-assisted polymerization of monoglycerylcetyldimethylammonium chloride (*above*) and  $\epsilon$ -caprolactone (*below*) at set temperatures of 130°C and 180°C, respectively. The *left panels* display temperatures recorded with an FO sensor, and the *right panels* display results recorded with an IR sensor (see [45])

**Table 2** Activation energy ( $E_a$ ) values for CRP

CRP	Monomer	Solvent	$E_a$ (kJ/mol)	Refs.
RAFT	MMA	DMF	100	[47]
RAFT	Styrene	Bulk	106.4	[48]
NMP	Styrene	Bulk	120	[49]
	Butylacrylate		130	
NMP	Styrene	Bulk	107	[50]
		Benzene	116	
NMP	AM	Water	140	[5]
ATRP	MA	Toluene	61.3	[51]
ATRP	MA	Bulk	114	[52]
	Styrene		67–74	
	MMA		58	

acceleration observed with microwave irradiation. However, such a conclusion can only be reached if comparing polymerization reactions conducted using the same irradiation mode. In other words, results can be meaningfully compared only if the irradiation procedure is controlled and clearly described. To date, most of the

relevant experiments were performed using a CEM apparatus, and a sufficient number of studies are available for comparison. Anton Paar (St. Albans, UK) now offers additional options for irradiation modes in their new microwave synthesizers. We are certain that there will be exciting developments in this field in the coming years; however, at present, the existence of the microwave effect is still a subject for debate.

## 5 Conclusion and Perspectives

Based on the aforementioned works, it appears that most of the published results for microwave-assisted CRP should be treated with caution because they lack a detailed protocol description. Nevertheless, for some polymerizations, EMS appears to enhance polymerization rates beyond the range that can be explained by the temperature effect, as demonstrated above for the experimental microwave-assisted polymerization rate and the  $E_a$  values reported in the literature. Accurate comparisons and conclusions can be drawn only if new articles are careful to provide detailed temperature profiles along with comparisons of the kinetics associated with microwave-assisted heating and conventional heating. Viscosity monitoring and/or stirring cam-recording would also be useful measurements to improve our understanding of this topic and could be useful for anticipating gel effects.

Currently, one of the major weaknesses of microwave-assisted chemistry is the inability to scale up. As mentioned earlier, the penetration depth of microwaves is limited; the most promising option for increasing yields lies in small-scale continuous processes. Such processes could be achieved by connecting several reactors or subunits with identical conditions in parallel (the “numbering-up” principle) [53]. In addition, a continuous flow system implemented in the microwave cavities allows production to proceed for extended periods of time, thereby generating large quantities of material (the “scale-out” principle). Strauss et al. pioneered the combination of microwave-assisted heating and flow chemistry [54]. In such a system, residence time is the key parameter and is related to the reaction rate. Parameters such as the mixing efficiency [55] should also be optimized to achieve complete conversion. In microwave-assisted CRP, fluidic systems were shown to be advantageous because they allow faster polymerization as a result of their excellent heat transfer; furthermore, they allow control over the polymer parameters to be maintained. One RAFT example illustrates that such a system can be used for the synthesis of block copolymers in a continuous fashion [56]. Other authors developed a way to combine high flow rate with complete conversion by using a batch-loop reactor that combines batch and tubular reactors. In contrast, for decades droplet-based technology has been a powerful tool for performing reactions and conducting chemical and biological analyses, and microwave-assisted free radical polymerization has been recently reported, with interesting results [57]. The latter process could represent an innovative and efficient way to produce droplets that



allow control of polymer particle shapes. For conventional microwave-assisted polymerization, one challenge lies in developing microfluidic or nanofluidic methods based on continuous flow or droplet technology with good temperature control and, thus, the ability to discriminate microwave effects from thermal effects.

## References

1. Gedye R, Smith F, Westaway K, Ali H, Baldisera L, Laberge L, Rousell J (1986) The use of microwave ovens for rapid organic synthesis. *Tetrahedron Lett* 27:279–282
2. Giguere RJ, Bray TL, Duncan SM, Majetich G (1986) Application of commercial microwave ovens to organic synthesis. *Tetrahedron Lett* 27:4945–4948
3. Sitaram SP, Stoffer JO (1993) Microwave initiated free-radical catalyzed polymerizations: polystyrene. Abstracts of papers of the American Chemical Society, 206:190-PMSE
4. Kappe CO (2013) How to measure reaction temperature in microwave-heated transformations. *Chem Soc Rev* 42:4977–4990
5. Rigolini J, Grassl B, Billon L, Reynaud S, Donard OFX (2009) Microwave-assisted nitroxide-mediated radical polymerization of acrylamide in aqueous solution. *J Polym Sci Part A Polym Chem* 47:6919–6931
6. Delfosse S, Borguet Y, Delaude L, Demonceau A (2007) Single-mode microwave-assisted atom transfer radical polymerization catalyzed by [RuCl<sub>2</sub>(p-cymene)(PCy<sub>3</sub>)]. *Macromol Rapid Commun* 28:492–503
7. Sugihara Y, Semsarilar M, Perrier S, Zetterlund PB (2012) Assessment of the influence of microwave irradiation on conventional and RAFT radical polymerization of styrene. *Polym Chem* 3:2801–2806
8. Bardts M, Gonsior N, Ritter H (2008) Polymer synthesis and modification by use of microwaves. *Macromol Chem Phys* 209:25–31
9. Brooks WLA, Sumerlin BS (2012) Microwave-assisted RAFT polymerization. *Isr J Chem* 52:256–263
10. Moad G, Rizzardo E, Thang SH (2012) Living radical polymerization by the RAFT process – a third update. *Aust J Chem* 65:985–1076
11. Zhang H, Schubert US (2004) Monomode microwave-assisted atom transfer radical polymerization. *Macromol Rapid Commun* 25:1225–1230
12. Wiesbrock F, Hoogenboom R, Schubert US (2004) Microwave-assisted polymer synthesis: state-of-the-art and future perspectives. *Macromol Rapid Commun* 25:1739–1764
13. Kempe K, Becer CR, Schubert US (2011) Microwave-assisted polymerizations: recent status and future perspectives. *Macromolecules* 44:5825–5842
14. Matyjaszewski K (2012) Controlled radical polymerization: state-of-the-art in 2011. In: Matyjaszewski K, Sumerlin BS, Tsarevsky NV (eds) *Progress in controlled radical polymerization: mechanisms and techniques*. American Chemical Society, Washington
15. Matyjaszewski K (2012) Atom transfer radical polymerization (ATRP): current status and future perspectives. *Macromolecules* 45:4015–4039
16. Nicolas J, Guillaneuf Y, Lefay C, Bertin D, Gigmes D, Charleux B (2013) Nitroxide-mediated polymerization. *Prog Polym Sci* 38:63–235
17. Brooks WLA, Sumerlin BS (2012) Reversible addition-fragmentation chain transfer polymerization under microwave heating conditions. In: Matyjaszewski K, Sumerlin BS, Tsarevsky NV (eds) *Progress in controlled radical polymerization: mechanisms and techniques*. American Chemical Society, Washington, pp 277–291
18. Moad G, Rizzardo E, Thang SH (2008) Radical addition-fragmentation chemistry in polymer synthesis. *Polymer* 49:1079–1131

19. Destarac M (2010) Controlled radical polymerization: industrial stakes, obstacles and achievements. *Macromol React Eng* 4:165–179
20. Destarac M, Deroo S, Lannibois-Drean H, Senechal A, Bzducha W (2009) MADIX technology: from innovative concepts to industrialization of block copolymers for emulsion stabilization. In: Matyjaszewski K (ed) *Controlled/living radical polymerization: progress in RAFT, DT, NMP & OMRP*. American Chemical Society, Washington, pp 347–359
21. Lowe AB, McCormick CL (2007) Reversible addition-fragmentation chain transfer (RAFT) radical polymerization and the synthesis of water-soluble (co)polymers under homogeneous conditions in organic and aqueous media. *Prog Polym Sci* 32:283–351
22. Bertin D, Marchand J, Guillauneuf Y, Autissier L, Gimes D (2011) Investigation of stable and unstable nitroxides to improve the NMP process. Abstracts of papers of the American Chemical Society, 242:7-POLY
23. Tomoeda S, Kitayama Y, Wakamatsu J, Minami H, Zetterlund PB, Okubo M (2011) Nitroxide-mediated radical polymerization in microemulsion (microemulsion NMP) of *n*-butyl acrylate. *Macromolecules* 44:5599–5604
24. Matyjaszewski K (2010) Synthesis of polymers with controlled architectures by ATRP. Abstracts of papers of the American Chemical Society, 240:21-PMSE
25. Matyjaszewski K (2011) Complex polymer architectures by ATRP. Abstracts of papers of the American Chemical Society, 242:252-POLY
26. Mueller L, Golas P, Matyjaszewski K (2009) From mechanism and kinetics to precise ATRP synthesis. In: Khosravi E, Yagci Y, Savelyev Y (eds) *New smart materials via metal mediated macromolecular engineering*. Springer, Dordrecht, pp 3–16
27. Moad G, Rizzardo E, Thang SH (2005) Living radical polymerization by the RAFT process. *Aust J Chem* 58:379–410
28. Moad G, Rizzardo E, Thang SH (2006) Living radical polymerization by the RAFT process – a first update. *Aust J Chem* 59:669–692
29. Moad G, Rizzardo E, Thang SH (2009) Living radical polymerization by the RAFT process – a second update. *Aust J Chem* 62:1402–1472
30. de la Hoz A, Loupy A (2012) *Microwaves in organic synthesis*, 3rd edn. Wiley-VCH, Weinheim
31. Kappe CO, Stadler A, Dallinger D (2012) *Microwaves in organic and medicinal chemistry*, 2nd edn. Wiley-VCH, Weinheim
32. Sinnwell S, Ritter H (2007) Recent advances in microwave-assisted polymer synthesis. *Aust J Chem* 60:729–743
33. Hoogenboom R, Schubert US (2009) Microwave-assisted organic and polymer chemistry. *Aust J Chem* 62:181–183
34. Hoogenboom R, Schubert US (2007) Microwave-assisted polymer synthesis: recent developments in a rapidly expanding field of research. *Macromol Rapid Commun* 28:368–386
35. Ebner C, Bodner T, Stelzer F, Wiesbrock F (2011) One decade of microwave-assisted polymerizations: quo vadis? *Macromol Rapid Commun* 32:254–288
36. Zong LM, Zhou SJ, Sgriccia N, Hawley MC, Sun RS, Kempel LC (2005) Dielectric properties of an epoxy-amine system at a high microwave frequency. *Polym Eng Sci* 45:1576–1580
37. Assem Y, Greiner A, Agarwal S (2007) Microwave-assisted controlled ring-closing cyclopolymerization of diallyldimethylammonium chloride via the RAFT process. *Macromol Rapid Commun* 28:1923–1928
38. Brown SL, Rayner CM, Graham S, Cooper A, Rannard S, Perrier S (2007) Ultra-fast microwave enhanced reversible addition-fragmentation chain transfer (RAFT) polymerization: monomers to polymers in minutes. *Chem Commun* 2007(21):2145–2147
39. Brown SL, Rayner CM, Perrier S (2007) Microwave-accelerated RAFT polymerization of polar monomers. *Macromol Rapid Commun* 28:478–483
40. Roy D, Ullah A, Sumerlin BS (2009) Rapid block copolymer synthesis by microwave-assisted RAFT polymerization. *Macromolecules* 42:7701–7708

41. Roy D, Sumerlin BS (2011) Block copolymerization of vinyl ester monomers via RAFT/MADIX under microwave irradiation. *Polymer* 52:3038–3045
42. Li J, Zhu X, Zhu J, Cheng Z (2006) Microwave-assisted nitroxide-mediated radical polymerization of styrene. *Radiat Phys Chem* 75:253–258
43. Buruiana EC, Murariu M, Buruiana T (2010) Copolyacrylates with phenylalanine and anthracene entities prepared by ATRP and microwave irradiation. *J Lumin* 130:1794–1801
44. Marcasuzaa P, Reynaud S, Grassl B, Preud'homme H, Desbrieres J, Trchova M, Donard OFX (2011) Microwave synthesis: an alternative approach to synthesize conducting end-capped polymers. *Polymer* 52:33–39
45. Hayden S, Damm M, Kappe CO (2013) On the importance of accurate internal temperature measurements in the microwave dielectric heating of viscous systems and polymer synthesis. *Macromol Chem Phys* 214:423–434
46. Rigolini J, Grassl B, Reynaud S, Billon L (2010) Microwave-assisted nitroxide-mediated polymerization for water-soluble homopolymers and block copolymers synthesis in homogeneous aqueous solution. *J Polym Sci Part A Polym Chem* 48:5775–5782
47. Wang G, Zhu X, Cheng Z, Zhu J (2003) Reverse atom transfer radical polymerization of methyl methacrylate with FeCl<sub>3</sub>/pyromellitic acid. *Eur Polym J* 39:2161–2165
48. Arita T, Buback M, Vana P (2005) Cumyl dithiobenzoate mediated RAFT polymerization of styrene at high temperatures. *Macromolecules* 38:7935–7943
49. Benoit D, Grimaldi S, Robin S, Finet J-P, Tordo P, Gnanou Y (2000) Kinetics and mechanism of controlled free-radical polymerization of styrene and *n*-butyl acrylate in the presence of an acyclic  $\beta$ -phosphonylated nitroxide. *J Am Chem Soc* 122:5929–5939
50. Drockenmuller E, Catala J-M (2002) Synthesis of a new stable  $\beta$ -sulfinyl nitroxide and the corresponding alkoxyamine for living/controlled radical polymerization of styrene: kinetic and ESR studies. *Macromolecules* 35:2461–2466
51. Haddleton DM, Kukulj D, Duncalf DJ, Heming AM, Shooter AJ (1998) Low-temperature living “radical” polymerization (atom transfer polymerization) of methyl methacrylate mediated by copper(I) *N*-alkyl-2-pyridylmethanimine complexes. *Macromolecules* 31:5201–5205
52. Davis KA, H-j P, Matyjaszewski K (1999) Kinetic investigation of the atom transfer radical polymerization of methyl acrylate. *Macromolecules* 32:1767–1776
53. Tonhauser C, Natalello A, Löwe H, Frey H (2012) Microflow technology in polymer synthesis. *Macromolecules* 45:9551–9570
54. Cablewski T, Faux AF, Strauss CR (1994) Development and application of a continuous microwave reactor for organic synthesis. *J Org Chem* 59:3408–3412
55. Paulus RM, Erdmenger T, Becer CR, Hoogenboom R, Schubert US (2007) Scale-up of microwave-assisted polymerizations in continuous-flow mode: cationic ring-opening polymerization of 2-ethyl-2-oxazoline. *Macromol Rapid Commun* 28:484–491
56. Hornung CH, Guerrero-Sanchez C, Brasholz M, Saubern S, Chiefari J, Moad G, Rizzardo E, Thang SH (2011) Controlled RAFT polymerization in a continuous flow microreactor. *Org Process Res Dev* 15:593–601
57. Zhendong L, Yangcheng L, Bodong Y, Guangsheng L (2013) Free radical polymerization of butyl acrylate in monodispersed droplets: comparison between two heating strategies. *J Appl Polym Sci* 127:628–635

# Microwave-Assisted Synthesis of Polyesters and Polyamides by Ring-Opening Polymerization

Martin Fimberger and Frank Wiesbrock

**Abstract** Microwave-assisted heating has been described as an efficient heating technique that can enhance the reaction rate for many reactions. Consequently, it is a key strategy for ring-opening polymerizations, which are often limited by low polymerization rates. This review summarizes recent efforts in the field of microwave-assisted polyester and polyamide syntheses from cyclic monomers and dimers, with a broad focus on poly(lactic acid)s and poly( $\epsilon$ -caprolactone)s. Homo- and copolymerizations as well as graft polymerizations are discussed. Both the polymerizations themselves as well as the preparation of composites/materials are addressed. Special attention is directed towards the discussion of non-thermal microwave effects.

**Keywords** Microwave-assisted polymerization · Non-thermal microwave effects · Polyamide · Polyester · Ring-opening polymerization

## Contents

1	Introduction .....	151
2	Poly(glycolic acid) .....	153
2.1	Copolymers of PGA .....	153
3	Poly(lactic acid) .....	155
3.1	Homopolymers of LA .....	155
3.2	Copolymers of LA .....	159

---

M. Fimberger

Polymer Competence Center Leoben, Roseggerstrasse 12, 8700 Leoben, Austria

Graz University of Technology, Institute for Chemistry and Technology of Materials, NAWI  
Graz, Stremayrgasse 9, 8010 Graz, Austria

F. Wiesbrock (✉)

Polymer Competence Center Leoben, Roseggerstrasse 12, 8700 Leoben, Austria

e-mail: [frank.wiesbrock@pccl.at](mailto:frank.wiesbrock@pccl.at)

4	Poly( $\epsilon$ -caprolactone) .....	163
4.1	Homopolymers of CL .....	163
4.2	Copolymers of CL .....	169
5	Polydioxanone .....	172
6	Polycarbonates .....	173
7	Various ROPs for the Synthesis of Polyesters .....	174
8	Polyamides .....	175
	References .....	178

## Abbreviations

(D/L)-LA	(D/L)-lactic acid
CH	Conventional heating
CL	$\epsilon$ -Caprolactone
$\mathcal{D}_M$	Molar mass dispersity
DMF	Dimethylformamide
DMSO	Dimethyl sulfoxide
DO	Dioxanone
DSC	Differential scanning calorimetry
GA	Glycolic acid
IR	Infrared (spectroscopy)
LCCC	Liquid chromatography under critical conditions
MALDI	Matrix-assisted laser desorption ionization
$M_m$	Mass-average molecular weight
$M_n$	Number-average molecular weight
mPEG	Methoxylated poly(ethylene glycol)
$M_v$	Viscosity-average molecular weight
MW	Microwave
NCA	<i>N</i> -Carboxyanhydride
P(D/L)LA	Poly((D/L)-lactic acid)
PAA	Poly(acrylic acid)
PCL	Poly( $\epsilon$ -caprolactone)
PDO	Polydioxanone
PEG	Poly(ethylene glycol)
PET	Poly(ethylene terephthalate)
PGA	Poly(glycolic acid)
PHA	Poly(hydroxy alkanooate)
PLGA	Poly(lactic- <i>co</i> -glycolic) acid
PS <sub>t</sub>	Polystyrene
PTMC	Poly(trimethylene carbonate)
PVA	Poly(vinyl alcohol)
ROP	Ring-opening polymerization
SBF	Simulated body fluid
SEC	Size exclusion chromatography
SEM	Scanning electron microscopy
<i>stat</i>	Statistical

TEM	Transmission electron microscopy
$T_g$	Glass-transition temperature
TGA	Thermogravimetric analysis
THF	Tetrahydrofuran
$T_m$	Melting temperature
TMC	Trimethylene carbonate
TOF	Time of flight (spectroscopy)
wt	Weight
XRD	X-ray diffraction
$\beta$ -TCP	$\beta$ -Tricalcium phosphate

## 1 Introduction

Ring-opening polymerization (ROP) is a polymerization technique in which a cyclic monomer is converted into a polymer composed of repetition units that are commonly acyclic (or contain at least one cycle less than the monomer). The mechanism of ROPs consists of the initiation, the propagation, and the termination, sometimes accompanied by chain-transfer reactions. Due to the versatile applicability of ROP, various cyclic monomers have been successfully polymerized by this technique, including the cyclic derivatives of ethers, acetals, amides, esters, and siloxanes.

As a “rule of thumb”, it is important to bear in mind that ROPs such as those of the 2-oxazolines have low polymerization rates (see “Microwave-assisted cationic ring-opening polymerization of 2-oxazolines” of this special issue [1]), which renders them favorable candidates for performing under microwave (MW) irradiation: Although the broad majority of polymerizations have been shown not to benefit from any non-thermal MW effects [2], the facilitated access to autoclave conditions provided by MW laboratory reactors eliminates the bottle-neck of temperature limitations by (solvents’) boiling points and, hence, paves the way for enhancing the polymerization rates (while of course the activation energy of the reaction itself remains unaffected) [3, 4].

In addition to the ROP of 2-oxazolines that yields side-chain polyamides (which is currently the type of ROP best investigated under MW irradiation and described in a dedicated chapter in this special issue [1]), the MW-assisted synthesis of polyesters and polyamides from the ROP of monomers such as lactones, lactams, and *N*-carboxyanhydrides has also been under investigation. The focus on that type of polymer largely originates from their wide field of application, including biomedical applications, and reciprocally provides an explanation for the thorough investigation of poly( $\epsilon$ -caprolactone)s (PCLs) and poly(lactic acid)s (PLAs) in the field.

Preceded by a critical review of MW-assisted ROPs in 2007 [5] and a mini-review of MW-assisted polyester and polyamide synthesis (broadly focusing on acyclic monomers) [6], this review aims to summarize the MW-assisted synthesis of polyesters and polyamides by ROPs with a focus on (1) advancements reported within the last 10 years and (2) the discussion of the existence or absence of

non-thermal MW effects. The sections are arranged such that the polyesters are discussed first, in ascending order with respect to the molecular weight of the repetition unit, from poly(glycolic acid) (PGA) to PCL. This is followed by discussion of poly(dioxanone)s, polycarbonates, and various other polyesters. The polyamides are discussed in the final section of this chapter; copolymers of polyesters and polyamides have also been included in that final section.

In order not to distract the reader's attention from the advantages of MW-assisted heating for the ROP technique, the nomenclature for lactic acid (s) (LAs) and lactides has been standardized throughout this review (and, correspondingly, might differ from the nomenclature used in the original literature). The term "lactic acid" has been used only for the linear monomers and repetition units (the "monomeric" units); the configuration of the chiral carbon atom has been referred to as L or D. The cyclic dimers of lactic acid are called lactides, and the combinations of configurations of the chiral carbon atoms have been referred to as *R,R*, *S,S*, and *R,S*. The pure (*R,S*)-lactide may be called *meso*-lactide (melting point of 52.8°C, in contrast to approximately 95°C for *R,R*- and *S,S*-lactide) [7], whereas the mixture of (*R,R*)-lactide, (*S,S*)-lactide, and (*R,S*)-lactide may be called *rac*-lactide (Scheme 1). A polyester composed of repetition units of D-LA (derived from the ROP of (*R,R*)-lactide) is consistently called PDLA, whereas,

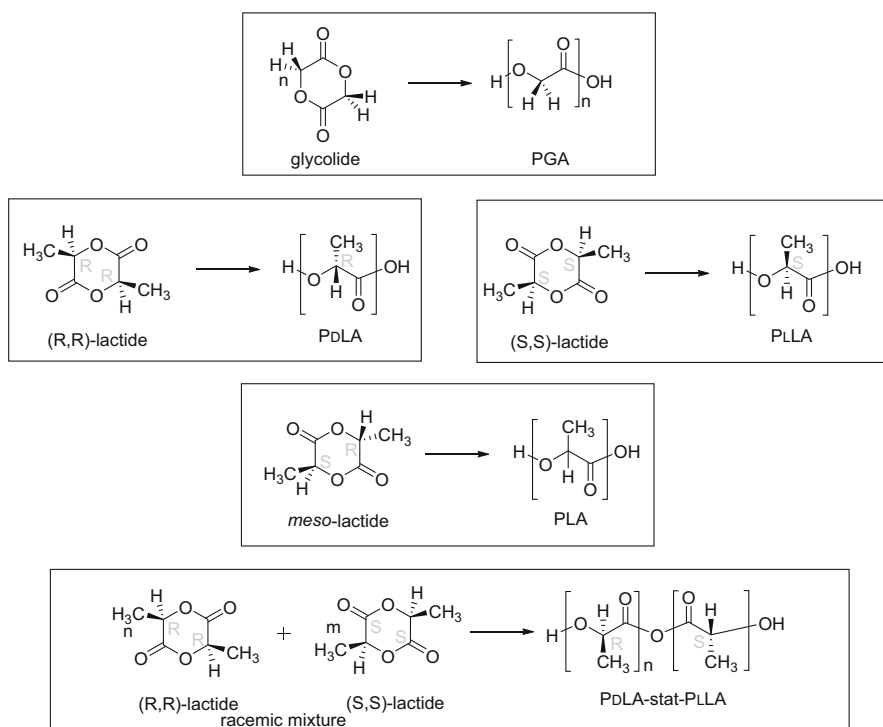

**Scheme 1** Structural formulae of glycolide, lactides, and the corresponding polyesters

e.g., a polyester derived from the ROP of *meso*-lactide (*rac*-lactide) is called PLA (PDLA-*stat*-PLLA). If the configuration of the lactide could not be retraced from the original literature, the corresponding polymer is also referred to as PLA. All other cyclic monomers described in this review, such as glycolides, caprolactones, and caprolactams, have a standardized nomenclature throughout the literature.

## 2 Poly(glycolic acid)

Recent reports of the MW-assisted polymerization of glycolic acid (GA) have focused on the preparation of copolymers of PGA, unlike the current research trends in the area of, e.g., PLAs and PCLs, in which the syntheses of homopolymers have been well investigated.

### 2.1 Copolymers of PGA

The MW-assisted copolymerization of *S,S*-lactide (referred to as *L*-lactide in the publication) and glycolide using stannous octanoate and octadecanol as initiating system was reported by Xiong and coworkers [8], who performed the reactions in a MAS-II MW oven at the 10 g scale. Mixtures of the dimers were molten under conventional heating (CH), and the preheated mixtures were subsequently irradiated by microwaves at 120°C for 3–9 min. The PGA-*stat*-PLLA copolymers that were recovered after 5 min of irradiation time had an inherent viscosity of 0.88 dL g<sup>-1</sup>, which was the highest within that series, indicating that longer reaction times induced degradation and/or transesterification. A variation in the relative monomer feed [ratio *n*(glycolide):*n*(*S,S*-lactide)] revealed that the molar component ratio of glycolide in the copolymers was higher than that in the initial feed ratio, which is indicative of higher reaction rates for the polymerization of glycolide under the conditions applied. Concomitant with the increase in glycolide content, the glass transition temperature ( $T_g$ ) of the copolymers decreased and the melting temperature ( $T_m$ ) of the copolymers increased.

The MW-assisted preparation of composites composed of PGA-*stat*-PLLA copolymers and  $\beta$ -tricalcium phosphate ( $\beta$ -TCP) was described by Yoon et al. [9]. The composites were prepared by adding variable amounts (0–30%) of  $\beta$ -TCP to mixtures (75:25 wt%) of glycolide and *S,S*-lactide (referred to as *L*-lactide in the publication). Stannous octanoate was used as catalyst; the reactions were performed in a Hankuk MW reactor employing a two-step procedure of heating at 3 kW and subsequent stirring at 0.1 kW (150°C). It was reported that the ceramic powder disturbed or interrupted the polymerization of the dimers, and analyses of the composites revealed a decrease in the average molecular weights of the PGA-*stat*-PLLA copolymers for increased contents of  $\beta$ -TCP in the range 0–10 wt% in the corresponding materials. Remarkably, a further increase in the  $\beta$ -TCP content induced an increase in the average molecular weight of the



copolymers. This trend, namely the decrease in average molecular weight for  $\beta$ -TCP contents of 0–10 wt% (but increase at >10 wt%) , was reproduced for the flexural strength as well as the Young's modulus of the composites. This observation was ascribed to non-thermal MW effects due to prime absorption of microwaves by the inorganic salt. Control experiments and temperature measurements, however, were not reported by the authors.

The degradation time of the composites was reported in other studies [10, 11], in which the authors correlated the degradation rates of the composites in simulated body fluid (SBF) with the  $\beta$ -TCP content and the initial molecular weight of the copolymers. Degradation of the  $\beta$ -TCP phase was observed after a certain incubation time, which was needed to detach  $\beta$ -TCP from the polymer (Fig. 1).

The release properties from microcomposites composed of PLA-*stat*-PGA copolymers and magnetic iron core nanoparticles (Scheme 2) under irradiation-free conditions and upon MW irradiation were described by Naik and Carpenter [12]. Using localized MW-assisted heating, the quantitative release of a fluorescent dye was found to be accomplished within three pulses of 2 s each of 2.4 GHz of MW irradiation. This could have application as a drug delivery platform for the controlled release of substances using MW irradiation.

The synthesis of drug delivery systems of the composition (PGA-*stat*-PLA)-*block*-PEG-*block*-(PGA-*stat*-PLA) from the reaction of telechelic hydroxy-functionalized poly(ethylene glycol) (PEG) as initiator with mixtures of glycolide and *R,S*-lactide (referred to as *D,L*-lactide in the manuscript) was reported by Hadizadeh and coworkers [13]. Stannous 2-ethyl hexanoate was used as catalyst.

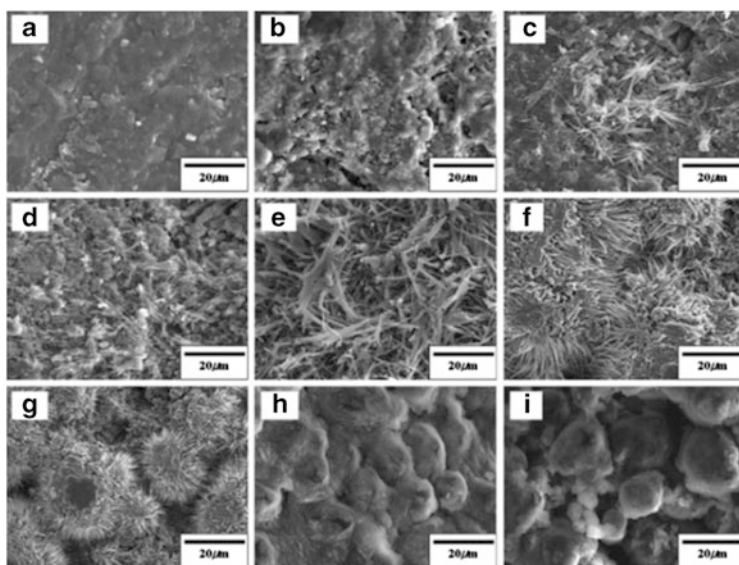

**Fig. 1** (a–i) States of degradation of PGA-*stat*-PLLA/ $\beta$ -TCP composites in simulated body fluid over 8 weeks. Reprinted from Jin et al. [11], with permission from Elsevier

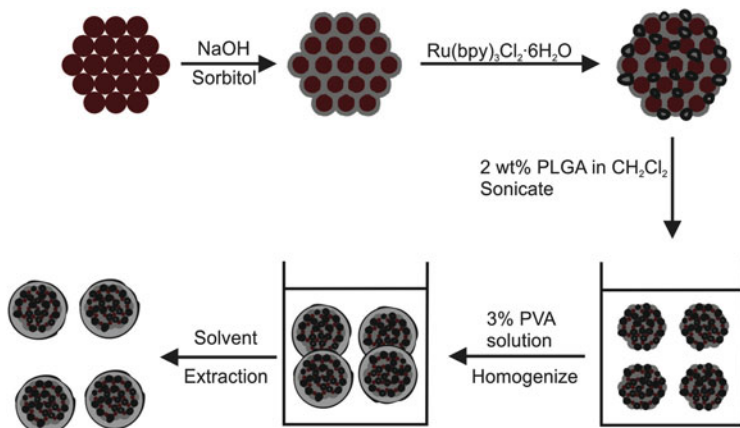

**Scheme 2** Formation of PLA-*stat*-PGA capsules containing iron core nanoparticles and a fluorescent dye

Notably, the copolymerizations were performed in control experiments under CH (150°C, stainless steel reactor) and MW-assisted heating (800 W, Milestone MicroSYNTH); temperatures of the MW-heated experiments, however, were not reported. The copolymers could be synthesized within 5 min under MW irradiation, whereas prolonged MW irradiation was not found to significantly (further) enhance the average molecular weights of the copolymers.

### 3 Poly(lactic acid)

The ROP of lactic acid (LA) is an excellent strategy for the synthesis of stereochemically defined polymers with narrow molecular weight distributions. The general demand for short reaction times and high yields has triggered an extensive discussion about the existence of non-thermal effects of MW-assisted heating. For the thoroughly investigated cationic ROP of 2-oxazolines, it has been shown that the acceleration can be traced back exclusively to thermal effects [14]; subsequent references have provided similar evidence for numerous other syntheses under MW irradiation [2]. Nonetheless, for the ROP of LA, there has been major debate about the (non-)existence of non-thermal MW effects, as will be addressed in the next section.

#### 3.1 Homopolymers of LA

In their work based on the polymerization of *R,S*-lactide (referred to as *D,L*-lactide), Grande and colleagues demonstrated that neither temperature-controlled MW

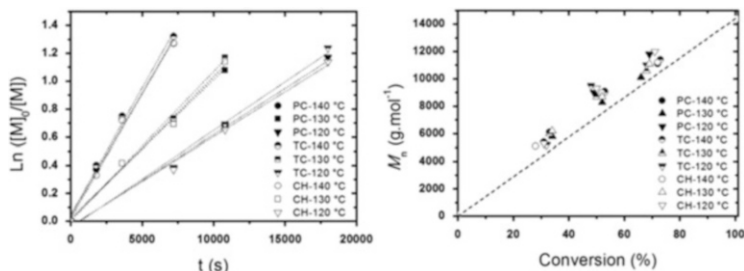

**Fig. 2** ROP of *R,S*-lactide: Kinetic evaluation and comparison of conventional heating (*CH*) with temperature-controlled (*TC*) and power-controlled (*PC*) MW-assisted heating. Reprinted from Ramier et al. [15], with permission from John Wiley and Sons

heating nor power-controlled MW heating exhibited significant differences compared with *CH* in terms of conversion rates or molar mass dispersity [15]. The slightly lower monomer conversion rate after 30 min reaction time during *CH* was attributed to the longer induction period needed to reach the reaction temperature of 140°C, compared with MW-assisted heating. A kinetic investigation at 120, 130, and 140°C was used to compare conversion rates versus time and to prove the living character of the ROP as well as first-order kinetics of the chain growth (Fig. 2). The kinetic constants were almost identical for all heating methods. All these results indicated that there were no specific MW effects involved in the polymerization of *R,S*-lactide.

The most common synthetic pathway for preparing PLA is the ROP of the dimeric cyclic esters, the lactides. A MW-supported two-step synthesis of *R,S*-lactide (referred to as *D,L*-lactide in the manuscript) was reported by Yang and Liu [16]. The initial polycondensation of a mixture of *R*-lactic acid and *S*-lactic acid to form oligomers of PLA was performed in a modified domestic MW equipment (Whirlpool T1202) with continuously tuneable power control. Reaction temperatures were reported to be around 170°C; the type of temperature detection, however, was not commented on. After oligomerization, the product was depolymerized in order to form the targeted *R,S*-lactide. Both reactions were accelerated dramatically by MW-assisted heating and the reaction times required to prepare *R,S*-lactide using zinc powder as catalyst were reported to be reduced by 50% as compared with *CH*. Overall yields of 40% were reported.

A similar synthesis was performed by Ohara and coworkers in their study of the preparation of PLLA without catalyst [17]. The polymerization was performed in two steps because the immediate heating of *L*-lactic acid under vacuum by microwave causes pressure surges. In order to overcome this issue, Ohara and colleagues prepared oligomers of PLLA by *CH*, and subsequently continued the polymerization using MW irradiation of a dedicated laboratory-scale MW reactor (CEM Discover). Temperature monitoring was provided by an internal IR sensor, allowing for accurate control. Compared to *CH*, a higher molecular weight of the polymer was reported, which was ascribed to the high dielectric constant of water and efficient heating. Notably, under MW irradiation, racemization was observed, which was attributed to transesterification. The mass-average molecular weight

( $M_m$ ) of the polymers reached a maximum of 5.3 kDa, and prolonged irradiation did not yield higher molecular weight polymers. Nevertheless, for prolonged reaction times, a higher DLA:LLA ratio in the polymers and discoloration of the product were observed. In addition, Ohara and coworkers reported the MW-supported depolymerization of oligomers of PLLA, aiming at obtaining diastereomerically pure *S,S*-lactide (referred to as *L,L*-lactide in the manuscript) [18]. Oligomers of PLA were irradiated at 120–180°C in a CEM Discover MW reactor. An increase in the yield of the lactide was observed, accompanied by a higher rate of racemization, yielding the *meso*-product. The racemization was found to depend on the pressure applied. Pressures below 15 mbar provided decreased ratios of the *meso*-product. This observation was ascribed to the rapid removal of the *S,S*-lactide from the reaction vessel under lower pressure.

As early as 2001, Liu et al. reported the MW-assisted ROP of *rac*-lactide with yields between 31 and 57% (in the manuscript, the melting point of 126°C was indicated, which is typical for a 50:50 mixture of *R,R*- and *S,S*-lactide [7]) [19]. Stannous octanoate was used as catalyst. A significant acceleration of the MW-assisted reaction was observed, resulting in reaction times as short as 1 h. In comparison, 24 h were required under CH. However, no comments on the applied MW equipment or temperature measurement were made; the MW-assisted heating was power-controlled. A further decrease in the reaction times required to obtain certain yields with increasing irradiation power was also reported. Prolonged irradiation times at high power levels (170 W) resulted in lower molecular weights and yields. The molar mass dispersity ( $\mathcal{D}_M$ ) values of the obtained PDLA-*stat*-PLLA ranged from 1.3 to 1.7, and the  $M_m$  values were found to range between 39 and 67 kDa. In a subsequent study, Liu and coworkers reported the synthesis of PDLA-*stat*-PLLA with  $M_m$  higher than 100 kDa [20]. The study investigated the influence of the irradiation power on the molecular weights (Fig. 3). Maximum  $M_m$

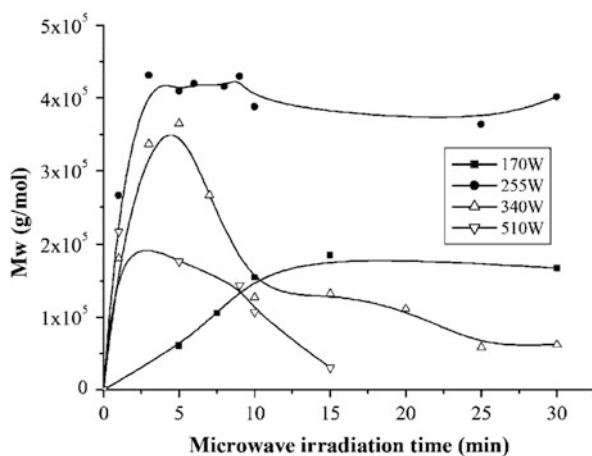

**Fig. 3** Molar mass of PDLA-*stat*-PLLA synthesized under MW irradiation and its correlation with irradiation time at different power levels. Reprinted from Zhang et al. [20], with permission from John Wiley and Sons

**Fig. 4** SEM image of PDLA-*stat*-PLLA microspheres obtained by spraying a THF solution of the polymer into a mixture of poly(vinyl alcohol) and water. Reprinted from Nikolic et al. [21], with permission from MDPI AG

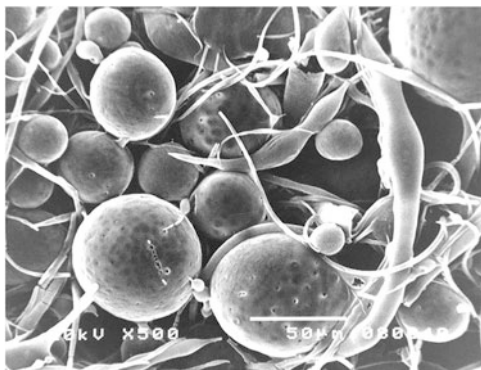

values of 431 kDa were observed at 255 W after 10 min. Prolonged irradiation times at even high power levels, however, induced polymer degradation.

The homopolymerization of *R,S*-lactide (referred to as *D,L*-lactide in the manuscript) using stannous 2-ethylhexanoate as catalyst under MW-assisted heating was reported by Nikolic et al. for monomer to catalyst ratios in the range of 1,000:1 to 10,000:1 [21]. The ROP was reported to proceed very fast in a CEM Discover MW reactor, namely within 30 min at 100°C. The reaction temperature was monitored by the built-in infrared pyrometer. The recovered polymers exhibited number-average molecular weight ( $M_n$ ) values of 26.7–112.5 kDa, and  $D_M$  values of 2.4–3.4. Notably, residual monomer was found in all reaction mixtures during work-up; the formation of cyclic by-products was not commented on. The microspheres of the PDLA-*stat*-PLLA polymer that were obtained from spraying tetrahydrofuran (THF) solutions of the polymer into a water/poly(vinyl alcohol) (PVA) mixture (Fig. 4) were found to exhibit diameters of 50  $\mu\text{m}$ , which is appropriate for phagocytosis by macrophages, and, consequently, were considered potential candidates for controlled-release devices.

The polymerization of *R,S*-lactide (referred to as *D,L*-lactide in the manuscript) with stannous octanoate under atmospheric conditions in a domestic MW oven was reported by Peng and coworkers [22]. High monomer purity was crucial in order to obtain polymers with high molecular weights, as residual hydroxyl groups were held responsible for chain-transfer reactions. The applied power of 450 W resulted in reaction times as short as 30 min. The measurement of temperatures was not reported; heat was generated using a dedicated MW-absorbing SiC-based heating medium in close contact with the open reaction vessel. Employment of monomers with a high purity of 99.99% and a heating media resulted in polymers with intrinsic viscosity mean values of  $2.46 \cdot 10^{-4}$ , which were the highest within the series of experiments. The influence of low pressure on the monomer conversion and molecular weight of the polymers was found to be marginal.

Given the toxicity of the commonly applied tin-based catalysts, alternative catalytic systems for the ROP of acid dimers (glycolide, lactide) are under constant investigation, in particular for medic(in)al applications of PLA. Frediani

et al. reported a calix[4]arene-based catalyst for the ROP of *S,S*-lactide (referred to as LLA in the manuscript) [23]. The cone-shaped macrocyclic titanium (IV) complex was stable up to 230°C. The catalytic activity was investigated under MW irradiation as well as under CH. Control experiments at 130°C under CH revealed enhanced polymerization rates for the MW protocol (temperature monitoring by an IR sensor placed below the vial). Further investigations revealed that the usage of this catalyst in the polymerization of *rac*-lactide enabled preparation of PLA polymers with isotactic stereoblock microstructure [24].

An alternative strategy for the in-situ inclusion of nanoparticles of calcium phosphate (see Sect. 2) into a matrix of PLLA according to MW-assisted protocols was described by Pandey and Aswath, who irradiated mixtures of calcium L-lactate, L-lactic acid, and ammonium hydrogen phosphate in a domestic MW oven [25]. PLLA polymers with  $M_m$  of 19 kDa were synthesized within 2 h under MW irradiation; the particles had sizes in the range of 10–20 nm. As the particles were synthesized in parallel to the polymerization, it was argued that the adhesion of the particles to the polymer matrix was enhanced.

Nanocomposites prepared from *R,S*-lactide (referred to as *D,L*-lactide in the manuscript) and organo-montmorillonite were reported by Wang and coworkers [26]. A domestic MW oven was modified such that it included a voltage regulator to adjust the power from 20 to 600 W. The temperature measurements were not commented on. Nanocomposites were synthesized by in-situ ROP in the bulk phase using stannous octanoate as catalyst, with reaction times as short as 10 min at power outputs of 90 W. The influence of the irradiation time on the mechanical properties of the obtained materials was ascribed to side reactions. It was argued that these reactions influence the chain propagation after prolonged irradiation times and lead to overheated reaction systems.

### 3.2 Copolymers of LA

Grande and coworkers reported the ROP of *R,S*-lactide (referred to as *D,L*-lactide in the manuscript) using poly(3-hydroxy alkanate)s (PHAs) as macroinitiator, yielding PHA-*block*-(PDLA-*stat*-PLLA) copolymers under MW-assisted heating (Scheme 3) [27]. The equipment used was an Anton Paar Monomode 300 MW reactor, providing a power output of up to 900 W. Temperatures were monitored by calibrated IR sensors at the bottom of the reaction vials. In order to synthesize PHA-*block*-(PDLA-*stat*-PLLA) copolymers of the targeted composition, the



**Scheme 3** Synthesis of PHA-*block*-(PDLA-*stat*-PLLA) diblock copolymers after initiation of the *R,S*-lactide polymerization by a poly(hydroxy alkanate) macroinitiator

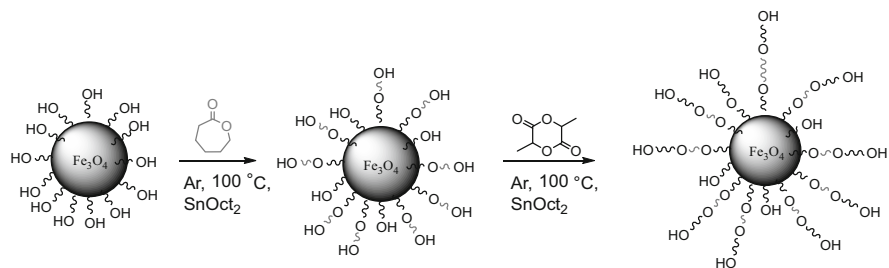

**Scheme 4** Surface-initiated ring-opening copolymerization of  $\epsilon$ -caprolactone and lactic acid

corresponding amounts of oligomeric PHA macroinitiators were used for initiation of the ROP of *R,S*-lactide. Macroinitiators with various molecular weights were prepared by methanolysis of PHA. Interestingly, the efficiency of the initiation was reported to be close to 100%. A reaction temperature of at least 115°C was needed for melting the macroinitiators, whereas higher temperatures had an adverse effect on the monomer conversion and the initiation efficiency. These findings were attributed to transesterification reactions. The polymerization of *R,S*-lactide was found to follow first-order kinetics, and the  $M_n$  of the polymers increased linearly with the monomer conversion. Monomer consumptions of 50–85% were obtained within 5 min. Size exclusion chromatography (SEC) analysis of the macroinitiator as well as the diblock copolymers revealed monomodal molecular weight distributions. The  $D_M$  values were determined to be between 1.5 and 1.9.

The preparation of hybrid core–shell particles consisting of magnetite cores with a shell of PLA, PCL or PCL-*block*-PLA (Scheme 4) was reported by Nan et al. [28]. They used a grafting-from strategy using inorganic magnetite particles that were modified with serine or glycolic acid as initiator, and used stannous octanoate as catalyst. The syntheses were performed under CH as well as in a MW reactor that enabled temperature and pressure measurement (no details of the type of reactor were given; see also reference [29]). A significant acceleration of the chain growth and the possibility of performing solvent-free syntheses were reported as the main benefits of MW-assisted heating. Transmission electron microscopy (TEM) characterization of the particles obtained after the homopolymerization of PCL revealed the successful synthesis of spherical hybrid nanoparticles with diameters of 22–27 nm.

Koroskenyi and McCarthy [30] described the MW-assisted homopolymerization of *S,S*-lactide (referred to as L-lactide) and  $\epsilon$ -caprolactone as well as grafting-from polymerizations of these monomers from various polymers such as acetylated starch or carboxymethylated konjac. Their work was performed in domestic MW ovens (Sharp Carousel II and Panasonic The Genius). Temperature acquisition was not reported. The authors reported grafting degrees of up to 25% and stated that higher degrees might be obtainable from reactions with optimized parameters.

The preparation of a chitosan-*graft*-(PDLA-*stat*-PLLA) copolymer by a grafting-from polymerization of *R,S*-lactide (referred to as *D,L*-lactide in the

manuscript) using chitosan (degree of deacetylation 90%) or hydroxyethyl-functionalized chitosan was described by Zhou and coworkers [31]. For the syntheses, a CEM Discover MW reactor was used. Optimized reaction parameters were found to be 130°C and 15 min of heating time. The polymerizations were catalyzed with stannous octanoate. Grafting degrees (derived from the weight gain) of more than 300% could be realized. In another study, Luo et al. described an increase in the grafting percentage from 320 to 632% when the monomer to initiator ratio was increased from 20:1 to 40:1 [32]. The lower crystallinity and thermal stability with higher monomer grafting percentages could be confirmed by X-ray diffraction (XRD) and thermogravimetric analysis (TGA).

A similar approach was followed by Yang and coworkers [33]. Instead of chitosan, they grafted an unspecified lactide from cellulose, using stannous octanoate as catalyst. The reaction mixture was heated at 130°C for 10 min using a Shanghai Yi-Yao MW reactor. The XRD and differential scanning calorimetry (DSC) analyses revealed lower crystallinity of the grafted cellulose; the thermal properties, however, remained unchanged due to the rigidity of cellulose.

Zhou and coworkers reported the application of a CEM Discover single-mode MW reactor for the grafting-from ROP of *S,S*-lactide (referred to as *L*-lactide) catalyzed with stannous octanoate; nano-hydroxyapatite was used as co-initiator [34]. Optimized reaction parameters in terms of maximum grafting degrees were found to be 140°C, 45 min reaction time, and 50 W MW power. Increasing the monomer to initiator ratio from 50:1 to 400:1 increased the grafting percentage from 15 to 36%. Notably, the core-shell particles were smaller in size than the pristine hydroxyapatite particles. This observation was referred to a lower agglomeration due to the organic shell.

The preparation of surface-grafted halloysite nanotubes was reported by Luo and coworkers [35]. Their work was aimed at the preparation of nanocomposite materials with enhanced mechanical properties from the interaction of the halloysite nanotubes with the PLLA matrix. For the graft polymerization, mixtures of *S,S*-lactide (referred to as *L*-lactide) and nanotubes in several ratios, together with various amounts of stannous octanoate, were heated in a CEM Discover laboratory scale MW reactor (Scheme 5). Residual solvents were removed by evacuation of the samples prior to the reaction. Optimized reaction conditions were found to be 130°C for 30 min and 30 W of irradiation power, resulting in grafting degrees of up to 42%.

The MW-assisted synthesis of PLLA-*block*-PEG-*block*-PLLA triblock copolymers (Scheme 6) was reported by Gong and coworkers [36]. Polymerizations were performed in a CEM Discover single-mode MW reactor using PEG with  $M_n$  of 1 or 2 kDa as initiator. *S,S*-Lactide (referred to as *L*-lactide in the manuscript) conversions of up to 92.4% were obtained within 3 min of irradiation using stannous 2-ethylhexanoate as catalyst. The  $M_n$  of the triblock copolymers determined by SEC ranged from 12.8 to 49.1 kDa, depending on the *S,S*-lactide to PEG ratio (ratios varied from 50:1 to 500:1). Reaction temperatures of 100°C were found to suppress polymer degradation, which was reported for prolonged irradiation times. Investigation of the polymers revealed the increase in  $T_m$  and  $T_g$  with higher PLA content.



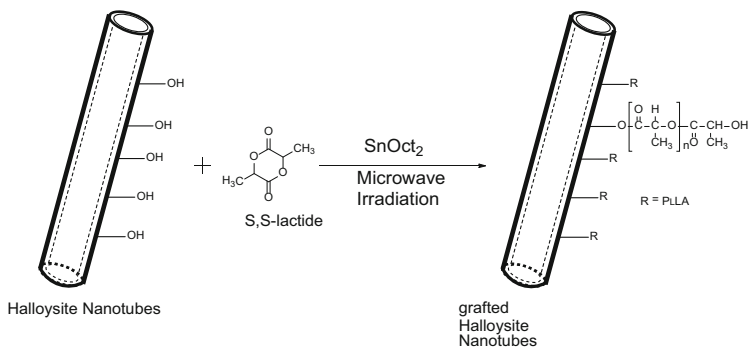

**Scheme 5** Graft-polymerization of *S,S*-lactide onto halloysite nanotubes

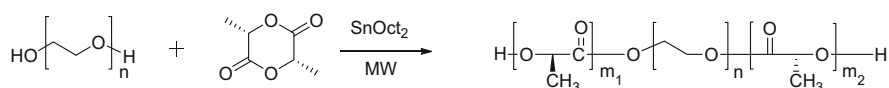

**Scheme 6** Synthesis of PLLA-*block*-PEG-*block*-PLLA triblock copolymers

A similar synthesis was reported by Gong and colleagues for a PLLA-*m*PEG diblock copolymer using methoxylated PEG (*m*PEG) as macroinitiator [37]. *S,S*-Lactide (referred to as *L*-lactide in the manuscript) was again used as monomer, and the MW-assisted polymerization was performed in a CEM Discover MW reactor, catalyzed by stannous octanoate. Block copolymers were obtained with  $M_n$  values of between 7.3 and 117.6 kDa. Notably, reaction times of 20 min at 100°C were found to be sufficient. For comparison, the syntheses were also performed using CH, revealing a pronounced acceleration under MW-assisted conditions. The authors also reported degradation of the block polymer at prolonged irradiation times, especially for polymers containing longer blocks of PEG.

The preparation of diblock copolymers such as PCL-*block*-PEG and PLA-*block*-PEG was reported by Karagöz and Dinçer [38]. Both polymerizations were initiated by methoxylated PEG of various weights (2 and 5 kDa) and catalyzed by stannous octanoate. The reactions were performed in a Milestone MicroSYNTH MW reactor under nitrogen atmosphere at 100°C for 5–60 min. In CH control experiments, the polymerizations needed at least 24 h for completion. Block copolymers with  $M_n$  of 5–13 kDa and  $D_M$  values of 1.12–1.19 were obtained in the case of PCL-*block*-PEG copolymers. The synthesis of PLA-*block*-PEG yielded copolymers with  $M_n$  values between 4.3 and 10.7 kDa and  $D_M$  values ranging from 1.10 to 1.16.

Ren and colleagues reported the MW-assisted synthesis of hexa-armed star-shaped PCL-*block*-PLLA copolymers using dipentaerythritol as initiator and stannous octanoate as catalyst (Scheme 7) [39]. The reactions were performed in a CEM Discover MW reactor. Using this initiator, first CL was polymerized and, subsequently, the polymerization was continued using *S,S*-lactide (referred

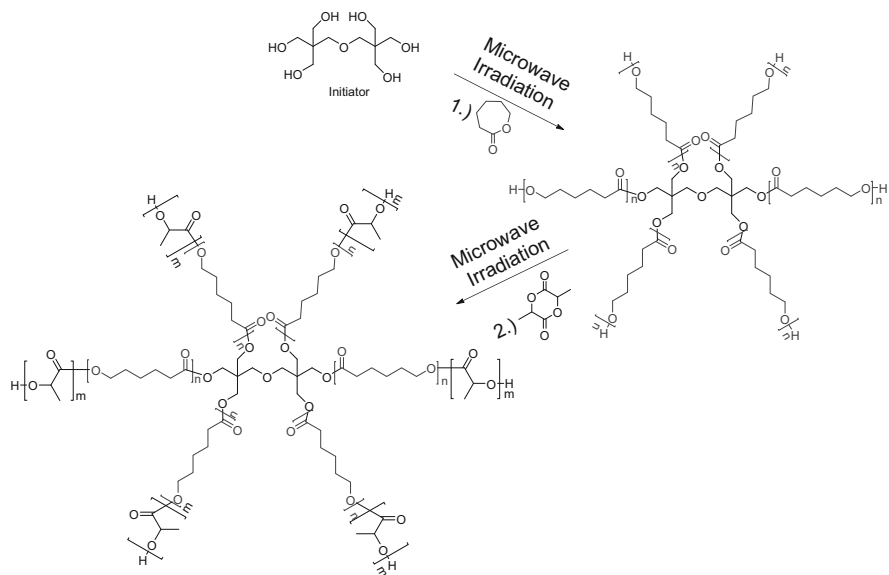

**Scheme 7** Synthesis of six-armed block copolymers of the composition PCL-*block*-PLLA

to as L-lactide in the manuscript) as monomer. Hydroxyl-terminated PCL was synthesized at 120°C for 40 min with an initiator to monomer ratio of 1:5.5. After recovery and cleaning steps, the product was used to initiate the polymerization of *S,S*-lactide. The polymerization was performed at 120°C for 20 min. The  $M_n$  values of the block copolymers ranged from 28.4 to 54.0 kDa, and the  $D_M$  values ranged from 1.16 to 1.25. The crystalline morphologies of the polymers were investigated by polarized optical microscopy.

## 4 Poly( $\epsilon$ -caprolactone)

### 4.1 Homopolymers of CL

Albert et al. investigated the ROP of CL using titanium tetrabutylate as catalyst [40] in a MW reactor (including temperature control by a fluoroptic temperature sensor) that provided monomodal irradiation of up to 850 W. The viscosity of the reaction mixture was measured in situ by a viscometer situated in the reaction vessel. The transmitted power decreased with rising temperature of the reaction mixture, indicative of increased absorption levels. Notably, the intensity of the transmitted radiation increased after some minutes, indicating a dramatic change in the absorption level of the reaction mixture. The changes in the viscosity of the reaction mixture were monitored for CH and MW-assisted heating; it increased earlier in the case of CH. Concomitant with monomer consumptions of 89–99%, the

$M_n$  values of the PCL ranged from 69 to 120 kDa, with  $D_M$  values of 1.8 to 2.1. Within reaction times of 4–68 min, no significant differences between CH and dielectric heating could be observed.

Barbier-Baudry and coworkers investigated the (hydrated) lanthanide halide-catalyzed synthesis of PCL oligomers [41]. The oligomerizations were performed in either a single-mode reactor by Prolabo (Synthewave S402 with temperature control by an IR detector) or in a GMP 12T reactor (Sairem, France, providing up to 1.2 kW of MW power). The group reported the successful synthesis of PCL with  $M_n$  values of 3.0–20.4 kDa and  $D_M$  values of 1.30–3.44. The molecular weights strongly depended on water in the monomer feed, which may act as co-initiator. Lower water contents enabled higher molecular weights. Correspondingly, coordinated water of the catalyst seemed to have an influence.

Liu and coworkers compared the MW-assisted, solvent-free polymerization of CL catalyzed by stannous octanoate or zinc powder with the CH polymerization under otherwise identical conditions [42]. An unspecified MW oven was used for dielectric heating at different power levels and a maximum heating time of 4.5 h. Using stannous octanoate as catalyst,  $M_m$  values of the polymers of 31.6–124 kDa were determined by SEC, concomitant with  $D_M$  values of 1.34–1.82. Zinc powder as catalyst yielded polymers with  $M_m$  values of 72.7–92.3 kDa and  $D_M$  values of 1.61–1.67. The polymers synthesized under CH were obtained with  $M_m$  values of 60 kDa after 24 h using stannous octanoate as catalyst or  $M_m$  values of 27 kDa after 48 h using zinc as catalyst.

Based on the aforementioned work, Liu and colleagues additionally surveyed the heating characteristics of the stannous octanoate-catalyzed ROP of CL [43]. The work was performed in a Whirlpool JA203 domestic MW reactor with a thermocouple inserted into the reaction vessel. For comparison, the polymerization was also performed using a salt bath for heating. Maximum temperatures in the range of 300–420°C were typically reached within 15 min of MW-assisted heating, while the temperature levels were reported to depend on irradiation power and the amount of CL in the reaction vessel. Exothermic heat generation was observed for reaction temperatures above 170°C. PCL with  $M_m$  values of 150 kDa was obtained within 1 h. In another study, the researchers used the National S570 domestic multimode MW oven for comparison experiments with flash CH [44]. The kinetic investigation of the polymerization revealed higher propagation for the flash-heated reaction than for the MW-assisted reaction. Furthermore, the average molecular weights were significantly higher at shorter reaction times. This finding was explained by a lower concentration of active species during flash heating. Liu and coworkers also reported the existence of non-thermal MW effects during the stannous octanoate-catalyzed polymerization of CL [45]. The National S570 domestic multimode MW oven was operated at power levels of 400, 500, 600, 700, and 800 W, yielding equilibrium temperatures of the polymerization mixtures of 165, 180, 197, 213, and 228°C. The rate constant did not increase with the observed increase in temperature, but abruptly increased at input powers of 500 W. By contrast, the polymerization under flash CH conditions followed the Arrhenius law, with an increase in the equilibrium temperature from 108 to 135, 151, 189, and 213°C. In

addition, the initiation time in the case of MW-assisted heating varied unsystematically with the temperature and was independent of the rate constant. Yet again by contrast, in the case of flash CH, initiation time was reduced exponentially from 127.5 to 36.40, 8.63, 1.22, and 0.579 min with the increase in polymerization temperature and rate constant. Due to these divergences between MW-assisted heating and CH, it was argued that the acceleration of the polymerization of CL by microwaves originated from non-thermal MW effects. It should be noted that the use of a domestic MW oven may have also led to a larger deviation of the results obtained under MW-assisted heating.

Liu and coworkers also investigated the ROP of CL initiated by carboxylic acids without the use of additional catalysts [46]; the ratio between benzoic acid and CL was 1:25. The MW equipment used as well as the kind of temperature measurement were not specified. Significant acceleration of the polymerization was observed, and PCLs with  $M_m$  values of up to 44.8 kDa and  $D_M$  values of 1.6 were reported. CH of an identically composed reaction mixture at 210°C for the same time yielded polymers with  $M_m$  values of 12.1 kDa and  $D_M$  values of 4.2.

A mechanistic investigation of the CL polymerization catalyzed by hydrogen phosphonates was reported by Liu and coworkers in 2009 [47]. In their work, a domestic MW oven (Whirlpool VIP 273F) was used. The mechanism of the polymerization was explained by an oligomerization of CL, initiated by traces of water in the reaction mixture. Subsequently, phosphorylated oligomers of PCL were formed by transesterification reactions until the hydrogen phosphonate species were completely consumed. Those oligomers were argued to act as catalyst for the MW-assisted ROP of the remaining CL monomers. In a more thorough report by the same group [48], the mechanism of the ROP of (water-free) CL catalyzed by hydrogen phosphonates was described as a two-step coordination–insertion reaction (Scheme 8).

Chang, Huang and colleagues prepared a nanocomposite material based on PCL-coated starch nanocrystals embedded in a PLA matrix [49] (see also reference [35]). For the preparation of the nanoparticles, CL and starch powder were mixed with stannous octanoate and subjected to 255 W of MW irradiation for 5 min. The MW equipment used was not specified. The recovered starch-*graft*-PCL was

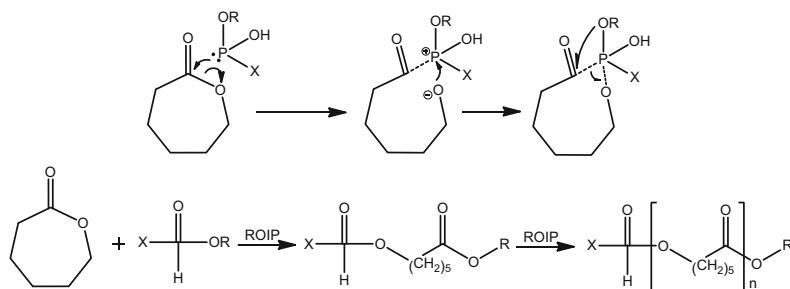

**Scheme 8** Coordination–insertion catalysis of the ROP of  $\epsilon$ -caprolactone in the presence of hydrogen phosphonates

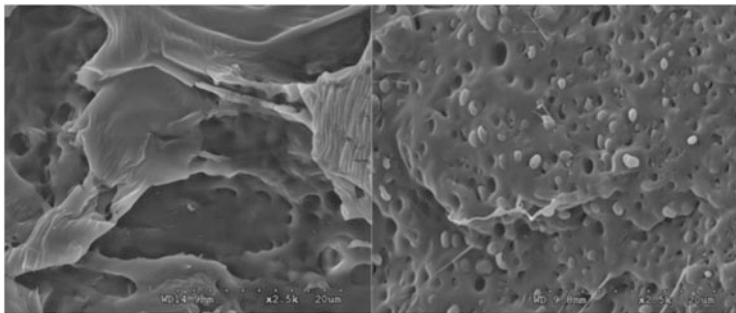

**Fig. 5** SEM images of fracture morphologies of pristine PLA (*left*) and starch-graft-PCL nanoparticles embedded in PLA at 15 wt% (*right*). Reprinted from Yu et al. [49], with permission from John Wiley and Sons

blended with commercially available PLA (81 kDa,  $D_M$  1.80) in different ratios. From these blends, films were fabricated. Figure 5 shows the morphologies of pure PLA and blends containing 15 wt% of the starch-graft-PCL nanoparticles (at fracture sites). The mechanical properties of the nanocomposites with 5 wt% nanoparticle content were reportedly better than those of pure PLA.

Gong and colleagues reported the preparation of clay/PCL nanocomposites by the ROP of CL with unmodified montmorillonite clay as well as with clay modified with quaternary ammonium cations bearing hydroxyl functions [50]. In their study, they found significant differences for MW-assisted heating in a CEM Discover single-mode MW reactor compared with CH in an oil bath: In reactions mixtures containing clay, monomer conversions of 98% under MW irradiation were found, as compared with conversions of 1% under CH (120°C for 1 h). The specific absorption of microwaves by the solid clay particles is a likely reason for the observed phenomena. Under MW irradiation, the amount of loading with unmodified Cloisite Na<sup>+</sup> had no direct effect on the  $M_n$  values (55.3–60.4 kDa), whereas the modified clay (Cloisite 30B) caused a decrease in the  $M_n$  values of the PCL with increasing clay loading as a consequence of the higher concentration of hydroxyl groups, which acted as initiators of the ROP (16.3–66.1 kDa).

In another study, Gong and coworkers investigated the thermodynamics of the preparation of montmorillonite/PCL-based nanocomposites in more detail [51], focusing on the Cloisite 30B clay. Pure CL, a polymerization mixture of CL and stannous octanoate, as well as a similar mixture additionally containing hydroxy-functionalized montmorillonite, were subjected to MW-assisted heating in a CEM Discover single-mode MW reactor. Power levels from 10 to 30 W in steps of 10 W were applied for 60 min while the temperature was monitored. As expected, for the pure CL, a temperature equilibrium was reached correlating with the irradiation power. For the polymerization mixtures, peaks and plateaus in the time–temperature curve revealed the exothermic character of the polymerization. For the montmorillonite-initiated polymerization, prolonged irradiation was found to have a degradative effect on the polymer.

The MW-assisted ROP of CL in the ionic liquid 1-*n*-butyl-3-methylimidazolium tetrafluoroborate was described by Liao, Gong, and colleagues [52]. In the Whirlpool JA203 MW reactor, the effect of up to 30 wt% of ionic liquid on the zinc oxide-catalyzed ROP of CL was investigated at power levels of up to 225 W. As observed before, the temperatures reached an equilibrium-state, with temperature levels depending on irradiation power and amount of the ionic liquid. The polymerization of pure CL was observed only at power levels of 170 and 225 W. The  $M_m$  values ranged from 2.2 to 11 kDa, with  $D_M$  values from 1.30 to 2.50. Addition of zinc oxide to the reaction mixture reduced the required power level for polymerization down to 85 W. The heating rate showed a strong dependency on the ionic liquid content. Without the presence of ionic liquid, however, no polymerization was observed even with catalyst. Depending on the ionic liquid content, average molecular weights of 2.4–15.8 kDa and  $D_M$  values of 1.5–2.4 were obtained.

Kerep and Ritter investigated the influence of MW radiation on enzyme-catalyzed ROPs [53]. CL was polymerized using the lipase Novozyme 435 as catalyst. A CEM Discover MW reactor with a fiber optic-based IR temperature sensor was used for MW-assisted heating. All polymerizations were performed in boiling solvents in open reaction vessels. Controversial findings were reported regarding the type of heating and the polarity of the solvent (THF, dioxane, toluene, benzene, and diethyl ether), which was conclusively argued by the authors to open a new field for further investigations. The enzymatically supported ROP of CL using mercaptoethanol as initiator was investigated by Kerep and Ritter in another study [54]. The MW-supported polymerizations were performed in CEM Discover reactor using the lipase Novozyme 435 as catalyst. Thiol-terminated PCLs with  $M_n$  values of 3.6 kDa were obtained, which compared well with the CH syntheses. The  $D_M$  values of the polymers were around 1.5 for both heating methods, while the yields nonetheless were significantly higher under dielectric heating. Additionally, the selectivity towards thiol-terminated PCLs was slightly increased under MW irradiation, despite their transesterification tendencies. Due to the thiol functions, the correspondingly thiol-functionalized PCL could be used as transfer-agent for the polymerization of styrene, yielding PCL-*block*-PSt copolymers.

A systematic and thorough investigation of the above-mentioned enzyme-catalyzed polymerization under solvent-free conditions was performed by Shah, Mahapatro and coworkers [55], comprising theoretical calculations and experimental validation. MW-assisted heating was performed on a CEM Discover reactor with integrated temperature monitor and compressed air cooling. Experimental results revealed that among the parameters tested, the reaction temperature had the highest positive influence on the properties of PCL such as the molecular weight, whereas high MW irradiation was found not to be desirable. Performance of the polymerization under optimized conditions (90°C, 4 h, and 50 W), yielded polymers with  $M_n$  values of 21 kDa and  $D_M$  values of 1.2. A cubic regression model was developed, and optimal process parameters were obtained using this model.

A MW-supported synthesis of PCL without metal catalysts was described by Liu and coworkers. [56]. Carboxylic acids and acid derivatives such as maleic anhydride, succinic acid, and adipic acid were used for initiation. The polymerizations were performed in an unspecified domestic MW oven at different power levels

from 270 to 720 W. PCL with  $M_m$  values of 4–12 kDa and  $D_M$  values of 1.1–1.8 was obtained for monomer consumptions of 30–85%. A linear relationship between MW power and the molecular mass of the polymer was found if the irradiation time and initiator to monomer ratio were kept constant. However, prolonged heating times were reported to cause degradation of the polymers. If the polymerizations of CL were performed from reaction mixtures containing ibuprofen, polymer/drug systems were obtained from which ibuprofen was released in a diffusion-controlled manner; polymer degradation was not observed during the release tests. In a consecutive study, Liu and coworkers tested the preparation of a drug release system based on PCL and its release characteristics [57]. PCL was prepared according to the above-mentioned method in the presence of 5 wt% ibuprofen. A 70% release of the encased drug within 12 h was reported by the authors.

Yu and Liu presented the polymerization of CL, initiated by benzoic acid without the use of additional catalyst, in a domestic MW device by Whirlpool (VIP275) [58]. SEC analysis revealed that the  $M_m$  values of the polymers were 2.2–44.8 kDa, compared with 2.0–7.8 kDa obtained from CH methods. The initiating activity of benzoic acid was proven by reference experiments: No polymer was obtained by heating the neat monomer alone. Three power levels of 340, 510, and 680 W were used to investigate the influence of MW power on chain propagation (Fig. 6). At high MW powers, significant degradation of the polymer was observed for prolonged reaction times.

The scale-up of the stannous octanoate-catalyzed MW-assisted ROP of CL was described by Zhu and coworkers [59]. The experiments were performed in a Nanjing WLD6S-01 multimode MW oven with a maximum power output of 6 kW. The reaction vessels had a volume of 1.8 L. The reaction temperature was measured by internal infrared sensors. Up to five reaction vessels could be loaded

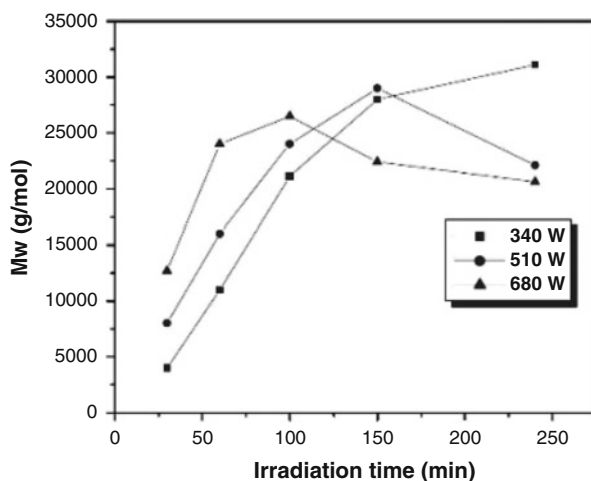

**Fig. 6** Correlation of  $M_m$  (referred to as  $M_w$ ) with reaction time at different irradiation powers for the polymerization of  $\epsilon$ -caprolactone with benzoic acid as initiator (monomer to initiator ratio = 5:1). Reprinted from Yu et al. [58], with permission from Elsevier

into the MW reactor, representing a total mass of 2.5 kg of CL. The recovered PCL exhibited  $M_m$  values of 100–1,000 kDa with  $\mathcal{D}_M$  values of 1.72–2.75. The monomer conversion rates reached 94%. Five consecutive experiments with 1.5 kg of CL performed at 850 W revealed  $M_m$  values of 95 kDa and conversion rates of over 90%, indicative of the good reproducibility of the large-scale reactions.

## 4.2 Copolymers of CL

The MW-supported stannous octanoate-catalyzed synthesis of PCL-*block*-PEG-*block*-PCL triblock-copolymers, either in bulk or solution, was thoroughly investigated by Sosnik and coworkers [60]. PEG oligomers with  $M_n$  values of 400 Da were used as initiator. The reactions were performed in a Whirlpool domestic MW oven. The spatial distribution of the MW intensity was determined prior to the polymerizations by using a  $\text{CoCl}_2$ -soaked filter paper, which changed color upon irradiation, indicating the areas of highest intensity. The bulk polymerizations were performed in open vessels. The highest monomer conversions were obtained for medium monomer to initiator ratios of less than 315:1 and reaction times of 10 min. The observation also made by other groups that prolonged irradiation time leads to polymer degradation could be confirmed. The triblock copolymers exhibited  $M_n$  values of up to 40 kDa. As the triblock copolymers contained a very low fraction of PEG only, they exhibited a hydrophobic character. The polymerization of CL in solution was studied using dimethyl sulfoxide (DMSO) and dimethyl formamide (DMF) as solvents. Reactions carried out in DMF showed results similar to the bulk polymerization. Upon usage of DMSO, solvent decomposition under the harsh conditions occurred.

The application of PCL-*block*-PEG-*block*-PCL triblock copolymers for controlled release of rifampicin, an effective drug against tuberculosis, was surveyed by Sosnik and coworkers in another study [61]. The work aimed at the preparation of micelles for controlled drug release and the subsequent correlation of the molecular properties of the triblock copolymers and drug release. The synthesis of the polymers was performed in an Iteco domestic MW device using stannous octanoate as catalyst, starting from commercially available PEG of different molecular weights as macroinitiators. A high-low-high power profile was applied in order to avoid overheating of the reaction mixture. For PEG blocks with a molecular weight of 20 kDa, DMF was added in order to overcome unfavorably high viscosity. In total, ten copolymers of different molecular weight and hydrophobic/hydrophilic character according to the PCL to PEG ratio were synthesized. The aggregation behavior of the copolymers was thoroughly investigated, and the encapsulation of rifampicin in the different copolymer families was evaluated. Micellar size appeared to be the determining property, being primarily controlled by the molecular weight of the PEG central block.

A similar study was performed by Yu and Liu [62]. Comments on the applied MW reactor were not provided. The ROPs of CL were performed using PEG with



**Scheme 9** Synthesis of PVA-*graft*-PCL copolymers

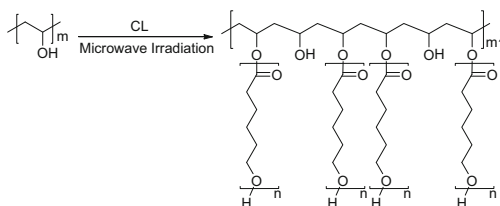

$M_n$  values from 800 to 4,000 Da as macroinitiator. It is noteworthy that no additional catalyst was used. A correlation of monomer conversion and irradiation time was observed: Conversion rates of 95% were obtained after 50 min at 680 W of irradiation power. At 340 W with otherwise similar conditions, no polymerizations were observed for the same reaction time. At constant reaction times of 120 min, monomer conversions of 42, 86, and 93% were reported for irradiation levels of 340, 510, and 680 W, respectively.

Yu and Liu reported the MW-assisted ROP of CL using PVA as initiator. The polymerizations were performed in a domestic MW oven (Whirlpool VIP275) [63]. Several PVA-*graft*-PCL comb-shaped copolymers (Scheme 9) were prepared with varying polymerization degrees of the grafted-from PCL segments. By increasing the MW power, higher polymerization degrees of between 3 and 24 were observed, concomitant with an increase in the substitution degree from 0.35 to 0.89. The monomer conversion correlated positively with irradiation time.

The preparation of starch-*graft*-PCL composites was described by Chang et al. [64]. No comment on the MW equipment applied was made. The synthesis was described as a one-pot reaction for the hydrophobic modification of commercially available starch (35% amylose and 65% amylopectin). Using stannous octanoate as catalyst, grafted PCL contents were in the range of 70%. Similar work was published by Huang and coworkers on the modification of cellulose by graft polymerization of CL from the surface [65]. Again, no specific information on the MW equipment was provided. The polymerization was catalyzed by stannous octanoate, and the weight ratio of cellulose to CL was set to 1:40. The obtained material, a cellulose whisker-*graft*-PCL dispersed in a matrix of PLA, showed enhanced mechanical strength and elongation properties compared with pristine PLA. In a similar study, thermoformable composite materials were reported by Feng and coworkers [66]. PCL was grafted-from chitin whiskers in order to obtain materials with enhanced strength and elongation. A positive correlation of these properties was reported with increasing amount of PCL.

A special pathway for the grafting polymerization of CL from chitosan was reported by Fang and coworkers, who used phthalic anhydride to temporarily protect the amino groups of the chitosan [67]. For the MW-heated synthesis, a Sanyo EV350S domestic MW oven was applied; the temperature measurement, however, was not described. The graft polymerization of CL was catalyzed by stannous octanoate, using the hydroxy groups of chitosan as initiators. The authors described an increased grafting percentage compared with CH. Additionally, an intense acceleration of the graft polymerization was reportedly observed, especially for irradiation powers of 450 W or more.

Tiwari and Prabakaran investigated the application of amphiphilic guar gum-*graft*-PCL as a drug delivery system [68]. The graft polymerization of CL was catalyzed by stannous octanoate and performed in domestic MW equipment (GE WES1130) operated at 55 W. The reaction mixtures were irradiated for up to 15 min and grafting percentages reached a maximum of 285% after 9 min. Guar gum with a molecular weight of 26 kDa was used as initiator. A significant acceleration of the graft polymerization was observed under MW irradiation. The obtained copolymers formed spherical micelles in aqueous solution, which were loaded after synthesis with ketoprofen and subjected to in-vitro tests, during which rapid release (4 days) of the model drug was observed at 37°C and pH 7.4.

Sinnwell and Ritter reported the application of a CEM Discover MW reactor for the amidation of PE-*stat*-PAA with 2-(2-aminoethoxy)ethanol [69]. The reaction yielded a hydroxy-functionalized PE-*stat*-PAA(OH) derivative, which was subsequently used as macroinitiator for the ROP of CL. This polymerization was performed under CH.

Nan et al. reported the polymerization of CL using D,L-serine-functionalized magnetite as initiator [29]. The polymerizations were performed using a CEM Discover laboratory-scale MW reactor with an internal IR device for temperature measurements, using stannous 2-ethylhexanoate as catalyst. The polymerizations were conducted at 200°C for 7 min at a power level of 200 W under solvent-free conditions. The authors reported accelerated chain propagation paired with a decreased rate of formation of growing centers.

Ritter and coworkers described the MW-supported synthesis of polyester macromolecules derived from the ROP of CL initiated by acrylic or methacrylic acid [70]. The polymerizations were performed in a CEM Discover MW reactor at the gram scale using stannous octanoate as catalyst. The power of MW irradiation was limited to 50 W, resulting in reaction temperatures of 180°C and favorable reaction times of 90 min. Despite the high temperature, spontaneous formation of radicals by the acrylic moiety was not observed. Samples with ratios of acrylic/methacrylic acid to CL ranging from 1:5 to 1:25 were prepared. SEC analyses revealed  $M_n$  values ranging from 1.3 to 2.9 kDa for the polymers initiated with methacrylic acid. The  $D_M$  values ranged from 1.8 to 2.1 and the conversion rates of the acid were between 39 and 71%. For the acrylic acid-initiated polymers, molecular weights of 1.2–2.3 kDa were obtained with  $D_M$  values of 1.7–2.1 (acid conversion of 61–100%).

The synthesis and characterization of PEG-*block*-PCL diblock copolymers was reported by Trathnigg and coworkers [71–73]. Several catalysts, namely stannous octanoate, sodium hydride, and boron trifluoride were applied. The polymerizations were performed in the Biotage Emrys Optimizer MW reactor under argon atmosphere. PEG methylesters with  $M_n$  values of 2.0 or 5.0 kDa were used as monofunctional initiators. The obtained polymers were analyzed by MALDI-TOF, SEC, and liquid chromatography under critical conditions (LCCC) revealing that stannous octanoate was the catalyst that yielded the lowest amount of by-products such as cyclic PCL and free acids. Trathnigg and coworkers expanded these investigations and analyzed the MW-assisted synthesis of PCL and its copolymers

with PEG by liquid chromatography and MALDI-TOF-MS. The polymerizations were catalyzed by stannous octanoate and initiated by PEGs with different degrees of polymerization. The polymerizations were performed utilizing an Emrys Optimizer EXP MW reactor by Biotage, operated at 140°C for 30 min. The analysis of the polymers by MALDI-TOF and SEC revealed a remarkably high content of the targeted triblock copolymers, indicative of effective initiation by both telechelic hydroxy groups of the polymers and oligomers of EG. The above-mentioned polymers were additionally subjected to two-dimensional chromatographic analyses by Trathnigg and coworkers in order to prove the applicability of these methods for analysis of the obtained polymers.

## 5 Polydioxanone

The ROP of dioxanone (DO) (Scheme 10) supported by MW irradiation was performed by Wang and coworkers in a domestic multimode MW oven (Whirlpool-J220), equipped with a thermocouple device for temperature measurement [74]. The device was capable of continuously controlling the irradiation power rather than pulse-wise applying the MW energy. Power levels of 90, 180, 270, and 360 W were applied for 25 min. The equilibrium temperature within the reaction mixtures (composed of the monomer DO and the initiator stannous octanoate) was reached after several minutes. The heating rates and temperature levels correlated with the irradiation power. For power levels of up to 270 W, a time-dependent increase in the viscosity-average molecular weight ( $M_v$ ) values of the polymers from 95 to 175 kDa was reported. Higher power levels led to degradation of the polymer. Compared to the CH reaction, intense acceleration was reported.

This study was expanded to other catalysts by Wang and coworkers, namely to triethyl aluminum, zinc, and tin powder [75]. A MAS-I MW reactor by Sineo was applied with a maximum power of 1,000 W and internal IR temperature acquisition. At a reaction temperature of 80°C and a reaction time of 30 min,  $AlEt_3$  exhibited the highest activity and yielded PDO with  $M_v$  weights of 197 kDa at a yield of 97%. In comparison, stannous octanoate yielded polymers with molecular weights of 102 kDa in 62% yield. As metallic catalysts, zinc and tin were compared. The metal powder catalysts were tested at 100°C for 60 min. At similar yields of 45%, tin powder yielded polymers with  $M_v$  masses of 40.5 kDa. Additionally, the influence of several parameters on the polymerization degrees and yields were investigated using  $AlEt_3$  as catalyst. At 100°C, 94% yield and  $M_v$  of 176 kDa were reached after 3 min; polymer degradation was observed for prolonged

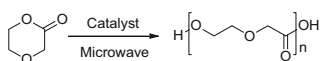

**Scheme 10** ROP of dioxanone

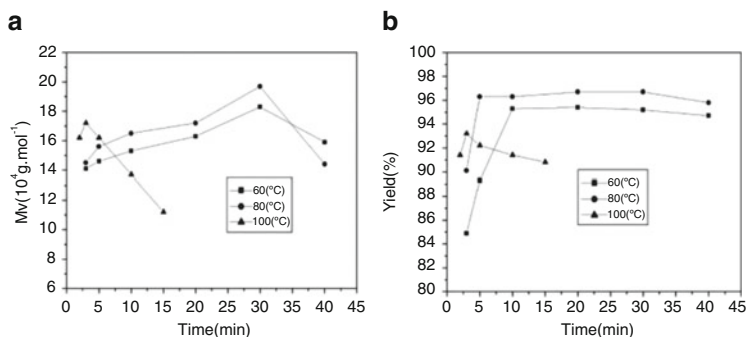

**Fig. 7** Viscosity-average molecular weight ( $M_v$ ) and yield of polydioxanone in correlation with MW power and irradiation time. The polymerization of dioxanone was catalyzed by triethyl aluminum. Reprinted from Chen et al. [75], with permission from John Wiley and Sons

irradiation times. This effect was not reported for lower temperatures (Fig. 7). The comparison of CH and MW-supported polymerizations of DO revealed an increase in yields and molecular weights under dielectric heating.

Wang et al. also used zinc L-lactate as catalyst for the MW-assisted ROP of DO in a MAS-I MW reactor by Sineo [76]. Initial investigations were performed with constant monomer to catalyst ratios of 400 and temperatures between 80 and 130°C. A temperature of 100°C applied for 6.5 h was found to be optimum, and PDOs with  $M_v$  values of 25.8 kDa were obtained. Monomer to catalyst ratios of 1,000:1 yielded polymers with higher molecular weights of 53.2 kDa. Dielectric heating accelerated the polymerization compared with CH; stannous octanoate, however, seemed to be more active than zinc L-lactate.

The dielectrically heated synthesis of biodegradable PCL-*stat*-PDO copolymers was investigated by Hao and coworkers [77]. Stannous octanoate was used as catalyst. No comments on the type of the MW equipment applied were made, but a reaction temperature of 140°C was reported. A series of experiments with a constant CL to DO monomer ratio of 60:40 and variation of irradiation time in steps of 5 min revealed almost complete CL consumption after 20 min. The DO consumption revealed a maximum of 74% after 20 min and decreased to 69% after 30 min. Variation of the CL to DO ratio between 90:10 and 60:40 had no significant influence on the monomer conversion.

## 6 Polycarbonates

Gong and colleagues reported the application of a CEM Discover MW reactor for the ROP of trimethylene carbonate (TMC) without the use of any metal catalysts [78]. The reactions were initiated by ethylene glycol; no additional solvent was added to the reaction mixtures. An integrated IR device enabled temperature measurements. Polymerizations were performed at remarkably low power levels

of 5, 10, 20, and 30 W. The temperature profile was designed such that it contained a two-step heating. After slow initial heating and a second more rapid temperature rise, followed by an exothermic peak, equilibrium temperatures in the range of 80–170°C were reached. Correlation of the power level with the equilibrium temperature was observed. Increased catalyst concentrations led to earlier exothermic reactions (not exceeding the equilibrium temperatures) and lower times required to reach the equilibrium temperature. An increase in molecular weight and monomer conversion, compared with the CH synthesis, was additionally reported.

Related to this work, Gong and coworkers also investigated the above-mentioned polymerization in the presence of the ionic liquid 1-*n*-butyl-3-methylimidazolium tetrafluoroborate [79]. Unlike the previous sets of experiments, this polymerization was catalyzed by stannous octanoate. The polymerization was significantly accelerated in the presence of 5 wt% of the ionic liquid, which was explained by the higher heating rates due to the increased absorbance. Higher amounts of ionic liquid, however, induced polymer degradation (after polymerization with high reaction rates). In summary, molar mass and monomer conversion rate were both significantly increased as compared with CH polymerizations.

As an alternative to the stannous octanoate-catalyzed polymerization of TMC, Gong and coworkers also investigated the application of zinc L-lactate and racemic zinc L-lactate/zinc D-lactate (as well as both types of zinc lactates in their hydrated form) as catalyst [80]. The syntheses were performed in a CEM Discover laboratory bench reactor on the gram scale. A temperature of 120°C was applied for 30 min. The four different zinc lactates were tested for catalytic activity and PTMC with  $M_n$  values between 2.9 to 75.4 kDa were obtained. The monomer consumption ranged from 85 to 98%. Both types of anhydrous zinc lactates yielded the highest molecular weights of PTMC within the test series. Although an acceleration of the polymerization under MW irradiation was reported, prolonged MW irradiation induced polymer degradation.

Gong and coworkers also reported the metal-free synthesis of triblock copolymers of the composition PTMC-*block*-PEG-*block*-PTMC [81], which were synthesized in a CEM Discover reactor. Telechelic PEG of different molar masses was used as macroinitiator. After dielectric heating at 120°C for 1 h, triblock polymers with  $M_n$  values of 16 kDa were obtained, and monomer consumptions of up to 97% for TMC were observed. Both values compared well with those obtained by CH syntheses. Increasing the ratios of TMC relative to PEG apparently had no effect on the monomer conversion rate and, hence, yielded triblock copolymers with higher molecular weights.

## 7 Various ROPs for the Synthesis of Polyesters

A different strategy for the MW-assisted synthesis of biodegradable polyesters was presented by Wang and coworkers, who investigated the step-growth polymerization of diglycidyl compounds and dicarboxylic acids in anhydrous DMF [82].

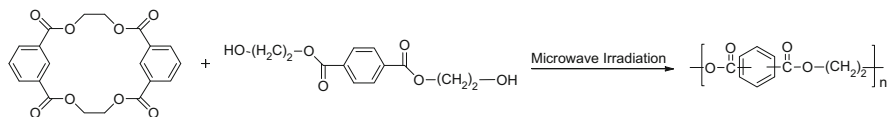

**Scheme 11** Synthesis of poly(ethylene terephthalate-*co*-isophthalate)

The synthesis was catalyzed by bis(tetrabutylammonium)sebacate. This catalyst was found to offer good biocompatibility, simple synthesis, and long storage stability. The polymerization was performed in a Biotage Initiator 2.5 MW reactor at 100°C for 10 min. Polymers exhibiting  $M_n$  values of up to 13 kDa were obtained with  $D_M$  values of 1.3–2.5. At very long irradiation times, the  $D_M$  values increased dramatically, with no effect on the yields of 76–88%.

Nagahata et al. presented the ROP of the cyclic dimer of ethylene isophthalate and bis(2-hydroxyethyl)terephthalate in the presence of catalytic amounts of 1,3-dichloro-1,1,3,3-tetrabutylstannoxan (Scheme 11) [83]. The polymerization was performed in a Toshiba ER-VS1 domestic MW oven operated at 500 W and at temperatures of approximately 200°C. Homopolymerizations of the dimer ethylene isophthalate failed under both conventional and MW-assisted heating. The copolymerization yielded polymers with  $M_m$  values of 5.9 kDa and high  $D_M$  values of 3 after 1 h under CH conditions. With MW support, polymers with  $M_m$  values of 8.4 kDa and a  $D_M$  of 2.4 were obtained after 30 min. Control experiments without catalyst failed to yield polymers with high molecular weights.

The MW-supported depolymerization of poly(ethylene terephthalate) (PET) was reported by Pingale and Shukla [84]. A domestic MW oven was heavily modified to enable the application of reflux conditions. Zinc acetate was, among other chemicals, used to catalyze the depolymerization. With yields comparable to those obtained by CH methods, the reaction time could be reduced dramatically. Achilias and coworkers reported a method for the depolymerization of poly(bisphenol-A carbonate) as an environmentally friendly strategy [85]. In their study, the alkaline hydrolysis of the material was performed in a CEM Discover MW reactor. An 80% degradation of the polymer was obtained after 40 min at 160°C using a 5% NaOH solution. Using 10% NaOH, the reaction time was reduced to 10 min.

## 8 Polyamides

Zhang and coworkers used a semi-telechelic  $\text{NH}_2$ -terminated PCL as macroinitiator for the stannous octanoate-catalyzed ROP of *N*-carboxy- $\gamma$ -benzyl *L*-glutamate anhydride [86]. The macroinitiator was prepared by the MW-supported ROP of CL initiated by aminoethanol, which was protected by a *tert*-butylcarbonyl group. After deprotection,  $\text{NH}_2$ -terminated PCL was obtained. The polymerization was performed on a Nanjing Jiequan industrial MW reactor at 500 W for 30 min. The

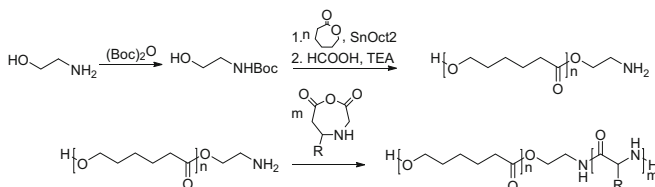

**Scheme 12** Synthesis of a PCL-based macroinitiator (*top*) and the ROP of *N*-carboxy- $\gamma$ -benzyl L-glutamate anhydride (*bottom*)

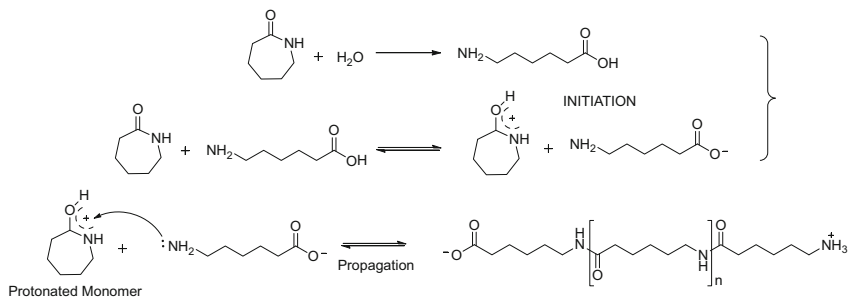

**Scheme 13** Reaction scheme for the ROP of  $\epsilon$ -caprolactam using amine initiators

ROP of the *N*-carboxyanhydride (NCA) monomer was performed under conventional conditions (Scheme 12).

Preceded by a report of the anionic copolymerization of  $\epsilon$ -caprolactam and  $\epsilon$ -caprolactone (initiated by lithium *tert*-butoxyaluminumhydride) [87], the MW-supported syntheses of poly( $\epsilon$ -caprolactam) as well as PCL were investigated by Scola and colleagues (Scheme 13) [88]. The syntheses were performed in a Teflon vessel that could be purged with nitrogen, using a LT 502Xb MW device. The MW furnace was operated at a variable frequency (4.69 GHz, frequency bandwidth of 1 GHz). Temperature measurement was available via a thermocouple, which was calibrated using an optical fiber thermometer prior to use. Unlike the standard industrial process for polymerization of  $\epsilon$ -caprolactam,  $\omega$ -aminocaproic acid was used as initiator (instead of water) at atmospheric pressure. The polymerizations were performed at 220, 250, and 280°C with reaction times ranging from 1 to 3 h. Poly( $\epsilon$ -caprolactam)s with molecular weights between 19.3 and 26.8 kDa were obtained with yields ranging from 79 to 89%. The polymerization of CL was initiated either by 1,4-butane-diol or trace amounts of water brought into the system by the stannous octanoate catalyst. Reaction times were set to 2 h and a range of temperatures between 120 and 200°C were applied. No polymerization was reported for the lowest temperature. For higher temperatures, yields of 90–95% were reported.  $M_v$  values of 10–12 kDa for the diol-initiated polymerization and 50.7–6.3 kDa for the water-initiated polymers were obtained.  $\bar{D}_M$  values were 1.7–1.9 and 2.3–2.5 for the diol- and water-initiated polymerizations, respectively.

The application of MW-assisted heating during the hydrolysis of polyamide-6 as an efficient recycling method was investigated by Klun and Kržan [89]. A Milestone MEGA 1200 industrial MW device was applied, operated at 500 W for 8 min. The hydrolysis was performed at the gram scale using zinc acetate, zinc chloride, zinc triflate, or phosphoric acid as catalysts. Zinc chloride seemed to be the only salt exhibiting the potential to catalyze the depolymerization of polyamide-6.

### Summary, Conclusions, and Outlook

The thorough review of recent advances in the research area of microwave-assisted synthesis of polyesters and polyamides by ring-opening polymerization presented here reveals five key messages:

1. The research area is still in its infancy, despite a continuously growing number of publications in the field.
2. By far the most interest and efforts are directed towards the polymerization of lactides and  $\epsilon$ -caprolactone; this exceptional interest assumingly originates from possible applications of the polymers and derived materials in the biomedical field. For the area of polyamides, pronouncedly little data is available.
3. With the exception of some studies (that, notably, are among the most cited and most recognized), the MW-assisted syntheses have been performed in domestic MW ovens. In addition to insufficient or completely absent safety devices, the measurement of temperature probably lacks accuracy. This fact paves the way for the next key message.
4. The discussion on the absence or existence of non-thermal MW effects currently lacks sufficient experimental data collected in a reproducible manner. MW effects might induce the ring closure of oligoesters (and to a lesser extent of oligoamides) because the water molecule eliminated is a medium MW absorber, in contrast to the rather low-absorbing cyclic monomers and polyesters. In a similar context, composites of polymers and metals or salts may be of a different micro- and nanocomposition if they are synthesized under MW irradiation instead of CH.
5. Regardless of possible non-thermal effects, MW irradiation causes significant enhancement of the rate of numerous polymerizations, rendering MW assistance the strategy-of-choice for the ROP of lactides,  $\epsilon$ -caprolactones, and  $\epsilon$ -caprolactames, polymerizations that are commonly associated with low reaction rates. Of special note are the utilization of ionic liquids as reaction media, use of enzymes as catalysts, and highly reproducible scale-up syntheses.

Predictions for the development of this research area must rely on the experiments performed to date. These have already shown the potential of

(continued)



this technique and have verified one major benefit of MW reactors: the fast heating of the reaction mixture to high temperatures. Given the comparatively small reaction scales accessible with MW reactors, a focus on PLAs and PCLs is a clever strategy because MW-assisted polymerizations currently seem to be favorable only for specialty and fine chemical syntheses. Further experimental data will be collected in the coming years, stimulating the discussion on non-thermal MW effects.

**Acknowledgement** The research work was performed within the K-Project “PolyComp” and at the Polymer Competence Center Leoben GmbH (PCCL, Austria) within the framework of the COMET-program of the Federal Ministry for Transport, Innovation and Technology and the Federal Ministry for Economy, Family and Youth, with contributions by the Graz University of Technology and Infineon Technologies Austria AG. Funding of the K-Project “PolyComp” is provided by the Austrian Government and the State Government of Styria; the PCCL is funded by the Austrian Government and the State Governments of Styria, Lower Austria, and Upper Austria.

## References

1. Luef KP, Hoogenboom R, Schubert US, Wiesbrock F (2015) Microwave-assisted cationic ring-opening polymerization of 2-oxazolines. *Adv Polym Sci*. doi:[10.1007/12\\_2015\\_340](https://doi.org/10.1007/12_2015_340)
2. Herrero MA, Kremsner JM, Kappe CO (2008) Nonthermal microwave effects revisited: on the importance of internal temperature monitoring and agitation in microwave chemistry. *J Org Chem* 73:36–47
3. Wiesbrock F, Hoogenboom R, Schubert US (2004) Microwave-assisted polymer synthesis: state-of-the-art and future perspectives. *Macromol Rapid Commun* 25:1739–1764
4. Ebner C, Bodner T, Stelzer F, Wiesbrock F (2011) One decade of microwave-assisted polymerizations: quo vadis? *Macromol Rapid Commun* 32:254–288
5. Zhang C, Liao L, Gong S (2007) Recent developments in microwave-assisted polymerization with a focus on ring-opening polymerization. *Green Chem* 9:303–314
6. Nakamura T, Nagahata R, Takeuchi K (2011) Microwave-assisted polyester and polyamide synthesis. *Mini-Reviews Org Chem* 8:306–314
7. Auras R, Lim L-T, Selke SEM, Tsuji H (eds) (2010) *Poly(lactic acid): synthesis, structures, properties, processing, and applications*. Wiley, Hoboken
8. Li G, Zhao N, Bai W, Chen DL, Xiong CD (2010) Microwave-assisted ring-opening polymerization of poly(glycolic acid-*co*-lactic acid) copolymers. *e-Polymers* 10:557–562. doi:[10.1515/epoly.2010.10.1.557](https://doi.org/10.1515/epoly.2010.10.1.557)
9. Jin H-H, Min S-H, Hwang KH, Park I-M, Park H-C, Yoon S-Y (2006) Synthesis of biodegradable  $\beta$ -TCP/PLGA composites using microwave energy. *Mater Sci Forum* 510–511:758–761
10. Park H-C, Jin H-H, Hyun Y-T, Lee WK, Yoon S-Y (2007) Degradation behaviors of  $\beta$ -TCP/PLGA composites prepared with microwave energy. *Key Eng Mater* 342–343:205–208
11. Jin H-H, Min S-H, Song Y-K, Park H-C, Yoon S-Y (2010) Degradation behavior of poly(lactide-*co*-glycolide)/ $\beta$ -TCP composites prepared using microwave energy. *Polym Degrad Stab* 95:1856–1861
12. Naik S, Carpenter EE (2008) Poly(D,L-lactide-*co*-glycolide) microcomposite containing magnetic iron core nanoparticles as drug carrier. *J Appl Phys* 103:07A313

13. Khodaverdi E, Tekie FSM, Mohajeri SA, Ganji F, Zohuri G, Hadizadeh F (2012) Preparation and investigation of sustained drug delivery systems using an injectable, thermosensitive, in situ forming hydrogel composed of PLGA-PEG-PLGA. *AAPS Pharm Sci Tech* 13(2): 590-600
14. Wiesbrock F, Hoogenboom R, Leenen MAM, Meier MAR, Schubert US (2005) Investigation of the living cationic ring-opening polymerization of 2-methyl-, 2-ethyl-, 2-nonyl-, and 2-phenyl-2-oxazoline in a single-mode microwave reactor. *Macromolecules* 38:5025-5034
15. Ramier J, Renard E, Grande D (2012) Microwave-assisted ring-opening polymerization of D,L-lactide: a probe for the nonexistence of nonthermal microwave effects. *Macromol Chem Phys* 213:784-788
16. Yang X-G, Liu L-J (2008) Improved preparation of D,L-lactide from D,L-lactic acid using microwave irradiation. *Polym Bull* 61:177-188
17. Hirao K, Masutani K, Ohara H (2009) Noncatalytic polycondensation of L-lactic acid under microwave irradiation. *J Chem Eng Jpn* 42:417-419
18. Hirao K, Masutani K, Ohara H (2009) Synthesis of L,L-lactide via depolymerization of oligo(L-lactic acid) by microwave irradiation. *J Chem Eng Jpn* 42:687-690
19. Liu LJ, Zhang C, Liao LQ, Wang XL, Zhuo RX (2001) Microwave-assisted polymerization of D,L-lactide with stannous octanoate as catalyst. *Chin Chem Lett* 12:663-664
20. Zhang C, Liao L, Liu L (2004) Rapid ring-opening polymerization of D,L-lactide by microwaves. *Macromol Rapid Commun* 25:1402-1405
21. Nikolic L, Ristic I, Adnadjevic B, Nikolic V, Jovanovic J, Stankovic M (2010) Novel microwave-assisted synthesis of poly(D,L-lactide): the influence of monomer/initiator molar ratio on the product properties. *Sensors* 10:5063-5073
22. Jing S, Peng W, Tong Z, Baoxiu Z (2006) Microwave-irradiated ring-opening polymerization of D,L-lactide under atmosphere. *J Appl Polym Sci* 100:2244-2247
23. Frediani M, Sémeril D, Matt D, Rizzolo F, Papini AM, Frediani P, Rosi L, Santella M, Giachi G (2010) L-lactide polymerization by calix[4]arene-titanium (IV) complex using conventional heating and microwave irradiation. *e-Polymers* 10:177-184. doi:10.1515/epoly.2010.10.1.177
24. Frediani M, Sémeril D, Matt D, Rosi L, Frediani P, Rizzolo F, Papini AM (2010) Ring-opening polymerisation of *rac*-lactide using a calix[4]arene-based titanium(IV) complex. *Int J Polym Sci*. doi:10.1155/2010/490724
25. Pandey A, Aswath P (2010) Microwave-assisted in situ synthesis of poly L-lactic acid with nanoparticles of calcium phosphate. *Int J Polym Mater* 59:911
26. Cao H, Wang P, Yuan W, Lei H (2010) Microwave-assisted preparation of poly-lactide/organomontmorillonite nanocomposites via in situ polymerization. *J Appl Polym Sci* 115: 1468-1473
27. Ramier J, Renard E, Grande D (2012) Microwave-assisted synthesis and characterization of biodegradable block copolyesters based on poly(3-hydroxyalkanoate)s and poly(D,L-lactide). *J Polym Sci Part A Polym Chem* 50:1445-1455
28. Nan A, Turcu R, Craciunescu I, Leostean C, Bratu I, Liebscher J (2009) Surface initiated ring-opening polymerization of lactones on iron oxide nanoparticles. *J Phys Conf Ser* 182:4pp
29. Nan A, Turcu R, Craciunescu I, Pana O, Scharf H, Liebscher J (2009) Microwave-assisted graft polymerization of  $\epsilon$ -caprolactone onto magnetite. *J Polym Sci Part A Polym Chem* 47: 5397-5404
30. Koroskenyi B, McCarthy SP (2002) Microwave-assisted solvent-free or aqueous-based synthesis of biodegradable polymers. *J Polym Environ* 10:93-104
31. Luo B, Yang J, Zhao J, Hsu CE, Li J, Zhou C (2011) Rapid synthesis and characterization of chitosan-g-poly(D,L-lactide) copolymers with hydroxyethyl chitosan as a macroinitiator under microwave irradiation. *J Appl Polym Sci* 125:E125-E131
32. Luo B-H, Zhong C-H, He Z-G, Zhou C-R (2009) Microwave-assisted synthesis of a brush-like copolymer of poly(D,L-lactide) grafted onto chitosan. In: Proceedings 3rd international conference on bioinformatics and biomedical engineering, 11-13 June 2009, Beijing, pp 1-3. doi:10.1109/ICBBE.2009.5163057

33. Duan J, Han C, Yang J (2012) Preparation of cellulose copolymer grafted polylactide(PLA) by the microwave method. In: Proceedings of the international conference on biobased material science and engineering, 21–23 October 2012, Changsha, pp 96–98. doi:[10.1109/BMSE.2012.6466189](https://doi.org/10.1109/BMSE.2012.6466189)
34. Luo B, Hsu CE, Yang J, Zhao J, Zhou C (2011) Synthesis of nano-hydroxyapatite surface-grafting poly(L-lactide) under microwave irradiation. *Adv Mater Res* 204–210:1929–1933
35. Luo B-H, Hsu C-E, Li J-H, Zhao L-F, Liu M-X, Wang X-Y, Zhou C-R (2013) Nano-composite of poly(L-lactide) and halloysite nanotube surface-grafted with L-lactide oligomer under microwave irradiation. *J Biomed Nanotechnol* 9:649–658
36. Zhang C, Liao L, Gong S (2007) Microwave-assisted synthesis of PLLA-PEG-PLLA triblock copolymers. *Macromol Rapid Commun* 28:422–427
37. Zhang C, Liao L, Gong S (2007) Synthesis of PLLA-MPEG diblock copolymers by microwave-assisted copolymerization of L-lactide and methoxy poly(ethylene glycol). *Macromol Chem Phys* 208:1122–1128
38. Karagöz A, Dinçer S (2010) Microwave-assisted synthesis of poly( $\epsilon$ -caprolactone)-*block*-poly(ethylene glycol) and poly(lactide)-*block*-poly(ethylene glycol). *Macromol Symp* 395:131–137
39. Zhang Z, Ren J, Feng Y, Li J, Yuan W (2010) Microwave-assisted synthesis of star shaped poly( $\epsilon$ -caprolactone)-*block*-poly(L-lactide) copolymers and the crystalline morphologies. *J Polym Sci Part A Polym Chem* 48:5063–5071
40. Albert P, Warth H, Mülhaupt R (1996) Comparison of thermal and microwave-activated polymerization of  $\epsilon$ -caprolactone with titanium tetrabutylate as catalyst. *Macromol Chem Phys* 197:1633–1641
41. Barbier-Baudry D, Brachais C-H, Cretu A, Loupy A, Stuerger D (2002) An easy way toward  $\epsilon$ -caprolactone macromonomers by microwave irradiation using early lanthanide halides as catalysts. *Macromol Rapid Commun* 23:200–204
42. Liao Q, Liu LJ, Zhang C, He F, Zhuo RX, Wan K (2002) Microwave-assisted ring-opening polymerization of  $\epsilon$ -caprolactone. *J Polym Sci Part A Polym Chem* 40:1749–1755
43. Liao LQ, Liu LJ, Zhang C, He F, Zhuo RX (2003) Heating characteristics and polymerization of  $\epsilon$ -caprolactone under microwave irradiation. *J Appl Polym Sci* 90:2657–2664
44. Li H, Liao L, Wang Q, Liu L (2010) Flash-heating-enhanced ring-opening polymerizations of  $\epsilon$ -caprolactone under conventional conditions. *Macromol Chem Phys* 207:1789–1793
45. Li H, Liao L, Liu L (2007) Kinetic investigation into the non-thermal microwave effect on the ring-opening polymerization of  $\epsilon$ -caprolactone. *Macromol Rapid Commun* 28:411–416
46. Yu ZJ, Liu LJ, Zhuo RX (2002) Microwave-improved polymerization of  $\epsilon$ -caprolactone initiated by carboxylic acids. *J Polym Sci Part A Polym Chem* 41:13–21
47. Tan BY, Cai S, Liao L, Wang Q, Liu L (2009) Microwave-assisted ring-opening polymerization of  $\epsilon$ -caprolactone in presence of hydrogen phosphonates. *Polym J* 41:849–854
48. Liu LJ, Cai SJ, Tan Y, Du JJ, Dong HQ, Wu XJ, Wu MY, Liao LQ (2009) Ring opening insertion polymerization of  $\epsilon$ -caprolactone with hydrogen phosphonate initiators. *J Polym Sci Part A Polym Chem* 47:6214–6222
49. Yu J, Ai F, Dufresne A, Gao S, Huang J, Chang PR (2008) Structure and mechanical properties of poly(lactic acid) filled with (starch nanocrystal)-*graft*-poly( $\epsilon$ -caprolactone). *Macromol Mater Eng* 293:763–770
50. Liao L, Zhang C, Gong S (2007) Preparation of poly( $\epsilon$ -caprolactone)/clay nanocomposites by microwave-assisted in situ ring-opening polymerization. *Macromol Rapid Commun* 28:1148–1154
51. Liao L, Zhang C, Gong S (2007) Microwave-assisted synthesis and characterization of poly( $\epsilon$ -caprolactone)/montmorillonite nanocomposites. *Macromol Chem Phys* 208:1301–1309
52. Liao L, Liu L, Zhang C, Gong S (2006) Microwave-assisted ring-opening polymerization of  $\epsilon$ -caprolactone in the presence of ionic liquid. *Macromol Rapid Commun* 27:2060–2064
53. Kerep P, Ritter H (2006) Influence of microwave irradiation on the lipase catalyzed ring-opening polymerization of  $\epsilon$ -caprolactone. *Macromol Rapid Commun* 27:707–710

54. Kerep P, Ritter H (2006) Chemoenzymatic synthesis of polycaprolactone-*block*-polystyrene via macromolecular chain transfer reagents. *Macromol Rapid Commun* 28:759–766
55. Matos TD, King N, Simmons L, Walker C, McClain AR, Mahapatro A, Rispoli FJ, McDonnell KT, Shah V (2011) Microwave assisted lipase catalyzed solvent free poly- $\epsilon$ -caprolactone synthesis. *Green Chem Lett Rev* 4:73–79
56. Song Y, Weng X, Zhuo R, Liu L (2002) Acid-initiated polymerization of  $\epsilon$ -caprolactone under microwave irradiation and its application in the preparation of drug controlled release system. *J Biomater Sci Polymer Edn* 14:241–253
57. Song Y, Liu LJ, Zhuo RX (2003) Microwave-assisted polymerization of  $\epsilon$ -caprolactone with maleic acid as initiator and drug release behavior of ibuprofen-poly( $\epsilon$ -caprolactone) system. *Chin Chem Lett* 14:32–34
58. Yu ZJ, Liu LJ (2004) Effect of microwave energy on chain propagation of poly( $\epsilon$ -caprolactone) in benzoic acid-initiated ring opening polymerization of  $\epsilon$ -caprolactone. *Eur Polym J* 40:2213–2220
59. Xu Q, Zhang C, Cai S, Zhu P, Liu L (2010) Large-scale microwave-assisted ring-opening polymerization of  $\epsilon$ -caprolactone. *Ind Eng Chem* 16:872–875
60. Gotelli GA, Bonelli P, Abraham GA, Sosnik A (2010) Fast and efficient synthesis of high molecular weight poly(epsilon-caprolactone) diols by microwave-assisted polymer synthesis. *J Appl Polym Sci* 121:1321–1329
61. Moretton MA, Glisoni RJ, Chiappetta DA, Sosnik A (2010) Molecular implications in the nanoencapsulation of the anti-tuberculosis drug rifampicin within flower-like polymeric micelles. *Colloids Surf B* 79:467–479
62. Yu Z, Liu L (2005) Microwave-assisted synthesis of poly( $\epsilon$ -caprolactone)-poly(ethylene glycol)-poly( $\epsilon$ -caprolactone) tri-block co-polymers and use as matrices for sustained delivery of ibuprofen taken as model drug. *J Biomater Sci Polymer Edn* 16:957–971
63. Yu Z, Liu L (2007) Biodegradable poly(vinyl alcohol)-graft-poly( $\epsilon$ -caprolactone) comb-like polyester: microwave synthesis and its characterization. *J Appl Polym Sci* 104:3973–3979
64. Chang PR, Zhou Z, Xu P, Chen Y, Zhou S, Huang J (2009) Thermoforming starch-*graft*-polycaprolactone biocomposites via one-pot microwave assisted ring opening polymerization. *J Appl Polym Sci* 113:2973–2979
65. Lin N, Chen G, Huang J, Dufresne A, Chang PR (2009) Effects of polymer-grafted natural nanocrystals on the structure and mechanical properties of poly(lactic acid): a case of cellulose whisker-*graft*-polycaprolactone. *J Appl Polym Sci* 113:3417–3425
66. Feng L, Zhou Z, Dufresne A, Huang J, Wei M, An L (2008) Structure and properties of new thermoforming bionanocomposites based on chitin whisker-*graft*-polycaprolactone. *J Appl Polym Sci* 112:2830–2837
67. Liu L, Li Y, Fang Y-E, Chen L (2005) Microwave-assisted graft copolymerization of  $\epsilon$ -caprolactone onto chitosan via the phthaloyl protection method. *Carbohydr Polym* 60:354–356
68. Tiwari A, Prabakaran M (2010) An amphiphilic nanocarrier based on guar gum-*graft*-poly( $\epsilon$ -caprolactone) for potential drug-delivery applications. *J Biomater Sci* 21:937–949
69. Sinwell S, Ritter H (2007) Microwave assisted hydroxyalkylamidation of poly(ethylene-*co*-acrylic acid) and formation of grafted poly( $\epsilon$ -caprolactone) side chains. *J Polym Sci Part A Polym Chem* 45:3659–3667
70. Sinnwell S, Schmidt AM, Ritter H (2006) Direct synthesis of (meth-)acrylate poly( $\epsilon$ -caprolactone) macromonomers. *J Macromol Sci Part A Pure Appl Chem* 43:469–476
71. Hasnat A, Trathnigg B (2009) Characterization of poly(ethylene glycol)-*b*-poly( $\epsilon$ -caprolactone) by two-dimensional liquid chromatography. *J Sep Sci* 32:1390–1400
72. Hasnat A, Trathnigg B, Kappe CO, Saf R (2009) Characterization of poly(ethylene glycol)-*b*-poly( $\epsilon$ -caprolactone) by liquid chromatography under critical conditions: influence of catalysts and reaction conditions on product composition. *Eur Polym J* 45:2338–2347

73. Ahmed H, Trathnigg B, Kappe CO, Saf R (2010) Synthesis of poly( $\epsilon$ -caprolactone) diols and EO-CL block copolymers and their characterization by liquid chromatography and MALDI-TOF-MS. *Eur Polym J* 46:494–505
74. Li Y, Wang X-L, Yang K-K, Wang Y-Z (2006) A rapid synthesis of poly(*p*-dioxanone) by ring-opening polymerization under microwave irradiation. *Polym Bull* 57:873–880
75. Chen Y-Y, Wu G, Qiu Z-C, Wang X-L, Zhang Y, Lu F, Wang Y-Z (2008) Microwave-assisted ring-opening polymerization of *p*-dioxanone. *J Polym Sci Part A Polym Chem* 46:3207–3213
76. Wang X-L, Chen Y-Y, Wang Y-Z (2010) Synthesis of poly(*p*-dioxanone) catalyzed by Zn L-lactate under microwave irradiation and its application in ibuprofen delivery. *J Biomater Sci* 21:927–936
77. Chen R, Hao JY, Xiong CD, Deng XM (2010) Rapid synthesis of biodegradable poly( $\epsilon$ -caprolactone-*co-p*-dioxanone) random copolymers under microwave irradiation. *Chin Chem Lett* 21:249–252
78. Liao L, Zhang C, Gong S (2007) Rapid synthesis of poly(trimethylene carbonate) by microwave-assisted ring-opening polymerization. *Eur Polym J* 43:4289–4296
79. Liao L, Zhang C, Gong S (2007) Microwave-assisted ring-opening polymerization of trimethylene carbonate in the presence of ionic liquid. *J Polym Sci Part A Polym Chem* 45: 5857–5863
80. Zhang C, Liao L, Gong S (2008) Zinc lactate-catalyzed ring-opening polymerization of trimethylene carbonate under microwave irradiation. *J Appl Polym Sci* 110:1236–1241
81. Liao L, Zhang C, Gong S (2008) Preparation of poly(trimethylene carbonate)-*block*-poly(ethylene glycol)-*block*-poly(trimethylene carbonate) triblock copolymers under microwave irradiation. *React Funct Polym* 68:751–758
82. You Z, Bi X, Jeffries EM, Wang Y (2012) A biocompatible, metal-free catalyst and its application in microwave-assisted synthesis of functional polyesters. *Polym Chem* 3:384–389
83. Nagahata R, Sugiyama J-I, Velmathi S, Nakao Y, Goto M, Takeuchi K (2004) Synthesis of poly(ethylene terephthalate-*co*-isophthalate) by copolymerization of ethylene isophthalate cyclic dimer and bis(2-hydroxyethyl) terephthalate. *Polym J* 36:483–488
84. Pingale ND, Shukla SR (2008) Microwave assisted ecofriendly recycling of poly(ethylene terephthalate) bottle waste. *Eur Polym J* 44:4151–4156
85. Tsintzou GP, Antonakou EV, Achilias DS (2012) Environmentally friendly chemical recycling of poly(bisphenol-A carbonate) through phase transfer-catalysed alkaline hydrolysis under microwave irradiation. *J Hazard Mater* 241–242:137–145
86. Wu Q, Zhou L, Zhang D, Song X, Zhang G (2011) Synthesis and characterization of biodegradable poly( $\epsilon$ -caprolactone)/poly( $\gamma$ -benzyl L-glutamate) block copolymer. *Polym Bull* 67:1227–1236
87. Fang X, Hutcheon R, Scola DA (2000) Microwave syntheses of poly( $\epsilon$ -caprolactam-*co*- $\epsilon$ -caprolactone). *J Polym Sci Part A Polym Chem* 38:1379–1390
88. Fang X, Simone CD, Vaccaro E, Huang SJ, Scola DA (2002) Ring-opening polymerization of  $\epsilon$ -caprolactam and  $\epsilon$ -caprolactone via microwave irradiation. *J Polym Sci Part A Polym Chem* 40:2264–2275
89. Klun U, Kržan A (2002) Degradation of polyamide-6 by using metal salts as catalyst. *Polym Adv Technol* 13:817–822

# Microwave-Assisted Cationic Ring-Opening Polymerization of 2-Oxazolines

**Klaus P. Luef, Richard Hoogenboom, Ulrich S. Schubert,  
and Frank Wiesbrock**

**Abstract** More than any other polymer class, the synthesis of (co-)poly(2-oxazoline)s has benefited tremendously from the introduction of microwave reactors into chemical laboratories. This review focuses on research activities in the area of (co-)poly(2-oxazoline)s prepared by microwave-assisted syntheses and summarizes the current state-of-the-art for microwave-assisted syntheses of 2-oxazoline monomers, microwave-assisted ring-opening (co-)polymerizations of 2-oxazolines, and prominent examples of post-polymerization modifications of (co-)poly(2-oxazoline)s. Special attention is paid to kinetic analyses of the microwave-assisted polymerization of 2-oxazolines and to the discussion of non-thermal microwave effects.

**Keywords** Microwave-assisted polymerization • Non-thermal microwave effects • Poly(2-oxazoline) • Post-polymerization modification • Ring-opening polymerization

---

K.P. Luef

Polymer Competence Center Leoben GmbH, Roseggerstrasse 12, 8700 Leoben, Austria

Graz University of Technology, Institute for Chemistry and Technology of Materials, NAWI Graz, Stremayrgasse 9, 8010 Graz, Austria

R. Hoogenboom

Supramolecular Chemistry Group, Department of Organic and Macromolecular Chemistry, Ghent University, Krijgslaan 281 S4, 9000 Ghent, Belgium

U.S. Schubert

Laboratory for Organic and Macromolecular Chemistry (IOMC), Friedrich Schiller University Jena, Humboldtstrasse 10, 07743 Jena, Germany

Jena Center for Soft Matter (JCSM), Friedrich Schiller University Jena, Philosophenweg 7, 07743 Jena, Germany

F. Wiesbrock (✉)

Polymer Competence Center Leoben GmbH, Roseggerstrasse 12, 8700 Leoben, Austria

e-mail: [frank.wiesbrock@pccl.at](mailto:frank.wiesbrock@pccl.at)

## Contents

1	Introduction .....	185
2	Synthesis of 2-Oxazoline Monomers .....	185
2.1	MW-Assisted Syntheses of 2-Oxazolines from the Reaction of Carboxylic Acids and Derived Compounds with Amino Alcohols .....	186
2.2	Other MW-Assisted Syntheses of 2-Oxazoline Monomers .....	188
3	Homopoly(2-oxazoline)s: Detailed Investigation of the Polymerization Kinetics .....	189
3.1	CROP of 2-Oxazolines with Aliphatic and Aromatic Side Chains .....	189
3.2	2-Oxazolines with Functionalized Side Chains and Higher Homologs of 2-Oxazolines .....	191
3.3	MW-Assisted Syntheses of Homopoly(2-oxazoline)s: Special Applications .....	193
4	MW-Assisted Copolymerizations of 2-Oxazolines .....	195
4.1	Block Copoly(2-oxazoline)s .....	195
4.2	Statistical Copoly(2-oxazoline)s .....	196
4.3	Gradient Copoly(2-oxazoline)s .....	196
5	Post-Polymerization Modifications .....	197
5.1	Click Chemistry .....	197
5.2	Crosslinking .....	199
5.3	Hydrolysis .....	201
6	Summary, Conclusions, and Outlook .....	202
	References .....	203

## Abbreviations

AFM	Atomic force microscopy
Bu <sup>=</sup> Ox	2-But-3'-enyl-2-oxazoline
CH	Conventional heating
CROP	Cationic ring-opening polymerization
Dc <sup>=</sup> Ox	2-Dec-9'-enyl-2-oxazoline
DLS	Dynamic light scattering
DP	Degree of polymerization
EtOx	2-Ethyl-2-oxazoline
IL	Ionic liquid
MALDI-TOF	Matrix-assisted laser desorption ionization – time-of-flight
MeOx	2-Methyl-2-oxazoline
MW	Microwave
NonOx	2-Nonyl-2-oxazoline
pBu <sup>=</sup> Ox	Poly(2-but-3'-enyl-2-oxazoline)
pDc <sup>=</sup> Ox	Poly(2-dec-9'-enyl-2-oxazoline)
PEG	Poly(ethylene glycol)
PEI	Poly(ethylene imine)
PET	Poly(ethylene terephthalate)
pEtOx	Poly(2-ethyl-2-oxazoline)
PhOx	2-Phenyl-2-oxazoline
pMeOx	Poly(2-methyl-2-oxazoline)
pNonOx	Poly(2-nonyl-2-oxazoline)

pPBO	Poly(1,3-phenylene-bis-2-oxazoline)
pPhOx	Poly(2-phenyl-2-oxazoline)
ROP	Ring-opening polymerization
SEC	Size-exclusion chromatography
wt%	Weight percent

## 1 Introduction

Of all polymerizations and polymer classes investigated under microwave (MW) irradiation, the cationic ring-opening polymerization (CROP) of poly(2-oxazoline)s is at the top of the list in terms of the number of research findings published. This type of ROP, which was reported by four research groups independently more than half a century ago [1–4], has been hibernating for decades because of the comparably low polymerization rates inherent to this type of polymerization. Performing these polymerizations in dedicated MW reactors provides access to autoclave conditions and, correspondingly, overrules limitations to the reaction temperature caused by the boiling points of the reactants and/or solvents. Concomitant with acceleration of the polymerization of 2-oxazolines at elevated temperatures, a vivid discussion has arisen concerning whether these accelerations can be traced to common laws of physical chemistry (in particular the Arrhenius law) or whether potential non-thermal MW effects should also be considered [5] (see Sect. 3.1).

Benefiting from “revived” research activities in the area of poly(2-oxazoline)s, a plethora of review articles has been published recently focusing on this polymer class and materials derived therefrom (particularly for medical and medicinal applications) [6–16]. This review addresses the benefits of MW irradiation for the CROP of poly(2-oxazoline)s. Following a description of the MW-assisted synthesis of 2-oxazoline monomers (Sect. 2), this review summarizes the current state-of-knowledge of reactions kinetics for the synthesis of homopoly(2-oxazoline)s (Sect. 3), addresses the synthesis of copoly(2-oxazoline)s (Sect. 4), and highlights examples of MW-assisted post-polymerization modifications (Sect. 5).

## 2 Synthesis of 2-Oxazoline Monomers

2-Oxazoline monomers are synthesized according to one of three well-known standardized synthetic protocols: from nitriles [17], carboxylic acids [18, 19], or the corresponding acid chlorides/activated esters [18] (Scheme 1). These syntheses are commonly performed under conventional heating (CH) or at room temperature. So far, MW-assisted synthesis protocols have been reported only for selected 2-oxazoline monomers. A clear focus on carboxylic acids and derived compounds as reactants can also be observed for MW-assisted protocols.



### Synthesis of 2-oxazolines from nitriles (solvent-free)

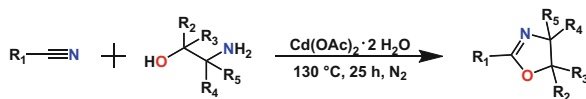

### Synthesis of 2-oxazolines from carboxylic acids/esters (solvent-free)

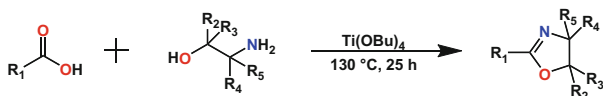

### Synthesis of 2-oxazolines with short side-chains

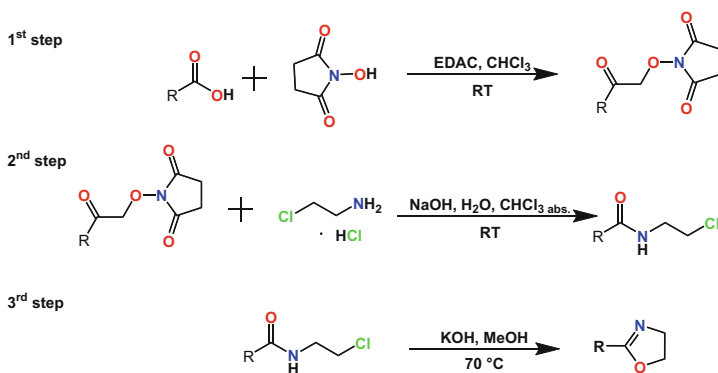

**Scheme 1** Common synthetic routes for the preparation of 2-oxazoline monomers involving amino alcohols

## 2.1 MW-Assisted Syntheses of 2-Oxazolines from the Reaction of Carboxylic Acids and Derived Compounds with Amino Alcohols

### 2.1.1 Carboxylic Acids

Marrero-Terrero and colleagues performed a detailed study of the MW-assisted solvent-free syntheses of 2,4,4-trisubstituted 2-oxazolines from the reaction of carboxylic acids and adequately substituted ethanol amines [20]. The experiments were performed in a multimode domestic MW oven as well as in a single-mode MW reactor dedicated to chemical synthesis (modified reactor S402 from Prolabo). Zinc oxide was used as a catalyst; yields of more than 90% could be achieved in syntheses at temperatures in the range of 200°C. Arsalani et al. reported solvent-free MW-assisted preparations of 2,4-disubstituted bis-2-oxazolines, which were

linked by a poly(ethylene glycol) (PEG)-based chain in their 2-positions [21]. Telechelic PEG diacid was reacted with primary tris(hydroxymethyl)methylamine. By applying MW irradiation of 600 W in a domestic microwave oven for approximately 0.5 h, yields of 79% could be obtained. Huang and colleagues described the solvent-free MW-assisted syntheses of 2-oxazolines carrying a hydroxyalkyl substituent in 2-position from the reaction of  $\alpha$ -hydroxy-substituted carboxylic acids and  $\beta$ -amino alcohols [22].

### 2.1.2 Acid Chlorides

The MW-assisted synthesis of chiral 2-oxazolines was reported by Mamaghani and coworkers [23]. Seven different benzoic acid chloride derivatives, which differed in the substitution pattern of the aromatic ring, were reacted with 2-amino-3-phenylpropanol at 0°C to produce the corresponding amides in high yield. These amides were subsequently converted in situ into tosylates, and ring-closed to obtain the corresponding 2,4-disubstituted 2-oxazolines under MW irradiation of 800 W (the type of MW reactor was not specified), notably in solvent-free syntheses.

### 2.1.3 Amides

The synthesis of 2-oxazolines from *N*-acylbenzotriazoles and 2-amino-2-methyl-1-propanol was reported by Katritzky et al. [24]. The experiments were performed from solutions of the reactants in chloroform in the single-mode MW reactor Discover (from CEM) as a two-step process with intermediate addition of thionyl chloride to the reaction mixture. The products were obtained in high yields (e.g. 95% in the case of 1,4-phenylene-bis-2-oxazoline). Notably, this product can also be derived from poly(ethylene terephthalate) (PET) bottle waste, the procedure of which was described by Shukla and colleagues [25]. Bis-(2-hydroxyethyl) terephthalamide, which was obtained in moderate to high yield from the aminolysis of PET waste according to CH or MW-assisted protocols, was subsequently chlorinated, brominated, or nitrated. All of the corresponding products were heated conventionally or in MW reactors in *N,N*-dimethylformamide/potassium carbonate suspension, yielding the bis-2-oxazoline. The MW reactor used was a domestic oven.

### 2.1.4 Nitriles

Wood and colleagues described a high-yielding MW-assisted synthesis of 2-oxazolines from the reaction of alkyl and aryl nitriles and 2,2-dimethylethanolamine [26]. A Lewis acid catalyst was required to enhance the yield of the 2-oxazolines. The MW-assisted reaction of amino alcohols with the so-called Pinner salts (imino ether hydrochlorides that can be obtained from the reaction of

nitriles with hydrochloric acid and alcohols) as well as with imino ethers (which can be derived from Pinner salts by removal of the hydrochloric acid) was reported by Garrigues and coworkers [27].

## 2.2 Other MW-Assisted Syntheses of 2-Oxazoline Monomers

Bazureau and coworkers reported the solvent-free MW-assisted synthesis of 4,4,5-trisubstituted 2-methyl-2-oxazolines; the substituents at the 4-position were one cyano and one carboxylate group, whereas the substituent at the 5-position was varied [28]. All reactions were performed in a Synthewave 402 ProLabo MW reactor from the reaction of 2-cyano-2-(1-ethoxyethylidene)aminoethanoate and various aldehydes (Scheme 2). During the cycloaddition, *trans:cis* selectivities of up to 85:15 could be obtained.

The conversion of  $\beta$ -lactam-containing peroxides into 2-oxazolines by the boron trifluoride etherate-catalyzed reaction with nitriles was performed by Cardillo and coworkers [29] (Scheme 2). Performing the reaction at room temperature yielded products with a yield of 30–60%, whereas the same reaction in the multimode MW reactor Milestone Microsynth (80°C, 2.5 min) delivered the 2-oxazolines in yields of 65–70%. Acidic hydrolysis of the 2-oxazolines was also investigated under MW irradiation. Tatibouet and colleagues reported the MW-assisted synthesis of 2-aryl-2-oxazolines from 1,3-oxazolidine-2-thiones under Suzuki or Stille reaction conditions [30] (Scheme 2). The MW-assisted reactions were performed at 100°C for 1 h, yielding the 2-aryl-2-oxazolines in yields of up to 86%.

**Scheme 2** Synthetic routines for the preparation of 2-oxazoline monomers under MW irradiation: cycloadditions (*top*), conversion of epoxides (*middle*), and Suzuki- and Stille-type of reactions (*bottom*)

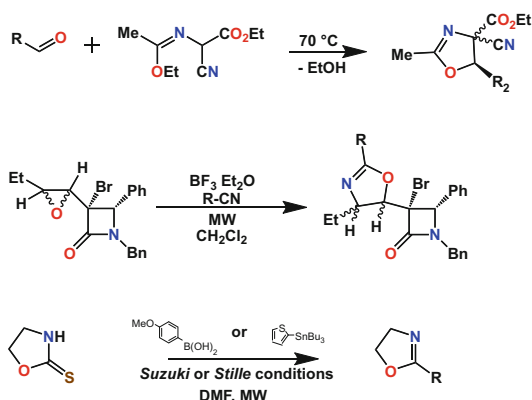

### 3 Homopoly(2-oxazoline)s: Detailed Investigation of the Polymerization Kinetics

Coming a long way from MW reactors for domestic use, single- and multimode MW reactors capable of exact control over the temperature and pressure during reactions were introduced approximately two decades ago. These new types of reactors rapidly found their way into chemical laboratories all over the world. The advantage of having fully controllable reactors that can be operated under autoclave conditions (eliminating the bottleneck of temperature limitations caused by the boiling points) makes them an ideal tool for chemical syntheses.

#### 3.1 CROP of 2-Oxazolines with Aliphatic and Aromatic Side Chains

Schubert and coworkers started their work on accelerating the living polymerization of 2-oxazolines in 2004 with the readily available monomer 2-ethyl-2-oxazoline (EtOx) (Scheme 3) [31]. Initiated by methyl tosylate, the monomer was polymerized in a Biotage single-mode MW reactor within a range of elevated temperatures, which were chosen for the kinetic analysis of the CROP of EtOx. At 190°C and 11 bar, full conversion of the monomer was achieved in less than 1 min [degree of polymerization (DP) = 60], compared with 6 h under CH in acetonitrile (reflux at 82°C). This acceleration of the ROP by factors of up to 350 was accompanied by (minor) side reactions, indicated by a slight change in the color of the polymer from transparent to yellowish. The optimum temperature

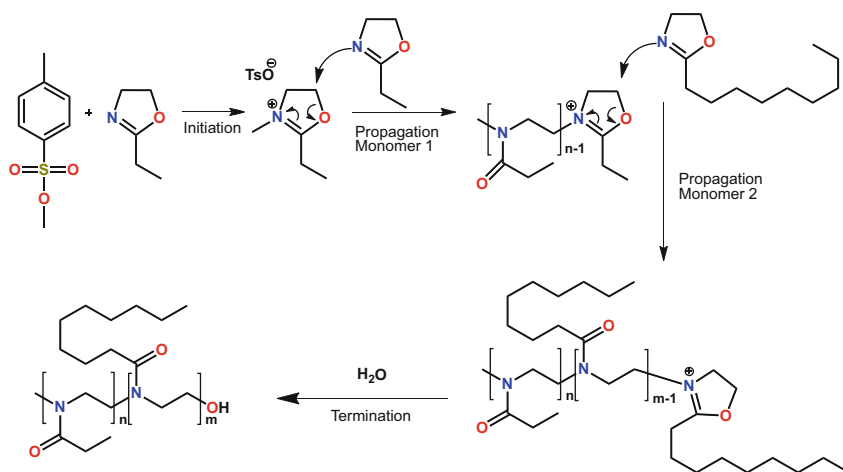

**Scheme 3** Mechanism of the CROP of 2-oxazolines, shown for the synthesis of the diblock copoly(2-oxazoline) pEtOx-*block*-pNonOx

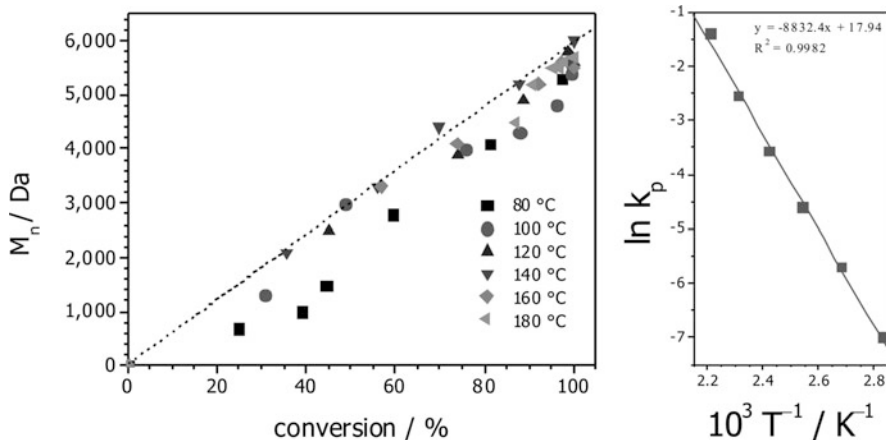

**Fig. 1** Kinetic analysis of the CROP of EtOx. *Left*: Number-average molecular weight ( $M_n$ ) plotted against monomer conversion. *Right*: Corresponding Arrhenius plot. Reprinted from Wiesbrock et al. [31] (doi: 10.1002/marc.200400369) with permission from John Wiley and Sons

was identified as 140°C (Fig. 1), giving acceleration by a factor of 70 without any observable side reactions. All polymers showed remarkably low (molar mass) dispersity of around 1.1, as determined by size-exclusion chromatography (SEC). The reaction rates ( $k_p$ ) were calculated and used in an Arrhenius plot, which showed no deviation from analogous CH polymerizations, revealing that no intrinsic MW effects were detectable (Fig. 1).

In a subsequent study, Schubert and coworkers expanded their kinetic studies of the CROP of 2-oxazolines by investigating 2-methyl-2-oxazoline (MeOx), 2-nonyl-2-oxazoline (NonOx), and 2-phenyl-2-oxazoline (PhOx) [32]. All monomers were polymerized at temperatures between 100 and 180°C, and were further characterized in terms of monomer conversion during CROP and the (molar mass) dispersity of the synthesized poly(2-oxazoline)s. It was found that the polymerizations could not only be carried out in highly concentrated solutions, but also in bulk. A narrow (molar mass) dispersity of <1.20 was maintained. All polymerizations followed the law of Arrhenius and did not exhibit any intrinsic (non-thermal) MW effects.

These reports were contradicted by a report from Sinnwell and Ritter, who also investigated the MW-assisted CROP of PhOx [33]. In their study, they compared CH with MW-assisted heating for the CROP of PhOx using an open single-mode MW system under atmospheric pressure. From the kinetic measurements, they concluded that the reaction rates were clearly enhanced under MW-assisted heating and claimed the existence of non-thermal MW effects. This phenomenon was explained by specific heating of the substrates caused by the strong response of the oxazolinium cation and its tosylate counterpart in the rapidly changing electromagnetic field of the microwaves. This idea was further backed up by additional experiments with varying monomer to initiator ratios, yielding the same results. In order to end the scientific controversy, Schubert and coworkers re-investigated the

CROP of PhOx in more detail: The authors compared the CROP of PhOx under CH and MW-assisted heating under the same conditions in a closed reaction vessel (autoclave conditions), and came to the conclusion that the rates of polymerization were identical and independent of the heating source, and argued that non-thermal MW effects could not be observed [34].

Schubert and colleagues got into more detail with their investigation of different poly(2-oxazoline)s. In 2005, a study correlating the length and shape of the side chain of various poly(2-oxazoline)s and their mechanical and thermal properties was published, enabling the desktop design of copoly(2-oxazoline)s with targeted properties [35]. Another study focused on the implementation of MW-assisted polymerization in a high-throughput workflow [36]. The ASW2000 synthetic platform was employed for the preparation of the reaction mixtures and, after MW-assisted polymerizations, for the preparation of polymer samples for further analysis.

More recently, a comparative study of various alkyl sulfonate initiators by Hoogenboom and coworkers revealed that alkyl tosylates are relatively slow initiating species, with the exception of methyl tosylate [37]. Alkyl nosylates and triflates revealed fast initiation and, based on the higher stability of alkyl nosylates, these species were identified as the most robust alkyl sulfonate initiating species. Furthermore, in the search for a good polymerization solvent for MeOx, Hoogenboom and colleagues discovered that sulfolane is a common rate-accelerating solvent for the CROP of 2-oxazolines [38].

Recent work by Shen and coworkers detailed the optimization of the initiation of the CROP of EtOx [39]. By employing rare-earth metal triflates such as Sc(OTf)<sub>3</sub> and using the same reaction conditions as in established protocols, a very efficient alternative to the initiator methyl tosylate was found. Concomitant with molar mass dispersities of 1.15 (or lower) and similar conversion rates, the rare-earth catalyst could also be used very efficiently for the CROP of EtOx. Mechanistic details of the regioselectivity of the initiation of the CROP of 2-oxazolines were recently reported by Wiesbrock and coworkers [40], who showed that the  $\pi$ -electron delocalization along the N–C–O segment in 2-oxazolines is comparable to its analog along the O–C–O segment in esters.

### ***3.2 2-Oxazolines with Functionalized Side Chains and Higher Homologs of 2-Oxazolines***

The versatility of the class of 2-oxazolines and their higher homologs such as 2-oxazines has enabled research on the synthesis and characterization of novel (co-)poly(2-oxazoline)s.

Schubert and coworkers reported the synthesis and polymerization of a difluorinated 2-phenyl-2-oxazoline, which was found to be the fastest reacting 2-oxazoline monomer so far reported [41, 42]. In order to verify the hypothesis

that the CROP of 2-phenyl-2-oxazolines can be accelerated by substitution with electron-withdrawing substituents, which lower the electron density of the aromatic system, a set of experiments was designed: All mono-fluorinated PhOx as well as the *ortho*-difluoro-2-phenyl-2-oxazoline were synthesized. The *para*- and *meso*-substituted monofluorinated PhOx showed a lowered polymerization rate, whereas *ortho*-monofluorinated and *ortho*-difluorinated PhOx had significant higher rates. In subsequent studies, Schubert, Hoogenboom and colleagues further expanded their investigation of the MW-assisted syntheses of homopoly(2-oxazoline)s by determination of secondary structure formation of main-chain chiral poly(2-oxazoline)s in solution [43]: Optically active 2-oxazolines were synthesized by the zinc acetate-catalyzed reaction of valeronitrile with chiral 2-amino-1-butanols. The polymers were characterized by solubility tests in various solvents and circular dichroism measurements. Polymers from diastereochemically pure monomers were found to form secondary structures such as helices in solution, whereas polymers and copolymers from racemic monomer mixtures formed random coils. This work was investigated in more detail, considering the effects of the alkyl side chains of 2-oxazolines on the secondary structure formation [44]: Five different chiral 2-oxazolines with varying side-chain lengths were polymerized, and their secondary structure in solution was investigated. It was observed that changes in the length of the alkyl side chain significantly influenced the optical properties. Further work addressed the thermoresponsive properties of poly(2-oxazoline)s [45]. In succeeding experiments, the behavior of 2-oxazolines and 2-oxazines (Scheme 4) with short side chains was investigated in detail [46]. It was shown that the cloud-point temperature of the poly(2-oxazine)s decreased with decreasing hydrophilicity, and that the additional methyl group in the backbone of the poly(2-oxazine)s [with respect to poly(2-oxazoline)s] made it more hydrophobic in general. Kinetic studies revealed that the MW-assisted polymerization of 2-oxazolines was about four times slower than that of the corresponding 2-oxazolines, which is similar to results reported for CH. In contrast, Ritter and coworkers reported a 1.8-fold acceleration of the CROP of 2-phenyl-2-oxazine under MW irradiation in the open vessel mode of the CEM Discover [47].

Very recently, the MW-assisted polymerization of methyl ester-functionalized 2-oxazoline monomers was reported by Hoogenboom and coworkers, revealing an unexpected acceleration of the polymerization of this monomer compared with that of MeOx and EtOx [48, 49]. Detailed kinetic studies complemented by molecular modeling revealed that the observed acceleration results from, on the one hand, interaction of the methyl ester side chains with the cationic oxazolinium chain end and, on the other hand, stabilization of the transition state for monomer addition by the methyl ester.

**Scheme 4** CROP of 2-oxazine monomers

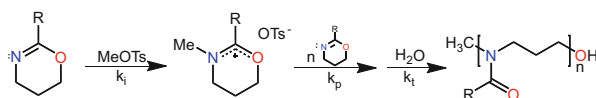

### 3.3 *MW-Assisted Syntheses of Homopoly(2-oxazoline)s: Special Applications*

#### 3.3.1 Renewable Resources

Motivated by the call for polymeric materials from renewable resources, a 2-oxazoline monomer from soy fatty acid with olefinic functionality in the side chain was synthesized by Hoogenboom and Schubert and investigated in kinetic studies [50]. The double bonds within the monomers made them an ideal target for crosslinking by UV irradiation. Notably, the unsaturated bonds were not affected by the CROP and were maintained in the polymer side chains. During CROP, full monomer conversion was reached within 8 min at 140°C under bulk conditions (DP = 60). The resulting polymers were successfully crosslinked by UV irradiation, yielding a product insoluble in organic solvents. The work on soy-based poly(2-oxazoline)s was continued and focused on the micellization behavior of corresponding copolymers [51]. Combining 2-“soy alkyl”-2-oxazoline and EtOx, novel copolymers were synthesized and characterized by SEC and <sup>1</sup>H NMR analyses. Via dynamic light scattering (DLS) and atomic force microscopy (AFM) analyses, the micellization of these amphiphilic copolymers was investigated and showed an increase in micellar size with increasing length of the hydrophobic block.

#### 3.3.2 CROP of 2-Oxazolines in Ionic Liquids

In order to meet the on-going demand for environmental awareness in the area of volatile organic solvents used during polymerizations, Schubert and coworkers investigated the MW-assisted CROP of 2-oxazolines in ionic liquids (ILs) [52]. ILs are commonly considered a favorable alternative to organic solvents because of their broad range of solubility properties and their inherent ability to be recycled. In the area of MW-heated reactions, their efficient uptake of MW energy is also a key asset. Five different ILs were tested as reaction media for the CROP of EtOx. 1-Butyl-3-methyl-imidazolium hexafluorophosphate proved to be the best-suited candidate, exhibiting faster polymerization rates than those for the CROP of EtOx in acetonitrile. Recovery and recycling of the IL was highly efficient (Fig. 2). This work was expanded towards different types and classes of monomers (including PhOx and MMA) as well as for establishing a more convenient approach for the purification of the polymer and recovery of the IL [53]. The recovery of polymers and copolymers from the reaction mixture was facilitated in cases where the polymer precipitated from the homogeneous reaction mixture after addition of



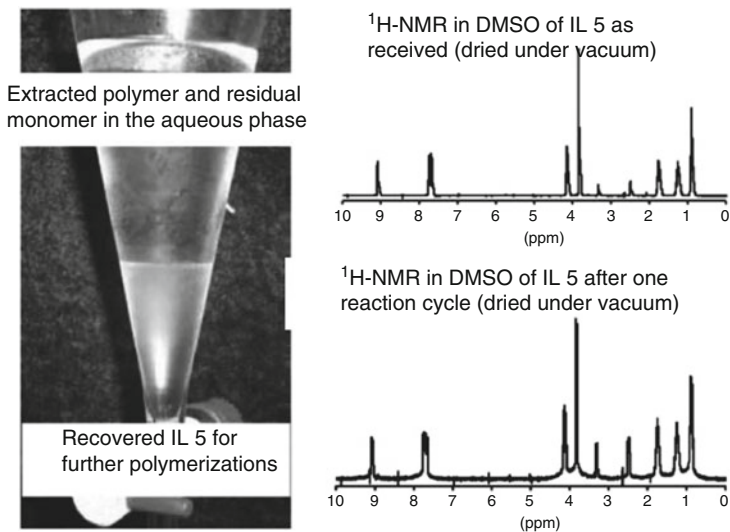

**Fig. 2** CROP of EtOx in ILs. *Left*: Easy and efficient recovery of the IL 1-butyl-3-methylimidazolium hexafluorophosphate and recovery of pEtOx by extraction with water. *Right*:  $^1\text{H-NMR}$  spectra of the IL as received and after one cycle of polymerization. Reproduced from Guerrero-Sanchez et al. [52] (doi: 10.1039/B608364A) with permission of The Royal Society of Chemistry

water. The IL could be removed from the polymer by filtration and subsequently recycled by MW-assisted flash distillation.

### 3.3.3 MW-Assisted Scale-Up

Work on the MW-assisted CROP of 2-oxazolines also includes studies of the scale-up of the polymerization. Initial investigations detailed the batch type of reaction. Schubert and coworkers reported the scale-up of the CROP of EtOx from the 400 mg to the 100 g scale using novel MW reactors from Biotage [54]. It was found that the synthetic protocols, which were optimized on the small scale, did not need to be further optimized. In a subsequent study, Schubert and coworkers reported the first homopolymerization of 2-oxazolines in continuous flow [55]. Using EtOx as a model monomer in different multimode MW systems, they investigated a set of experiments designed to find optimal reaction conditions in terms of pressure, MW penetration depth, and flow speed. Under optimized conditions, polymers with a molar mass dispersity of 1.33 could be synthesized.

## 4 MW-Assisted Copolymerizations of 2-Oxazolines

Following the first syntheses of homopoly(2-oxazoline)s in MW reactors, research addressed copoly(2-oxazoline)s, in particular combining different types of poly(2-oxazoline) repetition units to form novel copolymers with improved properties. Analogously, the combination of poly(2-oxazoline)s with entirely different polymer classes has become an active field of research. The ability to fine-tune the mechanical and thermal properties as well as the surface energies of these novel compounds makes them ideal materials for advanced applications.

### 4.1 Block Copoly(2-oxazoline)s

Schubert and colleagues prepared a 16-membered library of diblock copolymers and chain-extended homopolymers consisting of the four monomers MeOx, EtOx, PhOx, and NonOx [56]. Thermogravimetric analysis showed that all the polymers were stable up to temperatures of 300°C. Glass transition temperatures ( $T_g$ ) of the homo- and copoly(2-oxazoline)s were found to range between 57 and 107°C; notably, no  $T_g$  could be measured for the copolymers containing block(s) of pNonOx. The E modules of these diblock copoly(2-oxazoline)s were determined in dedicated characterization studies [57].

In a subsequent study, triblock copoly(2-oxazoline)s were reported: A 30-membered triblock copolymer library from MeOx, EtOx, NonOx, and PhOx was synthesized and characterized (Fig. 3) [58]. Each copolymer consisted of 33 repetition units of the respective monomer. The (total) polymerization times were remarkably short, ranging from 13 to 62 min. Special focus was given to the micellization behavior of some amphiphilic triblock copolymers: Micelles from copolymers with a hydrophobic middle block were smaller than those with hydrophilic middle blocks. This work was continued in more detail by a subsequent study of ter- and quarterpoly(2-oxazoline)s [59]. These novel copoly(2-oxazoline)s revealed molecular weight dispersities of 1.38 or lower, strongly depending on the presence or absence of repetition units of NonOx. The size of the micelles was

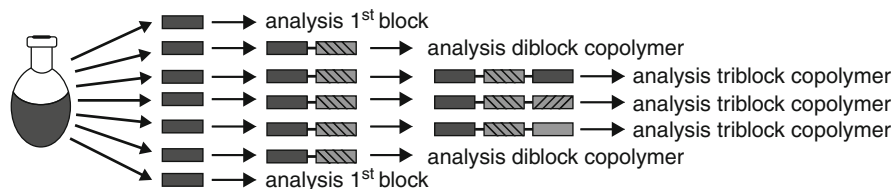

**Fig. 3** Synthetic procedure applied for the preparation of triblock copolymers with the same first and second blocks. Reprinted with permission from Hoogenboom et al. [58] (doi: 10.1021/ma060952a). Copyright (2006) American Chemical Society

found to correlate with their composition and confirmed previously established hypotheses. Triblock copoly(2-oxazoline)s composed of EtOx, 2-(1-ethylheptyl)-2-oxazoline, and 2-(2,6-difluorophenyl)-2-oxazoline were reported by Schubert and coworkers [60]. The triblock copolymers showed low molar mass dispersities of around 1.12; their composition was confirmed by fragmentation studies using MALDI-TOF.

## 4.2 Statistical Copoly(2-oxazoline)s

Schubert and coworkers reported a series of copoly(2-oxazoline)s with different molecular architectures, based on the monomers EtOx and NonOx [61]. Random and block copolymers of both monomers were compared in terms of molar mass dispersity, kinetics, and surface energy. Contact-angle measurements revealed the enrichment of alkyl side chains of the NonOx repetition units at the surface of polymer films, concomitant with a pronounced decrease in surface energy, which had been analyzed in detailed manner for diblock copoly(2-oxazoline)s [62, 63]. In the case of statistical copoly(2-oxazoline)s containing NonOx repetition units, this effect was less pronounced, and the tailor-made adaption of surface energies was enabled. Furthermore, random copoly(2-oxazoline)s had a lower degree of crystallinity and lower  $T_g$ , resulting in higher mechanical energy dissipation, lower E modules, and greater creep compliance, constituting viscoelastic properties.

Schubert and colleagues also prepared copolymers of EtOx and 2-(3-ethylheptyl)-2-oxazoline, the latter being a 2-oxazoline with a branched side chain [64]. The amount of EtOx repetition units in the copoly(2-oxazoline)s was varied in the range of 0–100%. The  $T_g$  was found to depend linearly on the percentage content (by weight) of 2-(3-ethylheptyl)-2-oxazoline in the copolymers. This enabled the simple fine-tuning of the  $T_g$  for specific applications. The significant influence of side-chain branching on chain mobility was investigated in a subsequent study of the effects on  $T_g$  and mechanical properties [65]. Random copolymers from MW-assisted syntheses were also reported for copolymers consisting of EtOx and “SoyOx”, a soy-based 2-oxazoline monomer with unsaturated side chains [66], as well as a set of different 2-oxazoline and 2-oxazine monomers, comprising the repetition units of MeOx, PhOx, and a substituted 4-ethyl-2-butyl-2-oxazoline. Results showed that the polymerization rate decreased with increasing steric hindrance [67].

## 4.3 Gradient Copoly(2-oxazoline)s

Hoogenboom, Schubert, and colleagues copolymerized representative combinations of MeOx, EtOx, NonOx, and PhOx for kinetic investigation of the terpolymerizations [68]. Because of (in particular) the low polymerization rates of PhOx, the

one-pot synthesis of “gradient-random,” “gradient-block,” and “random-block” terpolymers could be achieved, paving the way to “quasi-diblock” copoly (2-oxazoline)s from one-pot/one-step copolymerizations [69]. Gradient copolymers composed of NonOx and PhOx were the subject of a subsequent study [70] in which the reactivity ratios were determined. Gradient copolymers could be prepared, combining hydrophobic amorphous and semicrystalline poly(2-oxazoline) segments in one gradient copolymer.

Schubert’s group prepared copolymers of PhOx (or difluorinated PhOx) and EtOx in one-pot/one-step syntheses [71]. The corresponding gradient copoly (2-oxazoline)s showed amphiphilic behavior, resulting in self-assembly into micelles in aqueous solution. Due to the pronounced hydrophobic character of fluorinated PhOx, the corresponding copolymers were able to form larger micelles than those of the copolymers with (unsubstituted) PhOx.

## 5 Post-Polymerization Modifications

With the advent of MW reactors specifically designed for organic syntheses, the facilitated access to various types of copoly(2-oxazoline)s (eventually) with novel repetition units has significantly benefited research on (co-)poly(2-oxazoline)-based materials. Consequently, this area is also briefly addressed here, despite the fact that some of these post-polymerization modifications are not carried out under MW irradiation. However, the copoly(2-oxazoline)s in the center of those studies were derived from MW-assisted syntheses. The examples in this section comprise click chemistry reactions such as the UV-induced thiol–ene reaction, the formation of hydrogels and negative photoresists via crosslinking of the polymer side chains, and the hydrolysis of copoly(2-oxazoline)s. It should be noted that even though this section only includes examples that are based on polymers prepared by MW irradiation, there is a wide variety of beautiful work on clickable and reactive functional poly(2-oxazoline)s, for which the reader is referred to the relevant literature [7, 14, 19, 72–77].

### 5.1 Click Chemistry

The concept of click chemistry is shown by the example of UV-induced thiol–ene click reactions. This type of reaction can be conveniently performed at room temperature, reducing polymer degradation (and the degradation of eventually occluded organic molecules) to a minimum.

The cellular uptake of copoly(2-oxazoline)-based nanoparticles was studied using a copoly(2-oxazoline) consisting of EtOx and 2-dec-9'-enyl-2-oxazoline (Dc<sup>=</sup>Ox), end-capped with the dye fluorescein [78]. The double bond of the Dc<sup>=</sup>Ox repetition units enabled post-polymerization modification, whereas the

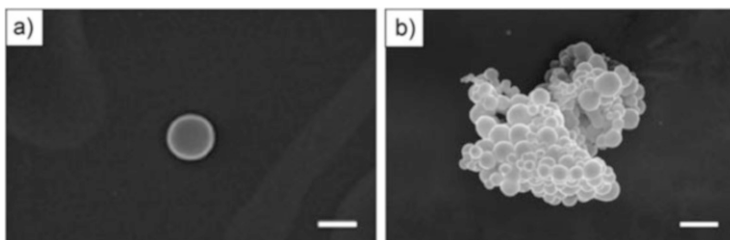

**Fig. 4** Nanoparticles of copoly(2-oxazoline) consisting of EtOx and Dc<sup>-</sup>Ox: (a) pEtOx-co-pDc<sup>-</sup>Ox-OH and (b) pEtOx-co-pDc<sup>-</sup>Ox-fluorescein. Reprinted from Kempe et al. [78] (doi: 10.1002/marc.201000283) with permission from John Wiley and Sons

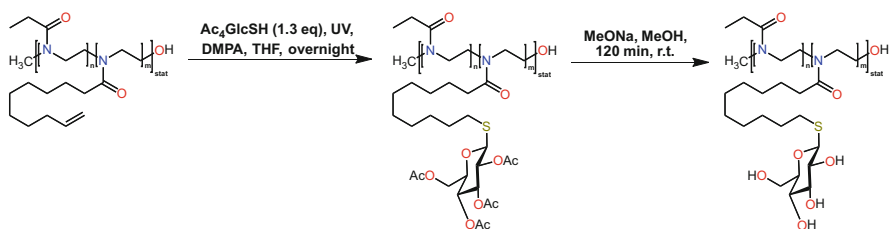

**Scheme 5** Preparation of glycopoly(2-oxazoline)s using thiol–ene click chemistry

covalently bound fluorescein enabled the study of cellular uptake (Fig. 4). Spherical nanoparticles with diameters of 200–800 nm were obtained by nanoprecipitation of copolymer solutions in a non-solvent. Confocal laser scanning microscopy showed the cellular intake and the homogeneous distribution of the nanoparticles within the cytosol.

Veronese, Schubert, Hoogenboom, and colleagues pursued a different approach in post-polymerization modifications [79]. By quenching the CROP of EtOx with sodium carbonate, they prepared semi-telechelic pEtOx with hydroxyl end groups. These hydroxyl groups could be modified into a carboxylate function in post-polymerization fashion and, after activation by an active ester, used for covalent binding to proteins. It was concluded that the modified pEtOx could be used as an alternative to PEG.

Glycopoly(2-oxazoline)s derived from a copoly(2-oxazoline) of EtOx and Dc<sup>-</sup>Ox were reported by Schubert and colleagues (Scheme 5) [80]. The olefinic functions of the Dc<sup>-</sup>Ox repetition units were used as “ene” component in UV-induced thiol–ene click reactions with the thiol 2,3,4,6-tetra-*O*-acetyl-1-thio-β-D-glycopyranose. In the final step, the acetyl protection groups of the sugar were cleaved in alkaline media, yielding the targeted glycopoly(2-oxazoline)s. The cloud points of these (unprotected) glycopoly(2-oxazoline)s were found to decrease with increasing number of sugar moieties, which was a result of hydrogen bonding between the hydroxyl sugar groups and the polymer backbone.

Surface modification of silicon substrates by MW-assisted click reactions with dedicatedly functionalized copoly(2-oxazoline)s was also shown by Schubert and colleagues [81]. The motivation for this work was the investigation of a novel heating process for the surface functionalization of self-assembled monolayers. Hence, an azide-functionalized silicon surface was reacted in a Huisgen 1,3-dipolar cycloaddition with a semi-telechelic acetylene-functionalized pEtOx.

Schubert and coworkers also reported a green approach for the synthesis and modification of olefinic poly(2-oxazoline)s.  $\text{Dc}^{\ominus}\text{Ox}$ , which can be derived from renewable resources, was polymerized in bulk under MW irradiation. For the post-polymerization thiol–ene click functionalization, a green solvent, namely 2-methyl-tetrahydrofuran, was chosen [82].

## 5.2 Crosslinking

If the thiol–ene click reaction of “ene”-functionalized copoly(2-oxazoline)s is performed with multifunctional thiols, crosslinked copolymers can be obtained. Furthermore, if UV irradiation is applied through a mask, crosslinking only occurs at the transparent areas of the mask; hence, only the areas preset by transparent segments of the mask become insoluble, yielding a so-called negative photoresist. Wiesbrock and colleagues developed water-developable negative photoresists (Fig. 5) based on, for example,  $\text{pEtOx}_{80}\text{-stat-pBu}^{\ominus}\text{Ox}_{20}$  and  $\text{pPhOx}_{80}\text{-stat-pDc}^{\ominus}\text{Ox}_{20}$  [83, 84], choosing a copoly(2-oxazoline) with short side chains on one hand, and one with longer (hydrophobic) side chains on the other hand. The photoresist

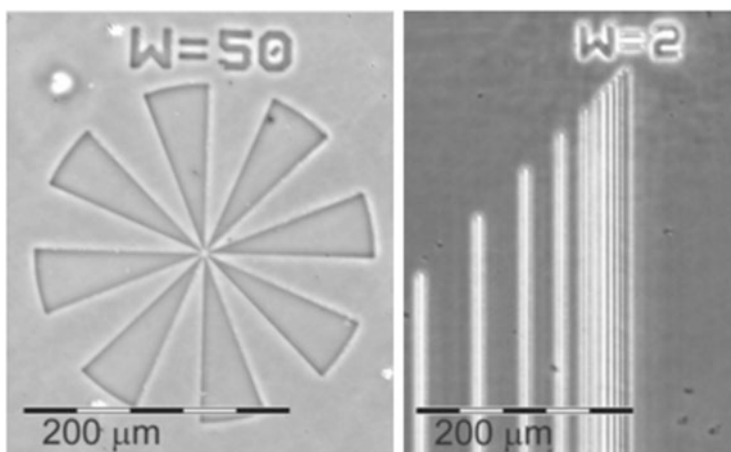

**Fig. 5** Phase contrast image of  $\text{pEtOx}_{80}\text{-stat-pBu}^{\ominus}\text{Ox}_{20}$  after UV-induced crosslinking with a tetrathiol for 60 s through a mask aligner and subsequent development in 1-methoxy-2-propanol for 30 s. Reprinted from Schenk et al. [83] (doi: 10.1002/marc.201100717) with permission from John Wiley and Sons

showed resolutions higher than 2  $\mu\text{m}$ . These findings were expanded in the context of MW-assisted green polymer chemistry [85]: The copoly(2-oxazoline)s constituting the base polymer of the photoresist were derived from NonOx and Dc<sup>=</sup>Ox, both from renewable resources, in energy-efficient MW-assisted copolymerizations in recyclable ILs. Preceded by crosslinking via UV-induced thiol–ene click reactions, the photoresist could be developed in ethyl lactate. With a resolution of higher than 1  $\mu\text{m}$ , this photoresist is an alternative to conventional products.

Schubert, Gohy, and coworkers reported the solvent-induced morphological transition in core-crosslinked block copolymer micelles based on a diblock copolymer consisting of EtOx and 2-“soy alkyl”-2-oxazoline [86]. The cores of the micelles were crosslinked under UV irradiation, yielding spherical micelles capable of swelling in acetone. Morphological changes within the micelles were observed.

Dargaville, Hoogenboom, and coworkers investigated cell attachment onto poly(2-oxazoline)-based hydrogels [87]. Hydrogels of poly(2-oxazoline)s, namely copoly(2-oxazoline)s of MeOx and Dc<sup>=</sup>Ox, were prepared and functionalized with the peptide CRGDSG and crosslinked with a dithiol by thiol–ene click chemistry. The interaction of the hydrogel and human fibroblast was investigated.

The swelling degrees of copoly(2-oxazoline)-based hydrogels were correlated with the gel composition by Wiesbrock and coworkers [88]. From a 32-membered library of poly(2-oxazoline)-based hydrogels of the composition pEtOx-pPhOx-pPBO, which were prepared in situ during the polymerization, they determined the swelling degrees in water, dichloromethane, and ethanol as solvent. The hydrogels were capable of incorporating (small) organic molecules either in situ during the (co-)polymerization or according to post-synthetic routines. Li et al. described the swelling and deswelling behavior of poly(2-isopropyl-2-oxazoline)-based hydrogels [89]. The hydrogels were prepared in situ by copolymerization with bis-functional 1,4-phenylene-bis-2-oxazoline. Detailed data on the swelling behavior were obtained from combined Fourier-transform infrared (FTIR) and two-dimensional correlation spectroscopy. Different dynamic transition mechanisms could be observed upon heating and cooling, resulting in volume phase transition temperatures of 35°C during heating and 41–30°C during cooling.

Hoogenboom and coworkers reported the crosslinking of poly(2-oxazoline)-based hydrogels via UV-induced thiol–ene reactions with a dithiol component [90]. The hydrogels were prepared by dissolving copolymers of Dc<sup>=</sup>Ox and either MeOx or EtOx (with a molar mass dispersity between 1.22 and 1.43) in ethanol and mixing the solution with a bis-functional thiol, either 2,2'-(ethylenedioxy) diethanethiol or ethylene glycol bis(3-mercaptopropionate). After addition of the photoinitiator 2,2-dimethoxy-2-phenylacetophenone to the solution and low energy UV irradiation of 2.2 mW cm<sup>-2</sup> for 4 min, hydrogel disks with a depth of 1 mm and a radius of 7 mm were obtained. All gels were characterized by swelling in phosphate-buffered saline and in HEPES buffer of pH 8. After an initial swelling period, degradation could be observed, expanding the potential use of poly(2-oxazoline) hydrogels in medic(in)al applications. The potential in this field was also discussed by Hoogenboom and colleagues on another occasion [91].

The synthesis of a novel 2-oxazoline monomer with a Boc-protected amino group in the side chain was described by Schubert and coworkers [92], in analogy to a synthesis previously described in the literature [93]. Homopolymerizations as well as copolymerizations with EtOx yielded novel compounds. The obtained poly(amino-2-oxazoline)s coordinated reversibly with DNA. The strength of these bonds correlated directly with the amount of amino groups within the copolymer. It was possible to crosslink the copolymers with epichlorohydrin, yielding hydrogels with adjustable swelling degree and the ability to absorb DNA. Further work of Schubert's group focused on the stabilization of Factor VIII, an essential human coagulation factor, through poly(2-oxazoline)-based hydrogels [94]. The hydrogels were prepared in situ by copolymerization of EtOx and bis-functional 1,4-phenylene-bis-2-oxazoline.

In the field of medical applications, Wiesbrock and colleagues demonstrated the enhanced adhesion of poly(2-oxazoline) hydrogels to cancer cells by functionalization with the RGD peptide motif [95]. Networks of different compositions of EtOx, NonOx, Dc<sup>-</sup>Ox, and bis-functional 2,2'-tetramethylene-bis-2-oxazoline were characterized by their degree of swelling in H<sub>2</sub>O, ethanol, and dichloromethane. These gels, which were coupled with the RGD protein motif (from a cyclic pentapeptide carrying a thiol function) via post-polymerization UV-induced thiol-ene reactions, showed preferential cell adhesion towards human pancreatic cancer BON cells. Fluorescence microscopy enabled recognition of the hydrogels, which were clearly attached to the BON cells.

### 5.3 Hydrolysis

Schubert and coworkers described a strategy for the MW-assisted quantitative hydrolysis of pEtOx, yielding poly(ethylene imine) (PEI), and optimized the reaction times and cleanup procedure [96]. The optimum hydrolysis conditions proved to be 1 h at 130°C at a concentration of up to 0.33 g of pEtOx in 1 mL of 6 M HCl, leading to significantly reduced reaction times. By dissolving the crude PEI in methanol and then precipitating it in diethyl ether, impurities could be removed efficiently. The purity of the polymer was verified by <sup>1</sup>H NMR spectroscopy and MALDI-TOF analysis.

Hoogenboom and coworkers addressed their investigations to the preparation of partially hydrolyzed pEtOx, namely the synthesis of pEtOx-*stat*-PEI, and the effects of temperature on the reaction [97]. The authors reported a maximum acceleration of the hydrolysis reaction at 180°C using dilute aqueous solutions of HCl. Further work on this topic focused on the influence of partially hydrolyzed pEtOx on in vivo systems, with regard to mucosal irritation and cytotoxicity [98]. No tissue damage was caused by polymers with hydrolysis degrees up to 25%, according to the slug mucosal irritation test. Additionally, the enzyme-catalyzed hydrolysis of pEtOx by digestive enzymes was studied, revealing that



this hydrolysis was quantitatively negligible (less than 0.2% hydrolysis after 6 h at 37°C).

Hoogenboom and coworkers published a study concerning the acidic- and alkaline-mediated hydrolyses of gradient and diblock copolymers consisting of MeOx and PhOx [99]. It was observed that, under acidic conditions, both side chains were cleaved from the polymer backbone, although hydrolysis of the MeOx repetition units was preferred. Under alkaline conditions, however, the hydrolysis rates for both types of repetition units were significantly slower. Because of the significantly lower rates for cleavage of PhOx repetition units, specific hydrolysis of the MeOx repetition units could be observed. This selectivity could be further enhanced by utilizing an ethanol–water mixture for hydrolysis [100]. With this improvement, a 95% hydrolysis of the methyl side chains of a pMeOx<sub>60</sub>-*block*-pPhOx<sub>15</sub> copolymer could be achieved.

The group of Wiesbrock developed contact biocides derived from partially hydrolyzed (co)poly(2-oxazoline)s [101]. Copoly(2-oxazoline)-*stat*-PEIs were prepared by acid-mediated (partial) hydrolysis of pEtOx and pNonOx. The copolymers were compounded as additives in polypropylene plates containing 5 wt% of the copolymers. The antimicrobial activity against *Escherichia coli*, *Pseudomonas aeruginosa*, *Candida albicans*, and *Staphylococcus aureus* was tested and showed significant reduction in microbe activity by mere contact with the compound plates. Notably, the hydrolysis of pEtOx could be performed at much higher rates than that of pNonOx under otherwise identical conditions.

## 6 Summary, Conclusions, and Outlook

Because of the comparably low polymerization rates inherent to the CROP of 2-oxazoline monomers, this class of polymers has significantly benefited from the introduction of MW reactors specifically designed for chemical syntheses. Concomitant with facilitated access to autoclave conditions and an unparalleled uniform heat distribution (at least for small-scale syntheses), MW reactors have become the reactor-of-choice for the CROP of 2-oxazolines. As for numerous syntheses in organic chemistry, there has also been discussion of the existence of non-thermal MW effects in the polymerization of 2-oxazolines; it could be shown by detailed kinetic analyses that intrinsic microwave effects do not exist.

Research in the areas of “poly(2-oxazoline)s” and “poly(2-oxazoline)-based materials” has benefited enormously from MW-assisted chemistry, in particular for:

- Development and (co-)polymerization of novel 2-oxazoline monomers, such as fluorinated congeners
- Systematic synthesis and investigation of block copoly(2-oxazoline)s, including studies of micellization behavior
- Introduction of aspects of “green chemistry” to the synthesis of (co-)poly(2-oxazoline)s, prominent examples being the performance of CROP in

(recyclable) ILs and the synthesis of 2-oxazoline monomers from renewable resources

- Novel poly(2-oxazoline)-based materials such as photoresists from renewable resources and (co-)poly(2-oxazoline)-based gels for applications in the medical sector

Almost exactly one decade after the first report of a MW-assisted CROP of a 2-oxazoline monomer [31] and concomitant with on-going intensive research at the international level, numerous and sustainable developments in this research area are likely to occur.

**Acknowledgement** F.W. and K.P.L. would like to gratefully acknowledge the Austrian Science Fund FWF for funding of the project I1123-N19 (MimiFlow). The work was performed at the PCCL in the context of the project PolyComp within the framework of the COMET-program of the Federal Ministry for Transport, Innovation and Technology and Federal Ministry for Economy, Family and Youth. The PCCL is funded by the Austrian Government and the State Governments of Styria, Lower Austria and Upper Austria. U.S.S. thanks the Carl-Zeiss Foundation and the TMWWdG (State of Thuringia).

## References

1. Seeliger W, Aufderhaar E, Diepers W, Feinauer R, Nehring R, Thier W, Hellmann H (1966) Recent syntheses and reactions of cyclic imidic esters. *Angew Chem Int Ed* 5:875–888
2. Tomalia DA, Sheetz DP (1966) Homopolymerization of 2-alkyl- and 2-aryl-2-oxazolines. *J Polym Sci A Polym Chem* 4:2253–2265
3. Bassiri TG, Levy A, Litt M (1967) Polymerization of cyclic imino ethers. I. Oxazolines. *J Polym Sci B Polym Lett* 5:871–879
4. Kagiya T, Narisawa S, Maeda T, Fukui K (1966) Ring-opening polymerisation of 2-substituted 2-oxazolines. *J Polym Sci B Polym Lett* 4:441–445
5. Herrero MA, Kreamsner JM, Kappe CO (2008) Nonthermal microwave effects revisited: on the importance of internal temperature monitoring and agitation in microwave chemistry. *J Org Chem* 73:36–47
6. Hoogenboom R (2009) Poly(2-oxazoline)s: a polymer class with numerous potential applications. *Angew Chem Int Ed* 48:7978–7994
7. Rossegger E, Schenk V, Wiesbrock F (2013) Design strategies for functionalized poly(2-oxazoline)s and derived materials. *Polymers* 5:956–1011
8. Hoogenboom R (2007) Poly(2-oxazoline)s: alive and kicking. *Macromol Chem Phys* 208:18–25
9. Kelly AM, Wiesbrock F (2012) Strategies for the synthesis of poly(2-oxazoline)-based hydrogels. *Macromol Rapid Commun* 33:1632–1647
10. Hartlieb M, Kempe K, Schubert US (2015) Covalently cross-linked poly(2-oxazoline) materials for biomedical applications – from hydrogels to self-assembled and templated structures. *J Mater Chem B* 3:526–538
11. de la Rosa VR (2014) Poly(2-oxazoline)s as materials for biomedical applications. *J Mater Sci Mater Med* 25:1211–1225
12. Konradi R, Acikgoz C, Textor M (2012) Polyoxazolines for nonfouling surface coatings – a direct comparison to the gold standard PEG. *Macromol Rapid Commun* 33:1663–1676
13. Luxenhofer R, Han Y, Schulz A, Tong J, He Z, Kabanov AV, Jordan R (2012) Poly(2-oxazoline)s as polymer therapeutics. *Macromol Rapid Commun* 33:1613–1631

14. Guillerme B, Monge S, Lapinte V, Robin J-J (2012) How to modulate the chemical structure of polyoxazolines by appropriate functionalization. *Macromol Rapid Commun* 33:1600–1612
15. Schlaad H, Diehl C, Gress A, Meyer M, Demirel AL, Nur Y, Bertin A (2010) Poly(2-oxazoline)s as smart bioinspired polymers. *Macromol Rapid Commun* 31:511–525
16. Sedlacek O, Monnery BD, Filippov SK, Hoogenboom R, Hruby M (2012) Poly(2-oxazoline)s – are they more advantageous for biomedical applications than other polymers? *Macromol Rapid Commun* 33:1648–1662
17. Witte H, Seeliger W (1974) Cyclische Imidsaeureester aus Nitrilen und Aminoalkoholen. *Liebigs Ann Chem* 6:996–1009
18. Beck M, Birnbrich P, Eicken U, Fischer H, Fristad WE, Hase B, Krause H-J (1994) Polyoxazoline auf fettchemischer Basis. *Angew Makromol Chem* 223:217–233
19. Gress A, Voelkel A, Schlaad H (2007) Thio-click modification of poly[2-(3-butenyl)-2-oxazoline]. *Macromolecules* 40:7928–7933
20. García-Tellado F, Loupy A, Petit A, Marrero-Terrero AL (2003) Solvent-free microwave-assisted efficient synthesis of 4,4-disubstituted 2-oxazolines. *Eur J Org Chem* 2003:4387–4391
21. Arsalani N, Zare P, Namazi H (2009) Solvent free microwave assisted preparation of new telechelic polymers based on poly(ethylene glycol). *Express Polym Lett* 3(7):429–436
22. Wei W, Zhang D, Yuan Q, Shen D, Huang B (2004) Synthesis of 2-( $\alpha$ -hydroxyalkyl)-2-oxazoline under microwave irradiation in bulk. *Yingyong Huaxue* 21(12):1329–1330
23. Mamaghani M, Nahmoodi NO, Fallah Ghasemi S (2010) An efficient synthesis of new chiral oxazolines. *J Iran Chem Soc* 7(4):972–977
24. Katritzky AR, Cai C, Suzuki K, Singh SK (2004) Facile syntheses of oxazolines and thiazolines with *N*-acylbenzotriazoles under microwave irradiation. *J Org Chem* 69:811–814
25. Parab YS, Shah RV, Shukla SR (2012) Microwave irradiated synthesis and characterization of 1,4-phenylene bis-oxazoline from bis-(2-hydroxyethyl) terephthalamide obtained by depolymerization of poly(ethylene terephthalate) bottle waste. *Curr Chem Lett* 2012:81–90
26. Clarke DS, Wood R (1996) A facile one stage synthesis of oxazolines under microwave irradiation. *Synth Commun* 26(7):1335–1340
27. Oussaid B, Berlan J, Soufiaoui M, Garrigues B (1995) Improved synthesis of oxazoline under microwave irradiation. *Synth Commun* 25(5):659–665
28. Fraga-Dubreuil J, Cherouvrier JR, Bazureau JP (2000) Clean solvent-free dipolar cycloaddition reactions assisted by focused microwave irradiations for the synthesis of new ethyl 4-cyano-2-oxazoline-4-carboxylates. *Green Chem* 2:226–229
29. Benfatti F, Cardillo G, Gentilucci L, Tolomelli A, Monari M, Piccinelli F (2007) A microwave-enhanced, Lewis acid-catalyzed synthesis of 1,3-dioxanes and oxazolines from epoxides. *Adv Synth Catal* 349:1256–1264
30. Silva S, Tardy S, Routier S, Suzenet F, Tatibouet A, Rauter AP, Rollin P (2008) 1,3-Oxazoline and 1,3-oxazolidine-2-thiones as substrates in direct modified Stille and Suzuki cross-coupling. *Tetrahedron Lett* 49(39):5583–5586
31. Wiesbrock F, Hoogenboom R, Abeln CH, Schubert US (2004) Single-mode microwave ovens as new reaction devices: accelerating the living polymerization of 2-ethyl-2-oxazoline. *Macromol Rapid Commun* 25:1895–1899
32. Wiesbrock F, Hoogenboom R, Leenen MAM, Meier MAR, Schubert US (2005) Investigation of the living cationic ring-opening polymerization of 2-methyl-, 2-ethyl-, 2-nonyl-, and 2-phenyl-2-oxazoline in a single-mode microwave reactor. *Macromolecules* 38:5025–5034
33. Sinnwell S, Ritter H (2005) Microwave accelerated polymerization of 2-phenyl-2-oxazoline. *Macromol Rapid Commun* 26:160–163
34. Hoogenboom R, Leenen MAM, Wiesbrock F, Schubert US (2005) Microwave accelerated polymerization of 2-phenyl-2-oxazoline: microwave or temperature effects? *Macromol Rapid Commun* 26:1773–1778

35. Hoogenboom R, Fijten MWM, Thijs HML, Van Lankvelt BM, Schubert US (2005) Microwave-assisted synthesis and properties of a series of poly(2-alkyl-2-oxazoline)s. *Des Monomers Polym* 8(6):659–671
36. Hoogenboom R, Wiesbrock F, Leenen MAM, Meier MAR, Schubert US (2005) Accelerating the living polymerization of 2-nonyl-2-oxazoline by implementing a microwave synthesizer into a high-throughput experimentation workflow. *J Comb Chem* 7(1):10–13
37. Glassner M, D'hooge DR, Park JY, van Steenberge PHM, Monnery BD, Reyniers M-F, Hoogenboom R (2015) Systematic investigation of alkyl sulfonate initiators for the cationic ring-opening polymerization of 2-oxazolines revealing optimal combinations of monomers and initiators. *Eur Polym J* 65:298–304
38. Vergaelen M, Verbraeken B, Monnery BD, Hoogenboom R (2015) Sulfolane as common rate accelerating solvent for the cationic ring-opening polymerization of 2-oxazolines. *ACS Macro Lett* 4:825–828
39. Hu F, Xie S, Jiang L, Shen Z (2014) Living cationic ring-opening polymerization of 2-oxazolines initiated by rare-earth metal triflates. *RSC Adv* 4:59917–59926
40. Fimberger M, Luef KP, Payerl C, Fischer RC, Stelzer F, Kállay M, Wiesbrock F (2015) The  $\pi$ -electron delocalization in 2-oxazolines revisited: quantification and comparison with its analogue in esters. *Materials* 8:5385–5397
41. Lobert M, Köhn U, Hoogenboom R, Schubert US (2008) Synthesis and microwave assisted polymerization of fluorinated 2-phenyl-2-oxazolines: the fastest 2-oxazoline monomer to date. *Chem Commun* 2008(12):1458–1460
42. Lobert M, Thijs HML, Erdmenger T, Eckardt R, Ulbricht C, Hoogenboom R, Schubert US (2008) Synthesis, microwave-assisted polymerization, and polymer properties of fluorinated 2-phenyl-2-oxazolines: a systematic study. *Chem Eur J* 14:10396–10407
43. Bloksma MM, Rogers S, Schubert US, Hoogenboom R (2010) Secondary structure formation of main-chain chiral poly(2-oxazoline)s in solution. *Soft Matter* 6:994–1003
44. Bloksma MM, Rogers S, Schubert US, Hoogenboom R (2011) Main-chain chiral poly(2-oxazoline)s: influence of alkyl side-chains on secondary structure formation in solution. *J Polym Sci A Polym Chem* 49:2790–2801
45. Bloksma MM, Weber C, Perevyazko IY, Kuse A, Baumgärtel A, Vollrath A, Hoogenboom R, Schubert US (2011) Poly(2-cyclopropyl-2-oxazoline): from rate acceleration by cyclopropyl to thermoresponsive properties. *Macromolecules* 44:4057–4064
46. Bloksma MM, Paulus RM, Van Kuringen HPC, Van der Woerd F, Lambermont-Thijs HML, Schubert US, Hoogenboom R (2012) Thermoresponsive poly(2-oxazoline)s. *Macromol Rapid Commun* 33:92–96
47. Sinnwell S, Ritter H (2006) Microwave accelerated polymerization of 2-phenyl-5,6-dihydro-4H-1,3-oxazine: kinetics and influence of end-groups on glass transition temperature. *Macromol Rapid Commun* 27:1335–1340
48. Bouten PJM, Hertsen D, Vergaelen M, Monnery BD, Boerman MA, Goossens H, Catak S, van Hest JCM, van Speybroeck V, Hoogenboom R (2015) Accelerated living cationic ring-opening polymerization of a methyl ester functionalized 2-oxazoline monomer. *Polym Chem* 6:514–518
49. Bouten PJM, Hertsen D, Vergaelen M, Monnery BD, Catak S, van Hest JCM, van Speybroeck V, Hoogenboom R (2015) *J Polym Sci A Polym Chem* 53:2649–2661
50. Hoogenboom R, Schubert US (2006) Microwave-assisted cationic ring-opening polymerization of a soy-based 2-oxazoline monomer. *Green Chem* 8:895–899
51. Hoogenboom R, Leenen MAM, Huang H, Fustin C-A, Gohy J-F, Schubert US (2006) Microwave-assisted synthesis and micellization behavior of soy-based copoly(2-oxazoline)s. *Colloid Polym Sci* 284:1313–1318
52. Guerrero-Sanchez C, Hoogenboom R, Schubert US (2006) Fast and “green” living cationic ring opening polymerization of 2-ethyl-2-oxazoline in ionic liquids under microwave irradiation. *Chem Commun* 2006(36):3797–3799

53. Guerrero-Sanchez C, Lobert M, Hoogenboom R, Schubert US (2007) Microwave-assisted homogeneous polymerizations in water-soluble ionic liquids: an alternative and green approach for polymer synthesis. *Macromol Rapid Commun* 28:456–464
54. Hoogenboom R, Paulus RM, Pilotti A, Schubert US (2006) Scale-up of microwave-assisted polymerizations in batch mode: the cationic ring-opening polymerization of 2-ethyl-2-oxazoline. *Macromol Rapid Commun* 27:1556–1560
55. Paulus RM, Erdmenger T, Becer CR, Hoogenboom R, Schubert US (2007) Scale-up of microwave-assisted polymerizations in continuous-flow mode: cationic ring-opening polymerization of 2-ethyl-2-oxazoline. *Macromol Rapid Commun* 28:484–491
56. Wiesbrock F, Hoogenboom R, Leenen M, Van Nispen SFGM, Van der Loop M, Abeln CH, Van den Berg AMJ, Schubert US (2005) Microwave-assisted synthesis of a 4<sup>2</sup>-membered library of diblock copoly(2-oxazoline)s and chain-extended homo poly(2-oxazoline)s and their thermal characterization. *Macromolecules* 38:7957–7966
57. Kranenburg JM, Tweedie CA, Hoogenboom R, Wiesbrock F, Thijs HML, Hendriks CE, Van Vliet KJ, Schubert US (2007) Elastic moduli for a diblock copoly(2-oxazoline) library obtained by high-throughput screening. *J Mater Chem* 17:2713–2721
58. Hoogenboom R, Wiesbrock F, Huang H, Leenen MAM, Thijs HML, Van Nispen SFGM, Van der Loop M, Fustin C-A, Jonas AM, Gohy J-F, Schubert US (2006) Microwave-assisted cationic ring-opening polymerization of 2-oxazolines: a powerful method for the synthesis of amphiphilic triblock copolymers. *Macromolecules* 39:4719–4725
59. Hoogenboom R, Wiesbrock F, Leenen MAM, Thijs HML, Huang H, Fustin C-A, Guillet P, Gohy J-F, Schubert US (2007) Synthesis and aqueous micellization of amphiphilic tetrablock ter- and quaterpoly(2-oxazoline)s. *Macromolecules* 40:2837–2843
60. Kempe K, Baumgärtel A, Hoogenboom R, Schubert US (2010) Design of new amphiphilic triblock copoly(2-oxazoline)s containing a fluorinated segment. *J Polym Sci A Polym Chem* 48:5100–5108
61. Fijten MWM, Kranenburg JM, Thijs HML, Paulus RM, Van Lankvelt BM, De Hullu J, Springintveld M, Thielen DJG, Tweedie CA, Hoogenboom R, Van Vliet KJ, Schubert US (2007) Synthesis and structure–property relationships of random and block copolymers: a direct comparison for copoly(2-oxazoline)s. *Macromolecules* 40:5879–5886
62. Wijmans S, De Gans B-J, Wiesbrock F, Hoogenboom R, Schubert US (2004) Characterization of a poly(2-oxazoline) library by high-throughput, automated contact-angle measurements and surface-energy calculations. *Macromol Rapid Commun* 25:1958–1962
63. Hoepfener S, Wiesbrock F, Hoogenboom R, Thijs HML, Schubert US (2006) Morphologies of spin-coated films of a library of diblock copoly(2-oxazoline)s and their correlation to the corresponding surface energies. *Macromol Rapid Commun* 27:405–411
64. Kempe K, Jacobs S, Lambermont-Thijs HML, Fijten MWM, Hoogenboom R, Schubert US (2010) Rational design of an amorphous poly(2-oxazoline) with a low glass-transition temperature: monomer synthesis, copolymerization and properties. *Macromolecules* 43:4098–4104
65. Kempe K, Rettler EF-J, Paulus RM, Kuse A, Hoogenboom R, Schubert US (2013) A systematic investigation of the effect of side chain branching on the glass transition temperature and mechanical properties of aliphatic (co-)poly(2-oxazoline)s. *Polymer* 54:2036–2042
66. Hoogenboom R, Thijs HML, Fijten MWM, Schubert US (2007) Synthesis, characterization, and cross-linking of a library of statistical copolymers based on 2-“soy alky”-2-oxazoline and 2-ethyl-2-oxazoline. *J Polym Sci A Polym Chem* 45:5371–5379
67. Lambermont-Thijs HML, Fijten MWM, Van der Linden AJT, Van Lankvelt BM, Bloksma MM, Schubert US, Hoogenboom R (2011) Efficient cationic ring-opening polymerization of diverse cyclic imino ethers: unexpected copolymerization behavior. *Macromolecules* 44:4320–4325
68. Hoogenboom R, Wiesbrock F, Leenen MAM, Van der Loop M, Van Nispen SFGM, Schubert US (2007) Kinetic investigations on microwave-assisted statistical terpolymerizations of 2-oxazoline monomers. *Aust J Chem* 60:656–661

69. Hoogenboom R, Thijs HML, Fijten MWM, Van Lankvelt BM, Schubert US (2007) One-pot synthesis of 2-phenyl-2-oxazoline-containing quasi-diblock copoly(2-oxazoline)s under microwave irradiation. *J Polym Sci A Polym Chem* 45:416–422
70. Lambermont-Thijs HML, Jochems MJHC, Hoogenboom R, Schubert US (2009) Synthesis and properties of gradient copolymers based on 2-phenyl-2-oxazoline and 2-nonyl-2-oxazoline. *J Polym Sci A Polym Chem* 47:6433–6440
71. Lobert M, Hoogenboom R, Fustin C-A, Gohy J-F, Schubert US (2008) Amphiphilic gradient copolymers containing fluorinated 2-phenyl-2-oxazolines: microwave-assisted one-pot synthesis and self-assembly in water. *J Polym Sci A Polym Chem* 46:5859–5868
72. Lava K, Verbraeken B, Hoogenboom R (2015) Poly(2-oxazoline)s and click chemistry: a versatile toolbox toward multi-functional polymers. *Eur Polym J* 65:98–111
73. Luxenhofer R, Jordan R (2006) Click chemistry with poly(2-oxazoline)s. *Macromolecules* 39:3509–3516
74. Lav T-X, Lemechko P, Renard E, Amiel C, Langlois V, Volet G (2013) Development of a new azido-oxazoline monomer for the preparation of amphiphilic graft copolymers by combination of cationic ring-opening polymerization and click chemistry. *React Funct Polym* 73:1001–1008
75. Le Fer G, Amiel C, Volet G (2015) Copolymers based on azidopentyl-2-oxazoline: synthesis, characterization and LCST behavior. *Eur Polym J* 71:523–533
76. Taubmann C, Luxenhofer R, Cesana S, Jordan R (2005) First aldehyde-functionalized poly(2-oxazoline)s for chemoselective ligation. *Macromol Biosci* 5:603–612
77. Legros C, de Pauw-Gillet M-C, Tam KC, Lecommandoux S, Taton D (2015) Aldehyde-functional copolymers based on poly(2-oxazoline) for post-polymerization modification. *Eur Polym J* 62:322–330
78. Kempe K, Vollrath A, Schaefer HW, Poehlmann TG, Biskup C, Hoogenboom R, Hornig S, Schubert US (2010) Multifunctional poly(2-oxazoline) nanoparticles for biological applications. *Macromol Rapid Commun* 31:1869–1873
79. Mero A, Pasut G, Dalla Via L, Fijten MWM, Schubert US, Hoogenboom R, Veronese FM (2008) Synthesis and characterization of poly(2-ethyl-2-oxazoline)-conjugates with proteins and drugs: suitable alternatives to PEG-conjugates. *J Control Release* 125:87–95
80. Kempe K, Neuwirth T, Czaplewska J, Gottschaldt M, Hoogenboom R, Schubert US (2011) Poly(2-oxazoline) glycopolymers with tunable LCST behavior. *Polym Chem* 2:1737–1743
81. Haensch C, Erdmenger T, Fijten MWM, Hoepfner S, Schubert US (2009) Fast surface modification by microwave assisted click reactions on silicon substrates. *Langmuir* 25(14):8019–8024
82. Kempe K, Hoogenboom R, Schubert US (2011) A green approach for the synthesis and thiolene modification of alkene functionalized poly(2-oxazoline)s. *Macromol Rapid Commun* 32:1484–1489
83. Schenk V, Ellmaier L, Rossegger E, Edler M, Griesser T, Weidinger G, Wiesbrock F (2012) Water-developable poly(2-oxazoline)-based negative photoresists. *Macromol Rapid Commun* 33:396–400
84. Wiesbrock F, Stelzer F, Schenk V, Ellmaier L, Polymer Competence Center Leoben GmbH, Austria Technologie & Systemtechnik AG (2013) Patent WO 2013/036979
85. Petit C, Luef KP, Edler M, Griesser T, Kremsner JM, Stadler A, Grassl B, Reynaud S, Wiesbrock F (2015) Microwave-assisted syntheses in recyclable ionic liquids: photoresists based on renewable resources. *ChemSusChem*. doi:10.1002/cssc.201500847
86. Huang H, Hoogenboom R, Leenen MAM, Guillet P, Jonas AM, Schubert US, Gohy J-F (2006) Solvent induced morphological transition in core-cross-linked block copolymer micelles. *J Am Chem Soc* 128:3784–3788
87. Farrugia BL, Kempe K, Schubert US, Hoogenboom R, Dargaville TR (2013) Poly(2-oxazoline) hydrogels for controlled fibroblast attachment. *Biomacromolecules* 14:2724–2732

88. Kelly AM, Hecke A, Wirmsberger B, Wiesbrock F (2011) Synthesis of poly(2-oxazoline)-based hydrogels with tailor-made swelling degrees capable of stimuli-triggered compound release. *Macromol Rapid Commun* 32:1815–1819
89. Li T, Tang H, Wu P (2015) Structural investigation of thermo-responsive poly(2-isopropyl-2-oxazoline) hydrogel across the volume phase transition. *Soft Matter* 11:1911–1918
90. Dargaville TR, Forster R, Farrugia BL, Kempe K, Voorhaar L, Schubert US, Hoogenboom R (2012) Poly(2-oxazoline) hydrogel monoliths via thiol-ene coupling. *Macromol Rapid Commun* 33:1695–1700
91. Dargaville TR, Holier BG, Shokoohmand A, Hoogenboom R (2014) Poly(2-oxazoline) hydrogels as next generation three-dimensional cell supports. *Cell Adh Migr* 8(2):88–93
92. Hartlieb M, Pretzel D, Kempe K, Fritzsche C, Paulus RM, Gottschaldt M, Schubert US (2013) Cationic poly(2-oxazoline) hydrogels for reversible DNA binding. *Soft Matter* 9:4693–4704
93. Cesana S, Auernheimer J, Jordan R, Kessler H, Nuyken O (2006) First poly(2-oxazoline)s with pendant amino groups. *Macromol Chem Phys* 207:183–192
94. Hartlieb M, Schubert S, Kempe K, Windhab N, Schubert US (2015) Stabilization of factor VIII by poly(2-oxazoline) hydrogels. *J Polym Sci A Polym Chem* 53:10–14
95. Schenk V, Rossegger E, Ebner C, Bangerl F, Reichmann K, Hoffmann B, Höpfner M, Wiesbrock F (2014) RGD-functionalization of poly(2-oxazoline)-based networks for enhanced adhesion to cancer cells. *Polymers* 6:264–279
96. Tauhardt L, Kempe K, Knop K, Altuntas E, Jäger M, Schubert S, Fischer D, Schubert US (2011) Linear polyethyleneimine: optimized synthesis and characterization – on the way to “pharmagrade” batches. *Macromol Chem Phys* 212:1918–1924
97. De la Rosa VR, Bauwens E, Monnery BD, De Geest BG, Hoogenboom R (2014) Fast and accurate partial hydrolysis of poly(2-ethyl-2-oxazoline) into tailored linear polyethylenimine copolymers. *Polym Chem* 5:4957–4964
98. Van Kuringen HPC, Lenoir J, Adriaens E, Bender J, De Geest BG, Hoogenboom R (2012) Partial hydrolysis of poly(2-ethyl-2-oxazoline) and potential implications for biomedical applications? *Macromol Biosci* 12:1114–1123
99. Lambermont-Thijs HML, Heuts JPA, Hoepfener S, Hoogenboom R, Schubert US (2011) Selective partial hydrolysis of amphiphilic copoly(2-oxazoline)s as basis for temperature and pH responsive micelles. *Polym Chem* 2:313–322
100. Van Kuringen HPC, De la Rosa VR, Fijten MWM, Heuts JPA, Hoogenboom R (2012) Enhanced selectivity for the hydrolysis of block copoly(2-oxazoline)s in ethanol-water resulting in linear poly(ethylene imine) copolymers. *Macromol Rapid Commun* 33:827–832
101. Kelly AM, Kaltenhauser V, Mühlbacher I, Rametsteiner K, Kren H, Slugovc C, Stelzer F, Wiesbrock F (2013) Poly(2-oxazoline)-derived contact biocides: contributions to the understanding of antimicrobial activity. *Macromol Biosci* 13:116–125

# Microwave-Assisted Polymer Modifications

Christoph Englert, Almut M. Schwenke, Stephanie Hoepfener,  
Christine Weber, and Ulrich S. Schubert

**Abstract** Modern microwave synthesizers allow a detailed adjustment and control of temperature and power, such that many polymer modification reactions are performed nowadays using established synthesis protocols. This chapter provides a broad overview of post-polymerization modification reactions where these advantages are exploited for functionalization of synthetic and natural polymers. Selected examples are discussed in detail to demonstrate the versatility of the technique but also to address the challenges of screening approaches often applied to identify the optimum reaction conditions. While microwave synthesizers are regarded as efficient heating devices in the field of synthetic chemistry, selective heating of, for example, conjugated polymers has opened non-standard opportunities for the development of novel nanomaterials.

**Keywords** Carbon nanomaterials • Microwave-assisted synthesis • Poly(ethylene imine) • Polymer modification • Polysaccharide • Post-polymerization modification

## Contents

1	Introduction .....	211
2	Microwave-Assisted Formation of Carbon Materials from Polymeric Precursors .....	211
3	Microwave-Assisted Modification of Polysaccharides .....	214
3.1	Dissolution and Degradation .....	214
3.2	Modification of Polysaccharide Hydroxyl Groups .....	215
3.3	Modification of Chitosan Amine Moieties .....	219

---

C. Englert, A.M. Schwenke, S. Hoepfener, C. Weber (✉), and U.S. Schubert (✉)  
Laboratory for Organic and Macromolecular Chemistry (IOMC), Friedrich Schiller University  
Jena, Humboldtstrasse 10, 07743 Jena, Germany

Jena Center for Soft Matter (JCSM), Friedrich Schiller University Jena, Philosophenweg 7,  
07743 Jena, Germany

e-mail: [christine.weber@uni-jena.de](mailto:christine.weber@uni-jena.de); [ulrich.schubert@uni-jena.de](mailto:ulrich.schubert@uni-jena.de)



3.4	Modification of Carboxylic Acid Functional Polysaccharides .....	220
3.5	Grafted Polysaccharides .....	221
4	Microwave-Assisted Modification of Synthetic Polymers .....	223
4.1	General Approaches for the Microwave-Assisted Modification of Synthetic Polymers .....	223
4.2	Polymer Functionalization Using Nucleophilic Reagents .....	225
4.3	Hydrolysis of Poly(2-Oxazoline)s .....	228
4.4	Modification of Polymer End Groups .....	230
4.5	Modification of Polymeric Resins .....	233
5	Summary, Conclusions, and Outlook .....	233
	References .....	234

## Abbreviations

ATRP	Atom transfer radical polymerization
bipy	Bipyridine
C-dots	Carbon dots
CL	$\epsilon$ -Caprolactone
DMF	<i>N,N</i> -Dimethylformamide
DMSO	Dimethylsulfoxide
DP	Degree of polymerization
dppp	Diphosphine 1,3-bis(diphenylphosphino)propane
DS	Degree of substitution
EDTA	Ethylenediaminetetraacetic acid
FRP	Free radical polymerization
LPEI	Linear poly(ethylene imine)
NBS	<i>N</i> -Bromosuccinimide
NMP	<i>N</i> -Methyl pyrrolidone
PAA	Poly(acrylic acid)
PCL	Poly( $\epsilon$ -caprolactone)
PE	Polyethylene
PEI	Poly(ethylene imine)
PEO	Poly(ethylene oxide)
PEtOx	Poly(2-ethyl-2-oxazoline)
PMeOx	Poly(2-methyl-2-oxazoline)
POx	Poly(2-oxazoline)
PPhOx	Poly(2-phenyl-2-oxazoline)
PPO	Poly(propylene oxide)
PS	Polystyrene
pTosOH	<i>p</i> -Toluene sulfonic acid
ROP	Ring-opening polymerization
SEM	Scanning electron microscopy
TEA	Triethylamine
TEBA	Triethyl benzyl ammonium chloride
TEM	Transmission electron microscopy
wt%	Weight percent

## 1 Introduction

Nature provides a vast and cheap amount of resources for polymer science. Naturally occurring polymers, i.e., biopolymers such as cellulose are readily available in large quantities and represent raw materials for many applications, in packaging, paper, or textile industry. However, the properties of these natural precursors often have to be tailored to make them suitable for specialized applications. Polymer modification reactions are ideally suited for this purpose. A major part of this chapter covers the microwave-assisted functionalization of polysaccharides. Functional moieties in synthetic polymers are often introduced by polymerization with functional monomers, initiators, or direct end-capping reagents. For such microwave-assisted polymerizations, the reader is referred to the respective chapters in this book [1–5]. Besides, microwave-assisted approaches also have been used for post-polymerization modification of synthetic polymers, which is the focus in this chapter.

From the perspective of material sciences, microwave irradiation is used for two kinds of polymer modifications. On the one hand, the morphology of solid polymers and their blends can be affected, as has been reported for both natural [6–8] and synthetic [9–13] polymers. Furthermore, polymer solutions and solid polymer structures can be treated with microwave irradiation, to obtain solid carbon materials. The latter is discussed at the beginning of this chapter. Subsequently, the chemical functionalization of natural and synthetic polymers via microwave-assisted approaches is summarized.

## 2 Microwave-Assisted Formation of Carbon Materials from Polymeric Precursors

The microwave-assisted heating of solutions containing a polymer can not only be used to introduce functionalities but can also induce reactions that result in the formation of carbon materials. Such processes are often accompanied by a color change to yellowish-brown as a result of the formation of carbon nanoparticles. The so-called carbon dots (C-dots), which often possess fluorescent properties, are highly useful for applications, for example as optical-imaging agents for life-science applications. Various carbonaceous precursors are reported to yield such C-dots in straightforward and rapid one-step synthesis protocols. For example a triblock copolymer composed of a poly(propylene oxide) central block and two poly(ethylene oxide) blocks (PEO-PPO-PEO) was irradiated in the presence of phosphoric acid for only 4 min, resulting in carbon particles with diameters of 5–20 nm [14]. By applying a microwave-assisted hydrothermal process (180 °C for

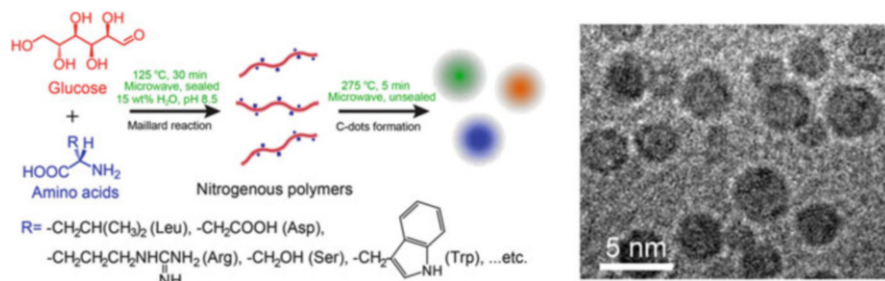

**Fig. 1** Synthesis scheme and TEM image of nitrogen-doped C-dots with tunable emission color [17]. Reprinted with permission of Macmillan Publishers Ltd: Scientific Reports 2014, 4, 3564, copyright 2014

20 min), aqueous solutions of natural resources such as flour yielded C-dots with diameters ranging from 1 to 4 nm [15]. Although the detailed mechanism remains unclear to date, the proposed pathway of the formation of C-dots from carbohydrate-based materials includes the decomposition of the precursor via hydrolysis and dehydration. The soluble compounds obtained are believed to polymerize via polycondensation reactions to yield different soluble polymeric products. Finally, the C-dots would be formed by subsequent aromatization and carbonization [16].

The synthesis of C-dots doped with hetero atoms can be accomplished by utilization of nitrogen or phosphorus-containing precursors. Therefore, precursor polymers were synthesized from a mixture of glucose and amino acids in a microwave-assisted synthesis via the Maillard reaction. Subsequently, an open vessel microwave treatment for 5 min at  $275^\circ\text{C}$  resulted in the formation of nitrogen-doped C-dots with tunable multicolor luminescence (Fig. 1) [17]. The irradiation of a tannin–melamine–hexamine polymer in the presence of polyphosphoric acid yielded nitrogen and phosphorus co-doped mesoporous carbon. Spherical structures were obtained after 10–30 min of irradiation [18].

Chains of graphitic carbon particles in the range from 340 to 620 nm were obtained from poly(ethylene glycol) by microwave-assisted heating in a hydrothermal setup (mixture of ethanol, water, and sodium hydroxide) [19]. After a prolonged irradiation (2 h at  $220^\circ\text{C}$ ), as well fibrous carbon structures were obtained.

When polymer structures are heated by microwave irradiation in the solid state, even the transformation of the polymer backbone into a more or less pure carbon material can be achieved. Because microwave radiation provides direct heating of the reactants and strongly interacts with specific types of materials, carbonization can occur within a short irradiation period of just a few minutes [20]. In particular, exceptional fast heating is observed when conductive polymer structures are irradiated, which efficiently absorb the microwave irradiation. Zhang and co-workers [21, 22] prepared nanostructured chlorine-doped polypyrrole precursors of different shapes including fibers, tubes, and spherical particles (Fig. 2). The structures were

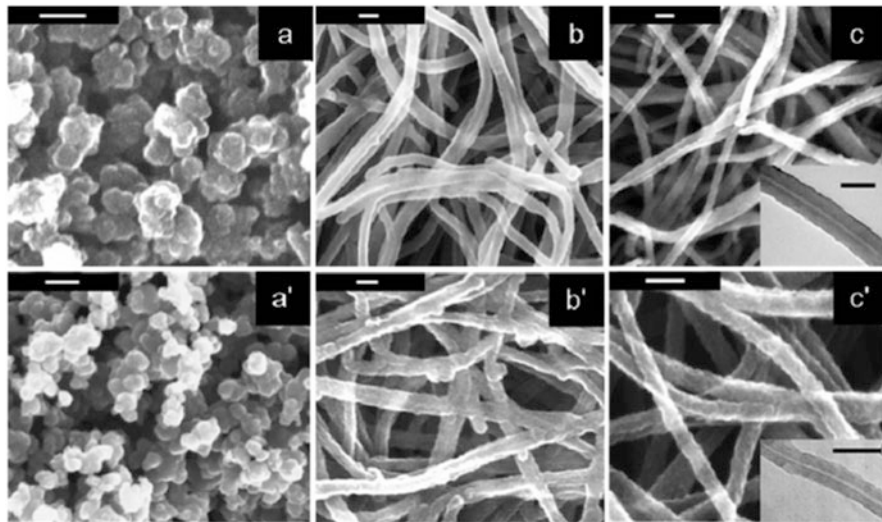

**Fig. 2** Microwave-assisted synthesis of nanostructured carbon from doped polypyrrole structures. SEM and TEM images before (a–c) and after (a'–c') heating. Scale: 100 nm. Reproduced from [22] with permission of The Royal Society of Chemistry

carbonized within 3–5 min when subjected to microwave radiation. Thereby, a weight loss of 50% occurred, and the carbon content of the material was increased from 56% to more than 90%. Despite being performed under non-inert conditions, no oxidation of the backbone took place, which is most likely prevented because of the very rapid heating and carbonization process. The morphology of the nanostructures was retained even though a slight shrinkage occurred.

Structures composed of non-conducting polymers can be as well carbonized by microwave irradiation although longer heating times are required. For example, poly(acrylonitrile) fibers were graphitized by a microwave plasma process in an argon atmosphere [23]. Biowaste materials such as cotton, wood, or filter paper could also be graphitized when polypyrrole was added as filler material to increase the heating efficiency. The morphology and porosity of the biowaste precursors was retained, but the materials exhibited a graphitic structure after the microwave-assisted treatment [24].

Additionally, graphitic materials with high crystallinity were prepared by microwave-supported heating and can be exfoliated into graphene in a two-step microwave protocol [25]. First, metal phthalocyanine was synthesized, which was carbonized at 450 °C in a second step. Direct quenching with a mixture of water and ice or with liquid nitrogen resulted in the exfoliation to graphene with typically one to eight layers [25].

### 3 Microwave-Assisted Modification of Polysaccharides

The manifold functional biopolymer moieties that nature has been developing over millions of years represent a rich pool of which synthetic chemists can take advantage. Microwave irradiation has been exploited for the functionalization of these raw materials since the 1980s. However, some of these functional moieties and their stereochemistry are exactly the reason that make natural polymers often difficult to dissolve in common solvents because of the presence of strong inter- or intramolecular hydrogen bonds. Because solubility represents a prerequisite for homogeneous functionalization reactions, the development of optimum reaction conditions is often challenging and requires harsh conditions or very aggressive solvents such as concentrated acids. The main advantages of the application of microwave irradiation in this respect are the high temperatures that can be applied (along with the opportunity to heat above the boiling point of the solvent in closed reaction vessels) and the very efficient heating of special solvents such as ionic liquids. However, the dissolution of barely soluble materials under rather drastic conditions can still be accompanied by a degradation of the polymeric materials, a fact that has been exploited for the tailored synthesis of polysaccharides with lower degrees of polymerization.

#### 3.1 Dissolution and Degradation

Starch consists of mainly two polysaccharide fractions. Although amylose is a linear polymer where the  $\alpha$ -D-glucose monomers are linked 1,4-glycosidically, additional 1,6-glycosidic linkages result in a branched structure and higher molar mass of the second component amylopectin (Scheme 1). Because starch is a natural product, its composition is prone to variation depending on the resource from which it was isolated. A large amount of different starches could be dissolved in dimethylsulfoxide (DMSO) without degradation using microwave irradiation [26]. At a constant power of 900 W, a few seconds of heating time were sufficient to dissolve the entire starch samples without noticeable degradation in most cases (35 s, maximum temperature 143 °C). On the other hand, microwave reactors can be used to tailor the degradation of starch during acidic hydrolysis. In a semi-dry process, the molar mass of granular starch was efficiently reduced in less than 2 min [27]. In particular, the amylopectin fraction was affected, and the final degree of polymerization (DP) could be tuned by the reaction temperature (60–85 °C) and the amount of hydrochloric acid catalyst. Higher reaction temperatures (up to 100 °C) resulted in the formation of dextrans, i.e., poly( $\alpha$ -D-glucose)s with much lower molar masses.

Because cellulose consists of  $\beta$ -D-glucose repeating units linked 1,4-glycosidically, strong hydrogen bonds are present that ultimately lead to its fibrous structure but make its dissolution extremely difficult. Applying ionic liquids

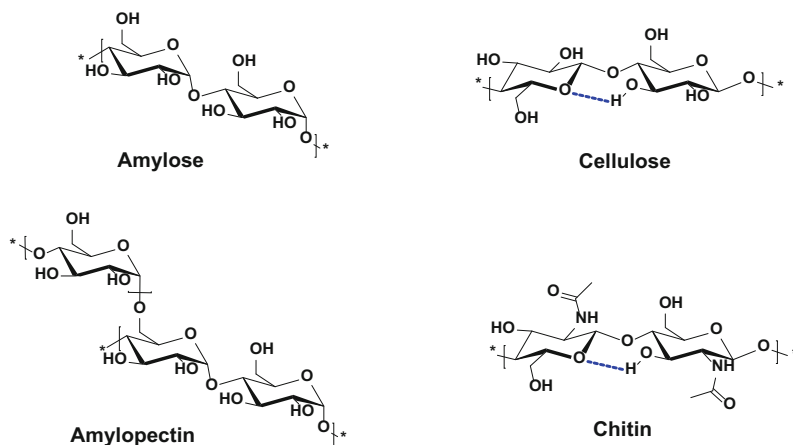

**Scheme 1** Schematic representation of the structure of selected polysaccharides. The *dashed blue lines* represent the hydrogen bonds that complicate the dissolution of polymers based on  $\beta$ -D-glucopyranose

in a screening approach using varying microwave settings proved suitable to dissolve up to 10 wt% of cellulose. Thereby, the DP was decreased by roughly a third in some cases [28]. Because the *N*-acetyl- $\beta$ -D-glucopyranin repeating units of chitin are linked in a similar fashion, its solubilization is also challenging [29]. As for cellulose, the combination of ionic liquids and microwave-assisted heating is helpful to overcome the tight hydrogen bonds of this polysaccharide. Hence, it is possible to prepare 20 wt% solutions [30]. Chitosan, i.e., partially deacetylated chitin, represents one of the few cationic polymers directly available from natural resources [31]. However, its solubility in water (which is often required for applications or further functionalization under mild conditions) is limited to polymers with a low DP [32]. Such oligomeric chitosans are obtained via degradation of high molar mass polymers using different methods. A mild treatment with hydrogen peroxide under microwave irradiation is highly reproducible and prevents the occurrence of undesired side reactions [33]. Appropriate adjustment of the reaction conditions even enables the tailoring of the DP of the oligomers [34].

Similarly, microwave-supported treatment has been reported for the preparation of sulfonated polysaccharides based on galactose with defined molar masses. Factors such as pH value, adjustment of microwave power, or heating time were varied to obtain both  $\lambda$ - and  $\kappa$ -carrageenan oligomers [35, 36].

### 3.2 Modification of Polysaccharide Hydroxyl Groups

All polysaccharides possess multiple hydroxyl functionalities, which can be used to modify the polymers' nature. Scheme 2 outlines the synthetic possibilities that have

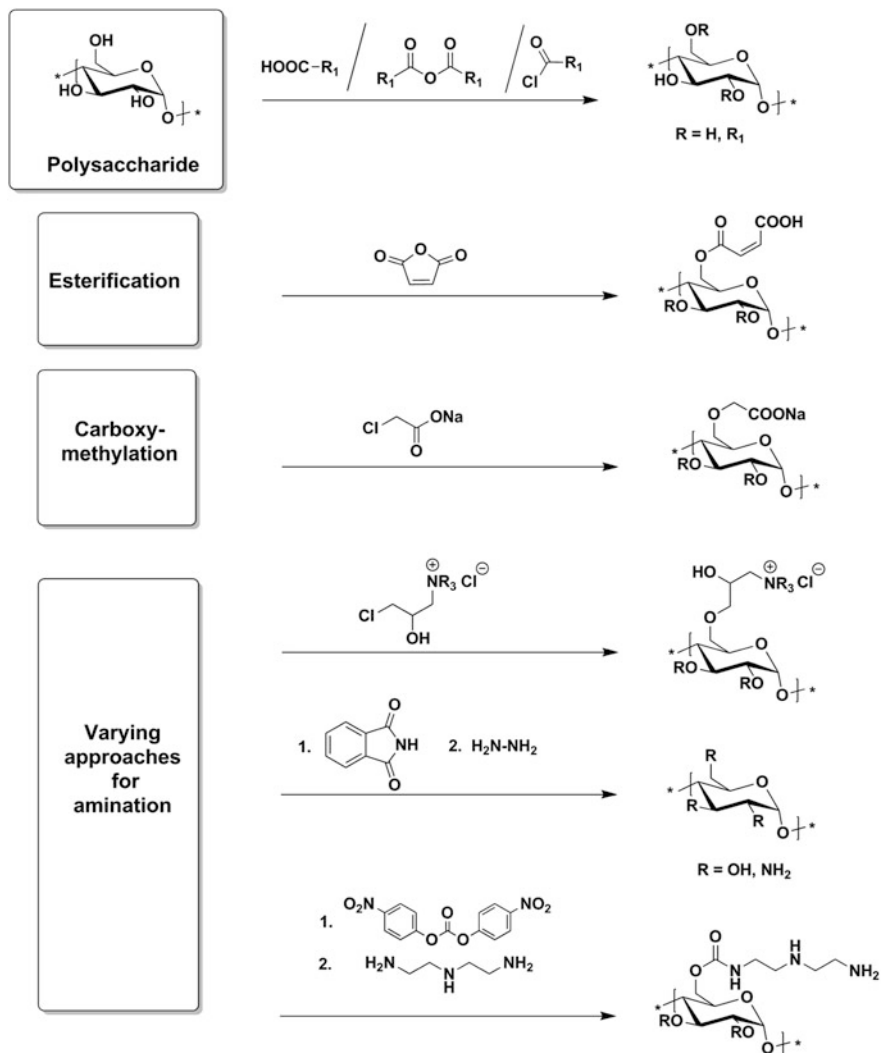

**Scheme 2** Schematic representation of microwave-assisted modifications of polysaccharides by utilization of hydroxyl functionalities. It should be noted that the polysaccharide structure is exemplary and varies as described in the text

been exploited using microwave-assisted synthetic approaches, which are summarized in the following section.

Among these, the most well-known strategy is the esterification of the  $-\text{OH}$  moieties. Similar to protocols utilizing traditional heating, common microwave-assisted approaches include enzymatically catalyzed esterification using simple carboxylic acids, acid chlorides, and the use of anhydrides with or without additional catalyst. Table 1 provides an overview of selected microwave-assisted

**Table 1** Esterification of polysaccharides using microwave-assisted chemistry

Poly-saccharide	Method	Product	Conditions	DS	References
Starch	Carboxylic acid/lipase	Acetate Laurate Stearate	DMF/DMSO 80/160 mW g <sup>-1a</sup> 60/120 min	0.03– 0.51	[37]
Starch	Carboxylic acid/lipase	Acetate Laurate Stearate	DMF/DMSO 25/80°C 120/300 min	0.01– 0.43	[37]
Starch	Anhydride	Acetate Succinate	NaOH/NaOAc 260–1,300 W 1–5 min	≤0.37	[38]
Starch	Anhydride Carboxylic acid	Acetate	Max. 650 W 150°C, 4–7 min Variable defined temperature programs	0.19– 0.78	[39]
Starch	Anhydride Carboxylic acid	Acetate	I <sub>2</sub> catalysis 100 W, 100°C 2–10 min	0.02– 1.27	[40]
Konjac	Anhydride	Succinate	600 W 100 s	0.17– 0.24	[38]
Cellulose	Anhydride	Acetate Propanoate Butyrate Pentanoate Hexanoate	Ionic liquid 30 W 80°C 8–12 h	1.5– 2.9	[41]
Cellulose	Anhydride	Acetate	0.01–0.15 equiv. I <sub>2</sub> 300–800 W, 80–130°C, 5–45 min	0.48– 2.8	[42]
Pectin	Anhydride	Linolate Oleate Palmitate	0.1 equiv. K <sub>2</sub> CO <sub>3</sub> 900 W 3–6 min	N/A	[43]
Carboxy-methyl starch	Anhydride	Octenyl-succinate	DMSO, 0.1 equiv. <i>p</i> TosOH 1–5 min, 140 W 90–160°C	0.05– 0.55	[44]
Hemi-cellulose	Acid chloride	Propionate Octanoate Laurate Oleate	DMF, 0.05 equiv. NBS 300 W, 78°C, 5 min	0.67– 1.28	[45]
Hemi-cellulose	Acid chloride	Laurate	DMF, LiCl, TEA, various catalysts 300 W, 78°C, 1–8 min	0.77– 1.64	[46]

<sup>a</sup>With reference to the amount of sample

synthesis conditions and the degrees of substitution (DS) that could be achieved, although a direct comparison is difficult because of the various types of microwave synthesizers that were applied in different modes. Despite the versatility modern (automatized) microwave synthesizers offer and the unique possibilities to design experiments design of experiments [40] with respect to the optimization of reaction



conditions, these opportunities should not replace critical thinking. It must be noted that the applied reaction conditions sometimes impose a strong influence on the materials obtained. Short reaction times are often reported at the expenses of high DS. Nevertheless, the efficiency of a careful adjustment of the reaction conditions in the microwave synthesizer was demonstrated by Possidonio et al., who could achieve very high and tailored DS values by reacting cellulose with a range of anhydrides in ionic liquids under microwave irradiation with negligible degradation of the polysaccharide [41].

Because of the manifold esters that can be obtained (ranging from acetates to fatty acid esters), this method offers access to polymers from renewable resources featuring a variety of properties. Besides the adjustment of hydrophobicity and the resulting variation of mechanical properties [47], the introduction of further functional moieties such as double bonds derived from fatty acids [43] or carboxylic acids has also been reported. The latter is easily possible in a one-step reaction by conversion of the polysaccharide hydroxyl groups with a cyclic anhydride such as succinic [38] or maleic [48] anhydride. Using appropriately designed anhydrides, the combination of both has been reported simultaneously in a one-step synthesis [44]. On the other hand, the selective esterification of the hydroxyl moieties of pectin, a polysaccharide which already contains carboxylic acid functionalities, has also been reported [43].

Carboxymethylation represents a common method to introduce carboxylic acid functionalities to polysaccharides using chloroacetic acid under alkaline conditions. This reaction has been performed under microwave irradiation with several natural polysaccharides, such as konjac [38], agarose [49], and hemicellulose [50]. In comparison to conventional heating, similar DS values could be achieved, although shorter reaction times were sufficient during microwave-assisted syntheses.

The utilization of analogous reactants (Scheme 2) makes it possible to introduce amine functionalities to polysaccharides via the hydroxyl groups already present. For starch, microwave irradiation proved superior to conventional heating in both reaction time and DS [38]. However, when the fraction of amines in chitosan was increased, conventional heating resulted in much higher DS because of the evaporation of the solvent in the microwave reactor [38]. This problem would probably be avoided by application of modern synthesizers which enable the use of closed reaction vessels nowadays.

An alternative approach towards amino-functional agarose involves the conversion of the agarose hydroxyl functionalities with phthalimide and subsequent hydrazinolysis [51]. During both steps of the Gabriel-like synthesis, optimized microwave-assisted procedures gave rise to DS of around 0.9. Activation of inulin using bis(4-nitrophenyl) carbonate via microwave-assisted chemistry represents another possibility to include amine moieties to a polysaccharide the basis of which functional groups are alcohols [52].

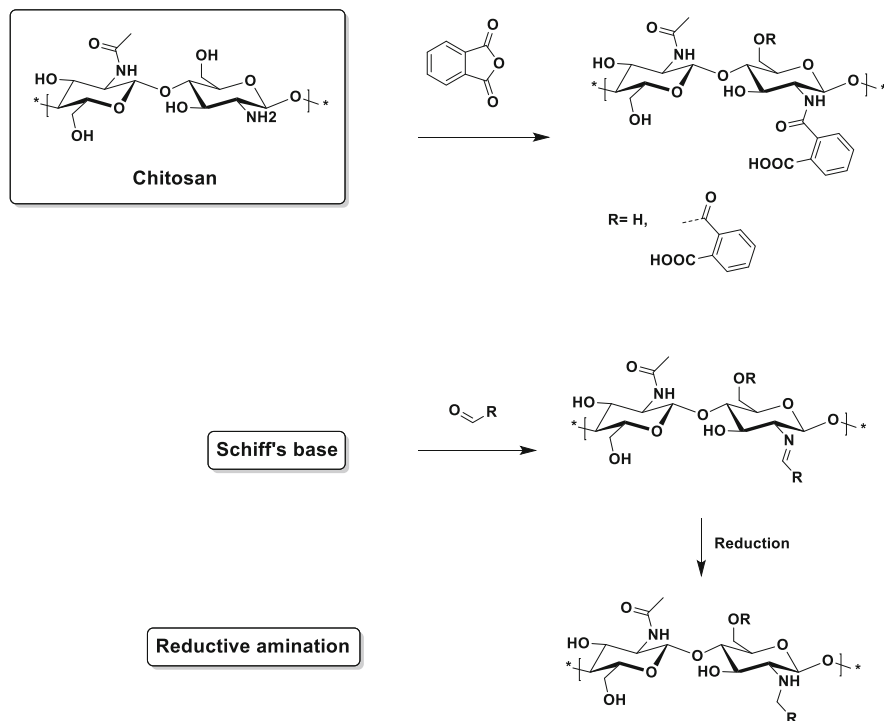

**Scheme 3** Schematic representation of the main strategies for microwave-assisted modifications of chitosan amine moieties

### 3.3 Modification of Chitosan Amine Moieties

The nucleophilicity of the primary amine functionalities of chitosan offers several ways for polymer modification (Scheme 3). However, in the case of unselective reactants, the polysaccharide hydroxyl groups are prone to reaction as well. One example is the application of phthalic anhydride, which was well investigated in terms of microwave-assisted as well as conventional heating [53]. Optimized reaction conditions in the microwave synthesizer (DMF, 500 W, 3 min) resulted in a DS value of 1.4, almost without degradation of the chitosan. To achieve a similar DS value by conventional heating, a reaction time of 5 h was necessary, which caused significant polymer degradation.

In contrast, the formation of Schiff's bases is a possibility to functionalize selectively the primary amine moieties of chitosan. If a reducing agent such as sodium boron hydride is added in situ, the selective alkylation is possible via the so-called reductive amination approach. This reaction has been studied by Petit et al., who compared the alkylation yields achievable via microwave-assisted synthesis in detail to conventional heating using octanal as an exemplary aldehyde reactant [54]. As depicted in Fig. 3, the microwave setup proved superior in terms

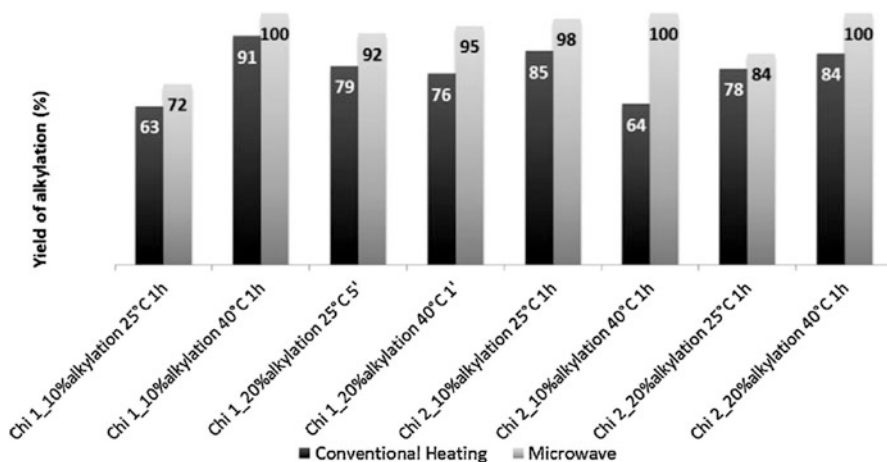

**Fig. 3** Comparison of yields obtained for the synthesis of alkylchitosan using conventional heating and microwave irradiation. Reprinted from *Carbohydrate Polymers* 116, C. Petit et al., Amphiphilic derivatives of chitosan using microwave irradiation: towards an eco-friendly process to chitosan derivatives, 26–33, Copyright 2015, with permission from Elsevier [54]

of alkylation yield, in particular when short reaction times were used. The rheological and surface active properties of the alkylated chitosan derivatives were similar to those of materials prepared by conventional methods.

To obtain scavenger materials for lead and mercury ions, the Schiff's base route was applied to prepare crosslinked chitosan using a double aldehyde functional crown ether via microwave irradiation (800 W, 10 min) [55]. On the other hand, this type of chemistry was reported useful to protect the amine functionalities of chitosan prior to crosslinking with epichlorohydrin [56]. Subsequent deprotection of the Schiff's bases from benzaldehyde under acidic conditions yielded the amino functionalities, which were then functionalized with EDTA via the anhydride method. Microwave-assisted chemistry was exploited in all of these five synthetic steps. A much simpler method to prepare crosslinked copper complexes from chitosan involves the direct complexation of chitosan amine functions followed by Schiff's base formation using glutaraldehyde to include covalent junctions in the network [57]. Both steps comprised the use of microwave synthesizers.

### 3.4 Modification of Carboxylic Acid Functional Polysaccharides

Alginic acid represents a polysaccharide based on  $\alpha$ -L-guluronic acid and  $\beta$ -D-mannuronic acid that naturally contains carboxylic acid functionalities which have been exploited for further modification of the biopolymer. The deprotonated alginate can be crosslinked by addition of calcium ions, a reaction which can also be

used for co-precipitation of proteins. The selectivity of this so-called affinity precipitation can be enhanced by pre-treatment of the native alginic acid [58]. In addition, sodium alginate was successfully applied as a stabilizing agent during the microwave-assisted synthesis of copper nanoparticles [59]. Besides the mere use of the carboxylic acid moieties for the formation of salts, their existence provides the opportunity for further chemical modification by amidation using amines. Without further activation of the carboxylic acid groups, DS between 0.5 and 1.0 could be achieved after reaction with an excess of varying diamines at 100 °C for 10 min using 300 W microwave irradiation, even in aqueous media [60]. The resulting amino-functional alginates were subsequently crosslinked using the natural fluorescent dye genipin. In a similar approach, the modified biopolymer carboxymethylated cellulose (see above) was reacted with ethylene diamine and subsequently crosslinked with alginic acid using the same reaction conditions [61]. Interestingly, microwave irradiation (800 W, 1 min) alone has been reported to be sufficient to crosslink carboxymethylated starch via formation of anhydrides because of dehydration during the heating process [62].

In an alternative approach, carboxymethylated cellulose was applied for transesterification of methyl esters derived from rapeseed oil via microwave-assisted heating [63]. Although the DS values achievable were moderate ( $DS < 0.1$ ), the environmentally benign synthetic approach using a mixture of water and DMF required only reaction times of a few minutes to produce efficient emulsifiers from almost entirely natural resources.

### 3.5 Grafted Polysaccharides

Singh and Sanghi have reviewed the microwave-assisted grafting of polysaccharides in 2012 based on a distinction between the different types of polysaccharides [64]. Hence, this topic is only briefly discussed here from a viewpoint that distinguishes the type of grafting mechanism based on the functional groups present in the polysaccharides and monomers used for the grafting (Scheme 4).

Because alcohols represent initiators for various ring-opening polymerizations (ROP) of lactones to yield polyesters, polysaccharides with their multiple hydroxyl groups seem to be ideal starting materials for grafting-from approaches. Microwave irradiation is especially favorable because the standard catalyst for this type of ROP, tin octoate, requires high reaction temperatures to promote the polymerization of, for example, the quite robust monomer  $\epsilon$ -caprolactone (CL). However, the large difference in hydrophilicity between unmodified polysaccharides and the hydrophobic CL and PCL gives rise to complications because of miscibility in bulk polymerizations. Only when unmodified starch was swollen in water microwave-induced polymerization of the monomer could be observed [38]. The grafting of PCL from the more hydrophobic acetylated konjac was reported to be more successful. In any case, water can initiate the ROP of CL as well, leading to the formation of PCL homopolymers, which requires exhaustive purification of the

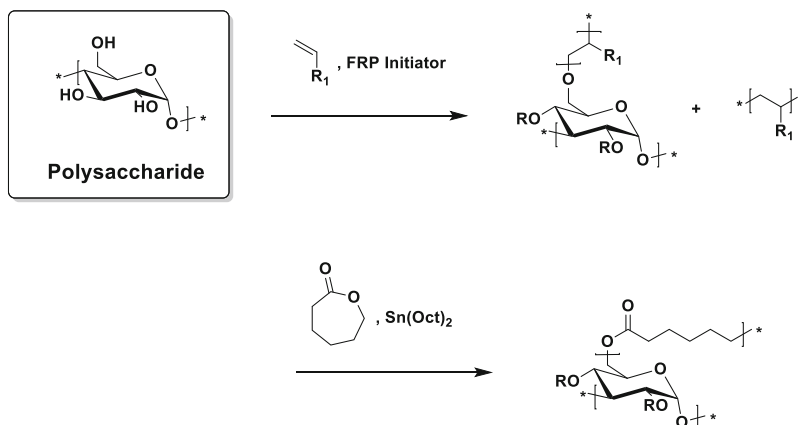

**Scheme 4** Schematic representation of microwave-assisted grafting modifications of polysaccharides using  $\epsilon$ -caprolactone (*bottom*) and FRP of vinylic monomers (*top*). It should be noted that the polysaccharide structure is exemplary and varies as described in the text

graft copolymers [65]. In addition, the exact determination of the composition of the isolated products by spectroscopic means is difficult, although the microwave-assisted bulk synthesis and purification of PCL grafted cellulose [65] and chitin [66] whiskers was achieved successfully in general. The grafting of PCL from chitosan is further complicated by the presence of amine functionalities, which have to be protected prior to the ROP [67]. Phthalic anhydride has been used for this purpose, although the subsequent deprotection via hydrazine can easily induce a degradation of the grafted PCL chains.

The grafting of polymers from vinylic monomers onto or from polysaccharides via microwave-assisted synthesis protocols is mainly performed using various initiator systems able to generate radicals on the polysaccharide. In particular, redox initiators and persulfates are utilized frequently. Hence, this represents a free radical polymerization (FRP), further complicated by the fact that the radical initiator systems are not only capable of creating active radical species on the polysaccharides but can also simply initiate polymerization of the vinylic monomers on their own [68]. This can be compensated to some extent by an addition of monomer subsequent to an “activation step” in which only the polysaccharide and the initiator are heated. It should be clearly stated that the combination of both FRP and unselective initiation results in the formation of considerable amounts of non-grafted synthetic polymer chains, which can be difficult to remove from the graft copolymer. However, optimization of microwave-assisted synthesis was suitable to reach high monomer conversions of acrylonitrile in very short reaction times of a few minutes [69]. On the other hand, longer reaction times (2 h) were reported to be more favorable as soon as the graft copolymers are purified and characterized thoroughly, as shown for alginate-*g*-poly(vinylpyrrolidone) [70].

The homopolymer removal plays a minor role when the surfaces of polysaccharide fibers [71, 72] or other solid materials based on cellulose (pine needles) [73] are

directly modified via such methods, because the separation of ungrafted polymer chains can easily be accomplished in this case. Bifunctional vinylic monomers are often added as crosslinkers, which results in the formation of hydrogels, i.e., insoluble materials that are again easy to purify [74–77].

## 4 Microwave-Assisted Modification of Synthetic Polymers

Microwave-assisted approaches for the modification of synthetic polymers comprise a wide field, ranging from recycling of commodity polymers over the introduction of functional moieties, which can be pendant or at the chain end groups, to the functionalization of resins or surfaces. Hence, we first provide an overview about the general possibilities and approaches that can be and have been applied. Subsequently, selected examples are discussed in more detail, in particular those where extensive investigations on the microwave-assisted syntheses were made and resulted in the establishment of optimized synthesis protocols.

### 4.1 General Approaches for the Microwave-Assisted Modification of Synthetic Polymers

A wide range of reaction types have been performed under microwave irradiation, ranging from “simple” modifications of commodity polymers to the precise adjustment of functionalities in speciality polymers (see Table 2). One of the first modifications reported is the rapid surface oxidation of polyethylene (PE) with potassium permanganate, which leads to the formation of vinyl and hydroxyl moieties [78]. This method represents an environmentally friendly technique without affecting the thermal properties of the PE and without the formation of hydroperoxy groups.

An additional application of microwave irradiation is the conversion of expanded polystyrene (PS) waste into polymeric flocculants by a sulfonation reaction using sulfuric acid in the presence of the catalyst silver sulfate [79]. The product revealed similar properties to the modified PS obtained after conventional heating and the reaction time could be significantly reduced (from 1 h to 15 min). The phosphonation of branched poly(ethylene imine) (PEI) via microwave-assisted synthesis using formaldehyde and phosphorous acid also provides similar products as conventional heating [80]. Although the DS could be well tailored in both methods, microwave-assisted heating proved faster and easier once more.

Taking advantage of the high temperatures that can be achieved, even in low-boiling solvents in closed reactions vessels, microwave-assisted approaches are especially useful for hetero-Diels–Alder reactions. The deprotection of furan–maleimide adducts pendant to PEO-based copolymers was only possible after

Table 2 Overview of general possibilities for microwave-assisted polymer modifications

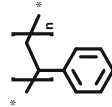
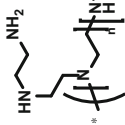
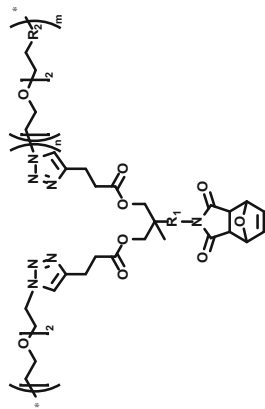
Polymer	Reactant	Solvent, catalyst	Microwave		References
			$t$ (min)	$T$ /Power	
	KMnO <sub>4</sub>	–	0.3–1.5	900 W	[78]
	H <sub>2</sub> SO <sub>4</sub>	Ag <sub>2</sub> SO <sub>4</sub>	5–30	80–110 °C	[79]
	CH <sub>2</sub> O, H <sub>3</sub> PO <sub>3</sub>	HCl	8	150 W	[80]
	–	CHCl <sub>3</sub> , CH <sub>3</sub> CN	60	110 °C	[81]

subjecting the protected polymers to microwave-supported heating in a chloroform–acetonitrile mixture, and attempts to use conventional heating failed [81]. Within 1 h, the complete removal of the furan protecting groups was achieved, and the copolymer itself remained intact.

## 4.2 *Polymer Functionalization Using Nucleophilic Reagents*





Nucleophiles such as amines, phenolates, or thiolates represent valuable reagents to introduce further functionalities or to simply modify the properties of a precursor polymer. In the following, suitable precursor polymer types are discussed, structured according to the underlying chemical reaction mechanisms. Table 3 provides an overview of the respective microwave-assisted polymer modifications, along with a general description of the utilized reaction conditions.





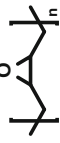
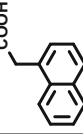
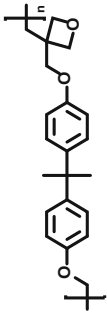
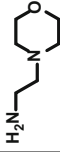
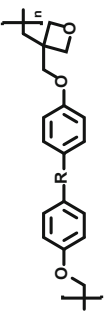

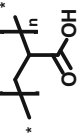
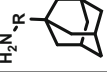
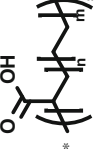
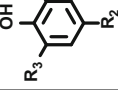
The nucleophilic ring opening of cyclic ethers represents an early example where microwave irradiation was studied as synthetic tool for further modification of polymers. In the easiest case, suitable polymers for this purpose can simply be epoxidized liquid natural rubber, as reported by Huy et al., who used  $\alpha$ -naphthyl acetic acid as nucleophilic reagent to open the three-membered ring [82]. As for many other reactions discussed above, microwave-assisted approaches resulted in higher conversions at shorter reaction time compared to conventional heating. The ring opening of oxetanes as the analogous four-membered rings with amines was successfully employed in a similar fashion to functionalize various polymers based on bisphenols [83]. Microwave-assisted synthesis approaches alone already gave rise to higher conversions. The addition of zinc chloride as catalyst enhanced this effect even further, presumably because its polarity made it an efficient microwave absorber [84].

The microwave-assisted amidation and esterification of various carboxylic acid-functional polymers has been thoroughly studied by Ritter and co-workers. A poly (acrylic acid) (PAA) homopolymer could be functionalized with various adamantyl moieties simply by mixing with the respective adamantyl-functional amine and subsequent use of microwave irradiation [85]. Without the requirement of solvents or coupling agents, copolymers with 5 mol% of adamantyl units were obtained, whose sodium salts were used to form hydrogels produced by the intermolecular association of the hydrophobic side chains. Utilizing *p*-toluenesulfonic acid (pTos–OH) as catalyst, poly[ethylene-*co*-(acrylic acid)] (PE-*co*-PAA) could be modified with phenol derivatives under solvent-free conditions [86]. In a direct comparison with conventional oil bath heating, the microwave irradiation was shown to promote effectively the esterification of the copolymer. A reaction within a few minutes resulted in a high level of reproducibility and conversion. An analogous approach proved suitable for the amidation of PE-*co*-PAA with (2-aminoethoxy) ethanol in a single step to obtain a polyinitiator for the ROP of CL [87]. Subsequently, the results were transferred to poly(ether sulfone)s as alternative polymer

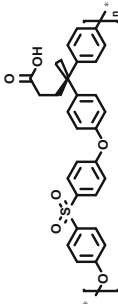
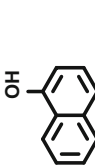

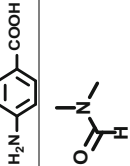
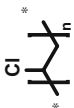
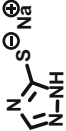
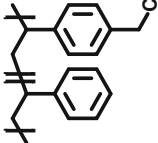
Table 3 Overview of microwave-assisted nucleophilic polymer modifications

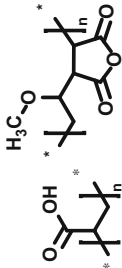
Polymer	Reactant	Solvent, catalyst	Microwave		References
			$t$ (min)	$T$ (°C)	
		Chlorobenzene, TEBA	5–15	150–240 W	[82]
		DMF	60–180	200–800 W	[83]
		DMF, ZnCl <sub>2</sub>	20	100	[84]
		–	20	220	[85]
		pTosOH	5	165	[86]
		Toluene	90	220	[87]

		pTosOH	3	200	[88]
		NMP	20	190	[89]
		Cyclo-hexanone	30–2,880	40–80	[90]
		DMF	15	195 W	[91]
		H <sub>2</sub> O	20	100–150	[92]

type, which could be successfully functionalized with 1-naphthol as well as 4-aminobenzoic acid, even in an apolar solvent such as xylene [88].

DMF can act as an excellent source for dimethylamine and carbon monoxide under microwave irradiation [89]. The in situ generation of these gases is especially advantageous for small-scale reactions where the direct use is impractical, as shown by the modification of poly(vinylimidazolium) salts. The proposed final copolymer structure contains mainly units of 1-vinylimidazole and some units of amines, formamides, and alkenes.

Microwave-assisted modifications of synthetic polymers are not limited to speciality polymers but have also proved to be useful for the functionalization of commodity polymers such as poly(vinyl chloride) [90]. A series of copolymers was obtained by nucleophilic substitution with 1,2,4-triazol-5-yl-sulfanyl groups. Using microwave irradiation as heating source, the reaction could be performed with the highest level of conversion, a significant decrease in reaction times and without the occurrence of secondary reactions. In a similar fashion, a copolymer of styrene and chloromethyl styrene was quaternized with tributyl amine to serve as phase transfer catalyst [91].

When a polymeric nucleophile such as poly(vinylalcohol) is used, hydrogels can be prepared directly from suitable precursor polymers such as PAA or poly(methyl vinyl ether-*alt*-maleic anhydride), taking advantage of the excellent microwave absorption of water [92]. Irradiation of appropriate combinations of polymers in aqueous solutions directly resulted in sterile hydrogels with high swelling ratios, which did not require further purification steps because the use of monomers could be omitted during the synthetic approach.

### 4.3 Hydrolysis of Poly(2-Oxazoline)s

PEI represents the “gold standard” for non-viral gene transfection and, thus, is of major importance in pharmaceutical research [93, 94]. However, the direct polymerization of its monomer aziridin results in the formation of branched polymers. Thus, linear PEIs (LPEIs) with defined molar masses are usually prepared by hydrolysis of its *N*-acyl derivatives, i.e., poly(2-oxazoline)s (POx). Although the required time for acidic hydrolysis ranges from a few hours to several days under conventional heating (depending on the substituent of the POx), the alkaline hydrolysis is even slower. Because drastic reaction conditions are frequently applied, intensive investigations have been carried out regarding the use of microwave-assisted synthetic approaches under several hydrolysis conditions to accelerate this type of reaction (Table 4).

The first reports relied on the use of the hydrophilic POx, i.e., poly(2-methyl-2-oxazoline) (PMeOx) and poly(2-ethyl-2-oxazoline) (PEtOx) [95]. Thereby, kinetic investigations during the microwave-assisted acidic hydrolysis revealed that 2 h were sufficient to reach conversions above 90%, even for the slightly more hydrophobic PEtOx. Subsequent optimization of the hydrolysis and purification

**Table 4** Overview of microwave-assisted hydrolysis of poly(2-oxazoline)s

Starting (co-) polymer	R <sub>1</sub>	R <sub>2</sub>	a (units)	Ox <sub>1</sub> :Ox <sub>2</sub> :EI (%) <sup>a</sup>	Hydrolysis conditions	References
Homo	CH <sub>3</sub>	–	5–200	1:99	HCl (16 wt%), 100 °C	[95]
	C <sub>2</sub> H <sub>5</sub>					
Homo	C <sub>2</sub> H <sub>5</sub>	–	10–200	1:99	HCl (16 wt%), 130 °C	[96]
Homo	C <sub>2</sub> H <sub>5</sub>	–	30, 500	5:95	HCl (3 wt%), 180 °C	[97]
Statistical	CH <sub>3</sub>	C <sub>6</sub> H <sub>5</sub>	a <sub>1</sub> = 60 a <sub>2</sub> = 40	0:2:98	HCl (16 wt%), 100 °C	[98]
Block				20:21:59	NaOH	
				0:16:84	HCl (16 wt%), 100 °C	
				23:36:42	NaOH	
Homo	CH <sub>3</sub>	–	100	5:95	HCl (12 wt%), 100 °C, EtOH:H <sub>2</sub> O 4:1	[99]
	C <sub>2</sub> H <sub>5</sub>			68:22		
	C <sub>6</sub> H <sub>5</sub>			87:13		
Block	CH <sub>3</sub>	C <sub>2</sub> H <sub>5</sub>	a <sub>1</sub> = 50 a <sub>2</sub> = 50	15:37:48		
		C <sub>6</sub> H <sub>5</sub>	a <sub>1</sub> = 60 a <sub>2</sub> = 15	4:18:78		
Homo	C <sub>2</sub> H <sub>5</sub>	–	100	5:95	HCl (16 wt%), 160 °C	[100]
	<i>n</i> -C <sub>9</sub> H <sub>19</sub>			13:87		

<sup>a</sup>The maximum degree of hydrolysis can be determined only within the limits of the <sup>1</sup>H NMR accuracy

procedure proved that even a reaction time of 1 h is sufficient if the reaction is performed at 130 °C [96]. An effective way to accelerate further the hydrolysis of PEtOx is to increase the reaction temperature while using comparatively low acid concentrations [97]. Detailed kinetic investigations, along with the determination of the Arrhenius parameters, revealed the best results at 180 °C with a low-concentrated aqueous solution of HCl. Further increase of the temperature resulted in main chain degradation.

The fact that the hydrolysis rate of hydrophilic POx is significantly enhanced compared to hydrophobic POx has been exploited to prepare gradient and block copolymers, where preferentially the hydrophilic block is transformed to PEI [98]. The preferential cleavage of the PMeOx block in block copolymers with poly(2-phenyl-2-oxazoline) (PPhOx) enabled the synthesis of novel PEI-PPhOx copolymers which exhibit thermoresponsive micellization behavior, and, in some cases, pH responsive micellization. Utilizing an ethanol–water mixture, the selectivity of the hydrolysis could be further enhanced, even allowing a certain differentiation of the hydrophilic PMeOx and PEtOx [99]. Similarly, the hydrolysis rate of PEtOx is higher than that of the hydrophobic poly(2-*n*-nonyl-2-oxazoline) under the same conditions, presumably because the *n*-nonyl chains collapse around the

polymer backbone in aqueous HCl [100]. Nevertheless, the degree of hydrolysis of both POx could be well controlled by adjustment of the reaction time. Hence, a range of copolymers with antimicrobial activity was obtained.

#### 4.4 Modification of Polymer End Groups

The fact that many polymers with defined end groups are accessible from living and controlled polymerizations has brought these “tiny” parts of the polymer chains into the focus of research. Although a range of polymers from microwave-assisted polymerizations can be end-functionalized in situ [101, 102], we only discuss end-group modifications here, where microwave-assisted synthesis approaches have actually been applied for the end-group modification (Table 5).

As a prominent polymer for life science applications, PEO and its copolymer with propylene oxide, PEO-*b*-PPO, have long been commercially available with hydroxyl end groups and with various architectures. Hence, these precursors are often applied to introduce further functionalities. In a two-step microwave-assisted approach, PEO-OH was functionalized with piperazinyl and diazepanyl moieties to serve as support for further preparation of guanidium derivatives [103].

PEO-diol and star-shaped PEO were also easily and quickly functionalized with methacrylate moieties on both end groups. The very simple and well described microwave-assisted procedure can also be adapted for functionalization of the *N*-termini of peptides [104]. The attachment of glucose to the end groups of PEO-*b*-PPO-*b*-PEO via microwave-assisted ring-opening of the sugar's lactone represents another example where microwave synthesizers were applied successfully for a reaction that typically requires high temperatures [105].

Bromo end groups derived from atom transfer radical polymerization (ATRP) or from the synthesis of polythiophenes represent another type of end functionality that has been further functionalized using microwave-assisted approaches. Thus, telechelic PS and poly(methyl methacrylate) functionalized with C<sub>60</sub> were prepared with an increased degree of functionalization in comparison to conventional heating, both polymer types remaining intact [106]. The coupling of highly regioregular poly(thiophene)-based multiblock copolymers can also be achieved and improved under microwave conditions taking advantage of active nickel complexes present as end groups of the individual blocks [107].

The azide-alkyne 1,3-dipolar cycloaddition has become a valuable tool in synthetic polymer chemistry. Microwave-assisted approaches make use of its versatility for step-growth polymerizations [110, 111], for dendrimer synthesis [112, 113], and for monomer preparation [114]. In terms of modification of polymer end groups, alkyne functional PCL has been utilized to synthesize star-shaped PCL with a  $\beta$ -cyclodextrin core via microwave-assisted “click” chemistry in a core-first approach [108]. The same PCL was also coupled to 3,6-di(pyridine-2-yl)pyridazine via a Diels–Alder reaction with inverse-electron-demand to give access to [2 × 2] grid-like metal complexes.

**Table 5** Overview of microwave-assisted polymer end-group modifications

Polymer	Functional unit	Solvent, catalyst	Microwave		References
			t (min)	T/Power	
		Toluene pyridine	10	200	[103]
		CH <sub>2</sub> Cl <sub>2</sub>	5	120 W	
		-	5	Max	[104]
		DMF, Sn(Oct) <sub>2</sub>	15	90–270 W	[105]

(continued)

Table 5 (continued)

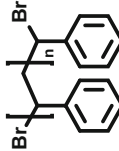
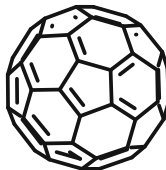
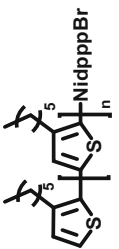
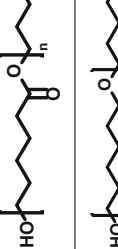
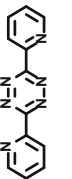
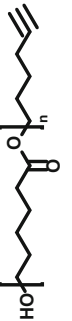
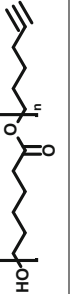
Polymer	Functional unit	Solvent, catalyst	Microwave		References
			t (min)	T/Power	
		Toluene, DMF	20	300 W	[106]
		CuBr, bipy	15		
	–	THF	10	120 °C	[107]
			150	150 °C	[108]
	$\beta$ -Cyclodextrin-N <sub>3</sub>	DMF, Cu <sub>2</sub> SO <sub>4</sub> , Na-ascorbate	15	100 °C	
	Surface-N <sub>3</sub>	H <sub>2</sub> O, EtOH, Cu <sub>2</sub> SO <sub>4</sub> , Na-ascorbate	15–25	120 °C	[109]

Microwave-assisted “click” chemistry on polymer end groups is not limited to reactions in solution. Relying on the azide-alkyne 1,3-dipolar cycloaddition, propargyl-end functional PEtOx was coupled to surfaces functionalized with azide-carrying monolayers in a microwave setup modified to fit silicon substrates inside the common reaction vessels [109]. Vice versa, silica surfaces with an immobilized polymer, i.e., poly(PEO-methacrylate) tethered with both azide and alkyne moieties obtained from surface-initiated ATRP, were subjected to this type of reaction with small molecules as counterparts to functionalize the surfaces further [115].

#### 4.5 *Modification of Polymeric Resins*

Merrifield resins represent very common substrates for a wide range of reactions on solid polymeric supports and are well known, for instance, in the field of solid phase peptide synthesis. Consisting of crosslinked PS with varying fractions of incorporated chloromethyl styrene, the benzyl chloride groups provide the reactive positions prone to attack by nucleophiles.

Microwave-assisted heating proved superior in comparison to conventional heating during the conversion of the resin’s chloride functionalities with PEO under alkaline conditions [116]. Even in 2 min, higher DS values of the resin were achieved than after 35 min during conventional heating, although the thermal degradation of the PEO was significantly reduced. Amines are the more common nucleophiles used with Merrifield resins, but thiols and imidazoles were also immobilized via microwave-assisted approaches [117]. Careful investigations of the obtained products from immobilization of *N*-methyl-D-glucanamine revealed that chemistry using microwave synthesizers is not superior to conventional methods in any case, a fact which is often disregarded upon selling novel synthetic approaches [118]. However, the direct volumetric heating and the possibility to work at higher temperatures than the boiling points of the solvents certainly are advantages which can help to improve reaction times and homogeneity. As such, microwave-assisted synthesis protocols can be very effective during the synthesis of peptides if the reaction conditions are thoroughly adjusted [119]. This also enables the custom-made synthesis of specially designed glycopeptides in a much faster fashion than under conventional heating [120, 121].

### 5 **Summary, Conclusions, and Outlook**

Since microwave synthesizers have found their way into synthetic chemical laboratories, a wide range of natural and synthetic polymers have been subjected to microwave-assisted modification reactions. However, the way these heating sources are applied has significantly changed since the 1990s. The pioneers had



to rely on household microwave ovens or self-built equipment and merely compared the properties of modified polymers derived from microwave-supported heating to those obtained by established synthesis protocols. In contrast, the modern microwave synthesizers allow a detailed adjustment and control of temperature and power, so that many microwave-assisted polymer modification reactions are performed nowadays using optimized synthesis protocols that could be established. In those fields, microwave synthesizers are recognized as common synthetic tools because of advantages such as fast and homogenous heating, the possibility to perform reactions at high temperatures and under pressure, and their ease of handling.

Other fields of research still struggle with the identification of optimum reaction conditions and questions of special microwave effects beyond more effective heating. Unfortunately, some of these investigations tend to lack critical judgment of the chemistry performed and merely highlight the systematic workflows applied. However, also in these fields detailed structural investigations of the products obtained will lead to reasonable synthetic approaches so that microwave synthesizers will become standard equipment for more synthetic polymer chemists in the future.

On the other hand, selective heating of, for example, conjugated polymers by microwave irradiation has opened non-classical opportunities in materials science. Hence, more developments of novel nanomaterials prepared from polymers via microwave-assisted approaches are to be discovered in this still vital field of research.

**Acknowledgement** The authors acknowledge the Carl-Zeiss-Foundation and the Thuringian Ministry of Economic Affairs, Science and Digital Society (TMWWdG).

## References

1. Fang L, Han G, Zhang H (2015) Microwave-assisted free radical polymerizations. *Adv Polym Sci*. doi:[10.1007/12\\_2013\\_276](https://doi.org/10.1007/12_2013_276)
2. Fimberger M, Wiesbrock F (2015) Microwave-assisted synthesis of polyesters and polyamides by ring-opening polymerization. *Adv Polym Sci*. doi:[10.1007/12\\_2014\\_293](https://doi.org/10.1007/12_2014_293)
3. Luef KP, Hoogenboom R, Schubert US, Wiesbrock F (2015) Microwave-assisted cationic ring-opening polymerization of 2-oxazolines. *Adv Polym Sci*. doi:[10.1007/12\\_2015\\_340](https://doi.org/10.1007/12_2015_340)
4. Mallakpour S, Zadehnazari A (2013) Microwave-assisted step-growth polymerizations (From polycondensation to C–C coupling). *Adv Polym Sci*. doi:[10.1007/12\\_2013\\_275](https://doi.org/10.1007/12_2013_275)
5. Reynaud S, Grassl B (2015) Microwave-assisted controlled radical polymerization. *Adv Polym Sci*. doi:[10.1007/12\\_2014\\_302](https://doi.org/10.1007/12_2014_302)
6. Ibrahim NA, Abou Elmaaty TM, Eid BM, Abd El-Aziz E (2013) Combined antimicrobial finishing and pigment printing of cotton/polyester blends. *Carbohydr Polym* 95:379–388
7. Jacquot C, Jacquot M, Marques P, Jasniewski J, Akhtar MJ, Didelot A-S, Desobry S (2014) Influence of microwave heating time on the structure and properties of chitosan films. *J Appl Polym Sci* 131:40779
8. Felix J, Gatenholm P, Schreiber HP (1994) Plasma modification of cellulose fibers – effects on some polymer composite properties. *J Appl Polym Sci* 51:285–295

9. Dinesh M, Chikkakuntappa R (2013) Microwave irradiation induced modifications on the interfaces in SAN/EVA/PVC and PVAc/BPA/PVP ternary polymer blends: positron lifetime study. *Nucl Instrum Meth B* 310:67–74
10. Manjula MK, Rai KML, Raj JM, Siddaramaiah CSM, Ranganathaiah C (2010) Microwave assisted improvement in physico-mechanical properties of poly(vinyl alcohol)/poly(ethylene imine)/gelatin blends. *J Polym Res* 17:89–98
11. Raj JM, Altaweel AMAM, Chandrashekara MN, Ramya P, Ravikumar HB, Ranganathaiah C (2011) An effective tool to characterize adhesion at the interface of binary polymer blends: a free volume study. *J Polym Eng* 31:93–96
12. Raj JM, Ranganathaiah C (2009) A new method of stabilization and characterization of the interface in binary polymer blends by irradiation: a positron annihilation study. *J Polym Sci B Polym Phys* 47:619–632
13. Raj JM, Ranganathaiah C, Ganesh S (2008) Interfacial modifications in PS/PMMA and PVC/EVA blends by e-beam and microwave irradiation: a free volume study. *Polym Eng Sci* 48:1495–1503
14. Mitra S, Chandra S, Kundu T, Banerjee R, Pramanik P, Goswami A (2012) Rapid microwave synthesis of fluorescent hydrophobic carbon dots. *RSC Adv* 2:12129–12131
15. Qin X, Lu W, Asiri AM, Al-Youbi AO, Sun X (2013) Microwave-assisted rapid green synthesis of photoluminescent carbon nanodots from flour and their applications for sensitive and selective detection of mercury(II) ions. *Sens Actuator B Chem* 184:156–162
16. Liu Y, Xiao N, Gong N, Wang H, Shi X, Gu W, Ye L (2014) One-step microwave-assisted polyol synthesis of green luminescent carbon dots as optical nanoprobe. *Carbon* 68:258–264
17. Wei W, Xu C, Wu L, Wang J, Ren J, Qu X (2014) Non-enzymatic-browning-reaction: a versatile route for production of nitrogen-doped carbon dots with tunable multicolor luminescent display. *Sci Rep* 4:3564
18. Bairi VG, Bourdo SE, Nasini UB, Ramasahayam SK, Watanabe F, Berry BC, Viswanathan T (2013) Microwave-assisted synthesis of nitrogen and phosphorus co-doped mesoporous carbon and their potential application in alkaline fuel cells. *Sci Adv Mater* 5:1275–1281
19. Harris AT, Deshpande S, Kefeng X (2009) Synthesis of graphitic carbon particle chains at low temperatures under microwave irradiation. *Mater Lett* 63:1390–1392
20. Schwenke AM, Hoepfner S, Schubert US (2015) Synthesis and modification of carbon nanomaterials utilizing microwave heating. *Adv Mater* 27:4113–4141
21. Zhang X, Liu Z (2012) Recent advances in microwave initiated synthesis of nanocarbon materials. *Nanoscale* 4:707–714
22. Zhang X, Manohar SK (2006) Microwave synthesis of nanocarbons from conducting polymers. *Chem Commun* 2477–2479
23. Kim S-Y, Kim SY, Lee S, Jo S, Im Y-H, Lee H-S (2015) Microwave plasma carbonization for the fabrication of polyacrylonitrile-based carbon fiber. *Polymer* 56:590–595
24. Wang C, Ma D, Bao X (2008) Transformation of biomass into porous graphitic carbon nanostructures by microwave irradiation. *J Phys Chem C* 112:17596–17602
25. Xu Z, Li H, Li W, Cao G, Zhang Q, Li K, Fu Q, Wang J (2011) Large-scale production of graphene by microwave synthesis and rapid cooling. *Chem Commun* 47:1166–1168
26. Bello-Perez LA, Roger P, Baud B, Colonna P (1998) Macromolecular features of starches determined by aqueous high-performance size exclusion chromatography. *J Cereal Sci* 27: 267–278
27. Klingler R, Busch KG, Vahedi B (1997) Acid modification of starch in a semi-dry process. *Starch* 49:391–395
28. Vitz J, Erdmenger T, Haensch C, Schubert US (2009) Extended dissolution studies of cellulose in imidazolium based ionic liquids. *Green Chem* 11:417–424
29. Jaworska MM, Kozlecki T, Gorak A (2012) Review of the application of ionic liquids as solvents for chitin. *J Polym Eng* 32:67–69

30. Qin Y, Lu X, Sun N, Rogers RD (2010) Dissolution or extraction of crustacean shells using ionic liquids to obtain high molecular weight purified chitin and direct production of chitin films and fibers. *Green Chem* 12:968–971
31. Wang J, Chen C (2014) Chitosan-based biosorbents: modification and application for biosorption of heavy metals and radionuclides. *Bioresour Technol* 160:129–141
32. Illy N, Robitzer M, Auvergne R, Caillol S, David G, Boutevin B (2014) Synthesis of water-soluble allyl-functionalized oligochitosan and its modification by thiol-ene addition in water. *J Polym Sci Part A Polym Chem* 52:39–48
33. Shao J, Yang Y, Zhong Q (2003) Studies on preparation of oligoglucosamine by oxidative degradation under microwave irradiation. *Polym Degrad Stab* 82:395–398
34. Sun T, Zhou D, Xie J, Mao F (2007) Preparation of chitosan oligomers and their antioxidant activity. *Eur Food Res Technol* 225:451–456
35. Zhou G, Yao W, Wang C (2006) Kinetics of microwave degradation of  $\lambda$ -carrageenan from *Chondrus ocellatus*. *Carbohydr Polym* 64:73–77
36. Tang F, Chen F, Li F (2013) Preparation and potential in vivo anti-influenza virus activity of low molecular-weight kappa-carrageenans and their derivatives. *J Appl Polym Sci* 127: 2110–2115
37. Lukaszewicz M, Kowalski S (2012) Low power microwave-assisted enzymatic esterification of starch. *Starch* 64:188–197
38. Koroskenyi B, McCarthy S (2002) Microwave-assisted solvent-free or aqueous-based synthesis of biodegradable polymers. *J Polym Environ* 10:93–104
39. Shogren RL, Biswas A (2006) Preparation of water-soluble and water-swelling starch acetates using microwave heating. *Carbohydr Polym* 64:16–21
40. Soetaredjo FE, Ismadji S, Huynh LH, Kasim NS, Tran-Thi NY, Ayucitra A, Ju Y-H (2012) Facile preparation of sago starch esters using full factorial design of experiment. *Starch* 64: 590–597
41. Possidonio S, Fidale LC, El Seoud OA (2010) Microwave-assisted derivatization of cellulose in an ionic liquid: an efficient, expedient synthesis of simple and mixed carboxylic esters. *J Polym Sci A Polym Chem* 48:134–143
42. Li J, Zhang L-P, Peng F, Bian J, Yuan T-Q, Xu F, Sun R-C (2009) Microwave-assisted solvent-free acetylation of cellulose with acetic anhydride in the presence of iodine as a catalyst. *Molecules* 14:3551
43. Calce E, Bugatti V, Vittoria V, De Luca S (2012) Solvent-free synthesis of modified pectin compounds promoted by microwave irradiation. *Molecules* 17:12234–12242
44. Čížová A, Sroková I, Sasinková V, Malvíková A, Ebringerová A (2008) Carboxymethyl starch octenylsuccinate: microwave- and ultrasound-assisted synthesis and properties. *Starch* 60:389–397
45. Xu F, Jiang J-X, Sun R-C, She D, Peng B, Sun J-X, Kennedy JF (2008) Rapid esterification of wheat straw hemicelluloses induced by microwave irradiation. *Carbohydr Polym* 73:612–620
46. Ren J-L, Xu F, Sun R-C, Peng B, Sun J-X (2008) Studies of the lauroylation of wheat straw hemicelluloses under heating. *J Agric Food Chem* 56:1251–1258
47. Suchaiya V, Aht-Ong D (2014) Microwave-assisted modification of cellulose as a compatibilizer for PLA and MCC biocomposite film: effects of side chain length and content on mechanical and thermal properties. *Polym Polym Compos* 22:613–624
48. Aime S, Gianolio E, Uggeri F, Tagliapietra S, Barge A, Cravotto G (2006) New paramagnetic supramolecular adducts for MRI applications based on non-covalent interactions between Gd (III)-complexes and beta- or gamma-cyclodextrin units anchored to chitosan. *J Inorg Biochem* 100:931–938
49. Chaudhary JP, Kondaveeti S, Gupta V, Prasad K, Meena R (2014) Preparation and functional evaluation of agarose derivatives. *J Appl Polym Sci* 131:40630
50. Peng X-W, Ren J-L, Zhong L-X, Cao X-F, Sun R-C (2011) Microwave-induced synthesis of carboxymethyl hemicelluloses and their rheological properties. *J Agric Food Chem* 59: 570–576

51. Kondaveeti S, Mehta GK, Siddhanta AK (2014) Modification of agarose: 6-aminoagarose mediated syntheses of fluorogenic pyridine carboxylic acid amides. *Carbohydr Polym* 106: 365–373
52. Sardo C, Farra R, Licciardi M, Dapas B, Scialabba C, Giammona G, Grassi M, Grassi G, Cavallaro G (2015) Development of a simple, biocompatible and cost-effective inulin-diethylenetriamine based siRNA delivery system. *Eur J Pharm Sci* 75:60–71
53. Liu L, Li Y, Li Y, Fang Y-E (2004) Rapid N-phthaloylation of chitosan by microwave irradiation. *Carbohydr Polym* 57:97–100
54. Petit C, Reynaud S, Desbrieres J (2015) Amphiphilic derivatives of chitosan using microwave irradiation. Toward an eco-friendly process to chitosan derivatives. *Carbohydr Polym* 116:26–33
55. Radwan AA, Alanazi FK, Alsarra IA (2010) Microwave irradiation-assisted synthesis of a novel crown ether crosslinked chitosan as a chelating agent for heavy metal ions (M + n). *Molecules* 15:6257
56. Ge H, Huang S (2010) Microwave preparation and adsorption properties of EDTA-modified cross-linked chitosan. *J Appl Polym Sci* 115:514–519
57. Cao Z, Ge H, Lai S (2001) Studies on synthesis and adsorption properties of chitosan cross-linked by glutaraldehyde and Cu(II) as template under microwave irradiation. *Eur Polym J* 37:2141–2143
58. Mondal K, Mehta P, Gupta MN (2004) Affinity precipitation of *Aspergillus niger* pectinase by microwave-treated alginate. *Protein Expr Purif* 33:104–109
59. Diaz-Visurraga J, Daza C, Pozo C, Becerra A, von Plessing C, Garcia A (2012) Study on antibacterial alginate-stabilized copper nanoparticles by FT-IR and 2D-IR correlation spectroscopy. *Int J Nanomedicine* 7:3597–3612
60. Chhatbar MU, Meena R, Prasad K, Chejara DR, Siddhanta AK (2011) Microwave-induced facile synthesis of water-soluble fluorogenic alginic acid derivatives. *Carbohydr Res* 346: 527–533
61. Sanandiya ND, Siddhanta AK (2013) Facile synthesis of a new fluorogenic metal scavenging interpolymeric diamide based on cellulose and alginic acids. *Carbohydr Res* 381:93–100
62. Grabowska B, Sitarz M, Olejnik E, Kaczmarska K (2015) FT-IR and FT-Raman studies of cross-linking processes with Ca<sup>2+</sup> ions, glutaraldehyde and microwave radiation for polymer composition of poly(acrylic acid)/sodium salt of carboxymethyl starch – part I. *Spectrochim Acta A* 135:529–535
63. Tomanová V, Pielichowski K, Sroková I, Žoldaková A, Sasinková V, Ebringerová A (2008) Microwave-assisted synthesis of carboxymethylcellulose – based polymeric surfactants. *Polym Bull* 60:15–25
64. Singh V, Kumar P, Sanghi R (2012) Use of microwave irradiation in the grafting modification of the polysaccharides - a review. *Prog Polym Sci* 37:340–364
65. Lin N, Chen G, Huang J, Dufresne A, Chang PR (2009) Effects of polymer-grafted natural nanocrystals on the structure and mechanical properties of poly(lactic acid): a case of cellulose whisker-graft-polycaprolactone. *J Appl Polym Sci* 113:3417–3425
66. Feng L, Zhou Z, Dufresne A, Huang J, Wei M, An L (2009) Structure and properties of new thermoforming bionanocomposites based on chitin whisker-graft-polycaprolactone. *J Appl Polym Sci* 112:2830–2837
67. Liu L, Li Y, Fang Y, Chen LX (2005) Microwave-assisted graft copolymerization of epsilon-caprolactone onto chitosan via the phthaloyl protection method. *Carbohydr Polym* 60: 351–356
68. Das R, Das D, Ghosh P, Ghosh A, Dhara S, Panda AB, Pal S (2015) Novel pH-responsive graft copolymer based on HPMC and poly(acrylamide) synthesised by microwave irradiation: application in controlled release of ornidazole. *Cellulose* 22:313–327
69. Meenkashi, Ahuja M, Verma P (2014) MW-assisted synthesis of carboxymethyl tamarind kernel polysaccharide-g-polyacrylonitrile: optimization and characterization. *Carbohydr Polym* 113:532–538

70. Yiğitoğlu M, Aydın G, Işıklan N (2014) Microwave-assisted synthesis of alginate-g-polyvinylpyrrolidone copolymer and its application in controlled drug release. *Polym Bull* 71:385–414
71. Kalia S, Sheoran R (2011) Modification of ramine fibers using microwave-assisted and cellulase enzyme-assisted biopolishing: a comparative study of morphology, thermal stability, and crystallinity. *Int J Polym Anal Ch* 16:307–318
72. Kalia S, Vashistha S (2012) Surface modification of sisal fibers (*Agave sisalana*) using bacterial cellulase and methyl methacrylate. *J Polym Environ* 20:142–151
73. Thakur VK, Thakur MK, Gupta RK (2013) Graft copolymers from cellulose: synthesis, characterization and evaluation. *Carbohydr Polym* 97:18–25
74. Sorour MH, El Sayed MM, Abd El Moneem NM, Talaat HA, Shaalan HF, El Marsafy SM (2013) Process and financial considerations pertinent to hydrogel manufacture. *Starch* 65:527–534
75. Sorour M, El-Sayed M, Abd El Moneem N, Talaat HA, Shalaan H, El Marsafy S (2013) Characterization of hydrogel synthesized from natural polysaccharides blend grafted acrylamide using microwave (MW) and ultraviolet (UV) techniques. *Starch* 65:172–178
76. Wei X, Chang G, Li J, Wang F, Cui L, Fu T, Kong L (2014) Preparation of pH- and salinity-responsive cellulose copolymer in ionic liquid. *J Polym Res* 21:535
77. Likhitha M, Sailaja RRN, Priyambika VS, Ravibabu MV (2014) Microwave assisted synthesis of guar gum grafted sodium acrylate/cloisite superabsorbent nanocomposites: reaction parameters and swelling characteristics. *Int J Biol Macromol* 65:500–508
78. Mallakpour SE, Hajipour AR, Mahdavian AR, Zadhoush A, Ali-Hosseini F (2001) Microwave assisted oxidation of polyethylene under solid-state conditions with potassium permanganate. *Eur Polym J* 37:1199–1206
79. Sulkowski WW, Wolinska A, Sulkowska A, Nowak K, Bogdal D (2008) Sulphonation of expanded polystyrene waste under microwave irradiation. *E Polymers* 7:65–71
80. Monteil C, Bar N, Moreau B, Retoux R, Bee A, Talbot D, Villemin D (2014) Phosphonated polyethylenimine-coated nanoparticles: size- and zeta-potential-adjustable nanomaterials. *Part Part Syst Charact* 31:219–227
81. Arslan M, Gok O, Sanyal R, Sanyal A (2014) Clickable poly(ethylene glycol)-based copolymers using azide-alkyne click cycloaddition-mediated step-growth polymerization. *Macromol Chem Phys* 215:2237–2247
82. Huy HT, Buu TN, Dung TTK, Han TN, VanQuang P (1996) Fixation of alpha-naphthyl acetic acid onto epoxidized liquid natural rubber in microwave reactor (monomode system). *J Macromol Sci Pure Appl Chem* 1957–1962
83. Hurduc N, Buisine JM, Decock P, Talewee J, Surpateanu G (1996) Influence of microwaves irradiation on modification of oxetane based polymers with 4-(2-amino-ethyl)morpholine. *Polym J* 28:550–552
84. Baudel V, Cazier F, Woisel P, Surpateanu G (2002) Synthesis and modification of oxetane based oligomers with 3-ethoxypropylamine by focused microwave irradiation. *Eur Polym J* 38:615–618
85. Kretschmann O, Schmitz S, Ritter H (2007) Microwave-assisted synthesis of associative hydrogels. *Macromol Rapid Commun* 28:1265–1269
86. Bezdushna E, Ritter H (2007) Microwave-assisted esterification of methacrylic acid and polymer-analogous esterification of poly[ethylene-co-(acrylic acid)] with dissimilar phenols. *Macromol Rapid Commun* 28:443–448
87. Sinnwell S, Ritter H (2007) Microwave assisted hydroxyalkylamidation of poly(ethylene-co-acrylic acid) and formation of grafted poly( $\epsilon$ -caprolactone) side chains. *J Polym Sci A Polym Chem* 45:3659–3667
88. Bezdushna E, Ritter H (2008) Microwave promoted polymer analogous amidation and esterification of poly(ether sulfone) bearing free carboxylic groups. *Macromol Chem Phys* 209:1942–1947

89. Dickmeis M, Ritter H (2009) Microwave-assisted modification of poly(vinylimidazolium salts) via N, N-dimethylformamide decomposition. *Macromol Chem Phys* 210:776–782
90. Lamanna M, D'Accorso N (2011) New copolymers with heterocyclic pendant groups obtained from PVC using microwave-assisted process. *J Appl Polym Sci* 121:951–956
91. Chen ZX, Xu GY, Yang GC, Wang W (2004) Preparation of non-cross-linked polystyrene-supported quaternary ammonium salts and use as phase transfer catalysts under microwave. *React Funct Polym* 61:139–146
92. Cook JP, Goodall GW, Khutoryanskaya OV, Khutoryanskiy VV (2012) Microwave-assisted hydrogel synthesis: a new method for crosslinking polymers in aqueous solutions. *Macromol Rapid Commun* 33:332–336
93. Englert C, Tauhardt L, Hartlieb M, Kempe K, Gottschaldt M, Schubert US (2014) Linear poly(ethylene imine)-based hydrogels for effective binding and release of DNA. *Biomacromolecules* 15:1124–1131
94. Rinkenauer AC, Vollrath A, Schallon A, Tauhardt L, Kempe K, Schubert S, Fischer D, Schubert US (2013) Parallel high-throughput screening of polymer vectors for nonviral gene delivery: evaluation of structure–property relationships of transfection. *ACS Comb Sci* 15:475–482
95. Lambermont-Thijs HM, van der Woerd FS, Baumgaertel A, Bonami L, Du Prez FE, Schubert US, Hoogenboom R (2009) Linear poly(ethylene imine)s by acidic hydrolysis of poly(2-oxazoline)s: kinetic screening, thermal properties, and temperature-induced solubility transitions. *Macromolecules* 43:927–933
96. Tauhardt L, Kempe K, Knop K, Altuntas E, Jaeger M, Schubert S, Fischer D, Schubert US (2011) Linear polyethyleneimine: optimized synthesis and characterization - on the way to “pharmagrade” batches. *Macromol Chem Phys* 212:1918–1924
97. de la Rosa VR, Bauwens E, Monnery BD, De Geest BG, Hoogenboom R (2014) Fast and accurate partial hydrolysis of poly(2-ethyl-2-oxazoline) into tailored linear polyethylenimine copolymers. *Polym Chem* 5:4957–4964
98. Lambermont-Thijs HML, Heuts JPA, Hoepfener S, Hoogenboom R, Schubert US (2011) Selective partial hydrolysis of amphiphilic copoly(2-oxazoline)s as basis for temperature and pH responsive micelles. *Polym Chem* 2:313–322
99. van Kuringen HPC, de la Rosa VR, Fijten MWM, Heuts JPA, Hoogenboom R (2012) Enhanced selectivity for the hydrolysis of block copoly(2-oxazoline)s in ethanol–water resulting in linear poly(ethylene imine) copolymers. *Macromol Rapid Commun* 33:827–832
100. Kelly AM, Kaltenhauser V, Mühlbacher I, Rametsteiner K, Kren H, Slugovc C, Stelzer F, Wiesbrock F (2013) Poly(2-oxazoline)-derived contact biocides: contributions to the understanding of antimicrobial activity. *Macromol Biosci* 13:116–125
101. Tauhardt L, Frant M, Pretzel D, Hartlieb M, Bucher C, Hildebrand G, Schroter B, Weber C, Kempe K, Gottschaldt M, Liefelth K, Schubert US (2014) Amine end-functionalized poly(2-ethyl-2-oxazoline) as promising coating material for antifouling applications. *J Mater Chem B* 2:4883–4893
102. Weber C, Czaplowska JA, Baumgaertel A, Altuntas E, Gottschaldt M, Hoogenboom R, Schubert US (2012) A sugar decorated macromolecular bottle brush by carbohydrate-initiated cationic ring-opening polymerization. *Macromolecules* 45:46–55
103. Chen C-H, Tung C-L, Sun C-M (2012) Microwave-assisted synthesis of highly functionalized guanidines on soluble polymer support. *Tetrahedron Lett* 53:3959–3962
104. Van Hove AH, Wilson BD, Benoit DSW (2013) Microwave-assisted functionalization of poly(ethylene glycol) and on-resin peptides for use in chain polymerizations and hydrogel formation. *J Vis Exp* 80, e50890
105. Glisoni RJ, Sosnik A (2014) Novel poly(ethylene oxide)-b-poly(propylene oxide) copolymer-glucose conjugate by the microwave-assisted ring opening of a sugar lactone. *Macromol Biosci* 14:1639–1651
106. Wu H, Li F, Lin Y, Yang M, Chen W, Cai R (2006) Synthesis of telechelic C60 end-capped polymers under microwave irradiation. *J Appl Polym Sci* 99:828–834

107. Ouhib F, Desbief S, Lazzaroni R, De Winter J, Gerbaux P, Jerome C, Detrembleur C (2012) Thermally induced coupling of poly(thiophene)-based block copolymers prepared by Grignard metathesis polymerization: a straightforward route toward highly regioregular multiblock conjugated copolymers. *Macromolecules* 45:6796–6806
108. Hoogenboom R, Moore BC, Schubert US (2006) Synthesis of star-shaped poly( $\epsilon$ -caprolactone) via “click” chemistry and “supramolecular click” chemistry. *Chem Commun* 4010–4012
109. Haensch C, Erdmenger T, Fijten MWM, Hoeppener S, Schubert US (2009) Fast surface modification by microwave assisted click reactions on silicon substrates. *Langmuir* 25: 8019–8024
110. Gloecklhofer F, Lumpi D, Kohlstaedt M, Yurchenko O, Wuerfel U, Froehlich J (2015) Towards continuous junction (CJ) organic electronic devices: fast and clean post-polymerization modification by oxidation using dimethyldioxirane (DMDO). *React Funct Polym* 86:16–26
111. Gloecklhofer F, Lumpi D, Stoeger B, Froehlich J (2014) Multigram synthesis of bis (trimethylsilyl)ethynyl benzenes suitable for post-polymerization modification. *New J Chem* 38:2229–2232
112. Malkoch M, Schleicher K, Drockenmuller E, Hawker CJ, Russell TP, Wu P, Fokin VV (2005) Structurally diverse dendritic libraries: a highly efficient functionalization approach using click chemistry. *Macromolecules* 38:3663–3678
113. Rijkers DTS, van Esse GW, Merckx R, Brouwer AJ, Jacobs HJF, Pieters RJ, Liskamp RMJ (2005) Efficient microwave-assisted synthesis of multivalent dendrimeric peptides using cycloaddition reaction (click) chemistry. *Chem Commun* 4581–4583
114. Trellenkamp T, Ritter H (2010) Poly(N-vinylpyrrolidone) bearing covalently attached cyclodextrin via click-chemistry: synthesis, characterization, and complexation behavior with phenolphthalein. *Macromolecules* 43:5538–5543
115. Liu X, Zheng H-N, Ma Y-Z, Yan Q, Xiao S-J (2011) Microwave irradiated click reactions on silicon surfaces via derivitization of covalently grafted poly(PEGMA) brushes. *J Colloid Interface Sci* 358:116–122
116. Yaylayan VA, Siu M, Belanger JMR, Pare JRJ (2002) Microwave-assisted PEGylation of Merrifield resins. *Tetrahedron Lett* 43:9023–9025
117. Pilsniak M, Trochimczuk AW (2007) Synthesis and characterization of polymeric resins with aliphatic and aromatic amino ligands and their sorption behavior towards gold from ammonium hydroxide solutions. *React Funct Polym* 67:1570–1576
118. Wolska J, Bryjak M (2011) Preparation of polymeric microspheres for removal of boron by means of sorption-membrane filtration hybrid. *Desalination* 283:193–197
119. Matsushita T, Hinou H, Kuroguchi M, Shimizu H, Nishimura S-I (2005) Rapid microwave-assisted solid-phase glycopeptide synthesis. *Org Lett* 7:877–880
120. Izumi R, Matsushita T, Fujitani N, Naruchi K, Shimizu H, Tsuda S, Hinou H, Nishimura S-I (2013) Microwave-assisted solid-phase synthesis of antifreeze glycopeptides. *Chem Eur J* 19: 3913–3920
121. Matsushita T, Hinou H, Fumoto M, Kuroguchi M, Fujitani N, Shimizu H, Nishimura S-I (2006) Construction of highly glycosylated mucin-type glycopeptides based on microwave-assisted solid-phase syntheses and enzymatic modifications. *J Org Chem* 71:3051–3063

# Microwave-Assisted Synthesis of Hybrid Polymer Materials and Composites

Dariusz Bogdal, Szczepan Bednarz, and Katarzyna Matras-Postolek

**Abstract** The fabrication of polymer–inorganic hybrid materials and composites under microwave irradiation benefits from a number of advantages such as reduction in processing time, more uniform heating of materials (i.e., reduced thermal gradient), faster curing of resins, and more efficient crosslinking of composite materials. For polymer hybrid materials, the advantages of microwave-assisted synthesis include smaller particle size, narrower particle size distribution, greater particle density, and higher exfoliation degree, which substantially improve the performance of the final material. A decrease in size of the various components is one of the cornerstones of the push towards improvements in electronic and optical devices, drug delivery, medical scaffolds, biosensors, imaging agents, and analytical technology. This chapter discusses recently published reports on the preparation and characterization of composite materials and polymer hybrids obtained under microwave irradiation using various types of polymer matrix and resins together with inorganic materials such as glass and carbon fibers, carbon black, layered materials (e.g., clays and double hydroxides), metal nanoparticles and nanowires, as well as carbon-based materials (e.g., fullerenes and nanotubes). A survey of past achievements in the preparation of polymer–inorganic hybrid nanocomposites under microwave irradiation can be found in a previously published review paper (Bogdal et al., *Curr Org Chem* 15:1782, 2011).

**Keywords** Composites · Hybrid · Inorganic · Microwave irradiation · Polymer

---

D. Bogdal (✉), S. Bednarz, and K. Matras-Postolek  
Cracow University of Technology, Faculty of Chemical Engineering and Technology, 24  
Warszawska St., 31-155 Krakow, Poland  
e-mail: [pcbogdal@cyf-kr.edu.pl](mailto:pcbogdal@cyf-kr.edu.pl)



## Contents

1	Introduction .....	244
2	Composite Materials .....	246
3	Nanocomposites and Hybrid Materials .....	254
3.1	Polycarbonate and Poly(ethylene oxide) .....	254
3.2	Poly( $\epsilon$ -caprolactone) .....	256
3.3	Poly(ethylene terephthalate) .....	258
3.4	Epoxy Resins .....	259
3.5	Acrylic Resins .....	261
3.6	Poly(vinyl carbazole) and Poly(carbazole) .....	267
3.7	Poly(tetrafluoroethylene) and Nafion .....	269
3.8	Cellulose and Chitosan .....	272
3.9	Other .....	284
4	Summary .....	291
	References .....	292

## Abbreviations

2bpy	2,2'-Bipyridine
AAEM	Acetoacetoxyethyl methacrylate
AgNP	Silver nanoparticle
AIBN	Azobisisobutyronitrile
AM	Acrylamide
AP	<i>p</i> -Aminophenol
APS	Ammonium persulfate
APTES	$\gamma$ -Aminopropyltriethoxysilane
BPA	Bisphenol A
BPO	Benzoyl peroxide
CA	2-Carboxyethyl acrylate
Cloisite <sup>®</sup>	Montmorillonite modified with a quaternary ammonium salt
CMC	Carboxymethyl cellulose
CNT	Carbon nanotube
CTAB	Cetyltrimethylammonium bromide
DDM	Diaminodiphenyl methane
DDS	4,4'-Diaminodiphenyl sulfone
DGEBA	Diglycidyl ether of bisphenol A
DMAc	<i>N,N</i> -Dimethylacetamide
DMT	Dimethyl terephthalate
DPC	Diphenyl carbonate
EDA	Ethylenediamine
EDMA	Ethylene glycol dimethacrylate
EP	Epoxy resin
F-FFF	Flow-field-flow-fractionation
FGM	Functionally graded materials
HA	Hydroxyapatite
HDPE	High-density polyethylene

HTAB	Hexadecyltrimethyl ammonium bromide
KPS	Potassium persulfate
LDH	Layered double hydroxide
LDPE	Low-density polyethylene
LED	Light-emitting diode
MA	Methyl acrylate
MBA	<i>N,N'</i> -Methylenebisacrylamide
MC	Microcrystalline cellulose
MMT	Montmorillonite
MROP	Microwave-assisted ring-opening polymerization
MSMA	3-(Trimethoxysilyl) propyl methacrylate
MSTT	Hybrid poly(acrylic)-SiO <sub>2</sub> /TiO <sub>2</sub> film
MWCNT	Multiwalled carbon nanotube
Nafion	Copolymer of tetrafluoroethylene and perfluoro-3,6-dioxa-4-methyl-7-octene-sulfonic acid
PAI	Poly(amide-imide)
PAMAM	Polyamidoamine dendrimers
PC	Polycarbonate
PCL	Poly( $\epsilon$ -caprolactone)
PCMA	Polycinnamamide Mg/Al mixed oxide nanocomposite
PDMS	$\alpha,\omega$ -Diacrylate poly(dimethyl-siloxane)
VSi-25	
PE	Polyethylene
PEG	Polyethylene glycol
PEMFC	Proton exchange membrane fuel cell
PEO	Poly(ethylene oxide)
PET	Poly(ethylene terephthalate)
PETI-5/IM7	Phenylethynyl-terminated polyimide
PMMA	Poly(methyl methacrylate)
PoPD	Poly( <i>o</i> -phenylenediamine)
PP	Poly(propylene)
PS	Polystyrene
PTFE	Poly(tetrafluoroethylene)
PU	Polyurethane
PVP	Poly(vinylpyrrolidone)
RGO	Reduced graphene oxide
ST	Styrene
SWCNT	Single-walled carbon nanotube
TBAB	Tetrabutylammonium bromide
TEMPO	(2,2,6,6-Tetramethylpiperidin-1-yl)oxyl
TIP	Titanium tetraisopropoxide
TMPTA	Trimethylolpropane triacrylate
Tween-20	Polyoxyethylenesorbitan monolaurate
ZSM	Zeolite Socony Mobil
$\epsilon$ CL	$\epsilon$ -Caprolactone

## 1 Introduction

Polymer composites are already well recognized for their improved characteristics in comparison with homogenous polymeric materials [1]. They are extensively used in civil engineering to design and build buildings, bridges, and roads, to strengthen structures, and to cover constructions. About 30% of all polymers produced each year (i.e., 280 million tons in 2011) are used in the construction sector and building industries. Moreover, polymer composites are also used in the transportation, marine, aerospace, biomedical, electronics, and recreation industries. Thus, further improvement in the properties of polymer composites, in addition to improved performance and application, are continually being researched [2]. On the other hand, polymer hybrid materials, which consist of functional inorganic particles or aggregates embedded in a polymer matrix, exhibit a number of intriguing properties that cannot be obtained with organic polymers or inorganic materials independently. For example, polymer hybrids containing nanoparticles were found to be suitable materials for optics and electronics, and have been used to produce devices such as light emitting diodes (LEDs), photodiodes, and photovoltaic cells [3, 4]. Owing to the implementation of simple fabrication processes, tunable size, surface charge, and high loading capacity, polymer hybrids offer numerous advantages in medical applications such as drug delivery [5, 6], scaffolds [7, 8], biosensors [9, 10], imaging agents [11, 12], and analysis [13].

The difference between composites and hybrid materials, according to current terminology, is attributed to interactions of the inorganic particles/aggregates with polymer matrix. A IUPAC technical report defines composites as “multicomponent materials comprising multiple different (non-gaseous) phase domains in which at least one type of phase domain is a continuous phase” [14], whereas elsewhere the notation “the components as well as the interface between them can be physically identified” is added [15]. In contrast to composites, hybrid materials are more difficult to classify because of their differing types and properties. In general, inorganic–organic hybrid materials are classified into two major classes [16]. The first type of hybrid materials are called “class I materials” when inorganic/structural material in the form of particles of varying sizes and shapes are mixed with a polymer matrix and the inorganic particles interact only weakly through hydrogen bonding or van der Waals interactions with the organic/polymer matrix. In class II materials, the organic/polymer and inorganic components are joined through covalent or ionic bonds and no boundaries are indicated at their interfaces [17].

Depending on the size scale of its components and the degree of mixing between the two phases, similarly prepared hybrid materials can exhibit significant differences in composite properties. For example, depending on the cation exchange capacity of layered silicates, three main types of materials can be obtained. First,

when the polymer is not capable of penetrating between the silicate sheets, phase-separated material is prepared with properties similar to traditional microcomposites. Second, when a single polymer chain is able to penetrate between the silicate layers, a well-ordered multilayer morphology results with alternating polymeric and inorganic layers, a so-called intercalated structure. Third, when the silicate layers are entirely and equally distributed in a continuous polymer matrix, an exfoliated structure is formed. In each case, the physical properties of the resultant composite or hybrid polymeric material are significantly different; intercalated and exfoliated composites are often called nanocomposites [18]. Thus, desired polymer composites and polymer hybrids have to be prepared with structural modeling and careful control of components. When the structural configurations of inorganic and organic/polymer components are far from their ideal configuration, the material properties are only the average of the properties of each component, depending on the concentration of each component [17].

The formation of multiphase composites and hybrid materials and associated improvement in properties compared with conventional organic and polymeric materials are not only the result of research in material engineering laboratories. Materials with such functional complexity can also be found in nature, for example, bones, teeth, and teeth enamel (composed of hydroxyapatite and proteins) [19] or the aragonitic nacreous layers of abalone shell [20]. However, at present, most synthetic protocols for preparation of composites and hybrid polymers need high temperature or pressure and very reactive chemicals, whereas these natural materials can be created at ambient temperature and in aqueous environments by biological systems. Therefore, nonconventional methods for the manufacture of polymer hybrids and composites with properties comparable to those of natural materials still have to be elaborated.

During the last three decades, microwaves have been applied in a number of highly useful methods as an efficient energy source during polymer synthesis and processing [21–24]. In addition to the application of microwave irradiation in polymer preparation, these microwave methods are also used for the preparation of polymer hybrids and composite materials [25, 26].

Because of the ability to interact directly with one or more components of composite materials through specific interactions, microwave irradiation offers a number of advantages compared with conventional heating methods. The methods that use microwave irradiation are applied for forming, joining, and bonding polymers and composites. In fact, most polymers are rather transparent to microwave irradiation, which means that they do not absorb enough microwave energy to be heated. However, acceptable microwave heating can be observed in the presence of fillers such as carbon black, graphite, carbon nanotubes (CNTs), clays, silicates, layered double hydroxides (LDHs), metal or metal oxide powders, nanoparticles, nanowires, and conducting polymers [26]. In such processes, microwave irradiation is used to soften and/or thaw thermoplastic polymers, cure monomers and prepolymers, and/or initiate reactions of inorganic particles or aggregates with the polymer matrix.

In this context, the application of microwave irradiation for the preparation of polymer nanoparticles allows control of the size distribution and reduced dispersity of nanoparticles within a shorter reaction time than with conventional heating methods because of more uniform and rapid heating [27]. The possibility of very rapid curing of polymer composites and hybrid materials under microwave irradiation and the formation of unique structures have been presented in a number of reports. A revision of past achievements in the preparation of polymer–inorganic hybrid nanocomposites under microwave irradiation can be found in a previously published review paper [1].

In this chapter, it will be shown that control of such parameters as particle size, particle size distribution, and particle density together with the application of microwave irradiation strongly influence the properties of the obtained materials. For example, a sample of polyamide-6/clay nanocomposite containing 5 wt% of clay had a heat distortion temperature 87°C higher than a plain polyamide-6 reference sample. In addition, the tensile strength and tensile modulus were 49% and 68% higher, while the impact strength did not change [28]. In another example, polyurethane (PU) foams were modified by addition of 5 wt% montmorillonite (MMT) clay during the foaming process, and in comparison with plain PU foams they exhibited increases of 650% and 780% in the reduced compressive strength and modulus, respectively [29].

## 2 Composite Materials

Regarding the preparation of composite materials, microwaves were investigated as an alternative to conventional heating methods for glass/epoxy laminates [30]. For this purpose, a numerical simulation of the one-dimensional transient temperature profile of the composite materials was elaborated for both microwave and conventional conditions. Bisphenol-F/epichlorohydrin epoxy resin and aromatic diamine as a hardener were applied as substrates. The microwave multimode applicator was a cylindrical cavity (500 L) equipped with multiple microwave inputs and a mode stirrer to ensure homogenous distribution of the microwave power. It was possible to control the cure of the composite materials and improve the properties of thick-section composites by feedback power control and through more efficient energy transfer under microwave conditions in comparison with conventional heating (Fig. 1). The power of microwave irradiation was changed constantly from 0 to 6 kW, which allowed more uniform heating of thick glass/epoxy laminates (25 mm) and eliminated thermal runaway caused by exothermic reactions during curing [30].

Applying differential scanning calorimetry (DSC), the cure kinetics of glass/epoxy composites were analyzed for samples cured under both conventional and microwave conditions [32]. Under conventional conditions, isothermal experiments were conducted at 135–175°C, the kinetic model was developed, and the relation between the degree of cure and time was estimated. For the cure kinetics under microwave conditions, a different approach was required because the cure process

**Fig. 1** Multimode microwave reactor with total volume of 500 L (Reprinted from [31] with permission)

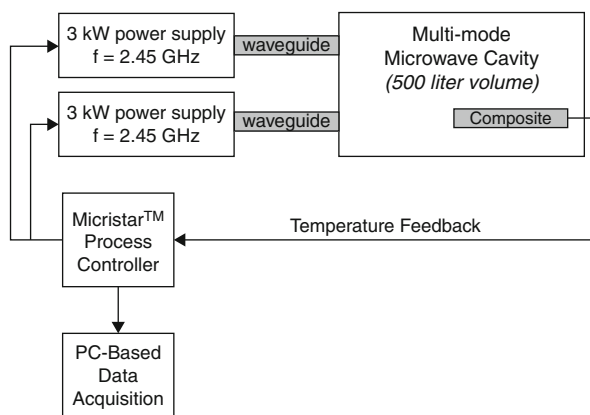
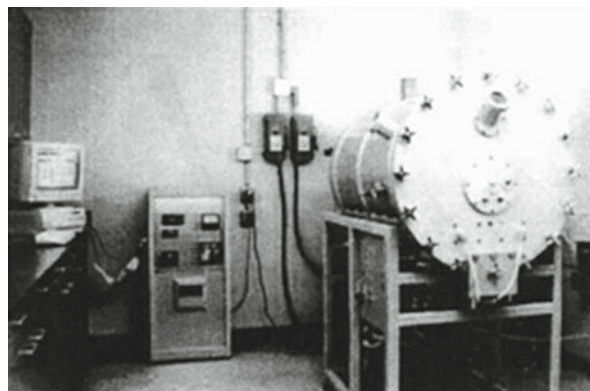

was difficult to control in situ within a microwave reactor. Samples placed in the microwave reactor were heated as fast as possible to the desired cure temperature, and the process was finished at a fix time by removing the sample from the reactor and cooling it. For each sample, the residual heat of reaction was measured by means of DSC to evaluate the progress of the cure reaction and conversion of substrates.

Even though thermal gradients were developed during the cure of composite materials under both conventional and microwave conditions, differences in solidification were observed. Under conventional conditions, highest values of the outside-in cure gradients were observed during the early stages of the cure cycle, and the maximum cure rate for the composite materials was noted at the beginning of cure. Both theoretical and experimental data revealed that microwave irradiation initiated an inside-out cure of the thick laminates as a result of volumetric heating, which substantially shortened the total processing time (Fig. 2) [31].

To observe a reasonable inside-out cure effect under conventional conditions, the cycle time needed was almost three times longer than under microwave conditions. Reduced thermal gradients were observed during the early stages of microwave processing, but the desired inside-out cure was successfully developed,

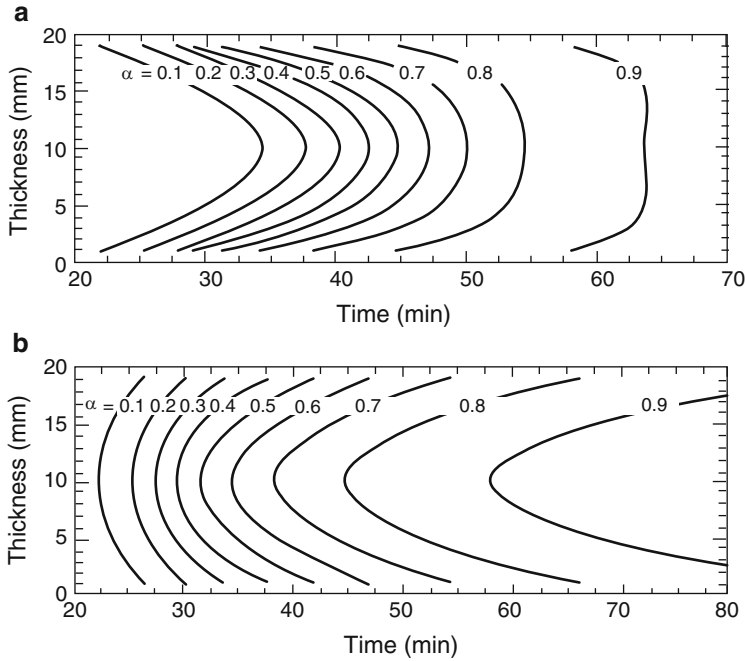

**Fig. 2** Formation of cure gradients with two laminates during (a) conventional and (b) microwave cures (Reprinted from [31] with permission)

which resulted in better control over the solidification behavior of composite materials and reduced the overall processing time [31].

In another report, it was shown that the sample size, amount, and geometry of substrate materials were important parameters during microwave processing. For instance, when the amount of irradiated material was changed from 5 to 15 g, the temperature increased by 32°C in 10 min at the same microwave power. Moreover, the sample of 5 g polyimide resin did not absorb enough microwave energy to be heated efficiently during irradiation, showing that a critical mass was needed to absorb the microwave energy by a substantial amount. Addition of a good microwave absorber (e.g., graphite) strongly increased the absorption of microwave energy by the composite material and resulted in efficient heating (Fig. 3) [33].

It was also shown that, depending on the type of filler (i.e., talc, zinc oxide, and carbon black), the susceptibility of the polymer for microwave absorption during processing was different [34]. The relative temperature rise of high-density polyethylene (HDPE) containing the same amount of various fillers during irradiation with 200 W of microwave power for 1 min is shown in Table 1. Irradiation of neat HDPE with the same power and time gave no significant temperature rise.

As can be expected, carbon black was the most effective filler for increasing microwave absorption of HDPE samples. Moreover, the efficiency of microwave absorption was proportional to the surface area of carbon black; thus, selecting a

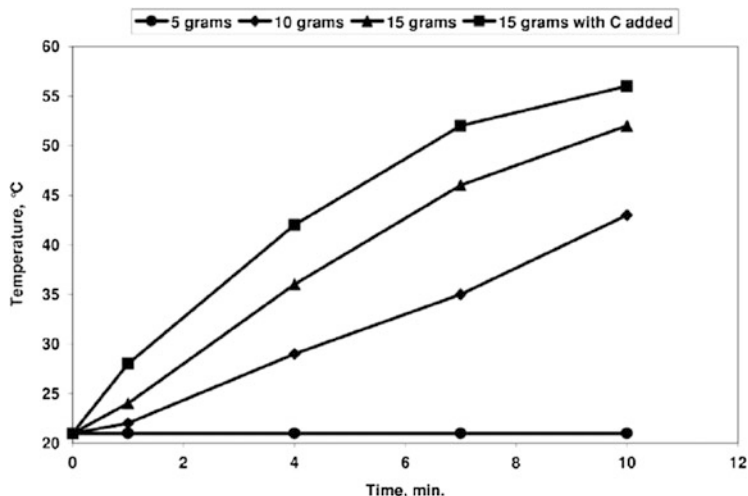

**Fig. 3** Effect of sample size on the microwave absorption of undried RP-46 resin (Reprinted from [33] with permission)

**Table 1** Relative temperature rise for HDPE at 16% v/v loading of different fillers

Filler	Temperature rise (°C/min)
Carbon black N550	177 ± 10
Zinc oxide	30 ± 5
Talc	3 ± 1

grade with a high surface area is recommended. Relative temperature rise and heat efficiency as a function of carbon black surface area are presented in Fig. 4 [34].

Carbon fibers were also applied as active components, which increased the susceptibility for microwave absorption during processing of phenylethynyl-terminated polyimide composites (PETI-5/IM7). For this purpose, six different microwave cure cycles in the frequency range of 2.4–7.0 GHz and three thermal cycles were carried out. It was found that glass transition temperatures ( $T_g$ ) were higher for the composites prepared under microwave irradiation in comparison with the composites prepared using the same time–temperature cure cycle under conventional conditions. In addition, microwave-cured composites showed higher shear strength, flexural strength, and modulus than conventionally cured composites, which were often characterized by incomplete crosslinking. It was also shown that under microwave irradiation it was possible to prepare unidirectional polyimide–(carbon fiber) composites with superior thermal and mechanical properties in half the time required for the conventional process (Fig. 5) [35].

For functionally graded materials (FGMs), the composition and structure gradually changes over the volume of the composite materials, resulting in corresponding changes in the mechanical properties of the material, so it is



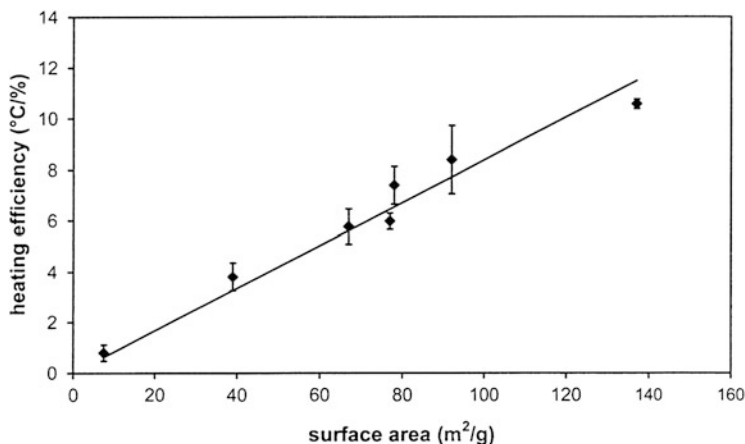

**Fig. 4** Relationship between microwave heating efficiency and surface area for carbon black (Reprinted from [34] with permission)

expected that these properties create new functions of the composite materials. The  $T_g$ , tensile strength, and modulus ( $E$ ) of FGMs obtained from an epoxy resin (EP)–polyurethane (PU) elastomer system in the presence of a stoichiometric amount of diaminodiphenyl methane (DDM) as crosslinking agent under microwave irradiation were investigated [36].

In a typical procedure, 65 wt% dichloromethylene solutions of EP/PU/DDM at different ratios of EP to PU were irradiated at 200 W for 20 min in poly(tetrafluoroethylene) (PTFE) molds to form a layer that was submitted for subsequent casting and irradiation. When all the layers were formed, each sample was irradiated at 400 W for 30 min. The obtained composite materials were characterized by  $T_g$  and modulus, which varied gradually from  $-54$  to  $162^\circ\text{C}$  and from 0.069 to 3.20 GPa, respectively (Table 2) [36].

In the last decade, carbon nanotubes (CNTs) have gained attention because of their unique structure and properties. Because of their remarkable mechanical and electrical properties, CNTs are used as fillers in the fabrication of polymeric composites. Moreover, CNTs show strong microwave absorption with intense heat release and very fast temperature increase [37, 38], although this phenomenon is not yet fully understood. The interaction was explained by dipole polarization induced by the alternating electric field, as well as mechanical vibrations caused by phonon–phonon interactions [39].

Recently, functional CNTs were incorporated on a polyethylene (PE) surface for a microwave welding process [40]. In order to study the interfacial strength of CNT/PE nanocomposites, two layers of CNT films were stacked between a pair of PE strips and welded under microwave irradiation for 30–90 s. For comparison, two PE sheets were compressed and microwave irradiated for the same time. During microwave irradiation, CNT films absorb energy from the microwave field and convert it into heat. The increase in temperature causes localized melting of PE,

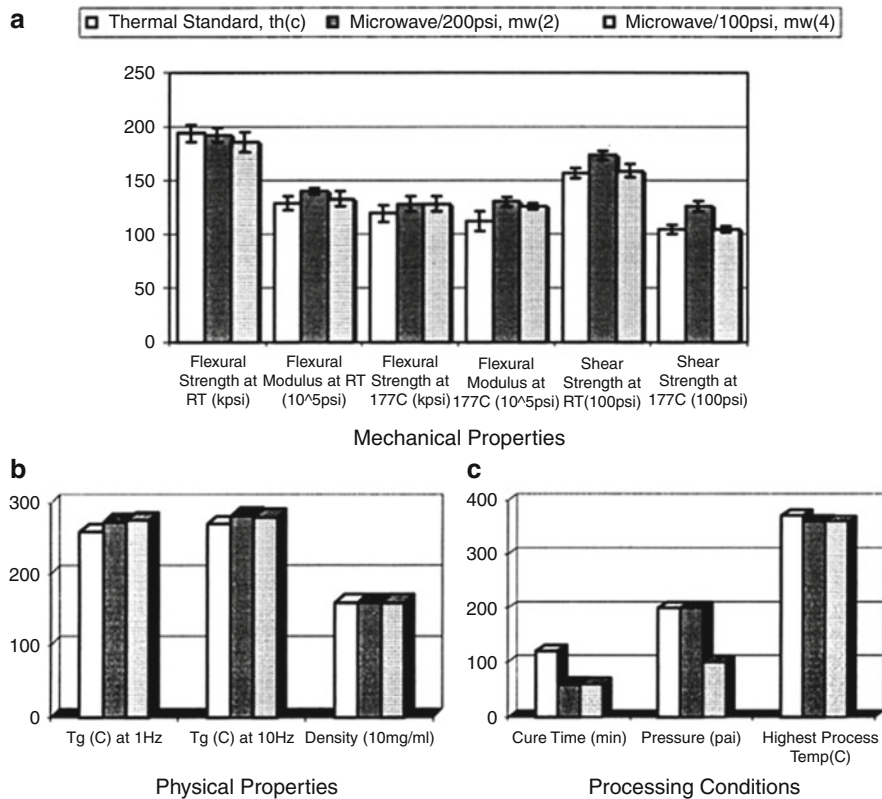

**Fig. 5** Comparison of processing conditions and properties of microwave and thermally cured phenylethynyl-terminated polyimide composites (PETI-5/IM7) reinforced with carbon fibers (Reprinted from [35] with permission)

**Table 2** Properties along the thickness direction in functionally graded composites of polyurethane and epoxy resin

Sample	PU/EP (w/w)	Tensile strength (MPa)	$T_g$ (°C)	Modulus ( $E$ ) (GPa)
1	10/0	4.65	-54.0	0.069
2	10/2	5.84	-9.3	0.078
3	10/4	11.6	25.4	0.245
4	10/6	15.2	45.7	0.86
5	10/8	20.8	83.2	0.99
6	10/10	25.8	99.0	1.01
7	8/10	27.4	109.2	1.44
8	6/10	32.5	113.2	1.58
9	4/10	45.8	139.6	2.62
10	2/10	75.9	145.0	2.72
11	0/10	64.8	162.0	3.20

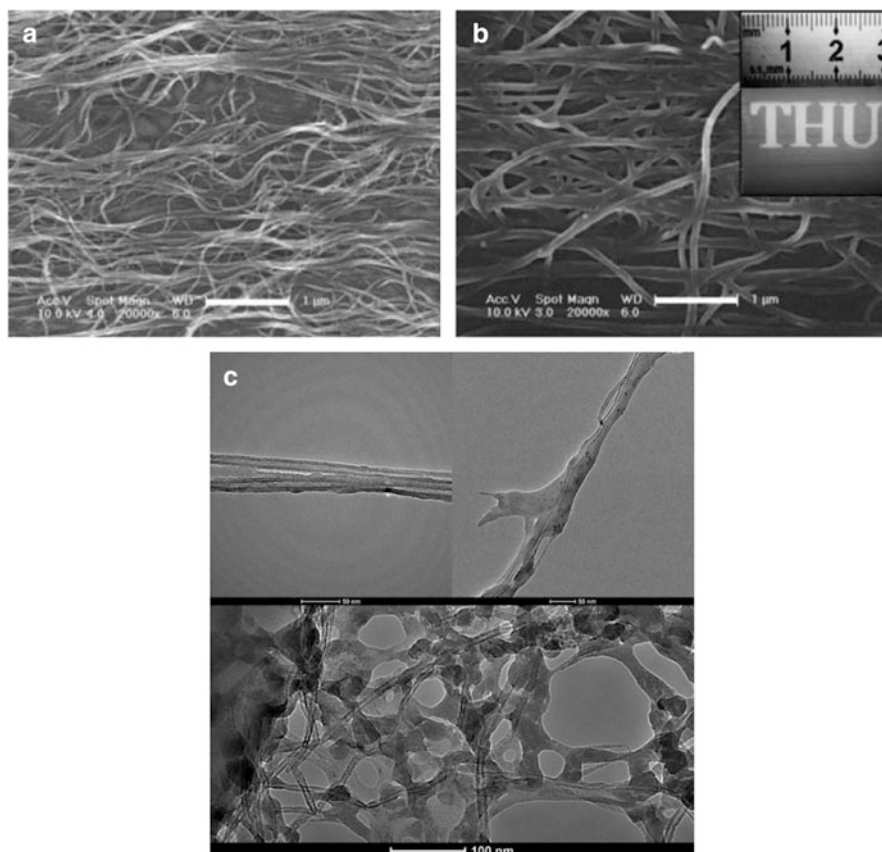

**Fig. 6** SEM images of two layers of CNT films on polyethylene surface (a) before and (b) after microwave welding. (c) TEM image of the composite, showing wetting and coating interactions between CNTs and the polymer (Reprinted from [40] with permission)

filling of CNT pores by melted PE, and wetting and wrapping of individual CNTs by the polymer (Fig. 6).

Additionally, the conductive network of CNTs was preserved by the polymer coating. Because of the short processing time, very small amount of CNTs ( $1.5 \mu\text{g}/\text{cm}^2$ ), and taking into account that PE is a microwave-transparent material, the bulk of PE sheets remained at room temperature during microwave welding and thus the polymer structure remained unchanged.

In another report, the preparation of poly(*o*-phenylenediamine)/reduced graphene oxide (PoPD/RGO) composite nanosheets using microwave heating was described and their effective adsorption of lead ions was examined [41]. In a typical synthesis of a hybrid PoPD/RGO composite, a homogeneously dispersed mixture of graphene oxide and *o*-phenylenediamine (oPD) in water was placed in a microwave

oven (210 W) for 20 min (Fig. 7). The final product was collected by filtration and washed with water. During the reaction process, graphene oxide nanosheets were used as oxidant to polymerize oPD monomer to form poly(*o*-phenylenediamine) (PoPD) on their surface, while the graphene oxide nanosheets themselves were reduced.

Hybrid PoPD/RGO composites were characterized by transmission electron microscopy (TEM) (Fig. 8), X-ray diffraction (XRD), and X-ray photoelectron spectroscopy (XPS). It was confirmed from TEM images that the microwave-assisted process successfully produced PoPD/RGO composite nanosheets with crumpled morphology. The obtained PoPD/RGO composite materials were tested and evaluated as a potential adsorbent for the removal of lead ions. The study showed that hybrid PoPD/RGO composites exhibited a favorable performance for the removal of lead ions and that the adsorption processes were well fitted by a pseudo-second-order kinetic model [41].

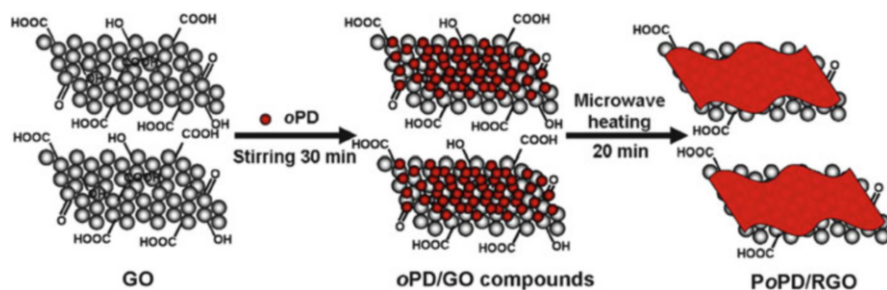

**Fig. 7** Fabrication of poly(*o*-phenyldiamine)/reduced graphene oxide (PoPD/RGO) composite nanosheets (Reprinted from [41] with permission)

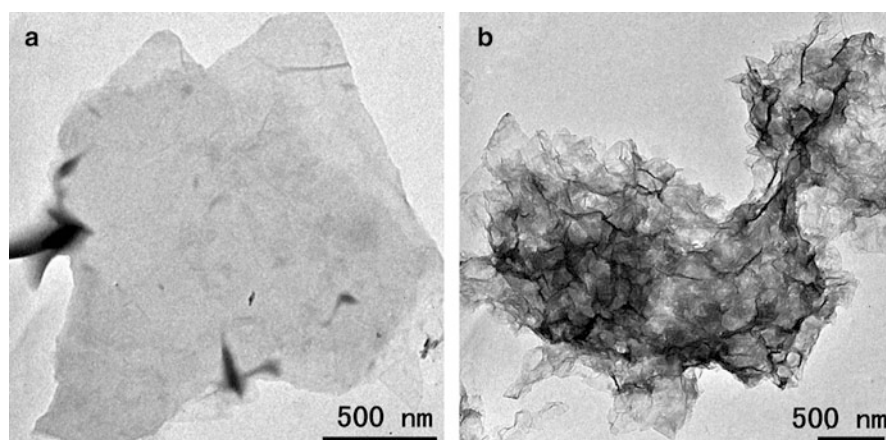

**Fig. 8** TEM images of (a) graphene oxide; (b) poly(*o*-phenyldiamine)/reduced graphene oxide composite nanosheets (Reprinted from [41] with permission)

### 3 Nanocomposites and Hybrid Materials

Polymer nanocomposites are materials in which inorganic components with an average particle/aggregate size of less than 100 nm are uniformly distributed in an organic polymer matrix; the relative concentration of the inorganic component is only a few percent by weight. Recently, nanocomposites composed of polymer and clay have received considerable interest for the preparation of novel structural and functional materials. Clays and other layered materials (e.g., LDHs) possess the ability to absorb microwave irradiation thanks to the water molecules that are present in the hydration shell of the material interlayer cations. When an inorganic component possesses a well-defined layer and the particles are homogeneously distributed in the polymer matrix, the competition between the intragallery polymerization reaction (which takes place between the clay layers) and the extragallery crosslinking of bulk reaction mixture results in two types of composite/nanocomposite structures [42, 43].

#### 3.1 Polycarbonate and Poly(ethylene oxide)

During solid-state polymerization of polycarbonate (PC) prepolymer for the fabrication of PC/MMT nanocomposites under conventional conditions, the reaction temperatures are often too high for organophilic groups in the gallery of MMT to endure during the polymerization [44]. Thus, microwaves were used for the polymerization of PC prepolymer, prepared by melt reaction of bisphenol A (BPA) with diphenyl carbonate (DPC) and intercalated with modified montmorillonite (m-MMT) by melt mixing and solution mixing techniques. The polymerization was carried out in a microwave oven with different irradiation times (6–12 s) at 220°C to afford PC/MMT nanocomposites in the solid state (Fig. 9).

XRD analysis proved that PC/MMT nanocomposites obtained under microwave conditions are characterized by a more homogenous dispersion of MMT silicate in the polymer matrix. Subsequently, WAXD showed that microwave irradiation during solid-state polymerization of PC prepolymers imposed a change in the nanocomposite structure from pre-intercalated into an exfoliated structure. Thus, solid-state polymerization under microwave irradiation was more successful in incorporating a homogenous dispersion of clay into the polymer matrix than polymerization under conventional thermal conditions [44].

Similarly, poly(ethylene oxide) (PEO) nanocomposites with MMT, hectorite, and laponite were obtained by a melting intercalation method under microwave conditions. It was confirmed that PEO chains were interposed between the clay layers to coordinate the interlayer cations (Fig. 10).

Study of the influence of irradiation time and power, and the amount and ratio of the components, on the polymerization reaction showed that it was impossible to obtain an intercalated structure for reaction times shorter than 5 min. For irradiation

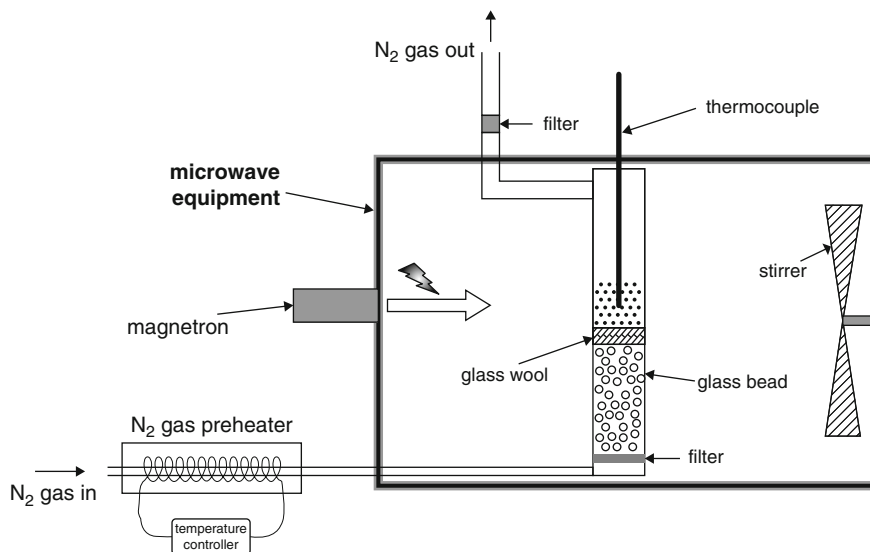

**Fig. 9** Microwave equipment for solid-state polymerization (Reprinted from [44] with permission)

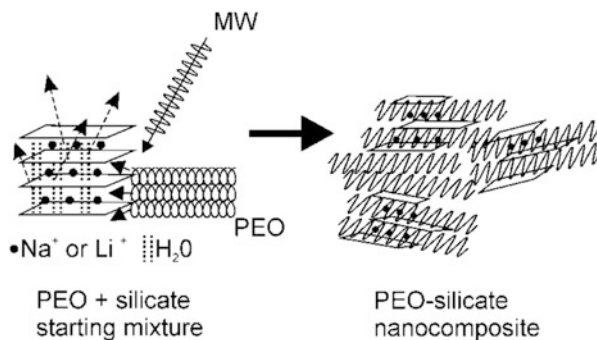

**Fig. 10** Scheme of microwave-assisted melt-intercalation reaction (Reprinted from [45] with permission)

times longer than 5 min, XRD patterns proved the PEO intercalation between clay layers, giving interlayer spacing of about 1.8 nm and various degrees of stacking order of the clay particles, which increased with longer irradiation time [45].

Polymer/clay composites can be applied as materials for manufacture of barrier layers for packaging [46]. Recently, poly(ethylene-*co*-vinyl acetate)/clay nanocomposites were prepared by solution intercalation under microwave irradiation [46]. A solution of copolymer in THF was mixed with MMT clay (Bentone 105) dispersed in toluene and irradiated for various times (5–15 min) at 80 or 135°C in a microwave reactor. Films were prepared by casting the mixture on Petri dishes

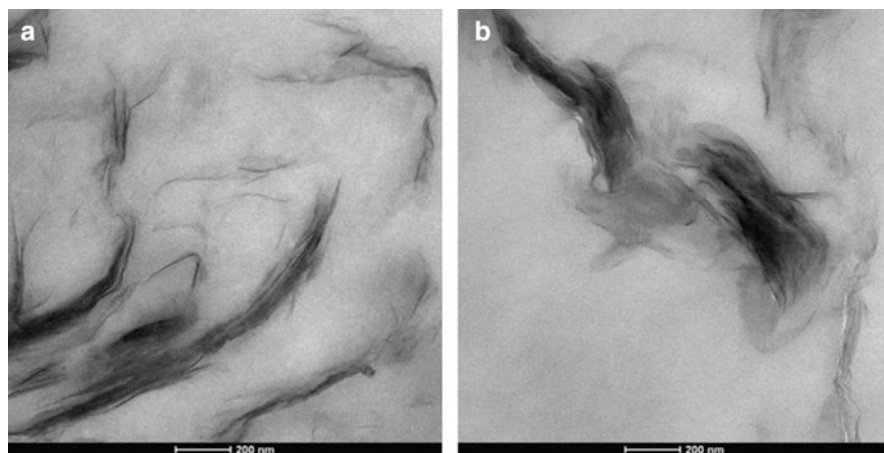

**Fig. 11** TEM images of poly(ethylene-*co*-vinyl acetate)/montmorillonite nanocomposites containing (a) 1 wt% and (b) 10 wt% clay prepared under microwave irradiation. (Reprinted from [46] with permission)

and drying. XRD data for the nanocomposites proved the intercalation process (increase in interlayer spacing) and also indicated no influence of microwave processing on the polymer/clay dispersion degree. These results were in a good agreement with the TEM data (Fig. 11), proving that the clay formed aggregates and that exfoliation was impossible at higher concentrations of inorganic material.

### 3.2 Poly( $\epsilon$ -caprolactone)

It was shown that poly( $\epsilon$ -caprolactone) (PCL)/clay nanocomposites have a number of enhanced properties in comparison with neat PCL [47–49]. PCL/MMT nanocomposites were prepared by microwave-assisted ring-opening polymerization (MROP) of  $\epsilon$ CL in the presence of either unmodified or modified MMT in 60 min [50]. In the case of unmodified MMT (Cloisite<sup>®</sup>Na<sup>+</sup>), PCL/MMT nanocomposite with a number-average molar mass ( $M_n$ ) of approximately 60,000 g/mol was prepared and exhibited an intercalated structure. In turn, applying MMT modified with an alkylammonium salt (Cloisite<sup>®</sup>30B) resulted in PCL/MMT nanocomposites with a predominately exfoliated structure, with  $M_n$  of PCL in the range of 16,300–66,100 g/mol for 0.5–5 wt% of MMT in the composite (Table 3).

Subsequent reports described MROP of  $\epsilon$ CL with Cloisite<sup>®</sup>30B as the nanofiller and catalyzed using either tin(II) 2-ethylhexanoate [Sn(Oct)<sub>2</sub>] or zinc powder. The mechanical properties of PCL/Cloisite<sup>®</sup>30B nanocomposites were examined. Applying microwaves at 680 W for only 30 min, PCLs with high weight-average molar weight ( $M_w$ ) of 124,000 and 92,300 g/mol were obtained in the presence of Sn(Oct)<sub>2</sub> and zinc powder, respectively [51]. The PCL/Cloisite<sup>®</sup>30B

**Table 3** Ring-opening polymerization of  $\epsilon$ -caprolactone

Heating	Filler type	Concentration (wt%)	Temperature (°C)	Conversion (%)	$M_n$ (g/mol)	Polydispersity index
Microwave irradiation	30B	0.5	120	98	66,100	1.5
	30B	3	120	97	34,800	1.7
	30B	3	100	93	43,900	1.5
	30B	5	120	95	16,300	1.8
	Na <sup>+</sup>	3	120	98	60,400	1.5
	–	0	120	85	44,300	1.7
Thermal (oil bath)	Na <sup>+</sup>	3	120	1	1,000	1.1
	30B	3	120	1	1,300	1.2
	–	0	120	17	6,500	1.1



**Fig. 12** Temperature–time profiles of polymerization mixture ( $\epsilon$ -caprolactone, 0.5 wt% Cloisite<sup>®</sup> 30B as nanofiller and 0.1 mol% Sn (Oct)<sub>2</sub> as catalyst) at different power levels (Reprinted from [52] with permission)

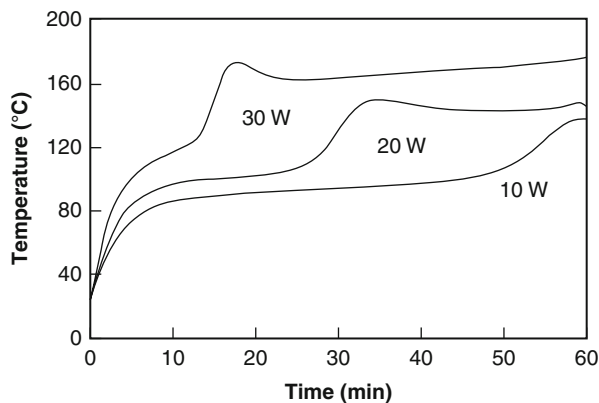

nanocomposites possessed a predominantly exfoliated structure. It was concluded that the power of microwave irradiation had a significant influence on the yield and  $M_w$  of PCL (Figs. 12 and 13) [51, 53].

### 3.3 Poly(ethylene terephthalate)

Layered double hydroxides (LDHs), known as anionic clays or hydrotalcite-like compounds, find application in catalysis, adsorption processes, and preparation of composite materials [54, 55]. In situ polymerization of poly(ethylene terephthalate) (PET)/LDH nanocomposites was performed under microwave irradiation [56]. LDHs were treated with dodecyl sulfate prior to the synthesis to improve compatibility between PET and LDHs and dispersed for 1 h in an ultrasonic bath in ethylene glycol prior to the reaction. Then, in considerably reduced reaction time compared with the conventional process, the polymer nanocomposites were prepared under reflux conditions by mixing 0.05 mol ethylene glycol, 0.25 mol dimethyl terephthalate (DMT), and 0.01 g zinc acetate as catalyst under microwave irradiation. The polymerization temperature was increased to 140°C (20°C/min), then to 200°C (12°C/min), and finally to 270°C and maintained for 35 min. Eventually, nanocomposites (1, 2, 5, and 10 wt% LDH) with uniformly dispersed and exfoliated LDHs in the polymer matrix were prepared. Nanocomposites with low concentration of LDH were thermally more stable than neat PET (Fig. 14).

Exfoliation and dispersion was complete for LDHs at 5 wt%; higher concentrations resulted in LDH aggregates in the nanocomposite. Moreover, compared with conventional processes, curing of the nanocomposites under vacuum can be avoided because it neither modifies the structure or properties of the nanocomposites nor enhances the thermal stability [56].

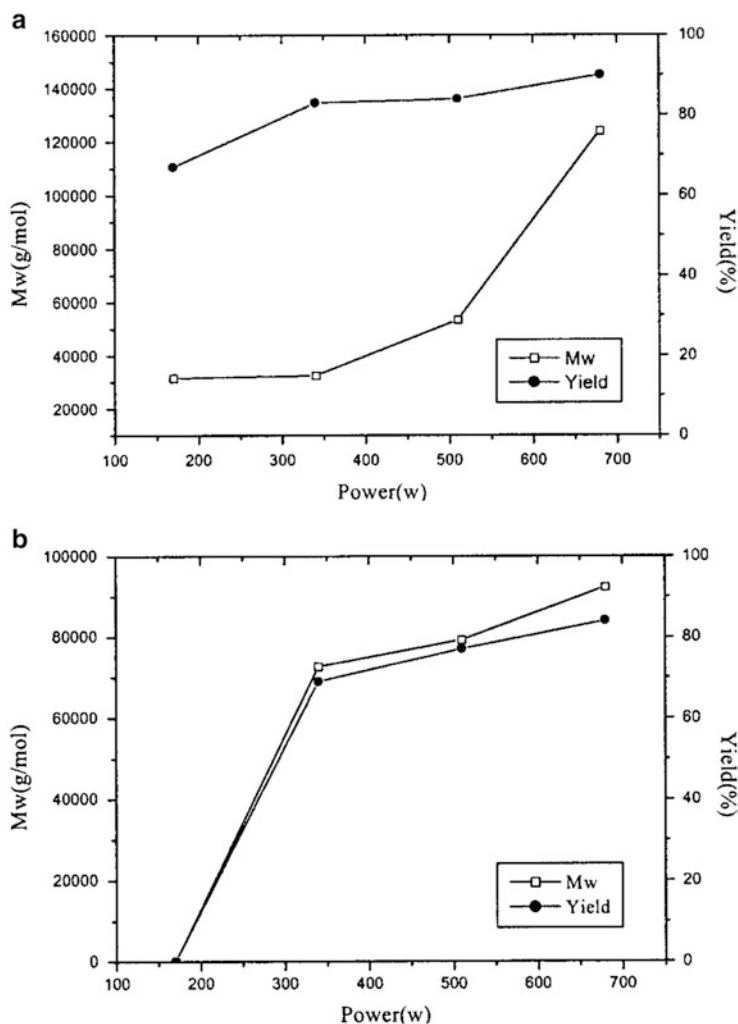

**Fig. 13** Effect of irradiation power on polymerization of poly( $\epsilon$ -caprolactone): (a) 0.1% Sn(Oct)<sub>2</sub> as catalyst, 30 min reaction time; (b) 1% zinc powder as catalyst, 270 min reaction time (Reprinted from [51] with permission)

### 3.4 Epoxy Resins

The synthesis of epoxy/MMT nanocomposites in the presence of silicone acrylate ( $\alpha,\omega$ -diacrylate poly(dimethyl-siloxane), PDMS V-Si21) under microwave irradiation has been described together with the effect of different clay modifiers [57]. The epoxy/MMT nanocomposites were prepared using MMT previously modified by dodecyl-, hexadecyl-, and octadecylamines or hexadecyltrimethyl ammonium

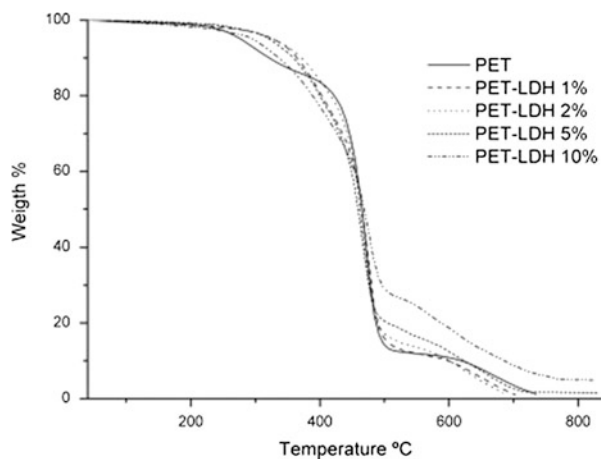

**Fig. 14** Thermogravimetric curves for PET and PET-LDH nanocomposites (Reprinted from [56] with permission)

bromide (HTAB). Physical activation of MMT before reaction with ammonium salts led to exfoliation of clay in the polymer matrix and also prevented agglomeration, resulting in a uniform structure [57]. The organoclays (3 and 5 wt%) were stirred with a BPA-based epoxy monomer at 80°C for 30 min and then 50 wt% of polyamine hardener was added to the epoxy resins. The mixture was poured into a mold and irradiated in a microwave reactor for 20 min at 400 W power. To obtain siloxane-modified samples, 5 or 10 wt% PDMS V-Si21 was mixed with the epoxy resins before addition of the hardening agent.

Epoxy/MMT nanocomposites containing HTAB-modified clay were characterized by better mechanical properties than those with dodecyl-, hexadecyl-, and octadecylamines. It was found that the modulus ( $E$ ) increased, with a corresponding decrease in toughness, with an increase in MMT content; however, an increase in PDMS V-Si 21 concentration resulted in the opposite effect. For each sample containing 5 wt% of MMT and 5 wt% of PDMS V-Si 21 (samples “8 Dodecylamine” and “8 HTAB” in Table 4), in which interlayer spacing was increased, the modulus was as high as that of neat epoxy (sample no. 1) but toughness was greater than that of neat epoxy. In such a way, the mechanical properties of samples containing MMT and PDMS V-Si 21 were improved (Table 4) [57].

Another paper describes the application of a microwave-assisted protocol for the fabrication of CNT/epoxy nanocomposites with a very high dielectric constant and low dielectric loss [58]. Multiwalled carbon nanotubes (MWCNTs) of average diameter <10 nm and length of 5–15  $\mu\text{m}$  were blended at 65°C with diglycidyl ether of bisphenol A (DGEMA) and an imidazole derivative as polymerization catalyst. Next, the mixture was cast into a mold and pre-cured under microwave irradiation (700 W) for 2 min in six cycles, followed by post-curing in a thermal oven at increasing temperature from 80 to 150°C for total time of 10 h. For

**Table 4** Mechanical characterization of nanoparticle samples containing modified clays

Sample no.	Young's modulus ( $E$ ) (MPa)	Maximum strength ( $\sigma_{\max}$ ) (MPa)	Strain at maximum force ( $F_{\max}$ ) (%)	Strength at break (MPa)	Strain at break (%)	Toughness ( $W$ ) at break (J)
1 <sup>a</sup>	1,433	34.0	6.0	23.5	11	0.60
8 Dodecylamine <sup>b</sup>	1,278	25.5	3.9	21.6	12	0.88
8 HTAB <sup>c</sup>	1,391	33.4	5.1	25.6	12	1.10

<sup>a</sup>Neat epoxy<sup>b</sup>Epoxy containing 5 wt% dodecylamine and 5 wt% PDMS V-Si 21<sup>c</sup>Epoxy containing 5 wt% HTAB and 5wt% PDMS V-Si 21

comparison, a series of composites was produced under conventional heating at similar curing parameters (temperature and time). Electrical conductivities and dielectric properties of the resulting composites were studied as a function of the MWCNT content (0.05–0.5 vol%) and method of curing (microwave versus thermal). Based on those investigations, it was suggested that, compared with thermally cured composites, MWCNTs in composites prepared under microwave conditions create uniform connecting paths and thus form a conducting network above the percolation threshold of the filler. Additionally, dielectric spectroscopy studies indicate that MWCNTs in composites cured under microwave conditions not only have better dispersion but also align in one direction, resulting in lower dielectric loss of the material. Microwave curing of MWCNT/epoxy composites allows the development of novel materials with high dielectric constant and low dielectric loss, which are very important for the electronic and power industries.

In another report, a microwave protocol was developed to reduce graphite oxide to graphene, which is used as a conductive additive in epoxy composites [59]. The reduction of graphite oxide at the gram scale was performed in a microwave oven operated at 1,000 W of microwave power. As confirmed by XRD studies and elemental and Fourier transform infrared (FTIR) analysis, 2–3 min of microwave irradiation was sufficient to obtain graphene. The work demonstrates that addition of only 0.3 wt% of graphene increases the electrical surface resistivity of the nanocomposite, which makes graphene/epoxy materials useful for batteries, electrodes, electromagnetic interference shielding materials, antistatic coatings, sensors etc.

### 3.5 Acrylic Resins

Microwave-assisted synthesis of polymeric/inorganic hybrid nanocomposites for encapsulation of photoelectronic devices has also been described [60, 61]. Several organic/inorganic composites have been fabricated under microwave conditions, for example, acrylic/alumina (Fig. 15a), polyurethane–acrylic/alumina (Fig. 15b), silicone–acrylic/alumina (Fig. 15c), silicone–polyurethane–acrylic/alumina

**Fig. 15** Synthesis of series of nanocomposites under microwave irradiation: (a) acrylic/alumina, (b) polyurethane–acrylic/alumina, (c) silicone–acrylic/alumina, (d) silicone–polyurethane/acrylic/alumina, and (e) acrylic/epoxy/mica/boron nitride

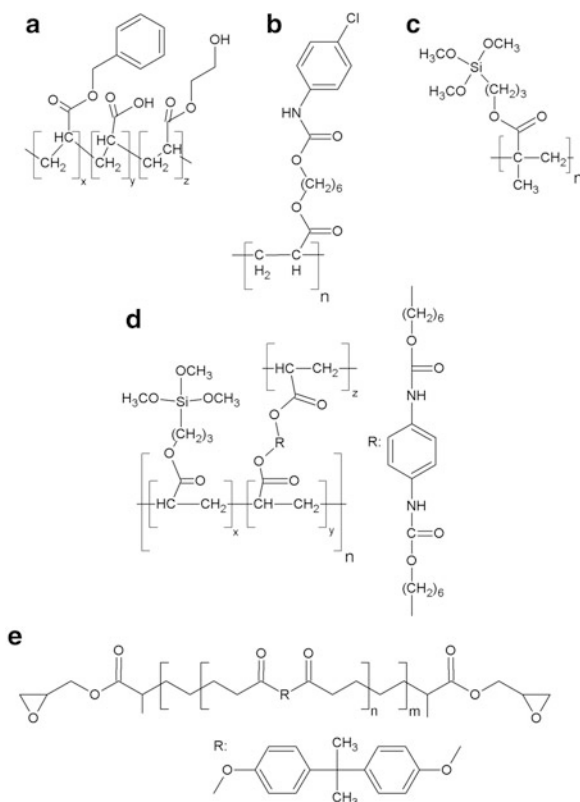

(Fig. 15d) [60], and acrylic–epoxy/mica/boron nitride (Fig. 15e) [61]. Alumina, mica, and boron particles of average diameter 30–100 nm, 1–10  $\mu\text{m}$ , and 1  $\mu\text{m}$ , respectively, were used as filler. With microwave irradiation, fabrication of the composites takes only 10 min, in contrast to conventional heating where the polymerization takes 8–24 h. Moreover, microwave-assisted synthesis yielded products with highly reproducible properties. The obtained composites with good adhesive strength, fast curing speed, moderate hardness, high refractive index, and excellent gas resistance were successfully applied for encapsulation of photoelectric devices (LED, OLED) [60]. Additionally, acrylic–epoxy/mica/boron nitride nanocomposites with gas barrier and heat dissipating capacities, were used to protect a top-emitting organic light-emitting diode (OLED) and prolong its lifetime.

In another report, microwave irradiation was applied for the preparation of silver nanoparticles (AgNPs) dispersed in methacrylate monomers. The silver particles possessed a narrow size distribution of 1.0–5.5 nm, with a mean diameter of 2.8 nm. Compared with conventional conditions, the microwave-assisted synthesis of AgNPs proceeded more uniformly to achieve full conversion of reagents at the same time in the whole reaction vessel. Consecutive polymerizations of the

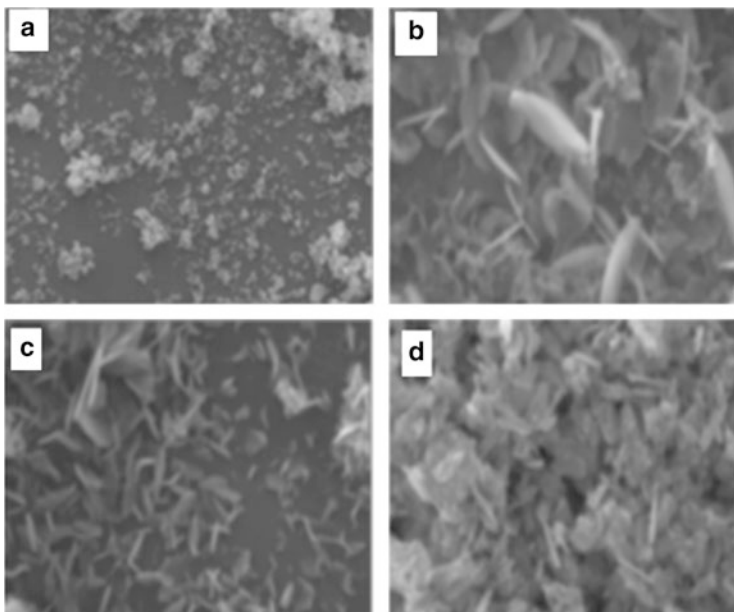

**Fig. 16** SEM images of ZnO nanoparticles prepared by the microwave method: (a) uncapped and using (b) PEG 300, (c) PVP, or (d) CTAB as capping agent (Reprinted from [63] with permission)

monomers with AgNPs produced silver nanoparticles dispersed in a polymer matrix [62]. In a typical procedure,  $C_{13}H_{27}COOAg$  powder (0.634 g) was stirred with cyclohexyl methacrylate (10.0 g) containing triethylamine ( $NEt_3$ , 0.191 g) and the mixture irradiated for 5 min at  $140^\circ C$ . Then, photoinitiator (1 wt% of Irgacure 9) was added and the solution spread onto a slide glass substrate. Films were polymerized for 30 min under UV light.

Recently, a microwave technique was used for the preparation of various morphological ZnO nanocrystallites for poly(methyl methacrylate) (PMMA) and PMMA/PU polymer matrices [63]. This work compared reflux and microwave heating methods of synthesis of ZnO nanoparticles. In both cases, poly(ethyleneglycol) (PEG 300), poly(vinylpyrrolidone) (PVP), and cetyltrimethylammonium bromide (CTAB) were used as capping agents. It was observed that, in the case of microwave irradiation, ZnO nanoparticles presented a very wide size distribution for various capping agents compared with the reflux method (Fig. 16). Under microwave irradiation, ZnO nanocrystals were obtained with different morphologies (spherical clusters, one-dimensional sheets, flakes, and platelets) and with cluster sizes between 50 and 400 nm.

ZnO nanoparticles with different morphologies were then incorporated into PMMA and PMMA/PU matrices and ZnO/PMMA nanocomposite films of 0.04 mm thickness prepared by the solution-casting method (Fig. 17). In both cases, the content of ZnO nanocrystallites in the polymer matrix was 0.1 wt%.



**Fig. 17** Photographs of ZnO/PMMA and ZnO/PU/PMMA sheets (Reprinted from [63] with permission)

By near infrared reflectance (NIR) and UV-vis spectra analysis of ZnO/PMMA and ZnO/PMMA/PU nanocomposites it was shown that addition of inorganic ZnO nanoparticles into a PMMA matrix significantly improved NIR reflectance efficiency compared with pure PMMA. For instance, neat PMMA had low reflectance of only 2% whereas ZnO/PMMA nanocomposites had increased NIR reflectivity of about 55% at a wavelength of 1,100 nm.

Additionally, the NIR reflectance was investigated and correlated with ZnO particle size and morphology. It was found that the morphology of ZnO plays a key role in obtaining a high NIR reflecting property. The best result (about 55% at 810 nm) was achieved using ZnO nanosheets obtained with PEG 300 capping under microwave irradiation. Taking into account the properties of the obtained ZnO/PMMA nanocomposite, these materials can find potential application as solar thermal control interface films [63].

Poly(acrylic)/SiO<sub>2</sub>/TiO<sub>2</sub> (MSMA–SiO<sub>2</sub>/TiO<sub>2</sub>) core–shell nanoparticle hybrid thin films were also prepared under microwave conditions [64]. The procedure was a combination of the sol–gel reaction, thermal polymerization, and spin coating. First, the colloidal SiO<sub>2</sub>–TiO<sub>2</sub> core–shell nanoparticles with OH groups on the surface were prepared, in which uniform layers of titania were deposited by controlled hydrolysis of tetrabutoxyltitanium (6–9 g) in the presence of colloidal silica particles. Then, the coupling agent 3-(trimethoxysilyl) propyl methacrylate (MSMA), colloidal SiO<sub>2</sub>–TiO<sub>2</sub> core–shell nanoparticles, deionized water, and THF were mixed in various proportions (Table 5) and the hydrolysis/condensation reactions carried out under microwave irradiation at 60°C for 5–40 min to obtain the MSMA–SiO<sub>2</sub>/TiO<sub>2</sub> colloidal solution. In order to obtain hybrid poly(acrylic)–SiO<sub>2</sub>/TiO<sub>2</sub> films (MSTT), the colloidal MSMA–SiO<sub>2</sub>/TiO<sub>2</sub> was subsequently mixed with a homogeneous THF solution of bifunctional acrylate of ethylene glycol dimethacrylate (EDMA) and a trifunctional acrylate of trimethylolpropane triacrylate (TMPTA) and benzoyl peroxide (BPO) as initiator. The polymerization reactions were run at 60°C for another 5–40 min under microwave irradiation. Then, the reaction solution was spin-coated on a 6-inch silicon wafer and the coated thin films cured on a hot plate.

**Table 5** Monomer composition and properties of the hybrid thin films MSTT0–MST100 prepared under microwave irradiation

	MSTT0	MSTT20	MSTT50	MSTT80	MSTT100
<i>Composition</i>					
Core–shell SiO <sub>2</sub> –TiO <sub>2</sub> (wt%)	0	20	50	80	100
MSMA (wt%)	25	20	13	5	0
TMPTA (wt%)	45	36	22	9	0
EDMA (wt%)	30	24	15	6	0
<i>Properties</i>					
<i>h</i> (nm) <sup>a</sup>	189	115	111	107	195
<i>n</i> <sub>633</sub> <sup>a</sup>	1.525	1.601	1.694	1.791	1.870
<i>k</i> <sub>633</sub> <sup>a</sup>	0.001	0.003	0.006	0.007	0.003
<i>R</i> <sub>a</sub> (nm) <sup>b</sup>	0.518	0.794	1.163	1.108	2.017
<i>R</i> <sub>a</sub> / <i>h</i> (%) <sup>b</sup>	0.274	0.690	1.047	1.035	1.034
<i>R</i> <sub>q</sub> (nm) <sup>b</sup>	0.676	0.853	1.202	1.129	2.114
<i>R</i> <sub>q</sub> / <i>h</i> (%) <sup>b</sup>	0.357	0.741	1.082	1.055	1.084
<i>T</i> (°C) <sup>c</sup>	350	247	232	233	–
TGA residue (wt%) <sup>d</sup>	9.14	38.72	64.40	81.72	99.28
TGA residue (wt%) <sup>e</sup>	6.06	24.85	53.03	81.21	100

<sup>a</sup>Thickness (*h*), refractive index at 633 nm (*n*<sub>633</sub>), extinction coefficient at 633 nm (*k*<sub>633</sub>) measured by ellipsometer

<sup>b</sup>Roughness (*R*<sub>a</sub> arithmetic mean roughness, *R*<sub>q</sub> quadratic mean roughness) measured by AFM

<sup>c</sup>Thermal glass transition and decomposition temperature measured by DSC

<sup>d</sup>Wt% of residue after thermogravimetric analysis

<sup>e</sup>Wt% of residue estimated from theoretical calculation

Although the particle content reached 90 wt%, SEM analysis of hybrid MSTT-90 thin films showed that the SiO<sub>2</sub>–TiO<sub>2</sub> core–shell nanoparticles were homogeneously dispersed in the polymer matrix. The particles kept their original size of 15–20 nm, indicating that there had been no particle growth or serious aggregation of the core–shell nanoparticles during the curing procedure. The extinction coefficients (*k*) of all the MSTT films were almost zero at 190–900 nm, and the films possessed high optical transparency in the UV and visible regions, which indicates that the particle size in the hybrid films was small enough to avoid significant light scattering loss (Table 5).

Finally, comparing the overall reaction times under microwave and conventional conditions, it was found that microwave-assisted synthesis of poly(acrylic)/SiO<sub>2</sub>–TiO<sub>2</sub> hybrid materials can be carried out faster (5–40 min) than by the conventional method (1–3 h) [64].

Silver nanoparticles have also been encapsulated in poly-*N*-isopropylacrylamide/acrylic acid microgels [65]. Poly-*N*-isopropylacrylamide/acrylic acid microgel particles crosslinked by *N,N'*-methylene bisacrylamide were prepared by surfactant-free emulsion polymerization. Next, microgel dispersion was soaked in aqueous AgNO<sub>3</sub> and glucose, and the mixture irradiated in a microwave oven for 15 s (Fig. 18). The resulting microgel-stabilized AgNPs had an average diameter of



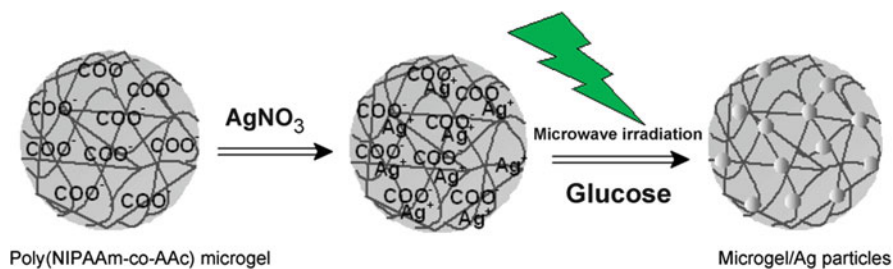

**Fig. 18** Microwave-assisted encapsulation of silver nanoparticles in copolymeric microgel (Reprinted from [65] with permission)

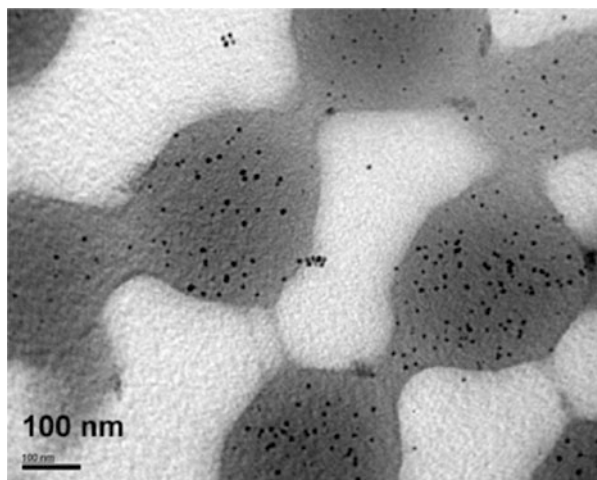

**Fig. 19** TEM image of microgel–silver particles after 8 months of storage (Reprinted from [65] with permission)

8.5 nm (Fig. 19) and were stable with negligible aggregation for more than 8 months at room temperature.

In another report, the microwave technique was used for curing hybrid nanocomposite coatings based on an acrylic modified silane (methacryloxypropyl-trimethoxysilane) ( $\text{SiO}_2$ ) and  $\text{TiO}_2$  nanoparticles. The hybrid nanocomposite coatings were made by the sol–gel method and deposited on a polycarbonate (PC) plate by dip coating. The  $\text{TiO}_2$  nanofilaments were added to acrylic modified silane to increase the absorption of microwaves during the microwave-assisted curing process. Finally, the obtained coatings were cured by different methods such as thermal, microwave, and ultraviolet radiation, independently as well as in a combination of microwave and UV methods. Microwave curing was carried out using a 1,000 W microwave oven at the maximum power setting for 2 min. In the case of thermal curing, the samples were thermally treated at  $130^\circ\text{C}$  for 4 h. UV

curing was carried using a 3 m medium-pressure mercury lamp (120 W/cm with total wattage/lamp of 12 kW) for 4 min. It was found that all the samples possessed very good optical properties and the visible light transmittance of all increased by 1% compared with neat PC film. It was also demonstrated that only the thermal method or a combination of microwave and UV treatment (MW + UV) caused an increase in pencil scratch hardness of samples (3H and 2H, respectively). Moreover, the dual curing process (MW + UV) seemed to be a very good alternative to thermal curing because of substantial time saving for the curing process and significant enhancement of the mechanical properties of samples [66].

Microwave irradiation was also applied for synthesis of poly(acrylic)/TiO<sub>2</sub> hybrid nanocomposite thin films with excellent optical properties [67]. In this study, colloidal TiO<sub>2</sub> nanoparticles stabilized with MSMA were synthesized using a hydrolysis/condensation process under microwave heating at 60°C. Resultant TiO<sub>2</sub> nanoparticles were then polymerized with an acrylic monomer and initiator under microwave irradiation to form a hybrid polymer solution. In this work, three different types of acrylic monomers were used: a single functional acrylate of methyl methacrylate (MMA), a bifunctional acrylate of ethylene glycol dimethacrylate (EDMA), and a trifunctional acrylate of trimethylolpropane triacrylate (TMPTA). The content of TiO<sub>2</sub> nanoparticles in acrylic monomer was changed from 0 to 100%. The thin films of poly(acrylic)/TiO<sub>2</sub> with different content of TiO<sub>2</sub> nanoparticles were spin-coated on a 6-inch silicon wafer. Poly(acrylic)/TiO<sub>2</sub> thin layers were characterized with respect to structure, morphology, and thermal and optical properties (Fig. 20). It was demonstrated that poly(acrylic)/TiO<sub>2</sub> hybrid thin films, even with a very high content of TiO<sub>2</sub> nanoparticles, have excellent optical properties and can be used as antireflection coatings for a various optical devices. Poly(acrylic)/TiO<sub>2</sub> hybrid thin films with the highest content of TiO<sub>2</sub> nanoparticles (90 wt%) had a refractive index  $n$  of 1.920. Additionally, optically highly transparent poly(acrylic)/TiO<sub>2</sub> hybrid three-multilayer film showed reflectance of less than 0.5% in the visible range [67].

In a later report, microwave-assisted synthesis of acrylic acid-based hydrogels containing AgNPs was described [68]. Simultaneous formation of a polymeric network by polymerization-crosslinking of acrylic acid with  $N,N'$ -methylenebisacrylamide in aqueous solution and preparation of AgNPs in situ by reduction of AgNO<sub>3</sub> led to nanocomposites with potential biomedical applications. The nanoparticles with average diameter of 10 nm were entrapped in polymeric matrix and it was found that the concentration of nanoparticles influenced the swelling capacity of the hydrogels.

### 3.6 *Poly(vinyl carbazole) and Poly(carbazole)*

Metal nanostructures have been extensively studied because of their use in applications such as catalysis, optics, electronics, optoelectronics, biological and chemical sensing, and surface-enhanced spectroscopy. Composites with nanocrystals are

**Fig. 20** TEM image and selected area electron diffraction (SAED) pattern of poly(acrylic)/TiO<sub>2</sub> hybrid material with 90% content of TiO<sub>2</sub> nanoparticles (MTT90) (Reprinted from [67] with permission)

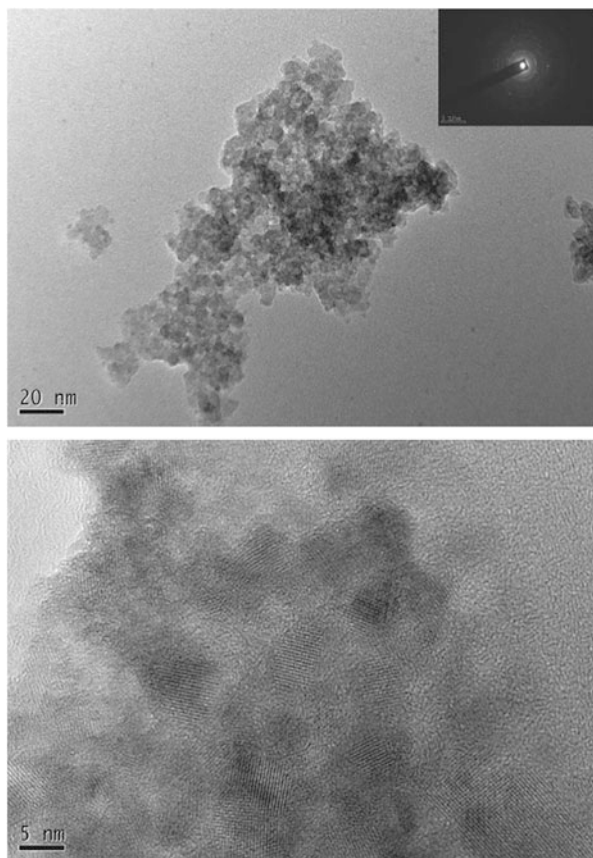

obtained by two methods: nanocrystals can be dispersed in a polymer matrix or can be prepared in situ in a polymer. For example, semiconductor–polymer nanocomposites of poly(vinylcarbazole) with nanocrystalline CdS were prepared under microwave conditions in pyridine as solvent. This solvent promotes the polymerization of *N*-vinylcarbazole in the presence of AIBN and formation of CdS nanocrystals from thiourea and cadmium acetate. The reaction mixtures were irradiated in a microwave reactor at 300 W for 5 min under nitrogen atmosphere. It was found that polymerization and formation of the crystalline inorganic salt nanoparticles progressed simultaneously. Thus, in this one-step method it was possible to obtain nanocomposites with uniformly dispersed nanocrystals in a polymer matrix [69].

Nanostructured poly(carbazole) was synthesized within bentonite clay galleries through solvent-free one-pot microwave-assisted reaction [70]. Mixtures of bentonite clay, carbazole, and ammonium persulfate (APS, oxidant) were irradiated for 2–6 min in a microwave oven. The temperature of the process was set at 30, 40, or 50°C. Then, the nano hybrids obtained were thoroughly purified by washing in

solvents. The effect of temperature and time of irradiation on the polymerization yield and morphology of poly(carbazole) nanoparticles formed in the inorganic matrix were studied and the spectroscopic characteristics of nanocomposites examined (UV-vis absorption and fluorescence). Based on thermogravimetric analysis (TGA), it was found that the hybrid materials contained 25–30% of carbazole polymer intercalated in the interlayer space of bentonite. Additionally, the polymer formed particles that ranged in size from 50 to 500 nm. The nanocomposites showed characteristic absorption spectra with three maxima at 250, 450, and 750 nm. They also exhibited blue fluorescence by a main maximum in the 450 nm region. These optical properties make poly(carbazole)/bentonite nanocomposites interesting materials, with potential application in LED and solar cell technologies.

In another work [71], the research focused on microwave-assisted solvent-free synthesis and properties of poly(carbazole)/clay composites. It was found that utilization of different oxidants to persulfate (i.e., benzoyl peroxide and hydrogen peroxide) influenced the molecular weight and morphology (size of nanoparticles) of the polymer formed in bentonite galleries.

Similarly, microwave irradiation was applied for solid-state in-situ polymerization and intercalation of poly(carbazole) between bentonite layers [72]. Mixtures of the clay, carbazole, and ferric chloride (oxidant) with 1:1, 1:0.5, and 1:0.25 weight ratios were irradiated in a microwave oven for 180 s at 35°C. During heating, the oxidant enters bentonite galleries through a cation-exchange process and carbazole molecules diffuse into the basal spacing of the clay where polymerization occurs. The nanocomposites obtained were purified by washing with water and methanol and dried. For some investigations, poly(carbazole) present in the clay galleries was extracted by hot methanol. The results obtained using FTIR, UV-vis, XRD, fluorescence microscopy, and TEM confirmed intercalation as well as polymerization of carbazole in the bentonite galleries. Moreover, at lower poly(carbazole) loading, the macromolecules were oriented transversely and distributed discretely in the clay. In contrast, at higher loading, polymer chains were entangled with each other and probably oriented longitudinally in the narrow space of the clay galleries. TEM images (Fig. 21) of the polymer extracted from the nanocomposites show that poly(carbazole) forms in interlamellar space fibers or organizes to produce cucumber-shaped structures. The results also reveal that the nanocomposites with a small amount of the polymer, due to specific macromolecule organization, show significant fluorescent properties, making the nanocomposite useful for production of fluorescence probes or electronic devices.

### 3.7 *Poly(tetrafluoroethylene) and Nafion*

Carbon black-supported poly(tetrafluoroethylene) (PTFE/C) nanocomposites were synthesized by an intermittent microwave irradiation (IMI) method for polymer electrolyte fuel cells, using PTFE emulsion as the precursor [73]. During preparation of the nanocomposite, Vulcan XC-72 carbon black (4.0 g) was added to

**Fig. 21** TEM image of poly(carbazole) extracted from bentonite/poly(carbazole) composite (Reprinted from [72] with permission)

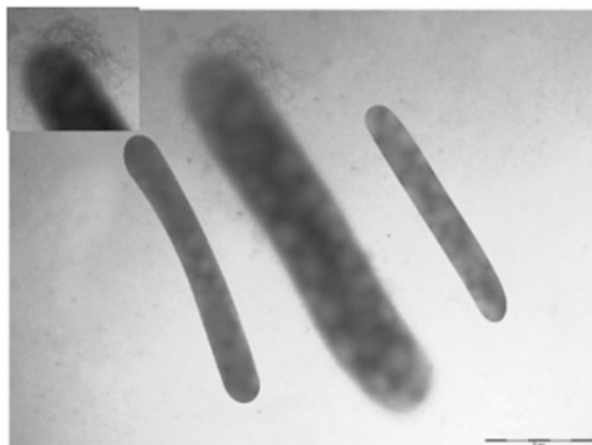

**Table 6** PTFE loading and BET surface area of PTFE/C nanocomposites synthesized under microwave irradiation (three bursts of 15–30 s duration)

PTFE/C composite	Carbon powder	PTFE/C-15 s	PTFE/C-20 s	PTFE/C-25 s	PTFE/C-30 s
PTFE loading (%)	0	36.8	27.9	16.7	14.8
BET surface area (m <sup>2</sup> /g)	232.6	50.8	101.2	142.2	161.2

150 mL deionized water and stirred. Next, PTFE (5 wt%) emulsion in deionized water (120 mL) was mixed together with Vulcan XC-72 carbon black dispersion. Then, water was evaporated from the solution and a nominal 60 wt% PTFE/C mixture was irradiated three times with cycles of 15–30 s microwaves on and 90 s microwaves off in order to decompose the surfactant in the PTFE emulsion and maintain the hydrophobicity of PTFE.

The particle diameters were in the range of 10–50 nm and were homogeneously distributed in the fabricated PTFE/C nanocomposite. Moreover, compared with conventional methods, additional high temperature treatment and mechanical milling under liquid nitrogen frozen conditions were avoided (Table 6). The PTFE/C nanocomposite was then mixed with Pt/C/Nafion to obtain a Pt/C/Nafion-PTFE/C electrocatalyst, which resulted in enhancement of the mass transportation of Pt electrocatalyst without any adverse effect on the electrochemical activity.

The power output of the cell with a Pt/C/Nafion-PTFE/C nanocomposite cathode was 0.66 W/cm<sup>2</sup>, which is 32% higher than that obtained for the cell with a standard Pt/C/Nafion cathode [73].

The microwave-assisted fabrication of Nafion 212/TiO<sub>2</sub> hybrid electrolytes for proton exchange membrane fuel cells (PEMFCs) operating at high temperature was also reported [74]. Nafion membranes dried at 110°C for 24 h were immersed in absolute ethanol with various concentrations of titanium tetraisopropoxide (TIP)

**Table 7** Water and methanol uptake for different membranes

Substrate	Water uptake (%)	Methanol (2M) uptake (%)
Nafion	10.06	9.90
Nafion/tetraisoopropoxide (TIP) 5%	13.35	9.56
Nafion/TIP 7%	14.40	8.80
Nafion/TIP 9%	17.77	7.91

precursor (5, 7, and 9% of TIP). To promote the formation of the Ti-peroxy sol, hydrogen peroxide was added and the membranes in solution mixtures were irradiated at different microwave power levels. Finally, the produced membranes were exhaustively treated with  $\text{H}_2\text{SO}_4$  (0.5 mol/L) and distilled water at  $70^\circ\text{C}$  to remove residues. It was found that the samples comprised a mixture of Nafion and  $\text{TiO}_2$  anatase phase, that the crystalline  $\text{TiO}_2$  nanoparticles were inserted in the hydrophilic sites, and that Nafion acts as a template for the inorganic phase. Moreover, the roughness value of pure Nafion membrane measured by atom force microscopy (AFM) was around 0.559 nm and increased to 0.6301 and 1.087 nm for hybrid Nafion with 5 and 7% TIP, respectively. The hybrid Nafion/ $\text{TiO}_2$  membranes showed a significant increase (10–30°C) in  $T_g$  of the polymers.

The hybrid membranes showed lower methanol absorption with increased amounts of TIP in the hybrid Nafion composites, which was a result of structure modification and higher crystallinity (Table 7). It was concluded that doping of nanosized inorganic oxide nanoparticles improved interconnection of ionic clusters in the polymeric matrix by providing a preferential pathway for proton hopping, thus enhancing proton conductivity. The results of electrochemical impedance spectroscopy (EIS) and solvent uptake measurements suggested enhancement of the hybrid membrane performance.

Microwave irradiation was also applied for in situ conversion of titania particles into titanate one-dimensional (1D) nanofilaments such as nanotubes and nanorods in a polymer Nafion matrix [75]. As a result, novel Nafion–titanate nanotube/nanorod composites for high-temperature direct ethanol fuel cells (DEFCs) were fabricated. In the first step, spherical nanoparticles of titania anatase were homogeneously dispersed into the conducting phase of Nafion using an in-situ sol–gel process. Then, titania particles were transferred in situ to titanate 1D nanofilaments by a microwave-assisted alkaline hydrothermal reaction. The process was carried out in a Teflon-covered stainless steel reactor placed in microwave oven at  $140^\circ\text{C}$  for 180 min (Fig. 22).

DEFCs based on Nafion–titanate hybrid electrolyte showed a significant enhancement of approximately 70% of the maximum power density compared with DEFCs using commercial Nafion without inorganic nanofilaments. It was also demonstrated that Nafion–titanate hybrid materials have enhanced mechanical stability at high temperature ( $\sim 130^\circ\text{C}$ ). This phenomenon was correlated with an effective interaction between organic and inorganic phases, which resulted in composite electrolytes with enhanced electrical and mechanical properties and reduced ethanol crossover [75].

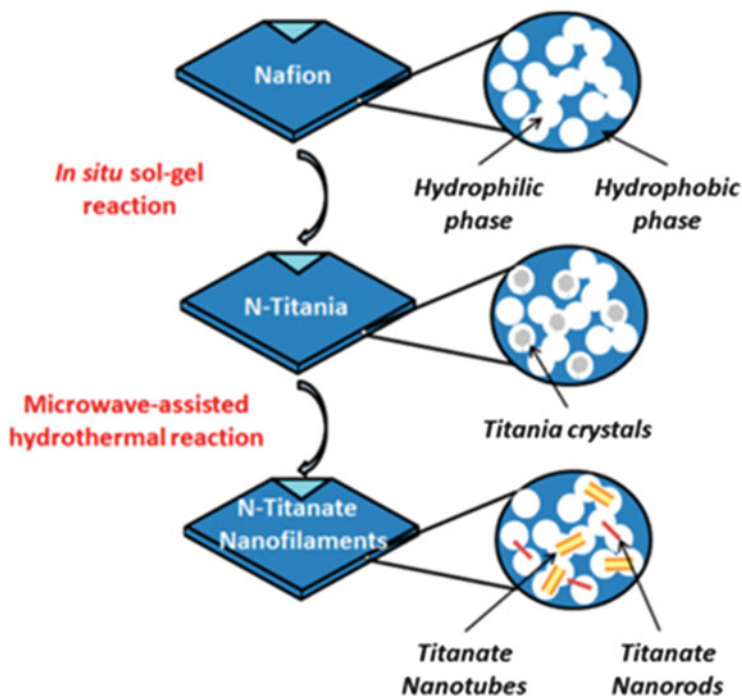

**Fig. 22** Synthetic route for the preparation of Nafion–titanate nanotube/nanorod hybrids (Reprinted from [75] with permission)

### 3.8 Cellulose and Chitosan

Microwave irradiation was applied during the deposition of noble metals on CNTs wrapped with carboxymethyl cellulose (CMC) [76]. Carbon nanotubes such as single- (SWCNTs) and multiwalled (MWCNTs) nanotubes, and buckminsterfullerene (C-60) were well dispersed using the sodium salt of CMC, and then the addition of noble metal salts generated noble metal-decorated CNT composites at room temperature. For this process, 50 mg of CNTs (SWCNTs, MWCNTs, or C-60) were dispersed in 4 mL of 3 wt% CMC (sodium salt) by sonicating for 3 h. To this dispersion, 4 mL of noble salts such as  $\text{Na}_2\text{PtCl}_6 \cdot 6\text{H}_2\text{O}$  (0.01 N),  $\text{HAuCl}_4 \cdot 3\text{H}_2\text{O}$  (0.01 N),  $\text{AgNO}_3$  (0.1 N), and  $\text{PdCl}_2$  (0.1 N) were added and irradiated in a microwave reactor, maintaining the temperature at  $100^\circ\text{C}$  for 5 min. Similar control reactions were carried out without microwave irradiation. The average size of the Ag particles was 50 nm, and longer reaction times caused the formation of larger Ag clusters on SWCNTs, MWCNTs, and C-60. This indicates rapid nucleation of the particles on nanotubes, which took an initial 30 s, followed by particle growth [76].

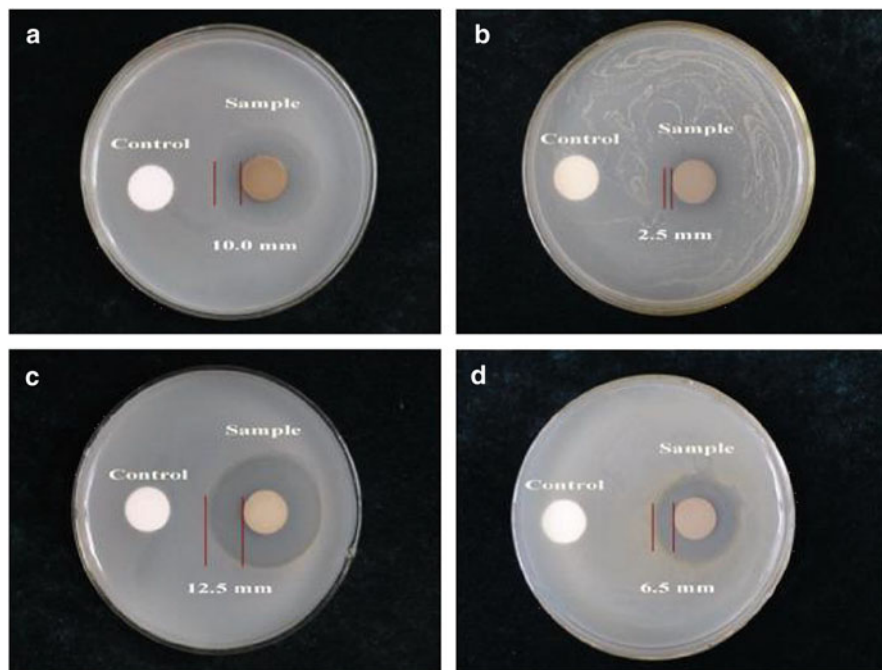
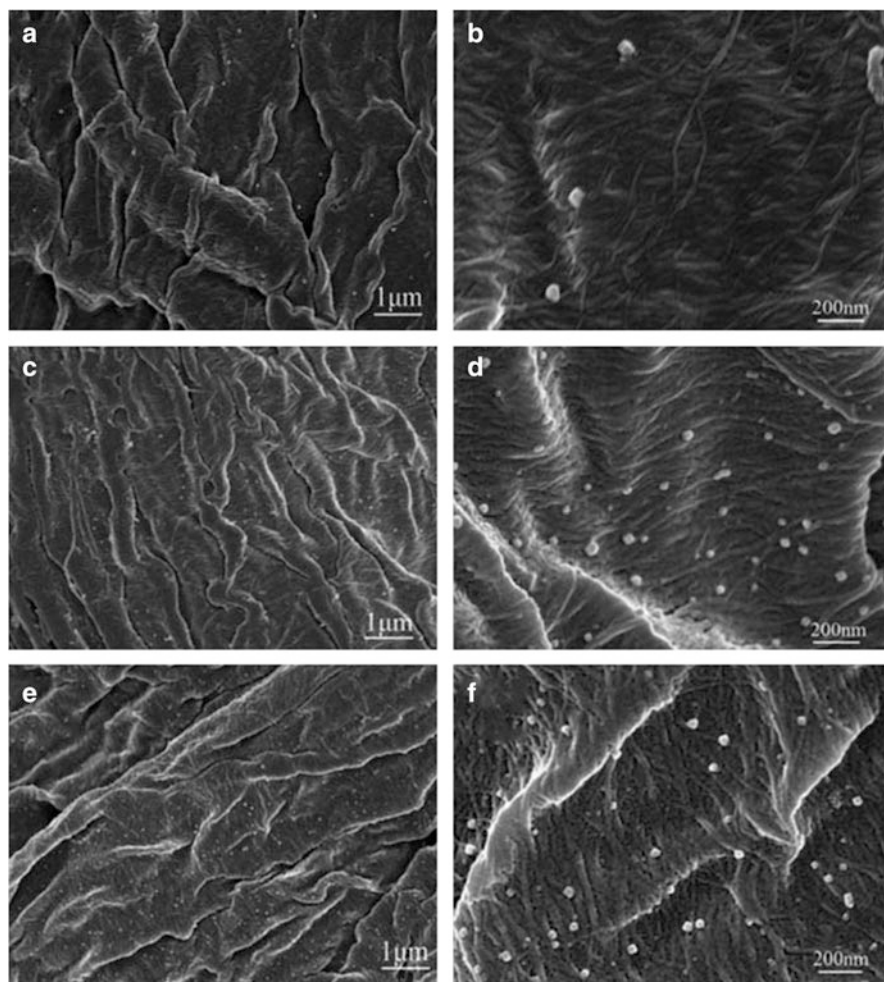

**Fig. 23** Antimicrobial activity of cellulose/Ag nanocomposites against (a, c) *Escherichia coli* and (b, d) *Staphylococcus aureus*. Amounts of cellulose/Ag composite used were (a, b) 0.075 and (c, d) 0.150 g (Reprinted from [77] with permission)

More recently, a number of reports have been published on the modification of cellulose and the fabrication of composites containing nanoparticles, particularly AgNPs, which exhibit antimicrobial activity [77]. For example, such materials were prepared from microcrystalline cellulose (MC, 1.000 g) and  $\text{AgNO}_3$  (0.340 g), which were vigorously stirred with ethylene glycol (50 mL) to form a uniform dispersed suspension. Then, the mixture was irradiated in a microwave reactor and kept at a certain temperature for 10, 30, and 60 min. The product was filtered, washed with ethanol, and dried under vacuum. SEM images showed that there were no significant differences in the morphology of the cellulose/Ag nanocomposites obtained under microwave irradiation at 140°C for 10, 30, and 60 min. Cellulose has a flake-like morphology and the silver particles with diameters of about 100 nm were homogeneously dispersed. Similarly, maintaining the reaction temperature (i.e., 140, 160, and 180°C) for 30 min only slightly influenced the structure and thermal stability of cellulose/Ag nanocomposites. The antibacterial activity of the cellulose/Ag nanocomposites was observed at low and high concentrations, i.e., 0.075 g (Fig. 23a, b) and 0.150 g (Fig. 23c, d) of cellulose/Ag nanocomposite.

The results showed that the cellulose/Ag nanocomposites had good antibacterial activity against both Gram-negative and Gram-positive bacteria, whereas MC does not have any antibacterial properties [77].





**Fig. 24** SEM micrographs of cellulose/Ag nanocomposites prepared with different amounts of silver nitrate solution: (a, b) 5, (c, d) 10, and (e, f) 20 mL (Reprinted from [78] with permission)

Similarly, a simple and efficient microwave-assisted method was developed to synthesize cellulose/Ag nanocomposites by reducing silver nitrate in aqueous solution [78]. To obtain the nanocomposites, 0.1 g glucose and 0.1 g PVP were mixed together with a certain amount of distilled water, and 1.0 g cellulose fiber was added with vigorous stirring. Then, different volumes of 0.01 M  $\text{AgNO}_3$  solution were added dropwise to the solution, which was then stirred for 15 min and irradiated in a microwave oven (560 W) for 10 min. SEM images showed that the AgNPs were well distributed on the surface of cellulose fiber and that the amount increased with increasing concentration of  $\text{AgNO}_3$  (Fig. 24). In turn, high

amounts of PVP were conducive to the formation of spherical nanosilver particles with smaller size, but decreased the silver content of nanocomposites.

Compared with microwave irradiation, the composites obtained under conventional heating conditions had lower silver content, larger size, and darker color. Moreover, the antibacterial test results of cellulose Ag/nanocomposites demonstrated strong antimicrobial activity against both *Escherichia coli* (Gram-negative bacteria) and *Staphylococcus aureus* (Gram-positive bacteria).

Microwave irradiation was also applied for the preparation of jute cellulose fiber/Ag nanocomposites with carboxylate functional groups [79]. The oxidized jute sample was immersed in 0.015 M AgNO<sub>3</sub> solution and kept in the dark at ambient temperature for 12 h and thoroughly rinsed with deionized water. Finally, the suspension containing oxidized jute and AgNO<sub>3</sub> was irradiated in a microwave reactor for 5 and 10 min. It was found that the increase in reaction time from 5 to 10 min resulted in an increase in the average diameter of AgNPs from 50.0 ± 2.0 to 90.0 ± 4.7 nm; however, the crystallinity of the cellulose slightly decreased from 73.10 to 71.12%, respectively. Field effect SEM (FE-SEM) analysis showed that the AgNPs were uniformly distributed on the oxidized jute cellulose substrate and exhibited a small size and narrow size distribution (Fig. 25).

XRD showed that all the samples were composed of a mixed phase of crystalline cellulose type II and crystalline silver with a cubic structure, suggesting successful reduction of silver by cellulose-Na. The cellulose/Ag nanocomposites possessed high crystallinity, good thermal stability, and high surface area and can be used in green nanocomposites, ultrafiltration devices, antibacterial dressing, food packaging, water treatment, and biomedical applications [80].

Later, cellulose/Ag nanocomposites with antimicrobial activity were prepared by hydrothermal synthesis using AgNO<sub>3</sub> as Ag source and sulfated chitosan (molecular weight ~20,000 g/mol) as reducing and stabilizing agent [81]. Detailed comparison between composites fabricated by conventional heating and microwave irradiation was performed and a wide range of preparation parameters evaluated (i.e., reaction time and temperature, AgNO<sub>3</sub> to reducing agent ratio, and stirring speed). Microwave-assisted processes were carried out in a single-mode reactor equipped with magnetic stirrer and internal fiber-optic temperature probe. Based on the results, it was concluded that the heating method has only a minor influence on the final properties of the materials (e.g., silver content, nanoparticle effective diameter, and polydispersity). Additionally, the materials obtained both under conventional conditions and microwave irradiation showed excellent antimicrobial activity towards *E. coli*.

Microwave irradiation was also applied to obtain in one-step cellulose/AgCl nanocomposites characterized by homogeneous distribution of AgCl nanoparticles in the cellulose matrix [82]. Microcrystalline cellulose (MC, 1.416 g) and LiCl (1.510 g) were mixed with *N,N*-dimethylacetamide (DMAc, 20 mL) under vigorous stirring at 90°C for 3 h. The obtained cellulose solution (5 mL) was added directly to DMAc (30 mL), and then AgNO<sub>3</sub> (0.169 g) was added to the resulting solution under vigorous stirring. The solution was heated to 150°C under microwave irradiation. The resulting precipitate was separated from the solution by

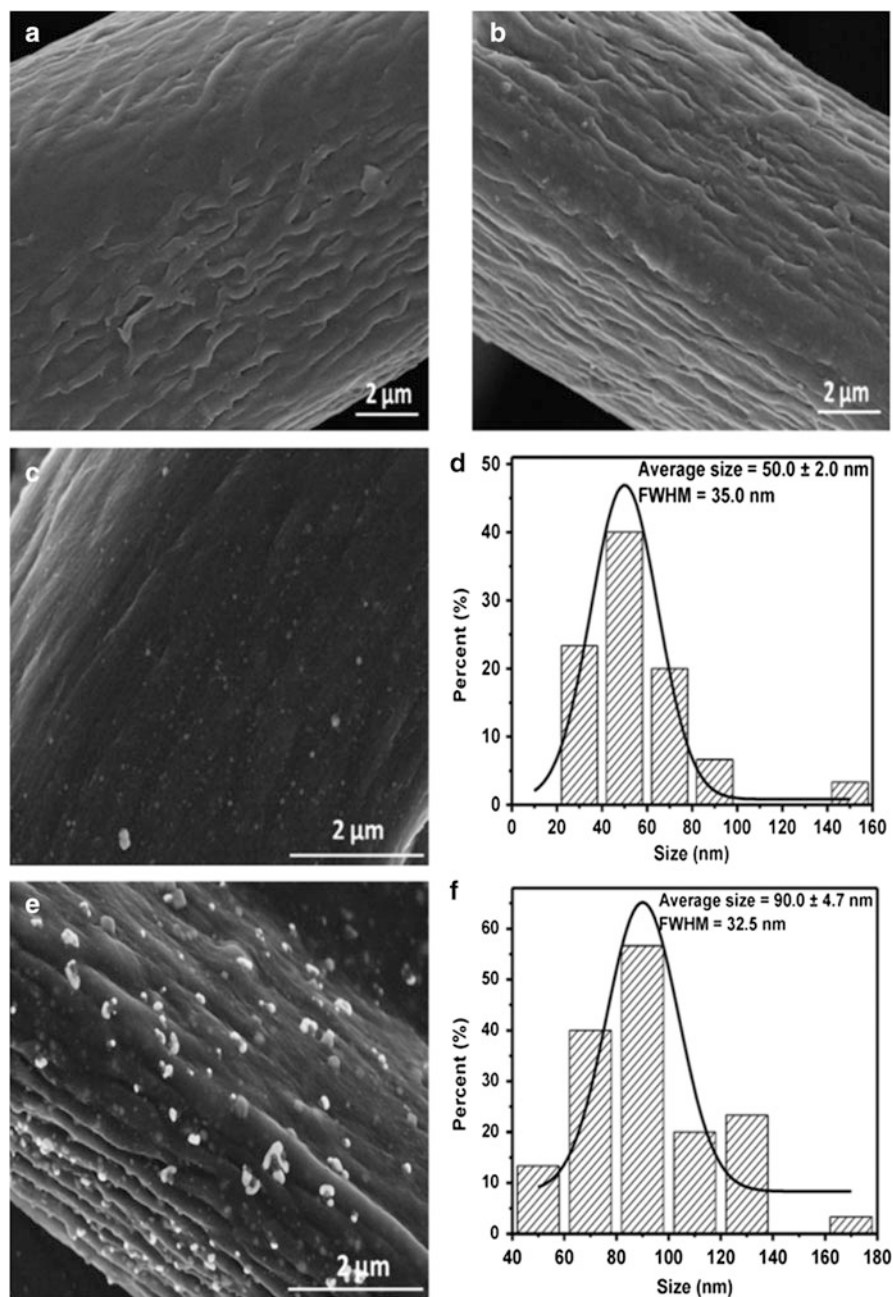

**Fig. 25** FE-SEM images of (a) control jute fibers, (b) TEMPO oxidized jute fibers, (c) jute fibers with AgNO<sub>3</sub> after microwave heating for 5 min and (e) 10 min. (d, f) Particle size distribution of nanosilver on the jute fiber after microwave heating for 5 min (d) and 10 min (f); *FWHM* full width at half maximum (Reprinted from [80] with permission)

centrifugation, washed with water and ethanol several times, and dried at 60°C. The results of XRD analysis showed that all samples comprised a mixed phase of crystalline cellulose type I and well-crystallized AgCl with a cubic structure. The simultaneous formation of AgCl nanoparticles and precipitation of cellulose led to a homogeneous distribution of AgCl nanoparticles in the cellulose matrix. The cellulose/AgCl nanocomposites had good antibacterial activity against both Gram-negative and Gram-positive bacteria [82].

Similarly, applying ionic liquids, microwave protocols were developed for the preparation of cellulose/calcium silicate [83], cellulose/copper oxide [84], and cellulose/calcium carbonate [85] from  $\text{Ca}(\text{NO}_3)_2 \cdot 4\text{H}_2\text{O}$  and  $\text{Na}_2\text{SiO}_3 \cdot 9\text{H}_2\text{O}$ ,  $\text{CuCl}_2 \cdot 2\text{H}_2\text{O}$ , and  $\text{CaCl}_2$  and  $\text{Na}_2\text{CO}_3$ , respectively. In the latter case, it was found that all samples had essentially no *in vitro* cytotoxicity and were comparable with the tissue culture plates.

The microwave-assisted route for the controlled synthesis of cellulose/hydroxyapatite (HA) nanocomposites from MC,  $\text{CaCl}_2$ , and  $\text{NaH}_2\text{PO}_4$  in DMAc [86] as well as cellulose/fluorine-substituted HA nanocomposites from MC,  $\text{Ca}(\text{NO}_3)_2 \cdot 4\text{H}_2\text{O}$ ,  $\text{KH}_2\text{PO}_4$ , and NaF in the presence of ionic liquids were developed [87]. In the typical protocol, the solutions of MC together with other components were heated under microwave irradiation to 150°C for 15, 20, and 30 min. The product was separated from the solution by centrifugation, washed with water and ethanol several times, and dried at 60°C. The XRD and SEM results indicated that HA nanostructures were synthesized *in situ* on the surface of cellulose and that the material consisted of cellulose and HA phase. TEM micrographs showed that the synthesized HA had a rod-like morphology and that the size of HA nanorods in the nanocomposites increased with increasing reaction time.

AgNPs were prepared in the presence of sodium citrate as a stabilizing agent by the *in-situ* reduction of  $\text{AgNO}_3$  on acrylamide (AM) grafted onto bagasse paper sheets in order to develop a novel hybrid material for food packaging [88]. To activate the reactive sites, bagasse paper sheet was immersed in distilled water for 24 h. Then, AM together with potassium persulfate (KPS) were added to the reaction flask, which was irradiated in a microwave oven for 30 s to initiate the graft copolymerization of AM on the paper surface. The grafted paper sheet was treated with acetone, washed with methanol:water (80:20), and dried in vacuum at 40°C. In the next step, the sheet was put into  $\text{AgNO}_3$  solution for 12 h and trisodium citrate solution for another 12 h to reduce  $\text{Ag}^+$  ions into AgNPs, and then allowed to dry. Morphological studies of the paper sheet, grafted paper sheet, and AgNP-doped grafted paper sheet were performed by SEM. Sufficient deposition/polymerization of AM onto paper sheets was observed. The surface of the grafted sheet was extremely rough in comparison with the non-grafted fibers, which was attributed to the high graft density (Fig. 26).

Antibacterial activity studies showed that larger inhibition zones against both Gram-negative and Gram-positive bacteria were observed with AgNP-containing paper sheet than with untreated and grafted paper sheets (i.e., without AgNPs), which did not exhibit any antibacterial activity. Because the procedure does not

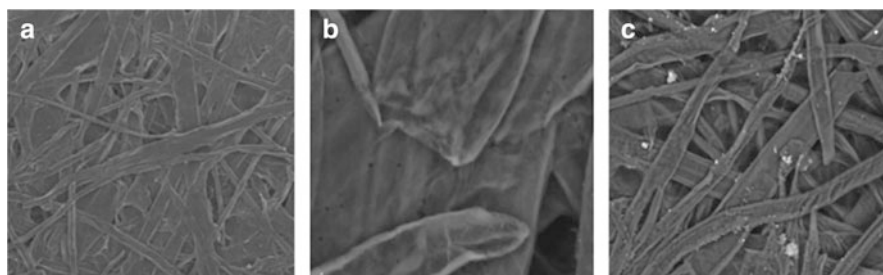

**Fig. 26** Surfaces of (a) untreated paper sheet, (b) graft paper sheet, and (c) AgNP-containing paper sheet (Reprinted from [88] with permission)

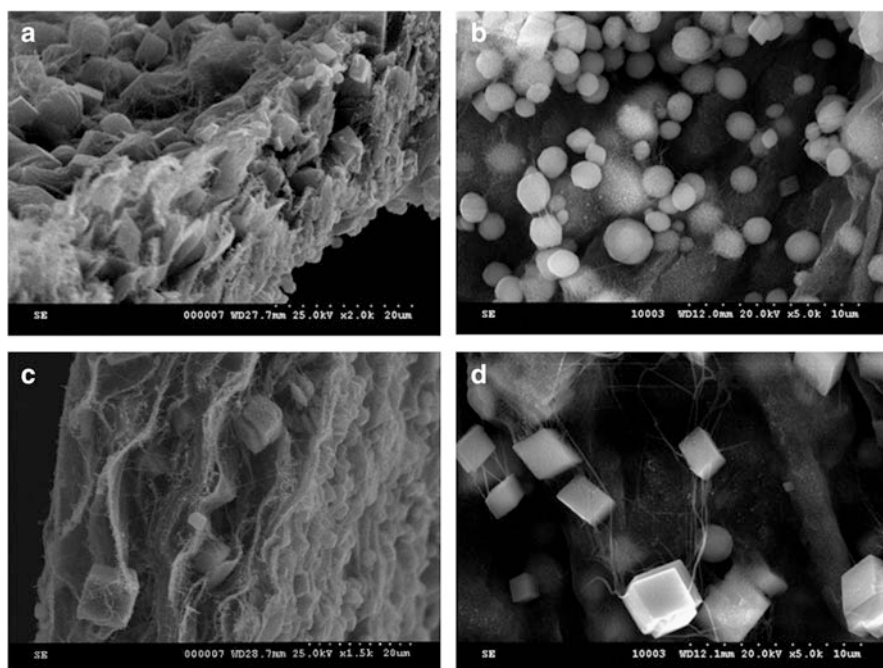

**Fig. 27** Cross-section (a, c) and surface (b, d) SEM images of films F1R2 (MW exposure time 0 min., temp. 70°C) (a, b) and F12 (MW exposure time 5 min., temp. 70°C) (c, d) (Reprinted from [90] with permission)

involve organic solvents or harsh conditions, this method can be applied for the manufacture of antibacterial food packaging material.

Bacterial cellulose (BC), which is synthesized as nanofibrils by *Gluconacetobacter xylinus*, has been commercialized as diet food, filtration membranes, paper additives, and wound dressings [89]. BC can also be used in new functional material biocomposites that are suitable as implants in the tissue engineering of artificial skin, blood vessels, cartilage, and bone.

The formation of calcium carbonate crystals on BC membranes using microwave irradiation was investigated. The BC gel-like membranes were cut into rectangular ( $9 \times 6.5$  cm) strip samples (25 g wet BC) and immersed for 10 min in a beaker containing 50 mL of 0.1 M sodium carbonate. Afterwards, some of the samples were immersed in 50 mL calcium chloride solution and kept under microwave irradiation at 90 W for 3 or 5 min, the final measured temperatures in the solution being 50 and 70°C, respectively. Other samples, with the same weight but without microwave irradiation, were immersed for the same amount of time as the irradiated samples in 50 mL calcium chloride solutions at 50 and 70°C. Finally, the membranes were rinsed with deionized water and dried at room temperature.

It was found that the samples treated under microwave irradiation exhibited significantly different morphology and even polymorphism of the calcium carbonate crystals in comparison with those obtained in the absence of microwave irradiation. For all the irradiated samples, the  $\text{CaCO}_3$  crystals were more uniform and their mean size was higher than those of the reference samples (Fig. 27) [90].

Synthesis of magnesium oxide (nano-Mg) chitosan-functionalized MWCNT composites, which are known for their antibacterial activity, was carried out under microwave conditions (Fig. 28). For this purpose, a mixture of 500 mg oxidized MWCNTs and chitosan solution (50 mg in 25 mL 2% acetic acid and 5 mL DMF) and 25 mg MgO were irradiated for 30 min in a microwave oven. Then, the reaction mixture was filtered, washed, and dried at 40°C under vacuum to obtain a composite material. SEM images indicated that a great amount of chitosan was attached to the MWCNTs. The attachment takes places not only at the tips but also at the side walls, with the thickness of the MWCNTs being about 10–15 nm, forming MWCNT–chitosan composites (Fig. 29). After nano-MgO grafting, the external surface roughness increased, whereas the tubular morphology of the

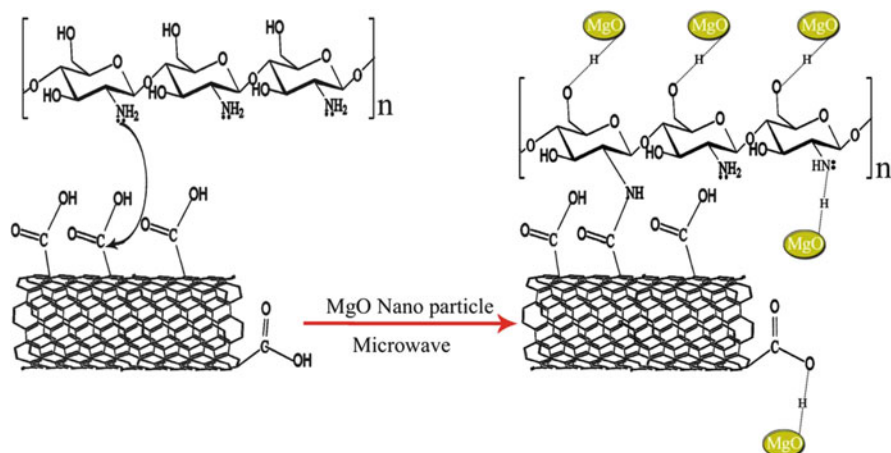

**Fig. 28** Reaction scheme for the preparation of magnesium oxide chitosan-functionalized multiwalled carbon nanotube composites (MWCNT–chitosan–MgO) (Reprinted from [91] with permission)

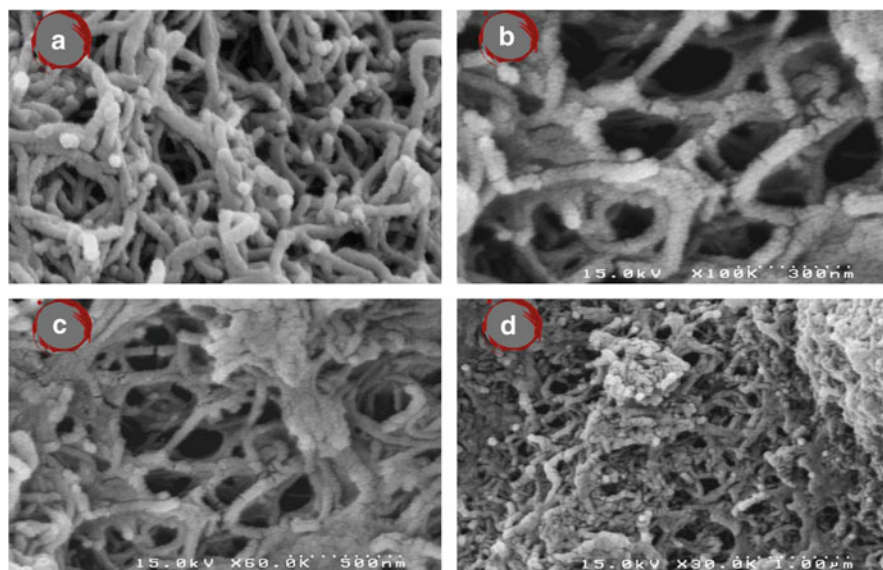
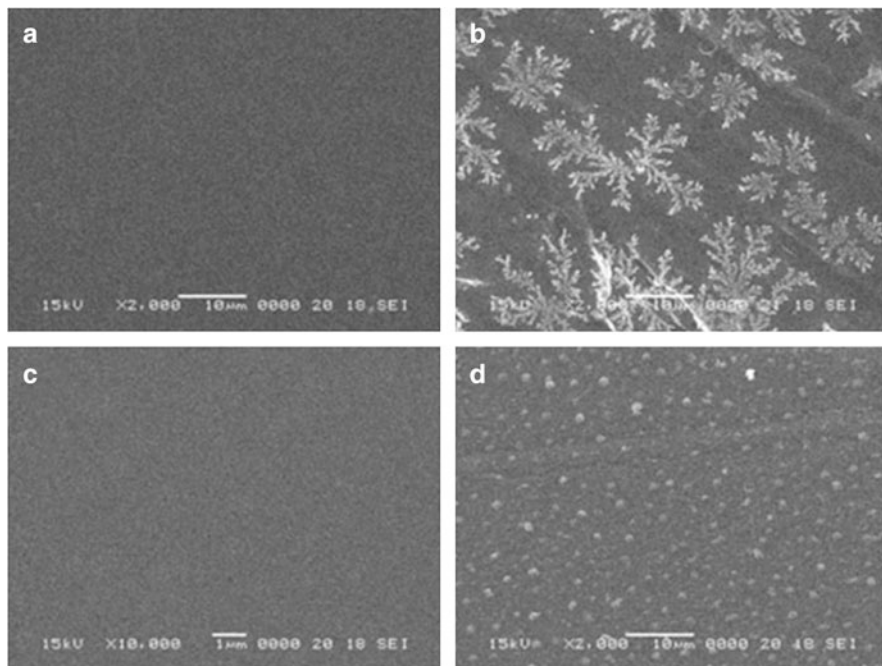

**Fig. 29** SEM images of (a) oxidized MWCNTs and (b–d) MWCNT–chitosan–MgO composites (Reprinted from [91] with permission)

individual nanotubes was retained. Moreover, the MgO nanoparticles were attached to the whole surface of MWCNT–chitosan composites [91].

In a similar approach, the surface of chitosan-functionalized MWCNTs was modified using 2-hydroxyethyl methacrylate (HEMA) in a two-step procedure. First, a mixture of 200 mg initial MWCNTs and 10 mL of 70% HNO<sub>3</sub> was sonicated (40 min) and then irradiated in a microwave oven (30 min) to afford oxidized MWCNTs (MWCNT-COOH). At the second step, a mixture of 100 mg of oxidized MWCNTs and chitosan solution (0.1 g chitosan in 5 L 2% acetic acid and 5 mL DMF) was treated for 30 min with microwave irradiation. Then, the mixture was filtered, washed, and dried at 40°C under vacuum. In SEM images of the HEMA–chitosan–MWCNT composite, it was observed that the smooth MWCNT-COOH surface changed to a rough surface in the HEMA–chitosan–MWCNT composites. Moreover, the thickness of the HEMA–chitosan–MWCNT composite was increased to 35–40 nm. These morphological observations demonstrated successful graft of chitosan and HEMA monomers onto the side wall and tips of MWCNTs. A special advantage of this composite was the surface of modified chitosan, which allows bonding to other organic molecules that are able to perform polymerization reactions [92].

In order to intensify the chemical properties of lignin and chitosan that make them suitable for electrochemical application [93], the sol–gel method of preparation of chitosan/silica and lignin/silica hybrids was applied [79]. The composites were fabricated by irradiation of a water-methanol solution of chitosan or lignin at appropriate pH with addition of an alkoxy silane in a microwave reactor at 200 W



**Fig. 30** SEM images of biopolymer/silica hybrids: (a) chitosan, microwave irradiation; (b) chitosan, conventional heating; (c) lignin, microwave irradiation; (d) lignin, conventional heating (Reprinted from [79] with permission)

for 20 min. In contrast, complete preparation of the composites under conventional heating at 60°C required more than 2 h, indicating that the rates of the sol–gel reactions were enhanced under microwave conditions compared with conventional heating. Moreover, application of the microwave-assisted method yielded completely homogenous nanoscale hybrids (Fig. 30a, c), whereas the silica composites prepared by conventional heating showed microheterogeneity (Fig. 30b, d). Thermostability of the biopolymer/silica hybrids and the porosity were almost the same, independently of the preparation method used.

A novel chitosan/ZSM molecular sieve composite used for the removal of Cu(II) ions from aqueous solution was prepared under microwave irradiation, applying a mixture of 0.5 g chitosan in 50 mL of 2% acetic acid to a ZSM molecular sieve. Then, 20% glutaraldehyde solution was added to the solution and the mixture irradiated for 3 min to crosslink the chitosan/ZSM composite. Composites with different ZSM contents and different crosslinker amounts were prepared. It was observed that introduction of ZSM improved the capacity for adsorption of Cu(II) ions in comparison with crosslinked chitosan. Finally, the effect of the amount of glutaraldehyde on Cu(II) adsorption was investigated and showed that the uptake of Cu(II) on chitosan/ZSM first increased and then decreased when the amount of crosslinker increased. The increase in Cu(II) adsorption was mainly attributed to the



**Fig. 31** Effect of ZSM content of a chitosan/ZSM molecular sieve on Cu (II) adsorption (Reprinted from [94] with permission)

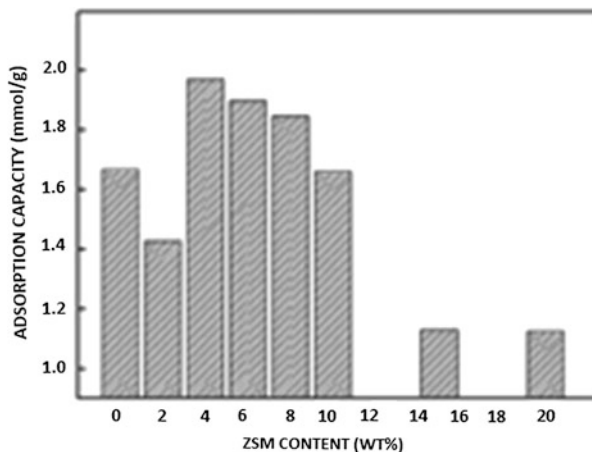

low levels of crosslinking agent in the complex, which prevented the formation of closely packed chain arrangements (Fig. 31) [94].

Superabsorbent nanocomposites, which are hydrophilic polymers with the ability to absorb, swell, and retain large quantities of aqueous liquids, were prepared via both microwave and conventional techniques from guar gum grafted sodium acrylate (GG-*g*-NaA). During the reaction procedure, a mixture of guar gum (1.00 g) and sodium acrylate (2 g) in distilled water (100 mL) was kept to form a colloidal slurry. Then, 4 mL of an aqueous solution of APS (100 mg) as initiator and *N,N'*-methylenebisacrylamide (MBA) (95 mg) as crosslinker were added, and the mixture irradiated at 70°C with 800 W of microwave power for 2–15 min. For comparison, the mixture was also heated by the conventional method. The reaction parameters of both techniques were optimized and the microwave-assisted method was proved to have higher grafting yield with shorter reaction time (2–15 min) compared with the conventional method (10–60 min). The effect of crosslinker concentration on water absorbency was investigated to show that the addition of Cloisite® 30B clay to the grafted material enhanced the swelling properties in all media, indicating its potential use in various applications, especially for dye removal (Table 8) [95].

Similarly, poly(acrylamide-aniline)-grafted gum ghatti [Gg-cl-poly(AM-aniline)]-based crosslinked conducting hydrogel, which can be applied for the manufacture of fuel cells, supercapacitors, and dye-sensitized solar cells, was prepared via a two-step synthesis method [96]. The first step involved microwave-assisted synthesis of a semi-interpenetrating (semi-IPN) polymer network based on acrylamide and gum ghatti using MBA and APS as a crosslinker–initiator system. In a typical experiment, 0.5 g gum ghatti was dissolved in 10 mL of water and calculated amounts of APS and MBA were added followed by dropwise addition of acrylamide under continuous stirring. The reaction mixture was irradiated with 850 W of microwave power for a fixed time and the product, Gg-cl-poly(AM), was

**Table 8** Optimization of time of grafting reaction of sodium acrylate to guar gum for conventional and microwave condition

Time (min)	Grafting (%)
<i>Conventional conditions</i>	
10	3.7
20	3.8
30	5.8
40	6.5
45	3.7
50	3.7
55	8.6
60	8.8
<i>Microwave irradiation</i>	
2	2.75
4	2.95
6	2.98
8	5.59
10	11.12
15	8.92

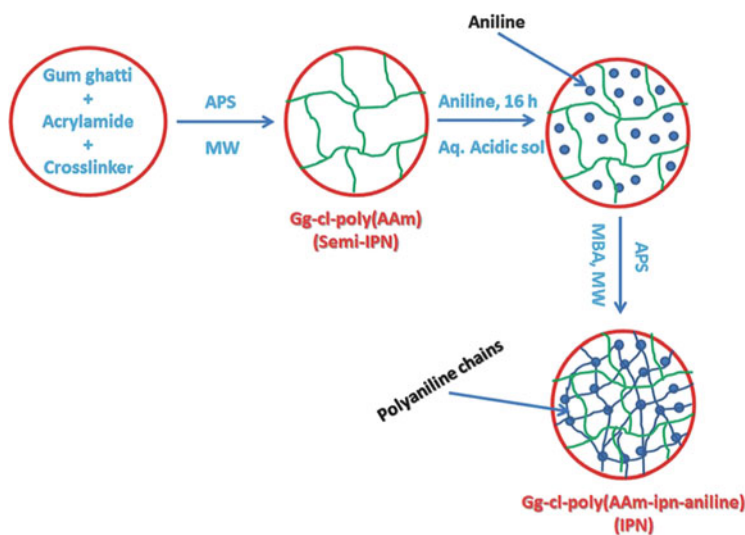
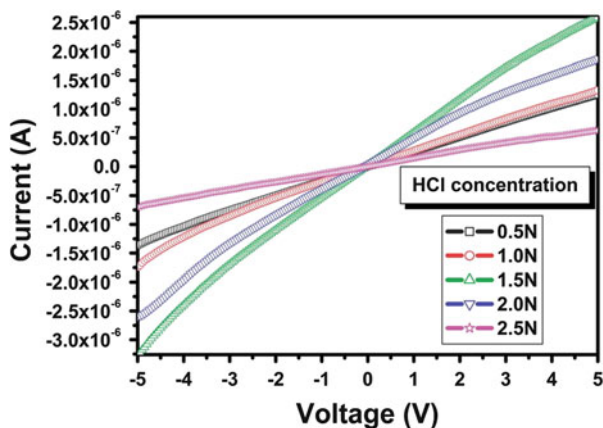

**Fig. 32** Synthesis of hydrogel based on poly(acrylamide-aniline)-grafted gum ghatti [Gg-cl-poly (AAm-ipn-aniline)]; *IPN* interpenetrating network (Reprinted from [96] with permission)

separated from homopolymer through solvent extraction using acetone. Then, Gg-cl-poly(AM-aniline) was prepared by treatment of Gg-cl-poly(AM) with aniline in 0.5 N aqueous hydrochloric solution (Fig. 32).

It was found that the prepared hydrogels were conductive and that the current-voltage characteristics for various concentrations of HCl-doped Gg-cl-poly

**Fig. 33** Current–voltage characteristics for various concentration of HCl-doped Gg-cl-poly(AAm-ipn-aniline) (Reprinted from [96] with permission)



(AM-aniline) were of linear nature and obeyed Ohm's law. The conductivity was first enhanced with an increase in HCl concentration, and then decreased gradually when HCl concentration was excessive (Fig. 33).

### 3.9 Other

Magnetic nanoparticles are applied in such fields as cell isolation, targeted drug delivery, protein and enzyme immobilization, immunoassays, and environmental and food analyses because of easy separation of particles in an external magnetic field. Monodisperse magnetic  $\text{Fe}_3\text{O}_4/\text{poly}(\text{styrene-co-acrylamide})$  [ $\text{Fe}_3\text{O}_4/\text{poly}(\text{ST-co-AM})$ ] nanoparticles were obtained by an emulsion polymerization of styrene and acrylamide monomers. The polymerization reactions were run in an aqueous solution of well-dispersed magnetic fluid solution ( $\text{wt}\% = 5.6 \times 10^{-2} \text{ g/mL}$ ), which was prepared by treatment of the reaction mixture in an ultrasonic bath for 3 min prior to polymerization, then  $8.2 \times 10^{-3} \text{ M}$  KPS solution was mixed with the magnetic fluid solution. Finally, the styrene and acrylamide mixture was added to the magnetic fluid solution and irradiated at  $75^\circ\text{C}$  by 130 W of microwave power for 3 h. The resulting monodisperse magnetic particles were separated by repeated magnetic separation [97].

In comparison with magnetic nanospheres prepared under conventional conditions, TEM revealed that magnetic  $\text{Fe}_3\text{O}_4/\text{poly}(\text{ST-co-AM})$  microspheres obtained under microwave conditions were characterized by smaller average size and more uniform distribution. Moreover, the average size of the magnetic  $\text{Fe}_3\text{O}_4/\text{poly}(\text{ST-co-AM})$  nanoparticles increased together with the initial styrene and acrylamide concentrations and decreased with higher magnetic fluid concentration, which was caused by surfactant effects (Fig. 34) [97].

During the investigations on MWCNTs incorporated into poly(propylene) (PP) together with HA it was shown that microwave techniques could be

**Fig. 34** Effects of ferrofluid content on the average particle diameter of magnetic  $\text{Fe}_2\text{O}_3$ /poly(styrene-*co*-acrylamide) microspheres (Reprinted from [97] with permission)

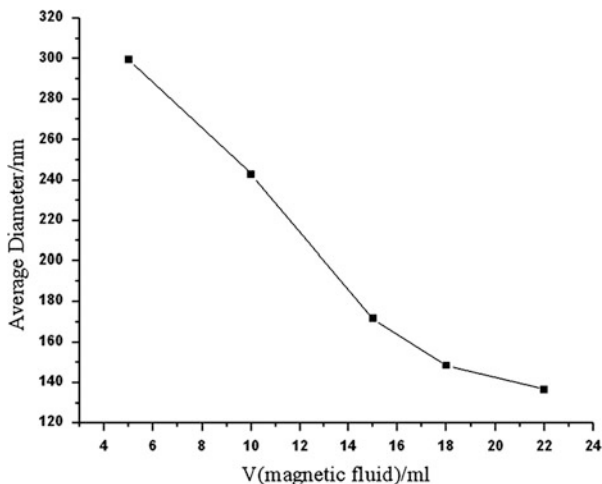

successfully applied for the faster processing of PP/MWCNT/HA biocomposites for bone tissue engineering [98]. Compared with conventional polymeric material processing methods, the heating time of PP/MWCNT/HA synthesis was significantly reduced to less than 1 min. In this study, MWCNTs were used as filler to improve the susceptibility for microwave absorption of the polymer during processing. The microwave-assisted synthesis of PP/MWCNT/HA with contents of PP (wt%) to MWCNTs (wt%) to HA (wt%) of 100:1:0, 100:1:5, 100:1:15, and 100:1:30 was carried out in a microwave reactor at 1,100 W of microwave power. The sintering time of each sample was measured. It was observed that the sintering time decreased with an increase in MWCNT and HA content. As expected, the incorporation of MWCNTs into the PP matrix improved the microwave energy absorption of the composites and consequently reduced sintering time. Moreover, SEM characterization of PP/MWCNT/HA nanocomposites demonstrated very uniform distribution of HA particles within the composites (Fig. 35). Additionally, it was observed that the composites with higher HA content (100:1:15) had the smallest pores and higher storage moduli [98].

Preparation and characterization of poly(amide-imide) (PAI) composites containing *p*-aminophenol (AP)-functionalized MWCNTs has been described [99]. Microwave irradiation was applied for the chemical functionalization of MWCNTs and synthesis of polymer matrix (Fig. 36). Amidation of carboxylated MWCNTs by AP was carried out in *N,N*-dimethylacetamide dispersion at 120°C for 15 min in a microwave oven with an output power of 700 W. PAI was synthesized by microwave-assisted polycondensation of 3,5-diamino-*N*-(4-hydroxyphenyl)benzamide (diamine) and *N*-trimethylilylimido-*L*-isoleucine (diacid) in the presence of triphenyl phosphite as a catalyst; molten tetrabutylammonium bromide (TBAB) was applied as reaction medium. It was found that the melted salt strongly absorbs microwave energy and after only 8 min of irradiation at 130°C the polymer was obtained at 88% isolated yield. Finally, the

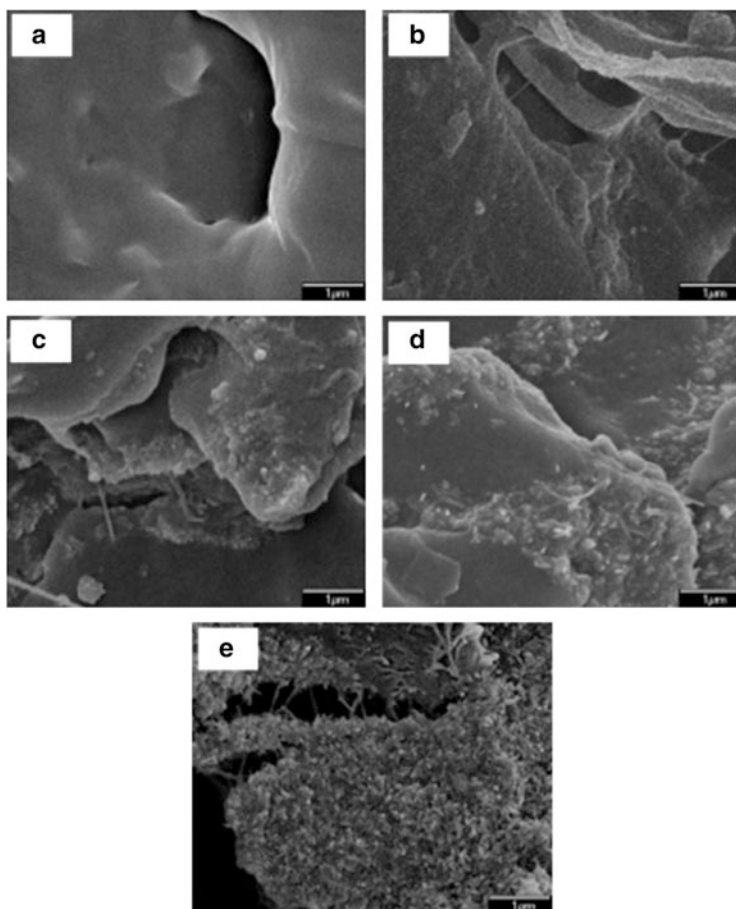

**Fig. 35** FE-SEM images of the fractured surfaces of (a) unfilled PP, and sintered PP/MWCNT/HA composites of (b) 100:1:0, (c) 100:1:5, (d) 100:1:15, and (e) 100:1:30 composition (Reprinted from [98] with permission)

MWCNT-AP/PAI nanocomposites were prepared by step-drying of films with the nanofiller (5, 10, 15 wt%) dispersed in a *N,N*-dimethylacetamide solution of PAI. Incorporation of MWCNT-AP in the PAI matrix improved both the thermal resistance and mechanical properties of the material.

The microwave procedure was also used for preparation of exfoliated graphite/phenolic resin composites [100]. In the first stage, graphite flakes were intercalated by treatment with oxidizing mixture ( $\text{KMnO}_4/\text{HClO}_4/\text{acetic anhydride}$ ) followed by microwave irradiation (domestic oven, 600 W for 50 s) to obtain exfoliated graphite (with high volume of  $\sim 500 \text{ mL/g}$ ). The exfoliated graphite/phenolic resin composites with various amounts (20–80 wt%) of exfoliated graphite filler were prepared by compression molding at room temperature using *p*-toluenesulfonic acid as crosslinking catalyst. It was found by electrical conductivity, microstructure, and

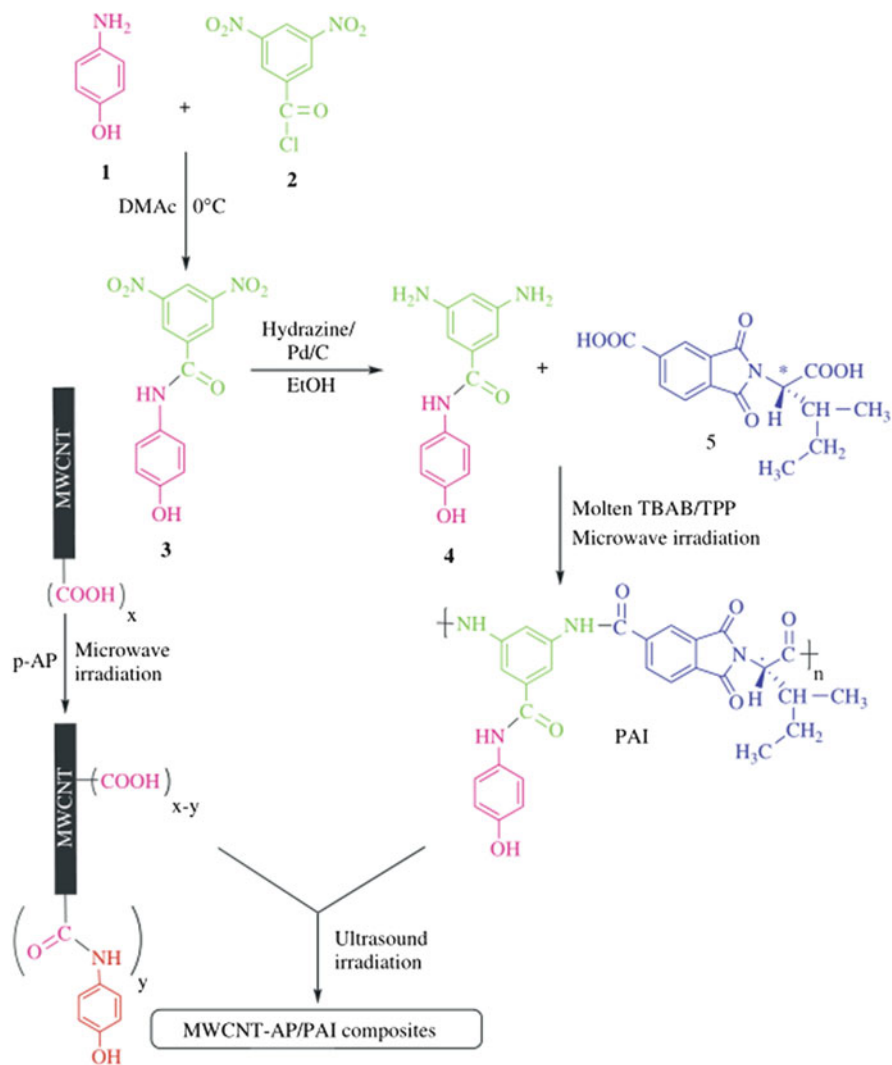

**Fig. 36** Preparation of MWCNT-AP and MWCNT-AP/PAI composites (Reprinted from [99] with permission)

porosity studies in connection with TGA that addition of 50 wt% of exfoliated graphite is sufficient to obtain composites that fulfill requirements for materials for fabrication of bipolar plates in polymer electrolyte membrane fuel cells.

Microwave irradiation was successfully applied for grafting of polyamidoamine (PAMAM) dendrimers on silica [101]. The silica was treated under microwave irradiation with a 10% solution of  $\gamma$ -aminopropyltriethoxysilane (APTES) in toluene at 50°C for 10 min. The APTES-modified silica (Si-G0) was washed with MeOH and dried at 50°C. Then, grafting of PAMAM to Si-G0 surface was carried

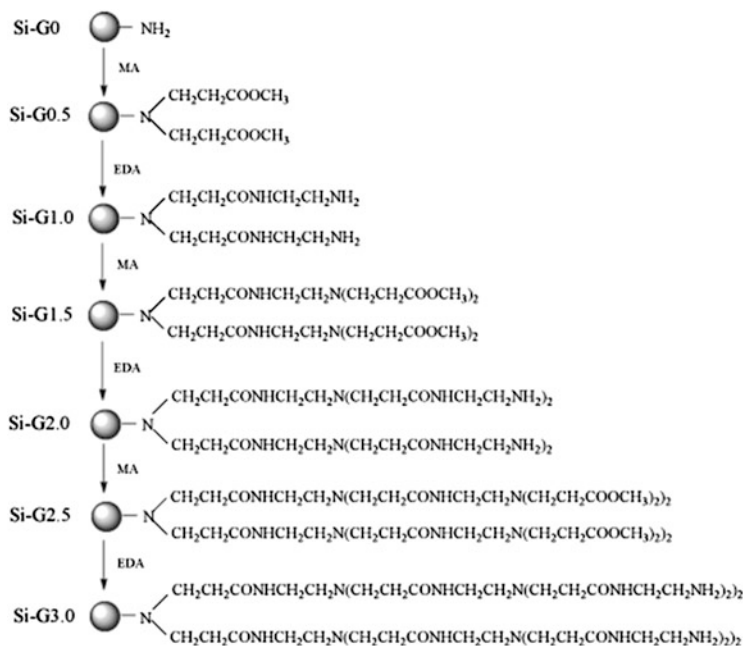

Fig. 37 Process of PAMAM grafting to silica (Reprinted from [101] with permission)

out in two steps: Michael addition of methyl acrylate to amino groups (Si-G0.5) followed by amidation of the resulting esters with ethylenediamine (EDA) (Si-G1.0), which were carried out in a microwave reactor at 40°C for 40 and 60 min, respectively. Then, Michael addition and the amidation reaction were repeated to graft further generations of dendrimer to the silica surface (Fig. 37).

Because PAMAM is highly fluorescent and fluorescence microscopy showed that the fluorescence intensity increased with increasing PAMAM generation, it can be assumed that PAMAM grew on the silica surface from the amino groups, whose content on the surface was also determined by titration (Fig. 38)

The reaction times under microwave irradiation and conventional heating conditions were compared. Conventional synthesis of Si-G0, Si-G0.5, and Si-G1.0 required 8, 24, and 24 h, respectively. Under microwave conditions, the reaction times were dramatically reduced to 10, 40, and 60 min, respectively.

Similarly, polycinnamamide (PCMA) Mg/Al mixed oxide nanocomposites (Fig. 39) obtained by a microwave-assisted process were found to be effective adsorbents of arsenate from aqueous medium [102]. The preparation route of PCMA hybrid nanocomposites consisted of several intermediate stages: polymerization of cinnamamide, synthesis of Mg/Al LDH, calcination of Mg/Al LDH into Mg/Al mixed oxide, and finally the coupling reaction of polycinnamamide gel with Mg/Al mixed oxide. The polymerization step and final coupling reaction were carried out in a microwave oven for several hours.

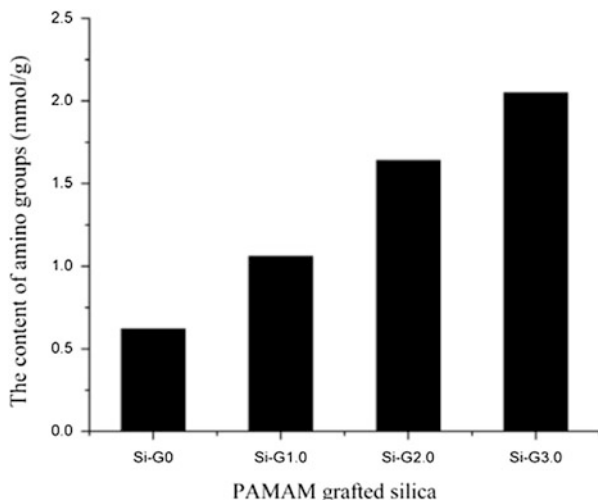

**Fig. 38** Content of amino groups introduced onto the silica surface during PAMAM grafting. See Fig. 37 for description of grafted silicas (Reprinted from [101] with permission)

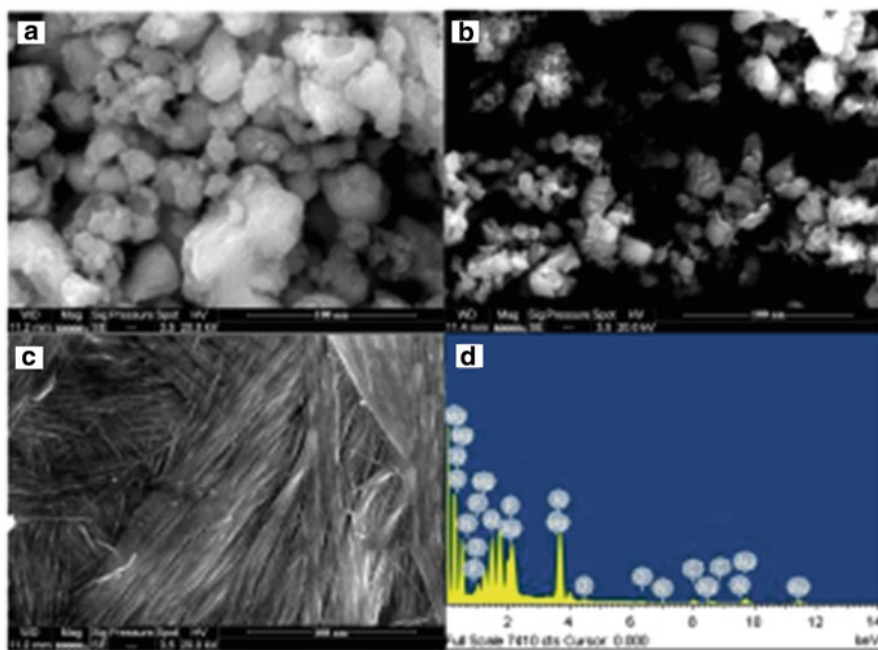

**Fig. 39** SEM images of (a) Mg/Al carbonate LDH, (b) calcined LDH, and (c) polycinnamamide Mg/Al mixed oxide nanocomposite. (d) Energy dispersive X-ray (EDX) spectrograph of polycinnamamide Mg/Al mixed oxide nanocomposite (Reprinted from [102] with permission)



The absorbent properties of as-prepared PCMA nanocomposites were studied with respect to the effect of various parameters such as contact time, pH (6–12), initial arsenate concentration (1–50 mg/L), interfering anions, etc. The adsorption process was well fitted by a pseudo-second-order kinetic model and the maximum adsorption capacity calculated from Langmuir isotherm model was about 11.54 mg/g at 25°C [102].

Comparative studies on the properties of benzoxazine-based resins based on BPA and bio-based humic acid (containing naturally ~38% of inorganic minerals) prepared under microwave and conventional heating have been described [103]. First, benzoxazine precursors were prepared by reaction of phenolic compound (i.e., BPA or humic acid) with paraformaldehyde and aniline under solvent-free conventional (110°C, 60 min) or microwave-assisted (120°C, 5 min) conditions. Next, xylene solutions of the precursors were heated at 130°C for 96 h and, finally, the obtained resins were step-cured at 160, 180, and 200°C for 1–2 h. Generally, application of microwave irradiation did not influence the chemical structure (FTIR), thermal resistance (TGA), or microstructure (XRD) of obtained materials. The only discrepancy was noticed for the glass transition ( $T_g$ ) of BPA-derived resins (DSC), probably caused by differences in the crosslink densities of prepolymers used.

The preparation of colloids with polymer core and inorganic shell consisting of AgNPs applied as building blocks for the manufacture of conducting composite films was reported [104]. The polymer colloids were prepared by copolymerization of styrene, butyl acrylate, 2-carboxyethyl acrylate (CA), and acetoacetoxyethyl methacrylate (AAEM) under microwave irradiation. The hydrophilic monomers CA and AAEM were used to introduce carboxylic and  $\beta$ -diketone groups into the surface layer of polymer colloids because they are able to complex metals and support growth of AgNPs on the polymer surface. The hydrophobic monomers styrene and butyl acrylate were used to form the core of polymer particles so that film formation was achieved at low temperatures. Then, hybrid particles were prepared by stirring polymer colloid (27 mL of 0.2 wt%) with silver salt solution (0.5 mL) for 30 min at room temperature. The reducing agent sodium hypophosphite was then added and the reaction mixture (5 mL) was irradiated in pressurized vessels for 2–5 min at various temperatures. The mixture was dialyzed against water for 3 days to remove substrates and by-products.

It was found that the content of AgNPs in composite samples was increased from 2 to 18 wt% when the reaction temperature increased from 80 to 120°C. Moreover, flow-field-flow-fractionation (F-FFF) experimental data showed that the formation of an inorganic shell around the polymer core took place only if synthesis was carried out at 120°C (Fig. 40). At lower reaction temperatures, secondary AgNPs and AgNP aggregates were detected as well as hybrid colloids.

It was also possible to prepare composite films with high electrical conductivity when AgNP loading on the polymer particle surface was above 20 wt%; the maximum loading of AgNPs on the polymer particle surface was 60 wt%. The application of hybrid colloids as building blocks for the formation of conducting films was feasible because of a combination of film-forming and conducting

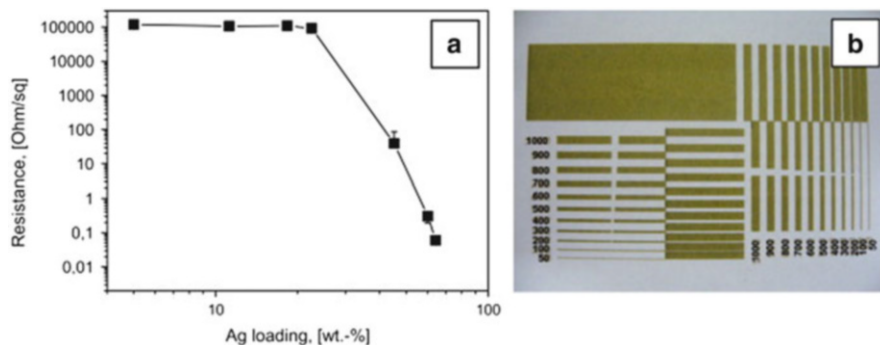

**Fig. 40** (a) Conductivity of composite films as a function of the AgNP content. (b) Array prepared by ink-jet printing of hybrid colloids containing 18.3 wt% AgNPs on paper substrate (the numbers near each line indicate the width of the line) (Reprinted from [104] with permission)

components in a colloid form that can be used as ink in jet-printers for printing conducting elements in low-cost electronics for textiles or packaging (Fig. 40).

## 4 Summary

In summary, the application of microwave irradiation in the preparation of polymer hybrid materials and composites has been an attractive research field over the last two decades. The fabrication of polymer hybrid materials and composites faces considerable research challenges because their properties depend on proper molecular modeling and structural control of components in order to gain synergistic effects and improved properties of materials. It was shown that control of such parameters as particle size, particle size distribution, and particle density in a deterministic way under microwave irradiation strongly influences the properties of these materials. As the structural configuration of components moves away from its ideal configuration, the material properties stay in the same range as those of traditional microcomposites.

Despite the progress presented in this chapter, there are still a number of considerable research challenges within this field that need to be solved in order to explore the real advantages of hybrid materials and composites over traditional composite materials. A comparison of conventional and microwave curing brings a new momentum when the temperature distribution inside the material is considered, and that is where the research capabilities should be found. Different mechanics of heat generation and transfer under conventional and microwave conditions mean that microwave energy, in contrast to conventional heating, is supplied directly to a large volume of material, thus avoiding the thermal lags associated with conduction and/or convection mechanisms. Consequently, temperature gradients and thermal runaway caused by exothermic reactions during polymerization

can be reduced by precise control of microwave power and/or pulsed on-off irradiation cycles. In large composite structures, high temperatures caused by exothermic reactions can lead to degradation of the material and lowering of the mechanical properties. Thus, by applying pulsed microwave irradiation, it is possible to process the materials at higher temperatures and reduce processing time without thermal degradation compared with conventional processing.

## References

1. Bogdal D, Prociak A, Michalowski S (2011) *Curr Org Chem* 15:1782
2. Lečkov M, Prandzheva S (2009) *Encyclopedia of polymer composites: properties, performance and applications*. Nova Science, New York
3. Matras-Postolek K, Bogdal D (2010) *Adv Polym Sci* 230:221
4. Skompska M (2010) *Synth Met* 160:1
5. Mandal B, Bhattacharjee H, Mittal N et al (2013) *Nanomed NBM* 9:474
6. Ge J, Neofytou E, Lei J et al (2012) *Small* 8:3573
7. Roach P, McGarvey DJ, Lees MR, Hoskins C (2013) *Int J Mol Sci* 14:8585
8. Iwasaki N, Kasahara Y, Yamane S et al (2011) *Polymer* 3:100
9. Yuan J, Gaponik N, Eychmüller A (2012) *Anal Chem* 84:5047
10. Prakash S, Chakrabarty T, Singh AK, Shahi VK (2013) *Biosens Bioelectron* 41:43
11. Krasia-Christoforou T, Georgiou TK (2013) *J Mater Chem B* 1:3002–3025
12. Mok H, Park TG (2012) *Macromol Biosci* 12:40
13. Shu JY, Panganiban B, Xu T (2013) *Annu Rev Phys Chem* 64:631
14. Work WJ, Horie K, Hess M, Stepto RFT (2004) *Pure Appl Chem* 76:1985
15. Gómez-Romero P, Sanchez C (2004) *Functional hybrid materials*. Wiley-VCH, Weinheim
16. Judeinstein P, Sanchez C (1996) *J Mater Chem* 6:511
17. Ávila-Orta CA, González-Morones P, Espinoza-González CJ et al (2013) Toward greener chemistry methods for preparation of hybrid polymer materials based on carbon nanotubes. In: Suzuki S (ed) *Syntheses and applications of carbon nanotubes and their composites*. InTech, Rijeka, p 167
18. Hussain F, Hojjati M, Okamoto M, Gorga RE (2006) *J Compos Mater* 40:1511
19. Fong H, Sarikaya M, White SN, Snead ML (2000) *Mater Sci Eng C* 7:119
20. Zaremba CM (1998) *Chem Mater* 10:3813
21. Bogdal D, Penczek P, Pielichowski J, Prociak A (2003) *Adv Polym Sci* 163:193
22. Wiesbrock F, Hoogenboom R, Schubert US (2004) *Macromol Rapid Commun* 25:1739
23. Hoogenboom R, Schubert US (2007) *Macromol Rapid Commun* 28:368
24. Bogdal D, Pisarek U (2012) Polymer chemistry under microwave irradiation. In: de la Hoz A, Loupy A (eds) *Microwaves in organic synthesis*. Wiley-VCH, Weinheim, p 1013
25. Bogdal D, Prociak A (2007) *Microwave-enhanced polymer chemistry and technology*. Blackwell, Ames
26. Hanemann T, Szabo DV (2010) *Materials* 3:3468
27. Zhang G, Niu A, Peng S, Jiang M, Tu Y, Li M, Ch W (2001) *Acc Chem Res* 34:249
28. Kojima Y, Usuki A, Kawasumi M et al (1993) *J Mater Res* 8:1185
29. Cao X, Lee LJ, Widya T, Macosko C (2005) *Polymer* 46:775
30. Thostenson ET, Chou T-W (1997) In: *Proceedings of 12th annual meeting American Society for Composites*, Dearborn
31. Thostenson ET, Chou T-W (2001) *Polym Compos* 22:197
32. Thostenson ET, Chou T-W (1998) In: *Proceedings of the 13th annual meeting American Society for Composites*, Baltimore

33. Liu Y, Xiao Y, Sun X, Scola DA (1999) *J Appl Polym Sci* 37:2391
34. Harper JF, Price DM (2005) In: 10th International conference on microwave and RF heating, Modena
35. Fang X, Scola DA (1999) *J Polym Sci Part A Polym Chem* 37:4616
36. Liu XQ, Wang YS, Zhu JH (2004) *J Appl Polym Sci* 94:994
37. Imholt TJ, Dyke CA, Hasslacher B et al (2003) *Chem Mater* 15:3969
38. Vázquez E, Prato M (2009) *ACS Nano* 3:3819
39. Ye Z, Deering WD, Krokhin A, Roberts JA (2006) *Phys Rev B* 74:75425
40. Xie R, Wang J, Yang Y et al (2011) *Compos Sci Technol* 72:85
41. Yang L, Li Z, Nie G, Zhang Z, Xiaofeng L, Wang C (2014) *Appl Surf Sci* 307:601
42. Chin IJ, Albrechta TT, Kima HC et al (2001) *Polymer* 42:5947
43. Jiankun L, Yucai K, Zongneng Q, Su YX (2001) *J Polym Sci Part B Polym Phys* 39:115
44. Yoo Y, Choi K-Y, Lee JH (2004) *Macromol Chem Phys* 205:1863
45. Aranda L, Mosqueda Y, Pérez-Cappe E, Ruiz-Hitzky E (2003) *J Polym Sci Part B Polym Phys* 41:3249
46. Urresti O, González A, Fernández-Berridi MJ et al (2011) *J Membr Sci* 373:173
47. Schmidt D, Sinha RS, Bousmina M (2005) *Prog Mater Sci* 50:962
48. Karaman VM, Privalko EG, Privalko VP et al (2005) *Polymer* 46:1943
49. Chen B, Evans JRG (2006) *Macromolecules* 39:747
50. Liao L, Zhang C, Gong S (2007) *Macromol Rapid Commun* 28:1148
51. Liao LQ, Liu LJ, Zhang C et al (2002) *J Polym Sci Part A Polym Chem* 40:1749
52. Liao L, Zhang C, Gong S (2007) *Macromol Chem Phys* 208:1301
53. Liao LQ, Liu LJ, Zhang C et al (2003) *J Appl Polym Sci* 90:2657
54. Wypych F, Satyanarayana KG (2004) *Clay surfaces: fundamentals and applications*. Elsevier, Amsterdam
55. Lee WD, Im SS (2007) *J Polym Sci Part B Polym Phys* 45:28
56. Martínez-Gallegos S, Herrero M, Rives V (2008) *J Appl Polym Sci* 109:1388
57. Uyanik N, Riza Erdem A, Fatih Can M, Çelik MS (2006) *Polym Eng Sci* 46:1104
58. Chang J, Liang G, Gu A et al (2012) *Carbon* 50:689
59. Pokharel P, Truong Q-T, Lee DS (2014) *Compos Part B* 64:187
60. Lin J-S, Chung M-H, Chen C-M et al (2011) *J Phys Org Chem* 24:193
61. Lin J-S, Chung M-H, Chen C-M et al (2010) *Curr Appl Phys* 10:1331
62. Wada Y (2007) *Polymer* 48:1441
63. Soumya S, Mohamed AP, Paul L, Mohan K, Ananthakumar S (2014) *Sol Energy Mater Sol Cells* 125:102
64. Chien W-C, Yu Y-Y, Chen P-K, Yu H-H (2011) *Thin Solid Films* 519:5274
65. Khan A, El-Toni AM, Alrokayan S et al (2011) *Colloids Surf A* 377:356
66. Sowntharya L, Subasrin R (2013) *Ceram Int* 39:4689
67. Yu Y-Y, Chen P-K (2013) *Thin Solid Films* 544:48
68. Tyliczszak B, Pielichowski K (2013) *J Polym Res* 20:191
69. He R, Qian X-F, Yin J et al (2003) *Mater Lett* 57:1351
70. Riaz U, Ashraf SM, Madan A (2014) *New J Chem* 38:4219
71. Riaz U, Ashraf SM, Kumar S, Ahmad I (2014) *Chem Eng J* 241:259
72. Riaz U, Ashraf SM (2012) *J Phys Chem C* 116:12366
73. Tian ZQ, Wang XL, Zhang HM et al (2006) *Electrochem Commun* 8:1158
74. Hammami R, Ahamed Z, Charradi K et al (2013) *Int J Hydrogen Energy* 38:11583
75. Matos BR, Isidoro RA, Santiago EI, Linardi M, Ferlauto AS, Tavares AC, Fonseca FC (2013) *J Phys Chem* 117:16863
76. Nadagouda MN, Varma RS (2008) *Macromol Rapid Commun* 29:155
77. Li S-M, Jia N, Ma M-G et al (2011) *Carbohydr Polym* 86:441
78. Xu Y, Zuo L, Lin T et al (2014) *Polym Compos* (in press) doi:10.1002/pc.23134
79. Kajiwara Y, Chujo Y (2011) *Polym Bull* 66:1039
80. Cao X, Ding B, Yu J, Al-Deyab SS (2013) *Carbohydr Polym* 92:571

81. Breitwieser D, Moghaddam MM, Spirk S et al (2013) *Carbohydr Polym* 94:677
82. Li S-M, Fu L-H, Ma M-G et al (2012) *Biomass Bioenergy* 47:516
83. Jia N, Li S-M, Ma M-G, Sun R-C (2011) *Mater Lett* 65:918
84. Ma M-G, Qing S-J, Li S-M et al (2013) *Carbohydr Polym* 91:162
85. Ma M-G, Dong Y-Y, Fu L-H et al (2013) *Carbohydr Polym* 92:1669
86. Ma M-G, Zhu J-F, Jia N et al (2010) *Carbohydr Res* 345:1046
87. Jia N, Li S-M, Ma M-G, Sun R-C (2012) *Mater Lett* 68:44
88. Kamel S (2012) *Carbohydr Polym* 90:1538
89. Lin S-P, Loira Calvar I, Catchmark JM et al (2013) *Cellulose* 20:2191
90. Stoica-Guzun A, Stroescu M, Jinga SI et al (2013) *Ind Crop Prod* 50:414
91. Shariatzadeh B, Moradi O (2014) *Polym Compos* 35:2050
92. Mahmoodian H, Moradi O (2014) *Polym Compos* 35:495
93. Jesionowski T, Klapiszewski Ł, Milczarek G (2014) *J Mater Sci* 49:1376
94. Li H, Huang D (2013) *J Appl Polym Sci* 129:86
95. Likhitha M, Sailaja RRN, Priyambika VS, Ravibabu MV (2014) *Int J Biol Macromol* 65:500
96. Sharma K, Kaith BS, Kumar V et al (2013) *RSC Adv* 3:25830
97. Huang J, Pen H, Xu Z, Yi C (2008) *React Funct Polym* 68:332
98. Chen L, Tang CY, Ku HS-l, Tsui CP, Chen X (2014) *Compos Part B* 56:504
99. Mallakpour S, Zadehnazari A (2014) *Polym Int* 63:1203
100. Sykam N, Gautam RK, Kar KK (2014) *Polym Eng Sci* (in press) doi:10.1002/pen.23959
101. Zhang C, Su P, Umar Farooq M et al (2010) *React Funct Polym* 70:129
102. Islam M, Mishra PC, Patel R (2013) *Chem Eng J* 230:48
103. İnan TY, Karaca BY, Dogan H (2012) *J Appl Polym Sci* 128:2046
104. Türke A, Fischer W-J, Adler H-J, Pich A (2010) *Polymer* 51:4706

# Upscaling Microwave-Assisted Polymerizations

**Richard Hoogenboom**

**Abstract** Driven by the success of microwave-assisted polymer chemistry as outlined in the other chapters of this series, the need for upscaling these processes has been identified. Within this chapter an overview is given of the general aspects of upscaling microwave-assisted polymerizations via both large batch reactors and continuous flow microwave reactors. Important challenges and limitations such as microwave penetration depth for large batch reactors and intrinsic temperature gradients in tubular flow reactors are discussed. An overview of the literature reports on upscaling of microwave-assisted polymerizations is also given.

**Keywords** Batch reactor • Flow reactor • Microwave-assisted polymerization • Upscaling

## Contents

1	Introduction .....	296
2	Upscaling Microwave-Assisted Polymerizations in Batch Mode .....	297
3	Upscaling Microwave-Assisted Polymerizations in Flow Mode .....	302
4	Summary, Conclusions, and Outlook .....	304
	References .....	305

## 1 Introduction

Microwave irradiation has been established as an alternative heat source for chemical reactions in the past few decades [1–3]. The rapid acceptance of this new heating method in organic synthesis has been driven by the numerous advantages of microwave-assisted heating, such as faster reactions and higher yields. The majority of these observations result from the higher attainable reaction temperatures in dedicated microwave synthesizers for chemistry allowing work to be carried out under pressure. Furthermore, these microwave synthesizers provide superb control over reaction temperature with rapid heating and cooling, allowing fast optimization of conditions for reactions and for studying reaction kinetics. The direct heating of the reaction mixture under microwave irradiation and the homogeneous heat profiles [4], especially when using smaller scale reactors, are the prime reason for observations of higher yields, as side reactions at intermediate temperatures or those caused by thermal overshoot can be suppressed. Moreover, in specific cases and conditions, specific absorption of microwaves by (heterogeneous) polar components in the reaction mixture may lead to altered reactivity and/or specificity, although this remains subject to debate, especially for homogeneous liquid reaction mixtures [5–7].

The advantages that have led to the widespread usage of microwave-assisted heating in organic synthesis have also attracted polymer chemists to explore the use of microwave-supported heating [8–11]. In nearly all sub-areas of polymer chemistry the use of microwave irradiation has been demonstrated to provide advantages compared to conventional heating, from simple acceleration following the Arrhenius equation to specific absorption effects up to claimed non-thermal microwave effects. The main achievements that have been made in the different areas have been discussed in the other chapters in this series focusing on polycondensation [12], free radical polymerization [13], controlled free radical polymerization [14], ring-opening polymerization of cyclic amides and esters [15], cationic ring-opening polymerization of 2-oxazolines [16], polymer modification (including click chemistry) [17], synthesis of hybrid polymer materials and composites [18], and, finally, polymer degradation [19].

The success of microwave irradiation in polymer chemistry on small-scale laboratory reactors has led to a need for scale-up possibilities. In general, there are two main strategies for upscaling: (1) increasing the size of the batch reactor leading to a larger scale or (2) transforming the reaction into a continuous flow process (Fig. 1). In organic chemistry, there is a general belief that microwave-assisted reactions can be directly scaled to larger reactors because of the direct and homogeneous heating provided by microwave irradiation [2]. Such direct scaling of microwave-assisted organic reactions has already been shown for batch reactions using either open reflux reaction vessels [20–23] or closed pressurized reaction vessels [22–27]. Furthermore, examples have been reported on direct upscaling of small-scale organic batch reactions to larger-scale continuous microwave-assisted flow processes [27–31]. For a comparison and overview of commercially available

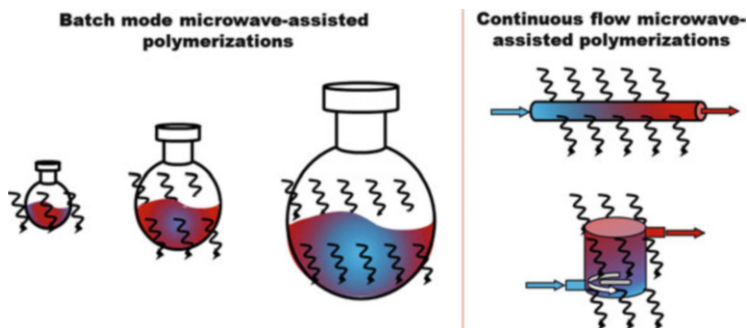

**Fig. 1** Schematic representation of the two routes to upscaling microwave-assisted polymerizations in batch mode (*left*) and continuous flow mode (*right*). Continuous flow can be subdivided into tube reactors (*top right*) and continuously stirred tank reactors (CSTR; *bottom right*). The color code in the figure provides a rough indication of the temperature profiles in the different type of reactors going from cold (*blue*) to hot (*red*)

equipment for medium scale microwave synthesizers the reader is referred to the work of Moseley [32].

In the current chapter, the upscaling of microwave-assisted polymer synthesis is discussed, subdivided in batch-mode upscaling by simply increasing the reactor size (Sect. 2) and continuous flow mode (Sect. 3). These sections start with a general discussion on the potential and limitations of the upscaling methodology for polymer synthesis, followed by an overview of the examples reported in the literature.

## 2 Upscaling Microwave-Assisted Polymerizations in Batch Mode

The most straightforward way of upscaling a reaction is by simply increasing the size of the reaction vessel. However, one should consider the effects of the larger vessel size on the heat and mass transfer, which are very different compared to the small-scale lab batch reactor. An important parameter for the upscaling of microwave-assisted polymerizations in batch mode is the microwave penetration depth, which is the distance required for all microwaves to be absorbed by the reaction medium [33]. The microwave penetration depth is inversely proportional to the loss factor,  $\tan \delta$ , of the medium, which is quantified as  $\tan \delta = \epsilon''/\epsilon'$  where  $\epsilon''$  is the dielectric loss and  $\epsilon'$  is the dielectric constant of the solvent. The  $\tan \delta$  of the polymerization mixture correlates positively with the efficiency of the microwave-assisted heating. However, a higher  $\tan \delta$  also decreases the microwave penetration depth, posing limitations on the fast and homogeneous direct heating of the entire reaction mixture by microwave irradiation.



For small-scale batch microwave-assisted reactions, the temperature profile of the reaction mixture is very homogeneous with a slightly higher temperature inside the reactor compared to its surface because of temperature losses from the wall to the environment [4] (Fig. 1, left: small batch reactor). This is particularly the case when the diameter of the reactor is equal to or less than twice the microwave penetration depth when irradiation is provided from all sides. If the reactor size is increased for upscaling and the diameter becomes larger than twice the microwave penetration depth, the outer layer of the reaction mixture is heated and heat transfer to the interior occurs, also depending on the efficiency of agitation (Fig. 1: medium-sized batch reactor). When the reactor becomes very large, only a minor outer layer of the reaction mixture is heated directly by absorption of microwaves and the heat profile becomes very similar to a conventionally heated batch reactor heated from the outside. In this case, there is a larger temperature gradient with higher temperatures at the outer layers compared to the middle of the reaction vessel (Fig. 1, right: large batch reactor). Such a large microwave batch reactor set-up is, thus, only applicable to reactions that are accelerated because of thermal effects and not for those that benefit from specific, selective microwave-absorption effects.

Generally, the microwave penetration depth of organic molecules lies in the range of several centimeters when using the standard 2.45 GHz frequency, but it varies with the temperature as does  $\tan \delta$ . As examples, Fig. 2 shows the calculated microwave penetration depth for water, (anhydrous) lactic acid, and an oligolactic acid as reported by Takeuchi and coworkers [34]. The microwave penetration depth for water is only 1.4 cm at 25°C although it increases to 5.7 cm at 95°C because of a decrease in  $\epsilon'$  [4]. When superheating water to near critical conditions, e.g., up to 300°C, the  $\epsilon'$  approaches zero, correspondingly leading to near infinite penetration depth on the one hand and highly inefficient microwave absorption and heating on the other. This illustrates that the microwave absorption efficiency and microwave penetration depth go hand in hand and are inversely proportional.

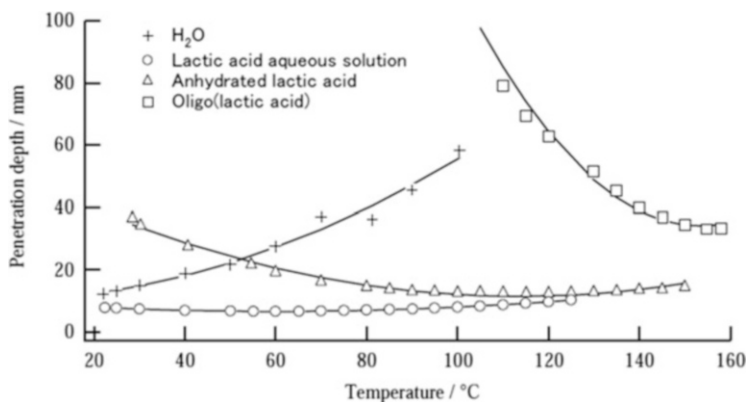

**Fig. 2** Microwave penetration depth as function of temperature for water (H<sub>2</sub>O) and several other components. Reprinted with permission from [34]

In addition to the less homogeneous heat distribution in the course of upscaling microwave-assisted polymerizations in batch mode, the efficiency of the agitation is lowered, especially when there is a significant increase of the viscosity during the polymerization. When going from small-scale lab reactions to larger batch reactors, it may be necessary to change from a magnetic stirring bar to a mechanical overhead stirrer. The latter poses some challenges to the microwave reactor design as the mechanical stirrer needs to be microwave transparent and, for working under closed-vessel conditions, it needs to be fully sealed. Nonetheless, these are engineering challenges that can be overcome.

Some early reports on microwave-assisted polymerizations already addressed the upscaling question unintentionally. In 2001, the microwave-assisted emulsifier-free emulsion polymerization was reported by Wu using a home-made microwave reactor based on a domestic microwave oven [35]. A large three-neck round-bottom flask was fitted in the microwave oven with a reflux condenser allowing open vessel emulsion polymerization of a 250-mL polymerization mixture. Even though such early examples report large-scale microwave-assisted polymerizations, the use of domestic microwave ovens is not advisable as the microwave field is inhomogeneous, leading to hot spots and cold spots compromising safety and reproducibility. In this respect, these open vessel conditions are mandatory in such a home-made set-up with a domestic microwave oven, as the boiling point of the solvent avoids thermal runaway and explosions.

Schubert and coworkers were the first to report the upscaling of a microwave-assisted polymerization in batch conditions from 4 mmol via 200 mmol up to 1 mol monomer corresponding to 1-mL, 50-mL, and 250-mL batch closed-vessel reactors [36]. Dedicated microwave reactors were utilized for the living cationic ring-opening polymerization of 2-ethyl-2-oxazoline, whereby the two smaller scales were performed using monomode microwave fields and the largest scale with a multimode. The polymerization conditions (reaction time and temperature) which were optimized at a 1 mL scale [37] were found to be directly applicable to the larger scales, albeit the initial microwave power setting needed to be adjusted to lower values to avoid thermal runaway for these highly exothermic polymerizations. Nonetheless, after adjustment of the microwave power settings, highly comparable polymers with low molar mass dispersity were obtained regardless of the scale (Fig. 3) as expected for this polymerization that is accelerated under microwave-assisted conditions because of thermal effects [37]. The microwave-assisted scale up of the copolymerization of 2-nonyl-2-oxazoline and 2-dec-9'-enyl-2-oxazoline in an ionic liquid was reported by Reynaud, Wiesbrock et al. [38]. Performance of the copolymerization on the 1.1 mol (0.7 L) scale in a batch reactor with mechanical stirring yielded copoly(2-oxazoline)s with a molar mass dispersity of 1.34.

Unlike the direct scalability of the homogeneous living cationic ring-opening polymerization of 2-ethyl-2-oxazoline, the upscaling of the heterogeneous synthesis of Rasta resins via nitroxide-mediated controlled radical polymerization of chloromethylstyrene initiated from a (2,2,6,6-tetramethylpiperidin-1-yl)oxyl (TEMPO) modified resin was not possible using direct scaling [39]. Pawluczyk

**Fig. 3** Size exclusion chromatograms as well as pictures of the polymerization mixtures for batch mode upscaling of the cationic ring-opening polymerization of 2-ethyl-2-oxazoline from 4 mmol (a) via 200 mmol (b) to 1,000 mmol (c) under superheated microwave conditions. Reprinted with permission from. [36]

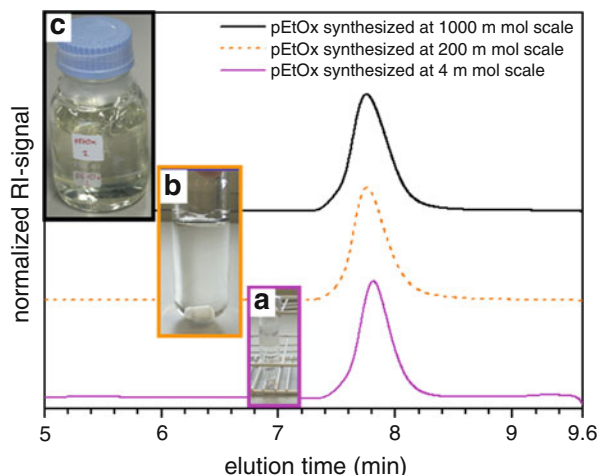

and coworkers reported that significant optimization of the polymerization conditions was required to enable large-scale synthesis up to 100-g batches with good batch-to-batch reproducibility in a closed-vessel multimode microwave reactor.

For even larger scale microwave-assisted batch reactions, there is no commercial dedicated equipment available and custom reactor design is required. Zhu and coworkers reported such a custom reactor design based on a large multimode microwave cavity in which they placed five 10 cm  $\times$  25 cm tubular reactors as well as IR temperature probes to monitor the reaction temperature [40]. Each of these tubes was filled with up to 800 g  $\epsilon$ -caprolactone monomer and stannous octoate catalyst and sealed under reduced pressure, allowing polymerization of up to 2,450 g monomer per run. The major advantage of the tubular reactor design is that it suffers less from the limited microwave penetration depth compared to a spherical reactor. The resulting poly( $\epsilon$ -caprolactone) had similar characteristics as a sample obtained in a small-scale microwave reactor [41], demonstrating the direct and easy scalability of this polymerization.

A specifically designed microwave-reactor system that approaches pilot plant scale production was reported by Takeuchi and coworkers, consisting of a 30-L reactor inside a 366-L multimode microwave cavity that operates with a single 6 kW magnetron (Fig. 4) [42]. In addition to this 30-L reactor, custom-made 70-mL and 300-mL batch microwave reactors were also developed and compared. All three reactors were utilized for the condensation of lactic acid using stannyl dichloride and para-toluenesulfonic acid as catalytic system. Polymerizations were performed at 180°C under reduced pressure conditions to remove the water formed in the course of the reaction. With all three reactors, polymers with similar molecular weights of around 10,000 g/mol were obtained, whereby the largest scale reaction comprised a polymerization mixture with a volume of 20 L. The authors demonstrated that the polymerization process became more energy efficient with increasing reactor volume, whereby the energy consumption of the polymerization



**Fig. 4** Pictures of the SMW-114 MW reactor showing the entire instrument (*left*) and the reaction cavity (*right*). Reprinted with permission from [42]

decreased from 4,600 kJ/mol to 160 kJ/mol if the reaction volume was increased from 70 mL to 20 L. Even though the energy consumption was claimed to be 70% less compared to the conventional conductive heating process, there are more differences (e.g., no catalyst required in the conventional process, and the scale and temperature of the conventional process were not specified) between the various production processes obstructing a one to one comparison. For a more in-depth discussion and comparison of the heating efficiency of microwave-assisted and conventionally heated processes, the reader is referred to a highly informative perspective article from Moseley and Kappe [43].

As final remark, the automation of such larger scale batch microwave reactors may be considered in a so-called stop-flow mode. As such, the polymerization mixture is pumped into the batch reactor, followed by polymerization and removal into a product collection flask. Such automation protocols may significantly enhance the production capacity, although it could be limited by the viscosity of the polymerization mixture which has to be cooled down below the boiling point of the utilized solvent before it can be pumped out.

### 3 Upscaling Microwave-Assisted Polymerizations in Flow Mode

The second possible mode for upscaling microwave-assisted polymerizations is in continuous flow mode. At a first glance, continuous flow microwave-assisted polymerizations seem to be the straightforward option as there are no issues with the microwave penetration depth as long as the continuous flow reactor has an inner diameter below 5–10 cm. Furthermore, continuous flow polymerizations are generally performed under pressurized conditions using a back-pressure regulator at the end of the flow reactor facilitating superheated polymerization conditions. However, there are some severe drawbacks and challenges to the use of continuous flow microwave reactors for polymerizations.

The first intrinsic limitation is the poor temperature control of tubular microwave flow reactors (Fig. 1, top right). If the polymerization mixture enters the microwave cavity at ambient temperature, it continuously heats up along the tube reactor, leading to a pronounced temperature gradient throughout the reactor, making it difficult to control the reaction kinetics. Furthermore, polymerizations that are very sensitive to temperature fluctuations cannot be performed in such a reactor. This pronounced temperature gradient can be overcome by using a continuously stirred tank reactor design, which comprises a mechanically stirred reactor which averages out the temperature profile (Fig. 1, bottom right).

The potential use of continuously stirred tank reactors for microwave-assisted polymerizations inherently bears a second challenge, namely the residence time distribution of the polymerization mixture in the continuous flow reactor. Unlike organic transformations, for which the residence time distribution does not have a great influence on the products, increasing or decreasing the residence time distribution during a polymerization has a direct influence on the polymer molar mass distribution, denoted as dispersity, especially for chain-growth polymerizations.

A third important aspect of microwave flow polymerizations is the viscosity of the polymerization mixture which should not become too high during the polymerization as this would lead to too high pressures and eventually to blockage of the reactor.

To date, there has been just one prominent report on the use of commercially available continuous flow microwave reactors for microwave-assisted polymerization, focusing on the living cationic ring-opening polymerization of 2-ethyl-2-oxazoline. This system was selected for the proof-of-concept as this polymerization proceeds without significant side-reactions at a wide range of temperatures ranging from 80 to 200°C [37]. The polymerization could be successfully performed despite the intrinsic temperature gradients that are present in tubular microwave flow reactors. The polymers resulting from the continuous flow microwave polymerizations using four different reactor set-ups were compared with the polymer obtained using a small-scale batch reactor (Fig. 5) [44]. Even though polymers were obtained with high monomer conversion with all microwave flow reactors, these polymers had molar mass dispersities ranging from 1.3 to 1.5 whereas the polymer

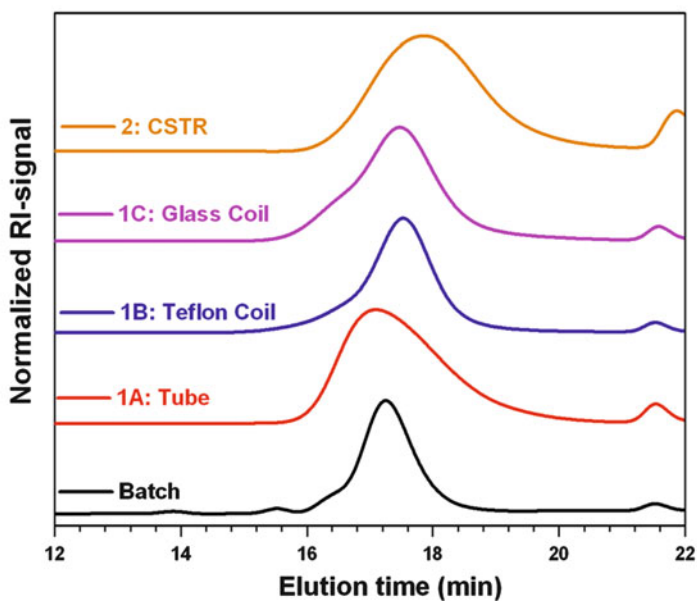

**Fig. 5** *Top*: Pictures of the continuous flow microwave synthesizers equipped with a 10-mL tube reactor (System 1A), 5-mL Teflon coil (System 1B), or 10-mL glass coil (System 1C) and a 200-mL continuously stirred tank reactor (CSTR, System 2). *Bottom*: SEC traces of the poly (2-ethyl-2-oxazoline)s obtained utilizing the different continuous flow microwave reactors and a reference polymer obtained by a small-scale microwave-assisted batch polymerization. Reprinted with permission from [44]

prepared in batch had a dispersity of 1.14, indicating lower control over the polymerization process. Determination of the residence time distribution for the four different continuous flow reactors provided a direct correlation between the width of the residence time distribution and the molar mass dispersity of the resulting polymers, revealing that further improvement of the continuous flow reactor design may allow further lowering of the dispersity. Importantly, the large-scale (200-mL) continuously stirred tank reactor with microwave-assisted heating enabled the production of nearly 300 g polymer per hour.

The intrinsic limitations and challenges discussed above associated with continuous flow microwave-assisted polymerizations severely limit the application potential of such reactors for polymer synthesis. A viable alternative for the upscaling of microwave-assisted polymerizations appears to be the use of conventionally heated (micro)flow reactors [45]. These offer comparably fast heating and homogeneous temperature profiles as small-scale batch microwave reactors, although the potential limitations arising from the pumping of viscous polymerization mixtures obviously persist. As a representative example, the living cationic ring-opening polymerization of 2-ethyl-2-oxazoline was recently reported to proceed with similar polymerization kinetics in a conventionally heated microflow reactor compared to the previously reported small-scale microwave batch reactor [37, 46]. Moreover, polymers with similarly narrow dispersities were obtained by both methodologies.

## 4 Summary, Conclusions, and Outlook

The success of microwave-assisted polymer chemistry as outlined in the other chapters of this series has resulted in a real need for upscaling these processes. Within this chapter an overview has been given of the general aspects of upscaling microwave-assisted polymerizations via both large batch microwave reactors and continuous flow microwave reactors.

Most effort has been dedicated to upscaling via large batch reactors, whereby it is important to realize that the temperature profile in larger batch microwave reactors is different from small-scale laboratory microwave reactors because of the limited penetration depth of the microwaves in the polymerization mixtures. This implies that thermal advantages of microwave heating can be very well reproduced in such large batch microwave reactors, but selective and/or specific microwave heating effects may be obscured. A major advantage of upscaling via batch microwave reactors is that the optimized polymerization conditions from small scale often can be directly applied to the larger reactors; the only reported exception being for a heterogeneous polymerization system. The largest reported batch microwave reactor has been utilized for a 20-L scale polycondensation of lactic acid, whereby the larger scale reactors were found to be more energy efficient.

A second strategy for the upscaling of microwave-assisted polymerizations involves continuous flow microwave reactors. These systems, however, have the

highly relevant intrinsic limitation that there is inevitably a pronounced temperature gradient along tubular flow reactors, limiting their use to polymerization processes which are largely unaffected by variations in temperature, other than a change in polymerization rate, such as the living cationic ring-opening polymerization of 2-oxazolines. Alternatively, a continuously stirred tank reactor design can be combined with microwave heating to limit the temperature gradient throughout the reactor. However, such reactors lead to broader residence time distribution profiles, directly leading to broader molar mass distributions. Therefore, besides upscaling via continuous flow microwave reactors, the use of conventionally heated (micro)flow reactors could also be considered as these have fast heating and homogeneous temperature profiles comparable to small-scale microwave batch reactors.

At this stage, most progress has been made in upscaling via microwave batch reactors, enabling up to 20-L polymerizations to be performed. It would, however, be too premature to draw a general conclusion on the preferred upscaling route. Nonetheless, there should be an in-depth case-by-case evaluation as to whether the use of microwave-assisted heating is justified for upscaling a certain polymerization process, both with regard to attainable products as well as economic viability, taking into account the investment costs and energy efficiency.

**Acknowledgement** RH acknowledges continuing support from Ghent University and the FWO Flanders.

## References

1. Hayes BL (2002) Microwave synthesis: chemistry at the speed of light. CEM, Matthews
2. Kappe CO, Stadler A (2005) Microwaves in organic and medicinal chemistry. Wiley, Weinheim
3. Leadbeater NE (2014) Microwave-assisted synthesis: general concepts. *Adv Polym Sci.* **10**. [1007/12\\_2013\\_274](#)
4. Kappe CO (2004) Controlled microwave heating in modern organic synthesis. *Angew Chem Int Ed* **43**:6250–6284
5. De la Hoz A, Diaz-Ortiz A, Moreno A (2005) Microwaves in organic synthesis. Thermal and non-thermal microwave effects. *Chem Soc Rev* **34**:164–178
6. Kappe CO, Pieber B, Dallinger D (2013) Microwave effects in organic synthesis: myth or reality? *Angew Chem Int Ed* **52**:1088–1094
7. Dudley GB, Richert R, Stiegman AE (2015) On the existence of and mechanism for microwave-specific reaction rate enhancement. *Chem Sci* **6**:2144–2152
8. Wiesbrock F, Hoogenboom R, Schubert US (2004) Microwave-assisted polymer synthesis: state-of-the-art and future perspectives. *Macromol Rapid Commun* **25**:1739–1764
9. Hoogenboom R, Schubert US (2007) Microwave-assisted polymer synthesis: recent developments in a rapidly expanding field of research. *Macromol Rapid Commun* **28**:368–386
10. Ebner C, Bodner T, Stelzer F, Wiesbrock F (2011) One decade of microwave-assisted polymerizations: quo vadis? *Macromol Rapid Commun* **32**:254–288
11. Kempe K, Becer CR, Schubert US (2011) Microwave-assisted polymerizations: recent status and future perspectives. *Macromolecules* **44**:5825–5842



12. Mallakpour S, Zadehnazari A (2013) Microwave-assisted step-growth polymerizations (from polycondensation to C–C coupling). doi:10.1007/12\_2013\_275
13. Fang L, Han G, Zhang H (2015) Microwave-assisted free radical polymerizations. doi:10.1007/12\_2013\_276
14. Reynaud S, Grassl B (2015) Microwave-assisted controlled radical polymerization. doi:10.1007/12\_2014\_302
15. Fimberger M, Wiesbrock F (2015) Microwave-assisted synthesis of polyesters and polyamides by ring-opening polymerization. doi:10.1007/12\_2014\_293
16. Luef KP, Hoogenboom R, Schubert US, Wiesbrock F (2015) Microwave-assisted cationic ring-opening polymerization of 2-oxazolines. doi:10.1007/12\_2015\_340
17. Englert C, Schwenke AM, Hoepfener S, Weber C, Schubert US (2015) Microwave-assisted polymer modifications. doi:10.1007/12\_2015\_347
18. Bogdal D, Bednars S, Matras-Postolek K (2015) Microwave-assisted synthesis of hybrid polymer materials and composites. doi:10.1007/12\_2014\_296
19. Achilias DS (2014) Polymer degradation under microwave irradiation. doi:10.1007/12\_2014\_292
20. Perio B, Dozias MJ, Hamelin J (1998) Ecofriendly fast batch synthesis of dioxolanes, dithiolanes, and oxathiolanes without solvent under microwave irradiation. *Org Process Res Dev* 2:428–430
21. Cléophas J, Liagre M, Loupy A, Petit A (2000) Application of focused microwaves to the scale-up of solvent-free organic reactions. *Org Process Res Dev* 4:498–504
22. Stadler A, Pichler A, Horeis G, Kappe CO (2002) Microwave-enhanced reactions under open and closed vessel conditions. A case study. *Tetrahedron* 58:3177–3183
23. Deetlefs M, Seddon KR (2003) Improved preparations of ionic liquids using microwave irradiation. *Green Chem* 5:181–186
24. Lehmann F, Pilotti A, Luthman K (2003) Efficient large scale microwave assisted Mannich reactions using substituted acetophenones. *Mol Divers* 7:145–152
25. Arvela RA, Leadbeater NE, Collins MJ Jr (2005) Automated batch scale-up of microwave-promoted Suzuki and Heck coupling reactions in water using ultra-low metal catalyst concentrations. *Tetrahedron* 61:9349–9355
26. Loones KTJ, Maes BUW, Rombouts G, Hostyn S, Diels G (2005) Microwave-assisted organic synthesis: scale-up of palladium-catalyzed aminations using single-mode and multi-mode microwave equipment. *Tetrahedron* 61:10338–10348
27. Erdmenger T, Paulus RM, Hoogenboom R, Schubert US (2008) Scaling-up the synthesis of 1-butyl-3-methylimidazolium chloride under microwave irradiation. *Aust J Chem* 61:197–203
28. Esveld E, Chemat F, Van Haveren J (2000) Scale continuous microwave dry-media reactor – part II: application to waxy esters production. *Chem Eng Technol* 23:429–435
29. Marquié J, Salmoria G, Poux M, Laporterie A, Dubac J, Roques N (2001) Acylation and related reactions under microwaves. 5. Development to large laboratory scale with a continuous-flow process. *Ind Eng Chem Res* 40:4485–4490
30. Shieh WC, Dell S, Repic O (2001) 1,8-Diazabicyclo[5.4.0]undec-7-ene (DBU) and microwave-accelerated green chemistry in methylation of phenols, indoles, and benzimidazoles with dimethyl carbonate. *Org Lett* 3:4279–4281
31. Pillai UR, Sahlé-Demessie E, Varma RS (2004) Hydrodechlorination of chlorinated benzenes in a continuous microwave reactor. *Green Chem* 6:295–298
32. Moseley JD, Lenden P, Lockwood M, Ruda K, Sherlock JP, Thomson AD, Gilday JP (2008) A comparison of commercial microwave reactors for scale-up within process chemistry. *Org Process Res Dev* 12:30–40
33. Veggi PC, Martinez J, Meireles MAA (2013) Fundamentals of microwave extraction. In: Chemat F, Crovotto G (eds) *Microwave-assisted extraction for bioactive compounds: theory and practice*, vol 4, Food engineering series. Springer, New York
34. Nakamura T, Nagahata R, Suemitsu S, Takeuchi K (2010) In-situ measurement of microwave absorption properties at 2.45 GHz for the polycondensation of lactic acid. *Polymer* 51:329–333

35. You LS, Wu HQ, Zhang WM, Fu Z, Shen LJ (2001) Preparation and stabilization of emulsifier-free macromolecule nanoparticle latex particles. *Chin J Chem* 19:814–816
36. Hoogenboom R, Paulus RM, Pilotti A, Schubert US (2006) Scale-up of microwave-assisted polymerizations in batch mode: the cationic ring-opening polymerization of 2-ethyl-2-oxazoline. *Macromol Rapid Commun* 27:1556–1560
37. Wiesbrock F, Hoogenboom R, Abeln CH, Schubert US (2004) Single-mode microwave ovens as new reaction devices: accelerating the living polymerization of 2-ethyl-2-oxazoline. *Macromol Rapid Commun* 25:1895–1899
38. Petit C, Luef KP, Edler M, Griesser T, Kremsner JM, Stadler A, Grassl B, Reynaud S, Wiesbrock F (2015) Microwave-assisted syntheses in recyclable ionic liquids: photoresists based on renewable resources. *ChemSusChem* 8:3401–3404
39. Pawluczyk JM, McClain RT, Denicola C, Mulhearn JJ, Rudd DJ, Lindsley CW (2007) Microwave-initiated living free radical polymerization: optimization of the preparative scale synthesis of Rasta resins. *Tetrahedron Lett* 48:1497–1501
40. Xu Q, Zhang C, Cai S, Zhu P, Liu L (2010) Large-scale microwave-assisted ring-opening polymerization of  $\epsilon$ -caprolactone. *J Ind Eng Chem* 16:872–875
41. Li H, Liao L, Liu L (2007) Kinetic investigation into the non-thermal microwave effect on the ring-opening polymerization of  $\epsilon$ -caprolactone. *Macromol Rapid Commun* 28:411–416
42. Nakamura T, Nagahata R, Kunii K, Soga H, Sugimoto S, Takeuchi K (2010) Large-scale polycondensation of lactic acid using microwave batch reactors. *Org Process Res Dev* 14:781–786
43. Moseley JD, Kappe CO (2011) A critical assessment of the greenness and energy efficiency of microwave-assisted organic synthesis. *Green Chem* 13:794–806
44. Paulus RM, Erdmenger T, Becer CR, Hoogenboom R, Schubert US (2007) Scale-up of microwave-assisted polymerizations in continuous-flow mode: cationic ring-opening polymerization of 2-ethyl-2-oxazoline. *Macromol Rapid Commun* 28:484–491
45. Diehl C, Laurino P, Azzouz N, Seeberger PH (2010) Accelerated continuous flow RAFT polymerization. *Macromolecules* 43:10311–10314
46. Baeten E, Verbraeken B, Hoogenboom R, Junkers T (2015) Continuous poly(2-oxazoline) triblock copolymer synthesis in a microfluidic reactor cascade. *Chem Commun* 51:11701–11704

# Polymer Degradation Under Microwave Irradiation

Dimitris S. Achilias

**Abstract** Development of advanced, environmentally friendly and energy-saving techniques for the chemical recycling of polymers is of paramount importance in the polymer industry. Understanding polymer degradation is the scientific key behind this technological challenge. Recent research on the application of microwave irradiation to polymer degradation is presented in this review. Results have shown the potential advantage of microwaves for complete polymer degradation in a significantly reduced time scale compared with conventional heating. The benefits of using microwave irradiation in the degradation of polyesters [e.g. poly(ethylene terephthalate) and polycarbonate], polyurethanes, polyamides, poly[alkyl (meth)acrylates], polystyrene and other polymers is presented. Moreover, the effect of microwave heating on the pyrolysis of commodity polymers such as polyethylene, is also discussed. Finally, the double role of materials used traditionally as solvents, reagents or catalysts, but now also as microwave absorbers in polymer degradation is explored.

**Keywords** Chemical recycling · Microwave irradiation · Polymer degradation · Pyrolysis · Solvolysis

## Contents

1	Introduction .....	310
2	Microwave-Assisted Chemical Degradation of Polymers .....	312
2.1	Poly(ethylene terephthalate) .....	312
2.2	Polycarbonate .....	326
2.3	Polyurethanes .....	330
2.4	Polyamides .....	332
2.5	Poly[alkyl (meth)acrylate]s and Polystyrene .....	334
2.6	Other Polymers .....	336

---

D.S. Achilias (✉)

Department of Chemistry, Aristotle University of Thessaloniki, Thessaloniki, Greece

e-mail: [axilias@chem.auth.gr](mailto:axilias@chem.auth.gr)

3 Microwave-Assisted Pyrolysis of Polymers .....	340
Conclusions .....	342
References .....	343

## Abbreviations

AIBN	2,2'-Azobisisobutyronitrile
DEG	Diethylene glycol
DSC	Differential scanning calorimetry
EG	Ethylene glycol
HDPE	High-density polyethylene
LDPE	Low-density polyethylene
MW	Microwave
PBMA	Poly(butyl methacrylate)
PC	Polycarbonate
PEG	Poly(ethylene glycol)
PEMA	Poly(ethyl methacrylate)
PET	Poly(ethylene terephthalate)
PG	Propylene glycol
PMMA	Poly(methyl methacrylate)
PP	Polypropylene
PS	Polystyrene
PTC	Phase transfer catalyst
TGA	Thermogravimetric analysis
TOMAB	Trioctyl methyl ammonium bromide
TPA	Terephthalic acid

## 1 Introduction

During the last few decades, the great population increase worldwide together with the need of people to adopt improved living conditions have led to a dramatic increase in the production and consumption of plastics (consisting of polymeric materials). Because the duration of life for a large number of polymer applications is very small (usually less than 1 month), there is a vast waste stream each year that is creating a serious environmental problem. Recently, strict legislation rules accompanied by the rising cost and poor biodegradability of most plastics have made disposing of the wastes to landfill undesirable. Therefore, recycling seems to be the best solution. The major driving force in today's recycling projects is not only to re-use the materials but also to produce secondary value-added products, thus reducing the consumption of natural resources and the amount of energy needed, while lowering CO<sub>2</sub> emissions in the environment. Understanding and controlling polymer degradation is the scientific key behind any successful polymer

recycling attempt. Nowadays, the investigation of new energy-efficient solutions for recycling processes of different plastic materials involves the application of microwave irradiation and other unconventional techniques for performing chemical degradation reactions. The recycling processes usually demand heating of the materials and, therefore, use of microwaves is an excellent alternative to conventional thermal heating because it offers increased reaction rates, lower reaction times and energy savings [1, 2].

In conventional heating, actual heating of the material begins when the furnace cavity reaches the predefined temperature. In contrast, using microwave irradiation the material is at a higher temperature than the surrounding area. Consequently, microwave heating favours devolatilization or heterogeneous reactions involving the solid materials, whereas conventional heating improves homogeneous reactions in the gas-phase. Additionally, undesirable side reactions can be avoided because of the lower temperatures employed in the microwave cavity [3].

Specific advantages of microwave irradiation as a heating technique compared with conventional heating include rapid heating with high specificity and without contact with the material to be heated, shorter reaction times, great convenience and significant overall cost saving. All these have made the use of microwaves a popular technique for heating materials in several processing techniques with many research and industrial applications [4]. The efficiency of microwave-assisted heating in different solvents has been recently addressed by Hoogenboom et al. [5, 6].

Normally, polymers have poor dielectric properties, being unable to absorb enough microwave energy to achieve the temperature necessary for degradation. Consequently, the use of a “microwave receptor”, also called microwave absorbing dopant or antenna, is necessary [3]. Therefore, the challenge is to use such a material (also acting as a reagent, solvent or catalyst) to absorb the incident microwaves and transmit the energy to the embedded target via short-range conduction. Different types of microwave receptors can be used, such as inorganic substances with conduction electrons, e.g. activated carbon, char and graphite [3].

In the following section, two different polymer degradation categories are distinguished. In the first, chemical reagents, solvents, catalysts, etc. are used to carry out the degradation of the polymer. This method is applicable to polymers with characteristic chemical groups (such as polyesters, polycarbonates, polyurethanes and polyamides) in their backbone structure. In the second approach, the polymer is heated in the absence of oxygen (pyrolysis), adding only a microwave absorber. This latter technique finds uses for polymers without characteristic chemical groups in the main macromolecular chain (such as LDPE, HDPE, PP, PMMA, PS, etc.). This review covers research carried out mainly during the last 5 years. For reviews on earlier publications one could consult the very informative works of Bogdal et al. [4], Bogdal and Prociak [1] and Fernandez et al. [3].

## 2 Microwave-Assisted Chemical Degradation of Polymers

### 2.1 Poly(ethylene terephthalate)

Poly(ethylene terephthalate) (PET) is a well-known engineering thermoplastic polyester showing excellent physical (e.g. transparency), thermal (high melting point, etc.) and mechanical (high strength, etc.) properties. Its main area of applications include food packaging (bottles for water and soft-drinks), the textile industry (carpets, T-shirts, etc.) and X-ray films. Although it is a non-toxic material, it implicitly contributes to the environmental pollution problem by the large amount of PET wastes that reach the final recipients each year. Therefore, recycling of PET wastes is necessary. The development of PET chemical recycling methods has boosted the research on the degradation of this polymer.

The chemical degradation processes for PET are divided according to the reagent used, as follows (Scheme 1) [7]:

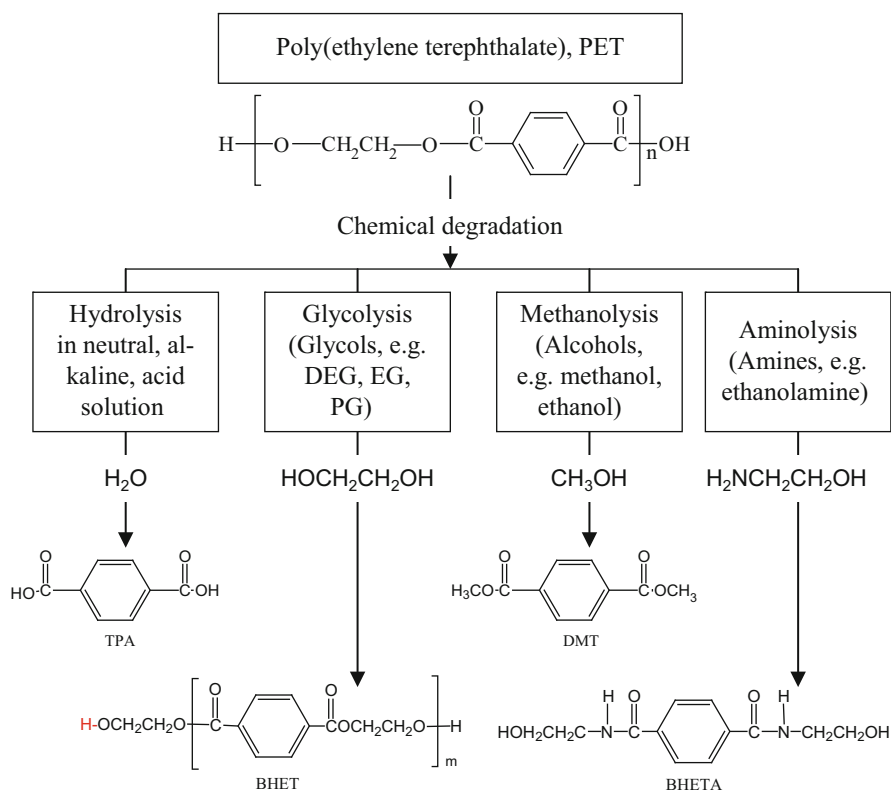

**Scheme 1** Methods for the chemical degradation of PET

1. Hydrolysis: Reaction with water in an acid, alkaline or neutral environment to produce the monomers terephthalic acid (TPA) and ethylene glycol (EG)
2. Glycolysis: Reaction with a glycol, such as ethylene glycol, diethylene glycol or propylene glycol to give bis(hydroxyalkyl) terephthalate, which is a substrate for synthesis of PET and other oligomers
3. Methanolysis: Degradation by methanol, with the main products being dimethyl terephthalate (DMT) and EG
4. Aminolysis: Reaction with an amine (e.g. ethanolamine) to produce secondary value-added compounds such as bis(2-hydroxyethyl) terephthalamide (BHETA)
5. Other processes (ammonolysis, etc.)

The need to carry out the chemical recycling of PET by environmentally friendly, energy-efficient and economic methods has led to the investigation of the effect of microwave irradiation on all these degradation techniques. Therefore, in recent years, studies on the effect of microwave irradiation on polymer degradation have most often been carried out using PET. A brief survey of the methods reported in the literature is reported next. Presentation is given according to the groups that studied the degradation rather than the particular method used.

Among the first to study PET depolymerization under microwave irradiation was Krzan [8, 9]. Degradation experiments in a closed system were carried out in a microwave oven. The reagents (solvents) used were methanol, propylene glycol (PG) and poly(ethylene glycol) 400 (PEG 400), with zinc acetate as catalyst. Methanol was found to result in complete PET degradation in the shortest time (i.e. only 4 min), followed by PG. More than 8 min was required in PEG 400 [8].

In a subsequent study, the author studied glycolysis of PET with diethylene glycol (DEG) or PG using  $\text{NaHCO}_3$ ,  $\text{K}_2\text{CO}_3$ ,  $\text{CaO}$ ,  $\text{KH}_2\text{PO}_4$  and  $\text{NaOCH}_3$  as potential catalysts [9]. Microwave irradiation power was set constant at 500 W and the reaction time was 5 min. The maximum temperatures and pressures detected during the degradation were approximately 240 and 200°C and 100 and 160 kPa for DEG and PG, respectively. Thus, the efficiency of using these basic catalysts during microwave-assisted glycolysis of PET was proved [9].

Also among the first to report on the microwave-assisted depolymerization of PET using basic catalysts were Ikenaga and Oyama [10]. An open microwave oven was used with glycerin and sodium bicarbonate. Quantitative yields of the monomer TPA were recovered at notably short reaction times of few minutes.

Instead of open systems, the group of Zhang [11–13] investigated the hydrolytic depolymerization of PET in a closed microwave reactor equipped with temperature and pressure sensors. Several experimental conditions for the hydrolytic depolymerization of PET were investigated, including the relative amounts of water and PET, microwave power and degradation time. They found that the time needed to reach the set reaction temperature was affected by the microwave irradiation power, whereas its effect on the degree of depolymerization was negligible. When degradation carried out in pure water without any catalyst, complete depolymerization of PET to its monomers, TPA and EG, was achieved within 120 min and the vessel pressure reached 20 bar [11].

**Fig. 1** Effect of irradiation time and temperature on the degree of PET depolymerization during hydrolysis in a microwave reactor with zinc acetate as catalyst. (Reprinted from Li et al. [12] with permission)

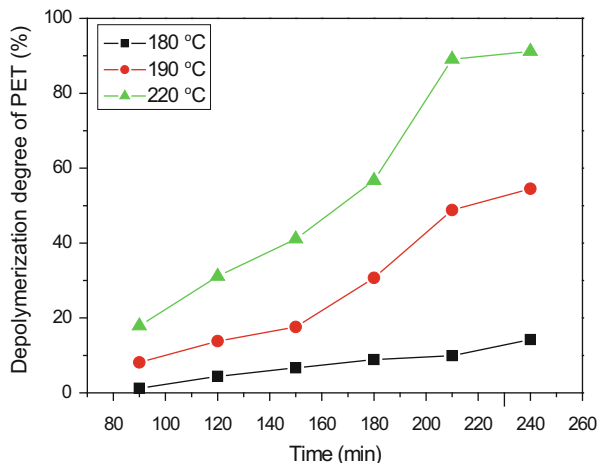

The effect of various catalysts on the depolymerization of PET under microwave irradiation was further investigated by the same group in a series of papers [12–14]. Li et al. [12] studied the effect of  $\text{MnCl}_2$ ,  $\text{NiCl}_2$ ,  $\text{Na}_2\text{C}_2\text{O}_4$ ,  $\text{CoCl}_2$ ,  $\text{Zn}(\text{CH}_3\text{COO})_2$ ,  $\text{CH}_3\text{COOK}$  and  $\text{Mn}(\text{CH}_3\text{COO})_2$  during hydrolysis of PET in a microwave reactor with controlled temperature and pressure. Of all the catalysts used, zinc acetate was testified as the most effective at an optimum amount of 0.4% relative to PET. Using this catalyst, further experiments were carried out at different temperatures and reaction times. As shown in Fig. 1, near complete depolymerization takes place at 220°C after 210 min of irradiation. The viscosity average molecular weight of the degraded PET was also measured using intrinsic viscosity. A dramatic decrease with the reaction time was obvious [13].

In addition, several metal oxides (including  $\text{Sb}_2\text{O}_3$ ,  $\text{MgO}$ ,  $\text{ZnO}$ ,  $\text{Fe}_2\text{O}_3$ ,  $\text{TiO}_2$ ,  $\text{Gr}_2\text{O}_3$ ,  $\text{MnO}_2$ ,  $\text{SnO}$  and  $\text{Cu}_2\text{O}$ ) were employed by the same group of authors to investigate their effect on the hydrolytic depolymerization of PET [14]; the degradation achieved using these catalysts, was 81.6, 77.7, 75.9, 84.4, 90.9, 79.3, 65.8, 75.4 and 79.3%, respectively. All these values were significantly larger than that obtained without using a catalyst, i.e. 59.3%. It was thus verified that metal oxides act as microwave receptors and can be used to facilitate the degradation reaction. The most effective catalyst, improving the depolymerization degree of PET by almost 32% compared with the noncatalytic reaction, was found to be stannous oxide (SnO).

The effect of the SnO catalyst on the depolymerization rate of PET at several reaction temperatures is illustrated in Fig. 2. It was clear that at reaction temperatures less than 160°C, the degradation of PET was negligible whether using the catalyst or not. The presence of the stannous oxide increased the depolymerization rate of PET compared with the noncatalytic reaction by 1.9, 9.1, 33.4 and 48.5% at 170, 180, 190 and 200°C, respectively. Thus, it was shown that the catalytic effect of stannous oxide was greatly influenced by the reaction temperature and improved with increasing temperature [14].



**Fig. 2** Effect of reaction temperature on the degree of PET depolymerization at 180 min reaction time and weight ratio of water to PET of 10:1. (Reprinted from Song et al. [14] with permission)

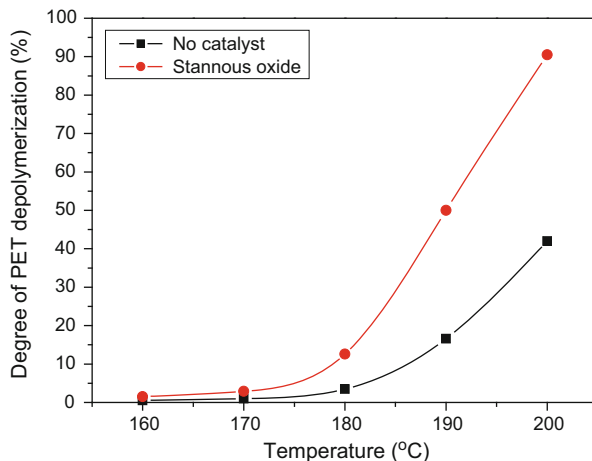

More research work was carried out at the same experimental conditions by the senior researcher and collaborators, revealing that:

1. The stronger the acidity or basicity of a metal oxide, the better the effect on the depolymerization of PET [15]
2. Super-acids, such as  $\text{SO}_4^{2-}/\gamma\text{-Al}_2\text{O}_3$  show good catalytic activity [16, 17]
3. Composite metal oxides, such as  $\text{ZnSrO}_2$  or  $\text{ZnO.SrO}$ , lead to a 93% degradation of PET at 180°C [18, 19]
4.  $\text{ZnSO}_4$ , among different sulfates, presents the best catalysis under 250 W microwave irradiation [20], with depolymerization occurring simultaneously on the surface and the internal part of PET chips [21]

Nikje and Nazari [22] used microwave irradiation during a hybrid hydro-solvolytic depolymerization of PET with alcohols such as methanol, ethanol, butanol, 1-pentanol and hexanol. Reactions were performed at short times (less than 1 h), with the main products being TPA and EG. Use of KOH was found to facilitate the reaction and, of the alcohols, 1-pentanol needed the least time (3 min) to result in more than 87% PET degradation. Repeating similar experiments under conventional heating, it was found that the time needed for PET degradation was almost 30 min. As well as alcohols, in subsequent research [23] the authors used glycols (i.e. DEG and EG) together with KOH or NaOH as catalysts, and the results were compared with those using conventional heating. Significant enhancement of the reaction rates in the microwave-assisted experiments was measured in comparison with experiments using conventional heating.

Another group that investigated the microwave-assisted depolymerization of PET by a number of different chemical degradation methods was that of Shukla and collaborators [24–28]. Pingale and Shukla [24] used a modified microwave oven to carry out glycolysis of PET taken from waste bottles, using EG in the presence of  $\text{Na}_2\text{C}_2\text{O}_4$ ,  $\text{Zn}(\text{CH}_3\text{COO})_2$ ,  $\text{Na}_2\text{CO}_3$  and BaOH catalysts under reflux. The virtual monomer bis(2-hydroxyethyl) terephthalate (BHET) was recovered. It

was observed that under identical conditions of catalyst concentration and PET to EG ratio, the yield of BHET was nearly the same as that obtained by conventional heating. However, substantial energy-saving was achieved because the time needed for complete degradation was reduced from 8 h to 35 min.

In a subsequent publication [25], these authors reported on the microwave-assisted aminolysis of PET with ethanolamine. The reaction was carried out under reflux (i.e. temperature 170°C) with the microwave oven power set to 700 W. Using microwave energy, pure BHETA was obtained in yields greater than 90% at a low reaction time (4 min) using common catalysts. Similar results were also obtained when hydrazine monohydrate was used for the aminolysis of PET, resulting in the production of terephthalic dihydrazide [26]. Compared with results obtained when carrying out the same reaction under conventional heating, it was found that the time required to obtain the same degree of degradation reduced from 4 h to 10 min under microwave irradiation [26]. Aminolytic depolymerization of PET was further investigated by Shah and Shukla [27] using other types of amines such as 2-amino-2-methyl-1-propanol and 1-amino-2-propanol under atmospheric conditions in the presence of  $\text{Zn}(\text{CH}_3\text{COO})_2$  or  $\text{CH}_3\text{COONa}$  as catalysts. The virtual products obtained in pure form and good yields were, respectively, bis(1-hydroxy-2-methylpropan-2-yl) terephthalamide (BHMPA) and bis(2-hydroxypropyl) terephthalamide (BHIPTA). The latter was subjected to cyclization using thionyl chloride under low-temperature conditions to obtain 1,4-bis(5-methyl-4,5-dihydrooxazol-2-yl) benzene (P BIOXA) (Scheme 2), which is used as chain extender in polyester and nylon compositions and as a crosslinking agent in powder paint compositions. The use of microwave irradiation compared with conventional heating drastically reduced the reaction time from 3 h to 5 min while keeping the same yield (higher than 84% for BHIPTA) and purity of the reactive monomers [27].

Recently, the same group [28] published a study on the use of microwave irradiation during aminolysis of PET with 3-amino-1-propanol, aiming at the production of a secondary value-added compound such as bis(3-hydroxypropyl) terephthalamide, which can be converted to bis-oxazin for use as a chain extender or crosslinking agent. The percentage recoveries were almost the same comparing microwave with conventional heating, whereas the time needed for degradation was shortened from 1–6 h using conventional heating to 1–9 min under microwave irradiation.

The glycolysis of PET with DEG under microwave irradiation in a pilot plant scale (i.e. using 0.2 kg of PET flakes) was investigated by Bogdal et al. [1]. Low percentage ratios of DEG to PET (in the range 0.5–2) were used in order to achieve complete conversion of the glycol, thus avoiding the use of additional purification of the recyclates. The degradation temperature was up to 230–240°C, and a reaction time of 25–30 min was adequate. From measurements of the full molecular weight distribution of the recyclates, four distinct fractions having number-average molecular weights of approximately 1,110, 835, 575, and 106 g/mol were identified. An increase in the weight ratio of DEG to PET resulted in an increase in the higher molecular weight fractions (i.e. 1,110 and 835 g/mol), while the 335 g/mol fraction

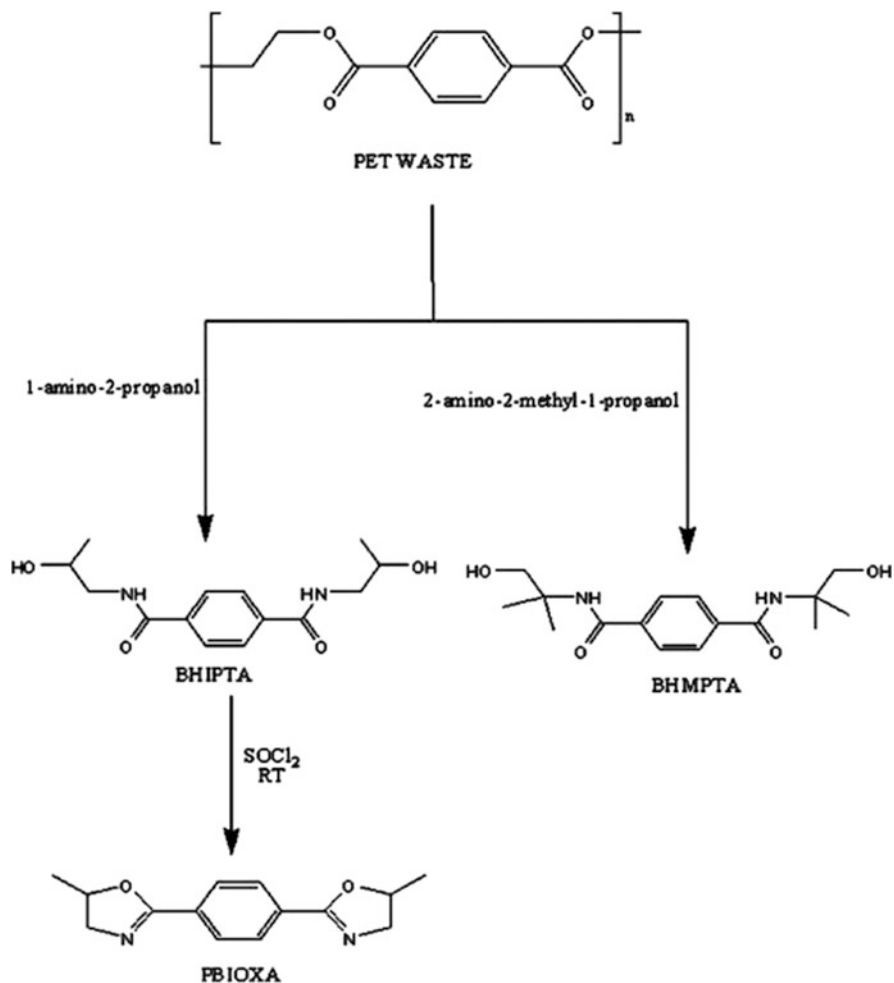

**Scheme 2** Aminolysis of PET waste and preparation of PBIOXA. *BHMPTA* bis(1-hydroxy-2-methylpropan-2-yl) terephthalamide, *BHIPTA* bis(2-hydroxypropyl) terephthalamide, *PBIOXA* 1,4-bis(5-methyl-4,5-dihydrooxazol-2-yl) benzene. (Reprinted from Shah and Shukla [27] with permission)

was reduced substantially. Optimization of the process experimental conditions resulted in the following values: reaction temperature 230–240°C, microwave irradiation for 30 min in the presence of 0.5 wt% catalyst [1].

Degradation of PET in a microwave reactor was also examined by the group of Achilias and collaborators using four different chemical reagents [29–32]. Initially, hydrolytic depolymerization in an alkaline solution was investigated [29]. The reaction apparatus consisted of a sealed microwave reactor with facilities for on-line recording of the mixture temperature and pressure. Microwave irradiation was found to significantly reduce the time needed to achieve a specific degradation

**Fig. 3** Effect of phase-transfer catalyst type on the terephthalic acid (TPA) yield versus depolymerization time during alkaline hydrolysis of PET at 90°C, with 5 wt% NaOH under microwave irradiation. (Reprinted from Siddiqui et al. [29] with permission)

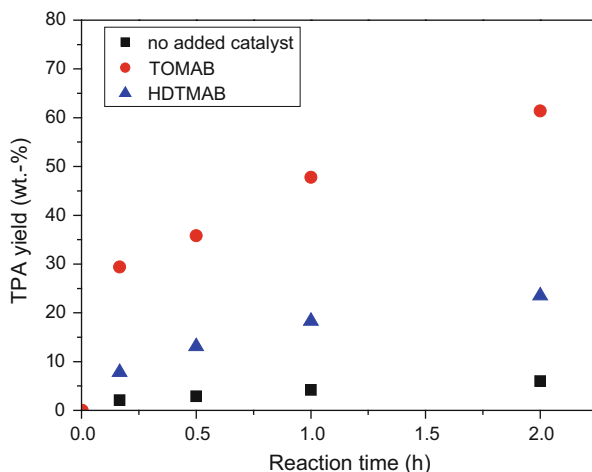

of PET, with almost complete depolymerization occurring in 30 min at 180°C and only 46 W of microwave power. Furthermore, addition of the phase transfer catalyst (PTC) trioctyl methyl ammonium bromide (TOMAB) resulted in achieving the same degradation of PET at a significantly lower depolymerization temperature. At the same reaction time (120 min), use of TOMAB resulted in a tenfold increase in the percentage of TPA recovered, compared with the uncatalyzed reaction. A lower increase (fourfold) in the amount of TPA recovered was measured when another PTC, i.e. hexadecyl trimethyl ammonium bromide (HDTMAB), was used. A comparison of the effect of different PTCs on the TPA yield appears in Fig. 3. The role of the PTC was to carry the hydroxide ion into the surface of the solid-organic phase, resulting in easier attack of the PET macromolecules and thus leading to depolymerization. The product (i.e. the monomer TPA) was obtained in such a pure state that it could be re-polymerized to form PET again.

A work similar to that of Siddiqui et al. [29] on the microwave-assisted hydrolysis of PET in an alkaline solution using a PTC was also presented by Khalaf and Hasan [33]. The effect of NaOH concentration, PET particle size, PTC and time on the TPA yield was investigated. Tetrabutyl ammonium iodide was used as a PTC at 200 or 400 W microwave power. Optimal degradation conditions were found at 10% NaOH solution, 60 min irradiation time and 3% of PTC, but microwave power did not seem to influence the results much.

Subsequently, glycolysis of PET with DEG was investigated in a microwave reactor [30]. The main degradation product, analyzed and identified by Fourier transform infrared (FTIR) spectroscopy, was an oligoester diol. From gel permeation chromatography (GPC) measurements, a decrease in the PET residue average molecular weight with the percentage of PET degradation was observed. Two different types of experiments were carried out at several time steps: in the first set, the reaction temperature remained constant, and in the second set, microwave power was applied. In the constant temperature experiments, it was clear that no

**Fig. 4** Effect of depolymerization temperature on the amount of PET reacted with time during microwave-assisted PET glycolysis. *Discrete points* refer to experimental data and *continuous lines* to the results of the simulation model. (Reprinted from Achilias et al. [30] with permission)

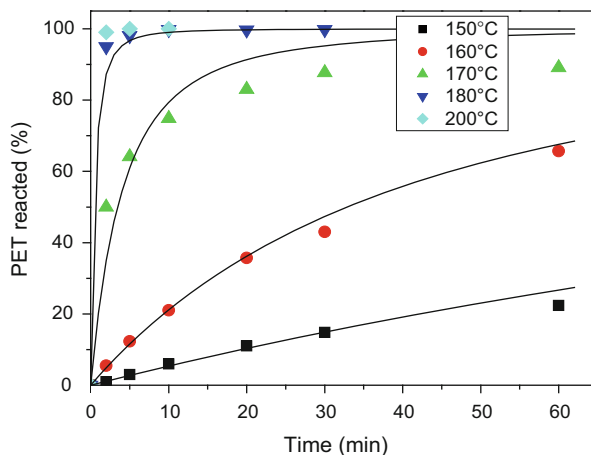

**Fig. 5** Effect of irradiation power on the variation of reactor temperature with time during PET glycolysis. (Reprinted from Achilias et al. [30] with permission)

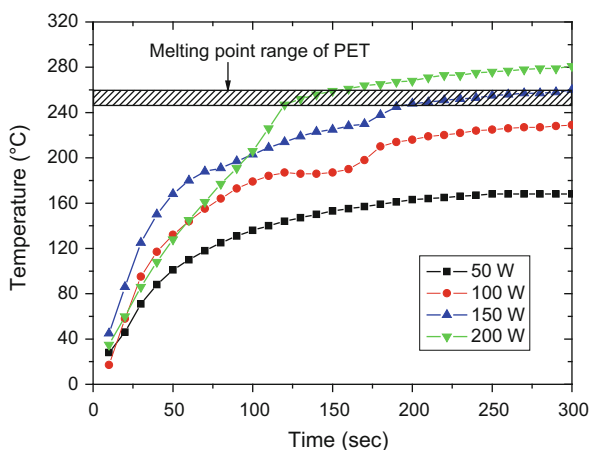

degradation occurs at temperatures below 150°C, whereas complete depolymerization takes place at temperatures greater than or equal to 180°C for 5 min (Fig. 4). These results, compared with those using conventional heating where more than 4 h was needed for complete PET degradation, confirm the importance of the microwave power technique and the substantial energy saving achieved.

In the second set of experiments, the power of the microwaves remained constant and it was found that only 2 min of irradiation was adequate for complete depolymerization at irradiation powers of 150 or 200 W, which increased to 5 or 10 min at 100 or 50 W, respectively. The particular microwave device also provided continuous measurement of temperature with time, as illustrated in Fig. 5. A sharp increase in temperature was observed during the first few minutes, followed by a further increase but with a lower slope, indicating that prolonging irradiation time results in a relatively small temperature increase. The final temperatures reached were 170, 230, 260 and 280°C for irradiation at 50, 100, 150 and 200 W,

**Fig. 6** Effect of irradiation power on the variation of reactor pressure with time during PET glycolysis. (Reprinted from Achilias et al. [30] with permission)

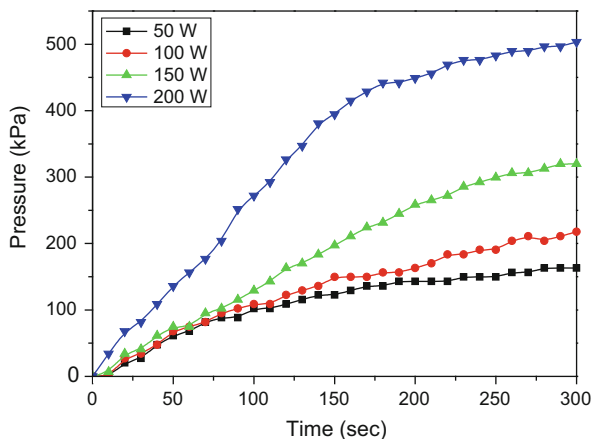

respectively. Because the melting point of PET is in the range of 250–260°C, the measurements showed that above 150 W, PET remains in a molten state after a few minutes. This is the main reason explaining complete degradation of PET after 2–3 min, because diffusional limitations between the solid phase of PET and the liquid DEG are overcome. At lower microwave powers (i.e. 50 W), the reaction is carried out with PET in the solid state, with much slower rates. In addition, pressure was found to continuously increase with time and was affected by the microwave power applied (Fig. 6). The final values reached were 165, 220, 324 and 510 kPa for irradiation at 50, 100, 150 and 200 W, respectively. It was clear that high microwave powers result in a great increase in pressure, whereas at 50 W the final value is only slightly above 1 atm.

Aminolytic depolymerization of PET with ethanolamine under microwave irradiation and without the use of any catalyst was investigated by Achilias et al. [31]. Experiments under constant microwave power or reactor temperature were performed. In the experiments carried out under constant microwave power, it was observed that complete depolymerization occurred in 5 min at 100 W, which decreased to 2 min at 150 W. Degradation at lower powers (i.e. 50 W) proceeds at very slow rates, reaching only 16% even after 30 min of irradiation (Fig. 7). Reaction temperature and pressure increased with time (Fig. 8) and at 100 W the melting point of PET was exceeded after only 3 min of reaction. The presence of volatile compounds such as ethanolamine (reagent), EG and water (products) in the reaction mixture resulted in an increase in the reactor pressure, with final values ranging between 380 and 1,015 kPa depending on the power used.

From the constant temperature experiments it was clear that at temperatures below 180°C limited degradation occurs, even after 60 min of irradiation time, whereas complete depolymerization occurs at temperatures greater than or equal to 260°C for only 5 min (Fig. 9).

The main product of PET aminolysis with ethanolamine was BHETA, identified by FTIR and differential scanning calorimetry (DSC) measurements, whereas gel permeation chromatography (GPC) was used to measure the average molecular

**Fig. 7** Percentage of PET degradation with depolymerization time during aminolysis of PET with ethanolamine under constant microwave power irradiation. (Reprinted from Achilias et al. [31] with permission)

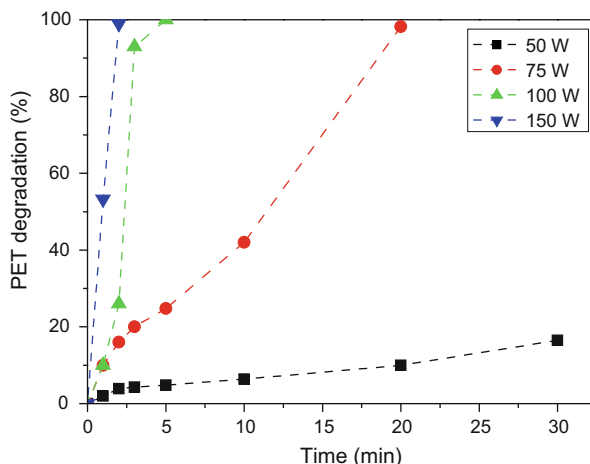

**Fig. 8** Variation of reaction temperature, microwave power and pressure with time during PET aminolysis under microwave irradiation at a constant power of 100 W. (Reprinted from Achilias et al. [31] with permission)

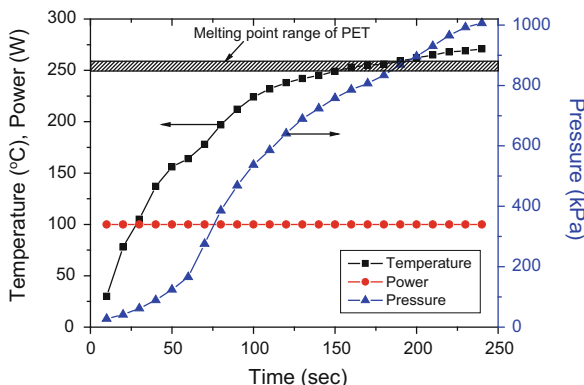

weight of PET residues. The molecular weight of the residues was found to decrease with the percentage of PET degradation, denoting a random chain scission mechanism to some extent (Table 1).

The next technique investigated for the degradation of PET under microwave irradiation was that of methanolysis carried out with methanol, with and without the use of zinc acetate as catalyst, in a sealed laboratory-scaled microwave reactor [32]. The main product, identified by FTIR and DSC measurements, was the monomer dimethyl-terephthalate. High degrees of depolymerization were measured at temperatures near 180°C and microwave powers higher than 150 W, whereas degradation was found mostly to occur during the initial 5–10 min and did not change significantly after 30 min of irradiation. Compared with conventional heating, an 80% degradation of PET was reached at 160°C after 30 min of microwave irradiation, whereas 250°C was needed when supercritical methanol was used [32].

At constant power experiments, it was found that at least 150 W was needed in order to achieve a depolymerization of 58.5%. Degradation rate increased with the

**Fig. 9** Effect of temperature on the percentage of PET degradation with depolymerization time during aminolysis of PET with ethanolamine under microwave irradiation. (Reprinted from Achilias et al. [31] with permission)

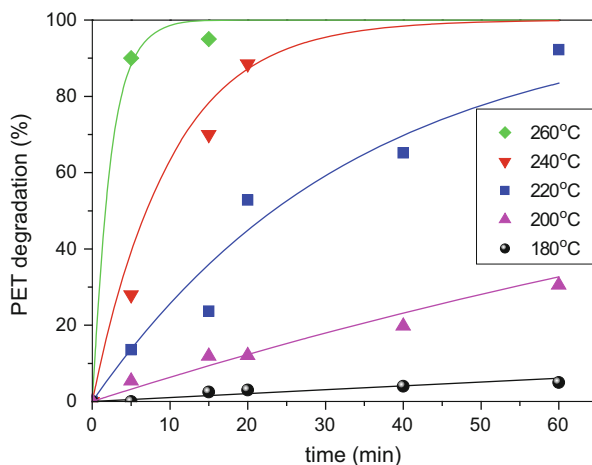

**Table 1** Intrinsic viscosity and number-average molecular weight  $\bar{M}_n$  of selected PET residues at different degrees of degradation, during aminolysis with ethanolamine under microwave irradiation. (Reprinted from Achilias et al. [31] with permission)

Sample	Microwave power (W)	Temperature (°C)	Time (min)	Degree of degradation of PET (%)	Intrinsic viscosity (dL/g)	$\bar{M}_n$
PET	–	–	–	–	0.79	22,930
Oligomer	50	–	30	17	0.24	3,650
Oligomer	–	220	15	24	0.22	3,230
Oligomer	75	–	10	42	0.20	2,680
Oligomer	150	–	1	53	0.18	2,340
Oligomer	–	220	40	65	0.15	1,770

microwave power. From on-line measurements of the reaction temperature with time at several constant microwave powers, it was clear that temperature initially significantly increased with time but later the increase was smaller (Fig. 10). This is attributed to the continuous supply of constant microwave power to the system. The final temperature values were strongly dependent on the power used and ranged between 120 and 194°C at 80 and 200 W, respectively. Therefore, the low degradation of PET measured at 80 W was due to the rather low temperature achieved in the reaction medium.

Comparing the effect of the reagent used on the degradation rate of PET achieved under microwave irradiation at the same experimental conditions (i.e. same reactor set-up and a constant temperature of 180°C) revealed that the best results were obtained by glycolysis, followed by hydrolysis and then methanolysis (Fig. 11) [32]. Aminolysis resulted in a low amount of PET degradation, although it should be kept in mind that no catalyst was used in these experiments.



**Fig. 10** Variation of reaction temperature with time during PET methanolysis under microwave irradiation at different constant microwave powers for 10 min. (Reprinted from Siddiqui et al. [32] with permission)

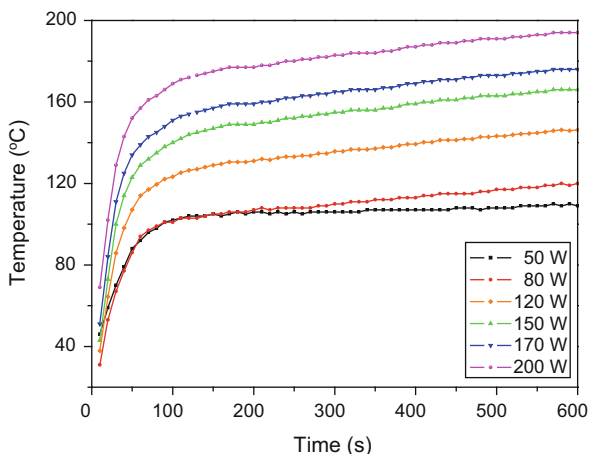

**Fig. 11** Variation of the amount of PET reacted with time during PET hydrolysis, glycolysis, aminolysis and methanolysis under microwave irradiation at 180°C for 60 min. (Reprinted from Siddiqui et al. [32] with permission)

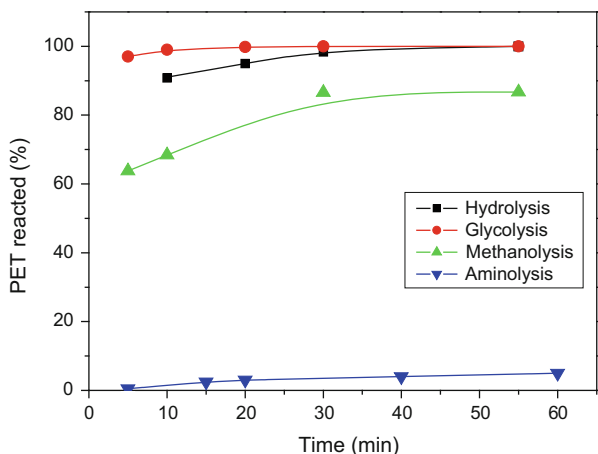

From the experimental data presented in Fig. 11, the importance of the effect of reaction medium during microwave irradiation was very clear. Accordingly, the presence of EG, which presents a high microwave absorbance level [34], can enhance the polymer degradation rate. Therefore, the role of EG (besides acting as the reagent or solvent) as a microwave absorber was verified.

Some other recent works on microwave-assisted PET degradation are presented next.

Glycolysis of PET with excess EG in the presence of zinc acetate catalyst under microwave irradiation was also presented by Chen et al. [35]. It was found that the glycolysis rate was significantly influenced by stirring speed and initial PET particle size. The optimal parameters for higher BHET yield were: temperature 196°C, power 500 W, time 35 min, weight ratio of catalyst to PET 1% and weight ratio of EG to PET 5:1.

PET glycolysis under microwave irradiation was also used for the production of polyurethane foams [36]. Different glycols were used, including EG, DEG and PEG 200, 600, 1,000 and 1,500, with zinc acetate as catalyst. Complete degradation was achieved in almost 30 min, resulting in the production of BHET when the reaction was carried out in the presence of EG. Reactivity of diols was found to decrease with increasing molecular weight. Moreover, when the trifunctional glycerol was used functionalized polyols were prepared, which can be further used for the production of polyurethane foams. These possessed cells of uniform dimensions and the flexibility of the foam was found to be directly proportional to the molecular weight of the glycol used during PET glycolysis.

The kinetics of PET hydrolytic depolymerization under microwave irradiation was studied by Zhang et al. [37]. Microwave depolymerization was found to occur both in the interior and the exterior of PET simultaneously and involved more than one kinetic process. Depolymerization was divided into at least two stages, before and after random chain scission, with corresponding activation energies of 142 and 378 kJ/mol. These energies were found to be much higher than the activation energy of the conventional thermal depolymerization.

Microwave-assisted nonaqueous glycolysis was carried out under alkali conditions to obtain a PET fabric with a highly hydrophilic surface [38]. The reaction was carried out in a commercial 700 W microwave oven with NaOH (0–5 %w/w) and EG (10:1) at times between 10 and 300 s. The results indicated that the treatment efficacy was mainly determined by the alkali concentration and the irradiation time. Higher PET mass loss (approximately 50%) was achieved at 180 s of irradiation time when the system temperature was raised to 144°C. This glycolysis treatment considerably enhanced the surface hydrophilicity of the treated PET, as indicated by instant wicking, vertical wicking tests and contact angle measurements. At 120 s of irradiation, the treated PET showed instantaneous wetting, even with 0.1% NaOH. Higher alkali concentrations and longer irradiation times increased strength [38]. In order to obtain a balance between high hydrophilicity and desired physical properties, the optimal glycolysis time was found to be 120 s. The benefit of the microwave-assisted modification was to reduce the treatment time from 1–2 h under conventional heating to less than 180 s.

Recently, use of silicon carbide (SiC) as a power modulator under microwave irradiation was used in the degradation of PET [39]. A domestic microwave oven with NaOH was employed by Shafique et al. [39]. Fusion of PET bottle chips with caustic soda was carried out on a clay crucible placed on a SiC slab in a microwave oven. Irradiation lasted for 4 min and the monomer TPA was recovered in pure form. A similar approach and using alcohol instead of caustic soda was used by Liu et al. [40]. The degree of PET degradation achieved after 30 min of microwave irradiation at 700 W and atmospheric pressure, with 60 g/L SiC, was up to 96%. It was thus concluded that as a type of inert and highly reusable power modulator, SiC could improve the transfer efficiency of the microwave energy in PET depolymerization.

Table 2 presents a comparison of methods used by different researchers on the microwave-assisted degradation of PET. The microwave type, the chemical

**Table 2** Methods for microwave-assisted chemical degradation of PET

Authors	Reagent	Catalyst	Microwave type	Power (W)	Temperature (°C)	Pressure (kPa)	Time (min)
Krzan, 1999	methanol, PG, PEG 400	Zinc acetate	Microwave oven (closed system)	400–800	–	–	2–8
Liu et al., 2005	Water	None	Microwave oven (closed system)	200–800	–	1,300–2,000	50–120
Li et al., 2008	Water	MnCl <sub>2</sub> , NiCl <sub>2</sub> , Na <sub>2</sub> C <sub>2</sub> O <sub>4</sub> , CoCl <sub>2</sub> Zn(CH <sub>3</sub> COO) <sub>2</sub> , CH <sub>3</sub> COOK, Mn(CH <sub>3</sub> COO) <sub>2</sub>	Microwave reactor (CEM)	260	220	1,360	210
Song et al., 2010	Water	MgO, Fe <sub>2</sub> O <sub>3</sub> , Gr <sub>2</sub> O <sub>3</sub> , ZnO, SnO, Sb <sub>2</sub> O <sub>3</sub> , TiO <sub>2</sub> , MnO <sub>2</sub>	Microwave reactor (CEM)	250	200	–	210
Nikje, 2006	Methanol, ethanol, butanol, pentanol, hexanol	KOH, NaOH, CH <sub>3</sub> COONa, Zn(CH <sub>3</sub> COO) <sub>2</sub>	Microwave reactor (open system)	500–950	–	–	3–61
Pingale and Shukla, 2008	EG	Na <sub>2</sub> CO <sub>3</sub> , sodium bicarbonate, Ba(OH) <sub>2</sub> , Zn(CH <sub>3</sub> COO) <sub>2</sub>	Microwave oven (reflux)	700	–	–	20–60
Pingale and Shukla, 2009	Ethanol-amine	CH <sub>3</sub> COONa, sodium bicarbonate, Na <sub>2</sub> SO <sub>4</sub>	Microwave oven (reflux)	700	–	–	3–8
Siddiqui et al., 2010	Water	NaOH, TOMAB	Microwave reactor (closed system)	Varied	70–180	–	30–120
Achilias et al., 2011	DEG	Mn(CH <sub>3</sub> COO) <sub>2</sub>	As above	50–200	150–200	170–510	2–60
Tsintzou et al., 2011	Ethanol-amine	–	As above	50–150	180–260	380–1,015	2–60
Siddiqui et al., 2012	Methanol	Zn(CH <sub>3</sub> COO) <sub>2</sub>	As above	50–200	160–200	–	2–60

reagents and catalysts used, together with the range of the experimental conditions (microwave power, temperature, pressure and irradiation time) are included. In general, the type of reagent or catalyst used affects the required degradation time, whereas the experimental conditions affect mainly the composition of the products. Reaction temperatures are in the vicinity of 200°C, lower than those usually used (i.e. near 250°C) in conventional heating. In addition, the time required for complete degradation ranges from a few minutes to almost 2 h, which is much lower than the time required for conventional heating, i.e. 3–5 h. The microwave power used ranged between 50 and 950 W.

## 2.2 Polycarbonate

Polycarbonate (PC) is an important engineering plastic featuring good optical clarity, high impact resistance and ductility at room temperature and below. Because of these attributes, PC is used in a wide variety of applications including electrical and electronic equipment, digital media (e.g. CDs, DVDs), automobiles, glazing in the building and construction industry, sports safety equipment and reusable food and drink containers. A major concern when PC is used as plastic packaging, and especially in baby bottles, is regarding the release of the toxic bisphenol-A (BPA) into the food. Initially, it was believed that it was a remnant from the polymerization procedure, where it is used as a monomer. However, recent studies have shown that BPA is primarily released by degradation of the PC, rather than through migration from the polymer [41].

The increase in the consumption of products based on PC has resulted in increased amounts of this polymer in the waste stream. Therefore, its recycling using some environmentally friendly degradation method is of paramount importance. With this aim, microwave irradiation was employed by Tsintzou et al. [42] to study the chemical recycling of PC in relatively mild experimental conditions that do not require large amounts of chemicals or energy. The method of hydrolysis in an alkaline (NaOH) solution was applied to poly(bisphenol-A carbonate) to depolymerize it into its starting monomer, BPA. It was found that degradation hardly occurs at relatively low temperatures, except if a phase-transfer catalyst (1-hexadecyl trimethyl ammonium bromide) is employed. The combination of irradiation time and NaOH concentration gave similar results, meaning that increased alkaline concentrations require less time. In all conditions, degradation of PC was minimal at temperatures below 110°C (Fig. 12). A significant increase was observed in the region from 130 to 160°C, and degradation values of more than 80% were measured at 170°C. Because the glass transition temperature,  $T_g$ , of PC is near 150°C, it seems that alkaline hydrolysis of PC under microwave irradiation is facilitated when the reaction temperature approaches this value. A polymer at its  $T_g$  changes from a stiff (hard) to a softer rubbery state, which causes the polymer to

**Fig. 12** Effect of depolymerization temperature on the amount of polycarbonate (PC) reacted during microwave-assisted PC alkaline hydrolysis after 40 min at 5% w/v NaOH, or 10 min at 10% w/v NaOH. (Reprinted from Tsintzou et al. [42] with permission)

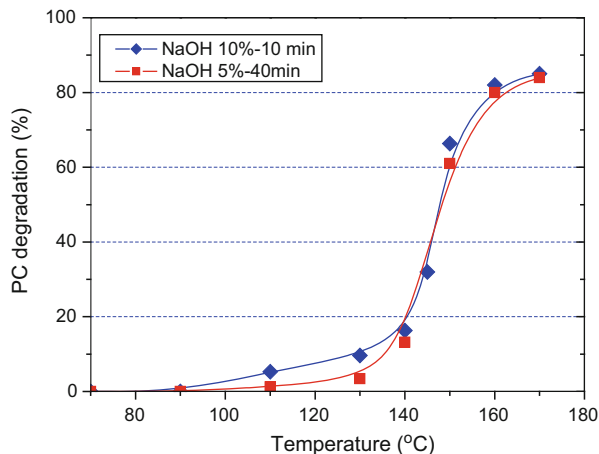

swell more easily in response to the alkaline reagent and hence facilitates the reaction. The importance of applying the microwave irradiation during PC alkaline hydrolysis was also confirmed by the observation that high PC decomposition was achieved after only 10 min of reaction with 10% NaOH at 160°C as compared with conventional heating, where more than 8 h was needed for similar results.

Because the presence of the PTC on the alkaline hydrolysis mechanism was found to be crucial, its role is explained next and presented in Scheme 3. Initially, the reaction mixture consists of the solid–organic phase of PC and the aqueous alkaline solution of NaOH. The PTC used, HDTMAB, fulfilled the requirements of having enough organic character to be lipophilic but being small enough to avoid steric hindrance. The cationic part of the catalyst is used to carry the hydroxide anion onto the surface of the solid phase through an interfacial mechanism. Thus, the carbon bonded to the three oxygens of the PC macromolecules on the surface of the flakes can be easily attacked by OH<sup>-</sup> (nucleophile) and thereby depolymerize. The anion returns to the aqueous phase and forms the BPA monomer as well as other substituted phenols. The reaction proceeds to complete depolymerization of PC, while the catalyst remains in the aqueous phase.

In the hydrolysis products, BPA monomer was obtained and identified by FTIR measurements. However, GPC measurements showed that the average molecular weight of the PC residues only slightly decreased, even after 70% degradation. These results confirm that, in alkali solutions, the rate of polymer hydrolysis is so fast that the reaction occurs mainly at the surface and degradation follows a “surface erosion” mechanism. The products, such as monomer and oligomer, are released from the surface and the polymer mass rapidly decreases, although its number-average molecular weight ( $\bar{M}_N$ ) is almost constant. Diffusion of the reactant into the bulk phase is slower than the rate of the chemical reaction. In contrast, during the “bulk erosion” mechanism occurring under acidic conditions, the reaction rate is so slow that the hydrolysis proceeds in the bulk phase of the polymer. The polymer mass does not change during the early stage of the reaction, whereas

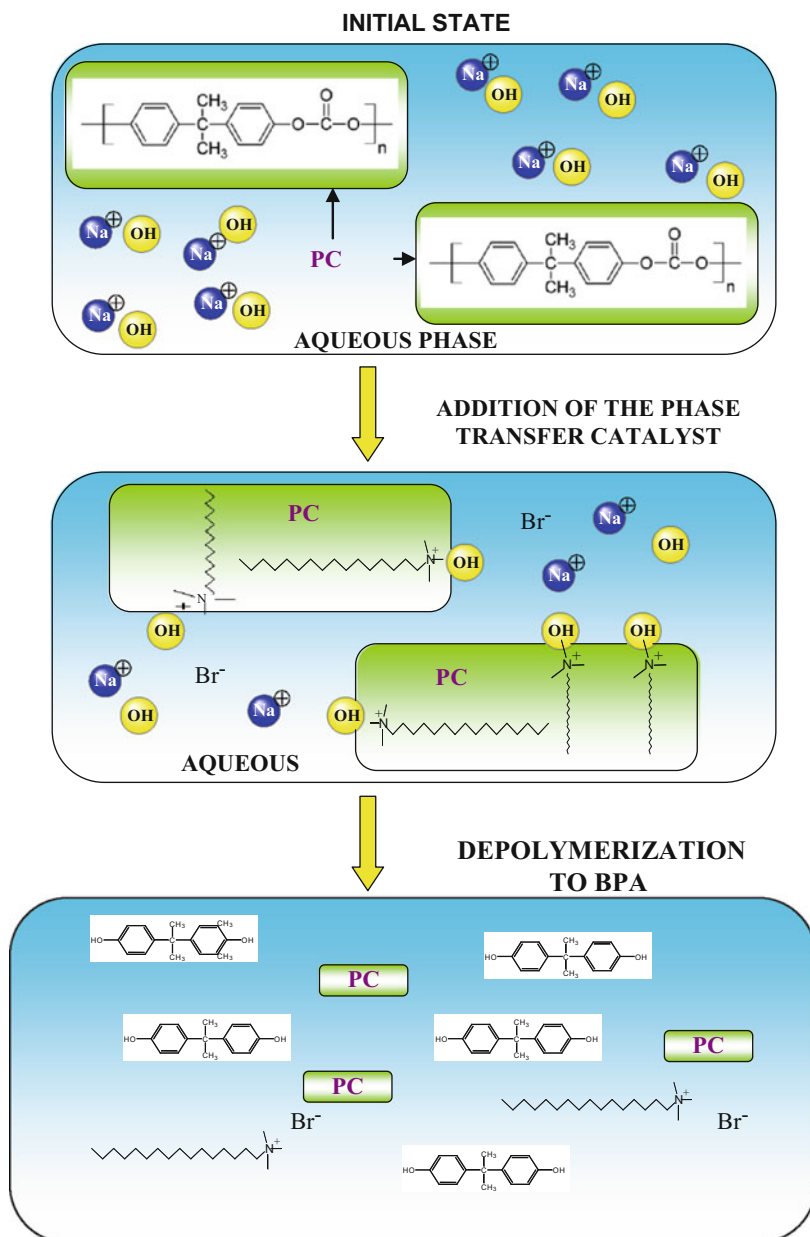

**Scheme 3** Phase transfer catalyzed depolymerization of polycarbonate (PC). BPA bisphenol-A. (Reprinted from Tsintzou et al. [42] with permission)

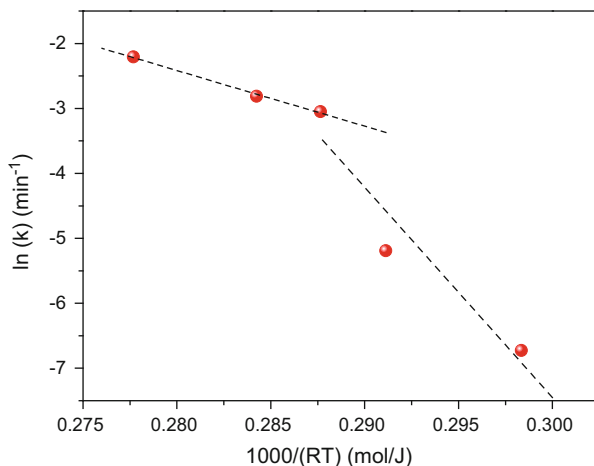

**Fig. 13** Arrhenius-type plot for the estimation of the activation energy above and below the glass transition temperature of polycarbonate during hydrolysis under microwave irradiation. (Reprinted from Tsintzou et al. [42] with permission)

$\bar{M}_N$  continuously decreases with the reaction time. The latter mechanism seems to be dominant during PC hydrolysis in a high-pressure and high-temperature steam.

Findings on PC degradation as a function of temperature (presented in Fig. 12) were also verified using a simple kinetic model. It was observed that plotting the kinetic rate constant ( $\ln k$ ) versus reciprocal temperature ( $1/T$ ) according to the Arrhenius expression and first order reaction kinetics, a linear curve was not verified (Fig. 13). Instead, a change in the slope of the curve was clear near the glass transition temperature of the polymer. The activation energies estimated at temperatures below and above 145°C were 323.5 and 85.7 kJ/mol, respectively. A drop in activation energy for an increase in temperature indicates that the controlling mechanism of reaction is changing. The lower activation energy observed at temperatures above the  $T_g$  of the polymer was attributed to the more elastomeric nature of the polymer at these conditions, meaning that the polymer could be easily penetrated by the ionic pairs of the PTC with the hydroxyl anions and become swollen, leading thus to a more rapid degradation [42, 43].

In addition, the same technique was applied to the degradation of waste compact disks. Depolymerization as high as 85% was achieved at 160°C using a 10% NaOH solution after microwave irradiation for 10 min [42].

Nikje [44] also studied glycolysis of PC in waste compact discs with EG using microwave irradiation in the presence of NaOH as catalyst in order to obtain the monomer BPA. The influence of various parameters such as concentration of the alkali metal catalyst and microwave irradiation power on product yield was reported in detail. The optimum concentration of NaOH was found to be 2 wt% and the optimum microwave power was 600 W. BPA recovery was affected by the reaction time and reached an optimum yield at 500 s [44].

## 2.3 Polyurethanes

Polyurethanes (PUs) constitute a class of polymeric materials with a fast-growing market due to the great variety of physical, chemical and mechanical properties that they present. PUs can be formed either as rigid or foam materials. PUs include a urethanic moiety in their chemical structure and can therefore be degraded using chemical methods similar to those applied for polyesters, particularly PET. Of these methods (i.e. hydrolysis, glycolysis, methanolysis and aminolysis), glycolysis is the most-studied method of PU degradation under microwave irradiation

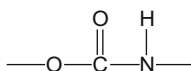

The necessity of using microwave irradiation during PU chemical degradation arises from the need to find environmentally friendly (not energy consuming) methods for the recycling of polymeric materials, of which large amounts reach the final recipients each year.

The group of Alavi Nikje has carried out a lot of work on this subject, which is presented below [45–50].

The degradation of rigid PU foam wastes through microwave-assisted glycolysis was investigated by Nikje and Nikrah [45]. DEG was used as a reagent-solvent and several catalysts were studied, including NaOH, KOH, CH<sub>3</sub>COONa and (CH<sub>3</sub>COO)<sub>2</sub>Zn. A microwave oven at atmospheric pressure was used and the microwave power was fixed to 180, 300, 450, 600 and 900 W. According to the results, the kinetics of the catalytic reaction is different to that of the non-catalytic reaction. The transesterification reaction was difficult to carry out without a catalyst, even under high microwave powers such as 600 W. Of the catalysts used, zinc acetate was found to present the weakest catalytic effect. Sodium and potassium hydroxides, which are convenient catalysts for transesterification reactions, could accelerate the glycolysis reaction and reduce the dissolution time. Using these catalysts it was found that only 3 min is required under 300 W power for complete dissolution of the PU foam (Fig. 14).

The microwave-assisted glycolysis of flexible PU foams was further investigated by Nikje et al. [46, 47]. Glycerin was used as a reagent with NaOH and KOH as catalysts. The depolymerization was carried out in a microwave oven at atmospheric pressure and at reaction temperatures of 160, 180, 200 and 220°C. NaOH was found to be the best catalyst, and the time needed to completely dissolve the PU foam was found to vary from 93 to 65 s when the temperature was raised from 160 to 220°C. For comparison, similar experiments were carried out with conventional heating. The obtained results at 180°C showed the ability of microwave irradiation to reduce the reaction time from 29 min to 92 s in KOH and from 42 min to 81 s in the NaOH-catalyzed process.

Microwave-assisted glycolysis of waste flexible PU foams was reported [48] using NaOH as catalyst and pentaerythritol in combination with glycerin as



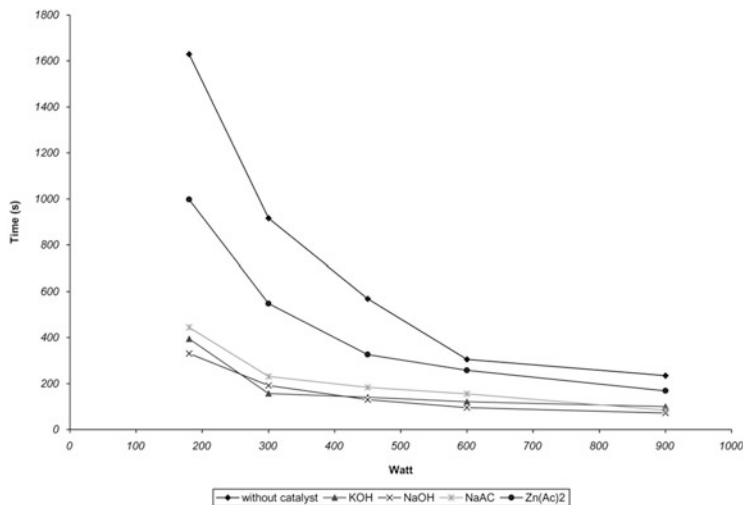

**Fig. 14** Comparison of various catalysts and microwave powers on the foam dissolution time during microwave-assisted degradation of polyurethane. (Reprinted from Nikje and Nikrah [45] with permission)

reagents. Split phases appeared after complete foam digestion. The upper phase contained recycled polyols while the lower phase was a brown liquid with highly functionalized oligomers, amines and unreacted reagents. Pentaerythritol has the advantage of having more than two hydroxyl groups, as is the case for conventional glycols. At 180°C and 800 W microwave power, the time required for complete dissolution ranged between 0.4 and 5 min.

The effect of water on the glycolysis of flexible PU foams under microwave irradiation at atmospheric pressure was presented by Nikje et al. [49]. The presence of water as a co-reagent besides glycerin causes hydrolysis reactions to take place in parallel to glycolysis. The hydroglycolysis reaction took place at 160°C with varying amounts of water. It was observed that increasing the water content in the reaction mixture resulted in increased reaction times. Nonetheless, water was considered as a potential low-cost replacement for up to 40% of the glycerin because reasonable dissolution times were still obtained (approximately 500 s). The times achieved were much less than the 10 h needed for conventional heating. The same author in a recent publication [50] used the products obtained from the microwave-assisted glycolysis of PU foam waste to synthesize new starch-based PU foams.

The effect of microwave irradiation on the glycolysis of microporous elastomer and rigid foams of PU with EG was investigated by Bogdal et al. [4]. A twofold excess of PU scraps to EG was employed because an equimolar ratio resulted in products with inferior properties. The polyols thus produced can be eventually used for the production of rigid PU foams. Furthermore, the application of microwave irradiation to the recycling of waste PUs allowed glycolysates to be obtained in a

fourfold shorter time (approximately 30 min), while their properties were the same as those produced under conventional heating conditions (Bogdal and Prociak [1]). As reported earlier for other polymers, the highest rate of PU decomposition resulting from the application of microwave irradiation was observed at the early stages of the reaction (during the first 20 min), whereas after 30 min the rate was slower to reach the final values. The strongest reduction in molecular weight of the reacting polymer was also observed during the first 20 min and this time was reduced with the addition of a catalyst. Under conventional heating conditions, the minimum time required for the desired homogenization of the reaction mixture was 2 h.

Glycolysis of PU was also carried out using DEG instead of EG in a twofold to tenfold excess of PU compared with DEG [1]. A multimode microwave reactor with a maximum power of 600 W was used, and 8–10 min was required to reach the reaction temperature of 200°C. Variation in the ratio of PU to DEG did not result in significant differences in the time taken to reach this temperature.

A discussion on earlier research on PU degradation can be found in Bogdal and Prociak [1].

## 2.4 Polyamides

Polyamide-6 (PA-6) is a widely used polycondensation polymer that finds application in a broad range of products requiring materials of high strength. It is widely used for gears, fittings and bearings, in the automotive industry for under-the-hood parts, and as a material for power tools housings. PA-6 can be recycled by hydrolysis, normally catalyzed by mineral acids, to its monomer  $\epsilon$ -caprolactam. Klun and Krzan [51, 52] presented microwave-assisted PA-6 hydrolysis in the presence of phosphoric acid as catalyst. The very high dipole moment of  $\text{H}_3\text{PO}_4$  also makes it an excellent microwave absorbent. As the authors noted, it should be used with caution and consideration to prevent equipment failure or other accidents. A sealed reaction vessel was used and microwave irradiation of 200 W was applied for 12–23 min. After 15 min of irradiation, a mixture consisting of 90%  $\epsilon$ -aminocaproic acid and its linear oligomers was obtained. In a later publication by the same authors, zinc acetate, zinc chloride and zinc triflate were evaluated as non-acid catalysts for the degradation reaction using microwave irradiation instead of conventional heating. The zinc salts were added at up to 40 wt% in the presence of 20 wt% phosphoric acid. Figure 15 shows how salts influence the degradation efficiency. Moreover, Table 3 presents the degradation of PA-6 in the presence of different amounts and types of metal salts; results obtained with a samarium salt are also included. Gravimetric and electron spray ionization mass spectrometry analysis of reaction products showed  $\text{ZnCl}_2$  to be the most effective salt catalyst. The acetate salt was ineffective, whereas the triflate was effective only when used as an

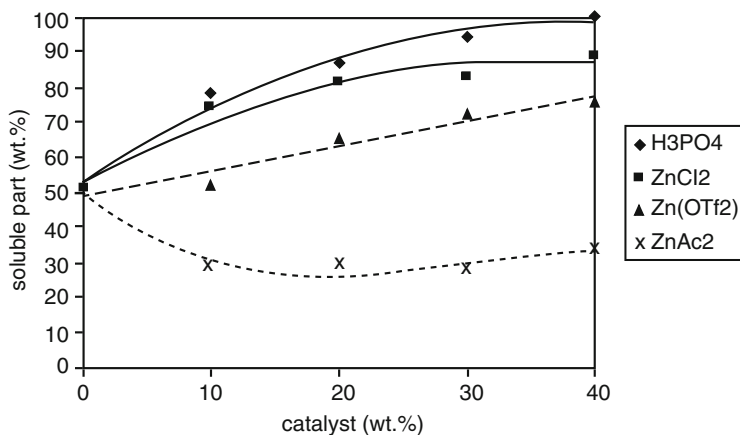

**Fig. 15** Influence of phosphoric acid and different catalysts ( $\text{ZnCl}_2$ ,  $\text{Zn}(\text{OTf})_2$  and  $\text{ZnAc}_2$ ) on the amount of water-soluble degradation products after 8 min microwave irradiation of polyamide-6 at 500 W. (Reprinted from Klun and Krzan [52] with permission)

**Table 3** Degradation of polyamide-6 using  $\text{H}_3\text{PO}_4$  and different metal and lanthanide salts as catalysts after 8 min microwave irradiation at 500 W. (Reprinted from Klun and Krzan [52] with permission)

Salt		$\text{H}_3\text{PO}_4$ (wt%)	Soluble part (%)
Type	Amount (wt%)		
None	–	10	37
None	–	20	51
None	–	60	100
$\text{ZnCl}_2$	10	20	74
$\text{ZnCl}_2$	20	20	81
$\text{ZnCl}_2$	40	20	89
$\text{ZnCl}_2$	50	–	75
$\text{Zn}(\text{OTf})_2$	10	20	52
$\text{Zn}(\text{OTf})_2$	20	20	65
$\text{Zn}(\text{OTf})_2$	40	20	76
$\text{ZnAc}_2$	10	20	29
$\text{ZnAc}_2$	20	20	30
$\text{ZnAc}_2$	40	20	34
$\text{Sm}(\text{OTf})_3$	10	10	30
$\text{Sm}(\text{OTf})_3$	50	–	–

addition to a mineral acid. FTIR and NMR spectroscopy of degradation products showed that dissociated ions from  $\text{ZnCl}_2$  bind to the amide group of the polymer. Using the triflate salt, no such interaction could be observed, indicating that the degradation and catalysis mechanisms differ for the chloride and triflate salts. Five water-stable lanthanide triflates showed no catalytic effect on the reaction [52].

## 2.5 *Poly[alkyl (meth)acrylate]s and Polystyrene*

Poly(alkyl methacrylate)s such as poly(methyl methacrylate) (PMMA) are thermo-plastic polymers that do not have characteristic chemical groups inside the carbon backbone. Therefore, these polyesters formed from addition polymerization, in contrast to polyesters synthesized via polycondensation reactions (e.g. PET), cannot be easily degraded to their monomers by simple chemical reagents. Instead, thermal or thermo-chemical degradation methods are usually applied. The monomer methyl methacrylate (MMA) can be obtained from the degradation of PMMA via an unzipping mechanism. Accordingly, a chain scission mechanism exists, which starts at weak chemical links inside the macromolecular chain and continues with end-chain scission, resulting in the production of large amounts of monomer [53].

Of the poly(alkyl methacrylate)s, the decomposition of PMMA has been extensively studied, although techniques developed for this polymer can be easily applied to other methacrylate polymers. Among other techniques, degradation of PMMA by photochemical reactions, oxidation, pyrolysis and high-temperature heating have been investigated. Thermal decomposition usually takes place at high temperatures and pressures and requires long reaction times. Compared with conventional thermal treatment by pyrolysis, sample digestion by microwave irradiation presents several advantages, such as energy saving by significantly reducing the time required, high decomposition efficiency by minimizing contamination and excellent control of degradation conditions.

Lin et al. [54] investigated the degradation of PMMA with an average molecular weight of 120,000 g/mol and proposed a kinetic model for the microwave-assisted decomposition by acid ( $\text{HNO}_3$ ) digestion. A microwave reactor was used with a Teflon-coated cavity, in which temperature and pressure were recorded and controlled. The polymer was mixed with  $\text{HNO}_3$  and digested at various temperatures. The effect of temperature on the digestion efficiency of PMMA is illustrated in Fig. 16. The pressure inside the closed vessel increased with temperature as a result of evaporation of  $\text{HNO}_3$  and partly from other volatile products such as MMA,  $\text{H}_2\text{O}$ , CO and  $\text{CO}_2$ . From Fig. 16 it seems that complete degradation occurred at 200°C by microwave/ $\text{HNO}_3$  digestion, whereas in conventional heating pyrolysis reactions, a temperature of 450°C was needed to completely degrade PMMA to its monomer [53].

According to the proposed mechanism of PMMA degradation by microwave irradiation in concentrated  $\text{HNO}_3$  solution, digestion resulted in the hydrolysis of the polymer to hydrophilic products. The dominant degradation products were MMA and hydrophilic compounds with carboxyl end-groups. As the digestion temperature increased, the particle size of PMMA decreased, resulting in increased surface area and a narrower particle size distribution. Furthermore, a kinetic model for PMMA decomposition was developed combining the carbon backbone scission via first-order kinetics with the side-chain scissions via zero-order kinetics. The model was used to simulate the variation of PMMA mass under different digestion

**Fig. 16** Variation of digestion efficiency of PMMA (with molecular weight of 120,000 g/mol) with temperature and endogenous pressure. (Reprinted from Lin et al. [54] with permission)

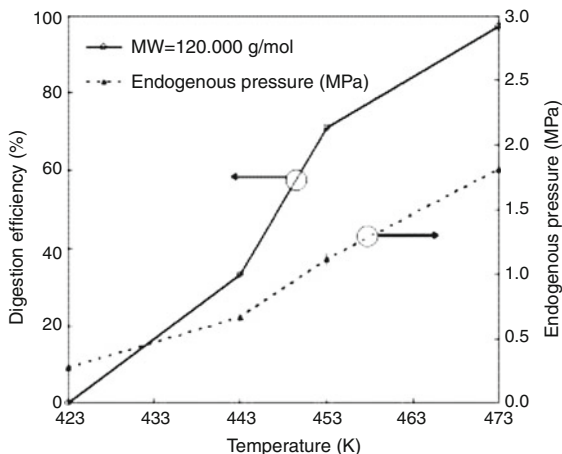

temperatures. It was found that main-chain scission dominated at high temperatures (453 and 473 K), whereas side-chain scission dominated at the lower temperature range (423–443 K). The latter temperature range resulted in enhanced efficiency of digestion of PMMA. The oxidizing potential of  $\text{HNO}_3$  was also verified by the finding that almost 100% digestion efficiency was measured at 473 K when the volume of nitric acid was more than 3 mL [54]. Similar works by the same group of authors have also been published [55, 56].

In order to enhance the degradation of poly(alkyl methacrylate)s, Marimuthu and Madras [57] used microwave-assisted oxidative degradation in dichlorobenzene solution. Poly(ethyl methacrylate) (PEMA), PMMA and poly(butyl methacrylate) (PBMA) were studied in the presence of typical free radical initiators such as benzoyl peroxide (BPO) or azo-bis isobutyronitrile (AIBN), which were used as oxidizers in different concentrations. The results were compared with those for thermal oxidative degradation and showed an enhancement of the degradation rate when microwave heating was used. The microwave-assisted oxidative degradation rate of poly(alkyl methacrylate)s increased with an increase in the number of carbon atoms of the alkyl substituents, following the order PBMA > PEMA > PMMA, and the activation energy decreased with the chain length. The molecular weight distribution of the degradation mixture approached an exponential distribution under both thermal and microwave-assisted oxidative degradation, indicating a random chain-scission mechanism. But, this needs to be further investigated by analysis of the degradation products.

Furthermore, the same authors (Marimuthu and Madras [58]) investigated the microwave-assisted oxidative degradation of several poly(alkyl acrylate)s such as poly(methyl acrylate) (PMA), poly(ethyl acrylate) (PEA) and poly(butyl acrylate) (PBA). It was found that the degradation rate under microwave irradiation decreased with an increase in the number of carbon atoms of the alkyl substituents and followed the order PMA > PEA > PBA. The kinetic rate coefficients of hydrogen abstraction and oxidative random chain scission were estimated from fitting to

experimental data and found to depend only on the type of polymer and not on the oxidizer used.

The same concept of microwave-assisted oxidative degradation was also applied to polystyrene (PS) by Sivalingam et al. [59]. The reaction kinetics was studied in dichlorobenzene solvent, using BPO as an oxidizing agent. It was proved that the oxidative degradation of PS in solution can be significantly enhanced by microwave irradiation. It should be pointed out here that the choice of the solvent is of significant importance. Because polymers such as PS have poor dielectric properties, the solvent used should be able to absorb the microwave energy to achieve the necessary temperature. Dichlorobenzene is such a good solvent. The reaction times were very low, ranging from 20 to 45 s, and several cycles of heating were applied. From measurements of the number-average molecular weight of unreacted PS, a rapid reduction in the initial 6 min of effective microwave exposure was observed. Under conventional thermal heating conditions, appreciable degradation of polystyrene was not observed.

## 2.6 Other Polymers

### 2.6.1 Poly(vinyl alcohol)

Poly(vinyl alcohol) (PVA) is a polymer that is used in the cosmetic industry, textiles, pharmaceuticals, paints and as a colloid protector in emulsion polymerizations. Degradation of solid PVA films by microwave irradiation has been reported in literature [60, 61]. It was found that polymer dehydration with formation of crosslinks via ether bridges occurs at moderate temperatures (100–150°C), whereas heating by microwave irradiation or by conventional means at higher temperatures causes formation of double bonds. So, crosslinking is ascribed specifically to a nonisothermal microwave effect. On the other hand, crosslinking reactions were not observed, even after 10 h of treatment, when another type of irradiation, UV, was used.

Although the majority of the studies have been carried out on bulk, solid materials, when it comes to particular applications (e.g. electrospinning and casting) PVA in the form of a solution in a suitable solvent is required. In order to enhance the dissolution rate and to overcome the relatively poor solubility of highly hydrolyzed PVA, the solutions are sometimes heated or even boiled. Bernal et al. [62] has investigated the stability of PVA solutions under microwave irradiation in EG. FTIR, UV–vis and GPC measurements showed that only minor changes took place in PVA after the microwave treatment. Consequently, microwave treatment within the investigated time scale of 20 min was recommended to be appropriate for heating of PVA solutions in EG. Therefore, it was proved that use of microwave-assisted heating of PVA in EG solution is beneficial in terms of shortening the time and reducing the cost of polymer processing.

### 2.6.2 Poly(ethylene oxide)

Poly(ethylene oxide) is a water-soluble polymer that can be degraded in an aqueous environment by the use of a water-soluble free radical initiator. Potassium persulfate,  $K_2S_2O_8$ , is such a free radical initiator and is widely used to produce the initial radicals needed in conventional emulsion polymerizations. This compound was also used as an oxidizing agent for the thermal and microwave-assisted oxidative degradation of poly(ethylene oxide) by Vijayalakshmi et al. [63]. Parameters that were found to increase the degradation rate included temperature, concentration of persulfate and heating cycle time. However, as the thermal decomposition of  $K_2S_2O_8$  is very slow at temperatures lower than  $50^\circ\text{C}$ , oxidative processes were mainly responsible for the polymer degradation. The degradation kinetics was also studied and the rate coefficients were obtained from a theoretical simulation model using the principles of continuous distribution kinetics. It was found that microwave-assisted degradation was far more effective than conventional heating in solution, in terms of reducing reaction time, lowering the activation energies and obtaining higher rates [63].

### 2.6.3 Crosslinked Polymeric Biomaterials

In order to study the degradation behaviour of some novel crosslinked polymeric biomaterials, Ghaffar et al. [64] proposed hydrolytic degradation in a microwave reactor. The polymeric biomaterials used included poly(2-hydroxyethyl methacrylate) (PHEMA), poly(lactide-*co*-glycolide 50/50)<sub>1550</sub>-diol, (PLGA(50:50)<sub>1550</sub>-diol), PLGA(50:50)<sub>1550</sub>-diol(HEMA)<sub>2</sub> and PLGA(50:50)<sub>1550</sub>-diol(etLDI-HEMA)<sub>2</sub> containing ethyl ester lysine diisocyanate (etLDI) linkers.  $^1\text{H}$  NMR spectroscopy was used to monitor the degree of hydrolysis and optimize the reaction time and temperature. Complete hydrolytic degradation was achieved after 24 h at  $120^\circ\text{C}$  and 3 bar pressure. Chemical structure elucidation of the degradation products was carried out using  $^1\text{H}$  and  $^{13}\text{C}$  NMR spectroscopy. The molecular weight of the polymethacrylic backbone was estimated via size-exclusion chromatography. A bimodal molecular weight distribution was found experimentally, also in the PHEMA starting material.

Hydrolysis was carried out in 1 M alkaline (KOH) solution in a 10-mL pressurized glass vial using a magnetic stirrer. The pressurized glass vial was internally lined with a PTFE tube of 1 mm thickness (see Scheme 4).

The main hydrolysis products, PMAA, EG, DEG, lactic acid (LA), glycolic acid (GA) and lysine were recovered almost quantitatively. The proposed reaction scheme for the hydrolytic degradation appears in Scheme 5.

**Scheme 4** Diagram of CEM discover microwave apparatus with additional PTFE lining of 1 mm thickness. (Reprinted from Ghaffar et al. [64] with permission)

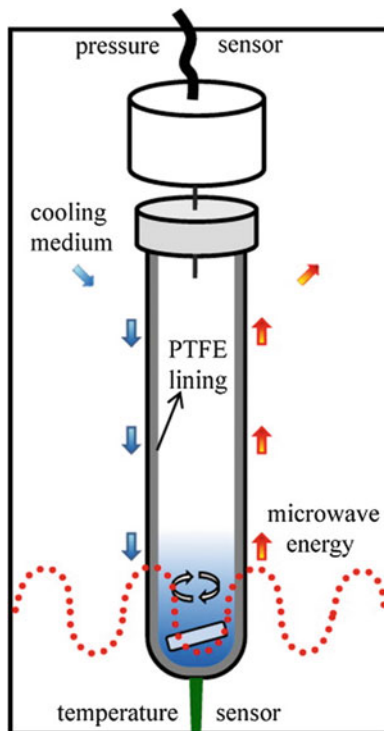

#### 2.6.4 Poly(vinyl chloride)

Poly(vinyl chloride) (PVC) is a polymer produced in large amounts worldwide and has a number of different applications. However, its use has been restricted recently, mainly as a result of problems related to its production from vinyl chloride (which is a potential carcinogenic), as well as because of the plasticizers (mainly phthalic esters) that are usually added to the polymer. In addition, during the thermal decomposition of PVC, hydrogen chloride is released, requiring special equipment and procedures. Therefore, dehydrochlorination is required in order for PVC to be treated by pyrolysis. Due to the existence of the chlorine atom in PVC's macromolecular backbone, it can absorb microwave power more efficiently compared with other commercially available thermoplastics. Moriwaki et al. [65] took advantage of this property to examine the dehydrochlorination of PVC under microwave irradiation. The objective was to elucidate the temperature dependency of microwave power absorption by PVC by observing the temperature profile during irradiation. The measurements showed that the dielectric loss was increased in proportion with a temperature rise in the first temperature domain; after that, this parameter started to rise quickly at temperatures exceeding 120°C. More than the 90% of the dehydrochlorination yield was achieved by microwave irradiation of



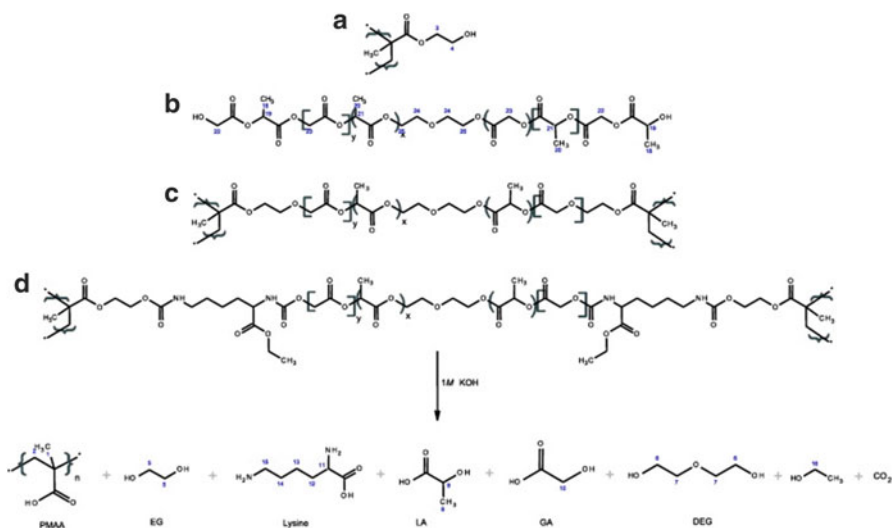

**Scheme 5** Proposed reaction scheme for the hydrolytic degradation of (a) PHEMA, (b) PLGA (50:50)<sub>1550</sub>-diol, (c) PLGA(50:50)<sub>1550</sub>-diol(HEMA)<sub>2</sub> and (d) PLGA(50:50)<sub>1550</sub>-diol(eLDI-HEMA)<sub>2</sub>. PLGA poly(lactide-*co*-glycolide), PHEMA poly(2-hydroxyethyl methacrylate), PMAA poly(methacrylic acid), EG ethylene glycol, DEG diethylene glycol, LA lactic acid, GA glycolic acid. The numbering corresponds to NMR peak assignments. (Reprinted from Ghaffar et al. [64] with permission)

PVC, indicating that preheating the material resulted in shorter irradiation times required to reach such yield.

In order to increase the dehydrochlorination rate of pure PVC, other compounds exhibiting a high loss factor for microwave energy absorption were examined [66]. The microwave absorbents found to affect the PVC decomposition process were activated carbon and Zn–Mn ferrite powder (Moriwaki et al. [66]). What was proved is that activated carbon is superior to the ferrite as an absorber of microwave energy. The dehydrochlorination ratio varies according to the irradiated microwave energy and the PVC grade.

In a similar paper, microwave irradiation was also applied to facilitate the removal of chlorine from PVC (Ito et al. [67]). High temperatures for the dehydrochlorination were used and the residual amount of PVC was found to depend on the thermal exposure time. A domestic microwave oven was used for the decomposition of PVC, operating at 2.45-GHz microwave irradiation by applying moderate electrical field intensity. As was reported previously for the degradation of polycarbonate, the microwave sensitivity was enhanced above the glass transition temperature of PVC (i.e. around 80°C). At the same time, preheating of the sample before irradiation was found to significantly enhance the dechlorination efficiency and seriously affect microwave absorption efficiency and PVC weight loss. A more detailed review can be found in the literature [1].

### 2.6.5 Devulcanization of Rubber

Vulcanized rubbers are materials commonly used in various industrial applications. In recent years, the dramatic increase in rubber wastes has forced the scientific community to pay considerable attention to its reclamation. During the reclaiming process, a series of changes is imposed on the material, providing it with unique properties that are different to those of the virgin rubber without curing. However, the devulcanization processes generally result in a product with inferior physical and mechanical properties. Microwave and ultrasound techniques have been applied in attempts to easily obtain and control the energy required for the devulcanization of the rubber. Microwave irradiation occurs by heating the sample using a source of energy radiation, resulting in the rupture of crosslinks (mainly the C–S and S–S linkages) [68].

In order to promote breakage of the crosslinks present in the macromolecular network of ethylene-propylene-diene rubber (EPDM-r) scraps from the automotive industry, Pistor et al. [68] studied the effect of using microwave irradiation instead of conventional heating. The influence of paraffinic oil on the devulcanization process was also studied. A conventional microwave oven was used, with exposure times ranging from 2 to 5 min. It was found that the presence of paraffin oil in EPDM-r affects the devulcanization process (gel content measurements) and that the glass transition temperature of EPDM-r decreased with an increase in the microwave exposure time (DSC measurements). The maximum exposure time for samples containing oil was 4 min. With the use of the paraffinic oil, the maximum temperature reached by the samples after the devulcanization process was lower than for the corresponding sample without oil (i.e. 216 and 372°C, respectively). The higher maximum temperatures measured when no paraffinic oil was used were caused by the increase in the carbon black content and the absence of evaporation or degradation of oil. In addition, carbon black has high thermal conductivity and heat capacity, allowing greater accumulation of internal energy and a better distribution of energy in the material. These two phenomena contribute to a more selective and uniform devulcanization of the material.

## 3 Microwave-Assisted Pyrolysis of Polymers

The term “pyrolysis” comes from the Greek word *pyr*, which means fire, and is defined as heating of a material in the absence of oxygen, resulting in its thermal degradation into three types of intermediate products: gaseous (low molecular weight gases), liquid (heavy molecular weight compounds that condense when cooled) and solid (char). Pyrolysis has been widely used in the recycling of different types of polymer, aiming for the recovery of either their monomers (i.e. PMMA, PS, etc.) or a liquid fraction with composition similar to common liquid fuels (LDPE, HDPE, PP) [69].

Microwave heating is emerging as one of the most attractive alternative technologies in the pyrolysis process. The advantages of microwave pyrolysis over conventional pyrolysis include fast heating times, easy control of operating parameters, bulk and targeted heating and lower operating temperatures and energy requirements. However, there are several major limitations that prevent this technology from being widely employed in the waste manufacturing industry. These include the absence of sufficient data to quantify the dielectric properties of the treated waste streams, the need for a multidisciplinary approach to design and develop the related conversion units and the uncertainty about the actual costs [3].

The type and properties of the materials used together with the operating conditions are the main factors affecting any pyrolysis process and determining the composition and yields of the gaseous and liquid products. However, when microwaves are used as heating method in the pyrolysis process, one must consider additional complications that could affect the heat, mass transportation mechanism and chemical reactions, together with the necessity of using microwave absorbing compounds.

Microwave-induced pyrolysis processes are relatively new and were initially developed by Tech-En Ltd. in Hainault, UK [70, 71]. The process involves the mixing of plastic-containing wastes, which are known to have very high transparencies to microwaves, with a highly microwave-absorbent material such as particulate carbon [72]. The carbon reaches temperatures of around 1,000°C within a few minutes in the microwave field, and energy is transferred to the shredded plastic by conduction, providing the efficient energy transfer associated with microwave heating processes. Ludlow-Palafox and Chase [72] investigated the microwave-induced pyrolysis of HDPE and aluminium/polymer laminates (toothpaste tube) in a semibatch bench-scale apparatus. The results showed that microwave pyrolysis had the same general characteristics as conventional heating pyrolytic processes, but with the advantage that it could deal with problematic wastes such as laminates. In the case of the commercial toothpaste tube, liquid and gaseous hydrocarbons were obtained from the degradation of the polymeric part, whereas very high quality aluminium was recovered from the aluminium foil. In an integrated unit, the gaseous fraction can be used in a self-sustaining process by burning the gas and using it as a fuel or energy source.

The information provided in this section is limited to very recent advances and the interested reader is directed to a recent detailed review on microwave-assisted pyrolysis by Fernandez et al. [3].

The group of Khan investigated pyrolysis of waste polystyrene in a metal coil reactor using aluminium as antenna and heat-generating material [73]. Temperatures as high as the melting point of aluminium were obtained in the microwave oven. The microwaves were applied in 2-min pulses for 10 min. Aluminium in the form of tightly coiled wires, strips and cylinders was used and the reaction rate was found to depend on the form, shape and size of the aluminium. Faster reaction was observed for the wire coil, slower for strips and negligible for the cylindrical form. The fraction of the pyrolysis products was 10% gases, 88% liquid and 2% char. The liquid portion contained substituted benzene in addition to polycyclic aromatics and

condensed ring aromatics. Aromatic compounds were also identified in the liquid fraction obtained from pyrolysis of polystyrene under conventional heating. The microwave-assisted pyrolysis results in higher quantities of liquid products of increased selectivity in a shorter time, and offers a cheap procedure for industrial-scale conversion of waste polystyrene into valuable commercial products. This method was extended by the authors to the co-pyrolysis of waste polystyrene with coal [74], where the oily liquid was found to contain mainly aromatic compounds such as 1-phenylethanol, 2-benzylphenol, 2-styrylphenol or methoxymethylbenzene in a narrow range. Conventional pyrolysis of polystyrene requires a temperature of 510°C and yields 92% liquid with almost 62% styrene monomer [75].

Recently, Russell et al. [76] performed microwave-assisted pyrolysis of HDPE using a reactor bed of catalytic activated carbon. As activated carbon is an excellent microwave absorbent, it served two primary functions: as a catalyst in the pyrolytic cracking of HDPE and also as the enveloping and energy transferring agent necessary for processing microwave-transparent material. The process resulted in a liquid product with a composition of hydrocarbons matching commercial fuels such as petrol and diesel. Greater cracking was observed across all operating temperatures, and a lighter liquid product with a narrower range of chain lengths was produced compared with the use of a bed of traditional coke.

Microwave-assisted pyrolysis has been also employed in the recycling of waste electric and electronic equipment [77]. This type of waste contains a number of polymeric materials, such as acrylonitrile butadiene styrene (ABS), polycarbonate (PC) and high impact polystyrene (HIPS). The process was successful in producing oil, gas and a solid residue with a rather stable mass reduction that was independent of the temperature scatter during pyrolysis.

### Conclusions

In this review, recent literature on the application of microwave irradiation to polymer degradation has been presented. The great importance of this process is obvious from the large number of papers published during the last 5–10 years. From a number of different polymers studied, the following conclusions can be drawn.

Microwave irradiation does not seem to affect the degradation mechanism of the polymer but it seriously shortens the reaction time needed to complete depolymerization.

(continued)

Because most of polymers do not absorb microwave energy, selection of the appropriate solvent, reagent or catalyst added is crucial. Such compounds, besides their typical role in the degradation mechanism, must be selected for their ability to absorb microwave energy.

Microwave-assisted polymer pyrolysis shows the potential to be extensively used in the coming years. Understanding polymer degradation under microwave irradiation will help in developing advanced techniques for polymer recycling. Perhaps microwave absorbers could be added to the polymer matrix during the production line so that final product plastics could be easily recycled after their end-use. In view of limited global resources and environmental problems, energy-saving and simple chemical recycling technologies for waste plastic materials, such as the use of microwave irradiation, will certainly contribute to the worldwide polymer industry.

## References

1. Bogdal D, Prociak A (2007) Recycling of plastics. In: Microwave enhanced polymer chemistry and technology. Wiley-Blackwell, Richmond
2. Achilias DS (2012) Material recycling-trends and perspectives. InTech Open Access, Croatia
3. Fernandez Y, Arenillas A, Menendez JA (2011) Microwave heating applied to pyrolysis. In: Grundas S (ed) Advances in induction and microwave heating of mineral and organic materials. InTech, Croatia
4. Bogdal D, Penczek P, Pielichowski J, Prociak A (2003) Microwave assisted synthesis, crosslinking and processing of polymeric materials. *Adv Polym Sci* 163:193–263
5. Hoogenboom R, Schubert US (2009) Microwave-assisted organic and polymer chemistry. *Aust J Chem* 62(3):181–183
6. Hoogenboom R, Wilms TFA, Erdmenger T, Schubert US (2009) Microwave-assisted chemistry: a closer look at heating efficiency. *Aust J Chem* 62(3):236–243
7. Karayannidis GP, Achilias DS (2007) Chemical recycling of PET. *Macromol Mater Eng* 292:128–146
8. Krzan A (1998) Microwave irradiation as an energy source in PET solvolysis. *J Appl Polym Sci* 69:1115–1118
9. Krzan A (1999) PET glycolysis under microwave irradiation. *Polym Adv Technol* 10:603–606
10. Ikenaga K, Oyama H (2006) Accelerated chemical degradation of PET by microwave basic catalysis. *Polym Prepr* 55:2469–2470
11. Liu L, Zhang D, An L, Zhang H, Tian Y (2005) Hydrolytic depolymerization of PET under microwave irradiation. *J Appl Polym Sci* 95:719–723
12. Li K, Song X, Zhang D (2008) Depolymerization of PET with catalyst under microwave irradiation. *J Appl Polym Sci* 109:1298–1301
13. Li K, Song X, Zhang D (2008) Molecular weight evaluation of depolymerized PET using intrinsic viscosity. *J Appl Polym Sci* 109:1294–1297
14. Song X, Zhang S, Zhang D (2010) Catalysis investigation of PET depolymerization under metal oxides by microwave irradiation. *J Appl Polym Sci* 117:3155–3159
15. Ge Y, Han C, Zhang D (2011) Study of PET depolymerization catalysed by metal oxide with different acidity/basicity under microwave irradiation. *Adv Mater Res* 233–235:1076–1079
16. Ma Y, Tang Q, Zhang D (2011) Catalysis investigation of PET depolymerization by super acid  $\text{SO}_4^{2-}/\gamma\text{-Al}_2\text{O}_3$  under microwave irradiation. *Adv Mater Res* 233–235:1073–1075

17. Yan H, Ma Y, Zhang W, Zhang D (2012) Catalytic effects of super acid  $\text{SO}_4^{2-}/\gamma\text{-Al}_2\text{O}_3$  to PET depolymerization under microwave irradiation. *Adv Mater Res* 550–553:280–283
18. Geng L, Han C, Zhang D (2011) Catalysis investigation of PET depolymerization by  $\text{ZnSrO}_2$  under microwave irradiation. *Adv Mater Res* 239–242:3194–3197
19. Zuo M, Zhang W, Feng Q, Han C, Zhang D (2012) Preparation of  $\text{ZnO.SrO}$  and its catalysis to PET depolymerization under microwave irradiation. *Adv Mater Res* 557–559:135–138
20. Tang Q, Ma Y, Zhang D (2011) Effects of temperature on catalytic hydrolysis of PET by zinc sulphate under microwave irradiation. *Adv Mater Res* 233–235:1628–1631
21. Zhang W, Shi X, Zhang X, Han C, Zhang D (2012) PET depolymerization catalysed by sulphates under microwave irradiation. *Adv Mater Res* 550–553:792–797
22. Nikje MMA, Nazari F (2006) Microwave-assisted depolymerization of PET at atmospheric pressure. *Adv Polym Technol* 25:242–246
23. Nikje MMA, Nazari F (2009) Simple and convenient method of chemical recycling of PET by using microwave radiation. *Polimery/Polymers* 54:635–638
24. Pingale ND, Shukla SR (2008) Microwave assisted ecofriendly recycling of PET bottle waste. *Eur Polym J* 44:4151–4156
25. Pingale ND, Shukla SR (2009) Microwave-assisted aminolytic depolymerization of PET waste. *Eur Polym J* 45:2695–2700
26. Parab YS, Pingale ND, Shukla SR (2012) Aminolytic depolymerization of poly(ethylene terephthalate) bottle waste by conventional and microwave irradiation heating. *J Appl Polym Sci* 125:1103–1107
27. Shah RV, Shukla SR (2012) Effective aminolytic depolymerization of poly(ethylene terephthalate) waste and synthesis of bisoxazoline therefrom. *J Appl Polym Sci* 125:3666–3675
28. Shah RV, Borude VS, Shukla SR (2013) Recycling of PET waste using 3-amino-1-propanol by conventional or microwave irradiation and synthesis of bis-oxazin therefrom. *J Appl Polym Sci* 127:323–328
29. Siddiqui MN, Achilias DS, Redhwi HH, Bikiaris DN, Katsogiannis K-AG, Karayannidis GP (2010) Hydrolytic depolymerization of PET in a microwave reactor. *Macromol Mater Eng* 295:575–584
30. Achilias DS, Redhwi HH, Siddiqui MN, Nikolaidis AK, Bikiaris DN, Karayannidis GP (2010) Glycolytic depolymerization of PET waste in a microwave reactor. *J Appl Polym Sci* 118:3066–3073
31. Achilias DS, Tsintzou GP, Nikolaidis AK, Bikiaris DN, Karayannidis GP (2011) Aminolytic depolymerization of poly(ethylene terephthalate) waste in a microwave reactor. *Polym Int* 60:500–506
32. Siddiqui MN, Achilias DS, Redhwi HH (2012) Recycling of poly(ethylene terephthalate) waste through methanolic pyrolysis in a microwave reactor. *J Anal Appl Pyrol* 98:214–220
33. Khalaf HI, Hasan OA (2012) Effect of quaternary ammonium salt as a phase transfer catalyst for the microwave depolymerization of poly(ethylene terephthalate) waste bottles. *Chem Eng J* 192:45–48
34. Hayes BL (2002) *Microwave synthesis: chemistry at the speed of light*. CEM Publishing, Matthews
35. Chen F, Wang G, Shi C, Zhang Y, Zhang L, Li W, Yang F (2013) Kinetics of glycolysis of poly(ethylene terephthalate) under microwave irradiation. *J Appl Polym Sci* 127:2809–2815
36. Chaudhary S, Surekha P, Kumar D, Rajagopal C, Roy PK (2013) Microwave assisted glycolysis of poly(ethylene terephthalate) for preparation of polyester polyols. *J Appl Polym Sci* 129:2779–2788
37. Zhang S, Song X, Zhang D, Tian Y (2011) Kinetics of the hydrolytic depolymerization of poly(ethylene terephthalate) under microwave irradiation. *Polym J* 43:811–815
38. Cho JY, Hong C-J, Choi H-M (2013) Microwave-assisted glycolysis for PET with highly hydrophilic surface. *Ind Eng Chem Res* 52:2309–2315

39. Shafique U, Zaman W, Anwar J, Munawar MA, Salman M, Dar A, Rehman R, Ashraf U, Ahmad S (2011) A rapid economical and eco-friendly method to recycle terephthalic acid from waste poly(ethylene terephthalate) bottles. *Int J Polym Mater Polym Biomat* 60:1147–1151
40. Liu Z, Liu R, Wang Y, Fan X, Tao C (2011) Microwave-assisted degradation of waste PET at atmospheric pressure using silicon carbide as power modulator. In: *Proceedings of the international conference on remote sensing, environment and transportation engineering, RSETE 2011*, pp 3276–3280
41. Biedermann-Brem S, Grob K (2009) Release of bisphenol-A from polycarbonate baby bottles: water hardness as the most relevant factor. *Eur Food Res Technol* 228:679–684
42. Tsintzou GP, Antonakou EV, Achilias DS (2012) Environmentally friendly chemical recycling of poly(bisphenol-A carbonate) through phase transfer-catalysed alkaline hydrolysis under microwave irradiation. *J Hazard Mater* 241–242:137–145
43. Kim D, Kim BK, Cho Y, Han M, Kim BS (2009) Kinetics of polycarbonate glycolysis in ethylene glycol. *Ind Eng Chem Res* 48:685–691
44. Nikje MMA (2011) Glycolysis of polycarbonate wastes with microwave irradiation. *Polimery/Polymers* 56:381–384
45. Nikje MMA, Nikrah M (2007) Chemical recycling and liquefaction of rigid polyurethane foam wastes through microwave assisted glycolysis process. *J Macromol Sci Part A Pure Appl Chem* 44:613–617
46. Nikje MMA, Nikrah M, Haghshenas M (2007) Microwave assisted “split phase” glycolysis of polyurethane flexible foam wastes. *Polym Bull* 59:91–104
47. Nikje MMA, Nikrah M (2007) Microwave assisted glycolysis of polyurethane cold cure foam wastes from automotive seats in “split phase” condition. *Polym-Plast Technol Eng* 46:409–415
48. Nikje MMA, Mohammadi FHA (2010) Polyurethane foam wastes recycling under microwave irradiation. *Polym-Plast Technol Eng* 49:818–821
49. Nikje MMA, Nikrah M, Mohammadi FHA (2008) Microwave-assisted polyurethane bond cleavage via hydroglycolysis process at atmospheric pressure. *J Cellular Plastics* 44:367–380
50. Nikje MMA (2012) Polyurethane foams produced from components received in microwave assisted recycling of PUR waste and starch liquefaction. *Polimery/Polymers* 57:11–17
51. Klun U, Krzan A (2000) Rapid microwave induced depolymerization of polyamide-6. *Polymer* 41:4361–4365
52. Klun U, Krzan A (2002) Degradation of polyamide-6 by using metal salts as catalyst. *Polym Adv Technol* 13:817–822
53. Achilias DS (2007) Chemical recycling of poly(methyl methacrylate) by pyrolysis. Potential use of the liquid fraction as a raw material for the reproduction of the polymer. *Eur Polym J* 43:2564–2575
54. Lin C-C, Guo G-L, Tsai T-L (2009) A bi-order kinetic model for poly(methyl methacrylate) decomposition in  $\text{HNO}_3$  using microwave irradiation. *AIChE J* 55:2150–2158
55. Tsai T-L, Lin C-C, Guo G-L, Chu T-C (2008) Chemical kinetics of poly(methyl methacrylate) decomposition assessed by a microwave-assisted digestion system. *Ind Eng Chem Res* 47:2554–2560
56. Tsai T-L, Lin C-C, Guo G-L, Chu T-C (2008) Effect of microwave-assisted digestion on decomposition behaviour of poly(methyl methacrylate). *Mater Chem Phys* 108:382–390
57. Marimuthu A, Madras G (2008) Continuous distribution kinetics for microwave-assisted oxidative degradation of poly(alkyl methacrylates). *AIChE J* 54:2164–2173
58. Marimuthu A, Madras G (2008) Effect of oxidizers on microwave-assisted oxidative degradation of poly(alkyl acrylates). *Ind Eng Chem Res* 47:7538–7544
59. Sivalingam G, Agarwal N, Madras G (2003) *AIChE J* 49:1821
60. Petrova N, Evtushenko A, Chikhacheva I, Zubov V, Kubrakova I (2005) *Russ J Appl Chem* 78:1158
61. Alekseeva N, Evtushenko A, Chikhacheva I, Zubov V, Kubrakova I (2005) *Mendeleev Commun* 14:170

62. Bernal A, Kuritka I, Kasparkova V, Saha P (2013) The effect of microwave irradiation on poly (vinyl alcohol) dissolved in ethylene glycol. *J Appl Polym Sci* 128:175–180
63. Vijayalakshmi SP, Chakraborty J, Madras G (2005) Thermal and microwave-assisted oxidative degradation of poly(ethylene oxide). *J Appl Polym Sci* 96:2090–2096
64. Ghaffar A, Verschuren PG, Geenevasen JAJ, Handels T, Berard J, Plum B, Dias AA, Schoenmakers PJ, van der Wal SJ (2011) Fast in vitro hydrolytic degradation of polyester urethane acrylate biomaterials: structure elucidation, separation and quantification of degradation products. *J Chrom A* 1218:449–458
65. Moriwaki S, Machina M, Matsumoto H, Kuga M, Ogura T (2006) *J Anal Appl Pyrolysis* 76:238
66. Moriwaki S, Machina M, Matsumoto H, Otsubo Y, Aikawa M, Ogura T (2006) *Appl Therm Eng* 26:745
67. Ito M, Ushida K, Nakao N, Kikuchi N, Nozaki R, Asai K, Washio M (2006) *Polym Degrad Stab* 91:1694
68. Pistor V, Scuracchio CH, Oliveira PJ, Fiorio R, Zattera AJ (2011) Devulcanization of ethylene-propylene-diene polymer residues by microwave-influence of the presence of paraffinic oil. *Polym Eng Sci* 51:697–703
69. Achilias DS (2009) Chemical recycling of waste plastics by pyrolysis: effect of polymer type on products distribution, chapter 14. In: Donahue WS, Brandt JC (eds) *Pyrolysis: types, processes, and industrial sources and products*. Nova Science, New York, pp 359–402
70. Holland KM (1995) Apparatus for waste pyrolysis. US Patent 5,387,321 A
71. Holland KM (1994) Process of destructive distillation of organic material. US Patent 5,330,623A
72. Ludlow-Palafox C, Chase HA (2001) Microwave induced pyrolysis of plastic wastes. *Ind Eng Chem Res* 40:4749–4756
73. Hussain Z, Khan KM, Perveen S, Hussain K, Voelter W (2012) The conversion of waste polystyrene into useful hydrocarbons by microwave-metal interaction pyrolysis. *Fuel Proc Technol* 94:145–150
74. Hussain Z, Khan KM, Basheer N, Hussain K (2011) Co-liquefaction of Makarwal coal and waste polystyrene by microwave-metal interaction pyrolysis in copper coil reactor. *J Anal Appl Pyrol* 90:53–55
75. Achilias DS, Kanellopoulou I, Megalokononimos P, Antonakou E, Lappas AA (2007) Chemical recycling of polystyrene by pyrolysis: potential use of the liquid product for the reproduction of polymer. *Macromol Mater Eng* 292:923–934
76. Russell AD, Antreou EI, Lam SS, Ludlow-Palafox C, Chase HA (2012) Microwave-assisted pyrolysis of HDPE using an activated carbon bed. *RSC Adv* 2:6756–6760
77. Andersson M, Wedel MK, Forsgren C, Christeen J (2012) Microwave assisted pyrolysis of residual fractions of waste electrical and electronic equipment. *Miner Eng* 29:105–111



# Index

## A

Acrylamide (AM), 96, 138–142, 277, 282  
Acrylic resins, 261  
Acrylonitrile butadiene styrene (ABS), 342  
Agarose, amino-functional, 218  
Aldol condensation, 21  
Alginate acid, 220  
Alkenes, 11, 228  
    hydrogenation, 22  
    metathesis, 11  
Alkoxy-carbonylation, 22  
Allyl phenyl ether, 16  
Amino alcohols, 73, 186  
Aminolysis, 187, 313, 322  
2-Amino-4-nitrophenol (4-NAP), 108  
3-Aminophthalic anhydride, 60  
Amylopectin, 215  
Anomerization, 21  
2-Arylpyridine, 13  
Atom transfer radical polymerization (ATRP),  
    90, 131, 134, 139, 230  
Atrazine, 108  
Azaluminazines, 26  
Azides, 28  
    cycloaddition, 14, 230

## B

Bacterial cellulose (BC), 278  
Baeyer–Villiger reaction, 77  
Batch reactors, 295  
Baylis–Hillman reaction, 21  
Beckmann rearrangement, 29  
Benzimidazole, 72  
Biginelli reaction, 20

Biodegradability, 310  
Biomaterials, crosslinked, 337  
3,3-Bis(chloromethyl)oxetane (BCMO), 59  
Bis(2-hydroxyethyl) terephthalamide  
    (BHETA), 313  
Bisphenol-A (BPA), 59, 73, 175, 254, 326  
Bisphenol-F/epichlorohydrin epoxy resin, 246  
BODIPY, 122  
Borylation, 10  
*N-p*-Bromophenylmaleimide (BrPMI), 97  
Buckminsterfullerene, 272  
Butyl acrylate (BA), 108, 290

## C

Carbohydrates, 14, 212, 220  
Carbon black, 241, 245, 340  
Carbon dots, 211  
Carbon nanomaterials, 209  
Carbon nanotubes (CNTs), 121, 245, 250, 272  
Carboxymethylation, 218  
Carboxymethyl cellulose (CMC), 272  
Carrageenan, 215  
Cationic ring-opening polymerization  
    (CROP), 185  
C–C coupling, 45, 76  
Cellulose, 214, 215, 222, 272  
    bacterial, 278  
C–H bonds, 12  
Chemical recycling, 309  
Chitin, 170, 215, 222  
Chitosan, 215, 219, 272  
Chitosan-*graft*-(PDLA-*stat*-PLLA), 160  
Cinchona alkaloids, 21  
Citalopram, 30

- Claisen rearrangement, 16, 17  
 Click reactions, 14, 197, 233, 296  
 Combinatorial chemistry, 1, 24  
 Composites, 241, 246  
 Condensation reactions, 17  
 Continuous-flow processing, 31  
   organic synthesis, 1, 4  
 Controlled radical polymerization (CRP), 133  
 Copoly(2-oxazoline)s, 185, 195, 299  
 Copper, 13  
 Coumarins, Pechmann synthesis, 20  
 Coupling reactions, 10, 25, 49, 76, 288  
 Cyanopyridines, 26  
 Cycloaddition, 1, 15, 21, 26, 188, 230, 233
- D**  
 Dean–Stark trap, 18  
 Dealumazines, 26  
 Dehydrochlorination, 339  
 Depolymerization, PET, 175, 313, 320–324  
   PLLA, 157  
   polycarbonate, 327, 328  
   PU, 330  
 Devulcanization, 340  
 Dextrins, 214  
 Diallyldimethylammonium chloride  
   (DADMAC), 136  
 Diamines, 65  
 Dieckmann condensations, 17  
 Diels–Alder reaction, 15, 22, 27, 223, 230  
 Dienyne ring-closing metathesis, 12  
 Diglycidyl ether of bisphenol A  
   (DGEMA), 260  
 1,4-Dihydropyridines (DHPs), 23  
*N,N*-Dimethylacetamide (DMAc),  
   66, 275, 285  
*N,N*-Dimethylacrylamide (NDMAM),  
   96, 137  
 Dimethylamine, 228  
*N,N*-Dimethylaminoethyl acrylate (DMA),  
   100, 137, 141  
 Dimethylaminoethyl methacrylate  
   (DMAEMA), 97  
 1,3-Dimethylbutadiene, 17  
 Dimethylformamide (DMF), 5, 100, 169, 187  
 Dimethylfulvene, 15  
 1,3-Dimethylimidazolidone (DMI), 50, 56  
 Dimethylsulfoxide (DMSO), 5, 60, 66,  
   169, 214  
 Dimethyl terephthalate (DMT), 258, 313, 321  
 Dioxanone, 172  
 3,6-Di(pyridine-2-yl)pyridazine, 230  
 Direct ethanol fuel cells (DEFCs), 271  
 Dopamine, 71
- E**  
 Electrodeless discharge lamps (EDLs), 23  
 Enhanced microwave synthesis (EMS), 135  
 Epibrassinolide, 108  
 Epoxy/MMT, 259  
 Epoxy resins, 246, 259–261  
 Esterification, 18, 32, 216, 225  
 Ethyl acetate, 6  
 Ethylene glycol dimethacrylate (EDMA),  
   264, 267  
 Ethylene-propylene-diene rubber (EPDM-r), 340  
 2-Ethylhexyl acrylate (EHA), 96  
 2-Ethyl-2-oxazoline, 299  
 Fe<sub>3</sub>O<sub>4</sub>/poly(styrene-*co*-acrylamide), 284  
 Flow reactors, 295  
 Fluorination, 13  
 Free radical polymerizations, 87, 91, 134,  
   222, 296  
 Fullerenes, 16, 241, 272  
 Functionally graded materials (FGMs), 249
- G**  
 Gases, 21  
 Gas-loading accessory, 22  
 Gellan gum, 120  
 Glass/epoxy laminates, 246  
 Glycolysis, 313, 329  
 Glycopeptides, 233  
 Gold, 14  
 Graphene, 213, 261  
   oxide, 252  
   sheets (GS), 121  
 Graphite, 5, 212, 245, 248, 286, 311  
 Graphite oxide, 261  
 Guar gum-*graft*-PCL, 171
- H**  
 Hantzsch reaction, 20  
 Heating, aids (passive heating elements), 5  
   conventional, 87, 324  
 Hemicellulose, 217  
 Hetero-Diels–Alder cycloadditions, 16  
 Heterogeneous polymerization, 87  
 Hexadecyl trimethyl ammonium bromide  
   (HDTMAB), 318  
 High impact polystyrene (HIPS), 342  
 High-density polyethylene (HDPE), 51, 248,  
   311, 340–342  
 Homogeneous polymerization, 87  
 Homopoly(2-oxazoline)s, 185, 189, 193  
 Huisgen cycloaddition, 14  
 Humic acids, 290  
 Hybrids, 241

**I**

Imines, solvent-free synthesis, 20  
Inorganic materials, 241  
Inulin, 218  
Iodoarenes, 12  
Ionic liquids, 5, 17, 23, 53, 101, 167, 174, 193, 214, 277, 299  
Iridium, 13

**K**

Knoevenagel condensations, 17

**L**

Lactams, 28, 151, 188  
Lactic acid, 64, 152, 155, 298, 300, 304, 337, 339  
  esterification, 32  
Layered double hydroxides (LDHs), 245, 258

**M**

MACOS (microwave-assisted continuous-flow organic synthesis), 27  
Magnetic nanoparticles, 284  
Mannich reaction, 21  
Metal catalysis, 1, 10  
Methacryloxypropyltrimethoxysilane, 266  
Methanolysis, 160, 312, 313, 323, 330  
Methyl acrylate (MA), 96  
Methyl ethyl ketone, 6  
Methyl methacrylate (MMA), 96, 136, 267, 334  
*N*-Methyl pyrrolidinone (NMP), 6  
8-Methylquinoline, 13  
Methyltrimethoxysilane (MeTMOS), 122  
Michael addition, 21, 30, 288  
Microcapillary reactors, 28  
Microwave-assisted ring-opening polymerization (MROP), 256  
Modes, 4, 6, 132, 135, 144, 217  
Molybdenum, 14  
Monomode microwave unit, 4, 7  
Montmorillonite, 159, 166, 246, 254  
Multicomponent reactions (MCRs), 19–26  
Multimode microwave unit, 4, 29, 92, 118, 134, 188, 247, 300  
Multiwalled carbon nanotubes (MWCNTs), 54, 115, 260, 272, 279

**N**

Nafion, 269–272  
Nanotubes, 16, 121, 245, 250, 272  
Nitroxide-mediated radical polymerization (NMP), 90, 131, 134, 138  
Non-thermal microwave effects, 3, 9, 149, 183

**O**

Oligonucleotides, 14  
Open-vessel mode, 7, 18  
  batch, 28, 29  
Organic light-emitting diode (OLED), 262  
Organocatalysis, 1, 21  
1-Oxa-2-oxocyclooctanone, 77  
2-Oxazolines, 151, 155, 183, 185

**P**

Palladium, 10, 13, 27, 30, 76  
Parallel processing, 24  
PBIOXA, 317  
Pechmann synthesis, 20  
Pectin, 217  
Penetration, ability, 32, 88  
  depth, 133, 144, 194, 295, 298, 304  
Pentaerythritol, 331  
PEO-PPO-PEO, 211  
Peptides, synthesis, 26  
PHA-*block*-(PDLA-*stat*-PLLA), 159  
Phase-transfer catalysis (PTC), 59  
*o*-Phenylenediamine (oPD), 252  
Phenylethynyl-terminated polyimide, 249  
2-Phenyl-2-oxazoline, 191  
PLLA-*block*-PEG-*block*-PLLA, 162  
Polyamides, 149, 175, 309, 332  
  polyamide-6 (PA-6), 332  
Polyamidoamine (PAMAM), dendrimers, 287  
Polycarbonates, 173, 254, 309, 326  
Polycinnamamide (PCMA), 288  
Polydioxanone, 172  
Polyesters, 149, 309  
Polyethylene, 51, 223, 248, 250, 309  
Polyethylene glycol, 75  
Polyimide-(carbon fiber) composites, 249  
Polymer degradation, 309  
Polymer modification, 209  
Polysaccharides, 209, 214  
Polystyrene (PS), 25, 223, 309, 334, 342  
Polythiophenes, sequential borylation/Suzuki coupling, 10  
Polyurethanes (PU), 246, 309, 330  
Poly(acrylamide-aniline)-grafted gum ghatti, 283  
Poly(acrylic acid) (PAA), 225  
Poly(acrylic)/SiO<sub>2</sub>/TiO<sub>2</sub>, 264  
Poly(alkyl methacrylate)s, 309, 334  
Poly(alkylene hydrogen phosphonate)s, 64  
Poly(amide)s (PA)s, 50  
Poly(amide-ester)s, 73  
Poly(amide-ether-urethane)s, 75  
Poly(amide-imide)s (PAIs), 67, 285  
Poly(amide-imide-urethane)s (PAIUs), 75  
Poly(butyl acrylate) (PBA), 108, 335

- Poly(butyl methacrylate) (PBMA), 114, 335  
 Poly( $\epsilon$ -caprolactone)s (PCL), 149, 151, 163, 256  
 Poly(carbazole), 267  
 Poly(2,5-dibutoxy-1,4-phenylenevinylene), 77  
 Poly(ester-imide)s (PEIs), 73  
 Poly(ester)s, 63  
 Poly(ether-ester)s, 73  
 Poly(ether-imide)s, 73  
 Poly(ether)s, 59  
 Poly(ethyl acrylate) (PEA), 335  
 Poly[ethylene-*co*-(acrylic acid)] (PE-*co*-PAA), 225  
 Poly(ethyleneglycol), 263  
 Poly(ethylene imine), 209, 223  
 Poly(ethylene oxide), (PEO) 254, 337  
 Poly(ethylene terephthalate) (PET), 258, 309, 312  
 Poly(ethylene terephthalate-*co*-isophthalate), 175  
 Poly(ethyl methacrylate) (PEMA), 335  
 Poly(2-ethyl-2-oxazoline) (PEtOx), 228  
 Poly(glycolic acid), 153  
 Poly(3-hydroxy alkanooate)s (PHAs), 159  
 Poly(2-hydroxyethyl methacrylate) (PHEMA), 337  
 Poly(imide)s (PI)s, 56  
 Poly(lactic acid)s, 66, 149, 155  
 Poly(lactide-*co*-glycolide) (PLGA), 339  
 Poly(methyl acrylate) (PMA), 335  
 Poly(methyl methacrylate) (PMMA), 92, 98, 100, 109, 113, 263, 311, 334  
 Poly(2-methyl-2-oxazoline) (PMeOx), 228  
 Poly(methyl vinyl ether-*alt*-maleic anhydride), 228  
 Poly(2-*n*-nonyl-2-oxazoline), 229  
 Poly(2-oxazoline)s (POx), 183, 228  
 Poly(*o*-phenylenediamine)/reduced graphene oxide (PoPD/RGO), 252  
 Poly(*m*-phenyleneethynylene)s, 76  
 Poly(2-phenyl-2-oxazoline) (PPhOx), 229  
 Poly(propylene) (PP), 284  
 Poly(tetrafluoroethylene) (PTFE), 30, 249, 250, 269, 337  
 Poly(thiourea)s, 65  
 Poly(urea)s, 65  
 Poly(vinyl acetate) (PVAc), 92, 137  
 Poly(vinyl alcohol) (PVA), 158, 170, 336  
 Poly(vinyl carbazole), 267  
 Poly(vinyl chloride) (PVC), 228, 338  
 Poly(vinylpyrrolidone) (PVP), 263  
 Post-polymerization modification, 183, 209  
 Proline, 21  
 Proteins, binding, 198  
     co-precipitation, 221  
     hydrolysis, 25  
     immobilization, 284  
 PTFE/C, 269  
 Pyrolysis, 309, 311, 334  
     microwave-assisted, 309, 340
- R**
- Ractopamine, 108  
 Rearrangement, 1, 26, 29  
 Reversible addition-fragmentation chain transfer (RAFT) polymerization, 90  
 Rhodium, 12, 23  
 Ring-closing metathesis (RCM), 11  
 Ring-opening polymerization, 3, 45, 87, 149, 183, 256, 296, 299, 302  
 Rubber, 225  
     devulcanization, 340  
     ethylene-propylene-diene rubber (EPDM-r), 340  
 Ruthenium, 11
- S**
- Safety, 9, 31, 89, 101, 132  
 Scale-up, 1, 28  
 Sealed-vessel batch processing, 30  
 Sebacic acids, 51, 73  
 Silicon carbide (SiC), 5, 17, 324  
 Simultaneous cooling, 4, 21, 139, 142  
 Single-walled nanotubes (SWCNTs), 16, 272  
 Solid-phase organic synthesis, 25  
 Solvent-free reactions, 20  
 Solvolysis, 309  
 Stable free radical polymerization (SFRP), 134  
 Starch, 214, 217  
 Step-growth polymerization, 45, 49, 89, 174, 230  
 Suzuki coupling, 10, 25, 27, 76
- T**
- Terephthalic dihydrazide, 316  
 Thiophenes, 10  
 Tipranavir, 14  
 Transesterification, 17, 63, 153, 160, 165, 221, 330

Trimethylene carbonate (TMC), 173  
Trioctyl methyl ammonium bromide  
(TOMAB), 318  
Triyne ring-closing metathesis, 12

**U**

Ugi reaction, 20  
Upscaling, 295–305  
Urazoles, 66

**V**

Van't Hoff rule, 89

**X**

Xanthates, 134

**Z**

Zn-Mn ferrite, 339  
ZnCl<sub>2</sub>, 333  
ZnO, 314, 325  
    nanoparticles, 263  
    PMMA, 263  
ZnSO<sub>4</sub>, 315