

ADVANCES IN NATURAL AND TECHNOLOGICAL HAZARDS RESEARCH



A. Iglesias · L. Garrote · A. Cancelliere  
F. Cubillo · D. Wilhite (Eds.)

# Coping with Drought Risk in Agriculture and Water Supply Systems

Drought Management and Policy Development  
in the Mediterranean



 Springer

# Coping with Drought Risk in Agriculture and Water Supply Systems

# Advances in Natural and Technological Hazards Research

---

VOLUME 26

---

For further volumes: <http://www.springer.com/series/6362>

# Coping with Drought Risk in Agriculture and Water Supply Systems

## Drought Management and Policy Development in the Mediterranean

*Edited by*

**Ana Iglesias**

*Department of Agricultural Economics and Social Sciences,  
Universidad Politécnica de Madrid, Spain*

**Luis Garrote**

*Department of Civil Engineering,  
Universidad Politécnica de Madrid, Spain*

**Antonino Cancelliere**

*Department of Civil and Environmental Engineering,  
University of Catania, Italy*

**Francisco Cubillo**

*Canal de Isabel II, Madrid, Spain*

and

**Donald A. Wilhite**

*National Drought Mitigation Center,  
University of Nebraska, NE, USA*





## *Editors*

Dr. Ana Iglesias  
Universidad Politécnica de Madrid  
Depto. Economía y Ciencias Sociales  
Agrarias  
Av. Complutense, s/n  
28040 Madrid, Spain  
ana.iglesias@upm.es

Dr. Luis Garrote  
Universidad Politécnica de Madrid  
Dpt. Ingeniería Civil: Hidráulica y  
Energética  
Av. Complutense, s/n  
28040 Madrid, Spain  
garrote@caminos.upm.es

Dr. Antonino Cancelliere  
Università di Catania  
Dipto. Ingegneria Civile e  
Ambientale  
Viale Andrea Doria, 6  
95125 Catania, Italy  
acance@dica.unict.it

Dr. Francisco Cubillo  
Canal de Isabel II  
Santa Engracia, 125  
28003 Madrid  
Spain  
fcubillo@cyii.es

Dr. Donald A. Wilhite  
University of Nebraska  
School of Natural Resources  
National Drought Mitigation Center  
239 L.W. Chase Hall  
Lincoln NE 68583-0749  
USA  
dwilhite@unlnotes.unl.edu

This book has been written within the framework of the MEDROPLAN (Mediterranean Drought Preparedness and Mitigation Planning) Project, co-funded by the European Union through the Euro-Mediterranean Regional Programme for Local Water Management (MEDA Water) and the Mediterranean Agronomic Institute of Zaragoza - CIHEAM (Spain; Coordinator), Universidad Politécnica de Madrid (Spain), University of Cyprus (Cyprus), National Technical University of Athens (Greece), University of Catania (Italy), Institut Agronomique et Vétérinaire Hasan II (Morocco), Canal de Isabel II (Spain), Confederación Hidrográfica del Tajo (Spain), Fundación Ecología y Desarrollo (Spain) and Ministère de l'Agriculture, de l'Environnement et des Ressources Hydrauliques (Tunisia).

ISBN: 978-1-4020-9044-8

e-ISBN: 978-1-4020-9045-5

DOI 10.1007/978-1-4020-9045-5

Library of Congress Control Number: 2008938018

© Springer Science+Business Media B.V. 2009

No part of this work may be reproduced, stored in a retrieval system, or transmitted in any form or by any means, electronic, mechanical, photocopying, microfilming, recording or otherwise, without written permission from the Publisher, with the exception of any material supplied specifically for the purpose of being entered and executed on a computer system, for exclusive use by the purchaser of the work.

Printed on acid-free paper

9 8 7 6 5 4 3 2 1

springer.com

# Preface

Over the last three decades drought episodes have resulted in severe social problems in Mediterranean countries, receiving wide attention from the international scientific and policy communities. The experiences in the development and implementation of drought management plans highlight the success and challenges of coping with drought for societies with different vulnerabilities. Based on these experiences and the current methods for evaluating risk, the book synthesises guidelines for drought management that can be applied to other regions.

This book addresses the growing issue of drought preparedness planning, monitoring, and mitigation, which has worldwide application. The methodologies and lessons learned are focused on a specific, drought-prone region so the applications have more significance. The Mediterranean is a region that has been identified as likely to experience significant climate changes in future decades because of increasing greenhouse gas emissions and other factors. Preparing for climatic extremes (i.e., managing climate variability) is an important first step in preparing for climate change. Finally, the Mediterranean region exemplifies many other drought-prone regions with rapidly expanding populations that are placing increased pressure on already limited water supplies.

The book comprises several chapters divided into three sections that appeal to a broad audience. First, the policy, social and hydrological context of Mediterranean countries is presented, discussing the interactions that have resulted in the complex institutional framework, and highlighting the common elements that support further drought policy development. Drought monitoring is a common element in all cases and is the essential first step for moving from disaster to risk management. This section emphasises the role of organizations, institutions, and civil stakeholders involved in drought preparedness and mitigation and/or on water management for designing effective risk-based strategies that mitigate the effects of drought in agriculture, water supply systems, and the environment. Finally, this section includes a chapter that presents guidelines for developing drought management plans. The management actions related to agriculture and water supply systems are presented with a common conceptual framework based on the use of drought indicators for evaluating the levels of drought risk (pre-alert, alert, and emergency), that allow linkages between science and policy to be established.

Second, the book presents scientific approaches to risk evaluation, including characterization of drought episodes, development of indicators of risk in agricultural and water supply systems, and analysis of the role of economic instruments and groundwater for risk mitigation. This section finalises with the description of an integrated method for evaluating social vulnerability and a discussion of methods for social participation to solve water-related conflicts.

The third section includes a collection of case studies with the description of effective measures taken in the past. These case studies provide the context for developing demand-driven guidelines that may be applied to other regions. The authors of these chapters can be viewed as stakeholders in drought management since they represent a broad range of sectors and institutions from Mediterranean European and North African countries. The topics addressed have implications for the international policy community interested in disaster mitigation, agricultural policy, and development.

This book is mainly a result of the collaborative research carried out within the framework of the Medroplan project (supported by the European Union MEDA-Water Programme) that analyses drought and water scarcity management in Mediterranean countries promoting a risk-based preparedness and mitigation approach. The multi-disciplinary efforts of the Medroplan teams produced a systematic approach to assist in the development of drought and water scarcity management plans linking science and policy (<http://www.iamz.ciheam.org/medroplan>). The contribution of all Medroplan research teams and collaborators is acknowledged for their valuable input. We acknowledge the support of the participant institutions and especially the Mediterranean Agronomic Institute of Zaragoza (IAMZ-CIHEAM) that coordinated the project and continues to support the NEMEDCA Network on Drought Management for the Near East, Mediterranean and Central Asia.

Madrid, Spain  
Madrid, Spain  
Catania, Italy  
Madrid, Spain  
Lincoln, NE

*Ana Iglesias*  
*Luis Garrote*  
*Antonino Cancelliere*  
*Francisco Cubillo*  
*Donald Wilhite*

# **Acknowledgment**

This book could only be realized thanks to priceless contributions of Antonio López-Francos of CIHEAM and Marta Moneo of the UPM coordinating the work of all authors during the four years of the MEDROPLAN project.

# Contents

## Part I Challenges to Drought Management in Mediterranean Countries

- 1 Drought Monitoring as a Component of Drought Preparedness Planning** ..... 3  
Donald A. Wilhite
- 2 Soft Law Principles for Improving Drought Management in Mediterranean Countries** ..... 21  
Esther López-Barrero and Ana Iglesias
- 3 A Checklist for Drought Policy Development** ..... 37  
Nicos X. Tsiourtis
- 4 An Environmental Focus on Drought: The Water Framework Directive** ..... 43  
Abel La Calle Marcos
- 5 Guidelines to Develop Drought Management Plans** ..... 55  
Ana Iglesias, Luis Garrote and Antonino Cancelliere

## Part II Methods and Approaches for Drought Management

- 6 Drought Characterisation in the Mediterranean** ..... 69  
G. Tsakiris and D. Pangalou
- 7 A Paradigm for Applying Risk and Hazard Concepts in Proactive Planning** ..... 81  
G. Tsakiris

<b>8</b>	<b>Assessment of Drought Risk in Water Supply Systems</b> . . . . .	93
	Antonino Cancelliere, Vincenzo Nicolosi and Giuseppe Rossi	
<b>9</b>	<b>Mathematical Models for Reservoir Operation in Tunisia</b> . . . . .	111
	M.H. Louati and F. Lebdi	
<b>10</b>	<b>Risk Management Instruments Supporting Drought Planning and Policy</b> . . . . .	133
	Alberto Garrido and Almudena Gómez-Ramos	
<b>11</b>	<b>Methods for Evaluating Social Vulnerability to Drought</b> . . . . .	153
	Ana Iglesias, Marta Moneo and Sonia Quiroga	
<b>12</b>	<b>Methods for Social Participation and Conflict Resolution</b> . . . . .	161
	Ignacio Celaya, Antonio Rodríguez Perea and Xavi Carbonell	
 <b>Part III Learning from the Case Studies</b>		
<b>13</b>	<b>Development of Drought Management Plans in Spain</b> . . . . .	175
	Luis Garrote, Ana Iglesias and Francisco Flores	
<b>14</b>	<b>Characterizing Drought Risk in a Sicilian River Basin</b> . . . . .	187
	Giuseppe Rossi, Brunella Bonaccorso, Vincenzo Nicolosi and Antonino Cancelliere	
<b>15</b>	<b>The Role of Groundwater During Drought</b> . . . . .	221
	María Casado Sáenz, Francisco Flores Montoya and Roberto Gil de Mingo	
<b>16</b>	<b>Drought Severity Thresholds and Drought Management in Greece</b> . . . . .	243
	D. Pangalou, D. Tigkas, H. Vangelis, G. Tsakiris and A. Nanou-Giannarou	
<b>17</b>	<b>Using and Testing Drought Indicators</b> . . . . .	257
	Luis García Amor, Alejandro Carrasco and Juan Carlos Ibáñez	
<b>18</b>	<b>Drought Management in the Urban Water Supply System of Canal de Isabel II, Spain</b> . . . . .	273
	Francisco Cubillo	

**19 The Role of Non-Conventional and Lower Quality Water for the Satisfaction of the Domestic Needs in Drought Management Plans** ..... 287  
Nicos X. Tsiourtis

**Annex 1 Glossary of Terms and Concepts** ..... 299

**Index** ..... 311

**CD-ROM enclosed, containing the Medroplan Drought Management Guidelines in several languages and a tutorial for application.**

# Contributors

## The editors

*Prof. Ana Iglesias* was the scientific coordinator of the MEDROPLAN project for the development of guidelines for drought management plans within the MEDA-Water programme of the European Union. She is a Professor in the Department of Agricultural Economics and Social Sciences at the Universidad Politecnica de Madrid in Spain. Her research focuses on understanding the interactions of global change with land and water resources. Scientific advances include national and regional evaluations of adaptation strategies, focusing on the risk of vulnerable populations. She has contributed to programmes of the U.N. Environmental Programme, UNESCO, U.S. Agency for International Development, and U.S. Environmental Protection Agency. She is currently a member of the Executive Board of the Integrated Project CIRCE (EU 6<sup>th</sup> Framework Programme) and co-leads research in relevant society strategies for adaptation to climate change. Her collaborative work has been published in over one hundred research papers.

*Prof. Luis Garrote* is a Professor of the Department of Civil Engineering, Hydraulics and Energetics at the Universidad Politecnica de Madrid in Spain and received formal training at the Massachusetts Institute of Technology, USA. His academic and scientific contributions to planning and management of hydrological systems include the development of hydrological models, flood forecasting, reservoir management, and intelligent decision support systems. His distinguished professional record in integrated water resources management includes collaborations with National and International Administrations. He has widely developed applied projects financed by research and development programmes of private companies, the Spanish Ministry of Education, Science and Technology, and the European Union.

*Prof. Antonino Cancelliere* is Professor of Water Resources Management at the University of Catania, College of Engineering, Italy. He graduated in Civil Engineering from the University of Catania and obtained his MSc and PhD in Civil Engineering at Colorado State University. His main research interests are in the field of stochastic hydrology, hydrological extremes with special reference to droughts and water supply systems modelling. He has coordinated and participated in several



research projects on drought analysis and management funded by the European Union, the Italian Ministry for the University and Research and other institutions. He has been the coordinator of the Italian team for Medroplan. He is the author of more than 70 papers in the field of stochastic hydrology, drought analysis and mitigation and water supply systems management and co-editor of an international book on drought mitigation.

*Francisco Cubillo* is the Deputy Director of I+D+I (Research, Development & Innovation) in Canal de Isabel II, Spain. He counts on more than 30 years of experience in the Management of Hydraulic Supply, Resources, Environment & Demand Management in the private and public sectors. In IWA (International Water Association), he chairs the international specialized group EO&M (Efficient Operations and Management Specialist Group); he is a member of the Strategic Council, the Programme Committee and the Utilities Steering Group. He is also the director of the International conferences Efficient. He is a member of the Expert Committee for Droughts of the Spanish Ministry of the Environment and Rural and Marine Affairs, and was a representative of the Ministry of the Environment and Rural and Marine Affairs at the (GCAG) Government Consultative Advisory Group DDP (Dams and Development Programme) of UNEP. Cubillo has published 13 books and more than 100 technical papers, and has lectured in a wide variety of courses on Management Supply Systems, Hydrology, Technological Development and Environment.

*Prof. Donald Wilhite* is the Director of the School of Natural Resources at the University of Nebraska–Lincoln, USA, where he has been on the faculty since 1977. Prof. Wilhite directed the National Drought Mitigation Center and the International Drought Information Center for over two decades. His research centers on drought management and preparedness, the policy implications of climate variability and climate change, and the effects of climate on society. In conjunction with this research, he has conducted training seminars and workshops in developing and developed countries to help governments create drought plans. The ongoing challenge of Prof. Wilhite's work is convincing policy makers of the advantages of drought preparedness plans and mitigation actions and programs, in contrast to the more typical crisis management approach. Policy makers often do not understand drought climatology, and scientists have trouble providing probability-based information in a format that non-scientists can comprehend. Risk-based drought management can eliminate or reduce many of the impacts associated with drought-induced water shortages. Governments at all levels should take a multidisciplinary, interagency approach to drought planning as pressure on water and other natural resources increases as a result of increasing and shifting population and many other factors.

## Authors

**Brunella Bonaccorso** Department of Civil and Environmental Engineering, University of Catania, V.le A. Doria 6, 95125 Catania, Italy, Phone: +39 0957382702, Fax: +39 0957382748, bbonacco@dica.unict.it

**Antonino Cancelliere** Department of Civil and Environmental Engineering, University of Catania, V.le A. Doria 6, 95125 Catania, Italy, Phone: +39 0957382718, Fax: +39 0957382748, [acance@dica.unict.it](mailto:acance@dica.unict.it)

**Xavi Carbonell** ARC Mediación Ambiental, Calle Figuera, 2, 22720 Echo (Huesca), Spain, Phone: +34 974 37 52 68, Fax: +34 974 37 50 23 22720, [rmediacion@arcmediacion.com](mailto:rmediacion@arcmediacion.com)

**Alejandro Carrasco** GETINSA, Canal de Isabel II, Santa Engracia, 125, 28003 Madrid, Spain, Phone: +34 915451000, Fax: +34 915533100, [acarrasco@getinsa.es](mailto:acarrasco@getinsa.es)

**María Casado Sáenz** Confederación Hidrográfica del Tajo, Av. de Portugal, 81, 28070 Madrid, Spain, Phone: +34 91 4539787, [maria.casado@chtajo.es](mailto:maria.casado@chtajo.es)

**Ignacio Celaya** Fundación Ecología y Desarrolla, Plaza San Bruno, 9, 50001 Zaragoza, Spain, [ecodes@ecodes.org](mailto:ecodes@ecodes.org)

**Francisco Cubillo** Canal de Isabel II, Santa Engracia, 125, 28003 Madrid, Spain, Phone: + 34 915451000, Fax: + 34 915451808, [fcubillo@cyii.es](mailto:fcubillo@cyii.es)

**Francisco Flores Montoya** Consejo de Obras Públicas, Ministerio de Fomento, c/ Fruela, 6, 28011 Madrid, Spain, Phone: +34 91 5978990, [fflores@fomento.es](mailto:fjflores@fomento.es)

**Luis García Amor** GETINSA, Canal de Isabel II, Ramón de Aguinaga, 8, 28028 Madrid, Spain, Phone: +34 91 418 21 10, Fax: +34 91 418 21 12, [lgarcia@getinsa.es](mailto:lgarcia@getinsa.es)

**Alberto Garrido** Department of Agricultural Economics and Social Sciences, Universidad Politécnica de Madrid (UPM), Spain, Phone: +34 913365782, Fax: +34 913365797, [alberto.garrido@upm.es](mailto:alberto.garrido@upm.es)

**Luis Garrote** Department of Civil Engineering, Hydraulics and Energy, Universidad Politécnica de Madrid (UPM), E.T.S.I. Caminos – Calle Profesor Aranguren, sn, 28040 Madrid, Spain, Phone: +34 913366751, [garrote@caminos.upm.es](mailto:garrote@caminos.upm.es)

**Roberto Gil de Mingo** Consejo de Seguridad Nuclear, C/ Justo Dorado, 11, 28040 Madrid, Spain, Phone: +34 91 346 01 00, Fax: +34 91 346 05 88, [rgm@csn.es](mailto:rgm@csn.es)

**Almudena Gómez-Ramos** Dpto. de Ingeniería Agrícola y Forestal (Economía, Sociología y Política Agraria), E.T.S. de Ingenierías Agrarias, Universidad de Valladolid, Av. de Madrid, 57, 34004 Palencia, Spain, Phone: +34 979 10 84 44, [almgomez@iaf.uva.es](mailto:almgomez@iaf.uva.es)

**Juan Carlos Ibáñez** Canal de Isabel II, Santa Engracia, 125, 28003 Madrid, Spain, Phone: +34 915451000, Fax: +34 915533100, jci@cyii.es

**Ana Iglesias** Department of Agricultural Economics and Social Sciences, Universidad Politécnica de Madrid (UPM), Spain, Phone: +34 913365794, Fax: +34 913365797, ana.iglesias@upm.es

**Abel La Calle Marcos** University of Almeria, Ctra. Sacramento s/n, La Cañada de San Urbano, 04120 Almería, Spain, Phone: +34 950 01 50 52, Fax: +34 950 01 50 52, alacalle@ual.es

**Fethi Lebdi** INAT, 43, Rue Charles Nicole, Cité Mahrajène, 1082 Tunis, Tunisia, Phone: +216 71 287110 / 840270, Fax: +216 71 799391, lebdi.fethi@iresa.agrinet.tn

**Esther López-Barrero** Department of Agricultural Economics and Social Sciences, Universidad Politécnica de Madrid (UPM), Spain, Phone: +34 913365794, Fax: +34 913365797, esther.lopez@upm.es

**Mohamed El Hedi Louati** Direction Générale des Barrages et des Grands Travaux Hydrauliques (DGBGTH), Ministère de l'Agriculture, et des Ressources Hydrauliques, 30, rue Alain Savary, 1002 Tunis, Tunisia, Phone: +216 71 840289, Fax: 892518, louati@iresa.agrinet.tn

**Marta Moneo** Dept. of Agricultural Economics and Social Sciences, Universidad Politécnica de Madrid (UPM), Spain, Phone: +34 913365794, Fax: +34 913365797, marta.moneo@upm.es

**Aikaterini Nanou-Giannarou** Lab. of Applied Hydraulics, School of Civil Engineering, National Technical University of Athens, Greece, Phone: +30 2107722811, knanou@central.ntua.gr

**Vincenzo Nicolosi** Department of Civil and Environmental Engineering, University of Catania, V.le A. Doria 6, 95125 Catania, Italy, Phone: +39 0957382718, Fax: +39 0957382748, vmnico@dica.unict.it

**Dialekti Pangalou** Lab. of Reclamation Works and Water Resources Management, School of Rural and Surveying Engineering, National Technical University of Athens, Greece, Phone: +302 107722700, Fax: +30 2107722632, gtsakir@central.ntua.gr

**Sonia Quiroga** Departamento de Estadística, Estructura Económica y O.E.I. Universidad de Alcalá, Plaza de la Victoria, 2, 28806 Alcalá de Henares, Spain, Phone: +34 91 885 51 98, Fax: +34 91 885 42 01, sonia.quiroga@uah.es

**Antonio Rodríguez Perea** Departament de Ciències de la Terra, Universitat de les Illes Balears, Cra. de Valldemossa km 7, 5, E-07122 Palma de Mallorca, Illes Balears, Spain, Phone: +34 971173162, arperea@uib.es

**Giuseppe Rossi** Department of Civil and Environmental Engineering, University of Catania, V.le A. Doria 6, 95125 Catania, Italy, Phone: +39 0957382718, Fax: +39 0957382748, grossi@dica.unict.it

**Dimitris Tigkas** Lab. of Reclamation Works and Water Resources Management, School of Rural and Surveying Engineering, National Technical University of Athens, Greece, Phone: +30 2107722700, Fax: +30 2107722632, gtsakir@central.ntua.gr

**George Tsakiris** Centre for the Assessment of Natural Hazards and Proactive Planning and Lab. of Reclamation Works and Water Resources Management, School of Rural and Surveying Engineering, National Technical University of Athens, Athens, Greece, Phone: +30 2107722700, Fax: +30 2107722632, gtsakir@central.ntua.gr

**Nicos X. Tsiourtis** Technical Consultant, 4, Epidavrou street, P.C. 2114, Platy, Aglanzia, Nicosia, Cyprus, Phone: +357 2 2332226, Fax: +357 22 33 22 26, tsiourti@globalsoftmail.com

**Harris Vangelis** Lab. of Reclamation Works and Water Resources Management, School of Rural and Surveying Engineering, National Technical University of Athens, Phone: +30 2107722700, Fax: +30 2107722632, gtsakir@central.ntua.gr

**Donald A. Wilhite** School of Natural Resources, 239 L.W. Chase Hall, University of Nebraska, Lincoln, NE 68583-0749, USA, Phone: +1 402 472 4270/402 472 6707, Fax: +1 402 472 6614, dwilhite2@unl.edu

**Part I**  
**Challenges to Drought Management**  
**in Mediterranean Countries**

# Chapter 1

## Drought Monitoring as a Component of Drought Preparedness Planning

Donald A. Wilhite

**Abstract** Drought is the most complex of all natural hazards. The lack of progress in drought preparedness planning and the development of national drought policies is a reflection of this complexity. As countries move toward a higher level of preparedness, drought monitoring and early warning systems become paramount because these systems provide the information necessary to make timely decisions regarding the management of water and other natural resources. Just as critically important is the development of delivery systems that provide decision makers at all levels and for all primary sectors with data and information that will assist them in making timely decisions. These decision support tools provide end users with information they need to reduce the most serious consequences of drought and reduce the need for government and donor intervention in the form of drought assistance and relief. The goal is to create more drought resilient societies. With the demand for water increasing because of expanding population, urbanization, changes in land use, and many other factors, the time to move to a more risk-based drought management approach is now. Given projected increases in temperature and uncertainties regarding the amount, distribution, and intensity of precipitation, the frequency, severity, and duration of drought may increase in the future. Developing improved drought monitoring and early warning systems in support of drought preparedness planning and policy is an urgent need for all drought-prone countries.

### Introduction

Drought is an insidious natural hazard that results from a deficiency of precipitation from expected or “normal” such that when it is extended over a season or longer period of time, the amount of precipitation is insufficient to meet the demands of human activities and the environment. Drought is a temporary aberration, unlike aridity, which is a permanent feature of the climate. Seasonal aridity (i.e., a well-defined dry season) also needs to be distinguished from drought. These terms

---

D.A. Wilhite (✉)

School of Natural Resources, University of Nebraska-Lincoln, NE, USA  
e-mail: dwilhite2@unl.edu

are often confused or used interchangeably. The differences need to be understood and properly incorporated in drought monitoring and early warning systems and preparedness plans.

Drought must be considered a relative, rather than absolute, condition. It occurs in both high and low rainfall areas and virtually all climate regimes. Scientists, policy makers, and the public often associate drought strictly with arid, semi-arid, and sub-humid regions. In reality, drought occurs in most nations, in both dry and humid regions. Drought is a normal part of climate, although the spatial extent and severity of drought will vary on seasonal and annual timescales. In many nations, such as Australia, China, India, and the United States, drought occurs over a portion of the country each year. Because of its frequency of occurrence and the profound impacts associated with drought, nations should devote more attention to the development of a national strategy or policy to reduce its economic, social, and environmental consequences.

Drought is a regional phenomenon and its characteristics will vary from one climate regime to another. Impacts are also regional in nature, reflecting exposure to the hazard and the vulnerability of society to extended periods of precipitation deficits. Impacts are a measure of vulnerability. Risk is a product of exposure to the hazard and societal vulnerability.

Drought by itself is not a disaster. Whether it becomes a disaster depends on its impact on local people, economies, and the environment and their ability to cope with and recover from it. Therefore, the key to understanding drought is to understand both its natural and social dimensions. The goal of drought risk management is to increase the coping capacity of society, leading to greater resilience and reduced need for government or donor interventions in the form of disaster assistance. Drought monitoring and early warning systems are the foundation of a national drought policy and preparedness plan.

## **Drought as Hazard: Concepts and Definitions**

Drought differs from other natural hazards in a variety of ways. Drought is a slow-onset natural hazard that is often referred to as a creeping phenomenon. It is an accumulated departure of precipitation from normal or expected (i.e., a long-term mean or average). This accumulated precipitation deficit may accumulate quickly over a period of time, or it may take months before the deficiency begins to show up in reduced stream flows, reservoir levels, or increased depth to the ground water table. Because of its creeping nature, the effects of drought are often slow to appear, lagging precipitation deficits by weeks or months. Because precipitation deficits usually first appear as deficits in soil water, agriculture is often the first sector to be affected.

It is often difficult to know when a drought begins. Likewise, it is also difficult to determine when a drought is over and on what criteria this determination should be made. Is an end to drought signaled by a return to normal precipitation and, if so, over what period of time does normal or above-normal precipitation need to

be sustained for the drought to be declared officially over? Since drought represents an accumulated precipitation deficit over an extended period of time, does the precipitation deficit need to be erased for the event to end? Do reservoirs and ground water levels need to return to normal or average conditions? Impacts linger for a considerable period of time following the return of normal precipitation, so is the end of drought signaled by meteorological or climatological factors, or by the diminishing negative impact on human activities and the environment?

Another factor that distinguishes drought from other natural hazards is the absence of a precise and universally accepted definition for it. There are hundreds of definitions, adding to the confusion about whether or not a drought exists and its degree of severity. Definitions of drought should be region and application or impact specific. Droughts are regional in extent and, as previously stated, each region has specific climatic characteristics. Droughts that occur in the North American Great Plains will differ from those that occur in Northeast Brazil, southern Africa, the Mediterranean region of southern Europe and North Africa, eastern Australia, or the North China Plain. The amount, seasonality, and form of precipitation differ widely between each of these locations.

Temperature, wind, and relative humidity are also important factors to include in characterizing drought from one location to another. Definitions also need to be application specific because drought impacts will vary between sectors. Drought means something different to a water manager, agricultural producer, hydroelectric power plant operator, and wildlife biologist. Even within sectors, there are many different perspectives of drought because impacts may differ markedly. For example, the impacts of drought on crop yield may differ greatly for maize, wheat, soybeans, and sorghum because they are planted at different times during the growing season and have different water requirements and different sensitivities at various growth stages to water and temperature stress.

Generally speaking, drought impacts are nonstructural and spread over a larger geographical area than are damages that result from other natural hazards such as floods, tropical storms, and earthquakes. This, combined with drought's creeping nature, makes it particularly challenging to quantify impacts and even more challenging to provide disaster relief for drought than for other natural hazards. These characteristics of drought have hindered development of accurate, reliable, and timely estimates of severity and impacts (i.e., drought early warning systems) and, ultimately, the formulation of drought preparedness plans. Similarly, it is difficult for disaster officials that are tasked with the assignment of responding to drought to deal with the large spatial coverage usually associated with its occurrence.

## **Principles of Drought Policy with Linkages to Drought Mitigation Planning**

A drought policy can be the instrument necessary to alter a nation's approach to drought management. In the past decade or so, drought policy and preparedness has received increasing attention from governments, international and regional or-



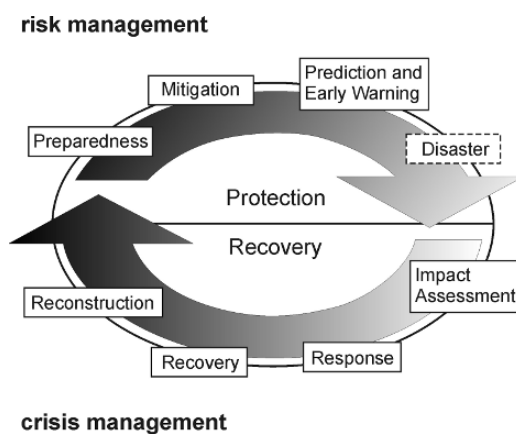
ganizations, and nongovernmental organizations. Simply stated, a national drought policy should establish a clear set of principles or operating guidelines to govern the management of drought and its impacts. The policy should be consistent and equitable for all regions, population groups, and economic sectors and consistent with the goals of sustainable development. The overriding principle of drought policy should be an emphasis on risk management through the application of preparedness and mitigation measures. This policy should be directed toward reducing risk by developing better awareness and understanding of the drought hazard and the underlying causes of societal vulnerability. The principles of risk management can be promoted by encouraging the improvement and application of seasonal and shorter-term forecasts, developing integrated monitoring and drought early warning systems and associated information delivery systems, developing preparedness plans at various levels of government, adopting mitigation actions and programs, creating a safety net of emergency response programs that ensure timely and targeted relief, and providing an organizational structure that enhances coordination within and between levels of government and with stakeholders.

The primary goal of an effective national drought strategy is to lessen the risk associated with severe drought events and therefore reduce impacts. This strategy has four key components: (1) the availability of timely and reliable information on which to base management and policy decisions; (2) policies and institutional arrangements that encourage assessment, communication, and application of that information; (3) a suite of appropriate risk management measures for decision makers; and (4) actions by decision makers that are effective and consistent in support of a national drought strategy. A drought monitoring and early warning system is designed with the goal of providing timely and reliable information to decision makers. This information is provided through a delivery system that is appropriate for the country in question. The delivery system can be primarily Internet-based, or it can rely on a combination of print and electronic materials distributed via the Internet, television, radio, or fax to agricultural extension personnel or advisers. This drought policy should promote the development of decision-support tools to aid decision makers from agricultural producers to policy makers. Risk management measures or mitigation tools should be ready to implement with the onset of drought conditions and tailored to the most vulnerable sectors, regions, and population groups. These measures must be developed in support of the national drought strategy and its principal goals as noted above. It will take some time for a full range of mitigation options to evolve for the most vulnerable sectors, regions, and population groups. The long-term goal is to create a more drought resilient society as discussed later in this chapter).

### ***Drought Mitigation Planning: Objectives***

As vulnerability to drought has increased globally, greater attention has been directed to reducing risks associated with its occurrence through the introduction

of planning to improve operational capabilities (i.e., climate and water supply monitoring, building institutional capacity) and mitigation measures that are aimed at reducing drought impacts. This change in emphasis is long overdue. Mitigating the effects of drought requires the use of all components of the cycle of disaster management (Fig. 1.1), rather than only the crisis management portion of this cycle. Typically, when a natural hazard event and resultant disaster has occurred, governments and donors have followed with impact assessment, response, recovery, and reconstruction activities to return the region or locality to a pre-disaster state. Historically, little attention has been given to preparedness, mitigation, and prediction/early warning actions (i.e., risk management) that could reduce future impacts and lessen the need for government or donor intervention in the future. Because of this emphasis on crisis management, countries have generally moved from one disaster to another with little, if any, reduction in risk. In addition, in most drought-prone regions, another drought event is likely to occur before the region fully recovers from the previous event.



**Fig. 1.1** Cycle of Disaster Management (Source: National Drought Mitigation Center, University of Nebraska–Lincoln, U.S.A.)

Past experience with drought management in most countries has been reactive or oriented toward managing the crisis. Individuals, government, and others consider drought to be a rare and random event. As a result, little, if any, planning is completed in preparation for the next event. Since drought is a normal part of climate, strategies for reducing its impacts and responding to emergencies should be well defined in advance. Almost without exception, the crisis management approach has been untimely and ineffective, and drought relief measures are poorly targeted and do little to reduce vulnerability to the next drought. In fact, it has been demonstrated in many cases that drought relief actually increases vulnerability to future events by reducing the level of self-reliance and increasing dependence on external assistance. If governments and others provide assistance to those most affected by drought, what incentive is there for relief recipients to alter those resource management practices that make them vulnerable? In addition, those agricultural producers

and natural resource managers that employ best management practices (BMPs) are usually not eligible for drought assistance programs. In reality, governments are not only promoting poor management through the provision of drought relief, but rewarding it.

Making the transition from crisis to drought risk management is difficult because governments and individuals typically address drought-related issues through a reactive approach, and very little institutional capacity exists in most countries for altering this paradigm. Drought mitigation planning is directed at building the institutional capacity necessary to move away from this crisis management paradigm. This change is not expected to occur quickly—it is in fact a gradual process that requires changes in government policies and human behavior.

Drought plan objectives will vary within and between countries and should reflect the unique physical, environmental, socioeconomic, and political characteristics of the region in question. General drought mitigation planning objectives that are recommended for countries to consider include the following:

1. Collect and analyze drought-related information in a timely and systematic manner.
2. Establish criteria for declaring drought emergencies and triggering various mitigation and response activities.
3. Provide an organizational structure and delivery system that assures information flow between and within levels of government.
4. Define the duties and responsibilities of all ministries, departments, and NGOs with respect to drought.
5. Maintain an inventory of government programs previously used and available to respond to drought emergencies.
6. Identify the most drought-prone areas and vulnerable economic sectors, population groups, or environments.
7. Identify mitigation actions that can be taken to address vulnerabilities and reduce drought impacts.
8. Provide a mechanism to ensure timely and accurate assessment of drought's impacts on agriculture, industry, municipalities, wildlife, tourism and recreation, health, and other sectors.
9. Keep decision makers and the public informed of current conditions and mitigation and response actions by providing accurate, timely information.
10. Establish and pursue a strategy to remove obstacles to the equitable allocation of water during shortages and establish requirements or provide incentives encouraging demand management.
11. Establish a set of procedures to continually evaluate and exercise the drought mitigation plan, with periodic revising so the plan will stay responsive to the needs of the country.

These objectives are an integral part of a drought mitigation plan developed through the application of the 10-step drought planning process, which is described in detail by Wilhite et al. (2005). This planning process provides a set of guide-

lines or a checklist of the key elements of a drought plan and a process through which they can be adapted to any level of government (i.e., local, state or provincial, or national) or geographical setting as part of a natural disaster or sustainable development plan, integrated water resources plan, or stand-alone drought mitigation plan. This planning process was based initially on interactions with many states in the United States and sought to incorporate their experiences and lessons learned. The process has gone through several iterations in recent years in order to tailor it to specific countries or subsets of countries. It has also been the basis for discussions at a series of regional training workshops and seminars on drought management and preparedness held in the United States and throughout the world over the past decade or so. With an increased interest in drought mitigation planning in recent years, this planning process has evolved to incorporate more emphasis on risk assessment and mitigation tools. One of the key attributes of this planning process is that it is intended to be generic and adaptable to any setting.

The 10-step drought planning process will not be discussed in detail in this chapter. However, Fig. 1.2 provides a general overview of the process. In brief, Steps 1–4 of the planning process focus on making sure the right people/organizations are brought together, have a clear understanding of the process, know what the drought plan must accomplish, and are supplied with adequate data to make fair and equitable decisions when formulating and writing the actual drought plan. Step 5 describes the process of developing an organizational structure or framework for completion of the tasks necessary to prepare the plan. The plan should be viewed as a process, rather than a discrete event that produces a static document. A risk assessment is undertaken in conjunction with this step in order to construct a vulnerability profile for key economic sectors, population groups, regions, and communities. Steps 6 and 7 detail the need for ongoing research and coordination between scientists and policy makers. Steps 8 and 9 stress the importance of promoting and testing the plan before drought occurs. Finally, Step 10 emphasizes revising the plan to keep it current and making an evaluation of the plan's effectiveness in the post-drought period. Although the steps are sequential, many of these tasks are addressed simultaneously under the leadership of a drought task force or commission and its complement of committees and working groups. These steps, and the tasks included in each, provide a "checklist" that should be considered and may be completed as part of the planning process.

Like other hazards, the impacts of drought span economic, environmental, and social sectors and can be reduced through mitigation and preparedness. Because droughts are a normal part of climate variability for virtually all regions, it is important to develop plans to deal with these extended periods of water shortage in a timely, systematic manner as they evolve. To be effective, these plans must evaluate a region's exposure and vulnerability to the hazard and incorporate these elements into a drought preparedness plan that is dynamic, evolving with societal changes. A comprehensive, integrated drought monitoring and early warning system is an integral part of drought preparedness planning.

**Fig. 1.2** 10-Step Drought Planning Process (Source: National Drought Mitigation Center, University of Nebraska–Lincoln, U.S.A.)

<b>Step 1</b>	Appoint a drought task force
<b>Step 2</b>	State the purpose and objectives of the drought preparedness plan
<b>Step 3</b>	Seek stakeholder participation and resolve conflict
<b>Step 4</b>	Inventory resources and identify groups at risk
<b>Step 5</b>	Prepare/write the drought preparedness plan
<b>Step 6</b>	Identify research needs and fill institutional gaps
<b>Step 7</b>	Integrate science and policy
<b>Step 8</b>	Publicize the drought preparedness plan and build public awareness
<b>Step 9</b>	Develop education programs
<b>Step 10</b>	Evaluate and revise drought preparedness plan

## The Challenge of Drought Monitoring and Early Warning as a Component of Drought Preparedness Planning

A drought early warning system (DEWS) is designed to identify climate and water supply trends and thus to detect the emergence or probability of occurrence and likely severity of drought. This information, if delivered to decision makers in a timely and appropriate format, can reduce impacts if mitigation actions and preparedness plans are in place. Understanding the underlying causes of vulnerability is also an essential component of drought management because the ultimate goal is to reduce risk for a particular location and for a particular group of people or economic sector.

Numerous natural indicators of drought should be monitored routinely to determine drought onset, end, and spatial characteristics. Severity must also be evaluated on frequent time steps. Although all types of droughts (i.e., meteorological, agricultural, and hydrological) originate from a deficiency of precipitation, it is insufficient to rely solely on this climate element to assess severity and resultant impacts because of factors identified previously. Effective drought early warning systems must integrate precipitation and other climatic parameters with water information such as stream flow, snow pack, ground water levels, reservoir and lake levels, and soil moisture into a comprehensive assessment of current and future drought and water supply conditions.

Monitoring drought presents some unique challenges because of the hazard's distinctive characteristics. Some of the most prominent challenges are:

- Meteorological and hydrological data networks are often inadequate in terms of the density of stations for all major climate and water supply parameters. Data quality is also a problem because of missing data or an inadequate length of record.

- Data sharing is inadequate between government agencies and research institutions, and the high cost of data limits its application in drought monitoring, preparedness, mitigation, and response.
- Information delivered through early warning systems is often untimely and too technical and detailed, limiting its use by decision makers.
- Forecasts are often unreliable at the seasonal timescale and lack specificity, reducing their usefulness for agriculture and other sectors.
- Drought indices are sometimes inadequate for detecting the early onset and end of drought. It is essential to use multiple drought indices, since each index has both strengths and weaknesses. Numerous drought and water supply indicators, such as stream flow and ground water levels, should also be incorporated.
- Drought monitoring systems should be integrated, coupling multiple climate, water, and soil parameters and socioeconomic indicators to fully characterize drought magnitude, spatial extent, and potential impact.
- Standardized impact assessment methodologies, a critical part of a drought monitoring and early warning system, are largely unavailable, hindering impact estimates and the creation of regionally appropriate mitigation and response programs.
- Delivery systems for disseminating data and information to users in a timely manner are not well developed, limiting their usefulness for decision support.

### ***Trends in Drought Monitoring and Early Warning***

To more effectively monitor drought and provide early warning requires a comprehensive and integrated approach. The collection of climatic and hydrologic data is fragmented between many agencies or ministries in most countries. These data are often not reported in a timely manner. Automating the data collection process can substantially improve the timeliness and reliability of drought monitoring and early warning systems. Automatic weather stations exist in many countries, but often these stations are not networked. Thus, timely information is not available for assessments.

The analysis of climate and water data is most effective when it is coordinated under a single authority. This authority could be a single agency/ministry or an interagency authority. This authority would be responsible for analyzing data and producing useful end products or decision-support tools for delivery to end users. Stakeholders must be involved from the early stages of product development to ensure the information will serve their diverse needs in terms of timing and content. A delivery system should reflect the needs of this diverse clientele. The Internet is the most cost-effective way to deliver information, but it is inappropriate in many settings. A combination of Internet, extension, and print and electronic media delivery may be required in many instances.

Monitoring and early warning systems to date have typically been based on a single indicator or climatic index. Recent efforts to improve drought monitoring and early warning in the United States and other countries have provided new early

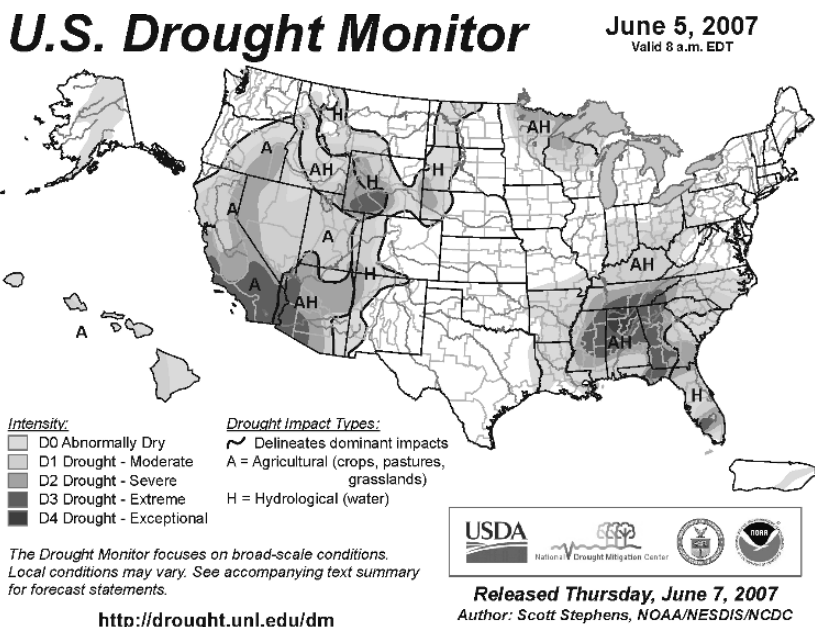
warning and decision-support tools and methodologies in support of drought preparedness planning and policy development. The lessons learned can be helpful models for other countries to follow as they try to reduce the impacts of future droughts as part of a comprehensive drought preparedness plan and policy. An effective monitoring, early warning, and delivery system continuously tracks key drought and water supply indicators and climate-based indices and delivers this information to decision makers. This allows for the early detection of drought conditions and timely triggering of mitigation and emergency response measures, key ingredients of a drought preparedness plan.

Until recently, a comprehensive, integrated drought monitoring, early warning, and delivery system did not exist in the United States. Between 1996 and 2007, severe droughts have been widespread in their occurrence and have affected most of the country, reinforcing the need for a more integrated monitoring and early warning system. During this period, many regions have been affected over several consecutive years and on more than one occasion. Some regions of the country have experienced as many as 5 to 7 consecutive drought years. These drought events have highlighted the deficiencies of the nation's drought monitoring efforts and stressed the importance of developing a more coordinated approach that would make optimum use of the Internet for data sharing and analysis, communication, and product delivery. A partnership emerged in 1999 between the National Oceanic and Atmospheric Administration (NOAA), the U.S. Department of Agriculture (USDA), and the National Drought Mitigation Center (NDMC) at the University of Nebraska-Lincoln with the goal of improving the coordination and development of new drought monitoring tools. The U.S. Drought Monitor (USDM) became an operational product on August 18, 1999. The USDM is maintained on the website of the NDMC ([drought.unl.edu/monitor/monitor.html](http://drought.unl.edu/monitor/monitor.html)). This website has evolved into a web-based portal for drought and water supply monitoring. Figure 1.3 shows the USDM for 5 June 2007. At the time of this writing, drought was affecting large portions of the southwest and western United States and most of the southeast region.

The USDM successfully integrates information from multiple parameters (i.e., climate indices and indicators) and sources to assess the severity and spatial extent of drought in the United States on a weekly basis. It is a blend of objective analysis and subjective interpretation. This map product has been widely accepted and is used by a diverse set of users to track drought conditions across the country. It is also used for policy decisions on eligibility for drought assistance. The USDM represents a weekly snapshot of current drought conditions. It is not intended to be a forecast. This assessment includes the 50 U.S. states, Pacific possessions, and Puerto Rico. The product consists of a color map, showing which parts of the United States are suffering from various degrees of drought, and accompanying text. The text describes the drought's current impacts, future threats, and prospects for improvement. The USDM is by far the most user-friendly national drought monitoring product currently available in the United States. Currently, the Internet is the primary distribution vehicle, although the map also appears in local and national newspapers and on television. Figure 1.4 illustrates the pattern of drought conditions across the United States from 2002 to 2005. A single weekly map illustrates the drought pattern



in each year. All USDM maps since 1999 are archived on the website and available to users for comparison.



**Fig. 1.3** U.S. Drought Monitor for 5 June 2007. (Source: National Drought Mitigation Center, University of Nebraska–Lincoln, U.S.A.; U.S. Department of Agriculture; and National Oceanic and Atmospheric Administration [drought.unl.edu/dm])

Because no single definition of drought is appropriate in all situations, agricultural and water planners and others must rely on a variety of data or indices that are expressed in map or graphic form. The authors of the USDM rely on several key indicators and indices, such as the Palmer Drought Severity Index, the Standardized Precipitation Index, stream flow, vegetation health, soil moisture, and impacts. Ancillary indicators (e.g., Keetch Byram Drought Index, reservoir levels, Surface Water Supply Index, river basin snow water equivalent, and pasture and range conditions) from different agencies are integrated to create the final map. Electronic distribution of early drafts of the map to field experts throughout the country provides excellent ground truth for the patterns and severity of drought illustrated on the map each week.

The USDM classifies droughts on a scale from one to four (D1–D4), with D4 reflecting an exceptional drought event (i.e., 1 in 50 year event). A fifth category, D0, indicates an abnormally dry area. The USDM map and narrative identify general drought areas, labeling droughts by intensity from least to most intense. D0 areas (abnormally dry) are either heading into drought or recovering from drought but still experiencing lingering impacts.



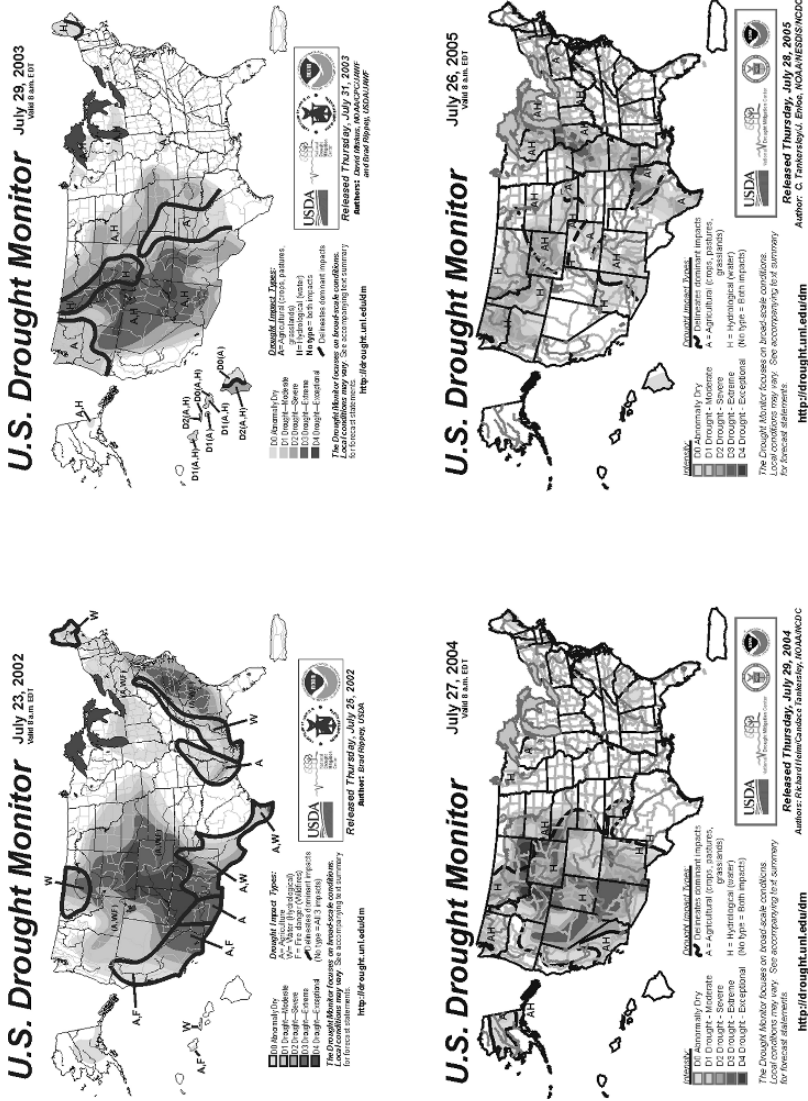
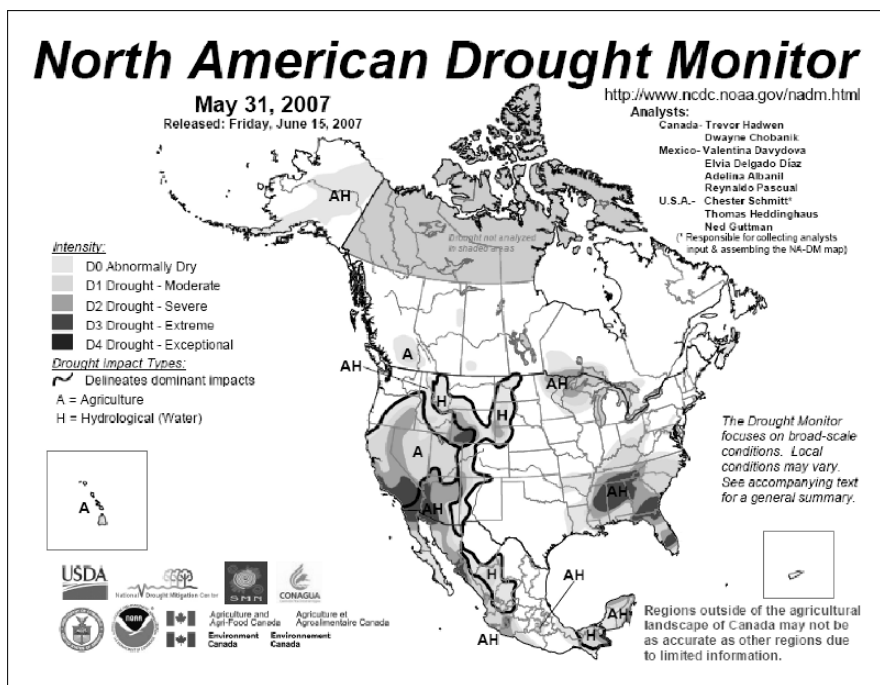


Fig. 1.4 The Pattern of Drought Conditions Across the United States from 2002 to 2005, according to the U.S. Drought Monitor. (Source: National Drought Mitigation Center, University of Nebraska–Lincoln, U.S.A.)

The USDM also shows which sectors are presently experiencing direct and indirect impacts, using the labels A (agricultural–crops, pastures, grasslands) and H (hydrological–water). For example, an area shaded and labeled as D2 (A) is in general experiencing severe drought conditions that are affecting the agricultural sector more significantly than the water supply sector. The map authors are careful to not bring an area into or out of drought too quickly, recognizing the slow-onset characteristics of drought, the long recovery process, and the potential for lingering impacts.

The methodology associated with the USDM has now been applied to the production of the North American Drought Monitor (NADM), a collaborative project between the United States, Mexico, and Canada. The partnership began in 2002 in an attempt to map drought severity and spatial pattern across the North American continent. Figure 1.5 illustrates the NADM for May 31, 2007. Multiple indices and indicators are used to map drought conditions, similar to the procedure used to create the USDM. Responsibility for this product is shared between NOAA’s National Climatic Data Center, the U.S. Department of Agriculture, and the National



**Fig. 1.5** Drought Conditions on May 31, 2007, for North America, according to the North American Drought Monitor. (Source: National Drought Mitigation Center, University of Nebraska–Lincoln, U.S.A.; U.S. Department of Agriculture; National Oceanic and Atmospheric Administration; Agriculture and Agrifood Canada; Meteorological Service of Canada; and National Meteorological Service of Mexico [www.ncdc.noaa.gov/oa/climate/monitoring/drought/nadm/])

Drought Mitigation Center at the University of Nebraska in the United States; the National Water Commission in Mexico; and Environment Canada and Agriculture Canada. This product is prepared on a monthly basis and is an excellent example of international cooperation on drought monitoring at the continental scale.

The trend of drought monitoring and early warning around the world reinforces the perceived need for a more integrated approach, incorporating those climate and water supply indicators that are available and relevant to the assessment process. A recent publication by the World Meteorological Organization (2006) on drought monitoring and early warning highlights some of this progress in countries such as China, Australia, Portugal, India, South Africa, and Eastern Africa. Drought is a multi-faceted hazard and can only be captured if a variety of tools are used in the assessment of severity. This information must also be delivered to end users in a timely manner and in an understandable format to be effectively used in the decision making process and as part of a drought preparedness plan with the ultimate goal of creating a more drought resilient society.

### ***The United States' National Integrated Drought Information System (NIDIS)***

In 2004, the Western Governors' Association, an association of governors from 19 western states in the United States and 3 U.S. Flag Pacific islands, issued a report on the proposed development of a National Integrated Drought Information System (NIDIS). The vision for NIDIS is a dynamic and accessible drought information system that provides users with the ability to determine the potential impacts and the associated risks they bring, and the decision support tools needed to better prepare for and mitigate the effects of drought (Western Governors' Association, 2004). The goals of NIDIS are to:

- Develop the leadership and partnerships to ensure successful implementation of an integrated national drought monitoring and forecasting system;
- Foster, and support, a research environment that focuses on impact mitigation and improved predictive capabilities;
- Create a drought early warning system capable of providing accurate, timely, and integrated information on drought conditions at the relevant spatial scale to facilitate proactive decisions aimed at minimizing the economic, social, and ecosystem losses associated with drought;
- Provide interactive delivery systems, including an Internet portal, of easily comprehensive and standardized products (databases, forecasts, GIS-based products, maps, etc.); and
- Provide a framework for interacting with and educating those affected by drought on how and why droughts occur, and how they impact human and natural systems.

Bills were introduced in both the U.S. House of Representatives and the U.S. Senate in 2006 to authorize funding for NIDIS. These bills were passed in late fall 2006 and signed into law by President Bush in December 2006. The implementing agency for NIDIS is the National Oceanic and Atmospheric Administration (NOAA). This process is moving forward at this writing and the drought portal (drought.gov) should be available by late 2007. The full implementation of NIDIS will take several years. The goal of this system is to support improved drought preparedness planning through the provision of better decision support tools. As the NIDIS program evolves and matures, the goal is to use this system as a model for other regions and nations in support of drought policy and preparedness models.

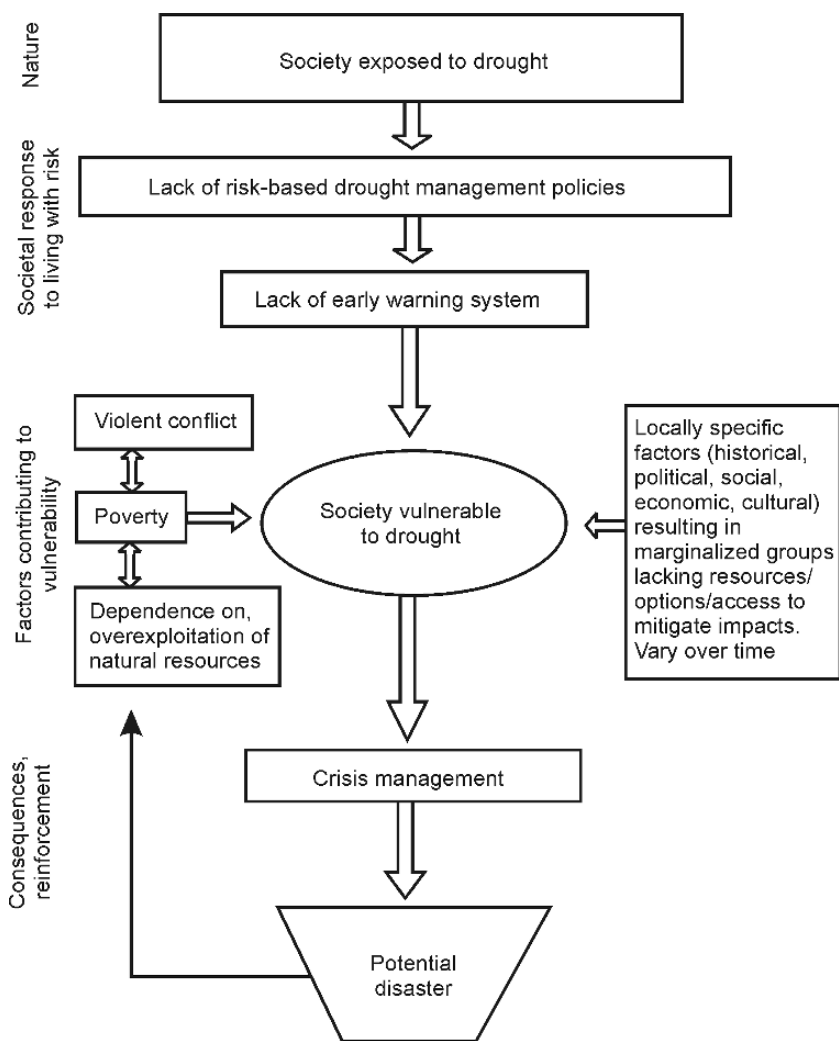


Fig. 1.6 Drought Vulnerable Society. (Source: ISDR, 2007)

## Drought Vulnerable vs. Drought Resilient Society

The Drought Discussion Group of the International Strategy for Disaster Reduction (ISDR) developed a new paradigm to improve understanding of the drought hazard in the macro and micro context with the goal of enhancing drought preparedness and mitigation efforts in all settings ranging from local to national and from developing to developed countries (ISDR Drought Discussion Group, 2003, ISDR, 2007). This new paradigm emphasizes greater understanding and description of both the physical features of the hazard and the social factors that influence societal vulnerability. Figures 1.6 and 1.7 are modified from the Drought Discussion Group’s early report (2003) and represent society’s current approach to drought management (i.e., crisis management) and ISDR’s vision for future drought management efforts, respectively.

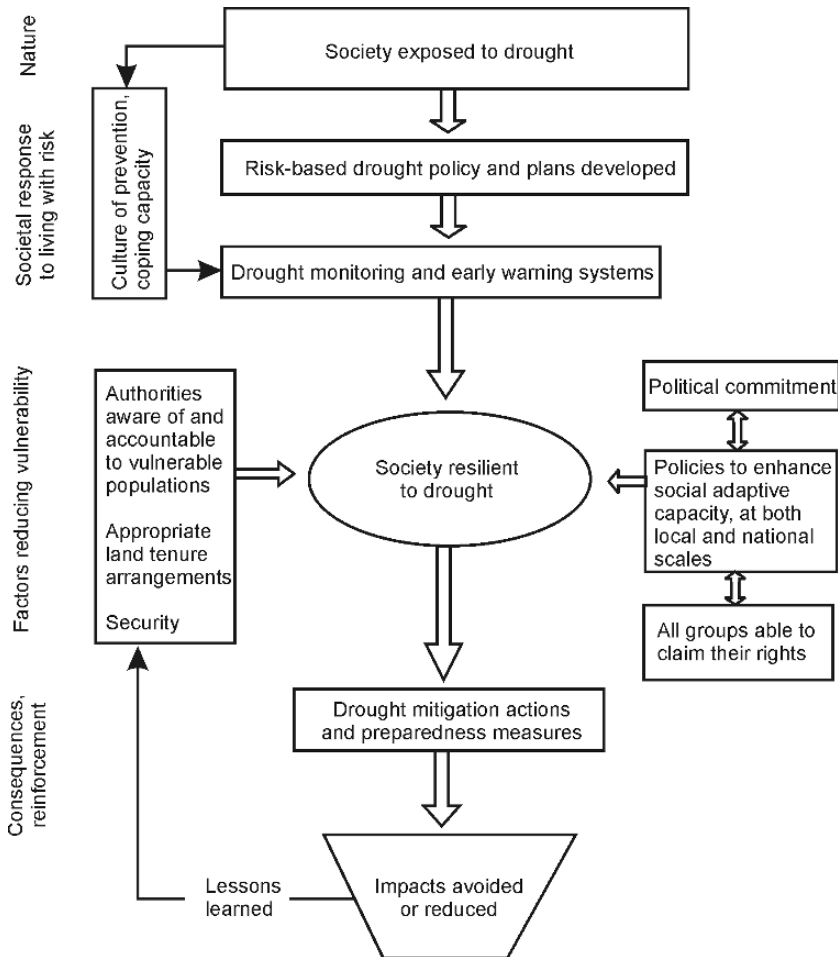


Fig. 1.7 Drought Resilient Society. (Source: ISDR, 2007)

Following the current approach, societies are exposed to drought but have not developed the institutional capacity to monitor its onset and end and to assess impacts in a timely way. They also have not completed a systematic assessment of who and what is at risk and why, a fundamental prerequisite of a risk-based approach to drought management. The result is a reactive approach to drought management, where the rule is always one of responding to crisis in the post-drought setting. This often leads to far-reaching and significant impacts and a long period of recovery. Often another drought episode will occur before the recovery process is complete. Under the new paradigm, a risk-based drought policy incorporating preparedness plans and proactive mitigation strategies is developed as part of a long-term management strategy directed at reducing societal vulnerability to drought. A comprehensive early warning system that integrates a wide range of physical and social indicators has been developed and implemented. Delivery systems are also well established to disseminate time-sensitive information to decision makers that are knowledgeable about how to apply this information as part of a comprehensive risk-reducing strategy.

## References

- ISDR (2007) Drought Risk Reduction Framework and Practices: To Facilitate the Implementation of the Hyogo Framework for Action on Drought. United Nations/International Strategy for Disaster Reduction, Geneva, Switzerland; and National Drought Mitigation Center, University of Nebraska–Lincoln.
- ISDR Drought Discussion Group (2003) Living with Risk: An Integrated Approach to Reducing Societal Vulnerability to Drought. ISDR Ad Hoc Discussion Group on Drought, United Nations/International Strategy for Disaster Reduction, Geneva, Switzerland. Available online at <http://www.unisdr.org/eng/task%20force/tf-adhoc/droughts/WGD-doc1.pdf>
- Western Governors' Association (WGA) (2004) Creating a Drought Early Warning System for the 21st Century: The National Integrated Drought Information System. Denver, CO. Available online at <http://www.westgov.org/wga/publicat/nidis.pdf>
- Wilhite D A, Hayes M J, Knutson C L (2005) Drought Preparedness Planning: Building Institutional Capacity. In Wilhite D A (ed.) Drought and Water Crises: Science, Technology, and Management Issues. pp. 93–135. CRC Press. Boca Raton, FL.
- Wilhite D A (2006) Drought Monitoring and Early Warning: Concepts, Progress, and Future Challenges. WMO–No. 1006. World Meteorological Organization. Geneva, Switzerland.

## Chapter 2

# Soft Law Principles for Improving Drought Management in Mediterranean Countries

Esther López-Barrero and Ana Iglesias

**Abstract** This chapter presents an analysis of the process of transformation of international initiatives for drought management into real regulations at the national and international levels, revising the current situation of legal and institutional systems dealing with drought management in the Mediterranean basin: Cyprus, Greece, Italy, Morocco, Spain and Tunisia. Based on the existence of such documents and according to the analysis of the institutional and legislative frameworks of the selected countries, this chapter proposes a further step in the development of new preventive and reactive policies in the Mediterranean area through the creation of a uniform principle code for drought management in the Mediterranean area. The proposed code would incorporate all the regional and international agreements dealing with drought management under the legislative figure of a soft law. The selection of this legislative figure is the next logical step in the evolution of legislation development aiming at the adequate management of drought in the Mediterranean area, just as described in this chapter.

## Introduction

During decades, droughts have been perceived as another natural hazard. However, the increase in frequency and intensity in the last 30 years has raised the awareness on the issue and has concentrated efforts on the study of the causes, consequences and potential circumstances that might minimize the impacts of this phenomenon. There are many studies that make a scientific analysis proposing different management alternatives for this natural disaster. The real improvement of management in this field requires an analysis of the current legislation behind the issue because

---

E. López-Barrero (✉)  
Department of Agricultural Economics and Social Sciences,  
Universidad Politecnica de Madrid (UPM), Spain  
e-mail: esther.lopez@upm.es

it compiles the meaning of policies and at the same time they are a guarantee for citizens towards adopted public commitments.

In the context of natural disasters management, the general trend is the combination of preventive and risk management strategies with emergency responses. This political approach is especially positive in the case of droughts because even if drought events are hardly predictable, the application of early warning and prevention mechanisms can considerably reduce the negative consequences of the phenomenon. In addition, effective policies in the context of drought management requires coordinated national and international action due to the extension reached by droughts, not dependent on administrative borders, therefore requiring effort co-ordination among the affected international stakeholders.

The Mediterranean is one of the regions where the impacts of drought events have shown an exponential increase during the last 20 years. The traditional approach adopted by governments in the basin has been the application of reactive responses in the short term with little analysis about the consequences, the problem or the effectiveness of the adopted measures, giving no continuity at all in the management of drought events. This approach has been generally supported by the legislative and institutional frameworks. As shown in the text, the legislative framework in the countries selected as case studies has developed continuously during the last decades but there are still important gaps that protect governments from the non-application of integrated drought management policies. However, there are some international and regional studies that reflect the consensus between countries in the area about the necessity of a policy change and the application of preventive measures (IUCN Centre for Mediterranean Cooperation, 2002).

## **Current Supporting Legislation**

The analyzed legislation frameworks of the selected countries do not deal with the problem of drought in an individual way. Its regulation is generally incorporated in the water legislation, in the civil protection normative, or in the legislation related to natural disasters emergency response. The attention devoted to drought in these documents is not sufficient, generally fragmented and in some cases non-existent.

For example, the legal framework for drought management in Cyprus is incorporated into the General Law for Disasters (Iglesias and Moneo, 2005). This law is practically inefficient because its application is complicated by the unclear definition of requirements and indicators for application. Spain and Italy are the countries that count on a more developed legal framework in the field of drought management; however, regulation is also fragmented and incomplete because it is dispersed in different legislative areas that do not provide an integrated response to drought events.

This scarce and dispersed legislation about drought at the national level also suffers from three main problems for application and efficiency: the lack of legislative definition of drought concept, the lack of technical indicators for drought declaration and the vague definition of responsibilities of the different institutions and organisms in all the analyzed cases.



The legal frameworks related to drought management in Mediterranean countries do not include an adequate definition of the drought phenomenon for the purpose of the application of legislation for the regulation of such events. This creates a wide margin for authorities to react in the way they consider most appropriate, based on any politically acceptable justification.

The definition of one single drought concept is not an easy task (Wilhite et al., 2000). One of its basic characteristics is that it is a temporal and site-specific phenomenon, in contrast with water scarcity or aridity. This characteristic complicates even more its definition in legislative terms, but it is not impossible. On the basis of the scientific characteristics that allow the identification of droughts and that differentiate them from other natural disasters, an adequate legal definition can be elaborated with the aim to include it in legislation. This definition would reduce potential misunderstandings or the misuse of the legislation due to a lack of adequate definition of the situation. At the same time the process for drought management would be somehow automatic, as action would follow a pre-established protocol. The complexity of the phenomenon itself makes it necessary that the definition included in the legislation be large and inclusive enough and it should be accompanied by technical indicators that allow for the definition of different types and severity levels of drought.

The absence of technical indicators that determine the type of drought or its evolution through the definition of severity stages for the adoption of management measures is another critical aspect in current legislation in Mediterranean countries. Such indicators that would complement the legal definition of drought should include technical criteria (World Meteorological Organization, Working Group on Hydrology Regional Association VI (Europe), 2005). The coordination between drought definition and indicators would facilitate the relationship between the different types of drought and its severity, as well as the potential alternative management actions that should be established for each of these severity levels to mitigate the negative effects of drought. This would derive in a faster response to drought events.

Some of the analyzed Mediterranean countries do somehow include this point in non-normative contexts, which are referred to in legislation texts and that include different indicators for the control and early warning of the evolution of drought. In addition, many Mediterranean countries are creating centres at the national level for the control of information about drought events and they generally apply indicators for the identification of droughts and their evolution stage (National Drought Observatories of Morocco and Spain). However, the absence of such control protocols in legislation prevents the automatic adoption of alternative management measures or the application of penalties in the case of administrative negligence or inaction during drought periods.

Another general weakness of Mediterranean drought-related legal frameworks is the absence of clear institutional responsibility attributions for management. Most of the analyzed texts avoid the specification of bodies in charge of adopting decisions, approving actions, execution and supervision. In those cases where the body in charge is clearly mentioned, the specific definition of competences is still not clearly determined, keeping an incomplete institutional structure. This unclear institutional

situation is a logical consequence of the little attention that has traditionally been paid to this problem in general legislation. The adequate attribution of responsibilities in legislation is essential for efficient drought management due to the generally unpredictable character of drought events.

The absence of a complete and adequate legislation reveals the limited political importance attributed to drought events. In the six analyzed countries drought management is equivalent to the one adopted for any other natural hazard, applying a reactive, short-term approach for the mitigation of negative impacts. However, due to the proved importance of drought in Mediterranean countries in comparison to other natural disasters, it would seem appropriate to develop more complex and integrated responses for the management of such phenomena, as agreed by the World Meteorological Organization, Working Group on Hydrology Regional Association VI (Europe), 2005.

## **Institutional System**

The absence of a unitary and coherent legal framework for drought management is revealed in the institutional systems in charge of drought management in Mediterranean countries. The legal limitations of the institutional system in charge of drought management have been previously mentioned. None of the analyzed cases have established a capable and exclusive administration for drought management, most of the countries included in the study have not even created special bodies for the control and monitoring of this natural disaster. Most of the countries include drought management in the context of general water planning legal frameworks, which are already large and complex enough (Iglesias and Moneo, 2005).

Institutional responses to drought in the Mediterranean countries can be classified in two groups: those that include drought management in the general water management systems, with no special provisions (Cyprus and Greece), and those that have developed an institutional context different to that of general water management. In this second case there are also some differences between the analyzed countries. In some cases legislation reflects some specificities of drought events and describes the participation of some institutions that have no competences in the general management of water resources (Tunisia), in some others competences of water resources management bodies are modified for the adoption of alternative measures during drought periods (Spain), and in some other cases drought is considered as an emergency situation that triggers a response system attributable to any kind of emergency (Italy) or specific for drought events (Morocco) that implies, in the latter, the intervention of a different institution (Iglesias and Moneo, 2005).

According to the current legislation and institutional organization and coordination schemes, we can conclude that the administrative systems described for drought management suffer from an important lack of clear attribution of competences and an excessive number of public participants that make the system even more complex and exclude the participation of individuals affected by drought. This leads to a

general inefficiency in the decision making process and the execution of alternative actions.

Likewise, the complexity of institutional systems affects the decision-making processes that also suffer from a lack of clear definition of the institutions involved and the attributed competences in this process. The absence of integrated drought management plans that include the definition of preventive and reactive measures to be adopted, limits the development of decision making processes to the eventual occurrence of drought, restricting the adoption of action to the reactive, short-term approach. The decision-making processes and the adoption of measures under the pressure of a currently developing drought event, limit the reaction capacity and the efficiency of the adopted mitigation measures as much as the potential implementation of integrated, long-term policies that deal with the problem of drought.

The limited reaction and planning horizon sums up to the unclear definition of institutional responsibilities and competences for the adoption of drought management measures and the lack of participation mechanisms for those affected by drought events. The example of Spain can be useful in this case. Spanish legislation attributes the management of drought events in a diffuse way to the River basin authorities, but no clear structure is defined to determine the particular competences at each moment. In the case of severe droughts, the competence for adopting drought emergency action, according to article 58 in the revised Water Law, is attributed to the Ministers' Council. This institution takes into account the reports presented by the correspondent river Basin Authority when adopting decisions in case of a drought event. This mechanism for the decision making process is only applied in the case of exceptional drought.

The adequate integrated response to drought events should be based on a close coordination and communication strategy between the Ministers' council, the river basin authorities and the other affected public organisms, even if coordinated action is not always possible. The absence of a regulating text that defines the competences and the tasks corresponding to each administration body or the inexistence of a structured protocol for decision making processes to overcome drought events delays the triggering of actions for mitigation and complicates the participation of affected individuals. In summary, the lack of legislation clarity, in terms of responsibility identification, affects the whole drought management process, including the decision-making phase.

This situation directly affects the involvement of individuals affected by drought. From their perspective, droughts affect farmers, industries and citizens in general as water consumers. Reactive response and emergency management in response to a drought event, excludes the participation of large parts of these groups from the decision making process. They bear the consequences of the situation with no option for defending their own interests. It is adequate to say that, in general terms, the drought management decision processes are not inclusive and they exclude the participation of affected individuals, in opposition to the trend defined by the most modernized legislation (Water Framework Directive 2000/60/EC).

The mechanisms for drought management are in coherence with the situation of institutional systems and the decision-making processes described above. Interven-

tions developed in the selected Mediterranean states to face drought events reflect a fragmented management strategy (Iglesias and Moneo, 2005). This is a direct consequence, on the one hand, of the decentralization of institutional systems' management and on the other hand, the lack of a coordination body for drought management in addition to the effect of decentralization on decision-making processes and the lack of clarity in competence distribution in the institutional organization schemes.

The absence of a coordinated and coherent management of drought events in the different countries prevents the adoption of efficient national policies to face this phenomenon.

From the institutional and decision-making perspective, there is general consensus on the appropriateness of adopting river basins as the management unit (Embid, 2006). The organization of these institutions allows for the participation of different affected groups, public administration bodies, interested individuals or expert groups. It is sensible to adopt a national strategy towards drought management, especially in the case of preventive actions. The current water management structure could be useful as a basis and a parallel structure could be adopted for drought management, complemented by a specific national body that would bear the responsibility to coordinate all actions at the national level for drought management. The adoption of a management system based on river basins would provide effective response to drought events attending to the particular characteristics of each hydrological system and its users, represented in the Users' Assembly.

## **The Real Practice of Drought Policy: Crisis Management Versus Risk Management**

Both legislation and the institutional organization in Mediterranean countries reveal a clear reactive approach towards the problem. Most countries have developed crisis response policies to face already developing drought events instead of designing risk prevention policies. The common reaction mechanism up to date has been the adoption of emergency planning. In some cases the application of preventive plans was not foreseen or the institutional structure did not allow for the application of such instrument, such is the case of Italy and Tunisia. And in other countries, such as Spain or Cyprus, the designed prevention mechanisms have not been adopted (Iglesias and Moneo, 2005).

The design of an effective preventive plan has some requisites: first, an adequate and objective definition of drought based on indicators that are able to measure the evolution of the problem and determine the level of risk in vulnerability situations, second, the mitigation measures must be defined together with the necessary actions for their application. It is also essential to define the participating institutions and the responsibilities that can be attributed to each of them. None of the analyzed Mediterranean countries have adopted a plan that responds to all these requisites. In the best case, some countries have established legislation for the adoption of preventive actions. However the development normative to apply it has not been adopted, as in

the case of Italy. There is some resistance to designing a preventive plan that totally covers the problem. This problem derives from several deficiencies, such as the unclear definition of drought events, lacking a scientific analysis that would provide better options for management in relation to the general water management system. This situation leads to the perception of drought as an unpredictable phenomenon limiting the adoption of preventive plans for intervention.

From another perspective, approved public policies seek short or medium-term results. However, drought requires a long-term preventive public policy, while reactive policies act in the short-term. Sometimes reactive policies are associated to the allocation of subsidies to mitigate the consequences of the event. Even if these subsidies are not effective from the environmental point of view, they make a difference in the electoral field. In order to move away from this approach, the Spanish Ministry of the Environment created in 2005 an expert commission that includes experts in different areas related to water with a consultative and assessment character for the ministry on the adoption of public policies related to water management in general and drought events in particular (Ministerio de Medio Ambiente, 2007).

## **A Common Approach for Further Policy Development: Uniform Principles**

Drought management is based on the political position adopted by the country to face this problem. However, efficient responses to drought require a global approach that sometimes does not correspond to political borders between countries. At the international level there are already some documents that attempt to address this limitation, as is the case of the United Nations Convention for Combating Desertification (UNCCD, 2003), that proposes some strategies for the mitigation of droughts. Also the United Nations International Strategy for Disasters Reduction (UNISDR, 2006) describes the protocol for the analysis of drought risk. Some other international initiatives are being developed with the aim to improve the response actions for drought (Wilhite, 2001; Boterill and Wilhite, 2005).

At the regional level, there is a general consensus among the Mediterranean countries on the need to change the current political approach towards drought events, which is clearly reflected in legislation (IUCN Centre for Mediterranean Cooperation, 2002).

This could be developed through the design of a list of common principles for regional action that could be put together in a “Best practice code” or in a “soft normative text”. It is not a matter of creating completely new principles but the collection and systematisation of already revealed intentions in relation to drought management.

## ***Soft Law as a Basis for Environmental Law Evolution***

Legislation in charge of the management of environmental problems is a relatively new branch in all jurisdictions. At the international level the development of this

type of legislation has been one of the key issues in legislation since the mid 20th century. From the perspective of legislation generation, the development of international legislation in this field is especially relevant because the protection of the environment reaches further than the political borders of countries and requires an integral response where coordination of several states is necessary. However, even if countries are aware of the importance of providing the environment with international legislative protection, it is also true that they are generally reluctant to assume international commitments in this field, especially when these commitments are not even approved internally. For this reason, the example of *soft law* has been applied from the international perspective to promote the evolution of environmental legislation.

Soft law or non-binding law includes all those legal and heterogeneous instruments that comply with two characteristics: they have some legislative relevance and they are non-binding legislation (Mazuelos Bellido, 2004). We are not facing compulsory rules, however we are facing texts that due to their content, adoption and application circumstances, they affect significantly the behaviour of the countries that approve them, therefore they have some legislative value. The lack of a compulsory character and their flexibility make this type of non-binding legislation the most attractive to start regulating new situations at the international level. This way they become an intermediate mechanism between the absence of regulation and the adoption of a binding legislation or hard law.

The concept of hard law includes all those pieces of legislation whose contents are compulsory, because they include legal and precise commitments and there is an established external authority in charge of interpreting and supervising the compliance with rules (Abbott and Snidal, 2000). The creation protocols for these types of mechanisms are formally established and they imply complicated negotiation processes. These processes are especially long at the international scale because the approval of an international binding normative always implies the transfer of some sovereignty from the States, losing some independence. That is why States do not usually commit with hard law until the issue to be regulated has been developed thoroughly in their own internal, national policy. In order to avoid these drawbacks, countries usually prefer to adopt non-binding legislation or soft law.

In fact, in an international and global society like the one today, the principle of international cooperation is an obligation to face the new problems arising on the international scene, such as the environment protection (Abbott and Snidal, 2000). Normally, the degree of treatment provided by the States to these new issues is not enough to decide on the creation of new binding legislation due to either the scarce development of internal national policies or to the existence of some kind of disagreement between the scientific and social perspectives. This is another reason for the States to prefer the adoption of soft law. Another advantage of this type of legislation is the flexibility for design and modification of these instruments, implying a higher adaptability of the contents to changes. On the other hand, it is a normative tool that implies a smaller transfer of sovereignty and probably it is easier to be adopted in those countries that are willing to cooperate. The adoption of

this type of soft legislation promotes the cooperation among states and the evolution of regulation in the international field encouraging the adoption of consensus.

The major advantage of this kind of regulation (not binding and flexible) is also its major weakness. Soft law does not count on legislative mechanisms that ensure the compliance of their contents and the consequences of non-compliance do not go further than the political sphere. However, the adoption of soft law by countries has limited the negative effects of such weaknesses. It is common that non-binding normative approved through international codes include monitoring and revision mechanisms to ensure the compliance of its contents (for example, the Commission on Sustainable Development for the management of Agenda 21 and the monitoring of the Johannesburg Plan of Implementation). In relation to the small consequences of non-compliance with the contents of the documents, it is remarkable that this kind of legislation is highly dependant on policy; the important issue is that there is a willingness to comply with the contents from all international stakeholders. The fact of adoption of a regulation, even if we are talking about soft legislation, already implies a certain level of political will. In this sense, the existence of soft law promotes the incorporation and a certain level of determination from the included States to comply with the contents of the developed document (Shelton, 2000). The logical evolution process of this legislation is the primary adoption of the non binding legislation, the creation of international agreements and finally the evolution to binding legislation.

This relationship between soft and hard law has been more evident in the field of environmental regulations. The regulatory responses related to changes in the environmental conditions have started from the adoption of soft law regulations because, as explained before, they are more flexible and adaptable to changing conditions and allow for the adoption of international consensus. This basis has provided the evolution to another kind of rules with binding character (Sand, 1993). This is the process followed by the regulations on pesticides and pollutant chemicals. The adoption of the Convention on the Prior Informed Consent Procedure for Certain Hazardous Chemicals and Pesticides in International Trade –*hard law*– in 1998 was the result of the evolution of another two non-binding documents: the International Code of Conduct on the Distribution and Use of Pesticides (the “Code”), promoted by FAO in 1985 and the London Guidelines for the Exchange of Information on Chemical in International Trade (the “Guidelines”), elaborated by UNEP in 1987.

Both the code and the guidelines included obligations as soft law regulations, States committed to keep an information exchange and a notification system about those products that included pesticides and chemicals included in the agreements. The exchange of information was the key issue of the legislative systems designed by both texts. The adoption of these agreements by the end of the 80s revealed the need to develop the regulation and consolidate the assumed international commitments. Under these conditions and with the support of FAO and UNEP, there was a negotiation process to create a binding system that could reach beyond the information exchange. The final result was the adoption of the Prior Informed Consent Procedure (PIC) included in the Convention on the Prior Informed Consent Procedure for Certain Hazardous Chemicals and Pesticides in International Trade,



that forced the Committing states to change their internal legislations to be adapted to the contents of the international agreement (Mekouar and Shelton, 2000).

A similar evolution process took place in the instruments adopted for the regulation of environmental problems in Antarctica. The basis of this process was the Treaty on Antarctica in 1959 (a detailed analysis on the evolution of this case can be found in C.C. Joyner, in Shelton, 2000). Another case is the one currently developing on forest regulation (Durrant and Maguire, 2007).

### ***Soft Law Proposal for the Mediterranean***

In relation to drought events in the Mediterranean there is already international consensus about the need to establish some kind of regulation in the field of disasters management that goes beyond reactive actions. From United Nations, through UNEP and the WMO, the development of legislation in this field is being promoted. The trend is to promote the creation of international regulations, not general, but regional. United Nations counts on the existence of regional economic commissions that bear the competence to promote negotiations on environmental issues (for example, the United Nations Economic Commission for Europe). The World Meteorological Organization is working on the development of regulation on drought events at the regional level. One of the geographical working areas is the Mediterranean basin.

On the other hand, at the Mediterranean level, there are already some initiatives that reveal the interest of States on the issue (for example, the Euro-Mediterranean Information System on know-how in the water sector). Also from the European Union, organization that includes half of the countries in the Mediterranean basin, some drought management initiatives have already been adopted trying to reach beyond the political field and can be considered as soft law (Mediterranean Water Scarcity and Drought Working Group, 2007). The interest of the European Union on the regulation of this issue seems to promote the legislative evolution.

From the pure legislative perspective, it would be appropriate to propose the approval of binding legislation for the regulation of droughts in the Mediterranean. However, the current state of international conventions, the absence of an international organization that has a competence on this issue in the region, and the treatment of drought issues in national legislations, it would be more appropriate to base the legislative regulation of drought in the Mediterranean on soft law. In coherence with these limitations and the common evolution described previously, the adoption of a regional code on drought management in the Mediterranean would be the most adequate step for the countries in the region for the development of policies for the control of this natural phenomenon.

The development of such document would promote the development of a regional policy strategy and a program for intervention planning. It would also enhance coordination and the flux of information at the internal and the regional level. The existence of such principles could serve as a reference for the States to evaluate



their own policies on drought management; this would reinforce the development of long-term actions. In summary, the development of such document would speed up the development of an integrated planning with a preventive management at the national and regional levels (Shelton, 2000).

What could be the content of this code on drought management for the Mediterranean? As explained above, this code would not create a completely new regulation system, but it would compound and articulate the already existing pieces of legislation of the Mediterranean countries and would develop new rules on the basis of the already existing international agreements that are not currently supported by legislation. This would provide for better coordination among the countries in the Mediterranean basin and would generate a real regional risk management policy.

Attending to experience and the already existing legislation in Mediterranean countries, the starting point of this code would be the recognition of water as a public good. The code would include three different sections: the first devoted to the definition of drought events, the second devoted to the principles of institutional coordination and finally a third one devoted to defining a framework for potential actions to mitigate drought impacts. The code should also include the creation of an international technical secretariat that would be in charge of the management of the contents of the code (Technical Secretariat for the management of drought in the Mediterranean).

The definition of drought would be based on international and regional consensus dealing with the concept of drought. The definition would include the different types and severity levels of drought in the area. The definition would be complemented with the provision of a set of technical indicators that would allow for early warning and the definition of emergency situations and the subsequent evaluation of interventions.

In relation to the principles of institutional coordination, experience demonstrates the necessity to establish a national coordination body that centralizes the information about droughts in the country, that coordinates the actions of the different institutions and that articulates the triggering of these actions. In Morocco, for example, this central institution also incorporates the task of research promotion on drought. There is another example out of the European limits that is especially interesting for complex administrative countries such as Spain or Italy. It is the US Act to establish the National Drought Council in 2005. Some of the Mediterranean States already counted on more or less developed systems that centralize the information about drought in their countries, like in Spain. There could be a regional network for information exchange through the coordination of information fluxes among the bodies of the different countries. The responsible centre for regional information would be the Technical Secretariat for the management of drought in the Mediterranean.

The last section of the code could be devoted to collecting the principles of the actions that would be adequate for drought management. This component could include a catalogue of actions that could be adopted in the case of drought events. Actions incorporated here would include long-term management options as much as emergency actions, also including a protocol for the monitoring and evaluations of these measures. This catalogue would facilitate the application of integral policies

by the States as much as the subsequent evaluation of the adopted interventions, to readjust them in case of necessity.

The final component of the Code would include the creation of a Technical Secretariat, with an international character. This body would be in charge of collecting information about drought events in the area that would be provided by the States and the processing of this information to be used afterwards. The Secretariat would also supervise the compliance of the commitments adopted by the different countries. Finally it could also serve as a scientific and political discussion forum, becoming a platform for the promotion of legislation evolution in this field. There are already some international experiences in the creation of similar bodies, for example in the field of international trade, with very positive results (López Barrero, 2005).

The creation of the soft law code is something really new in the field of droughts. However, the objective is not to create a completely new set of legislation, but to go one step further, in coherence with the traditional evolution of environmental legislation. The code would, therefore, be based on current consensus and soft legislation and would evolve, according to the countries limitations, to a more complete drought management system. The creation of a technical Secretariat to centralize information, supervise the compliance with adopted commitments and facilitate further negotiations would be a key component for the development of policies and drought regulation in the Mediterranean.

From the point of view of State intervention, all the members of the Code would participate equally with the same responsibilities and capacities. In the environmental policy and legislation field it is common to make a distinction between responsible countries – generally developed countries – and countries affected by environmental problems – generally developing countries –. In the Mediterranean region there are both developed and developing countries, but in the case of drought management it does not seem effective to establish a difference between these two groups. All countries are at the same time responsible and affected by this phenomenon, therefore the development of a policy and a regulation that aims to be productive should be based on equity between participants.

## **The Water Framework Directive and the Soft Law Code for the Mediterranean**

The Soft Law Code for drought management in the Mediterranean directly affects the regulation on water management in the European Union because half of the countries involved are part of this international organization (in the selected case studies only two are non-member states).

In the year 2000 the EU adopted the Water Framework Directive (WFD) as the key text for water management regulation in all member states. The legislation framework presented in this directive proposes a sustainability model in the use of this natural resource, according to the environmental protection policy that the EU has been developing since the 70s. The objective of this water management

directive is to reach an acceptable environmental quality standard, guarantee the supply, mitigate the effects of floods and droughts and comply with the objectives of the international agreements (articles 1 and 4 in the Directive).

The Directive includes rules about the treatment of some natural disasters, drought being among them, but it does not address them in a detailed manner, addressing the regulation to the development of a future directive. In the case of drought, the WFD establishes two types of drought: the foreseeable and the exceptional. The first kind should be included in the river basin plans and envisage some mechanisms to avoid or minimize the impacts. The second kind are considered as natural disasters and these situations allow for the exceptional suppression of the general WFD requirements in terms of water quality and supply.

The WFD does not define drought events and does not establish criteria for the classification of the phenomena in one or another group. It is Member States who have the responsibility to build the rules to define drought in their national legislations. According to this, Member States have a large flexibility in the definition of drought events and can largely affect the application of the WFD depending on their own interest. The commission created a working group in charge of adopting a consensus on the basic criteria for the definition and management of drought inside the Mediterranean limits.

From this perspective, the existence of the proposed Code would complement the legislative gaps of the WFD and the work that the Mediterranean Water Scarcity and Drought Working Group is developing and would enhance the results obtained by the latter. At the same time it would harmonise the development of internal legislation in the Member States.

## Conclusions

Droughts are becoming a constant phenomenon in the Mediterranean area. Countries are aware of this fact and attempt to adopt policies that help to mitigate the impacts of this natural disaster. However, the development of these national policies and the legislation and institutional systems they should rely on is commonly slow and unsatisfactory. This limits the capacity to adequately respond to drought control issues.

The development of national policies is important in the field of drought management; however the development of international initiatives is also essential for dealing with a phenomenon that does not depend on administrative borders for distribution of impacts. These international policies should rest on a well-established basis of mature legislation that articulate the development of actions adopted in the case of drought events.

In coherence with these limitations and the common evolution described previously, the adoption of a regional code on drought management in the Mediterranean would be the most adequate step for the countries in the region for the development of policies for the control of this natural phenomenon. The code would adopt the

characteristics of a soft law, and would complement and support the evolution of national legislation. It would include those aspects already reflected in national legislations but it would also try to go one step further to develop some aspects that have not been included in national legislation. In order to facilitate the development of legislation at the regional level as well as the information exchange among countries in the Mediterranean – a basic issue for the mitigation of drought impacts – we propose the creation of a technical Secretariat. This body would be in charge of collecting information about drought events in the area that would be provided by the States and the processing of this information to be used afterwards. The Secretariat would also supervise the compliance of the commitments adopted by the different countries. Finally it could also serve as a scientific and political discussion forum, becoming a platform to promote the evolution of legislation in this field.

The creation of a legislative document such as this one follows the logical evolution of the international environmental legislation. States in the development of international legislation of new problems and especially in the environmental field, usually adopt political declarations, then soft laws and they finally approve agreements on hard laws. Assuming that the resolution of environmental problems reaches beyond administrative borders and that the improvement of drought management is an emergency for all countries in the Mediterranean, the adoption of the proposed text would be an important step forward in the field of drought management at the regional level.

## References

- Abbott K W, Snidal D (2000) Hard and Soft Law in International Governance, *International Organization*, 54(3):421–456.
- Boterill L C, Wilhite D A (2005) *From Disaster Response to Risk Management*. Australia's National Drought Policy, Springer, Dordrecht 209 pp.
- Durrant N, Maguire R (2007) An integrated Legal Approach to global environmental governance: combating climate change, drought and deforestation, <http://www.2007amsterdamconference.org/Downloads/07SummerSchool%20-%20Durrant.pdf>, 56 p.
- Embid Irujo A (dir) (2006) *El derecho al agua*, Thomson-Aranzadi, p. 316.
- European Union, Directive 2000/60/EC of the European Parliament and of the Council of 23 October 2000 establishing a framework for Community action in the field of water policy, <http://europa.eu/scadplus/leg/en/lvb/l28002b.htm>.
- FAO (2006) *Adopting Drought Mitigation Strategies in the Near East Region*, <ftp://ftp.fao.org/unfao/bodies/nerc/28nerc/J6999E.pdf>.
- Iglesias A, Moneo M (2005) *Drought Preparedness and Mitigation in the Mediterranean: Analysis of the Organizations and Institutions*, CIHEAM, 199 pp.
- IUCN Centre for Mediterranean Cooperation (2002) *Drought Preparedness and Risk Management in the Mediterranean Region*.
- López-Barrero E (2005) *El Sistema Institucional y el Proceso de Toma de Decisiones en la Organización Mundial del Comercio*, Tesis leída en la Universidad Complutense de Madrid.
- Mazuelos Bellido A (2004) *Soft Law: Mucho ruido y pocas nueces*, *Revista Española de Estudios Internacionales*, 4, [www.reei.org](http://www.reei.org).
- Mediterranean Water Scarcity and Drought Working Group (2007) *Mediterranean Water Scarcity and Drought Report*, April 2007, <http://www.emwis.net/topics/WaterScarcity>.

- Ministerio de Medio Ambiente de España, *La sequía en España (2007) Directrices para minimizar su impacto*. Ministerio de Medio Ambiente.
- Sand P H (1993) *International Environmental Law after Rio*, *European Journal of International Law*, 4:377–389.
- Shelton D (ed.) (2000) *Commitment and compliance. The role of non-binding norms in the International Legal System*, Oxford University Press, p. 560.
- UNCCD (2003) *Background paper for implementing thematic programme network on strengthening capacities for mitigating drought impact and desertification control (TPN5)*, [http://www.unccd.int/regional/asia/meetings/regional/TPN5\\_7\\_2003/background.pdf](http://www.unccd.int/regional/asia/meetings/regional/TPN5_7_2003/background.pdf).
- UNISDR (2006) *United Nations International Strategy for Disaster Reduction*, United Nations, Geneva. <http://www.unisdr.org> (last visited August 2008).
- Wilhite D A (2001) *Global Drought Preparedness Network. Creating a Network of Regional Drought Preparedness Networks*, <http://www.wg-crop.icidonline.org/4doc.pdf>.
- Wilhite D A, Hayes M J, Knutson C L, Smith K H (2000) *Planning for drought: Moving from crisis to risk management*, *Journal of the American Water Resource Association*, 36:697–710.
- World Meteorological Organization (2005) *Working Group on Hydrology Regional Association VI (Europe), Drought Assessment and Forecasting, WGH/RA VI/Doc.8 (26.IV.2005)*.

# Chapter 3

## A Checklist for Drought Policy Development

Nicos X. Tsiourtis

**Abstract** Water shortages can be the result of drought phenomena but can also be the result of human actions such as the increase of water demand due to population growth, or changes of habits or due to bad water management plans. This chapter outlines an example of diagnostic search that water policy makers, water managers, decision makers and other stakeholders, should take before embarking on the preparation of drought preparedness plans, so that they know the cause of water shortage and the need of drought preparedness plans is ascertained. The first step in such diagnostic search is to investigate if the right and adequate institutional and legal framework exists, and if the necessary data and the information are available and in a usable condition. Next, a search must be carried out to investigate whether the water management is done in a rational manner and water shortages are caused either by drought and/or by human actions. The next diagnostic step would be to find out if the scientific knowledge and methodologies for carrying out the risk analysis, the drought characterization and the drought preparedness plans are available with the technical staff of the institutions. Environmental needs during normal conditions and under drought conditions should be estimated and be included in the water demand schedules, their benefits should be evaluated and taken into consideration during the water allocation process under normal and drought conditions. The use of common language on water resources and droughts is very vital and this must be investigated and steps should be taken to introduce and use a common language. Finally a diagnostic search should be carried out to find out if the stakeholders in general are aware of the water issue of their country, region or town/village and they know how to use the water in an efficient and effective manner. If the results from this diagnostic search are negative in any of the searched items, the relevant authorities must take the necessary measures and actions so that the proper environment is created in each of the items so that the preparation and implementation of drought preparedness plans is facilitated, in an effective and efficient way.

---

N.X. Tsiourtis (✉)  
Technical Consultant, Nicosia, Cyprus  
e-mail: tsiourti@globalsoftmail.com

## **Introduction**

The immediate result of a drought event is water shortage with impacts on the economy and social life and the environment. However water shortages or better water scarcity can be caused by human actions such as population growth, wasteful use of water, inefficient water of water and in many cases by non rational water balanced water management plans. Since drought preparedness plans constitute a part of the water resources management plans and since the drought preparedness plans (which involve too many economic, social and other measures and actions), are put into operation when certain indicators or water supply alarms levels are reached, it is imperative that before preparing the drought preparedness plans a diagnostic search is carried out to analyze the framework within the plan will be implemented, as well as to find out whether the water shortages are the result of drought or the result of human actions and inefficient water management plans. In view of the above, those responsible for the preparation of the drought preparedness plans in close cooperation with those responsible to prepare the water management plans, should carry out a diagnostic search which is outlined in the present paper.

## **Diagnostic Search Description**

The main items of a diagnostic search preliminary to drafting drought preparedness plans are briefly described in what follows.

### ***Is the Institutional and Legal Framework Adequate?***

The preparation of drought preparedness plans, requires continuous monitoring of the meteorological conditions, the hydrological conditions, the water demand change, the nature of the activities taking place within the geographic scope of the plan, the physical and operational condition of the structures and equipment of the water supply systems, the set up and performance of the operation and maintenance personnel of the infrastructures and generally the overall performance in meeting the water supply objectives. The collected information on each and every activity has to be analyzed and evaluated on a continuous basis, enabling the water managers to deduct conclusions and make projections concerning the water availability, water demand and water scarcity and the proposal of additional works to increase efficiencies, and water resources availability if necessary. The above can be carried out within an institution, which shall be given the legal rights and the power and means to execute their functions in the best possible manner. Governments should have established the appropriate institutions whose duties and responsibilities shall be clearly defined with their rights and powers to execute the duties and responsibilities defined in the legal frameworks. If appropriate institutional and legal Frameworks, for the preparation of the water resources management plans and the preparation of

drought mitigation plans, are not available, both plans shall suffer from deficiencies and most probably shall not be effective and efficient. Every country which considers seriously the good governance of its limited, fragile, and threatened water resources, if it has not sufficient institutional and legal frameworks, should prepare and establish one as soon as possible.

### ***Is Water Shortage Caused by Droughts or Something Else?***

Water governance includes all those institutional, legal and administrative actions and measures that together with the national or regional policies set the framework for water management. Good water governance means that water demand to a water supply system does not exceed the water supply except under drought conditions. This means that under normal conditions there is no water scarcity. In order to achieve this, water managers must be able to revise continuously the water management plans to take into account the increase in water demand (population growth, irrigation growth, industrial growth, rising of standard of living and increase in environmental demands etc.), and the water supply changes mainly water supply decrease due to climatic changes, or groundwater depletion. While water demand increases due to population growth and due to other reasons, the water supply usually remains the same or even decreases due to environmental reasons, resulting in water scarcity. The increasing water scarcity of a project with demand exceeding the available water resources, at the national, the regional or project level, due to human actions (population growth, irrigation growth, industrial growth, rising of standard of living and increase in environmental demands etc.), if not taken into account in the preparation of the general water management plans, will result in frequent water shortages, which together with drought events may create an intolerable situation.

If the water management plans are not updated then it is necessary to take this action as soon as possible. If water scarcity is increasing then either water demand should be reduced or additional water resources should be made available to the project so that the average demand does not exceed the average water resources available to the project.

### ***Is There Sufficient Scientific Knowledge and Acquaintance with the Methodologies and in Depth Knowledge of the Project in General?***

The preparation and implementation of water management plans and drought preparedness plans requires scientific knowledge, and methodologies which are provided within these guidelines, but it also requires good knowledge of the project (water impounding structures, aquifers, their yields, the structures capabilities etc), their design specifications and limitations. All above require continuous educational and training both in office and in the field of those involved in these activities. Water



management plans and drought preparedness plans are project specific and those involved in these activities should be well acquainted with the project operational capabilities on top of the scientific and methodological know-how. Water Institutions must encourage and facilitate their personnel to acquire the scientific knowledge and the methodologies required for the risk analysis and drought characterization necessary for drought preparedness plans but also on the preparation of rational water resources management plans.

### ***Are Environmental Needs Taken into Consideration?***

Water supply under drought conditions is very critical since the satisfaction of the environmental needs in business as usual are rated very low compared to domestic and industrial water supply, and supply for agricultural consumption and usually are not taken into consideration under drought conditions. Environmental needs must be estimated and the consequent benefits evaluated. According to the water needs and the benefits derived, they must be ranked in priority of supply in comparison to the other economic sectors. This will enable the decision makers to take into account these needs during the allocation and distribution of the limited water resources under drought conditions and contribute towards the satisfaction of the basic environmental needs.

### ***Is a Common Language Used by all Stakeholders?***

Drought, water scarcity, hazards, vulnerability, and other terms and concepts have a different meaning for different stakeholders. It is necessary that all the stakeholders have a common language concerning the water resources management and drought preparedness plans. Acquaintance and knowledge of the terminology is a must for those involved in the drought preparedness plans and on water management preparation and implementation plans.

### ***Are the Water Users Aware of the Water Issue and Educated to Use Water?***

The preparation and implementation of water management plans and drought preparedness plans requires that water users have knowledge on the efficient and effective uses of water. Since water is a very important commodity for the social, economic and environmental development of a country and since water is treated by many as a social good, with the supply and demand not defined by the free market but by the demand and willingness of the water users, it is not easy to regulate the supply of water. In view of the above the supply and demand, should be regulated by the consumers, by being aware that the water resources are limited, fragile and

threatened by unwise, inefficient and ineffective use. Governments not willing or, due to other reasons, not able to apply water tariffs for the regulation of supply and demand should intensify their efforts to create water awareness by educating the consumers on the water availability issues and on the efficient and effective use and utilization.

## **Final Remarks**

If during the diagnostic research it is concluded that there are deficiencies in any of the investigated items, it would be advisable that the relevant authority takes steps to remedy or improve the situation. Institutional and legal frameworks should be adequate to enable the collection, process, storage and analysis of the data and information required for the preparation of rational water management plans and efficient and effective drought preparedness plans. The legal frameworks should give the right, the power and means to those responsible to implement the water management plans under drought conditions to act within legal and rational frameworks so that they are effective and efficient. It is also necessary to make sure that drought preparedness plans are made for water shortages caused by drought phenomena and not by human actions. To avoid this all stakeholders should contribute to the formulation of rational water management plans, which under normal conditions do not create water shortages or water scarcity. Other deficiencies such as scientific know-how and methodologies of those responsible with the execution of these operations should be made up with the attendance to training and educational courses including the use of common language. Finally but most important is the creation of awareness on the water issues and the education of the users to consume water in an efficient, and effective way. The best Drought Preparedness Plans are probably destined to fail if the water users cooperation and understanding is not secured.

# Chapter 4

## An Environmental Focus on Drought: The Water Framework Directive

Abel La Calle Marcos

**Abstract** Since the 1970s the European Union has maintained a programme for protecting the environment. In the development of this aim the Union began the 21st century unveiling a new legal framework related to its policy for water resources, the Water Framework Directive (Directive 2000/60/EC). The purpose of the protection of water resources established by the Water Framework Directive is set out in a series of general objectives and in some other more concise ones termed “environmental objectives”. The requirement to achieve the environmental objectives is not absolute and certain conditions exist which could permit a temporal suspension of their fulfilment. This paper analyzes the drought conditions that may constitute a short-term exception to the fulfilment of the obligations set out in the Water Framework Directive.

### Introduction

Since the 1970s the European Union has maintained a programme for protecting the environment, which entailed the introduction of a policy of sustainable use as one of the current common objectives in the constitutional treaties (article 2 of the Treaty establishing the European Community (TEC) and of the Treaty on European Union (TEU)). To achieve this objective the Union considers it essential to guarantee a high level of protection for the environment (articles 2 and 172 of the TEC), which, in addition to creating an opportunity for internal action, covers the remaining range of public activities in which it should be incorporated at the time of defining and carrying out other policies (article 6 of the TEC).

The aims of this policy of sustainability are the conservation, the protection and the improvement of the quality of the environment, the protection of the health of the individual, the prudent and rational use of natural resources, and the promotion of an international scale of measures to deal with environmental problems at both regional and worldwide levels (article 174.2 of the TEC).

---

A. La Calle Marcos (✉)  
University of Almeria, Spain  
e-mail: alacalle@ual.es

In the development of these aims the Union began the 21st century by unveiling a new legal framework relating to its policy for water resources through the Water Framework Directive (Directive 2000/60/EC) in the understanding that water is not a commercial product like other products but, rather a national asset which must be protected, defended and treated as such.

The most important aspect, perhaps, of this new legal framework is the concept that this asset is an essential element of the ecosystem in which we live and on which we depend in contrast to the previously held view that regarded it merely as one element among the many natural resources available to support economic growth.

This change of attitude appears to be due to the state of over-exploitation and deterioration to which we have submitted water resources and their ecosystems, the resulting difficulty of using it as an economic resource or of enjoying it in our recreational and mental development, the integration of current scientific knowledge of the biosphere, and the inefficiency experienced with the fragmented protection of water resources which serve human use.

The aims of this new policy for water resources are in summary: to achieve a good state of water resources by 2015 at the latest; to guarantee an adequate supply of water of a quality suitable for sustainable use; to alleviate the effects of floods and droughts; and to fulfil the aims set out in international agreements (articles 1 and 4 of the Directive 2000/60/EC).

To fulfil these objectives the Directive proposes an integrated policy which is efficient and relevant to the water resources which represent its basic objective: to make provision for, protect and improve aquatic ecosystems and related terrestrial systems; to promote their sustainable use based on a long-term programme of protection and cost recovery, and to reduce or prevent the contamination of water systems (whereas (9) and articles 1, 9 and 14 of the Directive 2000/60/EC).

The character of this “integrated” (whereas (9) and (18) of the Directive 2000/60/EC) policy requires that the planning and management of water resources unite the sectors which previously operated independently, into a unified whole. The Directive is aimed expressly at the integration of the objectives of the water resources policy (articles 1 and 4 of the Directive 2000/60/EC) in themselves and in other public policies (whereas (16) of the Directive 2000/60/EC), the quantitative and qualitative aspects of the water (whereas (34) of the Directive 2000/60/EC), all water resources (article 1 of the Directive 2000/60/EC), programmes of measures and all the required measures (whereas (26), article 11 and annex VI of the Directive 2000/60/EC), and including the control of contamination combining the criteria of the best available techniques and the emission limit values (article 10 of the Directive 2000/60/EC).

The policy, therefore, also implies that the planning and management of water resources should incorporate all the measures necessary to fulfil the agreed aims for protecting and guaranteeing supply together with the aim of alleviating the effects of droughts.

## The Environmental Objectives

The purpose of the protection of water resources established by the Water Framework Directive is set out in a series of general objectives already mentioned, and in other more concise objectives termed “environmental objectives” (article 4 of the Directive 2000/60/EC). It involves a series of aims both fixed and time-dependent in the majority of cases which are to be achieved through the programmes of measures and which are grouped according to whether they relate to surface waters, ground waters or to protected zones.

The model of planning and management set out in the Directive through the environmental objectives entails a substantial change in respect of the existing model for water resource planning. Whilst in many cases the planning focussed in the past on the distribution and volume of water supplies for the various uses and types of user, current planning is aimed at the protection and sustainable use of such resources. On the other hand, in order that this protection and sustainable use are not mere official pronouncements or ceremonial statements of no practical application, the environmental aims and the Programmes of objectives and their monitoring are set out in detail.

The schedule of the Programmes of measures draws particular attention to the realisation of the results in such a way that for each body of water it offers a standard for testing and an objective for the improvement of water status both in terms of volume and quality since quality of the environment is dependent on surface water resources. The monitoring also has a particular relevance in this system since continuous evaluation can ensure whether the expected results are being achieved and, if not, a review of the testing may be called for and new complementary or additional measures applied.

The Member states are required to pursue these environmental objectives. It is a statutory requirement (article 249 of the TEC) whereby states are required to adopt all the appropriate general or particular measures to ensure their achievement and the obligation to refrain from all such measures which may put their realisation in jeopardy (article 10 of the TEC). The non-fulfilment of these objectives may result in an action for illegal violation of the rules before the Justice Tribunal (article 226 of the TEC) and, in the case of persistent transgression of this nature, may result in the imposition of important sanctions (article 228 of the TEC).

The linking character of these objectives was the subject of debate over the drawing up of the Directive between the European Parliament and the Commission, both of which aimed to create a text free from ambiguities in this respect, and the Council, which proposed statements of a conditional nature (Legislative Observatory European Parliament COD/1997/0067). The approved text is free of ambiguities on the linking character of these concrete objectives, and as compensation in the precept various exceptions to its fulfilment are included amongst which are those for recognised periods of drought.

## The Exceptions to the Fulfilment of the Environmental Objectives

As has been described above the requirement to achieve the environmental objectives is not absolute and certain conditions exist which provide for a deferment of their fulfilment, a reduction in the severity of the objectives, a temporal suspension of their fulfilment, and the removal of sanctions for objectives not reached (article 4.3–7 of the Directive 2000/60/EC). Nevertheless, any of the above involves the condition of exception for which the interpretation has to be strict in definition and the conditions established for their application must be rigorously adhered to (Judgments in Case C-328/91 Thomas [1993] ECR I-1247, paragraph 8, and Case C-287/98 Linster [2000] ECR I-6917, paragraph 49).

These exceptions to the fulfilment of the environmental objectives were introduced during the discussion stage and, among others, States such as Spain proposed in the Council an exception to fulfilment in the case of drought or flood. The Spanish representation perhaps had in mind the recent condemnation by the Justice Tribunal for the Directive on water used for bathing purposes in which it put forward the drought experienced as reason for an exception to the fulfilment of conditions (“In this case, the Spanish Government has not provided any specific evidence, for the individual regions concerned, either of the abnormal nature of the alleged drought or of the resultant inability on the part of the authorities to achieve the minimum standard for bathing water imposed by the directive, even by undertaking further efforts. Suffice it to note, in that regard, that many of the bathing waters not meeting the requirements laid down in the directive are, as the Advocate General has observed in point 28 of his Opinion, situated in the north of Spain which, as the Commission has stated without being contradicted, has been less affected by the drought” Case C-92/96 Commission v Spain [1998] ECR I-505, paragraph 32).

Before analysing the exception of the drought and its legal consequences one must point out that the characterisation of the exceptional drought that the Water Framework Directive mentions, entails a fundamental distinction between the droughts that are exceptional and those that are not.

Starting from this point of differentiation one may conclude that the droughts that are not exceptional cannot defend failure to meet the requirement of ensuring non-deterioration of the body of water. Therefore, the planning set out in the Water Framework Directive must take account of the measures necessary to deal with all situations of scarcity of water supply both social and economic, and the situations of non-exceptional droughts, without additional deterioration of the state of the body of water by reason of human use. This reinforces in an extraordinary way the principle of non-deterioration (article 1 of the Directive 2000/60/EC: «The purpose of this Directive is to establish a framework for the protection of inland surface waters, transitional waters, coastal waters and groundwater which: (a) prevents further deterioration and protects and enhances the status of aquatic ecosystems. . .») established in the Directive since it only allows a short-term deterioration as an exceptional circumstance and under strict conditions.

Nevertheless it is clear that situations of drought may cause an additional deterioration of natural origin in the status of masses of water, logically responsibility for this deterioration cannot be laid upon the State, since what is prohibited under the Directive is that human use may increase the above-mentioned deterioration and obstruct the achievement of environmental objectives.

This need to integrate the shortage and non-exceptional droughts is, moreover, the clear correlative of the legal framework relating to exceptional droughts that is analysed below.

## **Drought as an Exception to the Fulfilment of Environmental Objectives**

In specified conditions drought may constitute a short-term exception to the fulfilment of the obligations set out in the Water Framework Directive, in particular the requirement to predict all additional possibilities of deterioration in the aquatic ecosystems and of the fulfilment of environmental objectives (article 4.6 and 11.5 of the Directive 2000/60/EC).

As has been mentioned above, the vision of the Directive underlines the viewpoint that droughts constitute a phenomenon that should be incorporated into water planning and management in all situations but with a separate legal framework. In the case that one is faced with a drought that is unexceptional and, therefore, capable of being predicted, it should be taken account of in a manner that causes no additional deterioration through human use of the water resources. In the case of a drought of exceptional nature it must be taken account of in the planning but with the difference from the previous condition that allows the possibility of a short-term deterioration of the body of water as a consequence of human use of the water resources.

For practical purposes this should entail that in areas subject to regular periods of drought as in the case of mediterranean regions, considerable effort should be devoted to monitoring the quality level of the body of water, which in turn improves the resilience of ecosystems and so facilitates its recovery. Maintaining a high index level of the exploitation of water resources as exists in many Mediterranean hydrographic basins may create deterioration incompatible with the Water Framework Directive and, more seriously, a collapse of certain ecosystems. In this respect it is necessary to draw attention to the strategic importance of the good status of water resources in areas suffering severe water problems, since it is difficult to imagine that in the case of a body of water at risk of failing to meet the environmental targets as a consequence of over-exploitation, restrictions for extraction of water will be more rigorous when they are more urgently required as a result of being confronted with a period of drought. This does not remove the requirement that in such cases certain environmental conditions, as for example the ecological flow of a river or the volume for refilling an aquifer, will need to adapt to instances of drought in the same way that the removal and extraction of different bodies of water are required to adapt to their circumstances.

## The Conditions Necessary to Apply an Exception

As in the rest of the exceptions to the environmental targets contained in the Water Framework Directive the short-term exception in conditions of drought should be interpreted in a restrictive manner, and requires strict adherence to the fulfilment of the agreed conditions.

The conditions agreed in the case of exception provide a guarantee that it will not be misused and aim to prevent contrary abuse of the aims of the Directive. The conditions are set out in accordance with the nature of the drought and with the adoption of earlier, current and measures yet to be agreed.

## Conditions for the Characterisation of Drought

As regards the concept of drought it should be remembered that in community law it is an autonomous legal system having priority over the internal rights of Member states in consequence of which its terminology includes a special definition that takes precedence over national law. In other words the transfer of competencies of the States to the European Union entails the need for these to respect the categories and legal concepts that form part of the “glossary” of the Community Law. One might say with Professor Roldán Barbero that the transfer of competencies in favour of the European institutions in consequence results in the transfer of the possibility of defining legal concepts. In truth this requirement has obliged the community jurisprudence to declare the existence of concepts exclusive to the community which are imposed on the different national concepts, as is the case with “worker” or “conditions of work” (See: Fabio Pappalardo, “La notion de “conditions de travail” en droit communautaire”. *Revue du Droit de l’Union Européenne*. 2006–3. pp. 609–617) or the controversial community concept of “waste”.

Moreover, one of the requirements of the result (articles 249 and 10 of the TEC) which the framework Directive for water resources imposes on the State is that it includes in its legal system through an obligatory rule the concepts established therein. Such is the declaration of the Tribunal of Justice of the European Communities in the case of the Commission against Luxembourg for the incorrect application of this directive (Judgment in Case C-32/05 *Commission v Luxembourg* [2006], paragraph 61–65). This confirms the need for member States to include in their internal Law the exception that is under analysis.

In the establishment of these conditions for the characterisation of drought there are at least two relevant underlying aspects: the ambiguity of the term ‘drought’ and the need to guarantee the useful effect of the Directive.

The term drought is used to describe different events although all relate to the shortage of water resources. For example in Spain dictionaries with special relevance to this area offer different definitions for the principle meaning: “period of dry weather of lengthy duration” (*Diccionario de la Real Academia de la Lengua Española*, 22<sup>a</sup> edición, RAE, Madrid, 2003), “lack of rainfall which leaves fields



dry, and causes the reduction or disappearance of water currents” (María Moliner, *Diccionario de Uso del Español*, 2<sup>a</sup> edición, Editorial Gredos, Madrid, 2001), or “prolonged lack of rainfall” (Manuel Seco (Coord.), *Diccionario del Español Actual*, Aguilar, Madrid, 1999). Whatever the case, the important point to note is the need to determine via defined conditions the precise meaning used by the legislator when speaking of drought, since the fulfilment or non-fulfilment of the community standards may depend on this point. On the other hand the useful effect of the community standard ought to be supported with strict conditions in order that the exception is not in danger of becoming a mere hotch potch of decisions which would enable it to defend any case of non-fulfilment.

In this sense it is of interest to mention the definition of drought proposed by Antonio Estavan who draws attention to the fact that what we refer to regularly as drought is merely the state caused by pursuing a water resources policy based on the continually increasing use of water resources. This policy has created demands, which cannot be supported by the actual availability of resources, which in turn has created excessive pressure on aquatic ecosystems and a corresponding increase in our vulnerability in the face of any reduction in natural supplies. As a consequence, so our author informs us, it is necessary to revise the bases of water resource planning, with particular respect to the supplies produced by our over-estimated ecosystems, and to base our usage on the principle of caution (Estevan, 2005).

With these thoughts on the definition of drought we can proceed to analyse the characteristics which a drought must be fulfil to justify the non-fulfilment of the requirement to prevent deterioration of water resources as set out in the Community legislation.

Perhaps the most important condition is that the drought should be the result of “natural causes or force majeure”. This condition aims to prevent that a drought caused by human activity should justify the short-term deterioration of the body of water. However, to distinguish the causes of the drought is not always a clear and simple matter. To achieve this distinction it is necessary to rely on a range of indicators whose data may not be influenced directly by anthropic action. For example the level of water in a reservoir or the piezometric level of an aquifer depend directly on human action in managing supply and cannot, therefore, be considered in itself an adequate indicator to demonstrate the natural cause of a drought, although it still offers an extremely useful indicator of scarcity of resources for management purposes. It is, therefore, necessary, to revise existing indicators and to differentiate those which show exclusively natural climatological events from those which show situations of water shortage capable of influencing human life. Only on the basis of indicators for natural climatological phenomena can we make a legal decision on whether the drought is the result of natural causes or not.

The Directive moreover describes a drought as “of prolonged nature” but offers no definition of the length of such a period of time. When a drought is referred to in everyday language as of prolonged duration an element of comparison or point of reference is made to the usual duration of periods of drought. A drought would be prolonged in the measure in which its persistence or duration exceeded the normal period. To determine the threshold of frequency which might enable us to discover

whether we are facing a prolonged drought or not, it will be necessary to resort to statistics of occurrences in the relevant Hydrographic Table. In any event and as a preliminary approximation it seems logical that in the mediterranean climate a prolonged drought always lasts more than a hydrological year.

Drought has, moreover, to be “exceptional or one not capable of reasonable prediction”. An exceptional drought is one that is distinguished from the general norm, which tends to happen when it is of an abnormal duration or intensity. A drought which cannot be reasonably predicted is one whose occurrence is improbable, that is to say a drought, which given the frequency with which it occurs within a determined location and period of time, is unlikely to occur. It appears that both cases lead to an abnormal drought and one that is, therefore, exceptional and difficult to predict. However, in order to be able to establish a starting point from which a drought might be considered abnormal in a specific Hydrographic table it is necessary to resort to a historical analysis of occurrences. In any event and as a preliminary approximation it appears logical that an exceptional drought and one which is difficult to predict in a mediterranean hydrographic basin may be one which has a recurring timescale of at least fifty years according to the study undertaken by Prof Pita López (Pita, 2007).

The drought and the conditions which must coincide should be set out in a prior and specific manner in the Hydrographic plan for the basin as well as the indicators and, therefore, the criteria which need to be taken into account. It should be borne in mind that there are at least two criteria which must be taken into consideration: on the one hand the evolution of climate change constitutes a factor with a growing influence on the scarcity of water supplies and drought, and on the other hand the rigorous application of the principle of environmental forward planning.

In short the only type of drought which can justify a temporary deterioration in the body or mass of water is that which, in accordance with the specific indicators and values set out in the Hydrological basin plan, is identified and regarded as of natural origin and has a duration and intensity which are unusual and not capable of prediction in the range of the Hydrographic tables.

## **Conditions Related to the Adoption of Measures**

In addition to the conditions described on the characteristics of drought the Water Framework Directive also establishes the conditions of operational character for considering that the response to drought conditions may justify a short-term deterioration in the state of water. Implicit also in the establishment of these operational conditions is the need to guarantee the useful effect of the Directive and to guarantee under strict conditions that the exception is not used in an inappropriate or fraudulent way to support unjustified failure to comply with requirements.

The aim of these operational conditions focuses on the different aspects of environmental protection, in other words the prevention of new situations of deterioration and the protection and improvement of the state of the ecosystems. In this way

we are faced with the requirement to adopt measures of a preventive nature for the body of water affected or at risk of becoming so, and the measures of recovery for those bodies of water already affected.

The rule demands that all feasible measures should be adopted to prevent the further deterioration of the status of the body of water and to prevent risk to achieving the Directive's targets for other bodies of water not affected by these circumstances. It is a question of a coherent condition with the principle of environmental forward planning in the Community legislature (article 174.2 of the TEC), moreover it should be borne in mind that the aim of the Directive is to establish a framework for the protection of water resources which "might prevent all additional deterioration" in the state of aquatic and directly dependent surface and wetland ecosystems (article 1 of the Directive 2000/60/EC). The achievement of this condition shares its specific character with the principle set out in the Directive since reference is made to "all" feasible measures which is to say that if any measure exists which was capable of being adopted and which was not considered for fulfilling this objective, it would be regarded as a failure to comply with this legal condition. To determine which measures fulfil the condition of "feasible" or capable of being adopted one must remember that the Water Framework Directive distinguishes between basic, complementary and additional measures (article 11 of the Directive 2000/60/EC) and incorporates an annexe listing such measures (annex VI of the Directive 2000/60/EC), as a result of which in the definition of feasible measures one must include in all cases those listed in this source. As a limit the Directive requires that the measures available should not put at risk the recovery of the quality of the body of water once the circumstances that have brought about their adoption have abated. As for the time allowed to react to events, although the Directive makes no express comment on this point, logic leads us to conclude that a quick response is essential, using the least time possible since delay in reacting and adopting measures tends to lead to a disproportionate increase in the costs of recovery.

The Water Framework Directive also requires that the measures that must be adopted in these exceptional circumstances be included in the Programme of measures. One might ask whether it is possible to adopt a measure even though it is not included in the established Programme of measures, the Directive does not exclude this possibility at a later stage if its adoption is justified and it conforms to all the conditions applicable and in a simultaneous or successive form might promote its inclusion in the corresponding Programme of measures.

With reference to the territorial field of measures to be adopted the Framework Directive on Water Policy also includes a preventive judgement which covers both the bodies of water already affected as well as those bodies not yet affected but which are liable to become so, and accordingly are at risk of failing to meet the environmental targets.

As regards the short-term extension of its application one must remember that the requirement to adopt protective measures is a matter of dynamic character and therefore, makes no response to a single moment, rather to a process of application and monitoring which requires the adoption of all additional measures which turn

out to be necessary as a result of the annual review of the effects of drought. The additional measures will be required to meet the same conditions as those already adopted.

## **Conditions of Information and Public Participation**

However briefly it is important to draw attention to the necessity of integrating public participation in the planning and management of droughts and to raise a few points.

There exists a series of requirements in the field of environment with regard to access and dissemination of information, public participation in the taking of decisions and legal protection of those rights, which is included in the Treaty of Aarhus 1998 (Convention on Access to Information, Public Participation in Decision Making and Access to Justice in Environmental Matters, done at Aarhus, Denmark, on 25 June 1998) which has been confirmed in the Community body of legislation (Regulation (EC) No 1367/2006, Regulation (EEC) No 1210/90, Directive 2003/4/EC and Directive 2003/35/EC). These requirements apply in the subject field that is the object of this study.

In addition to these general requirements, however, the Water Framework Directive expressly states that "Member states will promote the active participation by all interested parties in the application of the present Directive" (article 14 of the Directive 2000/60/EC), this requirement serves to reinforce the general demands and imposes the need to involve all interested parties, whether through general interest such as environmental protection or from private economic interest such as those of users.

In this respect it is necessary that all interested parties be identified and that the matter be promoted by means of the dissemination and provision of access to the information, in the same way as via its consultation from the very beginning when all options are still open.

It should be pointed out that in a planning process which regards drought as a natural risk, which should be acted upon in a preventive and progressive manner, the establishment of thresholds for the adoption of measures should include among the interested parties the operators affected by the said measures. A case worthy of mention on the progressive participation by certain agents involved in the adoption of measures is to be found for the urban supplies in the concept of Francisco Cubillo for the Canal de Isabel II (Cubillo, 2003). In whatever case one must not fail to include among the interested parties those non-governmental organisations that monitor the interests of the environment.

Nevertheless the consumption of water in situations of shortage or of drought depends to a large measure on social habits and to change these customs it is essential to devote strenuous effort to promoting the understanding and joint responsibility of the public in general. One should bear in mind that whoever is involved in the decision making process will feel an obligation through his own volition and not from pressure from elsewhere.

In summary the participation by interested parties and by the public in general in the plans and programmes aimed at alleviating the effects of drought is a requirement laid down in the Community legislation (Directive 2000/60/EC, Directive 2003/4/EC and Directive 2003/35/CE) and, although in the application of the said plans or measures the sole requirement is for the participation of interested parties as has already been described, it is equally necessary to involve the general public to ensure its effectiveness.

## Conclusions

The Water Framework Directive has as its principal objective the protection of the water resources to prevent all additional deterioration and, protect and improve the status of aquatic terrestrial ecosystems and the dependent wetland systems for which only in exceptional cases set out by the Directive is permission given for non-fulfilment of this requirement and the environmental objectives which specify it for all bodies of water.

The system of planning and management set out by the Water Framework Directive requires that the responses to all situations of shortage of water resources which have a social cause must be integrated into the Hydraulic Basin Plan and its Programmes of Measures and Response as a result of which no justification is possible under any circumstance for the short-term deterioration of the state of the body of water.

Equally the responses to the droughts of natural origin whose intensity and duration may not be exceptional or which it may have been possible to predict with reasonable accuracy, must also be included in the above-mentioned planning. Consequently these droughts also cannot be used to justify the short-term deterioration of the state of bodies of water.

The characterisation of situations of exceptional drought, the indicators and appropriate thresholds together with the measures to be adopted for the protection of water resources and ecosystems which may be affected, must be included in the Hydrological Basin Plan and in the programmes of measures and corresponding follow-up.

Only droughts of natural origin and of exceptional character on account of their duration and intensity which, as a result, could not be predicted with reasonable certainty, justify the implementation of a temporary deterioration in the state of the body of water provided the appropriate feasible measures have been adopted to prevent the continuing deterioration of the body of water affected or at risk of becoming affected, or where the fulfilment of environmental objectives are at risk.

It is incumbent on Member States of the European Union to adapt their internal legislature to the Water Framework Directive which requires that hydrological planning regulates the situations of exceptional and non-exceptional drought within its hydrological planning and to have established in a compulsory standard the conditions whereby the exceptional drought may justify a short-term deterioration of the body of water.

The Member States must make up the informational gaps on the rights, usage and actual updated consumption of water resources, distinguishing those protected by law from those that are not protected. This information may be disseminated publicly via the Internet. This data together with updated and effective figures for the quantity of water available will facilitate a more efficient and effective planning programme and one capable of coping with situations of shortage or drought.

It is necessary to review the current system of indicators in order to clearly distinguish the indicators which enable us to determine whether a drought is the result of natural causes or, on the contrary, whether human intervention may also be a factor in its origin. The use of planning indicators such as the levels of water in reservoirs or the piezometric level of the aquifers are unsuitable for this purpose since they are subject to the effect of human action. It will also be necessary to establish indicators to define the environmental requirements in the event of drought in accordance with its level of intensity, and to define the thresholds that involve the need to adopt defensive measures to meet such eventualities.

In the event that the State draws up specific plans to alleviate the effect of droughts, it is equally necessary that such plans should be designed and structured in such a way as to be capable of integration into the future Hydrological Basin Plans. The measures that will be established in these planning tools will need to be evaluated in the same form as the Directive requires for the Programmes of measures of which they form part. Among the measures to consider for these plans will figure those for environmental protection which will determine in a fixed and forward-looking form an adaptation to the environmental needs at the different levels of intensity of drought, protective measures appropriate to confront the said needs, and measures required to restore the status in order to fulfil the environmental objectives once the exceptional situation has abated. These plans will need to create concrete measures to promote the active participation both of interested parties as well as of the public in general, also in a progressive form consistent with the intensity of the drought.

## References

- Estevan A (2005) Temas claves en la gestión de sequías. Gestión de sequías viejos problemas, nuevas soluciones. Sevilla University Pablo de Olavide
- Cubillo F (2003) Manual de abastecimiento del Canal de Isabel II. Canal de Isabel II, Madrid
- Pita López M F (2007) Recomendaciones para el establecimiento de un sistema de indicadores para la previsión, el seguimiento, y la gestión de la sequía. In: La Sequía en España: Directrices para minimizar su impacto. Ministerio de Medio Ambiente, Madrid

# Chapter 5

## Guidelines to Develop Drought Management Plans

Ana Iglesias, Luis Garrote and Antonino Cancelliere

**Abstract** The purpose of the Guidelines is to provide countries with a framework for effective and systematic approach to prevent and/or minimize the impacts of drought on people. The Guidelines are the result of the research carried out within the framework of the MEDA-Water project Medroplan that analyses drought and water scarcity management in Mediterranean countries promoting a risk-based preparedness and mitigation approach. The experiences in the development and implementation of drought and water scarcity management plans highlight the success and challenges of coping with drought for societies with different vulnerabilities and emphasize risk-based drought management as a critical approach to mitigate the impacts associated to drought-induced water shortages. Based on these experiences and the current legislation, management, technology and methods for evaluating risk, the Guidelines aim to assist in the development of drought management operational actions that link science and policy, responding to the growing issue of drought preparedness planning, monitoring, and mitigation.

### Introduction

Droughts occur very frequently in the Mediterranean countries with severe economic and social consequences also connected to the vulnerability of the water supply systems, the agricultural systems and of society in general (Iglesias et al., 2007). Such vulnerability is due to situations of permanent water scarcity, quality deterioration and increasing water demands deriving from population growth, tourist development and irrigation needs. Thus, a policy for drought management explicitly addressing the risk of droughts and its reduction is required based on actions aimed to improve drought preparedness and to mitigate impacts of ongoing droughts (Garrote et al., 2007).

---

A. Iglesias (✉)  
Department of Agricultural Economics and Social Sciences,  
Universidad Politécnica de Madrid (UPM), Spain  
e-mail: ana.iglesias@upm.es

The Medroplan project (Mediterranean Drought Preparedness and Mitigation Planning) has developed a systematic approach for dealing with drought risk and to assist in the development of drought and water scarcity management plans linking science and policy (<http://www.iamz.ciheam.org/medroplan>) (Iglesias et al., 2006; Iglesias and Moneo 2005). In particular, one of the main outcomes of the project has been the development of Drought Management Guidelines designed to contribute to key social and policy questions such as:

- How can water management under drought conditions be improved, and how best can people benefit from such changes? The present contribution argues that there are options to minimize the risk of drought impacts by promoting drought preparedness and management plans.
- How can research help the development of innovative institutional arrangements and decision-support tools? The Guidelines provide a framework and systematic approach to link academic knowledge to operational and policy aspects of drought risk management.

Drought management is a tool to complement water resources management. The integrated drought planning concept of the guidelines includes five components: The planning framework, the organizational, methodological, operational and public review components. In addition, a compendium of examples of application to different case studies from Mediterranean countries is included.

The present chapter outlines the main contents of the Guidelines. As such, the contribution of the Medroplan research teams and collaborators is acknowledged for their valuable input.

## **Defining a Common Language Among Stakeholders**

The stakeholder dialogue provides essential information and insights about drought preparedness since the relevant wisdom is not limited to scientific specialists and public officials. A multi-stakeholder dialogue is necessary to increase the quality and acceptance of drought management plans and to increase acceptance of or trust in the science that is in the basis of the planning. Nevertheless, stakeholder engagement presents some key challenges and it is necessary first to identify initiatives and means for engaging them and ensure that the stakeholders represent the decision making in realistic terms. A main challenge in the dialogue process is to ensure that complex models and methodologies that form the basis for drafting drought management plans are transparent and provide insight to individual users.



A frequent problem when establishing a dialogue among the scientists and stakeholders arises from the interpretation of the concepts. Drought, aridity, water shortage, water scarcity and desertification are common and overlapping processes in Mediterranean countries and often are misinterpreted and misused. Starting with clear and agreed definitions and concepts contributes to the development of clear methods and to the correct interpretation of the results for developing drought management plans.

**Drought** is a natural casual (random) temporary condition of consistent reduction in precipitation and water availability with respect to normal values, spanning a significant period of time and covering a wide region. **Aridity** is a natural permanent climatic condition with very low average annual or seasonal precipitation. **Water shortage** in a water supply system represents a water deficit with respect to the demand which can occur due to a drought or other man-induced causes (e.g. low water quality, ill services) **Water scarcity** indicates a permanent condition of unbalance between water resources and water demands in a region (or in a water supply system) characterized by an arid climate and/or a fast increase of water demand, associated to population growth, extension of irrigated agriculture, etc. **Desertification** indicates the degradation of land in arid, semi-arid and other areas caused primarily by over-exploitation and inappropriate land use interacting with climatic variance.

According to the different component of the natural hydrologic cycle affected by a drought event, it is possible to distinguish between: meteorological, agricultural or hydrological drought. With reference to Fig. 5.1, a **meteorological drought** indicates a condition of reduction of precipitation with respect to normal values, consequent to precipitation variability probably caused by earth processes (as geophysical and oceanographic interactions), interactions with the biosphere and maybe by sunlight energy fluctuations. As a direct consequence of meteorological drought, a soil moisture deficit occurs (agricultural drought), depending on the entity of the meteorological drought transformed by the water storage effect. In particular, such water storage causes a delay in the deficit occurrence and modifies its entity in relation to the initial condition and to the evapotranspiration process. Agricultural drought affects especially agriculture and livestock systems in rainfed conditions. Subsequently, when the previous deficit affects surface water bodies (rivers) and groundwater (aquifers), a **hydrological drought**, as a surface and/or groundwater flow decreasing with respect to the normal values, occurs. Drought can have effects on water supply systems leading to water shortages. The latter condition is sometimes defined as **operational drought**, and in relation with the environmental, economic and social system features it can have economic and intangible impacts. Both the water availability reduction and its impacts depend, besides of the importance of the drought event, on the efficiency of the mitigation measures adopted in water supply and socio – economic systems. Finally, the definition of **socio-economic drought** is also used to indicate impacts of water shortage on population and economy.

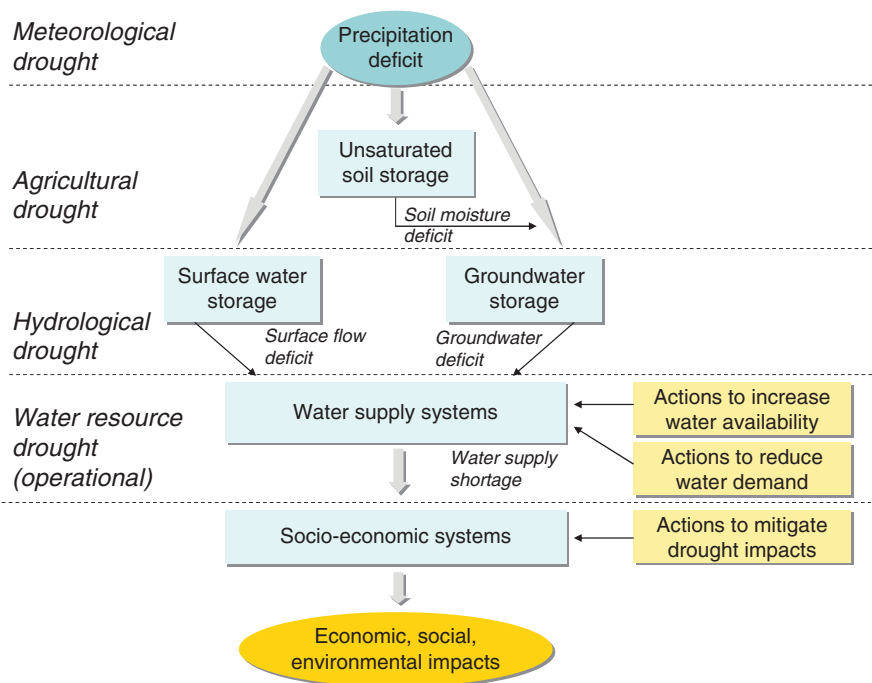


Fig. 5.1 Drought phenomenon types and role of preparedness and mitigation measures

## Risk Management Approaches

### *Planning in Advance*

A **crisis management approach** is based on the implementation of measures and actions after a drought event has started and is perceived. This approach is taken in emergency situations and often results in inefficient technical and economic solutions since actions are taken with little time for evaluating optimal actions and stakeholder participation is very limited. On the other hand a **proactive approach** consists in planning in advance the necessary measures to prevent or minimize drought impacts. Such an approach includes planning tools, which enables to avoid or reduce the consequences of a possible water emergency, developed with the stakeholder participation, and the implementation of such plans when a drought occurs. It can be considered an approach to “manage risk” and it foresees a continuous monitoring of hydrometeorological variables and of the status of water reserves in order to identify possible water crisis situations and to apply the necessary measures before a real water emergency occurs.

In extreme cases, when it is not possible to avoid a water crisis, then government declaration of natural public calamity may be issued and a drought contingency plan may be implemented until the establishment of normal conditions. It is evident that a proactive approach, even if more complex, is more efficient than the traditional

approach, since it allows defining in advance drought mitigation measures (both long term and short term) improving the quality of interventions.

### ***Multiple Aspects of Drought Management***

The implementation of a proactive approach implies drafting plans in which the mitigation measures are clearly defined together with the instructions for their implementation. To this end, a clear assignment of competences among the different involved institutions appears to be a key issue and therefore a legislative act that defines the responsibilities is necessary in each country. Such act could be part of national water resources policy and/or strategy to fight desertification (e.g. within the U.N. convention).

Nonetheless, no single management action, legislation or policy can respond to all the aspects and achieve all goals for the effective drought management. Multiple collaborative efforts are needed to integrate the multidimensional effects of drought on society. Other important aspects to take into account include stakeholder participation, management and changes in water rights legislation allowing water exchange during droughts, and definition of standards of efficiency to foster water saving and sanctions for those who do not respect them.

### ***Institutional and Legal Framework for Coping with Drought in Europe***

The European Union Water Directive 2000/60 explicitly defines planning as the main tool to guarantee protection of water bodies and indicates mitigation of flood and drought effects as main objectives. However it does not take into account criteria and actions to face drought risk, references to drought are rare and ambiguous and often misleading and mitigation measures are only considered optional.

Most European countries have not issued a legal framework to face drought risk and emergency actions are generally managed by Civil Protection Agencies or carried out in accordance with some legislative acts referring to natural disaster recovery. The lessons learned during recent droughts have shown the inadequacy of the legal and institutional systems, and advocate the planning of drought mitigation measures and the substitution of subsidies to cover damages in agriculture with insurances. In the European context, Spain is one of the most advanced examples of institutional support for taking these initiatives. The success in most cases is due to the management of water at the basin level, allowing coordination of policy, physical and technical aspects. For example, in Spain there is a clear share of competences among the bodies involved, as well as a clear definition of the contents of drought mitigation plans. The Law 10/2001 applies a proactive approach to face drought risk: it defines the basis to develop a system of hydrologic indicators to monitor and forecast drought events; gives responsibility to the Basin Authorities (Confederaciones Hidrográficas) to prepare their drought plans and to the municipal

water agencies to prepare drought emergency plans; and assigns responsibilities for drought declaration.

## Risk Analysis

### *The Complexity of Drought Calls for Complex Methods of Analysis*

In general terms, risk analysis comprises several activities oriented to quantifying the drought hazard and the risk to different systems, as well as to identifying the causes of risk, and the operational aspects to decrease risk. These aspects can be evaluated in isolation or in an integrated approach although their complexity suggests a wide range of possible evaluation methods. Each method has its own merit and they are usually supportive of each other, therefore a combination of methods is usually most rewarding. The results of the risk analysis provide elements that support the controversial official declaration of drought and of its different levels of alert.

### *Defining the Concepts: Hazard, Risk, and Vulnerability*

Risks are generally created or exist within social systems, therefore it is important to consider the social contexts in which risks occur and that people do not necessarily share the same perceptions of risk and of their underlying causes. Thus, the formal definition of the risk concept has implications for the analytical methods for its analysis. Nevertheless, defining risk and vulnerability is difficult since these concepts are used loosely in many different contexts, from medicine to poverty and development literature. They are part of the common language and are used by most people in daily life. In the context of natural hazards, the concepts are often derived from the social sciences since there is an explicit demand for increasing social protection to natural hazards. In contrast, the concept of risk in engineering is physically based on the computation of failure probabilities in a system. Regardless of the nuance of risk definitions, the key concepts are: (1) risk relates to the consequences of a disturbance, rather than its agent; and (2) risk is a relative measure and critical levels of risk must be defined by the analyst.

There is not clear definition that includes cross sector (social and physical) concepts. The concepts that appear in most policy documents follow the definitions provided by the United Nations International Strategy for Disaster Reduction (UNISDR, 2006), here reported:

**Hazard.** A potentially damaging physical event, phenomenon and/or human activity, which may cause the loss of life or injury, property damage, social and economic disruption or environmental degradation. Each hazard is characterized by its location, intensity, frequency and probability.

**Vulnerability.** A set of conditions and processes resulting from physical, social, economic, and environmental factors, which increase the susceptibility of a community to the impact of hazards. Positive factors, that increase the ability of people

and the society they live in, to cope effectively with hazards and can reduce their susceptibility, are often designated as capacities.

**Risk.** The probability of harmful consequences, or expected losses (deaths, injuries, property, livelihoods, economic activity disrupted or environment damaged) resulting from interactions between natural or human induced hazards and vulnerable conditions.

## Evaluating Risk in Water Supply Systems

### *Specifying the Risk Concept in Water Supply Systems*

In water supply systems, drought is characterized by a high level of complexity. Risk in water supply systems is directly related with water shortage, which differs from drought because it is related to a shortage of water availability to satisfy demands. The shortage results from an unbalance between water supply and demand, which is originated by a meteorological phenomenon, but is also conditioned by other time-varying factors, such as demand development, supply infrastructures and management strategies. The result of the unbalance is water shortage, which is of concern for water managers.

Risk evaluation in water supply systems consists of identifying demands that may not be fully satisfied with available water resources, and quantifying the estimated impacts of water shortage. It is usually not economically efficient to satisfy at 100% all the demands in a system, because the cost would be too high for too little enhancement.

In general, a set of performance indices, attempting to capture different aspects related to concepts such as reliability, resiliency and vulnerability, is used. Indeed, the presence in some cases of many conflicting demands and the uncertainty related to the actual impacts of extreme events such as droughts, make the risk assessment of a water supply system a problem that is better faced through a set of several indices and/or by analyzing the probabilities of shortages of different entities.

The complexity of risk assessment in water supply systems requires simulation of the system to be carried out by means of appropriate mathematical models. Nonetheless, preliminary risk assessment can be performed with reference to the following simple indices:

- Water demand to average inflows ratio. Provides information about the degree of development of water resources in the system. Ratios close to 1 mean frequent system failures, depending on inter-annual or seasonal variability of hydrologic series.
- Water demand to reservoir capacity ratio. This provides information about the quantity that the system is able to supply.
- Reservoir capacity to average inflows ratio. This provides information on the capacity of the system to overcome inflow irregularities (droughts).

- Annual water demand to current reservoir storage ratio. This represents the expected time to failure, in years, if future inflows are neglected. The variable provides information on the margin of operation of the system.

### ***Defining the Acceptable Risk Level***

The acceptable risk level is conditioned by available water resources and infrastructures and depends on demand characteristics and their elasticity. In this context, the risk analysis should consider four main aspects: (1) probability of failure occurrence (probability of not satisfying the demand); (2) severity of failures (magnitude of the deficit); (3) failure duration (time span when deficits occur); and (4) economic impact of failures. These factors determine also the operational rules for system management during droughts. In regulated systems, reliability and water supply capacity are linked by operational rules and risk management strategies. At the river basin or water catchment level, there are inter-dependent risk management units that implement different risk management plans. Reliabilities are defined depending on location of the risk management unit (e.g., up or down stream). Up-stream units need to consider also the risk of down-stream units.

## **Defining and Selecting Drought Management Actions**

### ***Long Term and Short Term Actions***

Measures that are taken before the initiation of a drought event aim to reduce the vulnerability to drought or improve drought preparedness. They are long-term measures oriented to increase the reliability of water supply systems to meet future demands under drought conditions through a set of appropriate structural and institutional measures. The measures taken after the start of a drought are short-term measures that try to mitigate the impacts of the particular drought event within the existing framework of infrastructures and management policies, on the basis of a plan developed in advance and adapted to the ongoing drought, if necessary.

In order to incorporate the actions to drought management plans it may be useful to determine the proactive or reactive, as well as the public or private character of the measures. The following Table 5.1. lists a range of long-term and short-term actions, subdivided into the three categories of water supply increase, water demand reduction and drought impact minimization. For each action the affected sectors are also indicated.

### ***Criteria for Selecting the Actions***

Drafting drought management plans requires the selection of the most appropriate combination of long term and short-term actions with reference to the vulnerability

**Table 5.1** Long and short-term drought mitigation actions and sectors affected by the implementation of the actions

Category	Type of actions	Affected sectors
	<b>Long-term actions</b>	
Demand reduction	Economic incentives for water saving	UAIE
	Agronomic techniques for reducing water consumption	A
	Dry crops in place of irrigated crops	A
	Dual distribution network for urban use	U
	Water recycling in industries	I
Water supply increase	Conveyance networks for bi-directional exchanges	UAI
	Reuse of treated wastewater	AIE
	Inter-basin and within-basin water transfers	UAIE
	Construction of new reservoirs or increase of storage volume of existing reservoirs	UAI
	Construction of farm ponds	A
	Desalination of brackish or saline waters	UAE
Impacts minimization	Control of seepage and evaporation losses	UAI
	Education activities for improving drought preparedness and/or permanent water saving	U
	Reallocation of water resources based on water quality requirements	UAIE
	Development of early warning systems	UAIE
	Implementation of a Drought Management Plan	U
	Insurance programs	AI
	<b>Short-term actions</b>	
Demand reduction	Public information campaign for water saving	UAIE
	Restriction in some urban water uses (e.g. car washing, gardening, etc.)	U
	Restriction of irrigation of annual crops	A
	Pricing	UAIE
	Mandatory rationing	UAIE
Water supply increase	Improvement of existing water systems efficiency (leak detection programs, new operating rules, etc.)	UAI
	Use of additional sources of low quality or high exploitation cost	UAIE
	Over exploitation of aquifers or use of groundwater reserves	UAI
	Increased diversion by relaxing ecological or recreational use constraints	UAIE
Impacts minimization	Temporary reallocation of water resources	UAIE
	Public aids to compensate income losses	UAI
	Tax reduction or delay of payment deadline	UAI
	Public aids for crops insurance	A

U (urban); A (agriculture); I (industry); E (environment)

of the specific water supply system or agricultural system and to the drought severity. Given the high number and the different types of mitigation measures, it is necessary to adopt a proper evaluation procedure for the choice of the best combination. A selection procedure based on purely economic criteria could include equating the marginal costs of long-term measures with the marginal costs of implementing short-term measures. A more advanced procedure could be based on assessing by Monte Carlo simulation the expected cost of each combination of long and short-term measures. However, due to the variety of drought impacts and in particular to the difficulty of assessing in economic terms environmental and social impacts, a purely economical analysis does not seem adequate to simulate the real decisional process. Application of multicriteria analysis on the other hand may overcome the above difficulties also because of its ability to take into account the points of view of different stakeholders on the different alternatives.

### ***Ranking of Actions***

The general objective of every operational action is to minimize impacts of drought and water scarcity while maintaining social and ecological water services. However, not all actions are suitable and applicable in every situation and moment. The ranking of actions allows for a certain level of prioritization depending on the evaluation of selected aspects, such as:

- Consideration of effectiveness to minimize the risk of impacts, cost, feasibility, and assistance required for adoption
- Consideration of adequacy for situations without drought (win-win strategy)
- Each action is ranked and defined from different points and valuation criteria that include the full range of stakeholders.

### **Public Review of Drought Management Plans**

Public review has to play an important role throughout the process of developing a plan since the social and environmental conditions may change and aspects of risk analysis and management improve and evolve. Once the plan is developed, it may be necessary to revise certain aspects of an existing plan periodically.

In all cases public revision is complex, but in most cases includes two aspects: Dissemination of the information to be revised and multi-stakeholder dialogue to revise the information. The feedback from stakeholders may be collected by means of the responses to questionnaires, group interviews, or other methods to obtain information. The interviews may be public in order to allow the participation and discussions among all stakeholder groups.

A periodic revision of the plan by institutions and stakeholders is very advisable, as situations change and plans should be adapted to these changes. Moreover, it is obvious that an in-depth revision of a drought management plan should be made



after each drought episode, analyzing the response of all the aspects of the plan. This analysis would provide elements to adapt and improve the plan, in a continuous feedback process that keeps it updated.

## References

- Garrote L, Flores F, Iglesias A (2007) Linking drought indicators to policy actions in the Tagus basin drought plan. *Water Resources Management* 21:873–882
- Iglesias A, Moneo M, Gabiña D (2006) Guidelines for drought management. Executive summary, CIHEAM – IMAZ, Special publication of the Medroplan Project, Spain. <http://www.iamz.ciheam.org/medroplan>
- Iglesias A, Garrote L, Flores F, Moneo M (2007) Challenges to manage the risk of water scarcity and climate change in the Mediterranean. *Water Resources Management*, 21:775–788
- Iglesias A, Moneo M (eds) (2005) Drought preparedness and mitigation in the Mediterranean: Analysis of the Organizations and Institutions. *Options Méditerranéennes, Series B*, no. 51. CIHEAM, Centre International de Hautes Etudes Agronomiques Méditerranéennes, Zaragoza
- UNISDR (2006) United Nations International Strategy for Disaster Reduction, United Nations, Geneva. <http://www.unisdr.org> (last visited August 2008).

**Part II**  
**Methods and Approaches for Drought**  
**Management**

# Chapter 6

## Drought Characterisation in the Mediterranean

G. Tsakiris and D. Pangalou

**Abstract** Drought identification and characterisation is a complicated task, because drought is a complex natural phenomenon difficult to detect. Several methodologies have been proposed for drought characterisation, based either on the consequences or on specially devised indices. This chapter focuses on the critical presentation of some of the most popular drought indices. Duration and spatial extent of drought are also dimensions that are analysed.

### Introduction

Drought is a complex natural phenomenon, which, from a hydrological perspective, is characterised by a significant decrease of water availability during a significant period of time and over a large area.

Identification, quantification and monitoring of drought phenomena are difficult tasks, since these phenomena are very complex and cannot be detected directly at the time they occur.

Several methodologies have been proposed for drought assessment. The major categories of these methodologies are the following:

- (a) Methodologies based on indications of consequences
- (b) Methodologies based on indices, which are special combinations of meteorological, hydrological or other indicators.

The first category is more comprehensive for the analysis of historical droughts; however, it fails to identify and monitor drought episodes in real time. Therefore,

---

G. Tsakiris (✉)

Centre for the Assessment of Natural Hazards and Proactive Planning and, Lab. of Reclamation Works and Water Resources Management, School of Rural and Surveying Engineering, National Technical University of Athens, Athens, Greece  
e-mail: gtsakir@central.ntua.gr

although this category of methodologies is generally useful, it cannot practically assist the decision makers to face developing drought events.

The second category of methodologies for drought assessment involves several drought indices. It is customary to characterise drought as meteorological, hydrological, agricultural, socio-economic etc. Although this type of categorisation has been widely accepted by the scientific community, the authors support the idea that drought is a unique natural phenomenon, the impact of which affects various sectors and systems. Therefore, what is different is not the type of drought but the sectors that are affected and used for its quantification.

Drought indices provide representations of historical droughts and therefore place current conditions in historical perspective. They are valuable for planning purposes as well as for providing decision makers with a representative value of negative deviation from normal conditions of water availability.

A key issue, when drought indices are used, is the establishment of the thresholds representing the boundaries of the severity classes. Unfortunately, these thresholds cannot be the same for all the cases studied, since they are dependent on the location and the system, which is analysed. Therefore, if a drought index is used for decisions during a drought episode, the thresholds should somehow be associated with the affected area and the affected system. To overcome this drawback, the drought index should be accompanied by a vulnerability and risk analysis based on the assessment of historical drought events and the recorded consequences.

In any case, drought indices are useful tools for planning and management especially in the arid and semi-arid zones. They can also be used as the basis for monitoring and early warning systems, provided they will be used with care.

A comprehensive characterisation of a drought event affecting a certain system, from a water resources management point of view, is comprised of the following determinants:

1. Temporal dimension including the onset and termination of drought (timing and duration of drought)
2. Severity dimension, measured by drought indices
3. Spatial dimension estimated by the territorial area affected by the drought event.

This chapter addresses all these dimensions. However, the emphasis is given on the severity issue and the drought indices, which are used for its estimation.

No special reference is made on the various satellite-derived indices, since they come from a very different background. They are based on the monitoring of vegetation changes and interpretation of the impacts of climatic events on the biosphere. Comprehensive reviews on satellite-derived drought indices may be found in other specialised publications (e.g. Justice et al., 1989, Franklin and Hiernaux, 1991, Vogt et al., 2000, Kühbauch and Rademacher, 2000, Tsiros et al., 2004).

## Basic Notions

### *Indices Attributes*

For the selection of indices, which are most appropriate for estimating the severity of drought, a number of items could be examined. The most important of these items are:

- Simplicity (to be easily used and understood by the stakeholders)
- Rationality (scientifically sound, physically meaningful)
- Sensitivity (wide range of values)
- Timely response (short lag time)
- Transferability (appropriate for use in other areas)
- Data availability (including long time series and good quality data)
- Cost effectiveness (low cost for procuring the data needed)

As it can be easily understood, some of the above items are conflicting with each other. This means that if an index requires many determinants and is scientifically sound, it may not be acceptable for use, due to the lack of the required data or to the long lag time needed for recording the drought event. Needless to say, that some of the indices are better for the analysis of historical droughts, whereas others are preferred for monitoring purposes.

Before the critical presentation of some widely used or promising indices, it would be wise to discuss three important issues for the use of drought indices. These are the “normal conditions”, the time step of the required data, the reference period and the territorial unit for drought analysis.

### *Normal Conditions*

Since drought has been postulated as the deficient deviation from the normal conditions, it is necessary to clarify what is meant by *normal conditions*. Some researchers use a general level, which corresponds to the level for fulfilling certain consumption. Most of the researchers however use the mean figures of meteorological or hydrological parameters to establish the normal conditions. If, for instance, the precipitation is the key parameter to measure annual drought, the arithmetic mean of annual precipitation based on a significant number of years is the level taken as the basis for calculating the deviations.

From results of various studies, it can be inferred that the *median* instead of the arithmetic mean can represent the normal conditions in an area more reliably. This is mainly because extreme values of fatal outliers do not influence the median as they influence the arithmetic mean. The same happens when new data are added to the existing series of data, that is the median is not easily affected.

In conclusion, in several cases, the arithmetic mean could be replaced by the median for establishing the normal conditions mainly for large reference periods.

A simplifying assumption for determining the normal conditions is that of “stationarity”. However, this assumption should be examined before establishing the level of normal conditions. Care should also be taken for establishing seasonal normal conditions due to seasonality effects.

### ***Time Step and Reference Period***

The data required for drought assessment are usually monthly data. No smaller time step has any significant effect when drought is assessed by drought indices. Only in some very specialised indices related to crucial water deficit aspects, could a smaller time step possibly be used.

Therefore, for the purpose of establishing drought-monitoring networks, monthly values of the key meteorological/hydrological parameters are required.

Further regarding the *reference period* for drought assessment, it seems wise to consider long periods of time, including a significant number of months. If a short reference period is selected, many complications will be encountered related to carry-over quantity of water from period to period. Furthermore, lag time in hydrological processes makes any kind of drought assessment unreliable if a short reference period is adopted.

Based on these thoughts, the task of assessing droughts using general indices can be more efficiently implemented, if the reference period is an entire season or an entire year.

### ***Spatial Integration***

It is generally accepted that drought is characterised by its spatial coverage. However, meteorological information is collected from selected stations, which can be considered as representing the area attributed to them (e.g. by Thiessen polygons). The spatial integration is based on these areas/polygons. Polygons under drought are aggregated to estimate the total area affected by drought.

However, this approach disregards the hydrological processes, which are based on the hydrological basin scale.

It could be proposed that drought analysis is applied to the basin or sub-basin as the spatial unit, after transferring the data from the existing stations on the average basin scale. There might be cases in which one station can represent an entire basin or a sub-basin sufficiently and in this case, calculations for drought indices can be performed directly.

In case of assessment of drought at a basin scale the “interpolate – calculate” method could be also used. By this method, all principal data (e.g. precipitation, temperature, etc) are transferred to the squares in which the basin is divided. The

weighted average is used to calculate the representative meteorological data of the entire basin and then the drought indices are calculated. The opposite procedure, by which the drought indices are calculated at the locations of the meteorological stations and then transferred to the basin scale, should be avoided, mainly due to the “non-linearity” problems related to this transformation.

The approach above seems to give significant opportunities for relating meteorological drought to hydrological drought and also it will lead to a more efficient linkage between meteorological drought indices and the anticipated damage in the various sectors of the economy.

Apart from the approach suggested above, in a number of cases (e.g. very big river basins) it could also be possible to calculate severity indices on sub-areas corresponding directly to the existing meteorological stations. By this technique, isolines of the selected indices could be constructed, which show the spatial variability of the drought severity.

## **Selected Drought Indices**

From the numerous drought indices developed, some have been selected for review, whereas only three are briefly presented below. These indices (of general meteorological type) are the Deciles, the Standardised Precipitation Index, and the new promising Reconnaissance Drought Index.

### ***Deciles***

A simple meteorological index is the rainfall deciles (Gibbs and Maher, 1967), in which the precipitation totals for the preceding three months are ranked against climatologic records. If the sum falls within the lowest decile of the historical distribution of 3-month totals, then the region is considered to be under drought conditions (Kinninmonth et al., 2000). The drought ends when a) the precipitation measured during the past month already places the 3-month total in or above the fourth decile, or b) the precipitation total for the past three months is in or above the eighth decile.

The first decile is the precipitation amount not exceeded by the lowest 10% of the precipitation occurrences. The second decile is the precipitation amount not exceeded by the lowest 20% of occurrences. These deciles continue until the rainfall amount identified by the tenth decile is the largest precipitation amount within the long-term record. By definition, the fifth decile is the median, and it is the precipitation amount not exceeded by 50% of the occurrences over the period of record. The deciles are grouped into five classes. Table 6.1 presents the classes of drought conditions according to deciles.

The advantage of the decile approach is its computational ease, but its simplicity can lead to conceptual difficulties. For example, it is reasonable for a drought to terminate when observed rainfall is close to or above normal conditions. But minor

amounts of precipitation during periods in which little or no precipitation usually falls, can activate the first stopping rule, even though the amount of precipitation is trivial and does not terminate the water deficit. A supplemental third rule, that considers the total precipitation since the beginning of drought, may be used (Keyantash and Dracup, 2002). According to this rule, if the total precipitation exceeds the first decile for all drought months, then the meteorological drought may be considered terminated.

**Table 6.1** Classification of drought conditions according to deciles

Decile classes	
deciles 1–2: lowest 20%	much below normal
deciles 3–4: next lowest 20%	below normal
deciles 5–6: middle 20%	near normal
deciles 7–8: next highest 20%	above normal
deciles 9–10: highest 20%	much above normal

### ***Standardised Precipitation Index***

The Standardised Precipitation Index (SPI) was developed for the purpose of defining and monitoring drought (McKee et al., 1993).

The SPI calculation for any location is based on a series of accumulated precipitation for a fixed time scale of interest (i.e. 1, 3, 6, 9, 12, . . . months). Such a series is fitted to a probability distribution, which is then transformed into a normal distribution so that the mean SPI for the location and desired period is zero (Edwards and McKee, 1997). Positive SPI values indicate greater than mean precipitation, and negative values indicate less than mean precipitation. Because the SPI is normalised, wetter and drier climates can be represented in the same way, and wet periods can also be monitored using the SPI.

The Gamma probability distribution is used for representing cumulative precipitation time series, which are needed for the SPI calculation. However, since the gamma probability function cannot incorporate zeros, a composite probability function  $H(x)$  is proposed (Eq. 6.1):

$$H(x) = q + (1 - q) G(x) \quad (6.1)$$

where  $q$  is the probability of a zero and  $G(x)$  the cumulative probability of the gamma distribution. The composite probability  $H(x)$  is then transformed to the standard normal probability through the random variable  $z$  with mean zero and variance one, which is the value of the SPI. Once standardised, the strength of the anomaly is classified as set out in Table 6.2. This table also contains the corresponding probabilities of occurrence of each severity arising naturally from the normal probability density function. Thus, at a given location for an individual month, at least moderate



droughts ( $SPI \leq -1$ ) have an occurrence probability of 15.9%, whereas extreme droughts ( $SPI \leq -2$ ) have an event probability of 2.3%. Extreme values in the SPI will occur, by definition, with the same frequency at all locations.

**Table 6.2** Drought classification by SPI value and corresponding event probabilities

SPI value	Category	Probability (%)
2.00 or more	Extremely wet	2.3
1.50 to 1.99	Severely wet	4.4
1.00 to 1.49	Moderately wet	9.2
0 to 0.99	Mildly wet	34.1
0 to -0.99	Mild drought	34.1
-1.00 to -1.49	Moderate drought	9.2
-1.50 to -1.99	Severe drought	4.4
-2 or less	Extreme drought	2.3

The SPI can track drought on multiple time-scales. The U.S. National Drought Mitigation Center (NDMC) computes the SPI with five running time intervals, i.e. 1-, 3-, 6-, 9-, and 12-months. This can provide an overwhelming amount of information (sometimes confusing), unless researchers have a clear idea of the desired intervals. Moreover, being a standardised index, the SPI is particularly suited to compare drought conditions among different time periods.

The method of calculation includes the following steps:

1. Data preparation. Computation of a time series of cumulative precipitation for a fixed time scale. At least 30 years of data are highly recommended.
2. Determination of a probability frequency distribution that statistically fits the time series of precipitation data.
3. Calculation of the non-exceedence probabilities related to the cumulative values.
4. Derivation of the corresponding normal standard quantiles, which represent the SPI values.

### ***Reconnaissance Drought Index (RDI)***

The “Reconnaissance Drought Index – RDI” is based on the ratio between two aggregated quantities of precipitation and potential evapotranspiration (Tsakiris and Vangelis, 2005, Tsakiris et al., 2007a). The initial value of the index for a certain period, from the beginning of the hydrological year up to the k-month, is calculated by the following equation:

$$\alpha_k = \frac{\sum_{j=1}^{j=k} P_j}{\sum_{j=1}^{j=k} PET_j} \quad (6.2)$$

in which  $P_j$  and  $PET_j$  are the precipitation and potential evapotranspiration of the  $j$ -th month of the hydrological year respectively. The hydrological year for the Mediterranean region starts in October, hence for October  $k = 1$ .

Equation. 6.2 may be calculated for any period of the year. It can be also written starting from any month of the year different from October if necessary (Tsakiris et al., 2007b).

For real world applications if  $a_k$  is calculated as a general index of meteorological drought it is advisable to use periods of 3, 6, 9 and 12 months. In cases where a 12-month period is selected, the result could be directly compared with the Aridity Index produced for the area under study. If  $a_{12}$  for a certain year is lower than Aridity Index calculated according to UNEP (1992) then the area is suffering from drought during this year.

Two additional expressions of the Reconnaissance Drought Index are the Normalised RDI and the Standardised RDI:

The Normalised RDI ( $RDI_n$ ), which represents the deviation from the normal conditions, is computed as follows:

$$RDI_n(k) = \frac{a_k}{\bar{a}_k} - 1 \quad (6.3)$$

in which  $\bar{a}_k$  is the arithmetic mean of  $a_k$ s for a number of years.

Finally, the Standardised RDI ( $RDI_{st}$ ) is computed following a similar procedure to the one that is used for the calculation of SPI:

$$RDI_{st}(k) = \frac{y_k - \bar{y}_k}{\hat{\sigma}_k} \quad (6.4)$$

in which  $y_k$  is the  $\ln a_k$ ,  $\bar{y}_k$  is its arithmetic mean and  $\hat{\sigma}_k$  is its standard deviation.

Regarding Eq. 6.4 the standardisation is achieved by assuming that  $a_k$  follows a lognormal distribution. This assumption was tested using data from a variety of stations in Greece. Although the choice of lognormal distribution is not constraining, it does assist in devising a unique procedure for assessing drought severity. The gamma distribution may also be used instead.

The Standardised RDI ( $RDI_{st}$ ), behaves in a generally similar way to the SPI and therefore the interpretation of the results is similar since the same thresholds as SPI can be used.

### ***Other Drought Indices***

Apart from the general indices that were presented so far, it is also worth presenting concisely some specific indices that are quite widely used. These indices are used for agricultural, economic, industrial, tourist and recreational uses.

The *Palmer Drought Severity Index (PDSI)* was introduced by Palmer (1965) for the assessment of the meteorological drought. Although, PDSI is referred to as an index of meteorological drought, however, the procedure considers precipitation,

evapotranspiration, and soil moisture conditions, which are determinants of hydrological drought, i.e. the period during which the actual water supply is less than the minimum water supply necessary for normal operations in a particular region.

The *Palmer Hydrological Drought Severity Index (PHDI)* has a similar behaviour to PDSI. The distinction between PHDI and PDSI is that the PHDI has a more stringent criterion for the elimination of the drought or wet spell, which results in the index rebounding gradually and more slowly than the PDSI towards the normal state. It should be mentioned that PDSI can be computed only when the drought event finished, i.e. only on past series, while PHDI can be computed in the current time interval (Alley, 1984).

The *Bhalme – Mooley Drought Index (BMDI)* (Bhalme and Mooley, 1980) provides a good measure of the current status of drought that is the effect of short periods of dry weather. It is an easy index to calculate, since it does not involve terms such as evapotranspiration or soil water capacity, which are parameters especially difficult to estimate and it is based only on monthly precipitation.

The *Rainfall Anomaly Index (RAI)* was developed by Van Rooy (1965) to incorporate a ranking procedure to assign magnitudes to positive and negative precipitation anomalies.

A traditional assessment of hydrological drought is the *Total Water Deficit*, which is synonymous with drought severity *S*. This severity is the product of the duration *D*, during which observed flows are consistently below some truncation level, and magnitude *M*, which is the average departure of streamflow from the truncation level during the drought period (Dracup et al., 1980).

This method basically coincides with the *Run Method*, which can also be applied to streamflow.

The *Surface Water Supply Index (SWSI)*, developed by Shafer and Dezman (1982), explicitly accounts for snowpack and its delayed runoff. The SWSI is a suitable measure of hydrological drought for mountainous regions, where snow contributes significantly to the annual streamflow.

Palmer (1968) developed the *Crop Moisture Index (CMI)* to monitor short-term changes in moisture conditions affecting crops. The CMI is the sum of an evapotranspiration deficit (with respect to normal conditions) and soil water recharge.

The *Palmer Moisture Anomaly Index (Z-Index)* is the moisture anomaly for the current month. The Z-Index can track agricultural drought, as it responds quickly to changes in soil moisture values. Karl (1986) found that the Z-Index is preferable for quantifying agricultural drought than the more commonly used CMI. However, like all the Palmer indices, it suffers from a complicated formulation and computation and it is only slightly less complex than the PDSI.

The *Soil Moisture Anomaly Index (SMAI)* was developed by Bergman et al. (1988) to characterise droughts on a global basis. The method inherently relies upon the moisture accounting method of Thornthwaite and operates within a two-layer soil model used to track the movement of water, ultimately resulting in a running assessment of percent soil saturation.

A complete overview of drought indices is provided by Hayes (2004).

## Duration and Spatial Extent of Drought

### *The Run Method*

The use of run analysis has been proposed as an objective method for identifying drought periods and for evaluating the statistical properties of drought. According to this method, a drought period coincides with a “negative run”, defined as a consecutive number of intervals where a selected hydrological variable remains below a chosen truncation level or threshold (Yevjevich, 1967).

Such a threshold can be a fixed value in the case of a non-periodic (e.g. annual) stationary time series or a seasonally varying truncation level in the case of a stationary periodic series. The truncation level in each time interval is somewhat arbitrary and it must be selected based on the objective of the study. Usually it is assumed equal to the long-period mean (or median) of the variable of interest, while other possible choices include a fraction of the mean (Clausen and Pearson, 1995), a value corresponding to a given non-exceedence probability (Zelenhasic and Salvai, 1987, and Correia et al., 1987), or a level defined as one standard deviation below the mean (Ben-Zvi, 1987). In any case, the threshold should be chosen in such a way to be considered representative of the water demand level (Yevjevich et al., 1983, Rossi et al., 1992).

The advantage of using the run method for drought definition consists in the possibility of deriving the probabilistic features of drought characteristics (such as duration, cumulative deficit) analytically or by data generation, once the stochastic properties of the basic variable are known. This possibility is not limited to relatively simple cases where time dependence of consecutive values can be neglected but also when a Markov chain structure is assumed for the underlying variable (Cancelliere et al., 1998; Fernandez and Salas, 1999). Furthermore, procedures to assess the return period of droughts defined according to the run method have been derived recently (Shiau and Shen, 2001; Bonaccorso et al., 2003; Cancelliere and Salas, 2004), thus making the method an ideal candidate to perform drought risk analysis.

### *The Cumulative “or more” Curves*

A better representation of the spatial extent of drought can be achieved using a type of curves known as cumulative ‘or more’ curves (ogives) (Tsakiris et al., 2007a). These curves can be produced by plotting the severity of drought (y-axis) versus the percentage of the affected area (x-axis). The severity of drought is presented by a drought index and the area refers to that affected by at least the corresponding severity level. This type of graph can be used not only for the characterisation of drought and the determination of its areal extent, but also for comparisons with the critical area percentage (related to severity) directly. Clearly, more than one threshold referring to the percentage of critical area can be used defining different levels of severity.

## Concluding Remarks

Drought as a regional phenomenon can be identified and quantified if its severity, its timing, duration and its spatial extent are known. Drought severity indices are proposed to identify and characterise drought (severity, timing and duration) whereas duration and spatial extent estimation can be achieved by the “run” method or the “or more” cumulative curves.

In this chapter, an attempt to review the most popular drought severity indices was made. Although the list of indices is not comprehensive, the critical assessment of the most popular of them revealed their usefulness and applicability.

It was concluded that indices exhibit attributes, which make them appropriate either for the analysis of past drought events or for the monitoring and operational management of droughts during the time they occur.

It should become clear that drought indices accompanied by their thresholds of drought severity classes should always be referred to the local conditions.

In order to associate drought indices with consequences, a thorough analysis of vulnerability and risk of the areas or systems, which could be affected by drought, should always be conducted.

## References

- Alley W M (1984) The palmer drought severity index: Limitations and assumptions. *Journal of Climate and Applied Meteorology*, 23:1100–1109.
- Ben-Zvi A (1987) Indices of hydrological drought in Israel. *Journal of Hydrology*, 92: 179–191.
- Bergman K H, Sabol H, Miskus D (1988) Experimental indices for monitoring global drought conditions. *Proceedings of the 13th Annual Climate Diagnostics Workshop*, Cambridge, U.S. Dept. of Commerce, pp. 190–197.
- Bhalme H N, Mooley D A (1980) Large scale droughts/floods and monsoon circulation. *Monthly Weather Review*, 108:1197–1211.
- Bonaccorso B, Cancelliere A, Rossi G (2003) An analytical formulation of return period of drought severity, *Stochastic Environmental Research and Risk Assessment*, 17:157–174.
- Cancelliere A, Salas J D (2004) Drought length properties for periodic-stochastic hydrological data. *Water Resources Research*, 40, W02503, doi: 10.1029/2002 WR001750.
- Cancelliere A, Ancarani A, Rossi G (1998) Distribuzioni di probabilità delle caratteristiche di siccità. *Atti del XXVI Conv. di Idr. e Costr. Idrauliche*, Catania 9–12 settembre, CUECM, Catania, pp. 327–340.
- Clausen B, Pearson C P (1995) Regional frequency analysis of annual maximum streamflow drought. *Journal of Hydrology*, 173:111–130.
- Correia F N, Santos M A, Rodrigues R (1987) Engineering risk in regional drought studies. In Duckstein L, Plate E J (eds.) *Engineering, Reliability and Risk in Water Resources*, Proc. of ASI, Tucson, Arizona (U.S.A.), 1985, Martinus Nijhoff Publ.
- Dracup J A, Lee K S, Paulson Jr., E G (1980) On the definition of droughts. *Water Resources Research*, 16:297–302.
- Edwards D C, McKee T B (1997) Characteristics of 20th century drought in the United States at multiple time scales. *Climatology Report Number 97–2*, Colorado State University, Fort Collins, Colorado.
- Fernandez B, Salas J (1999) Return period and risk of hydrologic events. I. mathematical formulation. *Journal of Hydrologic Engineering*, 4(4):297–307.

- Franklin J, Hiernaux P (1991) Estimating foliage and woody biomass in Sahelian and Sudanian woodlands using a remote sensing model. *International Journal of Remote Sensing*, 12:1387–1404.
- Gibbs W J, Maher J V (1967) Rainfall deciles as drought indicators. Bureau of Meteorology Bulletin No. 48, Commonwealth of Australia, Melbourne.
- Hayes M J (2004) Drought Indices, National Drought Mitigation Center, <http://drought.unl.edu/whatis/indices.htm>.
- Justice C, Townshend J, Chaudary B (1989) Comparison of AVHRR and SMMR data for monitoring vegetation phenology on the continental scale. *International Journal of Remote Sensing*, 14, 603–608.
- Karl T R (1986) The sensitivity of the Palmer Drought Severity Index and Palmer's Z-index to their calibration coefficients including potential evapotranspiration. *Journal of Climate Applied Meteor*, 25:77–86.
- Keyantash J, Dracup J A (Aug 2002) The Quantification of Drought. An Evaluation of Drought Indices. *Bulletin of the American Meteorological Society*, 83(8):1167–1180.
- Kinninmonth W R, Voice M E, Beard G S, de Hoedt GC, Mullen C E (2000) Australian climate services for drought management. In Wilhite D A (ed.) *Drought. A Global Assessment*, Routledge, New York, pp. 210–222.
- Kühbauch W, Rademacher I (2000) Key elements of remote sensing based systems for assessing drought impact on EU agriculture. In Vogt J, Somma F (eds.) *Drought and Drought Mitigation in Europe*, Kluwer Academic Publishers, New York, pp. 221–229.
- McKee T B, Doeskin N J, Kleist J (1993) The relationship of drought frequency and duration to time scales. *Proceedings of the Eighth Conference on Applied Climatology*, Anaheim, CA, January 17–23, 1993. American Meteorological Society, Boston, MA, pp. 179–184.
- Palmer W C (1965) Meteorological drought. Research Paper No. 45. U.S. Weather Bureau, Washington, DC.
- Palmer W.C. (1968) Keeping track of crop moisture conditions, nationwide. *The new Crop Moisture Index*. *Weatherwise*, 21:156–161.
- Rossi G, Benedini M, Tsakiris G, Giakoumakis S (1992) On the Regional Drought Estimation and Analysis. *Water Resources Management*, 6(4):249–277.
- Shafer B A, Dezman L E (1982) Development of a Surface Water Supply Index (SWSI) to assess the severity of drought conditions in snowpack runoff areas. In *Proceedings of the Western Snow Conference*. Colorado State University, Fort Collins, Colorado, pp. 164–175.
- Shiau J, Shen H W (2001) Recurrence analysis of hydrologic droughts of differing severity. *Journal of Water Resources Planning and Management*, 127(1):30–40.
- Tsakiris G, Vangelis H (2005) Establishing a Drought Index incorporating evapotranspiration, *European Water*, 9–10:1–9.
- Tsakiris G, Pangalou D, Tigkas D, Vangelis H (2007a) Assessing the areal extent of drought. *Proceedings of EWRA Symposium*, Chania – Crete 14–16 June 2007.
- Tsakiris G, Pangalou D, Vangelis H (2007b) Regional Drought Assessment Based on the Reconnaissance Drought Index (RDI). *Water Resources Management*, 21(5):821–833
- Tsiros E, Domenikiotis C, Spiliotopoulos M, Dalezios N (2004) Use of NOAA/AVHRR-based VCI and TCI for drought monitoring in Thessaly-Greece. *Proceedings of EWRA Symposium*, Izmir, 2–4 September 2004, 769–783.
- UNEP (1992) *World Atlas of Desertification*. Edward Arnold, London.
- Van Rooy M P (1965) A rainfall anomaly index independent of time and space. *Notos*, 14, 43–48.
- Vogt J, Niemeyer S, Somma F, Beaudin I, Viau A (2000) Drought monitoring from space. In Vogt J, Somma F (eds.) *Drought and Drought Mitigation in Europe*, Kluwer Academic Publishers, New York.
- Yevjevich V (1967) An objective approach to definitions and investigations of continental hydrologic droughts, *Hydrology Paper no. 23*, Colorado State University, Fort Collins, CO, Colorado.
- Yevjevich V, Da Cunha L, Vlachos E, (1983) *Coping with droughts*, Water Resources Publications, Littleton, Colorado.
- Zelenhasic E, Salvai A (1987) A method of streamflow drought analysis. *Water Resources Research* 23(1):156–168.

# Chapter 7

## A Paradigm for Applying Risk and Hazard Concepts in Proactive Planning

G. Tsakiris

**Abstract** The concepts of risk and hazard have been used with different meaning in a wide spectrum of disciplines. Even in the area of natural hazards such as the floods and droughts, the definitions used for all the related terms are still confusing the scientific community and the stakeholders. The objective of this chapter is to attempt to clarify some of these terms and propose a methodology for the risk assessment. Emphasis is given to the risk assessment of the affected areas due to the occurrence of droughts. Simplified examples are presented for illustrating the use of these terms. Particular attention is given to the concept of vulnerability, mainly in relation to proactive planning.

### Introduction

Several concepts have been used over the past decades to describe the potential threats from natural phenomena and the capacity of the various structural and non-structural systems to protect people, properties and the environment from these threats.

Concepts such as hazard, risk and vulnerability are the most commonly used terms although they have different meanings for different people. In some cases there is also a lack of understanding between scientists and engineers who attempt to quantify these concepts, and the stakeholders who are asked to apply them in the real world.

Furthermore quantification is not an easy task. It is possible that some parameters affecting the above concepts are beyond quantification. However even so it is

---

G. Tsakiris (✉)

Centre for the Assessment of Natural Hazards and Proactive Planning and, Lab. of Reclamation Works and Water Resources Management, School of Rural and Surveying Engineering, National Technical University of Athens, Athens, Greece  
e-mail: gtsakir@central.ntua.gr

necessary to find a way for analyzing these parameters and assessing their importance in the final impact (Brauch, 2005, Thywissen, 2006).

From the above it is understood that a wide systematic effort should be undertaken in order to clarify all these concepts and propose a practical and easy to understand methodology for calculating them in the various disciplines and specialised applications (Klein, 2003).

Towards this initiative this chapter is attempting to address these concepts and propose practical algorithms for calculating them in the area of droughts, and their effect on agriculture (Tsakiris, 2006). The approach used however is to build a general framework in which several natural hazards could be incorporated and analyzed. For this purpose drought hazards are analyzed following the proposed general algorithm.

## Hazard

According to Tsakiris (2007), the term “hazard” due to a natural phenomenon may be defined as:

1. a source of potential harm
2. a situation with the potential to cause damage
3. a threat or condition with the potential to create loss or damage to lives or to initiate any failure to the natural, modified or human systems.

The causes of hazard may be external (e.g. flooding) or internal (e.g. defective section of protection levees). Also under a different categorization hazards may be natural (meaning that the cause is natural (e.g. storm)) or human-induced (e.g. deforestation). Although this distinction may be unclear for certain cases it applies to the majority of applications.

Hazard according to the general definition above should be treated as a type of threat to lives, environment, cultural heritage and development. However this threat should be quantified somehow. This quantification may remain at a qualitative level by describing the number of people, the properties, the affected area etc being under threat or by estimating the frequency of a certain level of threat derived from the existing historical events. Therefore, although the numerical assessment is difficult and may be subjective, the hazard can be assessed in a softer way by characterizing it as small, moderate or high.

In a more structured form, hazard may be quantified in two ways:

1. The probability of occurrence of the hazardous phenomenon (e.g. discharge occurring once in twenty years with magnitude equal to or greater than the given value)
2. The sum of potential consequences of the affected area provided no protection system is in operation (e.g. in case of a catastrophic drought the damage to the rainfed agricultural area due to the loss in crop yield). The calculation of the potential consequences could be performed bearing in mind that a sort of basic



protection mainly for low severity events can be found in most of the systems. However this could be regarded as the reference level corresponding to the “totally unprotected” area.

Under certain conditions the first or the second way can be considered as more appropriate. In general it can be said that natural hazards caused mainly by external causes can be quantified by probabilistic approaches. On the contrary human-induced phenomena caused by mainly internal causes are better quantified through deterministic approaches by calculating the potential consequences from a very “critical” scenario of failure. Obviously the critical scenario selected represents the basis for designing any protection system.

Concentrating on the natural hazards in which the cause of initiating the failure mode is natural it can be argued that only the frequency is not sufficient to describe the level of hazard. In a more comprehensive way, natural phenomena may be described by their magnitude together with the frequency of their occurrence.

Since the magnitudes of the phenomenon (and therefore the anticipated consequences) follow, in most of the cases, a certain probability distribution, the following equations may be written:

$$F(x) = P(D \leq x) = \int_{-\infty}^x f_D(x)dx = \int_0^x f_D(x)dx \quad (7.1)$$

$$\text{or } 1 - F(x) = P(D > x) = 1 - \int_{-\infty}^x f_D(x)dx \cong 1 - \int_0^x f_D(x)dx \quad (7.2)$$

in which  $x$  is the sum of potential consequences of each hazard event of the phenomenon,  $F(x)$  and  $P(D \leq x)$  are the cumulative density functions (c.d.f.),  $P(D > x)$  is the exceedance probability, and  $f_D(x)$  is the probability density function (p.d.f.).

It should be noticed that for the calculation of  $f_D(x)$ , the relationship between  $F(x)$  and  $x$  should be known. In general, this type of relationship may be any curve, not necessarily following a certain probability distribution. The  $F$ - $x$  curve is produced from a table linking cumulative frequencies to magnitudes of the phenomenon and the estimated potential consequences (in case of a totally unprotected area).

The figure which gives a representative measure of hazard is the expected value  $E(D)$  which considers both the potential consequences and their probability of occurrence, provided that the area under threat is totally unprotected:

$$E(D) = \int_0^{\infty} x \cdot f_D(x) dx \quad (7.3)$$

Since  $E(D)$  is a measure of “average” (annualized) expected hazard it would be useful to calculate the variance ( $Var(D)$ ) as a complementary figure for estimating not only the most expected outcome but also the range of this outcome.

$$Var(D) = \int_0^{\infty} (x - \mu)^2 \cdot f_D(x) dx \tag{7.4}$$

in which  $\mu$  is represented by  $E(D)$ .

$$\text{or } Var(D) = E(D^2) - (E(D))^2$$

$$Var(D) = \int_0^{\infty} x^2 \cdot f(x) dx - (E(D))^2 \tag{7.5}$$

When applying the above equations, an important assumption should be met. That is the function relating the potential consequences to the magnitudes of the phenomenon to be a 1 – 1 function. These functions are usually of geometric type and are called “loss functions”.

In some cases return periods are associated with the magnitudes of the phenomenon without attempting to relate the phenomenon with the consequences.

A numerical example is provided for illustrating the procedure to estimate annualized hazard. Table 7.1 provides the data associating return periods of magnitudes of the hazardous phenomenon to the anticipated potential consequences.

**Table 7.1** Return periods and anticipated potential consequences

Return period T (y)	Potential consequences D(M €)
2	0
10	400
50	800
100	1170
1000	3000
>1000	3000

Further from Table 7.1 another table (Table 7.2) is produced relating the frequency of each class of magnitude to the mean potential consequences of the class.

Based on Table 7.2 the (mean) expected value of potential consequences is calculated corresponding to the average hazard of the phenomenon.

**Table 7.2** Frequency vs mean potential consequences of each class

Frequency $F(x_{i+1}) - F(x_i)$	Mean potential consequences $\frac{x_i + x_{i+1}}{2}$
0.40	200
0.08	600
0.01	985
0.009	2085
0.001	3000

$$\begin{aligned}
 E(D) &= \sum_{i=1}^n \left( \frac{x_i + x_{i+1}}{2} \right) \cdot [F(x_{i+1}) - F(x_i)] \\
 &= 80 + 76.6 + 28.6 + 18.8 + 3 = 207 \text{ M€}/y \\
 \text{Var}(D) &= \sum_{i=1}^n \left( \frac{x_i + x_{i+1}}{2} \right)^2 \cdot [F(x_{i+1}) - F(x_i)] - (E(D))^2 \\
 &= 37414.75 - 48849 = 24565.75
 \end{aligned}$$

The standard deviation is then

$$SD = \hat{\sigma} = \sqrt{\text{Var}(D)} = 156.73 \text{ M€}/y$$

That is, the average rate of potential consequences is estimated as 207 M€/y with a standard deviation of 156.73 M€/y.

## Vulnerability

Vulnerability of a certain system is generally defined as the degree of susceptibility to damage from a hazardous phenomenon or activity. In most of the cases quantification of vulnerability is a very difficult task. However some kind of assessment of vulnerability is required in order to estimate the real threat from an existing source of hazard. Therefore in most of the cases quantitative approaches could be implemented for assessing vulnerability.

A common characterisation of vulnerability is with the scale “low, moderate, high”.

In a more detailed approach vulnerability may be characterised as related to the anticipated damages as follows:

1. Negligible or slight damage
2. Moderate damage
3. Substantial to heavy damage
4. Very heavy damage
5. Total destruction

As it can be easily understood, vulnerability of a system comprises of two components: the coping capacity of the system to withstand the hazardous event and the exposure of the system to this event. The assessment of vulnerability based mainly on the capacity of the system has no meaning, unless the system is exposed to the hazardous event.

In general, vulnerability of a system related to a hazardous phenomenon is dependent upon a large number of factors, most of which are listed below:

1. *Exposure*
2. *Capacity of the System*

- Infrastructure
- Condition of the system
- Institutional set up
- Quality of governance
- Motivation to react
- Skills and education of people
- Resources available
- Preparedness status
- Monitoring capabilities
- Existence of an emergency plan
- Development status
- Resilience / time of recovery
- Initial conditions of the system
- Interaction of interrelated components

### 3. *Characteristics of the hazardous event*

- Magnitude of the event
- Duration of the stress
- Timing of the event
- Conditions which may influence the destruction capacity

Under a different categorization the above factors may be grouped in four categories:

1. Exposure of the System (E)
2. Capacity of the System (S)
3. Social Factor (SF)
4. Severity and destructive capacity of the event ( $Q_{max}$ )
5. Conditions and interrelated factors (I)

It should be mentioned that in some formulations the Exposure is considered separate to vulnerability.

In mathematical terms

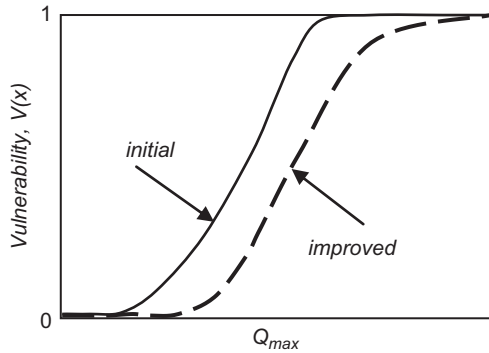
$$V = V(E, S, SF, Q_{max}, I) \quad (7.6)$$

In more simplistic terms, vulnerability could be considered as a function ranging between 0 and 1.

In general terms, vulnerability may be related to the entire system or it may be necessary to disaggregate the system into a number of components and perform a detailed analysis on each of them. The aim of reclamation and protection works is to reach a lower level of the system's vulnerability. A comprehensive indicator of the improvement of a system is the ratio of anticipated consequences after the improvement divided by the initial potential consequences. A graphical representation of vulnerability and its reduction presented versus the magnitude of the hazardous

phenomenon appears in Fig. 7.1. As can be seen the improvement of the capacity of the system is represented by a shift to the right of the vulnerability curve.

**Fig. 7.1** Vulnerability vs magnitude of the phenomenon for the initial and the improved capacity of the system



The routes for reducing vulnerability may follow the main items upon which it is dependent. That is:

1. Improving the coping capacity of the system
2. Mitigating the magnitude of the phenomenon (and its potential consequences)
3. Improving social capacities to deal with the phenomenon (capacity building)
4. Controlling internal and external factors and their interrelations
5. Changing the exposure of the system

## Risk

Risk may be defined as an existing threat to a system (life, health, properties, environment, cultural heritage) given its existing vulnerability. In a metaphor hazard could be viewed as a source with a beam of rays, vulnerability as the filter and risk as the beam of penetrating rays through the filter affecting the system.

Risk is similar to hazard but it is not a potential; it is a real threat. It is customary to express risk (R) as a functional relationship of hazard (H) and vulnerability (V).

$$\{R\} = \{H\} \square \{V\} \quad (7.7)$$

in which the symbol  $\square$  represents a complex function incorporating the interaction of hazard and vulnerability. A simple example of such a function is the simple product of hazard and vulnerability.

$$\{R\} = \{H\} \times \{V\} \quad (7.8)$$

Since vulnerability is a dimensionless quantity, risk could be measured in the same quantities as hazard. That is, risk could represent the probability of harmful

consequences or the expected damages resulting from interactions of hazard and vulnerable conditions.

Following the methodology for calculating the average (annualized) hazard, the average risk can be calculated as follows

$$R(D) = \int_0^{\infty} x \cdot V(x) \cdot f_D(x) dx \quad (7.9)$$

in which  $x$  is the potential consequence caused by the phenomenon of the corresponding magnitude, the p.d.f. of which is  $f_D(x)$  and  $V(x)$  is the vulnerability of the system towards the corresponding magnitude of the phenomenon.

Important issues when calculating the risk are the characteristics of the cause of initiating the failure mode and causing damage. These causes may be natural or due to human error or human involvement. If the triggering factor is due to human intervention or activity, then this process cannot be described probabilistically, but deterministic simulation is needed.

Therefore, to assess the risk threatening a certain area (“area at risk”) or population (“population at risk”) the worst conditions should be considered. For example, the breach of levees protecting an area can occur in the night under adverse conditions instead of midday on a sunny day. The assumption of the “critical” scenario could be the worst scenario in case lives or important properties or heritage are at risk.

If risk is calculated on the basis of probabilities of extreme events or processes care should be taken on the possibility of two or more causes of failure occurring at the same time. Then the total damage might be higher from the damage caused by the two causes occurring independently of each other.

The above analysis is based on the assumption that the system at risk is a uniform entity that is exposed to a certain hazard. If this system is considered as an element of a much wider and non-uniform system then the total risk could be calculated by integration over the sum of elements at risk.

## Application of Drought Hazard to Rainfed Agriculture

An agricultural area is cultivated with cereal crops. No irrigation or other drought protection system is in operation. Analyzing a long historical record the frequency of a number of drought severity classes was associated with the crop production losses in monetary units. The severity of drought was calculated by a general drought index, the Reconnaissance Drought Index (RDI) on an annual basis (Tsakiris and Vangelis, 2005, Tsakiris et al., 2007). According to the thresholds adopted for this index four classes of severity were used. The results of this analysis are represented in Table 7.3.

**Table 7.3** Drought frequency and crop yield losses from the agricultural area under study

Severity of annual drought	Probability of occurrence	Anticipated losses (k€)
0 > RDI > -1	1 : 3	20
-1 > RDI > -1,5	1 : 7	150
-1,5 > RDI > -2	1 : 12	400
RDI < -2	1 : 25	900

Based on Table 7.3, Table 7.4. is produced:

**Table 7.4** Average losses from each class of drought severity vs frequency

$\bar{x}_{i,i+1}$ (k€)	$F(x_{i+1}) - F(x_i)$
20	0.333
150	0.142
400	0.083
900	0.040

The average (annualized) hazard due to drought occurrence can be calculated from the above table as follows:

$$E(D) = \sum \left( \frac{x_i + x_{i+1}}{2} \right) \cdot (F(x_{i+1}) - F(x_i)) \text{ or} \tag{7.10}$$

$$E(D) = 6.66 + 21.3 + 33.2 + 36 = 97.16 \text{ k€}/y$$

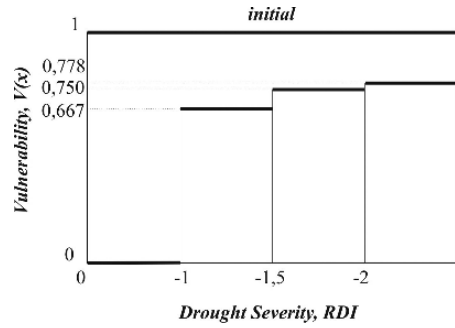
To protect the area from the above hazard several measures were taken. For example, the existing irrigation system was put into operation only during the most sensitive period of the growing season by using water conveyed from outside the affected area. The cost of the water transferred to the area in question is covered by the state as an aid to the farmers. By applying these measures, the following results concerning vulnerability are expected (Table 7.5).

**Table 7.5** Average yield losses and expected vulnerability of the improved system for each class of drought severity

$\bar{x}_{i,i+1}$ (1)	$F(x_{i+1}) - F(x_i)$ (2)	$V(\bar{x}_{i,i+1})$ (3)
(1)	(2)	(3)
0	0.333	0
100	0.142	0.667
300	0.083	0.750
700	0.040	0.778

The vulnerability of the system is therefore reduced, compared to the vulnerability of 1 of the initial system. The vulnerability is presented for each level of  $\bar{x}_{i,i+1}$  (column 3 of Table 7.5). In Fig. 7.2 the vulnerability of the initial and the improved system is plotted against the severity of drought represented by RDI.

**Fig. 7.2** Vulnerability of initial and improved system plotted against the drought index RDI



The average risk is therefore calculated for the improved system as:

$$R(D) = \sum \{ \bar{x}_{i,i+1} \cdot V(\bar{x}_{i,i+1}) \cdot f(\bar{x}_{i,i+1}) \} = 0 + 14 \cdot .2 + 24 \cdot .9 + 28 = 67.1 \text{ k€}/y$$

Similarly the standard deviation is calculated 152.14 k€/y.

Therefore due to the improvement of the system the average risk is reduced from 97.16 to 67.1 k€/y or about 31%.

### Concluding Remarks

An attempt to clarify some of the parameters associated with the assessment of hazard and risk due to natural phenomena was made. Particular emphasis was given to droughts that affect rainfed agricultural areas.

It was concluded that the most difficult task in the process of calculating risk is the assessment of vulnerability of the affected system. With regard to drought risk, the average (annualized) risk is proposed incorporating both the frequency of each class of drought severity (expressed by drought indices) and the consequences measured as loss in crop yield.

Although rainfed agriculture was used as a simplified example for calculating the average risk, irrigated agriculture could be also studied in a similar manner assessing its vulnerability. Similar difficulties may be encountered in case the vulnerability of other systems affected by extreme natural phenomena is assessed. It is a challenge for researchers to investigate methodologies for assessing vulnerability of the various systems affected by droughts such as agricultural areas, municipalities, industry, tourism and environment.

Since natural phenomena may be of different magnitude and frequency for the future as compared with the events of the historical record some sort of modification in the proposed probabilistic methodology is required. That is climatic changes could be introduced so that the calculated average risk is more representative of the future than of the past.



## References

- Brauch H G (2005) Threats, Challenges, Vulnerabilities and Risks in Environmental and Human Security, SOURCE/1, Publication of United Nations University – Institute for Environment and Human Security. (UNU – EHS).
- Klein R (2003) Environmental Vulnerability Assessment. <http://www.pik-potsdam.de/~richardk/eva/>
- Thywissen K (2006) Components of risk. A Comparative Glossary, SOURCE/2, Publication of UNU – EHS.
- Tsakiris G (2006) Water Scarcity Management: An Introduction PRODIM / [www.waterinfo.gr](http://www.waterinfo.gr)
- Tsakiris G (2007) Practical Application of Risk and Hazard Concepts in Proactive Planning. *European Water* 19/20: 47–56.
- Tsakiris G, Pangalou D and Vangelis H (2007) Regional drought assessment based on the reconnaissance drought index (RDI), *Water Resources Management*, 21(5):821–833.
- Tsakiris G, Vangelis H (2005). Establishing a Drought Index incorporating evapotranspiration. *European Water* 9/10: 1–9.

# Chapter 8

## Assessment of Drought Risk in Water Supply Systems

Antonino Cancelliere, Vincenzo Nicolosi and Giuseppe Rossi

**Abstract** The present chapter introduces concepts and methods related to risk and risk assessment of water shortages due to drought in water supply systems. The main aim of the chapter is to provide methodologies able to quantify in a probabilistic way the risk of failure of a water supply system. Two procedures for unconditional (planning) and conditional (operation) drought risk assessment of water supply systems are proposed. Both methodologies are based on Montecarlo simulation of a water supply system, in order to take into account the stochastic nature of the hydrological input to the system. The proposed methodologies result in an effective aid during both the planning and operating stages of a water supply system providing valuable information about expected frequency and amount of water shortages due to drought of demands supplied by the system under study.

### Risk Assessment in Water Supply Systems

Different definitions of risk are adopted in various disciplines, according to the objective of the analysis, as well as to the nature of the event under study. Despite the differences, definitions can be broadly divided into two main categories: risk defined as the *probability of an adverse event*, and risk defined as the *expected (mean) consequence of an adverse event*. The first category includes the concept of risk according to statistical hydrology, where risk is defined as the probability that a hydrological variable  $X$  (e.g. maximum annual discharge) exceeds a given threshold  $x_o$  at least once in  $n$  years:

$$\text{Risk} = P[\text{at least 1 year in } n \text{ years where } X > x_o] = 1 - P[X \leq x_o \text{ in } n \text{ years}] \quad (8.1)$$

---

A. Cancelliere (✉)  
Department of Civil and Environmental Engineering, University of Catania, V.le A. Doria 6, 95125  
Catania, Italy  
e-mail: acance@dica.unict.it

Assuming stationarity and independence of the events, risk can be computed by the well known formula (Yen, 1971):

$$\mathbf{Risk} = 1 - P[X \leq x_o]^n \quad (8.2)$$

Similarly, in reliability theory, risk is defined as the probability of failure for of the system under investigation. More specifically, risk is defined as the probability that the load  $L$  (i.e. the external forcing factor) exceeds the resistance  $R$  (an intrinsic characteristic of the system), leading to failure (Mays and Tung, 1992):

$$\mathbf{Risk} = P[L > R] \quad (8.3)$$

The second category (risk as expected consequence) includes the definitions developed within the strategies for natural disasters mitigation. In particular, risk is defined as “*the expected losses due to a particular natural phenomenon as a function of the natural hazard and the vulnerability of an element at risk*” (UNDRO, 1991). In the above definition, the natural hazard represents the probability of occurrence, within a specified period of time in a given area, of a potentially damaging natural phenomenon, whereas the vulnerability is the degree of loss to a given element at risk or set of such elements resulting from the occurrence of a natural phenomenon of a given magnitude and expressed on a scale from 0 (no damage) to 1 (total loss). It follows that, according to the above definition, risk is measured in some physical terms or in economic (damages) and/or social (lives lost) terms. Also, such risk definition has found widespread application in flood analysis, since it is particularly suited for the development of inundation risk maps in a given area (Kron, 2005).

When dealing with drought risk in water supply systems characterized by a high level of complexity and interactions among their different components, it is easy to recognize that none of the above definitions is able to full include all the different consequences related to water shortages. Therefore, traditionally, characterization of shortages in a water system has been carried out by means of a set of performance indices, attempting to capture different performance aspects of water supply systems such as reliability, resiliency and vulnerability (Hashimoto et al., 1982). Indeed, the stochastic nature of inflows, the high interconnection between the several components of the system, the presence of many often conflicting demands, the definition of the elements at risk, and the uncertainty related to the assessment of impacts of extreme events such as droughts, make the risk assessment of a water supply system a problem that is better faced through a set of several indices and/or by analyzing the probabilities of shortages of different entities (Alecci et al., 1986).

With regard to *risk analysis* it is generally recognized that it can be divided into *risk assessment* and *risk management*. The former is oriented to the estimation of the probabilistic features of an adverse phenomenon, whereas the latter is generally defined as a pro-active approach for coping with risk through planned actions, as opposed to crisis or emergency management. Risk assessment therefore has the

objective of quantifying in a probabilistic way the occurrence of an adverse phenomenon, as well as estimating its consequences. Risk management has the objective of identifying in advance a set of measures oriented to prevent or mitigate consequences of the adverse phenomenon and of implementing these measures.

Risk assessment can find application either at the planning stage or during the operation of a given system. For instance, with reference to water supply system planning, risk assessment enables to quantify and compare the risk associated with different planning alternatives, generally on a long-term basis. On the other hand, during the operation of the system, short-term drought risk assessment can be carried out in order to compare and define alternative mitigation measures, on the basis of the consequent risk during a short time horizon (e.g. 1–3 years) in the future. The two approaches differ, not only with regard to the objective of the analysis and to the different lengths of the time horizons, but mostly because of the way the probabilistic assessment is carried out. In the first case, the assessment is generally *unconditional*, i.e. without regard to the initial state/condition of the system and therefore it provides information on what could happen at any time during the planning horizon. For instance, with reference to a water use, one may be interested to know the probability of occurrence of a given water shortage during the planning horizon. The short-term risk assessment, on the other hand, is generally *conditional*, in the sense that the initial state/conditions of the system are taken into account in the evaluation. Furthermore, the assessment is generally oriented to estimating what could happen at a specific time in the immediate future. Again, with reference to a water use, one may be interested in the probability of occurrence of a given water shortage three months ahead, given the present state of the system (e.g. volumes stored in reservoirs). As such, the conditional assessment can be adopted for early warning purposes. Since the results of the conditional risk assessment strongly depend on the initial conditions, it follows that the procedure must be repeated as new information becomes available.

### ***Unconditional (Long Term) Risk Assessment***

Unconditional risk assessment has the objective of comparison and selection of preferred drought mitigation alternatives through the simulation of the system behaviour over a long time horizon (30–40 years) by using generated series. Then, the risk is evaluated in terms of a synthetic assessment of failure based on the analysis of the satisfaction (both in time and volume) of consumptive demands, also considering specific objectives such as the satisfaction of ecological requirements or the pursuing of target storages in reservoirs.

The term *unconditional* here refers to a risk assessment without regards to the initial state/condition of the system, and therefore the procedure is oriented to provide information on what could happen at any time during the explored planning horizon. To achieve the above objective, the study can start at any initial condition of the system because this will be irrelevant to the overall behavior of the system during a long time horizon.

Figure 8.1 shows the proposed methodology for unconditional drought risk assessment for a water supply system. The procedure is divided into three main tasks, namely system identification, hazard analysis and risk assessment. The system identification task consists of the definition of all the relevant information regarding the water supply systems, namely hydrological inputs, the physical features of the elements of the system, the different uses as well as their water demands and historical consumptions.

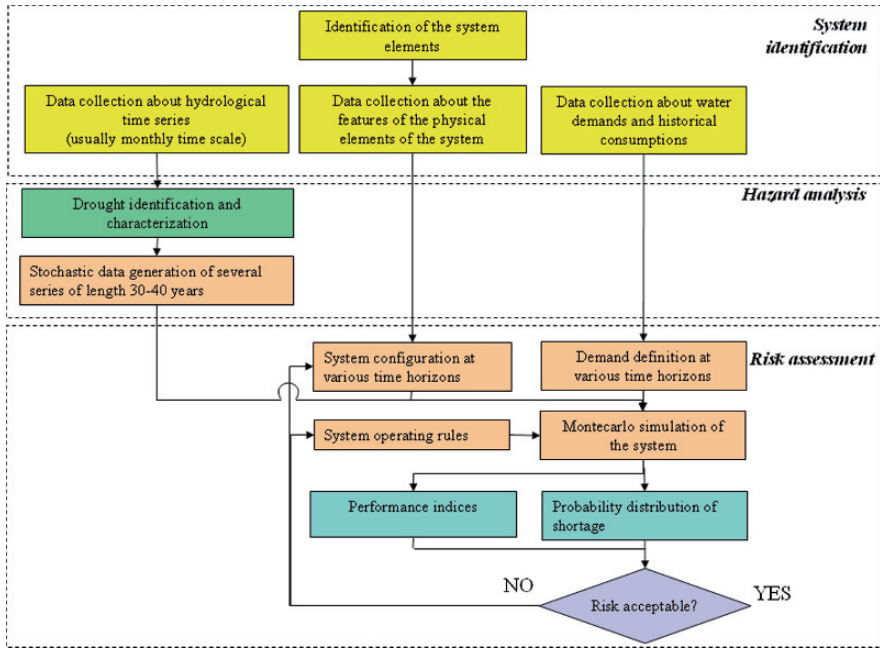


Fig. 8.1 Methodology for unconditional drought risk assessment in water supply systems planning

Then, a hazard analysis is carried out, with the objective of characterizing in a probabilistic way drought events that can potentially produce impacts on the water supply system under study. Such a characterization can be performed for instance by estimating the return period of droughts of different severities, by means of the methodologies implemented in the software REDIM (Rossi and Cancelliere, 2003).

Within the risk assessment task, one of the primary objectives is to evaluate the system state variables and other variables related to the satisfaction of various demands (e.g. water supply shortages) under a given system configuration and a given set of operating rules by considering, as hydrological input, several generated streamflow series. Furthermore, a similar assessment is also required for the satisfaction of ecological requirements, such as instream flow requirements or target storages in reservoirs. Synthetically generated series can be obtained by means of a stochastic model calibrated on observed series, such that the generated series resemble, in a statistical sense, the observed ones. Thus, each generated series can

be considered as one of the possible series that could occur in the future and, as a consequence, the resulting data can be seen as a large sample from the population of all the possible system behaviors in the future (Montecarlo simulation). Then, probabilistic features of the impacts of drought can be assessed by performing a statistical analysis of the simulation results.

The results of the Montecarlo analysis enable to verify whether the system exhibits an acceptable probability of water shortage for different uses under the given configuration and set of operating rules. If this is not the case, the procedure can be repeated by analyzing different configurations and/or operating rules.

### ***Conditional (Short-Term) Risk Assessment***

The proposed procedure for conditional (operational) risk assessment has the objective of evaluating the risk of shortages within a short time horizon by using generated series. The procedure makes use of the same basic tools (namely stochastic data generation, water system simulation and synthetic assessment of performance), but in this case the analysis is performed with reference to a shorter time horizon (2–3 years) and by taking into account the initial state/conditions of the system. Thus, the results will depend on when the analysis is performed, since they will change as new information is available. Therefore, such procedure should be carried out at given time steps (e.g. every month) during the operation of the system, in order to identify potential failures in the future and to implement the necessary measures.

Different criteria could be applied to decide the length of the time horizon for conditional risk assessment of a given system. In particular it should be defined taking into account the length of historic droughts, consolidated operating rules of the system, the need to avoid the increase of evaporation losses caused by management of reservoirs with carry-over storage capacity.

With reference to the scheme depicted in Fig. 8.2, the system identification will include the monitoring of current meteo-hydrological conditions and of storage volumes in reservoirs as well as definition of water demands. Then a hazard analysis is carried out in order to probabilistically characterize the current drought conditions. Again, such characterization can be performed in terms of return periods of droughts identified for instance on streamflow series. The first step of the risk analysis is carried out by generating several series over a short time horizon (1–3 years), conditioned on the hydrological observations up to the moment when the analysis is performed. Then, the system is simulated, by assuming as initial conditions (e.g. volumes in reservoirs) the actual ones when the analysis is carried out. Thus the risk assessment will enable to estimate the risk at specified intervals in the immediate future (e.g. 1 month, 2 months, etc.) since such conditional risk is strongly affected by the initial conditions.

Application of the proposed methodology enables the probabilistic assessment of the short-term risk of failures considering the actual condition of the system, thus giving the opportunity to explore effects of different policies of management and mitigation measures.

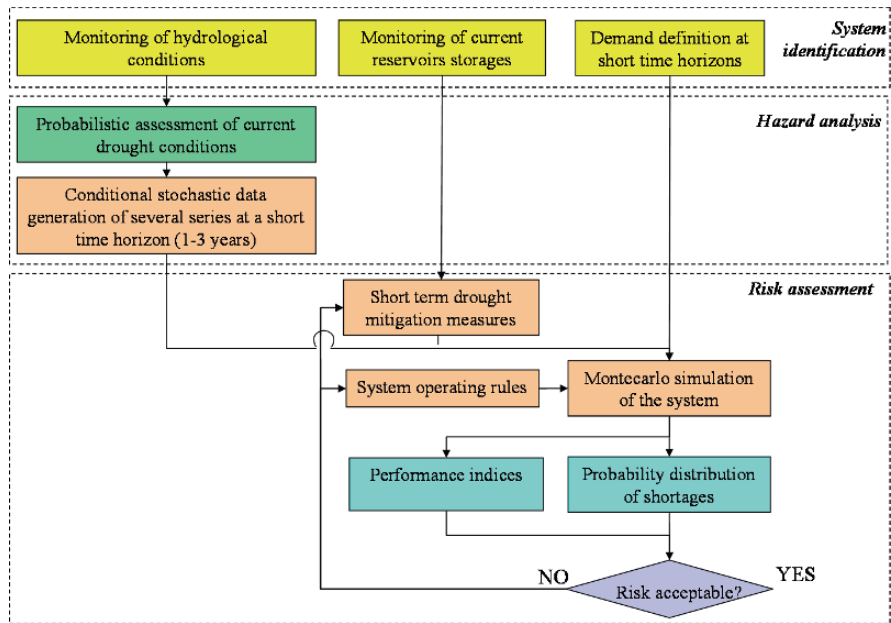


Fig. 8.2 Methodology for conditional drought risk assessment during water supply systems operation

## Tools

### Simulation of Water Supply Systems

Simulation has the objective of reproducing the real world based on a set of assumptions and conceived models of reality (Ang and Tang, 1984, Labadie, 2004). The purpose of a simulation model is to duplicate reality, and therefore it is a useful tool for evaluating the effects of different hydrology, designs, mitigation measures against drought and/or operating policies on system performances.

Simulation models are perhaps the most widely studied and applied methods for analyzing and evaluating alternatives to manage water supply systems. The reason for their popularity lies in the fact that such models can approximate very closely the systems using relatively simple mathematics and furthermore they are easily understood by water managers. Water supply systems are generally *complex systems* in which the components (e.g. reservoirs, diversions, etc) are arranged as a mixture of in-series and in-parallel, or in the form of a loop. When dealing with a complex system, the general approach is to reduce the system configuration, based on its component arrangement or modes of operation, to a simpler system for which the analysis can be performed easily.

Any simulation model is typically based on mass balances of water volumes in the elements that constitute the whole system. The system dynamics equations

are generally based on conservation of mass throughout the system and follow a node-arch approach to describe the system network. Mass balance equation can be written as follows:

$$\mathbf{S}_{t+1} = \mathbf{S}_t + \mathbf{C} \cdot \mathbf{r}_t + \mathbf{q}_t - \mathbf{l}_t(\mathbf{S}_t, \mathbf{S}_{t+1}) - \mathbf{d}_t \text{ for } t = 1, \dots, T \quad (8.4)$$

where  $\mathbf{S}_t$  = storage vector at the beginning of time  $t$ ;  $\mathbf{q}_t$  = inflow vector during time  $t$ ;  $\mathbf{C}$  = system connectivity matrix mapping flow routing within the system;  $\mathbf{r}_t$  = downstream releases from reservoirs or diversion points;  $\mathbf{l}_t$  = vector combining spills, evaporation, and other losses during time  $t$ ; and  $\mathbf{d}_t$  = releases from the system to satisfy demands and or water transfers. Calculation of evaporation and other water losses in term  $\mathbf{l}_t(\mathbf{S}_t, \mathbf{S}_{t+1})$  is usually difficult to evaluate correctly, and therefore approximations are generally adopted. All flow units are expressed in storage units per unit time. Spatial connectivity of the water system network can be fully described by the routing or connectivity matrix  $\mathbf{C}$  having 1 in the  $i, j$  elements to connect node  $i$  to node  $j$  and 0 otherwise (Labadie, 2004).

The output of a simulation model includes the series of releases to the water users, the series of volumes stored in reservoirs, as well as other information such as downstream releases, withdrawals from marginal resources, etc. Thus, for any set of design and operating policy parameter values, simulation provides a rapid mean for evaluating the anticipated performance of a system. Simulation models do not identify optimal operating policies but they are an excellent aid to water managers in evaluating effects on the system, including risk of drought, of different alternatives (planning) or given mitigation measures and/or operating policies (operation).

Critical issues for simulation models are the definition of the boundaries of the system that is to be simulated, the level of detail within the system that should be modeled and the time scale. Furthermore there are difficulties associated with sampling in the multidimensional space which contains the vector of the operating decision variables (Loucks, 1996).

Simulation models have to be able to be connected to other models (i.e. stochastic generation models); they have to be general but versatile enough to simulate peculiar features and operating conditions of virtually any system. Furthermore they have to be easy to use and to understand in order to be accepted both by decision makers and end-users making really effective the proposed mitigation measures, operating rules and/or procedures to cope with risk.

In the case of water supply systems, simulation models can be particularly useful for defining the: choice of supplies, connections between elements of the system, withdrawal order from different sources in order to satisfy demand patterns and, in the case of shortages, assessment of their distribution in time and among the different users. Furthermore they have to be able to evaluate actual effectiveness of proposed mitigation measures, helping to define triggers to activate operating policies and giving results in a comprehensive manner.

Simulation models can be *time-sequenced* or *event-sequenced*, *deterministic* or *stochastic*, dealing with *steady-state* or *transient* conditions (Loucks et al., 1981). The model to be used in the proposed methodology should be time-sequenced able



to deal with transient conditions; that is, implementation of different alternatives for the planning (e.g. unconditional risk assessment where both changes in configuration and in operating rules must be taken into account during the simulation time horizon).

Simulation models can effectively be used to manage a complex system on a continuous basis but also to manage extreme events such as drought that occur over a relatively short time horizon. These two different types of applications will require models to have different temporal and/or spatial resolutions. Planning models are used sequentially but, being the time horizon longer than operating models, the interest is focused on the overall behavior of the system including major changes in its configuration to compare different scenarios.

Operating models need to be continually updated and rerun to obtain the most current estimates of what operating decisions should be made for each component constituting the whole system in each future decision period.

Some of the most important simulation models are HEC-PRN (Hydrologic Engineering Center, 1993), AQUATOOL (Andreu et al., 1996), MODSIM (Labadie et al., 2000), STELLA (Stein et al., 2001).

Simulation models or descriptive models are surrogate for asking “what-if” questions regarding the performance of alternative operational strategies. They can accurately represent system operations and are useful for Montecarlo analysis in examining long or short-term reliability of proposed operating strategies.

Simulation models of water resources systems, whether used for planning or for operating management, merely provide information. Actual decisions still need to be taken by water managers using models as aids in order to make “informed” decisions. In order to be well accepted by water managers and thus really effective for real cases, models have to be as versatile as possible offering a range of non-prescriptive alternatives. Stimulation models cannot determine which assumptions and data are best, they can only help to identify impacts of those assumptions and data (Tung, 1996).

### ***Generated Hydrological Series***

Because of the stochastic nature of the hydrological inputs to water supply systems, Montecarlo simulation results in a powerful tool to cope with uncertainty affecting risk assessment both in the planning and operating stages. In order to perform Montecarlo analysis, an appropriate stochastic model must be selected for generating numerous synthetic hydrological series that preserve some statistical properties of historical series.

The general aim of a stochastic model is to reproduce as closely as possible the true marginal distribution of seasonal and/or annual hydrological variables. Also, modeling the joint distribution of flows at a different site in different months, seasons, and years may be required for multi-component water supply systems. The persistence of flows often described by their autocorrelation is another important

aspect, since it affects the reliability with which a reservoir of a given size can provide a specific yield.

Several models have been developed with the aim of preserving one or more characteristics of investigated series. They usually differ according to the time scale of the analysis, since for instance in the case of data aggregated at a sub-yearly time scale the seasonality of the statistics must be taken into account. Accordingly, models can be stationary or periodic. Models can also be classified according to whether the interest lies in modeling one series (univariate models) or several series jointly preserving for example the cross correlation (multivariate models). Also, while most models are developed in the normal domain thus requiring a preliminary data transformation, in the case of non-normal observations some models are able to generate directly skewed data (Salas, 1993).

One of the most widely used stochastic model is the AR(p) model that can be written as follows:

$$y_t = \mu + \sum_{j=1}^p \phi_j (y_{t-j} - \mu) + \varepsilon_t \quad (8.5)$$

where  $y_t$  is the stochastic variable to be modeled,  $p$  is called order of the model while  $\varepsilon_t$  is a normally distributed uncorrelated random variable called *noise*, *error term*, or *series of shocks* with mean zero, variance  $\sigma_\varepsilon^2$  and uncorrelated with the  $y_t$  process.

Since  $\varepsilon_t$  is normally distributed then also  $y_t$  is normal. Model parameters are  $\mu$ ,  $\phi_1 \dots \phi_p$  and  $\sigma_\varepsilon^2$ . Lower order models, with  $p = 1, 2$  or  $3$  have been widely used to generate synthetic annual series.

The simplest model, AR (1) can be written as:

$$y_t = \mu + \phi_1 (y_{t-1} - \mu) + \varepsilon_t \quad (8.6)$$

with mean and variance:

$$E [y] = \mu \quad (8.7)$$

$$Var [y] = \sigma^2 = \frac{\sigma_\varepsilon^2}{1 - \phi_1^2} \quad (8.8)$$

while the autocorrelation function is:

$$r(k) = \phi_1^k \quad (8.9)$$

A more versatile model than the AR(p) is the *autoregressive moving average model* ARMA(p,q) with  $p$  autoregressive parameters and  $q$  moving average terms. Using the same notation adopted in (8.5) an ARMA(p,q) model can be written as follows:

$$y_t = \mu + \sum_{j=1}^p \phi_j (y_{t-j} - \mu) + \varepsilon_t - \sum_{j=1}^q \theta_j \varepsilon_{t-j} \quad (8.10)$$

A simple version of the ARMA(p,q) model is the ARMA(1,1):

$$y_t = \mu + \phi_1 (y_{t-1} - \mu) + \varepsilon_t - \theta_1 \varepsilon_{t-1} \quad (8.11)$$

with mean and variance:

$$E[y] = \mu \quad (8.12)$$

$$Var[y] = \sigma^2 = \frac{\sigma_\varepsilon^2}{1 - \phi_1^2} (1 - 2\phi_1\theta_1 + \theta_1^2) \quad (8.13)$$

where  $\phi_1$  is:

$$\phi_1 = \frac{r_2}{r_1} \quad (8.14)$$

and  $\theta_1$  is a function of  $\phi_1$  and  $r_1$ .

When the original series is characterized by seasonality PAR( $p$ ) (*periodic autoregressive model*) and PARMA( $p,q$ ) (*periodic autoregressive moving average model*) are able to reproduce this feature.

Assuming that a periodic hydrological process is represented by  $y_{v,\tau}$ , in which  $v$  defines the year and  $\tau$  defines the season, such that  $\tau = 1, \dots, \omega$  and  $\omega$  is the number of seasons in the year (seasons, months, weeks) a PAR( $p$ ) model is defined as follows:

$$y_{v,\tau} = \mu_\tau + \sum_{j=1}^p \phi_{j,\tau} (y_{v,\tau-j} - \mu_{\tau-j}) + \varepsilon_{v,\tau} \quad (8.15)$$

in which the meaning of the symbols is similar to that given before for the AR( $p$ ) and ARMA( $p,q$ ) models and the parameters of the model to be estimated are  $\mu_\tau, \phi_{1,\tau}, \dots, \phi_{p,\tau}$  and  $\sigma_\tau^2(\varepsilon)$  for  $\tau = 1, \dots, \omega$ .

By considering a moving average component, a PAR( $p$ ) becomes a PARMA( $p,q$ ) model, that can be written as follows:

$$y_{v,\tau} = \mu_\tau + \sum_{j=1}^p \phi_{j,\tau} (y_{v,\tau-j} - \mu_{\tau-j}) + \varepsilon_{v,\tau} - \sum_{j=1}^q \theta_{j,\tau} \varepsilon_{v,\tau-j} \quad (8.16)$$

When synthetic data generation models are used in a Montecarlo simulation of a water supply system with several hydrological inputs, it is generally necessary to generate series that preserve also the cross correlation between the different inflows. Formulation of this kind of models is similar to the one shown for AR( $p$ )

and ARMA( $p, q$ ) models with the difference that a matrix notation is now needed. Specific models such as MAR( $p$ ) and MARMA( $p, q$ ) (*multivariate autoregressive models* and *multivariate autoregressive moving average models*) are useful for this task.

Consider a multiple time series  $\mathbf{Y}$ , a column vector with elements  $y_t^{(1)}, \dots, y_t^{(n)}$  in which  $n$  is the number of series (number of sites or number of variables) under consideration. The multivariate MAR (1) model is defined as:

$$\mathbf{Z}_t = \mathbf{A}_1 \mathbf{Z}_{t-1} + \mathbf{B} \varepsilon_t \quad (8.17)$$

in which  $\mathbf{Z}_t = \mathbf{Y}_t - \mathbf{m}$ ,  $\mathbf{A}_1$  and  $\mathbf{B}$  are  $n \times n$  parameter matrices and  $\mathbf{m}$  is a column parameter vector with elements  $m^{(1)}, \dots, m^{(n)}$ . The noise term  $\varepsilon_t$  is also a column vector of noises each with zero mean, uncorrelated with  $\mathbf{Z}_{t-1}$  and normally distributed.

Using the same notation MARMA( $p, q$ ) models can be introduced. The simplest MARMA( $p, q$ ) is the MARMA(1,1) that can be defined as:

$$\mathbf{Z}_t = \mathbf{A}_1 \mathbf{Z}_{t-1} + \mathbf{B} \varepsilon_t - \mathbf{C}_1 \varepsilon_{t-1} \quad (8.18)$$

in which  $\mathbf{C}_1$  is an additional  $n \times n$  parameter matrix useful to consider the moving average component of the original series.

Using the full MAR( $p$ ) and MARMA( $p, q$ ) models often leads to complex parameter estimation, thus some model simplifications have been suggested. For instance a simpler model considers  $\mathbf{A}_1$  to be a diagonal matrix. In general a *contemporaneous* ARMA( $p, q$ ) (CARMA) model results if the matrices  $\mathbf{A}_p$  and  $\mathbf{C}_q$  are considered to be diagonal. In this case the model implies a contemporaneous relationship in which only the dependence of concurrent values of the  $y$ 's are considered important.

Skewed hydrological processes must be transformed into normal processes before AR or ARMA models are applied. However, a direct modelling approach that does not require a transformation may be a viable alternative. For instance, the *gamma autoregressive process* offers such an alternative. It is defined as:

$$y_t = \phi (y_{t-1}) + \varepsilon_t \quad (8.19)$$

where  $\phi$  is the autoregressive coefficient,  $(\varepsilon_t)$  is a random component that can be obtained as a function of  $\phi$  and the parameters of a Gamma distribution (location, scale, shape).

Data can be generated at a time scale and then transformed to be used at a different one. For example one could be interested in generating annual data due to the fact that generally these are not intermittent series and then disaggregate these annual data into monthly data using appropriate disaggregating models (Lane, 1979).

Stochastic data generation models are often said to statistically resemble the historic flows if the model produces synthetic flows with the same mean, variance, skew coefficient, autocorrelation, and/or cross-correlation as in the historic series. The drawback of this approach could be that it shifts the modeling emphasis on

reproducing arbitrarily selected statistics of the available data. Therefore, for any particular water supply system, and depending on the purpose of the analysis one must determine what particular characteristics has to be modeled. Such decision should depend on what characteristics are important to the operation of the system being studied as well as on the data available.

### ***Analysis and Representation of Results***

The output of Montecarlo simulation of a water supply system consists of several series of storage levels in reservoirs, downstream releases, releases to the demands, etc. Analysis of such results can be carried out by means of synthetic indices, able to catch different features of the analyzed series. Here, for the purpose of risk analysis of water shortages due to droughts, the following synthetic assessment of system failures in terms of satisfaction of consumptive demands are proposed:

- Water supply system performance indices (reliability, resilience and vulnerability)
- Accumulated frequency plot of shortages
- Histogram of monthly frequencies of shortages
- Sample frequency of monthly shortages
- Return period of shortages defined as the average inter-arrival time between two annual shortages exceeding a given value

A similar assessment can be proposed for the satisfaction of ecological requirements, such as instream flow requirements, and for target storages in reservoirs.

Some of the most meaningful water supply system performance indices are:

- Temporal reliability
- Volumetric reliability
- Average shortage period length
- Max monthly shortage
- Max annual shortage
- Sum of squared shortages

Temporal reliability is defined as the probability that the system is in a satisfactory state.

$$Aff_t = \Pr[X_t \in S] \quad (8.20)$$

where  $X_t$  represents the state of the system at time  $t$  and  $S$  is the ensemble of the satisfactory states.

If by satisfactory state we indicate the complete fulfilment of demands, this probability can be estimated as the ratio between the number of intervals during which demand is fully met and the total number of intervals considered.

$$rel_T = \frac{n_s}{N} \quad (8.21)$$

where  $n_s$  is the number of intervals during which demand is fully met and  $N$  is the total number of intervals considered. This index gives information about the time reliability of the system with respect to a given demand. Time-reliability indices can be also computed considering as a satisfactory state that one where release is greater than a threshold that describes a tolerable water storage for a given use.

Volumetric reliability is expressed as the ratio between the total volume released and the total demand volume:

$$rel_V = \frac{\sum_{t=1}^N R_t}{\sum_{t=1}^N D_t} \quad (8.22)$$

where  $R_t$  and  $D_t$  are respectively the volumes released and the demands at the  $t$  interval. This index helps in the evaluation of the total volumes released by the system with respect to a given demand.

The average shortage period length is defined as:

$$Av_{def} = \frac{N - n_s}{N_p} \quad (8.23)$$

where  $n_s$  is the number of intervals during which demand is fully met,  $N$  is the total number of intervals considered and  $N_p$  is the number of periods of deficit defined as a continuous series of deficit intervals.

The maximum monthly and annual shortages are defined as the maximum of the annual and monthly shortages series and give information about the vulnerability of the system to drought phenomenon in a single interval.

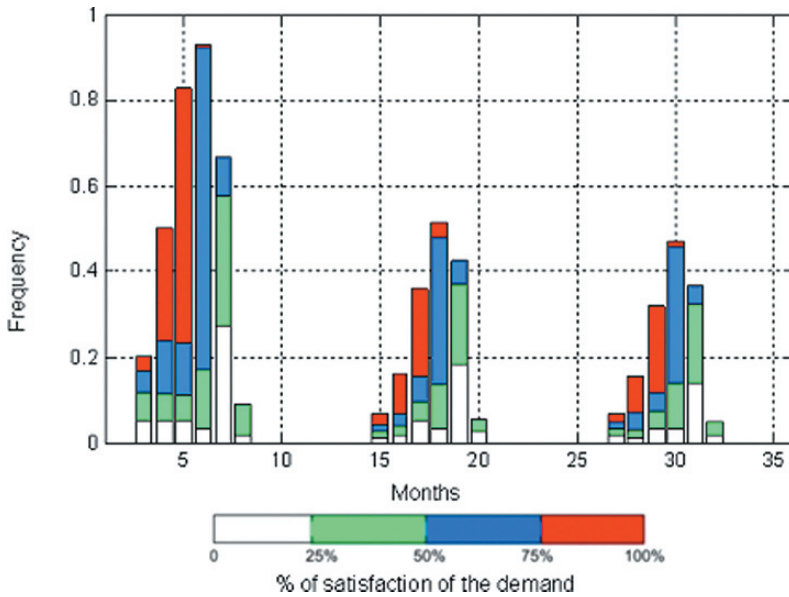
The sum of squared shortages index gives information about the amount of the shortages and is a good proxy variable of the damages to the system. This index can be expressed either in terms of volume or as a percentage of the demand.

The above-mentioned indices give an objective estimation of performance of the system but are not sufficient to capture some interesting statistical features of the shortage series.

Histogram of monthly frequencies of shortages, sample frequency of monthly shortages and return period of shortages defined as the average inter-arrival time between two annual shortages exceeding a given value, expressed in form of graphs, can help to describe and represent the stochastic features of shortages.

In particular, histograms of monthly frequencies of shortages, as depicted for example in Fig. 8.3, represent the frequency of shortages belonging to one of the four proposed classes expressed as a percent of the demand of a given interval (0–25%, >25%–50%, >50%–75%, >75%–100). This representation gives infor-

mation about the overall monthly probability of water shortages and their distribution among the classes.



**Fig. 8.3** Example of histogram of monthly frequencies of shortages in percentage of demand

Accumulated frequency of monthly shortages, as depicted for example in Fig. 8.4, represents non exceedence probabilities of shortages giving the opportunity to estimate the frequency of shortages of different entity as a continuous curve.

Return period of shortages, defined as the average inter-arrival time between two annual shortages exceeding a given value, gives information about the rarity of the shortages.

An example of the comparison of return period of shortages for two different operations of the system (with or without mitigation measures) is depicted in Fig. 8.5. From the figure, it can be inferred how the return period of dimensionless shortages greater than 0.3 when mitigation measures are applied is longer than the corresponding return period when no measures are applied. Thus it can be concluded that the adoption of the measures is beneficial for dimensionless shortages greater than 0.3 since the inter-arrival time increases significantly.

Comparison between the above mentioned indices and graphs calculated for simulations corresponding to different implemented mitigation measures can help in evaluating in a statistical sense the impacts of mitigation measures for reducing shortages of different demands of the system under investigation.

Even if it is not possible to define a unique synthetic index to assess the risk of a given water supply system, an analysis based on the mentioned indices and graphs can give a good idea of the multifaceted behavior of a water supply system under drought conditions.

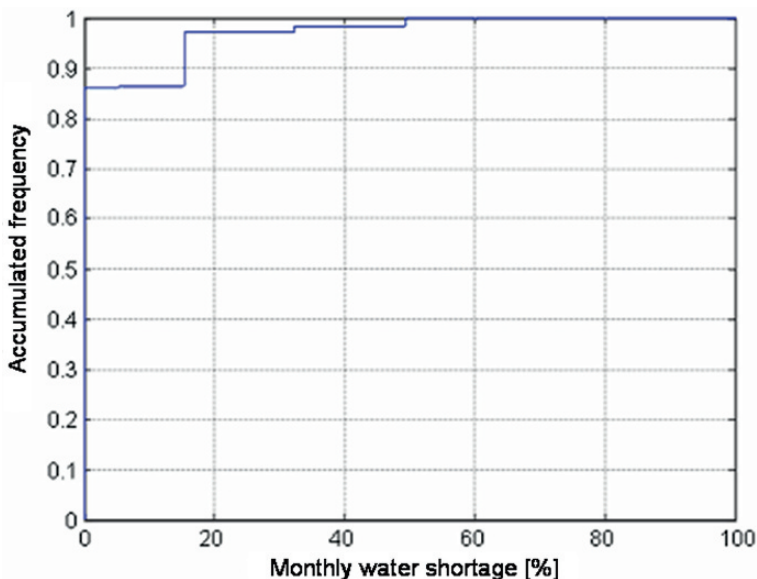


Fig. 8.4 Sample frequencies of monthly shortages

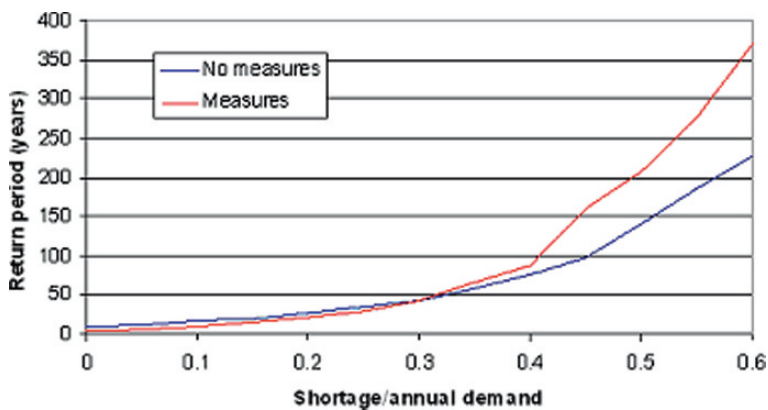


Fig. 8.5 Comparison of return period of shortages in two different operating modes of the system

## Conclusions

Even though several definitions of risk exist, there is a general agreement that risk attempts to measure the uncertainty of the consequences of a given phenomenon. Such uncertainty stems from the stochasticity that characterizes most of the natural phenomena, as well as from the difficulties in assessing in a deterministic way their consequences and impacts. When assessing drought risk for a water supply system, it should be also considered that the same drought can have different consequences



on the same system, depending on the degree of preparedness (i.e. mitigation measures) of the system.

Therefore, a correct approach to assess risk in water supply system has to be based on tools able to deal with the stochastic nature of the drought phenomenon, as well as to evaluate the effects of different management alternatives of the system. Within this framework, Montecarlo simulation represents an ideal tool, since it enables to overcome the limitations of a probabilistic evaluation of risk of shortage based on historical hydrological series, which is hindered by the generally limited sample length availability. Simulation of the system using generated series also enables to extend the analysis, besides the planning stage, also during the operation of the system, by assessing the conditional risk, i.e. the risk of shortages in a short-term time horizon as a function of the current states of the system. Furthermore, an appropriate analysis of the results of Montecarlo simulation allows the multifaceted features of water shortages to be caught, thus allowing for an improved assessment of the impacts of droughts to be carried out.

## References

- Alecci S, Reitano B, Rossi G (1986) Evaluation of alternatives in management of water resources systems through performance indices. In Proceedings of the International Conference on water Resources Needs and Planning in Drought Prone Areas, Khartoum (Sudan), December 15–17.
- Andreu J, Capilla J, Sanchis E (1996) Aquatool, a generalized decision support system for water resources planning and operational management. *Journal of Hydrology*, 177(3/4): 269–291.
- Ang A H S, Tang W H (1984) Probability Concepts in Engineering Planning and Design, Vol.II: Decision, Risk and Reliability. John Wiley, New York.
- Hashimoto T, Loucks D P, Stedinger J R (1982) Reliability, resiliency, robustness, and vulnerability criteria for water resource systems. *Water Resources Research*, 18(1).
- Hydrologic Engineering Center (1993). HEC-PRN Simulation model, User's Manual. U.S. Army Corps of Engineers, Davis, California.
- Kron, W. (2005). Flood risk = Hazard\*Values\*Vulnerability. *Water International*, 30(1):58–68.
- Labadie J, Baldo M, Larson R (2000) MODSIM: Decision support system for river basin management. Documentation and user manual. Department of Civil Engineering, Colorado State Univ., Ft. Collins, Colorado.
- Labadie J (2004) Optimal operation of multi-reservoir systems: state of the art review. *Journal of Water Resources Planning and Management*, ASCE, 130(2):93–111.
- Lane W L (1979) Applied Stochastic Techniques (Last Computer Package); User Manual. Division of Planning Technical Services, U.S. Bureau of Reclamation, Denver, Co.
- Loucks D P (1996) Surface water resource systems in Mays, L.W. *Water Resources Handbook*, Chapter 15 McGraw-Hill, New York.
- Loucks D P, Stedinger J R, Haith D A (1981) *Water Resources Systems Planning and Analysis*. Prentice Hall, New Jersey.
- Mays L, Tung Y (1992) *Hydrosystem Engineering and Management*. McGraw-Hill, New York.
- Rossi G, Cancelliere A, (2003) At-site and regional drought identification by REDIM model. In Rossi G, et al (eds.) *Tools for Drought Mitigation in Mediterranean Regions*, Kluwer Academic Publishing, Dordrecht, pp. 37–57.
- Salas J D (1993) Analysis and modeling of hydrologic time series. In Maidment D (ed.) *Handbook of Hydrology*, Chapter 19. McGraw-Hill, New York.
- Stein S, Miller C, Stout S, Webb J (2001) Big Sandy River basin STELLA reservoir regulation model, Proceedings of the World Water and Environmental Congress, ASCE, Orlando, Fla.

- Tung Y K (1996) Uncertainty and reliability analysis in Mays, L.W. *Water Resources Handbook*, Chapter 7 McGraw-Hill, New York.
- UNDRO (1991) *Mitigating Natural Disasters. Phenomena, Effects and Options. A Manual for Policy Makers and Planners*. United Nations, New York.
- Yen B C (1971) Risks in hydrologic design of engineering projects, *Journal of the Hydraulics Division*, 97(9), pp. 1525–1526.

# Chapter 9

## Mathematical Models for Reservoir Operation in Tunisia

M.H. Louati and F. Lebdi

**Abstract** A genetic algorithm model has been developed and applied to solve a planning problem of optimum allocation of water resources within a complex reservoir system. The specific conditions of the surface water resource utilization in Tunisia, exemplified in a 10-reservoir case study system (Louati 2005 thèse de doctorat en sciences agronomiques “Spécialité: Génie rural eau et forêts”, Inat, Tunis, Tunisie), have required that the allocation of the available resources be analyzed considering both the quantity as well as salinity of supply. Therefore, the analyses included resource allocation optimization under the assumption of five different objective functions reflecting the relationship between the two supply criteria. In addition, the obtained solutions under the five objective assumptions have further been assessed across a range of system performance indicators. This step has proven essential in obtaining a more comprehensive insight into the operation of the system under the different objectives.

### Introduction

The availability of, and the demand for water form one of the most complex relationships the mankind is facing. Under “availability of water” one should primarily underline the limiting amount and acceptable quality of water in our hydrological cycle in arid and semi arid zones, and the uneven distribution of its quantities in space and time. By “demand for water” one should consider drinking and agricultural water consumption as the essential preconditions for human life sustenance, as well as the areas of water use, which could be considered as contributing factors to the improvement of the quality of life (i.e. non consumptive household, industrial and tourism, energy production, recreation water demands etc.).

---

M.H. Louati (✉)

Direction Générale des Barrages et des Grands Travaux Hydrauliques, Ministère de l’Agriculture, et des Ressources Hydrauliques, 1002 Tunis, Tunisia  
e-mail: louati@iresa.agrinet.tn

Quality factor is the required to reconcile water availability and minimum required quality demand, as drinking water or some crop irrigation requirements. On the one hand, the quality of available water resources determines, to a varying degree, their suitability for different purposes. The quality of water released back to the environment after its use, on the other, influences the extent of environmental pollution and, in turn, prospects for the maintenance of the sustainable use of the water resources in the future. Furthermore, both the use of the available water resources and the release of the used effluents back to the environment have an impact on the environmental balance in the affected areas.

The aforementioned quantitative and qualitative aspects of the balance of water resources have been recognized as crucial in the strive to maintain the necessary environmental quality, ensuring at the same time that everyone gets a just share of water of good quality. The water resources management aims to improve the water use efficiency, equity of distribution and sustainability of the water system.

The objective criterion is to optimize the water management rules, with the quality as salinity and quantity objectives, for dams' network. The case study system consists of 15 large reservoirs in the Northern part of Tunisia. The reservoirs are mutually interconnected in either serial or parallel fashion, both through natural river reaches as well as man-made water transfers.

The system encompasses 36 individual demand centers grouped into three principal water user types: urban (five demands), irrigation (30 demands) and environmental (one demand). The demands have been described by two parameters: demand volume and the maximum acceptable supply salinity.

System topology studied indicates that the analyses are to address a rather difficult operations research problem. On the one hand, the system itself can contain multiple reservoirs and demand centers, which can be linked together in an intricate network. On the other hand, the consideration of salinity of reservoir inflows and releases, and thereby allocations to individual demands, adds additional complexity to the operation problem. It is obvious therefore that the optimization problem must apply criteria that will be able to address both the quantity and salinity of reservoir allocations to individual demands. Furthermore, reservoir operating storage targets (rule curves) are considered as an additional objective criterion.

The primary goal of the analyses is to identify the preferable water resource allocation strategies within a complex water supply reservoir system and, at the same time, to derive the respective optimum operating policies of system reservoirs. To achieve this goal, three objective criteria have been defined and adopted for the analyses:

- To minimize the supply quantity deficit;
- To minimize the violation (surpassing) of supply salinity thresholds set for individual demands; and
- To minimize the deviation of the operating final storage of reservoirs from the predefined final storage targets.

## Structure of the Optimization Problem

The main goal of this work is to assess the applicability of a combination of several operations research approaches to a strategic operational problem of complex reservoir supply systems. System topology requires that the adopted approach for the analyses be able to tackle rather complex system configurations. With regard to such a system topology, the focus of the work is limited to the optimization of the long-term operating strategy of a multiple reservoir water supply system. In principle, an operating strategy of such a complex system may be understood as a composition of two main parts:

- Reservoir-demand allocation patterns; and
- Reservoir operating policies reflecting the aforementioned allocation patterns.

Such a decomposition of the operating strategy is justified by the fact that the original problem is rather complex and mathematically none polynomial.

Reservoir-demand allocation patterns are introduced to resolve the problem of demand sharing among groups of reservoirs. The task of optimization is therefore to identify those demand sharing patterns that would lead to the best allocation of water resources within a system.

Once reservoir-demand allocation patterns have been derived, the optimization of individual reservoir operating policies can be carried out. This process is therefore based on the assumption that the derived allocation patterns have to be complied with in policy optimization. As a consequence, the obtained operating policies will preserve the imposed reservoir-demand allocation patterns.

The stochasticity of reservoir inflows is considered where uncertainty of the inflow processes is sufficient for the case being analyzed. With regard to the temporal discretization, the analyses are limited to monthly time steps assuming the stationarity of the stochastic properties of monthly river flows (i.e. the probability distribution of a stochastic process is not changing over time). Monthly water demands, on the other hand, are assumed to be deterministic and considered to be recurring in annual cycles. Since the chosen monthly time base is long enough the required time for the released water to travel between any two serially linked reservoirs and any reservoir and the respective demand centers can safely be neglected.

Since the size of such a problem can be prohibitively large (i.e. number of reservoirs and demand centers, the complexity of reservoir-reservoir and reservoir-demand interconnections, consideration of flow stochasticity, and multiple objectives), it is inevitable to employ an iterative derivation procedure to arrive at the respective solution. One common characteristic of almost all the approaches of this kind is, however, that the global optimality of the obtained solution cannot be guaranteed. It is, therefore, necessary to emphasize that the starting point of this work was not to pursue a methodology which would guarantee the derivation of the global optimum operating strategy at any cost, but rather to try and identify a relatively simple and transparent, however yet efficient and effective approach for the analysis of the operation of complex reservoir systems. With this notion in view, the decomposition applied in this study is done at two levels:

- Problem decomposition may be understood as a coupling of reservoir system (topology) decomposition and reservoir-demand allocation patterns; and
- Reservoir operating policies reflecting the aforementioned allocation patterns. The main features of the applied system decomposition approach as iterative approach are:
  - A multiple reservoir system is decomposed into single-reservoir sub-systems;
  - Appropriate optimization/simulation techniques are applied to single-reservoir sub-systems;
  - Single reservoirs are entering an iterative cycle of analyses in a predefined sequence;
  - The interaction between the reservoirs is modeled by an auxiliary model, which is selected on the basis of the type of problem being solved (i.e. reservoir-demand allocation patterns or reservoir operating policies).

Based on the aforementioned description of the problem and its decomposition, optimization and general structure of adopted approach to derive long-term operating strategy of a complex reservoir system can be formulated as follows:

- Decompose the problem into resource allocation and policy optimization;
- Decompose the reservoir system into individual reservoir sub-systems;
- Solve the resource allocation sub-problem applying the appropriate optimization method combined with the reservoir system decomposition principles;
- Solve the policy optimization sub-problem applying the appropriate optimization method combined with the reservoir system decomposition principles;
- Simulate the operation of the system according to the derived resource allocation patterns and operating policies;
- Evaluate the performance of the system.

Namely, the resource allocation sub-problem is solved by a genetic algorithm (GA) based search model. The principal idea of a GA search is to sweep the objective function space looking for solutions that bring improvement to the objective function. In this specific case, the GA model assumes that a solution is a collection of reservoir-demand allocation targets for the entire system and uses reservoir system simulation to estimate the objective function value for each potential solution to the allocation problem.

The adopted methodology for the optimization of the long-term operating policies for individual reservoirs combines a physical decomposition of the system into individual reservoir subsystems, stochastic dynamic programming (SDP) optimization of a single reservoir operation, simulation and release allocation among each reservoir's water users. Since the SDP model derives the operating policy for a single reservoir (as opposed to the GA model which derives the allocation pattern for the entire system) its application has to be combined with system decomposition, simulation and release allocation. In addition, the developed SDP model utilizes the reservoir-demand allocation patterns derived by the preceding run of the GA.

Finally, simulation of the system operation according to the derived policies is essential due to three reasons:

- It is necessary for the evaluation of potential solutions in the genetic algorithm;
- It is an integral component of the stochastic dynamic optimization model; and
- System performance evaluation could be done using simulation.

To transform the multi-objective decision making problem into a single objective optimization, the obvious choice is to opt for a composite objective function, which would include all three objectives. The composite objective has been made to combine two objective criteria in deriving reservoir-demand allocation patterns, and different pairs of criteria for the optimization of reservoir operating policies:

- Reservoir-demand allocation patterns: supply quantity and supply salinity objectives; and
- Reservoir operating policies reflecting the aforementioned allocation patterns: supply quantity and storage target objectives.

To solve this, a genetic algorithm search is used to derive reservoir-demand allocation patterns. A GA search is based on objective function estimation using simulation of system operation and, therefore, it is no problem to develop a simulation model for a single reservoir that is able to simulate both the volumetric and salt balance of water in a reservoir during a time step. Hence, supply salinity objective can be applied to the first problem without difficulty. On the other hand, stochastic dynamic programming is applied to derive reservoir-operating policies and considers reservoir inflows as a stochastic process. Thus, SDP describes reservoir inflows as a Markov process through estimation of monthly inflow transitional probabilities. Consideration of salinity would therefore also require that inflow salinity time series is also described as a Markov process, which would impose that joint probability distributions of flow volumes and salinities are estimated. This would however, render a discrete SDP formulation rather complicated. Furthermore, salinity data available for the research show very little variability over the years of record, thus justifying the assumption that the consideration of supply salinity objective only in reservoir-demand allocation sub-problem. That is, the derived allocation patterns would then sufficiently reflect the objective to minimize the violation of supply salinity threshold and would thereafter implicitly incorporate the salinity consideration into the SDP-based operating policies derived within the second sub-problem.

Genetic algorithm search for the best reservoir-demand allocation patterns is also used to derive the storage targets of individual reservoirs.

Finally, the combination of supply quantity and storage target objectives in SDP optimization of reservoir operating policies completes the combination of the three objectives. In addition, the derived SDP operating policies would reconcile, in a single policy, the aim to maintain the optimum level of supply quantity and salinity, and the desired storage target curve.

Since there are three objective criteria adopted, the selection of performance indicators must also reflect the criteria themselves. Therefore, three distinctive sets

of performance indicators are defined to provide additional information on the analyzed system performance:

- Performance indicators for the supply quantity objective;
- Performance indicators for the supply salinity objective; and
- Performance indicators for the storage target objective.

## Reliability Criteria Assessment in Evaluation of Reservoir Performance

Within stochastic optimization concepts the most frequently used objective criteria include either the maximization of the expected system output or benefit function, or the minimization of the expectation of some form of loss function. Utilization of this type of criteria provides the estimate of the expected performance of the system in the long run. However, they cannot shed any light on the frequency of the system's failing to provide the required service, the duration and severity of potential failures, nor the ability of the system to return to a satisfactory operating state once a failure has occurred. These important facets of a system's performance are widely known as reliability indicators. Consequently, substantial effort has been put into the explicit consideration of reliability in the optimization of the operation of reservoir systems. It could be said that the most significant in the field started with the work on chance-constrained programming by ReVelle et al. (1969), which was further extended by, to name just a few, ReVelle and Kirby (1970), Eastman and ReVelle (1973), ReVelle and Gundelach (1975), Gundelach and ReVelle (1975), Lebdi et al. (1997, 2003), Loucks and Dorfman (1975), Houck (1979), Houck and Datta (1981), and many others, including the works on reliability programming by Simonovic and Mariño (1980, 1981, 1982).

Recognizing that the simulated estimates of the mean and the variance of the selected performance measure (e.g. output, operating cost) could not provide accurate information about the frequency and magnitude of operational failures, Hashimoto et al. (1982) used three additional performance indicators (PI) to compare a number of different operating policies of a single irrigation water supply reservoir. They introduced *reliability* to describe how often the system failed to meet the target; *resiliency* to assess how quickly the system managed to return to a satisfactory state once a failure had occurred; *vulnerability* to estimate how significant the likely consequences of a failure might be. Based on simulation of the reservoir's operation over a long synthetic inflow time series, a set of operating strategies was evaluated by deriving trade-offs among the expected loss, reliability, resiliency and vulnerability. For instance, one conclusion that could be drawn from the analyses was that, for the given case study, high system reliability was always accompanied by high vulnerability (i.e. the fewer failures the reservoir had, the higher the deficits encountered in the failure periods). The authors also pointed out that each problem bears its own unique features and, therefore, the selection of appropriate performance indicators should always reflect upon those unique characteristics of the problem.



Similar conclusions were also drawn by Moy et al. (1986) in their study of the operation of a single water supply reservoir. They used mixed-integer linear programming to derive trade-off curves among the virtually same three performance indicators presented by Hashimoto et al. (1982). Namely, they defined *reliability* as the probability of failing to meet the desired target; *resilience* as the maximum number of consecutive failures prior to the reservoirs return to the full supply state of operation; and *vulnerability* as the maximum supply deficit observed during simulation. The major finding described the relationship between vulnerability and the other two PIs. In general, the results showed that a reservoir would likely exhibit higher vulnerability (i.e. larger magnitude of failures) if it were more reliable (i.e. had fewer operating failures), or if it were more resilient (i.e. had short sequences of repeated failures).

The extensive study of Bogardi and Verhoef (1995) presented a more detailed analysis of the sensitivity of the operation of the same three-reservoir Mahaweli river development scheme in Sri Lanka. Using a range of different objective criteria, they optimized the operation of the system by means of SDP and subsequently appraised the derived operating strategies by simulation. In addition to the simulated objective criterion estimates, the comparisons were carried out on the basis of an array of both energy and irrigation related PIs (n.b. for each PI, separate estimates were derived for energy and irrigation).

Nandalal and Bogardi (1996) used an array of quantity-related PIs to evaluate the performance of a single water supply reservoir whose operating strategies were derived by optimization considering both the quantity and quality of reservoir releases. Specifically, they adopted seven PIs to investigate the impact of different salinity reduction measures of reservoir releases on the quantitative aspects of the reservoir's performance.

A number of PIs is selected to compare different operating strategies of the case study system in this work. The defined PIs do not depict the operating details of individual reservoirs. They rather describe the performance of the entire multiple-reservoir system with respect to the quantitative fulfillment of the water demand imposed upon the system (n.b. a similar approach has also been adopted in Milutin and Bogardi, 1995, 1996a and 1996b). The set of PIs used in this case study includes a number of criteria defined to evaluate various facets of reliability, resilience and vulnerability of the system's operation. A detailed definition of the adopted PIs is given in "Performance Indicators".

## Objective Criteria

This section provides the detailed description of the three objective criteria used. Each of the three objective functions (i.e. supply quantity achievement, salinity threshold non-breach and reservoir storage target achievement) is presented in its full mathematical formulation. In addition, an introduction and an argumentation about the combined use of the objective functions in different optimization steps are given here as well.

### ***Supply Quantity Objective***

The supply quantity objective aims at minimizing the deviation of supply from the respective demand targets. The objective function is defined as an aggregate of the squared supply deviations from the respective demand targets over all individual demands and over the entire time span of the analyses:

$$Z_1 = \sum_{t=1}^T \sum_{i=1}^N (R_{ti} - D_{ti})^2 \quad (9.1)$$

Where:

- $Z_1$  supply quantity objective criterion achievement
- $T$  number of time steps in the objective criterion assessment
- $N$  number of demands
- $R_{ti}$  allocation of supply to demand  $i$  in time step  $t$
- $D_{ti}$  demand  $i$  in time step  $t$

To force the optimization procedure to seek the solution that is reducing the risk from extreme supply shortages, this objective is penalizing the supply deviation from its respective target as the square of the resulting deviation. If the objective function were linear, the optimization procedure would not make any distinction between, for example, a single large deficit and a number of smaller deficits amounting to the same total volume.

By adopting such an objective function form, it is ensured that the optimization procedure will disregard, to the maximum extent possible, solutions that result in excessive supply shortages or surpluses. This approach therefore strives to reduce the vulnerability of the system performance.

### ***Supply Salinity Objective***

In essence, the initial assumptions used to define this objective function have been very similar to the ones used in the definition of the other two objectives. That is, given a certain salinity threshold beyond which the salinity of supply to a demand center should not occur, this objective function should represent a penalty if such a case does happen. There are two principal differences between the supply salinity threshold objective and the other two objective functions:

- Supply salinity objective penalizes only the surplus of salt concentration beyond the specified threshold value, whereas the other two penalize the deviation from their respective target; and
- The units and the magnitude of surplus of salinity differ significantly from those in the other two objectives.

The first difference is no obstacle for the definition of the objective function. However, the second one does require careful consideration when defining the objective function. This is due to the fact that the intrinsic multiobjective decision making problem is to be transformed into a single (composite) objective optimization, thus requiring that different objective function components be additive (i.e. supply quantity achievement and salinity threshold non-breach objectives).

Since the objective functions should be used jointly in optimization, the second obstacle is overcome by redefining the supply salinity surplus formulation into a volumetric equivalent (volume of water) describing the relationship between the supplied volume and salinity, and the imposed supply salinity threshold. Namely, let the following be the variables and relations describing the aforementioned quantities:

- Salt concentration of the allocated supply to a demand center ( $C_{ti}$ ):

$$C_{ti} = \frac{\sum_{j=1}^M r_{tij} c_{tj}}{\sum_{j=1}^M r_{tij}} \tag{9.2}$$

- The total amount of water allocated ( $R_{ti}$ ) to meet the demanded volume  $D_{ti}$

$$R_{ti} = \sum_{j=1}^M r_{tij} \tag{9.3}$$

where the newly introduced symbols so far are:

- $r_{tij}$  volume released from reservoir  $j$  for demand  $i$  in time step  $t$
- $c_{tj}$  salinity of release from reservoir  $j$  in time step  $t$

If the salinity of the supply  $C_{ti}$  is beyond the maximum threshold salinity  $C_{i\max}$  for that particular demand, one can assume that the supplied volume will have to be additionally treated or partially replaced by some fresh water amount (volume  $A_{ti}$  of salinity  $c_{ext}$ ) which would then reduce the salinity of the originally supplied water to the threshold level, or lower. This amount of additional fresh water can be estimated from the salt balance inequality:

$$R_{ti} \cdot C_{i\max} \geq (R_{ti} - A_{ti}) \cdot C_{ti} + A_{ti} \cdot c_{ext} \tag{9.4}$$

or, expressed as the equality for estimating the minimum value of the volume  $A_{ti}$ :

$$A_{ti} = \begin{cases} R_{ti} \frac{C_{i\max} - C_{ti}}{c_{ext} - C_{ti}} , & C_{ti} > C_{i\max} \\ 0 & , \text{ otherwise} \end{cases} \tag{9.5}$$

It need not be mentioned that the assumed salinity  $c_{ext}$  of this “external” source of fresh water must be lower than the supply salinity threshold  $C_{i_{max}}$  of the demand in question.

Given the estimates of the required external source supply  $A_{ti}$  to dilute the allocated volumes in each time step when the supply salinity threshold breach occurs, the objective function value can be estimated as:

$$Z_2 = \sum_{t=1}^T \sum_{i=1}^N A_{ti}^2 \quad (9.6)$$

The objective is penalizing the volumetric equivalent of the supply salinity surplus beyond its respective threshold as the square of the equivalent volume of fresh water needed to dilute the allocated salinity to the respective threshold value. Again, the choice of a squared rather than linear form of the penalty is forcing the optimization procedure to opt for more failures of lesser magnitude rather than just a few high ones.

### ***Reservoir Storage Target Objective***

The reservoir storage target objective function is very similar in its form to the supply quantity objective described before. Namely, it penalizes the deviation of the final storage volume of a reservoir observed in optimization/simulation from the respective target storage volume. The function itself is defined as an aggregate of the squared final storage volume deviations from their respective targets over all individual reservoirs and over the entire time span of the analyses:

$$Z_3 = \sum_{t=1}^T \sum_{j=1}^M (SF_{tj} - ST_{tj})^2 \quad (9.7)$$

where the newly introduced symbols so far are:

- $Z_3$  reservoir storage target objective criterion achievement
- $M$  number of reservoirs
- $SF_{tj}$  observed final storage volume of reservoir  $j$  in time step  $t$
- $ST_{tj}$  target final storage volume of reservoir  $j$  in time step  $t$

Similarly to the discussion on the other two objective functions presented in “Supply Quantity Objective and Supply Salinity Objective”, the storage target objective function is also defined as an aggregate of squared deviations to force the optimization procedure to avoid solutions with fewer high deviations as opposed to those with numerous lower deviations from the target.

### ***Composite Objective Within Resource Allocation Optimization***

A genetic algorithm search for the best resource allocation pattern is based on the objective that minimizes the value of a so-called fitness function. In essence, a genetic algorithm fitness function is the equivalent of an objective function in an optimization procedure. The adopted fitness function is defined as an aggregate of two distinct components:

- Quantity-related squared deviation of supply from the target demand, multiplied by the respective weight factor; and
- Salinity related squared penalty of a volumetric equivalent of the violation of the maximum acceptable supply salinity, multiplied by the respective weight factor.

Given the definition of the two individual objective functions in “Supply Quantity Objective and Supply Salinity Objective”, it is necessary to adjust their estimation for the purpose of their combined use in the aforementioned fitness evaluation. It should also be noted here that in the definition of the genetic algorithm’s fitness evaluation model the allocated consumptive release cannot exceed the respective demand. Therefore supply shortage is the only possible quantitative supply failure, and surplus can never occur.

The penalty associated with a failure of meeting the quantity and/or quality requirement is derived under the assumption that either of the two is to be compensated for from an imaginary external source with water of a constant (low and known) salt concentration. The joint penalty for utilization of such a source is proportional to the square of the amount of water withdrawn regardless of the purpose of such a withdrawal (i.e. to compensate for quantity shortage or to improve the quality of delivered water or both). The penalty is thus estimated in four steps described below:

1. Based on the observed quantitative supply deficit associated with a demand during a certain time step, the imaginary external source provides full compensation for the incurred shortage. The external compensation for the supply deficit affects the salt concentration of the water delivered to the demand center. The estimation of the resulting salinity of the assumed “full supply” is computed from the following equations:

- Salinity of the original supply from the associated reservoirs:

$$C_{ti} = \frac{\sum_{j=1}^M r_{ij} c_{ij}}{\sum_{j=1}^M r_{ij}} \quad (9.8)$$

- Total volume supplied by the associated reservoirs:

$$R_{ti} = \sum_{j=1}^M r_{ij} \quad (9.9)$$

- Salinity of “full supply” (including the volume provided by the external source):

$$C'_{ti} = \frac{R_{ti} \cdot C_{ti} - (D_{ti} - R_{ti}) \cdot c_{ext}}{D_{ti}} \quad (9.10)$$

- Salinity of “full supply” (in a slightly different form):

$$C'_{ti} = \frac{R_{ti}}{D_{ti}} \cdot C_{ti} + \left(1 - \frac{R_{ti}}{D_{ti}}\right) \cdot c_{ext} \quad (9.11)$$

2. Having estimated the salinity of the “full supply” after the initial compensation from the external source for the quantitative shortage, it is necessary to assess whether the newly obtained supply salinity is below the supply salinity threshold associated with this demand:

- The “full supply” salinity is below the threshold value,

$$C'_{ti} \leq C_{i\max} \quad (9.12)$$

and there is no need for additional fresh water supply, i.e.  $A_{ti} = 0$ .

- The “full supply” salinity is still higher than the threshold value,

$$C'_{ti} > C_{i\max} \quad (9.13)$$

and the additional fresh water volume ( $A_{ti}$ ) is estimated from the salt balance equation for this demand (it needs no mention that  $c_{ext} < C_{i\max}$ )

$$D_{ti} \cdot C_{i\max} = (D_{ti} - A_{ti}) \cdot C'_{ti} + A_{ti} \cdot c_{ext} \quad (9.14)$$

which leads to

$$A_{ti} = D_{ti} \cdot \frac{C'_{ti} - C_{i\max}}{C'_{ti} - c_{ext}} \quad (9.15)$$

3. The total penalty  $f_{ti}$  (both quantity and salinity related) associated with the supply to this demand center during one time step then becomes ( $w_q$  and  $w_s$  are penalty weights associated with the quantity and quality penalty components respectively):

$$f_{ti} = w_q \cdot (R_{ti} - D_{ti})^2 + w_s \cdot A_{ti}^2 \quad (9.16)$$

where

$$w_q \geq 0 \tag{9.17}$$

$$w_s \geq 0 \tag{9.18}$$

$$w_q - w_s = 1.0 \tag{9.19}$$

4. Summing up these individual penalties over all demand centers and over the entire period under consideration gives the total penalty associated with the system for the chosen release distribution pattern:

$$f = w_q \sum_{t=1}^T \sum_{i=1}^N (R_{ti} - D_{ti})^2 + w_s \sum_{t=1}^T \sum_{i=1}^N A_{ti}^2 \tag{9.20}$$

The volume  $(R_{ti} - D_{ti})$  in the above equation is the penalty base associated with the quantitative supply shortage whereas the amount of water  $A_{ti}$  represents the penalty base for the inadequate salinity of the delivered water.

Since genetic algorithms are essentially maximization search procedures, the presented penalty function must be transformed into an equivalent whose maximum will refer to the optimum solution of the allocation problem. In this case, the choice of transformation is rather simple. Namely, the actual fitness (objective) function  $f^*$  used is computed as the difference between the maximum possible penalty  $f_{max}$  estimated on the basis of equation (9.20) and the actual penalty  $f$  for a particular alternative solution (equation (9.20)):

$$f^* = f_{max} - f \tag{9.21}$$

where  $f_{max}$  is estimated assuming the following:

- Weight factors  $w_q$  and  $w_s$  are set to 1.0 and 0.0, respectively.
- Demands supplied by a single reservoir only encounter 100% deficit (no supply).
- Demands supplied by multiple reservoirs receive full demand supply from each of the reservoirs (maximum surplus.) It should be noted here that such a case is actually not possible within the settings of the genetic algorithm model. Nevertheless, it does ensure that the maximum possible fitness be certainly beyond any penalty value that can be encountered in the search.

### ***Composite Objective Within Operating Policy Optimization***

The operating policy optimization is carried out using stochastic dynamic programming (SDP). The SDP model applies reservoir system decomposition and optimizes the operating policies of individual reservoirs in an iterative fashion. Therefore, the objective function does not reflect the objective achievement of the entire system like the allocation optimization model (Composite Objective Within Resource

Allocation Optimization), but only a contribution of a single reservoir operation to the overall objective function value. The adopted objective function is the sum of two components:

- The annual aggregate of the squared monthly deviation of release from the respective demand, multiplied by a given weight factor; and
- The annual aggregate of the squared deviation of monthly final storage volume from the respective target storage volume, multiplied by a given weight factor.

Since this model applies stochastic dynamic programming, the objective function value represents the expectation of the objective achievement covering the span of one annual cycle.

Unlike the combination of supply deficit and supply salinity objectives (Composite Objective Within Resource Allocation Optimization), this compound objective function does not require transformation of either of its components since both represent volumetric quantities of the same type:

$$G = w_d \cdot \sum_{t=1}^T (R_{tj} - D_{tj})^2 + w_v \cdot \sum_{t=1}^T (SF_{tj} - ST_{tj})^2 \quad (9.22)$$

where the newly introduced symbols so far are:

- $w_d$  weight factor for supply deviation component ( $w_d \geq 0$ )
- $w_v$  weight factor for storage target deviation component ( $w_v \geq 0$ )
- $R_{tj}$  total consumptive release of reservoir  $j$  in time step  $t$
- $D_{ti}$  total demand imposed upon reservoir  $j$  in time step  $t$

Suffice it to say at this stage that both weight factors are predefined positive real numbers and must meet the condition:

$$w_d - w_v = 1.0 \quad (9.23)$$

## Performance Indicators

This section gives a full description of the risk and reliability indicators, hereafter referred to as performance indicators (PI), used in the present work. Performance Indicators (PIs) provide specific information about the performance of a system with regard to, for instance, the likelihood of the occurrence of insufficient supply, the probable severity of such a failure and the estimate of the likely duration of periods of full and insufficient supply, respectively. Since there are three objective criteria, the description distinguishes which indicators are appropriate for use in which of the objective cases. Furthermore, and due to the complexity of the system being analyzed, the estimation of performance indicators can be applied either to the system as a whole, to individual reservoirs or groups thereof, or to individual/groups



of demand centers. The ultimate choice among the aforementioned alternatives is made during the analyses and is addressed accordingly.

### Definitions

Since there are three distinct objective criteria considered it is deemed appropriate to introduce a few important terms at this stage to ensure that consistent terminology is used throughout the text:

- **Level of service.** The term “level of service” describes the extent to which a “service provider” (i.e. reservoir, reservoir system) fulfils its obligations towards meeting the agreed requirements of its “client(s)” (i.e. demand centers) during a single time step.
- **Failure vs success.** Contrary to a “success” event, a “failure” event indicates that a “service provider” has not managed to provide the full service to meet the requirement of its “client(s)” during a certain time step (e.g. supply shortage occurred, maximum acceptable salinity of supply surpassed, storage target not achieved).
- **Quantity-based performance indicators.** This set of PIs evaluates the performance of the selected system (i.e. single reservoir, system of reservoirs, single or group of demands) from the level of service point of view (i.e. supply quantity, supply salinity, storage target). Thus, the performance is assessed reflecting the magnitude of failure events and not their temporal distribution.
- **Time-based performance indicators.** Contrary to quantity-based PIs, time-based indicators describe the temporal facets of failure and success event occurrence related to the level of service of the selected system (i.e. single reservoir, system of reservoirs, single or group of demands).

### Quantity-Based Performance Indicators

1. *Quantity-based reliability* ( $PI_1$ ), is a simulation-based estimate of the mean level of service delivery over the entire period under consideration:

$$PI_1 = \frac{\sum_{i=1}^{N_f} \max(0, T_i - S_i)}{\sum_{i=1}^{N_f} T_i} \quad (\text{failure: shortage}) \quad (9.24)$$

2. *Average magnitude of failure* ( $PI_3$ ) is the simulation-based estimate of the mean magnitude of failure:

$$PI_3 = \frac{\sum_{i=1}^{N_t} \max(0, T_i - S_i)}{N_t} \quad (\text{failure: shortage}) \quad (9.25)$$

$$PI_3 = \frac{\sum_{i=1}^{N_t} \max(0, S_i - T_i)}{N_t} \quad (\text{failure: surplus}) \quad (9.26)$$

$$PI_3 = \frac{\sum_{i=1}^{N_t} (T_i - S_i)}{N_t} \quad (\text{failure: deviation}) \quad (9.27)$$

3. (*Undershooting*) vulnerability (PI<sub>5</sub>) indicates the magnitude of the most severe failure, i.e. shortage failure type, observed over the entire simulation period:

$$PI_5 = \max_i [\max(0, T_i - S_i)] \quad (\text{failure: shortage}) \quad (9.28)$$

4. (*Overshooting*) vulnerability (PI<sub>6</sub>) indicates the magnitude of the most severe failure, i.e. surplus failure type, observed over the entire simulation period:

$$PI_6 = \max_i [\max(0, S_i - T_i)] \quad (\text{failure: surplus}) \quad (9.29)$$

### ***Time-Based Performance Indicators***

5. *Time-based reliability* (PI<sub>7</sub>) is the simulation-based estimate of the long-term probability that the system service will be able to meet the target (consequently, the likelihood that the system will fail to provide the targeted service is  $1 - PI_7$ ):

$$PI_7 = 1 - \frac{1}{N_t} \sum_{i=1}^{N_t} u_i \quad (9.30)$$

6. *Average (success) recovery time* (PI<sub>8</sub>) is defined as the average number of successive time steps the system continuously fails to meet the target, thus stating the expected time required by the system to switch to an operating mode characterized by full service delivery once it has encountered an operating service failure during one time step (this PI can thus be described as the *average duration of failure*):

$$PI_8 = \frac{\sum_{i=1}^{N_t} u_i}{\sum_{i=1}^{N_t} v_i} \quad (9.31)$$

7. *Average (failure) recurrence time* ( $PI_9$ ) is defined as the average number of successive time steps the system sustains full service delivery before switching to a failure operating mode. In other words, it gives the estimate on how long the system may be expected to provide full service once it has recovered from an operating failure (this PI can thus be described as the *average duration of success, or full service*):

$$PI_9 = \frac{N_t - \sum_{i=1}^{N_t} u_i}{\sum_{i=1}^{N_t} w_i} \tag{9.32}$$

8. *Resilience (or failure persistence)* ( $PI_{10}$ ) is the longest interval  $\Delta i$  (in number of time steps) of consecutive operating failure events:

$$PI_{10} = \max_i (\Delta i | v_i = 1 \wedge w_{i+\Delta i} = 1, \Delta i \geq 0 \wedge u_j = 1 \forall j \in \{i - 1, \dots, i - \Delta i - 1\}) \tag{9.33}$$

9. *Resistance (or success persistence)* ( $PI_{11}$ ) is the longest interval  $\Delta i$  (in number of time steps) of consecutive full operating service:

$$PI_{11} = \max_i (\Delta i | w_i = 1 \wedge v_{i+\Delta i} = 1, \Delta i \geq 0 \wedge u_j = 0 \forall j \in \{i - 1, \dots, i - \Delta i - 1\}) \tag{9.34}$$

The notation used in equations above is described in the following:

- $i$  the index depicting a time step (i.e. month);
- $N_t$  the length, in time steps (i.e. months), of the simulation time period;
- $N_y$  the length, in years, of the simulation time period;
- $T_i$  the target that the system service is expected to reach in time step  $i$ ;
- $S_i$  the service that the system is expected to provide in time step  $i$ ;
- $\sum_{i=1}^{12} T_{ij}$  the annual target that the system service is expected to reach in year  $j$ ;
- $\sum_{i=1}^{12} S_{ij}$  the annual service that the system is expected to provide in year  $j$ ;
- $u_i$  the *success/failure* ( $u_i = 0/u_i = 1$ ) descriptor which indicates whether the system has managed to provide the expected service during time step  $i$ :

$$u_i = \begin{cases} 1, & T_i > S_i \\ 0, & T_i \leq S_i \end{cases}, \quad \forall i \quad (\text{failure: shortage}) \tag{9.35}$$

$$u_i = \begin{cases} 0, & T_i \geq S_i \\ 1, & T_i < S_i \end{cases}, \quad \forall i \quad (\text{failure: surplus}) \quad (9.36)$$

$$u_i = \begin{cases} 0, & T_i = S_i \\ 1, & T_i \neq S_i \end{cases}, \quad \forall i \quad (\text{failure: deviation}) \quad (9.37)$$

$v_i$  the descriptor indicating a *success-to-failure* operating transition:

$$v_i = \begin{cases} 1, & u_{i-1} = 0 \wedge u_i = 1 \\ 0, & \text{otherwise} \end{cases}, \quad \forall i > 1, \quad v_1 = u_1 \quad (9.38)$$

$w_i$  the descriptor indicating a *failure-to-success* operating transition:

$$w_i = \begin{cases} 1, & u_{i-1} = 1 \wedge u_i = 0 \\ 0, & \text{otherwise} \end{cases}, \quad \forall i > 1, \quad w_1 = 1 - u_1 \quad (9.39)$$

It should be noted here that the definitions and functional relationships of all the PIs have been presented assuming that the system’s operation is characterized by both success and failure events thus excluding a possibility of a division by zero in the estimation of any of the PIs. Similarly, it is assumed that the target service imposed upon the system over the whole simulation span, as well as the length of the simulation period, are not zero.

To conclude, Table 9.1 summarizes the applicability of individual PIs to the assessment of system performance with regard to each of the three objective criteria.

**Table 9.1** Summary on performance indicators applicability

Performance indicator	Objective		
	Supply quantity	Supply quality	Storage target
<b>Quantity-based</b>			
1 Reliability	✓		
2 Shortage index	✓		
3 Average magnitude of failure	✓	✓	✓
4 Average absolute magnitude of failure			✓
5 (Undershooting) vulnerability	✓		✓
6 (Overshooting) vulnerability		✓	✓
<b>Time-based</b>			
7 Reliability	✓	✓	✓
8 Average (failure) recurrence time	✓	✓	✓
9 Average (success) recovery time	✓	✓	✓
10 Resilience (or failure persistence)	✓	✓	✓
11 Resistance (or success persistence)	✓	✓	✓

## Case Study and Results

The methodology is summarized in Fig. 9.1.

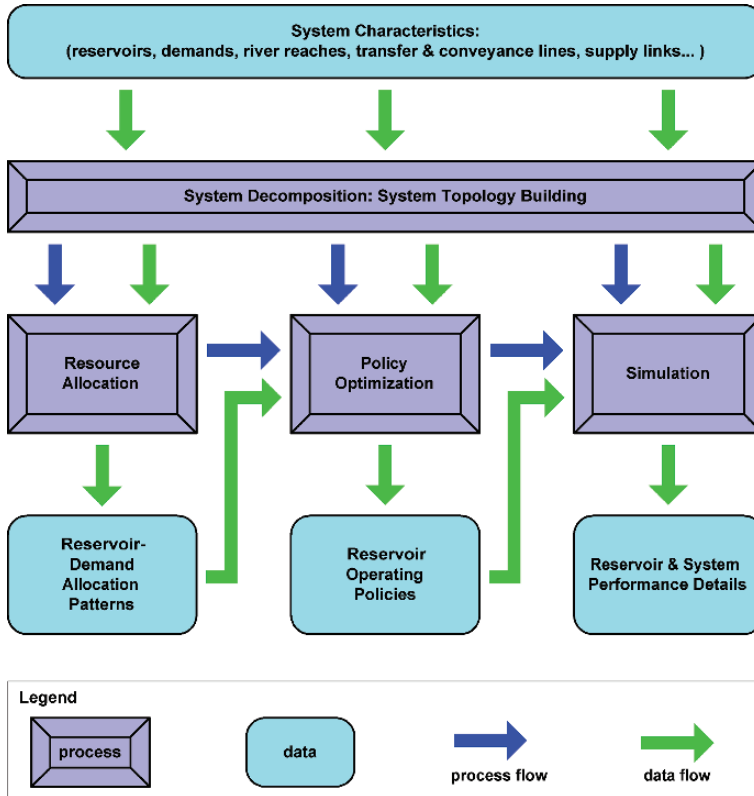


Fig. 9.1 The adopted approach for system operation optimization

The approaches developed and applied in this work have been thoroughly tested on the 15-reservoir case study system (Louati, 2005). It is therefore of primary importance to seek an opportunity for further research to appraise the applicability of these methods to different reservoir systems.

This study has been restricted to several long-term operational aspects associated with a multiple-reservoir-multiple-demand water supply system. Two particular optimization problems have been identified in this regard:

- Optimum allocation of available resources within such a system; and
- Optimization of the individual reservoir operating policies.

The two aforementioned optimization problems have been formulated and solved so as to reflect the desire of a decision maker to reconcile two primary objectives and one secondary goal. The primary objectives have been defined as:

- Quantitative satisfaction of water demand imposed upon the system; and
- Maintenance of supply salinity below the salt concentration limits predefined for each of the individual demands.

The work has focused on the assessment of applicability of a technique combining system and optimization problem decomposition, resource allocation, operating policy optimization and simulation to solving a strategic operational problem of a “multiple-reservoir-multiple-demand” water resource system. The complexity of the operational problem has brought about an assumption that the problem itself could be split into two main components. Namely, an operating strategy of such a complex system may be understood as a composition of two main parts:

- Resource (reservoir-demand) allocation patterns; and
- Reservoir operating policies reflecting the aforementioned allocation patterns.

The effectiveness of the proposed optimization and search methods have been appraised and compared not only on the basis of the applied objective criterion but rather over an array of simulated performance indicator estimates describing different aspects of system operation.

Given the findings of this research, genetic algorithms seem to be a good choice for this type of water resource management problems. The main advantage is their robustness and insensitivity to the size of the problem. Secondly, genetic algorithms rely on the objective function estimate derived by simulation, thus allowing the use of detailed simulation models. Finally, genetic algorithms can easily identify a number of equally good alternative solutions, which is frequently the case in water resources management problems.

The selected genetic algorithm-based resource allocation strategy has further been used to estimate the individual reservoir storage targets. The storage targets have been computed upon simulation of the entire system operation over 20 sets of 250 years of synthetic monthly inflows to individual reservoirs. The inflows to individual reservoirs have been generated using the autoregressive lag-one Thomas-Fiering model with seasonally varying coefficients, however without modeling the stream flow cross-correlation among the different streamflow processes.

It should be noted that the reservoir storage targets are derived assuming equal importance of supply towards all demand types, i.e. drinking water, irrigation and environmental needs. The simplification of the approach in this regard is made because this issue is extending beyond the scope, main objectives and resources of this research and should be treated to a greater detail elsewhere.

Since flood control is an integral part of any reservoir operation, additional analyses are required to assess the effects of flood control rules on the system operation. The consideration of flood control may also prove important to the assessment of the scope and magnitude of policy violation simulation used in this work. Namely, seasonal flood control related storage limitations would certainly influence the extent of the applied violations of stochastic dynamic programming policies. However, such an approach would also require deeper consideration of issues like river flow forecasting and/or rainfall-runoff modeling.

Ultimately, the findings of this research have shown that there are multiple aspects of system operation affecting the final decision on the preferred planning option. Namely, the use of performance indicators depicting the reliability, risk, resilience and vulnerability of different aspects of system performance have proven invaluable in making the final assessment of the efficiency and effectiveness of the proposed resource allocation and reservoir operating policy options. It is therefore sensible to assume that further research considering objective criteria like reliability, risk and/or vulnerability in devising water resource allocation plans may offer additional valuable insight into the available planning alternatives for such a reservoir system.

## References

- Bogardi J J, Verhoef A (1995) Reliability analysis of reservoir operation. In Kundzewicz Z W (ed.), *New Uncertainty Concepts in Hydrology and Water Resources. Proceedings of the International Workshop on new Uncertainty Concepts in Hydrology and Water Resources (Madralin, 1990):306–315. Cambridge University Press.*
- Eastman J, ReVelle C (1973) Linear decision rule in reservoir management and design.3. Direct capacity determination and intraseasonal constraints. *Water Resources Research*, 9(1):29–42.
- Gundelach J, ReVelle C (1975) Linear decision rule in reservoir management and design. 5. A general algorithm. *Water Resources Research*, 11(2):204–207.
- Hashimoto T, Stedinger J R, Loucks D P (1982) Reliability, resiliency, and vulnerability criteria for water resource system performance evaluation. *Water Resources Research*, 18(1):14–20.
- Houck M H (1979) A chance constrained optimization model for reservoir design and operation. *Water Resources Bulletin*, 15(5):1011–1016.
- Houck M H, Datta B (1981) Performance evaluation of a stochastic optimization model for reservoir design and management with explicit reliability criteria. *Water Resources Bulletin*, 17(4):827–832.
- Lebdi F, Slimani M, Parent E (1997) Empirical strategy for water resources system management : The example of the semi arid irrigated perimeter. *Revue des sciences de l'eau*, 10(1):121–134.
- Lebdi F, Bergaoui M, Bouslimi M A (2003) Optimisation of reservoir management in semi arid countires: Case of lakhmess in tunisia. In Rossi G, et al. (eds.). *Tools for drought mitigation in mediterranean regions*, pp. 293–304.
- Louati M H (2005) *Optimisation des règles de gestion des réservoirs multiples avec considération du risque, thèse de doctorat en sciences agronomiques “Spécialité: Génie rural eau et forêts”, Inat, Tunis, Tunisie.*
- Loucks D P and Dorfman P J (1975) An evaluation of some linear decision rules in chance-constrained models for reservoir planning and operation. *Water Resources Bulletin*, 11(6):777–782.
- Milutin D and Bogardi J J (1995) Reliability criteria in the assessment of a multiple reservoir operational strategy under Mediterranean conditions. *Proceedings of the European Symposium on Water Resources Management in the Mediterranean Under Drought or Water Shortage Conditions: Economic, Technical, Environmental and Social Issues (Nicosia, 1995)*, pp. 265–271. Rotterdam: Balkema.
- Milutin D, Bogardi J J (1996a) Hierarchical versus distributed release allocation within optimization of a multiple reservoir system operation. In Rao K (ed.), *Proceedings of the International Conference on Aspects of Conflicts in Reservoir Development and Management (London, 1996)*, pp. 485–494. London City University.
- Milutin D, Bogardi J J (1996b) Application of genetic algorithms to derive the release distribution within a complex reservoir system. In Muller A (ed.), *Hydroinformatics '96, Proceedings of*

- the Second International Conference on Hydroinformatics (Zurich, 1996), pp. 109–116. Rotterdam: Balkema.
- Moy W-S, Cohon J L, ReVelle C S (1986) A programming model for analysis of the reliability, resilience, and vulnerability of a water supply reservoir. *Water Resources Research*, 22(4):489–498
- Nandalal K D W, Bogardi J J (1996) Reliability analysis of a reservoir for salinity control. *Proceedings of the International Conference on Water Resources and Environment Research: Towards the 21st Century* (Kyoto, 1996), pp. 263–269. Kyoto University.
- ReVelle C, Joeres E, Kirby W (1969) The linear decision rule in reservoir management and design 1. Development of the stochastic model. *Water Resources Research*, 5(4):767–777.
- ReVelle C, Kirby W (1970) Linear decision rule in reservoir management and design 2. Performance optimisation. *Water Resources Research*, 6(4):1033–1044.
- ReVelle C, Gundelach J (1975) Linear decision rule in reservoir management and design. 4. A rule that minimizes output variance. *Water Resources Research*, 11(2):197–203.
- Simonovic S P, Mariño M A (1980) Reliability programming in reservoir management: 1. Single multipurpose reservoir. *Water Resources Research*, 16(5):844–848.
- Simonovic S P, Mariño M A (1981) Reliability programming in reservoir management: 2. Risk-loss Functions. *Water Resources Research*, 17(4):822–826.
- Simonovic S P and Mariño M A (1982) Reliability programming in reservoir management: 3. System of multipurpose reservoirs. *Water Resources Research*, 18(4):735–743.



# Chapter 10

## Risk Management Instruments Supporting Drought Planning and Policy

Alberto Garrido and Almudena Gómez-Ramos

**Abstract** This chapter looks at the role of risk-sharing mechanisms to help alleviate and reduce the economic and social consequences of droughts and water scarcity periods. We group various instruments according to different criteria, and review their potential and practical difficulties. By categorising the reviewed instruments under the stages of drought on which are best applied or referring to whether they are targeted to agricultural and operational droughts, we provide a framework for discussing their merits and drawbacks. This same framework is also used to evaluate the potential of each instrument and the evidence available to support it. We conclude by highlighting the limitation of economic instruments to manage drought risks. In part, this is because avoiding drought effects has public good properties. The chapter concludes, based on the available evidence, that there is still potential to manage part of the drought risks using financial instruments and insurance.

### Scope and Objectives

Droughts create social stress, economic losses and environmental damage. As in many other environmental and resource issues, economics, as a social science, has a say both in prescribing efficient policies and in explaining economic outcomes. Economic prescriptions and analyses are subject to considerable criticisms. Most often the attacks are based on the fact that economic models pose complex environmental systems in a very simplistic manner, disregard social and cultural dimensions, and overlook equity issues. While these are very critical issues in social decision-making, it is also the case that economics is centered primarily on evaluating the efficiency of observed results and policy alternatives. It is up to the decision makers,

---

A. Garrido (✉)  
Department of Agricultural Economics and Social Sciences,  
Universidad Politécnica de Madrid, Spain  
e-mail: alberto.garrido@upm.es

legislators and stakeholders to place more or less importance on the economic consequences of following one or another course of action.

The objective of this chapter is two-fold. First, it attempts to provide a representation of the economic risks of droughts and how they can be conceived in order to prepare agencies to become more efficient and conscious of the economic implications of droughts. Second, the chapter tries to review the policies that have potential to deliver more protection against drought effects at the minimum economic and social cost. For this, we review the most updated literature and practice, and synthesize the lessons that can be drawn from them. In general, we shall focus on the Mediterranean context, seeing it as a combination of particular climatic and geophysical characteristics rather than a world specific region.

The chapter starts by defining briefly the primary water environmental services and the types of droughts for which policies and instruments are proposed. Then, we review a number of economic instruments that can be applied to face the types of droughts that fall within the scope of the chapter. In the fourth section, we review the institutional and technical requirements of each instrument, as well as identify the major advantages and limitations. We summarise the main lessons and recommendations in the last and fifth section.

## Environmental Services Linked to Water Resources

Seminal work by Costanza and de Groot (1997) provided a framework to conceptualize the value of world natural resources and assets to humankind. This framework distinguishes between ecosystem functions from environmental services. Ecosystem functions refer to system properties and processes. Services represent the benefits that society derives, directly or indirectly, from ecosystem functions. A summary of these authors' evaluation of annual flows of water-related ecosystems at world scale is shown Table 10.1. With it, we wish to highlight the importance of non-commercial water services and draw a boundary for the services we will be focusing on here.

**Table 10.1** Summary of average global value of annual water-related ecosystem services (US\$ ha<sup>-1</sup>yr<sup>-1</sup>)

Environment	Area Hax1	Water reg.	Water supply	Waste treat.	Habitat refugia	Food prod.	Recreation	Cultural	Total (\$yr <sup>-1</sup> )
Wetlands	330	15	3,800	4,177	304	256	574	881	4,879
Lakes/rivers	200	5,445	2,117	665		41	230		1,700

Source: (Costanza and de Groot, 1997)

As the numbers show in Table 10.1, humans enjoy many different services from water-related ecosystems in addition to water supply. Note, for example, that one hectare of wetlands can generate almost \$4200 per year in waste treatment services. While this evaluation was certainly preliminary at the time it was produced, it conveys a clear idea about the costs and damages that water scarcity can provoke. The mere recognition of many of the identified services valuable for society has huge

implications for drought policy design and implementation. Chief among this is the fact that many of these services have public nature features, which means that they are non-rival and non-exclusive goods. As scientists have learned to identify and value them, water policy must take into account and ensure that decisions are compromised among both productive and non-productive services (National Research Council, 2004).

Water supply reliability, as a service that transcends use benefits, can also be considered a public good. In general, supply reliability cannot be priced, unless options contracts or some other form of risk-transfer mechanisms are implemented. For this reason, reducing water use in times of shortage is generally not stimulated via pricing mechanisms, but rather with command-and-control and rationing mechanisms. However, as we will review below, pricing mechanisms can contribute indirectly to increase supply reliability by reducing water consumption and lowering the probability of shortages.

For the purposes of the instruments we will be reviewing here, it is important to highlight the limited scope and potential of economic instruments in targeting drought's direct effects on environmental services of public good nature, including supply reliability or the management of shortages. Yet, in some of the cases we will be reviewing below there are indirect benefits attached to the protection of ecosystems on which key environmental services are based. We wish to state from the outset that environmental services, inasmuch as they are influenced by droughts, are primarily supported by command and control policies and not by economic instruments. This explains why the chapter does not pay specific attention to them.

## **Types of Droughts and Categories of Economic Instruments**

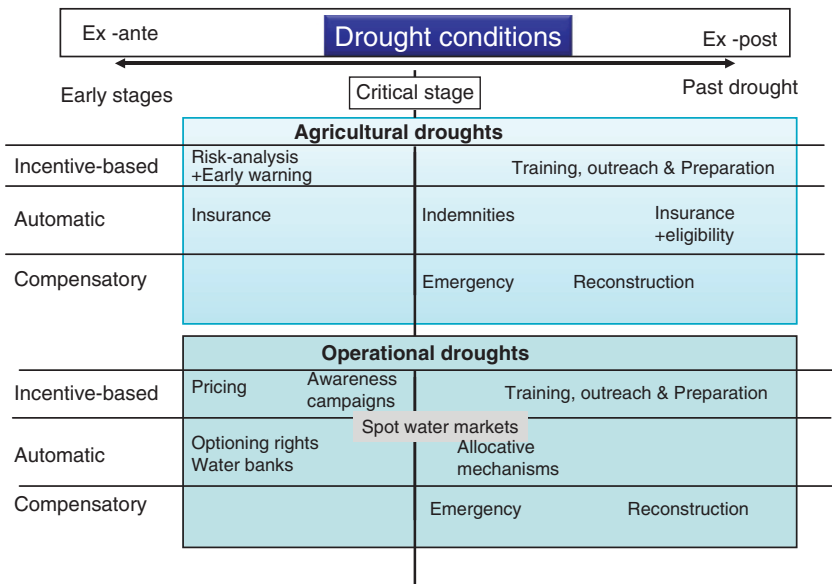
There are numerous definitions of droughts (Vogt and Somma, 2000). For the purpose of this chapter, we will only focus on two large categories, namely, agricultural droughts and operational droughts. Other chapters of this book deal with other types of droughts and certainly policies to prepare and plan for them. Agricultural droughts occur when soil moisture is below normal levels. Water that can be used by plants has been coined 'green water'. Of course, 'green water' scarcity has multiple manifestations, in addition to those pertaining to range and rain-fed agriculture.

In the same vein, operational droughts, also called hydrological droughts, ensure when available resources are insufficient to meet normal demands, including the protection of aquatic ecosystems. Operational droughts are situations of abnormally low levels of 'blue' water, which refers to the amount of water in lakes, rivers, reservoirs and accessible aquifers. The root of these situations is not only from persistent periods of abnormally low precipitation, but also from the criteria with which reservoirs are generally operated (Iglesias et al., 2007).

The connection between agricultural and operational droughts is obvious, as both are caused by prolonged periods of abnormally low precipitation, and indirectly by higher temperatures. But the set of menus with economic instruments to reduce

social risk and vulnerability to both types of droughts is entirely different. This marked difference is especially important in Semi-arid and Mediterranean contexts.

The policies this chapter reviews are depicted in the following conceptual graph (Fig. 10.1). The following ideas are represented in the graph. First is the timing of the application of instruments with respect to the onset of droughts. There are ex – ante instruments which are meant to reduce the risk or uncertainty by taking action in advance in order to anticipate the impacts of drought. There are also ex –post instruments, which can be better developed, applied or enforced right after the most severe situation is finished. Finally there are instruments that are meant to operate when the worst situation prevails.



**Fig. 10.1** Conceptual representation of economic instruments to face drought risks

We are aware of two limitations of this conceptual approach. First, there is uncertainty about the severity and duration of droughts, so no one can be sure about the precise stage in which a given situation is to be qualified. And yet, this uncertainty can be evaluated in terms of probabilities and likely effects. Secondly, the difference between ex –ante and ex –post approaches is equally ambiguous, because of the cyclical nature of droughts. With ex –post, we refer primarily to instruments that help prepare and convey learning messages about drought events. With ex –ante, we refer to instruments that reduce the vulnerability to droughts and lay down the institutional framework for the eventual practical application of risk-sharing mechanism.

There is another criterion to differentiate economic instruments. Figure 10.1 identifies ‘incentive-based’, ‘automatic’ and ‘compensatory’ instruments. Incentives are meant to send scarcity signals, promote technological change and in general

reduce the physical water-base of society and the economy. Automatic instruments are those triggered by pre-established conditions and enable the exchange of risks, rights or services between agents whose livelihood, activity or well-being depend on water availability. Compensatory instruments provide relief or reconstruction payments or financial support to those affected by droughts.

## **Economic Instruments for Efficient Risk Sharing and Preparation for Droughts**

Drought risks can be efficiently shared in the economy. Risk sharing includes numerous forms and strategies to distribute the burden of drought effects in the most effective manner. When risk-sharing instruments are in place, firms, entrepreneurs and even consumers can pursue their objectives knowing that they can transfer their risks to someone else or find coverage for those in the economy. Some of these risks can be handled by private markets or shared among the agents themselves, and some others would ultimately fall on the government. In a well-functioning economy, one in which markets react flexibly to the scarcity or abundance of goods, agents are more equipped to deal with many of the risks characterised by known probabilities. This is part of what economic instruments can contribute to more society preparation. And explains the tremendous difficulties of developing countries to face natural risks, such as droughts and other hazards.

With the conceptual framework sketched in Fig. 10.1 in mind, we now review the instruments that deserve more attention because of practical experience, literature findings and hypothesized potential.

### ***Instruments to Cope with Meteorological and Agricultural Drought***

Traditionally, farmers have developed some informal strategies to cope with weather risks by actions taken before (ex-ante) or after (ex-post) the risk event occurs. Those strategies include changing labour allocations, varying cropping practices, and conservation tillage that protect soil moisture. Recent experiences have demonstrated that these weather risk management strategies are costly and inefficient because they have important shortfalls resulting in negative implications for economic and social development (Hess et al., 2002, Anderson, 2006).

In developing countries, farmers have little access to credit markets and agricultural insurance. Private insurance markets and credit markets provide at best partial coverage but fail due to poor contract enforcement mechanisms, information asymmetries, high transaction costs and covariate risk exposure (Barnett et al., 2005). These market failures imply a limited scope for crop insurance, a low number of insurers, adverse selection of farmers that take up insurances and finally, moral hazard problems. The failure of formal and informal risk management mechanisms implies disadvantages to farmers in dealing with numerous other risk sources deriving

from markets, policies and institutions implying high production costs (Siegel and Alwang, 1999). Even in developed countries, compensation for drought effects makes up a large proportion of the total ad-hoc and relief payments to farmers (European Commission, 2007). This suggests that more could be done to facilitate risk sharing or risk-transfer using privately developed instruments, instead of relying on taxpayers and government support.

Since early-warning systems and risk-analyses are covered in other chapters of this book, we focus on 'automatic instruments' and 'compensatory schemes'.

Crop insurance is the most obvious form of an automatic instrument. In general two types of farm insurance covering drought risks can be identified. The traditional family of insurance is defined by the coverage, crop conditions and a loss adjustment procedure. Yield losses due to insufficient soil moisture are thus indemnifiable. Losses are either evaluated for a given agricultural demarcation and applied as such to all subscribing farmers included, or determined in situ farm by farm. Spain and the US have experimented with this type of insurance for decades, with moderate success (Cafiero et al., 2005). In Spain, about 4 to 5 million hectares (45% of the eligible area) of winter cereals and other arable crops are insured against yield losses caused by droughts or other climatic effects.

More recently, new formats of drought insurance have been launched in a number of countries, both developed and developing. They are based on drought indices and are often referred to as 'parametric insurance'. Examples of these insurance schemes are Index-based risk transfer products (IBRTPs) or Weather Index Insurance (WRW, World Bank, Morocco). The common feature of both is that they are designed in a simpler contract than those required for yield insurance. The key innovation of such contracts is that the insurance is linked to the underlying systemic risk (i.e., low rainfall), defined as an index and recorded at a regional or local level. The insurance scheme transfers covariate risk out of the region or country into international financial markets, previous transforming weather risk into weather derivatives.

Wu and Wilhite (2004) have developed an operational model framework to assess agricultural drought risk by establishing a predictable relationship between some drought indices such as SPI or Crops Specifics Drought index and crop yields. This kind of modelling provides information in a timely manner about potential agricultural drought risk on dry land crop yields to decision makers ranging from agricultural producers to policy makers from local to national level. This operational model would be the basic framework for a formal contract based on weather risk markets which is able to offer yield assistance to farmers.

What has been named 'parametric' or 'index' insurance is just a one way of creating contracts that underlie the risk of experiencing long periods of low precipitation. A few countries, including Morocco and some Sub-Saharan countries, have developed insurance policies that operate as call option contracts. Others, including Spain, Canada, US and France developed 'vegetation index drought insurance' which pay indemnities if the index, based on remote sensing, falls below a certain level. The European Commission has evaluated the cost of setting up similar technologies for the EU as a whole, reaching figures within a reasonable range (European Commission, 2007).

Both parametric insurance based on accumulated precipitation and insurance based on vegetation indices have allowed France, Spain and the US to integrate in their drought planning a system that creates automatic triggers for compensation. The major appeal of such instruments is that a good part of those agents vulnerable to drought events can find protection against them. In the case of Spain or France, droughts account for the highest income losses that both countries can experience. In France, about 50% of the €75 mio./year paid by the *Fond Calamités* is related to drought costs (Garrido and Bielza, 2007). In the US, index insurance based on vegetation indices has been available on 40 mill acres since 2006. Its unique feature is that producers may choose to insure only those acres that are important to their grazing program or hay operation, and are not required to insure the acreage for the entire crop year. There have been a number of proposals in this line:

- Water table, rainfall and droughts in India (Agarwal, 2002).
- Rainfall indices in Morocco (Skees et al., 2001).
- Rainfall indices in Romania (Hou et al., 2004).

Compensatory schemes are generally ad-hoc relief programmes. In the EU, ad-hoc payments are more frequently used than any form of insurance to grant compensation to farmers (European Commission, 2007). Common avenues of compensation are tax relief, support for input substitution for livestock growers relying on pastures, and many diverse forms of financial support to eligible farmers. This book reviews some programmes as they are applied around the Mediterranean countries.

In countries where agricultural insurance is growing or fully established, eligibility for disaster assistance is increasingly being conditioned on having purchased at least basic coverage insurance. By these means, disaster assistance, no matter in what format it is delivered, is linked to pro-active measures which, in the case of France, increase the contributions to the disaster funds, via taxes. Furthermore, in France larger insurance coverage implies eligibility of greater aids in case of disaster resulting from non-insurable risks. In Spain, aids for farmers hit by severe droughts were conditioned on the commitment to purchase drought insurance for the following three years (Garrido and Bielza, 2007). In addition, in Spain risks for which insurance policies are offered cannot be compensated with ad-hoc relief funds. The European Union requires that, starting in 2010, farmers' eligibility to aid measures shall be conditioned on their contracting minimum coverages of crop insurance (EC, 2006).

### ***Instruments to Cope and Prepare for Operational Droughts***

Presently, the context in which water allocation evolves in the Mediterranean basins is characterized by overall scarcity and by increasingly uncertain availability. Even in highly controlled basins, many users are subject to considerable uncertainty regarding their water supply. In many Mediterranean basins, farmers' annual water allotment is highly variable so agricultural producers generally face some uncertainty



about the final allotment (Calatrava and Garrido, 2005a, Iglesias et al., 2003). In the case of the urban sector, water supply reliability is one of the major worries of the urban water authorities. Actually, urban water utilities are designed to meet demand during drought records or the most severe actual hydrological event on record. Risk analysis and evaluation are becoming essential components at all levels of water management, from retail supply services to large-scale basin management (Hashimoto et al., 1982, Iglesias et al., 2006).

In contexts where there is large artificial and natural storage capacity, water scarcity risks are endogenous to management institutional and practical criteria. Actual demands and allocations have been shown to influence the chances of experience water shortages (Giansante et al., 2002, Lise et al., 2001). Just as we did with agricultural droughts, we turn to the economic instruments to cope and prepare for operational droughts.

We have identified four instruments in Fig. 10.1 under this category: 'water pricing', 'awareness campaigns', 'spot water markets' and 'training, outreach and preparation'. The latter is covered in other chapters of this volume, so we will focus only on water pricing and markets. Note also that markets are centered on the borderline between the groups of incentive-based and automatic instruments.

### **Pricing Mechanisms**

Pricing mechanisms can be used to address scarce water supplies. Municipal water utilities used to face drought conditions imposing a temporary drought surcharge to achieve conservation goals. Sometimes this surcharge is meant to recoup the costs of extraordinary measures put in place to respond to water scarcity. In the case of irrigation water management, there are many ways to address scarce water supplies by water pricing, like applying higher marginal cost prices during seasonal shortage to ration all the water demand. An efficient water pricing mechanism implies that prices would rise to reflect the relative scarcity value of water supply. But there are several limitations to apply marginal cost pricing related to difficulties in defining the marginal cost itself.

Water tariffs could be applied successfully in the long term but can be less effective for short-term demand reduction. In the first case, when a new water tariff is being designed, it must consider the cost of all water schemes (capital cost of dams and waterworks) and consequently the average cost of water to consumers. Also pricing schemes must consider the reliability of supply during drought in order to minimize the economic loss due to restrictions. Those imply that operational policy for reservoirs may be designed to enable water to be conserved during drought and, as a consequence must be internalized in the water tariff system. In the short-term drought management by means of tariffs raise problems of time lags. The establishment and promulgation of punitive tariffs to meet certain requirement may require months before the tariff is charged, detected and evaluated by consumers who will then change their consumption, but possibly not by the amount desired by the price. The use of a two-part tariff method can solve this problem as far as the scarcity cost is covered by a fixed charge and higher consumptions are penalized by a volumetric



part. Quota allotments are often included in the volumetric part of the tariff by charging the water volume exceeding the amount of quota. In this way quota systems coordinated with water pricing systems avoid inequity issues (Rieu, 2006).

### **Awareness Campaigns**

Evidence from several campaigns shows that awareness building can effectively reduce water demand. Seen from an economic point of view, campaigns are effective means to change the preferences of consumers and in turn their behavior. For example, in Saragossa (Spain) large water conservation awareness campaigns made it unnecessary to raise the level of reservoir as had been planned earlier.

Persuasion campaigns for demand management are mostly effective in times of drought or water shortages. There are many examples of improvement of drought exposure as a consequence of the awareness campaign. Canal de Isabel II, the water company, has reduced the water consumption in Madrid and surrounding cities (5.5 mill) by 10–12% at a cost in terms of media publicity of 15 million euro. The savings ratio may be in the range of 0.3 €/m<sup>3</sup>, which is quite low considering the risk of entering into serious water shortage conditions. In these cases the immediate need is obvious and there is high motivation in the community to conserve water. However, the success of awareness campaigns depends on developing the persuasion model in a scientific and systematic way. Effective water conservation campaigns need to research behavioral change models systematically not only during drought periods (Syme et al., 2000).

### **Water Markets**

Exchanges in water markets are widespread economic instruments that have been developed in the past decades in mature water economies (California, New Mexico, Australia, Spain, Chile . . .). But it has also been recognized that the effectiveness of water trading is explicitly influenced by various uncertainties existing in water use systems (Luo et al., 2007, Calatrava and Garrido, 2005b). This uncertain context implies that water markets exchanges among farmers usually take place when water allotments are known but the positioning of each exchanging party is partly subordinated to decisions taken under uncertainty (Calatrava and Garrido, 2005a). Also, water-trading effectiveness is sensitive to trading costs, the exchanges failing when the cost is too high (Easter et al., 1998, Luo et al., 2007). Trading costs are directly related with uncertainty of water available. However with sufficient training and practice, markets can become a commonly used instrument to face supply instability.

Reallocation of water resources through voluntary water markets generates substantial gains for economic agents especially when supply is reduced by the occurrence of drought. The purpose of reducing risk through water stabilization is better achieved through annual spot markets than permanent water rights. In the latter case, risk is being shared inefficiently between seller and buyer, who hold a riskier position, as he would need to acquire an unknown surplus of water during drought

years. On the contrary annual spot markets allow for a more efficient distribution of supply risks among the exchanging parties.

Another important issue related with sharing risk by means of a water market is the definition of formal water trading rules. Calatrava and Garrido (2006) propose a redefinition of informal priority rights into formal water rights as a way to reward risk-taking water users and increase total collective output. In this context expectations that markets can emerge spontaneously from a decentralized negotiation process among farmers themselves may be too optimistic. In this sense the role of institutions like basin agencies is quite important in establishing criterion to distribute available resources among all right-members. As a consequence, water markets are allowed to work effectively and reliably, thus reducing society's drought vulnerability.

In contexts where the frequency of droughts augments, water markets may need other water policy requirements to ensure that water markets can effectively move water to higher value users during drought periods. Often it is necessary to develop optimal conditions to activate previously unused water entitlements. For Bjornlund and Rossini (2005), more sophisticated markets and instruments need to be developed to ensure that these constant redistributions of entitlements and seasonal allocations can take place quickly and at low transactions costs. For this aim, it is necessary to design a long-term, secure and well-defined water right, and ensure that land and water rights are kept separate. Some times it is even necessary to define rights for storage capacity. In this sense, Iglesias et al. (2003) recommend that, prior to establishing water markets which are complex institutions and not always very active, water institutions should begin by defining special types of water rights which promotes voluntary water saving across seasons. Irrigators facing uncertain water supplies would probably be interested in using the banking option as a strategic response to reduce their vulnerability to drought periods.

### **Risk-Sharing Instruments that Underlie Natural Supply Variations**

The risk of suffering operational droughts can be shared or pooled together with other societal risks. However, designing feasible risk-sharing instruments for operational droughts is a challenging task. This is because water uses are generally inter-connected and there are numerous sources of externalities. It is thus difficult to isolate two water users that can share natural supply risks, following optioning rights or a similar format, without compromising other uses or in-stream services. Formal risk-sharing instruments require agreements to be formulated in such a manner that there might be little room for ambiguities or problems of enforcement. But this rigidity enables the contracting parts to plan ahead and evaluate the resulting risks more rigorously. Most treaties to manage transboundary water resources have these types of risk-sharing components. In Spain, the Tagus-Segura transfer is run with reference to the storage of key reservoirs that dictate when and how much can be transferred at any given time. But very often, political pressure is put on by decision makers to allow for the use of short reserves, as happened in Spain in 1993–95 (Giansante et al., 2002).

Allocation of water resources has to take into account that not only do users demand secure access to water but also a reliable access, that is, water supply reliability. This reliability is not equally valued or demanded by all users. This premise must be taken into account by water institutions in designing new instruments to allocate water resources. That means the water authorities' main objective is not only to assign water use in an efficient way but also the risk derived from uncertain availability of water resources. These instruments also must have the possibility to compensate water right holders when water reallocations are required. A common feature to all instruments analyzed in this section is that they introduce the concept of economic value of water depending on the timing, location and quantity of water demanded. In other words, any institutional program attempting to capture adequately the value of water must be flexible enough to adjust to a range of market conditions (Hurt, 2005).

### **Water Banks**

Centralized water management instruments such as Water Banks diminish the uncertainty because the final equilibrium water price reflects water scarcity and influences irrigators' production decisions. Considering that farmers must take ex-ante decisions before knowing what their actual water allowance will be, markets regulated by water authorities such as water banks diminishes the uncertainty stemming from water availability because farmers may participate in a pre announced water bank. Water banks work effectively and reliably achieving not only a better water allocation but also more efficient tactical responses to face supply uncertainty (Calatrava and Garrido, 2005a).

Experience acquired from 1992 and 1992 Drought Emergency Water Bank in California bring us some lessons for the future development of drought water banks. Israel and Lund (1995) highlight the vital role of water authorities for future adoption and acceptance of water transfer in water management. Water authorities accelerate the use of water transfer, reduce risk and uncertainty involved in water transfer and reduce cost of implementing water transactions.

Success of water banks depends on the integration of water transfers with supply and demand management approaches included in water planning at river basin scale. Environmental, legal and third-party considerations are important in the development and implementation of water banks. For these aims drafting and enforcing binding contracts among various entities is required as well as protecting conserved water as it flows to downstream users (Hurt, 2005). In addition, an educational effort of the water authorities to inform potential buyers and sellers of water rights about the mechanism of water bank is necessary.

### **Optioning Rights**

Supply uncertainty brings out the necessity to seek new allocation instruments that ensure equitable resource access which take into account risk aspects, incorporating them in the planning process (Gómez-Ramos and Garrido, 2004). It is necessary

to develop contracts that are capable of transferring risk as a means for reducing social and economic exposure to drought cycles. They rely on the heterogeneous means of water users for coping with periods of water shortage. Coinciding with the requirements of water rights advanced by Bjornlund and Rossini (2005), an efficient risk sharing mechanism also requires greater flexibility in water rights transfer, so that only some of the risk-related attributes of the water rights can be transferred. Under uncertain water availability, elements such as access security under prefixed conditions or the timely access to acquire scarce resources are essential attributes to plan demands and available resources in risk contexts.

An Option Contract can become an appropriate new instrument to facilitate this kind of exchanges based on specific rights' attributes. Their properties ensure efficient sharing of the risks associated with supply and the market price resulting from exchanges between common users – such as the irrigation sector – and potential water buyers – such as urban suppliers. As a result of these attributes' exchanges, water markets become more active and efficient.

Option Contracts can be the optimal framework to develop a formal long term arrangement that allows urban water authorities to control water rights just to suffice during normal years and to buy additional water allocations during periods of scarcity avoiding high transaction costs due to the necessity to buy in the “greed-of-the-moment” when the authorities have to ‘panic’ buy and the sellers are at an advantage (Bjornlund, 2006). The main drawback is that contracts must account for and detail all eventualities, and the valuation for both parties may become quite complex. For example, external prerequisites associated with the fulfillment of ecological flows in sensitive river tracts may be added to the contract's provisions to reduce third party or environmental effects.

### **Other Automatic Instruments**

A number of studies have proposed the use of derivatives to handle water supply availability, but there are very few real case examples. Rainfall indexes are suggested as proxy to water storage and availability for irrigation in Australia proposed by Skees and Zeuli (1999). Flow derivatives in Mexico are suggested to control for water supply risks by Leiva and Skees 2005.

### **Putting Economic Drought Instruments into Practice**

Many of the instruments reviewed have not inspired practical applications. For one thing, this reflects the daunting task of implementing them in a predictable and reliable manner. Also, it attests for the ironic fact that, although economics is the science of dealing with scarce goods, droughts are not easy handled by economic instruments, however rational it may seem from an academic standpoint. And yet, technology developments and applications enable agencies to have a closer look on how land and water is being used at given moment. Transactions costs of any of the

instruments reviewed above have been lowered to the extent that they are now more cost-effective than letting droughts onset freely.

The literature and the world wide web offers plenty of experiences and evaluations. In this section we evaluate each instrument based on the requirements needed to be applicable and on the balance of advantages and disadvantages.

### *Agricultural and Meteorological Droughts*

Table 10.2 includes the set of economic instruments meant to address agricultural and meteorological droughts. In the final column we add a score indicating whether the instrument's conclusions are robustly based on the available experience and the literature. The main conclusions that emerge from the table can be summarised in the following points:

Yield insurance, as the result of gradual improvements of multiple-peril crop insurance, can be expanded to cover yield losses caused by droughts and other hazards. Yet loss adjustment costs increase substantially the administrative loading of the premia. It is safe to conclude from the literature that, in the absence of subsidies, yield insurance could hardly be profitable. Yield insurance is popular among cereal farmers because they receive indemnities when yield losses occur. Refinements in Spain, US and Canada, and new initiatives in France, show that costs can be reduced when long farmers' records enable insurers to charge the right premium.

The alternative to yield insurance is 'parametric' or 'index' insurance, which is much cheaper to set up and administer. Parametric insurance provides coverage to crops with yields strongly correlated with simple precipitation indices. Based on the initiatives in US, Spain, and France, and experimentally in Ukraine and South Africa, vegetation indices computed from satellite images are used to offer commercial insurance to livestock growers relying on rangeland pastures. Other crops, like fruit, horticultural and even broad field crops are insufficiently covered with parametric insurance, which in turn reduces its appealing to farmers. When precipitation indices are essential for ensuring sufficient food production in developing countries, parametric insurance could be used by donors and FAO to protect against budgetary outlays connected to food security emergencies. Local or regional governments could also use this type insurance to provide financial assistance to the most vulnerable communities.

Compensatory schemes and relief programmes are often used in developed and developing countries. Generally, they are triggered only in cases of severe droughts. Buying insurance is now a prerequisite to become eligible for catastrophic relief in France. Spain precludes drought relief to farmers whose crops are insurable against drought hazards. The EU requires contracting insurance for aid given to farmers after 2010. These examples reflect that ad-hoc payments are difficult to administer, opting to subsidise yield insurance. Innes (2003) shows that ex-ante risk reduction policies can deter farmers that will eventually be in need of ex-post alleviation measures. He goes on to suggest that it would be efficient for governments to pay the riskiest subsidized farmers to finish their operations.

Table 10.2 Economic instruments for agricultural and meteorological droughts

Instrument	Requirements		Advantages	Disadvantages	Robustness/ Reliability of conclusions	
	Legal/ institutional	Economic				
Yield insurance	Sound insurance regulations Private participation	Long records of farmers Loss adjustment procedures	Willingness to pay expensive premia (Doubtful without subsidies)	Protects against drought losses No basis risk	High loading factor Expensive loss adjustment Prone to adverse selection Administrative demanding Very few crops are insurable	Very robust (long experience) Spain and US
Parametric insurance (based on precipitation indices and vegetation indices)	Sound insurance & commercial regulations	Needs long precipitation records meteorological stations Data handling and servicing Challenging for satellite systems	Definition of contracts Out-reach and extension services	Cheap to administer No asymmetric information Fixed and simple premium	Large basis risk Lack of farmers' understanding	Still in early stages: Based on remote sensing and vegetation indices in Spain, France and US Experimentally in Ukraine & South Africa Functioning in Morocco Proposed in India and Mexico Very robust
Compensatory schemes and relief programmes	Ad-hoc legislation and calamities programmes	Evaluation techniques and data recording	Need ad-hoc relief funds Limited access to financial markets	Helps business recovery Allows for targeting groups	Moral hazard Slow reaction processes Very bureaucratic Entirely based on governmental budgets	

## *Hydrological and Operational Droughts*

Many studies have attempted to analyse and compare the suitability of economic instruments based on economic efficient criteria, on effects on third-party and the environment and also considering risk management ability. But this section also tries to afford this task considering the requirements and limitations for its implementation valuing the capacity to allocate water supply reliability. Table 10.3 summarizes the main findings and lessons with regards to the instruments reviewed earlier.

Water prices may reflect water scarcity values but they can hardly reflect the value of supply reliability. In general, water tariffs are not able to convey information about the uncertainty dimension of supply reliability. However, water tariffs indirectly increase water supply reliability, because they provide incentives for self-restraint and more frugal consumption. This adjustment is achieved further if water tariffs are accompanied by awareness campaigns and educational efforts. In this way, applying a water tariff system under ex-ante drought management criteria diminishes drought risks in the long run. In short, water pricing is a robust long-term policy to reduce scarcity risks, but it is not sufficiently flexible to face shortage situations.

Quotas and other rationing mechanisms can avoid inequity problems derived from exclusion of the systems of low-income groups that require at the same time similar levels of reliability as other economic agents. Direct public intervention in allocating scarce resources is fully justified when basic human needs are threatened, or the probability of experiencing such situation goes beyond certain thresholds. We do not advocate the use of economic instruments under such conditions.

Awareness campaigns are necessary instruments not only during drought periods. An effective campaign must be persistent in time because in this way it is able to change consumers' behaviour and preferences. For this aim, it needs systematically monitoring of behavioural change models. Awareness campaigns do not only seek to reduce consumption but also to increase citizens' concern about the value of resources as public goods.

Water markets need sound regulatory frameworks, broad acceptance and transparency to ensure that exchanges occur frictionless. Everyone must accept that during shortages prices can skyrocket, choking the demand of non-competitive bidders. If this situation is to be avoided, market bounds and limits must be pre-announced beforehand. But then rationing mechanisms would eventually become unavoidable, encumbering right-holders that may have hoarded resources to sell them at high prices.

Part of the problems of completely liberalised allocation mechanisms can be overcome with centralized water management instruments like Water Banks. With sufficient learning and experience, water banks may become a real risk management instrument, creating an automatic response triggered by pre-established conditions captured by the regulatory framework. These exchange mechanisms may assist basin authorities to reallocate water resources, to create awareness of the resource cost and to reduce drought effects. The main challenge of Water Banks is to adjust water demand and supply in a timely manner, facilitating water exchanges. As publicly run water banks can easily be monitored and scrutinised, they are more transparent and enjoy greater acceptance.

Table 10.3 Economic instruments for operational/hydrological droughts

Instrument	Requirements			Advantages	Disadvantages	Robustness/ reliability of conclusions
	Legal/ institutional	Technological	Economic			
Water tariffs (including punitive tariffs)	Water law and pricing policies Water rights	Metering devices	Capacity to pay	Incentives to save water Lower basins' demand	Insufficient to face water shortages Not flexible enough to approach market clearing prices Not applicable for groundwater	Very robust
Quota allotment	Enforced water rights Implementation bodies and decisions processes	Metering devices	Sometimes includes compensatory packages	Based on statutes Taken by public agencies Users' participation Sense of equity Easy to prioritise	Inflexibility Economic inefficiency Inadequate to reward risk taking and more valuable crops Poor as a risk management instrument	Very robust
Water shortage awareness campaigns	A well defined set of agencies' responsibilities	Adequate sociological expertise	Availability of funds	Lower consumption Increases awareness Changes preferences	Low persistence effects Low savings per € of expenditure	Varies across case studies
Spot water markets	Water rights Market regulation Reliable institutions	Transportation, storage and conveyance facilities Metering devices	Ability to create and distribute market signals Mature water economies Needs proper water tariffs on the 1 <sup>st</sup> place	Demand and supply equilibrium Market clearing prices Market as a risk management instrument	Transaction costs Third-party effects and externalities Misalignment with social/ environmental priorities Not popular among farmers Not very liquid/ active	Robust
Water banks/ optioning rights	Same as spot water markets, plus Ad-hoc agency to run/ monitor exchanges	Storage and conveyance facilities	Preparation Understanding rules by agents Mature water economies	Good risk management instrument Can be combined with optioning rights Agencies set prices or market rules	Institutionally demanding Needs storage Potentially thin	Based on very few examples



Option contracts, be they connected or unconnected with water banks, can facilitate the transfer of water rights in prearranged terms, before drought periods begin. This is an efficient way to transfer supply risks, because it is not necessarily accompanied with actual water exchanges. Gómez-Ramos and Garrido (2004) and Michelsen and Young (1993), among others, show that option contracts are much more efficient than erecting new dams to add more supply stability. Both option contracts and water banks are capable to transfer risk as a means for reducing social and economic exposure to droughts.

## Conclusions and Practical Lessons

Droughts have many social implications, some in the public domain and some manifested at the household and firm level. Economic instruments are meant to reduce the probability of experiencing shortages, increase the efficiency of resource allocation and enable risk-transfer mechanisms that increase social welfare. This chapter has reviewed some of the most commonly used economic instruments applied to manage both agricultural and operational droughts.

Three main conclusions summarise this chapter. First, drought risks can be defined in such a manner that allows for the development of contracts that enable risk transfer in the economy. This principle can be applicable both in ideal conditions and suboptimal conditions. More information, technology, data and degree of law enforcement just makes the multiplication of contract options and market activity easier. In their absence, countries and regions can still develop simpler instruments that can transfer the most crucial risks to agents that can handle them (the State could be one). When agents, households and firms can buy risk protection at a reasonable cost, society and the economy win. Drought insurance and optioning rights are the best examples to find inspiration for policy action and research.

Second, droughts have public good consequences that predicate government action, no matter how inefficient command and control and public allocation may seem. Meeting households' basic needs, protecting essential ecosystems and ensuring minimum levels of economic activity should be top public priorities. By no means does this second conclusion contradict the first. They reinforce each other to the extent that these key objectives can be partly accomplished by a well-functioning market economy.

Third, all economic instruments can be placed along an imaginary discretionary-automatic axis. Discretion generally requires flexibility but cannot avoid the costs of improvisation. At the policy level, targeting will be difficult and rent seeking may erode the efficiency of transfer of support. Automatic instruments are triggered by objectively measured means and reach the target much quicker. Conditions or prerequisites can be embedded in them, allowing for better screening and more accurate targeting. Yet combating drought risks needs discretionary as well as automatic instruments.

## References

- Agarwal A (2002) A New Approach & Model for Weather Derivative Instrument based on Water Table for Floods, Droughts and Rainfall. *Finance India*, 16(3):877–914.
- Anderson J (2006) Drought: Economic Consequences and Policies for Mitigation Global Overview. Paper presented at the 26th Conference of the International Association of Agricultural Economists, Gold Coast, Australia, pp. 14–18 August 2006.
- Barnett B J, Black J R, Hu Y, Skees J R (2005) Is areas yield insurance competitive with farm yield insurance. *Journal of Agricultural and Resources Economics*, 30:285–301.
- Bjornlund H (2006) A framework for the next generation of water market policies. National Water Initiative. Australia.
- Bjornlund H and Rossini P (2005) Fundamentals determining process and activities in the market for water allocations. *Water Resources Development*, 21(2):355–369.
- Cafiero C, Capitanio F, Cioffi A, Coppola A (2005) Risks and Crisis Management in Agriculture. Study. Agriculture and Rural Development, Policy Department Structural and Cohesion Policies, Directorate General Internal Policies of the Union, European Parliament.
- Calatrava J, Garrido A (2006) Difficulties in adopting formal water trading rules within user' association. *Journal of economic issues*, XL(1):27–42.
- Calatrava J, Garrido A (2005a) Modelling water markets under uncertain water supply. *European Review of Agricultural Economics*, 32(2):119–142.
- Calatrava J, Garrido A (2005b) Spot markets and risk in water supply. *Agricultural economics*, 33:131–143.
- Costanza R R, de Groot R (1997) The value of the world's ecosystem services and natural capital. *Nature*, 387:253–260.
- Easter K W, Rosegrant M, Dinar A (eds.) (1998) *Markets for Water – Potential and Performance*. Kluwer Academic Publishers, New York.
- European Commission (2007) *Agricultural Insurance schemes*. Brussels.
- European Commission (2006) COMMISSION REGULATION (EC) No 1857/2006 of 15 December 2006 on the application of Articles 87 and 88 of the Treaty to State aid to small and medium-sized enterprises active in the production of agricultural products and amending. Regulation (EC) No 70/2001. Brussels.
- Garrido A, Bielza M (2007) Risk management instruments in the EU: lessons from the past and prospective for the future. Working Document. Madrid.
- Gómez-Ramos A, Garrido A (2004) Formal risk-sharing mechanisms to allocate uncertain water resources: the case of option contracts. *Water Resources Research*, 40(12):W12302. doi: 10.1029/2004ER003340.
- Giansante C, Babiano M, Aguilar M, Garrido A, Gómez E A, Iglesias E, Lise W, Moral, L (2002) Institutional adaptation to changing risk of water scarcity in the lower Guadalquivir Basin. *Natural Resources Journal*, 42(3):521–563. The University of new México, School of Law.
- Hashimoto T, Stedinger J R, Loucks D P (1982) Reliability, resilience and vulnerability criteria for water resources systems performance evaluation. *Water Resources Research*, 18(1):14–20.
- Hess U, Rithter K, Stoppa A (2002) Weather risk management and agri-business in developing countries. In R S Dischel (eds). *Climate risk and the weather markets*. London Risk Books, London.
- Hou Jiang, Jerry Skees and Venkat Veeramani (2004). Potential Analysis of Rainfall-Indexed Insurance in Romania. American Agricultural Economics Association Meetings, Denver, Colorado. July 30–August 5.
- Hurt C E (2005) Risk management instrument for water reallocation [www.card.iastate.edu](http://www.card.iastate.edu). Consulted 1th April, 2007.
- Iglesias E, Garrido A, Gómez-Ramos (2007) Evaluations drought management index to evaluate water institutions' performance under uncertainty. *The Australian Journal of Agricultural and Resources Economics*, 51:17–38.

- Iglesias E, Garrido A, Gómez-Ramos A (2003) Evaluation of drought management in irrigated area. *Agricultural Economics*, 29:211–229.
- Iglesias A, Garrote L, Flores F, Moneo M (2006) Challenges to manage the risk of water scarcity and climate change in the Mediterranean. *Water Resources Management*, 21(5):775–788.
- Innes R (2003) Crop insurance in a political economy: an alternative perspective on agricultural policy. *American Journal of Agricultural Economics*, 85:318–35.
- Israel M, Lund J R (1995) Recent California water transfer: implication for water management. *Natural Resources Journal*, 35:1–32.
- Michelsen A M, Young R A (1993) Optioning agriculture water rights for urban water supplies during drought. *American Journal of Agricultural Economics*, 75:1010–1020.
- National Research Council (2004) *Valuing Ecosystem Services*. National Academies Press Publications, Washington, D.C.
- Leiva A J, Skees J J (2005) Managing irrigation risk with inflow-based derivatives: the case of Río Mayo irrigation district in Sonora, Mexico. Selected paper presented at AAEA Annual Meetings, Providence, Rhode Island, July 24–27.
- Lise W, Garrido A, Iglesias E (2001) A game model of farmers' demand for irrigations water from reservoir in Southern Spain. *Risk, Decision and Policy*, 6:167–185.
- Luo B, Huang G H, Zou Y, Yin Y (2007) Towards quantifying the effectiveness of water trading under uncertainty. *Journal of environmental management*, 83:181–190.
- Rieu T (2006) Water pricing for agriculture between cost recovery and water conservation: where do we stand in France? In OECD ed. *Water and agriculture: sustainability, markets and policies*. OECD report. 2006. Paris.
- Siegel P B, Alwang J (1999) An asset-based approach to social risk management: A conceptual framework. *Social Protection Discussion Paper No. 9926*. The World Bank: Washington, D.C.
- Skees J (1999) Opportunities to improve efficiency in risk sharing using capital markets. *American Journal of Agricultural Economics*, 81(5):1228–1233.
- Skees, J.R. and K. Zeuli. (1999). *Using Capital Markets to Motivate Water Market Efficiency*. Dept. Agr. Econ., Staff Paper No. 396, University of Kentucky.
- Skees, Jerry, Stephanie Gober, Panos Varangis, Rodney Lester, Vijay Kalavakonda (2001) *Developing Rainfall based Index Insurance in Morocco*. Policy Research Working Paper No. 2577. The World Bank. April.
- Syme G J, Nancarrow B E, Seligman C, (2000) The evaluation of information campaigns to promote voluntary household water conservation. *Evaluation Review*, 24(6):539–578.
- Vogt J, Somma F (2000) *Drought and Drought Mitigation in Europe*. Kluwer Academic Publishers. The Netherlands. pp 197–20.
- Wu H, Wilhite D (2004), An operational agricultural drought risk assessment model for Nebraska, USA. *Natural Hazards*, 33:1–21.

# Chapter 11

## Methods for Evaluating Social Vulnerability to Drought

Ana Iglesias, Marta Moneo and Sonia Quiroga

**Abstract** Social vulnerability to drought is complex and it is reflected by society's capacity to anticipate, cope with and respond. Here we estimate these aspects of social vulnerability, evaluating the natural resource structure, the economic capacity, the human and civic resources, and aspects of agricultural innovation. These factors are components of a vulnerability index and they can be weighted appropriately in computing the final value of the index. In this chapter we present the results of the index under two valuation scenarios. For Scenario 1 all components are valued equally. For Scenario 2 the human resources component is given 50% of the weight, the economic and natural resource components are given 20% of the weight each, and the agricultural technology is given 10% of the weight. This reflects the assumption that a society with institutional capacity and coordination and mechanisms for public participation is less vulnerable to drought and that agriculture is only one of the sectors affected by drought. The vulnerability index establishes robust conclusions since the range of values across countries does not change with the assumptions under the two scenarios.

### Introduction

The objective of the vulnerability assessment is to identify underlying causes of risk derived from inadequate structures, management, and technology, or by economic, environmental, and social factors. Vulnerability refers to the characteristics of a group in terms of its capacity to anticipate, cope with, resist and recover from the impact of drought. Vulnerability assessment is to identify characteristics of the systems that modify the level of risk derived from inadequate structures, management, and technology, or by economic, environmental, and social factors.

---

A. Iglesias (✉)  
Department of Agricultural Economics and Social Sciences,  
Universidad Politécnica de Madrid (UPM), Spain  
e-mail: ana.iglesias@upm.es

Yohe and Tol (2002) proposed a method for developing indicators for social and economic coping capacity in the context of climate change. Later, a simple index to quantify adaptive capacity was used by Ionescu et al. (2008) including only GDP, literacy rate, and the labour participation rate of women. Yohe et al. (2006) used the Vulnerability-Resilience Indicator Prototype (VRIP) developed by Brenkert and Malone (2005) as a proxy to adaptive capacity index, considering the capacity to adapt to environmental change as implicit in the vulnerability assessment.

Iglesias et al. (2007b) develop an Adaptive Capacity index (AC index) with three major components that characterize the economic capacity, human and civic resources, and agricultural innovation. A similar approach has been taken in the context of drought (Moneo, 2007). The approach is flexible and can be applied to managed and natural ecosystems as well as to socio-economic systems.

The overall vulnerability is determined by combining: vulnerability derived from the direct exposure to drought, and vulnerability to drought derived from social and economic aspects. For example, given a specific farm, the vulnerability is directly related to the intensity of the drought event. In contrast, given a defined drought event, the most vulnerable farming system is the one that has less social and economic resiliency; in general marginal and poor farming systems suffer the largest consequences of drought.

## **Vulnerability Directly Related to Drought**

This component analyses the vulnerability directly related to the exposure to drought in the present. The underlying causes of risk may be related to structural problems, such as lack of adequate hydraulic infrastructures or technology, and also to management, economic and social features that increase the vulnerability of the region, watershed or water supply system under analysis. For example, the direct impact of precipitation deficiencies may be a reduction of crop yields. The underlying cause of this vulnerability, however, may be that the farmers did not use drought-resistant seeds, either because they did not believe in their usefulness; their costs were too high, or because of some commitment to cultural beliefs.

Another example could be farm foreclosure related to drought. The underlying cause of this vulnerability could be many things, such as small farm size because of historical land appropriation policies, lack of credit for diversification options, farming on marginal lands, limited knowledge of possible farming options, a lack of local industry for off-farm supplemental income, or government policies.

## **An Index to Evaluate Socio-Economic Vulnerability to Drought**

An index that estimates social vulnerability to drought is developed and calculated in selected Mediterranean countries. The methodology is appropriate to integrate both quantitative and qualitative characterizations of vulnerability – this permits the

involvement of stakeholders in the process. The index can be applied locally or spatially and with different aggregation levels of the input data. The intermediate components can be evaluated independently, allowing comprehensive interpretation of the strengths and weaknesses of each system.

The sequential steps taken for the quantification of the vulnerability index are: (a) select proxy variables for factors that contribute to the vulnerability; (b) normalize the proxy variables with respect to some common baseline; (c) combine the sub-component proxy variables within each vulnerability category by weighted averages; and (d) quantify vulnerability as the weighted average of the components.

### *Selection of Variables*

The socio-economic vulnerability components (Table 11.1) and the variables included were selected because: (1) data is readily available and an example may be computed to assist stakeholders in defining the sensitivity of the system; and (2) the variables are drought-scenario dependent and geographically explicit. The vulnerability index may be used to understand the sensitivity of the system and to assist in the selection of measures to be adopted. For example, improving the efficiency of agricultural water use, decreasing population under the poverty line, increasing adult literacy rate, and increasing agricultural technology, are measures that result in an overall vulnerability decrease.

The components of socio-economic vulnerability and the representative variables that have been used to characterize it are provided in Table 11.1. A final indicator for each category of exposure may be computed as the weighted average of all the representative variables within the category.

**Table 11.1** Components of socio-economic vulnerability and representative variables that can be used to characterize the vulnerable groups

Components	Proxy variables
Natural component	Agricultural water use (%)
	Total water use (% of renewable)
	Average precipitation 61–90 (mm/year)
	Area salinized by irrigation (ha)
	Irrigated area (% of cropland)
Economic capacity	Population density
	GDP millions US\$
	GDP per capita US\$
	Agricultural value added/GDP %
	Energy use (kg oil equivalent per capita)
Human and civic resources	Population below poverty line (% population with less than 1 US\$/day)
	Agricultural employment (% of total)
	Adult literacy rate (% of total)
	Life expectancy at birth (years)
	Population without access to improved water (% of total)
Agricultural innovation	Fertilizer consumption (100 gr/ha of arable land)
	Agricultural machinery (tractors per 100 km <sup>2</sup> of arable land)

### ***Normalization to Some Common Baseline***

The variables in Table 11.1 were normalized between the different countries in order to be able to more directly compare the results. The standardization has been made with respect to the maximum value of each variable across the countries to combine within the categories and guarantee the index being a percent rate. The sub-component proxy variables are combined within each category by using either a geometric mean (MOSS et al., 2000) or a weighted mean with weights inversely proportional to the impact uncertainty level.

### ***Combination of the Sub-Components***

Sub-component proxy variables can be combined within each category by using either a geometric mean or a weighted mean with weights inversely proportional to the impact uncertainty level. This study considers the weights separately for each of the categories, as in Iglesias et al. (2007b), in order to evaluate them independently. This allows evaluation of the strengths and weaknesses of each component of the total vulnerability index within each country. It should be pointed out that the vulnerability components have an inverse interpretation to the adaptation capacity components.

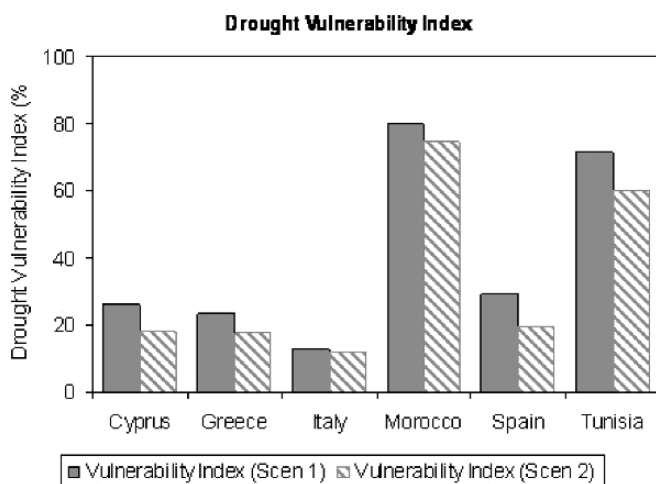
### ***Quantifying Vulnerability***

The total vulnerability index has been quantified as the weighted average of each of the four components. The four components of the index and the total computation are shown on Table 11.2 and Fig. 11.1 also illustrates the drought vulnerability index. The scores of the vulnerability index range on a scale of 0 to 100, the least vulnerable being 0 and the most vulnerable 100. The total index is generated as the average of all components. The final value of the index depends on the valuation of each component. Here we present the results of the index under two valuation scenarios. In Scenario 1 all components are valued equally. In Scenario 2 the human resources component is given 50% of the weight, the economic and natural resource components are given 20% of the weight each, and the agricultural technology is given 10% of the weight. This reflects the assumption that a society with institutional capacity and coordination and the ability to incorporate public participation in the process is less vulnerable to drought and that agriculture is only one of the sectors affected by drought.

The results of this evaluation led to the identification of actions to minimize risk by reducing the underlying causes (vulnerability). The results contribute to increasing adaptive capacity and developing policy decisions to increase adaptation options. The vulnerability assessment bridges the gap between impact assessment and policy formulation by directing policy attention to underlying causes of

**Table 11.2** Components of the social vulnerability index and total values of the index under two different scenarios of valuation of the vulnerability components. Source of data: FAO 2007, Iglesias and Moneo 2005

Component of the index	Drought vulnerability index (%)					
	Cyprus	Greece	Italy	Morocco	Spain	Tunisia
Renewable natural capital	40	26	36	69	37	70
Economic capacity	34	37	4	96	15	88
Human and Civic Resources	1	5	7	65	7	39
Agricultural innovation	29	26	4	91	57	90
Drought Vulnerability Index (Scenario 1)	26	24	13	80	29	72
Drought Vulnerability Index (Scenario 2)	18	18	12	75	20	60



**Fig. 11.1** Social vulnerability index across MEDROPLAN countries under two different scenarios of valuation of the vulnerability components

vulnerability rather than to its result, the negative impacts, which follow triggering events such as drought (Wilhite, 2005). The vulnerability evaluation helps to define the sensitivity of the systems to external shocks and to identify the most relevant aspects that decrease the level of risk.

## Discussion

Vulnerability to drought in the Mediterranean region may intensify in the future, particularly in association with climate change and the pressures associated with development, increasing populations, water management that is already regulating most available water resources, and agricultural systems that are often not well adapted to local conditions. Evidence for the vulnerability of socio-economic and agricultural



systems in the Mediterranean region can be documented in recent history. For example, water reserves were not able to cope with sustained droughts in the late 1990s in Morocco and Tunisia, causing many irrigation-dependent agricultural systems to cease production. In 2007, the vulnerability of Moroccan agriculture to drought was also quite apparent. In addition, effective measures to cope with long-term drought and water scarcity are limited and difficult to implement because of the variety of the stakeholders involved and the lack of adequate means to negotiate new policies. Climate change projections indicate an increased likelihood of droughts (Kerr, 2005). The combination of long-term change (e.g., warmer average temperatures) and greater extremes (e.g., droughts) can have decisive impacts on the vulnerability of many regions (Arnell, 1999). If drought impacts intensify as a result of climate change, Mediterranean water delivery systems and control may become increasingly unstable and vulnerable (IPCC 2007, Reilly and Schimmelpfennig, 1999, Iglesias et al. 2007a, Burton 1997). Water managers may find planning more difficult and current agricultural water management strategies based on irrigation should be revised.

## References

- Arnell NW (1999) Climate change and global water resources, *Global Environmental Change*, 9(1):S31–S49.
- Brenkert A, Malone E (2005), Modeling vulnerability and resilience to climate change: A case study of India and Indian States. *Climate Change*, 72(1–2):57–102.
- Burton I (1997) Vulnerability and adaptive response in the context of climate and climate change *Climatic Change*, 36:185–196.
- FAO (2007) FAOSTAT and AQUASTAT Database Collections. In Internet: <http://www.fao.org>, Food and Agriculture Organization of the United Nations, Rome. Last visited December 2006.
- Iglesias A, Garrote L, Flores F, Moneo M (2007a) Challenges to manage the risk of water scarcity and climate change in the Mediterranean. *Water Resources Management*, 21(5):775–788.
- Iglesias A, Mougou R, Moneo M (2007b) Adaptation of Mediterranean agriculture to climate change. In: *Key vulnerable regions and climate change*, Battaglini A (ed), European Climate Forum, Germany.
- Iglesias A, Moneo M (eds.) 2005 *Drought Preparedness and Mitigation in the Mediterranean: Analysis of the Organizations and Institutions*. Options Méditerranéennes, Série B, No. 51. Zaragoza: CIHEAM. ISBN: 2-85352-320-9.
- Ionescu C, Klein RJT, Hinkel J, Kumar KSK, Klein R (2008) Towards a formal framework of vulnerability to climate change. *Environmental Modeling and Assessment* (Submitted).
- IPCC (2007) *Climate Change (2007): Impacts, Adaptation and Vulnerability Contribution of Working Group II to the Third Assessment Report of the Intergovernmental Panel on Climate Change* Cambridge University Press, Cambridge.
- Kerr, Richard A (2005) Millennium's Hottest Decade Retains its Title, for Now, *Science* 307, 11 February.
- Moneo M (2007) *Agricultural vulnerability of drought: A comparative study in Morocco and Spain*. IAMZ-CIHEAM, Zaragoza.
- Moss R et al. (2000) *Measuring Vulnerability: A Trial Indicator Set*. Pacific Northwest National Laboratory, Richland, WA, USA.
- Reilly J, Schimmelpfennig D (1999) Agricultural impact assessment, vulnerability, and the scope for adaptation *Climatic Change*, 43:745–788.

- Wilhite DA (2005) Drought and water crisis: Science, technology and management issues. Taylor and Francis, New York.
- Yohe G, Malone E, Brenkert A, Schlesinger M, Meij H, Xing X (2006) Global Distributions of Vulnerability to Climate Change, *Integrated Assessment Journal*, 6:3, 35–44.
- Yohe G, Tol R S J (2002) Indicators for social and economic coping capacity-moving toward a working definition of adaptive capacity. *Global Environmental Change* 12:25–40.

# Chapter 12

## Methods for Social Participation and Conflict Resolution

Ignacio Celaya, Antonio Rodríguez Perea and Xavi Carbonell

**Abstract** Droughts can result in restrictions to water supplies, which cause alarm in towns and cities or wherever they are enforced; a situation the news media never fails to cover with photos of deserts and death disseminated far and wide. It is clear that droughts place hydraulic systems under an extreme amount of strain – especially rivers and aquifers. It is therefore essential to make use of successful experiences to create a new conception of the field. It will however take some time for this to be accepted as the norm, since drought management will continue to generate situations involving conflict between the interests and values of different individuals and groups.

Prevention, negotiation, mediation, arbitration, judicialization and imposition are the successive steps towards solution of the conflict. First steps are preferable than the last ones because normally they lead to more sustainable success.

### The Context and Objectives

Droughts can result in restrictions to water supplies, which cause alarm in towns and cities or wherever they are enforced; a situation the news media never fails to cover with photos of deserts and death disseminated far and wide.

It is clear droughts place hydraulic systems under an extreme amount of strain – especially rivers and aquifers. It is therefore essential to make use of successful experiences to create a new conception of the field. It will however take some time for this to be accepted as the norm, since drought management will continue to generate situations involving conflict between the interests and values of different individuals and groups.

---

I. Celaya (✉)  
Fundación Ecología y Desarrollo, Plaza San Bruno, 9, 50001  
Zaragoza, Spain  
e-mail: [ecodes@ecodes.org](mailto:ecodes@ecodes.org)

Water disputes occur whenever the demand for water cannot be met by the hydrological resources in a particular region or sector. Typically the disputes are related to years of frustration, waiting, conflict, pain and emotion. Solutions therefore require the application of tools and techniques used in the alternative management of conflicts. Climatic change and drought management have made it necessary for us to be imaginative, generous and responsible when taking action.

The goal of any type of alternative conflict management must take into account not only solutions to the water use and management problems, but also the particular characteristics of the conflict so the foundations can be laid to avoid a recurrence of the conflict. Water disputes are a specific type of environmental conflict; they have specific characteristics and affect collectives; they are complex and normally difficult to quantify in economic terms; they take place in the public domain and their resolution has a significant effect on future generations. Disputes can also worsen or be resolved in accordance with temporary changes in the weather, with droughts accentuating and rains reducing the conflict. And all too often during negotiations environmental interests are underrepresented, which results in agreements that have a detrimental affect on non-renewable resources.

One of the bases for the resolution of water disputes is prevention, which feeds off the principles of demand management and the application of which is becoming less and less problematic, especially during droughts. When conflicts do occur, negotiation represents the next stage in the search for a solution. Success often depends on the correct representation of the parties involved. When negotiations fail, the next option for the resolution of the dispute is mediation. Success at this stage still holds the virtue of the potential control over the agreement of the parties involved. If mediation does not work, there is arbitration. This should be the main role of the Water Authorities when agreement is not reached between the parties or when the agreement results in an inadmissible environmental cost. To this end, the Water Authorities should aim to acquire or increase their prestige so as to be recognized by everyone involved. The second from last possibility for the resolution of the water disputes is judicialization. This stage should only be reached when all the previous possibilities for reaching a solution have been exhausted. And the last possibility is imposition. In this case one of the parties imposes their will on another. This is normally a false solution, which is only valid temporarily. History is however replete with experiences of this type.

Strategies for the resolution of water disputes can be classified in three groups: *prevention strategies*, actions aimed at pre-empting the crystallization of the conflict. *Balancing strategies*, when protest or community groups counteract unbalanced perceptions. Lastly, there are *mediation strategies* that are undertaken by individuals either in institutions or otherwise, which bring the parties involved together and create conditions favourable to an agreement.

In short, and as a comparative analysis between a range of experiences, we can conclude that truly participatory water planning is the best tool for the prevention of disputes. The symbolic value of water is underestimated in the majority of cases. Multidisciplinary analyses are not generally undertaken prior to the conflict and the representation of the parties involved should be improved. The role of the water

authorities is fundamental in the avoidance of agreements that contravene the law, scientific principles, or transfer damages to third parties, especially when they are to the detriment of the water resources of the future.

The aim of this chapter is to make use of specific Spanish experiences arising from a situation of conflict (either manifest or dormant) in the context of water management to schematically:

- Describe the features that define this type of conflict.
- Analyse in depth the contributions made by the range of disciplines involved and their complementarity.
- Present the range of approaches to conflict resolution.
- Show the potential of certain tools and techniques for social intervention in water disputes.
- Place the processes observed in the range of experiences in an easily understandable conceptual framework.

## **Water Disputes**

Disputes can be defined in many ways, but all include the lowest common denominator, which is a situation of conflict, but at the same time an opportunity. Conflict in that there is a confrontation of interests, perceptions, and/or attitudes between two or more parties. This confrontation should not be interpreted negatively, since there are positive aspects to conflicts, which allow the development of beneficial outcomes for all the parties involved. Disputes can therefore be viewed as opportunities to create conditions for finding solutions that satisfy all parties (“I win you win” Cornelius and Faire (1995)), with the potential to promote changes in social conditions and introduce new ways of thinking. Consequently innovation and creativity are inherent to the management of conflicts.

The two extremes of confrontation and opportunity and the grey areas in between are in our opinion conditioned by two groups of factors: cultural conditioners and public awareness conditioners. A hetero-cultural perspective facilitates the management of conflicts involving collaboration in the handling of natural resources.

Water is a privileged natural resource for analysing conflicts connected to consumer and non-consumer demands; its use as a means of transport, for the maintenance of certain habitats, or as a recreational or symbolic area (well documented in publications such as González Alcantud and Malpica, 1995).

As is the case in other environmental conflicts, when we talk of water disputes, we mean a particular type of social conflict in which the problems encountered are related to the quality of life of the people involved (in its widest sense) and the environmental conditions. The following characteristics differentiate these disputes from other types of environmental conflict:

- They involve collective actions. They involve or confront groups of people, who are not all organized to the same degree.

- They are complex processes: Entailing the unstated interests of the range of parties, whose public and private positions may differ. On a local level, there is an extensive and continuous need for harmonious coexistence between the parties. There are economic, social, cultural and scientific ramifications. Finally, a great deal of information is required.
- The process is carried out in the public domain.
- Conflicts are on many occasions the result of different values, perceptions and meanings, which cannot be quantified.
- The participants are publicly recognized, whether or not they are considered legitimate.
- There are participants who are not present, and whose importance should be stressed, who are the future generations.
- There is normally a high degree of uncertainty, because it is complicated to predict the environmental impact of proposed actions, or because the information required to estimate these impacts is not available.

In the end water disputes are slightly more complex because of the institutional dimension, but on the whole similar to other conflicts involving natural resource management, in which conflicts exist due to the scarcity of the resource, or because of conflicts between values, power, information, interests, or, most commonly, an interrelation of them all.

Water disputes do however have certain specific features. They almost always occur during droughts and their resolution is often connected to the end of the period of scarcity. And since during periods of abundance there is no public demand to take decisions, actions required for the long-term solution of problems are put off until the next drought. Problems therefore become entrenched and exacerbated, the only hope being a technological miracle that never materialises.

This corollary should be highlighted. The most unpopular actions required to resolve water disputes are taken during periods of hydrological stress, normally as emergencies, with very high economic, social and environmental costs. And between droughts the conflict is forgotten, water is abundant and its price often too low. The needs that caused the problem are met, and nobody takes it upon themselves to return the water to the ecosystems from which it was taken in order to resolve the conflict.

Another defining characteristic of water disputes are the unequal levels of representation between the ranges of interests involved. Water users, and in particular farmers and supply companies are usually over-represented, either directly or through professionals who depend on them, whereas the representation of environmental interests is often purely symbolic. The water company typically takes on the role of the arbitrator, which is naturally inclined to tend to the more powerful interests. Water resources are therefore overexploited during hydrological crises, because those groups interested in defending them are nearly always in a position of inferiority.

In short, the alternation between periods of drought and periods of abundance marks the rhythm of the generation and resolution of water disputes, which therefore

differ from other types of natural resource management conflicts. This characteristic could be of assistance in the resolution of the problem, but often leads to temporary solutions, which are erroneous and typically only work by reducing the resources available to future generations.

## Conflict Analysis

Water disputes embrace a very wide range of disciplines: Ecology, social studies, politics, economics, etc. It is therefore very important to identify the approach or discipline used to present the analysis, because the perspective chosen will condition any subsequent actions.

The field of the management and analysis of environmental conflicts is constantly advancing as a multi-disciplinary field. We feel it is important to highlight the contributions of the following disciplinary approaches:

- Sociology (the work of Pont (2004) on the protest movement against the National Hydrological Plan).
- Environmental psychology (the work of Corraliza (2000) and Castro (2000))
- Anthropology (studies on water disputes in the Pyrenees by Mairal and Bergua (1997))
- Political science and its contribution to the concept of environmental governance (the team of the IGOP of the UAB, of the Universidad Pablo Olavide and Seville (Moral and Paneque, 2004))
- Socio-ecology (Folch, 1999)
- Political ecology (the reflections of the school of Martínez Alier, 2005)

A comparison is also made of the tools used by each of them: discourse analysis, open interviews, questionnaires, active listening, analysis of organizations and policies, multi-factor techniques, etc.

The preliminary conclusions can basically be grouped as follows:

- Many approaches suffer from an excessively biased view of the conflict. To this end we have adopted the reflections of Villasante (Villasante and Carballo, 2007) when he describes the example of the situation of violence in a Columbian neighbourhood, and the range of responses obtained according to how, who and where questions are asked (Montañés et al., 2001).
- The different approaches often underestimate the role of the parties involved in the definition of the analysis of the conflict.
- Efforts have been made to quantify factors, which do not connect with determinant qualitative aspects, such as power relationships.
- Neither have tools been developed sufficiently for the simulation of scenarios, which could be of great interest for the creation of consensus.

## **Different Approaches to Conflict Resolution: The Pyramid of Conflicts**

There is a range of ways of tackling the resolution of conflicts. A brief description is given below of each. If they were ordered in a pyramid, the options at the base would involve a greater degree of consensus, and the further up the pyramid the higher the level of conflict.

The ideal strategy would be to **AVOID** the conflicts in the first place. This would however necessitate a cultural change requiring time and money spent on prevention, which in the case of environmental conflicts would mean a strong emphasis on hydrological participation and planning, not as a strategy, but rather a profound conviction that recognises the multiple demands on the resource, and that the interests of all the parties are equally legitimate, that the problems are complex and that the management of the shared knowledge teaches us responsibility and enables us to accept the decisions taken. This is the approach of the New Culture of Water; water disputes can be forecast, discussed and resolved before the event because the hostility of the conflict is greatly reduced in periods of abundance, and increases progressively during droughts. An efficient Water Administration Company can and should forecast conflicts and take advantage of the enhanced capacity for resolving these when they are dormant, in order to improve their prevention.

**MEDIATION** would be third from the bottom of the pyramid. It is not a universal remedy for resolving water disputes, but a powerful tool that should neither be sold short nor overvalued. Solutions reached in a consensus enable all parties to feel empowered by the decisions taken. From this point on if the agreement respects the interests of all parties, the problem resides in encountering the appropriate means to satisfy these as far as is possible. A sensible combination of technical and political decision making, and respect for what realities leave etched on the collective imagination, may be the key to making a reality of the perceived paradox which is the possibility of all the parties being winners in the resolution of the conflict.

A good agreement must enable each party to return to their field, or economic or social sector with their head held high because they are convinced the agreement reached is stronger and represents more progress than any option recognising winners and losers.

Another common method for resolving conflict is **ARBITRATION**. All parties must approve its choice, but the decision taken by the arbitrator is always independent of their wishes. The Water Administration Company should once again be capable, through their actions, of earning the prestige required to be worthy of taking on the role of arbitrator, which they are awarded on many occasions in the legislation. This is a difficult task, and more so when all too often the role is executed with partiality and in response to the corporate interests of the technicians involved.

In recent times **JUDICIALISATION** has also often been used as a method to tackle water disputes; only possible in democracies. The parties understand the procedure, and have certain legal rights, but have no effective control over their execution, the individuals involved, or the result. Everyone knows how to initiate



a court case, but no one knows what the result will be. In the case of water disputes, as in others, the lack of specific training in water issues of lawyers and judges combined with the complexity of the problem mean there is a tendency to reach decisions in economic terms that grossly underestimate the true values of the issues under consideration.

Lastly, it is sometimes the case that due to the disparity between the strength of the parties involved, one makes an IMPOSITION upon the other and ignores any type of reasoning. Imposition may also occur when it is impossible to reach an agreement or when an agreement is patently unethical and the Water Administration Company imposes a necessary solution. In the first case, the imposition has mortgaged its future to later increases in strength of the losing party; and in the second case, success depends solely on the virtue of the imposed solution.

We have wide-ranging experiences in this history of the management and exploitation of water in our country, which has always been interpreted in terms of a confrontation between individuals, interests and territories. The conflicts are inherently good because they show us the diversity and the range of points of view concerning the same problems. However, our ability to resolve them is a measure of the health of our democracy in a society such as ours, which cannot face up to the challenges of the twenty first century without properly addressing this topic.

## **Intervention Tools for Management Disputes**

Certain people have sustained that intervention in the management of conflict is a mix of art and science, and they are not without reason in our experience. Science in terms of systematic analysis, definition of the conflict and design of the intervention process, and art in terms of flair, personal skills and know-how during its execution.

We are therefore specially interested in processes with a collaborative, informal and voluntary emphasis, which are complementary to formal mechanisms for the resolution of conflict (i.e. strict adherence to the rule of law).

Consequently good conflict management would be where the parties involved (directly or those affected by the conflict) all have a real opportunity to understand their mutual needs and to develop a range of alternatives that meet their expectations and enable them to reach a mutually satisfying solution (Lewis, 1988, Lewis, 1996). To this end, we have analysed the application of tools used to avoid confrontation and hostility in the selected cases, by means of a third party who assists the collectives in conflict in reaching a mutually satisfying solution and facilitates the end of the negotiation process.

Our experience in water disputes to date enables us to group intervention methods in three general types. The first one is based on conflict prevention strategies. In this case there is a range of intervention methods aimed at being a step ahead of the emergency arising from the conflict and basically include environmental and dynamic education actions related to forecasts of the future. The following projects could be included in this group: “Voluntary Workers”, “Saragossa, a City Saving Water”, and the Malaga and Balearic Island Water Forums.

A second group of strategies appear confrontational and incommunicative, but in reality seek to readjust the balance of power by means of protest organizations to broaden the participation of the general public. The following experiences could be included in this group: the Anti-dam organisations (COAGRET) and the Platform for the Defence of the River Ebro. These normally become direct negotiation processes.

Finally, there are strategies in which the intervention of a third party or a team of collaborators creates the circumstances required for mediation by moving the range of parties towards a future relation of constructive, cooperative and potentially more productive work than if the conflict were left to develop by itself. The following experiences could be included in this group: “The Social Initiative for Mediation” and “The Water War in the Metropolitan Area of Barcelona” in its last phase. It is possibly useful to make a distinction in the case of mediation between the role of an institutional mediator linked to one of the parties, and as a result closer to a political mediation, and the role of a team or individual external to the parties involved in the conflict.

We should also analyse the tools used in each case (communication tools, leadership, interests vs. positions, empathy, active listening, anger control, reformulation, reframing, etc.) and attempt to understand how the processes evolve. We should also be able to compare the tools used to support each of them: discussion analysis, open interviews, questionnaires, active listening, analysis of organizations and policies, multi-factor techniques, etc.

## Conclusions

Conclusions have been reached by means of a comparative analysis of a range of experiences:

*1. Participatory water planning is the best tool for the prevention of conflict.* When discussing conflict resolution, we should not lose sight of the fact that prevention is always better than a cure. There is no better solution than the non-existence of the problem. The quality of water planning can in fact be evaluated in terms of the number of conflicts that are avoided, the success of which would depend on the participation of interested parties. One example of many we could give was the composition of the National Water Council during the processing of the previous National Hydrological Plan. The history of the Ebro water basin has demonstrated the fact that many of the water conflicts arising in the last few decades could have been avoided by means of suitable water planning, better information for those involved, and efficient consultancy processes, in which the general public participates as well as the major users and irrigators. Many authors cite one of the advantages of participation as being the possibility of preventing future conflict (Font, 2001, Martí et al., 2001, Montañés et al., 2001, Pindado, 2000). Nevertheless, this benefit has not been studied in depth and the importance of the opportunities available from this type of community action, where a wide-ranging, complete, integrated and specific

participation process is carried out, has not been assimilated. Here we refer to active public participation.

The implementation of the EU Water Framework Directive (2000) has greatly changed European Union policies for water resource management. One of its most important provisions is the requirement of public participation, which will contribute to the protection of the environment and an adequate management of natural resources. The Water Framework Directive describes participation not only in terms of a one-way communication process, where simply more information is made available, but refers to a two-way communication process in which information and opinions are exchanged in an inquiry process. The member countries have committed to fostering a type of active participation, which can never be considered either too early or excessive. The specific methodology used to carry out a participation process must be adapted to its context, and to the interests and expectations of those involved. Exact formulas do not exist, because those involved are the ones responsible for the construction of the participation process, with the assistance of a facilitator who coordinates its design and execution in accordance with the will of the interested parties.

2. *Interventions often lack a prior multi-discipline analysis of the conflict.* Interventions, which require a high degree of personal dedication and involvement from everybody, can be a failure because records are not provided by other disciplines that could open new areas for negotiation between those involved.

3. *The interests of all those involved must be respected equally.* Those involved may be right or wrong from a logical or scientific point of view, their views may be supported by more or less individuals, but the interests, objectives and wishes of everybody involved must be respected.

If those involved feel the mediator does not value or respect their beliefs, confidence will soon be lost in the process and it will collapse before it even gets going. A real participation process, as described in the Water Framework Directive, ensures everybody is listened to and their ideas recognized, which increases the chances of a successful outcome agreed between everyone.

4. *Conflicts are complex, and so are their solutions.* It would be naive to think conflicts that have developed over a long period of time and become increasingly complex can be resolved easily. The time required to unravel a knot is proportional to how tangled it has become. Complex problems require complex solutions.

5. *Agreements cannot be reached that contravene the law, science or which transfer damages to third parties.* Those involved reach agreements as is the aim of the mediation process. Agreements however have limits. Damages must not be transferred to third parties, and neither should they be passed on to the present or future water resources. In the case of major hydraulic works, the public administration is more than just the witness to an agreement between others. It plays the lead role in the agreement. In fact it is legally competent to promote the decisions taken and must ensure agreements do not contravene existing legislation.

6. *The critical factor: the willingness of those involved to reach an agreement.* No type of methodology can replace the most critical factor: the willingness of those involved to reach an agreement. An incentive to this willingness comes in the form

of the conviction that a safe agreement is preferable for all. In other words it is better to be sure of 100% of an end document which meets 85% of your expectations than to reach a doubtful and weak agreement that meets 100% of your intentions.

7. *Consensus agreements are more practical.* When agreements are made through the consensus of all involved, no one places legal obstacles or obstacles of any type in the way of the implementation of the agreement. The agreement will therefore be executed earlier, and public administrations will be keen to invest in them, happy in the knowledge that there is no opposition. Reaching a consensus is often laborious and time is lost during the decision making. A lot of time is gained however during the execution. The end result of an agreed plan, is that the work is normally completed much earlier than one imposed upon one of the parties involved.

8. *Specific methodology is required for each conflict.* There is no such thing as a universal methodology that can be applied to any context and situation. Generally valid mediation principles need to be adapted to specific situations. The people involved, the history of the case, the socio-political situation, and the existing legal frameworks are all unique to each specific conflict. And unique components need to be tackled specifically in each case. A little craftsmanship is required, where generosity, responsibility and honesty are needed to make the best use of the materials at hand.

9. *The role of the general public.* Dialogue and mediation as the main strategies for the resolution of conflicts in water management and use can perfect the democratic process if and when the general public makes the necessary commitment. Much is still to be learned concerning the reciprocal relationships between public administrations and the general public in order to increase our understanding of participation, tolerance and consensus creation.

Finally, mediation is not a universal remedy for the resolution of water conflicts in Spain, and neither is it the best solution. Ideally conflicts would be avoided in the first place, as explained as the first step of the pyramid for the resolution of conflicts described above in the spirit of the New Water Culture. And in the event of conflict, those involved would ideally be able to reach a mutually satisfactory solution by means of a direct negotiation process without the need for external assistance. We are however convinced that given the current culture of Spanish society, and specifically the main players in water conflicts during the droughts that are now again upon us, participation, its principles and methodology can contribute a great deal towards the construction of a water culture that listens to the sensibilities of Spanish society at large concerning the management of the resource, and which also meets the demands of the new Water Directive of the European Union.

## References

- Balearic Island Water Forums / El Foro del Agua de las Islas Baleares. [http://www.ecodes.org/pages/areas/mediacion\\_participacion/documents/Dcl\\_Bal\\_03.pdf](http://www.ecodes.org/pages/areas/mediacion_participacion/documents/Dcl_Bal_03.pdf)
- Castro R de. (2000) Educación Ambiental. In Aragonés J A, Amérigo M (eds.), *Psicología Ambiental*, ISBN 84-368-1515-7, pp. 357–380

- COAGRET Coordinadora de Afectados por Grandes Embalses y Trasvases [www.coagret.com](http://www.coagret.com)
- Corraliza J A (2000) Emoción y Ambiente. In Aragonés J A, Américo M (eds.), *Psicología Ambiental*. ISBN 84-368-1515-7, pp. 59–76.
- Cornelius H, Faire S (1995) *Tú ganas, yo gano. Como resolver los conflictos creativamente y disfrutar con las soluciones*. Ed. Gaia.
- EU Water Framework Directive (2000) Directive 2000/60/EC of the European Parliament and of the Council of 23 October 2000 establishing a framework for Community action in the field of water policy. OJ C 327 22.12.2000
- Folch R (1999) *Diccionario de Socioecología*. Editorial Planeta. Barcelona.
- Font J (coord) (2001) *Ciudadanos y decisiones públicas*. Barcelona: Ariel.
- González Alcantud J A, Malpica A (eds.) (1995) *El agua: mitos, ritos y realidades*. Diputación Provincial de Granada. *Antropología*, 30.
- IGOP, Institut de Govern i Polítiques Públiques, <http://igop.uab.es/>
- Lewis D (1988) Desire as Belief I. *Mind*, 97(387):323–332.
- Lewis D (1996) Desire as Belief II. *Mind*, 105(418):303–313.
- Mairal G, Bergua J A (1997) El conflicto territorial. In Mairal G, Puyal E, Bergua J A (eds.), *Agua, tierra, riesgo y supervivencia: un estudio antropológico sobre el impacto socio-cultural derivado de la regulación del río Ésera*. ISBN 84-7733-489-7, pp. 241–258.
- Malaga Water Forum / Foro del Agua de Malaga Declaración del Foro de Malaga 01.02.2003 <http://www.unizar.es/fnca/includes/noticias/print1.html>
- Martí J, Montañés M, Rodríguez-Villasante T (coord.) (2001) *La investigación social participativa. Construyendo ciudadanía*. Barcelona: El Viejo Topo.
- Martínez J (2005) *El ecologismo de los pobres: conflictos ambientales y lenguajes de valoración*. ISBN 84-7426-743-9. Icaria Ed.
- Montañés M, Rodríguez-Villasante T, Martín-Gutiérrez P (coord.) (2001) *Prácticas locales de creatividad social*. Barcelona: El Viejo Topo.
- Moral L, del, Paneque, P. (2004) Tres décadas de debates sobre el agua: de la Conferencia del Mar del Plata a la Nueva Cultura del Agua. In Suárez J M (ed.), *Las miradas del agua*. Sevilla: EMASESA.
- National Water Council/Consejo Nacional del Agua <http://hispagua.cedex.es/instituciones.php?c=detalle&pg=0&localizacion=Administracion%20General&id=10024>
- New Culture of Water/Fundación Nueva Cultura del Agua <http://www.unizar.es/fnca/index3.php?pag=11&id=3>
- Pindado F (2000) *La participación ciudadana en la vida de las ciudades*. Barcelona: Ediciones del Serbal.
- Platform for the Defence of the River Ebro/Plataforma en defensa de l'Ebre <http://www.ebre.net/>
- Pont J (2004) *La ciudadanía se moviliza. Los movimientos sociales y la globalización en España*. Barcelona: Flor del Viento Ediciones.
- Saragossa, a City Saving Water/Zaragoza, ciudad ahorradora de agua. <http://www.ecodes.org/>, <http://cmisapp.zaragoza.es/ciudad/medioambiente/centrodocumentacion/objetivos.htm>.
- The Social Initiative for Mediation / Iniciativa Social de Mediación (ISM) <http://www.ecodes.org/pages/especial/ISM/index.asp>
- The Water War in the Metropolitan Area of Barcelona/Morera E, Perxacs H, (2000) El conflicto del rebu de l'aigua: el cas de Barcelona, *Revista Bibliográfica de Geografía y Ciencias Sociales*, 253, Universidad de Barcelona
- Villasante C S, Carballo A (2007) *La huella ecológica de una economía cerrada: consideraciones teóricas sobre el ajuste de comercio en el marco de análisis de la huella*. (<http://www.eumed.net/eve/resum/07-junio/cpvl.htm>)

**Part III**  
**Learning from the Case Studies**

# Chapter 13

## Development of Drought Management Plans in Spain

Luis Garrote, Ana Iglesias and Francisco Flores

**Abstract** This chapter presents the process of development of drought management plans in Spain. The Law of the National Hydrologic Plan, in 2001, included the obligation for all Basin Authorities to develop Special Drought Management Plans. The process was finished in 2007, with the approval of the Plans for Basin Authorities depending on the central government. The methodology applied for the technical analyses carried out is presented, together with a description of the drought management actions included in the Plans.

### The Planning Framework

#### *Drought, Water Scarcity and Aridity are Overlapping Issues in Spain*

Water resources in Spain are limited, scarce, and highly irregular in space and time. The potential use of surface water under the natural regime is only 7% of total natural resources. The availability has increased to 40% due to the intensive development of hydraulic infrastructures during the last century. Groundwater use is also intensive in many areas of the country, and it contributes to an additional 10% of the total available resources. Water use in Spain is mainly for agriculture (over 68% of water demand), but other economic and social water demands are rapidly increasing, such as tourism (current urban demand is 13%) and ecosystem services. With limited and scarce water resources and demand rising due to demographic shifts, economic development and lifestyle changes, water management problems are significant even without drought events (Table 13.1)

---

L. Garrote (✉)  
Department of Civil Engineering, Hydraulics and Energy,  
Universidad Politécnica de Madrid, Madrid, Spain  
e-mail: garrote@caminos.upm.es

**Table 13.1** Total freshwater resources, available resources, demands, and water reliability in the hydrological basins of Spain

Total Freshwater Resources (km <sup>3</sup> )	Available resources (km <sup>3</sup> ) (a)	Reservoir capacity (km <sup>3</sup> )	Regulated water (%) (b)	Demand (% of available resources)	Irrigation demand (% of total demand)	Pop. (millions)	Total resources per capita (m <sup>3</sup> / person)
Norte	44.2	4.4	15	37	42	6.7	6,542
Duero	13.7	7.7	60	47	93	2.2	6,071
Tajo	10.9	11.1	65	57	46	6.1	1,784
Guadiana	5.5	9.6	54	85	90	1.7	3,298
Guadalquivir	8.6	8.9	42	104	84	4.9	1,755
Sur	2.4	1.3	21	268	79	2.1	1,135
Segura	0.8	1.2	90	253	89	1.4	590
Júcar	3.4	3.3	58	149	77	4.2	819
Ebro	18.0	7.7	72	80	61	2.8	6,509
Catalonia	2.8	0.8	40	122	27	6.2	451
Balearic Is.	0.7		45	96	66	0.8	785
Canary Is	0.4		102	102	62	1.7	241
SPAIN	111.2	56.1	42	76	68	40.1	2,728

(a) Surface and groundwater.

(b) Regulated water: rate of available resources from total natural resources.



Drought can have serious effects on the economy and the environment of Spain and on the population's well being. The major drought of the mid 1990s affected over 6 million people, almost ten times more than the number of people affected by floods in Spain during the last fifty years. The economic damage caused by drought in Spain during the last twenty years is about five times more than in the entire United States (EM-DAT, 2007). Drought events affect water supplies for irrigation, urban, and industrial use, ecosystem health, and give rise to conflicts among users that limit coherent integrated water resource management. The reduction of wetland area (from over 1200 km<sup>2</sup> in the 1970s to less than 800 km<sup>2</sup> in 2000, excluding the Guadalquivir marshlands) has been in part related to recurrent drought episodes and surface water scarcity, and amplified by the excessive groundwater pumping to compensate for these problems. In addition to water scarcity, droughts also cause water quality problems, since water quality parameters deteriorate during drought due to lack of dilution and water may not be acceptable for human consumption.

### ***Legal and Institutional Framework***

There are two main legal sources of the Spanish water codes and statutes: the Spanish Constitution (1978) and the European Union Water Framework Directive (2000). These two legal bodies are at the top of the hierarchy of laws and statutes pertaining to water and droughts (Iglesias, Moneo, 2005). Three instrumental laws are identified as the context for drought preparedness and planning: The Water Law (2001), the Law of the National Hydrological Plan (2001) and the Agricultural Insurance Law (1978). The Law of the National Hydrological Plan explicitly ordered the development of Special Drought Management Plans for all basins and Drought Emergency Plans for all urban water supply systems serving more than 20,000 inhabitants.

The administrative body that is responsible for providing public service regarding water management in the basin is the Basin Authority, with competence on inland water and groundwater. The Basin Authority is an autonomous public organization subordinate to the Ministry of the Environment. The Ministry of the Environment also hosts the National Drought Observatory that provides updated general information. Table 13.2 summarizes the stakeholder groups that may compete for water during periods of drought and water scarcity.

The implementation of the new European WFD gives Spain the opportunity to develop integrated drought management plans that incorporate the extensive national experience in hydrological management with the new environmental challenges. Regarding exceptions, "prolonged droughts" are introduced in the WFD as "force majeure" events. The conditions under which exceptional circumstances are or could be considered have to be stated through the adoption of the appropriate indicators. Contingency drought plans must face these issues. Historically, the urban, cultural, and agricultural development in Spain has demonstrated a profound

**Table 13.2** Stakeholders in the Spanish basins

Stakeholder	Variable of interest	Preference and compromise
Farmers	Water to irrigation	More water May be willing to accept lower abstraction permits in exchange for lower prices (or vice versa, may be ready to pay higher prices to obtain more water)
	Price of water for irrigation	Lower price Subsidies for switching to less water-demanding crops
	Dam and reservoir capacity	More capacity (decrease vulnerability to drought)
Environmentalists	Residual water	Well above minimum flow requirement
	Dams and reservoirs	No additional investment to protect biodiversity Sustain ecological flow
Urban and Rural dwellers	Secure access to safe water	Closer safe water sources Guaranteed minimum water quantity Participatory water planning
Urban water supply companies	Dams and reservoirs	Increase storage capacity Infrastructure
Basin Authority	Dams and reservoirs	Integrated resource management Evaluate storage capacity First priority is urban water supply Other uses and services of water may be negotiated
	Ecological water	Guarantee ecological services and flow requirements

knowledge of adaptation strategies to drought, water scarcity, and precipitation variability.

### *Legal Instruments for Drought Management in Spain*

Institutional responses to hydrological drought or water scarcity in Spain are classified in two categories: proactive and reactive. Proactive measures are defined in River Basin Management Plans, and are in permanent progress. The set of structural and non-structural measures contemplated in RBMPs is designed to improve the reliability of water resource systems, reducing their vulnerability to drought. However, these measures may not eliminate completely the risks associated to droughts. Reactive measures were usually adopted under this contingency to compensate for water scarcity within the existing framework of water resources, demands and infrastructure in the basin.

Under the traditional approach, specific measures to react to the drought situation were adopted by the Government under the guidance of Basin Authorities and implemented through Royal Decrees. The Reservoir Release Commission of Basin Authorities can also agree with users on the activation of emergency drought management measures. For instance, special operating strategies have been defined

to limit consumption (programs for public awareness, restrictions of nonessential uses, intensification of control of water consumption and implementation of penalties for violators) and to increase supply (implementation of planned structural and non structural measures: the use of dead reservoir storage or water of lower quality, transient overexploitation of the aquifers, modification of usage priorities and resort to high-cost sources of supply). In general, these reactive responses are specific of drought periods, and are discontinued when the drought is over.

This approach based on reactive measures will probably have to be used in the future. However, the Law of the National Hydrologic Plan, approved in 2001, established new legal instruments for drought management in Spain. The action is based on three main instruments (Estrela, 2006)

- A drought monitoring system based on drought indicators for each Basin Authority and for the entire country
- Special Drought Management Plans for Basin Authorities
- Emergency Drought Plans for urban water supply systems serving more than 20,000 inhabitants

The National System of Drought Indicators was developed during 2006 by the Spanish Ministry of the Environment. It is currently operational, and may be accessed on the web page of the Ministry of the Environment, in the National Drought Observatory. The system of indicators is a general reference for Basin Authorities for formal declaration of drought situations, which can activate drought emergency measures with legal constraints or specific budget application.

Spain has recently completed the process of drafting Drought Management Plans for all Basin Authorities. Special Drought Management Plans (SDMP) at river basin level are complementary to River Basin Management Plans (RBMP) for drought conditions. SDMPs are mainly targeted to identify the conditions and schedule the activation of tactical measures to prevent or mitigate drought effects. Therefore, measures involved are mainly water demand management or water conservation measures and, with the progressive application of WFD schedule, measures to achieve and comply with good environmental status.

At local level, specific emergency plans for all public water supply systems serving more than 20,000 inhabitants will have to be developed. The objective of these plans is to ensure that a proactive approach is adopted for drought management in urban water supply, avoiding the need to implement improvised emergency measures under the pressure of imminent water shortages.

## **Drought Indicators System**

The basis of any drought management plan is a robust system of drought indicators that can identify and diagnose anomalies in water availability and can provide the basis for early detection of drought episodes. Drought characterization in highly regulated systems is complex and calls for multiple indicators. For instance, SPI and

other rainfall-based indices have been used with important limitations when applied in isolation, especially over short time periods. These indices show little correlation with water shortage situations, since water storage plays an important role in water resources management. Therefore, a more complex system of indicators is required in order to identify situations when there is risk of water shortages.

A comprehensive study of hydro-meteorological time series and drought indices in the basin is required for the definition of a drought indicators system. The methodology adopted is based on the analysis of water demand units. For each of them, a list of variables is selected to characterize the evolution of available water resources, such as water stored in reservoirs, piezometric levels in aquifers, river flow in stream gauges, rainfall in precipitation gauges, etc. Historic time series compiled for each variable are normalized on a scale from 0 to 1, with 0 corresponding to the minimum historic value, 1 to the maximum and 0.5 to normal conditions. The functions to relate variables and indicators are chosen to characterize the risk of water shortages and are validated through the analysis of historic values and drought episodes. Individual demands are grouped in water resources systems, obtaining average values of the indicators that are representative of the global situation of each system. Usually a weighted average is selected as the averaging procedure, with weights proportional to the relative importance of each demand unit. The system of indicators is in continuous revision, taking into consideration the availability of new information and the progress in knowledge of the hydrologic behavior of the basins.

The hydrologic state of every system as measured by the indicators is classified into four categories: Normal, Pre-alert, Alert and Emergency conditions, with the following meanings:

- Normal: The normal condition corresponds to situations in which there are no risks of water shortages in the near future
- Pre-alert: The pre-alert condition is declared when monitoring shows the initial stage of drought development, which corresponds to moderate risk (i.e. greater than 10%) of consuming all water stored in the system and not being able to meet water demands
- Alert scenario: The alert condition is declared when monitoring shows that drought is occurring and will probably have impacts in the future if measures are not taken immediately. There is a significant probability (i.e. greater than 30%) of having water deficits in some time horizon.
- Emergency scenario: The emergency condition is declared when drought indicators show that impacts have occurred and supply is not guaranteed if drought persists.

The current values of the system of indicators are published quarterly by the National Drought Observatory, and can be accessed in the web page of the Ministry of the Environment. As an example, the situation in September 2007 is shown in Fig. 13.1.

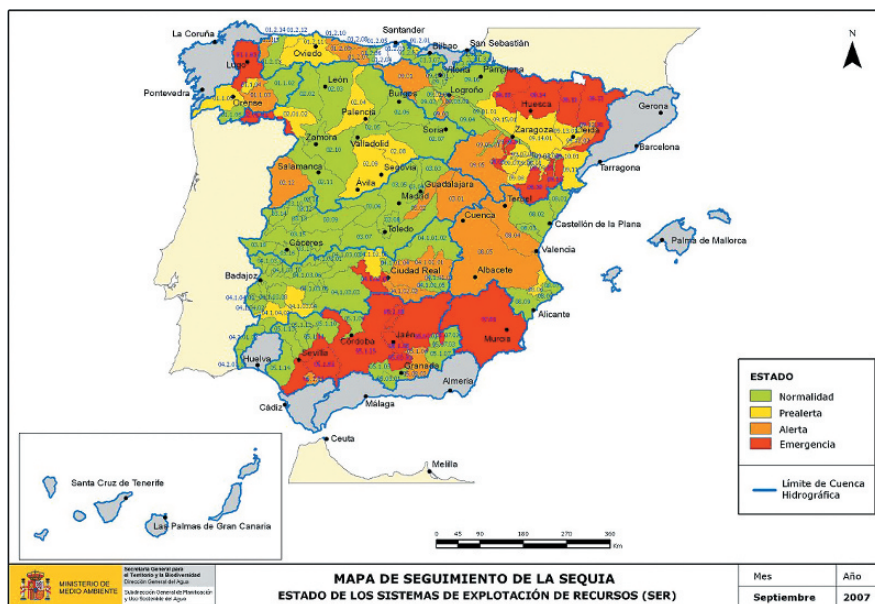


Fig. 13.1 Drought condition of main water resources systems in Spain in September 2007

### Special Drought Management Plans

The objective of Special Drought Management Plans is to anticipate drought situations and to plan solutions to satisfy water demands and to comply with environmental requirements (Iglesias et al., 2007). They are based on:

- A deep knowledge of water resources and their capacity to be stressed under water scarcity situations
- A deep knowledge of water demands and their vulnerability to water scarcity situations
- A system of drought indicators for early warning, to allow for the adoption of management actions contemplated in the plan.
- A catalogue of measures to reduce drought impacts for each drought condition
- An adequate administrative framework for the implementation of measures, allowing for the coordination of the administrative units involved.
- A plan for public participation to guarantee cooperation of all users involved and to disseminate important information

The elaboration of the SDMPs is the result of a complex process in which user participation is encouraged and stimulated. Once the Plan is drafted, it is submitted to public scrutiny, and concerned individuals and social or political groups can make allegations that are discussed and negotiated in the Water Council, where a majority vote is required for acceptance. If the drafted plan obtains a favorable vote, it is formally approved and is legally binding to all stakeholders.

## *Management Actions*

The basin drought policy is summarized as a list of possible actions to be taken in case of drought. The catalogue of possible actions is restricted by the legal competences that are attributed to Basin Authorities, but the resulting list includes a great number of actions of very diverse nature, like the examples presented in the following categories:

- **Internal operation.** Within the Basin Authority, most frequent measures include intensification of monitoring, prevention of leaks, or revision of rules for the operation of infrastructure.
- **Water uses.** Demand management measures include: information dissemination and user involvement, promotion or enforcement of water savings, prohibition of certain uses, temporary exemption of environmental obligations, etc.
- **Water resources.** Drought measures focus on conservation and protection of stored resources, activation of additional resources or monitorization of indicators of water quality.
- **Institutional.** The President of the Basin Authority may appoint committees or task forces to address specific issues, usually in conjunction with affected users, or enhance cooperation with other organizations or stakeholders.
- **Legal.** There are a number of legislative measures that can be adopted, ranging from the official declaration of emergency due to drought, to a long list of possible palliative measures with different objectives: subsidy, restrictions, emergency works, etc.

The operational effectiveness of SDMPs plan is greatly enhanced if the selected measures for every system are associated to each of the three drought states corresponding to increasing levels of severity: Pre-alert, alert, and emergency scenarios. The management actions associated to these scenarios are described in the following paragraphs.

The management objective in the pre-alert scenario is to prepare for the possibility of a drought. This means to ensure public acceptance of measures to be taken if drought intensity increases by raising awareness of the possibility of societal impacts due to drought. The kind of measures that are taken in the pre-alert situation are generally of indirect nature, are implemented voluntarily by stakeholders and are usually of low cost. The goal is to prepare the organism and the stakeholders for future actions. Regarding the Basin Authority, main actions are intensification of monitoring, usually through the creation or activation of drought committees, and evaluation of future scenarios, with special attention to worst case scenarios. Regarding the stakeholders, the focus is communication and awareness. Generally, non-structural measures are taken, aimed to reduce water demand with the purpose of avoiding alert or emergency situations.

The management objective in the alert situation is to overcome the drought avoiding the emergency situation by enacting water conservation policies and mobilizing additional water supplies. These measures should guarantee water supply at least during the time span necessary to activate and implement emergency measures. The

kind of measures that are taken in the alert situation are generally of direct nature, are coercive to stakeholders and are generally of low to medium implementation cost, although they may have significant impacts on stakeholders' economies. Most measures are non-structural, and are directed to specific water use groups. Demand management measures include partial restrictions for water uses that do not affect drinking water, or water exchange between uses. This may be a potential source of conflict because user rights and priorities under normal conditions are overruled, since water has to be allocated to higher priority uses. For example, irrigation can be supplied using waters from an alternative source, although farmers usually disagree with this option, since it may imply lower water quality or an increase in pumping costs.

The management objective in the emergency scenario is to mitigate impacts and minimize damage. The priority is satisfying the minimum requirements for drinking water and crops. Measures adopted in emergency conditions are of high economic and social cost, and they should be direct and restrictive. Usually there has to be some special legal coverage for exceptional measures, which are approved as general interest actions under drought emergency conditions. The nature of the exceptional measures could be non-structural, such as water restrictions for all users (including urban demand), subsidies and low-interest loans, or structural, like new infrastructure, permission for new groundwater abstraction points and water transfers.

### ***Risk Analysis***

The operational implementation of the plan requires a connection between the system of drought indicators and selected measures. To avoid untimely negotiations, the drought plan contemplates the activation of the set of measures associated to a drought scenario when the system of drought indicators reaches a predefined level. The final goal is to achieve a balance between the frequency of declaration of drought scenarios and the effectiveness of the application of the measures. If drought scenarios are declared too early, users are frequently exposed to unnecessary restrictions. If the declaration of drought scenarios is delayed, it may be too late for the measures to be effective.

The process of plan discussion and negotiation is very important, since consensus is a major goal to achieve before the plan is operational. In discussions, all users generally agree on the importance of drought indicators and on the rationale of the proposed measures. The disagreements usually concern the timing of measures. Users that are going to be benefited by measures, because their demands will be protected due to the high priority of urban supply, tend to encourage early action, even at the risk of incurring frequently in false alarms and unnecessary restrictions. Users whose demands are going to be restricted, because of lower priorities of irrigation or power production, tend to support the delay of the application of exceptional measures, even at the price of depleting the reserves completely.



Risk analysis is an essential tool to analyze the problem and to find a consensus among users by testing different options. It is important that the rationale behind the measures proposed in the plan can be understood by all stakeholders that might be affected by them, and therefore, special emphasis has to be placed on developing a methodology to establish an objective link between quantitative drought indicators and concrete measures.

The methodologies applied in Spanish basins involve comprehensive analyses of alternative policies and objective procedures to plan the ordered implementation of management actions based on quantitative drought indicators. The details of the analysis differ from one basin to another, depending on local conditions. In most of them, water resources simulations models are applied to analyze the risk of water shortages and to test the effectiveness of management actions. As an example, a brief summary of the methodology applied in the Tagus basin is presented below. A detailed description can be found in Garrote et al. (2007) and Iglesias et al. (2007).

The objective of the analysis is to define the thresholds of drought indicator values for the declaration of the pre-alert, alert and emergency scenarios. Since future reservoir inflows are uncertain, these thresholds should be formulated in probabilistic terms. In the Tagus basin, thresholds are defined as the available storage in the system,  $S$ , that is required to satisfy a fraction,  $f$ , of the demand in a time horizon,  $h$ , with a given probability,  $p$ . Values of  $f$ ,  $h$  and  $p$  are model parameters that are analyzed with the help of a water resources simulation model and are fixed through discussion with stakeholders. They depend on several factors: the type of the demand in the system (urban, irrigation, hydropower, etc.), the reliability of the current water supply system, the alternative management strategies that can be applied during droughts, the vulnerability of the demand to deficits of a certain magnitude, etc.

The characteristics of demands in every system are the first factor to assign values to model parameters. Demands having only one single source of supply are more vulnerable and require stricter parameter values than those having alternative sources. In this group, demands having such sources available exclusively to themselves are less vulnerable than those sharing them with other demands. The expected effects of drought declaration should also be balanced versus drought risk. In systems where demands are close to average natural resources there is little margin for action, and drought declaration may have very important social and economic impacts. Most emergency measures imply having to alter existing water rights, face the development of new transport or storage facilities under great social pressure or impose stronger rules and penalties and stricter control. If the drought situations are declared very frequently, the global effects may be even worse than the no-action approach.

The proposed values for model parameters have to be validated by simulating system behavior for the period of historic record, implementing the proposed set of measures in every drought scenario. Final values are decided with the goal of meeting drought management objectives in each scenario and considering the possibilities of demand reduction and resource mobilization in the system. Other qualitative aspects have also to be taken into consideration. For instance, one of the issues



raised by technical staff in charge of water resources management was the situation of regulated systems for irrigation use at the end of the hydrological year. Normal operation of irrigation systems usually depletes reservoir storage at the end of the irrigation campaign. This is a normal feature of annual regulation systems. However, there is a significant probability of not being able to satisfy demands during the following year if reservoirs are almost empty in October. But declaring drought in October or November in an irrigation system is not perceived as good management policy. If the following autumn and winter are normal, the reservoirs will fill again, and there will not be a scarcity situation. If autumn and winter are dry, farmers cannot do anything to react to drought until spring. So for these systems based on annual regulation for irrigation use, declaration of drought might only make sense at the beginning of the irrigation campaign, when farmers are making decisions regarding their crops.

## **Drought Emergency Plans**

Urban water supply systems are very sensitive to drought conditions, since water shortages can have very significant impacts on the population. For this reason, special consideration has been given to drought management for urban supply systems. In Spain, all urban supply systems serving a population of more than 20,000 inhabitants must elaborate a Drought Emergency Plan (DEP).

The objective of drought management in urban supply systems is to reduce the risks of having large impacts due to water shortage through emergency actions that imply moderate impacts and costs. These costs are accepted to reduce the probability of facing situations of greater severity, with comparatively much larger impacts (Cubillo, de Castro, 2007). Risk analysis is essential to establish the criteria for the activation of low-impact measures to prevent possible large impacts in the future.

The objectives of the DEPs for urban supply systems are to define the states of risk of drought-induced water shortages in each system, to identify the conditions to declare different levels of drought emergency situations, to establish the management objectives for drought conditions in terms of demand management or supply enhancement and to catalogue the measures that should be activated under different drought conditions, specifying the level of responsibility of each institution involved.

DEPs are specific of urban supply systems, and should be adequately coordinated with basin SDMPs, since many of the measures contemplated in DEP affect other uses in the basin, like, for instance, the temporary allocation to urban supply of water resources assigned to other uses, which should be authorized by SDMPs. Measures that restrict urban supply should be applied last, since it is, in general, the most important use. Therefore, a special classification of drought states is required for urban supply management, different from the general classification applied in SDMPs. For DEPs, the following drought states are proposed:

- Phase I: Alert: Preparation for the formal declaration of operational drought
- Phase II: Reduction: Voluntary demand reduction and supply enhancement through the activation of measures contemplated in the SDMPs.
- Phase III: Restriction: Water shortages with socioeconomic impact
- Phase IV: Emergency: Great severity scenario, with large socioeconomic impacts.

Phase I corresponds to the final level of the Alert situation in SDMPs, and phases II to IV correspond to the Emergency situation in SDMPs.

From the methodological point of view, DEPs are similar to SDMPs. They are based on the definition of drought indicators, a set of measures and a risk-based methodology to identify conditions for the activation of measures. The differences correspond to the nature of the measures and the level of detail, which should be much more precise for urban systems.

## References

- Cubillo F, de Castro J, (2007) Guía para la elaboración de Planes de Emergencia por sequía en sistemas de abastecimiento urbano. Ministerio de Medio Ambiente, Spain.
- EM-DAT (2007) OFDA/CRED International Disaster Database. Université Catholique de Louvain [www.emdat.be](http://www.emdat.be)
- Estrela T (2006) La gestión de las sequías en España. *Ingeniería y Territorio*, 75: 52–59.
- Garrote L, Martín-Carrasco F, Flores-Montoya F, Iglesias A (2007) Linking Drought Indicators to Policy Actions in the Tagus Basin Drought Management Plan. *Water Resources Management*, 21(5):873–882
- Iglesias A, Garrote L, Flores F, Moneo M (2007) Challenges to Manage the Risk of Water Scarcity and Climate Change in the Mediterranean. *Water Resources Management*. 21(5):775–788
- Iglesias A, Moneo M, (2005) Drought Preparedness and Mitigation in the Mediterranean: Analysis of the Organizations and Institutions, *Options Méditerranéennes, Série B, No. 51, CIHEAM*, 2005.

# Chapter 14

## Characterizing Drought Risk in a Sicilian River Basin

Giuseppe Rossi, Brunella Bonaccorso, Vincenzo Nicolosi  
and Antonino Cancelliere

**Abstract** The chapter summarizes the results of the application of proposed methodologies for drought characterization and risk assessment in water supply systems to the Italian case study, namely the Simeto River basin in Sicily. In particular, after a general description of the case study, the results of the drought identification, carried out by means of several drought indices and methods such as the Standardized Precipitation Index (SPI), the Palmer Hydrological Drought Index (PHDI) and the Run Method, are presented. The application of a methodology developed for the assessment of return periods of drought events identified on historical series of annual precipitation is also reported. Then, the methodology for risk assessment presented in chapter 6 is applied to the Salso-Simeto water supply system, which is a part of the larger system of the Simeto River. In particular, a Montecarlo simulation of the system is carried out in order to assess both unconditional (long term) and conditional (short term) drought risk. Also, drought impact assessment on rainfed agriculture is presented. Finally, drought mitigation measures historically adopted within the Simeto River basin in order to reduce drought impacts in urban and agricultural sectors are described.

### Introduction

In the last twenty years, Italy has experienced many drought events both in semiarid southern regions (where the greater variability of the hydro-meteorological variables and the reduced availability of water resources versus the increasing demands, lay the basis to more frequent conditions of water deficit), as well as in the northern regions, characterized by humid climate and a large amount of water resources.

Despite the severity of past droughts, in particular the event occurred during the period 1988–1990 and the most recent drought of 2002–2003, apparently very few lessons have been learned at political and institutional levels, since the prevalent

---

G. Rossi (✉)

Department of Civil and Environmental Engineering, University of Catania,  
V.le A. Doria 6, 95125 Catania, Italy  
e-mail: grossi@dica.unict.it

approach for coping with drought remains reactive, with a preference to manage emergency situations rather than preventing them through an integrated approach to drought management.

Generally, ad hoc measures have been implemented to face severe droughts, considered as natural disasters. For instance, during the drought event of 1988–90, the Department of Civil Protection, which has been entrusted with the task of coping with natural disasters, has defined and implemented emergency interventions (generally structural measures, such as: deepening of wells or realization of new ones, extraordinary maintenance of the main hydraulic infrastructures, temporary allocation of water resources for irrigation purpose to drinking/municipal use, etc). Moreover, Commissioners for Water Emergency have been generally appointed by the Prime Minister during recent droughts.

Although several innovations have been included in the Italian legislation on water resources during the last decades, water management during drought conditions is not ruled properly. This is mainly due to the fact that (i) the necessity of a proactive approach to face efficiently drought consequences does not seem to be widely shared, (ii) a clear distinction between long term and short term measures for drought impact mitigation is lacking, and (iii) the assignment of competences among institutions in charge of planning, water supply agencies, and institutions in charge of emergency management, as the Department of Civil Protection, is ambiguous.

Other significant elements which limit the implementation of an appropriate drought management policy include: the lack of efficient drought monitoring and forecasting systems, the difficulty in transferring advanced methodologies of drought risk assessment to water managers, and the complexity in defining simple and objective criteria to properly select and implement mitigation measures.

In what follows, methodologies for drought identification and characterization, and for risk assessment in water supply systems are applied to an Italian case study, namely the Simeto River basin in Sicily. In particular, drought identification is carried out by means of the Standardized Precipitation Index (SPI) (McKee et al., 1993), the Palmer Hydrological Drought Index (PHDI) (Palmer, 1965) and the Run Method (Yevjevich, 1967). Drought characterization also includes the application of a new methodology for the assessment of the return periods of drought events (Bonaccorso et al., 2003, Cancelliere et al., 2003) identified on the historical annual precipitation series.

Then, the methodology for drought risk assessment in water supply system described in chapter 6 of this book (Cancelliere et al., 2009) is applied to the Salso-Simeto water supply system, which is a part of the larger system of the Simeto River basin. In particular, a Montecarlo simulation of the system, making use of generated streamflow series and a water supply system simulation model, is carried out in order to assess both unconditional (long term) and conditional (short term) drought risk. Also, drought impact assessment on rainfed agriculture is presented. Finally, drought mitigation measures historically adopted during past drought events within the Simeto River basin, in order to reduce drought impacts in urban and agricultural sectors, are described.

## The Water Supply System of the Simeto River Basin

The Italian case study of the Medroplan project is the Simeto River basin, located in Eastern Sicily (see Fig. 14.1). The mean annual precipitation over the basin is about 600 mm. The climatic conditions are typical of a Mediterranean semi-arid region, with a moderately cold and rainy winter and a generally hot and dry summer.

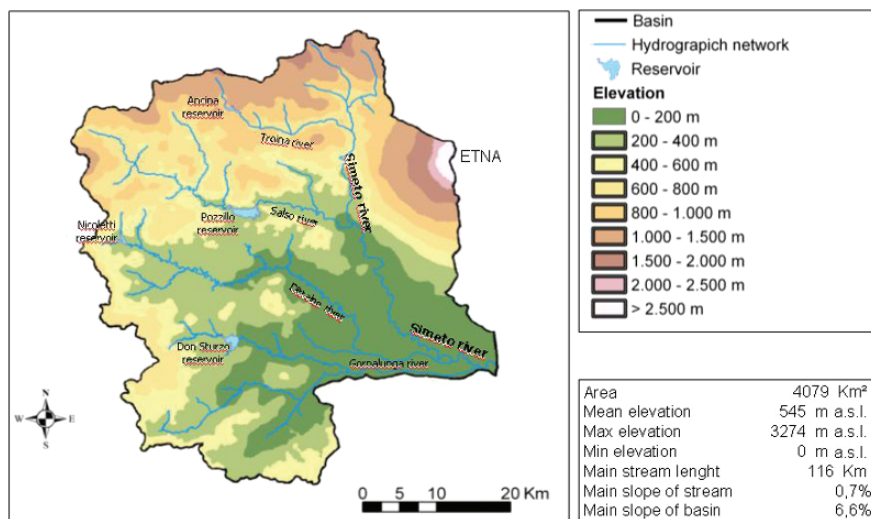


Fig. 14.1 The Simeto River basin

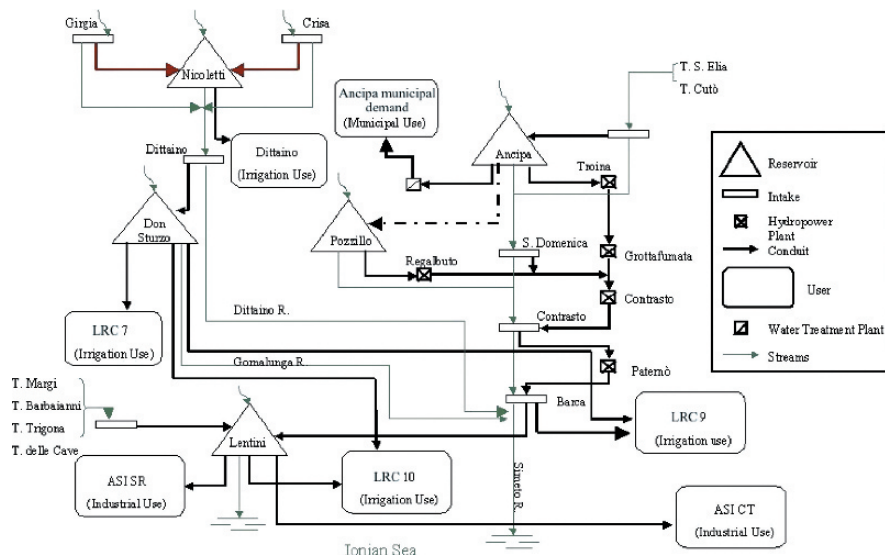
The basin includes various agricultural, municipal and industrial uses and is mainly supplied by a set of multipurpose plants for regulation and diversion of streamflows.

As shown in Fig. 14.2, the current water supply system can be divided in two sub-systems: the Salso-Simeto system and the Dittaino-Gornalunga system.

The Salso-Simeto system was built during the 50s. It includes two dams, Pozzillo on Salso River and Ancipa on Troina River, three intakes located on the Simeto River (S. Domenica, Contrasto and Ponte Barca), and five hydropower plants operated by the Electric Power Agency (Enel).

The Ancipa reservoir has a net design capacity of  $27.8 \cdot 10^6 \text{ m}^3$ , which is currently limited, due to structural problems, to  $9.35 \cdot 10^6 \text{ m}^3$ . A small portion of its releases are used to supply several municipalities in central Sicily, whereas the remaining portion is used for hydropower generation and irrigation purposes. The Pozzillo reservoir, which is mainly devoted to irrigation, has a current storage capacity of  $123 \cdot 10^6 \text{ m}^3$ . Most of the releases are routed for hydropower generation and irrigation of the main district of Catania Plain (irrigated area is about 18,000 ha), whose water conveyance and distribution network is operated and managed by the Land Reclamation Consortium no. 9 of Catania (LRC 9). Besides, a small amount of

release from Pozzillo is devoted to an irrigation district of the Land Reclamation Consortium no. 6 of Enna (LRC 6).



**Fig. 14.2** The water supply system of the Simeto River basin

In addition, the Lentini reservoir is connected to the system via the Ponte Barca intake on Simeto River. It has been recently built in order to meet the demands of the irrigation districts managed by LRC9 and the Land Reclamation Consortium no. 10 of Siracusa (LRC10), and of the industrial areas of Siracusa and Catania. It was designed for a net storage capacity of  $127 \cdot 10^6 \text{ m}^3$ .

The Nicoletti and Don Sturzo reservoirs, in the Dittaino-Gornalunga system, were built during the 70s for regulating streamflows and for irrigating the Dittaino valley. The Nicoletti reservoir has a storage capacity of  $17.4 \cdot 10^6 \text{ m}^3$ , whereas the Don Sturzo reservoir has a storage capacity of  $110 \cdot 10^6 \text{ m}^3$ . The Dittaino-Gornalunga water supply system is operated and managed by the Land Reclamation Consortia no. 6 of Enna (LRC6) and no. 7 of Caltagirone (LRC7).

The main features of the reservoirs of the Simeto water supply system are summarized in Table 14.1.

Available hydrological data include monthly series of precipitation at 22 rain gauges (with at least 80 years of observations starting from 1921), temperature at 4 stations (observations from 1926 to 2003) and streamflow at 10 hydrographic stations (with different sample size).

For the purpose of investigating the hydrological features of the basin, the whole basin has been divided in 9 sub-basins, which roughly coincide with sub-basins upstream of a diversion or of a reservoir or of a merging of two rivers. For each sub-basin, average seasonal precipitation, average mean temperature and historical series of different drought indices have been computed.

**Table 14.1** Basins drainage areas, storage capacities and average annual inflows of reservoirs in Simeto water supply system

Reservoir	Surface area (km <sup>2</sup> )		Storage capacity (10 <sup>6</sup> m <sup>3</sup> )	Annual average inflows (10 <sup>6</sup> m <sup>3</sup> )
	Direct basin	Tributary basins		
Ancipa	51	58	27.8 (9.3*)	57.54
Pozzillo	577	–	123	92.06
Lentini	16	1086+341	127	96.40
Don Sturzo	171	285	110	31.60
Nicoletti	49.5	13+42	17.4	22.70

\* Operational constraint

Moreover, a preliminary stationarity analysis on available precipitation series has been carried out in order to check for trends or jumps in the series, revealing that at least 50% of the considered annual series (computed with respect to the water year) present a significant trend and are not homogeneous in the mean.

## Drought Identification and Characterization

### *SPI*

The SPI (McKee et al., 1993) is one of the most widely applied tools for drought identification and monitoring. The dimensionless and standardized nature of the index allows droughts to be compared among regions with different climates, as well as droughts occurring during different seasons of the year.

According to the commonly adopted classification (see Table 14.2), negative values of the index describe drought conditions, while positive values indicate wet conditions.

**Table 14.2** Wet and drought period classification according to the SPI index, provided by National Drought Mitigation Center (NDMC, <http://www.ndmc.unl.edu>).

Index value	Class
$SPI \geq 2.00$	Extremely wet
$1.50 \leq SPI < 2.00$	Very wet
$1.00 \leq SPI < 1.50$	Moderately wet
$-1.00 \leq SPI < 1.00$	Near normal
$-1.50 \leq SPI < -1.00$	Moderate drought
$-2.00 \leq SPI < -1.50$	Severe drought
$SPI < -2.00$	Extreme drought

The SPI has been applied on the available monthly precipitation series aggregated at various time scale  $k$ , corresponding to the time intervals at which the different hydrological components are more sensitive to a significant reduction in precipitation. As an example, Fig. 14.3 represents the time series of SPI at Salso at Pozzillo



reservoir. It can be observed that the most critical droughts occurred between the mid 80s and the beginning of the 90s, and the end of the 90s and 2003.

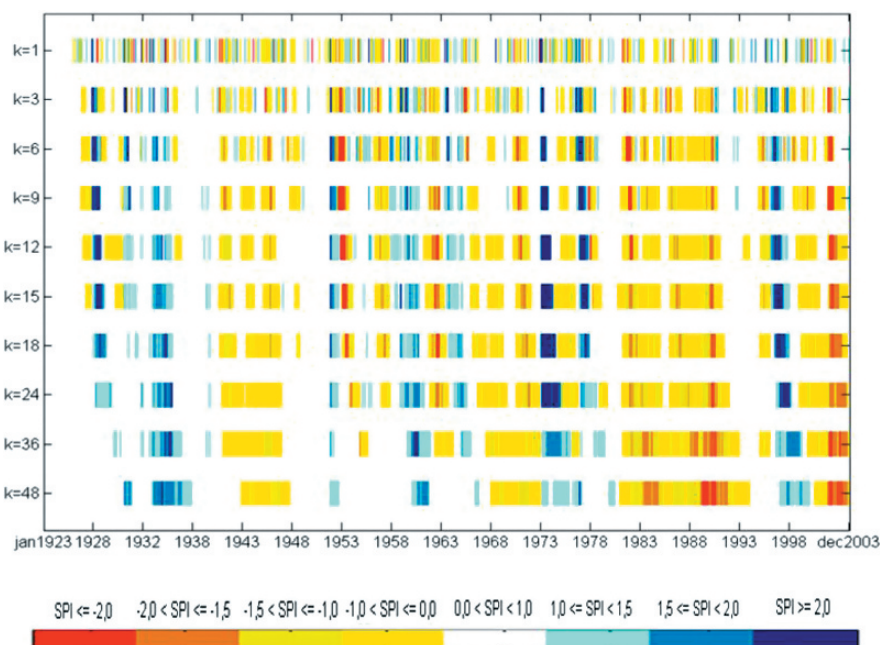


Fig. 14.3 Time series of SPI for different time scales  $k$  at Salso at Pozzillo reservoir

Another application of the SPI is presented in Fig. 14.4. In this case, the time series of the SPI at  $k = 12$  months are represented for each considered sub-basin of the Simeto River basin, reported in the vertical axis according to a geographical order, namely from North to South. A general coincidence of dry and wet periods can be observed among the different sites, which confirms that the climatic conditions are rather homogeneous over the whole basin, with a few exceptions.

### *PHDI Index*

The Palmer Hydrological Drought Index (Palmer, 1965) is based on a water balance model between soil moisture supply and demand for a two-layer soil on a monthly time scale. In order to evaluate such an index, precipitation and temperature series are required. Table 14.3 indicates the classification of dry and wet periods related to the Palmer Index.

In Fig. 14.5 time series of PHDI are represented for each sub-basin of the Simeto river basin. Results reported for PHDI are generally in agreement with those presented in Fig. 14.4, although PHDI seems to identify much longer and more severe drought conditions.



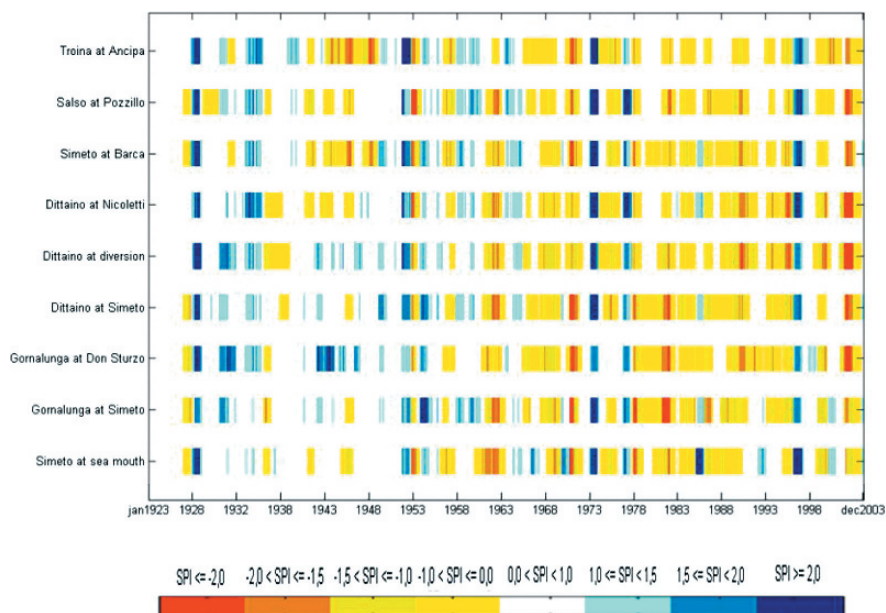


Fig. 14.4 Time series of SPI over the sub-basins of Simeto River ( $k = 12$  months)

Table 14.3 Wet and drought period classification according to the Palmer Index (PHDI)

PHDI	Class	PHDI	Class
$< -4$	Most severe drought	1 to 2	Nearly wet
$-4$ to $-3$	Severe drought	2 to 3	Medium wet
$-3$ to $-2$	Medium drought	3 to 4	Severe wet
$-2$ to $-1$	Nearly drought	$> 4$	Most severe wet
$-1$ to 1	Normal		

### Run Method

The run method (Yevjevich, 1967) allows an objective identification of drought periods and it can be applied for evaluating the statistical properties of drought. According to this method a drought period coincides with a “negative run”, defined as a consecutive number of time intervals where the observed values  $h(i)$   $i=1, 2, \dots, n$ , of a considered hydrologic variable, remains below a chosen truncation level or threshold  $h_0$ . For each drought event, the following characteristics can be derived:

- duration  $L$ , defined as the number of consecutive intervals where the variable remains below the threshold;
- accumulated deficit  $D$ , defined as the sum of the negative deviations with respect to  $h_0$ , extended to the whole drought duration;
- intensity of drought  $I$ , defined as the ratio between accumulated deficit and duration.

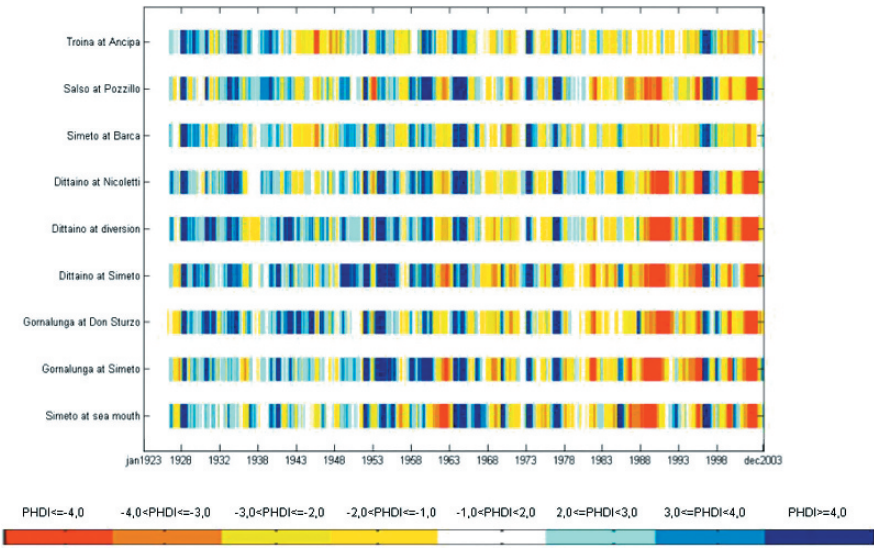


Fig. 14.5 Time series of PHDI over the sub-basins of Simeto River

The run method can also be extended to the case of regional droughts, i.e. droughts which affect large regions, by considering, in addition to the truncation level at each site, another threshold representing the value of the area affected by deficit, above which a regional drought is considered to occur.

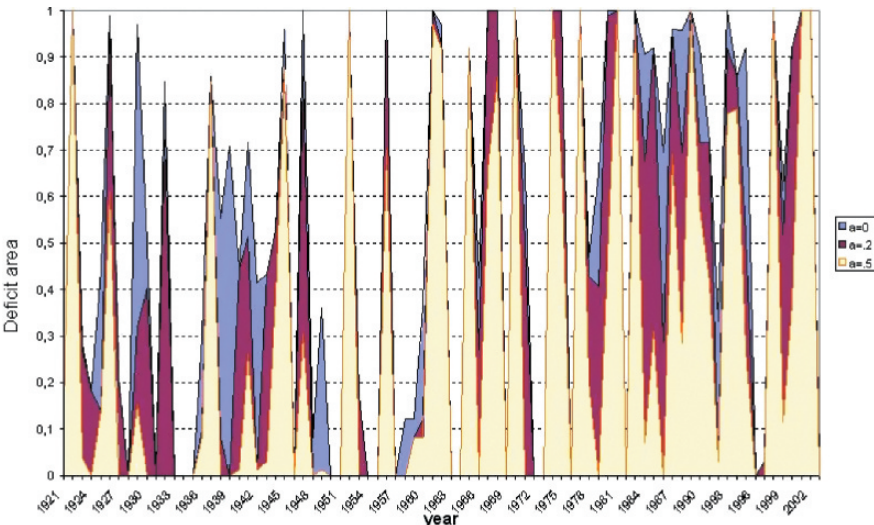


Fig. 14.6 Time series of deficit area over Simeto River basin for different threshold levels

Applications of the run method are illustrated in Figs. 14.6 and 14.7, where respectively the time series of deficit area (with respect to the total area of the basin), and areal deficit (i.e. the weighted average of deficits with respect to the influence areas of the stations where deficits occur) obtained by considering three different threshold levels at each site are shown. In particular, the threshold level is parametrized as  $h_0 = h_m - a \cdot s$ , where  $h_m$  is the sample mean,  $s$  is the sample standard deviation, and  $a$  is a dimensionless parameter assumed equal to 0, 0.2 and 0.5. The most critical drought can be recognized by the fact that the whole basin is under drought condition even for the minimum value among the considered threshold levels.

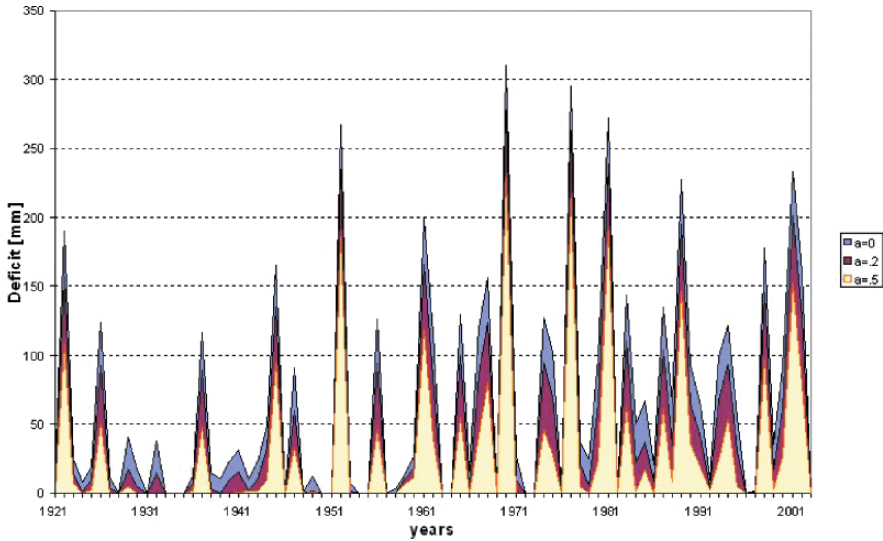


Fig. 14.7 Time series of areal deficit over Simeto River basin for different threshold levels

## Assessment of Drought Return Period

The return period of drought events can be defined as the expected value of the elapsed time or interarrival time between occurrences of critical events (Shiau and Shen, 2001). With reference to the generic critical drought event identified on stationary and serially independent series, the return period can be written as:

$$T = \frac{1}{p_1(1-p_1)} \cdot \frac{1}{P[A]} \quad (14.1)$$

where  $p_1$  is the probability of observing a surplus (i.e.  $P[h(i) \geq h_0]$ ) and  $P[A]$  is the occurrence probability of a critical drought event  $A$ .

The following cases have been taken into account:

- Drought event A with duration  $L$  equal to  $l$ , i.e.  $A = \{L = l, (l = 1, 2, \dots)\}$ ;
- Drought event A with duration  $L$  greater than or equal to  $l$ , i.e.  $A = \{L \geq l, (l = 1, 2, \dots)\}$ ;
- Drought event A with accumulated deficit  $D$  greater than a specified quantity  $d$ , i.e.  $A = \{D > d\}$ ;
- Drought event A with accumulated deficit  $D$  greater than a specified quantity  $d$  and duration  $L$  equal to  $l$ , i.e.  $A = \{D > d \text{ and } L = l, (l = 1, 2, \dots)\}$ ;
- Drought events A with accumulated deficit  $D$  greater than a specified quantity  $d$  and duration  $L$  greater than or equal to  $l$ , i.e.  $A = \{D > d \text{ and } L \geq l, (l = 1, 2, \dots)\}$ .

The probability distributions of drought characteristics above considered can be derived based on the distribution of the underlying hydrologic series and the threshold level (Bonaccorso et al., 2003; Cancelliere et al., 2003; Salas et al., 2005). In particular, the gamma distribution has been fitted to the precipitation series observed at the selected stations.

Such procedure has been implemented in a module of the software REDIM, specifically developed for drought identification and characterization by the Department of Civil and Environmental Engineering of the University of Catania (Rossi and Cancelliere, 2003), also including a routine for SPI computation.

In Fig. 14.8, an example of drought analysis carried out by REDIM, referred to the areal precipitation series over the Simeto River basin, for the period 1921–2003,

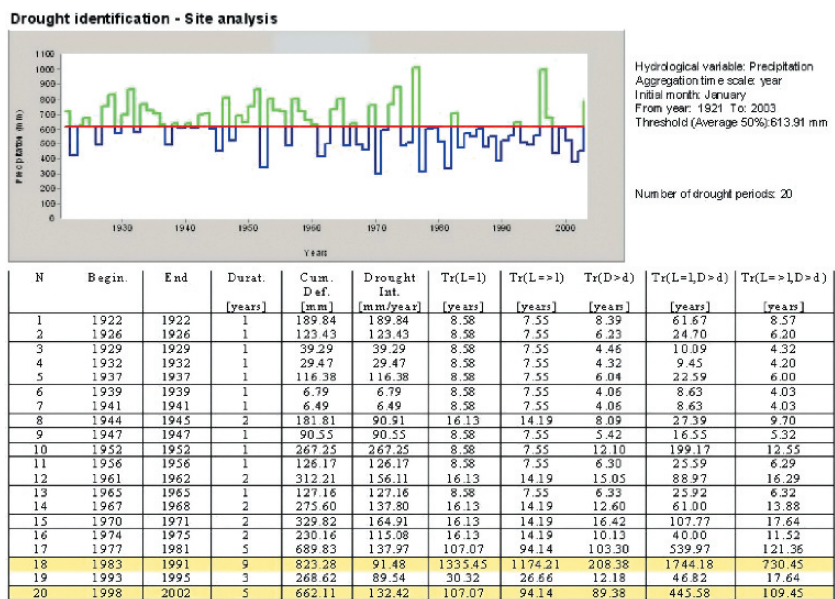
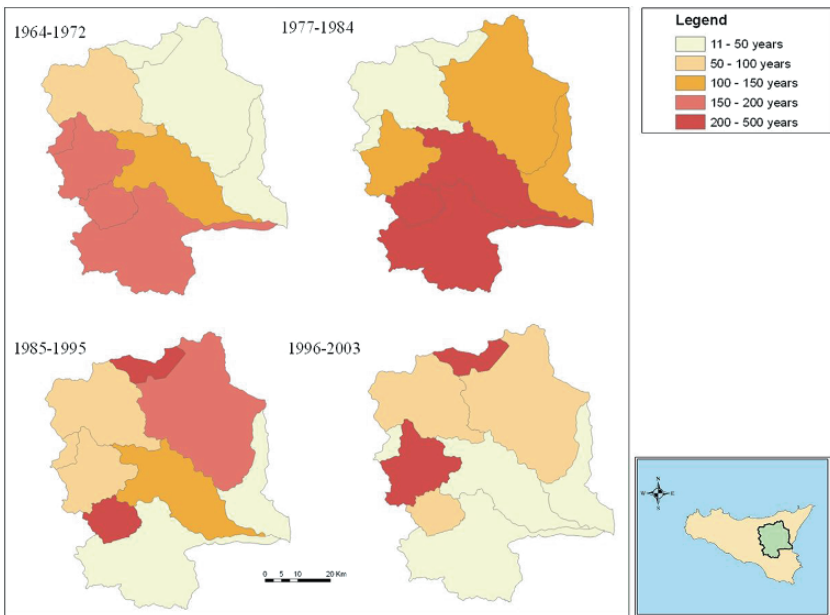


Fig. 14.8 Example of drought analysis carried out on the areal precipitation series over the Simeto River basin by using REDIM software

is presented. For each drought, identified by the run method using a truncation level equal to the long term mean, the beginning and termination years, together with related characteristics (duration, accumulated deficit, intensity) and return periods for all the cases previously mentioned are determined.

Also, the spatial distributions of drought characteristics and return period of historical drought events have been investigated. An example of such application is presented in Fig. 14.9, where spatial distributions of return periods  $T[L \geq l, D > d]$  corresponding to the most severe historical droughts occurred in the Simeto river basin are illustrated.

It is worth underlining that the differences in drought durations between Figs. 14.8 and 14.9 are clearly due to the fact that the first application is carried out on areal precipitation series, while the latter has been performed by interpolating local values of return periods computed on the basis of precipitation series observed in the considered 22 stations within the Simeto River basin.



**Fig. 14.9** Spatial distributions of return period  $T_r [L \geq l, D > d]$  of historical droughts occurred in the Simeto River basin

## Risk Assessment for Salso-Simeto Water Supply System

The methodology for the unconditional and conditional risk assessment of water shortages due to drought has been applied to the Salso-Simeto water supply system depicted in Fig. 14.10.



Fig. 14.10 Simeto River basin at Barca diversion

As shown in Fig. 14.11, the system under study includes two dams, Pozzillo on Salso River and Ancipa on Troina River, and one diversion located on the Simeto River. In addition, the Lentini reservoir is connected to the system via the Ponte Barca diversion on Simeto River.

Streamflow data include 42 years of reconstructed streamflows at Ancipa and Pozzillo reservoirs and Barca diversion, whereas the annual demands have been estimated as follows: demand for municipal use from Ancipa reservoir  $23.5 \cdot 10^6 \text{ m}^3/\text{year}$  with a constant distribution through the year, demand for irrigation uses  $121.4 \cdot 10^6 \text{ m}^3/\text{year}$  and  $3.4 \cdot 10^6 \text{ m}^3/\text{year}$  for Catania Plain (LRC9) and Enna (LRC6), unevenly distributed during the irrigation season from May to October. Furthermore, instream flow requirements (IFR) equal to  $9.1$ ,  $6.4$  and  $39.1 \cdot 10^6 \text{ m}^3/\text{year}$  downstream of Pozzillo and Ancipa dams and Barca diversion respectively have been also considered.



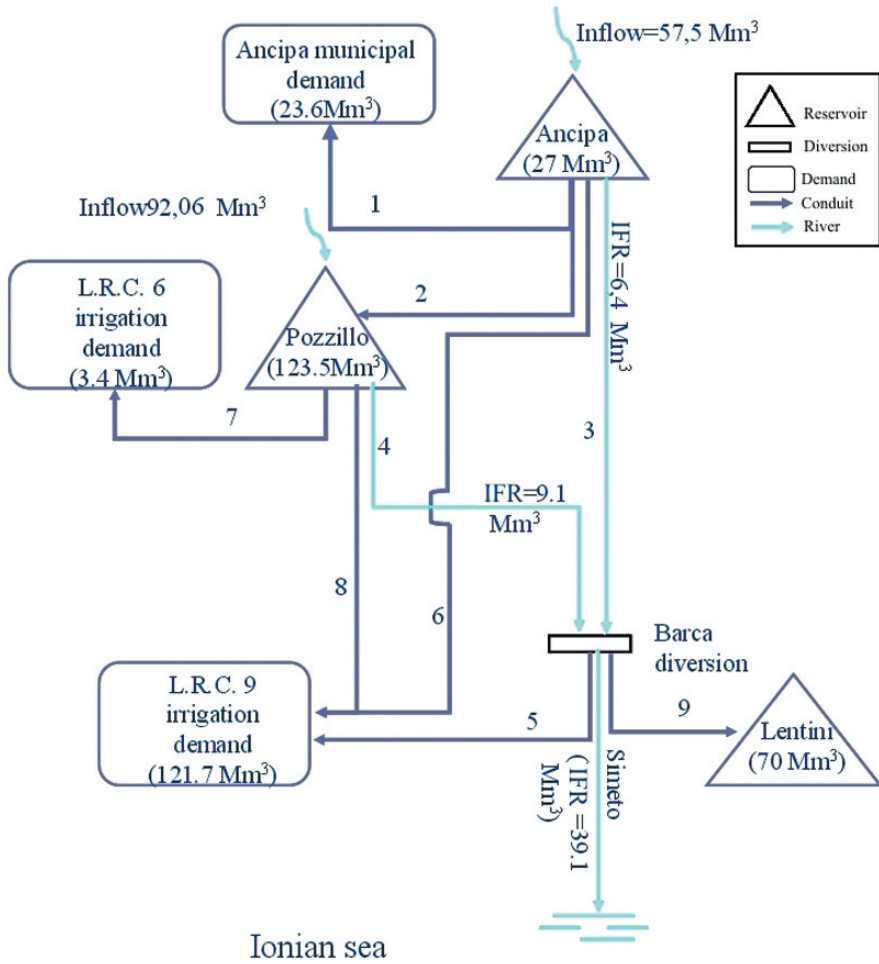


Fig. 14.11 Salso-Simeto water supply system

**Stochastic Generation of Streamflow Series for the Salso-Simeto Water Supply System**

In Fig. 14.12, the lag 0 monthly cross correlations between the three streamflow series (Pozzillo inflows, Ancipa inflows and Barca streamflows) are shown. From the figure, where the confidence limits under the no correlation hypothesis are shown by dashed lines, it can be inferred that in several months the series exhibit a significant cross correlation, while in others such cross correlation is negligible. Thus, the stochastic modeling of the three series must be carried out by means of a seasonal multivariate model, able to take into account the cross correlations, as well as their

seasonal variability from month to month. Generation of synthetic streamflow data has been performed by means of the software SAMS (Sveinsson et al., 2003).

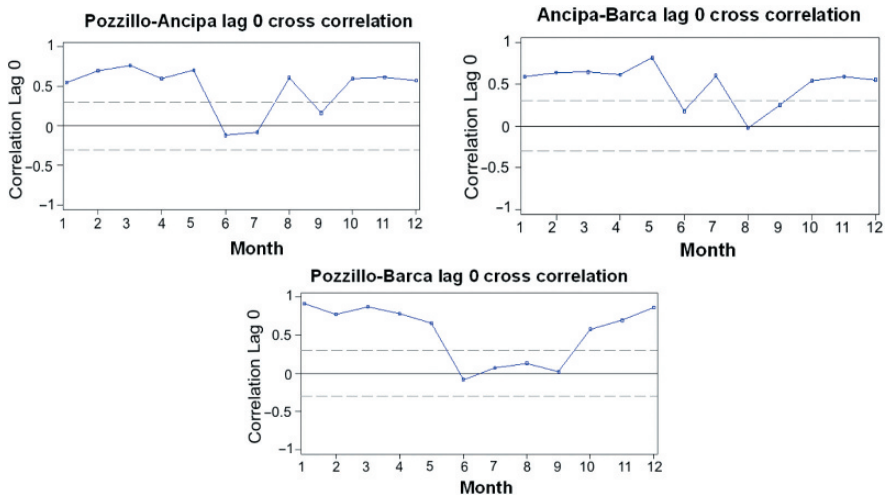


Fig. 14.12 Lag 0 monthly cross correlations between the three investigated series

Then, the proposed generation scheme is as follows:

First, annual and monthly data have been transformed, in order to reduce skewness, by means of the relation:

$$X_\nu = (X_\nu^* + a)^b$$

where  $X_\nu^*$  is the original (untransformed) data at year  $\nu$ ,  $X_\nu$  is the transformed data, approximately normally distributed, and  $a$  and  $b$  are parameters, obtained by imposing the minimization of the skewness of the transformed data.

Then, annual data are generated by means of multivariate autoregressive model:

$$\underline{X}_\nu = \underline{G}\underline{X}_{\nu-1} - \underline{L}\varepsilon_\nu$$

where  $\underline{X}_\nu$  is the vector of the values at year  $\nu$  at the three sites,  $G$  and  $L$  are square matrices (in our case 3x3), and  $\varepsilon_\nu$  is a vector of white noise.

Finally, monthly data are generated by means of a disaggregation scheme (Salas, 1993):

$$\underline{Y}_\nu = \underline{A}\underline{X}_\nu + \underline{B}\zeta_\nu + \underline{C}\underline{Y}_{\nu-1}$$

where  $\underline{Y}_\nu$  is the vector of the monthly values at year  $\nu$  at the three sites,  $\underline{Y}_{\nu-1}$  is a vector of values from the previous year,  $\zeta_\nu$  is a white noise vector and  $\underline{A}$ ,  $\underline{B}$  and  $\underline{C}$  are matrices of parameters.



In Table 14.4, the comparison between historical and generated annual statistics at the three sites is shown. It can be inferred that the model is able to preserve the main statistics of the observed series and therefore it is suitable for data generation.

**Table 14.4** Comparison between statistics of historical and generated annual streamflow series at the three sites

	Pozzillo		Ancipa		Barca	
	Historical	Generated	Historical	Generated	Historical	Generated
Mean [ $10^6$ m <sup>3</sup> ]	92.06	91.83	57.54	57.50	231.50	231.30
StDev [ $10^6$ m <sup>3</sup> ]	56.57	53.78	18.99	18.91	68.59	66.98
CV	0.61	0.59	0.33	0.33	0.30	0.29
Skew	1.57	1.06	0.52	0.21	1.01	0.79
Min [ $10^6$ m <sup>3</sup> ]	8.50	0.00	13.30	0.00	109.20	61.12
Max [ $10^6$ m <sup>3</sup> ]	295.10	540.40	116.20	155.90	438.50	728.90
$\rho(1)$	-0.03	0.06	0.13	0.15	-0.08	0.01
$\rho(2)$	-0.16	-0.08	0.02	-0.06	-0.04	-0.05

### *Simulation of the Salso-Simeto Water Supply System*

Simulation of the system has been carried out by means of the software SIMDRO (Cancelliere et al., 2006), specifically developed to simulate the implementation of drought mitigation measures according to a specified plan. SIMDRO simulates the system through a node-link network. Sources and uses are represented by numbered nodes whereas system connections are represented by links characterized by origin node (source) and final node (source or use).

One of the most important features of SIMDRO is that it is specifically oriented at the implementation of drought mitigation measures. In particular the software is able to simulate the system behaving differently in dependence of different hydrological states to which different possible drought mitigation measures defined by the user correspond.

Three different hydrological states namely *normal*, *alert* and *alarm* can be defined by the user as a function of the available storage in the reservoirs.

If in a given month water availability is less than the trigger defined for the hydrological state characterized by normal conditions, the system will switch from normal condition to alert conditions (or from alert to alarm), behaving as previously defined by the user, namely making effective the planned drought mitigation measures.

The drought mitigation measures to be set by the user, varying from normal to alert and alarm conditions, are listed below:

- priority of demands;
- priority of sources to meet a specified demand;
- maximum release in a given month;
- maximum in-stream ecological release for a given month;
- minimum stored volume on reservoirs under which not consider low priority demands;

- demands and their monthly distribution;
- level of rationing for each demand.

The general aim of the planned mitigation measures could be to impose small deficits in the present in order to reduce the risk of larger deficits in the future.

For the Salso-Simeto water supply system the simulation in normal conditions has been performed according to the following operating rules:

- Target storages are imposed at Pozzillo and Ancipa reservoirs, such that no water is released if the stored volume is below the target, with some exceptions. In Fig. 14.13, the monthly target storages at Pozzillo and Ancipa are shown.
- Municipal demand has the highest priority over the other demands and up to a percentage equal to 90% is not affected by target storages (i.e., 90% of the demand will be released regardless of the target storages).
- A water transfer up to  $8 \cdot 10^6$  m<sup>3</sup>/month from Ancipa to Pozzillo is activated during the winter months if the volume stored in Ancipa is greater than 85% of net storage ( $24 \cdot 10^6$  m<sup>3</sup>).
- Instream flow requirements are released from the reservoirs and the diversion, unless the upstream inflow in the time interval is less. In this case, the whole available streamflow is released.
- During the winter months, a water transfer from Barca to Lentini is activated up to  $11.7 \cdot 10^6$  m<sup>3</sup>/month.

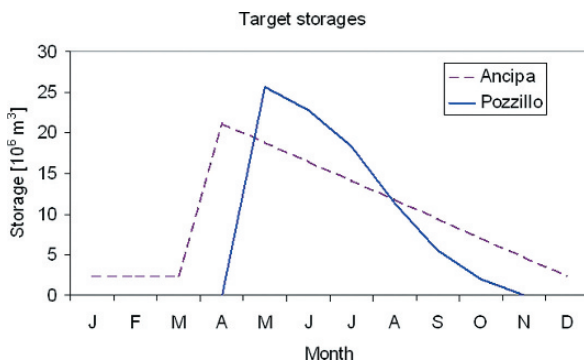


Fig. 14.13 Target storages at Pozzillo and Ancipa reservoirs

Alert and alarm conditions are activated by comparing the total storage in Pozzillo and Ancipa with triggering levels, shown in Fig. 14.14. In particular the following measures are adopted in case of:

Alert conditions:

- Relax target storage requirement for municipal
- Restrictions on irrigation use;
- No irrigation release from Ancipa;

Alarm conditions:

- As Alert + relax instream flow requirement.



Fig. 14.14 Triggering levels for normal, alert and alarm conditions

### *Unconditional Risk Assessment of Water Shortages Due to Drought*

Unconditional risk assessment of the Salso-Simeto water supply system has been carried out through two sets of simulations. In the first case, no mitigation measure has been considered, i.e. the system has been assumed to be always in normal conditions. In the second case mitigation measures have been activated as previously mentioned. Simulations have been carried out with reference to 500 generated series with the same length of the historical one (42 years).

In Tables 14.5 and 14.6, the performance indices obtained by simulating the system using the generated series are shown, with reference to the two main water uses of the system: municipal use (Ancipa aqueduct) and irrigation use (LRC9) respectively. From each table, the comparison between the system performances with or without mitigation measures can be inferred.

In particular, with reference to the municipal supply, both temporal and volumetric reliability show a reduction due to the mitigation measures of about 9% for temporal reliability and less than 1% for volumetric reliability. The reduction in the indices just mentioned is fully balanced by the gain of about 20% for the average shortage period length index (from 4.0 to 3.2 months), 50% for the maximum monthly shortage index (from 2.0 to 1.0  $10^6$  m<sup>3</sup>), 26% for the maximum annual shortage index (from 12.9 to 9.5  $10^6$  m<sup>3</sup>) and about 56% for the sum of squared shortage index (from 47.7 to 21.1  $10^6$  m<sup>3</sup>). Better values of the latter performance indices have to be ascribed to the implementation of mitigation measures such as restrictions on irrigation and no irrigation release from Ancipa.

**Table 14.5** Performance indices for municipal use (Ancipa aqueduct). Simulation on generated series

Ancipa aqueduct						
	Temporal reliability (% month)	Volumetric reliability (%)	Average shortage period length (months)	Max monthly shortage ( $10^6 \text{ m}^3$ )	Max annual shortage ( $10^6 \text{ m}^3$ )	Sum of squared shortage ( $10^6 \text{ m}^3$ )
No mitigation measures	96.8	97.4	4.0	2.0	12.9	47.7
Mitigation measures	88.1	96.9	3.2	1.0	9.5	21.1

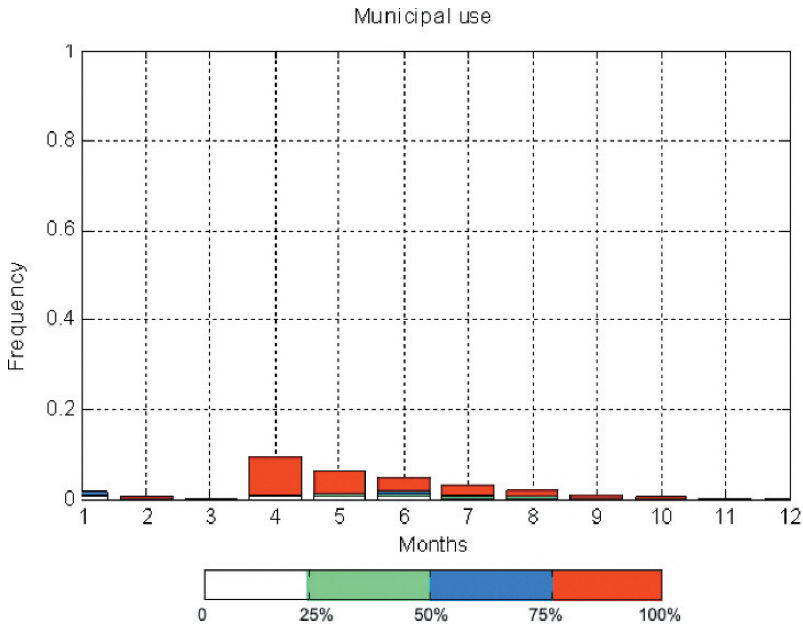
**Table 14.6** Performance indices for irrigation use (LRC9). Simulation on generated series

LRC9						
	Temporal reliability (% month)	Volumetric reliability (%)	Average shortage period length (months)	Max monthly shortage ( $10^6 \text{ m}^3$ )	Max annual shortage ( $10^6 \text{ m}^3$ )	Sum of squared shortage ( $10^6 \text{ m}^3$ )
No mitigation measures	71.4	81.9	3.1	34.1	104.0	7264
Mitigation measures	73.0	82.9	3.0	33.2	98.6	5920

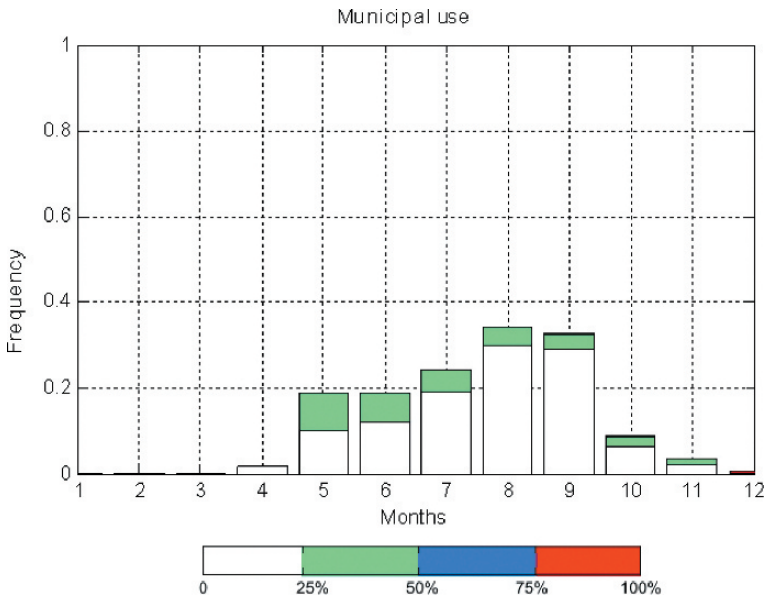
Table 14.6 shows that basically average shortage period length and maximum monthly shortage indices are slightly affected by the implementation of the drought mitigation measures, while temporal and volumetric reliability show very slight increases; on the contrary maximum annual shortage and sum of squared shortage indices are likely to decrease (5% for the first and about 18% for the latter) due to the relaxation of the target storage requirements for municipal use, implemented as mitigation measure both in alert and alarm conditions in order to make more water available for irrigation use.

Figure 14.15 shows monthly frequencies of shortages for municipal use as results of the simulation on generated series without mitigation measures. In this case shortages of more than 75% of the municipal demands appear for the whole period within March to August with an occurrence probability, expressed in terms of frequency of shortage, of about 0.05 with a peak for April of about 0.1, while almost no shortages appear from September to February.

Figure 14.16 shows the same type of results of Fig. 14.15 for the simulation implementing drought mitigation measures triggered by the defined hydrological states. The occurrence probabilities in the period from March to August is increased in comparison with the simulation without mitigation measures (on average 0.1 with a peak for August of about 0.3), but the entity of the shortages is reduced to the class of shortages less or equal than 50% of the municipal demand. The period from September to February shows shortage belonging to the class of less than 25% and



**Fig. 14.15** Monthly frequencies of shortages for Enna municipalities (simulation without mitigation measures)

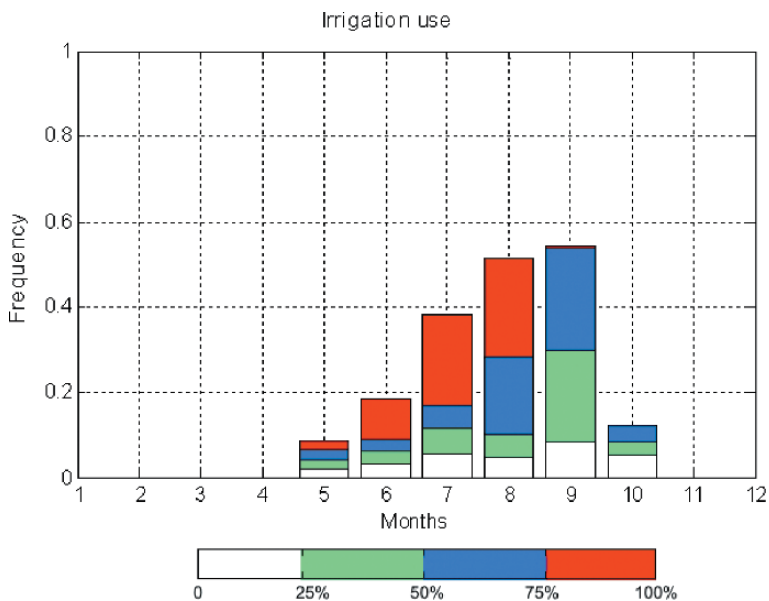


**Fig. 14.16** Monthly frequencies of shortages for Enna municipalities (simulation with mitigation measures)

only occasionally less than 50% of the municipal demand, while almost no shortages in the simulation without mitigation measures appeared.

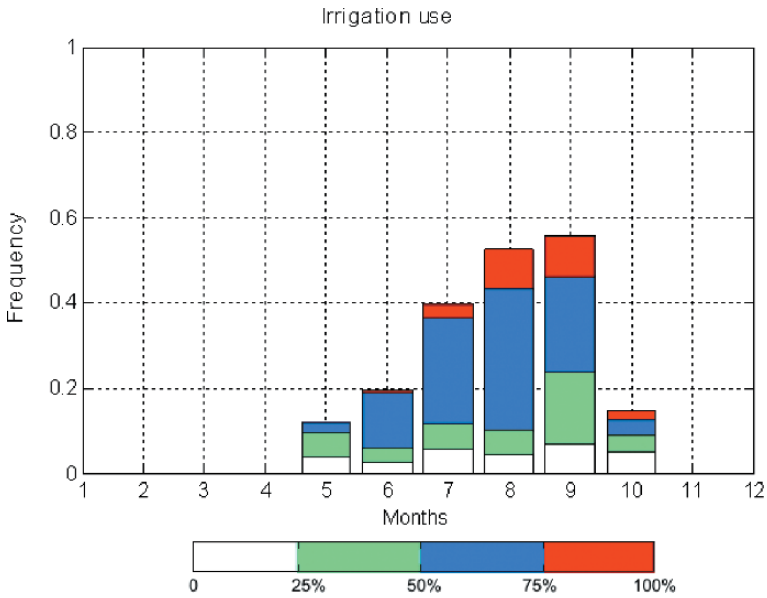
As expected the implementation of mitigation measures produces more frequent but slighter shortages, making a given drought event more tolerable for the particular demand.

Figures 14.17 and 14.18 show for the irrigation demand the same kind of behavior obtained for the municipal one. Implementation of mitigation measures produces almost the same monthly occurrence probabilities of shortages of the simulation without mitigation measures, but decreasing the class of shortage. For almost the entire irrigation season, indeed, Fig. 14.17 shows shortages greater than 75% of the irrigation demand, while Fig. 14.18 shows less occurrence probability of shortages belonging to this class. Globally, implementing mitigation measures helps to reduce the amount of shortages during the irrigation season.

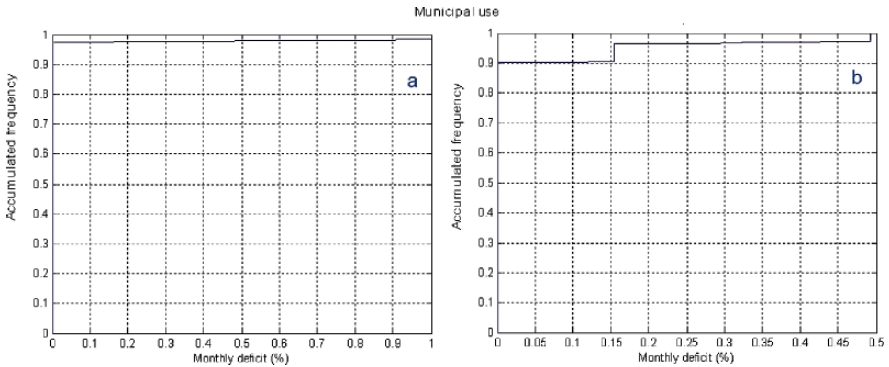


**Fig. 14.17** Monthly frequencies of shortages for LRC9 irrigation use (simulation without mitigation measures)

Figure 14.19 shows sample frequencies of monthly shortages for the municipal demand as a result of simulations using generated series with and without mitigation measures. As depicted in Fig. 14.19(a) simulations without mitigation measures produce almost the same probability for shortages of large or small entity whereas Fig. 14.19(b) shows that, implementing mitigation measures, monthly shortages of more than 50% of municipal demand are very unlikely, even if shortages of minor importance are more frequent than in the case without mitigation measures.



**Fig. 14.18** Monthly frequencies of shortages for LRC9 irrigation use (simulation with mitigation measures)



**Fig. 14.19** Sample frequencies of monthly shortages for municipal use (simulation (a) without and (b) with mitigation measures)

Sample frequencies of monthly shortages for irrigation demand (LRC9) reported in Fig. 14.20, respectively for simulations without and with mitigation measures, show almost the same pattern except for a step with shortages of about 67% of the irrigation demand, that goes from an accumulated frequency of about 0.91 to 0.97 for the case with mitigation measures. Again, implementation of mitigation

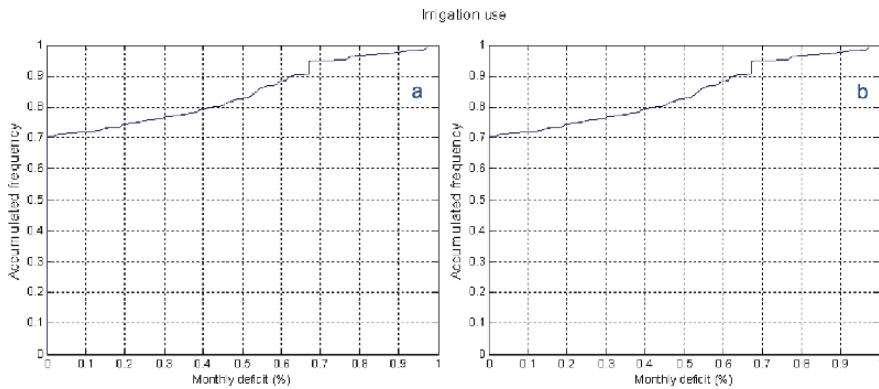


Fig. 14.20 Sample frequencies of monthly shortages for irrigation use (simulation (a) without and (b) with mitigation measures)

measures has reduced the occurrence of large shortages, leaving substantially unchanged non-exceedence probabilities of smaller shortages.

The two curves of Fig. 14.21 show return periods of annual shortages in municipal demand for simulations performed with and without mitigation measures. The curves are very close to each other for shortages less than 30% of municipal annual demand then start to depart from the same pattern, showing, for example, differences of about 33% (from about 140 to about 210 return period years) for shortages of 50% of the municipal demand. The curves show a more than linear direct relationship between percentage of shortage and return period that becomes more relevant for the simulations with mitigation measures.

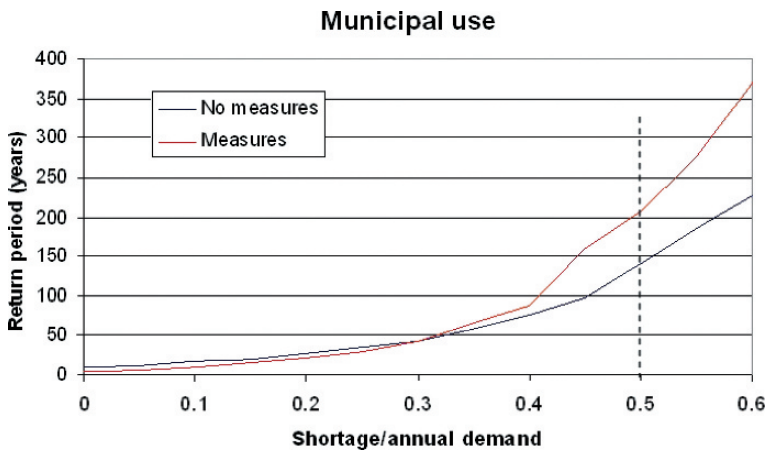


Fig. 14.21 Comparison between return period of annual shortages for municipal use simulating without or with mitigation measures



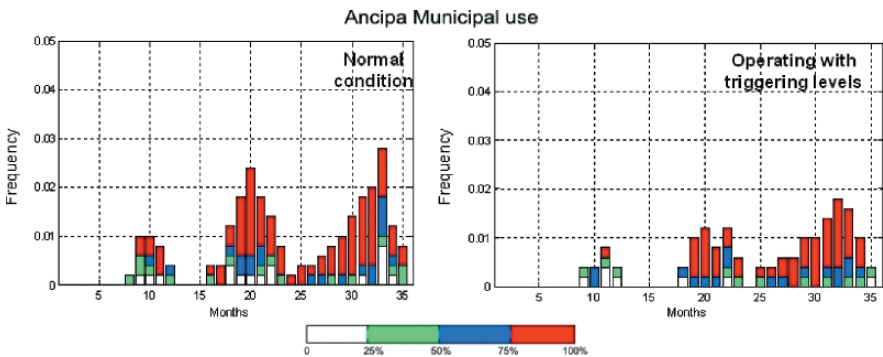
### *Conditional Risk Assessment of Water Shortages Due to Drought*

Conditional risk assessment of the Salso-Simeto water supply system has been carried out by means of 500 synthetically generated series of 36 months, starting from the initial condition that the system presented in correspondence of March 1989.

This particular condition has been chosen as consequence of the analysis performed over the whole available historic period. The historic simulation, indeed, shows that a significant period of shortages in irrigation and municipal demands started in 1989.

In order to perform the conditional risk assessment and to verify the goodness of the proposed mitigation measures, two different management criteria have been used. The first criterion considers the system managed as it was in normal condition, i.e. no activation of mitigation measures is implemented regardless of the actual state of the system. The second simulates the system following a possible drought mitigation plan providing triggers based on the actual volumes stored on the reservoirs of the system to activate the different state conditions and the relative mitigation measures (see Fig. 14.14).

Figure 14.22 shows the frequencies of shortage in municipal use for 36 months ahead, starting by the condition of the system of March 1989 for the two above mentioned management criteria.

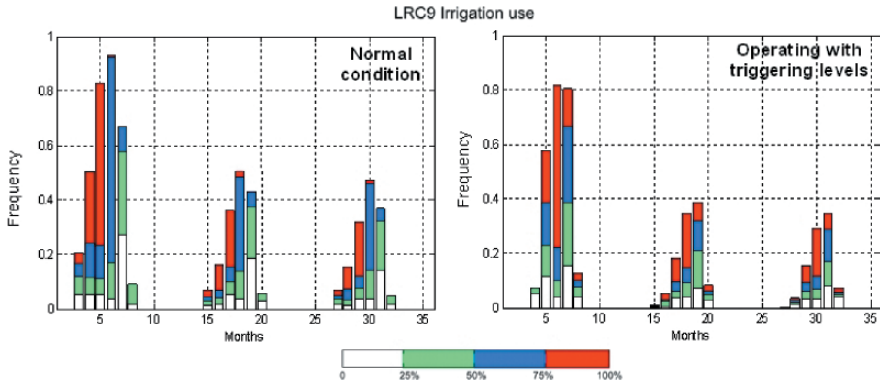


**Fig. 14.22** Frequency of shortage in municipal use in the 36 months following March 1989

From the figure it can be inferred that, if the system is managed following the policy typical of normal condition, greater and more frequent shortages appear with respect to those obtained in the case of operating the system with triggering levels.

Figure 14.23 shows the frequencies of shortage on irrigation use for 36 months ahead, starting by the condition of the system of March 1989.

Better results obtained for municipal demand respect to those obtained on irrigation varying management conditions are due to the fact that mitigation measures are particularly devoted to the satisfaction of municipal use as required by law.



**Fig. 14.23** Frequency of shortage in irrigation use in the 36 months following March 1989

In particular, during alert conditions, the absence of irrigation releases from Ancipa reservoir to the Land Reclamation Consortium 9 makes more water available for municipal use. Similar considerations can be drawn for the alarm conditions case.

On the contrary activation of migration measures does not gives good results for irrigation use as shown by Fig. 14.23. However, goodness of chosen mitigation measures is confirmed by the general reduction of the probability to have deficits during the future 36 months under investigation, and from the fact that in general the probability to have large deficits is decreased.

Results obtained by operating with triggering levels are better than those obtained by the simulation of the system always in normal condition. Indeed, the overall probability of deficits and their amount is less for both uses if the system is operated with triggering levels activating mitigation measures based on the provided thresholds.

The following Tables 14.7 and 14.8 report performance indices of the system calculated for the simulations in the two operational conditions considered. All indices, calculated as mean of indices obtained for each of the 500 simulations done,

**Table 14.7** Performance indices of the system operated in normal conditions

	Temporal reliability (% month)	Volumetric reliability (%)	Average shortage period length (months)	Max monthly shortage ( $10^6 \text{ m}^3$ )	Max annual shortage ( $10^6 \text{ m}^3$ )	Sum of squared shortage ( $10^6 \text{ m}^3$ )
Ancipa aqueduct (municipal use)	99.2	99.4	0.21	0.09	0.33	0.56
Irrigation use (LRC9)	65.3	75.5	2.90	16.97	36.33	756.22
Irrigation use (LRC6)	96.3	96.5	0.55	0.11	0.21	0.097

**Table 14.8** Performance indices of the system operated with triggering levels

	Temporal reliability (% month)	Volumetric reliability (%)	Average shortage period length (months)	Max monthly shortage ( $10^6 \text{ m}^3$ )	Max annual shortage ( $10^6 \text{ m}^3$ )	Sum of squared shortage ( $10^6 \text{ m}^3$ )
Ancipa aqueduct (municipal use)	99.5	99.6	0.14	0.06	0.21	0.33
Irrigation use (LRC9)	75.8	82.4	2.42	14.8	29.0	570.25
Irrigation use (LRC6)	86.8	91.5	1.36	0.28	0.42	0.18

provide a better performance when the system is managed by triggering levels either for municipal use and irrigation use (LRC9).

Satisfaction of irrigation use at LRC6 is penalized by the mitigation measures in comparison to the larger LRC9 irrigation use, because it can rely on alternative sources that are insufficient for LRC9.

Indices obtained operating the system with triggering levels represent the performance obtainable following the behavior of the water managers that tend to adapt the managing to real conditions of the system and not to follow pre-constituted operating rules.

Operating with triggering levels contributes to reduce risk of deficit both for municipal and irrigational demands, resulting in worse conditions only for irrigational demand during the third year, fully compensated by the gains obtained on municipal demands during the previous two years.

## Drought Damages in Rainfed Agriculture

Drought impacts in the agricultural sector strictly depends on the type of agriculture practiced in a specific area: rainfed or irrigated. Indeed, in rainfed agriculture drought impacts are usually very severe and often all or part of the crop production is lost.

Irrigation is, clearly, the best way to cope with the climatic variability, although in the farms or districts supplied by surface water the impacts of droughts can also be very severe. In the farms supplied by groundwater, drought impacts are almost negligible for events lasting a short amount of time. For long drought periods, the impacts are related to the decreasing of the water tables levels. In this case the farmer is forced to change the operating rules of the wells and/or of the irrigation system. In the farms supplied by an irrigation district or by a land reclamation consortium, the impacts are related to water resources available during the drought period. When water resources are limited, the district/consortium gives priority to the fruit orchards and change the irrigation scheduling with a longer turn of water delivery.

In order to evaluate the risk associated to drought events in agriculture, an analysis of the expected social and economic impacts has to be carried out. The main difficulty related to this issue is to collect all the possible data about drought damages and express such data in economic terms. Among these data, damages caused by drought either to rainfed and irrigated agriculture, expressed as production losses, are generally assessed by specific institutions that control agriculture activity. For instance, in Italy, the damages consequent to drought events, are assessed by the Provincial Agricultural Offices, on their own initiative or requested by farmers. In particular, for each crop cultivated in the target area, the percentage of Gross Sale Production (GSP) corresponding to the economic loss is evaluated, then the whole damage is computed as a weighted average. Only when the assessed damage reaches a given percentage (30% according to the Legislative Decree 102/2004, 35% according to the previous law) of GSP of the whole crops production of the target area, it is possible to request the “natural disaster declaration”. Once that the extreme nature of the occurred drought event, in terms of impacts on agricultural production, is ascertained, the status of natural calamity is declared and funding to cover income losses or insurance is supplied to the Regional Government and then to Provincial Agricultural Offices, which are in charge of building new infrastructures and/or allocating funding to the farmers for insurance.

With regard to the examined case study, data related to losses in crop production during the recent drought events, as estimated by the Provincial Agricultural Offices, have been collected in the Offices of Catania, Siracusa and Enna. For these provinces the soil use, together with the location of the considered rain gauges, is reported in Fig. 14.24.

The sample series of the areal rainfall with respect to the cultivated areas in each province has been computed, based on monthly precipitation data observed in the selected rain gauges during the period 1921–2000, by using the Thiessen polygons methods. Rainfall values for each kind of soil has been determined by considering a weighted average among the intersections between cultivated areas and relative polygons. Finally, the corresponding SPI series have been calculated for fixed aggregation time scales  $k$ .

In particular, SPI has been calculated by considering an aggregation time scale  $k$  equal to the crop cycle (from seeding to harvesting) and/or to the critical phenological phases of the different crops. For instance, for cereal, precipitation occurring from October to December is essential for the sowing, as well as precipitation from March to May, after which plants are not able to complete the crop cycle. Therefore, for this case, it can be useful considering SPI values in May with an aggregation time scale of 7 or 8 months, or in January with an aggregation time scale of 3 or 4 months.

As an example, in Fig. 14.25 a preliminary comparison between SPI values and the contemporary percentage of damages on cereals for Catania province is presented. It is easy to observe that, even if there is a good agreement for  $k = 3$  months, however there is no direct proportionality between percentages of damages and SPI values for  $k = 7$  months. This can be partially due to the fact that drought impacts

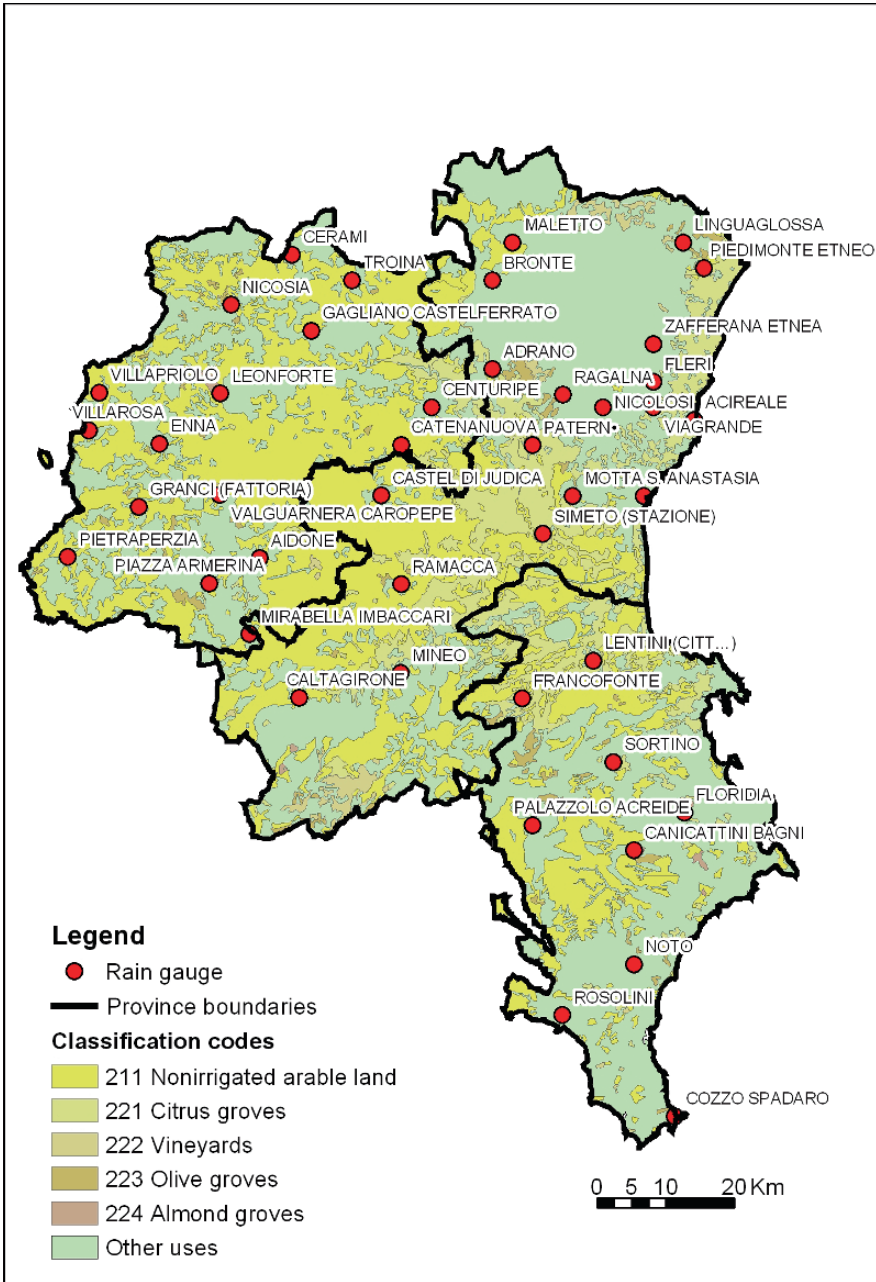


Fig. 14.24 Rain gauges and soil use for the provinces of Catania, Siracusa and Enna

on agriculture are roughly assessed, and in some cases they might be artificially increased in order to overcome the threshold for obtaining refunds according to current legislation.

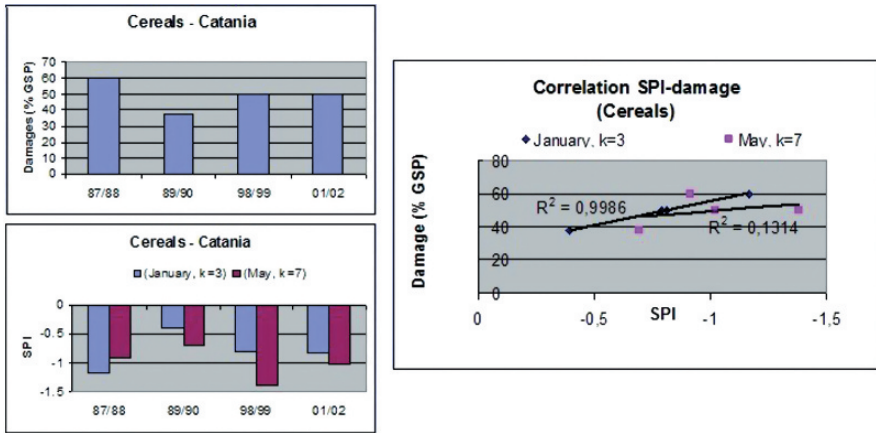


Fig. 14.25 Comparison between SPI and drought impacts on cereals for the province of Catania

### Drought Mitigation Measures for the Simeto River Basin

The measures to mitigate drought impacts can be classified in several ways (Rossi, 2000). A first classification (Yevjevich et al., 1978) refers to three main categories: i) water demand oriented measures, ii) water supply oriented measures, iii) drought impacts oriented measures. The first two categories of measures aim to reduce the risk of water shortage due to a drought event, while the third category is oriented to minimize the environmental, economic and social impacts of drought.

A second classification focuses on the type of response to drought problems, distinguishing between a *reactive* and a *proactive* approach. The *reactive* approach consists of measures adopted once that a drought occurs and its impacts are perceived, which aim to minimize drought impacts. The *proactive* approach consists of measures conceived and prepared according to a planning strategy (Yevjevich et al., 1983), which are implemented before, during and after a drought event. In particular, measures undertaken before a drought event aim to reduce the vulnerability of the system to droughts and/or to improve drought preparedness.

Within the proactive approach, a further classification can be made according to the time horizon of the measures, namely:

- long-term actions, oriented to reduce the vulnerability of water supply systems to droughts, i.e. to improve the reliability of each system to meet future demands under drought conditions by a set of appropriate structural and institutional measures;



- short-term actions, which try to face an incoming drought event within the existing framework of infrastructures and management policies.

Finally, for a more specific analysis of the various measures, the identification of the affected water use sector is necessary. Therefore, measures regarding at least 4 main categories, namely urban, agricultural, industrial, recreational and environmental, should also be distinguished.

Among the main actions undertaken at regional level, it is worth mentioning the activities carried out by the Water Observatory of the Sicilian Regional Agency for Waste and Water, formerly the Regional Technical Hydrographic Service of Sicily (STIR). In particular, a real time hydro-meteorological network, which also includes 40 gauges to measure the water level in the aquifers and 23 gauges to monitor the storage volumes in the most important Sicilian water supply reservoirs, has been developed in 2000.

Besides, a web-based monthly bulletin for drought monitoring has been developed by the Department of Civil and Environmental Engineering of Catania University for STIR, with the aim to provide the agencies in charge of water management in Sicily, with the information necessary in order to adopt appropriate drought mitigation measures and to improve drought preparedness. In Fig. 14.26, the home page of the drought bulletin for Sicily is shown.



Fig. 14.26 Home Page of the drought bulletin for Sicily

Moreover, campaigns for increasing population awareness to water saving, either at municipal and regional level, have been promoted by the Sicilian Regional Government.

About past actions to mitigate drought impacts in urban sector, during the last drought events, the Sicilian Aqueduct Agency, who manages reservoirs and main

aqueducts in Sicily, and the Municipal Water Supply Departments have implemented water supply increase measures, such as:

- diversion and reallocation of surface water resources (stored in Ancipa reservoir normally devoted to irrigation use);
- increase of groundwater withdrawal from wells for municipal use;
- use of groundwater withdrawal from private wells (normally devoted to irrigation use).

With reference to the actions adopted to mitigate drought impacts in agriculture, it is possible to distinguish between actions undertaken by Land Reclamation Consortia and by private farmers.

The main actions undertaken for the Simeto River basin by Land Reclamation Consortia of Catania, Caltagirone, Siracusa and Enna, have been:

- priority allocation of available resources for agricultural use in Ancipa and Pozzillo reservoirs to perennial crops (i.e. citrus trees) and restriction of water supply to annual crops;
- maintenance of canal networks for reducing water losses;
- projects to transform the canal network (conveyance and distribution) in pipelines;
- projects of emergency pumping plants of surface water stored in Lentini reservoir (currently not operational);
- projects of public ponds to improve the operation of irrigation systems.

The mitigation of damages in rainfed agriculture is principally linked to the *dry-farming practices* applied at farm level:

- collecting and saving rainfall (deep labour in summer, minimum tillage and weeding during the crop cycle, optimal planting and sowing, etc.);
- using water efficiently (low water consuming crop species, fertilization adapted to the water availability, selection of varieties able to accomplish their cycle within the length of the growing period, etc.).

In irrigated agriculture private farmers have implemented two different types of mitigation measure to cope with drought consequences:

- measures to increase preparedness to water scarcity;
- introduction of more efficient irrigation techniques (micro-irrigation);
- construction of farm ponds (to be filled by water delivered by the consortium before the irrigation season starts and/or from private wells);
- reduction of irrigated areas for annual crops.
- measures for coping with water shortage
- deepening of existing wells;
- construction of new wells;
- water transfer by trucks (in extreme cases and for small farms).

Also financial benefits for the farmers related to the “*natural disaster declaration*” by the national or regional government are to be mentioned. However, it should



be underlined that such benefits have been insufficient to cover the actual damages during the past drought periods (see Table 14.9).

**Table 14.9** Past actions to mitigate impacts in agriculture at state/regional level (financial measures to the farmers)

Province	Grant			Loan with 40% of grant			Five years loan		
	Amount requested (10 <sup>6</sup> €)	Amount provided (10 <sup>6</sup> €)	%	Amount requested (10 <sup>6</sup> €)	Amount provided (10 <sup>6</sup> €)	%	Amount requested (10 <sup>6</sup> €)	Amount provided (10 <sup>6</sup> €)	%
Catania	50.378	0.743	1.5	–	–	–	–	–	–
Siracusa	34.000	4.282	12.6	14.818	3.611	24.3	9.915	2.512	25.3
Enna	31.169	6.475	21.8	14.269	5.364	37.6	12.640	2.163	17.2

## Conclusions

The key issue for implementing an efficient drought management strategy should consist of the following steps: planning, monitoring and forecasting, implementation of mitigation measures planned in advance, management of emergency situations not foreseen during the planning process and recovery of drought damages.

In particular, drought monitoring and forecasting systems, able to promptly warn of the onset of a drought and to follow its evolution in space and time, as well as risk assessment procedures based on Montecarlo simulation of water supply systems under different scenarios, can help decision makers to timely select and implement appropriate measures to mitigate drought impacts on the water supply systems, the productive sectors and the environment.

In this chapter, applications of proposed methodologies for drought identification and characterization, risk assessment and risk management for water supply systems of the Simeto River basin in Sicily have been presented. More specifically, a detailed analysis of drought periods occurred in the Simeto River basin and related characteristics has been carried out by making use of SPI, PHDI and Run Method. Results show that the most critical droughts have been observed between mid '80s and the beginning of the '90s, and the end of the '90s and 2003.

Also, return periods of historical droughts occurred in the Simeto River basin, have been computed based on the probability distribution of the underlying hydrologic series and the truncation level adopted for drought identification through the Run Method. Results have highlighted that drought occurred between the mid 80s and the beginning of the 90s has been the most adverse event observed in the period 1921–2003. Moreover, spatial distribution of return periods of some of the most severe historical droughts occurred in the Simeto River basin has enabled drought prone areas to be identified within the basin.

With reference to the methodology for the unconditional risk assessment, aiming at comparing and selecting preferable mitigation alternatives through the Montecarlo simulation of water supply systems over a long time horizon (30–40 years),

application to the Salso-Simeto system has shown that it is possible to globally reduce higher monthly shortages by implementing mitigation measures. In addition, the methodology for the conditional risk assessment, performed through Montecarlo simulation with respect to a shorter time horizon (2–3 years) by taking into account the initial state of the system, represents a valuable tool which enables water managers to adapt managing rules to the real conditions of the water supply system by using appropriate triggering levels activating mitigation measures planned for worsening conditions of the system with regard to drought (Normal, Alert and Alarm).

Besides, an attempt to evaluate the risk associated to drought events in rainfed agriculture has been carried out, in terms of a preliminary comparison between SPI values and the contemporary percentage of damages on cereals for Catania province. Unfortunately, no direct proportionality between percentages of damages and SPI values can be inferred because drought impacts on agriculture are roughly assessed, and in some cases artificially increased in order to overcome the threshold for obtaining refunds according to current legislation.

Finally, the analysis of past actions to mitigate drought impacts both in the urban and agricultural sectors shows a prevailing recourse to emergency measures, some of which of structural type, with the purpose of increasing water supply, even though several projects have already been proposed aiming to reduce drought vulnerability of current systems, mainly in irrigated agriculture.

## References

- Bonaccorso B, Cancelliere A, Rossi G (2003) An analytical formulation of return period of drought severity, *Stochastic Environmental Research and Risk Assessment*, 17:157–174.
- Cancelliere A, Bonaccorso B, Rossi G, Salas J D (2003) On the probabilistic characterization of drought events, AGU 23rd Hydrology Days, Colorado State University, Fort Collins, Co.
- Cancelliere A, Rossi G, Nicolosi V M (2006) Valutazione del rischio di deficienza idrica dovuta a siccità in sistemi di approvvigionamento, Proceedings of the XXX Convegno di Idraulica e Costruzioni Idrauliche IDRA 2006, Rome, 10–15 September 2006.
- Cancelliere A, Nicolosi V M, Rossi G (2009) Assessment of drought risk in water supply systems, *in this book*.
- McKee T B, Doesken N J, Kleist J (1993) The relationship of drought frequency and duration to time scales, 8th Conference on Applied Climatology, Anaheim, California, 179–184.
- Palmer W C (1965) Meteorological drought. U.S. Weather Bureau. Research Paper 45, Washington, D.C.
- Rossi G (2000). Drought mitigation measures: a comprehensive framework, in *Drought and drought mitigation in Europe*, Vogt, J V, Somma F (eds.), Kluwer Academic Publishers, The Netherlands, pp. 233–246.
- Rossi G, Cancelliere A (2003) At site and regional drought identification by REDIM model, in Rossi G, Cancelliere A, Pereira L, Oweis T, Shatanawi M (eds.), *Tools for Drought Mitigation in Mediterranean Regions*, Kluwer Academic Publishers, Dordrecht, pp. 37–54.
- Salas J D (1993) Analysis and modeling of hydrologic time series, in Maidment D (ed.), *Handbook of Hydrology*, Chapter 19, McGraw-Hill, New York.
- Salas J D, Fu C, Cancelliere A, Dustin D, Bode D, Pineda A, Vincent E (2005) Characterizing the Severity and Risk of Droughts of the Poudre River, *Journal of Water Resources Planning and Management (ASCE)*, 131(5):337–408.

- Shiau J, Shen H W (2001) Recurrence analysis of hydrologic droughts of differing severity. *Journal of Water Resources Planning and Management*, 127(1):30–40.
- Sveinsson O, Salas J D, Lane W L, Frevert D K (2003) Progress in stochastic analysis modelling and simulation: SAMS-2003, 23rd Annual American Geophysical Union Hydrology Days, March 31–April 2 2003, Fort Collins, Co, USA, Colorado State University.
- Yevjevich V (1967) An objective approach to definitions and investigations of continental hydrologic droughts, Hydrology Paper no. 23, Colorado State University, Fort Collins, CO.
- Yevjevich V, Hall W A, Salas J D (1978) Proceedings of the Conference on Drought Research Needs, Water Resources Publications, Fort Collins, 276p.
- Yevjevich V, Da Cunha L, Vlachos E (1983) Coping with Droughts, Water Resources Publications, Littleton, Colorado, 417p.

# Chapter 15

## The Role of Groundwater During Drought

María Casado Sáenz, Francisco Flores Montoya and Roberto Gil de Mingo

**Abstract** Groundwater drought is a natural hazard that develops when groundwater systems are affected by drought, first groundwater recharge and later groundwater levels and groundwater discharge, that decreases. The origin of drought is a deficit in rain precipitation and that takes place in all the elements that comprise the hydrological cycle (flow in the rivers, soil humidity and groundwater). Depending on the deficit and duration of the drought this may affect all segments or not. This chapter analyses how drought influences and affects groundwater, which depends not only on the rain deficit but on some other parameters such as the physical properties of the aquifer, type of porous rock, aquifer dimensions and thickness of the unsaturated zone. Hydrological drought can be analysed using hydro-geological features and parameters such as piezometer levels, natural recharge or base flow. The usefulness of some indexes is presented here. The related concepts of water scarcity, overexploitation and groundwater mining are explained. This chapter reviews the importance and dependence of the different countries of the Mediterranean Basin on groundwater.

### Background

Although there are many books dedicated to analysing droughts, not so many are focused on the groundwater system. In Tallaksen and van Lanen (2004), all the concepts related to hydrological droughts are reviewed, including all the segments of the hydrological cycle, flow generating processes, best estimation methods to describe and analyse drought periods, drought indicators and modelling. A whole chapter is dedicated to the human influences and the type of measurements that can be implemented to cope with drought phenomena. Peters et al. (2005) and Peters et al. (2006), analyse the performance of a groundwater drought in terms

---

M. Casado Sáenz (✉)  
Confederación Hidrográfica del Tajo, Av. de Portugal,  
Madrid, Spain  
e-mail: maria.casado@chtajo.es

of reliability, resilience and vulnerability. New performance indicators that consider the relationship between drought frequency and severity are proposed. Propagation of droughts in the groundwater system, taking into consideration the spatial distribution is analysed for the Pang Catchment (UK), using modelled time series of recharge and hydraulic head.

Groundwater is an important issue in the Mediterranean Basin. The role of groundwater in the Mediterranean countries has recently been reviewed in MGR (2007) and in particular because drought situation and water scarcity are very frequent. The delayed or on some occasions inexistent influence of droughts on the groundwater system, makes this last one an ideal source of freshwater supply to alleviate and mitigate drought effects as has been pointed out by many authors. (Pulido, 1991). In Spain the Basin Drought Plans for each one of the riverbasins have recently been approved.

## **Groundwater and Drought**

### ***Groundwater in the Mediterranean Basin***

The Mediterranean region with its 23 countries with a coastline, extends over an area of 8.5 million Km<sup>2</sup>. The population is around 454 millions from the Mediterranean population the 33% is concentrated in these coastal regions and during the summer season the population increases substantially. The enormous extension implies a great variability not only on climatology and geology but in socio-economic and technological conditions too. The length of the coastline is 46,000 km, with 19,000 km belonging to islands. This long coastline must be remarked as groundwater salinisation problems are quite frequent.

Rainfall has an irregular distribution ranging as a mean from 1000 mm/year in the northern countries to values of 400 mm/year in the southern countries. Evapotranspiration values are very irregular too. Frequent situations of hydric stress are created by the combination of low precipitation and high evapotranspiration values, especially in the south. As a result, rivers are frequently ephemeral, hydrological regimes are hyperannual and recharge values to the aquifers very small (or even inexistent on the last decades), especially in those countries located in the Middle East and north of Africa. Aquifer behaviour is conditioned by these facts and creates important problems in relation to groundwater management especially in dry periods. Besides, for many countries, groundwater resources are the most important or even the only source of fresh water. A bad aquifer management may create serious harm not only in the present but for the future generations.

According to CWD (2006) and MGR (2007), in the Mediterranean region there are ten countries with a total population of around 100 million, with an availability of water less than 1000 m<sup>3</sup> per person and per year. Regarding this group of countries it is noteworthy that there are seven with a total population of 65 millions, Israel, Jordan, Malta, Tunisia, Algeria, Libya and West Bank and Gaza, in

which the resources are less than 500 m<sup>3</sup> per person and per year. Of the total water resources for the Mediterranean countries, equal to 1,197 km<sup>3</sup>/year, 317 km<sup>3</sup>/year (26.5%) are groundwaters, and only 75.6 km<sup>3</sup>/year are renewable groundwater resources (MGR, 2007).

Table 15.1 summarises the situation of different countries concerning groundwater use. There two sources of information in relation to those data, Margat (2004), and more recent data in CWD (2006), but only available for a small group of countries. The analysis is difficult because data from the first report sometimes are quite different from data from the second one.

**Table 15.1** Main characteristics of groundwater in the different countries of the Mediterranean Basin. Data from Margat (2004) and CWD (2006)

COUNTRY	EXT (10 <sup>3</sup> km <sup>2</sup> )	POP. (10 <sup>6</sup> in.)	TWR (km <sup>3</sup> /y)	TGR (km <sup>3</sup> /y)	GW% (%)	TGA (km <sup>3</sup> /y)	NRA (km <sup>3</sup> /y)
Spain	505.4	43.4	111.50	29.9	26.8	4.82	0.7
France	551.5	60.7	189.50	100	52.8	6.10	
Italy	301.3	57.5	191.30	43	22.5	10.40	
Malta	0.3	0.4	0.06	0.027	45.0	0.02	0.02
Slovenia	20.3	2	31.87	13.5	42.4	0.28	
Croatia	56.5	4.4	71.40	11	15.4	0.42	
Bosnia-Herzeg.	51.2	3.9	37.50	6	16.0	0.30	
Serbia-Monten.	102.2	8.2	208.50	3	1.4	1.00	
FYR Macedonia			6.40	1	15.6	0.20	
Albania	28.8	3.1	41.70	6.2	14.9	0.63	
Greece	132	11.1	74.25	10.3	13.9	3.56	
Turkey	783.6	72.6	231.70	69	29.8	6.00	
Cyprus	9.3	0.8	0.78	0.41	52.6	0.29	0.04
Syria	185.2	19	26.26	5.4	20.6	1.80	
Lebanon	10.4	3.6	4.80	3.2	66.7	0.40	
Israel	22.1	6.9	1.67	1	64.1	0.90	0.19
Gaza Strip	..	3.6	0.06	0.056	100.0	0.13	
West Bank			0.75	0.68	90.7	0.17	0.03
Egypt	1001.5	74	58.30	2.3	3.9	5.40	0.00
Libya	1759.5	5.9	0.82	0.5	61.0	0.65	3.63
Tunisia	163.6	10	4.57	1.55	33.9	1.40	0.18
Algeria	2381.7	32.9	19.00	7	36.8	3.5	0.41
Morocco	446.6	30.2	29.00	10	34.5	2.63	
Jordan	88.8	5.4					

EXT: Extension; POP: Population (2005); TWR Total water resources; TGR: Total groundwater resources; GW%: Groundwater as % of TWR; TGA: Total groundwater abstractions; NGA: Non-renewable groundwater abstractions

According to Messaoud (2006) in CWD (2006), Algeria, with 30% percent of its territory being desert, has 19 km<sup>3</sup>/year of total water resources. Of this amount, 7 km<sup>3</sup>/year are groundwater. Surface water resources are concentrated in the northern part. Groundwater abstractions are equal to 1.7 km<sup>3</sup>/year in the south of the country, (which is the Sahara Desert), and 1.8 km<sup>3</sup>/year in the north, the country has been under a serious drought over the past 25 years that has reduced the total resources to 10 km<sup>3</sup>/year.

In Tunisia total resources are  $4.57 \text{ km}^3/\text{year}$  and groundwater resources are about the 50% of this amount.  $1.55 \text{ km}^3/\text{year}$  of the groundwater resources are stored in shallow aquifers, which according to Hamzha (2006) in CWD (2006) are completely overexploited. The rest is stored in deep formations.

In the case of Cyprus, according to Margat (2004), more than 50% of the total resources is groundwater. According to Artemis (2006), in CWD (2006), groundwater abstractions are equal to  $290 \text{ Mm}^3/\text{year}$ , ( $110 \text{ Mm}^3/\text{year}$  according to Margat, 2004). The insular condition of the country together with the excessive groundwater abstractions, are creating an unsustainable situation due to saline intrusion. Besides this, precipitation has decreased by 15% in the last thirty five years (see Artemis, 2006, in CWD, 2006).

Groundwater abstraction in many aquifers in countries such as Spain, Israel, Palestine, Malta and Cyprus, are exceeding the recharge rates. Some other countries such as Tunisia, Algeria, and Libya are managing fossil aquifers following a mining strategy, because recharge is almost zero. This aspect is reviewed later in this chapter.

By way of summary it can be said that groundwater is a very important issue in the Mediterranean basin, especially because it represents a high percentage of the total water resources. In some regions it is the single source of fresh water and due to the fact that precipitation, as in the case of Cyprus, has been reduced dramatically in some countries. Nevertheless, is necessary to refine current knowledge on the hydro-geological behaviour of aquifers and to develop specific strategies to manage groundwater use, especially in those countries where groundwater is a non renewable resource and where aquifers are shared between nations, such as the case of the Nubian Sandstone Aquifer (in Egypt) that will be mentioned later.

### ***Response to the Hydro-Geological Systems to Drought***

Groundwater and surface water belong to the same and unique “Cycle of Water”. Whenever there is a deficit in rainfall precipitation, a deficit in recharge occurs, the water table is depleted and groundwater discharge through rivers and springs decreases or stops. Although this is true, it is not always a climatological drought that triggers a hydrological drought, especially if the groundwater system is considered. The response of an aquifer to drought is strongly dependent on the type of aquifer, hydraulic parameters (transmissivity, storage and specific yield), recharge, and depth of the saturated zone, flow paths and the size of the aquifer.

Aquifers with thick, deep unsaturated zones and large catchments are not affected by short drought periods, or even if they are, the aquifer response is subdued and delayed in time. This fact gives groundwater an opportunity as a source of fresh water during periods of scarcity and has conditioned the fact that the more valuable crops are irrigated frequently with groundwater or in mixed systems (Llamas, 2004).

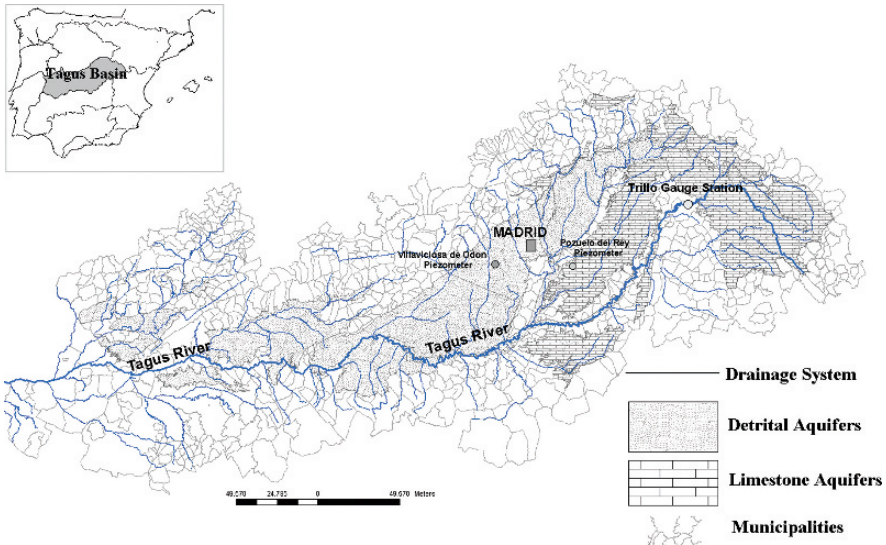
## *The Influence of the Type of Aquifer*

Basically there are two major types of aquifer, those with intergranular porosity and those with porous formations during a solution process. In the first type water is contained in pores between the grains of a detrital rock or sediment. In the second type, the so-called carstified aquifers, water is contained in the secondary porosity of the rock, produced during a process of carstification. Behaviour and drought management has to be completely different in one or in other.

Detrital aquifers are formed mainly by sands, clays, silts and conglomerates. Frequently these types of aquifer are formed by none consolidated and recent sediments, such as those coming from alluvial plains or alluvial fan depositional environments and for this reason, are frequently non confined aquifers. In the Tagus Basin in Spain both types of aquifer are represented.

### **Aquifers in the Tagus River Basin**

The Tagus basin (see Fig. 15.1) is a large sedimentary depression flanked by ranges. Aquifers at the head of the basin are formed mainly by cretaceous and Jurassic limestones (brick symbol in Fig. 15.1); while a detrital tertiary and very thick aquifer is developed around the Madrid Basin (dot symbol in Fig. 15.1). The tertiary aquifer, “Tertiary Aquifer of the Tagus River Basin”, extends over a surface area of 5,600 Km<sup>2</sup> and is considered to be more an aquitard than a real aquifer. It is formed mainly by interbedded clays and sands. Aquifer thickness is around 3,000 m in the very centre of the basin. The huge thickness, the big size and the 40 m deep unsaturated zone (on watershed) make this aquifer not sensitive to rainfall deficit.

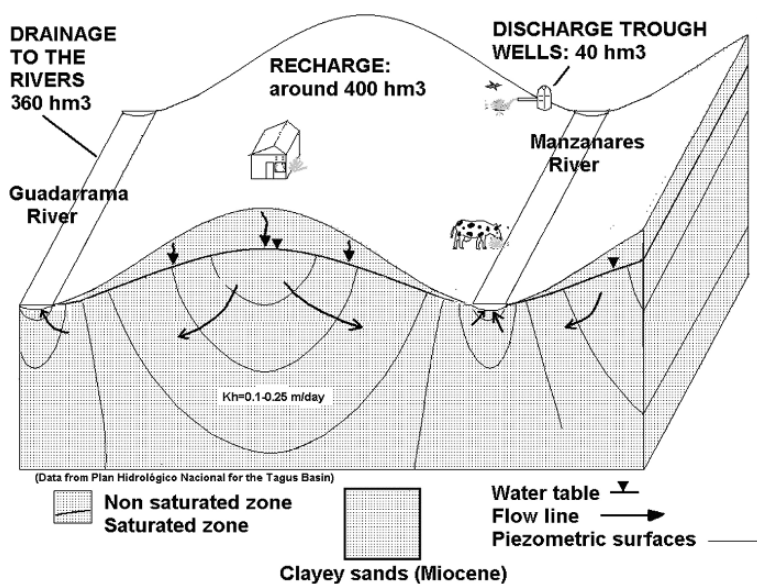


**Fig. 15.1** General Tagus River Basin situation. Aquifers and locations mentioned in the text



Typical transmissivity given by different authors ranges from 10 to 100 m<sup>2</sup>/day, but according to recent pumping tests carried out by the Basin Water Authority in 2006, this value only occasionally exceeds 40 m<sup>2</sup>/day. Although the hydraulic parameters are not very good from a hydrogeological point of view, the huge sediment thickness makes this aquifer quite interesting for drinking and irrigation water supply purposes.

According to the conceptual model that was proposed by Llamas and López Vera (1975) (see Fig. 15.2), under natural conditions, recharge (around 40 mm/year) came mainly from rain infiltration and the discharge occurred through underground drainage towards the main rivers. Nowadays, discharge is produced mainly by pumping, especially in dry periods, and although it is not clearly demonstrated is very likely that the rivers are now effluents rather than influents.



**Fig. 15.2** Conceptual Model for the Tertiary, detrital aquifer of the Tagus River Basin, for almost an unperturbed situation

The thick unsaturated zone makes a drop of water take a period of up to a hundred years to travel across the unsaturated zone. The effects of climatological droughts are attenuated or even imperceptible (Casado, 1998). This kind of aquifer is affected more by drought due to the increase in pumping rather than the effects of the drought itself. The delay response of the aquifer to the yearly recharge, drought or even discharge offers an opportunity to manage the water supply whenever there is a lack of surface water.

The public company, Canal de Isabel II, manages the Madrid System water supply and uses the aquifer as a strategic source of water supply during dry years. Moreover, to supply the almost 6,000,000 million inhabitants of the city of Madrid, groundwater is pumped from this aquifer in drought periods (more or less one every

four years) to help urban water surface supply. In fact, recently in 2005, from March 2005 to March 2006, one of the most dry years in the last thirty years, around 50 Mm<sup>3</sup> has been pumped.

### ***Groundwater Drought Analysis***

Drought is a complex phenomenon and it is necessary to decide, when analysing drought propagation over the groundwater system, which are the relevant parameters or characteristics that are suitable to describe it. It must be pointed out that there are many ways of describing a drought; different ways may lead to different conclusions, and results are conditioned by the availability of data (recharge, discharge and piezometric records). Long time series are needed and frequently they are not available, especially when looking into the groundwater system.

Indices are threshold levels of time series below which a groundwater system is regarded to be under a drought. For some authors an index, that is a single value, is not much more useful than raw data for decision making (cfr. Hayes, 2006). Although an index helps to define when a drought is established there are some other questions that need to be answered: which is the start, the end, the total duration and the severity of the drought (Rees et al., 2004), spatial distribution or occurrence probability, or even the vulnerability of the system. Groundwater drought analysis is not frequently included in drought analysis; and non-specific indices have been derived. Usually it is possible to analyse base flow to rivers and piezometric or even recharge records in the same way as other hydrological data are considered. Some examples are presented.

### **The Recession Curve of the Hydrograph**

Rees et al. (2004) describe the calculations and procedures to develop flow duration curves, (from which the low percentiles are selected), base flow separation techniques from which is possible to calculate “base flow indices”, and the classical analysis of recession curves of the hydrograph that can be plotted.

As an example the situation in the Trillo gauge station (E-3005) over the Tagus River (see the situation in Fig. 15.1) is presented in this epigraph. Trillo is located upstream, in the head of the Tagus River. The river at this point drains 1,000 km<sup>2</sup> of calcareous aquifers and 90% of the discharge is base flow (DGOH, 1998). There is a significant difference in seasonal flow discharge. Winter discharge may be more than ten times that of summer discharge.

Discharge at this point is relevant because there is a nuclear power plant that needs 1.5 m<sup>3</sup>/s for normal operations. The year 2005 was a very dry year and it was necessary to predict how groundwater discharge was going to evolve under a very long dry period. It was necessary to assess for how long the necessary flow for the plant would be guaranteed.

In order to analyse the different dry periods in the historical records, flow duration curves were prepared on a monthly basis (see Fig. 15.3). Figure 15.4 shows the

hydrograph on a monthly basis from 1955 to 2005. The percentile 90 was used to choose droughts in the record (grey coloured line). This line represents the flow that was surpassed in 90% of the months of the 73 years. Seven major drought events were analysed and the correspondent recession periods were studied. Dry periods are marked on the graph. It can be seen that 2005 was the worst year in whole period studied. It is a remarkable aspect to mention that for some reason, discharge is lower from the 80 s onwards, the peaks are smaller and less frequent.

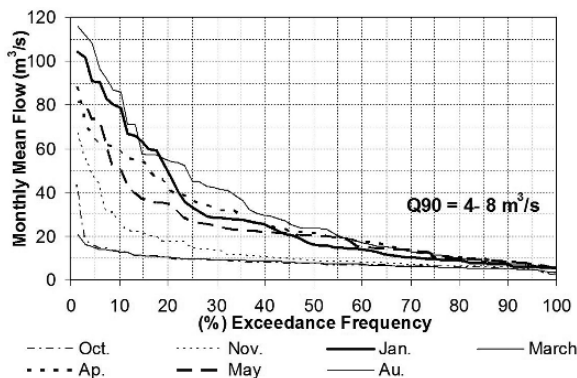


Fig. 15.3 Flow duration curves, made on a monthly basis for a historical serie of 73 years. To avoid a mesh of lines, only have been represented 7 months

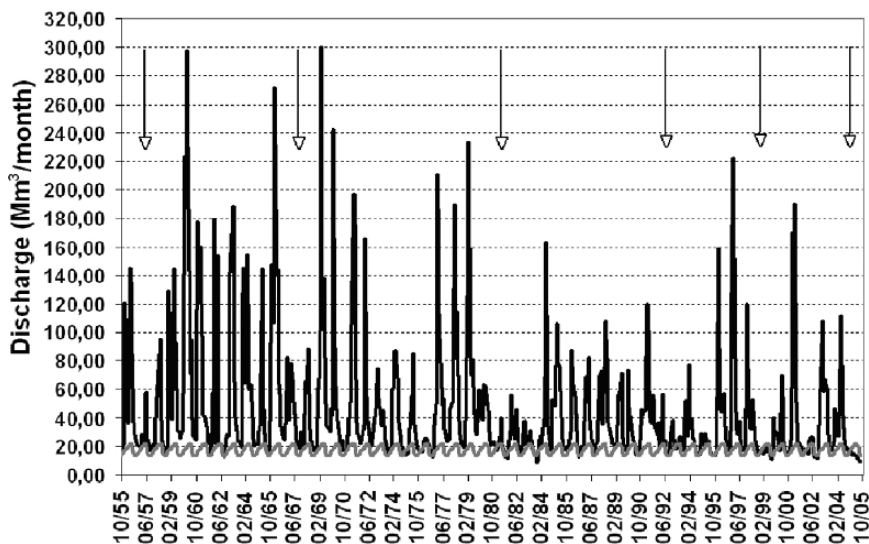


Fig. 15.4 Historical discharge in Trillo gauge station E-3005, from 1955 to 2005. Q90 is also shown in grey. Major drought events are marked with an arrow

It is well known that groundwater discharge to rivers follows (15.1) an exponential law (Custodio and Llamas, 1983, p.392),

$$q = q^{\circ} * e^{-\alpha t}, \tag{15.1}$$

Where  $q$  is discharge,  $q^{\circ}$  is the initial discharge when the recession begins,  $\alpha$  is a parameter that depends on aquifer transmissivity and specific yield. Plotted on a logarithmic base, the recession flow period can be drawn as a straight line (see Fig. 15.5). Once Alfa is known it is possible to calculate the volume that will be drained along a period of time “ $t$ ”. In Fig. 15.6 it can be seen how the aquifer would continue to drain enough water for a period of 300 days without any rainfall.

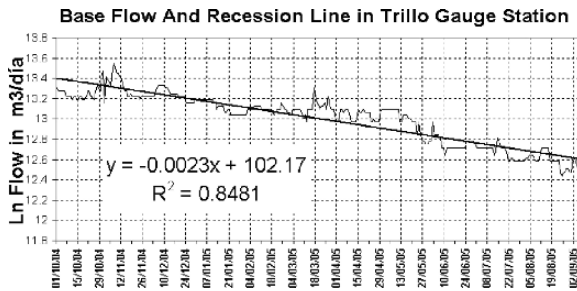


Fig. 15.5 Recession lines for the flow in Trillo along the hydrological year 2004/05 and the adjusted linear function

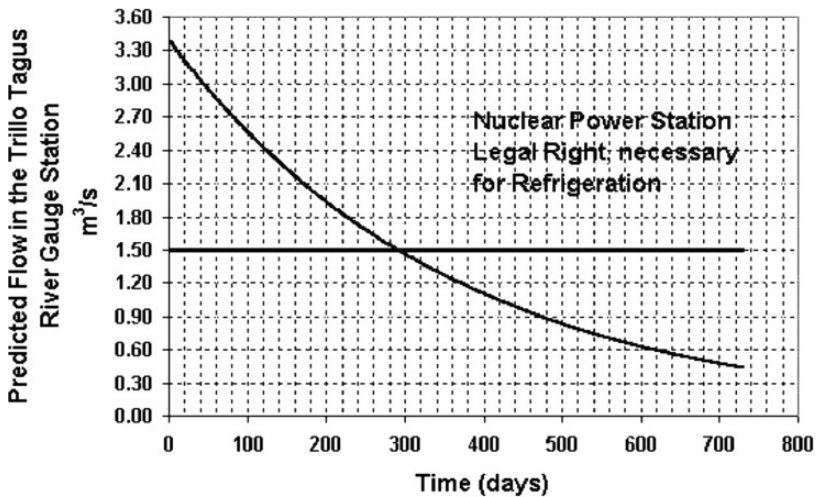


Fig. 15.6 Predicted base flow in Trillo, from a initial flow of 3.5 m³/s

### Piezometric State Index

A different type of index that has been used to define a drought in any element of a hydrological system is the “State Index” (Pi) (see CHJ, 2005). This kind of index could be used for piezometric levels. This index considers media, maximum and minimum values of a historical trend and is calculated according to the expressions:

$$(a)Pi = \left[ \frac{1}{2} \right] \left[ \frac{Vi - Vmin}{Vmean - Vmin} \right] \quad (b)Pi = \left[ \frac{1}{2} \right] \left[ \frac{Vi - Vmean}{Vmax - Vmean} + 1 \right]$$

When  $Vi < V Mean$       When  $Vi \geq Mean$

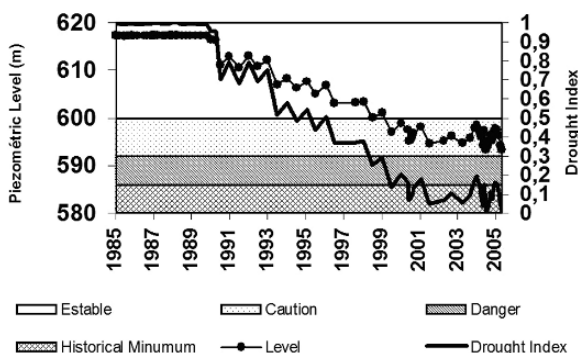
Where,  $Vmean$ : Mean of the historical record,  $Vmax$ : Maximum value of the historical record,  $Vmin$ : Minimum value of the historical record

This index gives an idea of how a single measure is related to the mean, maximum, and minimum values of the historical record. The index varies from 0 to 1. Normal situation is from 1 to 0.5. Caution from 0.5 to 0.3, danger from 0.3 to 0.15 and below 0.15 to 0 is the historical minimum. This approach seems to be suitable for some aquifers but has no meaning at all in others.

Groundwater levels are measured through piezometers. These are small-diameter cased wells, screened just at the depth of interest.

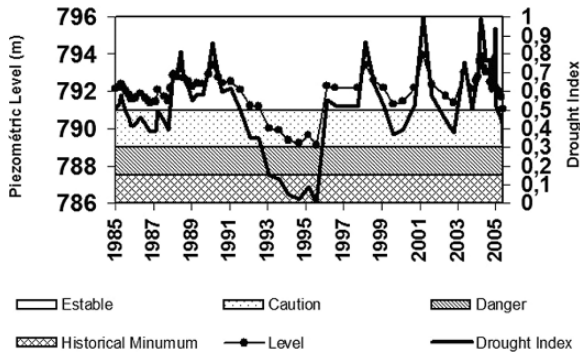
We present two examples of two piezometers located (see Fig. 15.1) in the Tagus Basin. One is located in the Tertiary Aquifer and the other is situated on a limestone aquifer. Results obtained are completely different in each case. In both cases the piezometer state index has been calculated.

Figure 15.7 shows a piezometer record from the aquifer of Madrid in Villaviciosa de Odón. As it was mentioned previously, this aquifer with a thick unsaturated zone is more sensitive to exploitation than to droughts. The record further reflects the intensive pumping that began in the 1992 drought, rather than the drought itself. From 1992 until now the aquifer is continuously under a historical minimum. It is clear than in an aquifer like this, this kind of index is not at all useful. The graph is continuously showing exploitation but not drought.



**Fig. 15.7** Piezometric record and piezometric index for a piezometer in the tertiary Detritical Aquifer of the Tagus Basin

Figure 15.8 presents the same kind of graph for a piezometer located at the head of the Tagus Basin in a limestone aquifer. Carstified phreatic aquifers, with high transmissivity, tend to have a quick response in a climatic event, high precipitation or a drought period. They are more sensitive to periods of low recharge. The very dry period in Spain from 1992 to 1995, is clearly marked. On this kind of aquifer, drought periods are well identified on piezometer records and the state index seems to be suitable.



**Fig. 15.8** Piezometric record and piezometric index for a piezometer located in Pozuelo del Rey on a limestone aquifer in the Tagus Basin

### Natural Recharge

A very important concept related to the hydrological drought in an aquifer is the concept of “natural recharge”. Lerner et al. 1990 defined this concept as “the downward flow reaching the water table, forming addition to the groundwater reservoir”. Recharge is not a constant but a variable, although the complexity of the measurement makes many managers consider it as a fixed figure. Recharge is a variable both in space and time. The immediate factor responsible for a groundwater drought is the decreasing recharge rate that may follow, a low soil humidity subsequent to a low precipitation period. It is possible to study drought periods on recharge records. Although the main problem related to this is the enormous difficulty to measure this parameter, it is possible to conduct recharge studies, using different kinds of technique.

As an example, some recharge calculations were done in Albacete (Spain) using borehole tensiometric techniques, during 1996, cfr. Casado (1996), see Fig. 15.9. The graph shows hydraulic gradient, unsaturated hydraulic conductivity and recharge, which is the product of both. These calculations were made at the bottom of a 300 cm profile. A negative flux means downward flow, while a positive flux means upward flow. Precipitation was 413 mm, distributed in six or seven major events. Results show how recharge ranged from 0.4 mm/day to less than zero (this is negative recharge or evaporation). The recharge on this experimental site was estimated to be around 50 mm for this specific year.



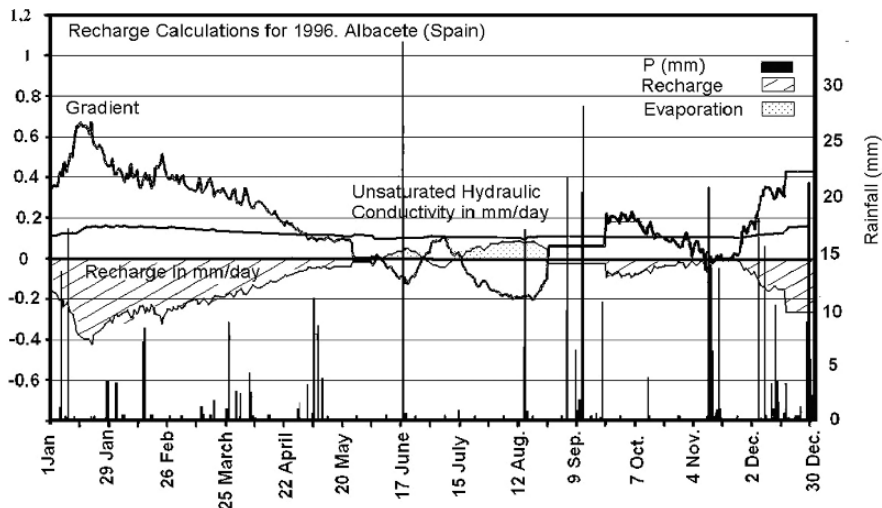


Fig. 15.9 Recharge measurements for the Aquifer Mancha Oriental (Albacete, Spain)

### *Some Groundwater Drought Related Concepts: Overexploitation, Water Scarcity and Groundwater Mining*

#### **Overexploitation**

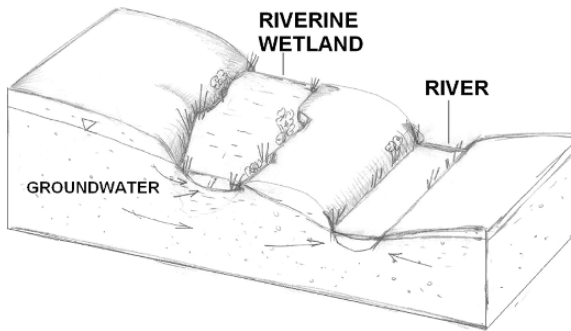
It is usually considered that an aquifer that experiments negative effects as a result of water abstraction is overexploited, or in other words, that the recharge rate is less than the pumping rate. This term has been specifically defined in the Spanish Water Act (1985) as the consequence of an aquifer exploitation to values higher or very close to the mean annual renewable resources of the aquifer or when the quality of the aquifer seriously deteriorates as a result of the exploitation. Custodio (2002) concludes that the negative effects observed on an aquifer (drawdown, worsening of water quality, decrease in discharge rate to springs and rivers, change in the river-aquifer relationship, dry up of wetlands) do not necessary imply that water abstraction are exceeding recharge rates. An increase in the abstraction rate or even a decrease in the recharge rate creates a transient situation inside the aquifer, that modifies the water head and that gradually stabilises when the aquifer discharge changes to compensate the change undergone. The transient period depends upon storage, transmissivity and aquifer dimensions.

The question to answer is to what extent can a region's groundwater resources be exploited without unduly compromising the principle of sustainable development? (cfr. Ponce, 2006). According to this author, a good definition of "Sustainable development" is the development that meets the needs of the present without compromising the ability of future generations to meet their own needs. In Foster and Louck (2003) the situation is analysed of some aquifers in the Mediterranean that are being used following a mining strategy policy, although it is recognized that

further analysis and studies are required, this ground water is the driving force of the economy of vast regions.

### Groundwater Scarcity

Groundwater abstraction without planning may initiate a hydrological drought or even a permanent situation of water scarcity. The case of the upper Guadiana Basin and Aquifer 23 in Spain is a good example. The Mancha Occidental Aquifer (aquifer 23), is a calcareous carstified shallow aquifer that extends over 5,500 Km<sup>2</sup>. Flat topography, interactions between shallow limestone aquifer and rivers, gave rise to many riverine wetlands (see Figs 15.10 and 15.11), like “Las Tablas de Daimiel”. Natural recharge was calculated to be from 200 to 500 Mm<sup>3</sup>/year, depending on the yearly rainfall. Discharge from the wetlands was mainly by evapotranspiration.



**Fig. 15.10** A riverine wetland, relation between the river and the groundwater feed wetland

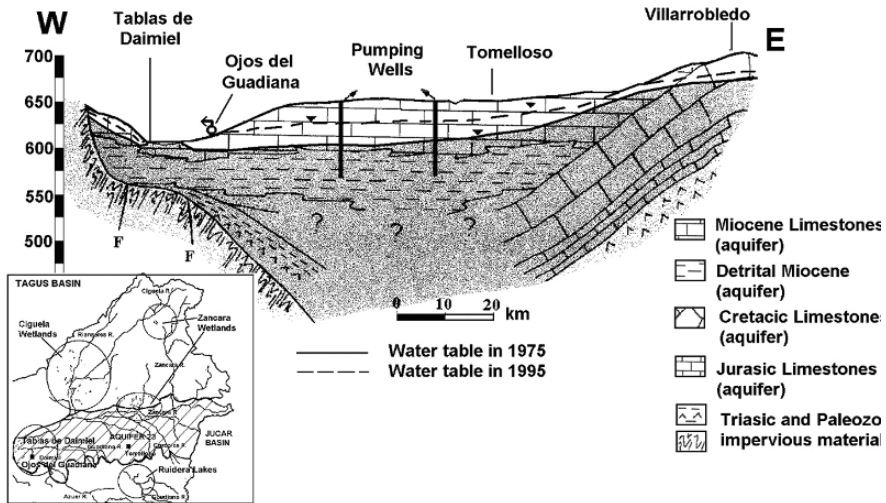
Due to changes in the aquifer land use from dry-farming to irrigation farming, irrigated land increased from 200 km<sup>2</sup> in the 70 s to 1300 km<sup>2</sup> in the 80 s, leading the region to a situation of permanent water scarcity. The irrigated farming was done mainly under private initiative and groundwater irrigation fed systems. In twenty years an amount of 3,000 Mm<sup>3</sup> was pumped from the aquifer, with a peak of 600 Mm<sup>3</sup> in 1988. Piezometric levels (see Fig. 15.10) decreased from 20 to 50 m in many places, the result being that many wetlands disappeared (like “Los Ojos del Guadiana”) and some others were seriously damaged as is the case of Las Tablas de Daimiel, which was already a National Park. The discharge of the aquifer no longer takes place by evapotranspiration. It seems that this figure has been reduced by 150 Mm<sup>3</sup>/year, (cfr. Cruces et al., 1997).

The total surface area of wetlands was around 10,000 ha in 1970, and nowadays is more or less 2000 ha (cfr. De la Hera, 2003, p.172).

### Groundwater Mining

Groundwater systems without recent recharge are quite common in the Mediterranean basin. Drought facts are irrelevant for such type of unit but groundwater use is crucial for the survival and socioeconomic development of such countries.





**Fig. 15.11** Cross section of the Aquifer Mancha Occidental System. Mod. From García and Llamas (1994)

Groundwater management in this kind of aquifer implies “mining of the aquifer storage reserves” (cfr. Foster and Loucks, 2006), and should be undertaken following some specific strategies, legal strategies (developing legal groundwater codes, preparing groundwater abstraction right systems, that treat the aquifer as public property, full participation of users, or concern campaigns) and the use of some key management tools such as improving knowledge, or developing numerical models that help to assess the mining strategies. One of the most important groundwater basins in the world is the “Nubian Sandstones Basin” (cfr. Bakhbakhi, 2006) that extends through Egypt, Libya, Sudan and Chad.

This is a complex system with confined and unconfined units. Total storage is around  $520,000 \text{ km}^3$ . Water quality is variable and the salinity ranges from 500 ppm to hyper saline water. Groundwater exploitation has increased steadily since the 60s, from this time  $40,000 \text{ Mm}^3$  have been pumped and as a result general groundwater drawdown has been 60 m. Traditional wells and springs have been replaced by deep boreholes.

Another similar example of the same situation is the North Western Sahara Aquifer System that extends over  $1,000 \text{ km}^2$  in Algeria, Libya and Tunisia. Natural recharge is around 1 mm/year and groundwater is used through 8800 wells, springs and boreholes (6,500 in Algeria, 1,200 in Tunisia and 1,110 in Libya).

### ***Drought Effects on Groundwater***

Some of the negative effects of drought on groundwater have already been explained. Drought may have a direct influence on the groundwater system, decreasing

the recharge rate so the water table is depleted, but usually the immediate effect of a dry period in many aquifers is a result of pumping.

According to Bachmat (1999), analysing the 1999 drought period in Israel, the effects of drought on groundwater were mainly two: 1) The shortage on the recharge rate 2) The second was the drastic increase in groundwater pumping. Other relevant effects were the lack of fresh water for artificial recharge and the increase in salinization of the wells.

### Coastal Aquifers

An important issue that should be taken in account is that whenever groundwater is pumped on a coastal aquifer in hydraulic connexion with the sea, the created gradients may induce the entrance of saline water in the aquifer. Fresh and saline water are mixed in a more or less thick zone called “zone of saline encroachment” (cfr. Fetter, 1994, p.368). Saline water as is denser than fresh water penetrates the costal zone below the fresh water and the contact between them can be sharp or may be enlarged in a thick mixture area, in which salt concentration decrease towards the continent. The shape and thickness of this mixture zone is dependant upon aquifer type, geometry and parameters, seashore and tidal conditions. Any increase in the pumping rate will make the intrusion to penetrate deeper on the continent. This evolution is called “aquifer salinization”. On phreatic aquifers, the intrusion propagates slowly and is possible to foresee on time if proper indicators are used, while on confined aquifer, intrusion is fast and difficult to be monitored. It is not possible to avoid a certain degree of salinization whenever a coastal aquifer in relation to the sea is pumped and this fact has to be keep in mind in order to make a good management.

Piezometric networks in coastal aquifers should monitor piezometric levels and some chemical indicators (Cfr. Custodio and Llamas, 1983), such as chloride concentration, relation between  $r\text{Mg}^{+2}/r\text{Ca}^{+2}$  and  $r\text{Cl}^{-}/r(\text{CO}_3\text{H}^{-})$ . In general an increase in the chloride content or in the relation,  $r\text{Mg}^{+2} r\text{Ca}^{+2}$ , is a good index of saline encroachment. The relation  $r\text{Cl}^{-}/r(\text{CO}_3\text{H}^{-})$  is about 0.1 to 5 in continental waters and from 20 to 50 in the sea.

### Groundwater Measurements

The delay or inexistent effect of dry periods in the underground part of the hydrological cycle makes groundwater a source of fresh water available whenever there is a lack of surface water.

Techniques like drilling the so called “drought” wells are widely used. In Spain in the 2005, the Jucar Basin Water Authority successfully drilled thirty “SOS wells”. In the 1992 drought the Spanish Government undertook a series of groundwater-based measures to increase water resources. According to Santafé (1996), the central government drilled a total amount of 268 wells, with a total abstraction capacity of 16,266 l/s.

Another technique is the artificial recharge of aquifers. In periods of surface water surplus, aquifers can be used as an additional element of the system infiltrating water through wells or ponds. Although the techniques required are complicated and not applicable always and everywhere, this technique is being used very successfully in Israel or in some parts of Spain as in the Aquifer of Los Arenales in Segovia.

It is necessary to improve:

- The level of knowledge. Usually managers invest most of the budget in surface water studies, while little effort is made on hydrogeological research. This research should be conducted during normal climatological periods in order to be prepared for a situation of drought stress.
- The integrated management of ground and surface water. The combined use of surface and groundwater has been carried out successfully in many places all around the world, but requires specific models that consider groundwater too.

### **The Integrated Management of Ground and Surface Water**

The integrated management of ground and surface water, considering both quality and quantity, is essential for the general interest of the users and inhabitants of the territory, whose resources should be considered jointly to acquire the best water use and to achieve a sustainable use of the water. The general goals should be to reach the good ecological status of the water body, to satisfy all the water demands, to find an equilibrium between the regional and sectorial development, increasing and protecting the quality of the water resources, in equilibrium and harmony with the environment and other natural resources. The main objectives mentioned previously are sometimes complementary goals while others are alternatives. In practice, uses and water demands, infrastructures, water reservoirs, aquifers, and the exploitation rules of the system together comprise a whole system and for these reasons the general rules of analysing systems can be applied.

In the case of hydraulic systems, there are highly developed techniques for their analysis. Some systems can present difficulties, due to the complexity of characterizing certain elements, as the aquifers, or in the case when it's necessary to coordinate many exploitation rules.

It is necessary to respect the principles mentioned previously in order to maximize the resources. The first task that should be accomplished is to establish the geographical territory of each system and afterwards to define the different elements that constitute the whole system.

On one hand aquifers are part of the natural elements that constitute the system, just as rivers, lakes and wetlands that together are the natural resources of the system under a natural regime. The natural cyclical behaviour is different in all of them due to the cyclical period of time of each. Because of these differences between them it is necessary to simplify the system in order to treat all of them together.

On the other hand it is necessary to characterize hydraulic infrastructures (reservoirs, channels, water tanks, impulsions, conductions) that together with the rules of

exploitation derived from the existing water demands, make it possible to establish available total resources.

The models chosen in each situation to simulate the system and prepare the water balances, will be imposed by the relative weight of the different system elements and their relation with the water demands.

When the weight of the surface resources is higher in the system than groundwater resources the models are usually made on a monthly basis. In some other situations the monthly basis is also used but then is necessary to use additional specific models to simulate groundwater flow.

Water supply to demand must be characterized through the following parameters:

- Volume of water supplies on a yearly basis and with temporal distribution. Quality conditions that will be required.
- Degree of guarantee for the different uses.
- The net consumption or the part of the water supply that will not return to the system
- The annual volume of the return, and its temporal distribution. The envisaged quality, before any treatment is done.

The way in which demands are satisfied from aquifers and reservoirs are the exploitation rules and are dependent on the resources, (amount, temporal distribution, aquifers, pipes, and other infrastructures. Experiences and models show that for each system there are some specific rules that are the most adequate to reach an optimum.

Results, for example, show that in a system the first uptake of water should be done in such points where if water is not taken will run off out of the system. In the cases of the aquifers, if there is a calcareous aquifer and a detrital aquifer, is convenient to pump water first from the carstified aquifer and second from the detrital aquifer.

Nevertheless, water management and exploitation involves not only technical, physical, ecological, and quality aspects, but social, economic and political criteria too.

Exploitation system analysis is a task that has to be done during the planning processes and consists of an analytical study that helps the manager in the decision-making process and to identify and select alternatives from a great number of variables in the system.

It has to be done with a logical and systematic approach, in which hypothesis, objectives, and criteria are clearly defined in order to help the manager to improve the knowledge on the aquifers, reservoirs, demands, exploitation rules, behaviour of the system and interconnections between subsystems.

A systems analysis procedure should be accomplished following these steps:

- Problem definition
- System identification and acquirement of data
- Definition of goals and time steps
- Quantitative and quality measures

- Alternatives
- Evaluation and selection of the best alternatives
- Checking, update and feedback.

A system is conditioned by multiple technical, economic, and legal factors that are self-limiting. Non-consideration of this fact may lead the manager to idealistic solutions that are far from reality. Some authors do not consider legal aspects, water property rights, or even use conditions before analysing system solutions to the system exploitation problem. This situation makes it quite difficult to integrate certain systems, such as the aquifers, on the general exploitation systems.

Another factor to be considered in a whole exploitation system is that there may be many actors involved in water management: Central state agents, usually the decision and law makers and the users, public or private, (some of them individuals, others water users communities). There are also local and regional administrations that take part in the construction, financing, exploitation and management of infrastructures. The principle of cost recovery is not regulated on a homogeneous basis so the result is that the application creates some results contrary to an efficient water use.

In Spain a new water act was implemented on 1985, this law meant a change in the previous trends. One of the main achievements of this regulation is that it declared water as a public good, the previous law stated that groundwater was private. This law established the so-called “Libro del Registro” in which all the waters rights should be included. As there were some legal groundwater rights previous to the 1985 law, a section called “Catálogo de Aguas Privadas” were included, which includes private groundwater rights.

Considering the aquifers in the system, analysis may be conducted in many ways, but all of them have a certain degree of difficulties; some of them require a long time, others a longer period of time and more human and economic resources: The present difficulties are:

A better knowledge of the content of the records, or “Libro del Registro”, in order to analyse what the total recognized legal volume of groundwater is necessary. Not many researchers have conducted this analysis, and some the results of the works undertaken to date are sometimes unrealistic.

It is necessary to evaluate the effects of groundwater exploitation, using technical and economic data, in order to evaluate what the effect of implementing a new and different groundwater abstraction regime would be. This new regime would obtain different benefits and would affect new beneficiaries, different from those of the past. In any case, affections to existing rights will have to be considered, as well as the costs of modifying or eliminating the current ones.

Parameters that are most commonly used to measure reliability and performance of a system are guaranty, vulnerability and resilience (Cfr. Hashimoto et al., 1982). Guaranty gives an indicator of the frequency of the failures that a system can suffer. Traditionally this concept applied to the hydraulic resources exploitation systems, refers to the measure of the ability of those systems to satisfy demands in a certain period of time.

In recent years many different ways have been suggested to calculate this parameter. None of them are universally accepted. In Spain, a good example are the different criteria used on the different Hydrological Basins' Plans or in the Libro Blanco del Agua (cfr. MMA, 2000). So the criteria used to measure guaranty are basic for the system analysis procedure.

Vulnerability is an index of the seriousness of the failures. Resilience is an indicator of the duration of the failures.

A good management policy will try to minimize resilience and vulnerability and will try to maximize guaranty. If resources are scarce in relation to demands, not all the parameters can be optimized, so if one of them improves the others become worse.

An conservative operation policy will try to diminish the vulnerability of the system reducing guaranty, and will increase the resilience of the system with small failures. A risky policy is the one that by increasing the temporal guaranty will reduce the resilience thus increasing vulnerability.

## Conclusions

1. Although groundwater and surface water take part in the same and unique "Cycle of Water" and a deficit in precipitation may produce a groundwater drought, the delayed and attenuated response that the groundwater system has, makes aquifers a very good source of fresh water during drought periods.
2. Groundwater is very important in most of the Mediterranean countries, being almost the only source of fresh water supply for some places like deserts or countries like Palestine.
3. Aquifer exploitation under a sustainability management condition requires an improvement in investments and knowledge. Monitoring networks need to be implemented, to control both quantity (piezometers and gauged springs) and quality. The current recharge rates need to be better estimated.
4. It is necessary to include the groundwater system in the basin's drought plans. The same type of analysis that is usually conducted to study hydrological drought can be applied to historical groundwater data, such as piezometer records, spring flows, base flow, and recharge rate records.
5. Drought affects different aquifer types in different ways. Selecting drought indices related to the groundwater systems should be done carefully. Aquifers with a thick unsaturated zone may not be affected by dry conditions at all. On the contrary, carstified shallow aquifers may respond quickly to a drought. In this type of aquifer, a selected piezometer could be a good tool to monitor drought.
6. There are many aquifer systems in the Mediterranean basin that do not recharge at all, or recharge is very small. These hydrogeological units are considered to be "fossil aquifers". Management of these aquifers needs to define what sustainable development is in each case. Sustainability does not necessary imply

water abstractions equal to the recharge rates. For some basins and countries a mining strategy may be adequate, although it is recognized that stronger efforts are necessary to understand the natural systems better, to improve regulations, to improve user coordination, to ensure coordinated management between the countries affected.

7. The main effects of a rainfall deficit in aquifers are: Replenishment of the groundwater table, diminishing of spring flows, increase in water salinity. The effects of drought in detrital aquifers with thick unsaturated zones may be simply an increase in the pumping rate.
8. Groundwater is a strategic resource of freshwater during dry periods. Drought wells, artificial recharge and mixed supply ground and surface water are alternatives to be implemented on drought management protocols.
9. The integrated management of ground and surface water, considering both quality and quantity is necessary in hydraulic system analysis. Uses and water demands, infrastructures, water reservoirs, aquifers, and the exploitation rules of the system together make up a whole system. General rules that include aquifers as one more element of the system can be applied.
10. The analysis of the system taking into account the aquifers may be conducted in many ways, but all of them have difficulties, including the following:
  - Gaining better knowledge of the content of groundwater being used legally, considering both the spatial and temporal distribution.
  - What is the real volume of groundwater used.
  - It is necessary to evaluate the effects of groundwater exploitation, technical and economic data, in order to evaluate what the effect of implementing a new and different groundwater abstraction regime would be.

## References

- Bachmat Y (1999) The 1999 drought, and its hydrological impact. Israel-Palestine Center for Research and Information, IPCRI. <http://www.ipcri.org/watconf/papers/yehuda.pdf>. Last access July 2007.
- Bakbakhki M (2006) Nubian Sandstone Aquifer in Non renewable groundwater resources. A guidebook on socially sustainable management for water policy makers. Foster S, Loucks D P (Ed.) IHP series on Groundwater n.10. IAH-UNESCO. 104pp.
- Custodio E (2002) Overexploitation. What does it mean? *Hydrogeology Journal*, 10(2):254–277.
- De la Hera (2003) Caracterización de los humedales de la Cuenca alta del río Guadiana. In: Coletto C, Martínez Cortina L, Llamas R, Conflictos entre el desarrollo de las aguas subterráneas y conservación de humedales. La Cuenca Alta del río Guadiana (Ed.) Mundi-Prensa. Fundación Marcelino Botín. 352pp.
- Casado Sáenz M (1988) Contribución al análisis de la Humedad del Suelo en el Terciario Detrítico de la Cuenca de Madrid. Tesis de Licenciatura. Facultad de CC. Geológicas. UCM.
- Casado M (1996) Contribución al estudio de la recarga natural en el Sistema Acuífero de los Llanos de Albacete. Tesis Doctoral. Facultad CC Geológicas. UCM.
- Conference of the Water Directors of the Euro-Mediterranean and South-eastern European Countries, Athens (Greece), CWD (2006). 2006-11-06/07; <http://www.emwis.net/documents/meetings/fo1148169/fo1106940>.



- Confederación Hidrográfica del Júcar (CHJ, 2005) Plan Especial de Sequías. Draft Version.
- Cruces J, Fornes J, Casado M, de la Hera A, Llamas R, Martínez Cortina L (1997) El marco natural agua y ecología. In Cruces J, Hernández J M, López Sanz G (Eds.) De la Noria a la Bomba. Conflictos sociales y ambientales en la Cuenca Alta del Río Guadiana.
- Custodio E, Llamas R (1983) Hidrología Subterránea. Ed Omega. 2 Tomos. 2.350pp.
- Dirección General Obras Hidráulicas, DGOH (1998) Estudio hidrogeológico de las unidades 03.02 Tajuña-Montes Universales y 08.02 Montes Universales. Ref 21.820.038/0411. Memoria y Anexos.
- Fetter C W (1994) Applied Hydrogeology. Mc. Millan. 3rd. Edition. 691 pp. ISBN 0-02-336490-4.
- Foster S, Loucks D P (2006) Non renewable groundwater resources. A guidebook on socially sustainable management for water policy makers. IHP series on Groundwater n.10. IAH-UNESCO. 104pp.
- Hayes M J (2006) What is Drought?, National Drought Mitigation Center. In: <http://www.drought.unl.edu/whatis/indices.htm>. Access Date: 3rd. of Dec, 2006.
- Hashimoto T, Stedinger J R, Loucks D P (1982) Reliability, resiliency, and vulnerability criteria for water resource system performance evaluation. *Water Resources Research*, 18(1):14–20.
- Lerner D N, Issar A S, Simmers I (1990) Groundwater recharge. A guide to understanding and estimating natural recharge. IAH series. Vol 8. Heise. 345 pp.
- Llamas M R, Lopez Vera F C (1975) Estudio sobre los recursos hidráulicos subterráneos en el área metropolitana de Madrid y su zona de influencia. Avance de las características hidrogeológicas del Terciario Detrítico del Jarama. *Revista Agua*, 88:36–55.
- Llamas M R (2004) La gestión de las aguas subterráneas y los conflictos sociales relativos al Plan Hidrológico nacional. *Rev. R Acad. Ciencias Exact. F. y Naturales*, 98(2):235–254.
- Margat J (2004) “Plan Bleu. L’eau des méditerranéens: situation et Perspectives. MAP Technical Reports Series no 158. Athens.
- Mediterranean Groundwater Report, MGR (2007) Technical Report on Groundwater Management in the Mediterranean and the Water Framework Directive. Mediterranean Groundwater Working Group (MED-EUWI WG ON GROUNDWATER).
- Ministerio de Medio Ambiente MMA (2000). Libro Blanco del Agua en España. Dirección General de Obras Hidráulicas y calidad de las Aguas. 622 pp. Madrid.
- Peters E, Lanen H A J van, Torfs P J J F, Bier G (2005) Drought in groundwater – drought distribution and performance criteria. *Journal of Hydrology*, 306:302–317.
- Peters E, Bier G van Lanen H A J, Torfs P J J F (2006) Propagation and spatial distribution of drought in a groundwater catchment. *Journal of Hydrology*, 321:257–275.
- Ponce V M (2006) Groundwater utilization and sustainability. In: <http://groundwater.sdsu.edu>.
- Pulido A (1991) “Algunas Reflexiones relativas a la sobreexplotación de acuíferos Kársticos”. *Hidrogeología* no.6, 47–58 pp.
- Pulido M, Andreu J, Sahuquillo A (2005) Optimización económica del uso conjunto de aguas superficiales y subterráneas en sistemas de recursos hídricos. Aplicación a la Directiva Marco Europea. Congreso Ibérico sobre Gestión y Planificación del Agua.
- Rees G, Marsh T, Roald L, Demuth S, van Lanen H A J, Kasperek L (2004) Hydrological Data. in Tallaksen L M, H A J van Lanen (2004) Hydrological Drought. Processes and estimations methods for streamflow and groundwater, Elsevier. *Development in Water Science*, 48:579. ISBN 0-444-51767-7.
- Santafé Martínez J M (1996) Actuaciones de emergencia durante la pasada sequía basadas en las aguas subterráneas. Aguas subterráneas y abastecimiento urbano. ITGE, Madrid.
- Spanish Water Act (1985) Texto refundido de la Ley de Aguas, 2001.
- Tallaksen L M, van Lanen H A J (Eds.) (2004) Hydrological drought. Processes and estimation methods for streamflow and groundwater. *Developments in Water Science* 48, Elsevier Science B.V., Amsterdam, the Netherlands.



# Chapter 16

## Drought Severity Thresholds and Drought Management in Greece

D. Pangalou, D. Tigkas, H. Vangelis, G. Tsakiris and A. Nanou-Giannarou

**Abstract** The objective of this chapter is the analysis of the three major components of drought assessment and management in Greece. First, the legal framework and the structure of services related to the water management are presented. Second, drought characterisation is applied for two river basins, Nestos and Mornos, and thresholds for drought management are defined. A new meteorological drought index, the Reconnaissance Drought Index (RDI), similar to the well-known Standardised Precipitation Index (SPI), is introduced. Finally, the operational component for drought management is analysed. This component consists of the formulation of a preparedness master plan and the adoption of proactive and reactive actions.

### Introduction – Drought Events in Greece

Due to its climatic conditions, Greece is a country often affected by droughts. Although the Greek organisations have not developed concrete strategies for facing droughts, they have dealt with this phenomenon on a case-to-case basis. However, the country needs a comprehensive effort to rationalise the entire drought analysis, monitoring and mitigation system. There are deficiencies in scientific organisations, legal framework and operational capabilities to combat drought and its consequences. An operating mechanism should be instituted for an effective application of rational measures resulting from a scientific analysis. During drought, water restrictions are imposed mainly in domestic water consumption. However, 85% of the water used in the country is consumed in the agricultural sector (Tsakiris, 2005). It is therefore reasonable, to re-direct water restrictions, giving emphasis to the agricultural use, which is the principal consumer of water. Last but not least, it should be noted that there is a severe gap in the measures for combating drought, i.e. the lack of insurance of people and properties in case of a drought episode.

---

G. Tsakiris (✉)

Lab. of Reclamation Works and Water Resources Management, School of Rural and Surveying Engineering, National Technical University of Athens, Greece.  
e-mail: dialecti@yahoo.com

The purpose of this chapter is to analyse briefly the three major components of drought assessment and management in Greece:

1. The legal framework and the structure of services related to water management.
2. The drought characterisation and the definition of thresholds for drought management.
3. The operational component for drought management, which consists of the formulation of a preparedness master plan and the adoption of proactive and reactive actions. In addition, actions in the short term and the availability of a reliable monitoring/warning system are of primary importance.

## **Drought and Greek Legislation**

### ***Legal Framework***

The key legal actions in Greece related to water and drought management are:

- (a) Law 1650/1986 “for the Protection of the Environment”
- (b) Law 1739/1987 “for the Management of Water Resources”
- (c) The legal implications of the United Nations Convention for Combating Desertification (1994)
- (d) European Directive 2000/60/EC
- (e) Law 3199/2003 of “Protection and Management of Water”

Laws 1650/1986 and 1739/1987 have constituted the statutory framework for Water Resources Management for 14 years, from 1986 till 2000, when the Water Framework Directive was adopted. The European Directive 2000/60/EC “Establishing a Framework for Community Action in the Field of Water Policy” imposed the need for adopting a new framework for water, fully compatible with its content. Law 3199/2003 for the “Protection and Management of Waters” is based upon the principles of the European Directive and establishes a framework for the achievement of a sustainable water policy. Provisions of the Water-Directive 2000/60 and of its Annexes, not included in Law 3199/2003, were embodied in Presidential Decrees. An important Presidential Decree, which acts as a key supplement of Law 3199/2003 was published recently (March 2007).

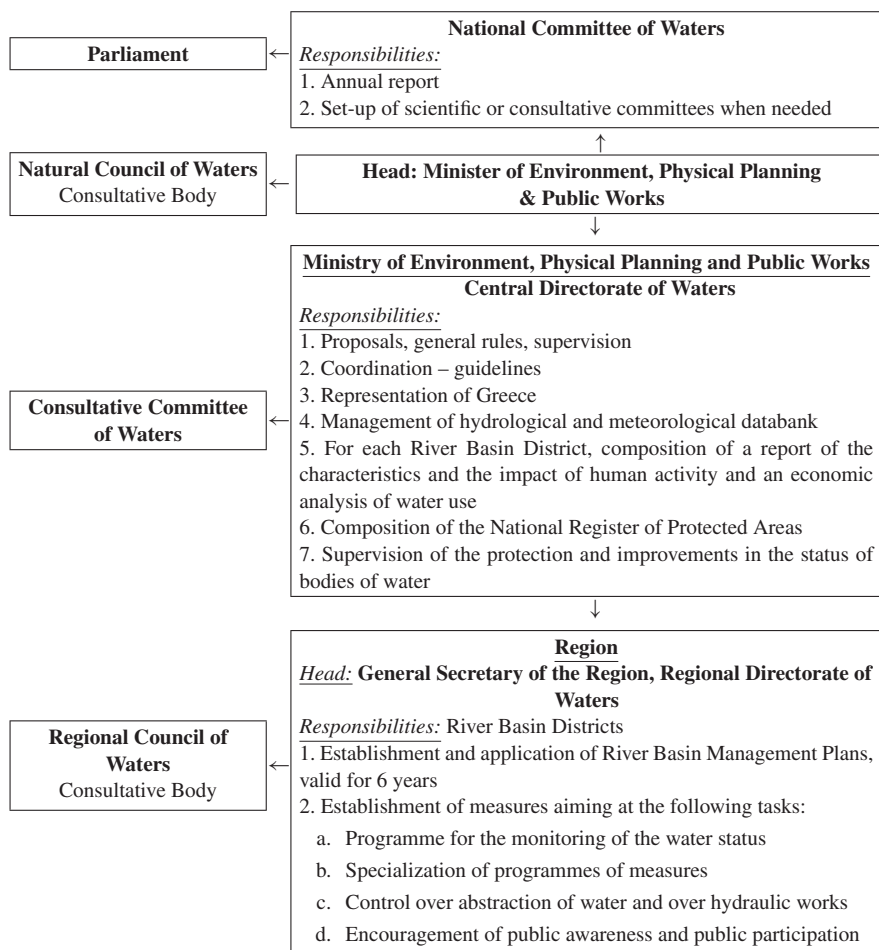
The river basin district was first introduced in Law 1739/87 as the fundamental area for any water balance. Greece was divided into 14 river basin districts. This has not been altered within the new Law. However, it is estimated that the existing river basin districts will be changed and reduced through merging of adjacent districts. Within this concept, it is expected that Greece will be divided into 7 to 9 districts. Although there are no specific articles regarding drought mitigation, it is implied that the bodies responsible for the water resources management will be also responsible for drought issues. Specific measures for drought mitigation have not been legislated in the past in Greece. However, in 1994 Greece signed the Desertification Convention of the United Nations, which was ratified by the Greek Parliament in 1997. Desertification may be considered as a process related to drought, since it is

usually provoked by persisting and frequent drought episodes, which are customary for the Mediterranean climate.

### ***Structure and Linkages Among the Relevant Institutions, Organisations and Stakeholders***

Law 3199/2003 establishes and defines the Institutions and Authorities responsible for water protection and management. The NGOs can express opinion and, from time to time, they are invited to make proposals to the responsible Ministries. The structure is depicted in Table 16.1.

**Table 16.1** Organisation chart of services responsible for water resources management in Greece



## Drought Characterisation and Risk Analysis

### *The Nestos and Mornos Basins*

Drought characterisation and operational management are analysed in the Nestos and Mornos basins (Fig. 16.1). The Nestos watershed is located in northern Greece. The catchment area belongs partially to Bulgaria (2,872 km<sup>2</sup>) and partially to Greece (2,312 km<sup>2</sup>). The study presented here covers only the Greek part of the basin. Meteorological data (mainly monthly precipitation and temperature) from 10 meteorological stations, covering a period from 1964 to 1996, have been used.

Mornos watershed is located in central Greece. The entire watershed occupies an area of 1,025 km<sup>2</sup>, while the study area (which is the area upstream of the Mornos dam) covers 571 km<sup>2</sup>. Analysis was performed with meteorological data collected from 8 stations from 1962 to 2001. Mornos reservoir is the main supplier of the greater Athens area with potable water.



Fig. 16.1 Nestos and Mornos basins in Greece

### ***Intensity, Frequency and Duration of Drought***

Two well-known indices, the Deciles (Gibbs and Maher, 1967) and the Standardised Precipitation Index (SPI) (McKee et al., 1993), and a new promising index, the Reconnaissance Drought Index (RDI) (Tsakiris and Vangelis, 2005, Tsakiris et al., 2007), were calculated. The “run method” was applied to further characterise the statistical properties of drought (Rossi et al., 1992). In general, all indices in all the stations of the Nestos basin show a period of time between 1989 and 1993 that is documented as the most severe drought period over the last decades in Greece (Karavitis, 1998, Voudouris, 2006). Results show that the RDI is a promising index that could be more widely used than the other two indices tested, since it is correlated with both of them. The RDI has a mean correlation coefficient equal to 0.9509 when correlated to the Deciles and a mean correlation coefficient equal to 0.9785 when it is correlated to the SPI. The RDI correlates relatively well with the Deciles and the SPI in Mornos basin, too. It has a mean correlation coefficient equal to 0.8924, when correlated to Deciles and a mean correlation coefficient equal to 0.9812, when correlated to the SPI. In order to calculate intensity, frequency and duration of drought, statistical analysis of precipitation data for both basins has been performed. Drought frequency was estimated as the probability of non-exceedance for the annual SPI for each precipitation station. A threshold of “severe drought” event was established, when the SPI was below -1. For each meteorological station in both basins, the different intensities and the return period for each drought spell were calculated.

The data analysis for the Nestos basin has shown that apart from duration, the drought spell of 1989–1993 was also relatively severe for almost all the stations. Furthermore, the northern part of the basin experienced an important drought period during the hydrological year 1984–1985. The main result of the analysis for the Mornos basin is that drought has been a frequently recurrent phenomenon since 1987: in most of the years since then, the Mornos watershed has suffered from drought in almost its entire area. The threshold of the run method was calculated based on the deciles index. The lowest 40% of the average precipitation occurrences was considered as the threshold in order to apply the run method. In Figs. 16.2 and 16.3, for every Thiessen polygon of each basin, the diagram that describes the droughts identified on the meteorological series and their characteristics (length, water deficit and intensity) are constructed. The accumulated water deficits for both basins are presented in Fig. 16.4.

### ***Drought Impacts on Runoff***

For the assessment of the drought impacts of runoff, the Medbasin software was used for both of the two case studies. Medbasin was developed at the Laboratory of Reclamation Works and Water Resources Management (National Technical University of Athens) and it includes two conceptual rainfall-runoff models, on a daily and monthly basis, respectively (Tigkas and Tsakiris, 2004).

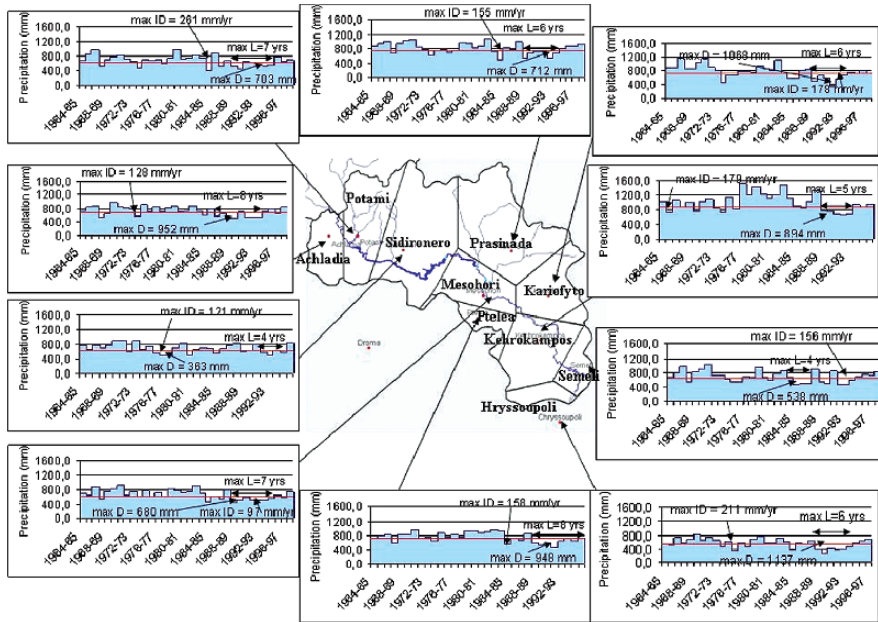


Fig. 16.2 Regional drought identification for Nestos river basin

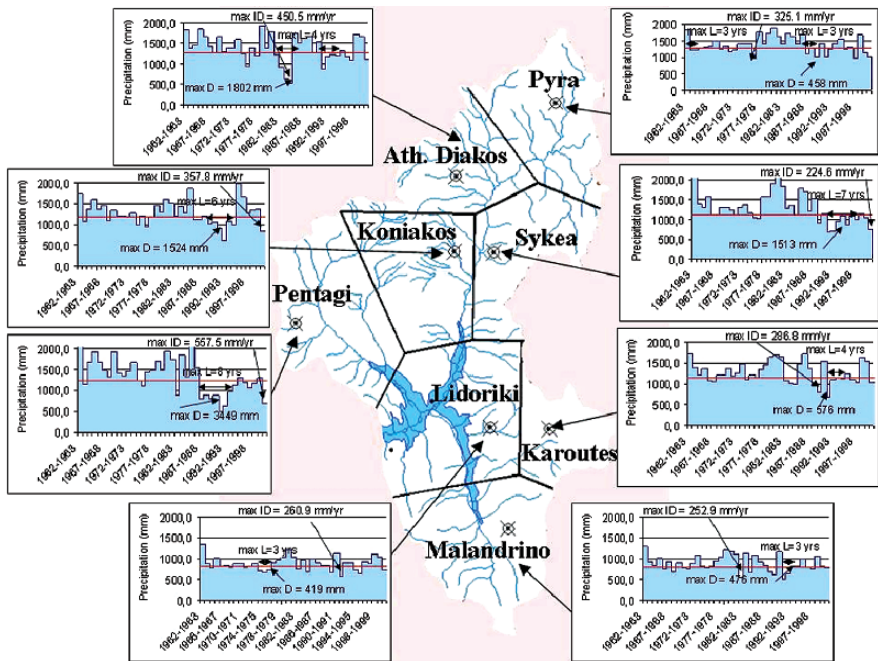
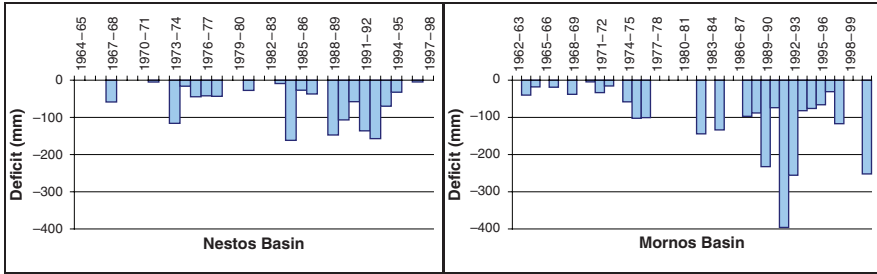


Fig. 16.3 Regional drought identification for Mornos river basin



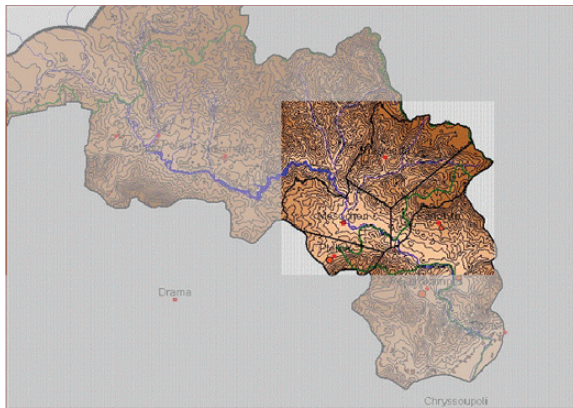


**Fig. 16.4** Water deficit along the Nestos and Mornos basins

The methodology followed is based on the formulation of several climatic scenarios, derived from the alteration of the normal climatic conditions of the study area (Tsakiris et al., 2004). For this task, a period of years with normal or near to normal climatic conditions was selected. By applying the climatic scenarios for this period in the rainfall – runoff model, the percentage of the change of runoff compared to the normal value was estimated. It should be stressed, that the results of this method are reliable only on an annual or multi-annual basis.

### The Nestos Basin

The selected area for the Nestos case study (Fig. 16.5) is a zone of 500 km<sup>2</sup> upstream of the river delta, between the hydrometric stations of Temenos (input) and Paskhalia (output). Using the Thiessen polygon's method, it was calculated that for the period of 1964–1996 the mean annual precipitation is 740 mm and the mean annual potential evapotranspiration is 710 mm.



**Fig. 16.5** Nestos basin: area of study

For the formulation of the climatic scenarios, the RDI was used in order to define the climatic conditions of the area (Fig. 16.6). A period of eight years (1971–1979) having near to normal conditions was selected in order to run the rainfall – runoff simulation. The input data were the spatial average precipitation and potential evapotranspiration of the area, while for the calibration of the model the measured streamflow data at Temenos and Paskhalia stations were used.

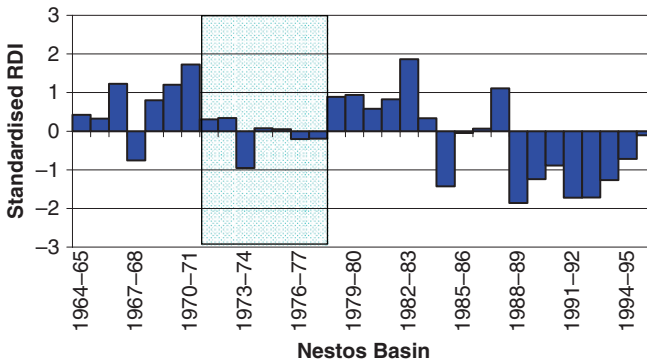


Fig. 16.6 Standardised RDI values for the study area of Nestos basin

About 120 climatic scenarios were synthesised by altering the original precipitation and the potential evapotranspiration data, by different percentages up to –40% and +24%, respectively. The results of the rainfall – runoff simulation of these scenarios are presented graphically in Fig. 16.7 on a two-dimensional diagram.

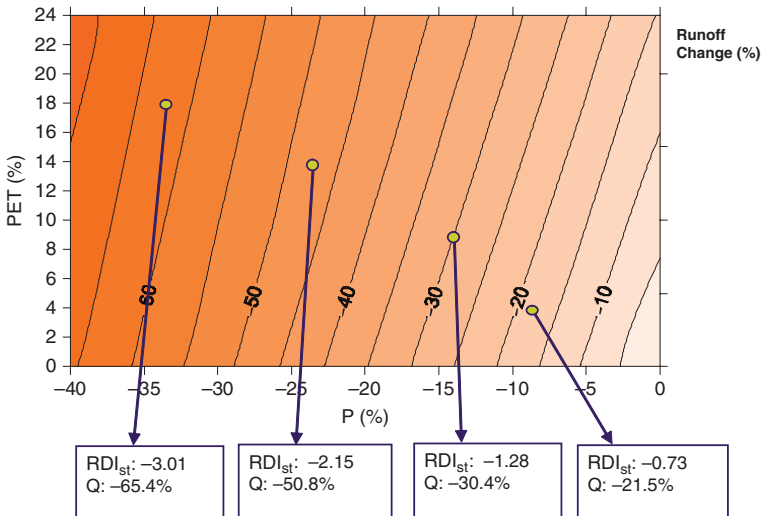


Fig. 16.7 Results of the rainfall – runoff simulation of the climatic scenarios for the Nestos study area



On the 2D diagram, some values of the  $RDI_{st}$  (Tsakiris et al., 2007) are presented together with the percentage of the runoff deviation from the normal value. As it can be seen, the runoff reduction is 20–35% for moderate drought conditions, 35–50% for severe droughts and can be up to 65% for extreme drought conditions. In order to check the accuracy of these estimations, they were compared to the actual values of runoff for the dry period of 1990–1995. For the first three years the estimation is good, while for the last two the actual runoff reduction is greater than the estimated. This may be caused by the cumulative effect of the sequence of the drought events, which is not taken into account in this approach.

**The Mornos Basin**

The same methodology was also applied to the Mornos river basin. Eight years were selected for the rainfall – runoff simulation (1967–1975, Fig. 16.8). The climatic scenarios were formulated by altering the original data of precipitation and potential evapotranspiration by various percentages up to –40 and 14%, respectively. About 170 scenarios were simulated and the results are presented in Fig. 16.9. The comparison of the results with the  $RDI_{st}$  shows that the reduction of runoff for moderate

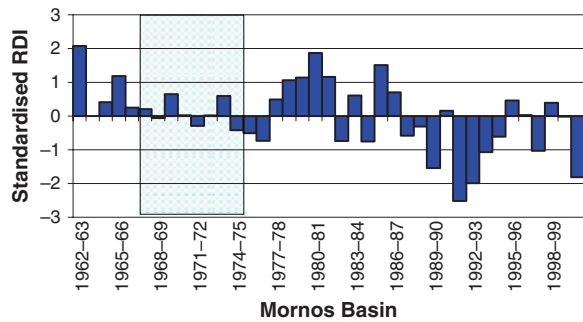


Fig. 16.8 Standardised RDI values for the study area of Mornos basin

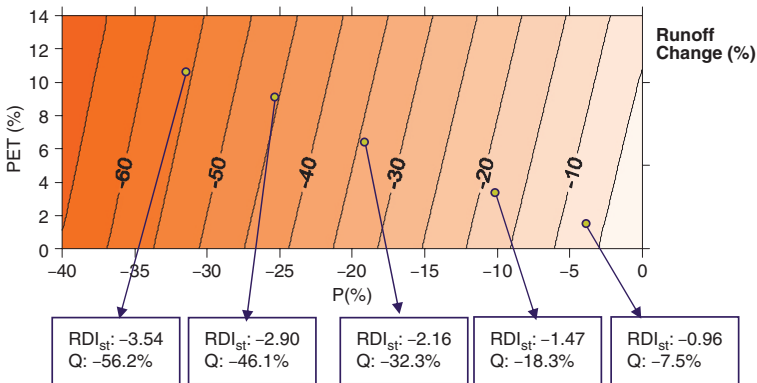


Fig. 16.9 Results of the rainfall – runoff simulation of the climatic scenarios for the Mornos basin

drought conditions is 8–20%, for severe droughts from 20–30% and for extreme droughts can be up to 50%.

### ***Potential Impacts of Drought***

For the needs of this work, major stakeholders were interviewed about the potential impacts of drought on the Nestos and Mornos basins. The first general conclusion from these interviews is that the most significant impacts of drought in the Nestos and Mornos basins refer to runoff reduction and reduction in agricultural production. In addition, in the Nestos river basin, the wetland ecosystem influence and biodiversity loss are important issues. In the Mornos river basin the pressure on the water supply system of the city of Athens is crucial.

## **Drought Management in Greece**

The operational component for the drought management consists of the formulation of a preparedness master plan and the adoption of proactive and reactive plans and actions. In addition, actions in the short term and the availability of a reliable monitoring/warning system are of primary importance. Practical examples of water reduction actions and stakeholder analysis are presented. Finally, the strengths and weaknesses of the current legal structure are shown.

### ***Preparedness Master Plan***

Regarding the preparedness plan, four are the main aspects that have to be considered:

1. *The technocratic dimension.* This dimension refers to the responsibilities and the timing related to drought management.
2. *The administrative and organizational issues.* It specifies the responsible bodies for each action.
3. *Time and space actions.* The time sequence of the actions as well as the spatial scale of the plan should be carefully scheduled. This step focuses mainly in planning the actions in advance.
4. *Public awareness and participation.* Public should be involved in the implementation of the plan. Non-governmental organisations (NGOs) should also play an important role in the fringe between the public and the authorities.

### ***Proactive and Reactive Plans and Actions***

The institutional and legal measures related to water resources and more specifically to the mitigation of drought, are partially covered by the EU Directive 2000/60 and the Greek Law 3199/2003.

The most relevant proactive actions in Greece, i.e. measures taken or planned compatible with the National Action Plan (NAP), include:

1. Construction of small earth dams for collection of rainwater;
2. Canal rectification to reduce water losses and
3. Modernisation and improvements of irrigation networks.

In essence, all proactive measures have the same aim: to increase the storage and improve the efficiency of the conveyance and distribution systems. In this context, important contribution to water saving is the gradual change from conventional surface irrigation systems to modern sprinkler and trickle irrigation systems.

The most relevant reactive actions in Greece include:

1. Constraints in water consumption
2. Intensification of the use of groundwater resources
3. Reallocation of water resources
4. Use of saline and brackish waters and
5. Water transfer and water supply systems interconnection

### ***Short Term Actions***

For the short term actions, two directions can be followed:

1. Reduction of the water demand and increase of the water supply. In an urban environment, this may be achieved through the administrative actions along with new and sometimes even strict laws and essentially through the stimulation of public awareness. Specific acts of this type are for example the prohibition of excessive use together with a legal framework for a more rational water use. Pricing policy regarding higher costs per unit for higher water consumptions may also be applied. A more successful measure could be the use of economic incentives from the water companies in order to lead the people towards lower water consumption.
2. Advertising and other means of public announcement is always essential not only in informing people of the water shortage situation but also in helping them to consume water in a more rational way in the long term. For the public awareness, information may be diffused through the mass media or leaflets distributed to the citizens, but an important aspect is to pass this information on to young people through schools (or any kind of educational campaigns), in order to form a life style that includes rationality in water use and compatibility with the existing constraints.

Regarding the rural environment, changes in agricultural structure will mainly lead to the desired results. Such changes may be the selection of less water consuming crop varieties, the control of evapotranspiration by artificial means, the optimisation of agronomic techniques and actions that are even more complicated (e.g. the soil enhancement).

## ***Practical Examples of Water Reduction Actions***

*Emergency water transfers:* Emergency water transfers and diversions is another auxiliary solution with the advantage that the source will not remain connected to the supply network after the crisis and the disadvantage of being a more expensive solution since appropriate infrastructure should be constructed just for a short period of time.

*Changes of water rights:* Diversions between different sectors of water consumption, that should be listed hierarchically in advance, may also be implemented during an emergency situation.

## ***Monitoring Systems***

The actions planned for drought mitigation will not be very effective unless information on drought incidents in temporal and spatial scale are available or can be acquired from monitoring systems. In brief, a monitoring system can give information of when a drought period started, how long it lasted, how severe it was and which were its spatial limits. Moreover, a monitoring system applied on historical data series can be useful in the identification of drought prone areas, which helps in a more efficient application of drought mitigation plans. Monitoring systems though, can mainly supply information on past events. A warning system of extreme situations is a more useful tool, since it can provide the authorities with sufficient time in order to apply measures to prevent the situation. A warning system can be the result of a combination between a monitoring system and a weather prediction system and its accuracy is based on meteorological predictions.

## ***Stakeholder Analysis***

In order to better investigate drought severity and its impacts on water resources, a questionnaire was distributed to five stakeholders. The interviewees face the drought phenomenon and the corresponding results from their interest and the interest of the people they represent. The vast majority of the stakeholders agreed that recreational uses (e.g. pools, fountains, etc.) have the last position hierarchically in the list of uses. However, according to Law 3199/2003, municipal water consumption is considered as the first priority.

## ***Strengths and Weaknesses of the Current Legal Structure***

*The main strengths* of the Greek institutional framework that stand out from the above analyses are:

1. A National Data Bank of Hydrological and Meteorological Information (NDBHMI) has been established. Various software applications are linked to the central Database of the NDBHMI supporting the analysis and synthesis of the data and the elaboration of secondary information. A GIS subsystem was developed to support the spatial analysis of hydrological data.
2. There are sufficient socio-economic data concerning water users mainly in the municipal and the industrial sector, with the exception of incomplete information on farmers and irrigation water.
3. According to the existing situation, all institutions involved in drought preparedness and mitigation, have a good experience concerning recent drought episodes. Although there are no specific plans for drought mitigation in Greece, many governmental and other institutions are dealing with the effects of drought on a case-to-case basis.
4. There is a sufficient number of reservoirs that are being used in drought situations and therefore the water reserves of the country are satisfactorily managed in most of the cases.
5. The domain of agriculture seems to have enough influence on the government and whenever irrigation farmers are affected by drought, the pressure exerted on the authorities has good results in order to combat drought.
6. Law 3199/2003 has been recently adopted. According to this law, all sectors affected by drought are represented in the National Council of Waters and the Consultative Committee of Waters.

*The main weaknesses* of the Greek institutional framework that stand out from the above analyses are:

1. Up to now, there is no provision for insurance or any compensation policy in the legal framework for the rainfed or irrigated agriculture.
2. No systematic monitoring of drought occurrence and regional extent ever existed in Greece in the past.
3. In the past, decisions concerning droughts were taken on a case-to-case basis. This empirical approach is considered unsatisfactory and it is therefore necessary to formulate a plan for drought mitigation, based on the institutional structure described in the Law 3199/2003 on Water Resources Management.
4. Up to now, there is a lack of information concerning the consumption of irrigation water by individual farmers. Although there are institutions and organisations with experience on the subject, there is no coordination among them and there is no managerial policy at a higher level from a central administration.
5. In Greece, little research was carried out in the past for defining droughts for the different sectors of the economy, i.e. agriculture, power production, domestic use etc. Similarly, drought indicators have not been tested with respect to their applicability in the Greek conditions.
6. There are no drought indicators or any other scientific indices applied in order to identify crisis situations.

## References

- Gibbs W J, Maher J V (1967) Rainfall deciles as drought indicators. Bureau of Meteorology Bulletin No. 48, Commonwealth of Australia, Melbourne.
- Karavitis C A (1998) Drought and urban water supplies: the case of metropolitan Athens. *Water Policy*, 1(5):505–524
- McKee T B, Doeskin N J, Kleist J (1993) The relationship of drought frequency and duration to time scales.. Proceedings of the Eighth Conference on Applied Climatology, Anaheim, CA, January 17–23, pp. 179–184. American Meteorological Society, Boston, MA.
- Rossi G, Benedini M, Tsakiris G, Giakoumakis S (1992) On the Regional Drought Estimation and Analysis. *Water Resources Management*, 6(4):249–277
- Tigkas D, Tsakiris G (2004) Medbasin: A Mediterranean Rainfall-runoff software package, *European water*, 5–6:3–11
- Tsakiris G (2005) Planning and integrated water management in the agricultural sector – Water Resources – Transport and distribution. Proceedings of New technologies and innovations in agricultural production and development, Volos, Greece 13–15 May 2005 (in Greek)
- Tsakiris G, Vangelis H (2005) Establishing a Drought Index incorporating evapotranspiration, *European Water*, 9–10:3–11.
- Tsakiris G, Pangalou D Vangelis H (2007) Regional Drought Assessment Based on the Reconnaissance Drought Index (RDI), *Water Resources Management*, 21(5):821–833
- Tsakiris G, Tigkas D, Pangalou D (2004) On the assessment of climatic and drought scenarios on runoff in Mediterranean island river basins. Proceedings of EWRA Symposium on Water resources Management: Risks and Challenges on the 21st Century – Izmir, Turkey, 2–4 September, pp. 629–637
- Voudouris K S (2006) Groundwater Balance and Safe Yield of the coastal aquifer system in North Eastern Korinthia, Greece. *Applied Geography*, 26(3–4):291–311

# Chapter 17

## Using and Testing Drought Indicators

Luis García Amor, Alejandro Carrasco and Juan Carlos Ibáñez

**Abstract** Several drought indices have been applied to different hydrological time series relevant to droughts in the Community of Madrid and its water supply system, managed by public company Canal de Isabel II (CYII). Results have been studied in order to establish how much useful information can be drawn from them with emphasis in its diagnosis ability and anticipation capacity.

The set of studied drought indices involve variables as precipitation, temperature, flow and simulated water storage. Their performance has been tested at monthly, seasonal, annual and biennial levels.

The widely known Standardized Precipitation index (SPI), and the so called SQI and SRI, (an attempt to extend the SPI approach to total inflow and water storage level), along with the Reconnaissance Drought Index, or RDI (Tsakiris, 2004) make up the family of standardized indices which have been studied in the first place. The Run Method as it has been proposed in Cancelliere et al. 2005 and the Palmer Drought Severity Index, or PDSI (Palmer, 1965) complete the set of studied indices.

The general descriptive power of drought indices is widely confirmed by the study. Indices efficiently characterize historical droughts and provide straightforward means to compare their severity in objective, general terms. Capability of the Run Method to provide sound values of return period for actual or hypothetical droughts is acknowledged.

The ability to foresee droughts or their future evolution provided by indices has been investigated. Finally, the potential utility of the indices in management of droughts and decision making has been considered.

### Introduction

Several drought indices have been applied to the hydrological time series relevant to droughts in the Community of Madrid and, specifically, to its water supply system, managed by public company Canal de Isabel II (CYII). Results have been studied

---

L.G. Amor (✉)  
GETINSA – Canal de Isabel II, Madrid, Spain  
e-mail: lgarcia@getinsa.es

in order to establish how much useful information can be drawn from them with emphasis on its diagnosis ability and anticipation capacity.

The following aspects specify the starting point for the study:

*Types of drought.* Four different types of drought have been considered, corresponding to four different aspects focused in each one: *meteorological* drought (meteorological conditions in a given period are drier than normal), *hydrological* drought (river flow in a given period is below normal levels), *hydraulic* drought (at some time, water reserve is below normal levels for that time of the year) and *operational* drought (water available in the system is not enough to meet the foreseen demand for a given period).

*Geographical scope.* The geographical scope of the study is restricted to the territory of the Community of Madrid, and it is perceived on two levels: a) the whole territory (where droughts are seen as natural phenomena with implications for agriculture, natural environment and urban environment) and b) CYII catchment area (where hydrological droughts may cause hydraulic and operational droughts in the water supply system).

*Time step and reference period.* Monthly data have been used and the analysis has been performed at the monthly, seasonal, annual and biennial levels (always considering hydrological years for the annual and biennial levels).

*Set of data.* Three types of data were used: meteorological, hydrological and hydraulic. Meteorological data are: monthly precipitation and monthly average temperature at the Retiro Station (Madrid), available for civil years 1901 to 2005. Hydrological data are monthly total inflow to the CYII reservoirs, available for hydrological years 1941–1942 to 2004–2005. Hydraulic data are the series of simulated water storage in the reservoirs of the CYII system at the end of each month, available for hydrological years 1941–1942 to 2003–2004.

*Drought indices.* The widely known Standardized Precipitation index (SPI), two others derived from a similar approach, which we have called SQI and SRI, and the Reconnaissance Drought Index (RDI), (Tsakiris, 2004) constitute the standardized indices family that has been studied and dealt with in this work. Possible applications of the Run Method as proposed in Cancelliere et al. 2005, together with those involving Palmer Drought Severity Index, or PDSI (Palmer, 1965) are also described.

## Standardized Indices

SPI and two additional indices developed from a similar approach have been tested. The two additional indices, which we have named SQI and SRI, refer to inflow and water storage respectively.

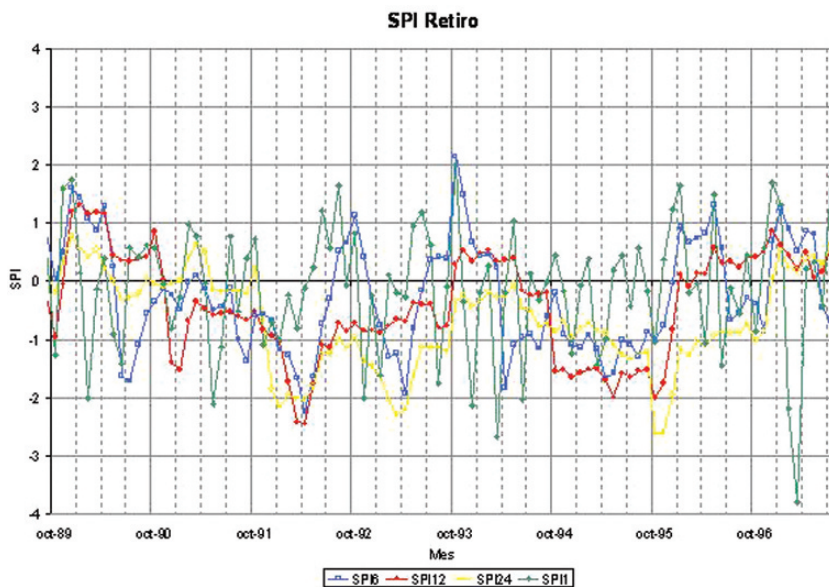
We have chosen to add the reference period in the notation of the index in such a fashion that SPI12, for example, will be an aggregate SPI per year (12 months).

### *SPI for Precipitation on Retiro Station*

Obviously, information that the SPI can convey is linked to the concept of meteorological drought.



The evolution of the small-scale aggregation SPI indices (between 1 and 3 months) provide information that is hardly relevant to the operator of the supply system (see Fig. 17.1). Monthly precipitations show high variability while one or a few abnormal months may have a small impact concerning hydraulic droughts in a system such as the CYII, which operates reservoirs designed for annual regulation. Moreover, due to a clearly marked seasonality, same values of SPI1 or SPI3 corresponding to different times of the year may have completely different meanings in relation to operational droughts. For example, SPI1 of August has nothing to do with droughts in Madrid, whatever its value.



**Fig. 17.1** SPI evolution index for different reference periods at Retiro station (Madrid, Spain). The severe dry spell of 1991–1995 is clearly shown in SPI12 and SPI24 series, but not so in SPI1 or SPI6

However, monthly or seasonal SPI can be used for certain short term, season-sensitive decision making tasks. This is the case with evaluation of how harmful banning irrigation of parks and gardens may result, conditioned mainly by how rainy the flowering period has been. In a similar fashion, the value of SPI for the last few months may serve as an estimator of the degree of saturation of soil in the catchment area.

SPI index series corresponding to greater reference periods (6 to 24 months) may be far more interesting from the point of view of the operator of the supply system concerned with droughts.

The greater the reference period the more inertia the indicator presents and, therefore, the smoother its evolution is over time (see Fig. 17.1). But in selecting a reference period in this longer range, it is worthwhile mentioning that annual or pluriannual scale indices are the ones presenting an inertia component less dependent of the month taken into consideration. This is because in calculation of the

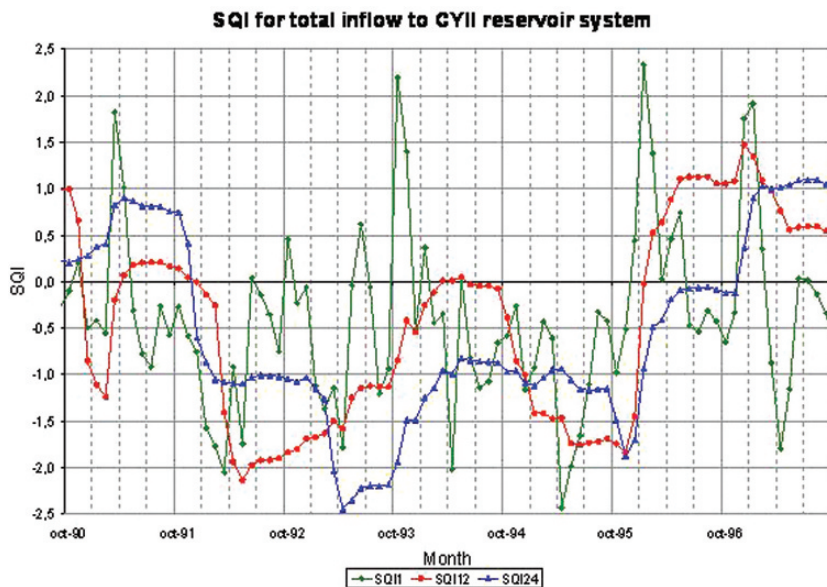
index it is always a whole year (or several whole years) the period whose precipitation is taken into account, no matter which month is considered. Monthly series of long reference period SPI only make sense for reference periods like 12, 24, 36, ... months. Other reference periods may provide useful information for particular purposes although they cannot be studied as a time series but only by taking into account which time of the year each value refers to.

In the case of Madrid, SPI12 and SPI24 seem to be the most interesting SPI indices to characterize drought phenomena related to the CYII water supply system, provided that it seems that one or few years is the time scale of the relevant operational droughts.

### *SQI for Total Inflow*

We have found it interesting to build an index identical to SPI but taking flow data as its base variable. We have named the index SQI and, in this work, it has been applied to the series of CYII catching area monthly total inflow. SQI is clearly linked to the concept of hydrological drought as SPI is linked to the concept of meteorological drought.

Results on inertia, small reference periods and suitability of annual or n-annual reference periods are as valid for SQI as they are for SPI. SQI12 and SQI24 seem to be fairly able to represent known historical droughts relevant for the CYII system (see Fig. 17.2). Differences between both SQI12 and SQI24 indices have been



**Fig. 17.2** SQI evolution index for total inflow to Canal Isabel II reservoir system for different reference periods. The severe dry spell of 1991–1995 is clearly shown in SQI12 and SQI24 series, but not so in SQI1

analyzed on the historical series but no definite conclusion can be drawn about which one is more suitable from the operational point of view. SQI24 seems to better represent the known long severe droughts but it may be the case that it is too conservative in identifying the end of a dry spell. Given the characteristics of the CYII reservoir system, a wet year (even a wet winter) may suffice to end any dry spell, whatever its severity, SQI24 being unable to respond quick enough in such a circumstance.

### ***SRI for CYII Simulated Water Storage***

SRI is an attempt to extend the standardized index approach to even another variable: water storage level. SRI may be seen as the standardized index that deals with hydraulic drought in the same way that SPI and SQI deal respectively with meteorological and hydrological droughts.

To match the time step chosen for the analysis, water storage at the end of each month has been taken as monthly calculation data. Since water storage is a state, not a cumulative variable, reference periods cannot be applied.

Obviously, the values of water storage in a reservoir system depend on its configuration and on the level of demand that it has to serve. Since both terms have undergone notable evolution over the last decades in the CYII reservoir system, its monthly water reserve levels do not constitute a homogeneous time series. Instead, we have chosen to use the simulated water storage values. These are obtained from the series of recorded inflows by means of simulation supposing a system having the present water storage capacity and serving a known demand similar to the present one, and reproducing actual operation of the system (use of ground water and water transfers).

Given a reservoir system, the water storage at any moment may vary from 0 to the maximum storage capacity (which, in turn, may depend on the time of the year following a seasonal freeboard policy). For this reason, not the gamma distribution function but the beta one (whose range is bounded both below and above) has been chosen for standardization purposes. Figure 17.3 shows how beta distribution functions are fitted to series of simulated water storage for months October to January.

SRI series for CYII reservoir system are presented in Fig. 17.4, along with the evolution of total storage. The variation pattern of the seasonal maximum storage capacity has also been included as a reference.

Storage follows the expected evolution for a reservoir system subjected to a notably seasonal regime. In winter, when inflows start to increase, reservoir levels rise until the maximum level is reached about the end of the thaw period. From this point on, demand surpasses inflows and reservoir levels drop until they reach their minimum at the end of the summer.

Hydraulic droughts are expected to be indicated by long spells of negative SRI, corresponding to water storage below normal levels for the time of the year. Following the graph in Fig. 17.4, a long hydraulic drought can be identified between January 1992 and January 1996.

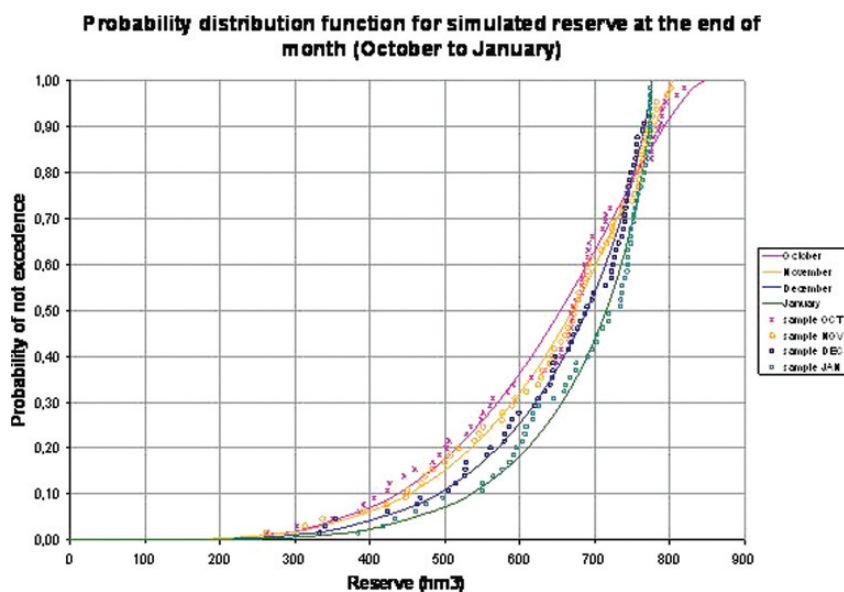


Fig. 17.3 Beta distribution functions for monthly simulated reserve levels, months October to January

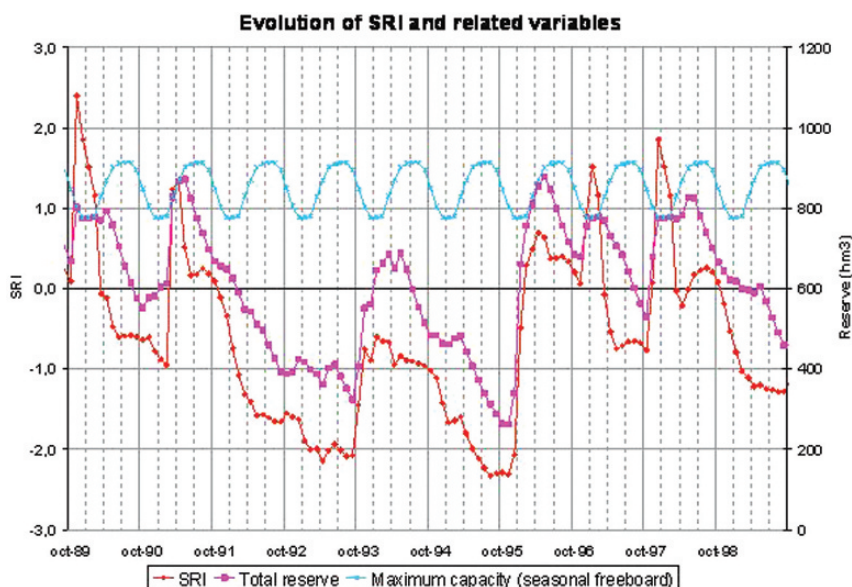


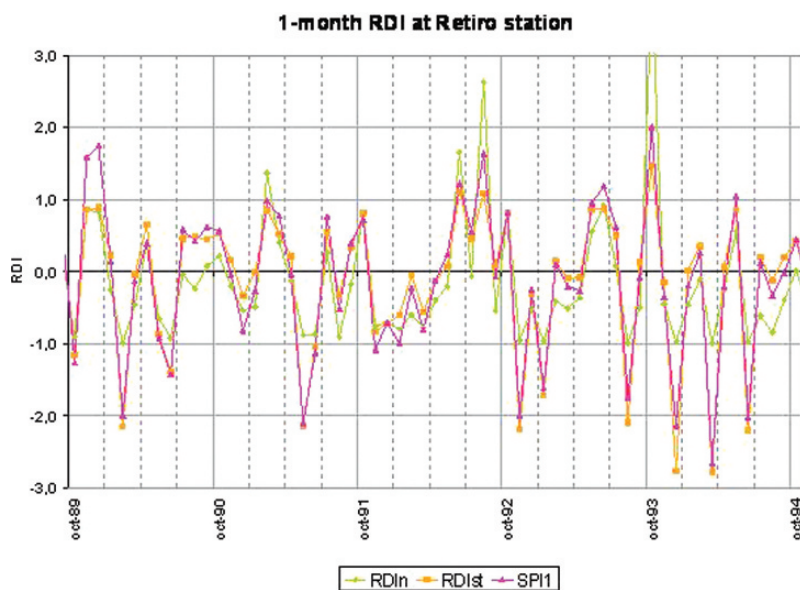
Fig. 17.4 Evolution of SRI index, water storage and maximum allowed storage capacity for each time of the year at CYII reservoir system

### *RDI for Precipitation on Retiro Station*

The Reconnaissance Drought Index (hereinafter RDI) is an index that has been developed within the frame of the MEDROPLAN project (Tsakiris, 2004). It can be seen as a kind of standardized index based on the quotient between accumulated precipitation and the potential evapotranspiration (PET) for a given period. It is, then, related to meteorological drought so it is SPI. However, RDI may be considered somehow more complete because it includes the effect of PET.

A monthly PET time series has been obtained from monthly average temperatures in Retiro station using the Thornthwaite method.

From both formulations presented in Tsakiris 2004, normalized RDI ( $RDI_n$ ) and standardized RDI ( $RDI_{st}$ ), we have preferred the latter, mainly because the former has a clearly non-symmetrical distribution, with a lower bound of  $-1$ . However both time series have been calculated. In Fig. 17.5 the series of  $RDI_n$  and  $RDI_{st}$  for a reference period of one month are shown along with SPI1 series, this last one included for comparison. Lack of symmetry in  $RDI_n$  can be clearly observed. It can also be seen that, in general,  $RDI_{st}$  and SPI1 show a very similar behavior, which seems to mean that introduction of PET in an index oriented to meteorological drought does not have a very significant effect (at least for the analyzed data set).



**Fig. 17.5** Evolution of RDI indices. SPI1 is shown for comparison. Retiro station (Madrid, Spain)

On the annual level differences between  $RDI_{st}$  and SPI12 are somehow more visible and they may carry some significant meaning. However, evolution of temperature-based data must be handled with care in the long run, due to the possibility of them being influenced by urban thermal island effect. This may be the



case for temperatures recorded in Retiro station, in the centre of Madrid. In the case studied, SPI may be preferable to RDI unless a series of PET free from urban thermal island effect is obtained.

### *Relationship Between Standardized Indices*

The following sequence may represent the initial evolution of a drought: a persistent enough meteorological drought causes a hydrological drought which, in turn, becomes a hydraulic or operational drought. The sequence suggests that the following precedence relationship may hold: a spell of low values of SPI precede a spell of low values of SQI which, in turn, precede a spell of low values of SRI. Should this be true, a certain capability to predict hydraulic droughts can be expected to be found in SPI or SQI.

The potential for prediction of SPI and SQI has been explored in this work, mainly by studying the cross-correlations between time series of SPI, SQI and SRI for several reference periods and several delays between them. Results, however, have not been very promising. Results for one year and two year reference periods (i.e., the ones found useful in diagnosing droughts in Community of Madrid) are commented below.

Correlation is fairly good between SQI12 and SPI12 for the preceding month ( $r = 0.782$ , see Table 17.1) and even SPI12 two months previous ( $r = 0.761$ ). Since correlation between synchronous SQI12 and SPI12 is slightly worse ( $r = 0.753$ ), it can be said that SPI12 for a given month conveys some amount of information about SQI12 for the next month or even two months in advance.

Correlation between synchronous SQI24 and SPI24 is quite good ( $r = 0.819$ , see Table 17.2) but slightly worse than correlation between SQI24 and SPI24 for the preceding month ( $r = 0.829$ ). Therefore, it can be said that there is a small amount of information about SQI24 that is carried by SPI24 for the preceding month but is lost in the synchronous SPI24.

**Table 17.1** Coefficient of correlation between SQI12 and SPI12 of a previous month

Months in advance	0	1	2	3	4	5	6
Coef. of correlation	0.753	0.782	0.761	0.720	0.670	0.615	0.558

**Table 17.2** Coefficient of correlation between SQI24 and SPI24 of a previous month

Months in advance	0	1	2	3	4	5	6
Coef. of correlation	0.819	0.829	0.812	0.784	0.750	0.716	0.682

Correlation of SRI is better with synchronous SQI12 ( $r = 0.814$ ) than with any other SQI, no matter what the reference period and the number of months in advance may be. So it can be concluded that SQI does not have any power to predict future values of SRI. Considering SPI indices, the best one correlated to SRI is synchronous SPI24 ( $r = 0.686$ ). Again, no predictive power for SRI is to be found in SPI indices.

## Run Method

The Run Method (Cancelliere et al., 2005) constitutes a simple conceptual approximation for characterizing droughts on an annual basis. Runs or spells, duration, deficit and intensity concepts are clear and intuitive. It must be pointed out however that the four concepts are linked to an arbitrary threshold value or truncation level, whose selection poses an initial difficulty to the application of the method.

The most interesting trait of the method is the possibility of estimating duration or total deficit, or the combination of both in relation to a return period. Three out of the five available types of return period have been found interesting for the study:

- T2. Drought with duration equal to or greater than a given value  $l_c$ .
- T3. Drought with greater deficit than a given value  $d_c$ .
- T5. Drought with duration equal or greater than  $l_c$  and deficit greater than  $d_c$ .

From the two available methods for estimating return periods, the parametric method has been adopted, because its implementation has been found to be far simpler.

### *Run Method for Precipitation on Retiro Station*

Mean annual rainfall for Retiro station amounts to 436.6 mm and the median value is 424.2 mm (hydrological years 1901–1902 to 2004–2005). Taking the median as truncation level, the run method produces the results shown in the Table 17.3. Figure 17.6 shows the series of annual precipitation and its runs over the median.

Up to 27 dry runs are identified. It can be seen that the three most severe episodes are those in the first half of the 1930s, the 1980s and the 1990s. The T5 return periods for these three episodes stand at about 50–100 years, which can be considered consistent with the fact that the series is about one hundred years long. The most severe run is the one in the decade of the nineties, with maximum run duration (5 years) and maximum accumulated deficit (377 mm).

Taking the mean as truncation level yields slightly different results. The same three severe episodes are outlined, T5 return periods in the range 75 to 150 years. The 1980s run is 7 years long (from 1979–1980 to 1985–1986) and is the most severe considering its T5 return period.

Less-centered truncation levels, as the suggested mean – standard deviation (m-s), do not produce useful results. The m-s truncation level produces 12 dry runs, all of them one single year long. Generally, the less centered the truncation level, the lower the number of runs it yields, resulting in an insufficient sample for the statistical analysis. It can be concluded that truncation level selection must better be based on statistical criteria (i.e.: it must be centered) than on operational ones.

**Table 17.3** Run method analysis for annual precipitation in Retiro 1901–1902 to 2004–2005. Truncation level 436.6 mm (median)

N	Initial year	Final year	Duration (years)	Accumulated deficit (mm)	Intensity (mm/year)	Return period (years)		
						T2	T3	T5
1	1902–1903	1902–1903	1	71.3	71.3	4.0	5.9	6,1
2	1904–1905	1904–1905	1	8.0	8.0	4.0	4,1	4,1
3	1906–1907	1906–1907	1	140.2	140.2	4.0	10,2	10,3
4	1908–1909	1909–1910	2	107.9	54.0	8.0	7,8	10,2
5	1912–1913	1912–1913	1	117.0	117.0	4.0	8,4	8,6
6	1915–1916	1915–1916	1	33.0	33.0	4.0	4,6	4,6
7	1917–1918	1917–1918	1	175.3	175.3	4.0	13,9	13,5
8	1922–1923	1922–1923	1	78.1	78.1	4.0	6,2	6,4
9	1924–1925	1926–1927	3	163.8	54.6	16.0	12,5	19,8
10	1928–1929	1928–1929	1	78.9	78.9	4.0	6,2	6,4
11	1930–1931	1933–1934	4	347.4	86.9	32.0	68,8	68,5
12	1936–1937	1938–1939	3	212.3	70.8	16.0	19,3	24,5
13	1943–1944	1944–1945	2	251.4	125.7	8.0	27,7	25,5
14	1947–1948	1949–1950	3	254.0	84.7	16.0	28,4	30,8
15	1952–1953	1954–1955	3	213.8	71.3	16.0	19,6	24,7
16	1956–1957	1957–1958	2	137.3	68.7	8.0	10,0	11,9
17	1964–1965	1964–1965	1	89.7	89.7	4.0	6,8	7,0
18	1966–1967	1967–1968	2	29.5	14.8	8.0	4,5	8,1
19	1969–1970	1969–1970	1	41.1	41.1	4.0	4,8	4,9
20	1973–1974	1974–1975	2	52.3	26.2	8.0	5,2	8,3
21	1979–1980	1982–1983	4	282.3	70.6	32.0	37,0	49,2
22	1984–1985	1985–1986	2	46.0	23.0	8.0	5,0	8,2
23	1988–1989	1988–1989	1	24.9	24.9	4.0	4,4	4,4
24	1990–1991	1994–1995	5	377.0	75.4	64.0	91,7	109,7
25	1998–1999	1999–2000	2	164.8	82.4	8.0	12,7	14,0
26	2001–2002	2001–2002	1	51.0	51.0	4.0	5,1	5,2
27	2004–2005	2004–2005	1	226.8	226.8	4.0	22,1	20,2

### *Run Method for Total Inflow*

The run method has also been applied to the series of annual total inflow to the CYII reservoir system (years 1940–1941 to 2004–2005). The median (768,7 hm<sup>3</sup>) has been taken as truncation level, taking into account what has been said above about truncation level selection.

Figure 17.7 shows the series of annual inflows and the formation of runs over and below the median. Table 17.4 shows the results of the analysis. Runs 9 and 12 are the most severe events recorded, and they are consistent with severe precipitation runs. There is even an overall consistency in return periods.

### *Application*

The ability of the run method to characterize historical droughts is obvious. Not only can it describe a dry spell in terms of duration or accumulated deficit but it can characterize its severity in terms of probability. For example: at Retiro, a period of



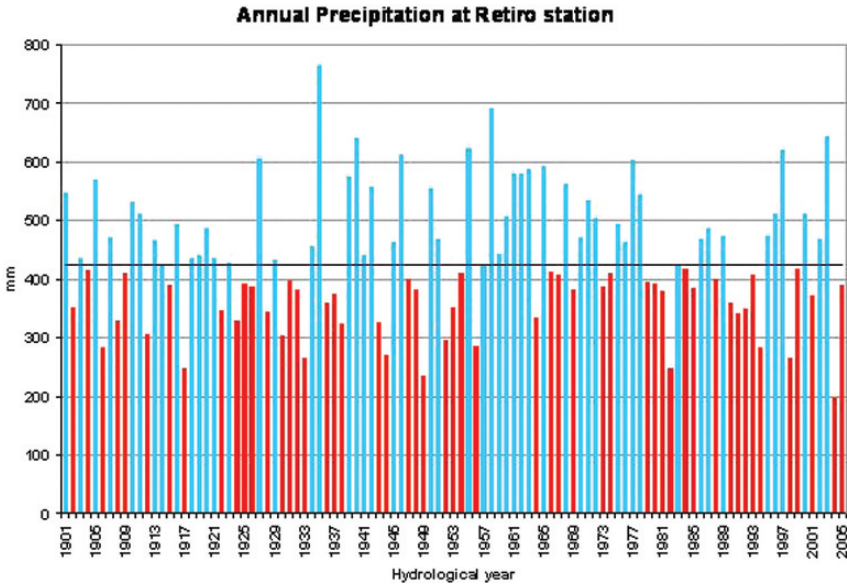


Fig. 17.6 Wet and dry spells for rainfall in Retiro (Madrid, Spain), taking the median as truncation level

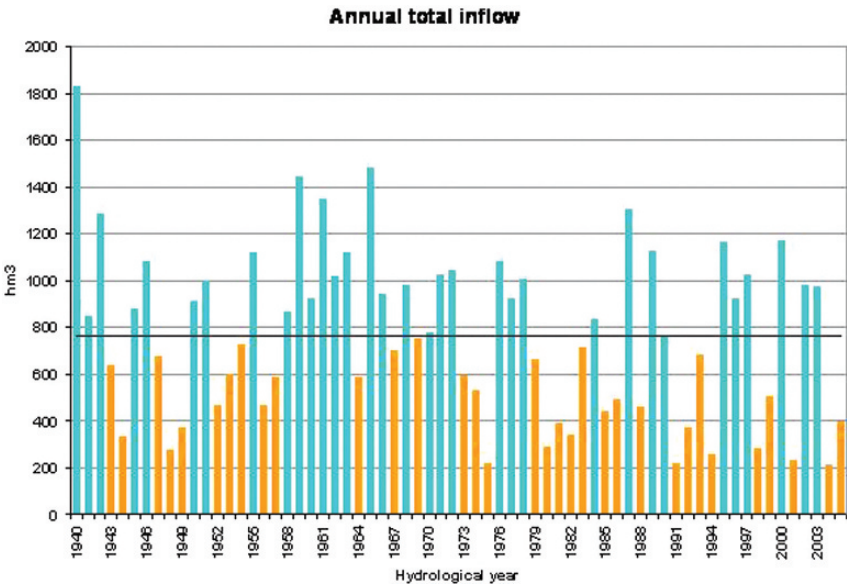


Fig. 17.7 Wet and dry spells for total inflow to the CYII reservoir system, taking the median as truncation level

**Table 17.4** Run method analysis for annual total inflow 1940–41 to 2004–05. Truncation level 768.7 hm<sup>3</sup> (median)

N	Initial year	Final year	Duration (years)	Accumulated deficit (hm <sup>3</sup> )	Intensity (hm <sup>3</sup> /year)	Return period (years)		
						T2	T3	T5
1	1943–1944	1944–2045	2	560.9	280.5	7.9	8.5	10.9
2	1947–1948	1949–2050	3	977.3	325.8	15.5	21.6	26.2
3	1952–1953	1954–2055	3	509.6	169.9	15.5	7.7	16.2
4	1956–1957	1957–1958	2	480.1	240.0	7.9	7.3	9.8
5	1964–1965	1964–1965	1	181.6	181.6	4.0	4.5	4.7
6	1967–1968	1967–1968	1	66.6	66.6	4.0	4.1	4.1
7	1969–1970	1969–1970	1	13.4	13.4	4.0	4.0	4.0
8	1973–1974	1975–1974	3	956.6	318.9	15.5	20.6	25.4
9	1979–1980	1983–1984	5	1440.4	288.1	60.2	69.2	86.9
10	1985–1986	1986–1987	2	600.4	300.2	7.9	9.2	11.6
11	1988–1989	1988–1989	1	306.8	306.8	4.0	5.4	5.9
12	1991–1992	1994–1995	4	1540.5	385.1	30.6	90.0	79.5
13	1998–1999	1999–2000	2	744.2	372.1	7.9	12.6	15.0
14	2001–2002	2001–2002	1	536.1	536.1	4.0	8.1	9.4
15	2004–2005	2004–2005	1	556.1	556.1	4.0	8.4	9.8

5 or more years of precipitation below median and accumulated deficit either equal or superior to that recorded in the 1990–1991 to 1994–1995 dry spell has a return period of about 100 years.

However, to adequately evaluate the meaning of return periods provided by this method the following must be taken into account:

- a) Results depend on a previous decision: the selection of the threshold value or truncation level.
- b) Statistical methodology for calculation of the return period is only approximate and subject to certain lack of accuracy. When applied with non-centered threshold values, results tend to be unreliable.

Selection of the threshold is crucial for application of the method. On the one hand, to endow the concepts of spell, deficit, etc. with meaning, it seems convenient to choose threshold values that have an operational significance. On the other hand, centered threshold values are necessary so that the estimate of return periods will hold acceptable precision. Specifically, the median of the series is the threshold value that provides a higher number of spells and, therefore, best accuracy in the results. Thus the recommendation is to systematically adopt the median as a threshold value and, if subsequently necessary, significant runs can be selected with criteria more related to system operation (unless an operational criterion yields a sufficiently centered truncation level).

The possibility of assigning return periods to hypothetical droughts may have an application for planning: it allows a probabilistic criterion to define “design droughts” to be established for which a drought management system may be designed. Once the statistical parameters are estimated from the data, a set of, for example, 100-year droughts can be defined and a drought management scheme can be designed using those droughts as a reference.

On the other hand, the method does not seem to have any practical use in management of an actual event.

## Palmer Drought Severity Index

Palmer Drought Severity Index, or PDSI (Palmer, 1965), and some variants of it, have been extensively used for several decades in the United States of America as indicators of meteorological droughts for agriculture.

The PDSI index is conceptually complex (far more complex than the other indices studied in this work) and despite its widespread use, its formulation can be considered, at least to some extent, site specific (in fact, it was developed and adjusted to describe some historical severe droughts recorded in Iowa and Kansas in the first half of the 20<sup>th</sup> century, see Palmer, 1965). This somehow local specificity of the index prevents its direct application to such a different geographical scope as that of this study. An adaptation has been considered necessary, but due to the complexity of the index, it is difficult to find generally acceptable, clear-cut criteria to carry it out.

Specification of PDSI for the Community of Madrid has consisted in the determination of the so-called duration coefficients  $p$  and  $q$  and climatic characteristic  $K_i$ . This task has been done following the method outlined in DMG 2006 and somehow emulating that originally followed by Palmer when creating his index, as it is described in Palmer 1965.

Duration coefficients  $p$  and  $q$  are obtained by means of approximate fitting of a straight envelope line to a scatter of points representing the most severe droughts recorded, which need to be identified and quantified in advance. This is a somehow fanciful method, provided that while an objective of the PDSI index is determination of the beginning and end of a drought, these instances have to be available beforehand in the historical data.

The value for climatic characteristic  $K_i$  has been established in such a way that 2% and 98% percentiles of the PDSI historical series is  $-4$  and  $4$  respectively.

It is an intrinsic property of the PDSI formulation that the actual value of the index may depend on future evolution of the situation, so it only can be known several months later. This is called *backtracking* and it poses another drawback to the application of the index. The use of Weighted PDSI (WPDSI) instead of original PDSI avoids this problem and therefore, this index has also been calculated for the Community of Madrid.

Evolution of PDSI and WPDSI along with the indices SPI12, SQI12 and SRI is presented in Fig. 17.8 for the dry period of the nineties. Since PDSI has a greater range of variation (between  $-4$  and  $4$ ), its series have been represented on a secondary axis, in such a manner that evolution of all five indexes can be compared easily. In the figure it can be seen that the general behavior of PDSI and that of SRI follow a similar pattern. As SRI is directly related to hydraulic drought, PDSI may have an interest as an indicator of hydraulic or operational droughts in the Community of Madrid.

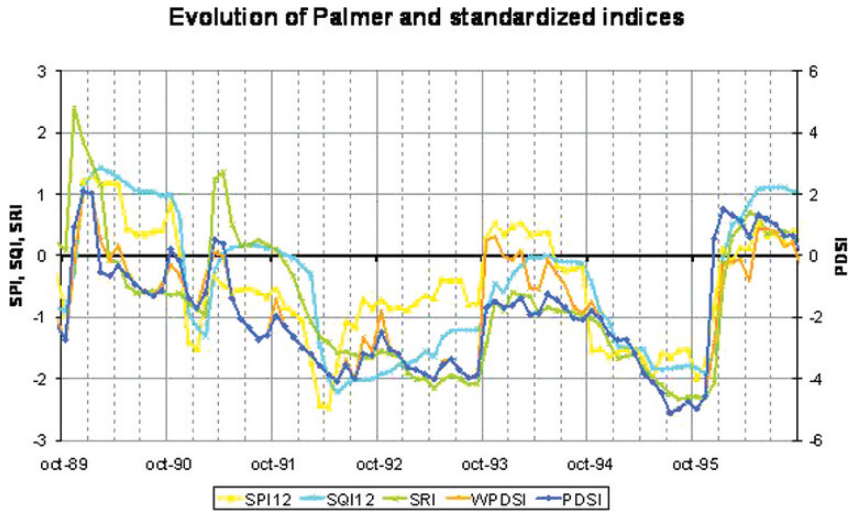


Fig. 17.8 Evolution of Palmer index and standardized indexes

## Conclusions

The following conclusions have been drawn from the evaluation of the drought indices by means of their application to the specific case of the Community of Madrid and CYII water supply system:

### Generic Indices can Provide Effective Support in Characterization of Drought Situations

The fundamental virtue of generic drought indices is their capacity for compacting and unifying relevant information, reducing it to a common language. Thus applications are evident:

It makes it easier to compare events produced in different seasons or locations. Thus,  $SPI_{12} = -2.5$  means the same everywhere and at all times.

It allows relating different variables or different drought concepts very easily. Indices SPI, SQI and SRI, representative of meteorological, hydrological and hydraulic droughts respectively, are expressed in the same scale (this being their essence: the three of them are *standardized*). Thus it is very easy, for example, to compare severity of a situation of shortage in precipitations with severity of a situation of shortage in inflows.

The ability to characterize historical droughts can be profited in planning tasks. It is the case of the Run Method, which could allow to define hypothetical “design droughts” based on return period.

The simplicity of the scales in which these indices (standardized, PDSI) are usually expressed may be useful in communication of drought situations to the population.

### **The Studied Indices do not Exhibit Significant Ability to Anticipate Droughts or Their Future Evolution**

Possibilities offered by the indices for anticipation of evolution of drought situations have been investigated in-depth and the result is fairly poor.

An *a priori* promising case is represented by the sequence *Meteorological Drought* → *Hydrological drought* → *Hydraulic or operational drought*. In principle it seems feasible that this sequence could be translated into behavior patterns of evolution of SPI, SQI and SRI for example. However, these patterns, if they were to exist, have not been identified.

In relation to the evolution of a drought, the prognosis ability of any of the indices is not different from the prognosis ability already held by the underlying variable. Evolution of a standardized index such as SPI does present some predictability, which only and exclusively arises by the inertia that is inherent to the temporary scale of analysis. Indeed, SPI12 for one month cannot be very different from SPI12 of the previous month, which is due to the mere fact that the index aggregates 12 months and the difference between one and the following is made by one single month. If prediction capacity does not exist for the next month's precipitation, predictability of SPI12 provided by its inertia does not contribute any significant information.

### **Generic Indices Cannot Compete with Specific Indicators as a Tool for Decision Making in Management of a Drought**

Its compact nature and general vocation provides the generic indices with their descriptive power, although in contrast, necessary simplifications and generalizations in their design reduce capability from their operational application.

In some cases indices are nothing more than a change of variable. For example, SPI provides a common scale that allows characterizing the situation no matter what the geographic scope may be. However, from the operational point of view, use of a SPI threshold is equivalent to use of a quantile or, if working on local data, a previously established precipitation threshold. This circumstance is observed in any of the standardized indices, including RDI.

On the other hand, management of a drought normally involves a complex set of variables, many of which are specific to the scope or system that is involved. The idea that relevant management decisions can be truly based on the value of one or even a set of standardized indices (each one collecting a single variable) seems quite unlikely. At any rate, this kind of index cannot compete with specific indicators developed for specific systems and supported by specific risk analysis

studies. For example, it does not seem probable that generic indices can actually provide significant improvement to the procedures currently under use for management of droughts in the CYII supply system, which are integrated in its operational rules (CYII, 2003).

An index with a remarkable built-in degree of sophistication is PDSI. Moreover, PDSI is supported by decades of experience in its widespread use in the United States as an indicator of meteorological drought in the agriculture sector. However, the same complexity in its definition implies the need to adapt it when it is to be applied in a region different from the original. We have not been able to find generally acceptable, straightforward criteria to carry out this adaptation. Therefore, conceiving a universal PDSI or importing experience on its use in other latitudes seems difficult. In this sense, our consideration of the PDSI would rather be that of a specific index.

In relation to the Run Method, its potential for characterization of historical events and even for designing drought management systems has to be acknowledged. Despite that, it has been seen that due to its nature, possibilities for operational application are practically non-existent.

## References

- Canal De Isabel II (2003) Manual de Abastecimiento del Canal de Isabel II. Madrid, March 2003
- Cancelliere A, Bonaccorso B, Cavallaro L, Rossi G (2005) Regional Drought Identification Module REDIM. Extended Version 2005.1. Reference Guide. University of Catania, October 2005.
- DMG 2006 European Commission – EuropeAid Co-operation Office, Euro-Mediterranean Regional Programme For Local Water Management, Mediterranean Drought Preparedness and Mitigation Planning (Medroplan). Drought Management Guidelines. November 2006.
- Palmer W C (1965) Research Paper No. 45. Meteorological Drought. U.S. Department of Commerce, Weather Bureau. Washington D.C.
- Tsakiris (2004) Guidelines for Using Annual RDI. Laboratory of Reclamation Works & Water Resources Management. National University of Athens.

# Chapter 18

## Drought Management in the Urban Water Supply System of Canal de Isabel II, Spain

Francisco Cubillo

**Abstract** The availability of enough and suitable resources to attend the different kinds of water demands in the urban context represents the main basis of supply services. The maintenance of balance between availability and demand is subject to threats of different kinds, and when this balance is lost it has a major impact on and generates costs to citizens, entities and those responsible for the supply. The break-up of this balance represents one of the main risks with which urban water service must cope. The problem has not yet been posed or solved in a homogeneous way internationally, not even in contexts involving situations of hydric stress. The solutions described in this paper summarize the methodological and operational aspects followed in the Comunidad de Madrid in Spain by the supply system responsible for providing that service to 6 million inhabitants. From the methodological point of view a clear difference of setting has been established, with a clear separation between those related to the failure or normal situation and indicators and corresponding conventions to be used in planning, operating and solving contingencies. As for the operational aspects, a division into stages or phases is set with their corresponding impacts and cost distribution among the different parties involved. In both approaches, considering risk as a main factor in analysis and decision making is the main pillar for the efficient management of resources and commitments with society and the environment.

### Managing Drought and Water Scarcity in Urban Water Supply Systems

Urban supply systems always cope with the result of a territorial, economic and social development model. They are placed in an environmental and institutional context that dictates many of the peculiarities and conditions under which this activity is developed.

---

F. Cubillo (✉)  
Canal de Isabel II, Santa Engracia, Madrid, Spain  
e-mail: fcubillo@cyii.es



The important temporary evolution that major cities around the world have undergone is in general linked to fast growth, representing a challenge involving opportune adaptation of urban services to the needs and expectations of the citizens and in particular to water. Increases in population, changes in climate conditions, modifications in the availability of resources and increased social demands determine a higher than desirable frequency of episodes in which service conditions do not satisfy citizens' desires and expectations.

Within this context, with such important dynamic components, non-desired situations arise with effects and impacts, or simply high probability values of the same situations occurring.

Societies in the 21st Century measure the degree of development by the capacity for reaction to these situations, through their prevention, mitigation and effective resolution, amongst other parameters.

Practices involving the design and operation of supply systems have historically incorporated different principles for facing these types of problem in accordance with the economic capacity of each case and circumstance and social expectations involving continuity, stability and service quality. Even so, applied technical procedures have adapted to the new legal and cultural frameworks and to the needs that have derived from the changing conditions of each system.

Currently, risk constitutes one of the fundamental components in management of urban supply systems, understood as a combination of the probability of certain threats arising that cause damage or impact upon one or more social agents.

Scarcity conditions and droughts are one of the episodes that represent a significant risk for many urban areas in the world, which is why urban water management must take into account episodes of drought and scarcity in their main guidelines for managing their supply systems.

There are some basic principles that urban water supply systems should adopt to cope with droughts and scarcity that could be summarized in following guidelines:

The main mission of a water supply is to ensure the supply to all its users, according to the conditions stipulated by the regulations in force.

The use of natural resources necessary for carrying out the function of a water supplying body to urban centres will be carried out within the framework of sustainability of ecosystems linked to the bodies of water whose conditions are affected as a consequence of the activity of the supply system.

All water resources in the supply system will be used under the principles of integrated management.

The guarantee of equilibrium between the availability of natural resources and the total consumption demanded in the supply system, for present and future scenarios, will be handled by giving particular priority to efficient management solutions of all the components of the supply and demand cycle.

The assurance strategies of the supply for future scenarios will be established in the corresponding planning studies, within the frameworks established by the National and Basin Master Plans.

All the actions considered for the assurance of the availability-demand equilibrium will be calculated with the evaluation of its social, environmental and economic implications.



Droughts, understood as periods with low precipitation patterns, are a normal phenomenon although of little frequency of occurrence. Droughts understood as a climatic phenomenon triggering episodes of high-risk of non-fulfilment of the service standards, constitute a main part of the planning, designing and management work of a supply system.

In a combined consideration of efficient utilization of resources and recognition of adjusted balances between availability and consumption, in present scenarios and those of the immediate future, the need to possibly require temporary reduction of consumption should be assumed. In spite of this, the commitment to always satisfy a certain amount of demand should be established, within the historically recorded climatic context.

The ecosystems dependent on the management of the supply system will also be affected by the conditions of scarcity of resources triggered by drought episodes. In these cases, the need to restrict the fulfilment of the conditions for normal assurance, on a subsidized basis with urban supply, should be assumed.

The assurance of the supply should also consider episodes of greater severity than those known. Within the principles of risks and contingencies management, the encountering of episodes of prolonged scarcity of resources for supply, as a consequence of the occurrence of one or more of the following situations should be considered such as:

- Periods of higher climatic severity than those recorded.
- Consumption increases in excess of those forecasted.
- The occurrence of eventualities that limit and condition the normal use of the infrastructure that forms the supply system.

Cubillo Fi (2007) describes guidelines to build management plans for urban supply in Spain.

## **Drought Management Context in the Madrid Water Supply System**

Canal de Isabel II is a public owned company responsible for providing drinking water to 6 million people in the Comunidad de Madrid in Spain, which includes more than 170 municipalities. Its commitment to the efficient use and management of the water resource is the best contribution to the quality of service to the citizens and environmental sustainability of the Community of Madrid. The materialization of this commitment is supported in the establishment of protocols for the better development of all the processes to ensure water supply. The Supply Manual (Cubillo, 1999) developed by Canal de Isabel II lies within these protocols and its main objective is to establish the general planning and operation guidelines of the Supply System, to ensure water supply to urban centres in compliance with all established standards. All this is in the context of sustainability in the maintenance of the good ecological status of all the bodies of water related to the supply system, and following the principles of efficient management of the water resource.

The supply standards should reflect the need for flexibility and adaptation of management to a high risk of insufficiency of resources to handle the present or immediate needs of each situation in areas with a broad climatic variability. These situations, usually generated by the occurrence of periods of low precipitation, constitute the main element of the dimensioning of the hydraulic systems and require specific management guidelines. Guidelines which should consider the worst meteorological records known as those which involve the occurrence of the most severe episodes, due to natural causes or those induced by man.

Among the outstanding objectives of the Supply Manual is the fulfilment of Law 10/July 5, 2001, of the National Hydrologic Plan (*Ley de Plan, 2001*), which in Article 27.3 establishes that for urban supply systems which serve a population in excess of 20,000 inhabitants, an "Emergency Plan in Case of Drought Situations" should be provided. Although the operation of this Emergency Plan is conditional to that established in the drawing up by the corresponding basin agency of a "special plan of action in situations of alert and possible drought," to which the Emergency Plan should adapt, the Supply Manual of Canal de Isabel II reflects the prevention and management proposals of situations of scarcity in the strict context of the supply system of Canal de Isabel II. The definition of the identification and management guidelines of the scenarios of scarcity constitute a significant section of the Supply Manual, which represents a complete revision of the Drought Management Manual of Canal de Isabel II, edited in 1999 and updated on an annual basis.

The proposals of this Manual, in case of a drought of a high severity, will fall under the competencies of the basin agency (*Confederación Hidrográfica del Tajo, CHT*), established in Article 55 of the rewritten text of the Water Act, as well as, if applicable, the exceptional measures approved by the Government, under the coverage of Article 58 of the same law.

With the considerations related to the fulfilment of the requirements of the water quality supplied being of prime importance in all the supplies, the scope of the Supply Manual does not cover these points, since it is considered that the water quality requirements, established by the standards in effect, will be satisfied through the use of available installations in the Canal de Isabel II system, under normal conditions in the operation and availability of resources, as well as in the scenarios of mild scarcity.

The document does not attempt to carry out a diagnosis of the Canal de Isabel II supply system or of the action requirements to handle medium- and long-term future scenarios. Nor does it attempt to determine and evaluate possible alternatives to guarantee an appropriate balance of resources and demands. The document focuses on short-term planning, making the potential risk situations publicly known and establishing the conditions to manage them.

The presentations of the Supply Manual cover from the resource planning criteria up to the establishment of operating procedures with a clear orientation toward ensuring the sufficiency of the system to handle demands. The appraisals have been carried out from the consideration of global volumes, with a breakdown according to the different catchment sources and the main demand areas. The operating guidelines considered are based on monthly intervals of decision, consequently, excluding the weekly or daily scale of operation.

In summary, the Supply Manual of Canal de Isabel II expresses the protocols and good practices to:

- Establish the risks of scarcity and incapacity of the supply system to satisfy all demands.
- Establish efficient management policies of the resource and water demand.
- Ensure an integrated and sustainable management of resources.
- Establish guidelines to operate the supply system handling short-term outlook.
- Integrate the satisfaction of environmental constraints and sustainability of related ecosystems into the operation of the supply system.
- Manage the supply under conditions of drought and scarcity of resources.
- Manage the supply system in case of large-scale contingencies and anomalies, such as floods.
- Plan actions to guarantee the water supply in the medium and long term with the established risk level.

## Water Scarcity Risk Scenarios

Canal de Isabel II establishes three degrees of risk of scarcity or insufficiency of resources to handle all its demands:

- Risk of severe scarcity
- Risk of heavy scarcity
- Risk of emergency scarcity

The process followed to integrate risk management in the supply assurance process is that of characterizing each of these possible scenarios of scarcity under the terms of risk related to them, and from this characterization, determine the levels which identify the commencement of the scenarios, and establish its corresponding management procedures.

Usually, the concept of risk is understood as the product of the probability of occurrence of an event by the consequences deriving from it. According to this concept, the impact or consequences of each risk scenario has been mainly characterized by the implications they would have in the quality of service, with this being understood to be reductions in the supply of the volumes of normal demands. These reductions will have a different scope according to the risk scenario involved and, in reality, will correspond to that established a priori to handle and resolve each scenario. In regard to the other component of the risk calculation, the probability of occurrence has been based on the volume of reserves stored in the system in each month of the year, since the probability that the reserves are below a determined value is the parameter which best reflects the capacity of the system to handle its immediate demands, and its value in each month of the year implies a specific probability of occurrence of runoff in the prior time intervals.

So, for each scenario the following is considered:

1. Probability of occurrence that the level of reserves falls below an established value.
2. Consequences, the impact on the supply, in the form of consumption reductions of a different intensity, implemented to solve each situation, and prevent the occurrence of a scenario of greater severity.

In reality, with the management of each scenario, reducing the consumption and seeking temporary augmentation of inflow of resources, what is being sought is to reduce the probability of occurrence of a risk of worse consequences. Or, in brief, reduce the total risk of non-fulfilment of the supply requirements.

In the context described previously, the scenarios are related to the characteristics of the situation, and particularly to the impact related to this and the indicative levels of the commencement of the scenario, of stored reserves and, consequently, the probability of occurrence.

Furthermore, the scenarios of scarcity and their consequences are described and, subsequently, the thresholds for these scenarios.

## Scenario Description and Thresholds

The impacts corresponding to each scenario of scarcity will be variable and proportional to the severity of the considered scenario. These impacts have been calculated from the basic principle of the management guidelines of this type of risk, which is to ensure the surmounting of the episode identified in the risk, together with the prevention of incurring the following scenario of greater severity.

The surmounting and prevention guidelines and the objectives considered for each type of action have been established from rigorous evaluations of feasibility of implementation of the management measures of the risk situations, with regard to the time required for obtaining the proposed objectives, and with regard to the amount of the proposed demand reductions.

The calculation of these scenarios has been carried out departing from the identification of severe scenarios, to be avoided through risk management procedures that are associated with each less severe situation.

Consequently, the method consists in beginning to consider the worst possible situation and, from this, determine the conditions under which it would be necessary to act and with which to prevent this situation from materializing, always in a context of a specific probability.

On the other hand, and as has been indicated, on listing the scenarios of scarcity considered, a graduation of three scenarios is presented, whose main differences are:

*Emergency scarcity.* Critical situation, which does not reach the total lack of supply, but would have certain dramatic effects of consumer rationing.

*Heavy scarcity.* This is the neatest scarcity scenario, with little probability of occurring, whose main management objective is to prevent the occurrence of an emergency scenario. It involves restrictions in the supply.

*Severe scarcity.* This is that of the lowest consequences for the users of the supply, and with little probability of occurrence, with impacts generally accepted by the

citizens and assumed in the hydrologic planning criteria and efficient and sustainable use of resources.

In the light of the situation indicated previously, the scarcity scenarios are listed hereafter, beginning with those of the greatest severity. Each scenario describes the main characteristics, the related impact for surmounting them and the hypothetical conditions under which it is assumed that its management will be carried out:

### **Emergency Scarcity Scenario**

The point of departure could have been the consideration of an episode of absolute absence of reserves in any of the storage elements of the system, as the most dramatic situation imaginable to be avoided, but this referent is unfeasible when applied to an urban population of more than five million inhabitants. Instead, an emergency scenario has been established, in which the situation would be more dramatic due to the social and economic implications that the simple fact of facing it in a set of large communities, as is the case of the Community of Madrid.

Notwithstanding, within the preventive measures of this scenario, the precautions against the hypothesis of the total absence of reserves has been considered.

This emergency scenario, which should be considered as a referent of a dramatic situation, which will correspond to the probability of occurrence component, an extremely low probability, would present a balance of surmounting with the following main parameters:

#### ***Impacts on Supply***

Demand rationed to the basic needs of the population, estimated at 80 l/inhabitant per day for domestic use, and 50% of the normal water duties for remaining activities.

The quality conditions of the water supplied could not be guaranteed with the same degree of commitment as in situations of less severity.

The environmental constraints of surface fluvial runoff cannot be fulfilled to any degree.

Only urban tree species of special value and interest would be provided with irrigation.

Anticipated maximum duration of 12 months.

The socioeconomic costs would be enormous in implementing a rationing system.

#### ***Management Conditions***

Surface runoff corresponding to that defined as extreme hydrologic droughts.

Reduced availability of groundwater reserves as a consequence of the continued use during scenarios of scarcity, which, by necessity would have occurred prior to this dramatic situation. An average extraction of 1.50 m<sup>3</sup>/s is estimated.

Runoff complement of 70 hm<sup>3</sup> from the Alberche.

Supply complement of 40 hm<sup>3</sup> obtained through the reuse of recycled water and exchanges from other concessionaires who may assign their rights.

The maximum duration of continuation in this dramatic situation should be 12 months, which it is understood would be the duration in providing the population with an extraordinary solution to alleviate the situation.

Notwithstanding, it is necessary to point out that the fulfilment of the conditions of inflow of resources and demands indicated would render a balance that would result in a prolonged continuation beyond that indicated.

## **Heavy Scarcity Scenario**

This scenario is of a transitional nature among the situations of severe scarcity, anticipated and assumed as part of the cyclical management of demand and the emergency scenario described previously.

This is an authentic drought situation, with significant social, environmental and economic impacts, which will be associated with the occurrence of climatic episodes of a greater severity than those recorded to date, and will occur as a consequence of the prolongation of a period of scarcity. Its solution will require forceful restrictive measures.

### ***Impacts on Supply***

Would correspond to average reductions of demand of 26%.

Anticipated maximum duration of 24 months, including the case of occurrence of one of the worst recorded hydrologic periods.

It is not possible to comply with the fluvial environmental constraints and an attempt would be made to maintain the urban tree species of value and interest and of the highest fragility. Loss of seasonal plant species.

The socioeconomic costs would be significant as a consequence of the water consumption restrictions in commercial and industrial activities.

### ***Management Conditions***

The reduction values will be reached as a consequence of restrictive and support measures, as described in Chapter 12 of the Supply Manual of Canal de Isabel II (Cubillo, 1999). The distribution of these demand reductions in the different types of use will be adapted to that indicated in Table 9 (Page 47) of this Manual.

Surface runoff equivalent to those of a heavy hydrologic drought (Table 2, Page 19 of the Manual).

Resource runoff complement by an amount of 192.5 hm<sup>3</sup>, of which, 60 will originate from strategic reserves, 101 from the Alberche, and the rest from the reuse and use exchanges.

## **Severe Scarcity Scenario**

This scenario corresponds to that of a moderate impact on users, considered within the cyclical management policies of demand, to adjust on an elastic basis the demands to the hydrologic irregularity and to the real supply capacities of the supply system. Its establishment may be imposed by policy-setting plans in the hydrologic plans, supply standards, preferential and acceptance studies among the users, or otherwise, in situations of imbalance between resources and demand, as the only way to adjust the availability to existing global demands.

In the case of Canal de Isabel II, this scenario has formed part of the efficient management policy for longer than a decade, is included in the basic principles and is in line with that established as general criteria to appraise the availabilities in the basin hydrologic plans (Technical Instructions and Recommendations for the Drawing Up of the Intercommunity Basin Hydrologic Plans, BOE, 1992).

### ***Impacts on Supply***

An average reduction of demand of 9% and a maximum duration of 12 months are considered.

The environmental impacts would translate into a reduction of the environmental constraints to only 25% of the discharges established for El Vado and El Atazar, from March to September.

The socioeconomic costs would be very low.

### ***Management Conditions***

The reduction values in the consumption will mainly be reached as a consequence of voluntary changes of the individual user's habits and attitudes, and in the temporary conservation from all public centres and institutions. The distribution of these demand reductions in different types of use will be adapted to that indicated in Table 9 of the Supply Manual of Canal de Isabel II (Cubillo, 1999).

The surface runoff is the same as those of a severe hydrologic drought.

Inflow of resources complement for an amount of 263 hm<sup>3</sup>, of which 79 will originate from strategic reserves, 169 from the Alberche, and the rest from the Sorbe and the Almoquera Mondéjar system.

## Threshold Levels of Risk of Scarcity

As was indicated previously, risk management is made from the identification and characterization of certain scenarios of very little frequency, and a measurement of the probability that this occurs. With both factors it is necessary to conclude in a series of values related to each risk scenario, which identifies these situations and serves as reference for the commencement of the corresponding corrective action.

The probability of occurrence of the risk scenarios indicated in the previous section will be a consequence of the combination of the following factors:

- Present or short-term forecasted consumption.
- Capacity of the supply system infrastructures.
- Reserve volumes stored in the different components of the system.
- Probability of a certain hydric runoff being produced.

The presentation followed is that of identifying the values of stored volumes, which will determine, for an established hydric runoff pattern, the commencement of each of the risk scenarios. The hydric patterns used have been those typified in the situations of drought and scarcity of resources section, and specifically those corresponding to hydrologic droughts.

The patterns considered and the resulting scenario commencement values were the following:

*Thresholds of risk of severe scarcity.* This would be the series of volumes stored monthly corresponding to the occurrence of a severe hydrologic drought or to any of the consecutive monthly sequences (from 1 to 48 months) to which a probability of occurrence equal to or less than 4% applies.

These values correspond to the distribution of consumption considered for the immediate future, but these values would be reached with a higher probability, as a consequence of demand growth in excess of that considered in the establishment of the operating policies of the system for the short term.

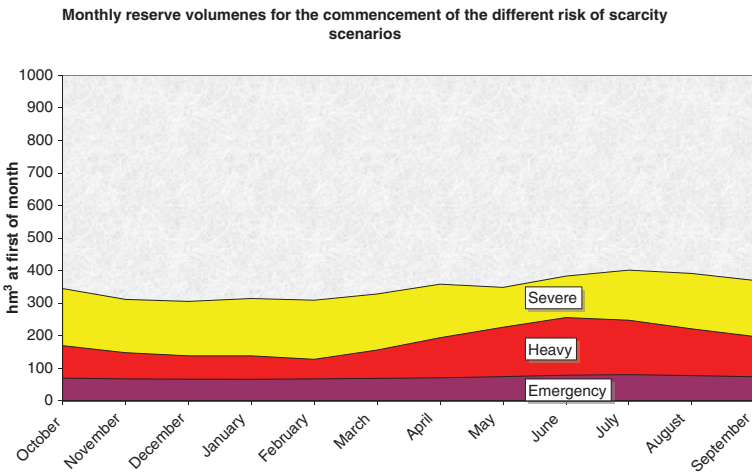
The thresholds of this risk scenario have been determined as the monthly reserve volumes in which only 4% of the years would be incurred. The extension of the scenario covers up to the monthly values which could be reached in case of the worst hydrologic sequence recorded (which is the border between the severe and heavy hydrologic droughts) and which, in addition, would ensure a minimum precautionary period of 12 months before incurring the scenario of heavy scarcity, even in case of the occurrence of the worst monthly sequences. The highest value is adopted each month, of those obtained with each of the criteria. This commencement level of the scenario of risk of severe scarcity corresponds to that which will be defined as the beginning of the drought situation in the supply system.

The values of monthly volumes of reserves which determine the commencement of this scenario included in the last printed version of the Manual of Supply are indicated in Table 18.1 below and are reflected in Fig. 18.1. These values are adapted on a yearly basis.



**Table 18.1** Monthly reserve volumes (in hm<sup>3</sup>), for the thresholds of different risk scenarios

	Level of severe scarcity	Level of heavy scarcity	Emergency level
October	345.2	169.6	69.9
November	311.9	148.0	67.7
December	305.7	138.5	66.9
January	314.5	138.5	66.5
February	309.3	127.6	67.6
March	328.4	156.3	69.2
April	358.5	194.1	70.7
May	348.6	226.4	74.4
June	383.4	255.9	78.9
July	401.7	248.0	80.4
August	391.6	221.5	77.7
September	369.8	198.0	73.9



**Fig. 18.1** Monthly reserve volumes as thresholds of the different risk of scarcity scenarios

*Thresholds of risk of heavy scarcity.* This will be the set of monthly values of surface storage corresponding to the occurrence of a hydrologic sequence of less runoff than the severe hydrologic drought (periods of less runoff than that historically recorded of a duration of less than six months should not trigger this scenario).

This scenario may also be incurred as a consequence of the non-fulfilment of the consumption reduction objectives, or inflow of resources to the system, considered for surmounting the scenario of risk of severe scarcity.

The thresholds of this scenario have been determined as those that would be incurred only in case of the occurrence of hydrologic droughts with lower runoff than those historically recorded. In addition, they would ensure a minimum precautionary period of 24 months before incurring the scenario of emergency scarcity, even in case of the occurrence of the worst consecutive monthly sequences of runoff corresponding to that typified as a heavy hydrologic drought, once immersed in this scenario.

These thresholds of the scenario of risk of severe scarcity correspond to those which will be defined as the commencement of a heavy drought situation in the supply system.

*Thresholds of risk of emergency scarcity.* This would be the set of monthly values of surface storage corresponding to the occurrence of a hydrologic sequence of less runoff than the heavy hydrologic drought (periods of less runoff than that typified as heavy of a duration of less than six months should not trigger this scenario).

This scenario may also be incurred as a consequence of the non-fulfilment of the consumption reduction objectives, or inflow of resources to the system, established for scenarios of risk of heavy or severe scarcity.

The thresholds of this scenario have been determined as those in which only in case of the occurrence of hydrologic droughts with runoff less than those typified as heavy and which in addition ensures a minimum precautionary period of 12 months to find an emergency solution which permits scenarios of a lesser severity to be recovered, even in case of the occurrence of the worst consecutive monthly sequences of runoff corresponding to that typified as an emergency hydrologic drought.

In spite of the theoretic positive balances of runoff and consumption established in the management of this scenario, it is assumed that the volume of surface reserves should be equivalent to two months of consumption under these rationing conditions at all times, in order to handle temporary irregularities of the minimum runoff forecast and the distribution of uses among the different reservoirs of the system.

This threshold of risk of emergency scarcity corresponds to that which will be defined as the commencement of the emergency drought situation in the supply system.

The values of monthly volumes of reserves which determine the commencement of this scenario for the printed version of the Manual of Supply are reflected in Fig. 18.1.

*Normal scenario.* Levels of surface reserves over the commencement values of a situation of severe scarcity. Harnessing of resources according to the normal guidelines and according to the priorities established.

The mission of this scenario, in relation to the risks of scarcity indicated previously, is to ensure the integrated and efficient use of the different sources of resources, under conditions of abundance, in order that the probability of occurrence of scenarios of scarcity is that initially established on defining the risk scenarios. This probability, which in previous sections is exclusively related to the hydrologic runoff pattern, will evidently be conditioned by the operating guidelines during the normality scenarios.

## References

- BOE (1992) ORDER of September 4, 1992, through which the technical instructions and recommendations for the drawing up of the Intercommunity Basin Hydrologic Plans are approved. Boletín Oficial del Estado.

Cubillo F (1999) Supply Manual of Canal de Isabel II.

Ley de Plan (2001) Hidrológico Nacional.

Cubillo F (2007) Guía para la elaboración de Planes de Emergencia por sequías. AEAS Asociación Española de Abastecimiento y Saneamiento.

# Chapter 19

## The Role of Non-Conventional and Lower Quality Water for the Satisfaction of the Domestic Needs in Drought Management Plans

Nicos X. Tsiourtis

**Abstract** This chapter outlines the potential and role that underground low quality water and non conventional water (recycled grey water, desalinated and domestic effluent water), have and can play in the preparation of drought mitigation plans especially in relation to the satisfaction of the domestic water supply needs. Low quality underground water, if available in aquifers within the city or village perimeters, can replace 34–42% of the good quality total domestic supply, which can be used in toilet flushing and for the irrigation of gardens. Similarly grey water discharged within the domestic effluents, which may vary from 36–41% of the total supply of an average household, after collection within the household perimeter can be treated and recycled to the system thus saving a percentage equal to 36–41% of the total domestic water consumption. The low quality water abstracted from the aquifers and the grey water discharged with the household waste can be developed and made available for use within a very short time on an individual basis, the water can be used without serious problems, the capital costs involved are relatively small (can be subsidized by the government), and can be repaid within 3–4 years with the savings made from the savings of potable water. The recycled domestic effluents, whose quality is improved with tertiary treatment is suitable for the irrigation of almost all plants (Roumagnac, 1995), is a very effective method of drought mitigation (Smith and Bernard, 1995) but this usually takes a long time to materialize, 5–10 years, but the farmers already using good quality natural water will rarely accept to use it, claiming its unsuitability for irrigation. Finally desalinated water from seawater or from brackish water increases the water availability, water quality is not a problem and it can be made available within very short time. The limitations/objections for using the desalinated water are emanating from its relatively higher marginal cost than the existing supplies and the alleged adverse environmental impacts.

---

N.X. Tsiourtis (✉)

Technical Consultant, Epidavrou, 4, PC 2114 Aglantzia, Nicosia, Cyprus  
e-mail: tsiourti@globalsoftmail.com

## Concepts and Objectives

Drought events in many cases result in acute water shortages, which force the water managers, in exceptional cases, to reduce the supply of potable water. To minimize the adverse effects of such actions the water managers may use non-conventional water resources, or low quality water for making up part or in total of the water cuts. This chapter outlines the role the non-conventional and low quality water can play in the drought mitigation management planning.

Non-conventional water is the non-naturally occurring water, not derived from the natural hydrological cycle. Non-conventional water may be desalinated or recycled water. Desalinated water: this water is produced from seawater, brackish water, or wastewater through a desalting process. This water can be used for any use, domestic, agricultural or industrial. Treated recycled water (re-use water) results after the biological and physical treatment of the collected domestic wastewater. The wastewater is made up from black water (water from water closets and kitchens of dwellings) and grey water (water from bathtub, washing machines and washing basins). This water may be used for the irrigation of many crops and for the flushing of toilets. The treated recycled water can take two forms, the re-used water from biologically and physically treated wastewater that occurs in sewage treatment plants, which may include black and grey water effluents, and the re-cycled grey water (which includes only grey water from the wastewater, after a physical process that takes place in a small local grey-water treatment plant).

Low quality water is the water slightly polluted or with relatively high salt content, suitable for the irrigation of garden plants and for flushing of the toilets. This water is mainly available in groundwater aquifers within the city perimeter and not developed due to quality problems.

## Domestic Water Consumption, Inflow and Outflow Quality Requirements and Classification

Table 19.1 shows the percentage of water consumption in relation to the total consumption, in each of the main activities in an average household in Nicosia, Cyprus (minimum to maximum percentage of each activity to total consumption), and the required quality of water for each activity. The percentages (Water Development Department of the Republic of Cyprus, 1996–2008, Tsiourtis, 1982–2002) are the minimum and maximum averages. Column 2 shows the activity, columns 3 and 4 show the minimum and maximum percentage of the total amount consumed to the total consumed, column 5 shows the minimum water quality required for each activity and finally column 6 shows the resulting water quality after the water is used in each activity. The minimum quality requirements for the water to be supplied for household consumption are set at two levels, the potable quality water and the low quality water. “Potable quality” water is classified as the water that must have the qualities specified for human consumption, where “Low quality” water is the water

**Table 19.1** Domestic water consumption classification by quality for supply and outflow (courtesy of the Water Development Department, Nicosia, Cyprus)

No (1)	Description of use activity (2)	Percentage use		Quality of water	
		From (3)	to (4)	Supply (5)	Waste (6)
1	WC/Toilet	28.00%	31.82%	Low	Black
2	Kitchen	13.00%	14.77%	Potable	Black
3	Bath/Shower	21.00%	23.86%	Potable	Grey
4	Washing Basins	8.00%	9.09%	Potable	Grey
5	Washing Machine	7.00%	7.95%	Potable	Grey
6	Cars and External	9.00%	10.23%	Potable	Consumed
7	Gardening	14.00%	2.2.7%	Low	Consumed
8	Total	100.00%	100.00%		

not suitable for human consumption but still unpolluted and of such chemical and physical composition that can be used for irrigation for short periods without adverse effects on the plants. Table 19.1 shows that “Low quality” water can be used for toilet flushing and for gardening, where for the remaining activities “Potable quality” water is required.

The domestic waste effluents, for our exercise, are classified into two categories, the black water and the grey water in accordance with the content of biological and physical loads. Table 19.1 shows that the waste effluents from toilets and kitchen basins are classified as “Black quality” water, where the waste discharged from wash basins, baths/showers and washing machines are classified as “Grey quality” water. On Table 19.1 it is also seen that water used for car washing and floor cleaning as well as water used for irrigation is not recovered by the waste collection system, and it is assumed as “Consumed water”. Table 19.2 shows the percentages of potable and non-potable water that must be supplied to the households and also the percentages of black, grey and consumed water, after its use. This table refers to data in Cyprus household consumption.

The data presented in Tables 19.1 and 19.2 allow the following conclusions to be established. First, the domestic water supply may consist of the potable qual-

**Table 19.2** Domestic water consumption input and outflow qualities (Nicosia, Cyprus)

No	Input water quality	Percentage of use	
		From	To
A	Domestic water supply quality		
A.1	Potable	58.00%	65.91%
A.2	Low Quality	42.00%	34.09%
	Total by Quality In	100.00%	100.00%
B	Wastewater effluent quality		
B.1	Black	41.00%	46.59%
B.2	Grey	36.00%	40.91%
B.3	Consumed	23.00%	12.50%
	Total by Quality Out	100.00%	100.00%

ity water comprising 58–65.91 % of the total supply, where the remaining supply (34.09–42%) may be made with low quality water. The domestic waste effluents are around 77–77.5% of the total supply, the remaining consumed for irrigation and for car washing and floor cleaning. Of the total domestic water supply, 36–40% is discharged, after use, as grey water. This grey water, after suitable treatment at the household level, may be recycled as low quality water for use in the toilet flushing and for gardening. The need for both activities amounts to 34–42% of the total supply, which matches closely the grey water effluent.

## **Availability of Low Quality Water**

Lower quality water may be available from groundwater and reclaimed grey water. Groundwater-low quality water in city or municipal area aquifers is derived from water losses from domestic water pressure pipelines, from sewage pipes and from storm water drainage pipes, and infiltrating rainfall water not collected by storm drainage pipelines, infiltrating water from soak pits built for various reasons legally or illegally, and underground seepage from neighboring areas. These waters are collected and stored in underground aquifers, within the city or municipality limits. This water may be slightly brackish and polluted and is usually not of potable quality and cannot be used for the activities requiring potable water. The low quality water can be used for flushing the toilets and the irrigation of the garden plants for short periods or after mixing with good quality water. From Table 19.1 the supply of low quality water to domestic houses may be as much as 34 to 42% of the total supply. The groundwater low quality water may be abstracted through small diameter boreholes than can be drilled in the yards of the individual houses.

Reclaimed grey water is also essential. As shown in Tables 19.1 and 19.2 from a typical household some 36–41% of the total supply after use is discharged as grey water. This water can be collected at the household level, and after treatment with sedimentation, coagulation and filtering can be used for the flushing of toilets and for the irrigation of the garden. To collect the grey water special arrangements should be made on the sewage discharge system of the house or the building, where for its treatment a special grey water treatment plant should be installed. Large volumes of grey water from playground activities (the shower water) may be collected and treated and used for the toilet flushing and the irrigation of the playground grass, saving great amounts of water.

## **Role of Low Quality Water in Drought Events and Works Required**

Under severe drought conditions domestic water cuts may be as high as 20% of the total supply, with variations at the individual household, due to distribution inefficiencies, and ground elevation variations (with high lying areas having less

water supplied). This 20% reduction in the quantities of the water supplied may cause acute water shortage to the households, or to playgrounds or to factories. This shortage may be avoided by the use of low quality water either by abstracting groundwater from the underlying aquifers (Tsiourtis, 2003, Tsiourtis, 1999, Water Development Department of the Republic of Cyprus, 1996–2008) (up to 42% of the total water demand), if available, or by collecting, treating and reusing the grey water discharged by the household wastes, amounting up to 41% of the total demand. For the development and use of the low quality groundwater and for the collection, treatment and re-use of the grey water, the following water works are required.

### ***Groundwater (Provided an Aquifer Exists with Suitable Quality Water)***

The following works/actions should be taken, for supplying up to 42% of the total domestic water demand (Water Development Department of the Republic of Cyprus, 1996–2008):

- Drill a borehole or sink a well depending on the level of the groundwater level in the aquifer.
- Take water samples and carry out chemical and bacteriological analysis.
- If groundwater water quality is suitable for toilet flushing and or irrigation, purchase and install an electric submersible pump, the supply pipelines to the storage tank.
- Purchase and install the storage tank and the plumbing system for the supply of the low quality water to the lavatories.

### ***Grey Water Recycling***

The following works/actions should be undertaken if the underground water is not suitable as low quality water, for the collection, treatment and use of the grey water, up to 42% of the total domestic water demand (Water Development Department of the Republic of Cyprus, 1996–2008).

- Carry out the necessary works for collection of the grey water from showers, washbasins and washing machines.
- Construct and install the grey water treatment plant, made from a one cubic meter tank for the sedimentation, flocculation and filtration processes at a relatively low capital and operation and maintenance costs (the system is patented by Mr. Chr. Kampanellas, Executive Engineer at the Water Development Department of Cyprus).



- Purchase and install the booster pump, the main feeding pipeline, the storage tank and the piping system for conveyance of the treated grey water to the irrigation system.
- Purchase and install the plumbing pipelines for the supply of the treated grey water to the lavatories.

## Promotion of Utilization of Low Quality Water

The development and use of low quality water for complementing the reduced water supply during a drought event is usually high in capital cost, for an individual, but obviously cheaper in operation and maintenance costs especially for groundwater. It is necessary to create the required legal framework, which shall allow the drilling of boreholes within the city or municipality limits, the installation of a dual plumbing system within the house, one for the supply of potable water to all fixtures and another plumbing system which shall be capable to supply low quality water to the lavatories and the irrigation system. In the case of the grey water re-use the necessary legal framework should be created to allow for the collection, treatment and use of the recycled water within the household perimeter. In both cases the necessary permits and licenses should be issued by the relevant authorities and must be obtained by the interested parties and the necessary checks should be carried out to avoid accidental mixing of potable quality water with low quality water. The permits and licenses should be issued with a minimum of bureaucracy, and no cost to the applicants.

The local or the national governments may promote the use of low quality water by subsidizing generously (not less than 50%), the capital costs for the drilling of the boreholes, the purchase and installation of the pump, the purchase and installation of the storage tank and the plumbing system for connection to the lavatories. A similar subsidy must be given to those that are willing to collect, treat and use the grey water (for non availability of groundwater in their vicinity).

In addition to the financial support the central or local government should provide technical advice and support concerning the groundwater availability and quality and the quality and treatment of the grey water, and should expedite the issue of the relevant permits, thus encouraging those wishing to develop low quality water to proceed quickly and without any delays, since the measures are destined to mitigate on going drought events (Water Development Department of the Republic of Cyprus, 1996–2008).

Both measures were used successfully in Cyprus during the drought events of 1996–2001 (Tsiourtis, 1982–2002). The consumers responded positively to the Government's call for the use of the low quality water (groundwater and grey water) and some 5–10% of the total water consumption was originated from the low quality water. The time for the approval and the materialization of the works was no longer than 1.5 months. More willing to use low quality water were those that found themselves in high lying areas where the supply of water from the public water distribution system was relatively less than that corresponding on the average supply.

The low quality water use can be used on an individual basis (one system per house) or on a collective/group of users basis (multistorey buildings or blocks of buildings), or to sports centers or playgrounds thus mitigating to a great extent their water supply problem during the drought events and saving large amounts of money both for water supply and sewage collection fees.

The low quality water use has the following advantages and disadvantages.

- It provides up to 40% of the total domestic needs for an individual customer, thus mitigating totally the water cuts that may be imposed on the specific consumer, during a drought event. However since not every consumer is using low quality water the water shortage problem is not totally resolved.
- The extra supply of water up to 40% of the total domestic consumption for each individual, thus saving good quality water (which is relatively more expensive) for use by others not having installed for various reasons the low quality water use system.
- It is a cheap solution to the water shortage problems caused by droughts and to the water scarcity faced by many Mediterranean countries. The repayment of the grey water recycled system or the groundwater development system is repaid within 3–4 years.
- It is a cheap solution in comparison to the desalination solution. A borehole or a grey water recycle plant is a very effective and quick solution to water shortage problems.
- It can be carried out at the individual level (individual dwellings or a group of flats or a group of houses and blocks of buildings).
- The recycled grey water quality can be used for the irrigation of almost all plants grown within the gardens of individual houses within the city, municipality or village perimeters.
- The disadvantage of both systems is that they require the continuous attention of the individuals, that the grey water treatment system must be operated by non-specialists, and the danger of having mixed the non-potable water with the potable water.

## **Desalination as an Alternative Water Supply Source**

Desalinated water may be considered in many cases as an alternative water resource in cases the conventional water resources are not enough to satisfy domestic and/or agricultural and industrial demands (Tsiourtis, 2001, Tsiourtis, 2003, Water Development Department of the Republic of Cyprus, 1996–2008, Tsiourtis 1982–2002). The decision to proceed with the desalination of sea or brackish water in some cases is taken under the pressure of water shortage but in other cases it is taken after techno-economic and financial feasibility studies prove that the project is technically, economically and financially sound compared to development of the conventional water projects. The desalination technology during the last decades has made advances in the membrane manufacture, in the high pressure pumps efficiencies,

in the pre-treatment processes, in the post treatment processes and in the energy recovery equipment which allowed the cost of seawater desalinated water to drop from around 2.0 US\$ per cubic meter in the 1990 to almost 0.6 US\$ per cubic meter in 2006 (Tsiourtis, 2001). On the other hand the cost of conventional water projects is increasing rapidly due the fact that the natural water resources left for development are relatively small, dam sites are not so favorable, groundwater if available is available in small quantities and has to be pumped from great depths and quality problems call for more costly treatment processes.

Desalinated water compared to the conventional water is the result of a desalination process of sea or brackish water usually found in inexhaustible quantities (mainly the seawater), whose chemical, physical and bacteriological characteristics are controlled. Therefore the quality of desalinated water may be set to meet the specific requirements of the consumers, compared to the conventional water, whose quality might not comply totally with the health standards. It is also true that the production of desalinated water is not dependent on the meteorological conditions and the reliability of supply is approaching 100% compared to the conventional water, whose supply depends on the meteorological conditions and its reliability of supply even under the best conditions cannot exceed 95%. The integration of seawater desalination plants into the existing water supply systems which supply conventional water usually improves the quality of the water and increases the reliability of supply.

The use of desalinated water for drought mitigation can be made on an individual basis for hotels and big installations (hotels, industries) or on a massive basis by towns, municipalities, villages or water utilities. In all cases the raw water supply (seawater, or brackish water or else), and the brine and wastewater discharge must be favorable and the relevant legal framework concerning seawater or brine water abstraction and brine or wastewater discharge must be in place. In addition environmental impacts must be seriously considered taking into account the impacts with and without the desalination plant and the additional quantities or deficit of water.

## **Domestic Effluent re-Use Schemes as an Alternative Source of Supply for Irrigation**

For environmental and health reasons domestic effluents and other effluents are collected treated and disposed safely to aquifers for the soil treatment process or are disposed to the water bodies whenever allowed (sea or lakes). In many countries the domestic effluents are treated to a level that will allow its use for unlimited or limited irrigation or for other uses. The domestic effluent re-use schemes provide good quality water (after tertiary treatment) which may re-enter the water projects thus providing additional water quantities either for saving of good quality water for domestic uses (in cases of drought) or for the extension of the irrigated areas. From Tables 19.1 and 19.2 above, some 77–87.5% of the total domestic water supply is recovered (36–41% as grey water and 41–46.6% as black water) by the sewage sys-

tems and after proper treatment can be recycled for use in irrigation thus augmenting the water availability.

Due to water deficits in the water balances of many countries, the re-use of the treated domestic effluents is becoming the policy of many governments and water authorities. The process includes the basic treatment of the effluents to a level for the disposal to the environment at the cost of the pollutants and then with additional treatment (tertiary treatment) for further reduction of the suspended solids and the biological oxygen demand, and for de-nitrification or removal of other elements, at the cost of the water users.

## **The Role of non-Conventional and Low Quality Water in Drought Management**

The technological advances in water treatment combined with low costs (such as desalination and wastewater treatment) made possible the use of non-conventional and low water quality for drought mitigation and as a source of water supply. In drought mitigation measures the role of non-conventional and low quality water is very important for the following reasons. Additional quantities of suitable quality water can be made available at the household level or the municipality level to make up the water shortage created by the water cuts, because of droughts.

The underground low quality water, where available, can be mobilized within a very short time at the household or group of households level, at a relatively low cost, saving equivalent amounts of good quality water for activities that need potable quality water and enabling the consumer to use the low quality water for toilet flushing and for gardening, i.e. keep healthy and keep the garden (the environment) in good condition. The use of low quality water in the households for toilet flushing and gardening may save a percentage of good quality water varying from 34–42% of the total domestic consumption.

The grey water, which is discharged as domestic effluent from washbasins, washing machines and bath/shower tabs, can be collected, treated and used for toilet flushing and for the irrigation of the gardens, enabling the consumers to keep the toilets running without limitations and the irrigation of the gardens even under drought conditions. From the total consumption of an average household some 36–41% is discharged as grey water, which after treatment can be recycled for use in toilet flushing and for irrigation of the garden. The low quality groundwater and the treated grey water can remain as permanent solutions, reducing the demand for good quality water from 36–41% in individual households, and enabling the consumers to take advantage of the lower costs.

The schemes for the re-use of domestic effluents water can be used to make up any cuts from water supply due to drought events, but the implementation of such projects requires a much longer period than the development of the low quality underground water and grey water solutions. The role of the domestic effluent re-use schemes is effective if the re-use water is recycled in the same project by replacing the good quality water with recycled water and using more good quality

water for domestic needs. From the total domestic supply a percentage ranging from 77–87.5% can be collected, treated and recycled for irrigation thus augmenting the water availability. The disadvantage of the re-use water projects in existing irrigation systems is that the irrigators do not easily accept the replacement of their water supply made up of natural high quality water with treated domestic effluents arguing that the treated effluent is of lower quality than what they receive now, and this will adversely affect the quality and the marketing prospects of their products and that they have to change the cropping pattern since the water supplied in most cases is not suitable for all existing crops. In many cases the existing cropping patterns include crops that cannot use the low quality water of the re-use schemes due to its chemical, biological and physical characteristics.

The desalination process is now available at a much lower capital and operation and maintenance costs. If conditions are favorable, the desalination process can be implemented to augment the water availability in a relatively short time 18–24 months and reduce the water shortage or totally balance the water supply and water demand. The quantity of water to be produced by the desalination plant is independent of the domestic effluents but it can be related to the minimum monthly water demand. The quality of the desalinated water can be fixed to a certain specification to meet the domestic and or irrigation quality requirements. Concerning financing of desalination projects there is now great interest by private banks and financial institutions that are willing to finance such projects provided the risks involved are shared fairly between the government or the public water utility and the private bank or institution. Today the Build, Operate and Transfer (BOT) method of financing is applied by many governments, with a consent period of 10–25 years to enable the strategic investors to recover their capital costs. Desalination plants can be used to solve water shortages as temporary solutions (until a re-use project is constructed and put into operation) or as a permanent solution. The disadvantage of desalinated water is the false impression most people have about the high marginal cost, the environmental impacts it has due to high energy consumption, and on the marine environment due to the discharge of the brine and wastewater to the sea.

## Conclusions

Non-conventional and low quality water can be used effectively in drought management plans and water demand management. Low quality water available in the aquifers underlying the city limits can be abstracted and used for the flushing of the toilets and the irrigation of the gardens around the house reducing the domestic water demand from the public water distribution system up to 40%. The cost of drilling of the borehole, the purchase and installation of the pumping equipment and the plumbing system can be recovered within a period of 3–5 years, depending on the cost of the domestic water supply. Grey water from domestic wastewater effluents at the household level may be used effectively in the drought mitigation plans and in the water demand management plans. It can reduce up to 32% the domestic water demand thus reducing the water demand on the potable water supply

system. This system can be applied to any household irrespective of whether there is groundwater in the area or not. However since its cost is normally higher than the borehole development it is applied in areas where there is no groundwater and in places where there is production of grey water and irrigation water demand is high such as in football stadiums. The re-use of the grey water requires rearrangement of the wastewater effluent system as well the plumbing system and in addition requires the installation of grey water treatment plant at the household level. The cost of this installation may be paid in a short period depending on the relative costs of domestic water supply and of the costs of the grey water re-use system.

Wastewater re-use schemes on a large scale at the level of the town, require actions at a higher level, and the re-cycled water will only provide water saving if it re-enters the domestic water supply balance sheet (transfer of natural water now used for irrigation to domestic water supply and replace this water with re-cycled water), something that is not always feasible. This requires a long period of 10–15 years and the consent of the farmers to exchange naturally occurring water with treated effluent water, which is not easily achievable.

Finally desalination offers the advantage of augmenting the water supply availability in a massive manner and in a relatively short period (2–3 years), with a high reliability good quality water. The cost of this water is not very high assuming that cost of the desalinated water is now around 0.9–1 Euro per m<sup>3</sup>. The alleged adverse environmental impact can be mitigated and even balanced by the benefit of the water supply augmentation.

Since the lower quality groundwater, the lower quality re-cycled grey water and the recycled water from the domestic effluent treatment plants, raise health and hygienic concerns to the user it is advisable that before embarking on the use of these categories of water, detailed investigations are carried out, and the necessary measures are taken to avoid or eliminate dangers to public health.

Concluding, it can be stated that non-conventional, lower quality water can contribute effectively in the planning of water shortage mitigation.

## References

- Roumagnac A (1995) Re-Use of wastewater from case studies to the definition of a philosophy. In Tsiourtis N X (ed.) *Water Resources Management under Drought or Water Shortage Conditions*. Published for EWRA by A.A. Balkema, Rotterdam.
- Smith AJ, Bernard IRA (1995) Innovative treatment technologies for non potable water re-use. In Tsiourtis N X (ed.) *Water Resources Management under Drought or Water Shortage Conditions*. Published for EWRA by A.A. Balkema, Rotterdam.
- Tsiourtis N X (2001) Desalination and the Environment. *Desalination*, 141: 223–236.
- Tsiourtis N X (2003) *Small Islands Water Resources Management-a Holistic Approach*. Water Development Department. Nicosia.
- Tsiourtis N X (1999) *Framework for Action for Mediterranean Islands*. Report published by GWP.
- Tsiourtis N X (1982–2002) Personal notes and experience on the subject during the years 1982–2002, at the Water Development Department, Nicosia, Cyprus.
- Water Development Department of the Republic of Cyprus (1996–2008) *Publications on water saving measures and programs 1996–2008*. Nicosia, Cyprus.

# Annex 1

## Glossary of Terms and Concepts

### Drought and Water Scarcity

#### *Drought: Concept*

Drought is a recurrent feature of climate that is characterized by temporary water shortages relative to normal supply, over an extended period of time –a season, a year, or several years–. The term is relative, since droughts differ in extent, duration, and intensity.

#### *Drought: Typologies*

Operational definitions define the onset, severity and the end of a drought and refer to the sector, system, or social group impacted by drought. In all cases, drought impacts occur when water supply systems cannot satisfy the needs and demands that are met under normal conditions. The main operational definitions are meteorological, hydrological, and agricultural drought.

*Meteorological.* Meteorological drought specifies the degree of deficient precipitation from the threshold indicating normal conditions (e.g. average) over a period of time, and the duration of the period with decreased precipitation. Definitions of meteorological drought are region specific since the atmospheric conditions that result in deficiencies of precipitation are highly variable from region to region. In addition to lower than normal precipitation, meteorological drought may also imply higher temperatures, high speed winds, low relative humidity, increased evapotranspiration, less cloud cover and greater sunshine resulting in reduced infiltration, less runoff, reduced deep percolation and reduced groundwater recharge. In many cases the primary indicator of water availability is precipitation.

*Agricultural.* Agricultural drought for rainfed agriculture: deficit in soil moisture following a meteorological drought that produces negative impacts on crop production and/or natural vegetation growth. Agricultural drought for irrigated agriculture: water shortage in irrigation districts due to drought in surface or groundwater resources supplying agricultural use.

*Hydrological.* Hydrological drought is concerned with the consequences of rainfall deficiency in the hydrologic system. It refers to the decline in surface and subsurface water supply. Hydrological droughts are usually out of phase with or lag behind the occurrence of meteorological and agricultural droughts (see above) because it takes longer for precipitation deficiencies to show up in components of the hydrological system. It can be measured as a threshold level of stream flow, lake, and groundwater levels.

### ***Water Shortage***

Water shortage refers to the relative shortage of water in a water supply system that may lead to restrictions on consumption. Shortage is the extent to which demand exceeds the available resources and can be caused either by drought or by human actions such as population growth, water misuse and inequitable access to water. At the national level water shortage is expressed as m<sup>3</sup> per capita per year. The greater the figure the greater is the shortage. Most of the Mediterranean countries are facing water shortages.

### ***Scarcity***

Scarcity refers to a permanent situation of shortage with reference to the water demands in a water supply system or in a large region, characterized by an arid climate and/or a fast growth of water consumptive demands.

### ***Hydrological Drought and Land Use***

It is defined as the land use change effect on the hydrological cycle. Land use changes may cause water shortage even when no change in precipitation occurs.

### ***Aridity***

Permanent climatic condition with very low annual or seasonal precipitation.

## **Weather and Climate**

### ***Weather***

Weather is the state of the atmosphere for a brief period of time in a particular geographical place.



## ***Climate***

Climate represents the normal or average state of the atmosphere for a given time of year and a given location.

## **Water Supply and Demand**

### ***Natural Water Resources***

The total water resources that flow in fixed rivers and or aquifers for a time interval (generally a year) as average amount or value of a defined probability.

### ***Water Supply***

Supply is the aggregate of all water resources that are likely to be used. It includes precipitation, natural resources including groundwater, and non-conventional sources. For a hydrological system, supply takes into account the distribution system, the dimensions and capacity of the infrastructures, the usage rights, and other conditioning factors that should be taken into account.

### ***Water Supply System***

Facilities for derivation and storage, conveyance, distribution of water and demand centres of use as municipalities, irrigation district, etc.

### ***Available Water Resources***

Available resources are usually the fraction of natural water resources that can be supplied where and when they are required. They are affected by hydrographic, geological, geographical and /or technological constraints (e.g. capacity of abstraction, storage and transport of water), socio-economic considerations, and they have complex institutional implications. They can change in time due to change in natural availability, new ecological constraints and new technological tools.

### ***Renewable Water Resources***

Renewable water resources are the long term average of freshwater volume supplied naturally by the hydrological cycle, derived from the total runoff (surface and underground). Renewable water resources generally refer to the river basin unit. When

the geographic unit is different from the basin unit, it is necessary to differentiate between internal resources over the territory, and external or transboundary resources outside the territory.

### ***Guarantee of Water Supply***

Guarantee of water supply is the acceptable level of water supply required for a particular supply system. In most countries and systems this value is defined by administrative normatives or recommended by voluntary standards.

### ***Water Consumption***

Water consumption is the portion of the withdrawals (water supplied) that is not returned to the environment after use, it is either consumed by activities or discharged into the sea or evaporated.

### ***Water Demand***

Water demand is the actual need for water under current water use practices (i.e. irrigation techniques, efficiency of the system, water pricing policies, present cultural practices, standard of living, etc.). It is determined by the needs of users' activities.

### ***Consumptive Demand***

Demand of water that is not returned to the environment after use, being either consumed by the activities or discharged to the sea or evaporated. It includes part of urban demand, irrigation, and industrial water demands.

### ***Non-Consumptive Demand***

Demand for water that is returned to the environment without significant alteration to its quality. It includes hydroelectric generation, cooling systems, aquaculture, domestic effluents, irrigation return and environmental flows. Non-consumptive water demand strongly conditions and limits the supply of the consumptive uses, because it needs to be available –in time and space– and with the appropriate quality.

### ***Environmental Demand***

Environmental demand is the water necessary –in quantity and quality– to support the ecological functioning of ecosystems including their processes and biodiversity. Under some legal frameworks, in-streamflow requirements may impose constraints on other off-stream demands.

### ***Future Water Demand***

Future demand of water based upon future scenarios of water management policies, and influenced by demographic, socio-economic and cultural changes.

### ***Water Efficiency***

Water efficiency is the percentage of water that is actually used out of the total abstracted volume.

### **Hydrological Systems**

Some general terms referring to hydrologic system and water resources extracted from the EC Framework Directive 2000/60.

### ***Hydrographic District***

The area of land and sea, made up of one or more neighbouring river basins together with their associated groundwater and coastal water, which is identified under Article 3(1) as the main unit for management of river basins.

### ***Hydrographic Basin***

The area of land from which all surface run-off flows through a sequence of streams, rivers and, possibly, lakes into the sea at a single river mouth, estuary or delta.

### ***Sub-Basin***

The area of land from which all surface run-off flows through a series of streams, rivers and, possibly, lakes to a particular point in a water course (normally a lake or a river confluence).

### ***Body of Surface Water***

A discrete and significant element of surface water such as a lake, a reservoir, a stream, river or canal, part of a stream, river or canal, a transitional water or a stretch of coastal water.

### ***Aquifer***

A subsurface layer or layers of rock or other geological strata of sufficient porosity and permeability to allow either a significant flow of groundwater or the abstraction of significant quantities of groundwater.

### ***Body of Groundwater***

A distinct volume of groundwater within an aquifer or aquifers.

### ***Water Services***

All services which provide, for households, public institutions or any economic activity:

- a. abstraction, impoundment, storage, treatment and distribution of surface water or groundwater,
- b. waste-water collection and treatment facilities which subsequently discharge into surface water.

### ***Catchment or Basin***

Catchment or basin is the area of land drained by a river and its tributaries.

### ***Runoff***

Runoff is the portion of rainfall that is not immediately absorbed into the soil and which becomes surface flow.

### ***Flow or Discharge***

Flow is the amount of water that passes a specified point in a hydraulic system (i.e. river).

### ***Base Flow***

Base flow is the flow in rivers and streams that occurs in dry weather and usually from groundwater inflows.

### ***Flow Regime***

Flow regime is the pattern of water flow in a river or stream. In undeveloped rivers and streams flow regimes are related to climatic conditions. In regulated rivers (i.e. dammed rivers), flow regimes are often altered from natural patterns.

### ***Groundwater***

Groundwater is the water that occurs beneath the ground held in or moving through saturated layers of soil, sediment or rock.

### ***Recharge***

Recharge is the portion of rainfall or river flow that percolates down through the soil and rock formations to reach the groundwater.

## **Risk, Impacts, Vulnerability and Preparedness**

### ***Vulnerability***

A set of conditions and processes resulting from physical, social, economic, and environmental factors, which increase the susceptibility of a community to the impact of hazards.

### ***Vulnerability Assessment***

This provides the framework for identifying or predicting the underlying causes of drought related impacts. In many cases drought may only be one factor along with other adverse social, economic and environmental conditions that create vulnerability.

### ***Hazard***

A potentially damaging physical event, phenomenon and/or human activity, which may cause the loss of life or injury, property damage, social and economic disruption or environmental degradation. Each hazard is characterized by its location, intensity, frequency and probability.

### ***Risk***

The probability of harmful consequences, or expected losses (deaths, injuries, property, livelihoods, economic activity disrupted or environment damaged) resulting from interactions between natural or human-induced hazards and vulnerable conditions.

### ***Risk Analysis***

A process to determine the nature and extent of risk by analysing potential hazards and evaluating existing conditions of vulnerability that could pose a potential threat or harm to people, property, livelihoods and the environment on which they depend.

### ***Uncertainty***

Uncertainty is the situation when the probability of occurrence and potential impacts of a damaging phenomenon are not known.

### ***Disaster***

A serious disruption of the functioning of a community or a society causing widespread human, material, economic or environmental losses which exceed the ability of the affected community or society to cope using its own resources.

### ***Capacity to Face with Risk***

Capacity is a combination of all the strengths and resources available within a community or organization that can reduce the level of risk, or the effects of a disaster.

### ***Preparedness***

Preparedness is the reduction of risk and uncertainty. Preparedness therefore refers to the activities and measures taken in advance to ensure effective response to a potential impact of hazards.

### ***Prevention***

Prevention is the reduction of risk and the effects of uncertainty. Prevention therefore refers to the activities that provide outright avoidance of the adverse impacts of hazards.

### ***Mitigation***

Mitigation is the set of structural and non-structural measures undertaken to limit the adverse impact of hazards.

### ***Strategic Reserves***

Strategic reserves are those of restricted access, only to be made use of for the resolution of shortage or drought scenarios or for the prevention of similar situations in the near future.

### ***Forecast***

Forecast is the statistical estimate or the definite statement of the occurrence of a future event.

### ***Early Warning***

Early warning is the provision of timely and effective information, through identified institutions, that allows individuals at risk of a disaster, to take action to avoid or reduce their risk and prepare for effective response.

### ***Crisis Management***

Crisis management is the unplanned reactive approach that implies tactical measures to be implemented in order to meet problems after a disaster has started.

### ***Proactive Management***

Proactive management are the strategic measures, actions planned in advance, which involve modification of infrastructures, and / or existing laws and institutional agreements.

### ***Drought Impact***

A specific effect of drought on the economy, on the social life or on the environment, which is a symptom of vulnerability.

### ***Drought Impact Assessment***

This is the process of assessing the magnitude and distribution of the effects due to drought.

## **Organizations, Institutions, Networks, and Stakeholders**

### ***Organizations***

A group of persons formally joined together for some common interest.

### ***Institutions***

A public organization with a particular purpose or function in relation to law, policy, and administration and that establishes rules for its operation.

### ***Networks***

Network is a group that interacts or engages in informal communication for mutual assistance or support.

### ***Stakeholders***

Stakeholders are those actors who are directly or indirectly affected by an issue and who could affect the outcome of a decision-making process regarding that issue or are affected by it.



In MEDROPLAN, stakeholders can be individuals, organizations, institutions, decision-makers, or policy-makers, who determine or are affected by water use and exposure to drought and water scarcity.

On the one hand, stakeholders enact institutions –sets of rules, norms, shared strategies– and, on the other hand, they are constrained by them in their responses to drought preparedness and management. Therefore a purposeful description of the map of legitimate actors, as well as an analysis of their interests, values and approaches to risk is a pre-requisite for the understanding of their link with institutional drought policy.

## **Data, Indicators and Indices**

### ***Data***

Individual measurements; facts, figures, pieces of information, statistics, either historical or derived by calculation, experimentation, surveys, etc.; evidence from which conclusions can be inferred.

### ***Proxy Data***

Data used to study a situation, phenomenon or condition for which no direct information such as instrumental measurements is available.

### ***Indicator***

Observed value representative of a phenomenon to be studied (social, economic or environmental). In general, indicators quantify information by aggregating different and multiple data. The resulting information (about complex phenomena) is therefore synthesized and simplified.

### ***Index***

A weighted combination of two or more indicators. An index is designed to be a summary of a system. For example, an “environmental index” may include data about air quality, water quality, soil quality, etc. Another example are economic indicators which are used to forecast economic activity, such as GDP growth rate. An index can be used to lead to a particular fact or conclusion.

### ***Correlation***

The extent to which two variables vary together (either in a positive or negative relationship). A positive correlation exists when one variable increases as the other increases. A negative correlation exists when one variable decreases as the other increases. A fundamental principle of statistics is that correlation does not necessarily imply causation. This is easy to forget in the quest to understand relationships between different indicators. In the case of drought for example, a positive correlation may exist between deteriorated water quality and a drought index, but the deteriorated water quality does not cause drought.

### ***Accuracy***

Refers to how well the measurement of an object or phenomenon reflects its actual state.

### ***Precision***

The fineness of the measurement. Values from an instrument that measures parts per million are more precise than values from one which measures in parts per hundred. More precise measurements are not necessarily more accurate.

# Index

## A

Adaptive Capacity index (AC index), 154  
Agarwal, A., 139  
Agricultural droughts, 135, 299  
Agricultural Insurance Law, 177  
Aguilar, M., 49  
Alecci, S., 94  
Alley, W. M., 77  
Alwang, J., 138  
Amor, L. G., 257  
Anderson, J., 137  
Andreu, J., 100  
Ang, A. H. S., 98  
Anti-dam organisations (COAGRET), 168  
Aquifer  
    artificial recharge of, 236  
    carstified, 225, 231, 233  
    exploitation, 232, 234, 236–238  
    fossil, 224  
    salinization, 235  
    in Tagus River basin, 225–227  
    types, 225  
    unsaturated zones, 224, 226, 230  
Aridity, 57  
Arnell, N. W., 158  
Automatic instruments, 137  
Autoregressive moving average model (ARMA), 101  
Availability of water, 112, 143  
Average magnitude of failure, 125–126  
Average recovery time, 126  
Average recurrence time, 127  
Average shortage period length, 105

## B

Bachmat, Y., 235  
Backtracking, 269  
Bakhbakhi, M., 234  
Barnett, B. J., 137

Base flow indices, 227  
Basin Authority, 177  
Basin drought policy, 182  
Ben-Zvi, A., 78  
Bergman, K. H., 77  
Bergua, J. A., 165  
Bernard, I. R. A., 287  
Best practice code, 27  
Bhalme, H. N., 77  
Bhalme – Mooley Drought Index (BMDI), 77  
Bielza, M., 139  
Bjornlund, H., 142, 144  
Black quality water, 289  
Bogardi, J. J., 117  
Bonaccorso, B., 78, 187, 188, 196  
Boterill, L. C., 27  
Brauch, H. G., 82  
Brenkert, A., 154  
Burton, I., 158

## C

Cafiero, C., 138  
Calatrava, J., 140, 141, 142, 143  
Canal de Isabel II, 52, 141, 226, 257, 275, 276, 277  
    supply manual, 275–277  
Cancelliere, A., 55, 78, 93, 96, 187, 188, 196, 201, 257, 258, 265  
Carballo, A., 165  
Carbonell, X., 161  
Carrasco, A., 257  
Carstified aquifers, 225  
Casado, M., 226, 231  
Casado Sáenz, M., 221  
Castro, R. de, 165  
“Catálogo de Aguas Privadas”, 238  
Celaya, I., 161  
Clausen, B., 78  
Coastal aquifers, 235

- “Code”, 29  
     components, 31–32  
     sections, 31  
 Compensatory instruments, 137  
 Compensatory schemes and relief programmes,  
     139, 145  
 Conditional drought risk assessment  
     methodology for, 98  
 Conflict prevention strategies, 167  
 Consumed water, 289  
 Cornelius, H., 163  
 Corraliza, J. A., 165  
 Correia, F. N., 78  
 Costanza, R. R., 134  
 Crisis management, 58  
     *versus* risk management, 26–27  
 Crop insurance, 138  
 Crop Moisture Index (CMI), 77  
 Cruces, J., 233  
 Cubillo, F., 52, 185, 273, 275, 280, 281  
 Cumulative ‘or more’ curves, 78  
 Custodio, E., 229, 235, 332  
 Cycle of water, 224
- D**
- Datta, B., 116  
 De Castro, J., 185  
 Deciles, 247  
 De Groot, R., 134  
 De la Hera, A., 233  
 De Mingo, R. G., 221  
 Desalinated water, 288, 294  
 Desalination as alternative water supply  
     source, 293–294  
 Desertification, 57  
 Design droughts, 268, 270  
 Detrital aquifers, 225  
 Dezman, L. E., 77  
 Diagnostic search  
     awareness on efficient and effective uses of  
         water, 40–41  
     consideration of environmental needs, 40  
     institutional and legal framework, 38–39  
     need for scientific knowledge,  
         methodologies and knowledge of  
         project, 39–40  
     use of common language by  
         stakeholders, 40  
 Dittaino-Gornalunga system  
     Nicoletti and Don Sturzo reservoirs, 190  
 Domestic effluent, 289  
     re-use schemes, 294–295
- Domestic water consumption, 288–290  
     classification, 289  
     input and outflow qualities, 289  
 Dorfman, P. J., 116  
 Dracup, J. A., 74, 77  
 Drought, 57  
     assessment, methodologies for, 69–70  
     conditions for characterisation of, 48–50  
     as creeping phenomenon, 4  
     damages in rainfed agriculture, 211–214  
         rain gauges and soil use, 213  
         SPI *vs.* drought impacts on cereals, 214  
     definition, 3, 4, 49  
     duration and spatial extent of  
         cumulative “or more” curves, 78  
         run method, 78  
     effects on groundwater, 234–235  
     events in Greece, 243–244  
     exceptional, 50  
     as exception to fulfilment of environmental  
         objectives, 47  
     as hazard, 4–5  
     identification and characterization  
         adverse event occurred between mid  
             80s and 90s in 1921–2003, 192  
         PHDI Index, 192–193  
         run method, 193–195  
         SPI, 191–192  
     impacts, 5, 211  
         mitigation measures, 7, 31, 58, 181,  
             214–217  
         on runoff, 247–249  
     indicators, 23  
     indicators system  
         drought conditions, 180  
     influences on carstified/unsaturated zone  
         aquifers, 224–226, 230–231, 233  
     regional, 194  
     risks, 137, 149  
     severity thresholds, 247  
     types of, 135–137, 258  
 Drought characterisation, 188, 193  
     basic notions  
         indices attributes, 71  
         normal conditions, 71–72  
         spatial integration, 72–73  
         time step and reference period, 72  
     indices  
         classification of drought conditions, 74  
         deciles, 73–74  
         others, 76–77

- Reconnaissance Drought Index (RDI), 75–76
  - standardised precipitation index, 74–75
  - probability distributions, 196
  - and risk analysis
    - impacts on runoff, 247–249
    - intensity, frequency and duration, 247
    - Nestos and Mornos basins, 246–250
    - potential impacts, 252
- Drought early warning system (DEWS), 10
- Drought hazard to rainfed agriculture,
  - application of, 88–90
  - average yield losses and expected vulnerability, 89
  - calculating risk, 90
  - drought frequency and crop yield losses, 89
  - frequency of drought severity classes, 89
  - vulnerability of initial and improved system, 90
- Drought indices, 70, 258
- Drought management, 56
  - actions
    - criteria for selecting, 62–64
    - long and short term, 62, 63
    - ranking of, 64
  - current supporting legislation, 22–24
  - lack of clarity, 22–23
  - problems for application and efficiency, 22
  - in Greece, 252–255
    - legal framework, 244–245
    - monitoring systems, 254
    - organisation chart of services, 245
    - practical examples of water reduction actions, 254
    - preparedness master plan, 252
    - proactive and reactive plans and actions, 252–253
    - short term actions, 253
    - stakeholder analysis, 254
    - strengths and weaknesses, 254–255
    - structure and linkages, 245
  - guidelines, 56
  - institutional system, 24–26
    - characteristics, 23
    - decision processes, 25
    - lack of legislation clarity, 24–25
  - in Madrid water supply system, 275–277
  - practice of drought policy, 26–27
    - design of preventive plan, requisites for, 26
  - in urban water supply system
    - emergency scarcity scenario, 279–280
    - heavy scarcity scenario, 280–281
    - scenario description and thresholds, 278–279
    - severe scarcity scenario, 281
    - water scarcity risk scenarios, 277–278
- Drought management plans
  - emergency plans, 185–186
  - drought states, 186
  - guidelines to develop
    - defining common language among stakeholders, 56–57
    - drought phenomenon types, 58
  - indicators system, 179–181
  - management actions, 182–183
    - associated to pre-alert, alert, and emergency scenarios, 182–183
  - basin drought policy, 182
  - planning framework
    - drought, water scarcity and aridity, 175–177
    - legal and institutional framework, 177–178
    - legal instruments, 178–179
    - resources, demands, and water reliability, 176
    - stakeholders, 178
  - public review of, 64–65
  - risk analysis, 183–185
    - water resources simulations models, 184
- Drought management policy
  - limitations, 188
- Drought mitigation measures for Simeto River basin, 214–217
  - actions to mitigate impacts in agriculture, 216
  - classification of measures, 214
  - dry farming practices, 216
  - home page of drought bulletin, 215
  - in irrigation, 216
  - past actions to mitigate impacts in agriculture, 217
  - water supply increase measures, 216
- Drought mitigation planning objectives, 8
- Drought monitoring, 188, 191, 215
  - challenges, 10–17
    - conditions for North America, 15
    - pattern of drought conditions across United States, 14
    - trends and early warning, 11–16

- United States' National Integrated Drought Information System (NIDIS), 16–17
    - vulnerable society, 17
  - Drought policy, 5–6
    - development, 37–41
    - principles of, 5–10
      - cycle of disaster management, 7
      - mitigation planning, 6–10
      - 10-step planning process, 10
  - Drought preparedness plans, 38–41
  - Drought relief, 7–8, 145
  - Drought resilient society, 18
  - Drought return period
    - assessment of, 195–197
      - drought analysis on areal precipitation series, 196
      - spatial distributions of return period, 197
  - Drought vulnerable vs. drought resilient society, 18–19
  - Drought wells, 235
  - Durrant, N., 30
- E**
- Easter, K. W., 141
  - Eastman, J., 116
  - Economic instruments
    - categories of, 135–137
    - drought risks, 136
    - limitations, 136
    - meteorological and agricultural drought, 137–139
    - in practice, 144–149
      - agricultural and meteorological droughts, 145–146
      - hydrological and operational droughts, 147–149
    - preparation for operational droughts, 139–140
  - Ecosystem functions, 134
  - Edwards, D. C., 74
  - “Emergency Plan in Case of Drought Situations”, 276
  - Emergency scarcity scenario, 278
    - impacts on supply, 279
    - management conditions, 279–280
  - Environmental objectives, 45
    - exceptions to fulfilment of, 46–47
  - Estevan, A., 49
  - Estrela, T., 179
  - European Union Water Framework Directive, 177
  - Ex –ante instruments, 136
  - Exploitation system analysis, 237
  - Ex –post instruments, 136
- F**
- Failure vs success event, 125
  - Faire, S., 163
  - Fernandez, B., 78
  - Fetter, C. W., 235
  - Fitness function, 121
  - Flores, F., 175, 221
  - Folch, R., 165
  - Foster, S., 16, 232, 234
  - Franklin, J., 70
- G**
- Garrido, A., 133, 139, 140, 141, 142, 143, 149
  - Garrote, L., 55, 175, 184
  - Genetic algorithm fitness function, 121
  - Genetic algorithm search model, 114, 115, 121, 123, 130
  - Geographical scope, 258
  - Giansante, C., 140, 142
  - Gibbs, W. J., 73, 247
  - Gómez-Ramos, A., 133, 143, 149
  - Grey quality water, 289
  - Groundwater
    - discharge, 224, 226–229
    - and drought
      - analysis, 227
      - in Mediterranean basin, 222–224
      - related concepts, 232–234
      - response to hydro-geological systems, 224
      - types of aquifer, 225
    - drought effects on, 234–235
    - integrated management of surface water and, 236–239
      - analysis, 238–239
      - systems analysis procedure, 237–238
      - water supply to demand, 237
    - measurements, 235–239
    - in Mediterranean basin
      - characteristics, 223
      - mining, 233–234
    - negative effects of drought on, 232
    - recharge, 224, 226
    - resources, 221–222
    - as source of fresh water during scarcity, 222
    - scarcity, 233
      - riverine wetland, 233
  - Groundwater-low quality water, 290
  - Guaranty, 236
  - Gundelach, J., 116

**H**

- Hard law, 28
- Hashimoto, T., 94, 116, 117, 140, 238
- Hayes, M. J., 77, 227
- Hazard, 60, 82–85
  - frequency vs mean potential consequences, 84
  - quantification, 82
  - return periods and anticipated potential consequences, 84
- Heavy scarcity scenario, 278
  - impacts on supply, 280
  - management conditions, 280–281
- Hess, U., 137
- Hiernaux, P., 70
- Houck, M. H., 116
- Hurt, C. E., 143
- Hydrograph, recession curve of, 227–229
  - flow duration curves, 228
  - historical discharge, 228
  - predicted flow in Trillo, 229
  - recession flow period, 229
- Hydrological drought, 57, 300
  - See also* Meteorological drought; Operational drought; Socio-economic drought

**I**

- Ibáñez, J. C., 257
- Iglesias, A., 21, 22, 24, 26, 55, 56, 140, 153, 154, 156, 157, 158, 175, 177, 181, 184
- Iglesias, E., 135, 140, 142
- Incentive-based instruments, 136
- Index-based risk transfer products (IBRTPs), 138
- Indices, 227
- Innes, R., 145
- International Strategy for Disaster Reduction (ISDR), 18
- Ionescu, C., 154
- Israel, M., 143

**J**

- Justice, C., 70

**K**

- Karavitis, C. A., 247
- Karl, T. R., 77
- Kerr, R. A., 158
- Keyantash, J., 74
- Kinninmonth, W. R., 73
- Kirby, W., 116
- Klein, R., 82

- Kron, W., 94
- Kühbauch, W., 70

**L**

- Labadie, J., 98, 99, 100
- Lane, W. L., 103
- Lanen, H. A. J. van, 221
- Law of National Hydrological Plan, 177
- Lebdi, F., 111, 112, 116
- Leiva, A. J., 144
- Lerner, D. N., 231
- Level of service, 125
- Lewis, D., 167
- “Libro del Registro”, 238
- Lise, W., 140
- Llamas, M. R., 224, 226, 229, 234, 235
- López-Barrero, E., 21
- Loss functions, 84
- Louati, M. H., 111, 129
- Loucks, D. P., 99, 116, 234
- Low quality water, 288–289
  - advantages and disadvantages, 293
  - availability, 290
  - promotion of utilization of, 292–293
  - role of, 290–292
    - grey water recycling, 291–292
    - groundwater, 291
  - role of non-conventional and, 287–297
    - concepts and objectives, 288
    - in drought management, 295–296
- Lund, J. R., 143
- Luo, B., 141

**M**

- Maguire, R., 30
- Maher, J. V., 73, 247
- Mairal, G., 165
- “Malaga and Balearic Island Water Forums”, 167
- Malone, E., 154
- Mancha Occidental Aquifer, 233
  - cross section, 234
- Marcos, A. La Calle, 43
- Margat, J., 223, 224
- Martí, J., 168
- Martínez, J., 165
- Mathematical models for reservoir operation
  - case study and results, 129–131
    - objectives, 130
    - operating strategies, 130
    - optimization problems, 129
    - system operation optimization approach, 129

- objective criteria
  - operating policy optimization, 123–124
  - reservoir storage target, 120
  - resource allocation optimization, 121–123
  - supply quantity, 118
  - supply salinity, 118–120
- performance indicators
  - definitions, 125
  - quantity-based, 125–126
  - time-based, 126–128
- reliability criteria assessment, 116–117
  - performance indicators, 116–117
- structure of optimization problem, 113–116
  - composite objective function, 115
  - operating strategies of reservoir systems, 113–114
  - simulation of system operation, 115
- Maximum monthly and annual shortages, 105
- Mays, L., 94
- Mazuelos Bellido, A., 28
- McKee, T. B., 74, 188, 191, 247
- Medbasin software, 247
- Medroplan project, 56
- Meteorological drought, 299
- Meteorological drought, 57
  - See also* Hydrological drought; Operational drought; Socio-economic drought
- Michelsen, A. M., 149
- Milutin, D., 117
- Moneo, M., 22, 24, 26, 56, 153, 154, 157, 177
- Montañés, M., 165, 168
- Montoya, F. F., 221
- Mooley, D. A., 77
- Moral, L., 165
- Mornos basin, 246, 251
  - regional drought identification, 248
  - results of rainfall, 251
  - standardised RDI values, 251
  - water deficit, 249
- Moss, R., 156
- Moy, W.-S., 117
- Multivariate autoregressive models (MAR), 103
- Multivariate autoregressive moving average models (MARMA), 103
- Multivariate MAR model, 103
- N**
- Nandalal, K. D. W., 117
- Nanou-Giannarou, A., 243
- National Action Plan (NAP), 253
- National drought strategy, 6
- National policy, development of, 28
- National System of Drought Indicators, 179
- Natural disaster declaration, 212, 216
- Natural recharge, 231–232
  - measurements, 232
- Negative run, 193
- Nestos basin, 246, 249–251
  - regional drought identification, 248
  - results of rainfall, 250
  - standardised RDI values, 250
  - water deficit, 249
- Nicolosi, V. M., 93, 187
- NIDIS goals, 16
- Non-conventional water, 288
- North American Drought Monitor (NADM), 15
- North Western Sahara Aquifer System, 234
- “Nubian Sandstones Basin”, 234
- O**
- Objective function, 118, 120, 123, 124
- Operational droughts, 57, 135
  - See also* Hydrological drought; Hydrological droughts; Meteorological drought; Socio-economic drought
- Option Contracts, 144
- Overexploitation, 232–233
- Overshooting vulnerability, 126
- P**
- Palmer, W. C., 76, 77, 188, 192, 257, 258, 269
- Palmer Drought Severity Index (PDSI), 76–77, 269–270
  - evolution of, 270
- Palmer Hydrological Drought Index
  - time series, 194
  - wet and drought period classification, 193
- Palmer Moisture Anomaly Index (Z-Index), 77
- Pangalou, D., 69, 243
- Parametric/index insurance, 138, 145
- Parametric insurance, 138
- Participatory water planning, 162, 168–169
- Pearson, C. P., 78
- Perea, A. R., 161
- Performance indicators, 116, 124
  - applicability, 128
- Periodic autoregressive moving average model (PARMA), 102
- Periodic hydrological process, 102
- Peters, E., 221
- Piezometric state index, 230–231
  - record and, 230–231
- Pindado, F., 168
- Pita López, M. F., 50
- Platform for Defence of River Ebro, 168



- Policy development, approach to, 27  
 Poncem, V. M., 232  
 Pont, J., 165  
 Potable quality water, 288  
 Potential evapotranspiration (PET), 263  
 Preparedness master plan, aspects, 252  
 Proactive approach, 58, 214  
 Proactive measures, 178  
 Pulido, M., 222  
 Pyramid of conflicts, 166–167
- Q**  
 Quantity-based performance indicators, 125  
 Quantity-based reliability, 125  
 Quiroga, S., 153  
 Quotas, 147
- R**  
 Rademacher, I., 70  
 Rainfall Anomaly Index (RAI), 77  
 Reactive approach, 214  
 Reactive measures, 178  
 Reclaimed grey water, 290  
 Reconnaissance Drought Index (RDI), 75–76,  
 88, 247, 263  
     normalised, 76  
     standardised, 76  
 Rees, G., 227  
 Reilly, J., 158  
 Reliability, 117  
 Reliability indicators, 116  
 Renewable water resources, 301–302  
 Reservoir-demand allocation patterns, 113, 115  
 Reservoir operating policies, 113, 115  
 Resilience, 117, 127, 239  
 Resistance, 127  
 Resource allocation optimization, composite  
     objective within  
     penalties, 121–123  
 Return period of drought, 195  
 Return period of shortages, 104, 105, 106  
 ReVelle, C. S., 116  
 Rieu, T., 141  
 Risk, 61, 87–88, 93, 94  
     analysis  
       complexity of drought calls, 60  
       hazard, risk, and vulnerability, 60–61  
     assessment, 94–95  
       unconditional, 95  
     calculating, 88  
     concepts, 60  
     defined, 93, 94  
     management approaches, 94–95  
     institutional and legal framework,  
       59–60  
     multiple aspects of drought  
       management, 59  
     planning in advance, 58–59  
 management instruments  
     automatic, 144  
     awareness campaigns, 141  
     optioning rights, 143–144  
     pricing mechanisms, 140–141  
     risk-sharing, 142–143  
     scope and objectives, 133–134  
     water banks, 143  
     water markets, 141–142  
 River Basin Management Plans (RBMP), 179  
 Rossi, G., 78, 93, 96, 187, 196, 214, 247  
 Rossini, P., 142, 144  
 Run method, 193–195  
     advantage of, 78  
     application, 266–269  
     precipitation on retro station, 265–266  
     time series of deficit area and areal deficit,  
       194, 195  
     total inflow, 266–269  
     wet and dry spells, 267
- S**  
 Salas, J., 78, 101, 196, 200  
 Salso-Simeto Water supply system, 199  
     conditional risk assessment, 209–211  
       frequency of shortage, 209, 210  
       performance indices, 210, 211  
     simulation, 201–203  
       in alarm conditions, 203  
       in alert conditions, 202–203  
       drought mitigation measures, 201–202  
       in normal conditions, 202  
       target storages, 202  
     stochastic generation of streamflow series,  
       199–201  
       historical vs. generated annual  
       statistics, 201  
       lag 0 monthly cross correlations, 200  
     unconditional risk assessment, 203–208  
       performance indices, 204  
       return periods of annual shortages, 208  
       sample frequencies of monthly  
       shortages, 207, 206  
       simulations, 203  
       simulation with/without mitigation  
       measures, 205, 206, 207  
 Salvai, A., 78  
 Sand, P. H., 29

- Santafé Martínez, J. M., 235  
 “Sarangossa, a City Saving Water”, 167  
 Scarcity, 300  
 Schimmelpfennig, D., 158  
 Set of data, 258  
 Severe scarcity scenario, 278–279  
   impacts on supply, 281  
   management conditions, 281  
 Shafer, B. A., 77  
 Shelton, D., 29, 30, 31  
 Shen, H. W., 78, 195  
 Shiau, J., 78, 195  
 Siegel, P. B., 138  
 SIMDRO, features of, 201  
 Simonovic, S. P., 116  
 Simulation models, 98–100  
 Skees, J. J., 144  
 Skees, J. R., 139, 144  
 Smith, A. J., 287  
 “The Social Initiative for Mediation”, 168  
 Social participation and conflict resolution  
   conflict analysis, 165  
   context and objectives, 161–163  
   different approaches to conflict resolution,  
     166–167  
   intervention tools for management disputes,  
     167–168  
   lack prior multi-discipline analysis, 169  
   water disputes, 163–165  
 Social vulnerability index, 157  
   components and total values of index, 157  
 Socio-economic drought, 57  
   *See also* Hydrological drought;  
     Meteorological drought;  
     Operational drought  
 Socio-economic vulnerability to drought  
   combination of sub-components, 156  
   components and variables, 155  
   discussion, 157–158  
   normalization to common baseline, 156  
   quantifying vulnerability, 156–157  
   selection of variables, 155  
 Soft law, 28  
   advantages, 28  
   as basis for environmental law evolution,  
     27–30  
   proposal for Mediterranean, 30–32  
   *See also* Hard law  
 Soft Law Code, 32–33  
 Soil Moisture Anomaly Index (SMAI), 77  
 Somma, F., 135  
 SOS wells, 235  
 Spain  
   legal instruments for drought management  
     in, 179  
   Spanish Constitution, 177  
   Special Drought Management Plans (SDMP),  
     objective, 179  
 SPI  
   time series, 192, 193  
   wet and drought period classification, 191  
 Standardised Precipitation Index (SPI), 247,  
   257  
   composite probability function, 74  
   drought classification, 75  
   method of calculation, 75  
 Standardized indices  
   evolution of, 270  
   RDI for precipitation on retiro station,  
     263–264  
     evolution indices, 263–264  
   relationship between  
     correlation between SQI12 and  
       SPI12/SQI24 and SPI24, 264  
   SPI for precipitation on retiro station,  
     258–260  
     evolution index, 259  
   SQI for total inflow, 260–261  
     evolution index, 260  
   SRI for CYII simulated water storage,  
     261–262  
     beta distribution functions, 262  
     evolution index, 262  
 Stein, S., 100  
 10-step drought planning process, 9–10  
 Stochastic data generation models, 103  
 Stochastic dynamic programming (SDP), 114,  
   115, 123  
 Stochastic model, 100–101  
 Storage target objective function, 120  
 Sum of squared shortages index, 105  
 Supply Quantity Objective and Supply Salinity  
   Objective, 120, 121  
 Supply salinity objective, 118  
 Surface Water Supply Index (SWSI), 77  
 Sustainable development, 232  
 Sveinsson, O., 200  
 Syme, G. J., 141
- T**  
 Tagus River Basin, 225–227  
 Tallaksen, L. M., 221  
 Tang, W. H., 98  
 Temporal reliability, 104  
 Tertiary Aquifer of Tagus River Basin,  
   225, 226

- Threshold levels of risk of scarcity, 282–284  
 emergency scarcity, 284  
 heavy scarcity, 283–284  
 monthly reserve volumes, 283  
 normal scenario, 284  
 severe scarcity, 282
- Thresholds, 184
- Thywissen, K., 82
- Tigkas, D., 243, 247
- Time-based performance indicators, 125
- Time-based reliability, 126
- Time step and reference period, 258
- Tol, R. S. J., 154
- Tools  
 analysis and representation of results,  
 104–107  
 comparison of return period of  
 shortages, 107  
 histogram of monthly frequencies of  
 shortages, 106  
 sample frequencies of monthly  
 shortages, 107  
 generated hydrological series, 100–104  
 simulation of water supply systems,  
 98–100
- Treated recycled water, 288
- Treaty on European Union (TEU), 43
- Tsakiris, G., 69, 75, 76, 78, 81, 82, 88, 243,  
 247, 249, 251, 257, 258, 263
- Tsiourtis, N. X., 37, 287, 288, 291, 292, 293,  
 294
- Tsiros, E., 70
- Tung, Y., 94, 100
- U**
- Unconditional drought risk assessment  
 methodology for, 96
- Undershooting vulnerability, 126
- United Nations Convention for Combating  
 Desertification (UNCCD), 27
- United Nations International Strategy for  
 Disasters Reduction (UNISDR), 27
- Urban water supply systems, 185
- U.S. Drought Monitor (USDM), 12
- U.S. National Drought Mitigation Center  
 (NDMC), 75
- V**
- Vangelis, H., 75, 88, 243, 247
- Van Lanen, H. A. J., 221
- Van Rooy, M. P., 77
- Vegetation index drought insurance, 138
- Verhoef, A., 117
- Villasante, C. S., 165
- Vogt, J., 70, 135
- Volumetric reliability, 105
- “Voluntary Workers”, 167
- Voudouris, K. S., 247
- Vulnerability, 60–61, 85–87, 117,  
 153, 239  
 anticipated damages, 85  
 assessment, 153  
 components, 85  
 dependent factors, 85–86  
 directly related to drought, 154  
 routes for reducing, 87  
 vs magnitude of phenomenon, 87
- Vulnerability-Resilience Indicator Prototype  
 (VRIP), 154
- W**
- Water banks, 143, 147
- Water demands, 112, 113, 117
- Water disputes, 162, 163–165  
 characteristics, 163–164  
 disciplines, 165  
 features, 164  
 participatory water planning tool for  
 prevention of, 162  
 strategies for resolution, 162
- Water Framework Directive, 32–33  
 conditions of information and public  
 participation, 52–53  
 conditions related to adoption of measures,  
 50–52  
 necessary conditions for exception, 48
- Water governance, 39
- Water Law, 177
- Water management during drought conditions  
 unlikely, 188
- Water markets, 147
- Water resource allocation strategies  
 goal of, 112
- Water resources  
 environmental services linked to, 134–135  
 annual flows of water-related  
 ecosystems, 134
- Water scarcity, 57  
 risk scenarios, 277–278  
 in urban water supply systems, 273–275
- Water shortage, 57, 300  
 awareness campaigns, 147  
 causes, 39  
 by drought, 39  
 by human actions, 39  
 risk analysis of, 104
- Water supply reliability, 135

- Water supply systems
    - risk assessment for Salso-Simeto, 198–211
    - risk assessment in, 93–98
      - conditional, 97–98
      - Montecarlo simulation, 97, 100, 104, 108
      - performance indices, 104
      - short-term, 95
      - unconditional, 95–97
    - risk evaluation in, 61–62
      - acceptable risk level, 62
      - risk assessment, 61–62
    - Simeto River basin, 189–191, 198
      - features, 191
  - Water tariffs, 147
  - Water user types, 112
  - “The Water War in the Metropolitan Area of Barcelona”, 168
  - Weather Index Insurance (WRW), 138
  - Wilhite, D., 3, 8, 23, 27, 138, 157
  - Wu, H., 138
- Y**
- Yen, B. C., 94
  - Yevjevich, V., 78, 188, 193, 214
  - Yield insurance, 145
  - Yohe, G., 154
  - Young, R. A., 149
- Z**
- Zelenhasic, E., 78
  - Zeuli, K., 144
  - Zone of saline encroachment, 235