

The Handbook of Environmental Chemistry 30  
Series Editors: Damià Barceló · Andrey G. Kostianoy

Tamim Younos  
Caitlin A. Grady *Editors*

# Potable Water

Emerging Global Problems and  
Solutions

 Springer

# **The Handbook of Environmental Chemistry**

**Founded by Otto Hutzinger**

**Editors-in-Chief: Damià Barceló • Andrey G. Kostianoy**

**Volume 30**

## **Advisory Board:**

**Jacob de Boer, Philippe Garrigues, Ji-Dong Gu,  
Kevin C. Jones, Thomas P. Knepper, Alice Newton,  
Donald L. Sparks**

# The Handbook of Environmental Chemistry

Recently Published and Forthcoming Volumes

## **Potable Water: Emerging Global Problems and Solutions**

Volume Editors: T. Younos  
and C.A. Grady  
Vol. 30, 2014

## **Risk – Informed Management of European River Basins**

Volume Editors: J. Brils, W. Brack,  
D. Müller, P. Négrel, and J.E. Vermaat  
Vol. 29, 2014

## **The Turkmen Lake Altyn Asyr and Water Resources in Turkmenistan**

Volume Editors: I.S. Zonn and  
A.G. Kostianoy  
Vol. 28, 2014

## **Oil Pollution in the Baltic Sea**

Volume Editors: A.G. Kostianoy and  
O.Yu. Lavrova  
Vol. 27, 2013

## **Urban Air Quality in Europe**

Volume Editors: M. Viana  
Vol. 26, 2013

## **Climate Change and Water Resources**

Volume Editors: T. Younos and C.A. Grady  
Vol. 25, 2013

## **Emerging Organic Contaminants in Sludges: Analysis, Fate and Biological Treatment**

Volume Editors: T. Vicent, G. Caminal,  
E. Eljarrat, and D. Barceló  
Vol. 24, 2013

## **Global Risk-Based Management of Chemical Additives II: Risk-Based Assessment and Management Strategies**

Volume Editors: B. Bilitewski, R.M. Darbra,  
and D. Barceló  
Vol. 23, 2013

## **Chemical Structure of Pelagic Redox Interfaces: Observation and Modeling**

Volume Editor: E.V. Yakushev  
Vol. 22, 2013

## **The Llobregat: The Story of a Polluted Mediterranean River**

Volume Editors: S. Sabater, A. Ginebreda,  
and D. Barceló  
Vol. 21, 2012

## **Emerging Organic Contaminants and Human Health**

Volume Editor: D. Barceló  
Vol. 20, 2012

## **Emerging and Priority Pollutants in Rivers: Bringing Science into River Management Plans**

Volume Editors: H. Guasch, A. Ginebreda,  
and A. Geiszinger  
Vol. 19, 2012

## **Global Risk-Based Management of Chemical Additives I: Production, Usage and Environmental Occurrence**

Volume Editors: B. Bilitewski, R.M. Darbra,  
and D. Barceló  
Vol. 18, 2012

## **Polyfluorinated Chemicals and Transformation Products**

Volume Editors: T.P. Knepper  
and F.T. Lange  
Vol. 17, 2012

## **Brominated Flame Retardants**

Volume Editors: E. Eljarrat and D. Barceló  
Vol. 16, 2011

## **Effect-Directed Analysis of Complex Environmental Contamination**

Volume Editor: W. Brack  
Vol. 15, 2011

## **Waste Water Treatment and Reuse in the Mediterranean Region**

Volume Editors: D. Barceló and M. Petrovic  
Vol. 14, 2011

## **The Ebro River Basin**

Volume Editors: D. Barceló and M. Petrovic  
Vol. 13, 2011

# Potable Water

## Emerging Global Problems and Solutions

Volume Editors: Tamim Younos · Caitlin A. Grady

With contributions by

M.M. Abou Rayan · E.R. Blatchley III · B. Djebedjian ·  
O. Farooqi · H.E. Gall · J.L. Garland · C.A. Grady · M. Joshi ·  
C.J. Kroehler · S. Lawson · J. Lee · G.R. Mohan · O. Mina ·  
D. Murray · T.-H. Pai · T.F. Speth · S.-C. Weng ·  
T. Younos · Q. Zhang

*Editors*

Tamim Younos  
The Cabell Brand Center for Global Poverty  
and Resources Sustainability Studies  
Blacksburg  
Virginia  
USA

Caitlin A. Grady  
Purdue University  
Lafayette  
Indiana  
USA

The Handbook of Environmental Chemistry

ISSN 1867-979X

ISSN 1616-864X (electronic)

ISBN 978-3-319-06562-5

ISBN 978-3-319-06563-2 (eBook)

DOI 10.1007/978-3-319-06563-2

Springer Cham Heidelberg New York Dordrecht London

Library of Congress Control Number: 2014948231

© Springer International Publishing Switzerland 2014

This work is subject to copyright. All rights are reserved by the Publisher, whether the whole or part of the material is concerned, specifically the rights of translation, reprinting, reuse of illustrations, recitation, broadcasting, reproduction on microfilms or in any other physical way, and transmission or information storage and retrieval, electronic adaptation, computer software, or by similar or dissimilar methodology now known or hereafter developed. Exempted from this legal reservation are brief excerpts in connection with reviews or scholarly analysis or material supplied specifically for the purpose of being entered and executed on a computer system, for exclusive use by the purchaser of the work. Duplication of this publication or parts thereof is permitted only under the provisions of the Copyright Law of the Publisher's location, in its current version, and permission for use must always be obtained from Springer. Permissions for use may be obtained through RightsLink at the Copyright Clearance Center. Violations are liable to prosecution under the respective Copyright Law.

The use of general descriptive names, registered names, trademarks, service marks, etc. in this publication does not imply, even in the absence of a specific statement, that such names are exempt from the relevant protective laws and regulations and therefore free for general use.

While the advice and information in this book are believed to be true and accurate at the date of publication, neither the authors nor the editors nor the publisher can accept any legal responsibility for any errors or omissions that may be made. The publisher makes no warranty, express or implied, with respect to the material contained herein.

Printed on acid-free paper

Springer is part of Springer Science+Business Media ([www.springer.com](http://www.springer.com))

*For  
Taesha, Camina, Abigail, Emma, Hannah,  
Thomas and all children of the world.*



---

## Editors-in-Chief

Prof. Dr. Damià Barceló

Department of Environmental Chemistry  
IDAEA-CSIC  
C/Jordi Girona 18–26  
08034 Barcelona, Spain  
and  
Catalan Institute for Water Research (ICRA)  
H20 Building  
Scientific and Technological Park of the  
University of Girona  
Emili Grahit, 101  
17003 Girona, Spain  
*dbcqam@cid.csic.es*

Prof. Dr. Andrey G. Kostianoy

P.P. Shirshov Institute of Oceanology  
Russian Academy of Sciences  
36, Nakhimovsky Pr.  
117997 Moscow, Russia  
*kostianoy@gmail.com*

## Advisory Board

Prof. Dr. Jacob de Boer

IVM, Vrije Universiteit Amsterdam, The Netherlands

Prof. Dr. Philippe Garrigues

University of Bordeaux, France

Prof. Dr. Ji-Dong Gu

The University of Hong Kong, China

Prof. Dr. Kevin C. Jones

University of Lancaster, United Kingdom

Prof. Dr. Thomas P. Knepper

University of Applied Science, Fresenius, Idstein, Germany

Prof. Dr. Alice Newton

University of Algarve, Faro, Portugal

Prof. Dr. Donald L. Sparks

Plant and Soil Sciences, University of Delaware, USA





# **The Handbook of Environmental Chemistry**

## **Also Available Electronically**

*The Handbook of Environmental Chemistry* is included in Springer's eBook package *Earth and Environmental Science*. If a library does not opt for the whole package, the book series may be bought on a subscription basis.

For all customers who have a standing order to the print version of *The Handbook of Environmental Chemistry*, we offer free access to the electronic volumes of the Series published in the current year via SpringerLink. If you do not have access, you can still view the table of contents of each volume and the abstract of each article on SpringerLink ([www.springerlink.com/content/110354/](http://www.springerlink.com/content/110354/)).

You will find information about the

- Editorial Board
- Aims and Scope
- Instructions for Authors
- Sample Contribution

at [springer.com](http://springer.com) ([www.springer.com/series/698](http://www.springer.com/series/698)).

All figures submitted in color are published in full color in the electronic version on SpringerLink.

## **Aims and Scope**

Since 1980, *The Handbook of Environmental Chemistry* has provided sound and solid knowledge about environmental topics from a chemical perspective. Presenting a wide spectrum of viewpoints and approaches, the series now covers topics such as local and global changes of natural environment and climate; anthropogenic impact on the environment; water, air and soil pollution; remediation and waste characterization; environmental contaminants; biogeochemistry; geoecology; chemical reactions and processes; chemical and biological transformations as well as physical transport of chemicals in the environment; or environmental modeling. A particular focus of the series lies on methodological advances in environmental analytical chemistry.



## Series Preface

With remarkable vision, Prof. Otto Hutzinger initiated *The Handbook of Environmental Chemistry* in 1980 and became the founding Editor-in-Chief. At that time, environmental chemistry was an emerging field, aiming at a complete description of the Earth's environment, encompassing the physical, chemical, biological, and geological transformations of chemical substances occurring on a local as well as a global scale. Environmental chemistry was intended to provide an account of the impact of man's activities on the natural environment by describing observed changes.

While a considerable amount of knowledge has been accumulated over the last three decades, as reflected in the more than 70 volumes of *The Handbook of Environmental Chemistry*, there are still many scientific and policy challenges ahead due to the complexity and interdisciplinary nature of the field. The series will therefore continue to provide compilations of current knowledge. Contributions are written by leading experts with practical experience in their fields. *The Handbook of Environmental Chemistry* grows with the increases in our scientific understanding, and provides a valuable source not only for scientists but also for environmental managers and decision-makers. Today, the series covers a broad range of environmental topics from a chemical perspective, including methodological advances in environmental analytical chemistry.

In recent years, there has been a growing tendency to include subject matter of societal relevance in the broad view of environmental chemistry. Topics include life cycle analysis, environmental management, sustainable development, and socio-economic, legal and even political problems, among others. While these topics are of great importance for the development and acceptance of *The Handbook of Environmental Chemistry*, the publisher and Editors-in-Chief have decided to keep the handbook essentially a source of information on "hard sciences" with a particular emphasis on chemistry, but also covering biology, geology, hydrology and engineering as applied to environmental sciences.

The volumes of the series are written at an advanced level, addressing the needs of both researchers and graduate students, as well as of people outside the field of "pure" chemistry, including those in industry, business, government, research establishments, and public interest groups. It would be very satisfying to see these volumes used as a basis for graduate courses in environmental chemistry. With its high standards of scientific quality and clarity, *The Handbook of*

*Environmental Chemistry* provides a solid basis from which scientists can share their knowledge on the different aspects of environmental problems, presenting a wide spectrum of viewpoints and approaches.

*The Handbook of Environmental Chemistry* is available both in print and online via [www.springerlink.com/content/110354/](http://www.springerlink.com/content/110354/). Articles are published online as soon as they have been approved for publication. Authors, Volume Editors and Editors-in-Chief are rewarded by the broad acceptance of *The Handbook of Environmental Chemistry* by the scientific community, from whom suggestions for new topics to the Editors-in-Chief are always very welcome.

Damià Barceló  
Andrey G. Kostianoy  
Editors-in-Chief

# Volume Preface

Despite magnificent advances in many facets of human life, access to safe drinking water and adequate sanitation still remain beyond the reach of much of the world's population. Across the globe acute and chronic diseases caused by the consumption of contaminated water affect millions of people. Many urban and rural regions suffer from water scarcity and require long-distance transportation of water to meet potable water needs. This increased demand strains energy resources needed for both water treatment and transport. Additionally, providing safe drinking water to many rural and lightly populated areas remains cost prohibitive.

This volume by no means presents all complex issues related to potable water. However, it presents a timely and comprehensive glimpse of current and emerging issues of concern related to potable water access and presents possible alternative ways and solutions to alleviate current and emerging global potable water problems. Themes and issues discussed in this book include the following: (1) historical perspective of the evolution of drinking water science and technology, standards and regulations, and global potable water problems; (2) emerging issues of drinking water quality, water distribution, and energy demand for water treatment and transportation; and (3) using alternative water sources and alternative methods of water treatment and distribution that could resolve current and emerging global potable problems.

This book contains eight chapters. The chapter, "Potable Water Quality Standards and Regulations: A Historical and World Overview," presents an overview of the evolution of drinking water technology and standards from ancient to modern times. The chapter, "Global Potable Water: Current Status, Critical Problems and Future Perspectives," presents potable water access as a human rights issue and discusses problems relating to providing global potable water including social and political factors. The chapter, "Coping with Emerging Contaminants in Potable Water Sources," provides an overview of the types of emerging contaminants found in potable water sources, their removal in treatment plants, and a social perspective of emerging contaminants in potable water. The chapter, "Drinking Water Distribution: Emerging issues in Minor Water Systems," provides an overview of drinking water distribution systems with a focus on emerging issues in minor systems, i.e., plumbing systems in homes and other buildings, and contaminant intrusion in minor systems. The chapter, "The Effects of the Water–Energy Nexus on Potable Water Supplies," discusses energy demand for water treatment and

delivery and an overview of the ways in which the water–energy nexus creates challenges and opportunities in meeting potable water demands. The chapter, “Municipal Wastewater: a Rediscovered Source for Sustainable Water Use,” discusses municipal wastewater as a viable source and provides an appraisal of the varying qualities and characteristics of municipal wastewater affecting water reuse. The chapter, “Advances in Desalination Technologies: Solar Desalination,” discusses seawater as a potable water source, provides an overview of desalination technologies, and discusses methods and advantages of small- and large-scale solar desalination technologies. The chapter, “Bottled Water: Global Impacts and Potential,” discusses problems associated with bottled water production and consumption and the potential advantage of bottled water as a decentralized system for delivering potable water.

In “Potable Water Quality Standards and Regulations: A Historical and World Overview,” Kroehler provides an overview of drinking water in ancient times and the development of water treatment systems and discusses the evolution of water analysis and drinking water standards. The chapter also includes examples of current standards and regulations around the world, emerging standards and regulatory challenges, and global drinking water goals.

In “Global Potable Water: Current Status, Critical Problems and Future Perspectives,” Grady, Weng, and Blatchley provide an overview of critical problems related to providing potable water in both developed and emerging countries. Issues discussed include acute and chronic health issues attributed to unsafe drinking water; natural and human influences that will alter our current water supply in the coming decades; the technical limitations to water treatment in both developed and emerging economies; social and political factors influencing potable water access such as government capacity, competing interests, and the influence of food choices on water availability; and some current innovative approaches and suggested strategies for future water management.

In “Coping with Emerging Contaminants in Potable Water Sources,” Gall and Mina discuss emerging contaminants, such as pharmaceuticals and hormones, their sources, and their pathways to drinking water systems. Authors provide an overview of the types of emerging contaminants found in potable water sources, issues associated with their removal in water treatment plants, and a social perspective of the public’s concerns regarding emerging contaminants in potable water.

In “Drinking Water Distribution: Emerging issues in Minor Water Systems,” Lee and Farooqi discuss emerging issues in minor drinking water systems (in-building plumbing) along with general characteristics of drinking water distribution systems as a whole. The authors describe experimental studies which demonstrate that hydraulic transients triggered from water mains result in low-pressure occurrences in service lines. Such occurrences can allow possible intrusion of microbial and chemical contaminants at the service line. Lee and Farooqi conclude that structural integrity of service lines and hydraulic integrity at drinking water distribution systems should be maintained so that any public health risks will be minimized.

In “The Effects of the Water–Energy Nexus on Potable Water Supplies,” Lawson, Zhang, Joshi, and Pai discuss complicated interactions between water and energy in potable water systems. A rising global population will increase energy demand for treating and delivering water and may necessitate the energy-intensive treatment of alternative water sources such as wastewater and saline water for potable use. Authors also discuss the impact of electricity production and climate change on potable water sources. The chapter provides an overview of the ways in which the water–energy nexus creates challenges and opportunities in meeting potable water demand.

In “Drinking Water Distribution: Emerging issues in Minor Water Systems,” Mohan, Speth, and Garland argue that while significant progress has been made in building new water infrastructure, there exists a considerable difference between the supply of and demand for high-quality water. They assert that both the cost and unsustainable nature of diverting large volumes of water to water-stressed areas have become difficult to justify. The authors state that municipal wastewater has been identified as a viable alternative water source, and they provide an appraisal of the various qualities and characteristics of municipal wastewater affecting its reuse. Conventional and advanced technologies used for treating municipal wastewater to meet reuse standards are then evaluated; several case studies demonstrating water reuse schemes in different parts of the world are described in brief.

In “Advances in Desalination Technologies: Solar Desalination,” Abou-Rayan and Djebedjian provide an overview of desalination technologies and state that advances in these technologies clearly show that potable water can be obtained from desalinated water. The authors state that introducing solar energy as the power source in the desalination process has opened a new way to expand desalination technology. For countries suffering from freshwater shortages, particularly in rural and isolated areas, they argue for the importance of solar desalination. The chapter highlights existing solar desalination technologies and case study projects in several countries.

In “Bottled Water: Global Impacts and Potential,” Younos discusses the rationale beyond global expansion of bottled water and the problems associated with its production and consumption, energy demands, health concerns, and plastic pollution. The authors conclude that the current bottled water industry is not part of a sustainable solution to the overall challenge of providing potable water worldwide. However, bottled water could become part of an overall future solution to global lack of potable water shortages and community development. This would involve the bottled water industry to incorporate innovative water treatment technologies, renewable energy, and biodegradable plastics (or similar materials) in bottled water production and infrastructure systems.

Key issues will continue to influence access to potable water in both developing and developed countries: population growth, human migrations, competing demands among various water consumers such as agriculture, water infrastructure that has deteriorated or is wholly absent, energy constraints, and climate change. As scientific investigations and water treatment technologies continue to evolve, potable water shortages can be more efficiently addressed by developing alternative



sources such as treated municipal wastewater and desalinated brackish and seawater. Likewise, as renewable energy technologies advance and water infrastructure becomes decentralized, treatment and delivery of potable water will become less dependent on fossil fuels.

Avenues of research not addressed here include analysis of the life cycles of potential solutions and evaluation of social and political facets of sustainable potable water access and water use. There is a critical need worldwide to consider innovative procedures that will enable policy and decision-makers to consider bold intellectual and financial investments that will provide potable water to unserved communities.

We hope this volume serves as a valuable resource and reference for graduate and undergraduate students and for researchers concerned with global potable water sustainability. Equally, we hope it will be a useful guide to those affiliated with international agencies working to provide safe water supplies to communities around the world.

Blacksburg, VA  
West Lafayette, IN

Tamim Younos  
Caitlin A. Grady

# Contents

<b>Potable Water Quality Standards and Regulations: A Historical and World Overview</b> .....	1
Carolyn J. Kroehler	
<b>Global Potable Water: Current Status, Critical Problems, and Future Perspectives</b> .....	37
Caitlin A. Grady, Shih-Chi Weng, and Ernest R. Blatchley III	
<b>Coping with Emerging Contaminants in Potable Water Sources</b> .....	61
Heather E. Gall and Odette Mina	
<b>Drinking Water Distribution: Emerging Issues in Minor Water Systems</b> .....	95
Juneseok Lee and Owais Farooqi	
<b>The Effects of Water–Energy Nexus on Potable Water Supplies</b> .....	125
Sarah Lawson, Qi Zhang, Mimansha Joshi, and Tzu-Han Pai	
<b>Municipal Wastewater: A Rediscovered Resource for Sustainable Water Reuse</b> .....	153
Gayathri Ram Mohan, Thomas F. Speth, Daniel Murray, and Jay L. Garland	
<b>Advances in Desalination Technologies: Solar Desalination</b> .....	181
Magdy M. Abou Rayan and Berge Djebedjian	
<b>Bottled Water: Global Impacts and Potential</b> .....	213
Tamim Younos	
<b>Index</b> .....	229

# Potable Water Quality Standards and Regulations: A Historical and World Overview

Carolyn J. Kroehler

**Abstract** Since ancient times humans have understood the importance of clean drinking water and have used various techniques to improve its quality. In modern times, municipal and public water treatment systems began providing water to consumers worldwide, and safe drinking water became first a public health issue and then a human rights issue. Many countries have drinking water regulations and have set standards for maximum allowable levels of contaminants in drinking water. In wealthier nations, people have been living for nearly a century in a “water paradise,” with inexpensive and safe drinking water readily available in most places. In many developing countries, people lack access to safe water; waterborne disease is a major cause of death, especially among children under 5; and countries that have set drinking water standards often lack the resources to implement or enforce them. The World Health Organization (WHO) has developed a set of standards and guidelines for implementation to help countries lacking regulations and, along with the United Nations Children’s Fund (UNICEF), has set goals aimed at providing all people with safe drinking water, especially focused on the poor and disadvantaged of the world. This chapter provides an overview of drinking water in ancient times, the development of water treatment systems, the evolution of water analysis and drinking water standards, examples of current standards and regulations around the world, emerging standards and regulatory challenges, and global drinking water goals.

**Keywords** Drinking water • Historical perspectives on drinking water • History of water treatment • Evolution of drinking water standards and regulations • Emerging challenges • Global drinking water goals

---

C.J. Kroehler (✉)  
Blacksburg, VA, USA  
e-mail: [ckroehler@hotmail.com](mailto:ckroehler@hotmail.com)

## 1 Introduction

I begin this chapter with a personal experience. Blacksburg, Virginia, where I live, is located approximately 20 km from an industrial complex. In 2013, I attended a meeting hosted by the Agency for Toxic Substances and Disease Registry (ATSDR), a U.S. public health agency. The meeting was called for community members concerned about toxins that the complex had been discharging into the New River, the major source of drinking water for surrounding towns.

Of the more than 50 people in the elementary school gymnasium where the meeting was held, only half were simply local residents. Others attending included representatives from federal, state, and local agencies, such as the U.S. Environmental Protection Agency (EPA), the county school board, the U.S. congressional district representative's office, the Virginia Department of Environmental Quality, and the Virginia Department of Health. In addition to these government representatives, members of several local and national groups, including the Sierra Club, the National Committee for the New River, two local and regional newspapers, a local radio station, a nearby university, and a citizens' group called Environmental Patriots, were present. Finally, representatives from the industrial complex, including members of its environmental restoration program and its public relations department, also participated in the meeting.

I attended this meeting as a "concerned citizen" but also as a scientist and science writer interested in the communication of risks and regulations to the public. I was just beginning the research for this chapter, and I describe the scene here because the meeting illustrates a great deal about drinking water in the United States and in other developed countries. Citizens of the developed world want safe and clean drinking water, and for the most part they have it. Multiple local, state, and federal agencies, citizens' groups, and industries are involved in regulating and monitoring what goes into water sources and what is in drinking water when it is delivered to homes and other buildings.

In the developed world, the past century has been an "aquatic paradise," with drinking water becoming abundant, cheap, and safe [1]. Most of the people living in this water paradise take drinking water availability for granted, as it always flows out of the faucet when they need it. So abundant and inexpensive is the water in many areas of the United States, for example, that 97 % of treated water, safe for consumption and cooking, is used for other purposes—flushing the toilet, watering the lawn, doing the laundry, or washing the car [2].

In less wealthy and developing countries, the drinking water situation is very different. The disparity in water availability, reliability, and quality between the developed world and developing countries is enormous. Around the world, almost one billion people—more than a tenth of the world's population—lack access to safe drinking water [3]. Approximately 780 million people drink water from "unimproved" sources—an unprotected dug well or spring, for example, or a polluted river [4]. In addition, millions more people using water from so-called improved sources also are drinking contaminated water, as "improved" does not

necessarily mean the water is contaminant free [4]. Half the world's population depends on small community water suppliers for drinking water, and many small systems lack the financial resources to properly treat and monitor water quality [5].

According to the World Health Organization (WHO), about 2 million deaths each year can be attributed to unsafe water [5]. More children under the age of five die from diarrheal diseases—most related to unsafe drinking water—than die from malaria and HIV/AIDS combined. In 2011, 58 countries around the world reported nearly 600,000 cases of waterborne diseases—cholera, dysentery, typhoid, guinea worm infection, and other diseases caused by lack of access to safe drinking water.

In the twenty-first century, we are moving into an era of water scarcity that will be likely to affect most countries, in both the developing and the developed world [1]. Some of the drinking water challenges facing humanity include drought, overwithdrawal from aquifers, high demand due to population growth, water pollution, and increased competition for water from industry and agriculture. In addition to the basic issue of disease organisms in water, millions of people worldwide are exposed to chemical pollutants, both natural and man-made. In Bangladesh, Argentina, Chile, China, India, Mexico, and the United States, inorganic arsenic occurring naturally in groundwater presents a public health threat [6]. Naturally occurring fluoride also causes human health problems in some areas. The rate at which we introduce new man-made chemicals into the environment is much greater than the rate at which we evaluate their toxicity, creating significant water problems around the world [7]. And projected climate changes are expected to change water availability patterns and increase outbreaks of waterborne diseases [8].

How do we know our drinking water is safe? Unfortunately, that question is very hard to answer, because “safe” is a relative term. But in an attempt to provide safe water, many countries have adopted drinking water standards and regulations based on the health effects of exposure to contaminants. Some countries have set standards but have not fully implemented them. Others lack the resources to provide citizens with drinking water, safe or otherwise.

To understand today's drinking water standards and regulations, it is useful to have some knowledge about the historical, technical, and social aspects of drinking water. This chapter provides an overview of drinking water in the ancient world, the development of water treatment systems and of methods of water analysis, the evolution of drinking water standards and regulations around the globe, emerging contaminants and regulatory challenges facing the world, and global drinking water goals.

## 2 Drinking Water in the Ancient World

In many areas of the world today, water is transported from source to home in jugs or buckets. In developed countries, where most people have access to piped water in their homes, water is still transported in bottles or canteens for road trips, sports

events, hikes, and picnics. This use of containers for carrying water is not new; in fact, it is possible that humans have been using some form of water bottle for many thousands of years. Scientists know from archaeological evidence that 60,000 years ago people in southern Africa punctured ostrich eggs and decorated them [9]. Contemporary hunter-gatherers use similarly punctured ostrich shells as canteens to carry water into the Kalahari, and scientists speculate that the ancient shell fragments they have found are the remainders of canteens used 60,000 years ago.

While not much is known about the details of the use of water in prehistoric times, we do know that early humans lived near water sources, that their survival and emigration patterns were affected by access to water, and that they developed methods of carrying and storing water. Drinking water has played a role in the geography of human settlement, in politics, in economics, in epidemics, and in religions.

Nomadic peoples traveled from water source to water source and moved on when the cleanliness of the water supply was endangered by the encampment. When permanent settlements began to develop, they did so near sources of water, such as the City of Jericho's establishment near springs sometime between 8000 BCE and 7000 BCE [10]. Humans could not live in densely populated settlements without solving the problems of waste removal, drainage, and a reliable water supply, and settlement sites were selected for their springs, which were protected by the construction of "fountain houses" over them [11]. In Egypt, evidence of 5,000-year-old wells has been found, and in Mesopotamia stone channels directed the flow of rainwater some 4,000 years ago [10]. Additionally, the private houses in Ur in Mesopotamia had "water closets" and rainwater drainage systems [10]. In Pakistan, ancient wells and water pipes can still be found, and many houses there thousands of years ago had individual indoor wells [10].

According to water historian and engineer M. N. Baker (1948), Egyptian inscriptions and Sanskrit medical lore give us our earliest recorded information about water use and treatment in ancient times [12]. From as long ago as 2000 BCE, written documents provide evidence that humans had opinions about how water should be treated, including methods such as storing water in copper containers; exposing it to sunlight; filtering it through charcoal; boiling it if "foul"; dipping pieces of copper into it; and filtering it through sand and coarse gravel. In Egypt, drawings on the walls of tombs from as long ago as 1500 BCE show various sophisticated apparatuses for clarifying liquids, some using siphons and others using settling tanks and wicks.

Many examples indicate that humans have long been sensitive to the taste, odor, and appearance of water; aware that water was connected to human health; and sophisticated in their approach to collecting, treating, and storing water. A sampling of such evidence follows:

- 3000 BCE: The Indus civilization had bathrooms in houses and sewers in streets [11], evidence that those who lived there understood that wastewater needed to be kept separate from drinking water.

- 2000 BCE: In India, water purification techniques included boiling, keeping in direct sunlight, and filtering through sand [10]. The Minoans of Crete had flush lavatories and running water in their homes [11].
- 1500 BCE: A well in Cairo was 90 m deep, an indication that people understood that having access to clean water was worth a lot of work [10].
- Ninth century BCE: In Sparta, a special cup was used that both hid the color of the water and caused mud to stick to its sides, improving the quality of the water right in the cup [12].
- Seventh century BCE: Greeks were building long-distance water supply lines and wastewater drainage channels [11].
- Sixth century BCE: In Persia, King Cyrus the Great hauled water in silver flagons in mule-drawn carts when he went to war. The water was boiled ahead of time to “make it keep,” according to a Greek writer in the third and second centuries [12]. In Athens, wells of 45–60 feet were common.
- 460–354 BCE: Hippocrates, the “father of medicine,” recognized the importance of water to health and that various kinds of water differed in their health effects. He described water in terms we understand today: “marshy and soft,” “hard and running from. . .rocky situations,” and “saltish and unfit for cooking” [12].
- 384–322 BCE: Aristotle described a method for filtering water through clay [10].
- 312 BCE: The first aqueduct for bringing water to Rome was built, followed by a second in 272 BCE that also had a settling tank [13].
- 168 BCE: An account of a trip on the Nile described how the travelers made river water into drinking water by exposing it to sun and air, straining it, allowing it to settle overnight, and cooling it with evaporation by storing it in jars that slaves kept wet [12].
- 116–27 BCE: Varro listed water types by quality, spring water topping the list. It was followed by running water from a stream, water from a covered rainwater cistern, and finally water from an open-air pond [13].
- First century BCE: Vitruvius wrote about where to find water and described various kinds, including “muddy and not sweet,” “the best taste,” “a good taste,” “colder and more wholesome,” “salt, heavy-bodied, tepid, and ill-flavored” [11].
- 47 BCE: Underground aqueducts that brought water from the Nile to cisterns in which water was allowed to settle before use were discovered by Caesar to be the water supply for the city of Alexandria [12].
- 15 BCE: A three-part cistern was in use, allowing water to move from one tank to another, with the purification associated with settling taking place in each compartment [12].
- 23–79 CE: Pliny the Elder wrote his *Natural History* and had much to say about water, including that medical men condemned all “stagnant, sluggish waters” and agreed that running water was better for one’s health; cistern water was thought to be “bad for the bowels and throat” and held the record for most slime and “numerous insects of a disgusting nature” [14].
- 50 CE: In a document titled *Purification of Water*, Athenaeus of Attolia described channels that brought clean water from lakes or the sea, jars called “stacta” that

were used for purifying water, and single, double, and triple filtration systems [12].

- 97 CE: Frontinus became the water commissioner of Rome and wrote *Two Books on the Water Supply of Rome*, which Baker calls “the first known detailed description of a water works system” [12].
- First century CE: Macerated laurel, pounded barley, and bruised coral were all in use to improve bad-tasting water or to turn rainwater into drinking water. Pliny recommended the use of lime and “aluminous earth” as precipitants, a technique used in municipal water treatment plants many centuries later [12]. In Sri Lanka, reservoirs stored water for later use, as did “village tanks,” “large tanks,” and “feeder tanks” [15].
- 421 CE: Venice was founded and for the next 13 centuries used rainwater that was collected and stored in cisterns as drinking water; most of these cisterns were surrounded by sand filters. Drinking water was also brought from the mainland by boat, which gave the water a “pitch and tar” taste that Venetians learned could be removed by sand filtration [12].
- Fifth century CE: Greek cities recognized three kinds of water: drinking water, which was carried from flowing fountains or from springs; bathing and cleaning water, which was stored in cisterns in houses and was used for crafts and for livestock as well; and “gray water,” which was wastewater that had not been contaminated by fecal material and so could be used in other ways [11].
- Seventh century CE: The Greek physician Aegineta prescribed straining or boiling for impure or bad-smelling water [12].
- Eighth century CE: The Arabian alchemist Geber described distillation [12].
- Eleventh century CE: The Persian physician Avicenna advised travelers to boil water or to strain it through cloth before drinking it [12].

This list shows that in many ways, little has changed over the centuries with regard to the desire for clean drinking water and the need for treatment: people depended on taste, odor, and turbidity to determine whether to drink water several thousand years ago, and people today do not like to drink smelly, bad-tasting, cloudy water [7]. Cleaning up water through settling, filtering, and disinfecting also has been taking place for millennia.

### 3 The Impact of Human Activities on Drinking Water Sources

Historical and archaeological evidence suggests that for as long as people have been living in settlements, they have been aware that this way of living requires a convenient source of clean drinking water and a system for disposing of wastes. Despite this understanding, waste disposal often has led to the fouling of drinking water sources, and human population growth has exacerbated the problem.



Human waste in drinking water sources continues to be a problem in many parts of the world today. For large segments of the human population, toilets are not available, and “open defecation” creates major sanitation problems in some areas of the globe, affecting drinking water sources. The leader of India’s Ministry of Rural Development, Jairam Ramesh, recognizes the Bill and Melinda Gates Foundation’s “reinvent the toilet” challenge as a step toward solving the problem [16]. Ending open defecation is a major goal of WHO and of the United Nations Children’s Fund (UNICEF) [17].

Animal waste intrusion in bodies of water used as drinking water sources became an increasingly significant problem when humans began domesticating animals. Domestic animal waste continues to be a problem today, contributing 85 % of the world’s fecal material [18]. The intensive use of chemical fertilizers and pesticides for crop production has significantly impacted the quality of surface and ground waters in many regions of the world.

Urbanization has had and continues to have a major impact on drinking water sources. By the beginning of the nineteenth century, the rivers and wells of many countries had been polluted by both domestic sewage outflows and industrial activities [19], and stormwater runoff carrying lawn chemicals, oil, sediments, and other pollutants from settled areas is the major source of water contamination in many places today [2]. Historian Christopher Hamlin notes that early in the nineteenth century, British people were drinking what was “little better than dilute sewage” [20]. Open defecation is a public health problem today, but discharging untreated sewage into rivers immediately upstream from the intakes for drinking water, as often happened in England and elsewhere [20, 21], guarantees the addition of contaminants to drinking water sources. Before the demonstration by Dr. John Snow in 1855 that cholera is a waterborne disease and the discovery by Louis Pasteur in the late 1880s that microscopic organisms are able to cause disease and can live in water [22], people did not understand the dangers of sewage discharge into water bodies.

In the United States, during the 1700s, industrial and urban wastewater discharge and agricultural runoff caused enough degradation of surface waters that in the 1800s people began voicing concerns about the effects of these human activities on water quality [5]. In 1907, it was demonstrated that some of these wastes had toxic effects on aquatic organisms; and as we know now, such wastes also can be harmful to humans. At present, pesticides, chemical fertilizers, and animal wastes from agriculture; drugs, bacteria, and other contaminants from human wastes; and chemical effluents from industries affect drinking water sources all over the world. Some 2,000 new chemicals are introduced into the environment every year, and many of them end up in natural water systems [5].

## 4 The Evolution of Municipal Drinking Water Treatment Systems

The earliest methods for improving drinking water quality suggest that humans connected drinking water with health long before there was a scientific understanding of what might be in water and of the problems associated with contaminated water. This connection, and a desire for water that at least looked, smelled, and tasted good, motivated people to engineer ways of treating drinking water, and water treatment as an organized municipal-level phenomenon was the eventual result. Water historian M. N. Baker [12] used an impressive array of primary sources to produce his book *The quest for pure water: The history of water purification from the earliest records to the twentieth century*, and this section provides a brief overview of that information as it applies to municipal water treatment.

### 4.1 Early Water Treatment Methods

Many of the modern water treatment methods for improving the taste, smell, look, and safety of water are essentially the same as they have been throughout history. That is not to say that no improvements have been made; it's just that most methods of water treatment in use today are based on principles developed centuries or even longer ago. A few examples of ancient water treatment methods are illustrated below.

According to Baker [12], coagulation has been practiced since ancient times [12]. Coagulants that have been used include alum (aluminum sulfate), lime and iron used together, lime alone, almonds, beans and nuts, toasted biscuits, and Indian meal. A manuscript from 400 CE, summarizing ancient Aryan and Indic lore, tells about a nut that travelers used to clarify marsh waters, and alum was used for small-scale water clarification in ancient China [12]. At large industrial plants, coagulation has been in use since the early 1800s. Municipal water suppliers began incorporating coagulation into water treatment systems toward the end of the 1800s.

Sedimentation, the use of settling reservoirs to clarify turbid water, was used centuries ago. The earliest known city to use sedimentation was Laodicea, in what is now Turkey, about 260 BCE [12]. Vitruvius wrote about cisterns in 15 BCE: "If such constructions are in two compartments or in three so as to insure clearing by changing from one to another, they will make the water much more wholesome and sweeter to use" [12].

Disinfection has been around since civilization began, with the earliest written mention of disinfection via boiling in Herodotus (484–425 BCE) [12]. Other disinfection methods used through the centuries include heat, copper, silver, chlorine, ozone, and ultraviolet rays. A Sanskrit document from 2000 BCE advises exposing water to sunlight and filtering it through charcoal [12]. Chlorination was put into

practice at the beginning of the 1900s both in Belgium and in the United States [2, 23] and is used all over the world today. The Arabian chemist Geber (or Jabir), born in 721 or 722 CE, is thought to have written the first known treatise on distillation [12]. Aristotle explained that pure water could be obtained from sea water through evaporation, and many other ancient writers told readers that the vapor rising from water is more pure than the water itself.

Well before municipal treatment plants were common, smaller scale filtration units and other methods were being invented and used. Baker (1948) describes historic advances in the recognition of contaminants, including mineral salts and algae, and what to do about them. Sir Francis Bacon described boiling, distillation, coagulation, and filtration in a 1627 work on drinking water, and multi-section sand and pebble filters were both used and described in the late 1600s in Europe. Records from the 1700s show the use of techniques for sedimentation, softening, filtering, and distilling, along with the use of alum as a coagulant. In 1703 a French scientist proposed a plan for a rainwater cistern with a sand filter and a light-excluding cover to prevent the growth of what he referred to as “a greenish kind of moss.” This, he said, would ensure an excellent source of drinking water, equivalent to spring water.

Prior to 1711, it was thought by many that drinking water could be made from seawater by filtration. However, an experiment in which seawater was filtered 15 times through clay and sand demonstrated that it could not. From a 1732 publication, Baker found evidence of using sedimentation, exposure to the sun, and sand filtration to purify water, including specific directions for washing the sand periodically. Baker found multiple references to using various types of filters in published works throughout the 1700s: filters made of layers of sand between perforated copper plates; layers of stone; sand and pulverized glass; filtering paper; wicks of cotton; and bags of woolen, linen, or flannel cloth.

Baker also recounts the use of various additives to make potable water in the 1700s, such as burned biscuits, powdered ginger, vinegar, cream of tartar, ashes, alum, “oil of sulfur,” and lime. Although Baker found no evidence that the water supply for any city had been filtered before 1769, he noted a statement in a book published that year suggesting that water supplies for “great towns” should be purified and that common methods of filtering and softening should be used to prevent the diseases bad water could cause. Evidence of a man-made filtration system in use in Senegal was reported in 1776; pits dug into sand allowed filtered river water to collect and be stored. The efficacy of charcoal use to purify and deodorize water was established by a paper published in 1790.

## ***4.2 The European Experience***

Baker’s history describes early attempts to use filtration techniques in European towns and cities. In France, filters were patented, manufactured, and sold for individual household use in 1750. In the decades to follow, a filter plant for the

provision of larger quantities of drinking water was built, and filtered water in sealed containers was delivered to city residents. French inventor Joseph Amy was the first person to be issued a patent for a filter from any country, Baker reports, and Amy also published the first book on filters in the world, both in the mid-1700s. Amy wrote that layers of sand in copper containers had been used as household water filters since the 1550s. Later filters used in France contained sponge, charcoal, wool, sand, crushed sandstone, and gravel. People also were filtering water in their homes in England; a British patent was granted in 1790 to Mrs. Johanna Hempel, a Chelsea potter, for “a composition of materials and a means of manufacturing it into vessels” that would allow for the filtration of water and other liquids [12].

Baker’s historical overview tells us that Paisley, Scotland, in 1804 completed the first filter to supply water for a whole town—not through pipes, but delivered to customers by horse and wagon. A few years later, Glasgow began using pipes to deliver filtered water to customers. River water posed special problems, with flood waters clogging treatment systems, and in the early 1800s Glasgow held a filter design competition that attracted 22 plans. In 1810 a submerged pipeline and a filter gallery, each the first of its kind, were installed, the pipeline bringing water from a sand and gravel peninsula and a set of springs across the river from the city.

Throughout the 1800s, new and remodeled designs were built and tried out. A “self-cleaning” design solved a number of problems that had plagued city filter systems. Despite this, the use of municipal water treatment systems grew slowly. Between 1842 and 1870, a few cities in France built filters that were washed by upward reverse-flow water; Marseilles, Tours, and Dunkirk all installed such filters, joining Nantes in the distinction of being the only cities in France that filtered their entire municipal water supply before 1890.

Although filtration systems of a variety of designs were being built and used, Baker notes that at the beginning of the 1800s the understanding of how filtration worked was “vague and sometimes contradictory” [12]. For example, although most filters eventually came to be made up of sand and gravel arranged by size, with the finest sand at the top of the filter and the coarsest gravel or rock at the bottom, some were used by passing the water up from the bottom and others were used by passing the water down through the filter from the top. During the 1800s the goals of filtration also expanded from the removal of suspended material to a focus on organic matter. Before bacteria were known to exist, sand and gravel filters were removing microorganisms from drinking water. This benefit was proven toward the end of the century, by which time the function of filtration was well understood.

### ***4.3 The North American Experience***

Similar experiments in filtration were under way in North America, with the first—and unsuccessful—city filtration system in the United States in use in Richmond, Virginia, in 1832, and a charcoal, sand, and gravel filter at Elizabeth, New Jersey, in

1855, according to Baker. Kingston, Ontario, built a lake-intake filter in 1849, and Hamilton, Ontario, added one in 1859, but Baker reports that neither was successful [12]. In 1860, the United States had only 136 waterworks and Canada only 10. Not until 40 years after the first slow sand filters had been constructed in England and Continental Europe were they built in North America. Poughkeepsie, New York, built the country's first slow sand filter and began operating it in 1872 [12]. The city's 20,000 residents benefited greatly because the drinking water supply came from the Hudson River, which was often turbid, brackish, and full of raw sewage. In 1893 a water filtration plant for the city of Lawrence, Massachusetts, was opened, and the incidence of typhoid in the town was markedly reduced, a result that Baker says greatly increased confidence in water filtration in America.

The United States made three major contributions to municipal water treatment, according to Baker: (1) developing the rapid filter; (2) improving slow sand filter techniques; and (3) using chlorination to disinfect drinking water. By the end of 1900 there were 20 slow sand filters in the United States and 5 in Canada. Rapid filters were much more popular—by 1940 the United States had 2,275 rapid filter plants compared to 100 slow sand filtration plants. Canada at that time had 120 rapid filters and 12 slow sand filters.

Early attempts at filtration, before the advent of chlorine disinfection, did not always function as well as intended. In America, for example, throughout the nineteenth century, city residents relied on bottled water whenever they feared contamination of city water supplies [23]. During the first decades of the 1900s, Middlekerke in Belgium and Jersey City and Philadelphia in the United States began using chlorine to kill waterborne bacteria [2, 23]. By the early 1940s nearly all U.S. water treatment plants were chlorinating their water, effectively eliminating cholera and typhoid and the bottled water industry as well [2, 23].

#### ***4.4 Modern Water Treatment Methods***

Today's modern treatment systems typically include a pretreatment step, flocculation, filtration, chemical treatment, and disinfection [7]. The use of organic flocculants and chlorine, bromine, or chloramines for disinfection removes contaminants but can add carcinogens to water. Other advanced treatment methods include the use of activated carbon for organic chemical removal, ion exchange for inorganic metals, ozonation for disinfection and to oxidize organic constituents, ultraviolet light for bacterial and viral control, reverse osmosis to remove organic and inorganic compounds, and enhanced coagulation [7]. The science and technology of water treatment is continuously evolving. For details, the reader is referred to current textbooks and the scientific literature.

## 5 The Evolution of Methods for Water Analysis

Water is a universal solvent. In addition, many different materials can be suspended in water, and many organisms live in water. For most of human history and prehistory, however, we have not known what is dissolved, suspended, or living in water; when early methods of treating and filtering water were developed, humans did not know what was being removed. When Leeuwenhoek first observed living creatures through a microscope lens, it must have stunned him and everyone he told: “In the year 1675, I discovered living creatures in Rain water, which had stood but a few days in a new earthen pot. . . [some] put forth two little horns, continually moving themselves.” [12] These microscopic organisms were called “living Atoms,” or “Animalcula.”

### 5.1 Chemical Analyses

Historian Christopher Hamlin has noted that the analysis of water for its non-water components was used by the proprietors of “healing springs” to advertise the water’s medicinal properties long before such analysis was used by governments or water treatment plant operators to assure citizens that water was safe to drink [20]. Mineral springs and “baths” in Europe were very competitive, and the proprietors of such healing waters used mineral analyses printed on advertising cards to draw in customers. Historical evidence traces this as far back as the fifteenth century, when early spas were promoted by the odor, taste, color, and temperature of their waters.

A history of bottled spring waters explains that “taking the waters” at these healing springs was guaranteed to make you feel better if what you were suffering from was related to your normal source of drinking water, as “. . . filthy drinking water was the norm in most of Europe from the middle ages right up to the twentieth century” [23]. If you planned a 3-month stay, you might indeed find that your dysentery or chronic intestinal upsets would clear up, simply because you were no longer drinking contaminated water. But the beneficial health effects were attributed to healing qualities in the spring waters, not to the absence of health-endangering contaminants.

Those first four “healing” characteristics of water—odor, taste, color, and temperature—were augmented using tests with reagents, some of which dated back to Pliny, who used oak galls to test for iron in water [20]. Other tests, similarly based on a change of color, were developed in the 1500s, and as far back as the thirteenth century Italian physicians were testing the residues left from the evaporation of water. Hamlin also points out that the dyeing of cloth was a well-developed technology many centuries ago, and chemical knowledge gained from dyeing contributed to the development of water analysis [20].

## 5.2 *Early Attempts at Measuring Contaminants*

In 1784, Torbern Bergman published *Physical and Chemical Essays*, a work that prescribed three methods of testing water:

- Examine its physical properties (taste, texture, odor, rate of heating and cooling, and sound).
- Use reagents to do a qualitative assessment.
- Evaporate a large quantity of water and then measure the evaporative residue [20].

Before about 1860, Hamlin tells us, there was nothing comparable to the *Standard Methods* available now for the analysis of drinking water [20]. The mineral analyses that were used to promote the healing properties of the baths and spas were applied to drinking water analysis beginning in the middle of the nineteenth century in England.

Compared to today's science, chemistry a century or two ago was fairly primitive. But the development of chemistry as a discipline during the 1800s was a critical part of the development of our contemporary approach to producing safe water. Hamlin explains [20]: “We might be tempted to see [early chemists] as charlatans, for prior to the 1890s they were claiming to be analyzing water without (as we know now) any correct (or even very definite) idea of what components or contaminants of waters had active effects. . .[but] we need to recognize that the authority sold by these chemists was a real and a valued commodity.”

## 5.3 *Linking Human Disease to Bacteria*

Limitations in the understanding of what caused disease limited the usefulness of early water analyses. In 1866, for example, when a cholera epidemic swept London, chemical analysis showed that the city's water was safe to drink because chemical assays could not detect bacteria. Without accurate information about what can be dissolved in, or living in, water, all sorts of ideas were proposed in the 1800s. According to Hamlin, the smelly products of anaerobic decay got the most attention from scientists for a while, and it was thought that poisons were produced by matter decomposing in water [20]. These poisons, scientists thought, either weakened a person's resistance to disease or acted to cause disease. When microscopes allowed researchers to see some of water's living inhabitants, the images went viral in a nineteenth-century way: pub owners posted drawings of the “wriggling monsters” in shop windows to encourage consumers to drink ales and beers at the pub instead of drinking London's water, which was swarming “with living animalcules” [20].

Although in the mid-1800s people were beginning to suspect that water could be harmful and in some cases demonstrating *how* it could be harmful, chemists also were beginning to admit that whatever caused drinking water to be unsafe was not

something they knew how to detect or measure [20]. In 1865, when Edward Frankland was appointed to serve as the official analyst of the London water supply, the city was using permanganate disinfection and filtration through animal charcoal, but Frankland began to lose confidence in these methods. After presenting evidence that “the cholera poison” might be something that scientists would be unable to detect by chemical means, Frankland began using inorganic nitrogen compounds to calculate what he called the “previous sewage contamination” (PSC) of water [20].

Similarly, although just what caused cholera was still unclear, after Snow demonstrated in the 1850s that it was linked to water supplies [23], people were beginning to accept that various diseases might each be caused “by a unique morbid poison” [20]. The concept of the “germ” arose at this time. The word “germ” was already in use to mean an egg or a seed, an extremely tiny particle that grew into something larger, and this was the first application of the word to disease. Scientists began to understand that just one of the tiny things—a germ—could become many, contaminate an entire water supply, and cause disease [20]. Hamlin describes the German bacteriologist Robert Koch’s development of methods for culturing water-dwelling bacteria in a solid medium in the 1880s as a major breakthrough—it provided a reasonably reliable technique to detect potentially dangerous bacteria in a water supply [20]. Koch’s new culturing techniques also allowed the efficacy of filtration systems to be demonstrated, with tests showing many bacteria before filtration and hardly any after filtration. After many years of work on water-dwelling bacteria, Percy Frankland and his wife Grace Toynbee Frankland published “Micro-organisms in water: Their significance, identification, and removal,” which combined their research with a review of hundreds of experiments from around the world, including the survival periods of various microbes in various kinds of waters [20].

Over the course of the nineteenth century in England, water contaminated by fecal material came to be seen as a principal source of human disease [20]. Analysts became confident in the use of coliform counts as an indicator of unsafe water, new purification technologies were developed, sewage treatment processes were improved, and the potential of chlorination to solve bacterial contamination problems was recognized [20].

## 5.4 *Standardization of Analyses*

Scientists were working on similar problems in the United States. In the 1880s, the need for adopting water analysis methods that were more “uniform and efficient” resulted in the convening of a special committee by the American Association for the Advancement of Science’s chemical section [24]. The committee’s work was published in the *Journal of Analytical Chemistry* in 1889 in a report titled “A Method, in Part, for the Sanitary Examination of Water, and for the Statement of Results, Offered for General Adoption” [25]. The report covered methods for



measuring ammonia, oxygen-consuming capacity, nitrogen as nitrites, and total nitrogen as both nitrates and nitrites.

In 1895, the American Public Health Association (APHA) responded to concerns about how bacteria should be detected and quantified in water by sponsoring a convention of bacteriologists [24]. The results of the work that started then were submitted in 1897 and widely accepted as a standard method. In 1899, the same organization convened a committee to generate standard methods of water analysis so that other tests would be standardized as bacteriological tests had been. The result was the publication in 1905 of the first edition of *Standard Methods of Water Analysis*.

The American Public Health Association was joined in 1925 by the American Water Works Association (AWWA) and in 1935 by the Federation of Sewage Works Association (now called the Water Environment Federation) [24]. Since 1947, these three groups have worked together to review, revise, reorganize, and publish many editions of what is now called *Standard Methods for the Examination of Water and Wastewater*, a handbook that is still in use and is regularly updated. The 22nd edition, published in 2012, provides standard methods for the analysis of more than 150 contaminants or indicators of water quality. It also details water sampling methods, quality control issues, and precision and bias. Although color, smell, taste, and turbidity still indicate much about the quality of water, a wide variety of detection methods and instruments are now used. These include liquid and gas chromatography, radiation detection, mass spectrometry, ultraviolet absorption methods, electrophoresis, flow analysis, quantitative polymerase chain reaction, plasma emission spectroscopy, and many others.

## 6 The Evolution of Drinking Water Standards and Regulations

The transition from judging water quality on clarity, taste, and smell in the ancient world to using sophisticated laboratory techniques today was a gradual one. Baker [12] cites the testimony of an engineer at a hearing about a proposed water filter for London in the early 1800s, in which the engineer states that none of the men working on the project had any health complaints related to drinking the filtered water and that fish placed in the water did not die. How did we get from color, odor, taste, the presence of mud, and the death of fish to our contemporary sets of drinking water standards?

## ***6.1 Potable Water as a Government Responsibility***

Before standards can be set, we have to be able to detect and measure the contaminant in water; the development of methods of analysis was a critical element in setting standards. But the ability to find contaminants in water is only a small part of the development of drinking water standards. Hamlin's account of the evolution of drinking water standards and regulations in England in the nineteenth century [20] is relevant to drinking water problems around the world today.

During the late 1830s, providing safe water to its citizens was included with other public health issues as the British government fashioned its modern system of public health administration. Science was expanding rapidly at about the same time, and the idea that science could be used in public decision-making played a major part in developing standards. The Metropolis Water Act of 1871 established the government position of "water examiner," an official who would ensure that water filtration was carried out, and chemical analyses were soon included in the water examiner's reports [20].

Hamlin points out that compared to social, political, and economic factors, science was perhaps the simple part of working toward creating a safe water supply [20]. Drinking water standards are not only or even primarily the result of scientific discovery, he says. Rather, drinking water standards were hammered out by a number of interested parties—government, courts, consumers, various industries, water suppliers, farmers, and others. Each of these groups used "scientific arguments" to defend their positions at a time when it was not easy, or perhaps possible at all, to determine the reliability of these arguments [20]. Hamlin shows that although London's need for a safe drinking water supply was critical, factors that slowed the achievement of that goal included conflict over the political and financial control of the water supply and consumer objections to paying for water that was not always available or clean [20]. And what was the definition of pure water? Did it have to be entirely free of microscopic life? Was "soft water" pure water? If water had no microbial contamination, was it pure even if it had other contaminants? In the mid-1800s, Hamlin says, there was "a lack of consensus as to what standards of quality a public water supply ought to meet" [20].

"Safe water" is a relative concept and can be defined differently in different contexts or by different stakeholders in different countries. Because we depend upon the judgment of experts and because providing drinking water requires funding [2], the safety of drinking water today, as in the past, is tied to politics, economic factors, consumer satisfaction, and advances in science. The challenges of determining pricing, institutional control, testing, treatment, reporting, which parameters are important, and how parameter limits should be set are still being faced in many countries. But the importance of working to provide safer water is seen in the results of such work: between 1990 and 2010, for example, some two billion people worldwide gained access to improved water sources [26, 27].

## 6.2 Guidelines, Standards, and Regulations: An Introduction

Reading about drinking water can be confusing. Terms that mean one thing in one country may mean something else in another. The usual meaning of the word “standard,” as it applies to drinking water, is a numerical limit, a concentration above which the contaminant should not occur in drinking water. In the United States, where such standards are legally enforceable, the standards are referred to as “regulations” and include not just the numerical limit but also the requirements for water testing, sample collecting, reporting of results, and techniques for treating contaminated water. In countries without a regulatory framework in place for the enforcement of standards, drinking water standards may exist as “guidelines,” numerical values that water providers are expected to use as goals for providing safe water. The language used varies: In India, a list of drinking water parameters is titled “Standard Specifications” and includes comments about whether the limit can safely be extended if necessary or falls in the category of “no relaxation” of the limit. In Kenya, the list of parameters is called “Quality Standards.” In the United States, “National Primary Drinking Water Regulations” spell out the details of allowable contaminant levels.

These systems have one thing in common: Drinking water standards around the world are health based. Each standard is set to minimize the threat to human health. For some contaminants, the threat is immediate (acute), but many regulated contaminants pose a threat only if consumed over a long period of time (chronic). The development of standards takes into account how much water an individual drinks per day (for example, in the United States the assumption is 2 L for adults and one for children) and is based on the idea that the average person will drink water for about 70 years. Standards are set based on the effects of the contaminant on laboratory animals, human exposure health data, and the contaminant’s occurrence in water, food, and air.

A useful document for countries developing national drinking water quality standards and for those interested in the details of developing standards is *Guidelines for Drinking Water Quality Standards in Developing Countries* [28]. This WHO publication provides step-by-step directions for the entire process of standard development, from identifying the institution responsible for developing standards to surveillance and monitoring. Setting standards to ensure safe drinking water can include setting requirements for water sampling locations, frequency, and methods; laboratory accreditation; provision for the revision of standards; and many other aspects beyond just a contaminant level.

Selecting which drinking water contaminants need to be regulated is based on the threat posed by the contaminant, the prevalence of the contaminant in water sources, and various other factors. Back in 1850s Britain, Hamlin tells us, there was no understanding of the link between disease and human fecal contamination. But significantly for the development of drinking water standards, there was “a slow shifting of sensibility to the view that among types of filth, some types were significantly more dangerous than others” [20]. This recognition that some types

of “filth” are more dangerous allows government agencies to focus their regulatory efforts on the contaminants that are most likely to cause human health problems. Reviewing lists of contaminants and adding new contaminants are continual processes.

### ***6.3 Regulatory Framework: The United States***

Government regulation of the quality of drinking water is about 100 years old in the United States. In 1914, the U.S. Public Health Service set the country’s first drinking water quality standards; these standards regulated bacterial contaminants that could cause contagious diseases [29]. The standards applied only to drinking water that moved between states, such as water supplies moved by train or ship from a source water system in one state to an end use in another state. These drinking water standards were revised and expanded in 1925, 1946, and 1962, at which time 28 substances were regulated. Individual states adopted the federal standards either as unenforceable guidelines or as legally enforceable regulations.

The federal government conducted a number of drinking water quality studies after the 1962 revision and found that many water suppliers were not meeting the Public Health Service standards [30]. These and other studies led to the passage of the Safe Drinking Water Act (SDWA) in 1974. The SDWA was updated in 1986 and 1996; when the 1986 amendments passed, federal standards for only 22 contaminants had been set, and the amendments required developing standards for a total of 83 specific contaminants.

Under the SDWA, the EPA sets national health-based drinking water standards [30]. The amount of a contaminant in drinking water that the EPA determines will not endanger human health over a lifetime of exposure is listed as its Maximum Contaminant Level Goal, or MCLG. MCLGs are not legally enforceable, but they are critical to the setting of standards because they are used to determine the enforceable Maximum Contaminant Levels (MCLs). MCLs differ from MCLGs when the contaminant cannot be detected at levels as low as the MCLG or when it is not possible to remove contaminants from water to a level as low as the MCLG. The EPA also publishes a document called a Health Advisory for each contaminant, providing information on health effects based on 1-day, 10-day, and lifetime exposures. Tables of these Health Advisories and more information about various drinking water contaminants can be found at the EPA website [31].

The EPA oversees the implementation of these standards by states, localities, and the nation’s more than 160,000 public water systems [30]. Most states and territories provide oversight of their own drinking water systems, which EPA allows as long as systems meet standards that are at least as stringent as the national standards. When contaminant levels are exceeded, treatment plants are required to notify consumers and the state or EPA. Violations typically result in a state regulatory agency providing technical assistance to solve the problem; repeated violations can result in penalties.

## 7 Current Drinking Water Standards and Guidelines: A Global Overview

A set of drinking water standards accepted and enforced worldwide does not exist, and not all countries have adopted standards. Some countries have a set of standards or guidelines but lack the resources to enforce them. Some have a set of standards, but such a large proportion of their population gets water from sources other than water treatment systems that the standards do not affect many people. Other countries have both standards and a regulatory framework to enforce them. While many of the numerical values of the parameter limits are similar from country to country, others may differ significantly.

A majority of the world's population today lives in countries with drinking water standards. China's Ministry of Environmental Protection set drinking water standards in 2002. The European Commission enforces the European Drinking Water Directive of 1998, with member states required to enact appropriate legislation to implement and enforce the directive in their own countries. In the United States, the EPA is responsible for drinking water standards, as required by the SDWA of 1974. A number of countries have guidelines rather than standards, with states or provinces taking responsibility for creating a regulatory framework, including Canada, New Zealand, India, Argentina, and Australia. Many countries have adopted standards using the European Union, United States, and WHO lists as guides and making changes as needed for their circumstances.

The standards set by and enforced in different countries reflect the politics, economy, and concerns about public health of each country. For example, in developing nations, pesticides are usually of far less concern than acute water-related diseases, and the "best available technologies" to reduce waterborne diseases may be public education, hand pumps, communal taps, and latrines rather than water treatment plants or drinking water standards [7]. In countries lacking resources to deal with the list of contaminants regulated in wealthier nations, drinking water standards are more likely to be set for contaminants that occur frequently and have the greatest health impact [28].

This section presents information about the drinking water standards of selected countries around the world. These descriptions are not meant to provide comprehensive views of each country but rather to illustrate various aspects of drinking water standards used around the world. We will begin with the WHO guidelines, as this organization's work is central to the provision of safe water in many countries [32, 33].

### 7.1 World Health Organization

In 2011 the fourth edition of the WHO standards, *Guidelines for drinking-water quality* [32], was published. The document includes health-based targets, water

safety plans, information about microbial, chemical, and radiological parameters, a chapter on acceptability of water with regard to taste, odor, and appearance, and information about applying the guidelines in specific circumstances.

One of WHO's most downloaded documents, the *Guidelines* are used by many developed and developing countries to set national drinking water standards and to develop a regulatory framework for the enforcement of standards [2]. The European Union and Japan both have used this document to determine their approach to drinking water, and it forms the basis of Australia's drinking water guidelines. In addition to setting forth the standards for a variety of parameters, the *Guidelines* encourage the use of water safety plans, which require assessing risks at every step of the water supply process, from original source to consumer [33]. This approach, introduced in 2004, has spread to many areas of the world, including 60 of 74 developing countries that were assessed as part of the Millennium Development Goal (MDG) program [34].

WHO's *Water Quality and Health Strategy: 2013–2020* [2] details the organization's five strategic objectives for the next several years, which include obtaining evidence regarding water quality and health; providing water quality management guidelines and supporting resources; strengthening the capacity of member states to manage water quality; facilitating implementation of water quality activities; and monitoring the effect of these activities. The *Strategy's* vision is "to attain the highest possible reduction in waterborne and water-related diseases by providing up-to-date, evidence-based guidance and coordination, and support for water, sanitation and hygiene interventions" [2]. Its mission is "for WHO to be the authoritative source on health-based water quality information, for use by water and health regulators, policy-makers, their advisors and other stakeholders" [2].

Although WHO generated its first set of drinking water standards in 1958, and many of these standards have been adopted by many countries around the world, the organization also recognizes that in many areas of the world such standards still represent a distant goal. Many countries lack the regulatory framework to enforce the standards, the financial resources to implement the standards, the political stability to move forward on providing safe water, or the physical infrastructure to deliver treated water to residents. One of the goals of the *Strategy*, thus, is to support 20 additional countries in establishing a drinking water quality regulatory framework and implementation strategies by 2020 [2]. A second goal is to complete an assessment of 50 countries by 2015 to determine whether their regulatory frameworks are operating to guarantee safe drinking water to citizens.

A third goal of the WHO *Strategy* is to help countries establish policies on household water treatment and safe storage interventions, with a specific target of 50 additional countries having such policies by 2020 [2]. For people who depend on water from rivers, lakes, and other sources of untreated or unsafe water—the 780 million people who drink water that comes from unimproved sources and the millions of others who drink water that is unreliably "improved"—such interventions can dramatically improve water quality and decrease diarrheal diseases [6, 35].

## 7.2 United States

The United States currently has 87 National Primary Drinking Water Regulations (NPDWRs) and 15 National Secondary Drinking Water Regulations (NSDWRs). The NSDWRs are non-mandatory standards for 15 parameters affecting taste, odor, and color. They provide guidance for public water systems. The contaminants do not provide a health risk, but problems with taste, odor, and color can cause consumers to stop drinking water. These secondary regulations can be found at the EPA website [36]. They include aluminum, chloride, color, copper, corrosivity, fluoride, foaming agents, iron, manganese, odor, pH, silver, sulfate, total dissolved solids, and zinc.

Because sets of drinking water standards are fairly similar from country to country in wealthier nations, it may be instructive to provide here an entire list of contaminants. Regulated contaminants in the United States include:

- Microorganisms: *Cryptosporidium*, *Giardia*, *Legionella*, viruses, turbidity, a count of the variety of bacteria found in the water (heterotrophic plate count, or HPC), and total coliforms, a measurement that indicates whether harmful bacteria may be present;
- Disinfectants: chloramines, chlorine, chlorine dioxide;
- Disinfection by-products: bromate, chlorite, haloacetic acids, and total trihalomethanes;
- Inorganic chemicals: antimony, arsenic, asbestos, barium, beryllium, cadmium, chromium, copper, cyanide, fluoride, lead, mercury, nitrate, nitrite, selenium, thallium;
- Organic chemicals: acrylamide, alachlor, atrazine, benzene, benzo(a)pyrene, carbofuran, carbon tetrachloride, chlordane, chlorobenzene, 2,4-D, dalapon, 1,2-dibromo-3-chloropropane, o-dichlorobenzene, 1,2-dichloroethane, 1,1-dichloroethylene, cis-1,2-dichloroethylene, trans-1,2-dichloroethylene, dichloromethane, 1,2-dichloropropane, di(2-ethylhexyl) adipate, di(2-ethylhexyl) phthalate, dinoseb, dioxin, diquat, endosulfan, endrin, epichlorohydrin, ethylbenzene, ethylene dibromide, glyphosate, heptachlor, heptachlor epoxide, hexachlorobenzene, hexachlorocyclopentadiene, lindane, methoxychlor, oxamyl, PCBs, pentachlorophenol, picloram, simazine, styrene, tetrachloroethylene, toluene, toxaphene, 2,4,5-TP, 1,2,4-trichlorobenzene, 1,1,1-trichloroethane, 1,1,2-trichloroethane, trichloroethylene, vinyl chloride, xylenes; and
- Radionuclides: alpha particles, beta particles and photon emitters, radium 226 and radium 228, uranium.

A list of all primary drinking water contaminants and their maximum contaminant levels (MCLs), maximum contaminant level goals (MCLGs), common sources, and potential health effects can be found at the EPA website [37]. A table listing all the contaminants for which MCLs have been set also is available at this site [38].

MCLs are set as close to MCLGs as possible, taking both treatment and detection technology and cost into consideration, and represent the highest level at which a contaminant is allowed in drinking water. Because disinfectants that control microbial contaminants themselves have health effects, another set of standards has been set, Maximum Residual Disinfectant Level Goals and Maximum Residual Disinfectant Levels.

The 1996 amendments to the SDWA require the EPA to maintain a database of information about the occurrence of both regulated and unregulated contaminants found in public water systems. This information is found in the National Drinking Water Contaminant Occurrence Database at the EPA website [39].

Also found at this website is the “Six-Year Review of National Drinking Water Regulations,” a report generated by the SDWA’s requirement that EPA review each NPDWR at least once every 6 years. If new technology or a new health effects assessment makes it possible to protect public health better than the current NPDWR does, then EPA can revise the standard.

The second such 6-year review, of 71 NPDWRs that had been set before 2005, identified four NPDWRs to revise: acrylamide, epichlorohydrin, tetrachloroethylene, and trichloroethylene [40]. The review was conducted between 2003 and 2009. Fourteen NPDWRs were included in the review for which regulatory action had recently been taken or was under way: bromates, chloramines, chlorine, chlorine dioxide, chlorite (disinfectants); copper and lead; coliform bacteria, *Cryptosporidium*, *Giardia lamblia*, *Legionella*, viruses; HAA5 (haloacetic acid species); and TTHMs (total trihalomethanes).

The review found new information available for 24 NPDWRs but did not recommend revision to the standards because they were considered to be “low priority.” Another set of three NPDWRs, all pesticides (atrazine, carbofuran, and simazine), was not recommended for revision because of data gaps or information that was just emerging [40].

The contaminants currently regulated in the United States, along with information about contaminants under consideration for regulation, can be found at the EPA website [41]. The report on the second 6-year review, “Six-Year Review 2 Health Effects Assessment: Summary Report,” also is available online [42], as is general information on the 6-year review process [43].

### **7.3 The European Union**

The European Union’s Drinking Water Directive of 1998 states as its objective [44]: “to protect human health from adverse effects of any contamination of water intended for human consumption by ensuring that it is wholesome and clean.” The Directive applies to drinking water in bottles and containers, from tankers, and supplied by distribution systems serving more than 50 people or producing more than 10 m<sup>3</sup>/day (or smaller systems if it is part of an economic activity). It also applies to water used in the food-processing industry. This directive included



48 indicator, chemical, and microbiological parameters. Member states of the European Union must adhere to these quality standards and can also set additional standards [45].

The policy's goal is to protect human health over a lifetime of water consumption through the setting and revision of standards according to up-to-date scientific studies. It is part of more general European Union water and health policies and includes provisions for monitoring, assessment, enforcement, and communication with consumers. The Directive provides baseline standards and minimum monitoring requirements to achieve a level of consistency in drinking water quality among member states but also allows for autonomy for individual member states with regard to setting more stringent standards, standards for additional contaminants, and more frequent monitoring requirements [46]. It includes a requirement for reviewing standards every 5 years.

A web page for the drinking water section of the European Union's Directorate-General for the Environment site provides information about legislation and implementation related to drinking water standards [44]. Links to the websites for the European Union member states' official Drinking Water Directive implementation plans also are available [47].

The European Union's Water Information System for Europe (WISE) is a partnership among "the Group of Four" (Go4): the European Environment Agency, the Directorate-General for the Environment, Eurostat, and the Joint Research Centre. It provides information about, among other things, European Union water policies [48].

## 7.4 *China*

In 2011, 95 % of China's urban population had access to piped water on the premises, with another 3 % depending on another source of improved water and 2 % on unimproved water [17]. In rural areas, 45 % of the population had access to piped water on the premises and 40 % to another source of improved water, with 13 % dependent on an unimproved source and 2 % on untreated surface water. For the entire country, these figures are 70 % with access to piped water on premises, 22 % using another source of improved water, 7 % using an unimproved source, and 1 % depending on surface water. This represents a significant improvement since 1995, with 25 % of China's population having gained access to piped water on the premises between 1995 and 2011.

China's drinking water health standards, issued in 1985 (GB5749-85), were updated in 2006 by a set of mandatory standards (GB5749-2006), which implemented 13 national standards for drinking water testing [49]. The new requirement increased the number of parameters to be measured from 35 to 106, including 6 microbial indicators, 21 inorganic compounds, 20 sensory properties and general physical and chemical indicators, and 53 organic compounds.

The 2006 revision of standards also united rural and urban standards and applied to all types of centralized and distributed drinking water supplies.

According to the Ministry of Water Resources of the People's Republic of China [50], in 2005 about 300 million people in China did not have access to safe drinking water. About 63 million people in China are supplied with drinking water that exceeds their National Health Standards for fluorine. Another 38 million people drink brackish water, and 11 million people are at risk of waterborne diseases because of the quality of their drinking water. In rural populations, about 190 million people use drinking water that contains other harmful substances at levels exceeding health standards. China's National Safe Drinking Water Program for Rural Areas is being implemented through a series of 5-year planning periods, with the most recent (the eleventh 5-year plan) focused on the problems of high fluorine, high arsenic, brackish water, waterborne diseases, other pollution problems, and water shortages. Its goals are to provide access to safe drinking water to another 160 million rural residents during this planning period and to all rural residents by 2015.

## 7.5 *Australia*

The *2011 Australian Drinking Water Guidelines* represents the most recent revision by Australia's National Health and Medical Research Council in collaboration with the Natural Resource Management Ministerial Council. This document, the new edition of which includes new information about pharmaceuticals and endocrine disruptors, pesticides, microorganisms, and monitoring, can be found on the Research Council's website [51].

These guidelines are non-mandatory and are developed by teams of specialists. Regulatory frameworks are developed at the state level. The Victorian government, for example, passed a Safe Drinking Water Act in 2003, the first such legislation in Australia [52], and regulations went into effect in 2005, under the authority of the Essential Services Commission. According to the 2013 WHO-UNICEF report [17], all of Australia's population has access to piped water on the premises.

Quality is key to a sustainable future for Australian water resources, as it is elsewhere in the world [53]. Australia's major water quality problem is nonpoint source pollution; the country's population is primarily coastal, and point sources (industries and wastewater treatment plants) discharge into estuaries and oceans instead of into freshwater sources. Activities contributing to nonpoint source pollution include widespread clearing of native vegetation, irrigation, feedlots, and other agricultural activities.

According to an assessment published as part of Australia's State of the Environment technical papers series, Australian drinking water supplies are not, for the most part, obtained from sources affected by chemical industries [54]; this is very different from drinking water sources in North America, South America, Europe, China, and other regions of the world. The major tap water quality concerns

identified in this report include carcinogenic disinfection by-products; color, taste, and odor; corrosion of pipes and fittings and the leached products of such corrosion; hardness; salinity; toxic algae; toxic inorganic substances; and turbidity. The report authors point out that although many measurable parameters can serve as quality indicators, just a few are usually enough to provide a reliable overview: turbidity, color, total dissolved solids, water hardness, coliform bacteria, and a few chemical variables “have proved to be remarkably robust in their ability to track complex underlying water quality problems” [54].

## 7.6 Kenya

In Kenya, a Water Services Regulatory Board was established in 2003, in response to the Water Act of 2002, to oversee the provision of water and sewer services [55]. The Water Services Regulatory Board sets rules and enforces standards; it issues licenses to Water Service Boards, which contract with Water Service Providers to provide water services in their jurisdictions. The National Environment Management Authority (NEMA) lists 17 parameters and their maximum allowable Guide Values (pH, suspended solids, nitrate, ammonia, nitrite, total dissolved solids, *E. coli*, fluoride, phenols, arsenic, cadmium, lead, selenium, copper, zinc, alkyl benzyl sulfonates, and permanganate) [56]. Some of these standards are above and some below the WHO guidelines.

Like other developing countries, Kenya faces significant challenges with regard to drinking water. Instituting standards and a regulatory framework is a giant step, but often financial resources to implement standards, enforce regulations, and ensure compliance are lacking. A Water Services Regulatory Board performance review [57] shows that between the 2005/2006 reporting period and the 2010/2011 reporting period, the percentage of people living in urban areas who had access to safe drinking water increased from 40 % to 52 %, a significant increase but still far from the Board’s goal of reaching 80 % urban coverage by 2015. Only 7 of the country’s 65 urban Water Service Providers have reached the 80 % coverage benchmark. Growing population pressures in urban centers requires more investment in water services; especially underserved are low-income areas, and the 2012 review recommended extending coverage to these urban neighborhoods through water kiosks and yard taps.

In 2010/2011, 90 % of required tests for residual chlorine were submitted by 65 urban Water Service Providers, up from 84 % the year before. The rate of compliance in test results, however, decreased slightly over the same period. For bacteriological standards, the number of tests increased from 62 % to 76 % between 2009/2010 and 2010/2011, and the rate of compliance in test results dropped from 94 % to 87 %. Only 23 % of the Water Service Providers fell within the acceptable range for this test.

Although safe drinking water is becoming available to more Kenyans, the country, like the rest of the world, is working against increasing degradation of

its water resources. Many sewage treatment plants do not work properly and discharge untreated sewage into surface water; sediments, nutrients, and agrochemicals from farming threaten water quality; uncontrolled industrial discharges contribute to the deterioration of Kenyan waters; and saltwater intrusion caused by overuse of aquifers is contaminating groundwater supplies [58].

## 7.7 India

According to the 2013 WHO-UNICEF report, India has made significant progress over the past decades in providing safe drinking water to its citizens [17]. In 1954, India launched a national water supply program to build village systems. India's Ministry of Health includes the Central Public Health Environmental Engineering Organization, which runs the national drinking water supply program.

India's set of drinking water standards and a document called the *Uniform Drinking Water Quality Monitoring Protocol (2013)* [59, 60] together provide guidance for the provision of safe drinking water. The *Protocol* is a set of guidelines, not a set of regulations; each Indian state has its own rules and requirements. The document provides details about which parameters must be monitored and at which regulatory levels [60]. At the state laboratory level, there are 78 parameters to be monitored, including 6 physical parameters, 36 chemical parameters, 4 microbiological parameters, 18 individual pesticides, and 15 other specific parameters. At the district and subdistrict laboratories, 13 basic water quality parameters must be routinely monitored: total coliforms, thermotolerant coliform or *E. coli*, total alkalinity, total hardness, total dissolved solids, pH, turbidity, chloride, sulfate, iron, arsenic, fluoride, and nitrate. Drinking water standards include requirements for frequency of sampling; in India the timing of sampling and monitoring with respect to the monsoon is important.

India's monsoon climate affects more than just sampling schedules; water has to be stored for use during the dry season, and, as in many countries, water's various uses conflict. For example, despite increasing amounts of money dedicated to village water supplies in India, the increased use of groundwater for irrigation all over the country resulted in new village boreholes and hand pumps that did not always provide water.

Three percent of the government funding for India's National Rural Drinking Water Programme has been allocated for water quality monitoring and surveillance, and the *Uniform Drinking Water Quality Monitoring Protocol* provides information about sampling and testing procedures; equipment, supplies, chemicals, and personnel requirements; building space; and other details related to water testing [61].

The *Protocol* also lists the acceptable limits for 23 important parameters, along with the limit that is permitted in the case of no available alternative source of drinking water. Another useful set of tools is provided in the section on sanitary inspection forms, with specific questions appropriate to piped water, hydrants and

tanker trucks, gravity-fed piped water, boreholes with either mechanized or hand pumps, protected springs, rainwater collection and storage systems, and dug wells.

The government of India has long been committed to providing “safe water and sanitation for all” and took an active role in the United Nations MDG of reducing by half the population without safe water by 2015 [62].

## 7.8 *Israel*

According to the 2013 WHO-UNICEF report [17], all of Israel’s residents have access to piped water on the premises. Israeli drinking water standards are based on the guidelines and standards developed by the WHO, the EPA, and the European Union Environmental Directorate [63]. A guidance document was replaced by the Drinking-Water Quality Regulations issued by the Ministry of Health in 1974. The regulations, updated about every 10 years, include microbial, chemical, physical, and radiological standards along with requirements for monitoring. Israel’s standards are generally consistent with international norms and include both required and recommended levels. Although Israel’s water resources have been undermined by contamination and salinization, the quality of its drinking water has improved with more stringent regulations and effective water management interventions.

Israel’s approach to improving the safety of its drinking water incorporated a gradual adoption of increasingly stringent standards, an approach later followed in Palestine, where water treatment experts envisioned “a steady process of ratcheting down drinking-water contaminant levels” as resources to monitor and treat water and enforce regulations became available. The Palestinian experience can be compared to Israel’s [64]: “Initial Israeli drinking-water standards were low and gradually became more demanding as the country’s economic conditions improved. For instance, Israel understood that a standard of 90 mg/L was desirable for nitrates but couldn’t afford it. Today it can make this commitment.” Israel’s nitrate standard today is 70 mg/L [65], closer to the WHO standard of 50 mg/L [33] than to the standard of 10 mg/L in the United States.

## 8 Emerging Standards and Regulatory Challenges

New contaminants in drinking water—and new threats to human health—will continue to appear as long as humans continue to develop new chemicals for industry and agriculture, mine new areas of the earth, and dispose of pharmaceutical and other wastes in such a way that they can end up in water sources. Contaminants of concern also can take the form of already existing contaminants about which new information becomes available; already existing contaminants detected by new, more sensitive analytical techniques; and already existing contaminants that interact or combine with others in ways that create a threat to human health.

Because of the limitless potential for new contaminants [7], the United States and many other countries have built into their drinking water regulations provisions for the assessment and inclusion of new contaminants [66]. The WHO *Guidelines* are subject to a rolling revision; the European Union Directive requires reviewing standards every 5 years; and the EPA is required to review and revise standards every 6 years and to publish a list of nonregulated contaminants every 5 years [46]. This Contaminant Candidate List (CCL) is generated by evaluating data sources that identify potential microbial and chemical contaminants and serves to identify contaminants of concern for possible regulatory action [67].

The determination of risk for any contaminant requires extrapolating from studies on laboratory animals to humans and from experimental doses to the concentrations found in drinking water supplies [2]. Regulatory challenges include balancing the benefits of the use of various chemicals with the risks posed by their presence in water supplies and balancing the costs of monitoring and removing contaminants with the benefits of their removal.

This section provides information about some categories of emerging contaminants that pose significant regulatory challenges. More information is available in a later chapter of this book.

## ***8.1 Disinfection By-Products***

In the nineteenth century, when chemists were working to analyze water [20], they wondered whether the analyses would change or affect what was in the water being tested. Their concern was well founded. Scientists know now that some of the treatment methods used in contemporary water treatment can create other potentially dangerous contaminants [7].

One example of this is the suite of chemicals generated by disinfection. These disinfection by-products (DBPs) have been associated with bladder cancer, birth defects, and miscarriage [68]. Although several DBPs are regulated in the United States and in other countries, many others are not, and researchers are still finding new DBPs. In a project under way in the European Union, researchers are investigating the health impacts of long-term exposure to DBPs, looking both at the epidemiology of adverse pregnancy outcomes and at chemical and biological analyses of water from different types of water treatment plants from 11 cities in 5 European countries [69]. More than 70 DBPs have been identified as part of this work, including many that are not regulated and others that had not previously been reported, and research continues.

A specific example of a disinfection by-product is *N*-Nitrosodimethylamine (NDMA), one of a group of very potent carcinogens. NDMA is formed during wastewater chlorination and can enter drinking water supplies via municipal wastewater reuse, direct industrial contamination, and chlorination processes [70]. In finalizing its third Contaminant Candidate List in 2009, the EPA added to the CCL draft two disinfection by-products, chlorate and bromochloromethane [67].

## 8.2 *Pharmaceuticals*

Advancements in analytical instrumentation and new methods of analysis have allowed detection of smaller concentrations of contaminants in water [71–75]. One of the groups of contaminants that have received increasing attention in recent decades is pharmaceuticals, which enter drinking water sources through wastewater discharges from sewage treatment plants and from leaking sewer lines, landfills, and animal wastes [71, 72].

About 3,000 different substances are used as pharmaceutical ingredients [73]. One concern about pharmaceuticals is that the release of antibiotics into the environment can generate bacterial resistance, the so-called Super Bugs. Another fear is that some pharmaceutical compounds can disrupt the endocrine systems of both humans and wildlife. Illegal drugs also have been detected in drinking water sources. Methamphetamine and MDMA, or ecstasy, have been found in U.S. water sources, and cocaine was found in a river in Italy in 2005. Other illicit drugs now reported in water sources include morphine and other heroin metabolites, marijuana metabolites, codeine and metabolites, and methadone and its metabolites. Among drinking water contaminants that most people will recognize are caffeine; tobacco by-products; ibuprofen, also known as Advil, Nuprin, and Motrin; and acetaminophen, or paracetamol (APAP, Tylenol) [72, 74].

Chemist Christian Daughton reported in a 2010 review [72] that no toxicological risks have been documented for any of the pharmaceuticals detected in drinking water at the low concentrations detected. But contaminants present in only trace amounts may become a greater concern in the future, as we move toward indirect and direct water reuse, and combinations of various pharmaceuticals may present currently unknown risks. Pharmaceuticals also can form new contaminants in response to disinfection and other treatment processes. Ten pharmaceuticals, the antibiotic erythromycin and nine hormones, were added to the EPA's Contaminant Candidate List as it went from draft to final form in 2009 [67].

## 8.3 *Emerging Pathogens*

Waterborne diseases also present new challenges. The microbes responsible for disease can evolve, new diseases can be discovered, and the importance of previously known diseases can increase [76]. Resistance to antibiotics, also related to contaminants in water [73], can complicate treatment of patients suffering from waterborne diseases. Research shows that some bacteria grow in water distribution systems and home plumbing pipes, creating new threats after water has left the treatment plant [77].

Researchers studying zoonotic pathogens—pathogens carried by animals—have found that although many of these pathogens affect humans, there are five that frequently cause illness worldwide: *E. coli* 0157, *Giardia*, *Campylobacter*,

*Salmonella*, and *Cryptosporidium* [18]. Emergent or as-yet-unrecognized zoonotic pathogens are unlikely to be problematic contaminants in water supplies in which these five pathogens are successfully controlled. Controlling for zoonotic pathogens continues to be critical, however, as 85 % of the world's fecal waste is produced by domestic animals—sheep, pigs, cattle, poultry—and that waste, carrying pathogens, often makes its way to water sources. The increased use of wastewater for agricultural applications also increases the danger of outbreaks of waterborne disease [3].

The extreme weather events associated with global climate change will pose challenges. A review of waterborne disease outbreaks following such weather events found that heavy rainfall and flooding were implicated in more than half the outbreaks and that *Vibrio* and *Leptospira* were the most common pathogens involved [8]. Twelve microbial contaminants are listed on the EPA's Contaminant Candidate List [67]. They include adenovirus, caliciviruses, enterovirus, and the Hepatitis A virus, along with *Campylobacter jejuni*, *E. coli* 0157, *Helicobacter pylori*, *Legionella pneumophila*, *Mycobacterium avium*, *Naegleria fowleri*, *Salmonella enterica*, and *Shigella sonnei* [67]. *Legionella* and *Mycobacterium* are among the microbial contaminants known to multiply in plumbing systems [77].

## 9 Global Drinking Water Quality Goals

A global water policy framework can be traced back to 1972 and the Stockholm Declaration, and the first international forum on water was in 1977. At this international forum in 1977, the United Nations recognized the right to water as a human right [25]. Between 1990 and 2010, according to the United Nations, the MDG drinking water target was met, halving the proportion of the world's population that had no access to safe drinking water. More than two billion people gained access to improved drinking water sources over those decades [26], although definitions of “improved” and methods of measuring access make it possible that the number of people using safe water worldwide has been overestimated [27].

WHO and UNICEF have facilitated the formulation of drinking water goals for the future [17]. The Joint Monitoring Programme for Water Supply and Sanitation, known as the JMP and run by WHO and UNICEF together, plans to collect baseline data by 2015; this data set will be used to evaluate progress toward the goals. More information about the conferences that generated these targets, the working groups involved, and the proposal document itself can be found online [78]. The goals include:

- Target 1: By 2025, open defecation will be a practice of the past.
- Target 2: By 2030, everyone will have access to a basic drinking water supply and hand washing facilities at home, at school, and at health centers. A *basic drinking water supply* is defined as access to an improved drinking water source for which water collection takes 30 min or less, round trip. *Improved* is defined



as adequately protected by its construction from outside contamination, especially fecal matter.

- Target 3: By 2040, everyone will have adequate sanitation at home, the proportion of those without an intermediate drinking water supply at home will have been reduced by half, and the human waste from at least half of homes, schools, and health centers with adequate sanitation will be safely managed. An *intermediate drinking water supply* is defined as access to an improved drinking water source on the premises that meets basic microbiological standards (less than 10 colony-forming units of *E. coli* per 100 mL) and was available in acceptable quantities for at least 12 of the past 14 days.
- Target 4: The delivery of all drinking water supply, sanitation, and hygiene services will become more affordable, environmentally and economically sustainable, and accountable.

Each of the targets includes the progressive reduction of current inequalities in access to services and will be accompanied by a set of unambiguous indicators. The 2013 report listing the targets explains them this way: “Based on the simple inspirational vision of the universal access to safe water, sanitation and hygiene, they focus on the poor, disadvantaged and those excluded at the individual and household level, as well as in schools and health centres. Pursuing the elimination of inequities and inequalities, the targets seek to both increase the number of people using water, sanitation and hygiene as well as progressively improve levels of service.”

## 10 Conclusions

As the demand for water increases all over the world, we will increasingly use water sources that we have avoided in the past—sources that are more likely to be contaminated either naturally or by human and industrial wastes and overuse. Population increase, increased need for food production, the movement of the world’s population to cities, increasing uncertainties about precipitation, extreme weather events that result in water supply contamination, and continuing degradation of water quality all increase water stress, and half of the world’s population will be living in areas of water stress by 2025 [5]. Urban/rural disparities and inequities associated with poverty continue to affect access to safe drinking water, and work is needed especially in sub-Saharan Africa and the Pacific, where many people do not have safe sources of drinking water [79].

Unfortunately, we still live in a world where many people drink water that does not meet established drinking water standards. This is particularly true in countries that have not yet developed standards or that lack the regulatory framework and resources to treat and monitor water quality and enforce regulations. However, this is also sometimes true in developed countries. In the United States, for example, most community water supply systems are 50–100 years old, and most of their

annual budgets are used for repairs [7]. Many systems cannot afford to implement advanced treatment technology. When a regulated pollutant is found above the standard, the public is warned, allowing consumers to purchase bottled water or use home filtration or treatment systems but not necessarily providing safe water from the public water supply [7]. As occurs elsewhere in the world, financial and political problems can prevent the provision of safe drinking water.

Many people in developed countries use water that is not required to meet standards; the SDWA, for example, does not affect private wells or water systems that provide drinking water to fewer than 25 people [80]. Among the 30 Organization for Economic Co-operation and Development (OECD) countries, the percent of the population that is connected to a public water supply, and thus probably protected by a set of drinking water standards, ranges from 74 (Turkey) to 85 (Poland, Slovak Republic, and the United States) to 90 (Finland, Mexico, and Ireland) to 100 (Italy, Luxembourg, and the Netherlands) [81]. As in the United States, the OECD countries have increasing problems of aging treatment systems, communities with systems not conforming to new and more stringent regulation, and lapses in service quality [81].

The regulation of drinking water in developing countries is hampered by the same problems that faced nineteenth-century England. How to set, implement, and enforce regulations and how to get customers to pay for an uncertain and possibly unclean supply of water are issues that are still being worked out in many countries. For example, the Chief Executive Officer of Kenya's Water Services Regulatory Board, Robert Gakubia, includes the following problems in his list of the "huge challenges" that face Kenya with regard to water services [57]: low efficiency and effectiveness of investments, slow progress in coverage, financing gaps, resistance to compliance, and high levels of Non-Revenue Water, the water that is lost from the system through theft, metering inaccuracies, leaks, and other routes that bring the provider no money.

The existence of sets of standards and examples of regulatory frameworks in place in a variety of countries, along with the guidance of WHO and UNICEF, should ease the path toward the adoption of drinking water standards worldwide. Although the WHO/UNICEF goals for drinking water do not at this point specify standards beyond a basic microbial limit, they allow us to envision a future in which drinking water standards and regulations are relevant and protective of human health all over the world.

## References

1. Fishman C (2011) *The big thirst: the secret life and turbulent future of water*. Free Press, New York, NY
2. Salzman J (2012) *Drinking water: a history*. Overlook Duckworth, New York, NY
3. [http://www.who.int/water\\_sanitation\\_health/facts\\_figures/en/index.html](http://www.who.int/water_sanitation_health/facts_figures/en/index.html). Last accessed 5 Dec 2013

4. Khush R, Lantagne D, Montgomery M (2012) A toolkit for monitoring and evaluating household water treatment and safe storage programmes. World Health Organization, Geneva
5. World Health Organization (2013) Water quality and health strategy 2013–2020. World Health Organization, Geneva. [http://www.who.int/water\\_sanitation\\_health/publications/2013/water\\_quality\\_strategy/en/index.html](http://www.who.int/water_sanitation_health/publications/2013/water_quality_strategy/en/index.html). Last accessed 5 Dec 2013
6. World Health Organization (2012) Arsenic. Fact sheet no. 372. <http://www.who.int/mediacentre/factsheets/fs372/en/>. Last accessed 5 Dec 2013
7. Sullivan PJ, Argady FJ, Clark JJJ (2005) The environmental science of drinking water. Elsevier, Amsterdam
8. Cann K, Thomas D, Salmon R et al (2013) Extreme water-related weather events and waterborne disease. *Epidemiol Infect* 141:671–686. doi:10.1017/S0950268812001653
9. Texier P-J, Porraz G, Parkington J et al (2010) A Howiesons Poort tradition of engraving ostrich eggshell containers dated to 60,000 years ago at Diepkloof Rock Shelter, South Africa. *Proc Natl Acad Sci* 107(14):6180–6185. doi:10.1073/pnas.0913047107
10. Juuti PS, Nygård H, Katko TS (2010) Water and sanitation services in history: motivations, expectations and experiences. In: Tvedt T, Oesti T (eds) Ideas of water from ancient societies to the modern world, Volume 1, vol 1, A history of water. Series II. I. B. Tauris, London
11. Crouch DP (1993) Water management in ancient Greek cities. Oxford University Press, New York, NY
12. Baker MN (1948) The quest for pure water: the history of water purification from the earliest records to the twentieth century. The American Water Works Association, Inc., New York, NY
13. De Klein G (2001) The water supply of ancient Rome: city area, water, and population. J. C. Gieben, Amsterdam
14. Pliny the Elder. Book XXXI, Remedies derived from the aquatic production. The natural history. <http://www.perseus.tufts.edu/hopper/text?doc=Perseus%3Atext%3A1999.02.0137%3Abook%3D31%3Achapter%3D23>. Last accessed 5 Dec 2013
15. Scarborough VL (2003) The flow of power: ancient water systems and landscapes. SAR Press, Santa Fe
16. Bagla P, Stone R (2013) A role for science in poverty alleviation? *Science* 340:1034–1035
17. World Health Organization and UNICEF (2013) Progress on sanitation and drinking-water 2013 update. World Health Organization, Geneva. [http://www.wssinfo.org/fileadmin/user\\_upload/resources/JMPreport2013.pdf](http://www.wssinfo.org/fileadmin/user_upload/resources/JMPreport2013.pdf). Last accessed 5 Dec 2013
18. Dufour A, Bartram J, Bos R, Gannon V (2012) Animal waste, water quality and human health: WHO emerging issues in water and infectious disease. IWA Publishing, London
19. Roberts G (2006) Chelsea to Cairo: Taylor-made water through eleven reigns and in six continents. Thomas Telford, London
20. Hamlin C (1990) A science of impurity: water analysis in 19th century Britain. University of California Press, Berkeley, CA
21. Baker J (1992) Fighting for life. In: Ker Conway J (ed) Written by herself, autobiographies of American women: an anthology. Vintage Books, New York, NY, pp 145–146
22. U.S. Environmental Protection Agency (1999) 25 years of the Safe Drinking Water Act: History and trends. EPA Number 816R99007. <http://yosemite.epa.gov/water/owrcatalog.nsf/0/b126b7616c71450285256d83004fda48?OpenDocument>. Last accessed 5 Dec 2013
23. Chapelle FH (2005) Wellsprings: a natural history of bottled spring waters. Rutgers University Press, New Brunswick, NJ
24. Bridgewater L (ed) (2012) Standard methods for the examination of water and wastewater. American Public Health Association, Washington, DC
25. AAAS Special Committee (1889) A method, in part, for the sanitary examination of water, and for the statement of results, offered for general adoption. *J Anal Chem* 3:398 cited in Bridgewater L (ed) (2012) Standard methods for the examination of water and wastewater. American Public Health Association, Washington, DC

26. United Nations Environment Programme (2012) UN Millennium Development Goal drinking water target is met, 6 March 2012. <http://www.unep.org/Documents.Multilingual/Default.asp?DocumentID=2676&ArticleID=9068&l=en>. Last accessed 5 Dec 2013
27. Clasen T (2012) Millennium Development Goals water target claim exaggerates achievement. *Trop Med Int Health* 17(10):1178–1180. doi:10.1111/j.1365-3156.2012.03052.x
28. Solsona F (2002) Guidelines for drinking water quality standards in developing countries. OPS/CEPIS/PUB/02.77 Pan American Center for Sanitary Engineering and Environmental Sciences, Lima
29. AAAS Special Committee (1889) A method, in part, for the sanitary examination of water, and for the statement of results, offered for general adoption. *J Anal Chem* 3:398 *cited in* Franson MAH (2012) Standard methods for the examination of water and wastewater. American Public Health Association, Washington, DC
30. <http://water.epa.gov/lawsregs/rulesregs/sdwa/index.cfm>. Last accessed 5 Dec 2013
31. <http://water.epa.gov/drink/standards/hascience.cfm>. Last accessed 5 Dec 2013
32. World Health Organization (2011) Guidelines for drinking-water quality, 4th edn. World Health Organization, Geneva. [http://www.who.int/water\\_sanitation\\_health/publications/2011/dwq\\_guidelines/en/index.html](http://www.who.int/water_sanitation_health/publications/2011/dwq_guidelines/en/index.html). Last accessed 5 Dec 2013
33. World Health Organization (2012) GLAAS 2012 report: UN-Water global analysis and assessment of sanitation and drinking-water: the challenge of extending and sustaining services. [http://www.un.org/waterforlifedecade/pdf/glaas\\_report\\_2012\\_eng.pdf](http://www.un.org/waterforlifedecade/pdf/glaas_report_2012_eng.pdf). Last accessed 5 Dec 2013
34. [http://www.who.int/water\\_sanitation\\_health/dwq/WSP/en/](http://www.who.int/water_sanitation_health/dwq/WSP/en/). Last accessed 5 Dec 2013
35. [http://apps.who.int/iris/bitstream/10665/76568/1/9789241504621\\_eng.pdf](http://apps.who.int/iris/bitstream/10665/76568/1/9789241504621_eng.pdf). Last accessed 5 Dec 2013
36. <http://water.epa.gov/drink/contaminants/secondarystandards.cfm>. Last accessed 5 Dec 2013
37. <http://www.epa.gov/ogwdw/consumer/pdf/mcl.pdf>. Last accessed 5 Dec 2013
38. <http://water.epa.gov/drink/contaminants/index.cfm#List>. Last accessed 5 Dec 2013
39. <http://water.epa.gov/scitech/datait/databases/drink/ncod/databases-index.cfm>. Last accessed 5 Dec 2013
40. U.S. Environmental Protection Agency (2010) Fact sheet: announcement of completion of EPA's second review of existing drinking water standards. 2010. 815-F-09-002 March 2010 <http://www.epa.gov/safewater>. Last accessed 5 Dec 2013
41. <http://water.epa.gov/lawsregs/rulesregs/sdwa/currentregulations.cfm#one>. Last accessed 5 Dec 2013
42. [http://water.epa.gov/lawsregs/rulesregs/regulatingcontaminants/sixyearreview/second\\_review/upload/Six-Year-Review-2-Health-Effects-Assessment-Summary-Report.pdf](http://water.epa.gov/lawsregs/rulesregs/regulatingcontaminants/sixyearreview/second_review/upload/Six-Year-Review-2-Health-Effects-Assessment-Summary-Report.pdf). Last accessed 5 Dec 2013
43. [http://water.epa.gov/lawsregs/rulesregs/regulatingcontaminants/sixyearreview/second\\_review/index.cfm](http://water.epa.gov/lawsregs/rulesregs/regulatingcontaminants/sixyearreview/second_review/index.cfm). Last accessed 5 Dec 2013
44. [http://ec.europa.eu/environment/water/water-drink/index\\_en.html](http://ec.europa.eu/environment/water/water-drink/index_en.html). Last accessed 5 Dec 2013
45. [http://ec.europa.eu/environment/water/water-drink/legislation\\_en.html](http://ec.europa.eu/environment/water/water-drink/legislation_en.html). Last accessed 5 Dec 2013
46. Twort AC, Ratnayaka DD, Brandt MJ (2000) Water supply. Arnold and IWA Publishing, London
47. [http://ec.europa.eu/environment/water/water-drink/national\\_info\\_en.html](http://ec.europa.eu/environment/water/water-drink/national_info_en.html). Last accessed 5 Dec 2013
48. <http://water.europa.eu/>. Last accessed 5 Dec 2013
49. Ministry of Water Resources, People's Republic of China, and Standardization Administration of the People's Republic of China (2006) Standards for drinking water quality. Standards Press of China, Beijing
50. <http://www.mwr.gov.cn/english/sdw.html>. Last accessed 5 Dec 2013
51. <http://www.nhmrc.gov.au/guidelines/publications/eh52>. Last accessed 5 Dec 2013
52. <http://www.health.vic.gov.au/water/drinkingwater/legislation.htm>. Last accessed 5 Dec 2013

53. Smith DI (1998) *Water in Australia: resources and management*. Oxford University Press, Melbourne
54. Maher W, Lawrence I, Wade A (1997) *Drinking water quality. Australia: state of the environment technical paper series (inland waters)*, Department of the Environment, Sport and Territories, Canberra.
55. Water Services Regulatory Board (2013) *For performance and growth. Annual report 2011/12*. <http://www.wasreb.go.ke/images/WASREB%20AR%202011-2012.pdf>. Last accessed 5 Dec 2013
56. National Environment Management Authority (2006) *Kenya water quality regulations*. [http://www.nema.go.ke/~nemago/images/documents/water\\_quality\\_regulations.pdf](http://www.nema.go.ke/~nemago/images/documents/water_quality_regulations.pdf). Last accessed 5 Dec 2013
57. Water Services Regulatory Board (2012) *Impact: a performance review of Kenya's water services sector – 2010/2011. Issue 5*. Water Services Regulatory Board, Nairobi, Kenya. <http://www.wasreb.go.ke>. Last accessed 5 Dec 2013
58. Mogaka H, Gidere S, Davis R, Hirji R (2006) *Climate variability and water resources degradation in Kenya*. World Bank Working Paper No. 69. The World Bank, Washington, DC
59. <http://hppcb.gov.in/eiasorang/spec.pdf>. Last accessed 5 Dec 2013
60. *Uniform Drinking Water Quality Monitoring Protocol (2013)* [http://www.mdws.gov.in/hindi/sites/upload\\_files/ddwshindi/files/pdf/UniformDrinkingWaterQualityMonitoringProtocol.pdf](http://www.mdws.gov.in/hindi/sites/upload_files/ddwshindi/files/pdf/UniformDrinkingWaterQualityMonitoringProtocol.pdf). Last accessed 5 Dec 2013
61. Bhaskar T (2013) *Message and acknowledgments*. In: *Uniform drinking water quality monitoring protocol*. [http://www.mdws.gov.in/hindi/sites/upload\\_files/ddwshindi/files/pdf/UniformDrinkingWaterQualityMonitoringProtocol.pdf](http://www.mdws.gov.in/hindi/sites/upload_files/ddwshindi/files/pdf/UniformDrinkingWaterQualityMonitoringProtocol.pdf). Last accessed 5 Dec 2013
62. Black M, Talbot R (2005) *Water: a matter of life and health: water supply and sanitation in village India*. Oxford University Press, New Delhi
63. Halperin R (2010) *Israeli drinking-water resources and supply*. In: Tal A, Rabbo A (eds) *Water wisdom: preparing the groundwork for cooperative and sustainable water management in the Middle East*. Rutgers University Press, New Brunswick, NJ
64. Rabbo A (2010) *Drinking-water quality and standards: the Palestinian perspective*. In: Tal A, Rabbo A (eds) *Water wisdom: preparing the groundwork for cooperative and sustainable water management in the Middle East*. Rutgers University Press, New Brunswick, NJ
65. Kurtzman D, Shapira R, Bar-Tal A et al (2013) *Obtaining agro-hydrological sustainable nitrogen application rates via deep vadose zone observation, model-calibration, and simulation*. *Geophys Res Abstracts* 15 (EGU2013-2066)
66. <http://www.epa.gov/safewater/ccl/index.html>. Last accessed 5 Dec 2013
67. U.S. Environmental Protection Agency (2009) *Fact sheet: final third drinking water contaminant candidate list (CCL3)*. 2009. 815-F-09-001 September 2009 <http://www.epa.gov/safewater>. Last accessed 5 Dec 2013
68. Richardson S, Postigo C (2012) *Drinking water disinfection by-products*. In: Barceló D (ed) *The handbook of environmental chemistry: emerging organic contaminants and human health*, vol 20, Springer, New York, NY, pp 93–137
69. Richardson S, Anduri S, Bloodgood M et al (2012) *Combining mass spectrometry and toxicology for a multi-country European Epidemiologic study on drinking water disinfection by-products*. Presented at ASMS Conference, Vancouver, BC, Canada, 20–24 May 2012. [http://cfpub.epa.gov/si/si\\_public\\_record\\_report.cfm?dirEntryId=246558&fed\\_org\\_id=770&SIType=PR&TIMSType=&showCriteria=0&address=nerl/pubs.html&view=citation&personID=1155&role=Author&sortBy=pubDateYear&count=100&dateBeginPublishedPresented=](http://cfpub.epa.gov/si/si_public_record_report.cfm?dirEntryId=246558&fed_org_id=770&SIType=PR&TIMSType=&showCriteria=0&address=nerl/pubs.html&view=citation&personID=1155&role=Author&sortBy=pubDateYear&count=100&dateBeginPublishedPresented=). Last accessed 5 Dec 2013
70. Mitch WA, Sharp JO, Trussell RR et al (2003) *N-Nitrodimethylamine (NDMA) as a drinking water contaminant: a review*. *Environ Eng Sci* 20:389–404
71. Jelić A, Mira Petrović M, Barceló D (2012) *Pharmaceuticals in drinking water*. In: Barceló D (ed) *The handbook of environmental chemistry: emerging organic contaminants and human health*, vol 20, Springer, New York, NY, pp 47–70

72. Daughton C (2010) Pharmaceutical ingredients in drinking water: overview of occurrence and significance of human exposure. In: Halden R (ed) *Contaminants of emerging concern in the environment: ecological and human health considerations*. American Chemical Society, Washington, DC
73. Richardson S (2009) Pharmaceuticals, hormones, and endocrine disrupting compounds. *Anal Chem* 81:4655
74. Snyder S (2010) Occurrence of pharmaceuticals in U.S. drinking water. In: Halden R (ed) *Contaminants of emerging concern in the environment: ecological and human health considerations*. American Chemical Society, Washington, DC
75. Castiglioni S, Zuccato E (2010) Illicit drugs as emerging contaminants. In: Halden R (ed) *Contaminants of emerging concern in the environment: ecological and human health considerations*. American Chemical Society, Washington, DC
76. [http://www.who.int/water\\_sanitation\\_health/emerging/en/](http://www.who.int/water_sanitation_health/emerging/en/). Last accessed 5 Dec 2013
77. Younos T, Harwood VJ, Falkinham JO III, Shen H (2007) Pathogens in natural and engineered water systems: emerging issues. *Water Resour Impact* 9(3):11–14
78. <http://www.wssinfo.org/post-2015-monitoring/>. Last accessed 5 Dec 2013
79. Ramirez-Djumena N (2012) Water for people. *Fin Dev* 49(2):32–33
80. Prud'homme A (2011) *The ripple effect*. Scribner, New York, NY
81. Organisation for economic co-operation and development (2009) *Managing water for all: an OECD perspective on pricing and financing*. OECD, Paris

# Global Potable Water: Current Status, Critical Problems, and Future Perspectives

Caitlin A. Grady, Shih-Chi Weng, and Ernest R. Blatchley III

**Abstract** Providing access to potable water and sanitation has become a human right through various designations in international treaties and declarations. Many countries and international organizations have established water quality guidelines for potable water supplies, thereby defining standards for treatment processes to meet. Unfortunately, potable water for all is a goal that has not yet been fully realized. Water-related diseases remain the number one cause of death for children under five worldwide; these problems are particularly evident in rural areas of developing countries. In addition, emerging contaminants and disinfection by-products have been linked to chronic health problems for people in the developed and developing world. This chapter provides an overview of critical problems relating to the provisioning of global potable water. First, current health impacts of water-related illnesses as well as natural and human influences that will alter our current water supply in the coming decades are reviewed. The technical limitations to water treatment in both developed and emerging economies are then discussed. Additionally, a brief look at the social and political factors influencing potable water access such as government capacity, competing interests, and the influence of food choices on water availability will be discussed. Finally, some current innovative approaches and suggested strategies for water management in the future are presented.

**Keywords** Potable water access • Anthropogenic impacts • Water and health • Technical limitations • Societal challenges • Emerging issues

---

C.A. Grady (✉)

Ecological Sciences and Engineering Program, Purdue University, West Lafayette, IN, USA  
e-mail: [grady3@purdue.edu](mailto:grady3@purdue.edu)

S.-C. Weng • E.R. Blatchley III

School of Civil Engineering, Purdue University, West Lafayette, IN, USA

## 1 Introduction

Access to drinking water is a critical global issue. What constitutes water access? The currently accepted definition comes from the United Nations as outlined in 2000 [1]. This UN definition focuses on three distinct measurable characteristics of drinking water sources: (1) the quantity of water, (2) the safeness or quality of water, and (3) the distance for collecting water. The recommended quantity of safe water is 20 L per person, per day [1].

The second and third components of the UN definition of water access are progressively harder to measure. The UN definition articulates that safe water “does not contain biological or chemical agents directly detrimental to human health” [1]. In practice, this definition applies to treated surface water and untreated water from improved water sources such as protected springs, bore-holes, and sanitary wells. Water is often referred to as the “universal solvent” because of the wide range of constituents that can be dissolved or suspended in it. This allows for a broad spectrum of contaminants, both biological and chemical, to be present in water supplies. The UN definition of “improved sources,” which targets surface contamination, leaves much to be desired because water quality can be impacted by natural contaminants such as fluoride and arsenic [2].

The third and final pillar of the access to water is distance. As defined by the United Nations, a convenient distance for an urban population is less than 200 m from a place of residence. In rural areas, the third component is defined by a distance that allows people to not spend a disproportionate amount of time each day collecting water [1]. This too can be a difficult measure since a short distance may still constitute a large portion of time if many people are sharing the same water source [2].

Although the definition of water access may not encompass everything necessary to provide water to all people, it is a good starting point to define and measure water access. An aim of this chapter is to give the reader an overview of different limitations and setbacks with providing water access to people worldwide. After reading this chapter, the reader should have an understanding of the critical challenges facing water provisioning for citizens in both developed and emerging countries.

## 2 Anthropogenic Impacts on Drinking Water Sources

Agricultural production, industrial activities, and urbanization influence the status of water access. Climate change is an emerging factor which relates to multiple access issues. A contaminant’s origin, its properties, and how it may affect human health provide a clear understanding of the limitations for provisioning safe water. From health perspective, acute and chronic diseases caused by contaminated water influence the approaches needed to meet global potable water demand.



Natural water sources are commonly used to transport and “dispose” of wastes from domestic and industrial activities. Many of these waste products include components that are known to cause disease in human [3]. Domestic sewage has been a source of water pollution since the advent of communal settlements. Since the industrial revolution, additional pollutant burdens have also been introduced from agricultural runoff, industrial and mining operations, and urbanization [3]. All pollution sources present both technical and social limitations to access safe water worldwide.

## ***2.1 Agricultural Impacts***

Plant macronutrients (especially nitrogen and phosphorus) that are applied to agricultural lands through the application of synthetic and natural fertilizers have influenced the widespread occurrences of nutrient-enriched waters. Nutrient abundance in natural waters has become one of the most critical global water quality problems, particularly since the agricultural revolution of the 1960s and 1970s [3–5]. Excessive nutrient input to surface waters contributes to eutrophication, hypoxia, and ultimately marine organism deaths [6, 7]. Nitrate, which originates largely from agricultural production systems, is the most abundant chemical contaminant found in groundwater worldwide [3, 8]. Moreover, agricultural uses of pesticides, herbicides, and pharmaceuticals (e.g., antibiotics) have resulted in this global distribution of these compounds in drinking water sources and watershed soil [9, 10]. More details will be discussed in Chap. 7.

In addition to nutrient influxes caused by fertilizer application to agricultural land, modern agricultural practices can also alter the salinity of groundwater and mobilization of salts [11]. Overpumping groundwater in coastal areas has been linked to seawater intrusion, which results in increased groundwater salinity that tends to be difficult to remediate [12, 13]. Salinization is often an outcome of long-term changes in natural water flows caused by irrigated agriculture [14]. Salinization presents another difficult problem, a negative feedback loop that reduces agricultural production due to increased soil salinity [15]. Agricultural practices can also promote soil erosion, thereby leading to increases in sediment concentration in receiving waters. In addition to increases in turbidity that are caused by the introduction of colloidal particles, sediment inputs can function as carriers of many of the pollutants described above, thereby further contributing to degradation of surface water quality [16].

## ***2.2 Industrial and Mining Impacts***

Industrial processes such as pharmaceutical production, petroleum refining, paper manufacturing, textiles fabrication, and various mining operations can negatively

affect water quality. Wastewater generated from industrial operations often contains nutrients, sediments, heavy metals, a variety of other toxic chemicals, and microbial contaminants. There are many examples of correlations between industrial processes and degrading water quality. For example, in Malawi, water downstream of industrial practices was shown to be potentially harmful for human consumption [17]. Moreover, industrial water usage could foreclose public usage because of limited access to freshwater, as well deterioration of water quality. In China, the water-intensive industrial sectors cause abundant water withdrawals and generate large amounts of wastewater at the same time, which potentially contaminate drinking water sources. This issue exacerbates both ecological sustainability and economic growth [18]. Additionally, there are new and emerging questions about the impact of energy production on water quality worldwide. Traditional power plant processes such as coal-fired power plants increase surface water temperatures, which can affect ecosystem health [19]. New concerns about wastewater used in hydraulic fracturing and high intensity oil extractions such as tar sand extraction include various types of contaminants such as methane, ammonia, sulfate, chloride, and other pollutants [20, 21].

Mining activities also can introduce water quality problems. Mining can contribute heavy metals, salts, mercury, and many other contaminants to groundwater and surface water [3, 22]. Contaminants are transferred to water through mining operations, disposal of tailings, and runoff in and out of mine sites [22].

### ***2.3 Urbanization Impacts***

People have been migrating from the rural, agriculture-based areas to urban, industry-based cities for decades. Between 1990 and 2010 urban areas grew from 2.3 billion people to 3.5 billion people [23]. Urbanization has also been associated with increases in impervious surfaces, which in turn results in increased runoff and associated pollutants introduction to receiving waters [24, 25]. For example, in Shanghai, a 50-year case study demonstrated an extensive relationship between water quality and urbanization, particularly in and around industrial complexes in urban areas [26]. Increased impervious surfaces can cause increased transport of stormwater runoff-associated contaminants into surface waters. These contaminants include heavy metals, oils, and rubber residues, among others. In addition, improperly treated human wastes from urban and suburban areas cause significant water quality problems [3]. Increased migration of rural residents to urban areas in recent decades, largely attributable to the pursuit of employment, has caused significant sanitation and water quality problems. Population growth will only continue to exacerbate the issues of water quality management in urban areas.

### 3 Water and Health

Worldwide, millions of people, especially children, die from acute water-related diseases each year. In addition to short-term diseases, drinking contaminated water can also cause a variety of chronic diseases such as cancer. Acute and chronic diseases caused by unsafe water influence the access to potable water worldwide and new approaches are needed to meet global potable water demand.

#### 3.1 *Acute Diseases*

In developing countries, acute water-related diseases remain the number one cause of mortality. For children between the ages of 1 and 5, diarrhea and malaria, which are both related to water, account for approximately 1.3 million deaths annually [27]. While tremendous gains have been made in providing access to safe water throughout developing countries, there are still roughly 800 million people who do not have access to improved water and 2.5 billion people are without access to proper sanitation [23].

Acute water-related diseases can take many forms and transmit illnesses to people through several mechanisms. The classification system of water-related diseases, shown in Table 1, includes diseases that are directly transmitted through drinking contaminated water (waterborne), through lack of water for proper hygiene (water washed), through dermal uptake of contaminated water (water based), and through insects that consume water in one or more stages of their life cycle (insect vector).

Pathogens that lead to diarrheal diseases and malaria remain the largest threats to human health worldwide [27, 28]. Within the broad category of waterborne diseases, the most common pathogens include viruses, bacteria, and protozoa. It is estimated that diarrheal diseases kill between 2 and 5 million people annually [29]. Even if the United Nations Millennium Development Goals are achieved across the globe, water-related deaths have been estimated to total somewhere between 34 and 76 million deaths between the years 2000 and 2020 [30]. In addition to mortality, water-related diseases increase financial and social burdens on families, who are affected since illnesses increase the cost of health care, reduce ability to earn income, and cause children to miss critical periods of schooling, among other things [30–33]. While important strides have been made in providing access to improved water in an attempt to mitigate the impacts of water-related diseases, there are still many limitations to access safe water throughout the world. Limitations to access include both technical limitations and social and political factors which will be discussed throughout this chapter.

**Table 1** Common classification of acute water-related diseases [28]

Classification	Examples	Causes
Waterborne	Cholera Hepatitis Typhoid	Drinking contaminated water
Water washed	Scabies Trachoma	Lack of water for proper hygiene
Water based	Schistosomiasis Guinea worm Threadworm	Swimming or walking in contaminated water (through skin)
Water-related insect vector	Malaria Dengue fever Yellow fever	Bite by infected insects that breed near water

### 3.2 Chronic Diseases

While acute water-related diseases pose immediate health threat, some contaminants in drinking water have been linked to chronic diseases. Many of these contaminants occur naturally in rock formations and soils, are soluble in water, and are detected in both surface and groundwater sources. Table 2 provides a summary of some of the most common contaminants that are linked to chronic diseases in humans.

It is difficult to estimate the number of people affected by chronic water-related diseases across the globe. Most of these diseases can also be caused by other types of exposure and can also be underreported, especially in developing countries. Correlation between water contamination and chronic diseases can be deduced from health studies of exposed populations (Table 2); however global averages are not available. Many of contaminants that may be present in water are tasteless, odorless, and cannot be detected without performing field sampling and precise laboratory analysis. Additionally, as discussed in the preceding chapter, many chronic disease contaminants are unregulated. For example, Arsenic is a contaminant that has an enforceable compliance standard in the United States, while nitrate has a suggested health goal that is not enforceable [52, 53].

## 4 Technical Limitations

Limitations to water access can be grouped according to technical, social, and political factors. There are technical limitations in both developing and developed countries. Limitation characteristics are somehow different in emerging and developed countries. In emerging countries the technical limitations are observed in various design phases of water or wastewater infrastructure intervention strategies.

**Table 2** Contaminants in drinking water linked to chronic diseases in humans

Contaminant	Natural occurrence	Human-induced occurrence	Chronic diseases	Water and health studies
Arsenic	Rocks and soils	Animal production, legacy farm fields	Cancer (including bladder, kidney, skin, and lung), peripheral vascular disease	[34–37]
Heavy metals	Rocks and soils	Household plumbing, mining, construction, industrial wastes	Various cancers, brain damage, nervous system damage	[38, 39]
Fluoride	Rocks and soils	Drinking water treatment	Dental fluorosis, skeletal fluorosis	[40–42]
Radionuclides	Radioactive elements (e.g., uranium and radium), rock	Mining, nuclear plant failure	Cancer (including stomach and bone)	[43–45]
Nitrate and nitrite	Nitrogen compounds in soil	Animal waste, fertilizers, landfills	Methemoglobinemia, cancer (including bladder and ovarian), thyroid disruptions	[46, 47]
Pesticides, herbicides, and chemical pollutants	–	Industrial wastes, leaking tanks, household wastes, agricultural activities	Parkinson’s disease, various cancers	[40, 48, 49]
Disinfection by-products	–	Water disinfection processes	Cancer (including bladder, liver, kidney); skin rashes	[40, 50]
Pharmaceuticals	–	Agriculture activities, industrial processes, household wastes	Various cancers,	[49, 51]

In developed countries critical technical issues are often related to aging infrastructure and water availability.

#### 4.1 *Emerging Countries*

Constraints to water access include barriers to the design phase, implementation issues, monitoring and evaluation, as well as operation and maintenance. Technical constraints can include limitations that directly relate to the engineering aspects, the technical capacity of people implementing and running these water services, and costs associated with water provisioning.

**Table 3** Technical constraints to effective water provisioning in developing countries

Design process phase	Constraint examples
Design	Difficult sites and terrain Complicated site layout Conventional system overreliance
Implementation	Investment capital Institutional capacity Community participation
Monitoring and evaluation	Regulations, guidelines, standards Technical capacity Decentralization
Operation and maintenance	Finance, ability to pay Post-construction support Community participation

Table 3 shows a variety of constraints to water access in emerging countries. This list is by no means comprehensive; however it provides an overview of common technical problems.

#### 4.1.1 Design Phase Limitations

Design phase limitations include limitations that impact the planning stage of water and sanitation intervention strategies. These problems include having to design water and wastewater interventions on rough terrain and complicated site layouts. In addition, engineers and urban planners often design on traditional centralized systems even if those designs are not well suited for the situation.

Both urban and rural human populations living in poverty tend to live on undesirable pieces of land. Many of the poorest countries in the world are chronically dry, and the poorest people are often restricted to marginal lands [54]. This continues the cycle of poor people being trapped in a feedback loop between poverty and environmental degradation. In urban environments, the more undesirable the land, the less expensive it is. Slums, shantytowns, and favelas are often found on difficult terrain such as steep country sides and floodplains [55]. Although land values in these areas tend to be low, the cost of bringing services to them, such as water and sanitation, is generally higher than in other areas [56]. Additionally, even if water access can be established to these marginal lands, these areas are often most susceptible to landslides and floods, thereby causing disruption in services [56].

In addition to marginal and difficult site conditions, many cities, towns, and villages in emerging and developing countries have been developed without using appropriate and standard urban planning techniques. This lack of planning often leads to sites being developed haphazardly [56]. This presents challenges for the design phase of water and sanitation provisioning services, because engineers or

government institutions often have no record of what structures are in place, how the traffic flows, who manages shared resources, etc.

Finally, engineers and planners often rely on designing and implementing conventional water and sanitation service-delivery systems, even though these systems may not fit with the complexities of informal settlements and unplanned neighborhoods [56]. This limitation stems from traditional curricula of engineering schools as well as a lack of social and community engagement in traditional engineering design [56]. For some communities in developing countries, distributed models for delivery of potable water and sanitation services may represent a more appropriate approach than the conventional centralized systems that are common in developed countries [56].

#### **4.1.2 Implementation Phase Constraints**

The largest and most obvious constraint for providing access to water is financial. Capital investment for project implementation is not meeting the needs of current development efforts [57–59]. Additionally, the recent global financial crisis increased the number of people living in poverty and decreased the public and private financial support to the water and sanitation sector [59].

A second barrier to the implementation of water and sanitation projects in developing and emerging countries revolves around institutional capacity. First, large-scale projects require many aspects to come together. These include tasks such as land acquisition, displacement of people, and business contracts that require considerable institutional capacity of governments, which is not always possible [58]. Additionally, corruption in the water, energy, and transportation sectors is well documented in both developed and developing countries [58]. Community participation in implementation of water and sanitation projects is also important and often becomes a limitation or downfall of projects in developing countries.

#### **4.1.3 Monitoring and Evaluation Limitations**

For the purpose of this chapter, monitoring and evaluation refer to drinking water quality, while operation and maintenance have been separated to address limitations associated with overall function of water and sanitation systems. Monitoring and evaluating of water quality in developing and emerging countries are currently insufficient due to lack of resources, lack of capacity and expertise, time requirements, and management of institutions in charge of regulations and standards [3]. These limitations tend to be associated with lack of standards, regulations and guidelines, lack of technical capacity, and the decentralized nature of water and sanitation throughout these countries. Wide variations of drinking water standards and regulations are evident [60], which complicates assessments of the status of global access to safe water. Another challenge relating to standards and regulations is that groundwater use is often not regulated or monitored properly. Global

information on the quality of groundwater is very limited due to regulation variation, time, and cost of monitoring [3]. Having and maintaining the appropriate disinfection residual also remain a challenge in many developing countries [61]. This can occur due to both human and mechanical failures during the treatment process [62].

The technical capacity and expertise of professionals in developing and emerging countries should be strengthened to improve understanding of water quality throughout the world [3]. According to the World Health Organization, the authorities responsible for drinking water supply monitoring have roles that encompass not only water quality, but also public health of people with and without access, information management, and reporting of waterborne diseases [61]. Many public health ministries may not have the capacity to cover all of these tasks, leaving some to fall to other agencies or organizations. This can often lead to inadequate monitoring and reporting [61].

Currently, monitoring and evaluation of drinking water focus on centralized conventional water distribution systems, even though many people in the developing world obtain water access through decentralized community systems [61]. This presents monitoring challenges relating to the time, capacity, and resources needed to monitor rural decentralized systems. There is a need to develop different tools to support monitoring of small community supplies compared to large conventional piped systems [61].

#### 4.1.4 Operation and Maintenance Limitations

While monitoring and evaluation deal directly with overseeing the technical quality of the water service, operation and maintenance can refer to a more broad sense of system functionality. Overall, the percentage of water and wastewater treatment projects that fail to be sustained for long-term use ranges from 20 % to 75 %; many recent assessments have indicated that half of all water projects in developing countries fail within 5 years. As early as 1981, the United States Agency for International Development (USAID) recorded that 35–50 % of systems in preindustrial countries became “inoperable” before the end of 5 years due to the failure in resources required for maintenance of improved water and sanitation systems [62]. Regionally, the World Bank estimated that more than 33 % of all existing infrastructure in rural communities throughout South Asia, including water and wastewater, are dysfunctional [63]. A survey of approximately 700 boreholes constructed in the 1980s throughout Kenya showed 43 % did not have normal water flow by the year 2000 [64].

It is difficult to maintain these water systems when water tariffs cannot be collected, water prices are not set to adequately fund maintenance, or governments do not have the resources to subsidize access [56, 59, 62]. The long-term maintenance of water infrastructure reduces the cost-effectiveness of these interventions, especially when compared to other intervention strategies such as hygiene education [65]. Additionally, many projects funded by international development



agencies or nonprofit organizations have no mechanisms for post-construction support after projects are completed and grants are fully utilized. Post-construction support and community participation are critical to sustained operation of water and sanitation interventions in developing countries [66–68]. Operation and maintenance limitations are often linked to poor community participation, especially among decentralized rural water and sanitation programs that are common in many developing countries. In centralized water systems throughout emerging and developing countries, inadequate financial and human capacity can lead to large volumes of unaccounted water due to system leaks in the water conveyance system [69]. Other operational limitations include inadequate pressure, leaks, corrosion, and intermittent water supply [62].

Throughout this section, many technical limitations to water provisioning in emerging and developing countries were discussed. While each of these can be detrimental in singularity, these factors are often compounded and linked. Additionally, one system perturbation can cause negative feedback loops to form, which can lead to additional negative consequences. Many of the limitations derived from emerging and developing country systems can be attributed to the lack of uniformity in water provisioning. Countries with large rural populations often implement decentralized water systems. These tend to be economical to build and are often based on technologies that are simple to maintain, but may suffer from inadequate monitoring. There are also many countries that lack adequate capacity within the central governing body to implement and monitor water and sanitation systems. Obviously, financial resources related to capital and tariff pricing and collection can also have important impacts on more than one phase of this process.

## ***4.2 Developed Countries***

Limitations and constraints to water provisioning in developed countries can take many forms and encompass more than one aspect of the design phase. The limitations discussed here, while not all encompassing, give a general overview of constraints that fall into three categories: factors due to age, water extraction factors, and water treatment factors (Fig. 1).

### **4.2.1 Aging Infrastructure**

One of the most commonly cited constraints to effective water provisioning in developed countries is the “aging infrastructure” problem. Some components in water and sanitation conveyance systems in the United States and Europe are more than 100 years old [70, 71]. Aging infrastructure presents many technical limitations for effective water provisioning.

First, degradation of infrastructure system integrity leads to system losses and water leaks. The water lost in the conveyance process is often referred to as “non-

			Design phase			
			Design	Implementation	Monitoring & evaluation	Operation & maintenance
Constraints	Factors due to age	System losses/leaks				
		Restoration and decommissioning				
	Water extraction factors	Groundwater extraction				
		Surface water quantity				
	Water treatment factors	Disinfection byproducts				
		Emerging contaminants				
Water and Energy Nexus						

**Fig. 1** Technical constraints to effective water provisioning in developed countries

revenue water” because it leaves the system prior to the water meter, which is generally used to define cost paid by the user. For the United States, non-revenue water ranges from 10 % to 30 % of total water, while in England this value has recently been estimated to be 25 % [71, 72]. In addition to leaks in pipes, system losses can be caused by water main breaks or other failures due to aging infrastructure. In the United States, there are approximately 240,000 water main pipe breaks each year [71].

Constraints noted above present challenges to the design phase. First, this presents a question of the effectiveness of current design strategies. When a system is leaking or breaks, should the section of that system be replaced or should an alternative design be considered? Additionally, from a monitoring and evaluation standpoint, leaks in a system indicate the potential for introduction of contaminants. Often in developed and developing countries, the monitoring and evaluation of potable water quality occur at the point of treatment or the centralized water treatment plant. If there are leaks in the conveyance system after this treatment point, the water quality is not effectively monitored afterwards. Water quality is also affected by the corrosion of pipes [73]. Microbes can grow on corroded surfaces and iron oxides can become increasingly adsorbed, both of which can happen after the point of monitoring and evaluation [74]. Additionally, in reference to the operation and maintenance or broad sense of system functionality, the location of leaks can be difficult to pinpoint.

In addition to constraints for drinking water monitoring and evaluation constraints, there are difficulties with wastewater treatment in developed countries. The sewer networks in many urban areas of the United States, particularly the Midwest and Northeast, involve the use of combined sewers. By necessity, these systems must include combined sewer overflows (CSOs), which protect downstream operations from hydraulic overloading during runoff events. With increasing

populations and changes in rainfall patterns, wastewater overflows from CSOs have result in discharge of 11–38 billion liters of untreated wastewater to streams and rivers in the United States each year [71]. After this untreated wastewater enters the river system, downstream cities and towns then withdraw the water for municipal drinking water. The hydrologic cycle creates a system of impact where upstream parties contribute to the water quality of those downstream.

In addition to leaks and losses in the conveyance systems of water infrastructure, the rehabilitation and/or decommissioning of large infrastructure projects remains a significant challenge in most developed countries. The aging infrastructure, including but not limited to water-related infrastructure, in the United States will require over \$1.6 trillion dollars to bring up to acceptable standards and functionality [74]. The U.S. Environmental Protection Agency (EPA) estimates that the United States will have a funding deficit of \$533 billion dollars for water and wastewater infrastructure operation and maintenance costs between 2000 and 2019 [71]. These high costs introduce design and management questions. For example, is it preferable to rehabilitate an old system or replace it?

To date over 600 dams of the nearly 79,000 in the United States have been decommissioned or removed for safety and economic reasons [75]. The design and implementation phases for dam or levee decommissioning are complicated due to ecosystem connections, such as the value of artificial structures and change of water flow and fish habitat [75]. For example, the Three Gorges Dam in China, which was built for flood control, electricity generation, and navigation, has huge impacts on economy, ecosystem, geophysical processes (e.g., nutrients transportation and sedimentation), and water quality [75–77].

#### 4.2.2 Water Availability Limitations

Water availability is becoming increasingly critical in some areas due to population growth and increased water demand. Technical constraints to water access in developed countries include challenges associated with groundwater extraction and water treatment limitations due to degradation of surface water sources.

Groundwater use worldwide has increased in recent decades due to expanding crop irrigation, population increase, high water demand in larger cities, and increased water demand in arid and semiarid areas [3, 78]. Over-withdrawal of groundwater can cause increased soil salinity, water stress and vegetation changes, and other impacts [3, 79, 80]. The technical constraints to groundwater withdrawal and use relate to all phases of the design process. These constraints stem from a lack of information about the state and status of groundwater aquifers worldwide [3, 79, 81]. There is inadequate information on the quantity of water in aquifers, particularly fossil aquifers deep below the earth's surface. This lack of information can affect the use of groundwater. Additionally, monitoring and evaluation of groundwater can be difficult and costly due to the fact that we have a poor understanding of many of the locations, quantity, and functions in natural systems of groundwater resources [82]. Often, groundwater recharge rates and extraction estimates are

based on models relating to rainfall and not on specific well or groundwater monitoring [79, 83]. Since aquifers do not necessarily follow political boundaries, monitoring and evaluation as well as operation and maintenance of aquifers are often difficult to pinpoint [82]. For example, if one municipality designs a groundwater extraction system based on knowledge of local water quantity, this system can influence the quantity and quality of water available to other users of this same aquifer.

### 4.2.3 Water Treatment Limitations

In developed countries there are several technical constraints to water treatment requirements that will continue to present challenges in coming decades. Three of these challenges include disinfection by-products, emerging contaminants, and the water/energy nexus.

The term disinfection by-products (DBPs) refers to chemical compounds that form as a result of disinfection processes. Examination of DBP formation originated with the discovery of chloroform formation following application of chlorine [82]. Since chlorine is inexpensive and efficient for inactivation of many types of bacteria and viruses, it is often applied in treatment processes for drinking water and wastewater. However, chlorine is known to react with natural organic materials (NOMs) and organic pollutants to form a wide range of disinfection by-products [43, 83, 84]. Beyond chloroform and the other trihalomethanes, DBPs identified to date that are common to halogenated waters include haloacetic acids, chloramines, halonitriles, N-nitrosamines, and other compounds [85]. These DBPs have been linked to a wide range of acute and chronic health risks including cancer, skin infections, respiratory irritations, and birth defects. Not all DBPs in drinking water are regulated in the United States and European Union [86]. Moreover, new DBPs are still being discovered, in part because of improvements in instrumentation and methods for analysis of water quality. For some of these DBPs, their associated human health implications remain undefined [87, 88].

Emerging contaminants generally refer to the synthetic organic chemicals and pathogens that are not commonly monitored in the environment but have been recently detected in the environment. The true fate of these contaminants and the health risks associated with them are largely unknown, but are being examined [89–92]. Among the challenges that emerging contaminants present are monitoring and evaluation of operation and maintenance processes. From a monitoring and evaluation standpoint, there are a few regulations relating to the water and wastewater treatment industry for these emerging contaminants [93]. The practices of industrial and manufacturing breakthroughs have surpassed the regulatory practices, particularly in the most recent decades [93]. The challenges during the operation and maintenance of existing systems include the cost of retrofitting treatment plants to filter and treat these new contaminants. Additionally, many of these contaminants are present at low concentrations, which can make them difficult to analyze and

remove [93]. This threat on the global potable water is further developed in a later chapter of this book.

The water and energy nexus is often described when discussing limitations to water treatment because the water treatment process in centralized water distribution systems requires a large amount of energy. More generally, the water/energy nexus refers to the feedback loops between power generation and water treatment and provisioning [93, 94]. Many of the treatment processes capable of combating concerns such as disinfection by-products and emerging contaminants require more energy consumption than treatment processes currently in place. In addition, with increasing populations and increasing demand for electricity, water use is needed in more power generation plants. The feedback loops between water and energy will be a concern for both developed and developing countries in the decades to come.

## 5 Global Challenges

Focusing on the technical constraints to water and sanitation provisioning in developed and emerging countries, this chapter has touched on a variety of different issues, including the ones that will be developed in more detail later in this book. While these topics provide a framework to conceptualize important issues, it is critical to discuss global societal challenges that impact global potable water access. As with all of the topics discussed thus far, this section provides an overview of important societal issues. Three central issues that encompass a variety of societal questions include competing interests, virtual water, and water as a target for warfare.

### 5.1 *Competing Interests*

Potable water provisioning is a basic human right. This has been clearly articulated by international organizations such as the United Nations. However, access to food is also a human right. Providing food through agricultural production remains the single largest sector of water use worldwide. At present, about 70 % of the water withdrawn worldwide is used for agriculture [95]. With increasing population food demand, an increase in water demand associated with the agricultural sector is expected. In the coming decades, water managers will have to make difficult decisions on water provisioning for various sectors. Will water be given to municipal and domestic needs before agricultural needs? What about the impact of industrial water use? How does one weigh the benefits and drawbacks of water provisioning for competing sectors?

Due to the global nature of the economy, industrial practices have large impacts on livelihoods. Manufacturing provides goods sold all over the world, it provides jobs and income, and it processes food and other products critical to daily life. With

recognition that water is used worldwide to meet various demands, i.e., industrial processes, economic development, agriculture production, and of course drinking water, one can see the immense challenges, ethically and technically, in balancing needs versus the finite amount of available water. In part, these challenges stem from inadequate pricing and valuation of water [96].

## 5.2 *Virtual Water Use*

Virtual water is a term that refers to the hidden water use and associated costs of goods and services. It quantifies the amount of water required to produce a commodity [97, 98]. The virtual water concept was developed by J. Allen who conceptualized the significant amounts of food products imported into the Middle East and North Africa despite the relatively low water availability in those regions [97]. Since the concept was coined, it has been used to calculate the import and export of water based on food crops worldwide.

More than just conceptualizing trade flows according to the water demand of commodities: virtual water presents a dialogue on societal implications of food consumption. In developed countries, the concept of virtual water has popularized the amount of water required to produce beef and poultry compared to vegetables. Additionally, it has presented questions about the consumption rates and disposal of commercial products such as cell phones and clothing. These questions relating to water footprint of commercial goods have implications concerning the competition between multiple sectors, the water/energy nexus, and pricing. Appropriate pricing of water is still a topic of debate [62, 99]. Societal values are a part of the pricing decisions for a resource that is a basic human right. As discussed previously, financial resources are desperately needed for capital and operational maintenance costs. However, if water is too expensive, it can be cost prohibitive, particularly for people living in poverty. Additionally, current food prices in many developed countries do not reflect the cost of water or other agricultural inputs, due to subsidies and import and export tariffs.

## 5.3 *Conflicts*

The importance of water as a basic human need makes water infrastructure and water resources a clear target for violence, intimidation, sabotage, and terrorism [100, 101]. While, to date, water has never caused a direct war between nations, there have been many historical water conflicts [100–102]. Using water infrastructure as a political or military target dates back to over 2,500 years [101–103]. Deliberate water contamination is the easiest way to distribute biological or chemical agents for the purpose of terrorism [104]. The potential impact of a large-scale attack could potentially be catastrophic [103].

One critical challenge for combatting this global problem is that there are major knowledge gaps with regard to the inspection methods for protection of water against biological or chemical agents [104]. Additionally, there is no standard set of policies or procedures for operation and maintenance of water infrastructure to administrate readiness, response to terrorist events, and recovery [105]. Vulnerability assessments, increased security measures, and improved quality control measures can help to prevent death and illness from biological or chemical terrorism [104].

## 6 Discussion and Future Implications

Throughout this chapter, an overview of critical problems relating to the provisioning of potable water worldwide has been developed. First reviewed review of current health impacts of water-related illnesses was presented, including acute and chronic ailments, as well as natural and human influences that have led to our current status of degraded water quality. The technical limitations to water treatment in both developed and emerging economies were discussed utilizing the phases of the design process as a framing mechanism. Additionally, a brief mention of societal factors that influence potable water access, such as competing interests, and the influence of food consumption on water availability have been discussed.

Shifting climates, increasing and decreasing rainfall, and changes in water cycle timing will affect water quality and water access in coming decades. Some areas may see increases in rainfall while others see decreases. Additionally, the seasonality of rainfall patterns may shift. A large portion of the world population is already experiencing various forms of water stress [106]. Areas that experience an increase in rainfall due to climate change will likely experience an increase in sedimentation and contaminant runoff [3]. Regions of the world that become drier may see an increase in concentration of contaminants [3, 107]. Increased variability could also influence the transport of microbial agents that cause acute water diseases which may create more water-related disease outbreaks [108, 109]. There are numerous publications in the refereed literature that develop models and predictions for how climatic changes will influence the hydrologic cycle and water access. These data can be used to help prepare for future water management strategies. Additionally, this chapter presented the human-centered point of view relating to global potable water. Water management and water provisioning for human consumption must account for water needed to sustain ecological systems. Water needs for nature are important to factor into decision-making strategies for water management worldwide.

Despite all of the seemingly overwhelming critical problems faced in developed and emerging countries alike, there has been tremendous progress on providing access to potable water made in recent decades. Millions of people in emerging countries now have access to improved water supplies not available 20, 10, or even 5 years ago. Target 7c of the UN's Millennium Development Goals, to reduce by

half the number of people without sustainable access to safe drinking water, was met in 2010, 5 years before the goal deadline [23]. Between 1990 and 2010, over 2 billion people obtained access to improved drinking water sources [23]. In this same period, approximately 1.8 billion people gained access to improved sanitation.

Ongoing research continues to analyze risks associated with emerging contaminants and disinfection by-products. Governments and managers worldwide strive to update regulations and standards to keep water safe for all.

Public perceptions of wastewater reuse and water consumption habits have changed in some localities [110]. For example, in Singapore, government water managers have invested in not only the treatment of wastewater for reuse but also the marketing and acceptability of this NEWater as a viable potable bottled water source [110, 111]. This water reuse project is critical to the sustainability of Singapore's water systems since it is a small country with high population density and limited freshwater availability. Additionally, cities in the United States such as San Diego are currently employing educational outreach to combat perceptions and concerns for wastewater reuse.

Whatever the response will be to these critical problems, managers will need to develop diverse and resilient solutions for a diverse and variable time. One solution, pollution prevention of worldwide water resources, is often the cheapest and easiest way to protect the quality of potable water [3]. Strengthening the strategies to reduce harmful contaminants, both technically and socially, will foster progress in pollution prevention. Another necessary solution to increasing water access is to expand and improve water and wastewater treatment [1, 23, 30]. We can achieve this by investing in a variety of solutions including high tech, energy-intensive, centralized treatment mechanisms as well as low tech, small-scale, rapid-deployment point of use treatment systems. Increasing our understanding of contaminants will provide more insight into developing effective treatment systems. More importantly, the social values and cultural conditions of communities need to play a role in their water management strategies. Engineering technologies alone cannot solve current or future potable water problems.

## References

1. United Nations (2000) Charting the progress of populations. <http://www.un.org/esa/population/publications/charting/contents.htm>
2. Sullivan CA, Meigh JR, Giacomello AM, Fediw T, Lawrence P, Samad M, Mlote S et al (2003) The water poverty index: development and application at the community scale. *Nat Resour Forum* 27:189–199
3. Palaniappan M, Gleick PH, Allen L, Cohen MJ, Christian-Smith J, Smith C (2012) Water quality. In: *The world's water: the biennial report on freshwater resources*, vol 7. Island Press, Washington, DC, pp 45–72
4. UNESCO (2009) Water in a changing world. <http://www.unesco.org/new/en/natural-sciences/environment/water/wwap/wwdr/wwdr3-2009/downloads-wwdr3/>



5. UNESCO (2012) UN world water development report, 4th edn. <http://www.unesco.org/new/en/natural-sciences/environment/water/wwap/wwdr/wwdr4-2012/#c219661>
6. Nixon S (1995) Coastal marine eutrophication: a definition, social causes, and future concerns. *Ophelia* 41:199–219
7. Diaz RJ (2001) Overview of hypoxia around the world. *J Environ Qual* 30(2):275–281
8. Spalding RF, Exner ME (1993) Occurrence of nitrate in groundwater—a review. *J Environ Qual* 22(3):392
9. Petrovic M, Eljarrat E, Lopex de Alda MJ, Barcelo D (2004) Endocrine disrupting compounds and other emerging contaminants in the environment: a survey on new monitoring strategies and occurrence data. *Anal Bioanal Chem* 378(3):549–562
10. Konstantinou I, Hela D, Albanis T (2006) The status of pesticide pollution in surface waters (rivers and lakes) of Greece. Part I. Review on occurrence and levels. *Environ Pollut* 141(3):555–570
11. Scanlon BR, Jolly I, Sophocleous M, Zhang L (2007) Global impacts of conversions from natural to agricultural ecosystems on water resources: Quantity versus quality. *Water Resour Res* 43(3): W03437. doi:10.1029/2006WR005486
12. Kafri U, Arad A (1979) Current subsurface intrusion of Mediterranean seawater – a possible source of groundwater salinity in the Rift Valley system, Israel. *J Hydrol* 44(3–4):267–287
13. Lee J-Y, Song S-H (2007) Evaluation of groundwater quality in coastal areas: implications for sustainable agriculture. *Environ Geol* 52(7):1231–1242
14. Pitman MG, Läuchli A (2004) Global impact of salinity and agricultural ecosystems. In: Läuchli A, Lüttge U (eds) *Salinity: environment – plants – molecules SE – 1*. Springer, Netherlands, pp 3–20
15. Rengasamy P (2006) World salinization with emphasis on Australia. *J Exp Bot* 57(5):1017–1023
16. Sharpley AN, Chapra SC, Wedepohl R, Sims JT, Daniel TC, Reddy KR (1994) Managing agricultural phosphorus for protection of surface waters: issues and options. *J Environ Qual* 23(3):437
17. Phiri O, Mumba P, Moyo BHZ, Kadewa W (2005) Assessment of the impact of industrial effluents on water quality of receiving rivers in urban areas of Malawi. *Int J Environ Sci Technol* 2(3):237–244
18. Guan D, Hubacek K (2007) Assessment of regional trade and virtual water flows in China. *Ecol Econ* 61(1):159–170
19. Gleick P (1994) Water and energy. *Annu Rev Energy Environ* 19(1):267–299
20. Osborn SG, Vengosh A, Warner NR, Jackson RB (2011) Methane contamination of drinking water accompanying gas-well drilling and hydraulic fracturing. *Proc Natl Acad Sci U S A* 108(20):8172–8176
21. Allen EW (2008) Process water treatment in Canada’s oil sands industry: I. Target pollutants and treatment objectives. *J Environ Eng Sci* 7(2):123–138
22. Banks D, Younger PL, Arnesen RT (1997) Mine-water chemistry: the good, the bad and the ugly. *Environ Geol* 32(3):157–174
23. UNICEF, World Health Organization (2013) Progress on drinking water and sanitation 2012 update. New York. <http://www.wssinfo.org/>
24. Klein RD (1979) Urbanization and stream quality impairment. *J Am Water Resour Assoc* 15(4):948–961
25. Brabec E, Schulte S, Richards PL (2002) Impervious surfaces and water quality: a review of current literature and its implications for watershed planning. *J Plann Lit* 16(4):499–514
26. Ren W, Zhong Y, Meligrana J (2003) Urbanization, land use, and water quality in Shanghai: 1947–1996. *Environ Int* 29:649–659
27. Liu L, Hope L, Johnson SC, Perin J, Scott S, Joy E, Lawn IR et al (2012) Global, regional, and national causes of child mortality: an updated systematic analysis for 2010 with time trends since 2000. *Lancet* 379(9832):2151–2161

28. Wardlaw T, Salama P, Brocklehurst C, Chopra M, Mason E (2010) Diarrhoea: why children are still dying and what can be done. *Lancet* 375:870–872
29. Gleick PH (2002) Dirty-water: estimated deaths from water-related diseases 2000–2020. The Pacific Institute. [http://agecon.nmsu.edu/fward/age384/spring-2010/Dirty\\_Water\\_Peter\\_H\\_Gleick\\_2002.pdf](http://agecon.nmsu.edu/fward/age384/spring-2010/Dirty_Water_Peter_H_Gleick_2002.pdf)
30. Hutton G, Haller L (2004) Evaluation of the costs and benefits of water and sanitation improvements at the global level. World Health Organization. Report 04.04
31. Hutton G, Haller L, Bartram J (2007) Global cost-benefit analysis of water supply and sanitation interventions. *J Water Health* 5(4):481–502
32. Pegram GC, Rollins N, Espey Q (1998) Estimating the costs of diarrhoea and epidemic dysentery in KwaZulu-Natal and South Africa. *Water SA-Pretoria* 24(1):11–20
33. Verma BL, Srivastava RN (1990) Measurement of the personal cost of illness due to some major water-related diseases in an Indian rural population. *Int J Epidemiol* 19(1):169–176
34. Argos M, Kalra T, Paul J, Rathouz Y, Chen BP, Parvez F, Islam T et al (2010) Arsenic exposure from drinking water, and all-cause and chronic-disease mortalities in Bangladesh (HEALS): a prospective cohort study. *Lancet* 376(9737):252–258
35. Zierold KM (2004) Prevalence of chronic diseases in adults exposed to arsenic-contaminated drinking water. *Am J Public Health* 94(11):1936–1937
36. Tsai SM, Wang TN, Ko YC (2010) Mortality for certain diseases in areas with high levels of arsenic in drinking water. *Arch Environ Health* 54(3):186–193
37. Hopenhayn-Rich C, Biggs ML, Fuch A, Bergoglio R, Tello E, Nicolli H, Smith AH (1996) Bladder cancer mortality associated with arsenic in drinking water in Argentina. *Epidemiology* 7(2):117–124
38. Gupta R, Ahuja P, Khan S (2000) Microbial biosorbents: meeting challenges of heavy metal pollution in aqueous solutions. *Curr Sci* 78(8):17–21
39. Cantor KP (1997) Drinking water and cancer. *Cancer Causes Control* 8(3):292–308
40. Krishnamachari KA (1986) Skeletal fluorosis in humans: a review of recent progress in the understanding of the disease. *Progr Food Nutr Sci* 10(3–4):279–314
41. Jolly SS, Singh BM, Mathur OC, Malhotra KC (1968) Epidemiological, clinical, and biochemical study of endemic dental and skeletal fluorosis in Punjab. *BMJ* 4(5628):427–429
42. Mascarenhas AK (2000) Risk factors for dental fluorosis: a review of the recent literature. *Pediatr Dent* 22(4):269–277
43. Kurttio P, Komulainen H, Leino A, Salonen L, Auvinen A, Saha H (2004) Bone as a possible target of chemical toxicity of natural uranium in drinking water. *Environ Health Perspect* 113(1):68–72
44. Auvinen A, Kurttio P, Pekkanen J, Pukkala E, Ilus T, Salonen L (2002) Uranium and other natural radionuclides in drinking water and risk of leukemia: a case-cohort study in Finland. *Cancer Causes Control* 13(9):825–829
45. Auvinen A, Salonen L, Pekkanen J, Pukkala E, Ilus T, Kurttio P (2005) Radon and other natural radionuclides in drinking water and risk of stomach cancer: a case-cohort study in Finland. *Int J Cancer* 114(1):109–113
46. Fan AM, Steinberg VE (1996) Health implications of nitrate and nitrite in drinking water: an update on methemoglobinemia occurrence and reproductive and developmental toxicity. *Regul Toxicol Pharmacol* 23(1 Pt 1):35–43
47. Weyer PJ, Cerhan JR, Kross BC, Hallberg GR, Kantamneni J, Breuer G, Jones MP, Zheng W, Lynch CF (2001) Municipal drinking water nitrate level and cancer risk in older women: The Iowa women’s health study. *Epidemiology* 12(3):327–338
48. Daughton CG (2004) Non-regulated water contaminants: emerging research. *Environ Impact Assess Rev* 24(7–8):711–732
49. Gorell JM, Johnson CC, Rybicki BA, Peterson EL, Richardson RJ (1998) The risk of Parkinson’s disease with exposure to pesticides, farming, well water, and rural living. *Neurology* 50(5):1346–1350

50. Richardson SD, Postigo C (2012) Drinking water disinfection by-products. In: Barcelo D, Kostianoy AG (eds) *Handbook of environmental chemistry: emerging organic contaminants and human health*, 20th edn. Springer, Berlin, pp 93–137. doi:[10.1007/698](https://doi.org/10.1007/698)
51. Jelić A, Petrović M, Barceló D (2012) Pharmaceuticals in drinking water. In: Barcelo D, Kostianoy AG (eds) *Handbook of environmental chemistry: emerging organic contaminants and human health*, 20th edn. Springer, Berlin, pp 47–70
52. Environmental Protection Agency (2012) Basic information about the arsenic rule. <http://water.epa.gov/lawsregs/rulesregs/sdwa/arsenic/Basic-Information.cfm>
53. Environmental Protection Agency (2012) Basic information about nitrate in drinking water. <http://water.epa.gov/drink/contaminants/basicinformation/nitrate.cfm>
54. Kates RW, Haarmann V (1992) Where the Poor Live. *Environ Sci Policy Sustain Dev* 34 (4):4–28
55. Solo TM, Perez E, Joyce S (1993) Constraints in providing water and sanitation services to the urban poor. U.S. Agency for International Development. [http://pdf.usaid.gov/pdf\\_docs/pnabn953.pdf](http://pdf.usaid.gov/pdf_docs/pnabn953.pdf)
56. Kates RW (2000) Cautionary tales: adaptation and the global poor. In: Kane SM, Yohe GW (eds) *Societal adaptation to climate variability and change SE – 2*. Springer, Netherlands, pp 5–17
57. Scott A, Seth P (2012) Infrastructure services post-2015. Overseas Development Institute. <http://www.odi.org.uk/sites/odi.org.uk/files/odi-assets/publications-opinion-files/7867.pdf>
58. Rodriguez DJ, Van Den Berg C, McMahon A (2012) Investing in water infrastructure: capital, operations and maintenance. World Bank, Washington, DC
59. Fay M et al (2010) Infrastructure and sustainable development in post crisis growth and development. World Bank, Washington, DC
60. World Health Organization (2006) *Guidelines for drinking-water quality*, vol 1, 3rd edn. WHO, Geneva, pp 1–595. ISBN 978 92 4 154761 1
61. Lee EJ, Schwab KJ (2005) Deficiencies in drinking water distribution systems in developing countries. *J Water Health* 3(2):109–127
62. Elmendorf M, Isely R (1981) The role of women as participants and beneficiaries in water supply and sanitation programs. *Water and Sanitation for Health Project, USAID* (11):1–28
63. The World Bank (2004) *World development report 2004: making services work for poor people*. World Bank and Oxford University Press, Washington, DC, pp 1–288. ISBN 978-0-8213-5468-1
64. Miguel E, Gugerty MK (2005) Ethnic diversity, social sanctions, and public goods in Kenya. *J Publ Econ* 89(11–12):2325–2368
65. Zwane AP, Kremer M (2007) What works in fighting diarrheal diseases in developing countries? A critical review. *World Bank Res. Obser.* 22:1–24
66. Prokopy L, Thorsten R, Bakalian A, Wakeman W (2008) Evaluating the role of postconstruction support in sustaining drinking water projects evidence from Peru. *J Plann Educ Res* 27(3):294–305
67. Whittington D, Davis J, Prokopy L, Komives K, Thorsten R, Lukacs H, Bakalian A, Wakeman W (2009) How well is the demand-driven, community management model for rural water supply systems doing? Evidence from Bolivia, Peru and Ghana. *Water Pol* 11 (6):696
68. Prokopy LS (2005) The relationship between participation and project outcomes: evidence from rural water supply projects in India. *World Dev* 33(11):1801–1819
69. Mwendera EJ, Hazelton D, Nkhuwa D, Robinson P, Tjijenda K, Chavula G (2003) Overcoming constraints to the implementation of water demand management in southern Africa. *Phys Chem Earth, Parts A/B/C* 28(20–27):761–778
70. Environmental Protection Agency (2011) Addressing the challenge through science and Innovation. Washington, DC. <http://nepis.epa.gov/Adobe/PDF/P100EQ6Q.pdf>

71. Institution of Civil Engineers (2012) The state of the nation: water 2012. AMIA Annual Symposium Proceedings/AMIA Symposium. AMIA Symposium. <http://www.ice.org.uk/getattachment/86d84a07-f7d6-4027-b477-e751b845aaa5/State-of-the-Nation-Water.aspx>
72. Lambert AO (2002) International report: water losses management and techniques. *Water Sci Technol Water Supply* 2(4):1–20. <http://173.254.28.127/~leakssui/wp-content/uploads/2012/11/IWAIIntReport2001Berlin.pdf>
73. Grigg NS (2005) Institutional analysis of infrastructure problems: case study of water quality in distribution systems. *J Manage Eng* 21:152–158
74. Doyle MW, Stanley EH, Havlick DG, Kaiser MJ, Steinbach G, Graf WL, Galloway GE, Adam Riggsbee J (2008) Aging infrastructure and ecosystem restoration. *Science* 319:286–287
75. Yang Z, Wang H, Saito Y, Milliman JD, Xu K, Qiao S, Shi G (2006) Dam impacts on the Changjiang (Yangtze) River sediment discharge to the sea: the past 55 years and after the Three Gorges Dam. *Water Resour Res* 42(4):W04407
76. Muller B, Berg M, Yao ZP, Zhang XF, Wang D, Pfluger A (2008) How polluted is the Yangtze river? Water quality downstream from the Three Gorges Dam. *Sci Total Environ* 402(2–3):232–247
77. Okadera T, Watanabe M, Kaiqin X (2006) Analysis of water demand and water pollution discharge using a regional input-output table: an application to the City of Chongqing, upstream of the Three Gorges Dam in China. *Ecol Econ* 58(2):221–237
78. Wada Y, van Beek LPH, van Kempen CM, Reckman JWTM, Vasak S, Bierkens MFP (2010) Global depletion of groundwater resources. *Geophys Res Lett* 37, L20402. doi:10.1029/2010GL044571
79. Konikow LF, Kendy E (2005) Groundwater depletion: a global problem. *Hydrogeol J* 13(1):317–320
80. Jobbágy EG, Jackson RB (2004) Groundwater use and salinization with grassland afforestation. *Glob Change Biol* 10(8):1299–1312
81. Foster SSD, Chilton PJ (2003) Groundwater: the processes and global significance of aquifer degradation. *Phil Trans Roy Soc Lond B Biol Sci* 358(1440):1957–1972
82. Rook JJ (1974) Formation of haloforms during chlorination of natural waters. *Wat. Treat. Exam.* 23:234–243
83. Giordano M (2009) Global groundwater? Issues and solutions. *Annu Rev Environ Resour* 34(1):153–178
84. Nieuwenhuijsen MJ (2000) Chlorination disinfection byproducts in water and their association with adverse reproductive outcomes: a review. *Occup Environ Med* 57(2):73–85
85. EPA/600/R-02/068, September 2002
86. Richardson SD, Postigo C (2012) Drinking water disinfection by-products. *Emerg. Org. Cont. and Hum. Health* 20:93–138. doi:10.1007/698. [http://link.springer.com/chapter/10.1007/698\\_2011\\_125](http://link.springer.com/chapter/10.1007/698_2011_125)
87. Richardson SD, Thruston AD Jr, Caughran TV, Chen PH, Collette TW, Schenck KM, Lykins BW Jr, Rav-Acha C, Glezer V (2000) Identification of new drinking water disinfection by-products from ozone, chlorine dioxide, chloramine, and chlorine. In: Belkin S (ed) *Environmental challenges SE – 9*. Springer, Netherlands, pp 95–102
88. Krasner SW, Weinberg HS, Richardson SD, Pastor SJ, Chinn R, Sclimenti MJ, Onstad GD, Thruston AD (2006) Occurrence of a new generation of disinfection byproducts. *Environ Sci Technol* 40(23):7175–7185
89. Younos T (2005) Emerging threats to drinking water quality. *Renew Resour J* 23(2):6–12
90. Kolpin DW, Furlong ET, Meyer MT, Thurman EM, Zaugg SD, Barber LB, Buxton HT (2002) Pharmaceuticals, hormones, and other organic wastewater contaminants in U.S. streams, 1999–2000: a national reconnaissance. *Environ Sci Technol* 36(6):1202–1211
91. Richardson SD, Ternes TA (2005) Water analysis: emerging contaminants and current issues. *Anal Chem* 77(12):3807–3838

92. Bolong N, Ismail AF, Salim MR, Matsuura T (2009) A review of the effects of emerging contaminants in wastewater and options for their removal. *Desalination* 239(1–3):229–246
93. Water in the West (2013) Water and energy nexus: a literature review. [http://waterinthewest.stanford.edu/sites/default/files/Water-Energy\\_Lit\\_Review.pdf](http://waterinthewest.stanford.edu/sites/default/files/Water-Energy_Lit_Review.pdf)
94. Department of Energy (2006) Energy demands on water resources: report to congress on the interdependency of energy and water. <http://www.sandia.gov/energy-water/docs/121-RptToCongress-EWwEIAComments-FINAL.pdf>
95. Intelligence Community Assessment (2012) Global water security. ICA 2012-08. Intelligence Community Assessment, Washington, DC
96. Jury W, Vaux HJ (2007) The emerging global water crisis; managing scarcity and conflict between water users. *Adv Agron* 95:1–76
97. Allan JA (1998) Virtual water: a strategic resource. *Ground Water* 36(4):545–546
98. Oki T, Kanae S (2004) Virtual water trade and world water resources. *Water Sci Technol* 49(7):203–209
99. Tostet HWP, Gleditsch NP, Hegre H (2000) Shared rivers and interstate conflict. *Polit Geogr* 19:971–996
100. Wolf AT (2007) Shared waters: conflict and cooperation. *Annu Rev Environ Resour* 32(1):241–269
101. Gleick PH, Heberger M (2012) Water conflict chronology. *The Worlds Water* 7:175–214. doi:10.5822/978-1-61091-048-4
102. Gleick PH (1993) Water and conflict: fresh water resources and international security. *Int Secur* 18(1):79–112
103. Gleick PH (2006) Water and terrorism. *Water Policy* 8(6):481–503. doi:10.2166/wp.2006.035. <http://www.iwaponline.com/wp/00806/wp008060481.htm>
104. Khan AS, Swerdlow DL, Juranek DD (2001) Precautions against biological and chemical terrorism directed at food and water supplies. *Public Health Rep* 116(1):3–14
105. Copeland C, Cody BA (2007) Terrorism and security issues facing the water infrastructure sector. In: Linden EV (ed) *Focus on terrorism*, vol 9. Nova Science, Newyork, pp 257–272. ISBN 978-1-60021-709-8
106. Vörösmarty CJ, Green P, Salisbury J, Lammers RB (2000) Global water resources: vulnerability from climate change and population growth. *Science* 289(5477):284–288
107. Murdoch PS, Baron JS, Miller TL (2000) Potential effects of climate change on surface-water quality in North America. *J Am Water Resour Assoc* 36(2):347–366
108. Delpla I, Jung A-V, Baures E, Clement M, Thomas O (2009) Impacts of climate change on surface water quality in relation to drinking water production. *Environ Int* 35(8):1225–1233
109. Rose JB, Epstein PR, Lipp EK, Sherman BH, Bernard SM, Patz JA (2001) Climate variability and change in the United States: potential impacts on water- and foodborne diseases caused by microbiologic agents. *Environ Health Perspect* 109(Suppl 2):211–221
110. Po M, Nancarrow BE, Kaercher JD (2003) Literature review of factors influencing public perceptions of water reuse (pp. 1-39). CSIRO Land and Water, Victoria
111. Tortajada C (2006) Water management in Singapore. *Int J Water Resour Dev* 22(2):227–240

# Coping with Emerging Contaminants in Potable Water Sources

Heather E. Gall and Odette Mina

**Abstract** Humans use a large variety of chemicals in their everyday lives including over-the-counter medications, prescription drugs, and personal care products. The chemicals that comprise these items enter wastewater treatment systems when they are manufactured by companies and used by consumers. Wastewater treatment plants have various removal efficiencies, causing these chemicals, generally referred to as “emerging contaminants,” to enter surface water bodies. In addition to human sources of emerging contaminants, veterinary pharmaceuticals and hormones are given to livestock raised in concentrated animal feeding operations. The land application of biosolids and animal waste to agricultural fields as a fertilizer source also introduces emerging contaminants into the environment. Recent advances in technology have allowed researchers to detect these compounds in water samples at significantly lower concentrations, thereby allowing researchers to assess the exposure of humans and aquatic species to concentrations at the parts-per-trillion level. This chapter provides an overview of the types of emerging contaminants found in potable water sources, their major sources, issues associated with their removal in treatment plants, and a social perspective of the public’s concerns regarding emerging contaminants in their potable water.

**Keywords** Pharmaceuticals • Endocrine disrupting compounds • Drinking water • Wastewater treatment

---

H.E. Gall (✉) • O. Mina  
Department of Agricultural and Biological Engineering, The Pennsylvania State University,  
University Park, PA, USA  
e-mail: [heg12@engr.psu.edu](mailto:heg12@engr.psu.edu)

## 1 Introduction

On a global scale, access to clean, safe drinking water is an ongoing concern. Nearly one billion people do not have access to this very basic necessity. Globalization and the increase in human population have led to a wide range of problems related to water quantity and quality. Thousands of tons of personal care products are produced annually [1] and the number of prescriptions has increased from 2 to 3.9 billion in the United States from 1999 to 2009 [2]. In the United States, the number of chemicals produced tripled from 1941 to 1995 [3], with 80,000 chemicals in currently in use [4]. These products bring benefits along with great concerns for human health and the environment. The risks associated with exposure to consumption of such products are not yet well understood, and therefore regulations for surface water and finished drinking water have not been established. This class of compounds, generally referred to as “emerging contaminants” (ECs), includes hormones, pharmaceuticals, and personal care products (PPCPs). These chemicals continue to raise significant concerns among public health professionals, engineers, and scientists, as many are known or suspected to have endocrine disrupting properties. The occurrence of these contaminants has been documented in surface water and groundwater, but the extent of their distribution and the consequences of their presence are largely unknown.

In 2002, the United States Geological Survey (USGS) brought attention of the widespread detection of emerging contaminants (ECs) to scientists with results of the first nationwide study of organic wastewater contaminants (OWCs) [5]. This seminal study, which has been cited more than 2,800 times, included the collection of surface water samples from nearly 140 locations across the United States. The collected samples were tested for pharmaceuticals, hormones, and other OWCs, and 80 % of the sampled locations tested positive for at least one EC. It was this study that formed the basis for new areas of water quality research, including the fate and transport of ECs, the removal efficiency of water and wastewater plants of these unregulated compounds, and the understanding of their effects on human health and aquatic ecosystems.

In 2008, an Associated Press investigation surveyed 62 major water providers and found that at least 46 million US residents receive drinking water from water bodies contaminated with trace levels of one or more prescription drugs [6]. Sources of these contaminants include treated and untreated municipal sewage, industrial chemical wastes, surface application of manure and biosolids, and agricultural livestock wastes. The detected concentrations of ECs can be orders of magnitude lower than “traditional” contaminants, which are regulated by the Environmental Protection Agency (EPA) and have drinking water standards. However, concentrations as low as 1 ng/L are known to cause adverse effects on sensitive aquatic species [7] and the long-term effects on humans are not well understood. In addition, these pollutants undergo various physical, chemical, and biological transformations, with the products potentially causing additional risk to human health and aquatic ecosystems. Perhaps more importantly, these chemicals are known to



behave synergistically, causing poorly understood magnified effects when multiple compounds are present in the water simultaneously.

This chapter will explore major sources of ECs, their presence in drinking water sources, and the types of contaminants that have been detected and have the potential to adversely affect human health and aquatic ecosystems. In this chapter, we will also review the capabilities of currently available treatment technologies to remove these contaminants, and will close with an overview of public concerns regarding the presence of these unregulated contaminants in drinking water. The underlying motivation for this chapter is to provide readers with a general appreciation for the widespread nature of this problem and the need for ongoing research to adequately address this growing problem.

## **2 Emerging Contaminants: What Is in Drinking Water Sources?**

The USGS defines ECs as “any synthetic or naturally occurring chemicals or any microorganisms that are not commonly monitored in the environment but have the potential to enter the environment and cause known or suspected adverse ecological and/or human health effects” [8]. As is mentioned in the definition, ECs fall into two major categories, depending on their sources. Humans and animals naturally excrete hormones (androgens and estrogens), and these hormones are therefore classified as natural or endogenous chemicals. The second category includes a wide range of chemicals manufactured by humans that comprise pharmaceuticals, household products, personal care products, industrial products, and livestock implants and are classified as synthetic or exogenous chemicals. This section provides an overview of the various types of ECs and their sources.

### ***2.1 Natural Compounds***

All humans and animals naturally excrete steroid hormones from their bodies. These excretions are introduced into the environment through wastewater treatment plant (WWTP) effluent, combined sewer overflow events, and the land application of biosolids and animal manure. Lange et al. [9] suggested that humans and livestock excrete hormones at a rate that is on the same order of magnitude. However, human wastes are generally treated, albeit at varying efficiencies, whereas livestock wastes do not typically undergo treatment prior to their introduction to the environment. As a result, it has been estimated that the land application of animal wastes has the potential to introduce 200 times more estrogens to the environment than the land application of biosolids [7]. However, without estimates of hormones discharged to surface water bodies during the



release of raw sewage via combined sewer overflow events, the relative contributions of humans versus livestock remain unclear. The estrogens of natural origin, which are of concern in drinking water supplies, are  $17\beta$ - and  $17\alpha$ -estradiol (E2) and their metabolites estrone (E1) and estriol (E3). Natural androgens include testosterone (TST) and its environmental metabolite, androstenedione (AND).

Several other ECs have natural origins. However, their presence in the environment at elevated levels is directly related to human activities. For example, caffeine and nicotine originate from plants, but consumption of coffee and cigarette smoking have increased the presence of these compounds in surface water bodies. The effects of these increased concentrations in water bodies are not well understood.

## 2.2 *Synthetic Compounds*

A vast array of chemicals are contained in products that people use every day as medical treatments and household conveniences. These products benefit industry, agriculture, people, and animals; however, they often contain bioactive chemicals that affect living tissue and the environment. Synthetic compounds include chemicals used in PPCPs. Pharmaceuticals include both prescription and over-the-counter (OTC) drugs, and personal care products span a wide range of products used for personal hygiene.

The use of prescription medications and OTC drugs is a major source of ECs in the environment. People take medications for many health-related issues, including physical and mental health. Not all of the medicine is absorbed by the patient's body, and therefore active ingredients and their metabolites are excreted and enter the wastewater stream. The types of pharmaceuticals that have been found in drinking water sources are summarized in Table 1. Additionally, the synthetic hormone  $17\alpha$ -ethinylestradiol (EE2), which is used in birth control pills, is also commonly detected in wastewater and surface water bodies. This is of particular concern, as it is more potent than natural estrogens and therefore has the potential to cause greater adverse impacts on humans and aquatic organisms.

The livestock industry is also a major source of ECs in the environment. Approximately 80 % of antibiotics produced in the United States are given to animals raised to produce food [10]. In 2009, more than 13 million kg of antibiotics were sold for farm animal use [11]. Antibiotics given to animals are listed in Table 2. Because the majority of livestock are raised in concentrated animal feeding operations (CAFOs), there is a high potential for diseases to spread quickly in these facilities. Therefore, animals are given regular doses of antibiotics to suppress the spread of illness. Additionally, dairy cattle generally receive rBGH (recombinant bovine growth hormone), which is a synthetic hormone that increases milk production, and beef cattle are commonly given implants that contain synthetic androgens to increase their growth, allowing slaughter at a younger age. Although these compounds enable CAFOs to be more efficient and are not generally thought to have negative consequences for human consumption of milk and beef, these

**Table 1** Emerging contaminants originating from human medications

General type	Specific examples
<i>Prescription</i>	
Antacid	Cimetidine, ranitidine
Antiasthmatic	Salbutamol
Anticoagulant	Warfarin
Anticonvulsant	Carbamazepine
Antidepressant	Fluoxetine, paroxetine
Antihypertensive	Diltiazem, enalaprilat
Beta-blocker	Atenolol
Contraceptive	17 $\alpha$ -Ethinylestradiol, mestranol
<i>Over the counter</i>	
Analgesic	Acetaminophen, ibuprofen, codeine
Antihistamine	Diphenhydramine
<i>Antibiotics</i>	
Macrolides	Azithromycin, erythromycin, roxithromycin
Quinolines	Ciprofloxacin, lomefloxacin, norfloxacin, ofloxacin
Sulfonamides	Sulfadiazine, sulfamethoxazole, sulfathiazole
Tetracyclines	Doxycycline, oxytetracycline, tetracycline
Other human antibiotics	Chloramphenicol, lincomycin, trimethoprim

**Table 2** Emerging contaminants originating from veterinary antibiotics

General type	Specific examples
Macrolides	Tylosin, virginiamycin
Quinolines	Enrofloxacin, sarafloxacin
Sulfonamides	Sulfachloropyridazine, sulfadimethoxine, sulfamethazine
Tetracyclines	Chlorotetracycline
Other veterinary antibiotics	Ormetoprim

compounds and their metabolites are excreted by animals and enter the environment during land application of their wastes.

Many synthetic compounds in industrial and personal care products have been found in the environment. A list of general types of ECs from industrial and household products is given in Table 3. Many of these compounds are known or suspected endocrine disruptors. Musk is a common base in fragrances and is known to bind to hormone receptor sites. Although significant research has been conducted on the impacts of musk, more than a dozen other fragrance compounds have the potential to cause endocrine disruption [12]. Triclosan, a common antimicrobial used in many household products, is known to affect hind limb development in tadpoles at concentrations as low as 0.15  $\mu\text{g/L}$  [13].

While research on the impacts of some individual ECs on aquatic life is ongoing, these compounds are rarely, if ever, found in surface water bodies in the absence of other contaminants. Many ECs are known to behave synergistically, triggering endocrine disruption at concentrations lower than would be expected based on the

**Table 3** Emerging contaminants originating from industrial and household products

General purpose	Specific examples
Antioxidant	3-tert-Butyl-4-hydroxyanisole, 5-methyl-1H-benzotriazole
Cosmetics	Triethyl citrate
Detergent	Nonylphenol
Disinfectant	Triclosan
Flame retardant	Tri(dichloroisopropyl) phosphate, tributyl phosphate, tri(2-butoxyethyl) phosphate
Flavor	Camphor, menthol
Fragrance	Musk, isoborneol
Herbicide	Atrazine, bromacil, prometon
Insecticide	Carbaryl, carbazole, chloropyrifos, diazinon, <i>N,N</i> -diethyl-meta-toluamide (DEET)
Pesticide	Metalaxyl, metolachlor
Plasticizer	Diethyl phthalate, bis(2-ethylhexyl) phthalate, bisphenol A (BPA), triphenyl phosphate
Preservative	Anthracene, para-cresol
Sunscreen	Avobenzene, dioxybenzone, oxybenzone, sulisobenzene

concentrations of each individual compound. Therefore, the synergistic behavior exhibited by “contaminant cocktails” needs to be better understood to assess risks that these contaminants pose to aquatic life and humans.

### 2.3 Emerging Pathogens

In addition to emerging chemicals of concern, new microorganisms are being discovered that are considered “emerging pathogens.” Little is known about these emerging pathogens, and in some cases, microorganisms that had not previously been considered pathogenic are now being recognized as pathogens [14]. In 2005, the EPA listed several bacteria (*Aeromonas hydrophilia*, *Helicobacter pylori*, *Mycobacterium avium intracellulare*), viruses (Caliciviruses, Adenoviruses, Coxsackieviruses, Echoviruses), protozoa (Microsporidia), and cyanobacteria (blue-green algae) on its Contaminant Candidate List 2 [15]. This list was created as a way to identify chemicals and pathogens that pose a threat to human health and may require regulation in the future. Egli and Rust [16] list several other bacteria and viruses as pathogens of emerging concern in drinking water.

The major sources of these pathogens include livestock, stormwater, and human recreational activities; however, some sources may also include wildlife and aquatic species [17]. In general, little is known about the transmission routes of these pathogens, their minimum infective dose, or their virulence [14]. Additionally, little is known about the effectiveness of disinfection on inactivation of these

emerging pathogens. There is potential for regrowth during distribution from the drinking water treatment plant to consumers. Therefore, even if the levels of these pathogens leaving the treatment plant could be considered safe, levels in the tap water coming out of the faucet may be too high. Many drinking water treatment plants add a secondary disinfectant to the finished drinking water to help prevent additional growth in water distribution systems. However, without data regarding the minimum infective dose and the effectiveness of these disinfectants on emerging pathogens, safe levels and adequate primary and secondary disinfectant doses cannot be established.

## **2.4 Regulations**

One of the main issues surrounding ECs compared to other “traditional” contaminants is the lack of regulations. Various agencies, such as the Chemical Material Risk Management Directorate, the State of Massachusetts, and the State of South Carolina, have even included the lack of regulations as part of the definition of ECs [18]. Although their widespread presence in the environment has only recently been identified, it is likely that these contaminants have been in the environment for as long as they have been manufactured.

Currently, the data on the fate and transport of ECs in the environment and their risk to human and aquatic ecosystem health are insufficient for regulations to be developed. The Toxic Substances Control Act (TSCA) in the United States provides the EPA with the power to regulate new chemicals before they enter the market and existing chemicals, when they are found to pose a significant risk to human or environmental health. While the TSCA applies to any stage within a chemical’s life cycle, the lack of life cycle data for ECs would make regulation under the TSCA difficult. Additionally, when it was passed in 1976, it exempted approximately 62,000 chemicals that were currently in use [4]. While testing is currently being conducted on approximately 500 chemicals [19], this is a small fraction of the 80,000 chemicals currently produced, of which 8,000 are known to be carcinogenic [3]. The chemicals that are currently regulated include lead, asbestos, chlorofluorocarbons (CFCs), and polychlorinated biphenyls (PCBs).

In the United States, the government (i.e., the EPA) is responsible for the assessment of chemical risks. However, in the European Union, this responsibility falls on industry through the REACH (Registration, Evaluation, Authorisation, and Restriction of Chemicals) regulation. REACH is currently being phased in, but will take full effect in 2018. Under REACH, a chemical cannot be manufactured or imported into the EU unless it has been registered and passed REACH’s regulations. As a result of tighter regulations, some compounds that are used in the United States are banned in Europe. One such example is the use of growth promoting antibiotics for livestock, which were banned by Sweden in 1986, Denmark in 1995,

and the European Union (EU) in the 1999, but are widely used in the United States in CAFOs [20].

While some regulations do exist on the production side of the issues surrounding ECs, no drinking water regulations currently exist. In the United States, the EPA is predominantly focused on addressing PPCPs and has set a four-pronged strategy for addressing them: (1) improve science; (2) improve public understanding; (3) identify partnership and stewardship opportunities; and (4) take regulatory action when appropriate [21]. The EPA has launched educational campaigns to help consumers learn how to properly dispose of unwanted medications in order to reduce their threat to the environment. Additionally, the EPA has conducted various studies to assess the impacts of ECs on fish and the water quality implications of ECs used in livestock and poultry production. However, much research is still needed before regulations can be made. In preparation for future regulations, the EPA has created Contaminated Candidate List 3, which includes 104 chemicals and 12 microbiological contaminants that have been identified as occurring in public water systems and that pose a potential threat to public health [22]. The EU's Priority Substances Directive limits the concentrations of priority substances in ground and surface water bodies under the Water Framework Directive (WFD) in order to protect ecological health and drinking water sources. In 2011, the development of a watch list was proposed that would target the monitoring of ECs as part of the WFD's ongoing monitoring activities across the EU [23]. In 2013, 15 ECs were added to the watch list, including two estrogenic compounds and a painkiller [24]. After more research has been conducted, contaminants from the watch list may be placed on the priority substances list.

### 3 Pathways to Drinking Water Sources

ECs enter the environment from various pathways. The major sources include runoff and leaching from agricultural fields and effluent from wastewater treatment plants (domestic, hospital, and industrial). These sources have been studied at a variety of scales and locations nationally and internationally. ECs have also been detected in water that does not appear to be impacted by wastewater effluent or agricultural runoff. Other sources of ECs in the environment include leaching from landfills and septic tanks and the discharge of raw sewage into rivers and streams during combined sewer overflow (CSO) events. This section provides an overview of these pathways that ECs take to reach surface and groundwater.

### ***3.1 Pathways to Surface Water***

Contaminants in surface water originate from municipal wastewater, industrial wastewater, combined sewer overflow, hospital wastewater, and land application of human and animal wastes.

#### **3.1.1 Municipal Wastewater**

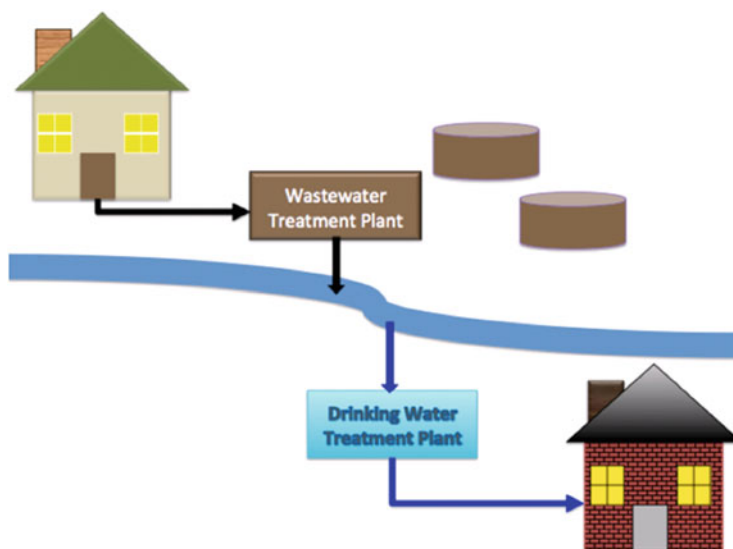
Products that we use in our everyday lives become part of the wastewater stream after use. We excrete medications that we take, as our bodies do not absorb all of the active ingredients. Active ingredients in products that we use for personal hygiene, such as shampoo, soap, deodorant, and cosmetics, are washed down the drain and become part of the wastewater stream.

Municipal WWTPs were not designed to remove ECs. Many plants in the United States were built in the mid-1900s, long before many of the contaminants classified as ECs even existed. Additionally, the EPA does not currently regulate the concentrations of these chemicals in wastewater effluent. Therefore, any removal during the wastewater treatment process is coincidental rather than intentional. The size, age, type of treatment processes, and operation of the WWTP all influence the removal rate of ECs.

Effluent from WWTPs is generally discharged to rivers and streams. Water from these surface water bodies may be the source water for drinking water treatment plants downstream. Figure 1 illustrates how wastewater generated from one household may become drinking water for someone living downstream. Because wastewater and drinking water treatment plants have varying removal efficiencies, some studies have found ECs in finished drinking water. The removal efficiencies of treatment technologies are discussed in Sect. 4.

#### **3.1.2 Industrial Wastewater**

Wastewater generated during the manufacturing of industrial and household products is a source of ECs to the environment. Often, wastewater generated by these manufacturing plants is treated prior to being sent to municipal wastewater treatment plants. However, ECs are not regulated, and therefore the discharge permits for these manufacturing plants do not include ECs. The USGS conducted a national study to assess the contribution of manufacturing plants to the release of pharmaceuticals to the environment. This study found that municipal WWTPs that received a significant amount of wastewater from pharmaceutical manufacturing facilities (>20 %) had effluent EC concentrations 10–1,000 times higher than municipal WWTPs that did not receive this type of wastewater [25].



**Fig. 1** Schematic of pathway emerging contaminants taken from use at one person's home to consumption at another

### 3.1.3 Combined Sewer Overflow Events

In the early 1900s, many cities in the United States installed combined sewer systems (CSSs) to collect both storm water and wastewater. During rain events, the combined volume of storm water runoff and wastewater can exceed the capacity of the WWTP. To prevent backup of sewage in residential areas, the mixture of storm water and wastewater is released to receiving waters (typically rivers or streams) untreated. Such an event is called a combined sewer overflow (CSO) event. More than 700 cities in the United States, primarily those located on the east coast, near the Great Lakes, and in the Pacific Northwest, have CSSs. CSSs are also present in Europe and other parts of the world.

Various studies have been conducted to assess the contribution of CSOs to ECs in receiving water bodies. Buerge et al. [26] used caffeine as an anthropogenic marker and conducted a mass balance to estimate the contribution of CSOs to streams in Switzerland. Caffeine loads exported by the streams were normalized on a per capita basis and found to be up to 10 times higher during CSO events than during normal flow conditions, suggesting that CSO events were responsible for a large contribution of ECs to these receiving streams. In the United States, Boyd et al. [27] found ibuprofen and triclosan concentrations in New Orleans stormwater canals receiving water from both sanitary and storm sewers. The study attributed the increased EC concentrations to the discharge of untreated sewage following rainfall events of 7 cm or greater.

In the Lake Champlain Basin, Phillips and Chalmers [28] initiated a study of the occurrence of organic wastewater compounds (OWCs), which are classified as ECs. They found that CSO events and urban storm runoff contributed to the presence of OWCs in Lake Champlain. Specifically, the OWCs that were effectively removed during wastewater treatment were found in CSO effluent at concentrations that were similar to or greater than in WWTP effluent. Caffeine, a flame retardant, and cholesterol had higher mass loadings in the CSO effluent than in the WWTP effluent. The results of this study emphasized the importance of identifying and treating waters that bypass normal wastewater treatment processes as part of the efforts invested in decreasing the amounts of OWCs entering receiving waters.

### 3.1.4 Hospital Wastewater

The wastewater generated by hospitals contains a wide variety of pharmaceuticals, disinfectants, and other compounds used for medical purposes that are classified as ECs. The diagnostic, research, and laboratory activities contribute to the presence of these compounds in wastewater, along with the excretion of pharmaceuticals and their metabolites by patients. Despite the differences in the levels of contaminants in domestic and hospital wastewater, hospital wastewater is generally sent to municipal WWTPs, often without any pretreatment. Sometimes hospital wastewater is disinfected using chlorine, but when pretreatment is used, it is generally for wastewater generated by the infectious disease ward of the hospital and not necessarily for all of the wastewater generated by the entire hospital [29]. Therefore, hospital wastewater has the potential to be an important source of ECs to municipal WWTPs.

Verlicchi et al. [30] compared the quality of urban and hospital wastewater using data collected and published in dozens of studies. Standard parameters used to evaluate wastewater quality include biochemical oxygen demand ( $BOD_5$ ), chemical oxygen demand (COD), and suspended sediment concentrations. Verlicchi et al. [30] found that each of these values was 2–3 times higher for hospital than urban wastewater. The average concentrations of ECs in hospital wastewater ranged from 1 to 150 times higher than EC concentrations in urban wastewater. Hormones and beta-blockers were on the same order of magnitude in both wastewater types. Analgesics, antibiotics, and cytostatics were present in hospital wastewater at concentrations up to 10–15 times greater than in urban wastewater. Some heavy metals (gadolinium and platinum) were 55–90 times higher in hospital wastewater. Iodine-based contrast media (ICM), used in radiology, was up to 150 times higher in hospital wastewater compared to urban wastewater. These elevated levels of many ECs in municipal WWTP effluent suggest that hospital wastewater can be a significant source of ECs to the environment, as the municipal WWTPs are not able to significantly reduce the elevated levels of ECs coming from hospital wastewater sources.



### 3.1.5 Land Application of Human and Animal Wastes

Land application of treated sewage sludge, commonly referred to as biosolids, offers the benefits of improving soil structure and fertility, given their richness in nutrients and organic matter [31]. In 2004, more than 6 million metric tons of biosolids were generated in the United States, and more than 50 % were land applied to agricultural fields [32]. Similarly, animal waste generated by animal feeding operations (AFOs) is often applied to agricultural fields as a nutrient source. Each year, over 50 million metric tons of manure is produced in the United States, with the majority being land applied. These wastes are known to be a source of ECs to the environment. Biosolids from municipal WWTPs contain natural hormones and a wide array of PPCPs. Manure contains natural hormones and veterinary pharmaceuticals.

While the land application of biosolids and manure is an excellent mechanism for managing waste, the contaminants that they contain can reach surface water via surface runoff. Various studies have reported ECs in surface runoff from fields following application, with some evidence of elevated concentrations in surface runoff for extended periods of time (i.e., several months) after application [33–37].

The presence of tile drains in agricultural fields also contributes to the presence of ECs in surface water bodies. Tile drains are a network of perforated pipes installed ~1 m below the soil surface to keep the water table below corn roots. They are generally installed in poorly drained soils in which corn is grown in order to provide the roots with the aerobic conditions they need to achieve desired yields. Although tile drains improve the efficiency of corn production, the reduction in the water holding capacity of the fields results in an increased amount of water discharged into nearby ditches and streams. Studies have shown that tile drains contribute to the presence of ECs in surface water bodies [36–38].

## 3.2 Pathways to Groundwater

Contaminants in groundwater can originate from rapid flow pathways, landfill leaching, and septic tanks.

### 3.2.1 Rapid Flow Pathways

The extent to which soil can act as an effective biogeochemical filter is directly related to the amount of time that a solute spends within the soil profile before reaching groundwater. This residence time is a function of physical soil properties (e.g., depth to groundwater, porosity), hydroclimatic properties (e.g., rainfall frequency, intensity, and depth), and solute properties (e.g., sorption coefficient, degradation rate constant). The ratio of the residence time to the rate of solute

degradation is a useful indicator of the extent to which the soil can effectively filter the soil prior to release to groundwater. The more effectively the soil acts as a filter, the lower the solute delivery ratio, which is calculated as the mass of solute that reaches the groundwater as a fraction of the mass applied to the soil surface. If the amount of time the solute resides in the soil is long compared to the rate at which it degrades, then the solute delivery ratio will be small. Conversely, the amount of solute mass that reaches groundwater is larger when the residence time is short compared to the degradation rate.

Soil structure plays an important role in controlling solute residence time and delivery ratio. Soils without preferential flow pathways are more effective biogeochemical filters because the residence time is longer compared to soils with extensive preferential and macropore flow pathways. These pathways enable solute transport to be short-circuited through the soil profile to groundwater and provide little opportunity for the solute to interact with the soil matrix, limiting sorption. Therefore, the activation of these flow pathways can cause significant solute transport. In cases when groundwater is shallow, solute residence time in these pathways can be on the order of hours. Without significant loss to the soil matrix via sorption and without significant loss via degradation due to the short travel times, the delivery ratio through these pathways can approach 1. The overall delivery ratio of the solute through the soil profile can be calculated as the sum of the delivery ratio through each pathway. Because the matrix delivery ratio is likely to be small for most ECs, the overall delivery ratio is limited by the fraction of water that is transported through these preferential flow pathways.

The results of some field-scale studies observed rapid transport of hormones to tile drains following manure applications to agricultural fields [36, 38], suggesting the importance of rapid flow pathways to EC transport. Although some studies have found ECs in groundwater, the presence of ECs in surface water bodies is much more widespread. Reif et al. [39] analyzed well water samples collected from six sites in Pennsylvania for 44 ECs, and only one compound (cotinine, a metabolite of nicotine) was detected. However, as many as 51 different compounds were detected in samples collected from streams across the state.

### 3.2.2 Landfill Leaching

The vast majority of the products we use eventually make their way to a landfill. Additionally, much of the biosolids that are not land applied are disposed of in landfills. Although landfills are lined to minimize leaching of contaminants to groundwater, leaching still occurs. Landfill leachate has the potential to be another source of ECs to the environment [40, 41].

Several studies have identified ECs in landfill leachate. Andrews et al. [42] sampled leachate from three landfill cells containing wastes of various ages: >25 years old, 3–16 years old, and an operating cell with wastes less than 5 years old. ECs were detected in leachate from each cell, with concentrations ranging from 0.11 to 114  $\mu\text{g/L}$ . The ECs detected included sterols of human and plant origin,

PPCPs, industrial compounds, hydrocarbons, and pesticides. The type of ECs found in leachate from each cell varied, with four ECs detected exclusively in leachate from the oldest cell, two exclusively in leachate from the intermediate cell, and none exclusively in the leachate from the operational cell. These results suggest that the age of the waste contained in a landfill may influence the types of ECs leaching. Eggen et al. [43] collected leachate samples from three landfills in Europe. Leachate samples contained flame retardants, plasticizers, insecticides, and PPCPs (ibuprofen, naproxen, and musk compounds) at concentrations on the ng and  $\mu\text{g/L}$  level. ECs were detected in both the aqueous and particulate phases of the leachate and were found to pose a threat to groundwater quality. Treatment technologies, which are commonly applied for landfill leachates, and based on short-term biological degradation, aeration, and sedimentation processes, may not be effective for removal of ECs. It may be necessary to apply other treatment processes such as membrane filtration or reverse osmosis in order to effectively reduce leachate concentrations [43].

### 3.2.3 Septic Tanks

Approximately 25 % of the US population has on-site septic tanks to treat their wastewater [84]. Discharge from septic tanks is released to groundwater, which is potentially problematic, as people with septic tanks generally get their drinking water from groundwater. Despite the potential importance of septic systems as a source of EC contamination in groundwater, Schaidler et al. [44] conducted a literature review and found that less than 20 studies have been conducted to investigate the ability of septic systems to remove ECs from wastewater influent. Of the studies that were conducted, removal is low within the septic tank itself due to anaerobic conditions that slow degradation processes [46, 47]. However, EC removal in leach fields is high due to sorption and aerobic conditions that promote faster degradation [45, 48]. The ECs found in septic tank leachate included antibiotics, prescription medications, over-the-counter medications, hormones, plasticizers, compounds from personal care products, flame retardants, and detergent metabolites [44]. The maximum concentrations of ECs detected in septic tank effluent were five orders of magnitude higher than those in leach field effluent; however, the median concentrations detected in leach field effluent were similar to those in municipal wastewater treatment effluent [44]. In addition to potentially contaminating groundwater, surface water may also be impacted by septic systems. Standley et al. [49] reported hormone concentrations in surface water whose headwaters were aquifers that were negatively impacted by septic systems.

### ***3.3 Spatial and Temporal Inequality***

This section describes the concept of inequality as it applies to transport of contaminants in natural systems.

#### **3.3.1 Quantifying Inequality**

In order to effectively reduce the export of ECs to water bodies, “hot spots” within watersheds and the periods of time during which they are most active (i.e., “hot events”) must first be identified. The heterogeneity and mixed land use typical of many watersheds generally cause small portions of the watershed to export disproportionately large solute loads to receiving water bodies. For example, in a watershed consisting of 20 % urban area and 80 % forest, hormone loads generated by the urban area are likely to contribute nearly 100 % of the loads exported by the entire watershed (neglecting endogenous hormones excreted by wildlife), despite comprising a much smaller fraction of the watershed’s area. Additionally, if the urban area contains combined sewer systems, the highest hormone fluxes are likely to occur during large rainfall events that cause the greatest amount of raw sewage to be discharged to nearby surface water bodies during combined sewer overflow events. Despite occurring perhaps 20 % of the time over the course of a year, these events might generate 80 % of the watershed’s annual hormone load. This example illustrates the Pareto Principle, which is also known as the 80-20 rule. In general, it means that a small portion of a population generates a disproportionately large percentage of an outcome. It is commonly used in economics to describe the inequality of distribution of money among people at various scales, but also has common applications in the natural world.

#### **3.3.2 Importance of Temporal Inequality**

While the quantification of temporal inequality in water quality and quantity data is new [50], prior studies demonstrated a general understanding of the disproportionate contribution of high-flow events to annual discharge and loads. One such study conducted by Royer et al. [51] collected long-term (8–12 years) discharge and nutrient data at three tile-drained watersheds in Illinois ranging from 101 to 481 km<sup>2</sup>. The results indicated that the export dynamics are highly seasonal, with the majority of export occurring in the late winter and spring months. These months generally experience large rainfall events resulting in periods of high flow. Discharges classified as extreme (i.e.,  $\geq 90$ th percentile) were responsible for more than 80 % of the dissolved reactive phosphorus loads and more than 50 % of the nitrate loads. Additionally, Richards et al. [52] found that over a 20-year period (1975–1995), more than 70 % of total phosphorus, soluble reactive phosphorus, nitrate, and suspended solids were exported from four predominantly agricultural

catchments in the Lake Erie Basin (88–16,400 km<sup>2</sup>) during storm runoff periods that accounted for ~1/3 of the time.

To conduct this kind of analysis, water quality data must be collected during periods of high flow. Grab samples collected at periods of time such as monthly are not likely to enable such an analysis, unless data were collected for a sufficiently long period of time to capture the full range of discharge. While such data sets are not uncommon for nutrients and other traditional contaminants, few sufficient data sets exist for ECs, and therefore our understanding of the temporal dynamics of EC export is weak. The data that do exist, however, suggest that EC loads exhibit high temporal inequality. Most field studies have found positive relationships between concentration and discharge. These chemograph dynamics cause the majority of export to occur during large storm events, as high concentrations are generally associated with periods of high flow. Gall et al. [37] calculated hormone loads exported during a 17-month study period at a tile-drained agricultural site in Indiana. The results of the study indicated high temporal inequality for hormone export, with 80 % of hormone loads exported during high flow occurring during 9–26 % of the study period. Similar to conclusions made by Royer et al. [51] and Richards et al. [52], the majority of the hormone export occurred during late winter and early spring during large rainfall events.

### 3.3.3 Importance of Spatial Inequality

Similar to temporal inequality, spatial inequality implies that portions of a watershed contribute disproportionately large contaminant loads to a receiving water body. This is generally done by calculating annual loads exported from sub-watersheds on a per area basis (i.e., kg/km<sup>2</sup>) and identifying locations that have the highest values. Such studies have been conducted to identify nutrient “hot spots” or “critical zones” in the Chesapeake Bay Watershed and Mississippi River Basin in order to better understand the sources that are contributing to hypoxia in these water bodies. This type of analysis has led to the identification of four critical nutrient hot spots in the Chesapeake Bay Watershed that coincide with animal production operations [53].

Due to the widespread presence of ECs in streams and rivers, such a spatial analysis for these compounds would prove useful in locating EC hot spots. The land use at these locations could then be investigated to identify the sources causing the highest loads within a particular watershed. Such an analysis would help us to better understand the relative contributions of the various pathways discussed in Sect. 3.1 to ECs in surface water bodies. Appropriate management plans to reduce loads could then be focused on these hot spots.

### 3.3.4 Implications for Best Management Practices

Due to local, regional, and national concerns regarding erosion, eutrophication, and coastal hypoxia, widespread efforts have been made to encourage the adoption of best management practices (BMPs). In general, BMPs is a term that refers to methods of controlling and reducing the transport of contaminants to receiving ground and surface water bodies. Urban BMPs aim to reduce the amount of stormwater runoff generated during rainfall events in an effort to mitigate the increase in runoff volume associated with an increase in impervious area and to improve water quality. Common examples of urban BMPs include green roofs, rain gardens, rain barrels, and porous pavement. Agricultural BMPs generally focus on reducing the transport of sediment, nutrients, and pesticides. BMPs include source management, such as the timing and amount of nutrient and pesticide applications; on-field practices, such as conservation tillage and cover crops; and practices that help to mitigate contaminants in stormwater runoff, such as constructed wetlands and conservation buffers.

Additional efforts have been made to understand the barriers to adoption of BMPs and to evaluate the effectiveness of various BMPs. However, many paired watershed studies have shown that the implementation of BMPs has little to no reductions in nutrient concentrations and loads [54, 55]. The large uncertainty regarding BMP effectiveness and long lag times between implementation and water quality improvement are problematic for promoting BMP adoption [56]. Additionally, the types of BMPs generally implemented by land owners are most effective at reducing loads during periods of low flow, rendering their overall benefits minimal to water quality improvements at larger temporal and spatial scales.

The consistent spatial and temporal patterns suggest that BMPs must effectively reduce loads during high-flow events from high load-generating areas in order to significantly improve downstream water quality. Properly identifying these “windows of opportunities” and “hot spots” is essential for targeting BMPs to mitigate loads in the most effective manner. These trends suggest that reducing loads during only a few high-flow events from a few locations (i.e., “hot spots”) can have a disproportionately large benefit to water quality. Therefore, properly assessing and quantifying the temporal and spatial inequality of ECs will facilitate the optimal design and implementation of BMPs. This approach has the potential to ensure that investments made in BMPs will translate to water quality benefits.

## 4 Removal in Treatment Plants

The growing awareness of ECs in drinking water sources has led to the need to understand the removal of these compounds during wastewater treatment processes. Since these compounds generally do not have surface or drinking water standards, there is no regulatory requirement for their removal during wastewater

and drinking water treatment. Therefore, any removal is coincidental rather than intentional. Treatment plants have a wide range of removal efficiencies, depending in part on the types of treatment technologies employed at the specific plant. The EPA synthesized the results of more than 80 studies into a report, which provides an assessment of the ranges of removal efficiencies for 16 selected ECs (bisphenol-A, caffeine, carbamazepine, DEET, diclofenac, estradiol, estrone, galaxolide, gemfibrozil, ibuprofen, iopromide, naproxen, nonylphenol, sulfamethoxazole, tri (chloroethyl) phosphate, and triclosan [57]). This section provides an overview of the current capabilities and efficiencies of commonly used treatment technologies to reduce the concentrations of ECs and brings attention to areas of innovative technologies that have the potential to improve removal efficiencies.

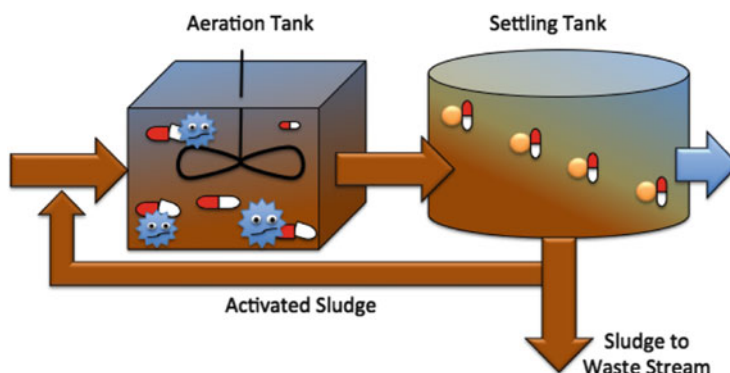
## ***4.1 Treatment Technology Removal Efficiencies***

Recent studies have been conducted to evaluate the removal efficiencies of various municipal wastewater and drinking water treatment processes: activated sludge, granular activated carbon, reverse osmosis, and disinfection. These treatment technologies and their removal efficiencies are discussed below.

### **4.1.1 Activated Sludge Treatment Process**

The activated sludge wastewater treatment process is the most commonly used secondary treatment in the United States. It consists of two stages, as shown in Fig. 2. The first stage consists of an aerated tank in which microbial growth is promoted to remove organic matter. The second stage is a clarifier, which is a settling tank designed to remove solids via gravitational settling. The solids are referred to as activated sludge. A portion of the activated sludge is returned to the aeration tank, and the rest becomes part of the treatment plant's waste stream.

This treatment process has a wide range of removal efficiencies for ECs, with an average removal of 22 % for carbamazepine and 94 % for caffeine. The overall average removal efficiency for all 16 ECs included in the EPA's report in the activated sludge treatment process is approximately 70 % [57]. These removal efficiencies refer to the removal of ECs from the treated water. The primary removal mechanisms are biodegradation in the aeration tank and sorption to the solid materials that enter the waste stream. Therefore, the half-life and partition coefficient play important roles in the amount of ECs removed from the water during this treatment process. Because a portion of the activated sludge stream is returned to the aeration tank, the ECs contained in this activated sludge reenter the tank. Additionally, the ECs in the activated sludge that becomes part of the waste stream may be introduced into the environment if these biosolids are land applied.



**Fig. 2** Removal of emerging contaminants, represented as pills, in the activated sludge treatment process by biodegradation (*left*) and settling of particulate matter to which they are sorbed (*right*)

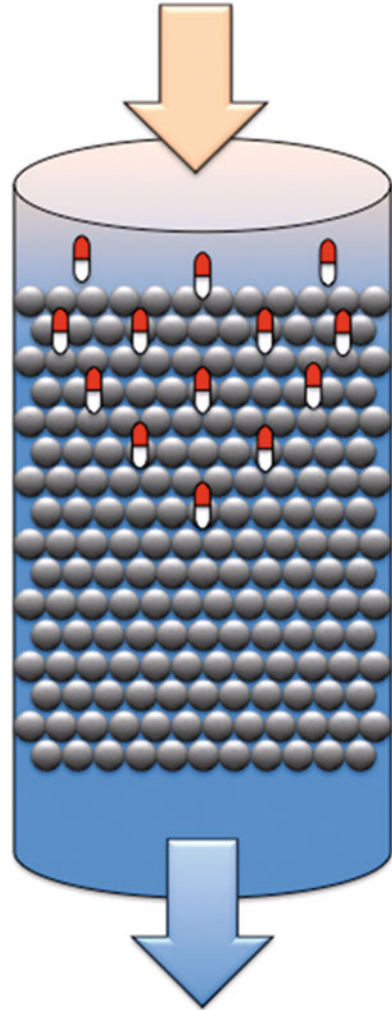
#### 4.1.2 Granular Activated Carbon

Granular activated carbon (GAC) is a commonly used media in granular filtration. It is widely used in household filtration systems to remove constituents in finished drinking water that cause an undesirable taste. At the larger scale, GAC is used in fixed bed columns (see Fig. 3) in the drinking water treatment processes, for further treating treated wastewater for water reuse, and can be used for tertiary wastewater treatment. GAC is an excellent sorbent, as it has a very high surface area. It performs best when the inflowing water is relatively clean, and is generally used to remove soluble organic compounds and inorganic compounds.

Many ECs are amenable to removal via adsorption onto GAC. The average removal efficiency for drinking water treatment ranges from 42 % for sulfamethaxazole to 79 % for gemfibrozil [57], with an overall average of ~60 %. For water reuse applications in which GAC is used to further treat the treated wastewater, the average removal efficiency of ECs ranges from 3.6 % for naproxen to 63 % for DEET [57], with an overall average EC removal efficiency of ~30 %. This lower average removal efficiency compared to drinking water treatment is likely due to the levels of EC concentrations present in the influent. As the wastewater effluent had already been treated, the 30 % average removal would be in addition to any removal that had already occurred during previous treatments. Therefore, the overall removal efficiency from untreated wastewater influent through treated effluent to water reuse standards would likely be significantly higher than 30 %, depending on the types of secondary and/or tertiary treatment used earlier in the treatment process.

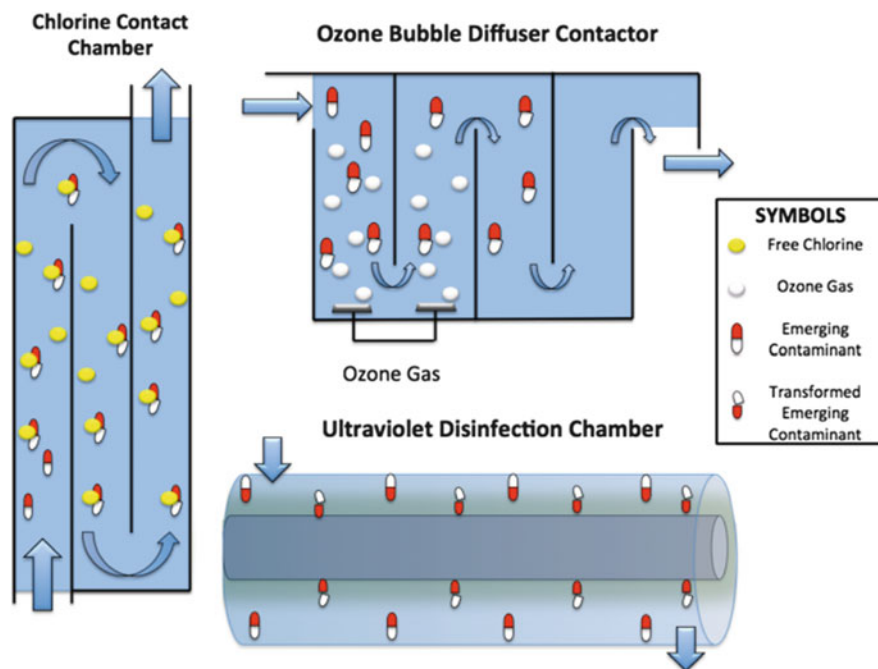


**Fig. 3** Removal of emerging contaminants, represented as pills, via adsorption to granular activated carbon (GAC) in a fixed bed column



#### 4.1.3 Disinfection

Disinfection is primarily used to inactivate pathogens present in water and wastewater. In drinking water treatment, this process is needed to protect consumers from exposure to pathogens at doses that could cause adverse health effects. In wastewater treatment, disinfection protects receiving water bodies and keeps pathogen levels low enough to enable the water to be used for recreational purposes. In some states, disinfection is not required during winter months when human contact with surface water bodies for recreational activities (e.g., swimming and fishing) is not expected.



**Fig. 4** Emerging contaminants, represented as pills, removed by three types of disinfection: chlorination, ozonation, and ultraviolet disinfection

There are three main types of disinfection: chlorine, ultraviolet (UV), and ozone (see Fig. 4). Overall average EC removal efficiencies for wastewater treatment were calculated based on the EPA's literature review [57] and were greatest for ozone ( $88 \pm 12\%$ ) and lowest for chlorine ( $65 \pm 27\%$ ). The average removal efficiency for treating drinking water was slightly higher for chlorine ( $39 \pm 16\%$ ) compared to UV disinfection ( $36 \pm 28\%$ ).

Disinfection is able to reduce ECs both directly and indirectly. Chlorine and ozone are strong oxidizers that can oxidize ECs, transforming them into other chemicals. UV disinfection cleaves bonds in ECs, transforming them into other compounds. UV disinfection can also indirectly reduce EC concentrations. The energy of UV light reacts with water, generating hydroxyl radicals. These radicals then react with ECs, causing them to transform into other compounds. The by-products of these reactions can sometimes be carcinogenic, as is often the case with chlorine disinfection. More research is needed on the products that form to assess whether the product compounds retain any endocrine disrupting properties. Although the disinfection by-products generated by ozone and UV are not as well understood as the by-products generated by chlorination, some disinfection by-products themselves are classified as ECs. For example, bromoform is a carcinogenic disinfection by-product classified by the USGS as an EC [39].

#### 4.1.4 Reverse Osmosis

Reverse osmosis is a type of membrane filtration that uses pressure to drive contaminant-laden water across a membrane (see Fig. 5). There are four types of pressure-driven membrane filtration, with the classification based on the size of the membrane pores: microfiltration (0.1–5  $\mu\text{m}$ ), ultrafiltration (0.01–0.1  $\mu\text{m}$ ), nanofiltration (0.001–0.01  $\mu\text{m}$ ), and reverse osmosis (0.0001–0.001  $\mu\text{m}$ ). Membranes can be selected to remove contaminants ranging from suspended particles (microfiltration) to dissolved compounds (nanofiltration and reverse osmosis). Therefore, reverse osmosis is necessary to remove ECs that are dissolved in the influent. Due to the very small pore size, reverse osmosis requires a significant amount of pressure to drive the influent across the membrane and is therefore an expensive treatment technology. However, the removal efficiencies for ECs are very high, with an overall average of  $95 \pm 6\%$  for water reuse applications for which treated wastewater is the influent [57].

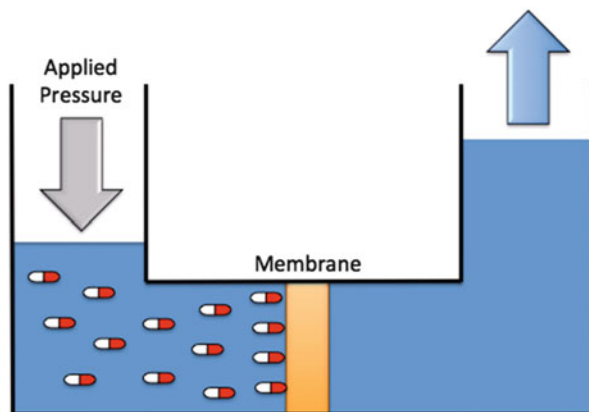
#### 4.1.5 Transformation Products

The removal efficiencies discussed in this section should not necessarily be interpreted as being equivalent to the removal of endocrine disrupting properties. The removal efficiencies were calculated based on the removal of a specific EC, but degradation metabolites and products of chemical reactions may possess endocrine disrupting or carcinogenic properties. Therefore, more research is needed to understand the products that are generated during treatment. For removal mechanisms that are physical rather than microbiological or chemical, the removal efficiency is likely equivalent to the removal of associated endocrine disrupting properties, as the parent compound has been removed via sorption, settling, or size exclusion (i.e., membrane filtration) and no products or metabolites were produced during these removal mechanisms.

### 4.2 *Technology Innovations*

In March of 2013, the EPA issued its first version of a “Blueprint for Integrating Technology Innovation into the National Water Program.” The document emphasized the serious water-related challenges that our country faces, including ECs. The purpose of the blueprint is to promote technological innovations that can help the United States to meet today’s demands for clean and safe water and to cope with the many challenges that will continue to face the US water resources. This section provides an overview of published work regarding lab- and pilot-scale studies of traditional treatment technologies and also presents an overview of state-of-the-art

**Fig. 5** Removal of emerging contaminants, represented as pills, using reverse osmosis membrane filtration



emerging technologies that have received high-profile funding for their potential to treat emerging contaminants.

#### **4.2.1 Lab- and Pilot-Scale Studies of Traditional Treatment Technologies**

In addition to the full-scale treatment technologies discussed in the previous section, some pilot- and lab-scale studies have been conducted to test the removal efficiencies of various treatment technologies for ECs. Far fewer studies have been conducted for removal during drinking water treatment compared to wastewater treatment. One pilot-scale study on drinking water treatment using ozonation found a 99 % removal efficiency of clofibric acid and naproxen [57, 58]. Two lab-scale studies assessed the removal efficiency of chlorine disinfection on caffeine, salicylic acid, trovafloxacin, and estradiol and found average removal efficiencies ranging from 42 % to 60 % [57, 59]. No data have been reported for the removal efficiencies of these compounds in full-scale drinking water systems.

Typically, removal efficiencies are higher in lab-scale studies than full-scale studies. However, data across scales are not currently comparable for many compounds of interest, and therefore studies that assess removal efficiencies of the same compounds for the same types of technologies across scales are needed. Then, lessons learned from bench-, lab-, and pilot-scale studies can be applied to improve removal efficiencies in full-scale treatment plants.

#### **4.2.2 Pilot-Scale Subsurface Flow Constructed Wetlands**

Constructed wetlands are sometimes used in wastewater treatment to remove nitrogen and phosphorus prior to discharge to receiving water bodies to prevent eutrophication. Some pilot-scale studies have been conducted to assess the ability

of subsurface flow constructed wetlands to remove ECs. Matamoros et al. [60] found that shallow beds performed better than deeper beds, likely due to more oxidized conditions. Additionally, they found the removal efficiencies in shallow beds were higher than removal in WWTPs in Germany and Brazil. Matamoros and Bayona [61] tested a pilot-scale subsurface flow constructed wetland's ability to remove PPCPs from residential wastewater in a 200-person urban housing development. They classified the compounds based on their removal efficiencies. Those classified as efficiently removed had a removal efficiency >80 % and included caffeine and salicylic acid. Moderately removed compounds had removal efficiencies of ~50 % and included ibuprofen and naproxen. Recalcitrant compounds included ketoprofen and diclofenac.

Although subsurface flow constructed wetlands may be appropriate for the removal of some ECs, others can actually exhibit greater endocrine disrupting properties after treatment. Some data suggest that under anaerobic conditions, the estrogen metabolite, E1, may convert back to its parent compound, 17 $\beta$ -E2 [62]. 17 $\beta$ -E2 is a more potent estrogenic compound than E1, and therefore the use of anaerobic treatment technologies has the potential to cause more harm than good with respect to the treatment of estrogenic compounds. Therefore, more research is needed to determine when different types of treatment technologies are appropriate. Results of this research will be critical to the development of recommendations for best management practices for treating wastewater.

### 4.2.3 Emerging Research for Emerging Contaminants

Current research on innovative technologies for treating emerging contaminants shows promise for improving the removal efficiency of ECs in wastewater. A brief overview of three areas of innovation is given in this section: photocatalysis, membrane bioreactors, and the Eco-Machine<sup>TM</sup>.

Some research has shown that ECs can undergo phototransformation in aquatic environments. This phototransformation is generally thought to play a minor role in the fate and transport of ECs [63]. However, there is potential for this process to be exploited for water treatment purposes. Photocatalysis uses a catalyst to accelerate the rate at which photoreactions occur. Liang et al. [64] built titanium dioxide (TiO<sub>2</sub>) anatase phase nanobelts to photocatalyze the oxidation of pharmaceuticals in wastewater. Over a period of 90 min, naproxen, theophylline, and carbamazepine concentrations were reduced by more than 90 %, suggesting that even some of the most persistent ECs can be removed effectively with photocatalysis [64]. Encinas et al. [65] found that the presence of other organic and inorganic compounds interferes with the effectiveness of photocatalysis. Therefore, it is likely that this technology would be best used as a tertiary treatment [65, 66].

Membrane bioreactors are an emerging technology in wastewater treatment. They are particularly attractive for water reuse applications, as they are able to produce high-quality effluent [67]. Trinh et al. [67] found that although the ability of membrane bioreactors to remove regulated organic contaminants was very high

(>90 %), the removal efficiencies for pharmaceuticals were lower (24–68 %). Forrez et al. [68] applied biogenic metals (manganese oxides and palladium) in membrane bioreactors at the laboratory scale as oxidative and reductive agents. This increased the removal efficiency of membrane bioreactors for PPCPs, with efficiencies ranging from 52 % to 95 %. The removal efficiencies for naproxen, codeine, and ibuprofen were greater than 90 %, while triclosan was ~70 %, and sulfamethoxazole was ~50 % [68].

The National Science Foundation (NSF) has currently invested in a project at The Pennsylvania State University to investigate the potential of fungi and bacteria to remove emerging contaminants in wastewater treatment plants [69]. Dr. Rachel Brennan's research group is currently conducting research at Penn State's Eco-Machine<sup>TM</sup>, a living, sustainable wastewater treatment plant. The goal of the research is to first identify the mechanisms used by fungi and bacteria to remove these contaminants and then develop ways to enhance these removal mechanisms. This research is expected to provide a significant cost savings over traditional wastewater treatment technologies and has the potential to establish a new paradigm for treating wastewater in a holistic manner.

## 5 Public Awareness

Over the past decade, the public has become increasingly aware of the presence of pharmaceuticals in drinking water sources. Numerous news articles have been published on this topic, and as the public's awareness increases, people are confronted with new decisions to make regarding their everyday habits. This section explores the issues surrounding ECs from a public perspective.

### 5.1 *Is Ignorance Bliss?*

As the general public becomes increasingly aware of the presence of ECs in their drinking water sources, are concerns that people have with respect to their personal health justified? Or is ignorance bliss? Although ECs are known to be harmful to aquatic organisms, these species are much more sensitive to the endocrine disrupting properties of many of these compounds than humans. Currently, there is no proof that consumption of ECs at such low levels is harmful to humans. The extremely low concentrations of ECs in drinking water suggest that people would need to consume a very large amount of water in order to receive the equivalent dose of one medication. Benotti et al. [70] collected data regarding the presence of ECs in drinking water for more than 28 million people in the United States. The most commonly detected pharmaceuticals were atenolol, carbamazepine, gemfibrozil, naproxen, and sulfamethoxazole. Based on the maximum concentrations detected in drinking water sources in this study, Table 4 shows the volume of water

**Table 4** Volume of water needed to consume to receive one dose of various medications

Compound (type of medication)	Maximum concentration in drinking water sources <sup>a</sup> (ng/L)	Dose <sup>b</sup> (mg)	Amount of water to consume one dose (L)
Atenolol (beta-blocker)	36	50–100	1,400,000–2,800,000
Carbamazepine (anticonvulsant)	51	800–1,200	15,700,000–23,500,000
Gemfibrozil (lipid regulator)	24	600	25,000,000
Naproxen (anti-inflammatory)	32	500–1,500	15,600,000–46,900,000
Sulfamethoxazole (antibiotic)	110	800	7,300,000

<sup>a</sup>Source: Benotti et al. [68]

<sup>b</sup>Source: <http://www.rxlist.com>

that would need to be consumed to receive the equivalent of one dose. For reference, the EPA recommends consuming 2 L of water per day. Therefore, the risk associated with drinking water containing even the maximum concentration of pharmaceuticals detected appears very low. However, ECs are known to behave in poorly understood synergistic ways in fish. The presence of multiple compounds in water appears to have a multiplicative effect, with the adverse impacts higher than would be predicted based on known effects of the concentrations of each individual compound. Therefore, there are potential concerns regarding the risks associated with consuming water tainted by low levels of many different contaminants (i.e., “contaminant cocktails”). The synergistic effects of compounds present in contaminant cocktails must be better understood so that the risks associated with consumption of drinking water containing multiple ECs can be better calculated.

An increase in public awareness has led to an increase in proper disposal of medications. Many educational campaigns have been launched in the United States at local and national levels to discourage the flushing of unwanted medications down toilets and discarding them in the trash. Municipalities across the United States have set up unwanted medication drop boxes, in which people can bring medications that expired or are no longer needed. These drop boxes have been very successful, with some bringing in hundreds of pounds of medications over the course of a year. In the United Kingdom, called “Only Order What You Need” (<http://www.medicinewaste.com>) was launched to educate the public about issues surrounding the improper disposal of unwanted medications and to provide information on where unwanted medications can be brought. Any unused and expired medications can be returned to pharmacies for proper disposal.

## 5.2 *Is Bottled Water Better?*

As people become more concerned about the quality of the drinking water supplied to them from their municipality or private well, bottled water consumption over the past few decades has experienced significant growth [71]. Regulations set by the EU's Drinking Water Directive apply to all drinking water, including bottled water. However, the EPA drinking water standards for tap water do not apply to bottled water, and therefore the exposure to potentially harmful contaminants in bottled water is largely unknown and difficult to assess [72]. Potential sources of organic pollutants in the bottled water may include the presence of pollutants in the water source, contaminant from the bottling plant, or the plastic containers themselves [73, 74].

Devier et al. [75] conducted an analysis to test for the presence of ECs, including hormones and other endocrine disrupting compounds, in Evian® and Volvic® brands of bottled water. The study found no detectable levels of 120 organic compounds that were tested, but did detect pharmaceuticals, alkylphenols, and phthalates. The detected pharmaceuticals were ketoprofen, salicylic acid, and caffeine. However, the study also reported the presence of the same contaminants in laboratory procedural blanks, which are used as part of the quality assurance and quality control protocol. This suggested that the contamination was likely introduced by the laboratory during analysis rather than in the bottled water itself. The source of water for these two brands is groundwater. Therefore, the absence of ECs in these two bottled water brands confirmed the effectiveness of the natural geologic protection and the long-term protection policies implemented on their watersheds. The study also tested for contaminants that may potentially originate from the plastic bottle itself, such as polypropylene terephthalate (PET), and the results confirmed that no leaching of the targeted compounds occurred under the test conditions.

The presence of bisphenol A (BPA) in water bottles is another issue that has gained widespread public recognition and led to an increased development of BPA-free products. BPA is known to be estrogenic and to possess endocrine disrupting properties. Cooper et al. [76] conducted a study to assess BPA release from reusable water bottles known to contain BPA (i.e., made from polycarbonate plastics) and those that claimed to be BPA free. Water stored in polycarbonate bottles had BPA concentrations of 0.2–0.3 mg/L. Water stored in aluminum bottles with epoxy-based resin lining had BPA concentrations ranging from 0.08 to 1.9 mg/L. Under extreme circumstances (e.g., boiling the water and then storing it in the reusable bottles), BPA leached at even higher levels. However, their results were encouraging in that they found that as long as the BPA-free bottles were used according to the manufacturer's instructions, products marketed as BPA free did not release BPA and effectively protected water from BPA contamination.



## 6 Conclusions

In general, the public sees any detectable levels of contaminants in their drinking water as undesirable, even if the risk associated with consumption of low levels of contaminants is extremely low. People accept much greater risks in their everyday lives, such as driving in a car, than the risks associated with drinking water that has been treated to EPA standards. However, since the risks associated with chronic consumption of low levels of unregulated ECs are not well understood, it is understandable that people would prefer ECs to be undetectable in their drinking water sources. As technology continues to improve, the detection limits for compounds decrease, making it possible to detect contaminants at increasingly lower concentrations. The cost associated with treating water to a level at which ECs would be present at concentrations below instrument limits of detection would be many times higher than the rates we currently pay for tap water. Therefore, the public is likely going to have to accept the presence of detectable levels of ECs in their drinking water, especially if the drinking water source is a surface water body. The EPA currently has a list of ECs that are candidates to be regulated. However, significant research is still needed before the risks associated with the long-term consumption of “contaminant cocktails” are better understood, and regulations are likely still years away.

Without regulations to reduce the discharge of ECs to the environment, one of the best ways to reduce the presence of ECs in the environment is to manage their sources more effectively. This approach is a preventative one, which aims to reduce ECs at their sources rather than treating them once they enter the water cycle. Education and outreach programs are likely the best chance we currently have to change human behavior and, in turn, reduce the presence of ECs in drinking water sources.

Because a significant source of ECs in the environment is from the land application of animal and human wastes, management strategies that reduce the presence of ECs in these wastes prior to their land application would reduce the amount of ECs introduced into the environment. Often, land application of wastes occurs based on the nitrogen (N) demand of crops. Due to different demands of crops for N and phosphorus (P) compared to the amounts of these nutrients in animal manure [77] changing to applications based on the P demand of crops would reduce application rates, thereby reducing the amount of ECs inadvertently applied to agricultural fields [78]. Additionally, various studies suggest that composting animal manure reduces EC concentrations [79–85].

Because the manufacturing and everyday usage of PPCPs contribute to ECs in the environment, we should make informed decisions about the products we buy and the ways in which we dispose of unwanted medications. It is becoming more common for municipalities to hold unwanted medication collection drives to encourage the proper disposal of these products. Because of successful educational and outreach programs, people are responding positively to these collection drives and are happy to be provided with the opportunity to be good environmental

stewards. Additionally, we drive industry with the purchasing decisions we make. Choosing to purchase personal care products made with natural ingredients can reduce our EC footprints.

It will take a collective effort to make source management successful. Although each individual action of land managers and consumers may seem small, an individual's decisions can influence the behavior of others. Collectively, these individual decisions can help to establish grassroots support for policy changes. Overall, the health of our aquatic ecosystems and the long-term sustainability of our water resources depend on the collective outcome of our individual decisions.

## References

1. USEPA (2010) Pharmaceuticals and personal care products. 28 October. <http://www.epa.gov/ppcp/faq.html>. Accessed 22 Jan 2014
2. Kaiser Family Foundation (2010) Prescription drug trends. <http://www.kff.org/rxdrugs/upload/3057-08.pdf>. Accessed 29 Jan 2014
3. United States (2008) Emerging contaminants in U.S. waters: Hearing before the Subcommittee on Water Resources and Environment of the Committee on Transportation and Infrastructure of the House of Representatives. 100th Cong. 2. September 18
4. Layton L (2010) U.S. Regulators lack data on health risks of most chemicals. The Washington Post, 2 August. <http://www.washingtonpost.com/wp-dyn/content/article/2010/08/01/AR2010080103469.html>
5. Kolpin DW, Furlong ET, Meyer MT, Thurman EM, Zaugg SD, Barber LB, Buxton HT (2002) Pharmaceuticals, hormones, and other organic wastewater contaminants in U.S. Streams, 1999–2000: a national reconnaissance. *Environ Sci Technol* 36:1202–1211
6. Associated Press (2008) Pharmaceuticals in water: 46 million americans drinking. [http://hosted.ap.org/specials/interactives/\\_national/pharmawater\\_update/index.html](http://hosted.ap.org/specials/interactives/_national/pharmawater_update/index.html). Accessed 11 Oct 2013
7. Leet JK, Gall HE, Sepúlveda MS (2011) A review of studies on androgen and estrogen exposure in fish early life stages: effects on gene and hormonal control of sexual differentiation. *J Appl Toxicol* 31:379–398
8. United States Geological Survey (2013) Emerging contaminants in the environment. <http://toxics.usgs.gov/regional/emc/>. Accessed 19 Aug 2013
9. Lange IG, Daxenberger A, Schiffer B, Witters H, Ibarreta D, Meyer HD (2002) Sex hormones originating from different livestock production systems: fate and potential endocrine disrupting activity in the environment. *Anal Chim Acta* 473:27–37
10. United States Food and Drug Administration (2009) Summary report on antimicrobials sold or distributed for use in food-producing animals. Center for Veterinary Medicine, Department of Health and Human Services
11. United States Environmental Protection Agency (2013) Literature review of contaminants in livestock and poultry manure and implications for water quality. EPA 820-R-13-002. Cincinnati, OH, Office of Water, July
12. Witorsch RJ, Thomas JA (2010) Personal care products and endocrine disruption: a critical review of the literature. *Crit Rev Toxicol* 40:1–30
13. Veldhoen N, Skirrow RC, Osachoff H, Wigmore H, Clapson DJ, Gunderson MP, Van Aggelen G, Helbing CC (2006) The bactericidal agent triclosan modulates thyroid hormone-associated gene expression and disrupts postembryonic anuran development. *Aquat Toxicol* 80(3):217–227

14. Younos T, Harwood VJ, Falkinhamm JO III, Shen H (2007) Pathogens in natural and engineered water systems: emerging issues. *Water Resour Impact* 9:11–14
15. United States Environmental Protection Agency (2012) CCL and regulatory determinations home. 25 July. <http://www.epa.gov/safewater/ccl/index.html>. Accessed 30 Jan 2014
16. Egli T, Rust A (2007) Pathogens in (drinking) water? Risk factors in water. *EAWAG News*. pp 26–28
17. Roy S, Heidel K, Chen L, Johnson K (2007) Pathogens of concern in aquatic systems and drinking water supplies. In: Conceptual model for pathogens and pathogen indicators in the central valley and sacramento-san joaquin delta. Tetra Tech, Lafayette, CA
18. Boxall ABA (2012) New and emerging water pollutants arising from agriculture. University of York, United Kingdom
19. United States Environmental Protection Agency (2012) Master testing list – introduction. 3 February. <http://www.epa.gov/opptintr/chemtest/pubs/mtlintro.html>. Accessed 30 Jan 2014
20. Casewell M, Friis C, Marco E, McMullin P, Phillips I (2003) The european ban on growth-promoting antibiotics and emerging consequences for human and animal health. *J Antimicrob Chemother* 52(2):159–161
21. United States Environmental Protection Agency (2013, February 28) Pharmaceuticals and personal care products (PPCPs) in water. <http://water.epa.gov/scitech/swguidance/ppcp/index.cfm>. Accessed January 28 2014
22. United States Environmental Protection Agency (2012) Contaminant Candidate List 3. 25 July <http://water.epa.gov/scitech/swguidance/ppcp/index.cfm>. Accessed 28 Jan 2014
23. Clayton H (2011) Emerging contaminants and the water framework directive. European Commission, DG Environment, Unit D1 – Water. EEA Workshop on emerging contaminants in European Waters, Copenhagen, 5–6 December
24. Chatain B (2013) Surface waters: 12 new controlled chemicals, three pharmaceuticals on watch list. European Parliament Press Service, 7 February <http://www.europarl.europa.eu/news/en/news-room/content/20130701IPR14760/html/Surface-waters-12-new-controlled-chemicals-three-pharmaceuticals-on-watch-list>. Accessed 30 Jan 2014
25. Phillips PJ, Smith SG, Kolpin DW, Zaugg SD, Buxton HT, Furlong ET, Esposito K, Stinson B (2010) Pharmaceutical formulation facilities as sources of opioids and other pharmaceuticals to wastewater treatment plant effluents. *Environ Sci Technol* 44(13):4910–4916
26. Buerge IJ, Poiger T, Mueller MD, Buser HR (2006) Combined sewer overflows to surface waters detected by the anthropogenic marker caffeine. *Environ Sci Technol* 40(13):4096–4102
27. Boyd GR, Palmeri JM, Zhang SY, Grimm DA (2004) Pharmaceuticals and personal care products (PPCPs) and endocrine disrupting chemicals (EDCs) in stormwater canals and Bayou St. John in New Orleans, Louisiana, USA. *Sci Total Environ* 333(1–3):137–148
28. Phillips P, Chalmers A (2009) Wastewater effluent, combined sewer overflows, and other sources of organic compounds to lake champlain. *J Am Water Resour Assoc* 45(1):45–57
29. Emmanuel E, Keck G, Blanchard JM, Vermande P, Perrodin Y (2004) Toxicological effects of disinfections using sodium hypochlorite on aquatic organisms and its contribution to aox formation in hospital wastewater. *Environ Int* 30(7):891–900
30. Verlicchi P, Galletti A, Petrovic M, Barcelo D (2010) Hospital effluents as a source of emerging pollutants: an overview of micropollutants and sustainable treatment options. *J Hydrol* 389(3–4):416–428
31. United States Environmental Protection Agency (1999) Bisolids generation, use and disposal in the United States. EPA530-R99-009. Office of Solid Waste, Washington, DC
32. Beecher N, Crawford K, Goldstein N, Kester G, Lono-Batura M, Dziezyk E (2007) A national biosolids regulation quality, end use & disposal survey. North East Biosolids and Residuals Association, Tamworth, NH
33. Dutta S, Inamdar S, Tso J, Aga DS, Sims JT (2010) Free and conjugated estrogen exports in surface-runoff from poultry litter-amended soil. *J Environ Qual* 39:1688–1698
34. Nichols DJ, Daniel TC, Moore PA Jr, Edwards DR, Pote DH (1997) Runoff of estrogen hormone 17 $\beta$ -estradiol from poultry litter applied to pasture. *J Environ Qual* 26:1002–1006

35. Nichols DJ, Daniel TC, Edwards DR, Moore PA Jr, Pote DH (1998) Use of grass filter strips to reduce 17 $\beta$ -estradiol in runoff from fescue-applied poultry litter. *J Soil Water Conserv* 53 (1):74–77
36. Gall HE, Sassman SA, Lee LS, Jafvert CT (2011) Hormone discharges from a midwest tile-drained agroecosystem receiving animal wastes. *Environ Sci Technol* 45(20):8755–8764
37. Gall HE, Sassman SA, Jenkinson B, Lee LS, Jafvert CT (2014) Hormone loads exported by a tile-drained agroecosystem receiving animal waste applications. *Hydrol Process* 28:1318–1328
38. Kjær J, Olsen P, Bach K, Barlebo HC, Ingerslev F, Hansen M, Sørensen BH (2007) Leaching of estrogenic hormones from manure-treated structured soils. *Environ Sci Technol* 41 (11):3911–3917
39. Reif AG, Crawford JK, Loper CA, Proctor A, Manning R, Titler R (2012) Occurrence of pharmaceuticals, hormones, and organic wastewater compounds in Pennsylvania waters. United States Geological Survey Scientific Investigations Report 2012-5106
40. Eckel WP, Ross B, Isensee RK (1993) Pentobarbital found in-ground water. *Ground Water* 31 (5):801–804
41. Ahel M, Jelicic I (2001) Phenazone analgesics in soil and groundwater below a municipal solid waste landfill, Chapter 6. In: Daughton CG, Jones-Lepp TL (eds) *Pharmaceuticals and Care Products in the Environment*, vol 791, ACS Symposium Series. American Chemical Society, Washington, DC, pp 100–115
42. Andrews WJ, Masoner JR, Cozzarelli IM (2012) Emerging contaminants at a closed and an operating landfill in Oklahoma. *Ground Water Monit Remed* 32(1):120–130
43. Eggen T, Moeder M, Arukwe A (2010) Municipal landfill leachates: a significant source for new and emerging pollutants. *Sci Total Environ* 408(21):5147–5157
44. Schaidler L, Rodgers K, Rudel R (2013) Contaminants of emerging concern and septic systems: a synthesis of scientific literature and application to groundwater quality on Cape Cod. Silent Spring Institute, Newton, MA
45. Conn KE, Siegrist RL (2009) Occurrence and fate of trace organic contaminants in onsite wastewater treatment systems and implications for water quality management. Colorado Water Institute, Fort Collins, CO
46. Wilcox JD, Bahr JM, Hedman CJ, Hemming JDC, Barman MAE, Bradbury KR (2009) Removal of organic wastewater contaminants in septic systems using advanced treatment technologies. *J Environ Qual* 38:149–156
47. Stanford BD, Weinberg HS (2010) Evaluation of on-site wastewater treatment technology to remove estrogens, nonylphenols, and estrogenic activity from wastewater. *Environ Sci Technol* 44:2994–3001
48. Heufelder G (2012) Contaminants of emerging concern from onsite septic systems. Barnstable County Department of Health and Environment, Barnstable, MA
49. Standley LJ, Rudel RA, Swartz CH, Attfield KR, Christian J, Erickson M, Brody JG (2008) Wastewater-contaminated groundwater as a source of endogenous hormones and pharmaceuticals to surface water ecosystems. *Environ Toxicol Chem* 27(12):2457–2468
50. Jawitz JW, Mitchell J (2011) Temporal inequality in catchment discharge and solute export. *Water Resour Res* 47:W00J14
51. Royer TV, David MB, Lowell EG (2006) Timing of riverine export of nitrate and phosphorus from agricultural watersheds in Illinois: implications for reducing nutrient loading to the Mississippi River. *Environ Sci Technol* 40:4126–4131
52. Richards PR, Baker DB, Kramer KW, Ewing DE, Merryfield BJ, Miller NL (2001) Storm discharge, loads, and average concentrations in northwest Ohio rivers, 1975–1995. *J Am Water Resour Assoc* 37:423–438
53. Wolf J (2008) Agricultural sources of total phosphorus: Delivered yield to Chesapeake Bay. Chesapeake Bay Program. [http://www.chesapeakebay.net/maps/map/delivered\\_yield\\_of\\_total\\_phosphorus\\_agricultural\\_sources](http://www.chesapeakebay.net/maps/map/delivered_yield_of_total_phosphorus_agricultural_sources). Accessed 11 Oct 2013

54. Lemke AM, Kirkham KG, Lindenbaum TT, Herbert ME, Tear TH, Perry WL, Herkert JR (2011) Evaluating agricultural best management practices in tile-drained subwatersheds of the Mackinaw River, Illinois. *J Environ Qual* 40:1215–1228
55. Mulla DJ, Birr AS, Kitchen NR, David MB (2008) Final report: Gulf Hypoxia and local water quality concerns workshop. In: Limitations of evaluating the effectiveness of agricultural management practices at reducing nutrient losses to surface waters. Society of Agricultural and Biological Engineers, St. Joseph, MI
56. Meals DW, Dressing SA, Davenport TE (2010) Lag time in water quality response to best management practices: a review. *J Environ Qual* 39(1):85–96
57. United States Environmental Protection Agency (2010) Treating contaminants of emerging concern: a literature review database. United States Environmental Protection Agency, Washington, DC
58. Boyd GR, Reemtsma H, Grimm DA, Mitra S (2003) Pharmaceuticals and personal care products (PPCPs) in surface and treated waters of Louisiana, USA and Ontario, Canada. *Sci Total Environ* 311(1–3):135–149
59. Bundy MM, Doucette WJ, McNeill L, Ericson JF (2007) Removal of pharmaceuticals and related compounds by a bench-scale drinking water treatment system. *J Water Supply Res Technol* 56(2):105–115
60. Matamoros V, Garcia J, Bayona JM (2005) Behavior of selected pharmaceuticals in subsurface flow constructed wetlands: a pilot-scale study. *Environ Sci Technol* 39(14):5449–5454
61. Matamoros V, Bayona JM (2006) Elimination of pharmaceuticals and personal care products in subsurface flow constructed wetlands. *Environ Sci Technol* 40(18):5811–5816
62. Czajka CP, Londry KL (2006) Anaerobic transformation of estrogens. *Environ Sci Technol* 367:932–941
63. Lin AYC, Plumlee MH, Reinhard M (2006) Natural attenuation of pharmaceuticals and alkylphenol polyethoxylate metabolites during river transport: photochemical and biological transformation. *Environ Toxicol Chem* 25(6):1458–1464
64. Liang R, Hu AM, Li WJ, Zhou YN (2013) Enhanced degradation of persistent pharmaceuticals found in wastewater treatment effluents using TiO<sub>2</sub> nanobelt photocatalysts. *J Nanopart Res* 15(10). doi:10.1007/S11051-013-1990-X
65. Encinas Á, Rivas FJ, Beltran FJ, Oropesa A (2013) Combination of black-light photo-catalysis and ozonation for emerging contaminant degradation in secondary effluents. *Chem Eng Technol* 36(3):492–499
66. Prieto-Rodriguez L, Miralles-Cuevas S, Oller I, Fernandez-Ibanez P, Aguera A, Blanco J, Malato S (2012) Optimization of mild solar TiO<sub>2</sub> photocatalysis as a tertiary treatment for municipal wastewater treatment plant effluents. *Appl Catal B Environ* 128:119–125
67. Trinh T, van den Akker B, Stuetz RM, Coleman HM, Le-Clech P, Khan SJ (2012) Removal of trace organic chemical contaminants by a membrane bioreactor. *Water Sci Technol* 66(9):1856–1863
68. Forrez I, Carballa M, Fink G, Wick A, Hennebel T, Vanhaecke L, Ternes T, Boon N, Verstraete W (2011) Biogenic metals for the oxidative and reductive removal of pharmaceuticals, biocides and iodinated contrast media in a polishing membrane bioreactor. *Water Res* 45(4):1763–1773
69. Brennan R, Dorman F (2012) Enzymatic biocatalysis of endocrine disrupting chemicals in wastewater: a sustainable technology for emerging contaminants. National Science Foundation, The Pennsylvania State University
70. Benotti MJ, Trenholm RA, Vanderford BJ, Holady JC, Stanford BD, Snyder SA (2009) Pharmaceuticals and endocrine disrupting compounds in us drinking water. *Environ Sci Technol* 43(3):597–603
71. Ferrier C (2001) Bottled water: understanding a social phenomenon. *Ambio* 30(2):118–119
72. Krachler M, Shotyk W (2009) Trace and ultratrace metals in bottled waters: survey of sources worldwide and comparison with refillable metal bottles. *Sci Total Environ* 407(3):1089–1096

73. Casajuana N, Lacorte S (2003) Presence and release of phthalic esters and other endocrine disrupting compounds in drinking water. *Chromatographia* 57(9–10):649–655
74. Nawrocki J, Dabrowska A, Borcz A (2002) Investigation of carbonyl compounds in bottled waters from Poland. *Water Res* 36(19):4893–4901
75. Devier MH, Le Menach K, Viglino L, Di Gioia L, Lachassagne P, Budzinski H (2013) Ultra-trace analysis of hormones, pharmaceutical substances, alkylphenols and phthalates in two French natural mineral waters. *Sci Total Environ* 443:621–632
76. Cooper JE, Kendig EL, Belcher SM (2011) Assessment of bisphenol A released from reusable plastic, aluminium and stainless steel water bottles. *Chemosphere* 85(6):943–947
77. Beegle DB, Lanyon LE, Sims JT (2002) Nutrient balances. In: Haygarth PM, Jarvis SC (eds) *Agriculture, hydrology, and water quality*. CABI Publishing, New York, NY, pp 171–192
78. Raman DR, Williams EL, Layton AC, Burns RT, Easter JP, Daugherty AS, Mullen MD, Saylor GS (2004) Estrogen content of dairy and swine wastes. *Environ Sci Technol* 38:3567–3573
79. Derby NE, Hakk H, Casey FXM, DeSutter TM (2011) Effects of composting swine manure on nutrients and estrogens. *Soil Sci* 176:91–98
80. Arikian OA, Mulbry W, Rice C (2009) Management of antibiotic residues from agricultural sources: use of composting to reduce chlortetracycline residues in beef manure from treated animals. *J Hazard Mater* 164(2–3):483–489
81. Arikian OA, Sikora LJ, Mulbry W, Khan AJ, Foster GD (2007) Composting rapidly reduces levels of extractable oxytetracycline in manure from therapeutically treated beef calves. *Bioresour Technol* 98:169–176
82. Ho YB, Zakaria MP, Latif PA, Saari N (2013) Degradation of veterinary antibiotics and hormones during broiler manure composting. *Bioresour Technol* 131:476–484
83. Ramaswamy J, Prasher SO, Patel RM, Hussain SA, Barrington SF (2010) The effect of composting on the degradation of a veterinary pharmaceutical. *Bioresour Technol* 101(7):2294–2299
84. Selvam A, Zhao Z, Wong JW (2012) Composting of swine manure spiked with sulfadiazine, chlortetracycline and ciprofloxacin. *Bioresour Technol* 126:412–417
85. Selvam A, Xu D, Zhao Z, Wong JW (2012) Fate of tetracycline, sulfonamide and fluoroquinolone resistance genes and the changes in bacterial diversity during composting of swine manure. *Bioresour Technol* 126:383–390
86. United States Environmental Protection Agency (2005) Decentralized wastewater treatment systems: A program strategy. EPA 832-R-05-002. Office of Water, Cincinnati, OH, January

# Drinking Water Distribution: Emerging Issues in Minor Water Systems

Juneseok Lee and Owais Farooqi

**Abstract** This chapter addresses general characteristics of water distribution systems with focus on minor systems. Major systems are water mains that bring drinking water from water treatment plant to the building premises. Minor systems include service lines that connect major systems to minor system and in-building plumbing system. This chapter provides a detailed review of minor systems and mechanisms of minor systems' failures and describes experimental studies designed to replicate the range of pressures encountered in actual minor water distribution systems and how a pressure transient triggered within major and minor systems can impact service lines with possible contamination intrusion in minor systems. It is demonstrated that hydraulic transients triggered from water mains result in low-pressure events in service lines which can allow possible intrusion of microbial and chemical contaminants in service lines. It is concluded that the structural integrity of service lines and the hydraulic integrity of water distribution systems should be maintained in order to minimize public health risks from contaminant intrusion in minor systems and tap water.

**Keywords** Contaminant intrusion • Copper pitting • Water distribution systems • Hydraulic transients • Plumbing systems

---

J. Lee (✉)

Department of Civil and Environmental Engineering, San José State University, San José, CA, USA

e-mail: [juneseok.lee@sjsu.edu](mailto:juneseok.lee@sjsu.edu)

O. Farooqi

Black & Veatch, Gaithersburg, MD, USA

## 1 Introduction

President Clinton's Commission on Critical Infrastructure Protection designated three important attributes of drinking water infrastructure, namely, adequate quantities of water on demand, delivering water with sufficient pressure, and safety and high quality of the water [1]. The National Research Council (NRC) categorized the drinking water distribution system's integrity in terms of the following components: (1) *physical integrity*, indicating the physical barrier between pipe externalities and inside the piping; (2) *hydraulic integrity*, consistently delivering the correct pressure, flow, water age, and capacity for providing fire flow; and (3) *water quality integrity*, maintaining a high standard of water quality without any degradation [2]. If any of the components fail to achieve the desired level of integrity, this can result in a serious *public health risk*. This indicates that the drinking water infrastructure bears significant operational and managerial responsibilities toward public health.

The growth in bottled water consumption and various kinds of point of use devices (filters) indicate citizens' concern regarding the quality of drinking water at the tap. However, the municipal public drinking water remains the top-ranked water supplier for established drinking water standards because of its cost advantage, the cost of maintaining point of use devices, and the relatively marginal water quality improvement which these devices provide.

The drinking water distribution system consists of "major system" and "minor system." A *major system* is generally defined as the water mains that bring drinking water from water treatment plant to the consumer's premises (homes and buildings) while a *minor system* is the plumbing system (including service lines) that transports water within the property boundaries [3]. Figure 1 shows a schematic diagram of the major and the minor systems. In the United States, major systems represent nearly 1.5 million km of piping [3]. America's water distribution infrastructure system is old and deteriorating. For major systems alone, 21,239 km of new pipes are installed every year to serve the nation's ever increasing population [4]. Minor systems are passive recipients of supplied water from the municipal system via major system network. It is noted that minor systems are known to be at least 5 or 10 times longer in total [3].

Over the past few decades, copper has been a preferred minor system (plumbing) material for a number of reasons including its proven record as a relatively corrosion resistant metal, as well as its durability, availability, affordability, better fire resistance, recyclability, and lower maintenance cost. A survey of materials used in plumbing found that 90 % of new homes had copper pipes, followed by PEX (cross-linked polyethylene) at 7 %, and CPVC (chlorinated polyvinyl chloride) at 2 % [5].

Table 1 shows the key characteristics of major and the minor systems. Municipalities manage major water distribution systems and management costs are distributed among consumers including schools, commercial buildings, residential housing, etc. However, when there is a leak in a house or building the property





**Fig. 1** Schematic of major and minor systems (figure developed by author)

owner must cover the repair/replacement costs in their plumbing systems (minor systems). These typically include water damage and repair costs, service disruptions, a possible reduction in property value, and potential health consequences resulting from the growth of brown mold growth on the surface of walls, floors, and ceilings, which can cause allergic reactions including irritation of the eyes, skin, and throat. Copper corrosion can also result in copper concentrations in drinking water above those allowed by the EPA (1.3 mg/l); the consumption of excessive amounts of copper can cause health problems such as nausea, vomiting, diarrhea, and stomach cramps [3].

Repairs associated with plumbing failure can take up to several weeks, as the repairs extend beyond replacing the leaking sections to making good all the related damage to the building. Extensive repairs may cost property owners thousands of dollars and in many cases property insurance may not cover damage resulting from leaks. In addition to the financial and time costs, property owners may experience emotional stress due to dealing with these problems [3]. In this chapter, we address emerging issues in minor drinking water systems along with general characteristics of drinking water distribution systems as a whole.

**Table 1** Characteristics of major and minor drinking water distribution systems [3]

Characteristic	Major system	Minor system
Pipe diameter	10–36 cm <sup>a</sup>	1.2–2.54 cm
Pipe material	Ductile iron, plastic, cast iron	Copper, plastic, galvanized iron
Pipe length	10 to several 100 km per utility; about 1.4 million km of drinking water piping in the USA	Several 100 m per building.
Pipe wall thickness	Ductile iron 6.6 mm and above	Copper: K 1.25–1.7 mm; L 1.02–1.3 mm; M 0.71–0.89 mm
Corrosion	Both internal and external	Internal
Water flow velocity	0.9–1.8 m/s	~1.2 m/s
Demand	Specified	Pressure driven
Layout	Looped	Branched
Boundary condition	Energy head at the source or pump station	Energy head at the street level lateral
Life expectancy	Ductile iron ~80 years	Copper ~80 years; Galvanized iron 40–50 years
Ownership	Utility	End user (homeowner, business, organization)
Regulation	Government	Some plumbing codes
Cost	Distributed by water rates	Individual/insurance; replace piping \$3,500–\$6,000
Property damage	Distributed—few 100 s to several 1,000 s of dollars	Few 100 s to a few 1,000 s of dollars
Service response	Immediate	Delayed
Customer Dissatisfaction	Marginal to serious	Serious
Availability of data	Records kept—computerized	May not have records

<sup>a</sup>This pipe size is only for main line distribution pipes (not including larger transmission pipes)

## 2 Hydraulics of Major and Minor Systems

Drinking water is transported through major systems (water mains) to reach the minor systems, passing through curb stop (dividing line between major and minor systems), water meter, backflow preventer, bends, valves, junctions, and faucets, all of which can cause significant head losses (Fig. 1). To counter this, major systems are pressurized to deliver adequate flow rates and pressures to consumers. Hence, the pressure and velocity distribution in a minor system is dictated by the pressure maintained by the major systems or water mains. Below is a discussion of water pressure in major systems and its impact on water pressure in minor systems.

## 2.1 Major Systems

As mentioned, the water pressure and velocity within a minor system highly depend on the street level pressure. Pressure at street level is measured at the water mains, making it a boundary condition for the minor system (Fig. 1). Equation (1) shows the relationship between street level pressure and pressure in the minor system following energy equation (under steady state condition):

$$\frac{p_i}{\gamma_{\text{water}}} + \frac{v_i^2}{2g} + h_i + H_{\text{Losses}} = \frac{p_{\text{street}}}{\gamma_{\text{water}}}, \quad (1)$$

where  $P_{\text{street}}$  is street level pressure,  $p_i$  is the pressure in any pipe ( $i$ ) in the minor system,  $v_i$  is the velocity of the water flowing through the pipe ( $i$ ),  $h_i$  is the difference in elevation between the street level and the minor system point of measurement,  $g$  is the acceleration due to gravity,  $\gamma_{\text{water}}$  is the specific weight of water (assumed to be of a constant density), and  $H_{\text{Losses}}$  is the sum of the minor and friction losses from the street level to the point of measurement. It is noted that street level's velocity head values are negligible compared to those of minor systems. From equation (1), it is clear that both the velocity and pressure in a minor system is greatly affected by any changes in the street level pressure [6].

In drinking water distribution systems, the pressure level in main pipes changes with the high- and low-pressure zones according to the location of the pumping station or the elevation of the served region, so depending on the location of the building, the boundary condition can change markedly. In situations where the street main pressure is low or more energy is needed to raise the water to the top floor of a tall building, a booster pump is often used to supply additional head to the system. In addition, the street level pressure may drop significantly during peak hours due to simultaneous water use causing much lower pressures and velocities than normal conditions. Fire flow situations, when a fire truck is withdrawing large amounts of water from a fire hydrant, can also cause significant pressure drop in a building. In a case study of Arizona water system where several pressure drop reports had been received from customers, investigation found no problem in the minor systems, but an analysis of the nearby major water systems indicated that abrupt valve closures in the main system were causing problems at the household level [7]. This real situation confirms that street level pressure is a critical boundary condition for pressure distribution within a residential house and buildings.

## 2.2 Minor Systems

A minor system in a typical building/residential unit is composed of a number of fixtures that may include faucets, connections for bathrooms and water closets, dishwasher, hot water heater, and washing machine. Inside a typical house, there

are three major locations for plumbing features: the kitchen, bathrooms, and the laundry room. The other elements in a domestic system include the service line that provides water to the building and the water meter, as well as various other internal valves, T-junctions, and bends.

The maximum pressure that the International Plumbing Code allows is 552 kPa and the typical steady state pressure for street level is 414–552 kPa [9]. In practice, water is normally distributed at pressures ranging between about 345 and 483 kPa through the street mains, which after factoring in the losses associated with the curb stop, water meter, backflow preventer, hot water heater, fittings, and friction, it drops to around 207 kPa at the end fixtures [9], Fig. 1. Novak [10] provides head loss calculations for a steady state system inside a house, given that the minimum pressure should be 241 kPa at the farthest point in the system and at least 138 kPa even in a fire flow situation [10]. This minimum pressure depends on the type of fixtures installed within the building. For example, if the hydraulically farthest plumbing fixture in the system requires 103 kPa, this will be the required minimum pressure. Significant amounts of energy (energy head) will dissipate through the various bends and T-junctions in a home plumbing system, and to maintain an adequate supply at the fixture, the minimum pressure must be satisfied.

In this vein, there are two boundary conditions for minor water distribution systems, the first of which is the pressure available at the street main and the second is that at the demand node or fixture, where minimum pressures are specified for each type of plumbing fixture. A conservative design process will utilize the minimum available street main pressure as this is the main source of energy for water flowing through a minor distribution network. The difference between the street main pressure and the required minimum fixture pressure defines the amount of acceptable head loss through the piping network.

Minor system demand is defined by the loads imposed by plumbing fixtures (i.e., toilets, showers, sinks, dishwasher, etc.), which are designed to operate at certain pressures. Because all fixtures operate under pressure, they are usually referred to as “pressure driven” and the basic requirement is to maintain a certain minimum pressure,  $p_{min}$ , to deliver the necessary flow demand. This relationship takes the form,  $Q = Kp^a$  (for  $p \leq p_{min}$ ), and  $Q = Q_{control}$  (for  $p > p_{min}$ ), where  $K$  = emitter coefficient,  $Q$  = flow,  $p$  = pressure,  $a$  = exponent, and  $Q_{control}$  = user controlled flow. Whenever  $p$  exceeds  $p_{min}$ , the pressure is capable of delivering more flow than actually needed [6].

### 3 Pipe Failure in Minor Systems

The predominant type of failures in minor systems is pitting or pinhole leaks. Pitting is defined as localized corrosion which develops as a result of nonuniform pitting corrosion [11–13]. Pipe corrosion is the major cause of pipe failure in minor systems. The cost of corrosion to public infrastructure was estimated to be about

\$276 billion in 2002 (3.1 % of the nation's Gross Domestic Product), with water and sewer systems accounting for \$36 billion, the largest share [14].

Lee and Loganathan [11] examined the nationwide distribution of pinhole pipe leaks for the period 2000–2004 and found that although pinhole leaks are a nationwide problem in the United States, several areas in California, Florida, Maryland, and Ohio experienced higher frequencies of leak incidents. A proactive monitoring system that involves condition inspection requires access to certain critical locations known to be prone to corrosion, but this is not currently available in most cases. Usually pipe leak data records are not kept by property owners and rarely reported to utilities. In order to address leak data deficiency, the Copper Development Association (CDA) collects failed pipe samples voluntarily donated by property owners, conducts analysis, and generates pipe failure reports which is cataloged in a database. While this is the largest national database of known copper water pipe failures, it has several limitations. Most notably, only pipe samples that are voluntarily submitted to CDA are analyzed. Due to this limitation, the database represents only a fraction of the copper pipe failures occurring in the United States.

Farooqi [12] mapped locations of copper pipe failures documented in CDA database. Some interesting conclusions can be drawn from the mapping geographical distribution of the reported pipe failures. Although failures have been documented nationwide, some localities have experienced a particularly high degree of premature pipe failures. Farooqi [12] found that data for certain states and certain large metropolitan areas were absent in CDA database. However, a telephone survey of a small number of plumbers in targeted communities in these areas confirmed that plumbers were called to repair pinhole leaks. Since a large percentage of pinhole leaks remain unreported, it can be inferred that, the extent of the problem is probably much larger than reflected in the failure database [13]. In the following section, an overview of copper pipe corrosion mechanisms and an in-depth literature review of the latest research in this area are presented, with a particular focus on those factors believed to cause pipe pitting and premature pipe failure in minor systems.

A number of different types of failures can occur in copper plumbing. One type of failure that has become particularly problematic in some communities is the pinhole leaks that develop as a result of nonuniform or pitting corrosion. In contrast to uniform corrosion, in which all parts of the internal pipe surface are attacked at roughly the same rate, nonuniform or pitting corrosion is localized, leading to the rapid loss of pipe wall thickness at that particular location.

Although copper is a relatively inactive metal, leaks due to corrosion are still the most common cause of residential copper pipe failures [13]. The term *corrosion* is exclusively used for metals [15, 16]. The four essential elements of aqueous electrochemical corrosion are an anode, a cathode, physical contact between the anode and the cathode, and an electrolyte [17]. In a drinking water pipe, an anode with a positive charge and a cathode with a negative charge are separated by a potential difference. The anode–cathode physical contact is the pipe permitting the electrons to flow from the anode to the cathode and the electrolyte is the water that conducts the ionic flow.

A metallic element,  $M$ , is oxidized as  $M \rightarrow M^{n+} + ne^{-}$ , constituting corrosion. The cathodic reactions are metal deposition by  $M^{n+} + ne^{-} \rightarrow M$ , metal ion reduction  $M^{n+} + e^{-} \rightarrow M^{(n-1)+}$ , hydrogen liberation in the absence of air or oxygen in a deaerated solution by  $2H^{+} + 2e^{-} \rightarrow H_2$ , and the reduction of oxygen in aerated solutions as  $O_2 + 2H_2O + 4e^{-} \rightarrow 4OH^{-}$  in a neutral or basic solution with  $pH \geq 7$  and  $O_2 + 4H^{+} + 4e^{-} \rightarrow 2H_2O$  in an acidic solution with  $pH < 7$ . In drinking water, dissolved oxygen and residual chlorine can cause copper to oxidize as  $Cu \rightarrow Cu^{+} + e^{-}$ . The cuprous ion  $Cu^{+}$  is further oxidized into cupric ion  $Cu^{2+}$ . The corrosion current for copper in aerated neutral water is so small that the corrosion rate is only  $10^{-2}$  mm/year [18]. However, real-world data point to the possible occurrence of nonuniform corrosion [12].

As mentioned, pitting is localized corrosion that occurs at a surface scratch or at a location of mechanically induced break in the protective film (passivation layer) or at a location where there is a material compositional heterogeneity such as an inclusion, segregate, or precipitate [19]. Pit formation can be explained as follows. Cuprous ion  $Cu^{+}$  combines with  $Cl^{-}$  to form cuprous chloride  $CuCl$  next to the copper metal. This cuprous chloride is usually removed from the surface by hydrolysis [forming cuprite (cuprous oxide)  $Cu_2O$  by  $2CuCl + H_2O \rightarrow 2HCl + Cu_2O$ ], oxidation, formation of cupric salts, and dissolution into the bulk solution. These reactions result in the formation of a passivating scale over the copper that protects it. However, when cuprous chloride is produced at a rate greater than its loss from the aforementioned processes, it remains under the cuprous oxide, leading to pitting. A comprehensive assessment of copper corrosion in drinking water systems is available in cited references [20, 21].

## 4 Copper Pipe Pitting

Several factors have been thought to influence pinhole leaks. However, scientific certainty regarding causal mechanisms of pinhole leaks is often limited due to inherent difficulty of reproducing pinhole leaks in controlled laboratory studies. As described below, copper corrosion and pitting reported in scientific literature can be broadly classified as either physical or chemical in nature. Most corrosion problems are due to the complex synergy between physical and chemical parameters [12, 13] and are affected by the source water, treatment plant processes, water quality changes within the major distribution system, and physical and chemical conditions within minor system. The formation of passive scales or dosing with corrosion inhibitors may also affect corrosion and pitting. The three most common conventional corrosion inhibitor additives are silicates, orthophosphates, and polyphosphates.

## 4.1 Chemical Parameters

Below water-related parameters are believed to influence corrosion in copper pipes, namely: (1) the concentration of dissolved oxygen (DO); (2) the pH; (3) the temperature; (4) the water flow velocity; (5) the concentration and type of chlorine residuals; (6) the chloride  $[Cl^-]$  and sulfate  $[SO_4^{2-}]$  ion concentrations; and (7) the concentration of dissolved inorganic carbon (DIC), defined in terms of the total alkalinity and pH [22].

One type of pitting that has been successfully reproduced in the laboratory included conditions of high pH ( $>7.8$ ), high residuals of free chlorine, aluminum solids, and continuous water flow [14, 23, 24]. The experimental conditions led to multiple pinhole leaks in new copper piping after 9 months: In many instances chloride is associated with pitting [25] and Nguyen [26] provides a detailed review of chloride-induced pitting.

Some gases such as carbon dioxide ( $CO_2$ ) and hydrogen sulfide ( $H_2S$ ) are considered to be particularly damaging to copper tubing. Research has shown that the copper corrosion rate increases with increasing concentrations of free carbon dioxide [27], but it is often difficult to differentiate between other influential corrosion factors that also affect carbon dioxide concentrations such as pH and alkalinity. Hydrogen sulfide, which is known for its characteristic “rotten egg” odor, can form from either the reduction of sulfur in mineral deposits or as a by-product of biological activity from sulfate reducing bacteria (SRB) [28, 29]. As little as 0.02 mg/l of  $H_2S$  can lead to perforations in copper, and sulfide attack can originate from sulfides present in the bulk water or from SRB growing on the pipe wall [30].

By-products from microbial activity are often thought to produce a chemical reaction causing microbial induced corrosion (MIC), such as in the case of SRB described earlier. Another suspected cause of failure is the presence of nitrifying bacteria, which could produce pH levels that are much lower than that in the average bulk water as the bacteria grow on the pipe surface. Corrosion or pitting can potentially increase due to the removal of natural organic matter (NOM) and poor practices after pipe installation [31]. For example, improper flushing of pipes followed by a long stagnation period between installation and building occupancy has been shown to cause pitting corrosion in new copper plumbing [32, 33].

## 4.2 Scale Layers

Pitting tendencies could potentially decrease if a protective layer of scale, known as a passivation layer, is allowed to form on the surface of the copper. A film of cuprous chloride ( $Cu_2Cl_2$ ) is formed when the copper is immersed in a solution containing the chloride ion. This cuprous chloride is removed from the surface by a number of pathways, including hydrolysis, to form cuprite (cuprous oxide  $Cu_2O$ ),

followed by the oxidation and formation of cupric salts, and dissolution into the bulk solution. These reactions typically result in a passivating scale [20]. However, if the rate of formation of cuprous chloride exceeds the rate of its loss by the aforementioned reactions, pitting can take place. All pits are thought to include a layer of basic copper salts overlying a cuprite  $\text{Cu}_2\text{O}$  layer, with the basic salts being predominantly malachite  $\text{Cu}_2(\text{OH})_2\text{CO}_3$  in cold water and brochantite  $\text{Cu}_4(\text{OH})_6(\text{SO}_4)$  in hot and soft waters [20].

Since the solubility is relatively lower for malachite ( $\text{Cu}_2(\text{OH})_2\text{CO}_3$ ) and tenorite ( $\text{CuO}$ ), other copper solids such as copper hydroxide, copper chloride, and cupric nitrate are not typically present within domestic plumbing systems [20]. Brochantite ( $\text{Cu}_4(\text{OH})_6(\text{SO}_4)$ ) is commonly present at high temperature (greater than  $60^\circ\text{C}/140^\circ\text{F}$ ) and is often found over pits in hot water pipes or hot water recirculation systems. The formation of the brochantite is subject to the concentration of bicarbonates ( $\text{HCO}_3^-$ ) and  $\text{pH} < 7$  conditions, and for waters with high sulfate to bicarbonate ratios pitting is therefore likely in hot water. In cold water pipes the formation of brochantite is favored at not only high sulfate to bicarbonate ratios but also high sulfate to chloride ratios. Brochantite formation is therefore likely to increase pitting in water that has undergone softening [20]. Sulfate ions are more aggressive than chloride ions in inducing pit germination and nitrate ions appear to be more aggressive than sulfate ions [34].

### 4.3 Inhibitors

Inhibitors may either form a protective film over the pipe surface or change the nature of the corrosion [22]. As noted earlier, the three most common conventional corrosion inhibitor additives are silicates, orthophosphates, and polyphosphates. The selection of an inhibitor may depend on factors such as water quality parameters (e.g., pH and alkalinity), the type of corrosion, and the material to be protected. Silicates ( $\text{H}_3\text{SiO}_4^-$ ) form a protective film by reacting with corrosion by-products on the pipe surface, thus forming a physical barrier between the pipe wall and its environment. Silicates have been shown to be more effective as inhibitors at a higher pH [22].

Orthophosphates ( $\text{HPO}_4^{2-}$ ) are thought to slow the rate of oxidation of copper at near neutral pH and even become counterproductive at pH values above 8.0 [22]. The early formation of a protective scale containing tenorite or cuprite [ $\text{CuO}$  or  $\text{Cu}_2\text{O}$ ] has been reported to depend on the pH in water containing chlorine and orthophosphate. Dosing with orthophosphates has successfully reduced the extent of pinhole leaks after 1 year of their application in some Maryland communities that were previously observing a high rate of failure [35].

Polyphosphates have also been found to be effective for treating localized or pitting corrosion by changing it to more uniform corrosion [22]. However, polyphosphates could interfere with the deposition of protective calcium containing layers and also enhance the solubility of the copper. The latter may not be as serious



problem as it first appears. Although it causes an increase in total metal loss, the overall life cycle of the pipe is increased since the corrosion becomes more uniform. Polyphosphates are sometimes used with orthophosphates to yield optimal benefits. While orthophosphate is believed to form Copper (II) Phosphate [ $\text{Cu}_3(\text{PO}_4)_2$ ] or a similar scale on the copper pipe surface, at a pH of 7.2 and alkalinity of 300 mg/l with calcium carbonate ( $\text{CaCO}_3$ ), the phosphate dosing led to increased copper release by hindering the formation of the malachite scale [14]. The same study also suggested that polyphosphates are not as beneficial as orthophosphate in controlling copper leaching to water.

#### 4.4 *Physical and Hydraulic Parameters*

Physical damage from erosion can also be responsible for the formation of pinhole leaks. The calculated, safe design flow velocity in copper tube has been cited to be anywhere from 0.4 to 4.2 m per second (m/s), but 1.5 to 2.4 m/s is the most commonly used upper bound for design [8]. Factors that can make a pipe more susceptible to failure at lower velocity include (1) the presence of particulate matter in water that can impinge on surfaces and exacerbate erosion and (2) bubbles that form due to either vaporous or gaseous cavitation that can cause wear by implosion or impingement [10]. In a typical situation a maximum velocity of 0.9 m/s is recommended for water temperature above 60 ° C [36], but if particulates or bubbles are present, failures can occur at even lower velocities.

Vapor pressure of water at ambient temperature (10–40 °C) typically varies between 1.2 kPa and 7.4 kPa and the total dissolved gas pressure of natural water is normally in the range 81.1 kPa to 121.6 kPa [37]. When the pressure of the medium drops below the saturation pressure of the dissolved gases it contains, bubbles of gas are formed and this phenomenon is known as *gaseous cavitation*. When the pressure in the liquid medium drops below the liquid's vapor pressure, vapor cavities are created in the liquid by phase transformation, or *vaporous cavitation*.

The primary dissolved gases in drinking water in the tap water are the same as those in the air we breathe, namely, nitrogen, oxygen, and carbon dioxide, though the precise composition of these gases changes according to the temperature, season, and even whether it is day or night [37]. The gas release rate is known to be proportional to the degree of under-pressurization. Drinking water in pipelines may contain a gaseous phase in the form of free bubbles suspended in the bulk solution or as nuclei adhering to or hidden in cracks on solid surfaces [10]. These bubbles can grow or shrink depending on a number of factors, including surface tension, ambient liquid pressure, vapor pressure of the liquid, and gas pressure inside the bubble. Also, large bubbles may be formed by two or more smaller bubbles coalescing, and from free gas molecules entering existing bubbles [38]. The cavity inside the bubble increases in size until the internal pressure is sufficient to offset the decreasing external pressure and surface tension [39]. When

this critical size is reached, the cavity becomes unstable and expands explosively, which can cause erosion corrosion [10].

Just as the major system is susceptible to hydraulic transients, water hammer within a domestic plumbing system can also induce transient pressure propagation. Water hammer is the term used to describe the destructive forces that manifest as pounding noises and vibration which develop in a piping system. When water hammer occurs, a high intensity pressure wave travels back through the pipe system until all the energies are dissipated [40]. The most common water hammer cause is the quick closing of valves in the plumbing system and it is known that the speed of the last 15 % of the valve closure is directly related to the intensity of the surge (hydraulic transients or water hammer) pressure. The average flow velocity in a plumbing system is 1.22–2.44 m/s. This destructive force may result in a number of undesirable outcomes, including ruptured piping, leaking connections, weakened connections, pipe vibration and noise, damaged valves, damaged check valves, damaged water meters, damaged pressure regulators and gauges, damaged recording apparatus, loosened pipe hangers and supports, ruptured tanks and water heaters, and the premature failures of other equipment and devices [41].

A survey of plumbers revealed that in their experience, most of water hammer incidences arise due to dishwashers and washing machines operated by mechanical solenoid valves [42]. They recommended the use of water hammer arrestors or mitigating the problem by designing flow velocities to not exceed 1.22 m/s (whereas the rest of the system is generally designed to provide flow velocity of around 1.83 to 2.44 m/s).

Attempts have been made to predict the likelihood that household plumbing will fail under a given set of conditions [43]. While there are reports in the literature identifying pipe failures due to the mechanisms and causal factors described above, there is no explanation as to why other pipes did not fail when subjected to similar water quality and hydraulic conditions. This anomaly can be resolved by assuming that these mechanisms have a certain likelihood of occurrence. In other words, the presence of a set of causal factors that have previously caused failures does not guarantee reoccurrence of failure and the term “scientific certainty” can be utilized as an index to measure the likelihood of failure [43]. It should be advantageous to associate failure mechanisms with the likelihood of failure as far as possible.

## 5 Alternative Pipe Materials for Minor Systems

Public perceptions of risk and reaction to hazards, while hard to measure, play a fundamental role in consumers’ drinking water-related decisions. Objective risks are based on the relative frequencies of historical occurrences or experimental studies. Perceived or subjective risk involves personal or subjective judgment and is a function of confidence [44]. Minor system decisions that may affect drinking water risks include the choice of when to repair or replace a minor system, as well as the type of material to use in replacement.

Information should be provided on the implications of risk to consumers. In the decision-making process, consumers are influenced by various factors. The main alternative pipe material includes various types of plastic or stainless steel. There is concern regarding the behavior of plastic pipes with respect to strength, fire hazard, final disposal, reaction to chlorine, and health effects. The regulations and standards of the federal, state, and local governments all have a major impact on ultimate decision making [11]. These regulations also influence plumbers, material producers (e.g., pipe manufacturers, interior coating providers), insurance companies, and water utility companies. Consequently, consumers are influenced by all of the above service providers.

When informed about the attributes of each plumbing material alternative, consumers can decide on the alternative most preferable to them based on the preference trade-offs among plumbing materials' attributes. The choice of an appropriate plumbing material can be based on various attributes of materials such as cost (material cost plus labor and installation cost), health effects, corrosion susceptibility, strength, property real estate values, and longevity in the event of a fire. In addition, the perception of risk for plumbing materials can be quantified by assessing the willingness-to-pay (WTP) for a (hypothetical) corrosion-free plumbing material or improvement in the performance of existing plumbing material. The estimate of WTP reflects socioeconomic characteristics and previous experiences of individual households [45]. Different materials pipe should be examined for cost, consumer preferences, corrosion, susceptibility, water quality including microbial growth, strength, and fire hazard. Table 2 shows the general characteristics of various plumbing materials and their unique attributes.

## 6 Economic Aspects of Pipe Pitting

This section summarizes the major findings of two surveys that focused on economic impacts related to minor systems [46, 47]. One study included a mail survey that was designed to identify the frequency of pinhole leaks [46]. This study, which was sent to residents of the Maryland in July 2004, also evaluated the financial impact, time, and emotional costs of these inconveniences [46]. The mail survey in Maryland included a variety of interesting findings. After weighting responses to account for disproportionate sampling in areas known for high leaks, an estimated 36 % of respondents in detached homes and 21 % of respondents in apartments or condominiums reported having experienced one or more leaks in their current dwellings. Nearly 30 % of respondents with pinhole leaks reported expenditures of at least \$500 for repairing leaks and collateral damages and about 10 respondents had spent more than \$10,000. These repair costs involve fixing ceilings, walls, and floors.

In addition, some homeowners had to move out of their houses during the renovation process, which raised the total damage cost. Several respondents commented on the loss of invaluable personal belongings such as family photos,

**Table 2** Attributes of plumbing water pipe materials [11]

	Copper	PEX	CPVC
Corrosion resistance	May corrode under select conditions	Not susceptible to corrosion	Resists corrosion and oxidation
Fire retardance	Can withstand temperatures up to 1,093 °C without melting and emitting toxic fumes	May melt and emit toxic fumes at temperatures above 80 ~95 °C	Can withstand temperatures up to 1,093 °C without melting and emitting toxic fumes
Taste/odor	Compounds released from this material in drinking water plumbing may give a bitter or metallic taste or odor to the water	Compounds released from this material in drinking water plumbing may give a chemical or solvent taste or odor to the water	No effects on taste and odor of drinking water have been found
Health effects	Compounds from plumbing made of this material that are released into drinking water, and exceed EPA standards, may cause vomiting, diarrhea, stomach cramps, and nausea	Compounds from plumbing made of this material that are released into drinking water may lead to microbial growth in water	No adverse effects on health have been found
Longevity	Plumbing made of this material has a 50-year manufacturer's warranty	Some types of plumbing made of this material have a 10-year manufacturer's warranty	Plumbing made of this material has a long life span
Price/m	½" diameter pipe: \$6.48 ¾" diameter pipe: \$10.04 (1 in. = 2.54 cm)	½" diameter pipe: \$2.84 ¾" diameter pipe: \$4.67 (1 in. = 2.54 cm)	½" diameter pipe: \$19.46 ¾" diameter pipe: \$30.11 (1 in. = 2.54 cm)

clothes, and inherited furniture. In addition, 70 % of the respondents who had pinhole leaks spent at least 10 h dealing with the leaks and the resulting damage. More than half of the respondents felt much stressed regarding this problem and "aggravated or worried" about the possibility of leaks in the future. The researchers concluded that overall anxiety increased due to (1) a lack of adequate knowledge and information on the causality of pinhole leaks, (2) a lack of sufficient advice or assistance from local water utility and insurance companies, (3) the full financial responsibility borne by the homeowner, and (4) the lack of a local government response to these problems [46].

A nationwide telephone survey was conducted to gain a better understanding of the cost of leaks to the owners of homes, apartment dwellings, and commercial buildings and homeowner's WTP for materials guaranteed to remain leak free for 50 years (give reference). Homeowners' reported time and out-of-pocket costs and plumbers' estimates of revenues from pinhole leak repairs became the basis for calculating leak costs. The estimated cost of pinhole leaks and pinhole leak

prevention cost (within the United States) is nearly \$930 million per year. More than 50 % is due to single-family homes while multifamily apartment dwellings and commercial buildings account for around 20 %. In single-family homes, 50 % of the cost is allocated to repairs, 30 % to homeowners' time spent on the repairs, and the remainder is for property damage. For those who have had leaks before, the mean WTP for leak-free materials was \$1,130, and for those who had not experienced leaks, the WTP for leak-free materials was \$1,007. 6 % of respondents were willing to pay a premium of at least \$4,000 [47].

## 7 Service Lines

Service lines connect major systems to minor systems and are known to be the weakest spot within the drinking water infrastructure. To make matters worse, the documentation of failures is rare because they occur on private property. Due to this documentation limitation predicting future failures using statistical analysis is difficult. This section examines the general characteristics of the service lines that connect the inner plumbing of homes (minor systems) to the municipal water mains (major systems).

Water utilities and regulators are responsible for the maintenance of the system, including its physical condition, water quality, etc., up to the curb stop but after that point a major portion of the service line and all of the dwelling's plumbing systems and water quality are the homeowner's responsibilities [2], Fig. 1. Water quality tests of lead and copper levels are measured at the consumer's tap, within the property line, while disinfectant residuals and disinfection by-products (DBPs) are measured within the main distribution systems [2]. It has been noted that the incidences of waterborne disease outbreaks due to distribution systems are increasing [2]. The major culprits are (1) cross-connections and backsiphonage outbreaks associated with distribution systems and (2) pipe breaks and contamination of storage facilities. Outbreaks at premise plumbing level may not be easily recognized and reported compared to water main outbreaks. Water has a long contact time with service lines due to the intrinsic nature of minor plumbing systems, which leads to low disinfectant residuals and consequently microbial regrowth and DBP formation [2].

As mentioned, service lines are structurally weakest components in drinking water infrastructure systems. Excessive water loss or a puddle in the front lawn may be the first signs of a service line failure. Leaks in the service line rarely flow upwards so it is possible for leaks to go unnoticed for relatively long periods of time. Some utilities have detected leak incidents lasting more than a month. In order to detect water leaks in a service line, sonic and ultrasonic leak detectors can be used for metallic service lines while for plastic service lines, tracer gas or ground penetrating radar must be used. Service lines are susceptible to both internal and external corrosion. For external corrosion, soil corrosivity, stray electrical current, soil stability, bedding conditions, and temperature extremes could all be important

factors. Major causes of failure for service lines include (1) contractors exposing piping with a backhoe or other mechanical equipment, (2) improper installation of fittings and pipes, and (3) the original installation supervision was inadequate [50].

As mentioned in pipe pitting section, hydraulic surges or transients are another cause of failures. Piping material, material age, size, location, service pressure, flows, and other hydraulic parameters will also dictate the general characteristic of failure mechanisms. Due to structural stability and economic issues, replacing all components of the service line is generally a better option than trying to repair the service line alone, so proper installation practice and workmanship (from licensed workers with good training) under strict supervision with inspection are essential in order to maintain the physical integrity of service lines [50]. This prolongs the life of the service line and reduces the need to engage in unnecessary and expensive repair/rehabilitation/replacement.

According to the American Water Works Association (AWWA), 60.5 % of service line materials are copper followed by polyethylene (12.4 %), galvanized steel (8.6 %), and PVC (6.3 %). Remaining service lines consist of other materials such as lead. Surveys of 12 utilities across the United States revealed that Portland Water Utility (ME), Louisville Water Company (KY), and Brown Deer Water utility (WI) all used copper for more than 90 % of the service lines, although new materials including PEX and tri-layer pipes are beginning to emerge in service line applications [48]. Copper pipe has a particularly high rated internal working pressure (for more details, please refer to [49]). Copper pipes have the added advantage that they do not become brittle or subject to fatigue failures, although they can be noisy at high water velocities.

According to the American Society of Mechanical Engineers Code for Pressure Piping (ASME B31), the allowable internal pressure for any copper pipe in service is based on the formula (units in English):

$$P = \frac{2S(t_{\min} - C)}{D_{\max} - 0.8(t_{\min} - C)}, \quad (2)$$

where  $P$  = allowable pressure (psi),  $S$  = maximum allowable pressure in tension (psi),  $t_{\min}$  = wall thickness (minimum, inch),  $D_{\max}$  = outside diameter (maximum, inch), and  $C$  = constant. For copper pipe, due to its superior corrosion resistance, the B31 code permits the factor  $C$  to be zero and the equation reduces to  $P = \frac{2St_{\min}}{D_{\max} - 0.8t_{\min}}$ . For the nominal or standard size of K, L, and M copper pipes, the outside diameter is the same for all three, but the inside diameters are different; K pipes are thicker than L pipes and L pipes thicker than M pipes. These values for the outside diameter, thickness, and maximum allowable pressure in tension enable the allowable pressure to be determined using the above formula. The technical data for rated pressure, burst pressure, and thickness can be found in the Copper Tube Handbook [49].

The pressures at which a copper tube will actually burst are many times higher than its rated working pressure, which ensures that tubes can withstand the

unpredictable pressure surges likely to occur during the long service life of the system. For domestic use, when designing a copper tube water supply system the minimum tube size for each branch is determined by considering the following criteria: available main pressure at street level, minimum pressure required at each fixture, static pressure losses due to height difference between service line and most distant fixture, demand at each fixture and total system, friction losses in the system (major and minor losses), and velocity limitations specified in the code [6].

Several testing methods are utilized for pressure piping materials: (1) a sustained pressure test, where test specimens are selected randomly and individual specimen tested with water at the three controlled temperatures and pressures given in The American Society for Testing and Measurement (ASTM) (ASTM F 876); (2) a burst pressure test, where the minimum burst pressure is determined for at least five specimens in accordance with ASTM Test Method D1599; (3) an environmental stress cracking test, where a notch is made on the inside walls of six randomly selected tubes in the axial direction in accordance with the standard burst pressure testing procedure; and (4) oxidative stability in potable chlorinated water is tested in accordance with ASTM Test Method F 2023 to determine the extrapolated time to failure.

The ASTM has developed a set of minimum performance standards to determine the suitability of PEX tubing for high temperature and pressure fluid distribution applications (ASTM F876). The following values have been defined for performance standards at three different temperature and pressure ranges: 1103 kPa (160 psi) @ 23 °C (73.4 °F), 689 kPa (100 psi) @ 82.2 °C (180 °F), and 552 kPa (80 psi) @ 93.3 °C (200 °F); Minimum Quick Burst Capability: 3,275 kPa (475 psi) @ 23 °C (73.4 °F), 1,448 kPa (210 psi) @ 82.2 °C (180 °F), and 1,241 kPa (180 psi) @ 93.3 °C (200 °F); and Sustained Pressure Tests: 1,000 h at 1,310 kPa (190 psi) @ 82.2 °C (180 °F). The water hammer pressure rise in PEX is 25 % of that in copper pipes, so water hammer arrestors are not necessary for PEX systems [51]. Table 3 shows the maximum pressure rise when water at a given velocity stops abruptly.

## 8 Contaminant Intrusion in Water Distribution Systems

It is widely believed that because a drinking water distribution system is pressurized, the water can only leak out of the system. However, there is considerable evidence to show that pump trips, the opening and closing of fire hydrants, valve closures or malfunctions, pipe breaks, sudden changes in demand, and resonance can all induce significant transients leading to low-pressure events within a drinking water distribution system. During such events, a greater external pressure can easily lead to contamination intrusion through available openings. Tests of the surrounding soil and pipe specimens from repair locations clearly demonstrate the presence of pathogens. In the year 2000 alone, 6,988 water systems affecting about 10.5 million people violated microbial drinking water standards in the United States [52].

**Table 3** Hydraulic shock for different pipe types

Velocity (m/s)	PEX (kPa)	Copper (kPa)
1	400	1,379
2	600	2,068
2	800	2,758
3	1,000	3,482

Intrusion is defined as the backflow situation in which contaminated water from the environment outside of the distribution piping enter into the pipe through leaking sections [52]. Comprehensive reviews and detailed discussions on the pathogen intrusion problems into the municipal drinking water systems are available in the literature [4, 53]. Water treatment plants are the primary barrier against pathogens before the water enters the distribution systems [4]. These barrier mechanisms include the removal (inactivation) of pathogens, turbidity and organic matter to prevent biological regrowth in the distribution system, as well as disinfection, treatment to maintain optimal contact time for bacterial inactivation, and filter blockage of particle–contaminant carryover into the distribution system. Any breakthrough in water treatment plant barrier is considered a high risk and the probability of contamination occurrence is also considered high. The physical mechanisms involved are separated into “transitory contamination” due to low-pressure propagation in the system drawing in contaminants from the exterior surroundings with a higher pressure; “cross-connection” between a potable water system and a source that can potentially introduce contaminants into the potable water; and “pipe break, repair, and installation” activities that expose the distribution system to externalities as routes of entries. Storage facilities both covered and uncovered, intentional contamination for terror purposes, growth, and resuspension serve as additional sources for pathogen intrusion.

Two epidemiology studies related to a drinking water distribution system in Montreal, Canada, found that people who consumed tap water had increased levels of gastrointestinal illnesses and that people who lived farther away from the treatment plant had the highest risk of gastroenteritis [54, 55]. Another study revealed that the same distribution system was extremely prone to negative pressures, with more than 90 % of the nodes within the system drawing negative pressures under power outage scenarios [4]. Although this system had a state-of-the-art treatment plant, its highly vulnerable water distribution system made it vulnerable to potential contamination.

## 8.1 Hydraulic Transients

Transient high and low pressures can be triggered by many different events, as explained above. LeChevallier et al. [52] provided pictures of an inundated air valve vault that initially had an oily film on the surface of the water. After a transient passes through, the vault is completely drained allowing the contents,



including the oil contaminant, to enter the distribution system. In another dramatic incident, a cracked sewer pipe lay on top of a leaky water pipe [4]. Soil and water quality tests at water main repair sites have been found to contain fecal coliform bacteria in 43 % of the water samples and 50 % of the soil samples, suggesting that waterborne pathogens are very common in the environment external to water distribution mains [4]. Another study found bacteria and viruses in 66 soil and water samples collected next to drinking water pipelines in eight water utilities with total coliform and fecal coliform bacteria in about 50 % of the samples; 56 % of the samples were positive for viruses, providing evidence of human fecal contamination immediately surrounding the exterior of the pipes [56].

A study of transitory low-pressure propagation in a municipal potable water system that typically uses 10.2 cm to 25.4 cm pipes documented intrusions of contaminants and low pressures of the order of negative 68.95 kPa [53]. Distribution mains downstream of pumps, high elevation areas, low static pressure zones, areas far away from elevated water storage tanks, and segments of pipes upstream and downstream of active valves in high flow areas are the most susceptible to low or negative pressures. Locations with frequent leaks and breaks, high water table regions, flooded air vacuum valve vaults, and high-risk cross-connections have the highest potential for contamination intrusion. Most hydraulic transients occur as the result of pump operations and outages [57]. Novak [10] provided experimental evidence that in a pipe bent at a 90° angle with a pressure range of less than 68.95 kPa and a flow velocity of about 1.83 m/s, contamination can indeed be sucked into downstream of the bend.

Leakage rates (water lost in transit between the treatment plant and minor systems) in drinking water systems has been found to reach 32 % in some utilities, which indicates a high potential of contamination intrusion [4] and some six billion gallons of treated water is disappearing during distribution every day [58]. According to AWWA [58], the majority of water leaks occur at service lines, service fittings, and connections. As mentioned, the lower total chlorine residuals, lack of dilution, and short detention time before potential consumption might increase the potential health threat to individual consumers if intrusions were to occur at service lines [2].

While it is known hydraulic transients are common inside a home, the range of pressures experienced within the plumbing system requires further investigation. As a minor system is a passive recipient from the water mains, if there is contamination in the service line this is bound to enter into tap water and thus poses a serious health risk. An experimental plumbing system that replicates the range of pressures typically encountered in service lines and minor plumbing systems when connected to the water mains was therefore designed and constructed. This experimental water system was then used to (1) examine how a low-pressure wave such as those produced by street level transients and transients triggered within a house moves through the service line in order to predict the potential intrusion of contaminants from the surrounding soil or water; (2) measure pressure variations at various locations within the minor systems, for example, in vertical sections

within a house, as a function of valve positions and sudden valve closing/opening; and (3) evaluate any cavitation produced by the hydraulic transients.

## 8.2 *Hydraulic Transient Scenarios*

Here, minor system was simulated by directly connecting the experimental system to the water mains. Three scenarios, referred to as Transient Scenarios I, II, and III, that can trigger a hydraulic transient in a service line were considered. For Transient Scenario I, transients were triggered by actions initiated from inside the house, such as shutting off a valve, shower heads, or the automatic on/off of the solenoid valve on the washing machine. For Transient Scenarios II and III, transient-causing actions were initiated from the major municipal water system upstream and downstream from the house, respectively. These examples would include, but are not limited to, pump on/off events, the opening and closing of fire hydrants, valve slams or malfunctions, pipe breaks, and sudden changes in demand and resonance (Table 4).

Hydraulic transients were induced by a valve suddenly closing the ball valve or solenoid valve in the pipe system, causing a sudden change in both velocity and pressure. As the pressure wave passed through the pipe, maximum and minimum pressure measurements of 100 readings per second were employed to visualize the pressure variation, with the baseline pressure being the water line's steady state pressure. The piezoelectric pressure sensor therefore provided a relative pressure measurement based on the water line's steady state pressure. For example, if the baseline water line pressure was 206.8 kPa (measured by the static pressure gage), then a 206.8 kPa static water line pressure would give a zero reading on a piezoelectric pressure sensor, but a regular static sensor would read 206.8 kPa.

The average static pressure in the water mains was  $551 \pm 27$  kPa when all the valves were closed. The fluctuations observed were probably due to the existing weak transients within the municipal system. However, when the faucets were fully opened (with a flow rate of  $37 \pm 3$  l/min), the residual pressure fell to 275.8–310.3 kPa within the experimental system. The level of residual pressure was controlled by adjusting the valve at the water mains. When the main valve was partially opened, the residual pressure was 103.4–137.9 kPa (a flow rate of  $20 \pm 3$  l/min). Initially, the system was set at a steady state of 275.8 kPa (residual pressure). The solenoid/ball valves were then abruptly closed/opened as required to produce the three transient scenarios (Table 4). The solenoid valve closing/opening time was  $< 0.3$  s according to the manufacturer, while the ball valve closing/opening time was less than 0.1 s after operator training.

**Table 4** Experimental conditions for each transient scenario [59]

	Transient scenario I	Transient scenario II	Transient scenario III
Valve 1	<i>Open/close</i>	Open	Open
Valve 2	Open	<i>Open/close</i>	Open
Valve 3	Closed (to maintain residual pressures)	Closed (to maintain residual pressures)	<i>Open/Close</i>
Test Description	Transient initiated from inside the minor system or household plumbing	Transient initiated from the major system or water main upstream from the house	Transient initiated from the major system or water main downstream from the house

### 8.3 Pressure Variations in Service Line

The pressure variations in the service line are shown in Figs. 2, 3, and 4. Transient Scenario I was triggered by the opening or closing of valve 1, Transient Scenario II by opening or closing valve 2, and Transient Scenario III by opening closing valve 3 (Table 4). During Scenarios I and II, no water was flowing through the branched sections in order to maintain a higher residual pressure inside the system.

Figure 2 show that when valve 1 was suddenly closed to trigger Scenario I, the pressure went up sharply to 482.6 kPa above the steady state. So, within a fraction of a second the service line experienced an instant pressure increase of the order of 482.6 kPa or a gage pressure of  $(275.8 + 482.6) = 758.4$  kPa, which could result in *repetitive fatigue impact on service lines* due to constant on/off events inside the house. However, when valve 1 was reopened, this caused an instant reduction in pressure of the order of  $-206.8$  kPa, with a gage pressure of 344.7 kPa (i.e., 551.6 kPa [system static pressure when valves 1 and 3 are closed]  $-206.8$  kPa [pressure variation]), which did not create a low enough pressure to cause suction. When the residual pressure was around 137.9 kPa, the trend was the same, but the magnitude was smaller than for the fully open case.

Scenario II was triggered by closing valve 2 in the major system upstream from the minor system and the resulting pressure variations (Fig. 3). After a sudden closure, the pressure dropped to  $-68.9$  kPa for a fraction of a second as Transient Scenario II caused an instant pressure drop of 344.7 kPa, leading to a negative pressure  $[275.8 \text{ kPa (steady state)} - 344.7 \text{ kPa (pressure variation)} = -68.9 \text{ kPa}]$  in the service line. When the residual pressure was 103.4 kPa, the pressure variation was smaller than in the fully open case but still caused a negative pressure.

Scenario III was triggered by closing a valve in the major system downstream from the minor system and the resulting pressure variations are shown in Fig. 4. After a sudden closure, the pressure variation rose to 170 kPa for a fraction of a second and Transient Scenario III caused an instant pressure drop of 200 kPa. Here, the residual pressure (steady state pressure) was around 130 kPa, which is lower than either of the other cases as the two branch pipes were open for both. Scenario III created pressure peaks but did not cause a negative pressure surge sufficient to cause suction when the valve was reopened.

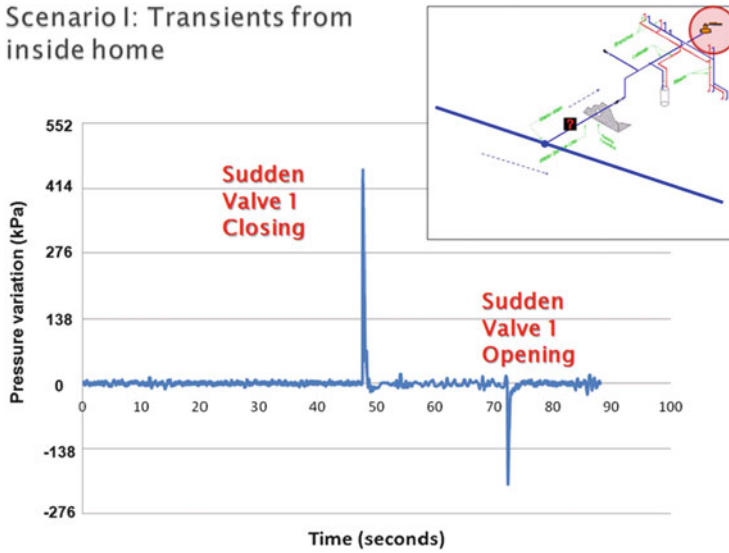


Fig. 2 Pressure variation at P3 due to valve 1 maneuver, Transient Scenario I [59]

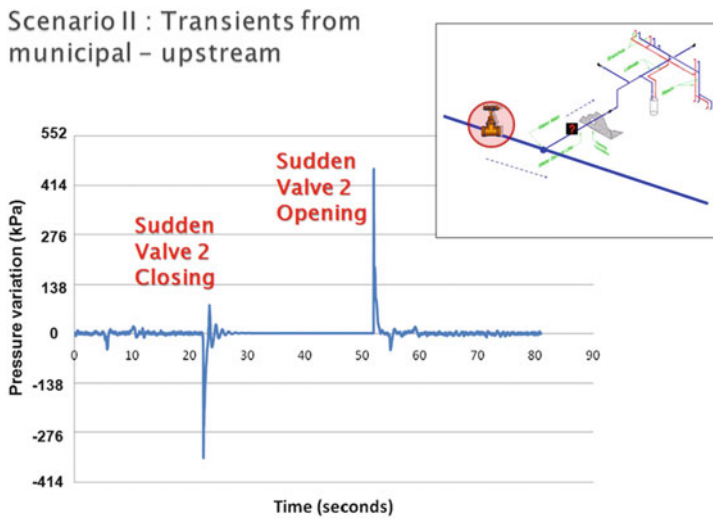


Fig. 3 Pressure variation at P3 due to valve 2 maneuver, Transient Scenario II [59]

### 8.4 Pressure Variations within Minor Systems

The pressure variations in a vertical riser section with a dead end were then measured when the transients were triggered. Figure 5 shows the pressure variations in this vertical section produced by Scenario I, which produced a very high-

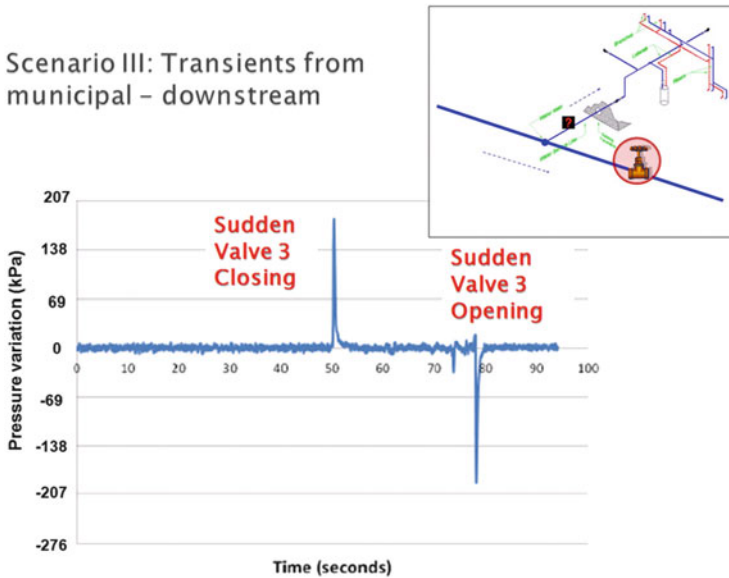


Fig. 4 Pressure variation at at P3 due to Valve 3 maneuver, Transient Scenario III [59]

pressure variation of more than 689.5 kPa when valve 1 was closed suddenly. Reopening the valve caused a much smaller negative pressure event, but this was again insufficient to create the type of serious suction likely to lead to contamination.

Pressure variations at the vertical riser with a dead end caused by the sudden closing of valve 1 showed pressure spikes of 827.4 kPa. Dead ends are thought to amplify pressures by factors of up to two, depending on the topology of the systems. Network simplifications that eliminate dead ends from transient analysis are invalid and modelers should therefore check key transient runs with a complete model that includes dead ends [60]. The results shown in Fig. 5 support Jung et al’s [60] findings regarding the high-pressure variations experienced in vertical dead-end sections.

### 8.5 Gaseous Cavitation

Using a High Definition video camera, an effort was made to capture the cavitation occurring within the horizontal pipework in the minor system by taking pictures of the clear section every 0.033 s (30 frames per second, Fig. 6). The number of bubbles created and their shapes appeared to be almost random, with gas evolution and dissolution timing remaining almost constant as long as the hydraulic transient triggering mechanism was controlled (i.e., the valve closing time remained

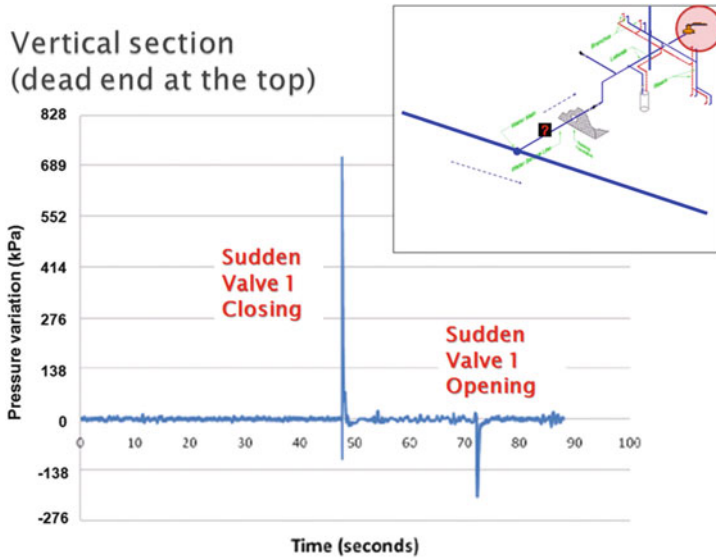


Fig. 5 Pressure variation at P2 (vertical riser with dead end), Transient Scenario I [59]

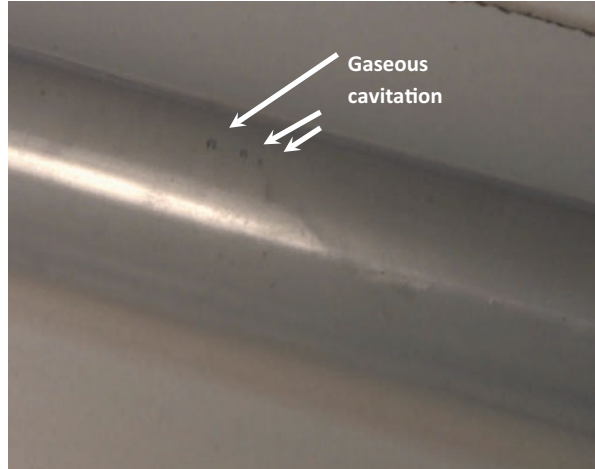
constant). As the diameter of the clear plastic pipe was known to be 1.9 cm, the size of the created bubbles could be estimated to a fair degree of accuracy.

In this experiment, whenever the pressure dropped to  $-68.9$  kPa (gage pressure) or below, the formation of gaseous bubbles in the clear plastic pipe section was observed. These bubbles disappeared within less than 1 s once the pressure recovered to above the gas saturation pressure. Interestingly, the bubble formation time was quicker (less than 1 s) than is provided for by the traditional theory of gaseous cavitation formation timing (from 1 to several seconds). However, the presence of preexisting gas nuclei attached to particles in the bulk solution may have provided nucleation centers, accelerating the growth of the observed bubbles.

## 9 Conclusions

In this chapter, we covered general characteristics of the drinking water distribution systems which consist of “major” and “minor” systems. A *major system* is generally defined as the water mains that bring drinking water from water treatment plant to the consumer’s premises (homes and buildings), while a *minor system* is the plumbing system (including service lines) that transports water within the property boundaries. America’s water distribution infrastructure system is old and deteriorating. It is noted that minor systems are known to be at least five or ten times longer in total than major systems. We focused on several emerging issues in minor

**Fig. 6** Hydraulic transients induced gaseous cavitation [59]



systems: pipe failure mechanisms, alternative pipe materials, economic aspect of pipe failures, and contamination intrusion into service lines.

The literature associates copper pinhole failures with a number of different causal factors (water quality, hydraulic, and anthropogenic conditions) that seemingly combine to act in a complex synergy. Given the inherent complexity of any plumbing system and the synergistic effects of causal mechanisms, at present, it is difficult to conclusively predict the extent of pitting with absolute certainty. For instance, controlling one mode of failure may not necessarily completely mitigate pitting and may even initiate other mechanisms of failure. This underlines the necessity for a global assessment that simultaneously encompasses all possible failure mechanisms.

To assess the impacts due to pipe failures and water quality deterioration, pressure variations at the service line corresponding to typical street level pressures encountered in a real water supply system were introduced and examined in detail [59]. This study was specifically developed for a typical one- or two-story house for a plumbing system consisting of 46–76 m of pipes. The major findings of this research were as follows:

1. Street level transients can propagate a low-pressure wave (up to  $-68.9$  kPa for a fraction of a second) along the experimental service line. This pressure drop would be sufficient to induce potential contamination intrusion in the service line.
2. A transient triggered within the house (due to sudden valve closure) may structurally tax the experimental service line but did not exhibit a possible suction effect. If an actual service line is not sufficiently robust, this may cause constant fatigue effects and may result in bursting.
3. Vertical sections with dead ends experience higher pressure variations (up to 758 kPa variations) when transients are triggered from inside the house. This may be related to noise effects in the home and could bear further examination.

4. Gaseous cavitation was observed due to water hammer-induced low pressure (as a result of street level transients), with bubble formation times due to gaseous cavitation of less than 1 s. This contradicts previous theories that predict times of 2–3 s. This phenomenon has practical implications for implosion or gaseous impingement of the kind that is known to erode protective scales on the wall.

Hydraulic transients in water mains clearly exhibit a high potential to create sufficiently low pressures in service lines to allow the possible intrusion of microbial and chemical contaminants. It is therefore recommended that this new knowledge should be broadly disseminated to homeowners, water utility personnel, homebuilders, and public health officials. Specifically, the *physical integrity of service lines* and the *hydraulic integrity of water mains* should be rigorously maintained, with the utmost effort being devoted to protecting against any possible human health risk involved with service lines. Appropriate outreach programs targeted at educating the public regarding these issues should be developed.

1. *Physical integrity of the service lines*: All service line construction and installation activities should be performed under strict supervision to ensure good workmanship (i.e., a professional license, including high-quality training). All the appurtenances associated with the service line (including piping materials, fittings, joints, and valves) should meet strict pressure ratings and corrosion susceptibility requirements for their specific environment. Leaks should be checked for after installation and leak detection performed on a regular basis. Service line condition should become part of the routine inspection carried out when purchasing a house. For water utilities, it is recommended to maintain a comprehensive database (e.g., GIS) for service lines that includes failure data, soil condition, pipe materials, installation date, and any repair/replacement history so future leaks can be predicted. The integrity of a service line can only be maintained with careful planning, management, and knowledge of the environmental conditions where the line is buried.
2. *Hydraulic integrity in the major systems*: As shown above, hydraulic transients from major systems largely dictate pressure variations in the service lines. At the utility level, it is recommended that surge protection devices be installed to protect against both negative pressures and high pressures (pipe bursts due to high-pressure spikes), which will include training or hiring transient flow analysts to identify weak spots. State or federal regulation may be needed to create tax incentives to encourage such industry initiatives.
3. *Public perception*: Water professionals and policy makers need to work on *bridging the gap between public perception and research results*. This can be done through broad education on water quality, public health risk, and drinking water infrastructures. Public education will encourage homeowners' increased awareness of little known but potentially serious problems such as the unique characteristics of service lines and their associated public health risks. Education can be done through *education outreach from research universities* to K-12 including high school and middle school teachers. Official websites maintained by government agencies or utilities should make this information available to



homeowners. Regular public newsletters or a small handbook issued to all homeowners could also be helpful.

Service lines should deliver water with no deterioration in quality, which may necessitate the development of new water sampling methods to detect possible intrusion events at distribution systems. Paradigm shift of ownership issues could also be considered. For example, the city government in Seoul, South Korea, is planning to include minor systems as part of their public assets and some utilities in the UK have opted to become responsible for the entire service line except for the plumbing system inside the house in order to facilitate the resolution of water leakage issues. These will lead to safer designs not only within dwellings but also better maintenance practices for municipal systems.

**Acknowledgments** This chapter is based upon authors' journal publications focusing on premise plumbing issues, which were completed under the guidance of Late Dr G.V.Loganathan. The Sect. 4 Literature Review of Copper Pipe Pitting and Sect. 8 Contamination Intrusion at Minor Systems have been included with written permission from the ASCE and the IWA, respectively. The authors gratefully acknowledge Dr. Paolo Scardina and Dr. Marc Edwards for their expert advice.

## References

1. The Report of President's Commission on Critical Infrastructure Protection (1997) Critical foundations: protecting America's infrastructures. Available at <https://www.fas.org/sgp/library/pccip.pdf>. Accessed 1 March 2014
2. Edwards MA (2006) Chapter 8: alternatives for premise plumbing. In drinking water distribution system: assessing and reducing risks. National Research Council, The National Academic Press, Washington DC
3. Loganathan GV, Lee J (2005) Decision tools for optimal replacement of plumbing system. *J Civil Environ Eng* 22(4):189–204
4. Kirmeyer G, Friedman M, Martel K, Howie D, LeChevallier M, Abbaszadegan M, Karim M, Funk J, Harbour J (2001) Pathogen intrusion into the distribution system. American Water Works Association Research Foundation, Denver, CO
5. Marshutz S (2001) Hooked on copper: a comparison shows the gap is narrowing with PEX gaining popularity as a preferred material in new construction and repiping work. *Reeves Journal*. <http://www.highbeam.com/doc/1G1-82881389.html>. Accessed 25 Dec 2013
6. Ladd J (2005) An evaluation and pressure driven modeling of potable water plumbing system. MS Thesis, Va Tech
7. Worthington W (2006) President, pipeline technology & pipetech international (Personal communication)
8. IPC (International Plumbing Code) (2000) International code council. Falls Church, Va
9. Stein B, Reynolds JS (1992) Mechanical and electrical equipment for buildings. Wiley, New York
10. Novak JA (2005) Cavitation and bubble formation in water distribution system. MS Thesis, Va Tech
11. Lee J, Kleczyk E, Bosch D, Tanellari E, Dwyer S, Dietrich A (2009) Case study: preference trade-offs toward home plumbing attributes and materials. *J Water Resour Plann Manag* 135 (4):237–243

12. AWWA Manual M27 (1987) External corrosion: introduction to chemistry and control
13. Farooqi OE (2006) An assessment and modeling of copper plumbing pipe failures due to pinhole leaks. MS Thesis, Va Tech
14. Edwards M, Rushing JC, Kvech S, Reiber S (2004) Assessing copper pinhole leaks in residential plumbing. *Water Sci Technol* 49(2):83–90
15. Basalo C (1992) Water and gas mains corrosion, degradation, and protection. Ellis Horwood, Chichester, UK
16. Chang R (1998) Chemistry. McGraw Hill, New York
17. Magnon PL (1999) The principles of materials selection for engineering design. Prentice Hall, Upper Saddle River, NJ
18. West JM (1986) Basic corrosion and oxidation. Ellis Harwood, Chichester, UK
19. Trethewey KR, Chamberlain J (1995) Corrosion for science and engineering. Longman, Harlow, UK
20. Edwards MA, Ferguson JF, Reiber SH (1994) The pitting corrosion of copper. *J Am Water Works Assoc* 86(7):74–90
21. Ferguson JF, von Franque O, Schock MR (1996) Corrosion of copper in potable water systems. In Internal corrosion of water distribution systems. Denver, CO., American Water Works Association Research Foundation
22. Schock MR (1999) Chapter 17: water quality and treatment. McGraw-Hill, In Internal corrosion and deposition control
23. Marshall B, Edwards M (2005) Copper pinhole leak development in the presence of  $\text{Al}(\text{OH})_3$  and free chlorine. Proceedings of the AWWA Annual Conference, San Francisco, June
24. Rushing JC (2002) Effects of chlorine and aluminum on copper pitting, temperature gradients on copper corrosion, and silica on iron release. MS thesis, Va Tech
25. El Warraky A, Shayeb HA, Sherif EM (2004) Pitting corrosion of copper in chloride solutions. *Anticorros Methods & Mater* 51(1):52–61
26. Nguyen CK (2005) Interactions between copper and chlorine disinfectants: chlorine decay, chloramine decay and copper pitting. MS Thesis, Va Tech
27. Sobue K, Sugahara A, Nakata T, Imai H, Magaino S (2003) Effect of free carbon dioxide on corrosion behavior of copper in simulated water. *Surf Coat Technol* 169–170:662–665
28. Jacobs S, Reiber S, Edwards M (1998) Sulfide-induced copper corrosion. *J Am Water Works Assoc* 90(7):62–73
29. Jacobs S, Edwards M (2000) Sulfide scale catalysis of copper corrosion. *Water Res* 34(10):2798–2808
30. Myers J, Cohen A (2005) Copper-tube corrosion in domestic water systems. In Boiler systems engineering. American Boiler Manufacturer's Association
31. Murray-Ramos NA (2006) Examining aspects of copper and brass corrosion in drinking water. MS Thesis, Va Tech
32. Rossum JR (1985) Pitting in copper water tubing. *J Am Water Works Assoc* 77(10):70–73
33. Cohen A, Lyman S (1972) Service experience with copper plumbing tube. *Mater Prot Perform* 11(2):48–53
34. Duthil JP, Mankowski G, Giusti A (1996) The synergetic effect of chloride and sulfate on pitting corrosion of copper. *Corros Sci* 38(10):1839–1849
35. Maryland Task Force Study (2004) Pinhole leaks in copper plumbing. Maryland Department of Housing & Community Development, December
36. Canadian Copper & Brass Development Association (2005) Hot water recirculation systems. <http://www.coppercanada.ca/publications/pubis97-02/pubis9702.html>. Accessed 25 Dec 2013
37. Scardina RP (2004) Effects of gas supersaturation and bubble formation on water treatment plant performance. Ph.D, Dissertation, Va Tech
38. Zielke W (1990) Chapter 1. Gas release in transient pipe flow. In Thorley ARD (ed) Pressure surges: Proceedings of the 6th international conference, Cambridge, UK October 1989. BHRA Fluid Engineering Center, Cranfield, UK

39. Wiggert D, Sundquist M (1979) The effect of gaseous cavitation on fluid transients. *J Fluids Eng* 101:79–86
40. Van Houten JJ (2003) Control of plumbing noise in buildings. *Plumb Syst & Des* March/April:30–37
41. Plumbing & Drainage Institute (1992) Water hammer arrestors: Standard PDI – WH 201
42. Farooqi O, Lee J (2005) Plumber survey: Phase I
43. Farooqi OE, Loganathan GV, Edwards MA, Bosch D, Lee J, Scardina P (2009) Copper pinhole failures: plumbing susceptibility and management. *J Water Resour Plann Manag* 135(4):227–236
44. Slovic P, Weber EU (2002) Perception of risk posed by extreme events. Conference on Risk Management Strategies in an Uncertain World. Palisades, New York, April
45. Champ PA, Boyle KJ, Brown TC (2003) A primer on nonmarket valuation. Springer, Netherlands
46. Kleczyk E, Bosch D (2006) Causal factors and costs of home plumbing corrosion: Sample selection bias. AAEA Annual Meeting, Long Beach, CA, July
47. Scardina P, Edwards M, Bosch D, Loganathan GV, Dwyer S (2007) Non-uniform corrosion in copper piping—assessment. Final report submitted to American Water Works Association Research Foundation. Va Tech, Blacksburg, VA
48. Research Foundation AWWA (2007) Installation, condition assessment, and reliability of service lines. Denver, CO., AWWA
49. Copper Development Association (2005) Copper tube handbook. [http://www.copper.org/publications/pub\\_list/pdf/copper\\_tube\\_handbook.pdf](http://www.copper.org/publications/pub_list/pdf/copper_tube_handbook.pdf). Accessed 25 Dec 2013
50. AWWA (American Water Works Association) (2004) Sizing Water Service Lines and Meters (M22). Denver, CO., AWWA
51. PPFA (2002) Cross-linked polyethylene (PEX) hot and cold water-distribution systems
52. LeChevallier M, Gullick R, Karim M, Friedman M, Funk J (2003) The potential for health risks from intrusion of contaminants into the distribution system from pressure transients. *J Water Health* 1(1):3–14
53. Friedman M et al. (2004) Verification and control of pressure transients and intrusion in distribution systems. Report 91001F. AWWA, Denver, CO
54. Payment P, Richardson L, Siemiatycki J, Dewar R, Edwards M, Franco E (1991) Randomized trial to evaluate the risk of gastrointestinal disease due to consumption of drinking water meeting microbiological standards. *Am J Public Health* 81(6):703–708
55. Payment P, Siemiatycki J, Richardson L, Renaud G, Franco E, Prevost M (1997) A prospective epidemiological study of gastrointestinal health effects due to the consumption of drinking water. *Int J Environ Res Publ Health* 7:5–31
56. Karim M, Abbaszadegan M, LeChevallier M (2003) Potential for pathogen intrusion during pressure transients. *J Am Water Works Assoc* 95(5):134–146
57. Gullick R, LeChevallier M, Svindland R, Friedman M (2004) Occurrence of transient low and negative pressures in distribution systems. *J Am Water Works Assoc* 96(11):52–66
58. AWWA Water Loss Control Committee Report (2003) Applying worldwide best management practices in water loss control. Available at <http://ascelibrary.org/doi/abs/10.1061/40941%28247%2933>. Accessed 1 March 2014
59. Lee J, Lohani V, Dietrich A, Loganathan GV (2012) Hydraulic transients in plumbing systems, IWA water supply. *Water Sci Technol: Water Supply* 12(5):619–629
60. Jung BS, Karney BW, Boulous PF, Wood DJ (2007) The need for comprehensive transient analysis of distribution systems. *J Am Water Works Assoc* 99(1):112–123

# The Effects of Water–Energy Nexus on Potable Water Supplies

Sarah Lawson, Qi Zhang, Mimansha Joshi, and Tzu-Han Pai

**Abstract** Feedbacks between water and energy complicate the daunting task of supplying safe drinking water to a growing population. Potable water treatment and distribution require large quantities of energy and at present largely rely on fossil fuels. While the available fuel source dwindles, the demand for energy to supply drinking water will likely increase due to a growing global population, higher demand for enhanced water treatment and distribution, and the necessary use of energy-intensive alternative water sources such as wastewater and saline water. Electricity production also requires significant quantities of water and may be in direct competition for freshwater resources with potable water supply. The quantity of water used in electricity production will likely increase in future years with rising electricity demand and changes in electricity production. Electricity production can also contaminate water supply sources. Finally, climate change is affecting precipitation patterns and water demand, which will further complicate supplying drinking water to a growing population. This chapter provides an overview of the ways in which the water–energy nexus creates challenges and opportunities in meeting potable water demand.

**Keywords** Water–energy nexus • Climate change • Water treatment and distribution • Electricity generation • Freshwater supply

---

S. Lawson (✉)

Departments of Environmental Studies & Science and Physics, Randolph College, Lynchburg, VA, USA

e-mail: [slawson@randolphcollege.edu](mailto:slawson@randolphcollege.edu)

Q. Zhang

Nicholas School of the Environment, Duke University, Durham, NC, USA

M. Joshi

School of Environment, Resources and Development, Asian Institute of Technology, Pathumthani, Thailand

T.-H. Pai

H2O Clinical LLC., Cockeysville, MD, USA

## 1 Introduction

Limitations on the supplies of freshwater and fossil fuels drive research and policy on water and energy. These two resources are highly related (Fig. 1), and in recent years, the feedbacks between water and energy, the water–energy nexus, have received increased attention and governments and nongovernmental organizations have realized that policy must consider both water and energy simultaneously. For example, in 2012, the International Energy Association’s (IEA) World Energy Outlook included a special section on the need for water in the energy sector noting the importance of water scarcity in energy resource planning and the rapidly increasing use of water for energy [2]. The United Nations Water program will focus World Water Day 2014 on the interactions between water and energy and will focus their first annual themed World Water Development Report on the water–energy nexus [3]. In the United States, the Government Accountability office (GAO) has written six reports since 2009 exploring the use of water for energy, energy for water supply, and the need for integrated government information. In their most recent report, the GAO recommends that the Department of Energy coordinate a program involving multiple federal agencies to address the water–energy nexus [4]. Nongovernmental organizations such as the Pacific Institute and the River Network have also reported on the water–energy nexus. In June 2013, the World Bank issued its report “Thirsty Energy” detailing the use of water for energy and the need for integrated policy [5]. This proliferation of work on the water–energy nexus indicates the growing awareness of the importance of feedbacks between water and energy and the lack of currently integrated approaches. Many of the efforts toward integrated water and energy policy are in early stages and based in the United States [5] and often focus on the need to supply water for the energy sector (i.e., 4). However, the water–energy nexus will also create challenges in expanding and maintaining the potable water supply.

The need for understanding these feedbacks will intensify as demand for water and energy increases. The United States Energy Information Administration (US EIA) predicts a 1.5 % annual increase in global total energy consumption from 2010 to 2040, while population is only expected to grow 0.8 % annually ([6], Fig. 2). Cai and Rosengrant [7] predicted a 72 % increase in global domestic freshwater use from 1995 to 2025 with over 90 % of this increase occurring in developing countries largely due to population growth and a 40 % increase in per capita water use. The energy use for water supply will also be affected by how people obtain water. Accessible and safe drinking water for all people is an important goal for global public health and economic opportunity. In 2010, 89 % of the world’s population obtained water from an improved water source, up from 76 % in 1990 [8]. While a water treatment and distribution system typical of a developed country is not required for an improved water source, the number of people obtaining water from piped on premise systems, bottled water, and public taps has increased during this time [8]. Unimproved water sources can require a large expenditure of human energy, often in the form of walking long distances,



**Fig. 1** A conceptual landscape illustrating some of the ways in which water and energy are related. Water is used in mining, irrigation of crops for biofuels, generation of electricity through hydropower, and cooling in thermoelectric power plants. Energy is used to treat, pump, and heat the water. Adapted from the US DOE (Figure I-1) [1]

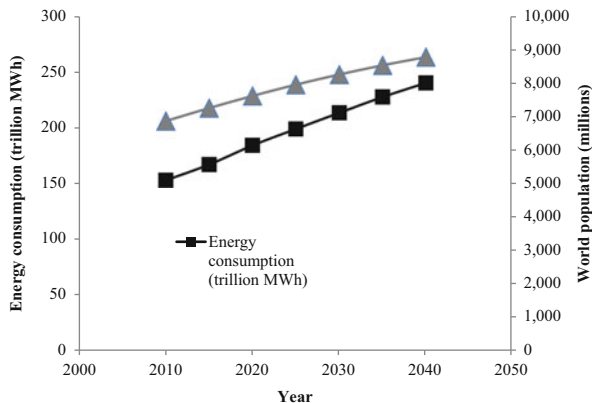
while improvements in water supply and sanitation are typically accompanied by an increase in (nonhuman) energy use due to water treatment and distribution.

This chapter focuses on challenges to expanding safe drinking water presented by the water–energy nexus. It provides an overview of challenges to supplying potable water related to the water–energy nexus.

## 2 Energy Demand for Potable Water Supplies

In countries in which access to safe drinking water is common, supplying water uses a significant amount of electricity. Water and wastewater combined use 2–19 % of electricity and water alone uses 0.5–3 % of electricity across a range of scales (Table 1). The variability in these values arises from differences in the energy intensity of water and wastewater services as well as the energy intensity of the overall economy. For example, water and wastewater services in India are expected to be more energy intensive because of initial poor water quality [11],

**Fig. 2** Predicted trends in population and energy consumption. Energy consumption is increasing at a faster rate than population. Data is from [6]



while in China [14] and Texas, United States [15], water services account for a small percent of total electricity use because of high electricity use across the rest of the economy. In California, the volumetric energy intensity of the water supply (the energy required per volume of water supplied often expressed as  $\text{kWh m}^{-3}$ ) is high because of long-distance pumping of water to arid or semiarid areas [16].

In coming years, energy intensity of water supply will likely increase as overall water quality deteriorates and populations turn to poorer quality and more remote sources of water to meet growing demands. Drinking water supply in the United States requires an average of  $0.51 \text{ kWh}$  of energy per  $\text{m}^3$  of drinking water [10], with public water systems using more energy than private wells [17]. This analysis by Arzbaecher et al. [10] indicates that the energy intensity of water supply in the United States has increased since the often-cited study by EPRI [17] which determined energy intensity between  $0.37$  and  $0.48 \text{ kWh m}^{-3}$  for public water supply in the United States. Overall, energy use for the water and wastewater services is expected to increase by approximately  $1/3$  over the next 20 years, partially due to the use of alternative water sources [18]. In Australia, traditional centralized water requires  $0.39 \text{ kWh m}^{-3}$ , but the energy used for water supply will increase as the country turns to more energy-intensive water sources such as desalination ( $4.3 \text{ kWh m}^{-3}$ ) and recycled water ( $1.7 \text{ kWh m}^{-3}$ ) [19]. On a volumetric basis, electricity use for water in China increased  $17\%$  (from  $0.079 \text{ kWh m}^{-3}$  to  $0.094 \text{ kWh m}^{-3}$ ) from 1997 to 2004 and in total increased  $14\%$  from 2003 to 2005 [14]. The demand for energy in supplying safe drinking water is not limited to developed countries, as boiling is often used in developing countries to make water biologically safe to drink, though a lack of fuel, or access to fuel, limits the viability of this solution for the poorest areas [20]. Other decentralized water treatment approaches such as ultraviolet light disinfection may also be limited by availability of energy, though innovative water treatment approaches driven solely by gravity or incoming solar radiation are emerging as viable options [20].

Energy is required in a typical potable water system in a developed nation to move and treat water. The energy required at a minimum to supply safe drinking



**Table 1** Percent of total energy use of localities around the world that is used for water or water and wastewater services

Location	Sector	% of total energy use	Percent of population with access to an improved water source <sup>a</sup>	Source
Toronto, Canada	Water and wastewater	2	100	[9]
India (various cities)	Water and wastewater	<3–16	91.6	[8]
United States	Water and wastewater	4	98.8	[10]
China	Water	0.5	91.7	[11]
Spain	Water	5.8	100	[12]
California, USA	Water and wastewater	19	98.8	[13]
Texas, USA	Water	0.5–0.7	98.8	[14]

<sup>a</sup>All data on access to an improved water source are from the World Bank

water in an area will depend on the topography, location and quality of the source water, and the length of the distribution system. Beyond this, energy use will be affected by the type of treatment used, pumping efficiency, leaks, and other issues largely within the control of the public water utility. The nature and extent of treatment required are dependent upon both the initial water quality and the desired final water quality. For example, much of the water supplied to the City of New York (United States) does not require initial filtering because of high source water quality, while water supplied to cities such as Los Angeles, California (United States), requires more extensive treatment [21]. In this section, we will focus on operational energy use in water supply instead of lifecycle energy use. The energy used for construction of water treatment plants is minimal compared to the lifetime operation of the plants [22–24]. In addition, while energy use to heat water is very important in considering lifecycle energy use due to potable water, this section will focus from the water source through delivery to the user, not including activities of the user. The use of energy for potable water supply and opportunities for decreasing this energy use can be examined in terms of water transport/pumping and water treatment. The expanding use of both alternative water supplies, such as reclaimed water, and alternative energy to power water supply will also affect the future energy use of potable water.

## 2.1 Water Extraction

To supply potable water, water is extracted and moved from the source to the water treatment plant and then moved from the water treatment plant to the consumer, typically by pumping. These two pumping stages are the most energy-intensive part of the water supply cycle [17, 25] and the volumetric energy intensity varies widely



among public water utilities. Carlson and Walburger [26] developed a benchmarking metric for water utilities in the United States. The metric shows that total volume of water, total horsepower, elevation, raw water pump horsepower, and distribution main length all positively correlate with total energy use. When combined with the quantity of purchased water, which negatively correlated with total energy use, these parameters explained 87 % of the variability in energy use of 176 public water utilities in the United States [26]. The high explanatory power of these variables demonstrates the strong influence of pumping on total water utility energy use.

### 2.1.1 Groundwater Extraction

Many public water systems and private water users extract water by pumping from an underground aquifer. These systems require about 30 % more energy than surface water systems largely because of the vertical lift required [17, 27]. The energy use depends on pump efficiency and the depth to the water table. Rothausen and Conway [28] estimated that at 100 % efficiency a pump uses 0.0027 kWh of energy for each 1 m it lifts 1 m<sup>3</sup> of water. However, additional energy is needed to maintain water pressures suitable for water treatment plants. For example, raising water 46 m requires 0.16 kWh m<sup>-3</sup> [29], but supplying that same water at a pressure of 400 kPa requires 0.367 kWh m<sup>-3</sup> [30]. The water pressure required will depend on the type of treatment used. For example, reverse osmosis requires higher water pressures than sand filtration. In addition, pumps rarely work at 100 % efficiency. Gay and Sinha [25] compared the minimum energy use for raw water intake, calculated from friction, static head (i.e., the required elevation increase), and pump efficiency, with the actual energy use for water utilities in Virginia. Excluding gravity-fed systems, the actual energy use for pumping was 1.2–27 times higher than the calculated minimum energy required. When compared to a theoretical ideal energy requirement, which does not include pump efficiency, water loss, and required pressures, the actual energy use was 1.3–226 times higher [25]. Across a range of systems, Plappally and Lienhard [30] found that 0.004 kWh m<sup>-3</sup> of energy was needed per meter of lift, almost 50 % higher than high efficiency estimate of Rothausen and Conway [28]. This gap between the minimum feasible energy and the amount of energy used represents an opportunity for energy savings, particularly where groundwater depletion increases the energy needed to pump groundwater.

### 2.1.2 Surface Water Extraction

In ideal conditions, water systems in which surface water is the source can rely on gravity to move water from the reservoir to the water treatment plant. However, pumping is often needed to transport raw surface water to the treatment plant using (in the United States) an average of 0.32 kWh m<sup>-3</sup> of energy [17]. As discussed in

Lawson [21], New York City and Los Angeles represent extremes of the energy intensity required to supply public water in the United States. Water from upper New York State is gravity fed to New York City to supply water for the urban population, while water to Los Angeles is supplied through the California Aqueduct which requires 2.09–2.62 kWh m<sup>-3</sup> of energy depending upon its path [21]. While raw water is transported long distances to both cities, desirable topography creates a much less energy-intensive water system in New York City. As summarized in Plappally and Lienhard [30], long-distance transport of surface water requiring significant energy inputs is not unique to Los Angeles. For example, installed and proposed projects from the United States, Australia, and Spain transport water distances up to 744 km with energy use per unit distance ranging from 0.002 to 0.007 kWh m<sup>-3</sup> km<sup>-1</sup> [30]. Topography, particularly the need to pump over mountain ranges, affects the energy intensity of transporting surface water, as seen in the much greater energy requirements of supplying water to Tijuana, Mexico, than other Mexican cities [31]. In addition to topography and distance, the amount of energy required to transport raw water also increases due to corrosion and friction increase in aged pipelines [25].

## 2.2 Water Distribution

After treatment, a pump is used again to deliver water to consumers. Approximately 85 % of the energy in supplying potable water in the United States is used for water distribution using pumps [32]. The energy intensity of water distribution varies widely, with reported values from 0.015 to 2.4 kWh m<sup>-3</sup> and lower values typical for greater volumes [30]. In some urban areas, such as Oslo, Norway, water distribution energy requirements can be less than water treatment energy requirements [33], though this is not typical. Distance, elevation change, pumping efficiency, required pressure, and pipe characteristics affect the amount of energy required to transport water. Piratla et al. [34] estimated that pumping energy required for a potable water distribution pipeline would be 3.5 % higher with a ductile iron pipe than a PVC-O pipe because of the increased friction due to corrosion in the ductile iron pipe.

While the amount of energy required to withdraw raw water and distribute treated water depends on topography and location of the water source [35], water utilities can reduce pumping energy requirements by improved system design. For example, in the United States, there are over 200,000 water mains break per year [36], which results in significant loss of treated and pressurized water and, therefore, energy loss. In Oslo, approximately 20 % of the water in the distribution network is lost due to leaks [33]. Pipe replacement and repair will minimize these losses and the total volume of water that will need to be supplied from the water treatment plant. In addition, pipe replacement and repair can reduce the friction losses due to corrosion and, therefore, significantly reduce the energy required to distribute water [37, 38]. Improvements in pumping efficiency, including

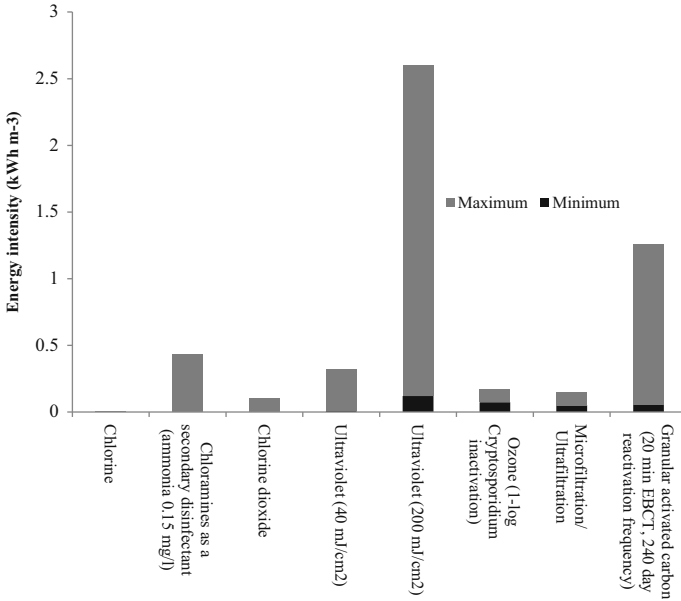
appropriate sizing and the use of variable frequency drive pumps, can also greatly reduce the energy demand of water pumping. For example, Arzbaeher et al. estimate that in the United States, improvements in pump and motor systems could save 2,600–7,800 million kWh of energy annually [10]. The need for pump efficiency is particularly enhanced in regions that rely on groundwater for water supplies. As noted earlier, declined water tables and deeper water wells will increase the energy required to pump water. For example, supplying groundwater from 37 m below the surface requires 143 kWh per 1,000 m<sup>3</sup>, while supplying groundwater from 120 m below the surface requires 528 kWh per 1,000 m<sup>3</sup> [39].

### 2.3 Water Treatment

Once water is taken from the raw water source, and before it is distributed, the water must be treated. For groundwater systems, this treatment is often minimal and may just include disinfection because in most areas groundwater is considered a relatively clean water source compared to surface water, though in some areas groundwater can be chemically contaminated and require similar treatment as surface water. Treatment of surface water is often more extensive and includes filtration, settling, and often multiple forms of disinfection.

The type of treatment used by the water utility will affect the energy intensity of the treatment. Electricity consumption for water treatment can vary from 0.05 to 0.7 kWh m<sup>-3</sup> dependent upon initial water quality and treatment technique [35]. Chlorine has historically been the primary disinfectant used in drinking water treatment. This form of treatment requires a relatively small quantity of energy (Fig. 3), but health concerns and regulations in many locations are leading to replacement of chlorine with more energy-intensive means of disinfection. Using advanced water treatment (ozone or microfiltration/ultrafiltration) instead of conventional water treatment can increase annual energy use for a 10-mgd ( $3.8 \times 10^4$  m<sup>3</sup> per day) water treatment plant by over one million kWh per year [41]. Elliot et al. [42] found that using microfiltration would increase energy use by 0.18 kWh m<sup>-3</sup>, while ozone disinfection would use 0.03–0.15 kWh m<sup>-3</sup> [29].

These more energy-intensive water treatment processes are gaining favor due to deteriorating source water quality and increasingly strict drinking water standards. For example, the increase in energy intensity of China's water supply from 1997 to 2004 is attributed to enhancement of the water supply systems to meet new water quality standards [14]. In the United States, two recent drinking water regulations (the Stage 2 Disinfectants and Disinfection Byproducts Rule (Stage 2 DBPR) and Long Term 2 Enhanced Surface Water Treatment Rule (LT2ESWTR)) could each increase the use of energy for drinking water supply by over 100 million kWh per year [12, 43]. The effects of these regulations are not cumulative because a single technology may satisfy requirements for both regulations. Even though the energy requirements are noncumulative, the regulations still represent a noticeable increase in energy requirements for water treatment. In addition, in a study



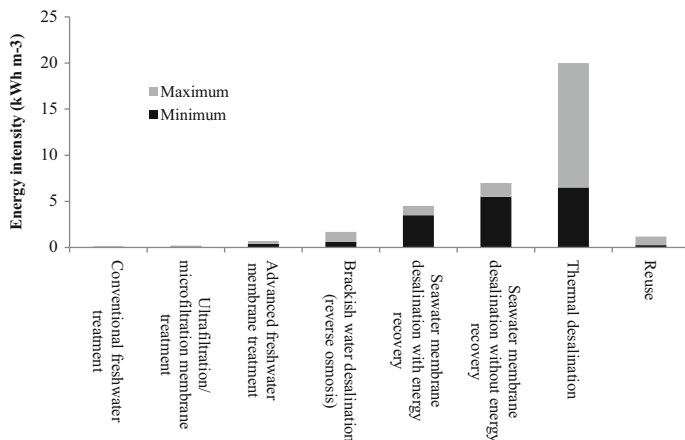
**Fig. 3** Energy requirements for chlorination [29] and advanced freshwater treatment ([40], based on Table 1 from [21]). Disinfection by chlorine requires much less energy per volume of water than other treatment techniques

comparing energy intensity of water and wastewater in India and the United States, Miller et al. [11] found that while wastewater treatment was typically more energy intensive in the United States, water supply and treatment in India were more energy intensive than wastewater treatment, a difference attributed to poorer initial source water quality in India.

Energy use for water treatment will likely increase in the future as source water quality deteriorates. New contaminants of concern, such as pharmaceuticals, may require new treatment techniques. For example, reverse osmosis is effective at removing organic micropollutants such as personal care products but low-energy reverse osmosis is less effective for removing these contaminants [44]. Reverse osmosis requires more energy per volume of water than other treatment techniques such as ozone and ultraviolet disinfection (Fig. 4).

### 2.4 Alternative Water Sources

Due to water stress, alternative water supplies such as recycled/reclaimed water (treated wastewater used for direct potable, indirect potable, or non-potable uses) and desalination are gaining popularity in many countries. The energy required for treatment of alternative sources is highly dependent upon the initial source water



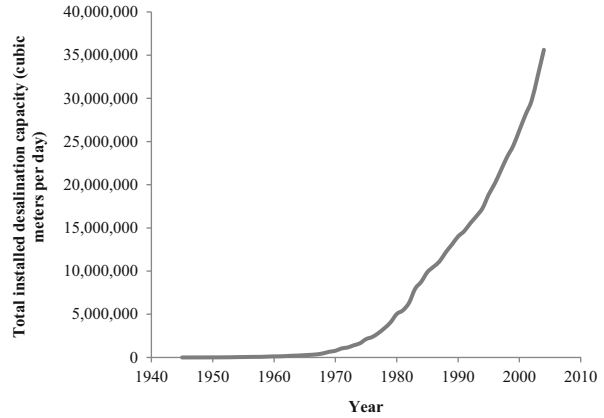
**Fig. 4** Energy requirements for water treatment of conventional freshwater treatment, advanced freshwater treatment, and alternative water supplies. Data from [35]. The energy required for distribution will be the same regardless of water supply, indicating that freshwater is less energy intensive if the energy use from source to treatment is relatively low

quality [45]. For example, a study of potential alternative water sources in southern California cities found that recycled water and imported water were two to five times less energy intensive than desalination, largely because of the energy-intensive reverse osmosis systems used in desalination [18]. Similarly, Kajenthira et al. [46] showed that using treated wastewater instead of desalination in six inland cities in Saudi Arabia would create an energy saving of  $4.0 \times 10^9$  kWh of energy annually.

Despite the high-energy intensity of desalination, water stress in many areas is leading to an expansion of desalination (Fig. 5). Reverse osmosis (RO) and thermal (evaporation/distillation) desalination are the most commonly practiced desalination technologies. Reverse osmosis has high energy requirements,  $3.9 \text{ kWh m}^{-3}$  in one case study [35] and typical energy use between  $3.5$  and  $4.5 \text{ kWh m}^{-3}$  [48]. The energy required for reverse osmosis depends on the level of salinity, with higher salinity water requiring greater energy consumption [49]. With optimal efficiency, RO systems can consume as little as  $1.6 \text{ kWh/m}^3$  [50], but this is atypical. RO systems are actually less energy intensive than thermal desalination, a methodology mostly used in some fuel-rich countries [48]. Energy recovery provides an opportunity for improved energy efficiency in the desalination process. Energy efficiency can be achieved through heat recovery or using the brine discharge to turn a turbine for generating electricity [48]. Raluy et al. [51] showed that when heat is recovered from thermal desalination projects, the environmental impact is similar to desalination by reverse osmosis.

Reclaimed wastewater represents another alternative water source. Wastewater reuse can be considered in terms of direct (treated wastewater is pumped directly for use) and indirect (treated wastewater is discharged into a water body that is used

**Fig. 5** Global installed desalination plant capacity 1945–2004. Desalination capacity has increased dramatically. Data from Pacific Institute [47]



a source water for potable water treatment) reuse and potable or non-potable use. In most developed countries, primary and secondary wastewater treatment is required before the water is discharged to the environment. The addition of tertiary (advanced) treatment makes this water suitable for non-potable uses. Wastewater treatment is generally energy intensive, so adding tertiary treatment to a plant typically does not significantly increase the energy use of the plant, but pumping energy use can be significant if the tertiary treatment is not ideally located, as can happen when tertiary treatment is added after the plant is built [52]. When used for non-potable urban and agricultural uses, reclaimed water can actually have a lower cumulative energy demand than traditional water sources [53, 54]. Other studies, such as Rygaard et al. [55], show that wastewater reclamation is a more energy-intensive water supply approach than traditional freshwater or groundwater. This difference may emerge from the intended use and the scope of treatment attributed to the wastewater reclamation process. Treating raw sewage to potable water standards is logically far more energy intensive than treating surface water or groundwater to potable water standards, but the additional treatment needed to bring treated wastewater that is ready for discharge to non-potable standards is likely small and may decrease as standards for wastewater treatment become more stringent. Differences also occur based on the type of treatment used with membrane technologies typically requiring more energy [56]. Most calculations of the energy intensity of reclaimed water (for example, references reported in [30]) indicate that reclaimed water is more energy intensive than traditional water supplies, but the results are highly variable.

## 2.5 Alternative Energy Sources

In the face of increasing water demand and increasingly energy-intensive water systems, alternative and renewable energy sources can dramatically reduce the

impacts of water production and facilitate expansion of drinking water services. While renewable energy, such as biogas generation, at wastewater treatment plants has received more attention than renewable energy at potable water treatment plants, renewable energy options for potable water are expanding. Solar energy has perhaps received the most attention for water treatment. For example, solar energy can be used to provide heat for desalination processes or can be used directly in disinfection of water [57]. At a household scale, solar energy can be used by simply exposing water to sunlight, preferably concentrated by lenses, mirrors, or aluminum foil, to produce bacteriological safe water [58]. Solar energy can also be used to power remote water pumping stations for a cost savings over using diesel pumps [59] and can be used in distillation processes to provide safe drinking water in areas where arsenic contamination exists [60]. While solar energy is well suited to direct application in water treatment, other renewable energy sources also can be used to provide electricity to water treatment plants and pumping systems. Lifecycle analysis demonstrates that supplying water treatment plants from renewable energy sources significantly decreases the environmental impact [35, 61]. In comparing the environmental impact of a real nanofiltration water treatment plant and a virtual conventional water treatment plant with granular activated carbon, Bonton et al. [62] found that the use of hydropower to supply the nanofiltration plant greatly reduced the environmental impact, even though nanofiltration is much more energy intensive than conventional filtration with granular activated carbon.

In summary, creating a clean, reliable water supply requires significant energy use and these energy requirements seem to be increasing. The relative importance of pumping and treatment varies dependent upon the type of system [18], and energy use for both treatment and pumping will increase as populations use poorer initial quality water and are forced to transport water greater distances. In addition to the energy used to supply drinking water, water use within buildings uses significant amounts of energy, particularly for heating, making water conservation important [1]. Energy use efficiency must be considered when improving existing water systems and developing new ones.

### 3 Water Use for Electricity Generation

Electricity generation uses large quantities of water and can be in competition with potable water supply while also damaging water quality. In the United States alone, power plants generated close to 4 trillion kWh of electricity in 2010, with 89 % of this electricity generation requiring cooling, typically using freshwater [63]. In the United States, thermoelectric power plants withdraw  $7.6 \times 10^8$  m<sup>3</sup> of water (freshwater and saline) per day, 49 % of all water withdrawals and 40 % of all freshwater withdrawals [64]. Water is also used in the mining and processing of fuels. Based on estimates of water use for mining in the United States (not including transportation and processing of coal), the US Department of Energy [1] estimates that coal mining uses 260,000–940,000 m<sup>3</sup> of water per day.

Much of the water used in electricity generation is used in thermoelectric power plants (including coal, natural gas, concentrating solar power, biomass, and nuclear). In thermoelectric power plants, heat from the fuel source is used to produce steam, which turns a turbine to generate electricity. Water is primarily used for cooling the steam in a condenser. In once-through cooling systems, the cooling water is immediately returned to a surface water body, while in recirculating or closed-loop systems, the same water is used multiple times for cooling. Power plants with recirculating systems withdraw (take from the surface or groundwater body) about 2 % of the water volume withdrawn for once-through cooling systems. However, a greater total quantity of water is evaporated in closed-loop cooling systems making the water consumption (removal of the water from the local system) higher in recirculating systems [65, 66]. Historically, virtually all thermoelectric power plants used once-through cooling systems, but these cooling systems are becoming less common due to concerns about thermal pollution caused by the discharge of the heated water. Virtually all new power plants use recirculating cooling systems [67].

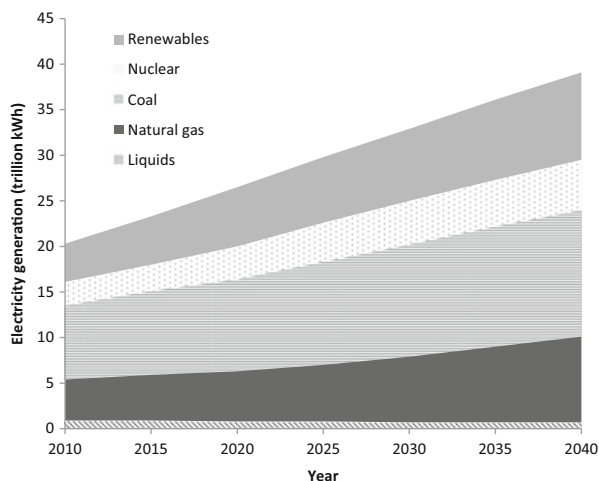
The change to recirculating cooling systems has implications for local water resources. Chen et al. [65] found that in the United States alone, freshwater withdrawal for thermoelectric power increased from  $1.1 \times 10^8 \text{ m}^3$  per day in 1950 to  $5.4 \times 10^8 \text{ m}^3$  per day in 2005, with most of this increase occurring before 1975. Water withdrawals from 1975 to 2005 remained relatively constant while electricity generation increased dramatically because of a change from once-through cooling systems to recirculating cooling systems [65]. The lower water withdrawal for closed-loop cooling reduces the overall withdrawal of water or allows withdrawal to stay constant, with increasing electricity production, but increases the consumption [65, 68–70]. Shifts in cooling system type alone may result in a 10 % increase in water consumption for electricity generation by the end of this century [70]. This increase in consumption may increase competition between electricity generation and potable water supply.

Technology designed to limit carbon emissions also affects water use. Reducing carbon emissions from coal-fired power plants can increase water use because of amine-based carbon storage practices which use water for cooling, increased electric demand because of the parasitic load from carbon capture and storage (CCS) technology, and the demand for water in sulfur scrubbers [68]. In Texas (United States), sulfur controls require an additional  $2 \times 10^7 \text{ m}^3$  of water for electricity generation per year [71]. The National Energy Technology Laboratory (NETL) [72] Estimating freshwater needs to meet future thermoelectric generation requirements 2010 estimates an increase of 58–91 % in water consumption when  $\text{CO}_2$  capture is installed in a coal or natural gas power plant. These values are similar to estimates in Texas that carbon capture on pulverized power plants will increase water consumption by 95 % or  $2.2 \text{ m}^3/\text{MWh}$  [71] and a study by Zhai et al. [73] that found that consumptive water use at coal-fired power plants doubled with the addition of amine-based CCS.

Finally, as energy use continues to grow, the relative contribution of different energy sources will change (Fig. 6) and the type of energy source affects water use.



**Fig. 6** Global electricity production by type. Electricity production overall is increasing with renewables growing at a faster annual rate (by percent) than other types. Data from [6]



In many climate change and energy debates, renewable and nonrenewable energy sources are considered opposite ends of the spectrum. For water use in electricity generation, thermoelectric and non-thermoelectric seem to be a more useful categorization. Across a broad range of data, thermoelectric power sources generally have the highest water use per megawatt-hour with most of this water used for cooling regardless of fuel type [68, 74]. For non-thermoelectric power sources, such as wind, solar PV, and hydropower, operational water use is generally low, but significant quantities of water may be used in manufacturing equipment [68]. The exception to this is hydropower. Estimates of hydropower water use vary widely, largely based on how much evaporation from the reservoir is attributed to the hydropower plant [68]. The reservoirs are typically multiuse (water supply, recreation, etc.) which makes attribution of all evaporative losses to hydropower a likely overestimation [70]. Transitioning to renewable energy sources may increase or decrease the total water use depending on reliance on water-intensive renewable sources (such as biomass) or sources such as wind and solar PV [66]. Studies have consistently shown that wind and photovoltaic power use the least water [66, 70, 74]. However, further research also needs to be conducted more accurately estimate the water intensity of electricity sources such as geothermal and biomass.

Translating the increase in water use of individual technologies into overall water future water use requires more than simple multiplication because installing carbon capture and storage is not the only option to meet carbon reduction goals. For example, under possible climate policy initiatives in the United States, Chandel et al. [63] found that increases in electricity prices will decrease overall electricity use and changes in the energy mix will actually decrease water withdrawals but may increase consumption in some regions. In addition, using post-combustion capture technologies or integrated gasification combined cycleplants instead of pulverized coal plants (both with carbon capture) could provide a more water-efficient means of reducing carbon emissions [63]. The National Energy

Technology Laboratory (National Energy Technology Laboratory (NETL)[72] Estimating freshwater needs to meet future thermoelectric generation requirements 2010) provides an estimate of the maximum impact of CCS as  $1.4 \times 10^7 \text{ m}^3$  per day of water withdrawal and  $8.3 \times 10^6 \text{ m}^3$  per day of water consumption, almost doubling the water consumption by 2035. More realistic estimates of the impact on water use of climate policy indicate that water withdrawal for electricity generation will decrease, but consumption will increase relative to business-as-usual scenarios with climate policies that attach a financial burden to carbon emissions [63]. This trend of decreased withdrawals and increased consumption will likely occur globally, with consumption increasing more dramatically if policies favor a mix of renewable energy sources that favors concentrating solar power, which uses large quantities of water [75].

Competition between water for thermoelectric power generation and other uses is not only an issue for the future as plants have already had to shut down for water-related issues, for example, in the United States during the drought of 2007 [76]. In the United States, the 2007 drought threatened 24 out of 104 nuclear power plants, while a 2003 drought decreased France’s nuclear power capacity by 15 % and hydropower capacity by 20 % [77]. In a county-by-county analysis of predicted population growth, electricity use, and water supply, Sovacool and Sovacool [69] estimate that 22 counties in the United States, housing 20 major metropolitan areas, will have severe water shortages by 2025 due to expansion of thermoelectric power capacity. While the authors of that report identify some methodological shortcomings of their approach, the study does highlight the potential for competition between water use for electricity generation and water use for public water supply.

## 4 Impact of Electricity Generation on Water Quality

Generation of electricity can impact water quality through extraction of fuel, transport of fuel, conversion to electricity, and storage of wastes, making the water unusable for potable uses or increasing the energy needed to treat the water. Fuel extraction, processing, and electricity generation can lead to metal, nutrient, or radiological contamination which may not be addressed by conventional treatment. In this case, local communities may be required to use more energy-intensive water treatment methods or import water. The types of contamination, risk of contamination, and public perception of the risk all vary for the different electricity sources including coal, nuclear, natural gas, and renewables.

### 4.1 Coal

Because of coal’s extensive use as an energy source, the environmental impacts of coal have been relatively well documented. Much of the research emphasis has

focused on atmospheric pollution from coal-burning power plants, but coal can also present a significant threat to surface and ground water quality. Some of the pathways through which coal can impact water quality include contaminant leaching from mining sites, deposition of combustion by-products in surface waters, and spills of waste materials.

For example, acid mine drainage can impact water quality for decades after site remediation with low pH, high sulfate concentrations, and contamination from metals such as iron [78]. Water pollution from mining operations can make freshwater unsuitable for drinking water [79] and reclamation efforts may have limited success to address concentrations of some dissolved contaminants such as sulfate in source water [80, 81]. The quality of water discharged from abandoned mine sites varies widely, but in a study in Pennsylvania (United States), less than 1 % of samples abandoned coal mine discharge met United States Environmental Protection Agency standards from drinking water concentrations of inorganic constituents [82]. In some cases, mine discharges, while not suitable for drinking water, are suitable for non-potable uses [83, 84].

Coal can also affect water quality sources near the power plant. Water percolating through stored coal [85] and waste piles [86, 87] can pick up metals and acidity and contaminate local surface and groundwater. When coal is burned to produce heat to generate electricity, the by-products of this combustion can lead to contamination of local water supplies through wet and dry deposition or leaching through waste piles. For example, Farooqi et al. [88] found extensive groundwater contamination by arsenic (mean concentration = 235  $\mu\text{g/l}$  in shallow groundwater 24–27 m) and fluoride (mean concentration = 11.0  $\text{mg/l}$  in shallow groundwater) in Punjab, Pakistan, as well as measurable concentrations of these contaminants in rainfall. The higher concentrations in the shallow groundwater than deeper groundwater, the isotopic signature, and the presence of these contaminants in rainwater indicate that the source of the groundwater contamination is open-air coal burning [88]. In addition, power plant effluents can contain high levels of metals and can contribute to making surface water supplies unsuitable for human consumption [89].

Studies have demonstrated that the drainage from abandoned mines can mix with local groundwater and surface water impacting local water resources [86, 90], though this mixing may not necessarily create water quality problems [91]. In Turkey, groundwater near the Yatagan Thermal Power Plant typically does not meet drinking water standards due to leaching from the coal waste disposal basins [92, 93]. Estimating risk or decreased availability of freshwater due to contamination from mining activities is complex, but the impact of coal mining on water resources is obvious. This impact is regulated in many countries, but universal regulation and enforcement do not exist.

## 4.2 *Nuclear*

The publicly perceived threat of water contamination from nuclear power plants is high, particularly following the damage caused by the Fukushima I nuclear power plant in Japan following a tsunami in March 2011. Following the incident, elevated levels of Iodine-131 were found in drinking water in Fukushima and some surrounding areas, leading to restrictions on water consumption [94] but minimal health risks [95]. Following the destruction of a single reactor at the Chernobyl nuclear power plant in the Ukraine, widely regarded as the worst nuclear power plant disaster in history, a contaminated cooling pond became one of the major sources of radionuclides to the Dnieper River and local groundwater, where concentrations of long half-life radionuclides such as  $^{90}\text{Sr}$  remained above drinking water thresholds for many years [96]. While these very rare disasters have an impact on water quality, research shows that under normal operation, contamination from nuclear power plants (other than thermal pollution) is virtually nonexistent. For example, radionuclide concentrations in the Vltava and Elbe Rivers showed no difference before and after the establishment of the Temelin Nuclear Power Plant, though monitoring data indicated an input of tritium to the rivers from the power plant as allowed by the permit and maintaining concentrations in accordance with drinking water standards [97]. Health risks from the operation of nuclear power plants are miniscule and the improved air quality that would result from replacing fossil fuel electricity with nuclear power would save close to 80,000 lives per year [98].

While power plant operation is not likely to affect the availability of local water resources for drinking water supply through contamination, mining, and processing of nuclear fuel can. In Caldas, Brazil, uranium mining caused fluoride, manganese, uranium, and zinc contamination of creek waters that feed a local water supply [99]. Surface water contamination due to uranium mining has also been found in China [100] and Russia [101].

## 4.3 *Natural Gas*

Natural gas has received increasing attention as a fuel source in recent years because of lower carbon dioxide emission than coal. Natural gas is often seen as a “bridging fuel” that will help mitigate global climate change, while the capacity for renewable, climate neutral energy sources is developed. While this strategy is criticized because it does not end reliance on a nonrenewable fossil fuel, the strategy, along with exploitation of nonconventional supplies, has led to increased use of natural gas. Much of the natural gas that is being exploited and used is extracted through unconventional means, such as hydraulic fracturing. The impact of these unconventional means on water supply is hotly contested in the scientific literature and more research may be needed to definitively identify the risks.

When natural gas is extracted from coal seams, large quantities of contaminated water can also be produced. This water typically contains heavy metals and other contaminants such as arsenic and is stored in on-site ponds or discharged to local waters. If soil conditions are correct, the produced water can be stored in these ponds without influencing local groundwater [102]. However, if the produced water is introduced to streams, it can negatively affect water quality, including increasing the salinity of the stream [103]. The use of chemicals to fracture the coal in hydraulic fracturing is another major consideration in the potential effects of natural gas on water quality. To release the natural gas from the coalbed, water, chemicals, and sand are pumped in at high pressure to create fractures. The potential for contamination of water supplies due to this practice is widely debated. In 2004, the USEPA released a report that found no evidence that drinking water wells had been contaminated due to hydraulic fracturing [104]. Osborn et al. [105] similarly found no evidence of fracturing fluid in drinking water wells, but did find elevated levels of methane in drinking water wells due to hydraulic fracturing. This finding has been criticized [106, 107] and consensus has not been reached on the water quality impacts of hydraulic fracturing, though the potential for contamination seems clear.

#### **4.4 Biofuels**

Renewable energy sources can also negatively affect water quality. Increased agricultural productions of crops such as corn with accompanying fertilizer and pesticide use can negatively affect the quality of local water resources. For example, continuous corn or canola production, as modeled in four watersheds in Michigan (United States), increased the pesticide concentration in surface waters far beyond safe drinking water standards [108]. In addition, nitrogen and phosphorus concentrations in water may also increase with increased biofuel production [109, 110]. Intensive agricultural production for biofuels will have the same negative water quality and quantity impacts as any other form of intensive agricultural production. In local areas, the demand for water for biofuels may limit water availability for food production [111]. While the impact will vary dependent upon the crop and intensity of cultivation, water issues must be considered in assessing the overall sustainability of biofuels.

Relatively little attention has been given to the impact of biofuel production on water treatment. One notable exception is a study of the impact of increased corn production in the United States to support ethanol production. Twomey et al. [112] found that the increased nitrate concentration in surface water and groundwater from the increased corn production would locally result in a very significant increase in energy needs for water treatment of polluted waters. The energy implications of this increased demand for water treatment or the need to import water to maintain a potable water supply warrants further research.

## 5 Impact of Climate Change on Water Supplies

Anthropogenic climate change is tied closely to the energy sector through greenhouse gas emissions and will affect potable water supplies. The Intergovernmental Panel on Climate Change (IPCC) predicts increases in global average temperature, changes in precipitation amount and intensity patterns, and decreases in snow and glacier cover depending on the geographic location [113]. These changes in climate will have a range of effects on drinking water supply. First, changing precipitation patterns, particularly significant decreases in annual rainfall in some areas, will affect surface and groundwater supplies. Second, rising sea levels will change the interface and pressure balance between salt and freshwater for both groundwater and surface water. Third, changes in snow and glacier cover will affect the timing of freshwater delivery to rivers which many communities depend upon for water supplies. Fourth, climate change will affect the demand for water, particularly for irrigation.

Climate change models show slightly different patterns in precipitation changes, but most models show that precipitation will increase in some areas and decrease in others. Most arid and semiarid regions will experience decreases in precipitation [114], indicating that changes in precipitation may most dramatically affect areas that already experience strained water supplies. For example, using results from global circulation models, de Wit and Stankiewicz predicted that Cape Town, South Africa, will lose over 50 % of its perennial supply of water [115]. Water resources stress will also increase in the Middle East and Mediterranean, with 53–113 million more people living in the countries with water stress by 2025 in modeling scenarios with climate change than in scenarios without climate change [116]. In the West Bank, a 16 % decrease in precipitation, a relatively high value in the range of model predictions, would cause a 30 % decrease in groundwater recharge, impacting the primary source of freshwater in the region [117]. Even when overall precipitation increases, changes in the timing of precipitation can seasonally decrease the water yield of river basins [118] and may create water stress [119]. While climate change will in general increase precipitation, climate change will enhance stress on water resources in some regions. The reduction in precipitation will also affect the availability of water for electricity generation, with an expected decrease in summer capacity at power plants in Europe and the United States due to water limitations by 2031–2060 [120].

Sea-level rise is associated with climate change and may cause salt water contamination of fresh groundwater aquifers and surface water resources. The saltwater/freshwater boundary in both surface and groundwater will be affected by freshwater flow as well as sea-level rise. In a study of saltwater intrusion in Monterey, California, United States, groundwater withdrawal affected saltwater intrusion more than sea-level rise [121], but even in areas where withdrawal is the primary driver of saltwater intrusion, this condition can be exacerbated by sea-level rise [122]. In one modeling case study, sea-level rise hastened the saltwater contamination of groundwater wells by 10–21 years compared to withdrawal

changes alone [122]. Predicted changes in precipitation can also affect saltwater intrusion and in the Netherlands, the combination of sea-level rise and changes in infiltration will result in salinity changes 5 km inland from the coast [123]. Similarly saltwater intrusion in estuaries is a balance between river flow and sea-level rise with sea-level rise producing a stronger effect during periods of low river discharge [124]. Even a modest rise in sea level can affect the salinity at drinking water intakes [125] necessitating energy-intensive treatment to meet drinking water standards.

In addition, climate change is affecting water supply in areas that rely on glaciers or regional snowfall and subsequent snowmelt. For example, much of the western United States relies on snowmelt for summer time water supply, but the amount of precipitation retained in the snowpack has decreased in recent years, largely due to human-induced climate changes [126, 127]. This change in snowpack leads to higher streamflow in late winter and early spring and reduced streamflow during the summer months, a trend that may continue in the future [118]. In many of these regions, snowpack serves as a water storage medium from wet to dry months and earlier melting and less precipitation falling as snow will affect the ability to meet summer time water demands. A few river basins have enough additional storage, such as man-made reservoirs, to buffer the impact of the earlier melting, meaning that much of the water will be lost to the ocean affecting the water supply of greater than 17 % of the human population [127]. In a modeling study on the effects of climate change on the Columbia River in the northwestern United States, Payne et al. [128] found that changes in streamflow due to changes in the timing of snowmelt will result in completion between water demand for hydropower and endangered species. Regions that rely on glacial meltwater, such as regions surrounding the Himalayas, will also be particularly affected as summer time flows initially increase (due to glacial melting) and then abruptly diminish (due to loss of the glaciers; [127]).

Climate change may also affect demand for water for diverse uses. Most notably climate change may increase demand for irrigation water. A combination of increased plant water demand due to changes in precipitation and temperature and extended growing seasons may result in a 395–410  $\text{gm}^3$  increase in global irrigation water demand by 2080 [129]. These increases will not be universal across the globe, with areas such as South Asia experiencing a much greater percent increase (15 %) in irrigation demand than the global aggregate (5–8 %) by 2070 [130]. An analysis of the effects of a 6 °C increase in temperature in the West Bank, a relatively high estimate of temperature increase, indicates a 17 % increase in irrigation demand [117]. These increases in irrigation demand may not directly translate to an increase in water withdrawal because of changes in efficiency which may mitigate some of the impacts. Climate change mitigation can also reduce these future irrigation demands by approximately 125–160  $\text{gm}^3 \text{y}^{-1}$  [129].

## 6 Conclusions

The topics covered in this chapter could be examined in much greater depth. However, this chapter only provides an overview of the ways in which the water–energy nexus creates challenges in supplying potable water. Water treatment and distribution require large quantities of energy and this value will likely increase as poorer quality water is used, water is pumped greater distances, and regulations on water quality improve. Electricity generation uses large quantities of water and maybe in competition with drinking water supply while also damaging water quality. All of these interactions between water and energy occur against a backdrop of growing population and climate change. However, there are opportunities to dramatically improve the situation. For example, coproduced water from some mining activities can be used for non-potable uses, decreasing the reliance on potable water sources. Combined water and energy plants, often used in desalination, can more efficiently use and produce these two resources. Most importantly, water and energy policy can be developed from a water–energy nexus approach, examining feedbacks between the two resources rather than considering them separately. In addition, conservation of both water and energy resources is vital and should never be overlooked as a strategy for protecting these resources and meeting increased demand simultaneously.

## References

1. US DOE (2006) Energy demands on water resources: report to congress on the interdependency of energy and water. U.S. Department of Energy
2. International Energy Agency (IEA) (2012) World energy outlook 2012. International Energy Agency, Paris
3. UN Water (2014) World water day. <http://www.unwater.org/worldwaterday/> Accessed 1 Jan 2014
4. GAO (2012) Energy-water nexus: Coordinated federal approach needed to better manage energy and water tradeoffs. GAO-12-880. <http://www.gao.gov/assets/650/648306.pdf>. Accessed 2 Jan 2014
5. Rodriguez DJ, Delgado A, DeLaquil P, Sohns A (2013) Thirsty energy: working paper. Washington, DC. World Bank. <http://documents.worldbank.org/curated/en/2013/01/17932041/thirsty-energy>. Accessed 12 Dec 2013
6. US Energy Information Administration (USEIA) (2013) International energy outlook 2013. Washington, DC. [http://www.eia.gov/forecasts/ieo/pdf/0484\(2013\).pdf](http://www.eia.gov/forecasts/ieo/pdf/0484(2013).pdf). Accessed 20 Aug 2013
7. Cai X, Rosegrant MW (2002) Global water demand and supply projections, Part 2: results and prospects to 2025. *Water Int* 27(2):170–182
8. WHO/UNICEF Joint monitoring programme for water supply and sanitation. Progress on drinking water and sanitation: 2012 update. <http://www.unicef.org/media/files/JMPreport2012.pdf>. Accessed 1 Jan 2014
9. Cuddihy J, Kennedy C, Byer P (2005) Energy use in Canada: Environmental impacts and opportunities in relationship to infrastructure systems. *Can J Civ Eng* 32(1):1–15



10. Arzbaeher C, Carns K et al (2009) Program on technology innovation: Electric efficiency through water supply technologies—A roadmap. Electrical Power Research Institute, Palo Alto, CA
11. Miller LA, Ramaswami A, Ranjan R (2013) Contribution of water and wastewater infrastructures to urban energy metabolism and greenhouse gas emissions in cities in India. *J Environ Eng* 139(5):738–745. doi:[10.1061/\(ASCE\)EE.1943-7870.0000661](https://doi.org/10.1061/(ASCE)EE.1943-7870.0000661)
12. USEPA (2005) Economic analysis for the final stage 2 disinfectants and disinfection byproducts rule, EPA 815-R-05-010. USEPA, Washington, DC
13. Navigant Consulting, Inc. (2006) Refining Estimates of Water-Related Energy Use in California. California Energy Commission, PIER Industrial/Agricultural/Water End Use Energy Efficiency Program. CEC-500-2006-118
14. Kahrl F, Roland-Holst D (2008) China's water-energy nexus. *Water Policy* 10(Suppl 1):51–65. doi:[10.2166/wp.2008.052](https://doi.org/10.2166/wp.2008.052)
15. Stillwell AS, King CW, Webber ME, et al (2011) The energy-water nexus in Texas. *Ecol Soc* 16(1):2. <http://www.ecologyandsociety.org/vol16/iss1/art2/>. Accessed 5 Nov 2013
16. California Energy Commission (2005) California's water energy relationship. <http://www.energy.ca.gov/2005publications/CEC-700-2005-011/CEC-700-2005-011-SF.PDF>. Accessed 8 Nov 2013
17. EPRI (2002) Water and sustainability: U.S. electricity consumption for water supply and treatment—The next half century. EPRI, Palo Alto, CA
18. Stokes J, Horvath A (2005) Life cycle energy assessment of alternative water supply systems. *Int J Life Cycle Assess* 11(5):335–343
19. Hall MR, West J, Sherman B et al (2011) Long-term trends and opportunities for managing regional water supply and wastewater greenhouse gas emissions. *Environ Sci Technol* 45:5434–5440. doi:[10.1021/es103939a](https://doi.org/10.1021/es103939a)
20. Peter-Varbanets M, Zurbrugg C, Swartz C et al (2009) Decentralized systems for potable water and the potential of membrane technology. *Water Res* 43:245–265
21. Lawson SE (2013) Mitigating climate change in urban environments: Management of urban water supply. In: Younos T and Grady C (ed) *Climate change and water resources*. Springer: New York
22. Friedrich E, Buckley CA, Pillay S (2007) The use of LCA in the water industry and the case for an environmental performance indicator. *Water SA* 33(4):443–51
23. Tarantini M, Federica F (2001) LCA of drinking and wastewater treatment systems of Bologna city: Final results. Paper presented at Fourth IRCEW Conference, Fortaleza, Brazil. <http://www.bologna.enea.it/ambtd/aquasave/files/Documents/PaperLCA.pdf>. Accessed 12 Dec 2013
24. Crettaz P, Jolliet O, Cuanillon J-M et al (1999) Life cycle assessment of drinking water and rain water for toilets flushing. *J Water Supply: Res Technol-AQUA* 48(3):73–83
25. Gay L, Sinha S (2012) Measuring energy efficiency in urban water systems using a mechanistic approach. *J Infrastruct Syst* 18(2):139–145. doi:[10.1061/\(ASCE\)IS.1943-555X.0000072](https://doi.org/10.1061/(ASCE)IS.1943-555X.0000072)
26. Carlson SW, Walburger A (2007) Energy index development for benchmarking water and wastewater utilities. AWWA Research Foundation, Denver, CO
27. Mo W, Zhang Q, Mihelcic JR, Hokanson DR (2011) Embodied energy comparison of surface water and groundwater supply options. *Water Res* 45:5577–5586. doi:[10.1016/j.watres.2011.08.016](https://doi.org/10.1016/j.watres.2011.08.016)
28. Rothausen SGSA, Conway D (2011) Greenhouse-gas emissions from energy use in the water sector. *Nat Clim Chang* 1:210–219. doi:[10.1038/NCLIMATE1147](https://doi.org/10.1038/NCLIMATE1147)
29. Arpke A, Hutzler N (2006) Domestic water use in the United States: a life-cycle approach. *J Ind Ecol* 10(1–2):169–183
30. Plappally AK, Lienhard JH (2012) Energy requirements for water production, treatment, end use, reclamation, and disposal. *Renew Sustain Energy Rev* 16:4818–4848. doi:[10.1016/j.rser.2012.05.022](https://doi.org/10.1016/j.rser.2012.05.022)

31. Scott C, Pasqualetti M, Hoover J, et al (2009) Water and energy sustainability with rapid growth and climate change in the Arizona-Sonora Border Region. Arizona Water Institute. <http://wsp.arizona.edu/sites/wsp.arizona.edu/files/Scott%20final%20report%2008.pdf>. Accessed 11 Nov 2013
32. Burton FL (1996) Water and wastewater industries: characteristics and energy management opportunities. Report CR-106941, Electric Power Research Institute Report, Los Altos, CA
33. Venkatesh G, Brattebø H (2011) Energy consumption, costs and environmental impacts for urban water cycle services: Case study of Oslo (Norway). *Energy* 36:792–800
34. Piratla KR, Ariaratnam ST, Cohen A (2012) Estimation of CO<sub>2</sub> emissions from the life cycle of a potable water pipeline project. *J Manage Eng (ASCE)* 28(1):22–30
35. Vince F, Aoustin E, Breant P et al (2008) LCA tool for the environmental evaluation of potable water production. *Desalination* 220:37–56
36. USEPA (2011) Aging water infrastructure research: science and engineering for a sustainable future, EPA 600-F-11-010. USEPA, Washington, DC
37. Venkatesh G (2012) Cost-benefit analysis—leakage reduction by rehabilitating old water pipelines: case study of Oslo (Norway). *Urban Water J* 9(4):277–286. doi:10.1080/1573062X.2012.660960
38. Fillion YR, MacLean HL, Karney BW (2004) Life-cycle energy analysis of a water distribution system. *J Infrastruct Syst* 10:120–130. doi:10.1061/(ASCE)1076-0342(2004)10:3(120)
39. Cohen R, Nelson B, Wolff G (2004) Energy down the drain: the hidden costs of California's water supply. Natural Resources Defense Council, New York
40. USEPA (2005) Technologies and costs document for the final Long Term 2 enhanced surface 782 water treatment rule and final Stage 2 Disinfectants and Disinfection Byproducts rule. USEPA, 783 Washington, DC, EPA 815-R-05-013
41. Raucher RS, Cromwell JE III, Cooney K et al (2008) Risk and benefits of energy management for drinking water utilities. AwwaRF, Denver
42. Elliot T, Zeier B, Xagorarakis I, Harrington GW (2003) Energy use at Wisconsin's drinking water facilities. Report 222-1. Energy Center of Wisconsin, Madison, WI
43. USEPA (2005) Economic analysis for the final long term 2 enhanced surface water treatment rule, EPA 815-R-06-001. USEPA, Washington, DC
44. Gomez V, Majamaa K, Pocerull E et al (2012) Determination and occurrence of organic micropollutants in reverse osmosis treatment for advanced water reuse. *Water Sci Technol* 66(1):61–71. doi:10.2166/wst.2012.166
45. Hardy L, Garrido A, Juana L (2012) Evaluation of Spain's water-energy nexus. *Int J Water Resour Dev* 28(1):151–170
46. Kajenthira A, Siddiqi A, Anadon LD (2012) A new case for promoting wastewater reuse in Saudi Arabia: Bringing energy into the water equation. *J Environ Manage* 102:184–192
47. Pacific Institute (2007) Table 22: installed desalination capacity by year, number of plants, and total capacity, 1945 to 2004. Available <http://worldwater.org/wp-content/uploads/2013/07/Table22.pdf>. Accessed 12 June 2013
48. Einav R, Hamssib K, Periyb D (2002) The footprint of the desalination processes on the environment. *Desalination* 152:141–154
49. Munoz I, Fernandez-Alba AR (2008) Reducing the environmental impacts of reverse osmosis desalination by using brackish groundwater resources. *Water Res* 42(3):801–811. doi:10.1016/j.watres.2007.08.021
50. Dundorf S, MacHarg J, Sessions B, Seacord TF (2009) Optimizing lower energy seawater desalination. The Affordable Desalination Collaboration. IDA World Congress, Dubai, UAE [http://www.usbr.gov/research/AWT/reportpdfs/ADC\\_SWRO\\_DA.pdf](http://www.usbr.gov/research/AWT/reportpdfs/ADC_SWRO_DA.pdf) Accessed 12 December 2013
51. Raluy RG, Serra L, Uche J (2005) Life cycle assessment of water production technologies: Part 1. *Int J Life Cycle Assess* 10(4):285–293. doi:10.1065/lca2004.09.179.1

52. Pasqualino J, Meneses M, Abella M, Castells F (2009) LCA as a decision support tool for the environmental improvement of the operation of a municipal wastewater treatment plant. *Environ Sci Technol* 43(9):3300–3307
53. Menses M, Pasqualino JC, Castells F (2010) Environmental assessment of urban wastewater reuse: Treatment alternatives and applications. *Chemosphere* 81:266–272. doi:[10.1016/j.chemosphere.2010.05.053](https://doi.org/10.1016/j.chemosphere.2010.05.053)
54. Amores MJ, Meneses M, Pasqualino J, Anton A, Castells F (2013) Environmental assessment of urban water cycle on Mediterranean conditions by LCA approach. *J Clean Prod* 43:84–92. doi:[10.1016/j.jclepro.2012.12.033](https://doi.org/10.1016/j.jclepro.2012.12.033)
55. Rygaard M, Binning PJ, Albrechtsen H-J (2011) Increasing urban water self-sufficiency: new era, new challenges. *J Env Manag* 92:185–194. doi:[10.1016/j.jenvman.2010.09.009](https://doi.org/10.1016/j.jenvman.2010.09.009)
56. Munoz I, Mila-i-Canals L, Fernandez-Alba AR (2010) Life cycle assessment of water supply plans in Mediterranean Spain: The Ebro River transfer versus the AGUA Programme. *J Indust Qual* 14(6):902–918. doi:[10.1111/j.1530-9290.2010.00271.x](https://doi.org/10.1111/j.1530-9290.2010.00271.x)
57. Blanco J, Malato S, Fernández- Ibañez P et al (2009) Review of feasible solar energy applications to water processes. *Renew Sustain Energ Rev* 13:1437–1445
58. Hindiyeh M, Ali A (2010) Investigating the efficiency of solar energy system for drinking water disinfection. *Desalination* 259:208–215. doi:[10.1016/j.desal.2010.04.004](https://doi.org/10.1016/j.desal.2010.04.004)
59. Al-Smairan M (2012) Application of photovoltaic array for pumping water as an alternative to diesel engines in Jordan Badia. Tall Hassan Station: Case study. *Renew Sustain Energ Rev* 16:4500–4507
60. Jasrotia S, Kansal A, Kishore VV (2012) Application of solar energy for water supply and sanitation in Arsenic affected rural areas: a study for Kaudikasa village, India. *J Clean Prod* 37:389–393. doi:[10.1016/j.jclepro.2012.07.030](https://doi.org/10.1016/j.jclepro.2012.07.030)
61. Barrios R, Siebel M, van der Helm A et al (2008) Environmental and financial life cycle impact assessment of drinking water production at Waternet. *J Clean Prod* 16:471–476. doi:[10.1016/j.jclepro.2006.07.052](https://doi.org/10.1016/j.jclepro.2006.07.052)
62. Bonton A, Bouchard C, Barbeau B, Jedrzejak S (2012) Comparative life cycle assessment of water treatment plants. *Desalination* 284:42–54
63. Chandel MK, Pratson LF, Jackson RB (2011) The potential impacts of climate-change policy on freshwater use in thermoelectric power generation. *Energy Policy* 39:6234–6242. doi:[10.1016/j.enpol.2011.07.022](https://doi.org/10.1016/j.enpol.2011.07.022)
64. Kenny JF, Barber NL, Hutson SS, et al (2009) Estimated use of water in the United States in 2005: U.S. Geological Survey Circular 1344, 52 p. <http://pubs.usgs.gov/circ/1344/pdf/c1344.pdf> Accessed 15 Aug 2012
65. Chen L, Roy SB, Goldstein RA (2013) Projected freshwater withdrawals under efficiency scenarios for electricity generation and municipal use in the United States for 2030. *JAWRA* 49(1):231–246. doi:[10.1111/jawr.12013](https://doi.org/10.1111/jawr.12013)
66. Macknick J, Newmark R, Heath G et al (2012) Operational water consumption and withdrawal factors for electricity generating technologies: a review of existing literature. *Environ Res Lett* 7(4):045802. doi:[10.1088/1748-9326/7/4/045802](https://doi.org/10.1088/1748-9326/7/4/045802)
67. Feeley TJ, Skone TJ, Stiegel GJ, McNemar A, Nemeth M, Schimmoller B, Murphy JT, Manfredo L (2008) Water: a critical resource in the thermoelectric power industry. *Energy* 33:1–11
68. Fthenakis V, Kim HC (2010) Life-cycle uses of water in U.S. electricity generation. *Renew Sustain Energ Rev* 14:2039–2048. doi:[10.1016/j.rser.2010.03.008](https://doi.org/10.1016/j.rser.2010.03.008)
69. Sovacool BK, Sovacool KE (2009) Identifying future electricity-water tradeoffs in the United States. *Energy Policy* 37:2763–2773. doi:[10.1016/j.enpol.2009.03.012](https://doi.org/10.1016/j.enpol.2009.03.012)
70. Davies EGR, Kyle P, Edmonds JA (2013) An integrated assessment of global and regional water demands for electricity generation to 209. *Adv Water Resour* 52:296–313
71. Grubert EA, Beach FC, Webber ME (2012) Can switching fuels save water? A life cycle quantification of freshwater consumption for Texas coal and natural gas-fire electricity. *Environ Res Lett* 7(4):045801

72. National Energy Technology Laboratory (NETL) (2010) Estimating freshwater needs to meet future thermoelectric generation requirements: 2010 Update. Available: [http://www.netl.doe.gov/energy-analyses/pubs/2010\\_Water\\_Needs\\_Analysis.pdf](http://www.netl.doe.gov/energy-analyses/pubs/2010_Water_Needs_Analysis.pdf). Accessed 15 Aug 2013
73. Zhai H, Rubin ES, Versteeg PL (2011) Water use at pulverized coal power plants with postcombustion carbon capture and storage. *Environ Sci Technol* 45(6):2479–2485. doi:10.1021/es1034443. Epub 2011 Feb 17
74. Meldrum J, Nettles-Anderson S, Heath G, Macknick J (2013) Life cycle water use for electricity generation: a review and harmonization of literature estimates. *Environ Res Lett* 8:015031. doi:10.1088/1748-9326/8/1/015031
75. Kyle P, Davies EGR, Dooley JJ et al (2013) Influence of climate change mitigation technology on global demands of water for electricity generation. *Int J Greenhouse Gas Control* 13:112–123. doi:10.1016/j.ijggc.2012.12.006
76. National Energy Technology Laboratory (NETL) (2009) Impact of drought on US steam electric power plant cooling water intakes and related water resource management issues. Available: <http://www.netl.doe.gov/technologies/coalpower/ewr/water/pdfs/final-drought%20impacts.pdf>. Accessed 15 Aug 2013
77. Hightower M, Pierce S (2008) The energy challenge. *Nature* 452:285–286
78. Wei X, Wei H, Viadero RC (2010) Post-reclamation water quality trend in a Mid-Appalachian watershed of abandoned mine lands. *Sci Total Environ* 409(5):941–948
79. Jablonska B (2008) Estimating the water pollution in Potok Golawiecki, Poland, based on selected water quality indicators. *Arch Environ Prot* 34(1):3–12
80. Hopkins RL, Altier BM, Haselman C et al (2013) Exploring the legacy effects of surface coal mining on stream chemistry. *Hydrobiologia* 713(1):87–95. doi:10.1007/s10750-013-1494-9
81. Runkel RL, Bencala KE, Kimball BA et al (2009) A comparison of pre- and post-remediation water quality, Mineral Creek, Colorado. *Hydrol Processes* 23(23):3319–3333. doi:10.1002/hyp.7427
82. Cravotta CA (2008) Dissolved metals and associated constituents in abandoned coal-mine discharges, Pennsylvania, USA. Part 1: Constituent quantities and correlations. *Appl Geochem* 23:166–202. doi:10.1016/j.apgeochem.2007.10.011
83. Singh AK, Mahato MK, Neogi B et al (2011) Hydrogeochemistry, elemental flux, and quality assessment of mine water in the Pootkee-Balihari mining area, Jharia coalfield, India. *Mine Water Environ* 30(3):197–207
84. Singh AK, Mahato MK, Neogi B et al (2010) Quality assessment of mine water in the Raniganj coalfield area, India. *Mine Water Environ* 29(4):248–262. doi:10.1007/s10230-010-0108-2
85. Ibeanusi VM, Wilde EW (1998) Bioremediation of coal pile run off waters using an integrated microbial ecosystem. *Biotechnol Lett* 20(11):1077–1079
86. Baba A, Tayfur G (2011) Groundwater contamination and its effect on health in Turkey. *Environ Monit Assess* 183:77–94. doi:10.1007/s10661-011-1907-z
87. Praharaj T, Powell MA, Hart BR, Tripathy S (2002) Leachability of elements from subbituminous coal fly ash from India. *Environ Int* 27:609–15
88. Farooqi A, Masuda H, Firdous N (2007) Toxic fluoride and arsenic contaminated groundwater in the Lahore and Kasur districts, Punjab, Pakistan and possible contaminant sources. *Environ Pollut* 145:839–849. doi:10.1016/j.envpol.2006.05.007
89. Rai PK (2010) Seasonal monitoring of heavy metals and physiochemical characteristics in a lentic ecosystem of subtropical region, India. *Environ Monit Assess* 165:407–433. doi:10.1007/s10661-009-0956-z
90. Ripley EA, Redmann RE, Crowder AA (1996) Environmental effects of mining. St. Lucie Press, Delray Beach, FL
91. Gammon CH, Brown A, Poulson SR et al (2013) Using stable isotopes (S, O) of sulfate to track local contamination of the Madison karst aquifer, Montana, from abandoned coal mine drainage. *Appl Geochem* 31:228–238. doi:10.1016/j.apgeochem.2013.01.008

92. Baba A, Kaya A, Birsoy YK (2003) The effect of Yatagan Thermal Power Plant (Mugla, Turkey) of the quality of surface and groundwaters. *Water Air Soil Pollut* 149:93–111
93. Demirak A, Balci A, Dalman O et al (2005) Chemical investigation of water resources around the Yatagan Thermal Power Plant of Turkey. *Water Air Soil Pollut* 162(1–4):171–181
94. Hamada N, Ogino H (2012) Food safety regulations: what we learned from the Fukushima nuclear accident. *J Environ Radioact* 111:83–99
95. Murakami M, Oki T (2012) Estimation of thyroid doses and health risks resulting from the intake of radioactive iodine in foods and drinking water by the citizens of Tokyo after the Fukushima nuclear accident. *Chemosphere* 87:1355–1360
96. Bugai DA, Water RD, Dzhepo SP, et al (1997) The cooling pond of the Chernobyl nuclear power plant: a groundwater remediation case history. *Water Resour Res* 33(4):677–688
97. Hanslik E, Ivanovova D, Jedinakova-Krizova V et al (2009) Concentration of radionuclides in hydrosphere affected by Temelin Nuclear Power Plant in Czech Republic. *J Environ Radioact* 100:558–563
98. Karecha PA, Hansen JE (2013) Prevented mortality and greenhouse gas emissions from historical and projected nuclear power. *Environ Sci Technol* 47(9):4889–4895
99. Rodgher S, de Azevedo H, Ferrari CR et al (2013) Evaluation of surface water quality in aquatic bodies under the influence of uranium mining (MG, Brazil). *Environ Monit Assess* 185:2395–2406. doi:[10.1007/s10661-012-2719-5](https://doi.org/10.1007/s10661-012-2719-5)
100. Qian Y, Zheng MH, Gao L et al (2005) Heavy metal contamination and its environmental risk assessment in surface sediments from Lake Dongting, People's Republic of China. *Bull Environ Contam Toxicol* 75(1):204–210
101. Chevychelov AP, D'yachkovskii AP, Sobakin PI et al (2010) Surface water radioactive pollution in South Yakutia anthropogenic landscapes. *Contemp Probl Ecol* 3(4):381–385
102. Sowder JT, Kelleners TJ, Reddy KJ (2010) The origin and fate of arsenic in coalbed natural gas-produced water ponds. *J Environ Qual* 39(5):1604–1615. doi:[10.2134/jeq2009.0428](https://doi.org/10.2134/jeq2009.0428)
103. Wang XX, Yang WH (2008) Modelling potential impacts of coalbed methane development on stream water quality in an American watershed. *Hydrol Processes* 22(1):87–103. doi:[10.1002/hyp.6647](https://doi.org/10.1002/hyp.6647)
104. US EPA Office of Water (2004) Evaluation of impacts to underground sources of drinking water by hydraulic fracturing of coalbed methane reservoirs. EPA 816-R-04-003. On-line. Available: [http://water.epa.gov/type/groundwater/uic/class2/hydraulicfracturing/wells\\_coalbedmethanestudy.cfm](http://water.epa.gov/type/groundwater/uic/class2/hydraulicfracturing/wells_coalbedmethanestudy.cfm). Accessed 10 Aug 2013
105. Osborn SG, Vengosh A, Warner NR, Jackson RB (2011) Methane contamination of drinking water accompanying gas-well drilling and hydraulic fracturing. *Proc Natl Acad Sci USA* 108(20):8172–8176
106. Saba T, Orzechowski M (2011) Lack of data to support a relationship between methane contamination of drinking water wells and hydraulic fracturing. *Proc Natl Acad Sci USA* 108(37):E663
107. Schon, SC (2011) Hydraulic fracturing not responsible for methane migration. *Proc Natl Acad Sci USA* 108(37):E664
108. Love BJ, Einhauser MD, Nejadhashemi AP (2011) Effects on aquatic and human health due to large scale bioenergy crop expansion. *Sci Total Environ* 409(17):3215–3229
109. Love B, Nejadhashemi AP (2011) Environmental impact analysis of biofuel crops expansion in the Saginaw River Watershed. *J Biobased Mater Bioenergy* 5(1):30–54. doi:[10.1166/jbmb.2011.1119](https://doi.org/10.1166/jbmb.2011.1119)
110. Secchi S, Gassman PW, Jha M et al (2011) Potential water quality changes due to corn expansion in the Upper Mississippi River Basin. *Ecol Appl* 21(4):1068–1084. doi:[10.1890/09-0619.1](https://doi.org/10.1890/09-0619.1)
111. de Fraiture C, Giordano M, Liao Y (2008) Biofuels and implications for agricultural water use: blue impacts of green energy. *Water Policy* 10(S1):67–81
112. Twomey KM, Stillwell AS, Webber ME (2010) The unintended energy impacts of increased nitrate contamination from biofuels production. *J Environ Monit* 12(1):218–224

113. IPCC (2007) Climate change 2007: synthesis report. Core Writing Team, Pachauri RK and Reisinger A (eds) Contribution of working groups I, II and III to the fourth assessment report of the intergovernmental panel on climate change. IPCC, Geneva, Switzerland, 104 pp
114. Ragab R, Prudhomme C (2002) Climate change and water resources management in arid and semi-arid regions: Prospective and challenges for the 21st century. *Biosyst Eng* 81(1):3–34. doi:[10.1006/bioe.2001.0013](https://doi.org/10.1006/bioe.2001.0013)
115. De Wit M, Stankiewicz J (2006) Changes in surface water supply across Africa with predicted climate change. *Science* 311(5769):1917–1921
116. Arnell NW (1999) Climate change and global water resources. *Global Environ Change* 9: S31–S49
117. Mizyed N (2009) Impacts of climate change on water resources availability and agricultural water demand in the west bank. *Water Resour Manag* 23:2015–2029. doi:[10.1007/s11269-008-9367-0](https://doi.org/10.1007/s11269-008-9367-0)
118. Rosenberg NJ, Brown RA, Izaurralde RC, Thomson AM (2003) Integrated assessment of HadleyCentre (HadCM2) climate change projections on agricultural productivity and irrigation water supply in the conterminous United States I. Climate change scenarios and impacts on irrigation water supply simulated with the HUMUS model. *J Agri Meteorol* 117:73–96. doi:[10.1016/S0168-1923\(03\)00025-X](https://doi.org/10.1016/S0168-1923(03)00025-X)
119. Oki T, Kanae S (2006) Global hydrological cycles and world water resources. *Science* 313:1068–1072. doi:[10.1126/science.1128845](https://doi.org/10.1126/science.1128845)
120. Van Vliet MTH, Yearsley JR, Ludwig F et al (2012) Vulnerability of US and European electricity supply to climate change. *Nat Clim Change* 2(9):676–681. doi:[10.1038/NCLIMATE1546](https://doi.org/10.1038/NCLIMATE1546)
121. Loaiciga HA, Pingel TJ, Garcia ES (2012) Sea water intrusion by sea-level rise: Scenarios for the 21st Century. *Groundwater* 50(1):37–47
122. Langevin CD, Zygnerski M (2013) Effect of sea-level rise on salt water intrusion near a coastal well field in southeastern. *Groundwater* 51(5):781–803
123. Faneca Sanchez M, Gunnink JL, van Baaren ES, Oude Essink GHP, Siemon B, Auken E, Elderhorst W, de Louw PGB (2012) Modelling climate change effects on a Dutch coastal groundwater system using airborne electromagnetic measurements. *Hydrol Earth Syst Sci* 16:4499–4516. doi:[10.5194/hess-16-4499-2012](https://doi.org/10.5194/hess-16-4499-2012)
124. Shaha DC, Cbo YK, Kim TW (2013) Effects of river discharge and tide driven sea level variation on saltwater intrusion in Sumjin River estuary: An application of finite-volume coastal ocean model. *J Coast Res* 29(2):60–470. Coconut Creek (Florida), ISSN 0749-0208
125. Rice KC, Hong B, Shen J (2012) Assessment of salinity intrusion in the James and Chickahominy Rivers as a result of simulated sea-level rise in Chesapeake Bay, East Coast, USA. *J Environ Manag* 111:61–69. doi:[10.1016/j.jenvman.2012.06.036](https://doi.org/10.1016/j.jenvman.2012.06.036)
126. Pierce DW, Barnett TP, Hidalgo HG, et al (2008) Attribution of declining Western U.S. snowpack to human effects. *J Clim* 2:6425–6444. doi:[10.1175/2008JCLI2405.1](https://doi.org/10.1175/2008JCLI2405.1)
127. Barnett TP, Pierce DW, Hidalgo HG, Bonfils C, Santer BD, Das T, Bala G, Wood AW, Nozawa T, Mirin AA, Cayan DR, Dettinger MD (2008) Human-induced changes in the hydrology of the western United States. *Science* 319:1080–1083. doi:[10.1126/science.1152538](https://doi.org/10.1126/science.1152538)
128. Payne JT, Wood AW, Hamlet AF, Palmer RN, Lettenmaier DP (2004) Mitigating the effects of climate change on the water resources of the Columbia River Basin. *Clim Change* 62:233–256
129. Fischer G, Tubiello FN, van Velthuisen H, Wiberg DA (2007) Climate change impacts on irrigation water requirements: Effects of mitigation, 1990–2080 *Technological Forecasting & Social Change* 74:1083–1107. doi:[10.1016/j.techfore.2006.05.021](https://doi.org/10.1016/j.techfore.2006.05.021)
130. Doll P (2002) Impact of climate change and variability on irrigation requirements: a global perspective. *Clim Change* 54(3):269–293. doi:[10.1023/A:1016124032231](https://doi.org/10.1023/A:1016124032231)

# Municipal Wastewater: A Rediscovered Resource for Sustainable Water Reuse

Gayathri Ram Mohan, Thomas F. Speth, Daniel Murray,  
and Jay L. Garland

**Abstract** Both population growth and movement put forth the need for increased regional water supplies across the globe. While significant progress has been made in the area of building new infrastructure to capture freshwater and divert it to urban and rural areas, there exists a considerable difference in the supply and demand of high-quality water. The cost and non-sustainability of diverting ever increasing volumes of water to stressed areas have become difficult to justify. Therefore, a key step in finding a solution to it is to identify alternate water resources. Given that approximately 45 million cubic meters of municipal wastewater is discharged every day in the United States, researchers and water industry planners have identified municipal wastewater as a viable source for water reuse. Given this potential source, an appraisal of the varying qualities and characteristics of municipal wastewater affecting water reuse is made. This is followed by a discussion on different sectors such as urban, agriculture, and industry that are potential consumers of reclaimed water. The conventional and advanced treatment technologies used to treat municipal wastewater to meet reuse standards are then evaluated; and a number of case studies demonstrating water reuse schemes in different parts of the world are described in brief.

**Keywords** Water stress • Wastewater reuse • Water quality • Municipal wastewater • Membrane bioreactors

---

G.R. Mohan (✉) • T.F. Speth • D. Murray • J.L. Garland  
U.S. Environmental Protection Agency, Cincinnati, OH, USA  
e-mail: [Rammohan.Gayathri@epa.gov](mailto:Rammohan.Gayathri@epa.gov)



## 1 Introduction

In the years past, wastewater generated from water used for societal needs was labeled sewage and discharged into water bodies [1]. Later in the twentieth century, the deleterious consequences of direct discharge of wastewater on the environment and human health led to the development and implementation of various treatment technologies, mainly with respect to removal of biodegradable matter, nutrients, and pathogens [2, 3]. Today, the steadily increasing global population with particularly higher rates of growth in urban areas is an issue of growing concern [4, 5]. With many anthropogenic activities such as urbanization, industrialization, agriculture, and other land practices altering the water balance in nature, it is no surprise that the limited quantity of high-quality renewable water supply is distributed unevenly on a global scale [6].

Sustainable water use can be achieved by creating a balance between the rates of water withdrawn and that replenished. With the amount of water withdrawn for agriculture, industry, and municipal applications growing steadily, looking at alternate sources of water has become a necessity in many parts of the world. As a result of this immense pressure on the water industry to provide safe and sustainable drinking water to match consumption, the focus has turned to reusing municipal wastewater for various end purposes. To help with the discussion, the descriptions for various terminologies used in this chapter that are related to water reuse are described below.

Terminologies related to water reuse

Terminology	Description
Recycle	Diversion of effluent from a specific process back to the front end, typically used in industrial settings
Reclamation	The process of treating wastewater to standards for reuse
Reuse	Beneficial use of treated wastewater
Direct reuse	Transfer of untreated or treated wastewater from the point of its generation to the site of intended application, such as industrial, agricultural, or landscape purposes
Indirect reuse	Treated wastewater when used to augment surface or groundwater supplies by surface spreading or reused via mixing or dilution
Direct potable reuse	Direct incorporation of treated wastewater into a drinking water supply, either the plant headworks or distribution system
Indirect potable reuse	Incorporation of reclaimed water into the source water of one or more drinking water utilities.

### 1.1 Water Availability

Although global hydrological cycle ensures abundant supply of freshwater that is sufficient to sustain several times the world population, most of this is inaccessible



for human use. A significant percent of the annual runoff reaches such remote locations in the world that pose physical and economic challenges to tap into. In 2006, the quantity of freshwater available on a global scale was  $8,462 \text{ m}^3/\text{capita-year}$  [7]. However, due to human demographics along with socioeconomic and cultural differences, water supply and usage patterns show significant variation in various parts of the world, leaving behind a small portion of the freshwater sources for human use [8–10]

With the current world population of seven billion that is expected to grow at least by 30 % in the next 30 years, more stress will be laid on the current water supply. Therefore, there will be call for measures such as robust water infrastructure and utilizing alternate renewable sources of water. Researchers have shown that hydraulic infrastructure such as dams, levees, and dikes built on water bodies tend to disrupt the balance in nature by affecting aquatic life. These effects are often followed by alteration in river's flow patterns, water temperature, DO levels, and nutrient content. Therefore, looking at alternate resources for sustainable water reuse, such as wastewater reuse, could be a suitable alternative goal to balance human and ecological goals.

Figure 1 shows various sectors and their usage of freshwater resources in the United States in 2009. Estimated projections have shown that by the end of 2025 about 61 % of the global population will be living in cities. As a result, the percent of annual water usage for household and industrial purposes in developing countries is expected to double. This will in turn lead to increased diversion of water supplies originally used for agricultural irrigation. Without subsequent changes to farming practices, this will most certainly affect the world's food supply. Also, the impact on the power industry could be significant in certain parts of the nation.

## 1.2 Water Stress

The pressure exerted on available water resources can be determined using water stress indices which is the ratio of a country's total water withdrawal to total renewable freshwater resources. A value of <10 % is considered low water stress, 10–20 % is where water availability is becoming limited and additional efforts are required to ensure sustained availability, and above 20 % is considered water stressed region where comprehensive management efforts are a necessity to balance supply and demand of available water resources [11].

The water stress plot of European countries (Fig. 2) shows the water stress index for the year 2000. The plot shows that many semiarid coastal areas and urbanized regions are affected by water stress. This trend is a result of uneven distribution, seasonal variations, and significant changes in global weather patterns. Various researchers have studied water stress around the globe and have used different parameters to contemplate the results. Various characteristics and the threshold values used to further characterize the water stress in different regions are as follows: (1) water stressed:  $<1,700 \text{ m}^3/\text{capita-year}$ , (2) chronic water scarcity:

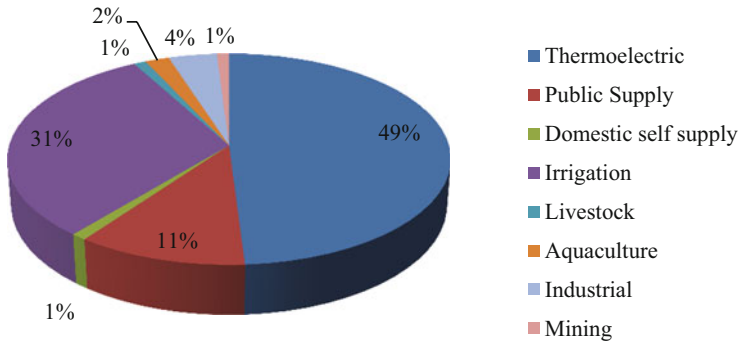


Fig. 1 Freshwater use in the United States (2009) [9]

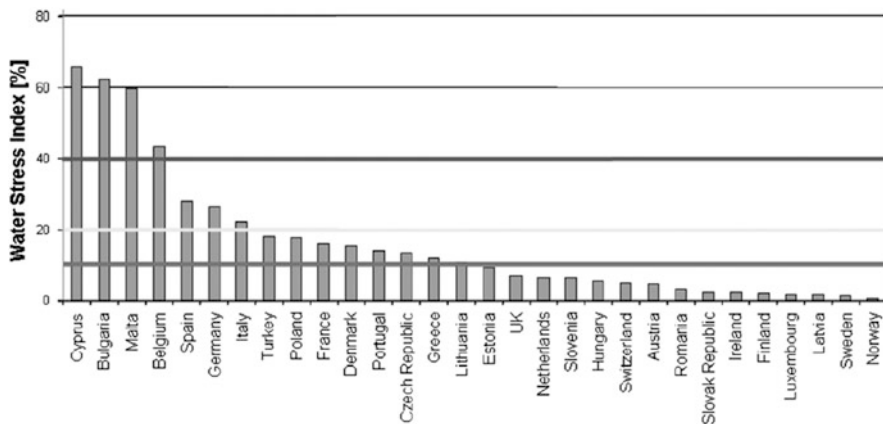


Fig. 2 Water stress index in European countries [11]

<1,000 m<sup>3</sup>/capita-year, (3) absolute water stress: <500 m<sup>3</sup>/capita-year, and (4) minimum survival level: <100 m<sup>3</sup>/capita-year [7]. Researchers have shown that currently about 11 % of the total world population lives with less than 1,000 m<sup>3</sup>/capita-year water, and the percentage population is expected to increase to 38 % by 2025.

Researchers have developed various tools to map the risk of water scarcity around the world especially due to the significant deterioration of the quality and quantity of water sources. Two metrics were developed at the Columbia University to study dry periods within a given year, called Normalized Deficit Index (NDI), and drought across years called Normalized Deficit Cumulative (NDC). Figure 3 shows the NDI- and NDC-based water risk assessment in the United States. NDI is calculated every year based on rainfall data in the particular area and the daily water needs; NDC is calculated as one number over the historical climate record. A value

of NDI or NDC  $< 1$  (ratio) indicates that the magnitude of cumulative risk is less than average annual rainfall, while greater than 1 indicates that shortage during a run of bad years is greater than the average annual rainfall locally [12].

Figure 4 shows the water stress index map for 2011 developed by Maplecroft that was determined using the ratio of domestic, industrial, and agricultural water consumption against renewable supply of water from precipitation, rivers, and groundwater [13]. While the Middle East and North African countries are identified as being at “extreme risk,” emerging economies such as India, China, and Korea have been categorized as “medium risk.”

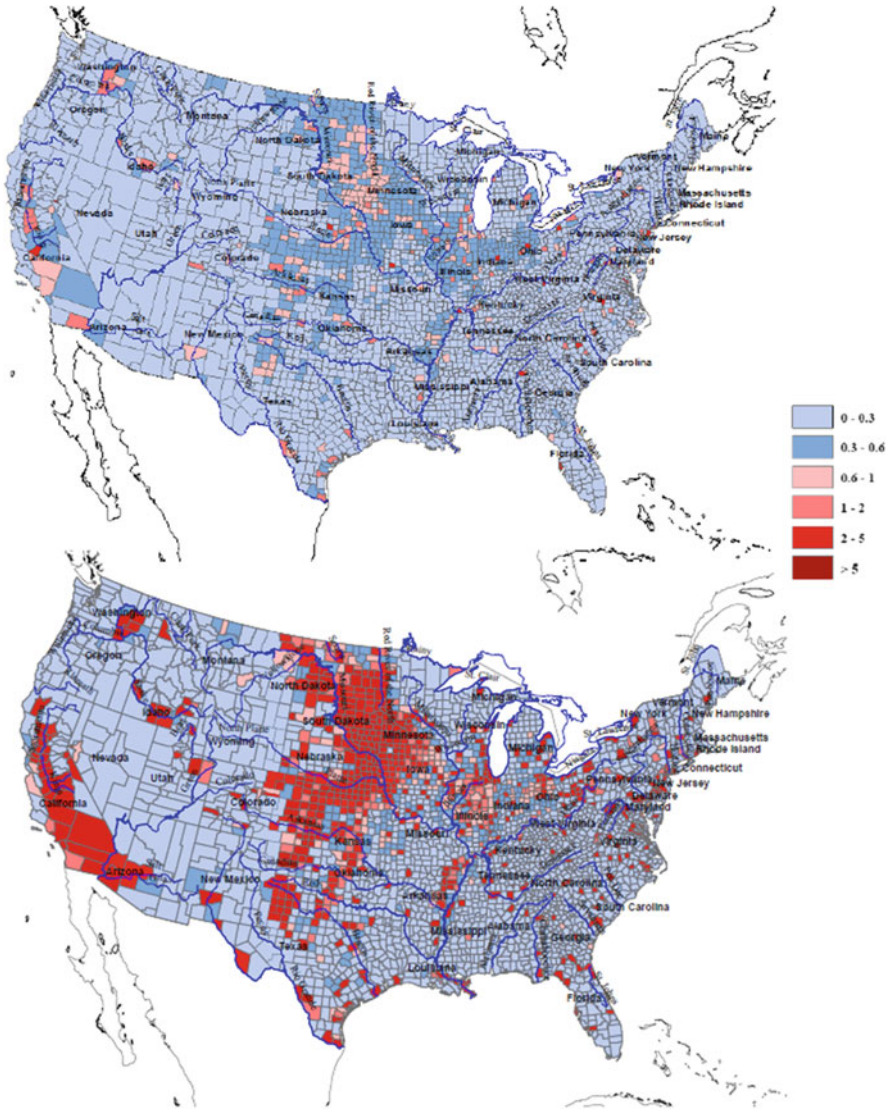
## 2 Water Reuse Applications

The ultimate goal of the water industry that encompasses drinking water, municipal wastewater, and industrial wastewater is to provide a sustained supply of safe drinking water while simultaneously protecting the environment. The main drivers for wastewater reuse vary from region to region and may range from issues such as lack of water, drought and famine, lack of sanitation, or due to socioeconomic reasons such as a population inclined towards greener management policies that include water reuse projects. Researchers have predicted that the number of water reuse projects and applications will steadily increase due to the drivers discussed above. By 2015 about 15,470 cfs water is estimated to be provided via reclaimed wastewater (Fig. 5) [14]. Table 1 shows the types of treatment and water reuse guidelines in the United States based on intended end usage. The three main sectors that have attracted most attention for application of water reuse are agriculture, industry, and direct and indirect municipal reuse.

Table 1 shows the types of treatment and water reuse standards based on intended end usage. The three main sectors that have attracted most attention for application of water reuse are agriculture, industry, and direct and indirect municipal reuse.

### 2.1 Agriculture

The agricultural sector accounts for 76 % of total water utilization in the world. The quantity of water needed to produce a balanced diet is 70 times more than the quantity used for regular household purposes. As a result of such high water usage, agriculture is also the sector that uses the highest percentage of recycled wastewater. Many countries reuse water in treated or untreated form to meet irrigation needs. The UN report released in 2003 showed that at least 50 countries worldwide are irrigating fertile lands using recycled polluted waters [7]. An advantage for farmers to irrigate with wastewater is the lack of necessity to supplement it with additional nutrients and the low costs associated with this practice. While such



**Fig. 3** Water stress in the United States defined by NDI (*above*) and NDC (*below*) developed by Columbia University [12]

practices are common in developing or underdeveloped countries, a similar practice in urban areas is referred to as “urban agriculture.” In urban agriculture, wastewater is reused to irrigate land used to cultivate fruit, flowers, and vegetables. The demand for fresh produce along with availability of large quantities of wastewater results in such practices. Although this is a step closer to managing wastes while recovering resources from it, consequences such as diseases caused from consuming such

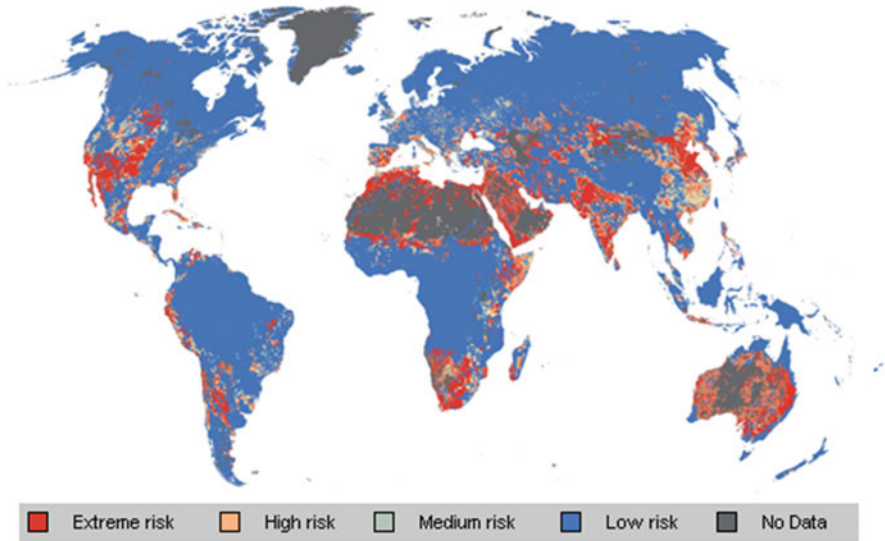


Fig. 4 Global water stress map [13]

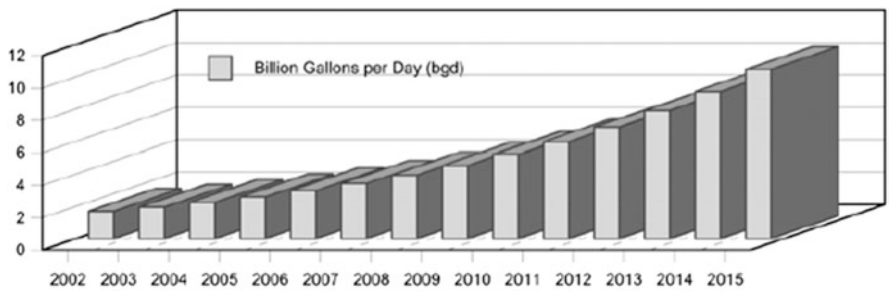


Fig. 5 Estimated growth of water reuse in the United States (2002–2015) [14] (one Billion gallons per day =  $3.785 \times 10^6 \text{ m}^3$  per day)

produce must not be neglected. To mitigate such exposure, affordable low-cost technologies have been implemented to treat the wastewater before reuse [10, 14, 16].

In Adelaide, Australia, approximately 30 million  $\text{m}^3$ /year of treated water from a sewage treatment plant is being used to irrigate horticulture crops. The wastewater is treated using dissolved air flotation and filtration processes [16]. In Mexico, about 90 % of the wastewater produced from advanced primary treatment, sand filtration, UV disinfection, and chlorination is reused for irrigation, particularly in the low rainfall areas that also have less fertile lands. Irrigating more than 9,000 ha of land with wastewater has not only improved the soil quality resulting in improved crop

**Table 1** Wastewater reuse guidelines for various intended purposes [15]

Category of wastewater reuse	Treatment type	Treatment goals
Urban reuse		
Unrestricted Eg., Landscape irrigation, in-building uses like toilet flushing	Biological, filtration, disinfection	pH 6–9 BOD < 10 mg/L Turbidity < 2 NTU Residual chlorine— 1 mg/L Fecal coliform—ND
Restricted Irrigation of golf courses or freeway medians	Biological, filtration, disinfection	pH 6–9 BOD < 30 mg/L TSS < 30 mg/L Residual chlorine— 1 mg/L Fecal coliform < 200/ 100 mL
Agricultural reuse		
Food crops	Biological, filtration, disinfection	pH 6– BOD < 10 mg/L Turbidity < 2 NTU Residual chlorine— 1 mg/L Fecal coliform—ND
Non food crops	Biological, disinfection	pH 6–9 BOD < 30 mg/L TSS < 30 mg/L Residual chlorine— 1 mg/L Fecal coliform < 200/ 100 mL
Recreational reuse		
Unrestricted	Biological, filtration, disinfection	pH 6– BOD < 10 mg/L Turbidity < 2 NTU Residual chlorine— 1 mg/L Fecal coliform—ND
Restricted	Biological, disinfection	pH 6–9 BOD < 30 mg/L TSS < 30 mg/L Residual chlorine— 1 mg/L Fecal coliform < 200/ 100 mL
Groundwater recharge	Site specific	Site specific
Direct potable reuse	Safe drinking water regulations	Safe drinking water regulations

yield, but has also helped increase groundwater recharge in the Mezquital Valley [16].

## **2.2 Industry**

Industrial effluents vary in quality and quantity based on the process they are subjected to and although reuse applications in industries are controlled by economic forces, generally private sector has its own well-defined rules and regulations for wastewater treatment to meet their specific needs [17]. Therefore, recycle of untreated wastewater is a common practice in industries as it saves them significant portion of associated water costs. While industries account for up to 18 % of direct reuse, their supply chains are more prone to water risk due to climate variability. In recent years, regulatory agencies have laid stringent rules, while also setting up generous incentive packages to promote reuse practice in industries. Some of the industries heavily involved in water reuse schemes are consequently the ones that have higher water usage such as bioethanol plants.

In power plants around the world, two main areas are well known for recycle of process water, namely, cooling towers and boiler feed. In the City of Phoenix, USA, where average annual rainfall is 175 mm/year, the cooling system makeup water is recycled within the station. Coco-Cola's Rainmaker beverage process water is collected and treated using conventional biological treatment, MBR filtration, reverse osmosis, ozonation, and UV disinfection before being reused. The Singapore Public Utilities authority has conducted research on suitability of recycled water treated using advanced technology for use in semiconductor industries. Because of the need for high purity water, the treatment train involves membrane filtration, reverse osmosis, and UV disinfection [16].

## **2.3 Municipal Sector**

The areas at higher risk of water stress are concentrated in the cities due to their growing populations. Municipal wastewater reuse is a sustainable alternative for efficient waste management and resource recovery that helps reduce our dependence on freshwater resources. Municipal wastewater reuse applications include a wide range of treatment options from low treatment levels for applications involving low health risks such as vehicle wash or toilet flushing to others that require higher levels of treatment, for example, direct potable reuse. While direct potable reuse is a complicated and less practiced scheme, increasing scarcity of water supplies means that increasing attention has to be diverted to this area to supplement the available resources to meet population demands.

California has been a pioneer in practicing municipal wastewater reuse from the late 1900s in the United States. The Los Angeles County Sanitation District has



used treated wastewater since 1962 to recharge groundwater through surface spreading basins [16]. Prior to recharge, the wastewater is disinfected and subjected to tertiary filtration. The State of California has also reported that the Whittier Narrows groundwater recharge meets the surface water quality standards. Windhoek, Namibia, where the nearest perennial river is at least 750 km from the city, was the world's first direct potable water reuse plant in 1968. The wastewater is subject to a dual membrane treatment process before reuse.

### **3 Municipal Wastewater Quality**

A significant growth in population size, urbanization, and increase in the number of industries in the United States since the mid-1900s has contributed toward a significant increase in the quantity of wastewater discharged to municipal collection systems. Figure 6 shows the changes in municipal wastewater quality during various stages of its use. Technological advancement and the type of industries play a key role in determining the wastewater characteristics. Studies have shown that many unidentified new compounds are added each year to wastewater as a result of emerging industrialization.

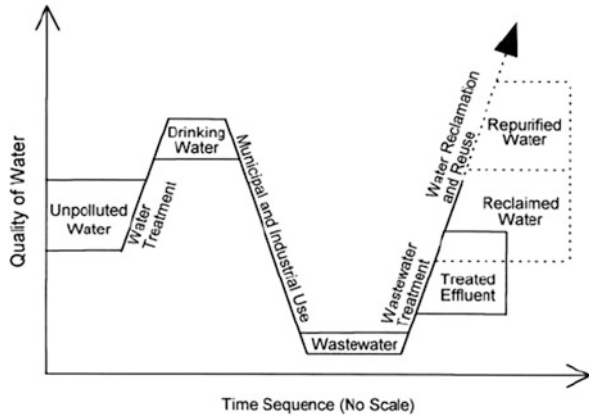
#### ***3.1 Factors Affecting Water Reuse***

The successful installation and operation of water reuse projects mainly depend on various social, economic, regulatory, and financial factors. With respect to technical factors, the treatment selection depends on the intended use of the reclaimed water. Extensive or intensive technologies may be applied depending on the compliance standards, costs associated with the treatment, and ease of operation and maintenance. The most challenging of all is the ability to achieve highly reliable operational, storage, and distribution networks [7].

The microbial water quality indicators for water reuse for irrigation purposes are shown in Table 2. In the United States, individual states have varying rules and regulations with regard to water reuse, such as California Title 22 criteria (1978). The USEPA released the water reuse guidelines in 2012 that detailed the current status of water reuse projects in the United States; however, they did not recommend specific regulatory levels [9]. The World Health Organization (WHO)-related regulations are based on Health guidelines for the use of wastewater in agriculture and aquaculture (1989) [10].



**Fig. 6** Changes in water quality during various stages of municipal water usage [6, 15]



**Table 2** Microbial indicators in wastewater treatment [9, 10]

Microorganisms	Indicators	Raw wastewater levels	Guidelines
Bacteria	Fecal, total coliform	< 10 <sup>5</sup> cells/1 L	WHO: 1,000 FC/100 mL
	<i>Streptococcus faecalis</i>		FL, AZ, CA—2.2 FC/100 mL
	<i>E. Coli</i>		
	<i>Vibrio cholera</i>		
	<i>Shigella</i>		
Virus	Hepatitis A and E	10 <sup>5</sup> –10 <sup>6</sup> cells/1 L	AZ, HI: <1 PFU/40 L
	Virus		
	Enteroviruses		
	Adenovirus		
	Rotavirus		
Helminths	Nematode eggs	–	WHO: < 1 Helminth egg/1,000 ml
	<i>Ascaris</i>	<10 <sup>3</sup> cells/1 L	
	<i>Trichuris</i>	<10 <sup>2</sup> cells/1 L	
	<i>Ancylostoma</i>	<10 <sup>3</sup> cells/1 L	
Protozoa	<i>Giardia</i>	<10 <sup>5</sup> cells/1 L	–
	<i>Cryptosporidium</i>	<10 <sup>4</sup> cells/1 L	
	<i>Entamoeba</i>	<10 <sup>2</sup> cells/1 L	

### 3.2 Wastewater Characteristics

#### 3.2.1 Microorganisms in Wastewater

Two broad categories of microbes are found in wastewater: (1) beneficial decomposers that aid in the degradation of nutrients and organics present in wastewater and (2) disease-causing pathogens that are derived from infected human feces [18, 19]. While wastewater treatment is benefited by the presence of the former, the survival of the latter depends on various factors such as pH, salinity, temperature, and humidity. Parasites such as protozoa and helminthes may be released in the

form of highly resistant spores, cysts, or oocytes that are to a great extent unaffected by environmental stress such as heat or freezing. Their physical state prevents disinfection via treatment such as chlorination or addition of chemical agents. However, due to their large size, sedimentation or filtration is very effective in removing these parasites. An effective treatment to destroy such pathogens is UV disinfection.

Bacterial levels in wastewater vary significantly due to regional and seasonal variations. Secondary biological treatment also helps remove pathogenic microorganisms from treated wastewater. Commonly used treatments include sedimentation, activated sludge, and disinfection. Indicator microorganisms are not themselves harmful to human health; however, they are used as a tool to determine the likelihood of health risks. Commonly monitored indicators in wastewater are fecal coliforms, total coliforms, and *E. Coli*. The variety and low concentration of pathogens in wastewater call for more advanced analytical laboratory testing protocols. While regulatory agencies require mandatory monitoring of basic indicators such as fecal and total coliforms, specific state regulations may call for more intense monitoring. For example, the states of Florida, Arizona, and California, require *Giardia* and *Cryptosporidium* monitoring.

### 3.2.2 Chemicals in Wastewater

#### Inorganics

Various inorganic constituents in wastewater include metals, salts, oxyhalides, nutrients, and nanomaterials whose concentrations vary greatly depending on the source of water and the type and degree of treatment received. The USEPA or the states set discharge standards for these chemicals in wastewater to avoid health risks. The Clean Water Act (CWA) requires that the concentration of toxic metals discharged in wastewater streams comply with the NPDES permit. EPA and WHO guidelines provide discharge standards for metalloids such as Boron, Aluminum, and Silicon. Due to higher costs for removal of salinity and management of brine, unless required in situations such as corrosion control or for potable water use, it is not a common practice. Oxyhalides such as bromate, chlorate, and perchlorate are priority pollutants whose bioaccumulative nature leads to high concentrations of the chemicals in certain plants. Sometimes due to the need for expensive treatment technologies such as ozonation, industries are advised to reduce oxyhalide formation during treatment.

Nutrients such as nitrogen and phosphorous are common in wastewater streams. The presence of excess nutrients in water bodies leads to eutrophication, a phenomenon associated with excessive growth of algae in contaminated water. Extensive research has been done in this area and various types of treatment options such as biological nitrogen or phosphate removal, struvite, calcium, or magnesium phosphate precipitation [17]. However, due to ease of operation and maintenance,

industries and wastewater treatment plants are inclined toward biological nitrogen and phosphate removal.

The use of engineered nanotechnology is a rapidly growing area of research which has been extensively studied for wastewater treatment, resource recovery, and water quality monitoring. Various forms of usage include nanosorbents, nanocatalysts, bioactive particles, nanostructured membranes, and filtration; however, none of these applications are commercially ready at this time. Regarding the fate and transport of engineered nanoparticles, inconsistency in the results from experiments has raised questions concerning the risks to human health and environmental health. This applies to the distinct nanoparticles, along with agglomerated nanoparticles which are predominant in natural environments. Being reactive in nature, nanoparticles often form larger entities with other engineered nanoparticles, natural nanoparticles, and natural materials. Although not a concern at present, consequences from release and exposure of nanoparticles to the environment are an area of emerging concern.

## Organics

Organic components of wastewater include household wastes, liquid wastes, humic substances, fecal matter, industrial wastes, fats, oils, and greases. Organics mainly cause odor problems due to their degradation and contribute to the colored appearance of wastewater. They also act as carbon source for microbial growth and sometimes lead to clogging issues as they promote filamentous growth in wastewater. Secondary biological treatment options are usually targeted to degrade the organic content of wastewater. Activated sludge, anaerobic treatment, and oxidation ponds are primarily employed to reduce the biological oxygen demand and the chemical oxygen demand of wastewater.

## Contaminants of Emerging Concern

There are a multitude of chemicals that do not fit under typical categories of wastewater characteristics, but have negative consequences on human health and the environmental. Trace chemicals are considered pollutants when detected in wastewater above their background concentrations. Various categories of trace chemicals include:

1. Industrial chemicals
2. Pesticides, biocides
3. Natural chemicals
4. Pharmaceuticals
5. Personal care products
6. Household chemicals and
7. Transformation products

In 2009, USEPA's Office of Water published results from a nine POTW study that focused on a number of above-mentioned Contaminants of Emerging Concern (CECs) in wastewater. Due to the diverse nature of these compounds, no single treatment technology can be used to reduce their levels to meet the discharge standards. Therefore various pilot- and large-scale demonstrations have employed a sequence of biological treatment coupled with advanced tertiary treatment such as activated carbon adsorption or chemical oxidation to remove such trace chemicals from wastewater. Although the USEPA compiled a Candidate Contaminant List (CCL3) and a proposed an Unregulated Contaminants Monitoring Rule 3 (UCMR3) list for contaminants in drinking water [20], currently there are no stringent rules for CECs for potable water reuse, and so, individual states are permitted to set their own regulations.

## 4 Municipal Wastewater Treatment Technologies

Following preliminary screening to remove rags, floatables, and grits using equipment such as rotary screens, wastewater is subjected to following treatments:

1. Solid–liquid separation or primary treatment
2. Secondary biological treatment
3. Tertiary or advanced treatment

Table 3 shows a list of various wastewater treatment technologies. Suspended particles greater than 3  $\mu\text{m}$  can be removed via coarse filtration, a solid/liquid removal process. Other solid removal processes used commonly in wastewater treatment are coagulation, flocculation, and sedimentation. Addition of chemical agents to cause precipitation or flocculation followed by gravity settling are commonly employed techniques for removal of colloidal matter and suspended solids.

Secondary wastewater treatment comprises of biological treatment that targets removal of organic matter and sometimes nutrients as well. In aerobic treatment, microorganisms oxidize organic matter into  $\text{CO}_2$  and  $\text{H}_2\text{O}$  in an aeration basin. Although aerobic treatment is more stable and common in industrial wastewater treatment, anaerobic digestion has several advantages such as production of a valuable biofuel-biogas, lower quantity of sludge production, and lower costs due to lack of aeration [22, 23]. However, anaerobic systems are more prone to instability than aerobic systems and typically require a post-aeration step to meet discharge standards. While aerobic and anaerobic systems are artificially designed and operated in a controlled environment, other natural systems such as oxidation ponds are also employed in certain areas where space and sunlight are not limiting factors.

The selection of the secondary wastewater treatment is heavily dictated by the economics of the process. Table 4 shows the cost prices for different conventional treatment technologies used in the past for various plant capacities [24].

**Table 3** Municipal and industrial wastewater treatment technologies [21]

Process	Description
Primary-solids separation	
Coagulation	Addition of coagulants such as alum to remove colloidal and suspended particles
Flocculation	Passive or active agglomeration of colloidal matter induced by addition of a clarifying agent
Filtration	Passage of water through a granular medium such as sand to remove suspended matter
Sedimentation	Gravity settling of flocs, precipitates, or particulate matter
Secondary biological treatment	
Aerobic-activated sludge	Breakdown of organic matter in wastewater by subjecting to aeration. Converts organics to CO <sub>2</sub> and H <sub>2</sub> O
Anaerobic treatment	Multistep digestion of organics in an oxygen-deprived environment, leading to production of methane and CO <sub>2</sub>
Natural treatment systems	Spacious, shallow oxidation ponds with abundance sunlight penetration are natural wastewater treatment systems. Algal growth consumes nutrients present in wastewater
Membrane bioreactors	Used as a replacement to conventional biological treatment. Allows uniform biofilm growth on a solid surface with high surface area. High reaction rates, stability, and compact size are key advantages
Tertiary treatment	
Activated carbon	Physical adsorption of contaminants on surface of granular activated carbon. GAC will also exhibit biological activity
Air stripping	Passage of forced air through wastewater for removal of ammonia and VOCs
Ion exchange	Ion exchange resins are used in flow through reactors to treat wastewater
Advanced treatment/disinfection	
Chlorine disinfection	Inactivation or elimination of pathogens from treated wastewater by addition of chlorine
UV	Exposure of biologically treated effluent to UV helps destroy microbial cells and disinfect the treated water
AOP—Ozone, H <sub>2</sub> O <sub>2</sub> , TiO <sub>2</sub> /UV	Advanced oxidation process involves use of a chemical agent and an auxiliary energy source to degrade recalcitrant residual organics and disinfect secondary effluent

**Table 4** Cost analysis for secondary wastewater treatment [24]

Biological Treatment Process	Costs (cents/m <sup>3</sup> )			
	4 mcm	14 mcm	40 mcm	90 mcm
Trickling filter	16.6	10.1	7.4	6.3
Activated sludge (AS)	20.3	12.1	8.6	7.2
AS + nitrification	23	13.7	9.7	8.2
AS + nitrification – denitrification	31.6	19.3	14.2	12.3

Membrane bioreactors (MBRs) are an exception to other add-on technologies that supplement the secondary biological treatment [15]. MBRs are considered emerging treatment technologies because they are typically designed to replace

secondary biological treatment. MBRs produce high-quality effluent and display higher performance efficiency as a result of higher reaction rates [25, 26]. In the late 1990s, MBRs were commissioned for small decentralized treatment in Europe. Recently, however, their use in wastewater treatment has been progressively increasing due to their compact size and higher stability.

Tertiary treatment involves technologies such as membrane processes ranging from commonly used sand filtration to more expensive treatment using microfiltration, ultrafiltration, nanofiltration, and reverse osmosis. Depending on the size of the contaminant to be removed (from suspended solids to simple molecules), different membrane schemes may be employed. Membrane filtration is most commonly used as a pre- or a posttreatment step for removal of coarse particles (i.e., microfiltration and ultrafiltration) [27]. Some water reuse schemes also employ a dual membrane treatment concept such as microfiltration followed by reverse osmosis in order to attain high purity water for potable reuse. Microfiltration is often used to prevent the fouling the expensive high-pressure reverse osmosis membranes. Other commonly used tertiary treatments include GAC adsorption, ion exchange, and air stripping [28].

## 5 Case Studies

As a result of global water scarcity, many developing and developed nations have embraced various water reuse practices. In this section, a number of case studies are discussed to give a real-world perspective to the current status of water reuse applications.

### 5.1 USA

#### 5.1.1 Phoenix, Arizona

The cities of Glendale, Mesa, Phoenix, Scottsdale, and Tempe form the Sub-Regional Operating Group (SROG) in Arizona. Municipal wastewater from the SROG cities is treated via nitrification–denitrification scheme at the 91<sup>st</sup> Avenue wastewater treatment plant (WWTP). Out of the 158,000 ac-ft/year of wastewater processed annually, 60 % is reused for various purposes such as cooling water makeup in nuclear and power stations, irrigation water, and constructed wetlands.

The 91<sup>st</sup> Avenue WWTP was originally built in 1958 as a 7.7 cfs plant near the Salt River in Phoenix. It has progressively expanded over the years to a 356 cfs plant that was built using a unified plant concept [9]. Such a plan allows uncoupling of a single unit process that needs repair or maintenance from rest of the unit processes, thus leaving the total treatment train unaffected at all times. The plant

has been constructed with provision for additional advanced tertiary treatment on the effluent (i.e., reverse osmosis membrane treatment) that will allow reuse of the treated wastewater.

### 5.1.2 Frito-Lay, Arizona

Since the 1970s, Frito-Lay, a key brand within PepsiCo, has taken environmentally cautious decisions in order to reduce their footprint. A near net-zero plant in the southeast region of the United States operates entirely on renewable energy and reclaimed water. It utilizes solar energy cells, generates steam from a renewable biomass boiler, and discharges zero landfill waste [9]. Their Process Water Recovery Treatment Plant (PWRTP) recycles up to 75 % of Frito-Lay's facility process water, reducing their freshwater demand by about 0.4 million cubic meters annually.

The treatment train used at Frito-Lay's plant is shown in Fig. 7. In order for the reuse water to meet EPA's drinking water standards, the oily wastewater is subjected to primary screening, pH adjustment, clarification, activated sludge with biological nitrogen removal (BNR), membrane bioreactor process (MBR), granular activated carbon adsorption (GAC), UV disinfection, low-pressure reverse osmosis, and chlorine disinfection. Resource recovery occurs at various stages in this plant:

1. The solids collected from screening are dewatered and centrifuged and eventually sold as animal feed.
2. Starch is recovered at different stages and reused in the process to reduce associated costs.
3. The treated water is reused for moving and washing potatoes and corn, for cleaning equipment, and for other production needs.

### 5.1.3 City of San Diego, California

California and Florida are pioneers in employing water reuse schemes in the United States. Figure 8 shows the water reuse patterns in the two states. While a significant portion of treated water is reused for agricultural purposes in California, the major consumer of reclaimed water is the landscaping sector in Florida. The water quality standards differ greatly based on the intended use which dictates the degree of treatment.

San Diego, the 8<sup>th</sup> largest city in the United States, receives only 25 cm of annual rainfall and therefore depends on the water imported from the Colorado River and California Water projects to meet its demands. The increasing costs of imported water have created the need for locally controlled water resources. While the city has reduced its imported water dependency by recycling water for irrigation and industrial purposes, the seasonal variation and need for special infrastructure have limited its use of recycled water. Since 2004, the city has embarked a water reuse

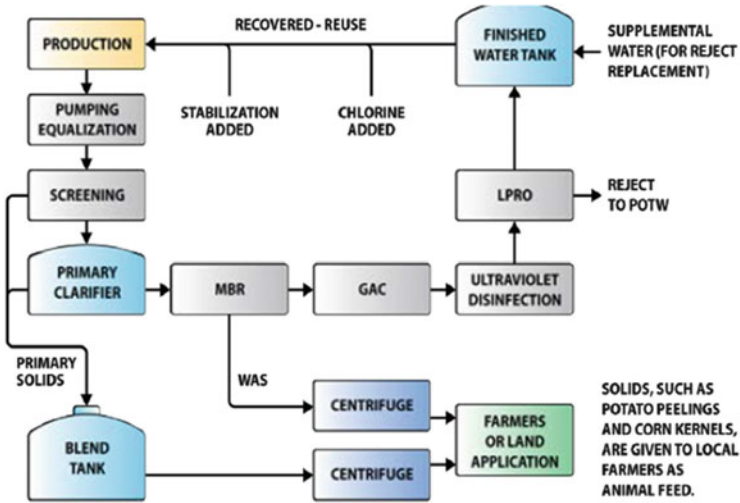


Fig. 7 Process flow diagram for Frito-Lay’s Process Water Recovery Treatment Plant (PWRTP) [9]

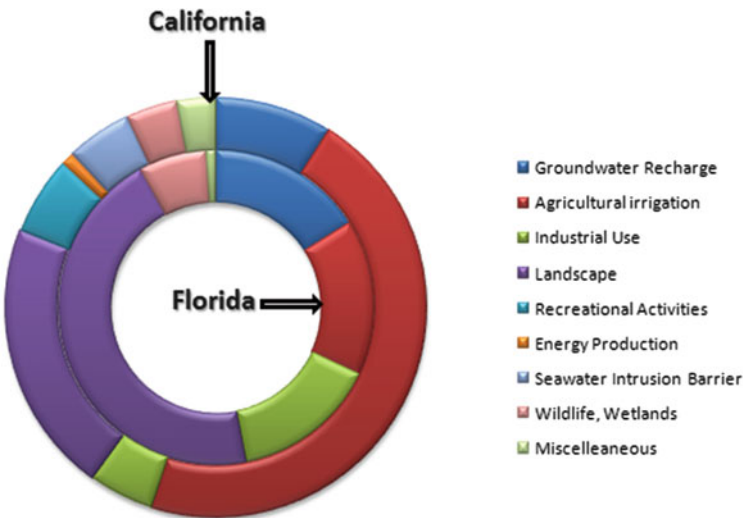
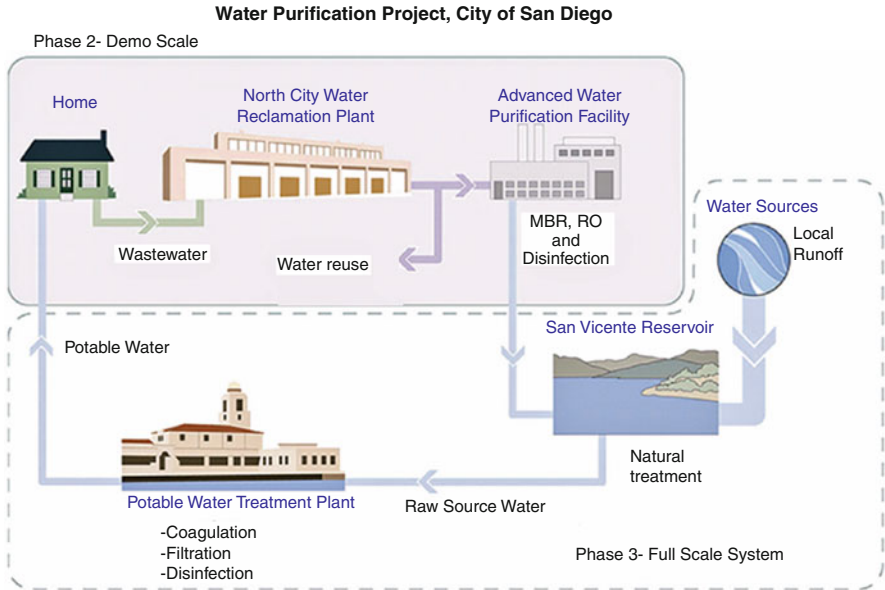


Fig. 8 Water reuse pattern in California and Florida [9]

program that was divided into three phases. During the initiation phase, a great deal of emphasis was laid on augmenting the reservoir storage capacity. The second phase will entail a demonstration of water purification at a 1.6 cfs facility. Finally, in the third phase, a fully functional large-scale plant will be constructed and operated. Figure 9 shows the plan for second and third phase of this plant [9].





**Fig. 9** Phase 2 and Phase 3 of the demonstration plant in San Diego, California [9]

The treatment sequence used in this facility included microfiltration and ultra-filtration membrane, reverse osmosis, and advanced oxidation process using UV and H<sub>2</sub>O<sub>2</sub>. The demo plant will be operated for a year and during this time, the water quality parameters such as nutrient levels, disinfection byproducts, trace chemicals, and other contaminants regulated by the State of California will be monitored to determine the efficiency of treatment. This demonstration project is the stepping stone to spreading awareness among public and a mode to continue regulatory involvement and public outreach that will eventually pave way to installation of the large-scale plant that can supply up to 23.2 cfs of purified water for indirect or direct potable reuse.

### 5.1.4 Leo J. Vander Lans Water Treatment Facility, California

In Southern California, the Water Replenishment District replenishes groundwater basins in the central and west coast using spreading basins and sea intrusion barriers. A 0.3 m<sup>3</sup>/s Leo J. Vans water treatment facility receives treated tertiary effluent from Los Angeles County Sanitation District and Long Beach water reclamation plant. The treatment sequence used at this facility is shown in Fig. 10. A microfiltration equipped with a backwash is followed by reverse osmosis and UV disinfection. The expanded plant is expected to have a 92 % water recovery rate and the treated water will be used for indirect potable purposes (Table 5).

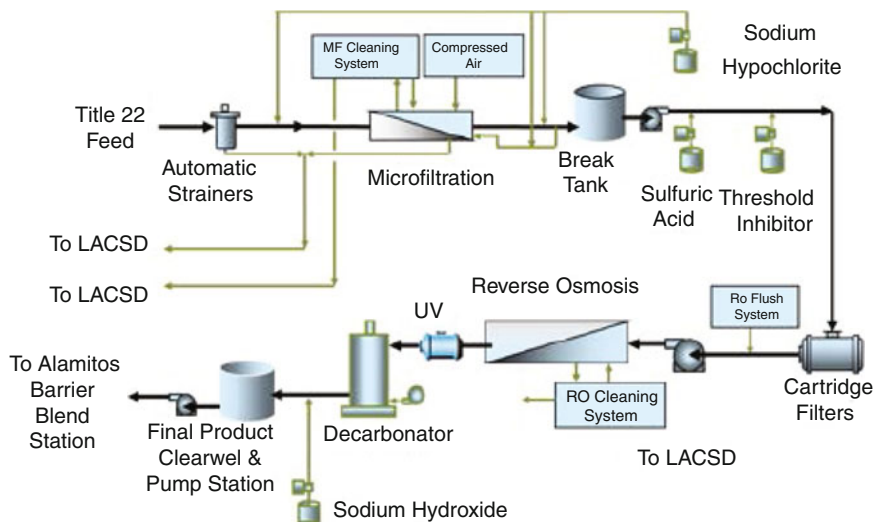


Fig. 10 Process flow diagram of LVLWTF [9]

Table 5 Water quality parameters in the Leo J. Vander Lans Water treatment Facility (LVLWTF), California [9]

Parameter	Units	Influent		Product
		LBWRP	LCWRP	LVLWTF
pH	pH units	7.9	7.9	8.12
Turbidity	NTU	0.48	0.5	0.07
Ammonia-N	mg/L	1.5	2.0	0.22
Nitrate-N	mg/L	6	5.3	1.74
Total N	mg/L	9	9.3	2.05
Total dissolved solids	mg/L	703	787	83
Total organic carbon	mg/L	6.7	7.5	0.44

### 5.1.5 Miami South District Plant, Florida

With three major water treatment plants serving the county’s 90 % of water supply, Miami Dade water and sewer department is the largest utility in Florida. Due to various factors such as rapidly growing population and environmental stress due to drought conditions, much pressure has been laid on the utility to restore the Everglades, while not overexploiting the groundwater reserve. Therefore, to address this, the tertiary effluent from the South District wastewater plant will be treated in the South District Water Reclamation plant in order to provide water for potable reuse. Treated water will be used to recharge the Biscayne aquifer that provides the main drinking water supply in the county. Similar to other water reuse projects, this reclamation plant includes the following unit processes to treat the wastewater: microfiltration, reverse osmosis, and UV-H<sub>2</sub>O<sub>2</sub>. The ammonia levels

will be maintained by ion exchange treatment post RO and the brine from the process will be discharged into a deep well [9]. This treatment scheme ensures availability of locally controlled, sustainable source of water treated using previously available infrastructure.

### 5.1.6 Reedy Creek, Florida

Walt Disney resort's municipal services are provided by the Reedy Creek District in Florida. Over the course of 20 years, the Reedy Creek Improvement District (RCID) has practiced water reuse beginning with water reuse for irrigation purposes to 100 % reuse for various other purposes such as wash down of sidewalks, cooling water makeup, vehicle wash, etc. About 7.7–9.3 cfs of treated water is currently reused for non-potable purposes. The treatment scheme used at RCID includes a five-stage Bardenpho process for C and N removal, followed by filtration and hypochlorite disinfection [9]. This facility meets the zero-discharge standards set under an FDEP permit and has met all USEPA standards for primary and secondary drinking water.

## 5.2 China

Scarcity of water in the world's most populated countries arises as a result of steeply growing population and urbanization. The uneven distribution of water resources in the country with abundant water supply is an issue of great concern. Added to the serious water shortage in many large cities, polluted surface water renders many sources unfit for potable purposes.

Currently, although water reuse is limited to industrial applications in China, a couple of reclamation facilities have demonstrated the immense potential for China's future water supply via advanced wastewater treatment. Table 6 shows the water quality standards for reuse of water in different sectors such as urban, surface water recharge, or for aesthetic purposes.

The Beijing Olympic Park water reuse scheme is an exemplary demonstration of the potential behind installation of advanced wastewater treatment (Fig. 11) [9]. During the 2008 Olympics, a 0.92 m<sup>3</sup>/s Qinghe water reclamation plant was built with the Zeeweed ultrafiltration MBR process followed by activated carbon filter for wastewater treatment. About 75 % of the reclaimed water was used for vehicle wash, road wash, toilet flushing, and other non-potable purposes in Haidian and Chaoyang districts.

**Table 6** Water quality standards in Beijing, China [29]

Parameters	Units	Scenic impoundments			Urban reuse			Surface water
		Restricted	Unrestricted		Toilet flushing	Irrigation	Washing	
BOD	mg/L	6	6	10	10	20	10	4
Total dissolved solids	mg/L	-	-	1,500	1,500	1,000	1,000	-
Turbidity	NTU	-	5	5	5	20	5	-
Total phosphate	mg/L	0.5	0.5	-	-	-	-	0.05
Total nitrogen	mg/L	15	15	-	-	-	-	1
Fecal coliform	cfu/100 mL	10,000	500	3	3	3	3	1,000



**Fig. 11** Wastewater treatment in Beijing Olympic Park (GE Water Treatment Technologies) [9, 29]

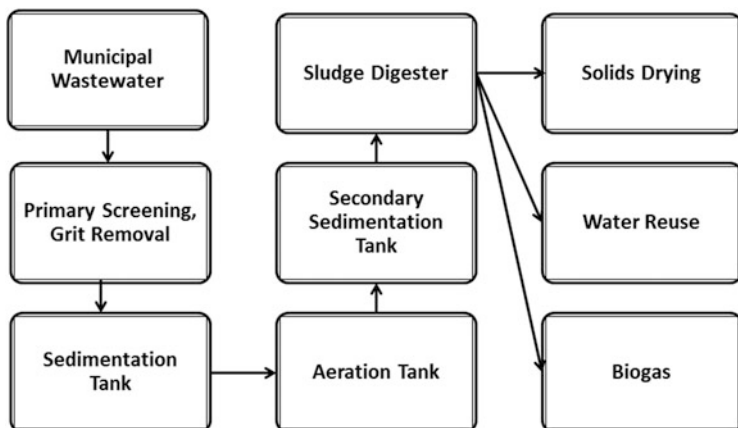
### 5.3 *India*

With poor sanitary conditions and limited access to safe potable water, India is exploring alternate options to provide safe and sustained supply of drinking water to its rapidly growing population. At the capital city of India, Delhi, the estimated water demand to serve the current population of 15 million is about  $48 \text{ m}^3/\text{s}$ .

The Okhla sewage treatment plant in Delhi has a capacity of  $7.2 \text{ m}^3/\text{s}$  and was developed in 5 phases with activated sludge process used to treat the wastewater (Fig. 12). The reclaimed water is currently being used to supply cooling tower makeup water to Badarpur Thermal Power station, for horticulture at the Central Public Works department, for irrigation to the Minor Irrigation department, and as discharge into the Agra canal.

### 5.4 *Australia*

Located in western Sydney and developed by the Sydney Water as a part of the New South Wales Metropolitan water plan, St Mary's advanced water recycling plant was started to provide alternate source for high-quality drinking water provided by the Warragamba Dam and to reduce the nutrient load in downstream river. The tertiary effluent received in this plant is further treated by ultrafiltration, reverse osmosis, decarbonation, and chlorine disinfection. A chemical monitoring program was started to test the treated water for toxicological chemicals such as disinfection by-products or endocrine disruptors. Since the reverse osmosis process was key barrier to trace chemicals, the chemical monitoring program was focused on this



**Fig. 12** Wastewater treatment scheme in the Okhla plant in New Delhi, India [9]

technology. Following the successful demonstration, a full-scale plant was constructed in June 2010 adjacent to the existing one.

## 5.5 Europe

The stringent regulations for effluent discharge laid by regulatory authorities combined with water shortage have led European countries to investigate alternate resources [30]. Water reuse is becoming increasingly popular in Northern European countries, especially in the coastal areas and in the Western and Southern islands of Europe. France, Spain, and Italy are some of the pioneers in integrated water resource management. Table 7 shows various EU-funded projects demonstrated in various continents around the world.

The serious water shortage in Belgium has been a key driver leading to 100 % reuse of renewable water resources in the country [10]. In the Wulpen WWTP, about 2.5 million m<sup>3</sup>/year of wastewater is treated via microfiltration and reverse osmosis and stored in an aquifer and used to augment the drinking water supply.

The early zero discharge systems in Europe were constructed in the coastal areas and on smaller islands such as Mt Saint Michael in France. On Noirmoutier Island in France, reclaimed wastewater is used to supply 100 % of agricultural irrigation demand. Water reuse helps increase available resources that are currently imported and also help prevent contamination of sensitive coastal areas. Techno-economic assessments of various water management scenarios showed the use of reclaimed water for irrigation and landscaping as the most economical way to overcome water shortage in the island [10].

With a water exploitation index exceeding 45 %, Cyprus is one of the most water stressed regions in Europe. With the rapidly expanding domestic and tourist sectors,

**Table 7** EU funded projects for water reuse [31]

EU funded projects	Description
CORETECH	Integrated sanitary, environmental and agricultural engineering for cost-effective treatment of wastewater, and reuse of treated water for agricultural purposes
NAORA	Simultaneous treatment of wastewater to reduce pollution and manage water scarcity by providing additional means of water for agricultural irrigation in the province of Settat
SWITCH	Challenge existing paradigms and create sustainable integrated urban water management
AQUAREC	Introduction of wastewater reuse as a major component to sustainable water management practices. Technologies to monitor and mitigate risks posed by chemicals and pathogens in wastewater were also investigated
EUROMBRA	Optimization of advanced wastewater treatment in European countries using MBR technology
PROMEMBRANE	Improvement of membrane technologies to protect water in the Mediterranean region

ensuring availability of sustained water supply to agricultural sector has been a challenge in the country [9]. Well known for their impressive water infrastructure projects, Cyprus's policy of "Not a drop of water to the sea" was initiated with an objective to increase utilization of runoff water. About 90 % of treated water is reused primarily for non-potable purposes such as irrigation of agricultural land, parks, and gardens, leaving a minor fraction for groundwater recharge.

## 6 Conclusions

Advanced treatment processes are pivotal in treating municipal wastewater to meet water quality standards to protect human health and the environment. Various socioeconomic drivers such as the monetary value of reclaimed water that is used to supplement water resources and availability of high purity water play a significant role in pushing for change and adoption of water reuse. In developed countries, incentives provided by Government agencies seem to attract application of expensive advanced wastewater treatment technologies for reuse purposes. In developing countries, the possibility to reuse nutrients from wastewater to improve the quality of soil in fertile lands is a driving force for reuse.

In this chapter we have briefly discussed water availability on a global and regional scale and the excessive pressure laid on fixed quantities of water available for human use by the ever growing population and other anthropogenic activities. Treating municipal wastewater for water reuse not only helps in handling large quantities of wastewater, but also provides a renewable resource for water supply. Various primary, secondary, and advanced treatment technologies used to treat wastewater have been discussed. Finally, case studies representing current status of water reuse applications from different parts of the world have been covered to give

a real-world perspective of the various components of water reuse schemes described in this chapter.

The implementation of treating wastewater for reuse applications mainly depends on public acceptance. Success has occurred when Government agencies help spread awareness among public. Singapore's NEWater projects are successful examples of a nation can implement water reuse. Space constraints and lack of infrastructure to collect and store rainwater were drivers behind installation of advanced treatment technologies such as membrane processes and UV disinfection that treat reclaimed water to safe potable water standards. Currently about 30 % of Singapore's water needs are met by reusing reclaimed water.

Although the deciding factor varies due to geographical and socioeconomic differences, there is no denying that municipal wastewater is indeed a sustainable, alternative resource for water reuse. With continued regulatory guidance, public outreach, and technological advancement, water reuse projects will become increasingly popular in the future.

**Disclaimer** The views expressed in this chapter are those of the authors and do not necessarily reflect the views or policies of the U.S. Environmental Protection Agency (EPA). The chapter has been reviewed in accordance with EPA policy and approved for publication. Mention of trade names or commercial products does not constitute endorsement or recommendation for use.

## References

1. Levine AD, Asano T (2004) Peer reviewed: recovering sustainable water from wastewater. *Environ Sci Technol* 38(11):201A–208A
2. Steneke N et al (2006) Risk and governance in water recycling public acceptance revisited. *Sci Technol Human Values* 31(2):107–134
3. Agyin-Birikorang S, O'Connor G, Pullammanappallil P, Mohan GR (2013) Recovery of essential plant nutrients from. *J Sustain Bioenergy Syst* 3:149
4. Otterpohl R, Grottker M, Lange J (1997) Sustainable water and waste management in urban areas. *Water Sci Technol* 35(9):121–133
5. Bakir H (2001) Sustainable wastewater management for small communities in the Middle East and North Africa. *J Environ Manage* 61(4):319–328
6. Asano T (2002) Water from wastewater- the dependable water resource. *Water Sci Technol* 45(8):24
7. Cisneros BEJ, Jiménez B, Asano T (2008) Water reuse: an international survey of current practice, issues and needs. IWA publishing, London
8. Postel SL (2000) Entering an era of water scarcity: the challenges ahead. *Ecol Appl* 10(4):941–948
9. USEPA (2012) Guidelines for water reuse
10. Lazarova V et al (2001) Role of water reuse for enhancing integrated water management in Europe and Mediterranean countries. *Water Sci Technol* 43(10):25–33
11. Bixio D et al (2006) Wastewater reuse in Europe. *Desalination* 187(1):89–101
12. Shi D, Devineni N, Lall U, Piñero E (2013) America's Water Risk: Water Stress and Climate Variability
13. Maplecroft. Available from: [http://maplecroft.com/about/news/water\\_stress\\_index.html](http://maplecroft.com/about/news/water_stress_index.html).



14. Wade Miller G (2006) Integrated concepts in water reuse: managing global water needs. *Desalination* 187(1):65–75
15. Mujeriego R, Asano T (1999) The role of advanced treatment in wastewater reclamation and reuse. *Water Sci Technol* 40(4):1–9
16. Anderson J (2003) The environmental benefits of water recycling and reuse. *Water Supply* 3(4):1–10
17. Mohan GR, Gadekar S, Pullammanappallil P (2011) Development of a Process Model for Recovery of Nutrients from Wastewater by Precipitation as Struvite. *Florida Water Resour J*
18. Moe C, et al (2007) Waterborne transmission of infectious agents. In: Hurst CJ et al (eds) *Manual of environmental microbiology*, 3 edn, pp 222–248
19. Ashbolt NJ (2004) Risk analysis of drinking water microbial contamination versus disinfection by-products (DBPs). *Toxicology* 198(1):255–262
20. Rammohan G, Nadagouda MN (2013) Green photocatalysis for degradation of organic contaminants: a review. *Curr Org Chem* 17(20):2338–2348
21. Tchobanoglous G, Burton FL (2003) Wastewater engineering. *Management* 7:1–4
22. Mohan GR et al (2013) Comparison of two stage mesophilic and thermophilic anaerobic digestion of OFMSW. In: George W (ed) *Materials challenges in alternative and renewable energy II: ceramic transactions*. Wiley-American Ceramic Society, Hoboken, NJ, pp 47–58
23. Tian Z, Mohan GR, Ingram L, Pullammanappallil P (2013) Anaerobic digestion for treatment of stillage from cellulosic bioethanol production. *Bioresour Technol* 144:387–395
24. Haruvy N (1997) Agricultural reuse of wastewater: nation-wide cost-benefit analysis. *Agr Ecosyst Environ* 66(2):113–119
25. Judd S (2010) *The MBR book: principles and applications of membrane bioreactors for water and wastewater treatment*. Elsevier, London
26. Sutton PM (2003) Membrane bioreactors for industrial wastewater treatment: the state-of-the-art based on full scale commercial applications. In: *Proceedings of the Water Environment Federation*, pp 23–32
27. Speth TF, Summers RS, Gusses AM (1998) Nanofiltration foulants from a treated surface water. *Environ Sci Technol* 32(22):3612–3617
28. Speth TF, Miltner RJ (1998) Technical note: adsorption capacity of GAC for synthetic organics. *J Am Water Works Assoc* 90(4):171–174
29. Ernst M et al (2007) An integrated wastewater treatment and reuse concept for the Olympic Park 2008, Beijing. *Desalination* 202(1):293–301
30. Angelakis A, Bontoux L, Lazarova V (2003) Challenges and prospectives for water recycling and reuse in EU countries. *Water Supply* 3(4):59–68
31. Lopez A (2013) The MEDIWAT Project. In: *Final Conference and Stakeholders Event*

# Advances in Desalination Technologies: Solar Desalination

Magdy M. Abou Rayan and Berge Djebedjian

**Abstract** Availability of freshwater is the prime mover of the human life activities. The advances in desalination technologies clearly show that desalinated water can be used as a substitute for freshwater to be used as potable water. A breakthrough in reverse osmosis costs has been reached, particularly in decreasing energy consumption. The introduction of nanotechnology in the membrane manufacture has resulted in reducing the volume of rejected brine which in turn alleviates the brine disposal issue. Several recent studies show that desalinated water for development of isolated areas is economically competitive to transportation of freshwater by pipeline. The introduction of solar energy to power desalination process has given a new dimension to the expansion of desalination technology. Several studies show the importance of solar desalination in countries suffering from freshwater shortage, particularly in isolated areas. This chapter presents an overview of desalination technologies with emphasis on solar energy-driven units. Some case studies are highlighted. The chapter concludes with a discussion of future avenues in solar desalination.

**Keywords** Solar desalination • Potable water • Water supply for remote areas • Economics of desalination

## Acronyms and Abbreviations

AD            Aggregate Demand  
ADIRA       Autonomous *Desalination* System Concepts for Seawater and Brackish Water in Rural Areas with Renewable Energies—Potentials, Technologies, Field Experience, Socio-Technical and Socio-Economic Impacts

---

M.M. Abou Rayan (✉) • B. Djebedjian  
Water Research and Industrial Projects Center, Mansoura University, El-Mansoura, Egypt  
e-mail: [magdy.abourayan@gmail.com](mailto:magdy.abourayan@gmail.com)

ADS	Autonomous Desalination Systems
ANOVA	Analysis of Variance
BWRO	Brackish Water Reverse Osmosis
CCGT	Combined Cycle Gas Turbine
CHF	Swiss Franc
CLP	Chilean Peso
ED	Electrodialysis
EDR	Electrodialysis Reversal
FAO	Food and Agriculture Organization
FIC	Innovation Fund for Competitiveness
GWI	Global Water Intelligence
HCPVT	High Concentration Photovoltaic Thermal System
HDH	Humidification Dehumidification
IDA	International Desalination Association
ITC	Instituto Tecnológico de Canarias
KACST	<a href="#">King Abdul Aziz City for Science and Technology</a>
KSA	Kingdom of Saudi Arabia
kW/h	kilowatt per hour
kWp	kilowatt peak
LCZ	Lower Convective Zone
m <sup>3</sup>	Cubic meter
MD	Membrane Distillation
ME	Multiple-Effect Distillation
MEB	Multiple-Effect Boiling
MED	Multiple-Effect Distillation
MEH	Multiple-Effect Humidification
MENA	Middle East and North Africa
mg/l	Milligrams per liter
MGZ	Main Gradient Zone
MIT	Massachusetts Institute of Technology
MNT	Institute for Micro- and Nanotechnology
MSF	Multi-Stage Flash Distillation
MVC	Mechanical Vapor Compression
NA	Nanofiltration
NCZ	Nonconvective Zone
PTSS	Portable Thermoelectric Solar Still
PV	Photovoltaic
R&D	Research and Development
RO	Reverse Osmosis
RSM	Response Surface Methodology
SGSP	Salinity-Gradient Solar Pond
SMC	Southern Mediterranean Countries

SWCC	Saudi Arabia's Saline Water Conversion Corporation
SWRO	Seawater Reverse Osmosis
TDS	Total Dissolved Solids
UAE	United Arab of Emirates
UCZ	Upper Convective Zone
UHCPV	Ultrahigh Concentrator Photovoltaic
UNEP	United Nations Environment Program
UPC	Unit Product Cost
VC	Vapor Compression
WDS	Water Distribution System
WHO	World Health Organization

## 1 Introduction

In several regions around the world, the water shortage problems, together with the tremendous urban growth, and population reallocation plans have increased the demand for freshwater. A review of advances in seawater desalination technologies shows the steady and increasing usage of seawater desalination around the world [1, 2].

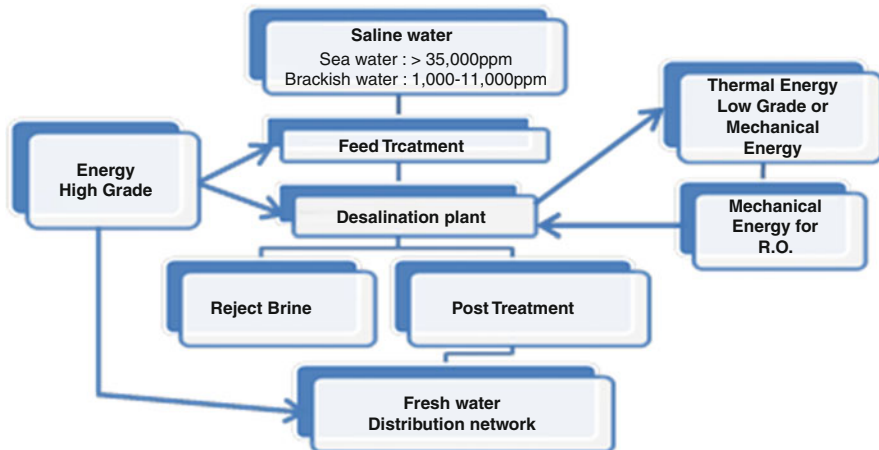
Desalination is a treatment process that removes salts from water. Saline solutions other than seawater with a salt concentration from 1,000 mg/l to 11,000 mg/l total dissolved solids (TDS) are typically described as brackish water. The TDS concentration of normal seawater is 35,000 mg/l–40,000 mg/l or higher, mostly sodium chloride.

Historically, seawater desalination has been considered as the most expensive way to produce drinking water at the commercial scale because of the high capital and energy costs [3–5]. However, desalination is increasingly recognized as a needed and viable option in order to respond to the freshwater shortage worldwide. The rapid increase of the world population [6] and also reduction in desalination installation cost have resulted in the increased implementation of desalination. It is projected that close to 70 % of the world population will face water shortage issues by 2025 [7–9] and approximately 50 % of the world's population lives within 200 km from seashore.

A typical desalination plant consists of a water pretreatment system, the desalination unit, and a posttreatment system. A desalination plant, as depicted in Fig. 1, may be considered as a “black box” through which streams of water and energy flow.

Table 1 shows the largest ten seawater reverse osmosis (SWRO) plants in the world. Mega plants over 100,000 m<sup>3</sup>/day capacity are becoming common around the world.

The cost and availability of energy required to drive desalination process present a challenge for the expansion of desalination technologies. Solar energy is a viable tool to power desalination process and an emerging and promising renewable



**Fig. 1** Water and energy flow diagram of a desalination unit (Source: Authors)

**Table 1** Largest 10 SWRO desalination plants in the world by capacity

Plant	Country	Capacity (m <sup>3</sup> /d)	Contractor	Status
Soreq	Israel	510,000	IDE	Planned
Mactaa	Algeria	500,000	Hyflux	Planned
Hadera	Israel	456,000	IDE	Online
Wonthaggi	Australia	444,000	Degrémont	Online
Ashdod	Israel	380,000	Valoriza	Planned
Ashkelon	Israel	326,144	IDE	Online
Tuaspring	Singapore	318,500	Hyflux	Planned
Ras Al-Khair	Saudi Arabia	309,128	Doosan	Planned
Adelaide	Australia	300,000	Acciona	Online
SSDP Perth	Australia	280,000	Valoriza/Técnicas Reunidas	Online

Source: Global Water Intelligence, [10]

energy technology for producing freshwater [6, 11–17]. Particularly, solar desalination is considered an ideal solution for providing cost-effective water supplies to rural and isolated areas. Furthermore, solar desalination would permit providing potable water by means of an environmentally friendly process.

The objective of this chapter is to present an overview of desalination technologies with focus on solar desalination technologies.

## 2 Desalination Technologies: Overview

Desalination technologies can be classified into major and minor desalination processes. The major desalination processes are split into two main categories: thermal (or distillation) and membrane processes (Fig. 2). The major processes

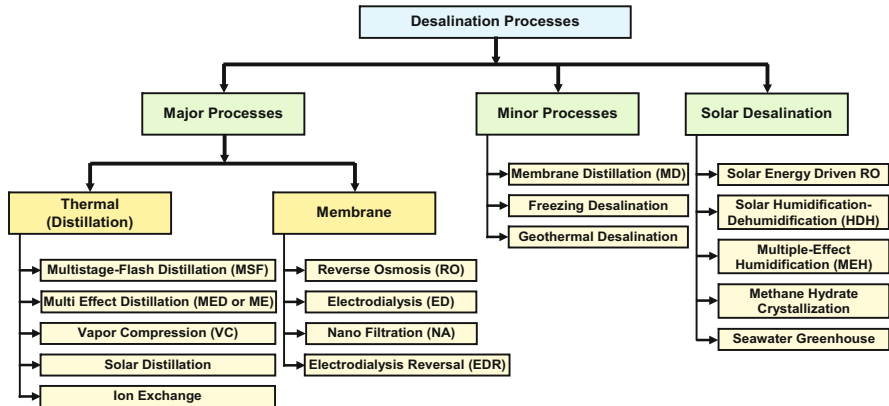


Fig. 2 Classification of the desalination processes (Source: Authors)

have the largest capacities. The minor processes including direct solar desalination are suitable for remote and isolated areas with expected low freshwater demand.

## 2.1 Thermal Processes

Thermal or distillation processes use heat energy. In this process, the seawater is heated to the boiling point to produce water vapor which is then condensed to form freshwater. Major thermal processes for desalination are described below.

### 2.1.1 Multiple-Stage Flash Distillation

Multiple-Stage Flash (MSF) distillation is the most widely used thermal desalination process. There are two configurations concerning MSF process: The “Once-Through” configuration and “Brine Recirculation.” “The Once-Through” configuration consists of two sections: (1) heat rejection section and (2) brine heater. The “Brine Recirculation” consists of three sections: (1) heat rejection section, (2) heat recovery section, and (3) brine heater (Fig. 3).

An MSF desalination plant can contain from 4 up to 40 stages. Increasing the number of stages reduces the required heat transfer surface, thus reducing the capital cost. To offset the cost of providing extra stages, complicated optimization calculations have to be undertaken where the main decision parameters are capital cost versus operating cost.

MSF distillation is being developed and adapted to large-scale applications, usually with capacities greater than 5,000 m<sup>3</sup>/day. At present, the largest MSF plant (Eljubil, Saudi Arabia) has a water production capacity of 60,000 m<sup>3</sup>/day [17]. The MSF process is also widely used in the Gulf countries with 75 % of the

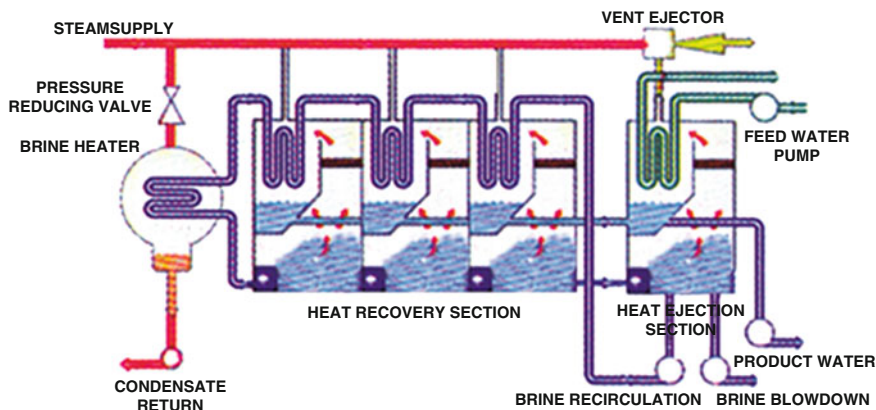


Fig. 3 Typical flow diagram of Multi-Stage Flash distillation plant [17]

global total installed capacity. In Europe, the MSF process is mainly used in Italy and in Spain.

### 2.1.2 Multiple-Effect Distillation

Multiple-Effect Distillation (MED or ME) was the first thermal process used for seawater desalination. It is widely used in the chemical industry where the process was originally developed. The MED process is similar to the MSF process. MED, like MSF, takes place in a series of vessels (called effect) and uses the principle of reducing the ambient pressure with various effects. This permits the feed water to undergo multiple boiling without supplying additional heat after the first effect. The principle of MED operation is shown in Fig. 4. MED plants tend to have a smaller number of effects than MSF stages. Usually 8–16 effects are used in typical large plants, due to the relation of the number of effects with the performance ratio (which cannot exceed the number of effects of the plant). As in an MSF plant, special attention is required concerning the operating temperature in order to avoid scaling and corrosion of materials. Also, extra care is required concerning the control of the brine level in each effect.

### 2.1.3 Vapor Compression

At present, two Vapor Compressor (VC) processes are widely in use: Mechanical Vapor Compression (MVC), in which a mechanical compressor is used; and Thermal Vapor Compression (TVC), in which a thermo compressor or ejector is used to increase the vapor pressure.

The fundamental concept of VC process is inherently simple, in that after vapor has been produced it is then compressed to increase its pressure and consequently

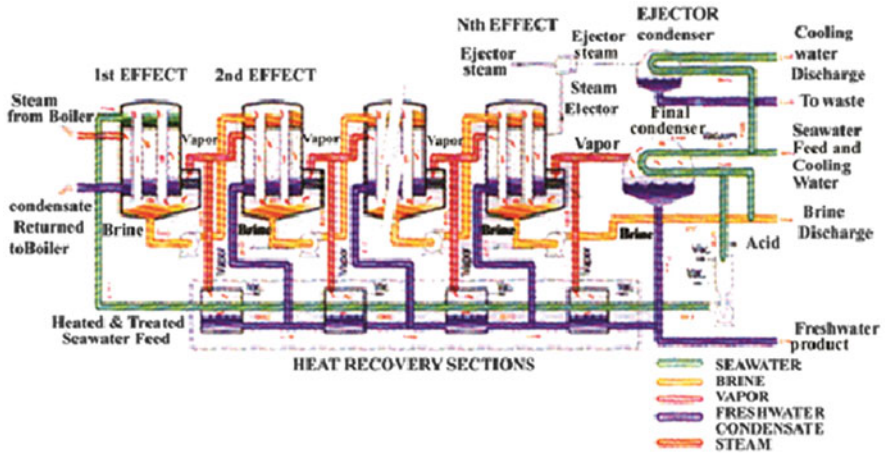


Fig. 4 Typical flow diagram of Multi-Effect distillation plant—Horizontal falling film plant [18]

its saturation temperature before it is returned to the evaporator as the heating vapor for the evaporation of more liquid. The main equipment used in the VC compression process includes the evaporator, the compressor, pumps, and the heat exchanger. In this process, the feed water is preheated using a heat exchanger or a series of heat exchangers by the hot discharge of the brine (Fig. 5).

The power consumption of the compressor, and therefore the efficiency of the process, depends on pressure difference. Thus, the compressor represents the main energy consumer in the system. Extra care is required with the control of the brine level in the evaporator and the proper maintenance of the compressor. Some manufacturers use compressors that rotate at very high speeds. Operation at low temperatures minimizes the formation of scaling and corrosion of materials.

## 2.2 Membrane Technologies

Membrane technologies, particularly reverse osmosis, are the most common desalination technologies used around the world. These technologies are described below.

### 2.2.1 Reverse Osmosis

Reverse Osmosis (RO) involves the forced passage of water through a membrane against the natural osmotic pressure to accomplish the separation of water and ions. Figure 6 shows the principle of RO process. A typical RO system consists of four



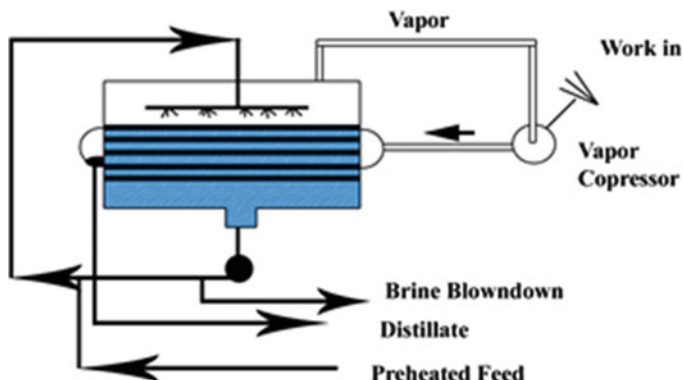


Fig. 5 Typical flow diagram of Vapor Compression plant (Source: Authors)

major subsystems (Fig. 7): (1) pretreatment system, (2) high-pressure pump, (3) membrane modules, and (4) posttreatment system.

Due to the RO unit operation at ambient temperature, corrosion and scaling problems are diminished in comparison with distillation processes. However, effective pretreatment of the feed water is required to minimize fouling, scaling, and membrane degradation. In general, the selection of the proper pretreatment, as well as the proper membrane maintenance, is critical to the efficiency and life of the RO system.

As a general rule, a seawater RO unit has a low capital cost but a significant maintenance cost due to the high cost of the membrane replacement. The cost of the energy use to drive the RO plant is also significant. The major energy requirement for RO desalination is for pressurizing the feed water. In recent years, energy requirements for seawater desalination (SWRO) have been reduced to  $4.0 \text{ kWh/m}^3$  by using energy recovery systems. For brackish water desalination, the energy requirement for RO is between 1 and  $3 \text{ kWh/m}^3$ .

### 2.2.2 Electrodialysis Process

Electrodialysis (ED) is an electrochemical process and a low-cost method for the desalination of brackish water. In ED process, ions are transported through a membrane by an electrical field applied across the membrane. An ED unit (Fig. 8) consists of the following five basic components: pretreatment system, membrane stacks, low-pressure circulation pump, power supply for direct current (rectifier), and posttreatment.

The ED process is not economically attractive for the desalination of seawater due to the dependency of the energy consumption on salt concentration in feed water.

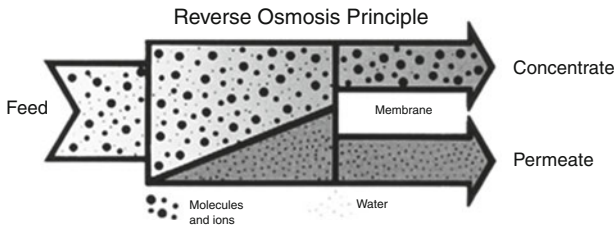
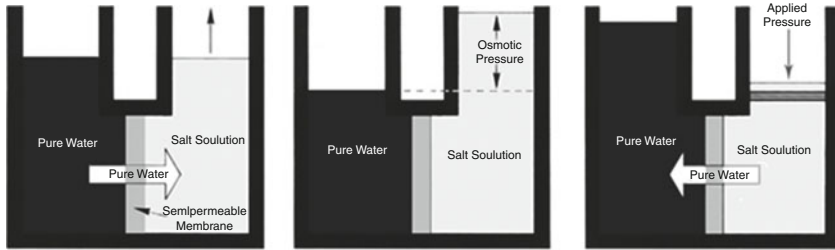


Fig. 6 Principles of RO process [18]

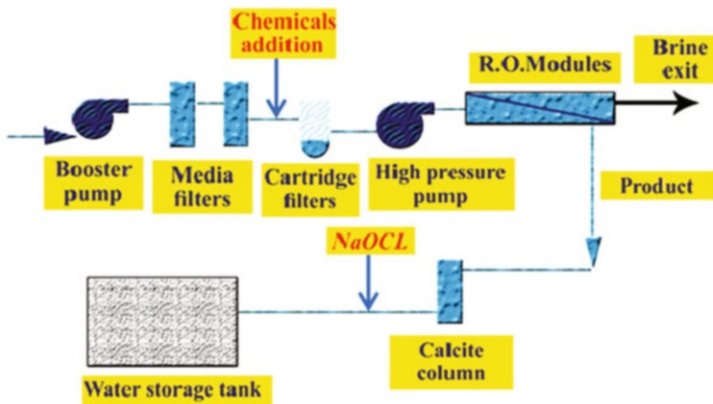


Fig. 7 Basic components of RO plant (Source: Authors)

### 2.3 Technology Selection

The choice of desalination technology is site specific and depends on the conditions of the feed water, energy availability and source, location, and cost. The cost of desalination is sensitive to plant capacity. Low capacity units have a higher installation cost per m<sup>3</sup> than the large units.

Table 2 shows a few selected desalination plants installed around the world. At present RO is the dominant desalination technology used worldwide.

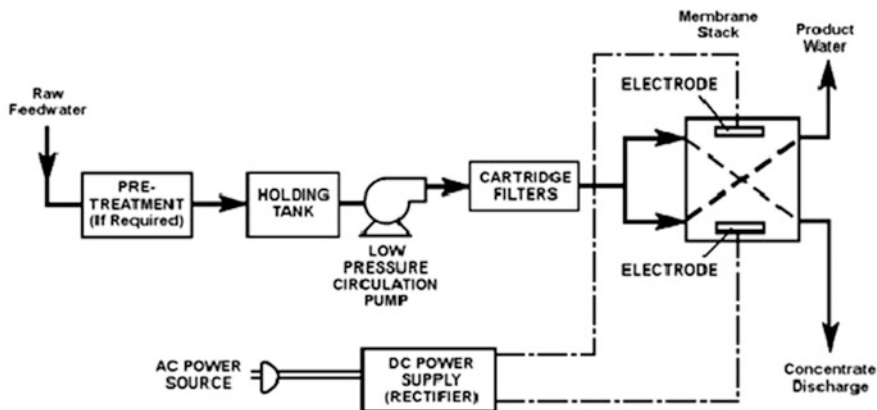


Fig. 8 Basic components of an ED plant (Source: Authors)

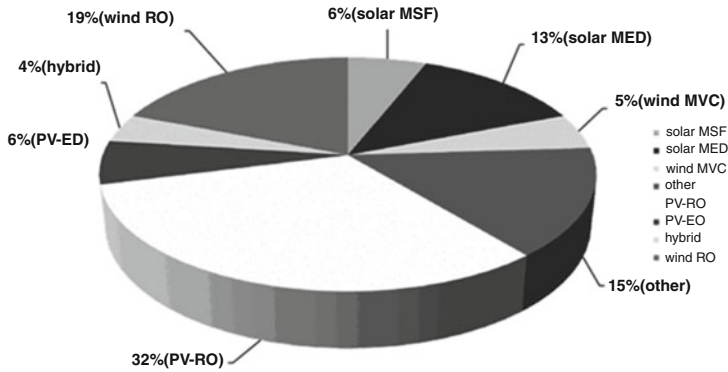
Table 2 Types of the major desalination technologies

Process	Feed water	Year of operation	Capacity (m <sup>3</sup> /day)	Location
MSF	Seawater	2013	91,000	Ras al-Zour, KSA
MED	Seawater	2008	160,000	Jamnagar, India
	Seawater	2015	178,000	Sadara, KSA
MVC	Seawater	1999	172,000	Sardinia, Italy
SWRO	Seawater	2011	460,000	Hedra, Israel
EDR	Brackish water	2009	220,000	Lioberg Rivez, Spain
MED+TVC	Seawater	2009	800,000	Jubail, KSA

The research directives now are aiming at increasing RO efficiency through improvement of membranes. The target is to reduce the rejected brine to go below 50 %. The energy recovery in RO system has achieved great progress. The classical thermal process is still more expensive. At present, the thermal process is based mainly on fossil energy use and waste heat. The development in nanotechnology research will have an impact on both thermal and membrane processes. But the research results are not yet available for commercial applications [19].

### 3 Using Renewable Energy for Desalination

Renewable energy sources include solar, wind, geothermal, waves, and biomass (Fig. 9). The trend of increasing use of renewable energy for desalination is encouraged by environmental protection agencies around the world [20]. Solar distillation is an ancient technology employed by humans for thousands of years. Early Greek mariners and Persian alchemists used this basic technology to produce



**Fig. 9** Renewable energy use according to desalination technology (Source: Global Water Intelligence, Publisher GWI [10])

both freshwater and medicinal distillates. Solar stills were in fact the first treatment method used on a large scale to convert contaminated water to a potable form [21].

Table 3 shows some common combinations of renewable energy that can be used for desalination. Some of these combinations are mature enough and commercially available.

## 4 Solar Desalination

At present, of the estimated 22 million m<sup>3</sup> of freshwater produced a day using desalination processes worldwide, less than 1 % is using solar energy [21]. Though solar desalination processes have not been fully commercialized at a large scale yet, the ongoing research shows that solar desalination is a valid option for future desalination plants [22]. At present, the energy storage system remains the real challenge for the use of solar energy.

There are two primary approaches for desalination using solar energy; through a phase change by thermal input or in a single phase through mechanical separation of salt and water [23]. Phase change (or multiphase) or thermal input can be accomplished by either direct or indirect distillation. Single phase or mechanical separation is predominantly accomplished by using photovoltaic cells to produce electricity that drive pumps, although there are experimental methods being researched using solar thermal collection to provide this mechanical energy [24]. An overview of solar desalination technologies is provided below.

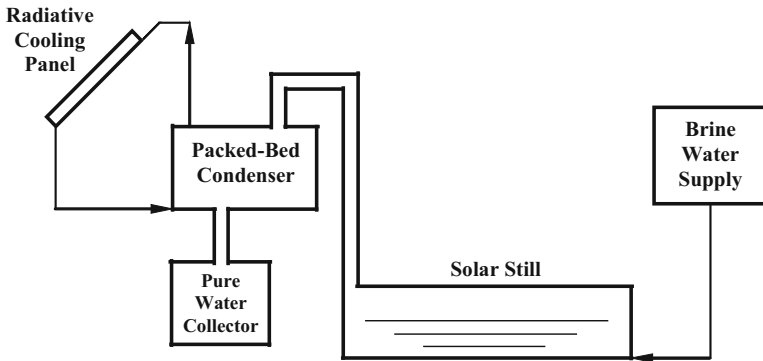
**Table 3** Renewable energy and desalination technology combinations

Energy sources	Method	Desalination process	Energy storage	Backup	
Solar	Thermal System	MSF	Hot fluid insulated tanks	Oil or gas	
	Parabolic collectors	MEB			
	Flat plates	MEB-TC			
	Evacuated tubes				
	Deep ponds				
	Electrical system				
	Solar thermal electric	EDR	Batteries and insulated tanks	Grid or diesel	
Wind	Wind turbine	Power generation	RO	Batteries	Grid or diesel
		Photovoltaic	RO	Batteries	Grid or diesel
			EDR		
			RO	Batteries	Grid or diesel
			EDR	Fly wheel	
Wave	Wells turbine	MVC	Pumped storage		
		RO	Batteries	Grid or diesel	
		EDR	Fly wheel		
Waste heat and biomass thermal		MVC	Pumped storage		
		MSF		Oil or gas	
		MEB			
Thermal electric power generation		MEB-TC			
		RO		Oil or gas	
		MVC			
		EDR			

#### 4.1 Direct Solar Desalination

Direct solar energy use includes solar stills, solar ponds, and other technologies. Sampathkumar et al. [25] provide a detailed review of direct solar distillation systems. The direct solar desalination is by definition the use of direct solar energy without conversion. In the direct method, a solar collector is coupled with a distilling mechanism and the process is carried out in one simple cycle [26].

A schematic view of a solar still is provided in Fig. 10. The original solar still can be described as a basin with a transparent cover (e.g., glass). The interior of the still contains seawater and air. When the seawater is heated by solar radiation, it starts to evaporate. The formed vapor is mixed with the air above the water surface and then condensate on the surface. The formed condensation drops will start running down the cover by gravitational forces and may then be collected at the side of the still.



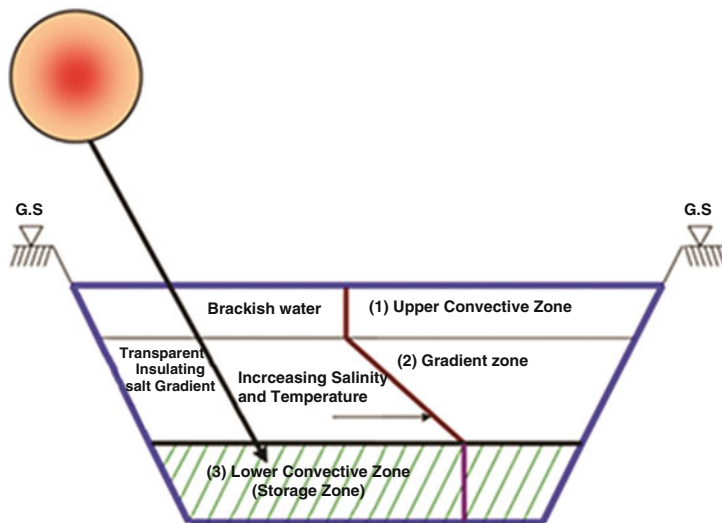
**Fig. 10** Schematics of the solar still and condenser [27]

Direct solar distillation potential is proportional to the area of the solar surface and the incidence angle and has an average estimated value of 3–4 L/m<sup>2</sup>/day [21]. Because of this proportionality and the relatively high cost of land and material for construction, direct solar distillation tends to favor plants with production capacities less than 200 m<sup>3</sup>/day [21]. There are some small commercial solar still units in existence in areas where freshwater demand is less than 200 m<sup>3</sup>/day [28].

Solar ponds (Fig. 11) are another direct method for desalination. Solar ponds are simple in design and low in cost. Such ponds may be a reliable source of heat for a wide range of industrial and agricultural applications such as process heating, space heating, desalination, and electricity generation [29]. The principal mechanism of solar pond is as follows. As the sun shines over a lake or a pond, the water absorbs irradiation and is warmed. However, surface water quickly loses this added heat due to heat and mass convection with the ambient air. Since the underlying water in the pond is now warmer and thereby lighter than the surface, it causes convective circulation, where warm water from the bottom rises and the colder water from the surface layer sinks [30]. Solar ponds require plenty of land area. Thus, it is reasonable to locate them in wastelands or in deserts, close to saltwater. Countries, such as Libya, which greatly depend on seawater desalination, are appropriate locations for solar ponds. Using solar ponds instead of fossil fuel for heating the desalination plants results in significantly lower water production costs [30].

Salinity-gradient solar ponds (SGSPs) combine solar energy collection with long-term storage potential [29]. A typical salinity-gradient solar pond (SGSP), Fig. 11, has three regions. The top region is called the surface zone, or upper convective zone (UCZ); the middle region is called the main gradient zone (MGZ), or nonconvective zone (NCZ); and the lower region is called the storage zone, or lower convective zone (LCZ) [29].

Figure 12 shows a more sophisticated direct use of solar energy. The process is using Membrane Distillation (MD), a process that can be adapted effectively for water desalination. This process requires moderate temperatures to produce the



**Fig. 11** Solar pond—typical salinity gradient [30]

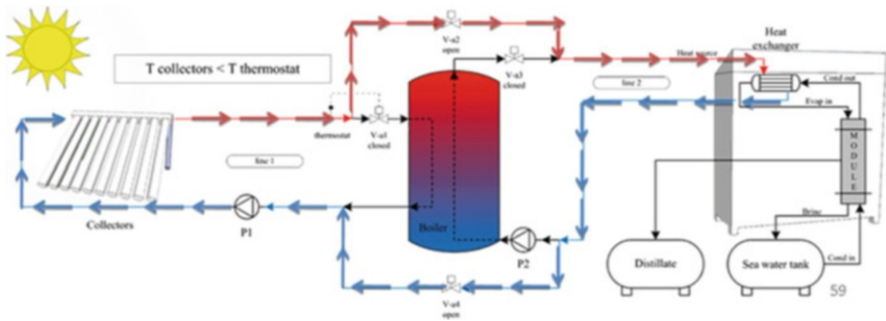
driving force across the membrane—the difference between the partial vapor pressures at both sides of the membrane (Fig. 12).

## 4.2 Indirect Solar Desalination

Indirect solar desalination employs two separate systems: a solar collection array, consisting of either photovoltaic or fluid-based collectors, and a conventional desalination plant [26]. Production by indirect method is dependent on the thermal efficiency of the plant and the cost per unit produced is generally reduced by an increase in scale. Many different plant arrangements have been theoretically analyzed, experimentally tested, and in some cases installed. They include, but are not limited to Multiple-Effect Humidification (MEH), Multiple-Stage Flash Distillation (MSF), Multiple-Effect Distillation (MED), Multiple-Effect Boiling (MEB), Humidification Dehumidification (HDH), Reverse Osmosis (RO), and Freeze effect distillation [32].

## 5 Comparison of Water Supply Systems

The economics and environmental impacts of a water supply system are important criteria. The economic evaluation of a municipal water supply project is subject to two important aspects: (1) the availability and quality of water source and (2) the



**Fig. 12** Schematic representation of the operating configuration 1 (cold hours of a sunny day): Solar energy is directly used to power the MD plant [31]

plant location, i.e., the plant distance from the water source and the existing water distribution network.

Whereas in most urban regions a secure, continuous energy supply is guaranteed, in many rural and coastal regions the lack of potable water is connected to unavailability of energy source. This often provokes a situation like “without energy there is no water.” Due to the fact that almost 60 % of the investment costs for energy supply systems are needed for the installation of the distribution system in rural regions, decentralized and renewable energy supply systems become increasingly important. By the utilization of renewable energy systems the water producer becomes independent from any supply of fossil fuel resources such as gas or diesel, but has to take into account the intermittent energy supplied by the sun or wind. However, the combination of renewable energies and water production by reverse osmosis has become the key technology for decentralized water supply plants.

In calculating the cost of supplying water through centralized and decentralized water systems, socioeconomic as well as environmental considerations should be taken into account (Table 4). These costs vary from one country to the other depending on labor cost, availability of local skills and expertise, and the extent of environmental damage. However, in all cases the benefit of developing isolated and remote areas is considered as an aggregate demand (AD) to the economy of many countries.

### 5.1 Cost of Conventional Water Supply Systems

The future capital expenditures up to the year 2018 show the increments of approximately 50 % cost increase for water supply infrastructure in the span of 7 years (Fig. 13).

Table 5 presents the marginal cost of a new conventional water supply system including water treatment and water transportation costs.



**Table 4** Characteristics of centralized and decentralized water supply systems [33, 34]

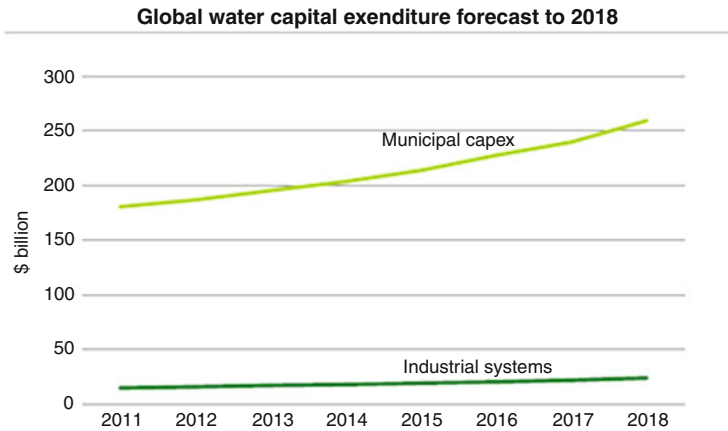
	Freshwater	Alternative sources of water
Centralized infrastructure	<i>Pros</i> – Scale effects – Provides consistent services – Financial solidarity at municipal level	<i>Pros</i> – Positive environmental externalities (resources, wastewater discharge) – Financial solidarity at municipal level
	<i>Cons</i> – A number of negative externalities (environmental, financial) – Capital intensive and fails to attract private capital	<i>Cons</i> – Costly (several networks) – Energy intensive
Decentralized infrastructure	<i>Pros</i> – Less water leakage in mains and less energy used to transport water – Reduced energy use – Flexible and resilient – Deferred and reduced investment costs	<i>Pros</i> – Positive environmental externalities (resource, wastewater discharge) – Reduced energy use – Flexible and resilient – Deferred and reduced investment costs
	<i>Cons</i> – Additional connections are needed for reliable sourcing – Unequal service provision in the municipality – Inadequate monitoring systems	<i>Cons</i> – May harness new sources of finance – Health issues related to potable reuse – Questions about relevance when central infrastructure is in place – Scale effect – Unequal service provision in the municipality – Inadequate monitoring and regulatory systems

The transport of water over long distances will increase the use of energy and the associated costs. Research shows that transporting water over long distances becomes more expensive than desalinated water produced locally [36]. The average cost of long-distance transporting potable water can be increased by 300 % over desalinated water which is produced and supplied to consumers locally.

## 5.2 Cost of Desalinated Water Systems

The cost of supplying desalinated water has gradually decreased with advances in desalination technologies. Table 6 shows the marginal cost of desalinated water.

The scale effect is an important deciding factor for desalination cost. Table 7 shows the capital cost and Unit Product Cost (UPC) for four desalination technologies and four different capacities. These costs were calculated using the correlations and cost breakdown for each plant [33].



**Fig. 13** Global water capital expenditure forecast to 2018 (Source: Global Water Market Report 2014, Publisher GWI [35])

**Table 5** The marginal cost of new water resources

Water source	Capital cost (per <sup>3</sup> /d)	O&M cost per m <sup>3</sup>	Notes
Shallow freshwater aquifer	\$3	<\$0.01	10,000 m <sup>3</sup> /d at 10 m depth
	\$7	\$0.07	10,000 m <sup>3</sup> /d at 200 m depth
Deep freshwater aquifer			
Long-distance transfer	\$3,000	\$0.15	500 km long; 100 m elevation; two million m <sup>3</sup> /d capacity
New reservoir and conveyance	\$1,700	<\$0.01	250,000 m <sup>3</sup> /d output with 20 km conveyance
Indirect potable reuse	\$800	\$0.45	50,000 m <sup>3</sup> /d facility with UF, RO, and UV—water returned to aquifer
Shipping water by bladder	\$60	\$1.50	10,000 m <sup>3</sup> bladder to port unloading facility 50 km away
Shipping water by tanker	\$120	\$1	100,000 m <sup>3</sup> tanker traveling 50 km with loading and unloading facilities

Source: Global Water Market Report 2014, Publisher GWI [35]

Table 8 shows the total costs for different energy sources in a desalination plant with a capacity of 20,000 m<sup>3</sup>. The indirect cost includes the environmental damage cost, CO<sub>2</sub> emission, pollution of water ways, etc. Cost calculations are subject to the prevailing prices in each country. Table 8 cost estimates are based on average US costs.

The actual and increased trend to supply desalinated water is based on availability of renewable energy. A good example is Saudi Arabia’s Saline Water Conversion Corporation (SWCC) which is looking into a string of new membrane desalination plants, including a 600,000 m<sup>3</sup>/day plant in Rabigh that would be the largest of its type in the world [10]. The move by SWCC, the world’s largest

**Table 6** The marginal cost of desalinated water

Water source	Capital cost (per m <sup>3</sup> /d)	O&M cost (per m <sup>3</sup> )	Notes
Brackish water desalination	\$480	\$0.29	10,000 m <sup>3</sup> /d facility
Indirect potable reuse	\$800	\$0.45	50,000 m <sup>3</sup> /d facility with UF, RO, and UV—water returned to aquifer
Membrane seawater desalination	\$1,200	\$0.47	100,000 m <sup>3</sup> /d capacity
Thermal seawater desalination	\$1,500	\$0.57	300,000 m <sup>3</sup> /d capacity

Source: Global Water Market Report 2014, Publisher GWI [35]

**Table 7** Cost for four desalination technologies of different capacities [33]

Desalination technology	Capacity (m <sup>3</sup> /d)	Capital cost (US\$ × 10 <sup>6</sup> )	UPC (US\$)
SWRO	10,000	20.1	0.95
	50,000	74.0	0.70
	275,000	293.0	0.50
	500,000	476.7	0.45
BWRO Source (Wittholz et al. [37])	10,000	8.1	0.38
	50,000	26.5	0.25
	275,000	93.5	0.16
MSF	500,000	145.4	0.14
	10,000	48.0	1.97
	50,000	149.5	1.23
	275,000	498.1	0.74
MED	500,000	759.6	0.62
	10,000	28.5	1.17
	50,000	108.4	0.89
	275,000	446.7	0.67
	500,000	734.0	0.60

**Table 8** Cost of desalination plants by source of energy including environmental costs (US dollars) [33]

	Coal	Oil	Natural gas	Nuclear	Solar	Wind
Operating cost of a desalination plant	5,110,000	5,110,000	5,110,000	5,110,000	7,950,000	6,570,000
Energy cost	1,422,624	9,584,929	2,005,011	973,608	6,668,550	3,867,750
Environmental cost	775,325	534,000	318,702	2,546	0	0
Total	5,885,325	5,644,000	5,428,000	5,112,546	7,950,000	6,570,000

desalination procurement body, ties in with a broader plan to shift the Kingdom's power generation system away from its reliance on fossil fuels by investing in nuclear, wind, and solar energy. This shift is likely to mean a change in the country's long-running ties with thermal desalination, which has remained a favored option in the Gulf even as it has been overtaken by membrane desalination

elsewhere. This was due to the artificially low operating costs that came with a ready supply of subsidized fuel and steam from collocated oil- or gas-fired power plants. Saudi Arabia's ambitious plans for renewable energy will mean changes for the country's pipeline of desalination projects—including what could be the world's largest membrane desalination plant.

### ***5.3 Cost of Solar Desalination Systems***

The produced water from solar desalination has the advantage of being a decentralized system due to the local availability of solar energy and saltwater. At present, the maximum capacity of commercial solar-powered desalination units is 170,000 m<sup>3</sup>/day. These small solar-powered desalination units are ideal for remote areas and it most often forces governments to subsidize its operations.

The approximate cost of solar-driven desalination units was presented in Fig. 9. Even if at the present time the capital cost of solar desalination is higher than the traditional energy-driven desalination process, solar desalination realizes two important objectives: reducing CO<sub>2</sub> emissions and reducing the reliance on fossil energy.

From information related to general desalination cost discussed earlier, it is evident that, in general, energy presents about half of the projected desalination cost. This cost will increase if environmental cost is added. Generally, the environmental cost evaluation of solar desalination depends on several factors that include CO<sub>2</sub> emission, environmental damage, and the development of isolated areas. The economic benefits that can be attributed to the development of isolated areas must be incorporated in cost evaluation. Therefore, the traditional cost–benefit analysis cannot be applied to solar desalination. Costs and benefits for solar desalination must be analyzed in the context of the macroeconomy. Even with the aforementioned facts, sometimes the absolute value of solar desalination becomes competitive with the increased cost of fossil energy.

### ***5.4 Water Quality Concerns***

The rising proportion of desalinated seawater consumed by both the domestic and agricultural sectors constitutes a public health risk. Seawater desalination provides freshwater that typically lacks minerals essential to human health. While heavy minerals such as mercury are harmful to human health, some other minerals such as magnesium and fluoride are indispensable for human health. The World Health Organization (WHO) reported on a relationship between sudden cardiac death rates and magnesium intake deficits [38]. A recent study undertaken to provide recommendations for water distribution system (WDS) quality control in terms of meeting optimal water quality requirements shows the importance of remineralization

**Table 9** WHO standards for potable water [39]

Constitutes	Concentration (mg/l) (Limited values)	TDS (mg/l) (Max. allowed values)
Total dissolved salts	500	1,500
Cl	200	600
SO <sub>4</sub> <sup>2+</sup>	200	400
Ca <sup>2+</sup>	75	100
Mg <sup>2+</sup>	30	150
F	0.7	1.7
NO <sub>3</sub> <sup>-</sup>	<50	100
Cu <sup>2+</sup>	0.05	1.5
Fe <sup>3+</sup>	0.10	1.0
pH	7–8	6.5–9

through blending desalinated water with natural water to achieve the desired quality [38].

The posttreatment of desalinated water is a must in order to meet the WHO standards for potable water (Table 9). Also, as shown in Table 10, the potable water quality will be considered excellent if the total dissolved solids (TDS) concentration is less than 300 mg/l.

## 6 Solar Desalination Case Studies and Projects

Several desalination studies are carried out in the southern Mediterranean countries within the ADIRA Project [13]. The ADIRA project addresses autonomous desalination system concepts for seawater and brackish water in rural areas using renewable energy sources. Below are descriptions of some unique solar desalination case studies and projects implemented or planned in various countries.

### 6.1 *DESSOL Project, Canary Islands*

Scientists at the Technological Institute of The Canary Islands (ITC) and the Aachen University of Applied Sciences are investigating seawater desalination by reverse osmosis supplied by renewable energy [11]. The ITC installed a pilot plant called DESSOL (Desalination with Solar energy) in Pozo Izquierdo to demonstrate the technical feasibility of the technology. The reverse osmosis plant with a nominal production capacity of 10 m<sup>3</sup>/day (specific energy consumption of 5.5 kWh/m<sup>3</sup>) is supplied by a 4.8 kWp photovoltaic (PV) generator and a 19 kWh battery backup system. The energy system was optimized to supply energy for the reverse osmosis plant. The principle construction details of the PV supplied reverse osmosis plant, the description of the automatic control unit which adjusts the plant operation to the changing and discontinuous PV energy supply generator, the plant

**Table 10** The water quality according to its TDS concentration

Quality	Total dissolved solids (mg/l)
Excellent	<300
Good	300–600
Fair	600–900
Poor	900–1,200
Unacceptable	>1,200

Source: WHO, 1984 [40]

operation performance, and the option of preheating the feed water are presented and discussed in the ITC report [11].

The DESSOL pilot operation has yielded important results related to the optimization of the plant operation and the coordination and timing of using solar energy in conjunction with RO system. For example, a solar thermal system was integrated into the energy supply system to increase the daily water production. As a result, the RO plant is now supplied with preheated seawater. This pilot plant experience has served for the manifestation of the technical concept of this technology and could be transformed into much larger drinking water production systems.

## 6.2 Agricultural University, Greece

The design of a stand-alone hybrid wind-PV system to power seawater RO desalination unit, with energy recovery using a simplified spreadsheet model, was tested at the Agricultural University of Athens, Greece [12]. A daily and monthly production simulation and economic analysis were also performed. The calculated freshwater production cost was 5.2 Euro/m<sup>3</sup>, and the realized energy saving was up to 48 % when a pressure-exchanger-type energy recovery unit is considered.

## 6.3 Madrid University, Spain

A solar thermal and photovoltaic-powered RO desalination plant has been constructed and optimized for desalination of brackish water at Madrid University [41]. The central composite experimental design of orthogonal type and response surface methodology (RSM) was used to develop predictive models for simulation and optimization of different responses such as the salt rejection coefficient, the specific permeate flux, and the RO-specific performance index that takes into consideration the salt rejection coefficient, the permeate flux, the energy consumption, and the conversion factor. The considered input variables were the feed water temperature, feed water flow rate, and the feed pressure. Analysis of variance (ANOVA) has been employed to test the significance of the RSM polynomial

models. The optimum operating conditions have been determined using the step adjusting gradient method. An optimum RO-specific performance index has been achieved experimentally under the obtained optimal conditions. The RO-optimized plant guarantees a potable water production of  $0.2 \text{ m}^3/\text{day}$ , with energy consumption lower than  $1.3 \text{ kWh/m}^3$  [41].

#### ***6.4 Portable Thermoelectric Solar Still, Iran***

A new type of Portable Thermoelectric Solar Still (PTSS) was designed in Semnan, Iran [42]. A thermoelectric module is used to improve the temperature difference between evaporating and condensing zones. Also, a heat-pipe cooling device is used to cool down the hot side of the thermoelectric cooler. To evaluate the performance of the PTSS, the equipment was tested under the climatic condition of Semnan ( $35^\circ 33' \text{ N}$ ,  $53^\circ 23' \text{ E}$ ). The measurement of solar intensity, wind velocity, ambient temperature, water production, and temperature of model components, for example, thermoelectric module, water, walls, and heat pipe, was conducted in the same manner each day. The results show that ambient temperature and solar radiation have a direct effect on still performance, but there is a reduction in water productivity when wind speed was increased.

#### ***6.5 Dubai Project***

The UAE would establish the world's largest solar-powered desalination plant that will process more than  $80,000 \text{ m}^3/\text{day}$  of potable water [43]. The new plant at Ras Al Khaimah emirate would also generate 20 MW of electricity. The project will implement the most advanced RO and filtration technologies, and when operational, it's expected to drastically push down the unit potable water production cost.

The Dubai project would set a new benchmark for the desalination business model and will be the world's greenest desalination plant with the least  $\text{CO}_2$  emissions. The new solar-powered desalination plant will complement the clean coal power plant project announced in 2012. The two plants together will generate power and water while reducing  $\text{CO}_2$  emissions by more than one million tonnes of  $\text{CO}_2$  per year. Masdar city initiative aims to install up to five pilot solar-powered desalination plants in the Emirates of Abu Dhabi [44].

#### ***6.6 Saudi Arabia Project***

Recently, an MED plant driven by an enhanced solar pond has been commissioned in Fujairah, Saudi Arabia. The project is expected to eclipse Kingdom's Al Khafji

plant by generating twice as much power with output capacity of 10 MW and 40 m<sup>3</sup>/day of water when completed [44]. Saudi Arabia's Saline Water Conversion Corporation (SWCC) is looking into a string of new membrane desalination plants, including a 600,000 m<sup>3</sup>/day plant in Rabigh that would be the largest of its type in the world.

## 6.7 High Concentration Photovoltaic Thermal Project

In recent years, indirect solar desalination using modern solar photovoltaic technology alongside desalination methods such as coupling RO with Multiple-Effect Distillation (MED) and membrane distillation (MD), with potential to operate at a much larger scale, have been investigated [44]. The IBM in cooperation with the King Abdulaziz Research Center has developed the new system High Concentration Photovoltaic Thermal (HCPVT) based on research conducted at MIT [45] (Figs. 14, 15, and 16). The HCPVT approach can both eliminate the overheating of solar chips while also using the energy for thermal water desalination and cooling.

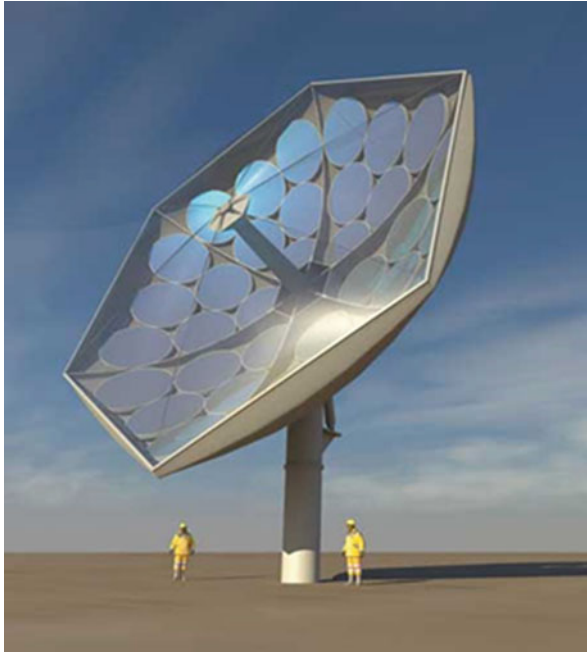
The prototype HCPVT system (Figs. 14, 15) uses a large parabolic dish, made from a multitude of mirror facets, which are attached to a sun tracking system. The tracking system positions the dish at the best angle to capture the sun's rays, which then reflect off the mirrors onto several microchannel-liquid cooled receivers with triple junction photovoltaic chips—each 1 × 1 cm chip can convert 25–50 W, on average, over a typical 8 h day in a sunny region.

The entire receiver of more than 500 chips can provide 25 kW of electricity. The coolant maintains the chips approximately at the same temperature for a solar concentration of 2,000 times and can keep chips at safe temperatures up to a solar concentration of 5,000 times. An initial demonstration of the multi-chip receiver was developed in a previous collaboration between IBM and the Egypt Nanotechnology Research Center [44].

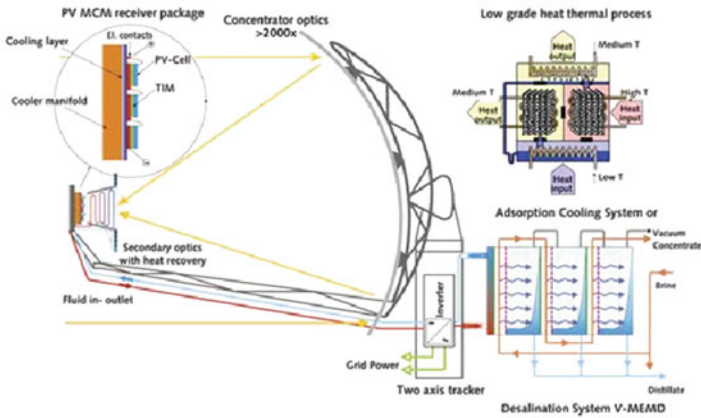
In the HCPVT system shown in Fig. 16, instead of heating a building, the 90 °C water is used to heat salty water which then passes through a porous membrane distillation system (MD) where it is vaporized and desalinated. This system can provide 30–40 l of drinking water per square meter of receiver area per day and generate 2 kW hours per day of electricity.

An application of large-scale HCPVT technology is planned in KSA. A desalination plant with an expected production capacity of 30,000 cubic meters per day will be built in the city of Al Khafji to serve 100,000 people. King Abdul Aziz City for Science and Technology (KACST) plans to power the desalination plant with the ultrahigh concentrator photovoltaic (UHCPV) technology that is being jointly developed by IBM and KACST.





**Fig. 14** The IBM's prototype HCPVT system uses a large parabolic dish constructed from a large array of mirror facets and connected to a sun tracking system (Courtesy of International Business Machines Corporation, ©International Business Machines Corporation [44])



**Fig. 15** The prototype HCPVT system under development (Courtesy of International Business Machines Corporation, ©International Business Machines Corporation [44])

**Fig. 16** The IBM HCPVT system's heated waste water is diverted to a desalination system, where it vaporizes and purifies saltwater (Courtesy of International Business Machines (IBM) Corporation, ©International Business Machines Corporation [44])



## 6.8 Chile Project

Membrane-based technologies of the type described by Sommariva [44] using solar energy have recently been employed in Chile. The demonstration facility, established at the Padre Francisco Napolitano Agricultural School in the Lluta Valley, is powered by an array of solar photovoltaic panels. The plant is “simple in its construction and operation” and costs only US\$ 210,000 (CLP 100 million). In the near future, the plant’s operations will be closely monitored. In addition, a market study and business model will be created—with the ultimate aim to commercialize the technology for use at other locations across northern Chile. The project is established by the Chilean government supported Fundación Chile, via its Climate Change Fund, and is supported by Chile’s national Innovation Fund for Competitiveness (FIC).

## 6.9 Australia Project

A Victorian company recently announced plans for the staged development of Australia’s first solar-powered desalination plant near Port Augusta in South Australia [46]. The plan combines solar energy-based power generation, seawater desalination, and commercial salt production, all integrated into a single \$370 million industrial complex.

The solar field will be laid out over a two-square-kilometer area with each solar mirror standing three meters tall. The captured heat will be used to create steam for electricity and desalination, with any excess heat going into thermal storage.

When the first stage is complete, the Point Paterson facility will produce 200 megawatts (MW) of electricity—50 MW solar thermal and 150 MW combined cycle gas turbine (CCGT). It will also produce 5.5 gegaliters of water per year—enough for 34,000 people. The plant will be configured to enable its expansion to produce more than 45 gegaliters of water—enough for more than 250,000 people per year.

Point Paterson will be a world-first plant that will combine large solar power station technologies and water desalination in a stand-alone, near-zero greenhouse gas emission facility. Unlike conventional desalination processes, Point Paterson will reduce or eliminate the need to dispose of by-product waste brine back into the sea. The technology is off-the-shelf, but the combination of the technologies in a high demand commercial environment for power, water, and salt is very unique.

## 7 Future Research Directives

The directives of future research needs are based on the mechanism of renewable energy use and innovations in membrane technologies. A few recent investigations are described below.

### 7.1 *Thermal Processes*

There are two inherent design problems facing solar thermal desalination projects. First, the system's efficiency is governed by preferably high heat and mass transfer during evaporation and condensation. The surfaces have to be properly designed within the contradictory objectives of heat transfer efficiency, economy, and reliability.

Second, the heat of condensation is valuable because it takes large amounts of solar energy to evaporate water and generate saturated, vapor-laden hot air. This energy is transferred to the condenser's surface during condensation. With most forms of solar stills, this heat of condensation is ejected from the system as waste heat. The challenge is to achieve the optimum temperature difference between the solar-generated vapor and the seawater-cooled condenser, maximal reuse of the energy of condensation, and minimizing the asset investment.

The directive in these trends is to reduce the temperature of phase change desalination process [14]. One possible solution is to create vacuum pressure within the feed saline water reservoir. In this process, saltwater is evaporated at near-ambient temperatures under near-vacuum pressures created by the barometric head without any mechanical energy input. This can be accomplished using a vacuum

pump which significantly decreases the amount of energy required for desalination. For example, water at a pressure of 0.1 atm boils at 50 °C rather than 100 °C [47].

The prospect of developing a cost-effective solar desalination system is based on the following: (1) distillation processes driven by solar collectors and solar PV–RO systems have similar high costs, above \$2/m<sup>3</sup> for large-capacity systems and even higher than \$4/m<sup>3</sup> [42, 48] for smaller production; (2) capital costs of conventional distillation units with capacities suitable for rural areas are much higher than those of large capacities; (3) although unlike RO, MD is not yet a mature technology, similar costs are predicted in the literature by conventional energy-powered MD and RO systems; (4) the MD process is more suitable for stand-alone operation and for rural areas than RO because of its simpler operation and maintenance requirements, and it withstands changes in operational parameters and operation failures for human error with no damage [49].

## 7.2 *Efficiency of Photovoltaic Cells*

An important factor in solar desalination is the efficiency of photovoltaic panels. At present, the photovoltaic conversion efficiency in the laboratory is over 45 %, while the efficiency of commercial panels remains below 20 %.

The ongoing research at MIT aims to improve both photovoltaic and RO efficiencies at the same time [45]. In general, a solar panel produces more power at lower PV cell temperatures and an RO unit produces more freshwater with increasing water temperature. These complementary behaviors are exploited by cooling the solar panel using the RO feed water. Cooling the solar panel also permits the use of concentrating mirrors, which further increases system production. The control unit must prevent overheating of the panel and RO unit and balance the pressure within the system. The laboratory results show an improvement in overall efficiency of 49 % [45].

## 7.3 *Nano-Composite RO Membranes*

It has been demonstrated that desalinated water production of RO system cost can be reduced if high permeability membranes are used. The high permeability can be achieved through the proper incorporation of nanoparticles within thin film Nano-composite membranes (NanoH<sub>2</sub>O) [50].

In the laboratory, Nano-composite membranes have shown performance exceeding that of existing commercial RO membranes. Nano-composite membrane technology is now in the process of being commercialized with trials and a specially designed full-scale manufacturing line is under way [51]. Moreover, other recent advances in membrane technology will provide further improvements in energy efficiency and cost savings [52–55].

## 7.4 Large Diameter Spiral-Wound Membranes

The 8-in. membrane elements have been the industrial standard size membranes used for RO in both seawater desalination and water reclamation processes (note: 1 in. = 2.540 cm) [48].

However, within large-scale RO plants, there is poor economy of scale for the 8-in. diameter membranes. Hallan et al. [56] reported that large diameter spiral-wound modules enable significant reductions in RO plant capital cost and lifecycle cost. The 16-in. diameter membrane was identified as the optimum diameter in view of the trade-off between cost savings and associated risks. The 16-in. diameter allows membrane active area and module productivity to increase 4.3 times more the standard SWRO module.

On the other hand, Koch Membranes recommends 18-in. as the optimum membrane diameter [57]. These different criteria over the standard format have resulted in the commercial development of elements and PVs of two dimensions. Dow Filmtec, Toray, and Hydranautics have developed 16-in. diameter  $\times$  40-in. length RO elements, and Koch Membranes has developed 18-in. diameter  $\times$  60-in. length RO elements. Today, large diameter RO membranes are commercially available and are being installed in demonstration SWRO plants [58].

## 8 Conclusions

The use of solar energy to drive desalination processes has become commercially feasible and in some cases an attractive option. The use of solar thermal energy in seawater desalination applications for capacities of up to 200 m<sup>3</sup> per day is a proven technology for providing potable water, but at present its implementation is mostly restricted to small-scale systems in rural and remote areas. The technical reasons are mainly the relatively low thermal efficiency and production rate of solar thermal energy compared to other systems.

However, the predicted shortages in fossil fuel supply and the growing need for freshwater demand for various uses have magnified the necessity for further development of desalination in conjunction with using renewable energies, particularly solar energy. At present, the most promising technologies are solar RO and the combination of different technologies such as MVC + RO. The conjunctive use of solar energy and large-scale desalination plants could also address some of the pressing environmental concerns such as CO<sub>2</sub> emission. The introduction of nanotechnology to water treatment is expected to result in higher efficiencies in both mechanical and thermal desalination processes.

**Disclaimer** This chapter provides an overview of desalination technologies and available information on solar desalination. The authors make no representations or warranties of any kind and assume no liabilities of any kind with respect to the accuracy or completeness of the contents. References are provided for

informational purposes only and do not constitute endorsement of any manufacturers, websites, or other sources cited in this chapter.

## References

1. Khawaji AD, Kutubkhanah IK, Wie J-M (2008) Advances in seawater desalination technologies. *Desalination* 221:47–69
2. Tanaka H, Ho Y-S (2011) Global trends and performances of desalination research. *Desalination and Water Treatment* 25:1–12
3. Service RF (2006) Desalination freshens up. *Science* 313(5790):1088–1090
4. Shannon MA, Bohn PW, Elimelech M, Georgiadis JG, Mariñas BJ, Mayes AM (2008) Science and technology for water purification in the coming decades. *Nature* 452(7185):301–310
5. Schiermeier Q (2008) Water: Purification with a pinch of salt. *Nature* 452:260–261
6. Bremner J, Frost A, Haub C, Mather M, Ringheim K, Zuehlke E (2010) Population Reference Bureau, World Population Highlights: Key Findings from PRB’s 2010 World Population Data Sheet. *Popul Bull* 65(2)
7. Mehanna M, Saito T, Yan J, Hickner M, Cao X, Huang X, Logan BE (2010) Using microbial desalination cells to reduce water salinity prior to reverse osmosis. *Energy Environ Sci* 3:1114–1120
8. Bajpayee A, Luo T, Muto A, Chen G (2011) Very low temperature membrane-free desalination by directional solvent extraction. *Energy Environ Sci* 4:1672–1675
9. Hoffman AR (2008) Water security: A growing crisis and the link to energy. *AIP Conf Proc* 1044(1):55–63
10. Anon (2012) Solar solutions point Saudis towards RO. *Global Water Intelligence* 13(12). <http://www.globalwaterintel.com/archive/13/12/general/solar-solutions-point-saudis-towards-ro.html>. Last day accessed 17 Feb 2014
11. Espino T, Peñate B, Piernavieja G, Herold D, Neskakis A (2003) Optimised desalination of seawater by a PV powered reverse osmosis plant for a decentralised coastal water supply. *Desalination* 156:349–350
12. Mohamed ES, Papadakis G (2004) Design, simulation and economic analysis of a stand-alone reverse osmosis desalination unit powered by wind turbines and photovoltaics. *Desalination* 164:87–97
13. Papapetrou M, Epp C, Teksoy S, Sözen S, Ortın VS, Seibert U, Vogt G (2005) Market analysis for autonomous desalination systems powered by renewable energy in southern Mediterranean countries, Case study on Turkey. *Desalination* 183:29–40
14. Gude VG, Nirmalakhandan N, Deng S (2011) Desalination using solar energy: Towards sustainability. *Energy* 36:78–85
15. The IDA Desalination Yearbook 2011–2012 9 Water Desalination Report
16. Anon. Solar powered desalination plant & reverse osmosis. Barefoot College. <http://www.barefootcollege.org/solutions/water-solutions/solar-powered-reverse-osmosis-ro-water-desalination-plants>. Last day accessed 18 Feb 2014
17. Abou Rayan M (2011) Desalination technologies as a response to water shortage strategy Problems (Case study in Egypt). In: Scozzari A, El-Mansouri B (eds) *Water security in the mediterranean region: an international evaluation of management, control, and governance approaches*. Springer (Springer Book ISBN 978-94-007-16223), pp 339–352
18. Abou Rayan M, Benchikh O (1995) *Technologie de dessalement de l’eau*. UNESCO publications, Paris
19. Kumar A, Gayakwad A, Nagale BD (2014) A review: Nano membrane and application. *Int J Adv Sci Eng Tech* 3(1):8373–8381

20. Eltawil MA, Zhengming Z, Yuan L (2009) A review of renewable energy technologies integrated with desalination systems. *Renew Sustain Energy Rev* 13:2245–2262
21. Kalogirou S (2009) *Solar energy engineering: Processes and systems*. Elsevier/Academic Press, Burlington, MA
22. Li C, Goswami Y, Stefanakos E (2013) Solar assisted seawater desalination: A review. *Renew Sustain Energy Rev* 19:136–163
23. Solar Desalination. [http://en.wikipedia.org/wiki/Solar\\_desalination](http://en.wikipedia.org/wiki/Solar_desalination). Last day accessed 18 Feb 2014
24. Attia A (2012) Thermal analysis for system uses solar energy as a pressure source for reverse osmosis (RO) water desalination. *Solar Energy* 86(9):2486–2493
25. Sampathkumar K, Arjunan TV, Pitchandi P, Senthilkumar P (2010) Active solar distillation—A detailed review. *Renew Sustain Energy Rev* 14:1503–1526
26. Garcia-Rodriguez L, Palmero-Marrero AI, Gómez-Camacho C (2002) Comparison of solar thermal technologies for applications in seawater desalination. *Desalination* 142:135–142
27. Haddad OM, Al-Nimr MA, Maqableh A (2000) Enhanced solar still performance using a radiative cooling system. *Renew Energy* 21:459–469
28. Lindblom J (2010) Solar thermal technologies for seawater desalination: State of the art. Luleå University of Technology, Sweden. [http://pure.ltu.se/portal/files/2778020/soa-seawater\\_desalination.pdf](http://pure.ltu.se/portal/files/2778020/soa-seawater_desalination.pdf). Last day accessed 14 Feb 2014
29. Lu H, Walton JC, Swift AHP (2001) Desalination coupled with salinity-gradient solar ponds. *Desalination* 136:13–23
30. Hussain AKM (2003) Solar energy utilization in Libya for seawater desalination. *Proceedings at the ISES Solar World Congress 2003, Gothenburg*
31. Cipollina A, Di Sparti MG, Tamburini A, Micale G (2012) Development of a membrane distillation module for solar energy seawater desalination. *Chem Eng Res Des* 90:2101–2121
32. Qiblawey H, Banat F (2008) Solar thermal desalination technologies. *Desalination* 220(1–3):633–644
33. Abazza H (2012) Economic considerations for supplying water through desalination in south Mediterranean countries, sustainable water integrated management—Support mechanism (SWIM-SM), Project funded by the European Union Economic, pp 1–48
34. Leflaive X (2010) Alternative ways of providing water: Emerging options and their policy implications. OECD Publishing, Paris. <http://www.oecd.org/dataoecd/53/38/42349741.pdf>. Last day accessed 14 Feb 2014
35. Anon (2013) The global water market, a bright new future for water? *Global Water Intelligence, GWI* 14(4):33. <http://www.globalwaterintel.com/archive/14/4/market-profile/bright-new-future-water.html>. Last day accessed 17 Feb 2014
36. Abou Rayan M, Djebedjian B, Khaled I (2001) Water supply and demand and a desalination option for Sinai, Egypt. *Desalination* 136:73–81
37. Wittholz MK, O'Neill BK, Colby CB, Lewis D (2008) Estimating the cost of desalination plants using a cost database. *Desalination* 229:10–20
38. Avni N, Eben-Chaime M, Oron G (2013) Optimizing desalinated sea water blending with other sources to meet magnesium requirements for potable and irrigation waters. *Water Res* 47:2164–2176
39. Delyiannis E, Belessiotis V (1995) *Methods and Systems of Desalination. Principles of Desalination Processes*, Greece
40. WHO (1984) *Guidelines for drinking-water quality. Health criteria and other supporting information, vol 2, 1st edn*. World Health Organization, Geneva, 335 p
41. Khayet M, Essalhi M, Armenta-Déu C, Cojocar C, Hilal N (2010) Optimization of solar-powered reverse osmosis desalination pilot plant using response surface methodology. *Desalination* 261:284–292
42. Rahbar N, Esfahani JA (2012) Experimental study of a novel portable solar still by utilizing the heatpipe and thermoelectric module. *Desalination* 284:55–61



43. Anon (2013) UAE to set up world's largest solar desalination plant [http://zeenews.india.com/news/eco-news/uae-to-set-up-world-s-largest-solar-desalination-plant\\_892791.html](http://zeenews.india.com/news/eco-news/uae-to-set-up-world-s-largest-solar-desalination-plant_892791.html). Last day accessed 17 Feb 2014
44. Williams A (2013) Solar powered water desalination heats up in Chile. *Water and Wastewater International* 28(3):24–28. <http://www.waterworld.com/articles/wwi/print/volume-28/issue-3/regional-spotlight-latin-america/solar-powered-water-desalination-heats.html>. Last day accessed 17 Feb 2014
45. Kelley LC, Dubowsky S (2013) Thermal control to maximize photovoltaic powered reverse osmosis desalination systems productivity. *Desalination* 314:10–19
46. Anon (2007) Solar-powered desalination plant leads the way. *EcosMagazine* 134(Dec-Jan):4. [http://www.ecosmagazine.com/?act=view\\_file&file\\_id=EC134p4.pdf](http://www.ecosmagazine.com/?act=view_file&file_id=EC134p4.pdf). Last day accessed 14 Jan 2014
47. Williams A (2004) Large scale solar desalination using multi effect humidification. *Global Warming Solutions*. <http://www.globalwarmingolutions.co.uk/LargeScaleSolarDesalinationUsingMultiEffectHumidification.html>. Last day accessed 17 Feb 2014
48. Peñate B, García-Rodríguez L (2012) Current trends and future prospects in the design of seawater reverse osmosis desalination technology. *Desalination* 284:1–8
49. Blanco GJ, García-Rodríguez L, Martín-Mateos I (2009) Seawater desalination by an innovative solar-powered membrane distillation system: the MEDESOL project. *Desalination* 246:567–576
50. NanoH2O Inc. <http://www.nanoh2o.com>. Last day accessed 17 Feb 2014
51. Kurth CJ, Burk RL, Green J (2009) Leveraging nanotechnology for seawater reverse osmosis. IDA World Congress, Dubai UAE
52. Lin NH, Kim M, Lewis GT, Cohen Y (2010) Polymer surface nano-structuring of reverse osmosis membranes for fouling resistance and improved flux performance. *J Mater Chem* 20:4642–4652
53. Kim M, Lin NH, Lewis GT, Cohen Y (2010) Surface nano-structuring of reverse osmosis membranes via atmospheric pressure plasma-induced graft polymerization for reduction of mineral scaling propensity. *J Membr Sci* 354:142–149
54. Zhou X, Xiao B, Liu W, Guo X, Yang J, Fan J (2010) Comparison of classical solar chimney power system and combined solar chimney system for power generation and seawater desalination. *Desalination* 250:249–256
55. Abou Rayan M, Djebedjian B, Khaled I, El-Sarraf S (2003) Desalination option within water demand management and supply for Red Sea coast in Egypt. *Seventh International Water Technology Conference, IWTC 2003, Cairo, Egypt*, pp 25–34
56. Hallan MJ, Johnson JE, Koreltz MS, Peery MH (2007) Design, development, and evaluation of 16 in. diameter RO modules. IDA World Congress on Desalination and Water Reuse, Maspalomas, Spain, pp 251–252
57. Koch membrane datasheets (Koch Membrane System Company). [http://www.kochmembrane.com/ps\\_exmem.html](http://www.kochmembrane.com/ps_exmem.html). Last day accessed 2 Jan 2010
58. Henthorne L, Wang F, Unni S, Deshmukh K (2007) Demonstration testing of innovative 16-inch SWRO in Arabian Gulf and Singapore waters. IDA World Congress on Desalination and Water Reuse, Maspalomas, Spain, pp 131–132



# Bottled Water: Global Impacts and Potential

Tamim Younos

**Abstract** This chapter discusses the rationale beyond global expansion of bottled water, components of bottled water industry, and problems associated with bottled water production and consumption; energy demand; health concerns; and plastic pollution. From technology perspective, bottled water can be considered a decentralized water system which distributes water for human consumption via a portable container instead of a pipeline which is a required component for transporting water via conventional water supply infrastructure. It is concluded that the current bottled water industry is not a part of a sustainable solution for the overall challenge of providing safe drinking water worldwide. However, bottled water can be a part of an overall solution to global lack of safe drinking water and community development if innovative water treatment technologies, renewable energy use, and biodegradable plastic (or similar materials) are incorporated into bottled water production and infrastructure system design.

**Keywords** Decentralized water system • Health impacts • Plastic pollution • Energy consumption • Sustainability

## 1 Introduction

Early civilizations used various types of vessel, made from animal skin or clay, to carry water from its source for consumption in royal palaces, peasant households, war zones, and other locations [1, 2]. In modern times, the synonym “bottled water” refers to various sizes of containers (10 oz to 20 L or larger) that provide water to consumers in various situations and environments.

---

T. Younos (✉)

The Cabell Brand Center for Global Poverty and Resources Sustainability Studies, Blacksburg, VA, USA

e-mail: [tyounos@gmail.com](mailto:tyounos@gmail.com)

The modern water bottling industry was launched in 1960s simultaneous with plastic invention. However, the industry mostly flourished in 1990s when polyethylene terephthalate (PET) plastic became available. PET plastic, because of its light weight and strength, is highly advantageous for packaging and transportation of bottled water. As a result, in 1990s, bottled water production grew worldwide from \$115 million to \$4 billion industry [3]. Today bottled water is a major global commodity, a \$22 billion industry that ranges from very small local bottling operations to giant international corporations [3, 4]. According to the International Bottled Water Association (IBWA), world's top 10 bottled water consumer countries are United States, Mexico, China, Brazil, Italy, Indonesia, Germany, France, Thailand, and Spain (2009 data) [5]. In terms of per capita consumption, the top 10 countries are Mexico (234 L/capita), Italy, United Arab Emirates, Belgium-Luxembourg, Germany, France, Lebanon, Spain, Hungary, and the United States (105 L/capita) [6].

Several factors have contributed to high consumption of bottled water. First, high consumption of bottled water is attributed to consumer preferences and perception [7–11]. Consumer preference for bottled water consumption appears to be due to its ease of transportability but most importantly due to public perception about quality of public water (tap water). Many consumers perceive bottled water as “cleaner” and/or “healthier” than tap water, and some prefer the taste of bottled water to that of tap water. Current literature supports the rationale of consumer perception about the quality of tap water. For example, recent literature cites the presence of emerging pathogens such as *Legionella spp.*, *Mycobacterium spp.*, *Aeromonas spp.*, and other opportunistic pathogens in drinking water distribution pipes and home plumbing systems [12].

Second, bottled water availability is considered a necessity in many rural and isolated communities of the developed countries as well as in rural and suburban communities of most developing countries [13]. Reasons for bottled water demand in these areas include lack of confidence in quality of public water as noted above and low quality of private water supplies such as household wells and privately owned small water supply systems. Furthermore, bottled water availability in these areas is justified due to high cost of extending centralized public water distribution pipelines to areas of low-density population and/or extreme topographic features. Third, around the world, bottled water is considered an absolute necessity during emergency conditions when public water supplies are disrupted, at least temporarily, due to natural disasters or man-made events.

## 2 Water Bottling Industry

Major components of a water bottling industry include plastic bottle production, water source development, water treatment technology, bottled water packaging, and bottled water transport and distribution to markets.

## ***2.1 Plastic Bottle***

Plastic bottles are mostly produced elsewhere and transported to the water bottling plants for packaging. As stated earlier, PET plastic is the most common type of material used in water bottling industry. PET plastic, a polymer resin derived from petroleum hydrocarbons, consists of a chain of repeating organic molecules with high molecular weight. A comprehensive discussion of PET plastic production is beyond the scope of this chapter. For details, the curious reader is referred to polymer chemistry publications; for example, see Speight and Lange [14].

## ***2.2 Water Source and Treatment***

Worldwide, depending on geography, all types of water—surface water, groundwater, spring water, and salt water are used to produce bottled water. Most water bottling plants are installed in the proximity of an available water source.

Selection of water treatment process to produce bottled water depends on quality of water source, scale of water bottling plant, and available financial resources. In general, water treatment processes in large bottled water industries are identical to those implemented in conventional and/or advanced public water treatment plants. Water treatment process at very small water bottling plants which mostly use spring water or groundwater is sometimes limited only to disinfection. Details of water treatment process are provided in Sect. 3.3 of this chapter.

## ***2.3 Bottled Water Packaging***

Bottled water packaging is a mechanical operation. Bottles are filled with water of acceptable quality and packaged appropriately for transportation and delivery to consumers. Important packaging considerations include quality control of bottled water, meeting various regulatory requirements, and cost-effectiveness of operation. For quality control purposes, bottled water packaging is regulated in accordance with established standards and regulations. Bottled water regulations are discussed in Sect. 4.1 of this chapter.

## ***2.4 Transportation and Marketing***

Bottled water transportation to markets and marketing strategies are critical parameters that influence energy consumption and bottled water cost. The impacts of

transportation mode and market distance on energy consumption are discussed in Sect. 3.4 of this chapter.

Consumer preference for increased bottled water consumption noted earlier indicates industry's successful marketing strategies. However, in recent years, in some European countries and the United States, high bottled water consumption has instigated a debate over necessity, appropriateness, cost, and negative environmental impacts of bottled water consumption. To combat the anti-bottled water movement, major bottled water industries have shifted marketing strategies promoting green technologies and ethical bottled water production [15, 16]. For example, Fiji Company has launched a campaign to market carbon neutral bottled water [17], and CocaCola Company markets Dasani bottled water which claims reduced bottle size and promotes recycling [18]. These marketing strategies exploit consumers' willingness, particularly in developed countries, to consume bottled water in an ethical manner for the sake of environmental protection, and therefore justify imposing additional cost to bottled water consumers.

### 3 Energy Demand

Energy demand is a significant factor in producing bottled water and its transport and distribution to markets and ultimately determines bottled water cost. An overview of energy consumption in various components of bottled water industry is provided below.

#### 3.1 PET Bottle Production

At present, bottled water industry depends largely on fossil fuels to meet its energy needs. O'Connor [19] estimated that in the United States about 2.4 million kL of fossil fuel is used for PET bottle production. According to Woods [20], worldwide, the amount of fossil fuel used for PET bottle production is about 48 million kL.

Gleick and Cooley [21, 22] have cited two comprehensive studies on energy demand for producing PET plastic and PET bottles. According to those studies [23, 24], energy required to produce PET resin is approximately 70–83 megajoules (MJ)/kg of PET resin. An additional 20 MJ/kg of PET is required to produce a finished PET bottle. It is estimated that approximately 300 billion MJ of energy is used for producing PET bottles in order to satisfy global bottled water demand [21].

### ***3.2 Water Source Development***

Energy is used to pump and transport water from water source to water bottling plant. Energy demand depends on the proximity of source water to bottling plant. Therefore, energy use is determined by the depth of groundwater aquifer, proximity of bottling plant to surface water, and landscape topography. In general, energy requirement for water source development in water bottling industry is similar to energy requirement for public water systems and can be estimated from existing publications; for example, see Larsen [25].

### ***3.3 Water Treatment***

Similar to public water, major factors that affect energy use for water treatment of bottled water include chemical and biological characteristics of water source and type of water treatment technology. As noted earlier, potential sources of water include various freshwater sources and saltwater with different degrees of treatment requirement. For example, energy demand for treatment of brackish and seawater is 4.0 kWh/1.0 m<sup>3</sup> to 10 kWh/1.0 m<sup>3</sup>, several times higher than energy need to treat freshwater using reverse osmosis technology [26]. Table 1 shows estimated energy needs for various water treatment technologies for public water which are also applicable to bottled water [21].

The major energy use in a small decentralized packaged water treatment system is attributed to a pump that operates the water treatment unit. For these packaged treatment systems energy usage is in the range of 3.0 kWh/1.0 m<sup>3</sup> to 3.5 kWh/1.0 m<sup>3</sup> depending on water quality [30].

### ***3.4 Bottled Water Transportation***

As noted earlier, bottled water transportation mode and distance to markets are major factors affecting energy use and ultimately cost of bottled water. Weber and Matthews [31] estimated average short travel distance for delivery to retailer and total lifecycle transportation travel distance as 330 km and 1,200 km, respectively. Furthermore, fuel consumption for 330 km and 1,200 km transport was estimated as 0.891 MJ/kg (844 BTU/kg) and 3.24 MJ/kg (3,073 BTU/kg), respectively.

Dettore [32] used lifecycle assessment (LCA) technique to quantify lifecycle energy need for plastic bottled water. The study concluded that more than 70 % of total energy demand in water bottling industry can be attributed to plastic bottle production if bottled water is produced and marketed locally, i.e., short travel distance. However, transportation energy needs will be the dominant factor if bottled water is transported long distances, for example, to national and overseas

**Table 1** Energy requirements for various water treatment technologies [21]

Treatment technique	Energy use (kWh/ million L)	Data source
Ozone		
Pre-oxidation (pretreatment)	30	SBW Consulting 2006 [27]
Disinfection	100	SBW Consulting 2006
Ultraviolet radiation		
Bacteria	10	SBW Consulting 2006
Viruses	10–50	SBW Consulting 2006
Microfiltration/ultrafiltration	70–100	SBW Consulting 2006
Nanofiltration (source TDS = 500–1,000 ppm)	660	AWWA 1999 [28]
Reverse osmosis		
Source TDS = 500 ppm	660	AWWA 1999
Source TDS = 1,000 ppm	790	AWWA 1999
Source TDS = 2,000 ppm	1,060	AWWA 1999
Source TDS = 4,000 ppm	1,590	AWWA 1999
Seawater Desalination (RO)	2,500–7,000	NRC 2008 [29]

**Table 2** Impact of transportation mode and travel distance on energy use [21, 22]

Scenario	Medium truck (km)	Heavy truck (km)	Railroad (km)	Cargo ship (km)	Energy use (MJ/L)
Local production	200 (local delivery)	0	0	0	1.4
Spring water from Fiji	100 (local delivery)	0	0	8,900 (Fiji to Long Beach, U.S.)	4.0
Spring water from France	100 (local delivery)	600 (Evian to Le Havre, France)	3,950 (New York to Los Angles)	5,670 (Le Havre to New York)	5.8

markets. As an example, Table 2 shows possible impact of transport mode and travel distance on bottled water energy use [21, 22].

## 4 Health and Environmental Impacts

Noted areas of health and environmental concerns related to bottled water production and consumption include inadequacy of regulation and/or lack of regulatory enforcement, potential contaminant leakage from plastic bottle to bottled water, plastic pollution due to indiscriminate disposal of used plastic bottles, potential air pollution due to incineration of used plastic bottles, and atmospheric CO<sub>2</sub> emission

due to high energy consumption attributed to bottled water production and transportation [33].

#### **4.1 Bottled Water Regulation**

Worldwide, bottled water regulations are developed to ensure safety of bottled water. In general, the World Health Organization (WHO) Guidelines for public drinking water systems are applicable to bottled water industry. Details about global drinking water standards and regulations are provided in Chap. 1 of this book. Below is an overview of typical bottled water regulations in several countries.

In the United States, bottled water production is regulated by the U.S. Food and Drug Administration (FDA) as a packaged commodity [U.S. Code of Federal Regulations (CFR), Title 21, Part 129 and Part 165.110(b)]. The FDA's bottled water standard of quality regulations generally follow national primary drinking water regulations for public water supplies (tap water) which is authorized by the Safe Drinking Water Act and regulated by the U.S. Environmental Protection Agency (EPA). Therefore, water quality standards for contaminants in bottled water are identical to the allowed Maximum Contaminant Levels (MCLs) in public drinking water supplies. Bottled water is labeled in accordance with type of source water based on the EPA classifications [34].

In Canada, similar to the United States., bottled water is regulated as a food package, and therefore, it must comply with Canada's Food and Drugs Act and Regulations [35]. Canadian regulations include specific microbiological standards, acceptable water treatment processes, and labeling requirements.

In most European countries bottled water production is regulated by the European Communities Regulations (e.g., FSAI [36]). These regulations provide the definition of mineral water, spring water and "other water," water source exploitation, water treatment, microbiological criteria, chemical contaminants, and bottled water labeling and packaging.

In China, bottled water industries use a variety of drinking water standards. These include national standards, local government standards, and standards developed by water bottling industries. However, according to China National Center for Food Safety Risk Assessment, unified national standards for regulating water bottling industry will be published in the near future [37].

In Japan, bottled water is usually referred to as "mineral water" and is regulated under the Consumer Product Safety Law [38]. Japanese regulations for bottled water cover safety, bottled water labeling, disposal of used containers, and importation of bottled water.

## 4.2 Regulation Inadequacies

Regulation enforcement and inadequacies are noted areas of concern related to safety of bottled water. Discussion below focuses on bottled water regulation in the United States as a typical example.

As noted above, in the United States, bottled water is regulated as packaged food. Investigators have identified the following problems with bottled water being regulated as packaged food: (1) the FDA requires only once a year testing for bottled water quality, while in comparison, the EPA mandates daily water quality testing and frequent monitoring of public drinking water supplies for contaminants; (2) the FDA does not have the specific statutory authority to require bottled water industry to use certified laboratories for water quality tests or to report test results, even if violations of the standards are found; and (3) the FDA's bottled water labeling requirements are similar to labeling requirements for other foods, but the information provided to consumers is less than what EPA requires of public water supplies under the Safe Drinking Water Act (GAO [39]).

The Natural Resources Defense Council (NRDC) conducted a comprehensive study of bottled water quality [40]. The investigation was based on published and unpublished data, surveys, expert interviews, and "snapshot" water testing of more than 1,000 bottles of water sold under 103 brand names. The NRDC study found that, in most cases, water treatment technologies for bottled water are similar to public drinking water supplies and reported some problems. For example, it was found that detected contaminants exceed established bottled water guidelines and standards in one-third of bottled water brands. It is noted that unlike public water supplies, bottled water is not packaged with a residual disinfectant such as chlorine. There is increased risk for bacterial growth since bottled water is often stored at relatively warm (room) temperatures in markets and elsewhere for extended periods of time. Studies show that during storage substantial growth of certain types of bacteria, such as *heterotrophic-plate-count-bacteria* and *Pseudomonas*, can occur in bottled water [40]. Even when there are relatively low levels of bacteria in finished bottled water, total bacteria counts in bottled water one week after storage can increase by 1,000-fold or more [41].

A study based on survey of 173 bottled water brands found that overall, 18 % of bottled waters producers fail to list the location of source water, and 32 % do not disclose water treatment process or water quality information [42]. Furthermore, the study noted that labels of nine of the ten top-selling domestic brands in the United States do not identify specific water source or water treatment process and do not provide contact information for consumers seeking additional information on water quality.



### ***4.3 Potential Contaminant Leakage***

The mechanism of contaminant leakage from plastic bottle to bottled water is not well understood. However, existing scientific literature presents a snapshot of potential contamination and implications of chemical leakage to bottled water. For example, Ceretti et al. [43] have noted leakage of acetaldehyde and formaldehyde. These two compounds are used in plastic bottle production and are contaminants with possible mutagenic or carcinogenic properties. The International Agency for Research on Cancer (IARC) has cited acetaldehyde as a possible human carcinogen that is genotoxic in many biological systems [44]. Formaldehyde has been identified as a genotoxic chemical that has demonstrated DNA and chromosomal damage to a number of organisms [45].

Bisphenol A (BPA), an organic compound, is also cited as a contaminant of concern in bottled water. A Japanese study found BPA concentrations of 0.24–3.5 µg/L in commercial bottled waters [46]. Additionally, antimony, a potentially harmful substance, has been observed to leak through plastic water bottles in both high temperature and long-term storage settings [47, 48].

### ***4.4 Plastic Waste Pollution and Management***

Around the world, plastic waste pollution of inland waters and oceans caused by disposal of used plastic bottles and similar products is major threat to protecting water quality and ecosystems (e.g., NRDC [49]). Therefore, implementing appropriate management practices for disposal of used plastic bottles is a critical global issue. Current management practices for disposal of used plastic bottles include landfill disposal (underground burial), incineration, and recycling.

#### **4.4.1 Landfill Disposal**

At present, landfill disposal is the most common practice for disposal of plastic bottles. For example, in the United States about 80 % of used plastic water bottles are disposed in landfills [3, 39]. However, landfill disposal is considered an environmental dilemma due to potential for chemical leachate from disposed plastic to soil and groundwater systems. It is estimated that it will take more than 1,000 years for a plastic bottle to decompose and be regarded environmentally safe [50]. In addition, land requirement for landfills is a major limitation particularly in urban areas and is expected to become more limited as the global urban population continues to rise. Significant amounts of used plastic bottles to be disposed of are transported to landfills away from urban centers, spreading plastic pollution to rural and isolated areas and increasing the energy footprint of the plastic bottle life cycle.

#### 4.4.2 Incineration

Incineration or combustion of plastic bottles is practiced worldwide as a part of incineration processes for other types of wastes generated in municipal areas. Incineration of plastic waste has been a common practice in some Asian countries since 1990s [51], and in recent years it is practiced in the United States as well. In 2011, the United States disposed of 29.3 million tons of waste by combustion process [52]. However, it is unknown how much of this waste specifically originates from PET plastics. It is estimated that rubber tires make up the majority of combustion programs in the United States.

Several studies show the impact of incineration on air pollution due to release of harmful gases [53]. However, energy generation and capture of heat during the consumption process are considered a positive outcome of incineration [54, 55]. Environmental friendly alternatives for thermal processing of plastic wastes, such as pyrolysis and gasification, are currently investigated through pilot projects and commercial scale research [55]. These new technologies show promise for safe disposal of used PET bottles in the future.

#### 4.4.3 Recycling

At present, recycling is considered the most appropriate management option for used plastic bottles. Recycling of used plastic bottles facilitates significant environmental benefits such as saving landfill space and less atmospheric pollution caused by incineration. However, worldwide, recycling of plastic bottles is not yet a common practice. For example, in the United States only about 28 % of used PET bottles are recycled [5]. Furthermore, there are limitations for implementing a successful recycling program. These include economic viability, capacity, distribution, and energy demand [51, 56, 57]. Ferrier [57] noted limited impact of recycling on energy conservation. It was estimated that increasing PET bottle recycling rate from 0 % to 100 % decreased energy use from 5.9 GJ/1,000 L to 4.1 GJ/1,000 L.

### 4.5 Atmospheric Pollution

Factors that contribute to atmospheric pollution include incineration of used plastic bottles noted earlier and dependency on fossil fuel consumption for bottled water production and transportation. Several studies show the impact of burning plastic and releasing of harmful particles such as  $\text{CO}_x$ ,  $\text{NO}_x$ ,  $\text{SO}_x$ , and polycyclic aromatic hydrocarbons to atmosphere [53]. High fossil fuel consumption can lead to atmospheric  $\text{CO}_2$  emission, a major contributor to global warming and climate change. However, atmospheric pollution concerns noted above are not unique to bottled

water industry and are a component of the overall plastic use and industrial activity in our modern society.

## 5 Bottled Water: A Decentralized System

As stated earlier, a major benefit of the bottled water is its practicality for providing safe drinking water to communities where extending public water distribution pipelines can be cost prohibitive. In these areas, small packaged water treatment bottling plants that use available local water sources can be installed to provide safe drinking water to affected communities.

Advances in small-scale and packaged water treatment technologies allow integration of these technologies into small-scale bottled water production as a decentralized system at the local level. A typical small-scale advanced water treatment package with a water treatment capacity of up to 50,000 L/day can be a unit that is 1.2 m long, 1.0 m wide, and 2.1 m high and can easily fit and operate in a small room [30]. The advanced water treatment package can provide multi-process purification of water with capability to remove a broad range of contaminants including arsenic, pesticides, and metals from any source water. Furthermore, the water bottling system can be equipped with a programmable logic control (PLC) component which facilitates automated operation of the system. The system allows for easy operator training and enables the operator to run the system without supervision.

Packaged water treatment bottling plants illustrated above are installed in several suburban Mexican communities using groundwater or other local water source to provide safe drinking water to needy communities [30]. In some communities, the bottled water plant owner provides 20 L bottled water to each household. Water consumers return empty plastic container to the bottling plant where it is rinsed and refilled for next use. Small volume (half-liter) bottled water is also produced for sale in the local markets and other nearby communities. This approach advances a secondary goal of bottled water production industry as a vehicle for creating small business and jobs at the local level. There are many other cases like this where small-scale micro-entrepreneurs in the water business are striving to provide clean water while also creating a stable income generation source for themselves and their families [58].

## 6 Conclusions

At present, in many areas, the cost of 1 L of typical bottled water is equivalent or higher than the cost of 1 L of gasoline and several hundred times higher than municipal tap water. As described in this chapter, disadvantages of bottled water consumption include health concerns, inadequate regulations, plastic pollution, and

significant energy demand for bottled water production and transportation. An understandable argument is made that the use of reliable public water supplies should not be replaced by more expensive, energy-intensive, and environmentally problematic bottled water. In the United States and a few other countries there is a movement to ban or restrict bottled water use and encourage more use of public water supplies. This movement is evidenced through numerous municipalities banning the use of funds to purchase bottled water, universities instituting a ban on bottled water in vending machines [59, 60], and some cities removing bottled water from market shelves [61], as well as several other instances of various approaches to control consumption of bottled water.

However, despite these concerns, bottled water consumption will continue to rise globally even though some countries for example Spain and Italy show decreasing trends of bottled water consumption [62]. Aside from its convenience of transportability, from health perspective, many consumers consider bottled water an alternative to high sugar content soft drinks. Furthermore, the huge plastic market which is not limited to plastic bottles is developing biodegradable plastic products. And there is strong momentum toward recycling of used plastic bottles. Industrial energy use efficiency and possible use of renewable energy resources for industrial production and commodity transport to the market are expected to alleviate the concern related to high energy consumption and atmospheric pollution due to production of bottled water.

Technically, bottled water production can be categorized as a decentralized water supply system. It facilitates drinking water distribution via bottles to consumers instead of constructing a high-cost conventional water supply infrastructure. Proper implementation of small decentralized water systems such as integrated bottled water and local water sources such as rainwater harvesting systems is expected to alleviate global scarcity of safe drinking water and improve human health and environment [63]. Therefore, with appropriate investment and improved regulation, there is a significant opportunity to incorporate bottled water production as a decentralized water system for community development and job creation in low-income areas as well as in affluent island resort areas where freshwater resources are limited and the island economy and water consumption significantly depend on seasonal tourists.

As the world population continues to climb past seven billion people and the demand for safe drinking water grows, it is critical to incorporate innovative procedures that will enable policy and decision-makers to make bold intellectual and financial investments that will result in providing safe drinking water to large unserved communities throughout the world. Bottled water can be a part of an overall solution to global lack of safe drinking water if innovative water treatment technologies, renewable energy use, and biodegradable plastic (or similar material) production are incorporated into bottled water production and infrastructure system design. Further advances in new and innovative water treatment technologies or using renewable energy sources such as solar and wind energy for water treatment are expected to reduce energy use and increase energy use efficiency for small decentralized water treatment systems including bottled water production.

## References

1. Siskos C (2001) Bottled water. In: LaMoreaux PE, Turner JT (eds) *Springs and bottled water of the world*. Springer, Berlin
2. Chapelle FH (2005) *Wellsprings: a natural history of bottled spring waters*. Rutgers University Press, New Brunswick, NJ
3. Columbia Water Center (2010) Bottled water. The Earth Institute at Columbia University. [http://water.columbia.edu/?id=learn\\_more&navid=bottled\\_water](http://water.columbia.edu/?id=learn_more&navid=bottled_water). Last accessed 30 Jan 2014
4. Wilk R (2006) Bottled water: the pure commodity in an age of marketing. *J Consum Cult* 6 (3):303–325
5. IBWA (2012) Facts about plastic bottles. International Bottled Water Association. <http://earth911.com/recycling/plastic/plastic-bottles/facts-about-plastic-bottles/>. Last accessed 30 Jan 2014
6. Rodwan JG (2010) Bottled water – challenging circumstances persist: future growth anticipated. U.S. and International Developments and Statistics. International Bottled Water Association. <http://www.bottledwater.org/economics/industry-statistics>
7. Johnstone N, Serret Y (2012) Determinants of bottled and purified water consumption: results based on OECD survey. *Water Pol* 14(4):668–679
8. Hu Z, Morton LW, Mahler RL (2011) Bottled water: United States consumers and their perceptions of water quality. *Int J Environ Res Public Health* 8(2):565–578
9. Wells DL (2005) The identification and perception of bottled water. *Perception* 34:1291–1292
10. Niccolucci V, Botto S, Rugani B, Nicolardi V, Bastianoni S, Gaggi C (2001) The real water consumption behind drinking water: the case of Italy. *J Environ Manage* 92:2611–2618
11. Doria M (2006) Bottled water versus tap water: understanding consumers-preferences. *J Water Health* 4:271–276
12. Younos T, Harwood VJ, Falkinham JO III, Shen H (2007) Pathogens in natural and engineered systems. *AWRA Water Resour Impact* 9(3):11–14
13. Grady C, Younos T (2012) Bottled water technology and its global ramifications: an overview. *Int Water Technol J* 2(2):185–194
14. Speight JG, Lange NA (2005) *Lange’s handbook of chemistry*, 16th edn. McGraw-Hill, New York, NY, pp 2.807–2.758
15. Sheehan KB (2014) The many shades of greenwashing: using consumer input for policy decisions regarding green advertisements. In: Kahle LR, Gurel-Atay E (eds) *Communicating sustainability for the green economy*. M.E. Sharpe, New York, NY, pp 43–55
16. Brei V, Böhm S (2011) Corporate social responsibility as cultural meaning management: a critique of the marketing of ‘ethical’ bottled water. *Bus Ethics Eur Rev* 20(3):233–252
17. Fliegelman JE (2009) The next generation of greenwash: diminishing consumer confusion through a national eco-labeling program. *Fordham Urban Law J* 37(4):1001–1028
18. The Coca-Cola Company (2013) Dasani. <http://www.dasani.com/>. Last accessed 30 Jan 2014
19. O’Connor J, O’Connor T (2010) The story of bottled water. Multimedia Presentation. H2o’C Engineering. Columbia, MO. <http://h2oc.com/pdfs/BottledWater.pps>
20. Woods A (2009) The cost of bottled water: how tap water can save thousands of dollars and the environment. Environmentalism. [http://environmentalism.suite101.com/article.cfm/tap\\_water\\_to\\_the\\_budget\\_rescue](http://environmentalism.suite101.com/article.cfm/tap_water_to_the_budget_rescue). Last accessed 30 Jan 2014
21. Gleick PH, Cooley HS (2009) Energy implications of bottled water. *Environ Res Lett* 4:1–6
22. Gleick PH, Cooley H (2012) Bottled water and energy. In: Gleick PH (ed) *The world’s water*, vol 7. The biennial report on freshwater. Pacific Institute for Studies in Development, Environment, and Security, Oakland, CA, pp 157–164
23. Bousted I (2005) Eco-profiles of the European plastics industry: polycarbonate. *Plastics Europe*. <http://lca.plasticseurope.org/pc7.htm>. Last accessed 30 Jan 2014
24. Franklin Associates (2007) Cradle-to-gate life cycle inventory of nine plastic resins and two polyurethane precursors. The Plastics Division of the American Chemistry Council. <http://www.nrel.gov/lci/database/default.asp>. Last accessed 30 Jan 2014

25. Larsen SG (2010) Determining energy requirements for future – water supply and demand alternatives. M.S. Thesis, Department of Civil and Environmental Engineering, The University of Utah
26. Younos T, Tulou K (2005) Energy needs, consumption and sources. In: Desalination – a primer. Journal of Contemporary Research and Education, Issue No. 132. Universities Council on Water Resources, Southern Illinois University, Carbondale, IL, pp 27–38
27. SBW Consulting Inc (2006) Municipal water treatment plant energy baseline study. Prepared for the Pacific Gas and Electric Company, Bellevue, WA
28. American Water Works Association (AWWA) (1999) Reverse osmosis and nanofiltration. AWWA manual M46. American Water Works Association, Denver, CO
29. National Research Council (NRC) (2008) Desalination: a national perspective. National Academies Press, Washington, DC
30. Bogle B, Younos T (2008) Decentralized and small-scale drinking water treatment systems: evaluation of case studies in Puebla and Querétaro, Mexico. In: 2008 NSF REU Proceedings of Research, VWRRC SR43-2008, Virginia Tech, Blacksburg, VA
31. Weber C, Matthews H (2008) Food miles and the relative impacts of food choices in the United States. *Environ Sci Technol* 42:3508–3513
32. Dettore CG (2009) Comparative life-cycle assessment of bottled vs. tap water Systems. Center for Sustainable Systems, School of Natural Resources and Environment, University of Michigan. Report No. CSS09-11
33. Grady CA, Younos T (2012) Bottled water: panacea or plague? *AWRA Water Resour Impact* 14(6):15–17
34. U.S. EPA (2005) Water health series: bottled water basics. Report 816-K-05-003. [http://www.epa.gov/OGWDW/faq/pdfs/fs\\_healthseries\\_bottlewater.pdf](http://www.epa.gov/OGWDW/faq/pdfs/fs_healthseries_bottlewater.pdf). Last accessed 30 Jan 2014
35. CFIA (2012) Bottled water. Canadian Food Inspection Agency (CFIS). <http://www.inspection.gc.ca/english/fssa/labeti/inform/wateaue.shtml>. Last accessed 30 Jan 2014
36. FSAI (2012) Bottled water. Food safety: authority of Ireland. [http://www.fsai.ie/faq/bottled\\_water.html](http://www.fsai.ie/faq/bottled_water.html). Last accessed 30 Jan 2014
37. Xiaodong W (2013) Unified standards for bottled water in the pipeline. China Daily News, 4 May 2013. [http://www.chinadaily.com.cn/china/2013-05/04/content\\_16474580.htm](http://www.chinadaily.com.cn/china/2013-05/04/content_16474580.htm). Last accessed 30 Jan 2014
38. Seubert C (2012) Japan bottled water regulations. [http://www.ehow.com/about\\_5437272\\_japan-bottled-water-regulations.html](http://www.ehow.com/about_5437272_japan-bottled-water-regulations.html). Last accessed 30 Jan 2014
39. GAO (2009) Bottled water: FDA safety and consumer protections are often less stringent than comparable EPA protections for tap water. Report to Congressional Requesters. United States Government Accountability Office, GAO-09-610, Washington, DC
40. Olson ED (1999) Bottled water: pure drink or pure hype? Natural resources defense council. <http://www.nrdc.org/water/drinking/bw/bwinx.asp>. Last accessed 30 Jan 2014
41. Ikem A, Oduyungbo S, Egiebor N, Nyavor K (2002) Chemical quality of bottled waters from three cities in eastern Alabama. *Sci Total Environ* 285:165–175
42. Leiba N, Gray S, Houlihan J (2011) 2011 bottled water scorecard. Environmental working group. <http://www.ewg.org/bottled-water-2011-home>. Last accessed 30 Jan 2014
43. Ceretti E, Zani C, Zerbini I, Guzzella L, Scaglia M, Berna V, Donato F, Monarca S, Feretti D (2010) Comparative assessment of genotoxicity of mineral water packed in polyethylene terephthalate (PET) and glass bottles. *Water Res* 44(5):1462–1470
44. IARC (1999) IARC monographs on the evaluation of carcinogenic risks to humans. Reevaluation of some organic chemicals, hydrazine and hydrogen peroxide, vol 71. International Agency for Research on Cancer, Lyon, France
45. IARC (2006) IARC monographs on the evaluation of carcinogenic risks to humans. Formaldehyde, 2-butoxyethanol and 1-tert-butoxypropan-2-ol, vol 88. International Agency for Research on Cancer, Lyon, France
46. Lim LW, Takeuchi T (2006) On-line precolumn enrichment of bisphenol A using boronate column in microcolumn liquid chromatography. *J Chromatogr A* 1106(1–2):139–145

47. Shotyk W, Krachler M, Chen B (2006) Contamination of Canadian and European bottled waters with antimony from PET containers. *J Environ Monit* 8:288–292
48. Westerhoff P, Prapaipong P, Shock E, Hillaireu A (2008) Antimony leaching from polyethylene terephthalate (PET) plastic used for bottled drinking water. *Water Res* 42(3):551–556
49. NRDC (2012) Plastic pollution in our oceans. Natural resources defense council. <http://www.nrdc.org/oceans/plastic-ocean/>. Last accessed 30 Jan 2014
50. City of Ann Arbor (2007) Bottled water issues summary. Compiled Fact Sheet. MI, U.S. [http://www.a2gov.org/government/publicservices/water\\_treatment/Documents/bottledwaterfactsheet12-3.pdf](http://www.a2gov.org/government/publicservices/water_treatment/Documents/bottledwaterfactsheet12-3.pdf). Last accessed 30 Jan 2014
51. Stein R (1992) Polymer recycling: opportunities and limitations. *PNAS* 89:835–838. <http://www.pnas.org/content/89/3/835.full.pdf+html>. Last accessed 30 Jan 2014
52. U.S. EPA (2011) Municipal solid waste in the United States: 2011 facts and figures. Environmental Protection Agency. [http://www.epa.gov/osw/nonhaz/municipal/pubs/MSWcharacterization\\_fnl\\_060713\\_2\\_rpt.pdf](http://www.epa.gov/osw/nonhaz/municipal/pubs/MSWcharacterization_fnl_060713_2_rpt.pdf). Last accessed 30 Jan 2014
53. Li CT, Zhuang HK, Hsieh LT, Lee WJ, Tsao MC (2001) PAH emissions from the incineration of three plastic wastes. *Environ Int* 27(1):61–67
54. Demirbas A (2011) Waste management, waste resource facilities and waste conversion processes. *Energy Convers Manage* 52(2):1280–1287
55. Brems A, Baeyens J, Dewil R (2012) Recycling and recovery of post-consumer plastic solid waste in a European context. *Therm Sci* 16(3):669–685
56. Rajendran S, Hodzic A et al (2013) Plastics recycling: insights into life cycle impact assessment methods. *Plast Rubber Compos* 42(1):1–10. <http://www.ingentaconnect.com/content/maney/prc/2013/00000042/00000001/art00001>
57. Ferrier C (2001) Bottled water: understanding a social phenomenon. World wildlife fund. [http://assets.panda.org/downloads/bottled\\_water.pdf](http://assets.panda.org/downloads/bottled_water.pdf). Last accessed 30 Jan 2014
58. Bayer R (2013) Drinking water as a source of income. Master's Thesis, Department of Human Geography, Lund University
59. Richard (2009) [http://www.polarisinstitute.org/university\\_of\\_winnipeg\\_bans\\_bottled\\_water](http://www.polarisinstitute.org/university_of_winnipeg_bans_bottled_water). Last accessed 30 Jan 2014
60. Daues (2008) <http://news.wustl.edu/news/Pages/13006.aspx>. Last accessed 30 Jan 2014
61. AFP (2009) <http://www.google.com/hostednews/afp/article/ALeqM5hZlHknsnA1YheZMnEDsF9w9U5qQ>. Last accessed 30 Jan 2014
62. Rodwan (2011) Bottled water 2011: the recovery continues. US and International Developments and Statistics. International Bottled Water Association. <http://www.bottledwater.org/files/2011BWstats.pdf>. Last accessed 30 Jan 2014
63. Younos T (2011) Paradigm shift: holistic approach for water management in urban environments. *Front Earth Sci* 5(4):421–427

# Index

## A

Acetaldehyde, 221  
Acetaminophen (paracetamol), 29  
Acid mine drainage, 140  
Activated carbon, granular (GAC), 79  
Activated sludge, 78, 164, 169, 175  
Acute diseases, 41  
Adenoviruses, 30, 66, 163  
Advil, 29  
*Aeromonas hydrophilia*, 66  
Aging, infrastructure, 47  
Agricultural impacts, 39  
Agriculture, 3, 39, 51, 142, 153, 157  
    impacts, 39  
    irrigation, 155, 176  
    runoff, 7, 39, 68  
    wastewater, 30  
    water reuse, 157  
Alkylphenols, 87  
Alternative energy sources, 135  
Alternative water sources, 133  
Alum, 8  
Aluminum, 164  
Ammonia, 15, 25, 40, 172  
Anatase, 84  
Androgens, 63  
Androstenedione (AND), 64  
Animal feeding operations (AFOs), 72  
Animal wastes, 7, 29, 61, 63, 72  
Anthropogenic impacts, 38  
Antibiotics, 29  
Arsenic, 43  
Asbestos, 67  
Atenolol, 85  
Australia, 24, 175, 205

## B

Bacteria, 164  
    human disease, 13  
Best management practices (BMPs), 77  
Biofuels, 142  
Biosolids, 72  
Bisphenol A (BPA), 78, 87, 221  
Boron, 164  
Bottled water, 86, 213  
Bovine growth hormone, recombinant (rBGH), 64  
Brine recirculation, 185  
Brochantite, 104  
Bromine, 11  
Bromochloromethane, 28

## C

Caffeine, 29, 64, 70, 78, 83, 87  
Calcium carbonate, 105  
Caliciviruses, 66  
*Campylobacter*, 29  
Carbamazepine, 78  
Charcoal, 10  
Chemical analyses, 12  
Chernobyl, 141  
Chile, 205  
China, 23, 173  
Chloramines, 11  
Chlorate, 28  
Chlorination, 8, 28, 81  
Chlorine, 8, 11, 22, 25, 50, 71, 81, 102, 113, 133, 160, 167, 175, 220  
Chlorofluorocarbons (CFCs), 67  
Cholera, 3, 7, 14, 42



Chronic diseases, 42  
 Clean Water Act (CWA), 164  
 Climate change, 125, 143  
 Clofibric acid, 83  
 Coagulation, 8  
 Coal, 139  
 Codeine, 29, 85  
 Combined sewer overflows (CSOs), 48, 68  
 Combined sewer systems (CSSs), 70  
 Competing interests, 51  
 Concentrated animal feeding operations (CAFOs), 68  
 Conflicts, 52  
 Contaminant candidate list (CCL), 28  
 Contaminants, emerging, 61  
   intrusion, 95  
   measurement, 13  
 Contaminants of emerging concern (CECs), 166  
 Copper corrosion, 97  
   pipe failures, 101  
   pitting, 95, 102  
 Corrosion, 101  
   inhibitors, 104  
   pipes, 100  
 Coxsackieviruses, 66  
 CPVC (chlorinated polyvinyl chloride), 96  
*Cryptosporidium*, 164  
 Cuprite, 103

## D

Decentralized water system, 213  
 DEET, 66, 78, 79  
 Desalination, 134  
   solar, 181, 191  
   technologies, 184  
 Design phase, limitations, 44  
 DESSOL (Desalination with solar energy), 200  
 Developed countries, 47  
 Developing countries, 17  
 Diarrhea, 3, 20, 41, 97  
 Diseases, acute, 41  
   chronic, 42  
   waterborne, 3, 29  
 Disinfectants, 21  
 Disinfection, 8, 11, 80  
 Disinfection by-products (DBPs), 28, 43, 50  
 Distillation, 9, 184  
 Drinking water, 1  
 Dysentery, 3, 12

## E

Echoviruses, 66  
*E. coli* 0157, 29

Electricity generation, 125, 136  
 Electrodialysis (ED), 188  
 Emerging challenges, 1  
 Emerging contaminants, 61, 165  
 Emerging countries, 43  
 Emerging issues, 37  
 Emerging standards, 27  
 Endocrine disrupting compounds, 61  
 Energy demand, 127  
 Erythromycin, 29  
 17 $\alpha$ / $\beta$ -Estradiol (E2), 64  
 Estriol (E3), 64  
 Estrogens, 63  
 Estrone (E1), 64  
 17 $\alpha$ -Ethinylestradiol (EE2), 64  
 Europe, 176  
 European Union, 22  
 Evaluation, limitations, 45  
 Evaporation, 9

## F

Fertilizers, 7, 39, 61, 142  
 Filtration, 9  
 Flocculants, 11, 166  
 Fluoride, 3, 43, 140, 199  
 Formaldehyde, 221  
 Freshwater supply, 125  
 Fukushima, 141

## G

Gaseous cavitation, 117  
 Gemfibrozil, 79  
*Giardia*, 21, 22, 29, 164  
 Glacial meltwater, 144  
 Global climate change, 30  
 Global goals, 1  
 Granular activated carbon (GAC), 79  
 Groundwater, extraction, 130, 143  
   pathways, 72  
 Guidelines, 17  
 Guinea worm, 3

## H

Health, 1, 37, 62, 199, 218  
   impacts, 213  
   public, 1, 46  
   water, 37, 41  
*Helicobacter pylori*, 66  
 High concentration photovoltaic thermal (HCPVT), 203  
 Historical water conflicts, 52  
 History, 1

Hormones, 61, 63, 71  
 Hospital wastewater, 71  
 Human disease, 13  
 Human wastes, 7  
 Humidification dehumidification (HDH), 194  
 Hydraulics, major/minor systems, 98  
 Hydraulic transients, 95, 112  
 Hydropower, 138

**I**

Ibuprofen, 29, 85  
 Implementation phase, constraints, 45  
 Improved sources, 2  
 India, 26, 175  
 Industrial effluents, water reuse, 161  
 Industrial impacts, 39  
 Industrial wastewater, 69  
 Inequality, 75  
 Integrity, 96  
 Intimidation, 52  
 Intrusion, 111  
 Iodine-131, 141  
 Iodine-based contrast media (ICM), 71  
 Ion exchange, 11  
 Israel, 27

**K**

Kenya, 25

**L**

Land application, 72  
 Landfills, 29, 221  
   leaching, 73  
 Lead, 67, 109  
 Leakage, 218, 221  
   rates, 113  
 Lime, 8

**M**

Maintenance, limitations, 46  
 Malachite, 104  
 Manure, 72  
 Maximum contaminant level goal (MCLG), 18  
 Maximum contaminant levels (MCLs), 18  
 Mechanical vapor compression (MVC), 186  
 Membrane bioreactors (MBRs), 84, 153, 167  
 Membrane distillation, desalination, 184  
 Membranes, spiral-wound, 208  
 Membrane technologies, 187

Metalloids, 164  
 Microfiltration, 82  
 Microsporidia, 66  
 Mining impacts, 39  
 Monitoring, limitations, 45  
 Motrin, 29  
 Multiple-effect distillation (MED/ME), 186  
 Multiple-effect humidification (MEH), 194  
 Multiple-stage flash (MSF) distillation, 185  
 Municipal wastewater, 153  
   quality, 162  
   reuse, 161  
   treatment, 166

*Mycobacterium avium intracellulare*, 66

**N**

Nano-composite RO membranes, 207  
 Nanofiltration, 82  
 Naproxen, 74, 79, 83, 86  
 National Primary Drinking Water Regulations (NPDWRs), 21  
 National Secondary Drinking Water Regulations (NSDWRs), 21  
 Natural gas, 141  
 Natural organic materials (NOMs), 50  
 Nicotine, 64, 73  
 Nitrates, 15, 21, 25, 39, 43, 75, 104, 142  
 Nitrites, 15, 21, 25, 43  
 Nitrogen, 15  
*N*-Nitrosodimethylamine (NDMA), 28  
 Nuclear disaster, 141  
 Nuclear power plants, 141  
 Nuprin, 29

**O**

Open defecation, 7  
 Operation, limitations, 46  
 Organic chemicals, 21  
 Organic wastewater contaminants (OWCs), 62, 71  
 Orthophosphates, oxidation of copper, 104  
 Over-the-counter (OTC) drugs, 64  
 Oxygen-consuming capacity, 15  
 Oxyhalides, 164  
 Ozonation, 11, 83, 161, 164

**P**

Paracetamol, 29  
 Passivation layer, 103  
 Pathogens, 163

- Pathogens (*cont.*)  
 emerging, 29, 66  
 Personal care products, 62, 74, 133  
 Pesticides, 7, 19, 22, 26, 43, 74, 77, 165, 223  
 PEX (cross-linked polyethylene), 96  
 Pharmaceuticals, 29, 61  
 Photovoltaic cells, 207  
 Phthalates, 87  
 Physical integrity, 96  
 Pinhole pipe leaks, 101  
 Pipe failure, 100  
 Pipe materials, 106  
 Pitting, localized corrosion 100  
 Plant macronutrients, 39  
 Plastic bottles, 215  
 Plastic pollution, 213, 221  
 Plumbing failure, 97  
 Plumbing systems, 29, 95  
 Polychlorinated biphenyls (PCBs), 67  
 Polyphosphates, pitting corrosion, 104  
 Polypropylene terephthalate (PET), 87, 215  
 Portable thermoelectric solar still (PTSS), 202  
 Potable water access, 37  
 Pressure variations, 116  
 Public health risk, 96
- Q**  
 Quality goals, 30  
 Quality standards, 17
- R**  
 Radionuclides, 21, 141  
 REACH, 67  
 Regulations, 1, 17, 67  
 Renewable energy, 190  
 Responsibility, 16  
 Reverse osmosis (RO), 11, 82, 134, 187
- S**  
 Sabotage, 52  
 Safe drinking water, 2, 16, 213  
 Safe Drinking Water Act (SDWA), 18  
 Salicylic acid, 84  
 Salinity-gradient solar ponds (SGSPs), 193  
 Salinization, 27, 39  
 Saltwater intrusion, 143  
 Sand filtration, 9  
 Scale layers, 103  
 SDWA. *See* Safe Drinking Water Act (SDWA)
- Sea-level rise, 143  
 Seawater reverse osmosis (SWRO), 183, 188  
 Security measures, 53  
 Sedimentation, 8  
 Septic tanks, 68, 74  
 Service lines, 109  
 pressure variations, 115  
 Sewage, 7  
 sludge, 72  
 Sewer lines, leaking, 29  
 Silicon, 164  
 Sludge, 7, 72  
 activated, 78  
 Societal challenges, 37  
 Soil salinity, 39  
 Solar desalination, 181, 191  
 Solar ponds, 193  
 Standardization, 14  
 Standards, 1, 15, 17  
 emerging, 27  
 Stockholm Declaration (1972), 30  
 Subsurface flow constructed wetlands, 83  
 Sulfamethaxazole, 78, 79, 85  
 Surface water, 69  
 extraction, 130  
 Sustainability, 213  
 Sustainable water reuse, 153  
 Synthetic compounds, 64
- T**  
 Tap water, 95  
 Technical limitations, 37, 42  
 Terrorism, 52, 112  
 Testosterone (TST), 64  
 Theophylline, 84  
 Thermal (distillation) processes, 185  
 Thermal vapor compression (TVC), 186  
 Thermoelectric power sources, 138  
 Titanium dioxide, 84  
 Toxic Substances Control Act (TSCA), 67  
 Toxins, 2  
 Transformation, 82  
 Transitory contamination, 112  
 Triclosan, 65, 85  
 Trovalfoxacin, 83  
 Typhoid, 3
- U**  
 Ultrafiltration, 82  
 Ultrahigh concentrator photovoltaic (UHCPV)  
 technology, 203

Ultraviolet (UV), 81  
Uranium, contamination, 141  
Urbanization, 7, 40, 154, 162, 173  
    impacts, 40

**V**

Vapor compression, 186  
Violence, 52  
Virtual water, 52  
Viruses, 11, 21, 66, 113, 163

**W**

Wastewater, chemicals, 164  
    microorganisms, 163  
    reclaimed, 134  
    reuse, 153  
Wastewater treatment plants (WWTPs),  
    municipal, 69, 166  
Water analysis, 12  
Water availability, 154  
    limitations, 49

Water conflicts, historical, 52  
Water distribution, 125, 131  
Water distribution systems, 95  
    contaminant intrusion, 111  
Water–energy nexus, 125  
Water extraction, 129  
Water Framework Directive (WFD), 68  
Water Information System for Europe (WISE), 22  
Water provisioning, 48  
Water quality, 153  
    integrity, 96  
Water reuse, sustainable, 153  
Water stress, 153, 155  
Water supply, remote areas, 181  
Water treatment, 1, 8, 125, 132  
    limitations, 50  
    technical limitations, 37  
Wetlands, constructed, 83  
WHO, 19

**Z**

Zinc, 21, 25, 141