

# Handbook of Engineering Hydrology

Environmental Hydrology and  
Water Management

Edited by  
Saeid Eslamian

 CRC Press  
Taylor & Francis Group

Handbook of  
**Engineering**  
**Hydrology**

Environmental Hydrology  
and Water Management

## Handbook of Engineering Hydrology

*Handbook of Engineering Hydrology: Fundamentals and Applications, Book I*

*Handbook of Engineering Hydrology: Modeling, Climate Change, and Variability, Book II*

*Handbook of Engineering Hydrology: Environmental Hydrology and Water Management, Book III*

# Handbook of Engineering Hydrology

Environmental Hydrology  
and Water Management

Edited by  
Saeid Eslamian



CRC Press

Taylor & Francis Group

Boca Raton London New York

---

CRC Press is an imprint of the  
Taylor & Francis Group, an **informa** business

MATLAB® is a trademark of The MathWorks, Inc. and is used with permission. The MathWorks does not warrant the accuracy of the text or exercises in this book. This book's use or discussion of MATLAB® software or related products does not constitute endorsement or sponsorship by The MathWorks of a particular pedagogical approach or particular use of the MATLAB® software.

CRC Press  
Taylor & Francis Group  
6000 Broken Sound Parkway NW, Suite 300  
Boca Raton, FL 33487-2742

© 2014 by Taylor & Francis Group, LLC  
CRC Press is an imprint of Taylor & Francis Group, an Informa business

No claim to original U.S. Government works  
Version Date: 20140115

International Standard Book Number-13: 978-1-4665-5250-0 (eBook - PDF)

This book contains information obtained from authentic and highly regarded sources. Reasonable efforts have been made to publish reliable data and information, but the author and publisher cannot assume responsibility for the validity of all materials or the consequences of their use. The authors and publishers have attempted to trace the copyright holders of all material reproduced in this publication and apologize to copyright holders if permission to publish in this form has not been obtained. If any copyright material has not been acknowledged please write and let us know so we may rectify in any future reprint.

Except as permitted under U.S. Copyright Law, no part of this book may be reprinted, reproduced, transmitted, or utilized in any form by any electronic, mechanical, or other means, now known or hereafter invented, including photocopying, microfilming, and recording, or in any information storage or retrieval system, without written permission from the publishers.

For permission to photocopy or use material electronically from this work, please access [www.copyright.com](http://www.copyright.com) (<http://www.copyright.com/>) or contact the Copyright Clearance Center, Inc. (CCC), 222 Rosewood Drive, Danvers, MA 01923, 978-750-8400. CCC is a not-for-profit organization that provides licenses and registration for a variety of users. For organizations that have been granted a photocopy license by the CCC, a separate system of payment has been arranged.

**Trademark Notice:** Product or corporate names may be trademarks or registered trademarks, and are used only for identification and explanation without intent to infringe.

**Visit the Taylor & Francis Web site at**  
**<http://www.taylorandfrancis.com>**

**and the CRC Press Web site at**  
**<http://www.crcpress.com>**

# Contents

---

Preface.....	vii
Editor .....	xi
Contributors.....	xiii
1 Anthropocenic Aquifer: New Thinking.....	1
<i>Anthony Richard Turton and Frederik Stefanus Botha</i>	
2 Artificial Recharge Experiences in Semiarid Areas .....	17
<i>Noureddine Gaaloul and Saeid Eslamian</i>	
3 Disinfection of Water and Nanotechnology .....	51
<i>Seyedeh Matin Amininezhad, Sayed Mohamad Amininejad, and Saeid Eslamian</i>	
4 Environmental Engineering for Water and Sanitation Systems.....	65
<i>Bosun Banjoko</i>	
5 Environmental Flows .....	85
<i>Sara Shaeri Karimi, Mehdi Yasi, Jonathan Peter Cox, and Saeid Eslamian</i>	
6 Environmental Nanotechnology .....	105
<i>Saeid Eslamian, Raheleh Malekian, and Mohammad Javad Amiri</i>	
7 Formation of Ecological Risk on Plain Reservoirs.....	119
<i>Svetlana Dvinskikh, Alexander Kitaev, Victor Noskov, and Olga Larchenko</i>	
8 Groundwater Vulnerability .....	145
<i>Jason J. Gurdak</i>	
9 Historical Development of Wastewater Management .....	163
<i>Giovanni De Feo, Georgios Pericles Antoniou, Larry Wesley Mays, Walter Dragoni, Hilal Franz Fardin, Fatma El-Gohary, Pietro Laureano, Eleni Ioannis Kanetaki, Xiao Yun Zheng, and Andreas Nikolaos Angelakis</i>	
10 Hydrofracturing and Environmental Problems.....	219
<i>Bosun Banjoko</i>	
11 Modeling of Wetland Systems .....	233
<i>Jennifer M. Olszewski and Richard H. McCuen</i>	
12 Modifications in Hydrological Cycle.....	247
<i>Jayantilal N. Patel</i>	

13	Nonpoint Source and Water Quality Modeling.....	261
	<i>Zhonglong Zhang</i>	
14	River Managed System for Flood Defense.....	299
	<i>Akram Deiminiat and Saeid Eslamian</i>	
15	Sediment Pollution.....	315
	<i>Qin Qian</i>	
16	Stormwater Modeling and Management.....	329
	<i>Xuheng Kuang</i>	
17	Stormwater Modeling and Sustainable Management in Highly Urbanized Areas.....	347
	<i>J. Bryan Ellis and Christophe Viavattene</i>	
18	Integrated Water Resource Management and Sustainability.....	365
	<i>Husain Najafi and Ehsan Tavakoli-Nabavi</i>	
19	Sustainable Wastewater Treatment.....	387
	<i>Erik Grönlund</i>	
20	Tourism and River Environment.....	401
	<i>Akram Deiminiat, Hassan Shojaee Siuki, and Saeid Eslamian</i>	
21	Transboundary River Basin Management.....	421
	<i>David Stephenson and Eva Sbrana</i>	
22	Transboundary Water Resource Management.....	433
	<i>Inga Jacobs and Anthony Richard Turton</i>	
23	Updating the Hydrological Knowledge: A Case Study.....	445
	<i>Olga Eugenia Scarpati, Eduardo Kruse, Marcela Hebe Gonzalez, Alberto Ismael Juan Vich, Alberto Daniel Capriolo, and Ruben Mario Caffera</i>	
24	Water Governance.....	461
	<i>Colin Green and Saeid Eslamian</i>	
25	Water Pollution Control Using Low-Cost Natural Wastes.....	485
	<i>Faezeh Eslamian and Saeid Eslamian</i>	
26	Water Resources Assessment in a River Basin Using AVSWAT Model.....	501
	<i>Aavudai Anandhi, V.V. Srinivas, and D. Nagesh Kumar</i>	
27	Water Scarcity.....	519
	<i>R.B. Singh and Dilip Kumar</i>	
28	Water Security: Concept, Measurement, and Operationalization.....	545
	<i>Chansheng He, Lanhui Zhang, Xifeng Zhang, and Saeid Eslamian</i>	
29	Water Supply and Public Health and Safety.....	555
	<i>Theodore C. Crusberg</i>	
	<b>Index.....</b>	<b>577</b>

# Preface

---

Hydrological and ecological connectivity is a matter of high concern. All terrestrial and coastal ecosystems are connected with water, which includes groundwater, and there is a growing understanding that “single ecosystems” (mountain forest, hill forest, mangrove forest, freshwater swamp, peat swamp, tidal mudflat, and coral reef) that are actually the result of an artificial perception and classification can, in the long term, only be managed by a holistic vision at the watershed level. It is essential to investigate ecosystem management at the watershed level, particularly in a changing climate.

In general, there are two important approaches:

1. Adaption to hydrological events such as climate change, drought, and flood
2. Qualitative and quantitative conservation of water, thereby optimizing water consumption

The *Handbook of Engineering Hydrology* aims to fill the two-decade gap since the publication of David Maidment’s *Handbook of Hydrology* in 1993 by including updated material on hydrology science and engineering. It provides an extensive coverage of hydrological engineering, science, and technology and includes novel topics that were developed in the last two decades. This handbook is not a replacement for Maidment’s work, but as mentioned, it focuses on innovation and provides updated information in the field of hydrology. Therefore, it could be considered as a complementary text to Maidment’s work, providing practical guidelines to the reader. Further, this book covers different aspects of hydrology using a new approach, whereas Maidment’s work dealt principally with classical components of hydrologic cycle, particularly surface and groundwater and the associated physical and chemical pollution.

The key benefits of the book are as follows: (a) it introduces various aspects of hydrological engineering, science, and technology for students pursuing different levels of studies; (b) it is an efficient tool helping practitioners to design water projects optimally; (c) it serves as a guide for policy makers to make appropriate decisions on the subject; (d) it is a robust reference book for researchers, both in universities and in research institutes; and (e) it provides up-to-date information in the field.

Engineers from disciplines such as civil engineering, environmental engineering, geological engineering, agricultural engineering, water resources engineering, natural resources, applied geography, environmental health and sanitation, etc., will find this handbook useful.

Further, courses such as engineering hydrology, groundwater hydrology, rangeland hydrology, arid zone hydrology, surface water hydrology, applied hydrology, general hydrology, water resources engineering, water resources management, water resources development, water resources systems and planning, multipurpose uses of water resources, environmental engineering, flood design, hydrometeorology, evapotranspiration, water quality, etc., can also use this handbook as part of their curriculum.



This set consists of 87 chapters divided into three books, with each book comprising 29 chapters. This handbook consists of three books as follows:

1. Book I: Fundamentals and Applications
2. Book II: Modeling, Climate Change, and Variability
3. Book III: Environmental Hydrology and Water Management

This book focuses on environmental hydrology and water management. The chapters can be categorized as follows:

- *Groundwater management*: Anthropogenic Aquifer: A New Thinking, Artificial Recharge Experiences in Semiarid Areas, Groundwater Vulnerability, and Hydrofracturing and Environmental Problems.
- *Purification, sanitation, and quality modeling*: Disinfection of Water and Nanotechnology, Environmental Engineering for Water and Sanitation Systems, Environmental Nanotechnology, Modeling of Wetland Systems, Nonpoint Source and Water Quality Modeling, Water Pollution Control Using Low-Cost Natural Wastes, and Water Supply and Public Health and Safety.
- *Surface water management*: Environmental Flows, River Managed System for Flood Defense, Stormwater Modeling and Management, Stormwater Modeling and Sustainable Management in Highly Urbanized Areas, Tourism and River Environmental Hydrology, and Transboundary River Basin Management.
- *Wastewater and sediment management*: Historical Development of Wastewater Management, Sediment Pollution, and Sustainable Wastewater Treatment.
- *Water law*: Water Governance, Water Scarcity, and Water Security: Concept, Measurement, and Operationalization.
- *Water resources management*: Formation of Ecological Risk on Plain Reservoirs, Modification in Hydrological Cycle, Sustainable Development in Integrated Water Resources Management, Transboundary Water Resource Management, Updating the Hydrological Knowledge: A Case Study, and Water Resources Assessment in a River using AVSWAT Model.

About 200 authors from various departments and across more than 30 countries worldwide have contributed to this book, which includes authors from the United States comprising about one-third of the total number. The countries that the authors belong to have diverse climate and have encountered issues related to climate change and water deficit. The authors themselves cover a wide age group and are experts in their fields. This book could only be realized due to the participation of universities, institutions, industries, private companies, research centers, governmental commissions, and academies.

I thank several scientists for their encouragement in compiling this book: Prof. Richard McCuen from the University of Maryland, Prof. Majid Hassanizadeh from Utrecht University, Prof. Soroush Sorooshian from the University of California at Irvine, Profs. Jose Salas and Pierre Julien from Colorado State University, Prof. Colin Green from Middlesex University, Prof. Larry W. Mays from Arizona State University, Prof. Reza Khanbilvardi from the City College of New York, Prof. Maciej Zalewski from the University of Łódź'-Poland, and Prof. Philip B. Bedient from Rice University.

In addition, Research Professor Emeritus Richard H. French from Las Vegas Desert Research Institute, who has authored the book *Open Channel Hydraulics* (McGraw-Hill, 1985), has encouraged me a lot. I quote his kind words to end this preface:

My initial reaction to your book is simply WOW!

Your authors are all well known and respected and the list of subjects very comprehensive. It will be a wonderful book. Congratulations on this achievement.

**Saeid Eslamian**

*Isfahan University of Technology  
Isfahan, Iran*

MATLAB® is a registered trademark of The MathWorks, Inc. For product information, please contact:

The MathWorks, Inc.  
3 Apple Hill Drive  
Natick, MA 01760-2098 USA  
Tel: 508-647-7000  
Fax: 508-647-7001  
E-mail: [info@mathworks.com](mailto:info@mathworks.com)  
Web: [www.mathworks.com](http://www.mathworks.com)



# Editor

---



**Saeid Eslamian** is an associate professor of hydrology at Isfahan University of Technology, Iran, where he heads the Hydrology Research Group at the Department of Water Engineering. His research focuses mainly on statistical and environmental hydrology and climate change. In particular, he specializes in modeling and prediction of natural hazards including floods, droughts, storms, wind frequency, and groundwater drawdowns, as well as pollution in arid and semiarid zones, particularly in urban areas.

Prof. Eslamian was born in Isfahan, a large city located in the center of Iran. He received his BS in water engineering from Isfahan University of Technology in 1986. Later, he was offered a scholarship for a master's degree at Tarbiat Modares University, Tehran. He completed his studies in hydrology and water resources in 1989. In 1991, he was awarded a grant for pursuing his PhD in civil engineering at the University of New South Wales, Sydney, Australia. His supervisor was Professor David H. Pilgrim, who encouraged him to conduct research on regional flood frequency analysis using a new region of influence approach. Soon after his graduation in 1995, Eslamian returned to Iran and worked as an assistant professor at Isfahan University of Technology (IUT). In 2001, he was promoted to associate professor.

Eslamian was a visiting professor at Princeton University, Princeton, New Jersey, in 2006 and at the University of ETH Zurich, Switzerland in 2008. During this period, he developed multivariate L-moments for low flow and soil–moisture interaction.

Eslamian has contributed to more than 300 publications in books, research journals, and technical reports or papers in conferences. He is the founder and chief editor of the *International Journal of Hydrology Science and Technology* and the *Journal of Flood Engineering*. He also serves as an editorial board member and reviewer of about 30 Web of Science (ISI) journals. Recently, he has been appointed as the chief editor for a three-set book series Handbook of Engineering Hydrology by Taylor & Francis Group (CRC Press).

Prof. Eslamian has prepared course material on fluid mechanics, hydraulics, small dams, hydraulic structures, surface runoff hydrology, engineering hydrology, groundwater hydrology, water resource management, water resource planning and economics, meteorology, and climatology at the undergraduate level and material on evapotranspiration and water consumption, open channel hydraulics, water resources engineering, multipurpose operation of water resources, urban hydrology, advanced hydrology, arid zones hydrology, rangeland hydrology, groundwater management, water resources development, and hydrometeorology at the graduate level.

He has presented courses on transportation, Energy and Agriculture Ministry; and different university departments in governmental and private sectors: civil engineering, irrigation engineering, water engineering, soil sciences, natural resources, applied geography, and environmental health and sanitation.

Eslamian has undertaken national and international grants on “Studying the impact of global warming on the Kingdom of Jordan using GIS,” “Study of the impact of different risk levels of climate change on Zayandehroud River Basin’s climatic variables,” “Feasibility of reclaimed water reuse for industrial uses in Isfahan Oil Refining Company,” “Microclimate zoning of Isfahan city and investigation of microclimate effect on air temperature, relative humidity and reference crop evapotranspiration,” “Feasibility of using constructed wetland for urban wastewater,” “Multivariate linear moments for low flow analysis of the rivers in the north-eastern USA,” and “Assessment of potential contaminant of landfill on Isfahan water resources.” He has received two ASCE and EWRI awards from the United States in 2009 and 2010, respectively, as well as an outstanding researcher award from Iran in 2013. Persian being his native language, Prof. Eslamian is also fluent in English and is professionally familiar with French and Arabic.

# Contributors

---

**Sayed Mohamad Amininejad**

Department of Water Engineering  
Isfahan University of Technology  
Isfahan, Iran

**Seyedeh Matin Amininezhad**

Department of Chemistry  
Islamic Azad University of Shahreza  
Isfahan, Iran

**Mohammad Javad Amiri**

Department of Water Engineering  
Fasa University  
Shiraz, Iran

**Aavudai Anandhi**

Department of Civil Engineering  
Indian Institute of Science  
Bangalore, India

and

Department of Agronomy  
Kansas State University  
Manhattan, Kansas

**Andreas Nikolaos Angelakis**

Institute of Iraklio  
National Agricultural Research Foundation  
Iraklio, Greece

**Georgios Pericles Antoniou**

Architect Engineer  
Athens, Greece

**Bosun Banjoko**

Department of Chemical Pathology  
and  
Institute of Public Health  
College of Health Sciences  
Obafemi Awolowo University  
Ile-Ife, Nigeria

**Frederik Stefanus Botha**

Water Hunters  
Pretoria, South Africa

**Ruben Mario Caffera**

Environmental System Unit  
School of Agronomy  
Uruguayan State University  
Montevideo, Uruguay

**Alberto Daniel Capriolo**

Center of Pharmacological and  
Botanical Studies  
National Research Council  
Buenos Aires, Argentina

**Jonathan Peter Cox**

Caribbean Institute for Meteorology and  
Hydrology  
Bridgetown, Barbados

**Theodore C. Crusberg**

Department of Biology and Biotechnology  
Worcester Polytechnic Institute  
Worcester, Massachusetts

**Giovanni De Feo**

Department of Industrial Engineering  
University of Salerno  
Fisciano, Italy

**Akram Deiminiat**

KPM Consulting Engineers  
Mashhad, Iran

**Walter Dragoni**

Department of Earth Sciences  
University of Perugia  
Perugia, Italy

**Svetlana Dvinskikh**

Geographical Faculty  
Department of Hydrology and Water Resources  
Protection  
Perm State University  
Perm Krai, Russian Federation

**Fatma El-Gohary**

Water Pollution Research Department  
National Research Centre  
Cairo, Egypt

**J. Bryan Ellis**

Urban Pollution Research Centre  
Middlesex University  
London, United Kingdom

**Faezeh Eslamian**

Department of Civil Engineering  
Isfahan University of Technology  
Isfahan, Iran

**Saeid Eslamian**

Department of Water Engineering  
Isfahan University of Technology  
Isfahan, Iran

**Hilal Franz Fardin**

Social Sciences Department  
French Institute of Pondicherry  
Paris, France

**Noureddine Gaaloul**

Department of Water Resources  
National Institute of Research in Rural  
Engineering of Water and Forestry  
Ariana, Tunisia

**Marcela Hebe Gonzalez**

Center of Atmospheric and Oceanic Sciences  
National Research Council  
and  
Department of Atmospheric and Oceanic Sciences  
Buenos Aires University  
Buenos Aires, Argentina

**Colin Green**

Division of Flood Hazard Research  
Middlesex University  
London, United Kingdom

**Erik Grönlund**

Division of Ecotechnology  
Department of Engineering and Sustainable  
Development  
Mid Sweden University  
Östersund, Sweden

**Jason J. Gurdak**

Department of Earth and Climate Sciences  
San Francisco State University  
San Francisco, California

**Chansheng He**

Key Laboratory of West China's Environmental  
System  
Lanzhou University  
Lanzhou, Gansu, People's Republic of China  
and

Department of Geography  
Western Michigan University  
Kalamazoo, Michigan

**Inga Jacobs**

Business Development, Marketing and  
Communication Section  
Water Research Commission  
Pretoria, South Africa

**Eleni Ioannis Kanetaki**

Architect Engineer  
Athens, Greece

**Alexander Kitaev**

Geographical Faculty  
Department of Hydrology and Water Resources  
Protection  
Perm State University  
Perm Krai, Russian Federation

**Eduardo Kruse**

Geological and Hydrological Area  
National Research Council  
Buenos Aires, Argentina

and

Faculty of Natural Sciences  
La Plata National University  
La Plata, Argentina

**Xuheng Kuang**

WRS Infrastructure and Environmental, Inc.  
Tampa, Florida

**Dilip Kumar**

Department of Geography  
Shaheed Bhagat Singh (Evening) College  
University of Delhi  
New Delhi, India

**D. Nagesh Kumar**

Department of Civil Engineering  
and  
Center for Earth Sciences  
Indian Institute of Science  
Bangalore, India

**Olga Larchenko**

Geographical Faculty  
Department of Hydrology and Water Resources  
Protection  
Perm State University  
Perm Krai, Russian Federation

**Pietro Laureano**

Bagno a Ripoli Firenze  
Tuscany, Italy

**Raheleh Malekian**

Department of Water Engineering  
Isfahan University of Technology  
Isfahan, Iran

**Larry Wesley Mays**

School of Sustainable Engineering and the Built  
Environment  
Arizona State University  
Phoenix, Arizona

**Richard H. McCuen**

Department of Civil and Environmental  
Engineering  
University of Maryland  
College Park, Maryland

**Husain Najafi**

Department of Water Resources Engineering  
Tarbiat Modares University  
Tehran, Iran

**Victor Noskov**

Geographical Faculty  
Department of Hydrology and Water Resources  
Protection  
Perm State University  
Perm Krai, Russian Federation

**Jennifer M. Olszewski**

Department of Civil and Environmental  
Engineering  
University of Maryland  
College Park, Maryland

**Jayantilal N. Patel**

Department of Civil Engineering  
Sardar Vallabhbhai National Institute of  
Technology  
Surat, India

**Qin Qian**

Department of Civil Engineering  
Lamar University  
Beaumont, Texas

**Eva Sbrana**

PDNA and Associates  
Botswana

**Olga Eugenia Scarpatti**

Center of Pharmacological and Botanical Studies  
National Research Council  
Buenos Aires, Argentina  
and  
Department of Geography  
La Plata National University  
La Plata, Argentina



**Sara Shaeri Karimi**

Dezab Consulting Engineers Company  
Ahvaz, Iran

**R.B. Singh**

Department of Geography  
Delhi School of Economics  
University of Delhi  
New Delhi, India

**Hassan Shojaee Siuki**

KPM Consulting Engineering Co.  
Mashhad, Iran

**V.V. Srinivas**

Department of Civil Engineering  
Indian Institute of Science  
Bangalore, India

**David Stephenson**

University of Botswana  
Gaborone, Botswana

**Ehsan Tavakoli-Nabavi**

School of Sociology  
Centre for Policy Innovation  
Australian National University  
Canberra, Australia

**Anthony Richard Turton**

Centre for Environmental Management  
University of Free State  
Bloemfontein, South Africa

**Christophe Viavattene**

Flood Hazard Research Centre  
Middlesex University  
London, United Kingdom

**Alberto Ismael Juan Vich**

Institute of Snow, Glaciology and Environmental  
Sciences  
National Research Council  
and  
Environmental Studies and Natural Resources  
Institute  
Cuyo National University  
Mendoza, Argentina

**Mehdi Yasi**

Department of Water Engineering  
Urmia University  
Urmia, Iran

**Lanhui Zhang**

Key Laboratory of West China's Environmental  
System  
Lanzhou University  
Lanzhou, Gansu, People's Republic of China

**Xifeng Zhang**

Key Laboratory of West China's Environmental  
System  
Lanzhou University  
Lanzhou, Gansu, People's Republic of China

**Zhonglong Zhang**

Badger Technical Services  
Environmental Laboratory  
U.S. Army Engineer Research and Development  
Center  
Vicksburg, Mississippi

**Xiao Yun Zheng**

Yunnan Academy of Social Sciences  
and  
International Water History Association  
Kunming City, Yunnan, People's  
Republic of China

# 1

## Anthropocenic Aquifer: New Thinking

---

**Anthony Richard  
Turton**

*University of Free State*

**Frederik Stefanus  
Botha**

*University of Free State*

1.1	Introduction .....	2
1.2	Understanding the Anthropocene .....	2
1.3	South African Hydrology .....	3
1.4	Possible Solution: Anthropocenic Aquifers .....	5
1.5	Case Study: Elands Platinum Mine .....	6
1.6	Future of Anthropocenic Aquifers .....	9
1.7	Summary and Conclusions .....	12
	References .....	12

### AUTHORS

**Anthony Richard Turton** received his DPhil from the University of Pretoria for his work on transboundary water resource management in Southern Africa. He is currently a professor at the Centre for Environmental Management at the University of Free State in Bloemfontein, South Africa. He has published widely on the issue of transboundary waters and is currently working on mine water as a subnational manifestation of transboundary water resource management. He is the past vice president of the International Water Resource Association (IWRA) and has served in leadership positions on the Board of Governors of the World Water Council. He serves on various editorial boards including Water Policy, Water International, and Water Alternatives and is a trustee of the Water Stewardship Council of Southern Africa.

**Frederik Stefanus Botha** has a PhD from the University of Free State. He is a water resource specialist, with a PhD in groundwater and MSc in engineering geology, with 15 years of experience in the government and private sector in both South Africa and Australia. He was involved in a number of water resource assessment and planning studies and recently his focus has shifted to mine water management and planning. He works both at strategic and implementation levels. His most recent work (2012) included the optimization of water use at Vanggatfontein for Kenton Energy. The result is that the mine can now operate with lower levels of raw water input thereby setting new production records. He is also directly involved in the platinum sector.

## PREFACE

With South Africa transitioning to a situation in which future economic growth and development is likely to be constrained by the fact that almost all of the national water resources have already been allocated to various users, the issue of alternative management paradigms becomes relevant. Given that South Africa has a mining-based national economy, the role of the mining sector in the development of possible future solutions to the constraints of fundamental water scarcity is starting to be explored. Traditionally, the hydraulic foundation of the national economy has been based on the capture of streamflow in large dams, so an alternative resource utilization paradigm based on the management of evaporative losses is becoming relevant. One possible approach is to store water in aquifers rather than dams, with the obvious advantage being the significant reduction in evaporative losses. Taking this logic one step further, this chapter explores the notion of using mining methods to deliberately engineer an aquifer as a component of a planned mine closure strategy. This provides benefits to society, mostly in the form of improved water yields arising from a significant reduction in evaporative losses. However, it also provides potential benefits to mining, most notably in the reduction of post-closure liabilities. It is therefore argued that the use of a reengineered mine void as an anthropogenic aquifer can change the business case for mining while also yielding other benefits to society in water-constrained countries.

## 1.1 Introduction

---

There is converging opinion among scientists that we are now living in a new geological epoch known as the Anthropocene [56,57]. This recognizes the impact that human beings have on processes that create the earth, raising the question of how we can continue to do this in a responsible manner. This chapter makes the case for an engineered aquifer (anthropogenic aquifer) as an element of responsible mine engineering in water-constrained areas that are ecologically and culturally sensitive.

## 1.2 Understanding the Anthropocene

---

The earth has evolved over geological timescales, each with clearly discernible characteristics, often associated with the stratigraphy of specific sedimentary rock sequences [23]. Transitions between epochs need to present clearly discernible signals that are omnipresent in all rocks of a given sequence globally, and approved by the International Commission on Stratigraphy, in order to be officially recognized. An example of such a transition is the so-called K-T boundary, which refers to the transition between the Cretaceous (abbreviated as “K”) and Tertiary (abbreviated as “T”) period, dated back to 65.5 ( $\pm 0.3$ ) million years before present [28]. This coincides with the end of the Mesozoic and the start of the Cenozoic Era, which occurred when a number of meteorites struck the earth [31], one known to be at Chicxulub on the Yucatan Peninsula [24,35]. The significance lies in the fact that the K-T boundary is rich in iridium, a rare radioactive element closely associated with meteorites [29], found in this specific geological stratum at levels many times stronger than background values [2]. The transition from the Cretaceous to the Tertiary period is thus identified by a strong iridium signal that is clearly discernible and totally unique.

The Holocene–Anthropocene transition on the other hand is a recent event. While there is not yet total consensus on the exact date of this, there is growing consensus on the existence of the Anthropocene [56,57], with some scientists now advocating 1945–1950 as the actual date of transition [27], citing the existence of elevated levels of radionuclide and heavy metals in recent sediment samples taken from major river systems, all showing a discernible spike at that specific date. In this

context, it is the elevated levels of radionuclide and heavy metals in river sediments (rocks of the future) that provide the peculiar signal in much the same way as iridium levels do in the K-T boundary. Significantly it is the existence of elevated levels of both radionuclide and heavy metals that characterize the South African aquatic ecosystems' draining areas of mining activities, suggesting that the Anthropocene signature is strong in that country, but more specifically along the Witwatersrand Mining Basin [10–12,51,54,55]. The most probable transition date (1945–1950) is associated with the advent of deep-level gold mining in the Far Western Basin, closely associated with high volumes of uraniferous tailings [26] and peak gold production [20].

It is therefore suggested in this chapter that the Holocene–Anthropocene transition in South Africa occurred around 1945–1950 when elevated levels of radionuclide and heavy metals started to report to the various wetland systems draining the continental watershed divide between the Orange and Limpopo River Basins. This watershed divide coincides with the Witwatersrand Mining Basin, which is characterized by varying strata of gold-bearing reef that is overlain to a large extent by one of the largest karst aquifer systems in the world [8,25,40,53]. The unintended consequence of mining is thus associated with heavy metal and radionuclide accumulations that can become impediments to the developmental potential of the country if left unmanaged [17]. This demands new thinking for responsible mining in South Africa, specifically with respect to the attenuation of pollution plumes.

### 1.3 South African Hydrology

South Africa has a mining-based national economy that is also water constrained [47]. The annual average precipitation is a paltry 497 mm/year with a high gradient from east to west [4]. The National Water Resource Strategy (NWRS), the official strategic planning document on which all government allocations are based, indicated that by the year 2000, South Africa had already allocated approximately 98% of its total national water resource at a high assurance of supply level [32]. Consistent with the concept of aridity, the evaporative demand to the atmosphere is very high, often exceeding the precipitation levels two- to threefold.

Furthermore, many of the 19 water management areas (WMAs) are overallocated, with some by as much as 120%. The most stressed of these WMAs also coincide with the hydrological boundaries of the Limpopo River Basin, which is shared by four countries—Botswana, South Africa, Zimbabwe, and Mozambique—to the extent that the basin is now closed with demand exceeding supply [46]. One of the major drivers of future development will continue to be mining, with significant mineral resources in the water-constrained areas. The most notable of these are platinum group minerals associated with the Bushveld Igneous Complex (BIC) in the North West Province and coal in Mpumalanga and Limpopo Provinces, all of which are located in different portions of the Limpopo River Basin. This raises the issue of the future role that mining can play, not only in creating the foundation for economic development in the short-term, but also by improving water security at local level that will benefit society during the post-closure phase of mining.

Two latent aspects need to be highlighted in order to substantiate the case being argued:

- The conversion ratio of mean annual precipitation (MAP) to mean annual runoff (MAR)
- The ramifications arising from what is known as the hydraulic density of population

The MAP–MAR conversion ratio gives an indication of the rate at which rainfall and other precipitation is converted into water in a river that can be used as the hydraulic foundation to economic development. In this regard, the MAP–MAR conversion at continental level in Africa is a paltry 20%, compared to that of Asia and North America (45%), South America (43%), and Europe, Australia, and Oceania (35%) [18,48]. This means that Africa as a continent is the least endowed with water when reflected as the natural capacity to convert MAP to MAR, to the extent that the continent is referred to as being “hostage to hydrology” [19]. This arises from the fact that economic performance of many African countries is closely correlated to rainfall. Conceptually, this suggests that the existence of hydraulic infrastructure decouples economic development from fundamental environmental drivers such as rainfall.

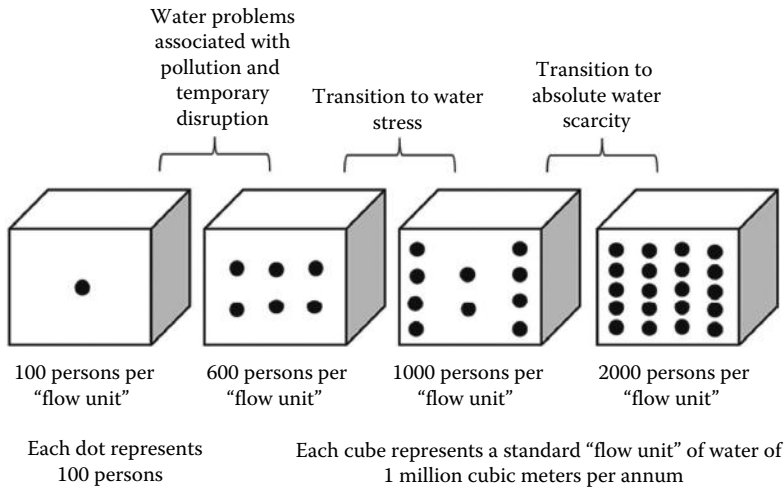
Unfortunately, the MAP–MAR conversion at river basin level varies significantly from the continental average. The two most significant river basins in terms of economic activity that they sustain in South Africa are the Orange and Limpopo, both of which are transboundary and both of which have a 5.1% conversion ratio at basin level [3]. More importantly however, this ratio is even less if one considers only the South African portion of those basins. In the case of the Orange, the MAP–MAR conversion is a paltry 3.4%, whereas the national average is around 8.5% [3]. From this it is evident that scale matters. It is only once one grasps the relevance of scale as it pertains to national development potential that the nuanced nature of infrastructure as the hydraulic foundation of a national economy becomes significant. In the case of the Orange River, the South African MAP–MAR is 3.4% yielding  $6,500 \times 10^6$  m<sup>3</sup>/year of streamflow, which is trapped in a combined storage volume of  $17,658 \times 10^6$  m<sup>3</sup>/year of dams. This means that the dam storage–MAR ratio is a staggering 271.3% [3]. Stated differently, there is almost three times as much storage capacity as there is water in the river in an annual average period. Conceptually, this means that there is a limit to the storage capacity in semiarid areas, because the larger the volume of water stored in dam profiles that tend to be flat and shallow because of the prevailing topography, the greater becomes the evaporative loss from the surface. Given the significance of the Orange River to the national economy of South Africa, it can be safely assumed that the resource is fully developed and all future economic growth and development will be constrained by this one simple factor. With respect to the Limpopo River Basin, the high silt loads, and stochastic nature of the flow, have resulted in limited dam development along the main stem of the river. However, the MAP–MAR of 5.1% results in a streamflow of  $5295 \times 10^6$  m<sup>3</sup>/year that is trapped in 100 dams with a combined storage capacity of  $3060 \times 10^6$  m<sup>3</sup>/year, reflecting a dam storage–MAR ratio of 57.8% [3]. While this suggests that more dams can still be built in the future, the reality is that the high silt loads make this inappropriate, and climate change predictions suggest that both the Orange and Limpopo River Basins will become hotter and dryer [37].

It can be safely assumed that the water resources of both the Orange and Limpopo River Basins are fully developed and that future economic growth and development, most notably driven by mineral resources, will be constrained by this one simple fact that is not yet accepted by major decision-makers.

This raises the second aspect of the problem, namely, the implications of a changing hydraulic density of population. The hydraulic density of population refers to the number of people being sustained from a given unit of water over a specified period of time. This concept was made relevant through the pioneering work of Falkenmark [15,16] during which a fundamental question was answered—is there a finite limit to the number of people a given unit of water can support over time?

Using a conceptual “flow unit” of water ( $1 \times 10^6$  m<sup>3</sup>/year), Falkenmark did a global study in which the population of all known countries was assessed in relation to the water availability. This resulted in what became known as the water crowding index (WCI) in which the notion of a water barrier was postulated. The water barrier takes current technology into consideration, because clearly the management of water scarcity is in part technology dependent, and was eventually defined as being 2000 p/10<sup>6</sup> m<sup>3</sup>/year. Evidence for this was the State of Israel, which is highly water constrained but also technologically advanced. Falkenmark thus accepted that with current technology, Israel represented the most extreme example of economic development in the face of water scarcity, so the water barrier could be safely assumed to be 2000 p/10<sup>6</sup> m<sup>3</sup>/year but subject to technology advancement over time. It is this technology advancement that is relevant to the current discussion. Significantly no empirical evidence was found that suggested social cohesion and sustained economic development in any country that had a WCI in excess of 2000 p/10<sup>6</sup> m<sup>3</sup>/year. A WCI value of 1000 p/10<sup>6</sup> m<sup>3</sup>/year is considered to be the reasonable upper limit of the number of people that available water supplies can sustain [3]. This meant that a WCI value of between 1000 and 2000 p/10<sup>6</sup> m<sup>3</sup>/year is defined as being water stressed as shown in Figure 1.1.

This pioneering work has now been developed to new levels of sophistication as reflected by the Royal Swedish Academy of Sciences when they decided to honor the lifetime achievement of Professor Falkenmark on October 21, 2011, during the workshop entitled “Facing the Human Security Dilemma.” Arising from this was a Round Table discussion with the various invited participants (which included the principal author) that will result in a publication provisionally entitled “New Water Challenges in the



**FIGURE 1.1** Falkenmark's concept of water crowding relates to the number of people competing for a given resource. Water-stressed conditions occur between 600 and 1000 p/10<sup>6</sup> m<sup>3</sup>/year, whereas 1000–2000 p/10<sup>6</sup> m<sup>3</sup>/year represents absolute water scarcity, with 2000 being the so-called water barrier. (Redrawn from Pallett, J. et al., *Sharing Water in Southern Africa*, Desert Research Foundation of Namibia (DRFN), Windhoek, Namibia, 1997.)

Anthropocene.” During this event, the principal author [45] presented the data for South Africa, most notably the WCI in the Limpopo River Basin, where the value was 4219 p/10<sup>6</sup> m<sup>3</sup>/year in 2000 and will be a staggering 4974 p/10<sup>6</sup> m<sup>3</sup>/year in 2025, based on projected demographic trends [3]. This is already more than double the water barrier value and will become 2.5 times that value by 2025, raising the issue of social cohesion and economic development potential of a region that is not only mineral rich but also water scarce and increasingly technologically constrained [52].

## 1.4 Possible Solution: Anthropocenic Aquifers

If we can accept that we are collectively already living in the Anthropocene, then why can we not engage in earth-forming activities in a responsible manner? Stated differently, is it possible to refine our thinking in the mining sector to the extent that we can deliberately engineer an aquifer that is useful in the post-closure phase of the life of mine? This will provide the technology needed to reduce evaporative losses and thus mitigate the constraints of a high WCI. More importantly, it will transform the mining sector from their current role as transient occupiers of land to becoming partners for regional development instead. In short, mine engineering can become the crucible from which new water management technologies emerge to the benefit of society beyond the simple extraction of mineral wealth.

The answer to that is possibly found in South Africa, where at present the gold industry is at the end of its useful life and significant media coverage is being generated by the unintended consequences of acid mine drainage (AMD) and radionuclide contamination [17,20,39,43,49,50]. The significance of the failure to anticipate the social and ecological consequences of mine closure in the gold sector in South Africa, through the provision of adequate mine closure planning, is that it has raised the risk for future mining operations currently in planning. Legacy issues thus constrain future greenfield operations because capital raising is now hampered by the bad media coverage.

It is in this context that an emerging concept is centered on using the mine void to engineer an aquifer as part of a planned mine closure strategy. The logic is based on three key elements.

First, the business case for mining is greatly enhanced if the void can be turned into an asset with benefits to society in the post-closure phase. This improves the net present value (NPV) of the mining operation, because the full cost of closure is discounted, making stocks attractive to institutional

investors, while also reducing the cost of the instrument of guarantee that is needed to offset the dis-benefit arising from the generation of AMD and other known impacts from mining. In other words, a liability can be turned into an asset, and this can change the fundamental business case for mining in certain circumstances.

Second, the MAP–MAR conversion ratio in the Orange and Limpopo River Basins is very low. Projected conditions of climate change suggest that these river basins will also become hotter and dryer [37], so the policy emphasis should shift from capturing streamflow (building dams) to reducing evaporative loss instead. This raises the case for groundwater storage to one of the major interests for both corporations and government, simply by virtue of the fact that evaporative losses are greatly reduced and assurance of supply is improved [30,41,42].

Third, the high WCI values in places like the Limpopo suggest that job creation in the future will become a critical element of social stability. In fact, it has been hypothesized by Turton [45] that “water scarcity inhibits economic growth, driving poverty and raising frustration levels, which can result in xenophobic violence where a clearly defined ‘enemy’ exists.” The case for xenophobic violence is being documented in South Africa [21,22,44], so it is not beyond the realm of possibility, leaving this hypothesis open for independent validation.

Collectively this makes a sound case for the consideration of anthropocenic aquifers as a deliberate part of a mine closure strategy.

## 1.5 Case Study: Elands Platinum Mine

Elands Platinum Mine (EPM) is situated approximately 10 km east of the town of Brits in the North West Province, located on the western limb of the platinum-rich BIC. Traditional land use is primarily agricultural, but mining is becoming more relevant. Most new mining developments receive their raw water from existing surface water sources, all of which are under pressure, and water availability for all users in becoming a constraint to future economic development. Natural climate variability, possibly exacerbated by the effects of climate change [37], increases water insecurity, raising the need for innovative water resource development and management strategies.

The Department of Water Affairs (DWA) developed the National Water Conservation and Demand Management Strategy (NWCDMS), which defines water conservation as “the minimization of loss or waste, care and protection of water resources and the efficient and effective use of water.” EPM has developed a strategic objective to change the way the mine manages its groundwater in order to mitigate the risk to future sustainability within the framework of the NWCDMS [7]. The DWA has also developed an artificial recharge strategy designed to introduce artificial recharge (AR) as a water management option [14]. In addition to this, an Integrated Water and Waste Management Plan (IWMP) is part of the South African water legislation, so when submitting a water use license application, technical information must be provided in the form of an IWMP. This should provide details, not only of the impact assessment, but also on appropriate management strategies. Included in the document should be measures on how to optimize and reuse water.

As a responsible corporate citizen with a progressive water management philosophy, Xstrata (the owners of the EPM) developed an Integrated Groundwater Resources Management Plan (IGRMP) as part of their IWMP [5]. The IGRMP was assimilated into the IWMP, making the IWMP a continuous process to improve and optimize water resources at EPM [6]. As part of the IWMP, an hourly water balance simulation model was used to assess different water management scenarios [38]. This provided a view of the mine on a background of a Google Earth image showing all the flows, storage facilities, and rates. Various scenarios were tested including the storage of water underground, the harvesting of open pit water, and the tailings storage return flows. An example is shown in Figure 1.2.

The EPM is underlain by mafic rocks of the Rustenburg Layered Suite (RLS) that forms part of the BIC. The RLS comprises a basal marginal zone (norite), the lower zone (norite), the critical zone (pyroxenite, norite, anorthosite, and chromitite), the main zone (gabbro–norite), and upper zone (magnetite–gabbro).

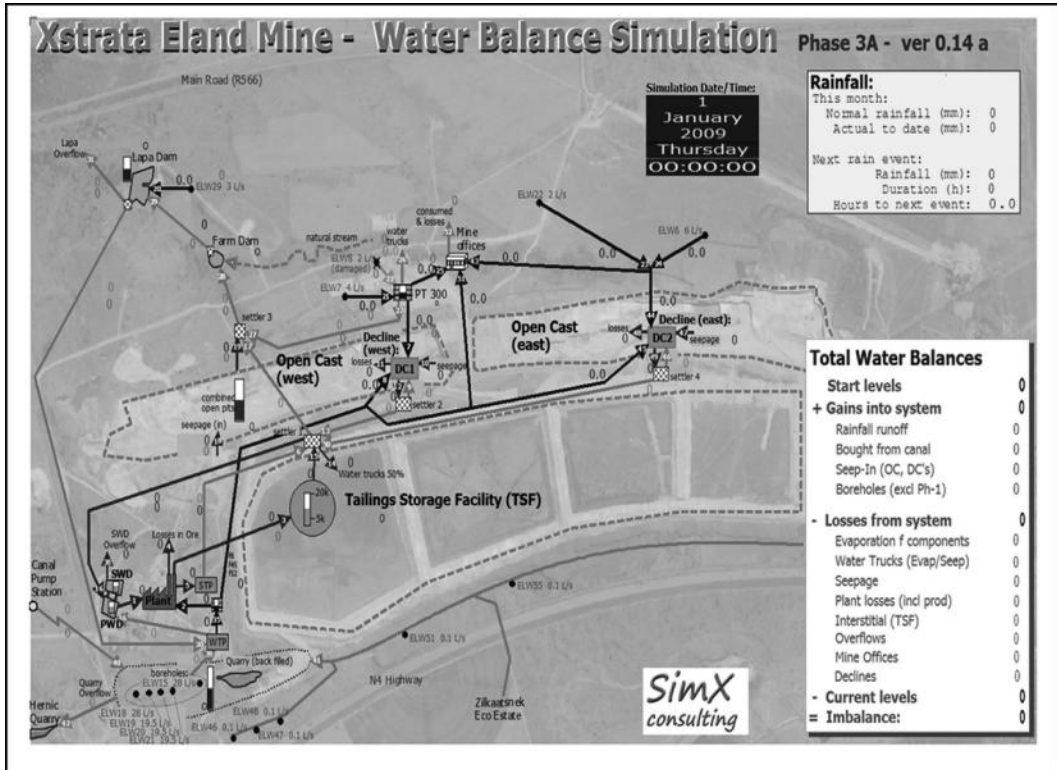


FIGURE 1.2 Example of the water balance simulation for the EPM. (From Botha, F. and Maleka, L., Results show that man-made aquifers within the platinum industry in South Africa can provide a solution for future water demands. Presentation to the Department of Water Affairs, Pretoria, South Africa, 2011; Image courtesy of Simx Consulting.)

The UG2 chromitite layers occur within the upper critical zone and are the primary mining target. In the Brits area, the BIC intrudes into the Pretoria Group and the Magaliesberg Formation forms the base of the BIC. Within the Brits area, the strata strike NE–SW and dip toward the NW. At EPM, the mining reef dips at 18° and will be mined to a depth of ~1200 m below ground level (mbgl) [36].

The groundwater specialist investigation for the Environmental Impact Assessment (EIA) was conducted by Africa Geo-Environmental Services (Pty) Ltd. (AGES), and findings from this investigation were used. The local hydrogeological conditions were classified into three aquifer types, namely, upper perched, middle weathered and fractured, and lower fractured [1]. The upper soil zone forms a rainfall-dependent perched aquifer with a thickness between 1 and 5 m and blow yields of less than 0.1 L/s, which are not viable. The middle aquifer can be classified as a semi-confined, shallow weathered aquifer with a thickness of 5–30 m. Blow yields are between 1 and 5 L/s and water quality is generally poor with high nitrates. Fault zone fractured rock aquifers form preferential flow pathways, resulting in variable spatial distribution or, in some cases, secondary fault zone aquifers [7]. High nitrate concentrations in borehole water samples (>25 mg/L) result in generally poor water quality at EPM. The upper limit for domestic water supply for nitrate is 20 mg/L. The average total dissolved solids (TDS) concentration is 740 mg/L and the average EC value is 100 mg/L. The upper limit for TDS in domestic water supply is 1000 mg/L [13].

Based on the aquifer conditions, a conceptual model was derived and nine stages were simulated as scenarios to determine the groundwater flow and impacts [1]. Simulated inflow rates into the open cast workings at the final mining depth (60 m) and calculated across the length of the open cast are between 300 and 700 m<sup>3</sup>/day, and dewatering of the open cast mine for 5 years will lower the existing groundwater



between 5 and 15 m that might be evident up to 2 km from the open cast workings. Simulated inflow rates into the underground mine workings at 1000 m are between 800 and 1000 m<sup>3</sup>/day.

During the deep groundwater assessment [36], 10 exploration boreholes were drilled to depths ranging from 150 to 198 m. The highest blow yield recorded was 30 L/s with major water strike at 148 m and a potential long-term yield of 5 L/s. The combined potential long-term yield was estimated at 11.5 L/s for a 24 h pump cycle. Borehole water quality ranges between class 0 and class 3. High nitrate levels in top aquifers may have contaminated deeper aquifer compartments. Continuous water level and temperature monitoring indicate definite differences between deep and shallow water strikes. Two permanent data loggers were installed in Eastern limb water (ELW) 2 and 5 and are used to gather long-term time-series groundwater level and temperature fluctuations. An additional exploration ODEX borehole (ELW 15) was drilled into the old Hernic quarry (OHQ) and was tested at  $\pm 25$  L/s with a maximum recorded water level drawdown during the step tests of 0.05 m. The borehole can be used as an emergency abstraction point in the quarry.

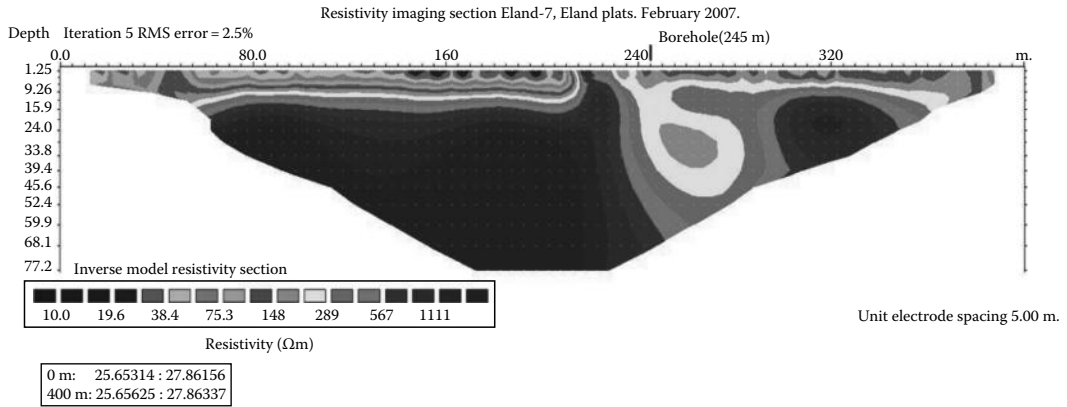
The mine gets its raw water from the eastern channel of the Hartbees Irrigation Board (HIB) and stores it in the OHQ. Hartbeespoort Dam drains an area receiving around 600–700 mm/year of precipitation but is located in an area that loses around 1700–1800 mm/year to evaporation [32] and is highly eutrophic [33]. The OHQ consists of an old open pit 40 m deep that is partially filled to a depth of 28 mbgl and then filled with water to roughly 21 mbgl. The quarry material consists of waste rock from the open pit, basically anorthosite and norite. The OHQ is divided by a dolerite dyke to form a western and eastern portion and modeled as W\_Qry and E\_Qry. During the groundwater exploration phase, an exploration ODEX borehole (ELW 15) was drilled into a backfilled portion on the western side of the OHQ. Prior to the aquifer recharge project, water was pumped from the OHQ *via* a floating barge fitted with four pumps to a treatment plant, where it is cleaned for both potable and process use.

The obvious advantages are that the natural rock filter lowers source water turbidity significantly with operating cost savings. ELW 15 is able to access water from the quarry for longer periods, so in case of a major canal breakdown, increased storage is available by using deeper borehole water. Under such a management regime, water in storage increases from an approximate 80,000–330,000 m<sup>3</sup>, and with the variable availability of irrigation water, the simulation model showed the mine capable of running for 160 days without makeup water. In contrast, with only the barge, it can run for a mere 39 days, so the additional yield from the aquifer is significant from a risk mitigation perspective.

Water quality, specifically nitrates, is a concern. Initial measurements for ELW 15 were 18.2 mg/L, similar to the regional groundwater measurements and close to the allowable domestic water limit of 20 mg/L (class 1 limit is 10 mg/L; class 2 is 20 mg/L). However, the storage of water and evaporation in the OHQ creates a salt sink, so over time, the backfilled portion will become more saline, reducing the potential of the OHQ for strategic storage. The boreholes provide the flexibility to dewater the OHQ while diluting it with low TDS and low nitrate source water. Furthermore, if the nitrate level is too high within the OHQ, then the canal water can be diverted directly to the water treatment plant, increasing redundancy.

At the OHQ, the topography dips slightly toward the west and water flows from east to west. The western portion of the OHQ is already rehabilitated and there is enough space available to develop additional boreholes. As a result, the western portion of the OHQ was selected to develop a new well field. Astersat images were used to identify where the backfilled portion of the OHQ is situated. Once the position was established, a series of multiresistivity profiling was done to identify where the high wall ends and where the deepest part of the OHQ is. This is shown in Figure 1.3. Based on the results, six sites were selected and drilled.

Boreholes were developed within the backfill material using an ODEX drill-and-drive method. Boreholes were drilled 6 m into the quarry floor using the normal air-percussion method. All ODEX sections have steel casings with inside diameters of 194 mm, and the air-percussion sections have inside diameters of 165 mm. ELW 16 and ELW 17 were drilled to confirm results from the geophysics, and ELW 18 to ELW 21 were drilled as production boreholes with recommended yields of between 19.5 and 28 L/s. All boreholes were tested for macro elements. The results show elevated TDS, electric conductivity (EC),



**FIGURE 1.3** Geophysical profile No. 7 at EPM showing the high wall and the location of the borehole. (From Botha, F. and Maleka, L., Results show that man-made aquifers within the platinum industry in South Africa can provide a solution for future water demands. Presentation to the Department of Water Affairs, Pretoria, South Africa, 2011.)

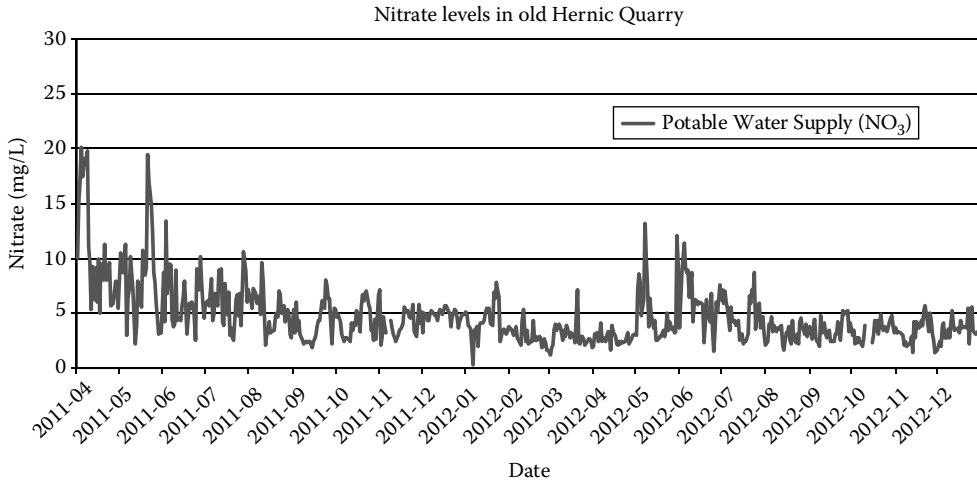
magnesium (Mg), and nitrogen (N) values, being classified as class 3, except ELW 15 that has lower TDS values. The boreholes were equipped with submersible pumps and connected with a separate pipeline to the process water tank at the treatment plant.

One of the major concerns was water loss from the OHQ to the surrounding aquifers. This is constantly checked by measuring input and abstraction volumes and also comparing water level data of two monitoring boreholes within the *in situ* aquifer next to OHQ. The boreholes are within 50 m from the quarry and show stable water levels some 6 m above the quarry water levels. Ingress into the aquifer is thus unlikely and it is more probable that the aquifer will decant into the quarry. Furthermore, the volumetric measurements over a period of 15 months show some 30,000 m<sup>3</sup> more water abstracted from the OHQ compared to water pumped into the quarry. Some of this might be attributed to rainfall and runoff water, but a portion probably originates from host aquifer ingress into the OHQ. On-site weekly data are taken to monitor water quality, specifically the nitrate values. The source water nitrate values range from 8 to 15 mg/L and the borehole water continues to have nitrate values between 10 and 30 mg/L. The stagnant water in the quarry and the waste rock could be the source of the higher salt load. Therefore, to remove stagnant water and flush the system of excess salts, the quarry was dewatered to levels below the backfilled area. During both dewatering attempts, the EC and nitrate levels showed significant increase correlating with periods of no pumping into the quarry. Water quality from the boreholes showed significant improvement, with nitrate levels below 10 mg/L and EC values below 60 mS/m, after the flushing event. Since early 2011, the quarry has been maintained at the same level, with salt and nitrate levels being stable. This is shown in Figure 1.4.

## 1.6 Future of Anthropocenic Aquifers

The results from the EPM suggest that mine voids can be used as strategic storage, thereby increasing assurance of supply under conditions of endemic water insecurity in areas with high evaporative losses off open dams. These lessons are now being applied in two distinct new spheres in South Africa:

The first is at Tharisa Minerals, located some 40 km west of EPM. This mine has no raw water sources, and alternative supply will only be available in 2014 when new water transfer infrastructure is scheduled. The company is currently commissioning a 100 kiloton/month platinum/chrome circuit, and this requires more water. This has resulted in the decision to assess the viability of an old open pit that

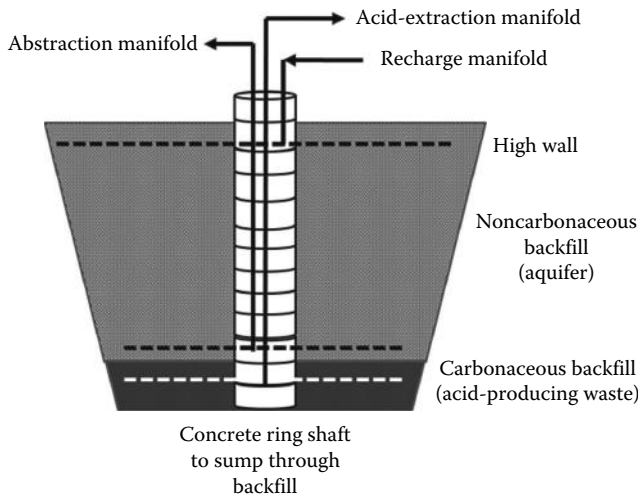


**FIGURE 1.4** Recharge versus nitrate levels in the OHQ at EPM. (From Botha, F. and Maleka, L., Results show that man-made aquifers within the platinum industry in South Africa can provide a solution for future water demands, Presentation to the Department of Water Affairs, Pretoria, South Africa, 2011.)

has been backfilled. Initial studies indicate that this open pit has intercepted both upper and lower aquifer water before decanting into a local stream. The current planning is to develop this as a source of process water. Three boreholes were drilled between 28 and 36 mbgl with blow yields greater than 20 L/s and water quality of low TDS, TSS, and nitrates. The tentative conclusion is that the backfilled void will thus become a viable source of water for this specific mine in future [7].

The second is a logical step in the same direction, where a purpose engineered aquifer has been proposed by Touchstone Resources (Pty) Ltd., as part of the formal mine closure strategy for a new coal mine that is still in the planning phase. This is shown conceptually in Figure 1.5.

If managed aquifer recharge is a formal element of the national water management policy, and if mine closure has thus far been problematic in South Africa, then why not deliberately design the mine plan in



**FIGURE 1.5** Conceptual design of an engineered aquifer for a rehabilitated open cast coal mine. (Image courtesy of Anthony Turton.)

such a way that rehabilitation occurs in a sequenced series of events that results in an artificial aquifer at the end of the life of mine? The advantages are as follows:

- The planned mine pit will be approximately 22 km long, 1.6 km wide, and about 200 m deep, yielding a probable live storage capacity of around  $1 \times 10^6 \text{ m}^3$  in an area that is extremely arid with a high WCI and thus limited future prospect of job creation.
- The proposed mine is the first of many in a new area as yet unmined, but with vast potential. This means that the first void can become strategic storage, consistent with the EPM case, for all future mines planned in the area.
- The proposed mine is located close to a dam that is used for irrigation water, but this is heavily silted and is likely to become dysfunctional during the life of mine. This means that the engineered aquifer would become an alternative water resource for human consumption in a densely populated area, even if it does not sustain irrigated agriculture in future.
- By engineering an aquifer, what is normally a liability at closure now becomes an asset, thereby reducing the cost of the instrument of guarantee and thus changing the business case for mining in a way that is investor friendly.
- In effect then, the mine will become a partner in long-term rural development that is sustainable, thereby creating a new Social Charter for Mining in a country where the mining sector has a dismal track record in the post-closure phase.

The planned aquifer is part of the feasibility study, but the company concerned wishes at this stage to remain anonymous, simply because the final decision has not yet been taken and the concept is as yet too new to create comfort in all of the management levels concerned. The concept is simple however. The geology of this specific area is such that a coal seam of about 2–3 m deep lies beneath overburden that is of consistent quality, made up mostly of sandstone. This has a naturally high saline content and a low transmissivity. The removal of the overburden will bulk up this rock, so when it is backfilled, both the transmissivity and storativity will be greatly enhanced. Once the initial salts have been flushed out of the system, the water quality is likely to improve to manageable levels. The coal seam consists of a number of distinct strata, each separated by carbonaceous middling of different grades. Given that the main purpose of the mine is to generate metallurgical coal, the middlings and other discard need to be separated and managed. The best option is to treat these at source, possibly by means of a briquetting plant that generates revenue while also reducing waste. This would be a revolutionary approach in the South African context, even if conceptually it is consistent with international best practice. The second best option is to return the carbonaceous waste to the bottom of the pit, where it will be capped in order to ensure anoxic conditions and thus reduce the AMD potential over time.

The unique aspect in the concept design relates to the deliberate installation of a manifold system in the carbonaceous waste stratum underneath the capped barrier. This will report to a central sump where it will be connected to the surface. The manifold will allow the water quality to be constantly monitored, and by retaining a slightly negative piezometric pressure across the capped barrier, the egress of AMD into the surrounding host aquifer, or upper engineered aquifer, will be reduced. The noncarbonaceous backfill will then be placed sequentially into the pit. Again a manifold will be built into the lower portions of this layer, in order to ensure even drawdown at levels above the capped barrier. This will also report to the central shaft, consisting of reinforced concrete rings placed sequentially until the environment critical level (ECL) has been reached. At that stage, a decision will be made as to whether the best option for recharge will be *via* vertical boreholes drilled into the backfill or by means of horizontal manifolds installed at that level. The backfilled pit will then be finished by means of a whaleback and revegetated as part of a formal environmental management plan (EMP).

The detailed engineering design has not yet been completed, so this remains only a concept at this stage. The natural trend in South Africa, with growing public pressure arising from the unintended consequences of an inadequate mine closure strategy, reinforced by the undeniable consequences of a

high WCI in the Limpopo River Basin specifically, suggests that the acceptance of this concept will be a logical evolution of mine design and operation in the future.

## 1.7 Summary and Conclusions

If we are indeed living in the Anthropocene with human-induced impacts on geological processes, then why not accept this and act in a responsible manner? The simple reality is that the global population has recently reached 7 billion and it has been estimated that by 2025, around 1.8 billion people will be living with absolute water scarcity—beyond the water barrier to use Falkenmark’s terminology—and two-thirds of the global population will be living under conditions of water stress [9]. What this will do in areas with an already high WCI is unknown, but suggestions are that social cohesion and job creation are likely to be at risk. This makes a compelling case for mine companies to rethink their role, from being reasonably independent players to becoming partners for rural development, by modifying their design to separate waste streams at source (consistent with international best practice) and to sequence backfill in such a way as to transform a liability into an asset with value to society post-closure. Just as South Africa has been a pioneer in deep-level gold mining, it can now be expected to become a pioneer in the design of anthropogenic aquifer systems.

## References

1. AGES. 2006. Eland Platinum Mine: Groundwater specialist report, Technical report. Version 5.0 Final, AG-R-2006-08-24. August 2006. Pretoria, South Africa: Africa Geo-Environmental Services (Pty) Ltd.
2. Alvarez, L.W., Alvarez, W., Asaro, F., and Michel, H.V. 1980. Extraterrestrial cause for the cretaceous-tertiary extinction. *Science*, 208(4448), 1095–1198.
3. Ashton, P.J., Hardwick, D., and Breen, C.M. 2008. Changes in water availability and demand within South Africa’s shared river basins as determinants of regional social-ecological resilience. In: Burns, M.J. and Weaver, A.V.B. (eds.) *Advancing Sustainability Science in South Africa*. Stellenbosch, South Africa: Stellenbosch University Press, pp. 279–310.
4. Ashton, P.J. and Turton, A.R. 2008. Water and security in sub-Saharan Africa: Emerging concepts and their implications for effective water resource management in the southern African region. In: Brauch, H.-G., Grin, J., Mesjasz, C., Krummenacher, H., Behera, N.C., Chourou, B., Spring, U.O., Liotta, P.H., and Kameri-Mbote, P. (eds.) *Facing Global Environmental Change: Environmental, Human, Energy, Food, Health and Water Security Concepts—Volume IV*. Berlin, Germany: Springer-Verlag, pp. 665–678.
5. Botha, F.S. 2008a. Deep groundwater assessment and water management at Eland Platinum Mine. In Praxos 741. Deep groundwater assessment and water management at Eland Platinum Mine. Technical Report for Eland Platinum Mine. *Artificial Recharge Strategy*. Version 1.3.
6. Botha, F.S. 2008b. Transforming groundwater from risk management to asset management in the mining sector, South Africa. *Oral Presentation to the International Mine Water Conference*, Praha.
7. Botha, F. and Maleka, L. 2011. Results show that man-made aquifers within the platinum industry in South Africa can provide a solution for future water demands. Presentation to the Department of Water Affairs, Pretoria, South Africa.
8. Buchanan, M. (ed.) 2010. *The Karst System of the Cradle of Humankind World Heritage Site: A Collection of 13 Issue*. Papers by the South African Karst Working Group. Pretoria, South Africa: Water Research Commission. ISBN 978-1-77005-969-6.
9. Chang, S.A. 2009. A watershed moment: Calculating the risks of impending water shortages. In *The Investment Professional*. Vol. 2, No. 4. New York: New York Society of Security Analysts.
10. Coetzee, H. 1995. Radioactivity and the leakage of radioactive waste associated with witwatersrand gold and uranium mining. In: Merkel, B.J., Hurst S., Löhnert E.P., and Struckmeier W. (eds.) *Proceedings Uranium Mining and Hydrogeology*, Freiberg, Germany: GeoCongress, pp. 1–583.

11. Coetzee, H., Wade, P., Ntsume, G., and Jordaan, W. 2002. Radioactivity study on sediments in a Dam in the Wonderfontein spruit catchment. DWAF report. Pretoria, South Africa: Department of Water Affairs and Forestry.
12. Coetzee, H., Winde, F., and Wade, P.W. 2006. An assessment of sources, pathways, mechanisms and risks of current and potential future pollution of water and sediments in gold-mining areas of the Wonderfontein spruit catchment. WRC Report No. 1214/1/06. Pretoria, South Africa: Water Research Commission.
13. DWAF. 1996. *South Africa Water Quality Guidelines. Vol. 1. Domestic Use*. 2nd edn. Pretoria, South Africa: Department of Water Affairs and Forestry.
14. DWAF. 2007. *External Guideline: Generic Water Use Authorization Application Process*. Pretoria, South Africa: Department of Water Affairs.
15. Falkenmark, M. 1989a. The massive water scarcity now threatening Africa: Why isn't it being addressed? *Ambio*, 18(2), 112–118.
16. Falkenmark, M. 1989b. Vulnerability generated by water scarcity. *Ambio*, 18(6), 352–353.
17. GDARD, 2011. Feasibility study on reclamation of mine residue areas for development purposes: Phase II strategy and implementation plan, Report No. 788/06/02/2011. Umvoto Africa (Chris Hartnady and Andiswa Mlisa) in association with TouchStone Resources (Anthony Turton).
18. Gleick, P.H. (ed.) 1993. *Water in Crisis: A Guide to the World's Water Resources*. New York: Oxford University Press, pp. 80–91.
19. Grey, D. and Sadoff, C.K. 2006. *Water for Growth and Development. Thematic Document of the Fourth World Water Forum*. Washington, DC: World Bank.
20. Hartnady, C.J.H. 2009. South Africa's gold production and reserves. *South African Journal of Science*, 105, 328–329.
21. Johnston, S. and Bernstein, A. 2007. *Voices of Anger: Protest and Conflict in Two Municipalities. Report to the Conflict and Governance Facility (CAGE)*. Johannesburg, South Africa: The Centre for Development and Enterprise.
22. Johnston, N. and Wolmarans, R. 2008. Xenophobic violence grips Johannesburg. *Mail and Guardian*. May 23, 2008.
23. Kearey, P. 2001. *Dictionary of Geology*. London, U.K.: Penguin.
24. Keller, G., Abatte, T., Stinnesbeck, W., Rebolledo-Vieyra, M., Fucugauchi, J.U., Kramar, U., and Stüben, D. 2004. Chicxulub impact predates the K-T boundary mass extinction. *Proceedings of the National Academy of Science*, 101(11), 3753–3758.
25. Kleyweght, R.J. and Pike, D.R. 1982. Surface subsidence and sink-holes caused by lowering the dolomitic table on the far west rand gold field of South Africa. *Annual Geological Survey of South Africa*, 16, 77–105.
26. Matic, M. and Frost, M. 1964. In situ leaching of uranium from gold mine residue dams. *The South African Industrial Chemist*, pp. 127–133.
27. Meybeck, M. 2011. Personal communication to the principal author during the Round Table Event hosted by the Royal Swedish Academy of Sciences on October 21, 2011, entitled "Facing the Human Security Dilemma". Forthcoming as Falkenmark, M., Rockström, J., Folke, C., Lannerstad, M., Allan, J.A., Gordon, L., Jägerskog, A. et al. (Submitted 2012). New Water Challenges in the Anthropocene, in *Ambio*. Volume and page numbers unknown.
28. McCarthy, T.S. and Rubidge, B. 2005. *The Story of Earth and Life: A Southern African Perspective on a 4.6 Billion Year Journey*. Cape Town, South Africa: Struik.
29. McDonough, W.F. and Sun, S. 1995. The composition of the Earth. *Chemical Geology*, 124(4), 223–253.
30. Moore, J.M., Marley, R., and Schuster, S. 2011. *Managed Aquifer Recharge*. Albuquerque, NM: Daniel B. Stephens and Associates (Inc.).
31. Mullen, L. 2004. Multiple impacts. In *Astrobiology Magazine*. <http://astrobio.net/exclusive/1253/multiple-impacts>.

32. NWRS. 2004. *National Water Resource Strategy*. Pretoria, South Africa: Department of Water Affairs and Forestry (DWAF). <http://www.dwaf.gov.za/Documents/Policies/NWRS/Default.htm>.
33. Oberholster, P.J., Cloete, T.E., van Ginkel, C., Botha, A.-M., and Ashton, P.J. 2008. *The Use of Remote Sensing and Molecular Markers as Early Warning Indicators of the Development of Cyanobacterial Hyperscum Crust and Microcystin-Producing Genotypes in the Hypertrophic Lake Hartbeespoort, South Africa*. Pretoria, South Africa: Council for Scientific and Industrial Research (CSIR).
34. Pallett, J., Heyns, P., Falkenmark, M., Lundqvist, J., Seeley, M., Hydén, L., Bethune, S., Drangert, J., and Kemper, K. 1997. *Sharing Water in Southern Africa*. Windhoek, Namibia: Desert Research Foundation of Namibia (DRFN).
35. Pope, K.O., Ocampo, A.C., Kinsland, G.L., and Smith, R. 1996. Surface expression of the chicxulub crater. *Geology*, 24(6), 527–530.
36. Praxos, 741. 2008. Deep groundwater assessment and water management at Eland Platinum Mine. Technical Report for Eland Platinum Mine.
37. Scholes, R.J. and Biggs, R. 2004. *Ecosystem Services in Southern Africa: A Regional Assessment*. Pretoria, South Africa: CSIR.
38. Simx Consulting. 2009. Xstrata, Eland Platinum, Water Balance Simulation Model, Addendum to Technical Report. Technical Report: SX-TR-08071-D3. Document Version: Draft 3.1.
39. Strachan, L.K.C., Ndengu, S.N., Mafanya, T., Coetzee, H., Wade, P.W., Msezane, N., Kwata, M., and Mengistu, H. 2008. Regional gold mining closure strategy for the Central Rand Goldfield. Council for Geosciences Report No. 2008–0174. Pretoria, South Africa: Department of Mineral Resources.
40. Swart, C.J.U., Kleyweght, R.J., and Stoch, E.J. 2003. The future of dolomitic springs after mine closure on the Far West Rand, Gauteng, RSA. *Environmental Geology*, 44, 751–770.
41. Tredoux, G., Murray, E.C., and Cavé, L.C. 2002. Infiltration basins and other recharge systems in Southern Africa. In: Tuinhof, A. and Heederik, J.P. (eds.) 2002. *Management of aquifer recharge and subsurface storage: Making better use of our largest reservoir*. NNC-IAH Publication No. 4. Wageningen, the Netherlands: Netherlands National Committee of the International Association of Hydrogeologists.
42. Tuinhof, A. and Heederik, J.P. (eds.) 2002. *Management of Aquifer Recharge and Subsurface Storage: Making Better Use of Our Largest Reservoir*. NNC-IAH Publication No. 4. Wageningen, the Netherlands: Netherlands National Committee of the International Association of Hydrogeologists.
43. Turton, A.R. 2008. Water and mine closure in South Africa: Development that is sustainable? *Development*, 51(1), 53–62.
44. Turton, A.R. 2009. Resource allocation and xenophobic violence. In: Purkitt, H. (ed.) *African Environmental and Human Security and AFRICOM in the 21st Century*. New York: Cambria Press, pp. 111–123.
45. Turton, A.R. 2011. Understanding Falkenmark's concept of water crowding in the context of the Limpopo province, South Africa. In, Falkenmark, M., Rockström, J., Folke, C., Lannerstad, M., Allan, J.A., Gordon, L., Jägerskog, A., Karlberg, L., Kummu, M., Kuylentierna, J., Meybeck, M., Molden, D., Postel, S., Savenije, H., Svedin, U., Turton, A.R., and Varis, O. (In Press 2013). *The Unfolding Water Drama of the Anthropocene – Scanning the Science Frontier for Future Research Needs*, in *Ambio*.
46. Turton, A.R. and Ashton, P.J. 2008. Basin closure and issues of scale: The Southern African hydropolitical complex. *International Journal of Water Resources Development*, 24(2), 305–318.
47. Turton, A.R., Patrick, M.J., and Rascher, J. 2008. Setting the scene: Hydropolitics and the development of the South African economy. In: Patrick, M.J., Rascher, J., and Turton, A.R. (eds.) *Reflections on Water in South Africa*, Special Edition of *International Journal of Water Resource Development*, 24(3), 319–323.
48. UNEP. 2002. *Vital Water Graphics: An Overview of the State of the World's Fresh and Marine Waters*. Nairobi, Kenya: United Nations Environment Program (UNEP).
49. Van Tonder, D. 2008. *Regional Mine Closure Strategy for the Far West Rand Goldfield*. Council for Geosciences Report No. 2008–0248. Pretoria, South Africa: Department of Minerals and Energy.

50. Van Tonder, D. and Coetzee, H. 2008. *Regional Mine Closure Strategy for the West Rand Goldfield*. Council for Geosciences Report No. 2008–0175. Pretoria, South Africa: Department of Minerals and Energy.
51. Wade, P.W., Woodbourne, S., Morris, W.M., Vos, P., and Jarvis, N.W. 2002. Tier 1 Risk assessment of selected radionuclides in sediments of the Mooi River catchment. WRC Project No. K5/1095. Pretoria, South Africa: Water Research Commission.
52. Walwyn, D. and Scholes, R.J. 2006. The impact of a mixed income model on the South African CSIR: A recipe for success or disaster? *South African Journal of Science*, 102, 239–243.
53. Werdmüller, V.W. 1986. The central rand. In: Antrobus, E.S.A. (ed.) *Witwatersrand Gold—100 Years*. Johannesburg, South Africa: The Geological Society of South Africa, pp. 7–47.
54. Winde, F. and Van Der Walt, I.J. 2004. The significance of groundwater-stream interactions and fluctuating stream chemistry on waterborne uranium contamination of streams—A case study from a gold mining site in South Africa. *Journal of Hydrology*, 287, 178–196.
55. Winde, F. 2009. Uranium pollution of water resources in mined-out and active goldfields of South Africa: A case study in the wonderfontein spruit catchment on extent and sources of U-contamination and associated health risks. Paper Presented at the *International Mine Water Conference*, October 19–23, 2009, Pretoria, South Africa.
56. Zalasiewicz, J., Williams, M., Smith, M., Barry, T.L., Coe, A.L., Bown, P.R., Brenchley, P. et al. 2008. Are we now living in the anthropocene? *GSA Today*, 18(2), 4–8.
57. Zalasiewicz, J., Williams, M., Steffen, W., and Crutzen, P. 2010. The new world of the anthropocene. *Environment Science Technology*, 44(7), 2228–2231.





# 2

## Artificial Recharge Experiences in Semiarid Areas

---

2.1	Introduction .....	18
2.2	Concept of Seawater Intrusion and Saline Groundwater.....	19
	General View of Groundwater Problems • Hydrogeochemical Processes • Seawater Intrusion • Groundwater Modeling	
2.3	Artificial Recharge Techniques in Semiarid Areas .....	22
	Artificial Recharge • History of Artificial Recharge • Methods for Artificial Recharge	
2.4	Tunisia's Experience in Artificial Recharge.....	28
	A 40-Year Artificial Recharge of the Aquifer by Water from the Dam • A 26-Year Artificial Recharge of the Aquifer by Treated Wastewater • Treated Wastewater Reuse for a Seawater Intrusion Hydraulic Barrier	
2.5	General Discussions .....	42
2.6	Summary and Conclusions .....	44
	References.....	45

**Noureddine Gaaloul**

*National Institute  
of Research in Rural  
Engineering of Water  
and Forestry*

**Saeid Eslamian**

*Isfahan University  
of Technology*

### AUTHORS

**Noureddine Gaaloul** is a water expert and full researcher in the National Research Institute for Rural Engineering, Water and Forestry (INRGREF-Tunis) from the University of Carthage. Working as a hydraulic engineer in Tunisia, he has more than 15 years of experience as a national and international expert on water management, with a focus on management and environmental aspects. He holds a PhD in Sciences and Technology of Water, from the University of Bordeaux I, France, in 1992. His work is in the Geology Company of Mining and Research (B.R.G.M.—French). He was involved in several strategic studies with the Tunisian Ministry Agriculture and Hydraulic Resources and has contributed to both the development of the Tunisian strategy for agriculture and water resources adaptation to climate change. He has published several papers and he is also author or co-author of several reports, consulting and expertise reports. He has given several scientific presentations in national and international high standard conferences such as international conference on Seawater Intrusion in Coastal Aquifers, and international seminars.

**Saeid Eslamian** received his PhD from the University of New South Wales, Australia, with Professor David Pilgrim. He was a visiting professor in Princeton University, USA, and ETH Zurich, Switzerland. He is currently an associate professor of hydrology in Isfahan University of Technology. He is founder

and chief editor of Journal of Flood Engineering and International Journal of Hydrology Science and Technology. He has published more than 200 publications mainly in statistical and environmental hydrology and hydrometeorology.

## **PREFACE**

In many parts of semiarid areas, groundwater development has already reached a critical stage, resulting in acute scarcity of the resource. Overdevelopment of the groundwater resources results in declining groundwater levels, shortage in water supply, intrusion of saline water in coastal areas, and increased pumping lifts necessitating deepening of groundwater abstraction structures. These have serious implications on the environment and the socioeconomic conditions of the populace.

This chapter describes the concept of seawater intrusion and saline groundwater, artificial recharge (AR) techniques in semiarid areas, and Tunisia's experience in AR (water from the dam and treated wastewater). "Tunisia's experience on AR of groundwater" is the first in the semiarid areas and has updated information on various aspects of investigation techniques for selection of sites, planning and design of AR structures, their economic evaluation, monitoring and technical auditing of schemes, and issues related to operation and maintenance of these structures.

## **2.1 Introduction**

The provision of freshwater for domestic or agricultural purposes is not only concerned with the spatial availability of water but has also a time dimension. On an annual basis, there should be enough water available to supply the spatial water demands, but the fluctuations throughout the year are equally important to secure the provision of water to consumers when it is needed. Storage is the keyword to smoothen out the gaps between water availability and consumer demand. Besides the short-term (overnight) storage in reservoirs to balance daily demand fluctuations, the longer-term (weekly and longer) storage is provided by surface storage in reservoirs or by groundwater storage.

In many arid and semiarid regions, surface water resources are limited and groundwater is the major source for agricultural, industrial, and domestic water supplies. Because of the lowering of water tables and the consequently increased energy costs for pumping, it is recognized that groundwater extraction should balance groundwater recharge in areas with scarce freshwater supplies. This objective can be achieved either by restricting groundwater use to the water volume that becomes available through the process of natural recharge or by recharging the aquifer artificially with surface water. Both options require knowledge of the groundwater recharge process through the unsaturated zone from the land surface to the regional water table.

Coastal zones contain some of the most densely populated areas in the world as they generally present the best conditions for productivity. However, these regions face many hydrological problems like flooding due to cyclones and wave surge and drinkable freshwater scarcity due to problem of saltwater intrusion. The development and management of coastal groundwater aquifers is a very delicate issue. Intrusion of seawater has become one of the major constraints affecting groundwater management. As seawater intrusion progresses, existing pumping wells, especially those close to the coast, become saline and have to be abandoned, thus reducing the value of the aquifer as a source of freshwater. As an aid to effective management, many models have been developed over the years to represent and study this problem. They range from relatively simple analytical solutions to complex state-of-the-art numerical models using large computing capacity.

Groundwater is becoming an increasingly important resource for living and environment; techniques are asked for an improved exploration. The demand is not only to detect new groundwater resources but also to protect them. Coastal areas in several countries, mainly those situated in the semiarid regions (Tunisia, Morocco, Algeria, Egypt, etc.), are characterized by groundwater vulnerable to salinization by seawater. This problem is resulting from the irrigation expansion leading to overexploiting groundwater resources. Moreover, groundwater salinization can be increased by natural processes and anthropogenic factors. The latter is a common phenomenon affecting Mediterranean groundwater. Tunisia is one of the countries that are facing this problem especially in coastal irrigated areas where groundwater is intensively used for irrigation.

## 2.2 Concept of Seawater Intrusion and Saline Groundwater

---

### 2.2.1 General View of Groundwater Problems

Groundwater is the water that occurs in the voids between the subsurface soil particles and in the cracks. The large quantities of groundwater are found in aquifers. Groundwater is the primary source of water for human activities such as agriculture, industry, and domestic drinking water especially in regions with limited annual precipitation [1,79]. Because groundwater is located at deep locations, it is less vulnerable to pollution. However, anthropogenic activities such as fertilization and other pollution sources besides overexploitation of the aquifers create serious problems to groundwater quality. These problems limit the use of groundwater and create additional problems in meeting the increasing water demand.

The intensive use of natural resources and the large production of wastes in modern society often pose a threat to groundwater from aspects of quantity and quality. Usually, quantity problems are directly related to groundwater extraction by human beings more or less. Overextraction of groundwater modifies drastically piezometric head fields and groundwater flow patterns, inducing various drawbacks [57]. The term “overextraction” can be defined as the condition in which the total amount of groundwater extraction from an aquifer is close to or greater than the total recharge for several years [24].

The following consequences are well known [9,24–26,52]:

- There is a progressive drawdown, which lasts until some stable situation is attained, provided extraction is less than actual recharge.
- Progressive decrease in spring discharge and river base flow or shrinkage in surface area of wetlands occurs so as to compensate for the difference between actual recharge and extraction. Hydraulic head of groundwater around pumping wells is changed, modifying groundwater flow pattern and affecting waters with different depths or origins. This means that quality (i.e., chemical composition) of extracted water may change progressively.
- Pore pressure decreases, often resulting in land subsidence at some areas where sediments are unconsolidated.

According to Bouwer [16], degradation of groundwater quality can take place over large areas by the plane (or diffuse) sources through deep percolation from intensively farmed fields, or it can be caused by point sources such as septic tanks, garbage disposal sites, cemeteries, mine spoils, oil spills, or other accidental entry of pollutants into the underground environment.

There are different types of pollutants that can be found in groundwater, such as nitrate, heavy metals, and salt water. Intrusion of salt water is the most common contamination occurrence in coastal aquifers [27]. Intrusion of salt water occurs when salt water displaces freshwater in an aquifer. The phenomenon can occur in deep aquifers with the advance of saline waters of geologic origin, in shallow aquifers from surface waste discharge, and in coastal aquifers from the invasion of seawater [79]. Overpumping of groundwater wells located near the shoreline is a major cause of encroachment of salt water into the aquifers and may lead to saltwater intrusion.

Many regions over the world were affected by these problems. For instance, it is the case of the Ogallala aquifer in the high plains of South Central USA [42,74]. Although the initial reserves were reckoned at about  $840 \times 10^9 \text{ m}^3$  in 1980, some  $160 \times 10^9 \text{ m}^3$  of groundwater reserves had been removed with a mean drawdown of 3 m in 40 years. This case is characterized by remarkable decrease in groundwater level or storage, while in the other cases, quality problems (i.e., groundwater contamination) have also arisen simultaneously.

Anthropogenic materials that are introduced into the environment by human activities are primarily sources of contamination. They include inorganic and organic chemicals used for agricultural, industrial, and domestic purposes. Such materials usually dissolve in the aqueous phase, especially the water. They may also enter the soil from leaky storage tanks, pipes, sewers, landfills, and evaporation ponds. These materials affect the groundwater quality via infiltration phenomenon [10]:

- Sources designed to release substances: structure for subsurface disposal of waste by percolation, injection wells, surface application (e.g., disposal of wastewater by surface irrigation), solution mining, and in situ mining
- Sources designed to store, treat, and/or dispose of substances, as well as discharge resulting from unplanned release: landfills for municipal and industrial waste
- Sources that retain substances during transportation or transmission: pipelines and material transportation
- Sources that discharge substances to the environment as part of various planned activities: irrigation practices, pesticide and fertilizer applications, and mine drainage operations
- Wells and construction excavation: oil and gas production wells and geothermal and heat recovery wells
- Naturally occurring sources whose discharge is created or exacerbated by human activities: saltwater intrusion and encroachment of poor quality water as a result of man-made changes in the flow regime in an aquifer

The last one is associated with the quantity problems, and hydrogeochemical study is one of the most promising ways to identify sources of contaminant and to solve some kinds of groundwater problems [1,75].

### 2.2.2 Hydrogeochemical Processes

The knowledge on hydrogeochemical processes helps to get insight into the evaluation of contributions of rock–water interaction and anthropogenic influences on groundwater quality. These geochemical processes are responsible for the seasonal and spatial variations in groundwater quality [46,58]. Groundwater chemically evolves by interacting with aquifer minerals or internal mixing among different groundwaters along flow paths in the subsurface [28,78,82].

These processes that govern the groundwater quality were the focus of many previous studies. Saether and de Caritat [76] were interested in the geochemical processes such as weathering taking place in catchments. The cation exchange in a coastal aquifer was the focus of Martinez and Bocanegra [59]; they studied the effect of overexploitation of an unconfined aquifer on the groundwater quality in the coastal aquifer of Mar del Plata in Argentina. Ikeda [41] found out that investigation on processes of groundwater quality formation including water–rock interaction and salinization process is a successful way to clarify the hydrological phenomena such as flow and mixing of water in the Southern foot of Mount Fuji. The study of Pulido-Bosch et al. [66] treated the effect of agricultural activities, high pumping, and dissolution of carbonate rocks on the aquifers' chemical compositions in the coastal aquifer of Temara in the Northwestern region in Morocco. Furthermore, the main target of Kumar et al. [47] was the identification of different hydrogeochemical processes such as dissolution, mixing, weathering of carbonate, and ion exchange in the groundwater of Muktsar, Punjab, using conventional graphical plots and multivariate analysis.

### 2.2.3 Seawater Intrusion

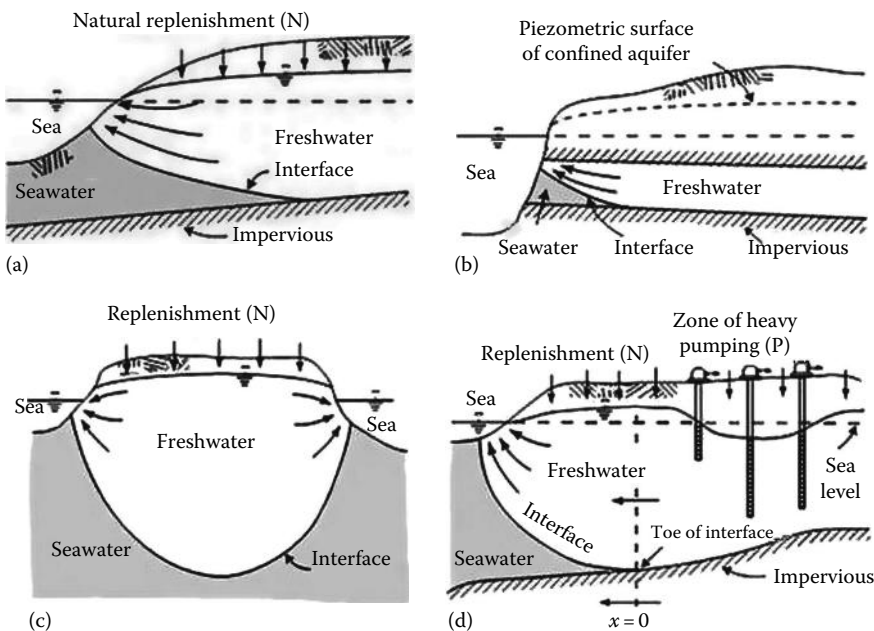
Saltwater intrusion is the movement of saline water into freshwater aquifers. Most often, it is caused by groundwater pumping from coastal wells or from construction of navigation channels or oil field canals. When freshwater is withdrawn at a faster rate than it can be replenished, the water table is drawn down as a result.

Seawater intrusion is a principal cause of fresh groundwater salinization in many regions of the world [11]. Fresh groundwater in arid and semiarid regions, like the Mediterranean basin, is even more threatened by this type of contamination. Indeed, such regions are characterized by a constant increase of water demand, especially for agricultural purposes, contrasting with the limited possibility of natural recharge and the high rates of evapotranspiration.

Seawater intrusion or “saltwater intrusion” is a specific process of groundwater contamination. This phenomenon draws special attention in the management of the coastal aquifers. As seawater intrusion progresses the part of the aquifer close to the sea become saline and pumping wells that operate close to the coast have to be abandoned. In such case, pumping wells operated there have to be controlled.

In general, hydraulic gradient from inland toward the sea exists in a coastal aquifer, because the sea serves as main outlet of freshwater from the aquifer. The seawater occupies the void space in the aquifer formation beneath the sea. This seawater zone in the aquifer extends to some distance landward from the coast below freshwater zone. Consequently, a zone of transition between freshwater and salt water exists, and it is referred to as “interface zone” or more simply “interface.”

Figure 2.1 presents some typical cross sections with interfaces in coastal aquifers under natural conditions (a, b, and c) and with pumping (d). It should be noted that these figures are highly distorted and not drawn to scale. The shape of the interface always has the form of a wedge in all aquifer types, while its size and details depend on many factors such as hydraulic conductivity of the aquifer and pumping rate.



**FIGURE 2.1** Schematic illustration of typical vertical cross sections of seawater intrusion in coastal aquifers: (a) unconfined aquifer, (b) confined aquifer, (c) freshwater lens on an island, and (d) unconfined aquifer with pumping. It should be noted that these figures are highly distorted and not drawn to scale. (From Bear, J., and Cheng, A.H.D., *Modeling Groundwater Flow and Contaminant Transport*, Springer, Dordrecht, the Netherlands, 834pp, 2010.)

After beginning or increase of pumping from the coastal aquifer, freshwater discharge to the sea is reduced, water level or piezometric head in confined aquifers drops close to or below the sea level, and the transition zone rises. The entire seawater and transition zone wedge advances landward until a new equilibrium state is established. Wells located within the wedge zone will pump saline water and thus have to be controlled or abandoned. When a pumping well is located above the transition zone, the seawater upcones toward the well [10].

Many researches have been carried out after the famous work of Gyben [32] and Herzberg [38] and the less-known work of Du Commun (1828) and Konikow and Reilly [48], leading to better understanding of the mechanisms governing seawater intrusion. For the flow regime in the aquifer above the intruding seawater wedge, it is known that the variable density and hydrodynamic dispersion are the dominant factors governing water and solute transport. Reviews of both theoretical work and field/laboratory investigations on seawater intrusion phenomenon can be found in the works of [12–15,33,70]. Several works deal with this coastal phenomena in many countries all over the world, including Egypt [73], Italy [17], and Australia [61]. Motz [54] focused on saltwater upconing as one of the most remarkable processes comprising the seawater intrusion phenomenon.

Although a lot of studies focused on the phenomenon of seawater intrusion worldwide, this important hydrogeochemical process still needs to deepen more, especially with the modeling tools, because they allow predicting the behavior of an aquifer system in response to pumping as excitations. If one will do it, decision makers can apply countermeasures to avoid the deterioration of groundwater quality, which might have socioeconomic effects.

#### **2.2.4 Groundwater Modeling**

Computer models have become an indispensable tool to study aquifers, to understand the interaction of different processes affecting the biogeochemistry and/or the heat distribution, to predict the effect of changes, and to solve practical groundwater problems. Examples are aquifer characterization, capture zone delineation, pumping and recharge well design and management, watershed simulation, groundwater pollution, potential hazards and remediation, acid mine drainage, natural attenuation, geo- and hydrothermics, and saltwater intrusion.

The simulation of groundwater flow systems and solute transport using computer codes is a standard practice in the field of hydrology. Models are used for a variety of purposes that include education, hydrologic investigation, water resources management, and legal determination of responsibility [31]. The main purpose of the model is to understand the behavior of an aquifer in response to stress conditions or change in the initial conditions.

Many studies have focused on the modeling of seawater intrusion, considering it as an important stress condition. Padilla and Cruz-Sanjulian [67] described the freshwater–seawater relationships in coastal aquifers in open boundaries by a 2-D numerical approach. Mikita et al. [56] studied the effect of anthropogenic changes in a confined groundwater flow system in the Bangkok basin by using a 3-D numerical model.

In spite of diversity of numerical studies treating seawater intrusion problem, some aspects remain unrevealed: relationship of the position and shape of seawater–freshwater interface with pumping rate and other geographical/hydrogeological factors. In particular, occurrence of saltwater upconing is one of the most interesting phenomena that need to be deepened with 3-D numerical simulations.

### **2.3 Artificial Recharge Techniques in Semiarid Areas**

---

#### **2.3.1 Artificial Recharge**

AR is the process whereby surface water is transferred underground to be stored in an aquifer. Underground water storage is an efficient way to store water because it is not vulnerable to evaporation losses, and it is relatively safe from contamination.

AR of groundwater generally results in an increased resistance to flow near the point of recharge. This is a result of clogging or plugging, which results in a decreasing rate of recharge or the need to continually increase the recharge head to maintain a constant recharge rate. Clogging can be caused by physical factors (such as air entrapment and suspended matter), bacteriological factors, and chemical factors. Clogging also has a negative impact on the recovery of artificially recharged water, since it increases drawdown during pumping (if the recovery borehole is clogged).

Groundwater is an important source of water for many villages, towns, and agricultural enterprises across South Africa. It is reliable and sustainable, provided its use is well managed.

As water use requirements increase, more demand is placed on aquifers and a number of different approaches have evolved whereby these can be topped up again, before they should empty and fail. The most common methods of AR involve either injecting surplus surface water into boreholes or transferring water into spreading basins where it infiltrates the subsurface. Catchment rehabilitation can also enhance infiltration. Aquifers may be used as a way of storing and reusing recycled wastewater.

AR is not only applied for restoration but also as an element in the continuous optimal exploitation of aquifers. AR of groundwater is applied for many reasons, such as to increase the sustainable yield, to control the groundwater table or the piezometric level (in order to restrict or to slow down land subsidence), to increase the volume of fresh groundwater available for emergencies, and/or as a barrier against inflow of saline groundwater.

AR can be realized by (increased) infiltration at the land surface or in surface waters or by means of recharge wells with well screens in aquifers at any desired depth. For the recharge of phreatic groundwater, both techniques can be applied. Confined and semi-confined groundwater in aquifers at some depth cannot be recharged from the land surface or surface waters due to the high hydraulic resistance between the land and water surface and the aquifers at some depth below the land and water surface.

At present, there is a growing opposition against AR by infiltration at the land surface or in surface waters. The objections are the occupancy of large surface areas and undesirable ecological effects due to changes in the phreatic groundwater regime, both in terms of groundwater tables and water quality. The first objection holds particularly in intensively used areas. The second objection holds in particular in case of scarcity of nature and its uniqueness.

A special form of AR is induced recharge, where groundwater is abstracted along and at short distance from rivers. If the rate of abstraction exceeds the rate of natural flow of groundwater toward the river, inflow of river water is induced and the abstracted water consists partly of river water. This affects the quality of the abstracted groundwater. In the most downstream reaches of rivers and in estuaries, the inflowing groundwater may be brackish or even saline [77], depending on the tidal regime and on the magnitude of the river flow. This should be checked before undertaking any project for induced recharge.

The potential sources of water for AR are surface water or pumped groundwater after its first use and proper treatment after that. Surface water can be taken from rivers or estuaries and be transported either by canals or by pipelines. It is obvious that the water should be fresh. Therefore, the intakes should be beyond the reach of saltwater intrusion in the rivers and estuaries [77], or the estuaries should be provided with dams and sluices. The quality of the water at the source should satisfy certain standards. Such standards depend mainly on the use of the water after recharge and subsequent recovery but also on the requirements for transport and subsequent recharge. These two latter aspects in themselves may already require some pretreatment. This holds in particular for recharge by means of recharge wells, in order to avoid clogging of these wells.

Apart from pretreatment of the water for recharge, the rate of recharge per well should be limited. Despite pretreatment of the water, the capacity of the recharge wells decreases during operation. Therefore, regeneration of the recharge wells is needed from time to time. Due to intensive research, much progress has been made both with respect to the pretreatment required for water of different quality and with respect to the techniques of regeneration.



In the phreatic case, more groundwater can be abstracted sustainably, and the interface between fresh and saline groundwater can be pushed down by application of AR. This latter fact implies that the reserve for temporal overdraft becomes greater.

This holds for islands in the sea as well as for sand dunes along the sea coast. If in the latter case the controlled groundwater tables at the land side of the sand dunes are below mean sea level, the inflow of saline groundwater underneath the freshwater lens in the sand dunes is reduced or, depending on the depth to the impermeable base, even halted.

With respect to the mutual location of recharge ponds, canals, or wells and the abstraction works, the following considerations hold. In order to assure a minimum residence time for improvement of the water quality, these works should be located at a minimum distance that can be calculated. The longer the residence times of the infiltrated water, the greater also the smoothing out of the fluctuations in the quality of the infiltrated water. A more constant quality of the abstracted water is generally appreciated by the consumers. Fluctuations can even more be flattened by applying variable distances between the lines of recharge works and abstraction works, respectively. Therefore, in the design of the combined recharge and abstraction system, one should make use of the topographic features of the terrain with respect also to the aspect of water quality fluctuations.

Another consideration relates to the question whether to locate a line of abstraction works in between two lines of recharge works (or in the center of a more or less elliptic configuration of recharge works) or the other way round, the line of recharge works surrounded by two lines or a more or less elliptic configuration of abstraction works. The latter layout has the advantage that the phreatic groundwater tables will be higher and, accordingly, the depths to the interface greater. This implies the availability of a larger volume of freshwater for emergencies. Moreover, due to the greater thickness, the residence times will be somewhat longer and somewhat more spread out. The regime of desired or accepted groundwater tables should also be judged in relation to the topography and the ecological features of the terrain.

Depending on the variation of the water requirements over time, as determined by the climate and weather, and on the availability of water of good quality for AR, the actual rates of abstraction and AR of groundwater may vary with time, periodically and incidentally. So the volume of fresh groundwater will also vary with time, and the boundary between fresh and saline groundwater will not only move up and down but the transition between fresh and saline will also become less sharp due to the effects of dispersion and retardation.

Attention should also be paid to the question where the displaced brackish and saline groundwater goes and what effects it has in the surroundings. So, for instance, increased seepage of brackish or saline groundwater in adjacent areas will generally not be appreciated. Therefore, the effects of the combined system of abstraction and recharge in the wider surroundings must be foreseen, predicted, and judged before undertaking any AR project.

### **2.3.2 History of Artificial Recharge**

AR applications have been documented from the early nineteenth century, when European countries first attempted to ease the stress on their groundwater supplies. According to European Environment Agency [53], a growing increase in AR is noted in several countries such as Belgium, Denmark, Finland, Greece, the Netherlands, Poland, Spain, and Switzerland. Other countries in which AR schemes are operating include Australia, Austria, Hungary, Iran, Israel, Jamaica, Morocco, and South Africa [43].

The motivation for AR is highly dependent of the country. While some countries practice recharge to match predevelopment levels, others go beyond these levels to create temporary storage for dry seasons. Coastal regions are more concerned about saline water intrusion, and industrialized countries might see AR as an alternative means for treating wastewater.

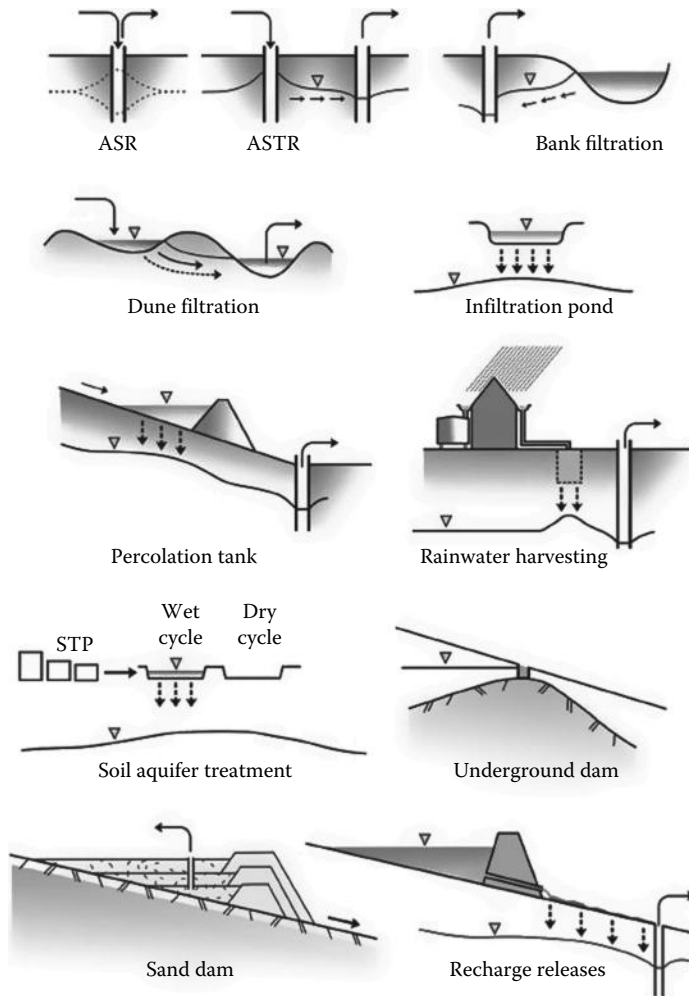


FIGURE 2.2 Schematic types of management of aquifer recharge. (After Dillon, P., *Hydrogeol. J.*, 13(1), 313, 2005.)

### 2.3.3 Methods for Artificial Recharge

A brief overview of terminology and descriptions of the major techniques is provided in the succeeding text [29]. These are represented in Figure 2.2.

AR methods can be classified into three broad groups: (1) direct methods, (2) indirect methods, and (3) combination methods.

#### 2.3.3.1 Direct Methods

##### 2.3.3.1.1 Surface Spreading Techniques

The most widely practiced methods of AR of groundwater employ different techniques of increasing the contact area and resident time of surface water with the soil so that maximum quantity of water can infiltrate and augment the groundwater storage. Areas with gently sloping land without gullies or ridges are most suited for surface water-spreading techniques.

**Flooding:** This technique is ideal for lands adjoining rivers or irrigation canals in which water levels remain deep even after monsoons and where sufficient noncommitted surface water supplies are

available. It is very useful in selected areas where a favorable hydrogeological situation exists for recharging the unconfined aquifer by spreading the surplus surface water from canals/streams over large area for sufficiently long period so that it recharges the groundwater body. This technique can be used for gently sloping land with slope around 1%–3% points without gullies and ridges.

*Ditches and furrows method:* In areas with irregular topography, shallow, flat-bottomed, and closely spaced ditches and furrows provide maximum water contact area for recharging water from the source stream or canal. This technique requires less soil preparation than the recharge basin technique and is less sensitive to silting.

*Recharge basins:* AR basins are either excavated or enclosed by dykes or levees. They are commonly built parallel to ephemeral or intermittent stream channels. The water contact area in this method is quite high that typically ranges from 75% to 90% points of the total recharge area. In this method, efficient use of space is made, and the shape of basins can be adjusted to suit the terrain condition and the available space.

#### 2.3.3.1.2 *Runoff Conservation Structures*

In areas receiving low to moderate rainfall, mostly during a single monsoon season, and not having access to water transferred from other areas, the entire effort of water conservation is required to be related to the available in situ precipitation.

*Gully plugs:* These are the smallest runoff conservation structures built across small gullies and streams rushing down the hill slopes carrying drainage of tiny catchments during rainy season. Usually, the barrier is constructed by using local stones, earth and weathered rock, brushwood, and other such local materials.

Sloping lands with surface gradients up to 8% points having adequate soil cover can be leveled through *bench terracing*: for bringing under cultivation. It helps in soil conservation and holding runoff water on terraced area for longer duration giving rise to increased infiltration recharge.

*Contour barriers:* These involve a watershed management practice so as to build up soil moisture storages. This technique is generally adopted in areas receiving low rainfall. In this method, the monsoon runoff is impounded by putting barriers on the sloping ground all along contours of equal elevation. Contour barriers are taken up on lands with moderate slopes without involving terracing.

In areas where uncultivated land is available in and around the stream channel section, and sufficiently high hydraulic conductivity exists for subsurface percolation, small tanks are created by making stop dams of low elevation across the stream. The tanks can also be located adjacent to the stream by excavation and connecting them to the stream through delivery canals. These tanks are called *percolation tanks* and are thus artificially created surface water bodies submerging a highly permeable land area so that the surface runoff is made to percolate and recharge the groundwater storage. Normally, a percolation tank should not retain water beyond February in the Indian context. It should be located downstream of a runoff zone, preferably toward the edge of a piedmont zone or in the upper part of a transition zone (land slope between 3% and 5% points). There should be adequate area suitable for irrigation near a percolation tank.

*Stream channel modification:* The natural drainage channel can be modified with a view to increase the infiltration by detaining stream flow and increasing the streambed area in contact with water. This method can be employed in areas having influent streams (streambed above water table) that are mostly located in piedmont regions and areas with deep water table (semiarid and arid regions and valley fill deposits). Stream channel modification methods are generally applied in alluvial areas.

*Surface irrigation:* Surface irrigation aims at increasing agricultural production by providing dependable watering of crops during gaps in monsoon and during non-monsoon period. Wherever adequate drainage is assured, if additional source water becomes available, surface irrigation should be given first priority as it gives a dual benefit of augmenting groundwater resources.

### 2.3.3.1.3 Subsurface Techniques

Subsurface techniques aim at recharging deeper aquifers that are overlain by impermeable layers, preventing the infiltration from surface sources to recharge them under natural conditions. The most common methods used for recharging such deeper aquifers are the following:

*Injection wells or recharge wells:* Infiltration wells or injection wells are used where permeable soils and/or sufficient land area for surface infiltration is not available. Well infiltration calls for very high quality of the infiltration water if clogging of the well screen and the aquifer in the vicinity of the well is to be avoided. The construction is more complicated and costly, and restoration of the hydraulic conductivity around the wells may be unfeasible if not impossible. The best strategy for dealing with clogging of recharge wells is to prevent it by proper treatment of the water before injection. This means removal of suspended solids, assimilable organic carbon, nutrients like nitrogen and phosphorous, and microorganisms [39].

*Recharge pits and recharge shafts:* Recharge pits are structures that overcome the difficulty of AR of phreatic aquifer from surface water sources. Recharge pits are excavated of variable dimensions that are sufficiently deep to penetrate less permeable strata. This measure is more suitable in piedmont regions and in areas with higher surface gradients. As in case of other water-spreading methods, the source water used should be as silt-free as possible. In case of hard-rock terrain, a canal bed section crossing permeable strata of weathered fractured rock or the canal section coinciding with a prominent lineament or intersection of two lineaments forms ideal sites for canal trench.

In case poorly permeable strata overlie the water table aquifer located deep below land surface, a shaft is used for causing AR. A recharge shaft is similar to a recharge pit but much smaller in cross section.

*Infiltration basins:* Infiltration basins require a substantial amount of land area with a suitable geology, allowing the water to infiltrate into the aquifer and percolate to the groundwater table. It is simple to maintain, and regular restoration of infiltration capacity and removal of clogging layers are relatively easy though time-consuming. This method also allows for natural, quality-improving processes to take place in the infiltration ponds and subsoil. Construction is normally comparatively simple and low cost. Impermeable topsoil may, however, raise the costs [40]. The infiltration from a recharge basin produces a groundwater mound above the original water table. The groundwater mound grows over time, and once the infiltration stops, it decays gradually.

### 2.3.3.2 Indirect Methods

Indirect methods for AR to groundwater do not involve direct supply of water for recharging aquifers, but aim at recharging aquifers through indirect means. The most common methods in this category are induced recharge from surface water sources and aquifer modification techniques.

#### 2.3.3.2.1 Induced Recharge from Surface Water Resources

It is an indirect method of AR involving pumping from aquifer hydraulically connected with surface water to induce recharge to the groundwater reservoir. In hard-rock areas, the abandoned channels often provide good sites for induced recharge. The greatest advantage of this method is that under favorable hydrogeological situations, the quality of surface water generally improves due to its path through the aquifer materials before it is discharged from the pumping well.

*Pumping wells:* Induced recharge system is installed near perennial streams that are hydraulically connected to an aquifer through the permeable rock material of the stream channel. The outer edge of a bend in the stream is favorable for location of well site. The chemical quality of surface water source is one of the most important considerations during induced recharge.

*Collector wells:* For obtaining very large water supplies from riverbed, lake bed deposits, or water-logged areas, collector wells are constructed. The large discharges and lower lift heads make these wells

economical even if initial capital cost is higher as compared to tube well. In areas where the phreatic aquifer adjacent to the river is of limited thickness, horizontal wells may be more appropriate than vertical wells. Collector well with horizontal laterals and infiltration galleries can get more induced recharge from the stream.

*Infiltration gallery:* Infiltration galleries are other structures used for tapping groundwater reservoir below riverbed strata. The gallery is a horizontal perforated or porous structure (pipe) with open joints, surrounded by a gravel filter envelope laid in permeable saturated strata having shallow water table and a perennial source of recharge. The galleries are usually laid at depths between 3 and 6 m to collect water under gravity flow. The galleries can also be constructed across the riverbed if the riverbed is not too wide. The collector well is more sophisticated and expensive but has higher capacities than the infiltration gallery. Hence, choice should be made by the required yield followed by economic aspects.

#### 2.3.3.2.2 *Aquifer Modification Techniques*

These techniques modify the aquifer characteristics to increase its capacity to store and transmit water through artificial means. The most important techniques under this category are bore blasting techniques and hydrofracturing techniques. Though they are yield augmentation techniques rather than AR structures, they are also being considered as AR structures owing to the resultant increase in the storage of groundwater in the aquifers.

#### 2.3.3.3 **Combination Methods**

Various combinations of surface and subsurface recharge methods may be used in conjunction under favorable hydrogeological conditions for optimum recharge of groundwater reservoirs. The selection of methods to be combined in such cases is site specific. Commonly adopted combination methods include recharge basins with shafts, percolation ponds with recharge pits or shafts, and induced recharge with wells tapping multiple aquifers permitting water to flow from upper to lower aquifer zones through the annular space between the walls and casing (connector wells).

## 2.4 **Tunisia's Experience in Artificial Recharge**

In arid and semiarid regions of North Africa, groundwater resources represent a source of life. They offer an opportunity to alleviate growing water scarcity, improve social welfare, and facilitate economic development. In Tunisia, groundwater is the only dependable source for urban and agricultural water supply. In recent years, groundwater pumping increased with increased population, and water level in the unconfined aquifer has largely obviously declined. Moreover, groundwater quality deteriorates progressively overall in the Cap Bon and in the Tunisian Sahel. Historically, the groundwater salinization has been thought to result from processes related to water-rock interaction and long-term irrigation practices. Tunisia has arid to semiarid climate. The average rainfall is 500–800 mm/year in the northern part of the country, whereas the South only receives 100–200 mm. The global water resources amount to 4.8 billion m<sup>3</sup>, 2.7 billion m<sup>3</sup> surface water and 2.1 billion m<sup>3</sup> groundwater. The net development rate of surface resources is 57% and that of groundwater 83% [37].

Comparing the water resources to the needs shows that, although the overall demand should be met up to 2050, some areas are already suffering from water scarcity and aquifer overdrawn. Furthermore, water resources often have a noticeable degree of salinity. Water shortage will become even more important as developing new water resources will be increasingly expensive. Desalination of brackish water is already implemented in Kerkennah Island and at Gabes. Wastewater reuse was an integral part of the water resources management, a 10-year plan adopted in 1991 is hardly surprising.

Treated wastewaters are used to recharge aquifer (Cap Bon) and irrigate fruit trees (citrus, olives, peaches, pears, apples, grenades), vineyards, fodder (alfalfa, sorghum), cotton, tobacco, cereals, golf courses (Tunis, Hammamet, Sousse, Monastir), and hotel gardens in Jerba and Zarzis.

### 2.4.1 A 40-Year Artificial Recharge of the Aquifer by Water from the Dam

The Teboulba region is situated in the Tunisian Sahel. This region has a semiarid to arid climate with mild, wet winters and dry, hot summers, a mean annual rainfall of the order of 375 mm, and a mean annual temperature of about 20°C. The studied sector of the region is part of the Sahelian watershed basin, built up on a low-lying coastal plain partly recovered from the sea. The monotonous topography and the geological cover, dominated by Quaternary formations, make it impossible to identify any hydrogeological basin structures. However, the depressions in the interior of the region and the wadis along the coastal zone help to identify the boundaries of more or less individual hydrological basins.

The study site is located on an alluvial plain whose geology is dominated by Quaternary deposits. The Teboulba area has relatively stable tectonics apparent in the tabular sedimentary structure. However, normal faults have clearly affected the structure of the deep layers. The Teboulba plateau, 10 km long and 4 km wide, plunges quite sharply toward the sea while a fairly gentle slope links it to the Moknine sebkha (a salt lake at the elevation of about 13 m below sea level). It contains an alluvial water table aquifer with lenticular geometry, short horizontal extent, and irregular vertical continuity. There are also a few perched aquifers lodged inside the formation in silt–sand layers and lenses intercalated between clay and clay–sand strata. The substratum of the aquifer, consisting of an impervious Mio-Pliocene clay–marl layer, lies at a depth of over 90 m.

The Teboulba aquifer covers a surface area of around 35 km<sup>2</sup> and represents a hydrological recharge potential estimated, on average, at 0.65 million m<sup>3</sup>/year with an exploited volume of 1 million m<sup>3</sup>/year. This heavily negative budget (deficit of 0.35 million m<sup>3</sup>/year) is compensated by reserves but, above all, by an inflow of salt water from the sea and/or the sebkha and by return flow of irrigation water from the neighboring regions, estimated at 0.53 million m<sup>3</sup>/year [18], only a part of which flows toward Teboulba. The overexploitation of the resources, which begun hundreds of years ago and particularly intensified in the last decades, has caused a drawdown of the aquifer to an elevation below sea level (over –30 m at some points) in a zone that covers almost 12 km<sup>2</sup>. This depression has provoked an intrusion into the aquifer layers of salt water from the sea in the north and from the sebkha in the south, and, as a consequence, the water quality has deteriorated to the extent that in some areas it can no longer be used for irrigation [3].

The Teboulba coastal aquifer is located in the sand–silt Plio-Quaternary formations, characterized by an effective porosity estimated at 7%, an average transmissivity of around  $2 \times 10^{-4}$  m<sup>2</sup>/s, and a storage coefficient of the order of  $3.5 \times 10^{-2}$ . It is a vivid example of overexploitation. The flow in this aquifer takes several directions but converges generally on the exploitation zone (Figure 2.3a). The flow toward the sea and toward the Moknine sebkha, two natural outlets of the aquifer, is relatively weak due to the strong depression created by the heavy exploitation in the western part of the region. The hydraulic gradients are very variable depending on the lateral facies changes in the aquifer formation and the drawdown linked to the overexploitation. The aquifer is naturally recharged mainly by rainwater and, to a lesser degree, by domestic wastewater from infiltration pits and re-infiltration of some irrigation water. Discharge occurs mainly by pumping for agricultural purposes and into the sea and sebkha. Saltwater intrusion from the sea and/or from the sebkha may disturb the hydrodynamics of the aquifer. All these factors make the water balance of the aquifer extremely complex and its hydrodynamic equilibrium very fragile and, above all, highly variable.

The history of this operation goes back to the 1970s. It concerns the recharge of the aquifer via a connection to the main pipe of the irrigation network [19,60,68].

As there was no excess water in the Nibhana dam because of the rainfall deficit during the period from 1978 to 1991, the recharge operation was interrupted at the end of 1978 and restarted in July 1992, lasting until 2000.

The monitoring installation was composed of 22 surface wells exploiting the aquifer and three piezometers. The analysis of the piezometric level fluctuations versus time in the control wells indicated two distinct behaviors. The first one showed a rapid and continuous recovery of the water level in the wells close to the zone where the recharge was strong. The second one was the continuous decrease

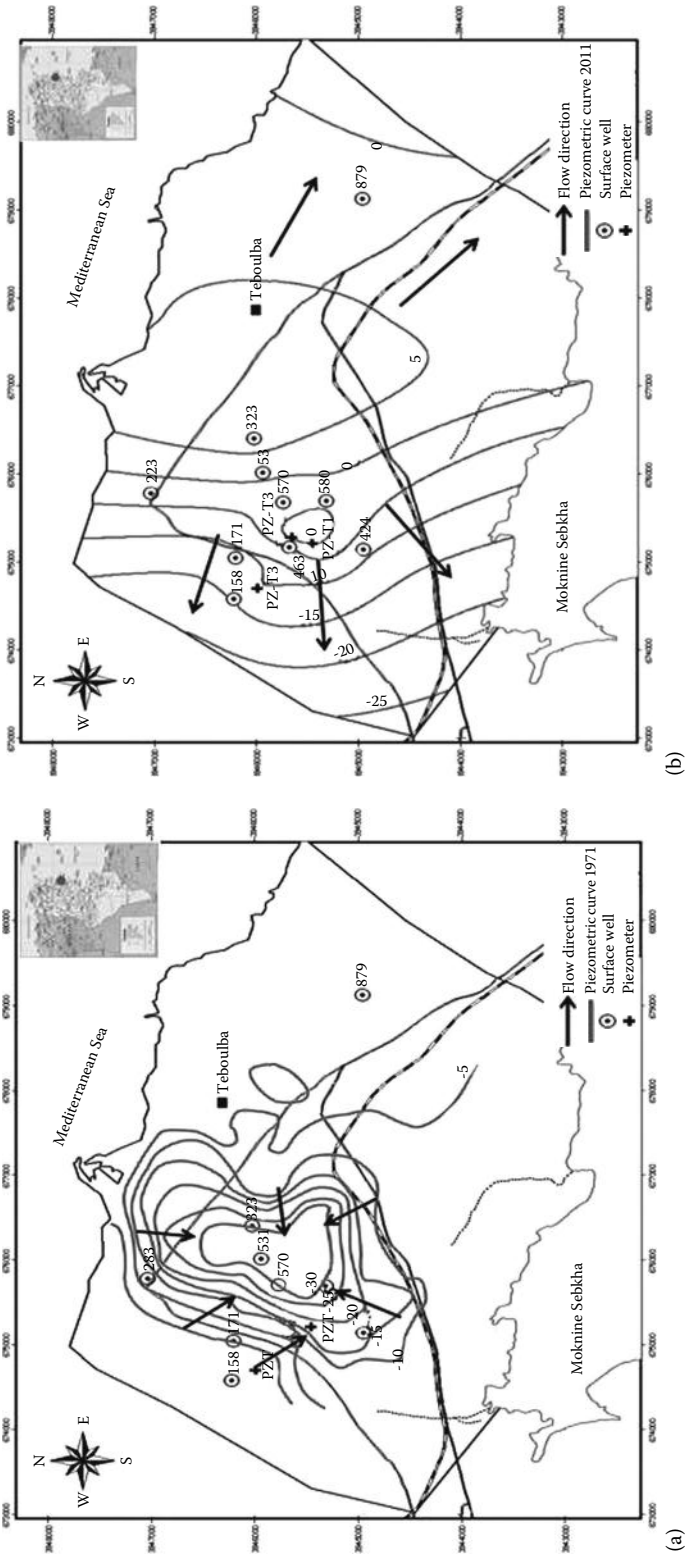


FIGURE 2.3 Piezometric map before recharge (a), 1971, and 40 years after recharge (b), 2011, in Teboulba coastal aquifer (Tunisian Sahel).

due to the exploitation of the aquifer by the surface wells. This can be explained by the great distance between the recharge zone and these wells and the weak natural recharge rate that does not compensate for the large quantities of water withdrawn by the farmers. Establishing the piezometric maps is sometimes made more difficult by the presence of small perched aquifers inside the weakly permeable lenticular formations.

After intense AR from 1971, an analysis of the piezometric situation of the aquifer, in 2011 (Figure 2.3b), further confirmed the existence of the localized domes, revealed in 1971, but definitely enhanced. The flow direction of the aquifer remained constant but still retained the depression in the western part of the aquifer. Furthermore, the map shows a narrowing of the depression cone compared to earlier situations. The water level had risen, sometimes by more than 13 m underneath the recharge site. The Teboulba aquifer is also recharged by infiltration return flow of treated wastewater used for irrigation. These irrigation volumes were 144,000 m<sup>3</sup> in 1992, 114,000 in 1993, and 255,000 in 1994 [18].

Furthermore, this aquifer is characterized by water with a fairly heavy load of salt. Its salinity may reach 4.5 g/L. The highest values have been recorded near the sea and the sebkha, whereas the lowest (1.5 g/L) is found toward the center of the aquifer (Figure 2.4a). The planned remedial action is to bring surface water from the overspill of the Nibhana dam and inject it into a few of the wells among the thousand existing ones.

The mean rainfall recharge to the aquifer was estimated with an infiltration coefficient of rainfall of 5% determined by Kamenski's method applied to triple wells aligned along a flow line and monitored every month (aquifer recharge calculated from the rise in its level after a rain event).

Luckily, because of the weak permeability of the water bearing layers, the saltwater intrusion has not progressed very far. The aquifer is exploited mainly by 806 surface wells, 465 of which are equipped with motor pumps enabling them to irrigate, by sprinklers, a surface area of about 200 ha.

Hydrochemical studies carried out from 1940 to 1971 show that the salt content in the aquifer water follows the same pattern as the piezometric levels measured between 1940 and 1971. The salinity map for 1971 (Figure 2.4a) shows values higher than 4.3 g/L, a sign that the aquifer water was becoming brackish. The high salinity values observed in the north and south of the region are explained by the contamination of the aquifer by saline intrusion from the sea and sebkha. This hypothesis is supported by the high chloride contents and the presence of inverse cation-exchange reactions, which are characteristic of sea- and freshwater mixing movements [20,49].

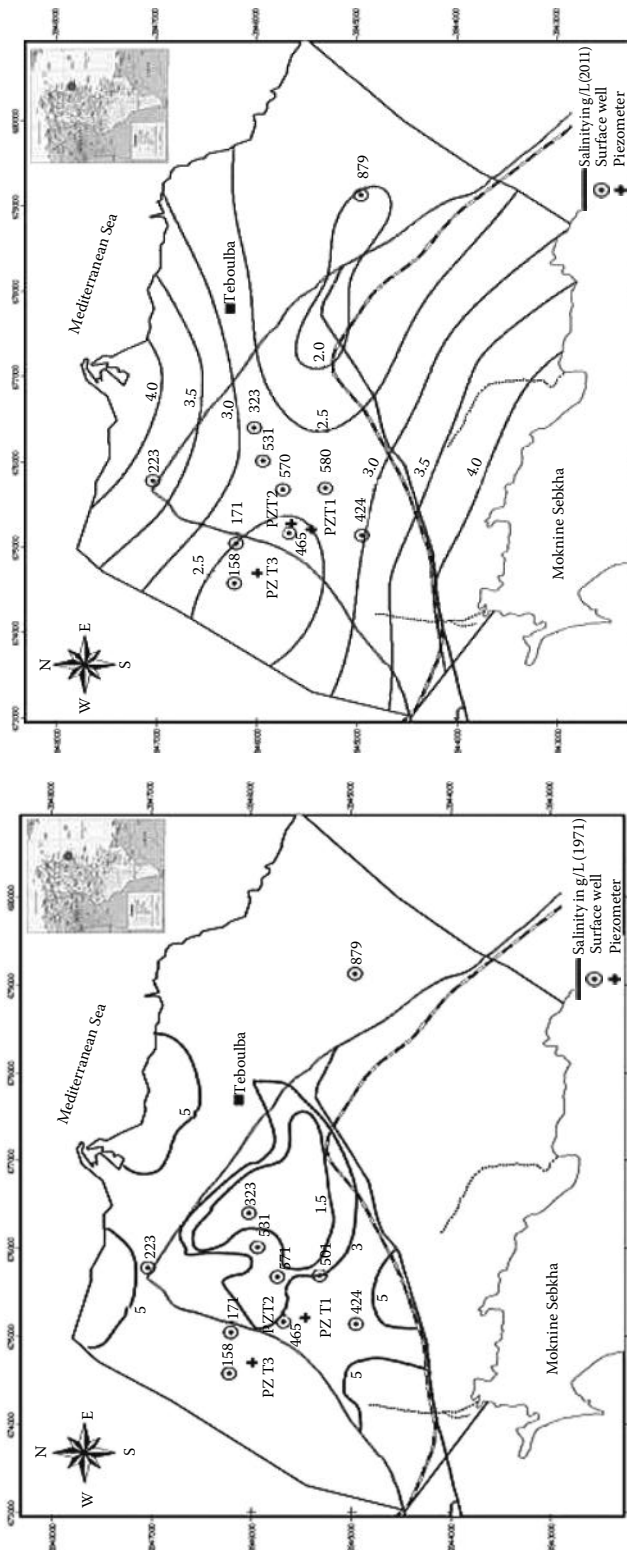
The salinity variations of its water, recorded in the control wells, were not very significant, due to the great surplus of rainfall that year that contributed to the natural recharge of the aquifer, thus maintaining both the piezometric levels and the water quality. The salinity map for the year 2011 (Figure 2.4b) shows a slight salinity reduction toward the west of the aquifer: the zone characterized by salinity lower than 2 g/L and situated near the recharge site becomes more extensive. This shows the influence of the mixing with less salty water from the Nibhana dam.

#### **2.4.2 A 26-Year Artificial Recharge of the Aquifer by Treated Wastewater**

Besides reclaimed water reuse for agricultural purposes, seasonal recharge of the shallow and sandy aquifer of Nabeul Oued Souhil has been performed since 1985. The field experiment was located in the experimental farm of Oued Souhil (INRGREF) in northeastern Tunisia (to about 60 km of Tunis). The climate is semiarid with 400 mm as mean annual precipitation at Nabeul city and 19°C as mean temperature. Dominant economic activities are tourism and agriculture with some agro-industries.

The groundwater AR by treated wastewater is the first pilot project in this field to be developed in Tunisia in 1986. The aquifer Hammamet–Nabeul is located at the northeastern coast of Tunisia along the Mediterranean Sea. The shallow aquifer contains more than 4000 surface wells that are used to irrigate citrus. The alluvial aquifer of Quaternarian age is formed by sand with no or very low content of clay. The thickness of this aquifer ranges between 10 and 20 m. It is underlain by a layer of Pliocenic clay, which reaches a thickness of more than 200 m. The aquifer is bordered at the west





(a) (b) **FIGURE 2.4** Salinity map before recharge (a), 1971, in g/L and 40 years after recharge (b), 2011, in mS/cm at the Teboulba coastal aquifer (Tunisian Sahel).

by an undifferentiated Pliocene, consisting of sand, sandstone, and clay being the main components. Soils in the Oued Souhil area were described as being composed of alluvia of coarse material belonging to the Quaternary marine formation. They are poor sandy to sandy-silty soils with low fine material content suitable for horticultural and orchard cultivation [23]. The vadose zone of the aquifer has been described previously [69,62] and more recently [45] as varying between 10 and 13 m thick from the riverbed to the infiltration basins. The permeability of the aquifer is estimated between  $10^{-5}$  and  $6 \times 10^{-3}$  m/s. The piezometric surface determined the isopotential lines are parallel to the coast. The thickness of this formation can be more than 300 m [5]. In a deep well (about 200 m) located near the border to the alluvial aquifer, brackish water has been found, which is oversaturated in  $\text{CaSO}_4$ . Four wells located several hundred meters upward, which penetrate only the upper levels, are pumping freshwater with a conductivity of about 1 mS/cm. Several springs exist at the upper level of this formation with water of good chemical quality.

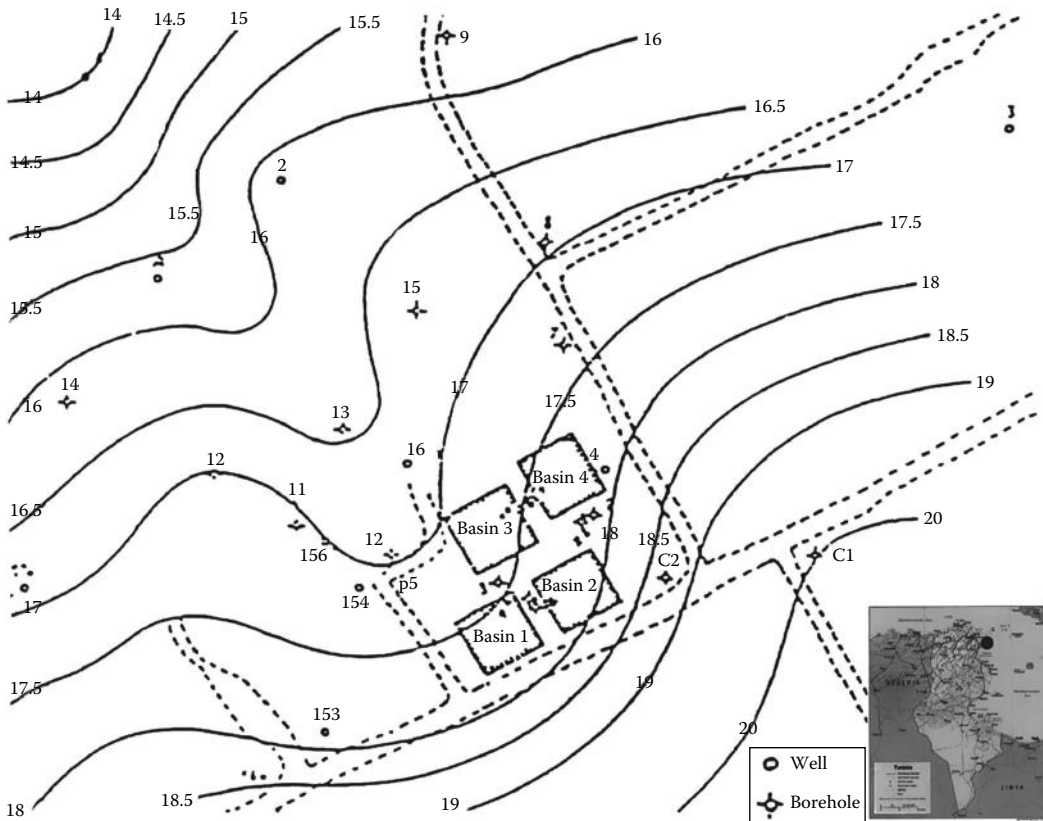
Artificial groundwater recharge is operated at experimental scale in infiltration-percolation basins, and the AR station Nabeul Oued Souhil is composed of four injection basins and 18 piezometers. Some of the observation wells are placed along two lines in direction of groundwater movement, the others, between and near the infiltration basins. Groundwater recharge efficiency was proven not only by the increase of the water level in the wells but also by the improvement of the production of the surrounding wells. This experiment allowed an underground storage and an additional treatment step as wastewater slowly infiltrated through the unsaturated zone (7 months after the end of the recharge, nitrogen concentrations were about few milligrams per liter). However, no clear conclusion could be drawn about the effect of reclaimed water on the bacterial and chemical composition of shallow groundwater since the initial contamination level of most of the wells was relatively high and subject to seasonal variations. According to the state of the art of soil aquifer treatment (SAT) [21,22], improved operation of this facility would lead to a groundwater quality meeting unrestricted irrigation requirement [71].

The coastal alluvial aquifers are crossed by five small rivers, the most important of which is the river Souhil with a basin of about 20 km<sup>2</sup>. These rivers are usually dry, and water flows only sporadically during the rainy periods. In spite of this, most of the recharge is provided by these rivers. Several hundreds of dug wells exist in the area. Due to overexploitation, the aquifer is practically exhausted: the average thickness of the saturated zone is about 2–3 m. The recirculation of the pumped water together with the solution of mineral manure has produced an important degradation of the chemical quality of the water. In some areas near the coast, marine intrusion has taken place. The piezometric surface determined during the present study is shown in Figure 2.5. As expected, the isopotential lines are parallel to the coast. The piezometric depression existing at the head of the river Souhil is a consequence of the concentrated pumping of Pliocenian water in this area. The piezometric gradient varies between 1% and 2.5% and corresponds more or less to the slope of the underlying impervious clay layer [64].

The recharge site is selected on the basis of lithologic character, hydrologic situation, and a favorable geohydrologic environment. This part of the aquifer is a typical homogeneous alluvial deposit consisting of fine to medium sand with some gravel deposits. The gross hydrologic characteristics are relatively uniform throughout the area. Also, the field of experimentation is a public property. The AR station is composed of four injection basins (length=20 m, wide=20 m, depth=1.7 m). The side slopes are covered with a layer of synthetic and permeable geotextile tissue (specific gravity=270 g/m<sup>2</sup>, permeability=0.0007 m/s) and 18 piezometers (Figure 2.5).

The piezometric map, as shown in Figure 2.5, plotted before AR reveals that the infiltration basins are placed on a preferential direction of groundwater movement. The local hydraulic gradient is about 0.015 [64].

Two hypotheses advanced to explain the mechanism of the wastewater recharge throughout the saturated and the unsaturated zone of the aquifer: (1) The injected wastewater itself moved and a mixing with the native water is produced. (2) Volumes of injected wastewater were sufficient to totally displace all native formation water and the mechanism is the “piston flow.” The use of isotopic tracer supports this last hypothesis.



**FIGURE 2.5** Experimental Hammamet-Nabeul recharge and the piezometry of the local groundwater (m).

Some hydraulic properties for the aquifer were determined during the study: (1) Plots of particle size distribution were constructed using data derived from core samples from test holes. The graphs show that for most of the intervals analyzed, there is a uniform range of fine and medium sand. To determine the theoretic velocity of groundwater, we have applied A. Hazen's law ( $K = c d_{10}^2$ ), based on the data of particle size distribution; the result was that the velocity obtained is about 0.0001 m/s ( $c = 135$ ). (2) Horizontal hydraulic conductivity derived from pumping test interpretations is reported to be about 0.0004–0.0005 m<sup>2</sup>/s. (3) On the site of the AR, the water table lies 12 m below ground, and the saturated zone has a limited depth (less than 4 m). (4) The lowest groundwater levels occurred during the end of the dry season (summer), and the highest water levels occurred during the end of the wet season (spring). Groundwater level fluctuations are about 1–2 m/year. (5)

From all the tests concerning the two couples (basin 1, basin 2 and basin 3, basin 4), the infiltration rates were determined to average about 1 m/day for a head of water of 1 m, the curve of recharge rate for all the basins. To resolve the problem of clogging, if oil is present, the procedure is drying combined with scarification of the soil surface. If oil is absent, only drying is sufficient. Concerning the environmental problems that have occurred, there was the limited presence of insects, some clumps of algae, odors only during the end of the cleaning out of the basins, suspended sediments, and, finally, some frogs. After drying, the analysis of the clogging film shows these proportions: organic substance 13%, clay 11%, loam 16%, and other part is attributed to fine sand. To survey the hydrodynamic impact of the recharge, the aquifer water levels have been measured daily before, during, and after the experimentation, in observation wells (18 piezometers and 22 shallow wells).

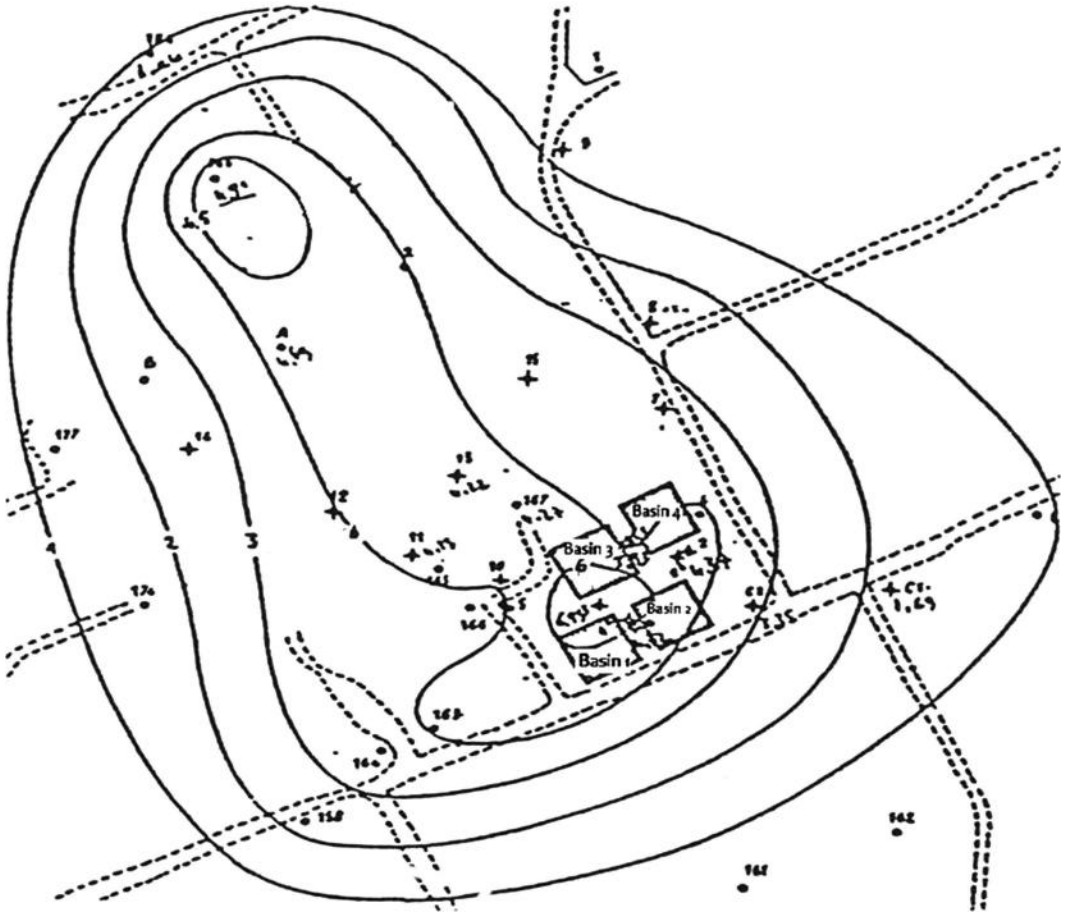


FIGURE 2.6 The curves of equal rise of the level in the experimental Hammamet–Nabeul.

When wastewater is injected into the basins, it forms a conical mound around the basins. The height of the cone is greatest under the recharge basins and decreases laterally with distance. It appears that the dimensions of the mound are governed by the basin size and shape, recharge rate, duration, and aquifer characteristics.

Figure 2.6 shows the spatial and temporal evolution of the mound throughout the aquifer. The top of the mound does never contact the bottom of the basins. The remarkable fact is that most of the injected water flows in the general direction of observation wells that are installed in direction of groundwater movement and particularly along the drainage zone.

### 2.4.3 Treated Wastewater Reuse for a Seawater Intrusion Hydraulic Barrier

The coastal aquifer of the Cap Bon Peninsula in Tunisia is one of the first studied examples of groundwater depletion and salinization under a semiarid climate. The large quantities of water abstracted by the agricultural and industrial sectors since the 1960s have resulted in a spatiotemporal evolution of piezometric depletion and groundwater quality degradation due to seawater intrusion [30]. AR of groundwater has been part of Tunisia's integrated management of water resources since the 1970s [64].

In 2008, a new pilot site was established in the Korba–Mida area to recharge the aquifer with treated domestic wastewater from the Korba treatment plant. The aim was a better evaluation of the mixing processes between seawater, groundwater bodies, and the new recharge contributor and of the changes due to intense groundwater withdrawal, which will be useful from a water resource management perspective aimed at controlling human interference on the Korba plain groundwater.

The east coast aquifer of the Cap Bon Peninsula, which lies 100 km east of Tunis, extends for about 45 km and underlies an area of approximately 475 km<sup>2</sup>. The region has a semiarid climate characterized by an average annual rainfall (determined from 1964 to 2010) of 480 mm with temporal irregularities; 65% of this is concentrated between November and March. The climatic deficit (rainfall minus evapotranspiration) covers a period of about 10 months, reaching its maximum (160 mm) in July and August. The summers are hot and dry and the winters cold and wet. Average annual temperatures vary between 17°C and 19°C. Monthly evaporation is high (around 1300 mm/year) with humidity between 68% and 76%. The dry season is pronounced, which aggravates the situation given that the highest water demand usually coincides with the period of drought [36].

The Korba aquifer can be divided into two hydrogeological units: the Late Miocene/Oligocene aquifer and the Plio–Quaternary aquifer. The aquifers have the same eastern and southern limits, but to the north and west, the Miocene/Oligocene aquifer is 300 km<sup>2</sup> larger than the Plio–Quaternary aquifer, particularly in the west of the study area.

The Korba–Mida aquifer is one of the more productive aquifers of Tunisia but suffers heavily from water scarcity and salinization due to seawater intrusion. Its exploitation began in the 1960s, mainly for irrigation purposes. Pumped abstraction of the groundwater by 2008 was estimated at 50 million m<sup>3</sup>, with meteoric recharge at 17 million m<sup>3</sup>, and irrigation return flow at 16% of the annual irrigation–water percolation to the aquifer between 1993 and 2003 [30,51,63]. More than 9240 wells were active throughout the region in 2008, mainly pumping the shallow Plio–Quaternary aquifer; the number of wells is proportional to the number of farms [35].

While the region's agricultural productivity levels in the 1990s were still increasing, its available water resources were already fully exploited with the prospect of major water problems looming in the following decade. Although agricultural activities (horticulture, viticulture, fruit growing, grain farming, and livestock) dominate, the region also hosts food, textile, dairy, and paper industries. All these activities require significant amounts of water, which are obtained primarily from the Plio–Quaternary groundwater and from surface water brought in from the high rainfall areas of northern Tunisia by the Medjerda–Cap Bon canal. The supplies at the time were not, however, sufficient to compensate the effects of traditional water management; recent hydrogeological models have shown that the situation in the central part of the Korba aquifer was critical in 2004 due to overexploitation amounting to 135% of the recharge [36,51]. The aquifer had thus become highly vulnerable with its multiple uses governed by agricultural and industrial pressures, along with tourism, and urban and rural development. A better rational management was needed, this being notably promoted in 2008 through adopting a managed aquifer recharge (MAR) using treated wastewater.

Multidisciplinary approaches have been used to study the consequences of seawater intrusion into the Korba plain. For the study of the hydrochemical investigation of the coastal and insular aquifers in Tunisia [34], the authors quantified the salinization in Korba that has primarily three origins (geological, seawater, and the irrigation salt concentration). This facilitates a qualitative description of the state of the resource. These data also permit to describe the evolution of the seawater intrusion. Obviously, the salinity distribution in the Korba–Mida aquifer is correlated with the piezometric evolution. The vertical salinity profiles measured before AR in three piezometers allowed delineating a distribution of salt concentrations in the aquifer.

The most recent studies, combining geophysics and hydrochemistry, were by Kouzana et al. [50] who quantified the inland invasion of seawater as reaching 1.5 km south of Wadi Chiba and 5 km south of Diar El Hajjej. According to the salinity maps, they identified five salinity zones with the least concentrated (2–4 g/L salinity) in the northern coastal aquifer and the most concentrated

(22 g/L salinity) in the north of Korba. Salinity was more pronounced along the coast, resulting in a large number of shallow wells being abandoned. Calculations of seawater mixing varied from 0% to 70%, reflecting the heterogeneity of the salinization process [8]; the high values were in piezometers of the Korba and Tafelloun area.

In order to provide a hydraulic barrier against seawater intrusion, the treated wastewater is infiltrated through ponds and undergoes SAT [2,65] to improve its quality, especially in terms of microbiology.

The Korba–Mida AR site lies 15 m above sea level (NGT) and contains three infiltration basins, of which two function simultaneously with a feed of 300–1400 m<sup>3</sup>/day. The treatment plant receives both urban wastewater and industrial wastewater from some 50 factories, mainly tomato or fish processing plants, slaughterhouses, and steel and tissue washing plants. A first flow modeling of the AR site of Korba has been realized to study the impact of injection of treated wastewater [36]. The results obtained by the Modflow simulations affirm that the AR will achieve its role of barrier against the sea intrusion and will contribute to the groundwater's resources conservation of the studied area.

Transmissivity at the selected recharge site is  $4 \times 10^{-3}$  m<sup>2</sup>/s, and the storage coefficient ranges between  $4.5 \times 10^{-4}$  and  $6 \times 10^{-4}$  [35]. These low values are due to the presence of hard sandstone intercalated in the sand at depth and slowing down vertical transfers. The recharged waters from the Korba treatment station are infiltrated after tertiary treatment. The monthly volume of water injected into the AR site's basins has ranged from a minimum of 5,948 m<sup>3</sup> (December 2008) to a maximum of 37,653 m<sup>3</sup> (July 2010), with a total of about 1.151 million m<sup>3</sup> of treated wastewater being injected into the three basins between December 2008 and March 2012.

The spatial variability of concentrations in the Korba–El Mida aquifer reveals the complexity of the groundwater contamination by salinization and anthropogenic activities. The insights given by the boron isotopic compositions from farm wells reveal significant back-and-forth  $\delta^{11}\text{B}$  shifts. This observation stresses the different temporal contributions of members like the Plio-Quaternary groundwater with various mixing rates with seawater, fresh groundwater, or possible groundwater from the Miocene or Pliocene aquifers under the constraint of meteoric recharge in a coastal context. The direct consequence is that the system equilibrium is permanently disturbed by the different temporal dynamics of continuous processes such as cation exchange and sorption, these being some of the main processes controlling element mobility, and by threshold processes linked to oxidoreductive conditions. The effects of a new contributor, AR, being superimposed has been well constrained by the combined use of boron isotopes and carbamazepine concentrations. It confirms the influence of the treated wastewater in only a few piezometers at the recharge site and the pollution of fresh groundwater by mixing in the close vicinity. The impact of AR is limited as a refresher when considering its brackish facies and is clearly polluting in view of the carbamazepine concentrations. The two tracers can be usefully associated for integrated water resource planning and can usefully be taken into account to build a hydrodynamic model of wastewater flushing in an aquifer linked to a precise hydrogeological model. More studies are needed to better understand the threshold processes associated with oxidoreductive conditions and also to assess the quality and quantity of organic matter derived from infiltrating wastewater subjected to mineralization in the unsaturated zone. As a source of boron and carbamazepine, wastewater treatments need to be greatly improved to prevent further degradation of groundwater quality.

The aquifer's permeability is estimated between 1.6 to  $2 \times 10^{-3}$  m/s. Its hydraulic gradient varies between 0.2 and  $1 \times 10^{-3}$  m/day, and flow velocity varies from 0.2 to 0.6 m/day. Infiltration tests at the bottom of the 1.5 m deep infiltration basin indicate infiltration flow between 5 and 60 m/day [35].

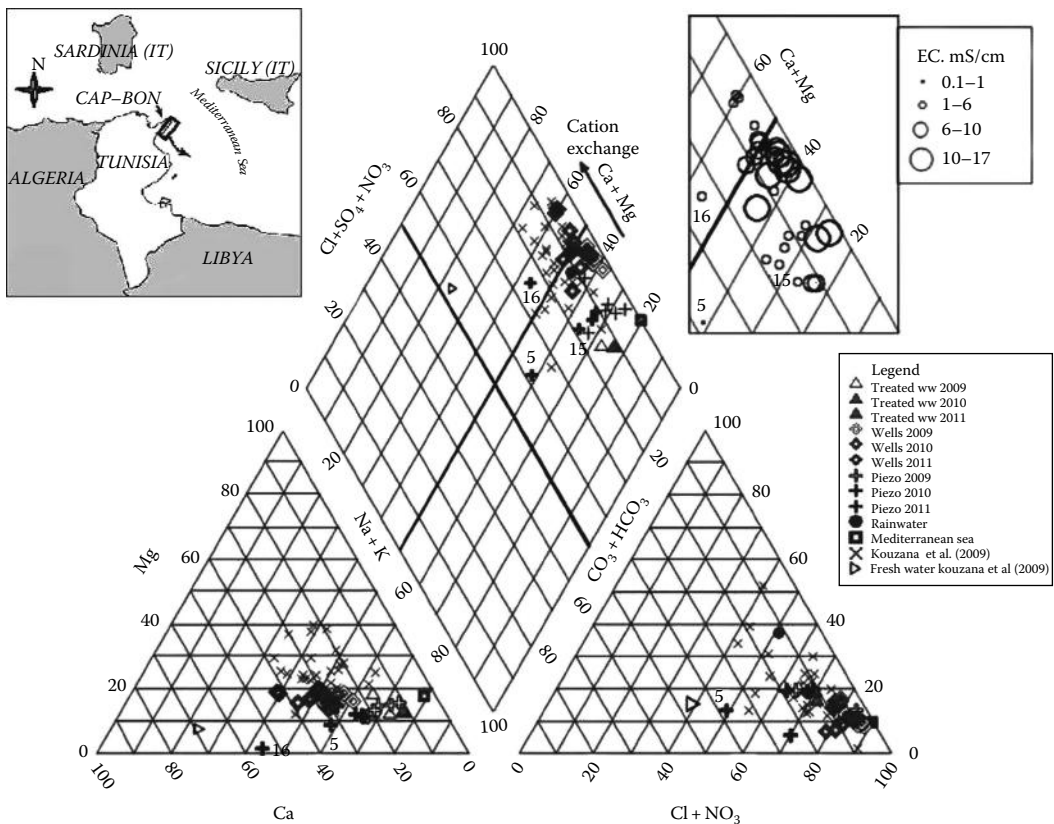
Where the seawater intrusion is concerned, ion exchange is the mechanism by which the fine fraction of the sedimentary aquifer matrix, with its large surface area and high cation-exchange capacity, is able to influence the ion concentration and isotopic composition of the groundwater.

Salinity at the recharge site decreased from 10 g/L in 2008 to 3–9 g/L in 2011 [35]; here, attention must be paid to the role of the fresh groundwater body whose refreshing effect must not be confounded with that of the recharge waters. A slight increase in the piezometric level was also recorded in the wells

between 2009 and 2011; here, the contribution of AR to the piezometric levels may be hidden because of continuous abstraction through irrigation wells in the area along with the installation of illegal surface wells, especially for agriculture.

The freshwater quality plotted in the Piper diagram (Figure 2.7) differs from that of the fresh groundwater and coastal aquifer samples and is closer to that of the deeper aquifer composition reported by Kouzana et al. [50]. The very low Ca, Mg, and  $\text{HCO}_3^-$  concentrations indicate a more likely equilibrium with sand, sandstone, or rainwater than with the Pleistocene carbonates. The B concentration in the 2011 piezometer 16 sample (2.77 mmol/L) is lower than that of free uncontaminated meteoric water in which the B content is  $<4$  mmol/L [72], and its pH (6.59) is consistent with equilibrium in a siliceous aquifer [35].

The 2009 Cl concentration in piezometer 5 (42 mmol/L) is close to that of piezometer 16 in 2009 (40.73 mmol/L), whereas the Cl of piezometer 5 in 2010 (2.01 mmol/L) is less than that of piezometer 16 in 2009 and 2011 (5.9 mmol/L). Knowing that AR had higher Cl concentrations of 30, 67, and 77 mmol/L, these major variations between fresh and brackish facies are interpreted as due to the spatial displacement and temporal mixing of freshwater, Plio-Quaternary water, and recharge water under various hydrodynamic constraints such as the infiltrated recharge volume, withdrawals at close vicinity, and meteoric recharge.



**FIGURE 2.7** Piper diagram of the water samples (in %meq). Data plotted from the piezometers and wells of the 2009, 2010, and 2011 campaigns and also from the June 2006 survey. (From Kouzana, L. et al., *Intrusion marine et salinization des eaux d'une nappe phréatique côtière, Korba, Cap-Bon, Tunisie, Revue internationale de géologie, de géographie et d'écologie tropicales* Tome 1, pp. 57–70, 2009.) Circle size in the insert zoom of the upper diagram is proportional to the level of conductivity.

The groundwater over 3 years of study was generally enriched in calcium, sulfates, and bicarbonates, compared with a simple mixing with seawater. All the wells and some of the piezometers showed a Na deficiency ( $\text{Na}_{\text{react}} < 0$ ), varying from  $-5$  to  $-22$  mmol/L, most commonly combined with a K deficiency ( $-0.1$  to  $-1.7$  mmol/L). Ca concentrations in the wells varied between 10 and 20 mmol/L with the amount of calcium reactant being strictly positive, except for piezometer 5 in 2010 ( $-1.7$  mmol/L). Strontium was also plotted in excess (points above the 1:1 line) versus  $\text{Na}^+\text{K}$ . Reactant magnesium had low positive or negative values ( $-0.9$  to  $2.9$  mmol/L).

According to the hydrogeological context, the following end-members are suggested:

1. A Plio-Quaternary salinized pole is composed of actively pumped wells 60, 151, 157, and 231 characteristic of local Plio-Quaternary groundwater with  $\delta^{11}\text{B}$  varying between 25 and 40.6 ‰, associated with various levels of boron (between 30 and 48  $\mu\text{mol/L}$ ). Submitted to human withdrawals and to marine intrusion under heterogeneous fluxes, the solution equilibrates and evolves toward the typical area of seawater intrusion [80] with higher  $\delta^{11}\text{B}$  than seawater ( $\delta^{11}\text{B}$  between 39.5 and 40.5 ‰ [7]. In 2011, it was especially clear in wells 235, 162, 231, and 40 with lower amounts of B (28–35  $\mu\text{mol/L}$ ) and higher  $\delta^{11}\text{B}$  (41.5–48 ‰). Stable isotopes  $^{18}\text{O}$  and  $^2\text{H}$  also confirm the marine contamination [8]. In these wells, no carbamazepine was found.
2. Treated wastewaters used for AR constitute another end-member that newly modified a complex system. Measured  $\delta^{11}\text{B}$  varied between 10.67 and 13.8 ‰ with high boron concentrations ranging from 65 to 348  $\mu\text{mol/L}$ . Although three samplings for wastewater will not give the global range of  $\delta^{11}\text{B}$  and concentration variations, these values are within the range of reported values [7, 44, 49, 80, 83]. Moreover, the rather large variation of B concentrations helps to define an expected local wastewater drawn in dashed points. Carbamazepine concentrations were high in wastewaters, ranging between 249 and 422 ng/L.

Treated wastewater mixing with Plio-Quaternary groundwater is represented by the 2010 composition of piezometer 15, 2, and 11, the latter two presenting the most spectacular shifts of  $\delta^{11}\text{B}$  from high  $\delta^{11}\text{B}$  (30–45 ‰) to 15–20 ‰ in 2010 and 2011. The B isotopic composition in piezometer 2 influenced by recharge waters was acquired after a maximum of 7 months and stayed constant in 2010. In piezometer 11, an important B isotopic composition decrease of 25 ‰ proving mixing with treated wastewaters occurred latter during the first year of functioning and was followed by a similar constancy of the isotopic ratio between 2010 and 2011. Water flux direction through circulation pathways was more favorable for water transfer from the infiltration ponds to piezometer 2 than for piezometer 11. According to the mixing lines, a maximum of 20%–40% of treated wastewaters were mixed in groundwater in these piezometers. In piezometers 2 and 11, CBZ concentrations increased, respectively, from 486 and 400 ng/L in 2010 to 910 and 593 ng/L in 2011. This unexpected observation shows that CBZ detected in the groundwater was higher than in the wastewater and that it increased of, respectively, 87% and 48% between 2010 and 2010 in piezometers 2 and 11. This observation has already been done by Bekele et al. [6] during a 39 month MAR field trial. The authors linked this to temporal changes in concentration in the recycled water, knowing that no sorption of CBZ has been evidenced. This may be the main explanation in our site, assuming that the contribution of urban wastewaters may sometimes be diluted by industrial waters in the treatment plant. The measured values are up to 6 times on groundwater after irrigation of agricultural soils with treated wastewaters.

3. Piezometer 16 in 2011 with very low B and Cl concentrations (2.8  $\mu\text{mol/L}$  and 5.9 mmol/L, respectively) and  $\delta^{11}\text{B}$  of 19.89 ‰ is used to represent a fresh groundwater end-member. Its pH was the most acidic pH of the area (6.59). The contribution of rainwaters to piezometer 16, even through an upstream recharge, is possible when looking at its B concentration and isotopic composition. The absence of carbamazepine definitively proved that groundwater of piezometer 16 was not in contact with treated wastewaters. Piezometers 13 and 15, not measured for B



isotopes, also showed no carbamazepine. Therefore, SAT is settled next to a contribution of fresh groundwater level at the top of the salinized Plio-Quaternary groundwater in 2004 [35].

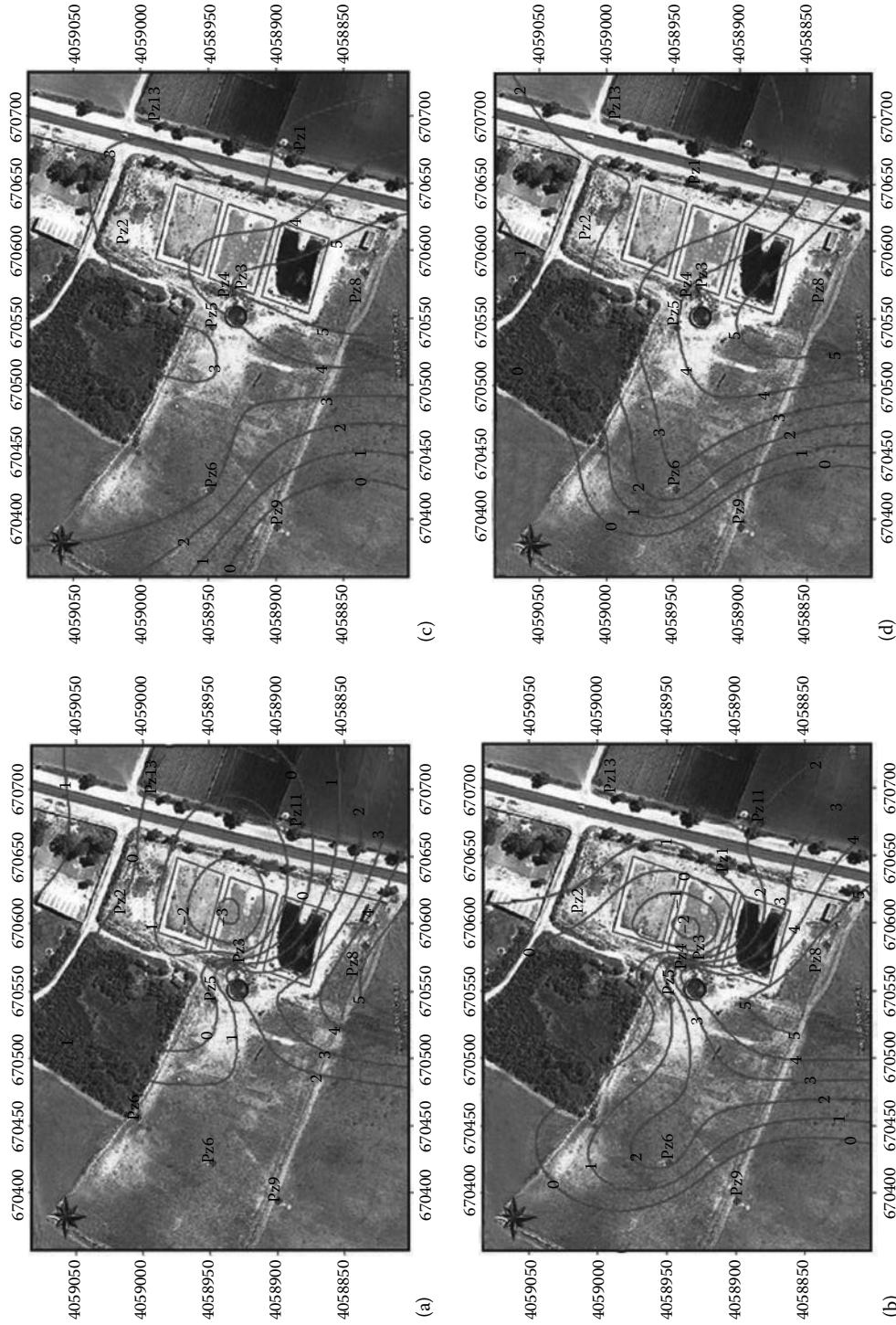
The composition of piezometer 5 varied in time under the influence of various mixings. Although it was clearly plotted in the Plio-Quaternary group in 2009 ( $\delta^{11}\text{B}$  of 33.35‰ and B concentration of 34.4 ng/L), it evolved toward the fresh pole in 2010 ( $\delta^{11}\text{B}$  of 13.46 ‰ and B concentration of 10.55  $\mu\text{mol/L}$ ) with a contribution of nearly 8% of wastewaters. The CBZ concentration was also very low in 2010 (20.4 ng/L). We can state that the very low CBZ concentration measured in piezometer 5 stands more surely for a low contribution of wastewaters or dilution by groundwater in good agreement with Arye et al. [4], rather than for the result of CBZ sorption on organic matter. In 2011, piezometer 4 with 24 ng/L of CBZ illustrated the same phenomenon. Although few piezometers were analyzed, these freshwaters seemed to poorly mix with Plio-Quaternary groundwater.

4. An unknown end-member with a  $\delta^{11}\text{B}$  around 15–20 ‰ with medium or high B concentrations. Brackish waters from the Pliocene and Miocene are possibly submitted to ascendant drainage [8]. This pole could be under the influence of the Miocene marls which usual signature in other places is 15–20 ‰ with high boron concentrations. This hypothesis is corroborated by the fact that Miocene marls can be encountered at shallow depth at around 10 m depth in some place. A mixing of this pole with the Plio-Quaternary groundwater explains the shift of  $\delta^{11}\text{B}$  in 2010 of wells 235, 157, 60, and 231, the whole being under the large constraint of rainwater recharge. This salinity would not come from actual seawater intrusion. This end-member could also be represented by the locally perched groundwater identified at low depth, which discharges in the wells. With lower B concentrations, another contribution could come from the freshwaters of the Miocene aquifer, used for irrigation at the North and West out of our site and also used for direct recharge in wells from our study site [35].

More particularly, close to the alluvial sediments of Wadi Chiba, wells 64 and 20 showed  $\delta^{11}\text{B}$  signatures that were distinct from the other dot groups. They can be explained by a mixing of this unknown end-member with the salinized pole with a direct contribution of seawater and meteoric which infiltration is favored through the upstream glacis incised by rivers within a porous lithology. Moreover, stable isotopes on samples close to rivers proved a fast and recent meteoric recharge [8].

5. Rainwaters are known to have very different isotopic compositions and concentrations, and some data from Millot et al. [55] were reported in the graph to show their variability and to complete our single rainwater analysis. Given the hydrogeological and geological context and models, actual rainwaters contribute largely to the Korba aquifer recharge, and this hypothesis was also validated by stable  $\delta^{18}\text{O}$  and  $\delta^2\text{H}$  distribution [8]. Moreover, meteoric recharge added to agricultural return flow leaches progressively the soil and highly contributes to transferring elements toward the saturated zone. The role of the perched groundwater is unknown but is expected to be noticeable locally, with an enrichment of groundwater by boron from dissolved calcite or other exchange phases. This phenomenon is perhaps not sufficient to impact the whole B signature because none of our dots was plotted in the influence area of agricultural drainage given by Vengosh [81] (B/Cl between 0.002 and 0.0045 and  $\delta^{11}\text{B}$  between 22 and 28 ‰).

Before initiation of AR by wastewater treated at the Korba–Mida site, the piezometric lines in 2008 (Figure 2.8a) shows a decrease in hydraulic head toward the north, where groundwater discharges to pumping wells and the Sidi Othman Wadi. The effects of pumping are indicated by a depression (–2 to –7 m) in the potentiometric surface in the center of the plain, likely the result of overpumping. All the piezometric levels are below the sea, over the entire study recharge are basins 1, 2, and 3 and varies between 0 and –3 m from basin 3 to basin 1, at the center of basin 2 which is a depression area (Figure 2.8a) [35].



**FIGURE 2.8** Piezometric evolution (m) at the Korba-Mida recharge site (m): (a) 2008, before recharge; (b) 2009, after injecting 342,286 m<sup>3</sup> of wastewater; (c) 2010, after injecting 715,898 m<sup>3</sup> of wastewater; and (d) 2011, after injecting 1.05 million m<sup>3</sup> of wastewater.

In 2010, after 25 months of artificial recharging by wastewater treated (volume cumulated 715,898 m<sup>3</sup>) the higher groundwater aquifer in the left side of the recharge site at +3 m and creates a bulging piezometric at the recharge site indicating a convergence of the groundwater flow. The piezometric surface appears with positive values in the recharge site (Figure 2.9c). A decrease of salinity of 1 g/L appears in all basins 1, 2, and 3 (Figure 2.9c) [35].

The salinity of groundwater in piezometers varied from 1 to 8 g/L (maximum in Pz<sub>2</sub>). Groundwater salinity in the aquifer increased toward the axis from Lebna Wadi to Chiba Wadi (groundwater salinity 22 g/L), this resulting to the high exploitation in this region (Figure 2.9a) [35].

After 13 months of artificial recharging by treated wastewater, the zero piezometric curve is displaced to its original state to the recharge site area, showing the drawdown of piezometric heads extending benefits in this region (Figure 2.9b). In the north of the study area, the salinity changes from a rate between 4 and 5 g/L (Pz<sub>2</sub> and Pz<sub>4</sub>); there has been a degradation of water quality of the aquifer (Figure 2.9b) [35].

## 2.5 General Discussions

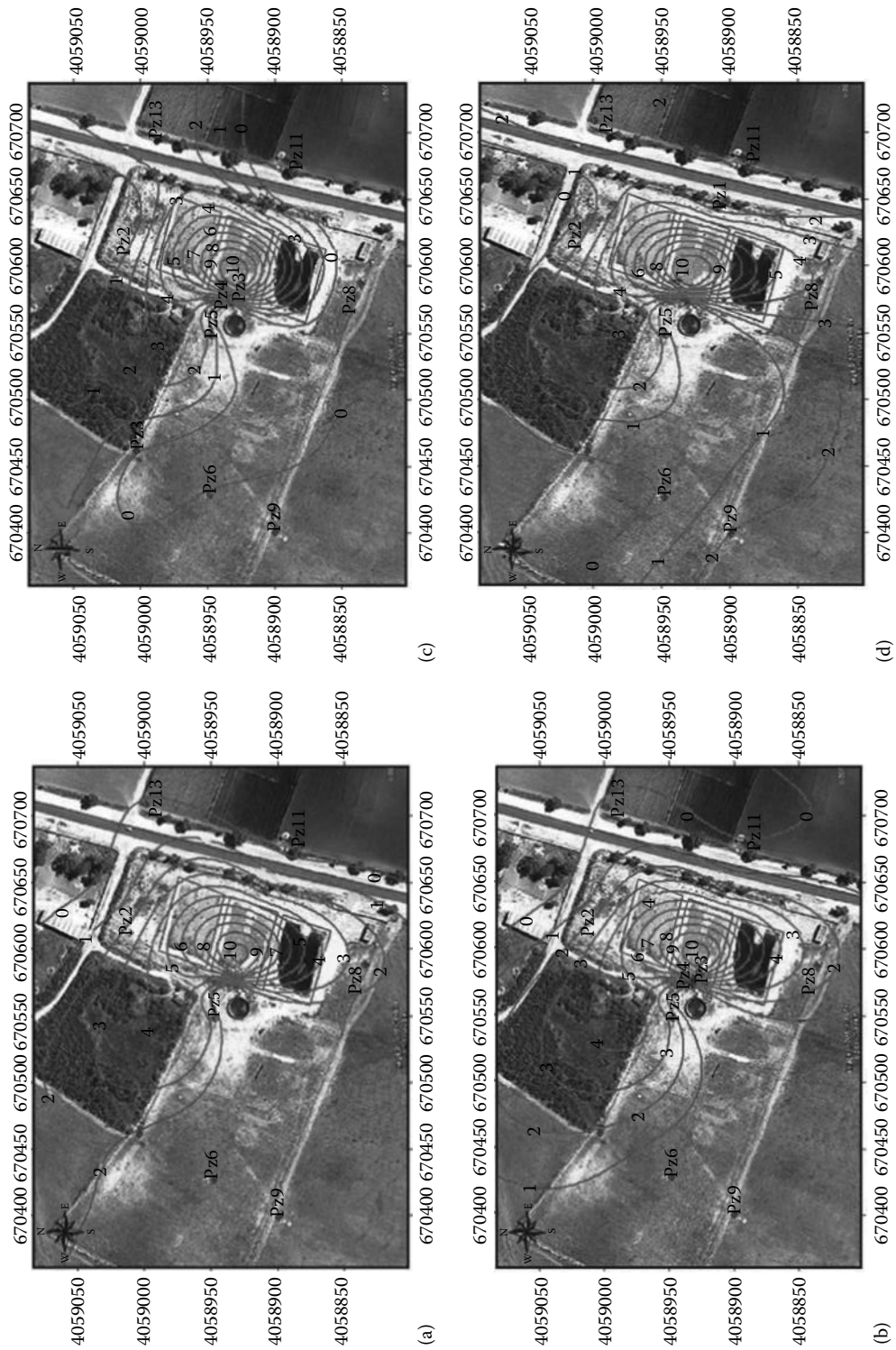
Human withdrawals, seawater intrusion, and meteoric and AR impact groundwater hydrodynamics. Water bodies are displaced and mixed, and the system reacts by establishing continuous transitional equilibrium affecting element mobility.

AR by dam water represents a valuable tool for managing water resources. The installations needed for the recharge operations are simple and relatively inexpensive. Although there are other methods of AR, the recharge by injection directly into the aquifer is the most efficient one for creating freshwater barriers against saline intrusion. However, clogging of the wells, which was quite random, and the doubts of the farmers concerning this technique might jeopardize the success of the recharge operation. Tunisia has acquired an extensive experience in the field of recharge. However, until now, the recharge has remained low and discontinuous in time and space.

The superimposition of a “recharge front” due to the new “treated wastewater” component modified the previous transitional states away from equilibrium by adding a new constraint, that is, the development of reductive conditions with the intrusion of high amounts of organic matter and the entry of a new boron and CBZ source. Although the natural amounts of metals in the aquifer is not known, pollutant metals issued from human activities were injected into the aquifer and the oxidoreductive conditions enhanced their mobility.

Salinity at the recharge site generally decreased from 10 g/L in 2004 to 2–3 g/L in 2011 [35]; here, attention must be paid to the role of the fresh groundwater body whose refreshing effect must not be confounded with that of the recharge waters. A slight increase in the piezometric level was also recorded in the wells between 2009 and 2011; here, the contribution of AR to the piezometric levels may be hidden because of continuous abstraction through irrigation wells in the area along with the installation of illegal surface wells, especially for agriculture. Nevertheless, further spatial and temporal studies need to assess the migration of the treated wastewaters plume, which is likely to migrate at depth until reaching the impermeable Miocene substratum.

The spatial variability of concentrations in the Korba–El Mida aquifer reveals the complexity of the groundwater contamination by salinization and anthropogenic activities. The insights given by the boron isotopic compositions from farm wells reveal significant back-and-forth  $\delta^{11}\text{B}$  shifts. This observation stresses the different temporal contributions of members like the Plio-Quaternary groundwater with various mixing rates with seawater, fresh groundwater, or possible groundwater from the Miocene or Pliocene aquifers under the constraint of meteoric recharge in a coastal context. The direct consequence is that the system equilibrium is permanently disturbed by the different temporal dynamics of continuous processes such as cation exchange and sorption, these being some of the main processes controlling element mobility, and by threshold processes linked to



**FIGURE 2.9** Salinity evolution (g/L) at the Korba–Mida recharge site (m): (a) 2008, before recharge; (b) 2009, after injecting 342,286 m<sup>3</sup> of wastewater; (c) 2010, after injecting 715,898 m<sup>3</sup> of wastewater; and (d) 2011, after injecting 1.05 million m<sup>3</sup> of wastewater.

oxidoreductive conditions. The effects of a new contributor, AR, being superimposed have been well constrained by the combined use of boron isotopes and carbamazepine concentrations. It confirms the influence of the treated wastewater in only a few piezometers at the recharge site and the pollution of fresh groundwater by mixing in the close vicinity. The impact of AR is limited as a refresher when considering its brackish facies and is clearly polluting in view of the carbamazepine concentrations. The two tracers can be usefully associated for integrated water resource planning and can usefully be taken into account to build a hydrodynamic model of wastewater flushing in an aquifer linked to a precise hydrogeological model, based on complementary deep wells monitoring. As a source of boron and carbamazepine, wastewater treatments need to be greatly improved to prevent further degradation of groundwater quality.

## 2.6 Summary and Conclusions

---

Conventional water resources are not enough to fulfill the increasing water demand that led to deterioration of the quality and quantity of the groundwater system in semiarid areas. Consequently, new nonconventional water recourses are sought such as desalination, reuse of treated wastewater, and harvesting of stormwater. Desalination is constrained by its high investment and operation costs and deficit of available electricity needed to operate the desalination plants.

AR of coastal aquifers, which are especially overexploited, can offer an efficient means of combating seawater intrusion and thus of preventing an inevitable degradation of the water quality that might prove irreversible. It has produced good results in recent decades and seems to have a promising future in arid and semiarid regions given that it is considered to be a conservation measure as well as a means of developing resources. In a country such as Tunisia, which suffers from lack of water and a capricious climate, AR by surface water would be very valuable for the aquifers because of the availability of the water and its remarkable annual regularity of occurrence.

Wastewater reuse is still in its early stages, where the treatment level does not meet the international standards for recharge and direct reuse, where more advanced treatment is needed, if it is recharged to avoid negative impact on the native groundwater. From the assessment of the pilot project carried out in Tunisia to recharge the aquifer with treated wastewater effluent, there were positive impacts by decreasing nitrate level in aquifer and increasing the groundwater level in the local area. However, there were also negative impacts on the chloride and boron level of the native groundwater that endanger human and agricultural lives. At this stage, where treatment of effluent is not enough, recharging the aquifer with stormwater is more attractive in terms of water quality. In the case of treated wastewater with higher values of organic matter, the removal efficiency is high and could exceed 90%, and as shown in studies carried out, it was found that at an infiltration rate of 0.1 m/day, and BOD concentration of 1–5 mg/L, the latter removal was complete. This value of organic matter is expected to be found in stormwater of both urban runoff and rooftop rainwater. Besides soil type of infiltration basin, the hydraulic load of infiltration system is an important factor, where organic removal is decreased by increasing infiltration.

New nonconventional water resources are consequently sought to bridge the gap in the water resources budget. In addition to seawater desalination and reuse of reclaimed wastewater, rainwater harvesting is one of these nonconventional water resources. It should be considered as a resource that provides benefits such as groundwater recharge.

Also, climate change, especially in semiarid and arid regions with their accentuated spatial and temporal variability of climatic phenomena, will strongly impact groundwater in both quantitative and qualitative terms. Consequently, mitigation and adaptation measures in coastal zones should be carefully considered. Addressing water stress in these zones through integrated water resources management is often made difficult not only by geological and hydrodynamic complexities but also by socio-economic contexts, conflicts of interest, legislation, and policies.

Water issues have nevertheless led to a reconsideration of traditional aquifer management by introducing integrated water resources planning that often relies on alternative water supplies such as desalination plants, MAR, subsurface storage, and subsequent utilization of treated sewage effluent through aquifer storage and recovery (ASR), possibly completed with SAT. More advanced and consistent knowledge is still needed to improve water resources management that addresses governance, health risks, regulations, and public perception.

## References

1. Afsin, M. 1997. Hydrochemical evolution and water quality along the groundwater flow path in Sandikli Plain, Afyon, Turkey. *Environmental Geology*, 31, 221–230.
2. Amy, G. and Drewes, J. 2007. Soil aquifer treatment (SAT) as a natural and sustainable wastewater Reclamation/Reuse technology: Fate of wastewater effluent organic matter (EfOM) and trace organic compounds. *Environmental Monitoring and Assessment*, 129, 19–26.
3. Amri, R. 1992. Note hydrogéologique de la nappe de Teboulba, rapport interne du Commissariat régional au développement agricole, Monastir, Tunisie.
4. Arye, G., Dror, I., and Berkowitz, B. 2011. Fate and transport of carbamazepine in soil aquifer treatment (SAT) infiltration basin soils. *Chemosphere*, 82, 244–252.
5. Bensalem, H. 1992. Contribution à l'étude de la Géologie du Cap Bon: Stratigraphie, tectonique et sédimentologie. Thèse de Doctorat, Faculté des Sciences de Tunis, Tunisia.
6. Bekele, E., Toze, S., Patterson, B., and Higginson, S. 2011. Managed aquifer recharge of treated wastewater: Water quality changes resulting from infiltration through the vadose zone. *Water Research*, 45, 5764–5772.
7. Barth, S. 2000. Utilization of boron as a critical parameter in water quality evaluation: Implications for thermal and mineral water resources in SW Germany and N Switzerland. *Environmental Geology*, 40, 73–89.
8. Ben Hamouda, M.F., Tarhouni, J., Leduc, C., and Zouari, K. 2011. Understanding the origin of salinization of the Plio-quaternary eastern coastal aquifer of Cap Bon (Tunisia) using geochemical and isotope investigations. *Environmental Earth Sciences*, 63, 889–901.
9. Bacchus, S.T. 2000. Uncalculated impacts of unsustainable aquifer yield including evidence of subsurface interbasin flow. *Journal of American Water Resources Association*, 36, 457–481.
10. Bear, J. and Cheng, A.H.D. 2010. *Modeling Groundwater Flow and Contaminant Transport*. Springer, Dordrecht, the Netherlands, 834 pp.
11. Bear, J., Cheng, A.H.-D., Sorek, S., Ouazar, D., and Herrera, I. 1999. *Seawater Intrusion in Coastal Aquifers—Concepts, Methods Practices*. Kluwer Academic Publishers, Dordrecht, the Netherlands, 625 pp.
12. Bear, J. 1972. *Dynamics of Fluids in Porous Media*. American Elsevier Publishing Company, New York, 764 pp.
13. Bear, J. 1979. *Hydraulics of Groundwater*. McGraw-Hill, New York, 569pp.
14. Bear, J. and Verruijt, A. 1987. *Modeling Groundwater Flow and Pollution*. Reidel Publishing Company, Dordrecht, the Netherlands, 414 pp.
15. Bear, J. 2004. Management of a coastal aquifer. *Groundwater*, 42, 317.
16. Bouwer, H. 1978. *Groundwater Hydrology*. McGraw-Hill Book Company, New York, 480 pp.
17. Barrocu, G., Vernier, A., Ardaù, F., Salis, N., Sanna, F., Sciabica, M.G., and Soddu, S. 2004. Hydrogeology of the island of Sardenya (Italy). In: *Proceedings of the 32nd International Geological Congress*. Florence, Italy, Vol. 5, pp. 37–54.
18. Beni-Akhy, R. 1998. Etude des impacts anthropiques sur les eaux souterraines du Sahel oriental tunisien: caractérisation hydrogéologique, modélisation mathématique et cartographie de la vulnérabilité' environnementale. PhD thesis, Tunis University, Tunis, Tunisia.

19. Besbes, M. 1971. Premier essai d'alimentation artificielle par puits de la nappe de Teboulba, rapport interne de la Direction Générale des Ressources en Eaux, Tunis, Tunisie, 28 p.
20. Bouri, S. and Ben Dhia, H. 2010. A thirty-year artificial recharge experiment in a coastal aquifer in an arid zone: The Teboulba aquifer system (Tunisian Sahel). *Comptes Rendus. Géoscience*, 342(1), 60–74.
21. Bouwer, H. 1991. Role of groundwater recharge in treatment and storage of water reuse. *Water Science and Technology*, 24(9), 295–302.
22. Brissaud, F. and Salgot, M. 1994. Infiltration percolation as a tertiary treatment. Hydrotop 94, Marseille, April 12–15, Vol. II, pp. 391–398.
23. Calo, A. 1964. *Etude pédologique du périmètre de Oued Souhil*.
24. Custodio, E. 2000. *The Complex Concept of Overexploited Aquifer*. Papeles de la Fundacion Marcelino Botin: Madrid, Spain, Vol. 2, pp. 1–45.
25. Custodio, E. 1993. Hydrogeological and hydrochemical aspects of aquifer overexploitation. In: *Aquifer Overexploitation. International Association of Hydrogeology*, Selected Papers 3, pp. 3–28.
26. Custodio, E. and Bruggeman, G.A. 1982. *Groundwater Problems in Coastal Areas (Studies and Reports in Hydrogeology)*. UNESCO, Paris, France, 650pp.
27. Charbeneau, R. 2000. *Groundwater Hydraulics and Pollutant Transport*. Prentice Hall, Upper Saddle River, NJ.
28. Domenico, P.A. 1972. *Concepts and Models in Groundwater Hydrology*. McGraw-Hill, New York, 416 p.
29. Dillon, P. 2005. Future management of aquifer recharge. *Hydrogeology Journal*, 13(1), 313–316.
30. Ennabli, M. 1980. Etude hydrogéologique des aquifères Nord Est de la Tunisie par une gestion intégrée des ressources en eau, PhD thesis.
31. El Yaouti, F., El Mandour, A., Khattach, D., and Kayfmann, O. 2008. Modelling groundwater flow and advective contaminant transport in the Bou-Areg unconfined aquifer (NE Morocco). *Journal of Hydro-Environment Research*, 2, 192–209.
32. Gyben, B.W. 1989. Nota in verband met de voorgenomen put boring nabij Amsterdam. The Hague. K. Inst. Ing. Tydschrift, 8–22.
33. Goswami, R.R. and Clement, T.P. 2007. Laboratory-scale investigation of saltwater intrusion dynamics. *Water Resources Research*, 43, W04418. (DOI:10.1029/2006WR005151.)
34. Gaaloul, N. and Cheng, A.H.D. 2003. Hydro chemical investigation of the coastal and insular aquifers in Tunisia. Ed. *International Association of Hydrogeologists*, Vol. 1, pp. 156–116
35. Gaaloul, N., Carry, L., Casanova, J., Guerrot, C., and Chaieb, H. 2012. Effect of artificial recharge by treated wastewater on the quality and quantity of the Korba-Mida coastal aquifer (Cap Bon, Tunisia). *La Houille Blanche. Revue Internationale de l'Eau* 4–5, 24–33.
36. Gaaloul, N., Marinos, P., and Pliakas, F. 2008. Apport des modèles à la gestion intégrée des ressources en eaux souterraines: l'exemple du modèle du Cap Bon. *Les Annales de l'INRGREF*, No. 11, pp. 139–150.
37. Gaaloul, N. 2011. Water resources and management in Tunisia. *International Journal of Water*, 6(1/2), 92–116.
38. Hertzberg, A. 1901. Die wasserversorgung enger nordsee baden. *Gasbeleuchtung Wasserversorgung*, 44, 818–819.
39. Herman, B. 1996. Issues in artificial recharge. *Water Science Technology*, 33(10–11), 381–390.
40. Herman, B. 2002. Artificial recharge of groundwater: Hydrogeology and engineering. *Hydrogeology Journal*, 10, 121–142.
41. Ikeda, K. 1989. Chemical evolution of groundwater quality in the southern foot of Mount Fuji. *Bulletin of the Geological Survey of Japan*, 40, 331–404.
42. Johnson, K.S. 1993. Exploitation of the tertiary-quadernary Ogallala aquifer in the high plains of Texas, Oklahoma and New Mexico, South-Western USA. In: *Aquifer Overexploitation. International Association Hydrogeology*, Selected papers 3, pp. 249–264.

43. Jos, H.P. 1996. Artificial recharge of groundwater. *Proceedings of an International Symposium*, June 3–5, 1996, Helsinki, Finland. Nordic Hydrological Program, Vol. 38, pp. 256–269.
44. Kloppmann, W., Chikurel, H., Picot, G., Guttman, J., Pettenati, M., Aharoni, A., Guerrot, C., Millot, R., Gaus, I., and Wintgens, T., 2009. B and Li isotopes as intrinsic tracers for injection tests in aquifer storage and recovery systems. *Applied Geochemistry*, 24, 1214–1223.
45. Kallali, H. and Yoshida, M. 2002. Soil and subsoil characterization of Souhil Wadi (Nabeul) pilot plant for wastewater infiltration-percolation. In: *Proceedings of International Symposium on Environmental Pollution Control and Waste Management (EPCOWM'2002)*, Tunis, Tunisia; Keenan, L. and Fetter, C.W. 1994. *Hydrogeology Manual*. Maxwell Macmillan International, New York, 135 pp.
46. Kumar, M., Ramanathan, A.L., Rao, M.S., and Kumar, B. 2006. Identification and evaluation of hydrogeochemical processes in the groundwater environment of Delhi, India. *Journal of Environmental Geology*, 53, 553–574.
47. Kumar, M., Kumari, K., Singh, U.K., and Ramanathan, A.L. 2009. Hydrogeochemical processes in the groundwater environment of Muktsar, Punjab: Conventional graphical and multivariate statistical approach. *Journal of Environmental Geology*, 57, 873–884. (DOI: 10.1007/s00254-008-1367-0).
48. Konikow, L.F. and Reilly, T.E. 1999. Seawater intrusion in the United States. In: Bear, J., Cheng, A., Sorek, S., Ouazar, D., and Herrera, A. (eds.), *Seawater Intrusion in Coastal Aquifers: Concepts, Methods and Practices, Book Series: Theory and Application of Transport in Porous Media*. Kluwer Academic Publishers, Dordrecht, the Netherlands. Vol. 14, pp. 559–590.
49. Kloppmann, W., Van Houtte, E., Picot, G., Vandenbohede, A., Lebbe, L., Guerrot, C., Millot, R., Gaus, I., and Wintgens, T. 2008. Monitoring reverse osmosis treated wastewater recharge into a coastal aquifer by environmental isotopes (B, Li, O, H). *Environmental Science and Technology*, 42, 8759–8765.
50. Kouzana, L., Ben mammou, A., and Gaaloul, N. 2009. Intrusion marine et salinisation des eaux d'une nappe phréatique côtière (Korba, Cap-Bon, Tunisie). *Revue internationale de géologie, de géographie et d'écologie tropicales* Tome 1, pp. 57–70.
51. Kerrou, J., Renard, P., and Tarhouni, J. 2010. Status of the Korba groundwater resources (Tunisia): Observations and three-dimensional modeling of seawater intrusion. *Hydrogeology Journal*, 18, 1173–1190.
52. Limas, M.L. 1989. Groundwater and wetlands: New constraints in groundwater management. Groundwater management: Quantity and quality. *International Association of Hydrological Sciences (IAHS)*, 188, 595–604.
53. Lallana, C., Krinner, W., Estrela, T., Nixon, S., and Leonard, J.B., J. M. 2001. *Sustainable Water Use in Europe—Part 2: Demand Management*. EEA, Copenhagen, Denmark.
54. Motz, L.H. 1992. Saltwater upconing in an aquifer overlain by a leaky confining bed. *Ground Water*, 30, 192–198.
55. Millot, R., Petelet-Giraud, E., Guerrot, C., and Negrel, P. 2010. Multi-isotopic composition ( $\delta^7\text{Li}$ - $\delta^{11}\text{B}$ - $\delta^{\text{D}}$ - $\delta^{18}\text{O}$ ) of rainwaters in France: Origin and spatio-temporal characterization. *Applied Geochemistry*, 25, 1510–1524.
56. Mikita, M., Yamanaka, T., and Lorphensri, O. 2011. Anthropogenic changes in a confined groundwater flow system in the Bangkok basin, Thailand, part I: Was groundwater recharge enhanced? *Hydrological Processes*, 25, 2726–2733.
57. Margat, J. 1977. De la surexploitation des nappes souterraines on aquifer overexploitation. *Eaux Souterraines et Approvisionnement en Eau de la France*. Ed BRGM, Orléans, pp. 393–408.
58. Matthes, G. 1982. *The Properties of Groundwater*. Wiley, New York, 498pp.
59. Martinez, D.E. and Bocanegra, E.M. 2002. Hydrochemistry and cation exchange processes in the coastal aquifer of Mar Del Plata, Argentina. *Hydrogeology Journal*, 10, 393–408.



60. Maalel, F. 1998. Note hydrogéologique sur la recharge artificielle de la nappe de Teboulba, rapport interne du Commissariat régional au développement agricole, Monastir, Tunisie.
61. Narayen, K.A., Schleeberger, C., and Bristow, K. 2007. Modelling seawater intrusion in the Burdekin delta irrigation area, north Queensland, Australia. *Agricultural Water Management*, 89, 217–228.
62. Plata Bedmar, A. and Rekaya, M. 1987. Application des techniques nucléaires aux études de recharge artificielle d'un aquifère côtier en Tunisie. Report.
63. Paniconi, C., Khlaifi, I., Lecca, G., Giacomelli, A., and Tarhouni, J., 2001. Modeling and analysis of seawater intrusion in the coastal aquifer of Eastern Cap-Bon, Tunisia. *Transport in Porous Media*, 43, 3–28.
64. Plata Bedmar, A. and Rekaya, M. 1988. *Use of Nuclear Techniques for Artificial Recharge Studies of a Coastal Aquifer in Tunisia*. IAEA, Vienna, Austria.
65. Pavelic, P., Dillon, P.J., Barry, K.E., Vanderzalm, J.L., Correll, R.L., and Rinck-Pfeiffer, S.M. 2006. Water quality effects on clogging rates during reclaimed water ASR in a carbonate aquifer. *Journal of Hydrology*, 334, 1–16.
66. Pulido-Bosh, A., Tahiri, A., and Vallejos, A. 1999. Hydrogeochemical characteristics of processes in the Temara aquifer in Northwestern Morocco. *Journal of Water, Air, and Soil Pollution*, 114, 323–337.
67. Padilla, F. and Cruz-Sanjulian, J. 1997. Modeling sea-water intrusion with open boundary conditions. *Ground Water*, 35, 704–712.
68. Rekaya, M. and Amri, R. 1992. Note sur les possibilités de recharge artificielle des nappes de Teboulba et Moknine à partir des eaux usées de la Direction Générale des Ressources en Eaux, Tunisie.
69. Rekaya, M. 1986. Expérimentation pilote de recharge artificielle à partir des eaux usées traitées. Cas de la nappe de l'Oued Souhil (Nabeul).
70. Reilly, T.E. and Goodman, A.S. 1985. Quantitative analysis of saltwater-freshwater relationships in groundwater systems—A historical perspective. *Journal of Hydrology*, 80, 125–160.
71. Rekaya, M. and Brissaud, F. 1991. Recharge de la nappe de l'Oued Souhil par des effluents secondaires. XXI<sup>e</sup> J. de l'Hydraulique: Les eaux souterraines et la gestion des eaux, Sophia Antipolis, 29–31 January, II. 4. 1-II. 4.8.
72. Reimer, H. 2001. On processes controlling the distribution and fluxes of boron in natural waters and air along transects across the South Island of New Zealand. *CATENA*, 44, 263–284.
73. Sherif, M.M. 1999. The Nile Delta aquifer in Egypt. In: Bear, J., Cheng, A., Sorek, S., Ouazar, D., and Herrera, A. (eds.), *Seawater Intrusion in Coastal Aquifers: Concepts, Methods and Practices, Book Series: Theory and Application of Transport in Porous Media*. Kluwer Academic Publishers, Dordrecht, the Netherlands, Vol. 14, pp. 559–590.
74. Sophocleous, M. 2000. From safe yield to sustainable development of water resources—The Kansas experience. *Journal of Hydrology*, 235, 27–43.
75. Stuyfzand, P.J. 1999. Pattern in groundwater chemistry resulting from groundwater flow. *Hydrogeology Journal*, 7, 15–27. (DOI: 10.1007/s100400050177).
76. Saether, O.M. and De Caritat, P. 1997. *Geochemical Processes, Weathering and Groundwater Recharge in Catchments*. A.A. Balkema, Rotterdam, the Netherlands, 400 pp.
77. Savenije, H.H.G. 1992. Lagrangian solution of St. Venant's equations for an alluvial estuary. *Journal of Hydraulic Engineering*, 118(8), 1153–1163.
78. Toth, J. 1984. The role of regional gravity flow in the chemical and thermal evolution of groundwater. In: *Proceeding of the First Canadian/American Conference on Hydrogeology*, Banff, Alberta, Canada.
79. Todd, A.D. 1980. *Groundwater Hydrology*. 2nd ed. John Wiley & Sons: New York.
80. Vengosh, A., Heumann, K. G., Juraske, S., and Kasher, R. 1994. Boron isotope application for tracing sources of contamination in groundwater. *Environmental Science and Technology*, 28, 1968–1974.
81. Vengosh, A. 2003. *Treatise on Geochemistry*, Chap. 9, pp. 333–365.

82. Wallick, E.L. and Toth, J. 1976. Methods of regional groundwater flow analysis with suggestions for the use of environmental isotope and hydrochemical data in groundwater hydrology. In: *Proceedings of an Advisory Group Meeting of the International Atomic Energy Agency (IAEA)*, Vienna, Austria, pp. 37–64.
83. Widory, D., Kloppmann, W., Chery, L., Bonnin, J., Rochdi, H., and Guinamant, J.-L. 2004. Nitrate in groundwater: An isotopic multi-tracer approach. *Journal of Contaminant Hydrology*, 72, 165–188.



# 3

## Disinfection of Water and Nanotechnology

---

Seyedeh Matin Amininezhad <i>Islamic Azad University of Shahreza</i>	3.1 Introduction .....	52
Sayed Mohamad Amininejad <i>Isfahan University of Technology</i>	3.2 Water and Wastewater Pathogens..... Bacteria • Viruses • Protozoan • Helminths	52
Saeid Eslamian <i>Isfahan University of Technology</i>	3.3 Disinfection of Water..... Chemical Agents • Physical Agents • Mechanical Tools • Radiation	54
	3.4 Nanotechnology and Water Disinfection..... Silver • Chitosan • Titanium Dioxide • Zinc Oxide • Fullerenes • Carbon Nanotubes	58
	3.5 Case Study.....	61
	3.6 Summary and Conclusions.....	63
	References.....	63

### AUTHORS

**Seyedeh Matin Amininezhad** received her master of science in inorganic chemistry from Islamic Azad University of Shahreza in Iran. She has basically done several researches on photocatalytic, antibacterial, and antifungal activity of nanostructures and Schiff-base complexes. Currently, she is working as a researcher on a number of projects. Also she has published several publications mainly in environmental chemistry.

**Sayed Mohamad Amininejad** is an alumnus of Isfahan University of Technology in Iran and received his bachelor's degree in water engineering. He has worked on some research projects on photocatalytic and antimicrobial activity of nanostructures. Also he has published some publications basically in environmental chemistry and pollution.

**Saeid Eslamian** received his PhD from the University of New South Wales, Australia, with Professor David Pilgrim. He was a visiting professor in Princeton University, United States, and ETH Zurich, Switzerland. He is currently an associate professor of hydrology in Isfahan University of Technology. He is the founder and chief editor of the Journal of Flood Engineering and International Journal of Hydrology Science and Technology. He has published more than 200 publications mainly in statistical and environmental hydrology and hydrometeorology.

## PREFACE

Water resources are essential to life and crucial to our standard of living, greatly affecting our ability to preserve health, grow food, and build powerful industries. In addition to old problems in water resources, like pesticides and *Escherichia coli*, new kinds of pollutants are being continually discovered in water streams and resources. The usage of personal-care products such as sunscreens, medicines, flame retardants, and plastic residues will contribute to the presence of trace quantities of new pollutants in waterways. Also microbial contamination of water is one of the main concerns, which endangers human's health and can lead to severe epidemics. Different methods are implemented for the removal of these contaminants and also for the disinfection of water and wastewater streams. Currently, nanotechnology has gained too much attention as one of these methods, which can be used for disinfection of water and also for the removal of other pollutants.

Nanotechnology is one of the newest sciences, which has explored and redefined the frontiers of our knowledge. Nanotechnology can be used to determine if water is clean, to enable the purification of dirty water, and to reduce water use, particularly in industrial processes.

In this chapter, it is attempted to review the advance of nanotechnology for disinfection of water and wastewater with regard to wide experiments and researches, which are conducted by scientists. Also other common methods for disinfection of water are discussed and their advantages and disadvantages are briefly mentioned. Finally, a case study has been performed.

## 3.1 Introduction

---

Waterborne diseases are the main indication of deterioration of water quality. The greatest waterborne risk, which poses a significant problem to human health, is microbial contamination of water sources, contributing to disease outbreaks [24]. Also it is estimated that the population living in water-stressed areas of the world will reach 44% by 2050 [18]. In terms of escalating demands and pollution of limited water sources, particularly in rural and developing communities, the condition will become even worse. To prevent or reduce the risk of waterborne diseases, many water utilities use disinfection processes to remove pathogens in water and wastewater. Nanotechnology is recognized as a new-generation technology that will influence economies through new commercial products, materials usage, and manufacturing methods [1]. Under this new technology, the use of nanoparticles for water disinfection is being explored. This chapter reviews water pathogens and common methods for disinfection of water and highlights recent progresses toward the development of nanotechnology in disinfection of water and wastewater.

## 3.2 Water and Wastewater Pathogens

---

Untreated and secondary treated effluent contains a range of pathogenic microorganisms that pose a significant risk to the health of humans. In the late nineteenth century, acute waterborne diseases, like typhoid fever and cholera, became common. It is essential to note that the host must have been in contact with required numbers of pathogenic organisms to cause a disease. These required numbers could differ for different types of organisms. Pathogens, which can be potentially presented in wastewater, are divided into four separate groups. These groups are the bacteria, viruses, protozoa, and helminths.

### 3.2.1 Bacteria

Bacteria are the most common microorganisms found in wastewater ranging from 0.5 to 5  $\mu\text{m}$  in size. A wide range of bacterial pathogens and opportunistic pathogens can be detected in wastewaters, and

some of them are used as indicator organisms of human wastes. The principal bacteria in wastewaters are the following:

- *Fecal coliforms* are naturally found in the human intestine and their presence can demonstrate fecal contamination of a water source.
- *Shigella* is a vast group of bacteria. The majority of waterborne infections are caused by *Shigella sonnei* species, and contaminated waters are the main source of *Shigella*-related diseases.
- *Salmonella*, of which there are more than 2000 known species, pose a risk to human health and mostly are causing gastroenteritis.
- *Campylobacter jejuni* is known to cause gastroenteritis for up to 1 week in humans.
- *Yersinia enterocolitica* causes gastroenteritis and can grow at low temperatures as low as 4°C. This bacterium is mostly resistant to chlorine and can be carried by both animals and humans.
- *Escherichia coli* is the most commonly used bacterial indicator of fecal contamination of water, which is 0.5 µm wide and 1–3 µm long. *E. coli* is transmitted through water and can cause gastroenteritis in humans and diarrhea in infants.
- *Vibrio cholerae* causes cholera, dehydration, vomiting, and diarrhea, and if no medical treatment is provided, death might happen after a few hours. This bacterium has led to major epidemics in the world.
- *Pseudomonas* is one of the premier causes of infections in swimming pools and is almost resistant to chlorination.
- *Leptospira* is transmitted by sewer rats and can be infected through ingesting contaminated water while swimming in lakes and rivers.

### 3.2.2 Viruses

Viruses are among the most important and potentially most hazardous of the pathogens found in wastewater. Viruses are not cells but are infectious particles ranging from 10 to 25 nm in diameter; therefore, they pass through filters and are hard to remove in water treatment. Viruses live only inside the host cell and they are inactive outside the host. All of the prevalent pathogenic viruses found in wastewater enter the environment through fecal contamination from infected hosts. The most important viruses in wastewater are as follows:

- *Hepatitis A virus* (HAV) affects the liver and causes infectious hepatitis. Symptoms are fever, vomiting, and diarrhea and, in acute cases, might lead to jaundice. HAV can be removed by flocculation, coagulation, and filtration.
- *Norwalk-type* viruses can lead to acute epidemic gastroenteritis.
- *Rotaviruses* can lead to acute gastroenteritis mostly in children and can cause mortality of infants in developing countries. Rotaviruses can be removed through flocculation, coagulation, and filtration.
- *Enteroviruses*, *Adenoviruses*, and *Reoviruses* are three different types of viruses that infect the enteric and upper part of respiration system in humans.

### 3.2.3 Protozoan

Protozoa are unicellular organisms, which are detected more prevalently in wastewater than in other environmental sources. Many types of protozoan can survive methods of disinfection like chlorination. The chief waterborne protozoa include the following:

- *Giardia lamblia* is a flagellated protozoan that can exist for up to three months as a cyst and can cause gastrointestinal disease. *Giardia* cysts are more resistant to chlorine than other organisms and can be removed by granular media filtration.

- *Cryptosporidium*, two species of *Cryptosporidium*, can cause infection in mammals. The symptoms in humans are acute diarrhea, abdominal pain, vomiting, and fever. The oocysts are resistant to chlorine but ultraviolet (UV) irradiation and ozonation can destroy them.
- *Entamoeba histolytica* is a protozoan and the cysts can be spread by the use of polluted water for irrigation or by using sludge as a fertilizer. *E. histolytica* causes amoebic dysentery, and this organism can invade the bloodstream and is able to reach other organs like the liver. The cysts are resistant to chlorine, but the large size of them helps their removal by conventional filtration.

### 3.2.4 Helminths

Helminths (rotifers and nematodes) are multicellular microscopic animals, which are common intestinal parasites and are usually transmitted by fecal–oral route. Small nonparasitic worms are present globally, even in finished drinking water at the faucet [3]. *Ascaris lumbricoides*, *Enterobius vermicularis*, *Fasciola hepatica*, *Hymenolepis nana*, *Taenia saginata*, *Taenia solium*, and *Trichuris trichiura* are the main helminths. Helminth eggs are resistant to chlorination, and studies have shown that eggs of *Ascaris* can survive in the sediments of oxidation ponds for up to 10 years [15].

## 3.3 Disinfection of Water

Disinfection is the partial inactivation or destruction of disease-causing pathogens. These pathogens and diseases caused by them were mentioned briefly in the last section. Disinfection of wastewater is currently achieved by the use of various methods, which are discussed in the following.

### 3.3.1 Chemical Agents

There are various chemical agents used as disinfectants, but chlorination, chloramination, usage of chlorine dioxide, and ozonation are the most common methods universally.

#### 3.3.1.1 Chlorination

Chlorine is the most common strategy of disinfection because it is economical, effective, and helpful in control of infection. Chlorine is a greenish-yellow gas that is 2.48 times as heavy as air and inactivates pathogens by reacting with their enzymes. Chlorine can be easily compressed and transformed into liquid; 450 mL of gas forms 1 mL of liquid.

Chlorine forms hydrochloric acid and hypochlorous acid in water and will lower the pH of water:



At pH above 7.5, hypochlorous acid ionizes into hypochlorite ion and hydrogen and it becomes less and less effective:



Chlorine gas is highly toxic and potentially poses health risks to treatment plant operators and the general public health if released by accident. Though hypochlorite salts, which are solid forms of chlorine, are used as an alternative for chlorine gas. Unlike chlorine gas, hypochlorite salts raise the pH of the water.

The effectiveness of chlorine is dependent on pH, chlorine type, temperature, contact time period, and concentration. As pH of water increases, the chlorine will become less effective, while the effectiveness of chlorine varies directly with the temperature. As temperature rises, the disinfection would

become quicker and the required contact time will become shorter. Longer contact time would contribute to more effective disinfection, and this required contact time varies at different temperatures to react with pathogens.

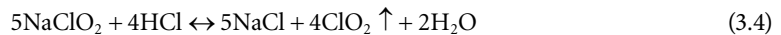
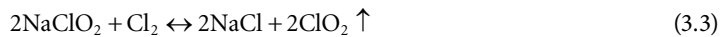
Higher concentration of chlorine would help the effectiveness of disinfection. According to the Safe Drinking Water Act (SDWA), the maximum permitted chlorine residual in water distribution systems is 4 mg/L, and the minimum required is 0.2 mg/L. 0.5–1 mg/L of free residual chlorine effectively disinfects water. Exposure to 1000 ppm of chlorine in the air will be rapidly fatal and the maximum allowed amount of chlorine in the air is 1 ppm.

### 3.3.1.2 Chloramination

Chloramination is the use of chloramines, which are formed by reacting ammonia with chlorine, for disinfection. Chloramines are less effective and slower than free residual chlorine. Therefore, to achieve to same degree of disinfection, higher dosage and longer contact time for chloramines are required relative to free residual chlorine. There are three types of chloramines: monochloramines, dichloramines, and trichloramines. Monochloramine is the most prevalent species among the others because it is more effective and less odorous. Overall, chloramination is more effective above pH 8.

### 3.3.1.3 Chlorine Dioxide Application

Chlorine dioxide, a yellow to red gas, is a very powerful disinfectant formed by reacting sodium chlorite with chlorine or an acid:



The efficiency of this process should be more than 95% and the efficiency is pH dependent with an optimum at a pH of 3–5. Chlorine dioxide is more effective when it is followed by chlorine or chloramines. Some disadvantages like being relatively expensive to produce, being explosive at a concentration above 10% in the air, and short stability have limited chlorine dioxide application.

### 3.3.1.4 Ozonation

Ozone was first used to disinfect water supplies in 1905 at Nice, France. Ozone, a blue gas with a distinct pungent odor, is a triatomic form of oxygen, O<sub>3</sub>. Ozone can be produced by electrolysis, photochemical reaction, or radiochemical reaction by electrical discharge. Ozone is mostly produced by UV light and lightning during a thunderstorm. The electrical discharge method is implemented for the production of ozone in water and wastewater disinfection processes. Ozone is generated from either air or oxygen when a high voltage is applied between two electrodes. Ozone is 20 times more soluble in water than oxygen and the maximum reported solubility of ozone in water is 40 mg/L. Ozone is chemically unstable and decomposes to oxygen very quickly after production and thus must be produced onsite. Its half-life at room temperature is only 15–20 min:



Ozonation treatment of water can be separated into three distinct sections: preparation of feed gas, production, and contact.

In the production process, the feed gas at a low pressure is passed through two electrodes, which are separated by a gap to produce ozone. At this stage, a large amount of heat is released into the cooling water.



**TABLE 3.1** By-Products of Chemical Agents

Disinfectant	Significant Organohalogen Products		Significant Inorganic Product	Significant Nonhalogenated Products
Chlorine	THMs	Chlorophenols		Aldehydes
Hypochlorous acid	Haloacetic acids	Halofuranones	Chlorate (mostly from hypochlorite use)	Cyanoalkanoic acids
	Haloacetonitriles	N-Chloramines		Alkanoic acids
	Chloral hydrate	Bromohydrins		Benzene
	Chloropicrin			Carboxylic acids
Chlorine dioxide	Haloacetonitriles	Chloramino acids	Nitrate	
Chloramine	Cyanogen chloride	Chloral hydrate	Nitrite	Aldehydes
	Organic chloramines	Haloketones	Chlorate	Ketones
			Hydrazine	
Ozone	Bromoform		Chlorate	Aldehydes
	Monobromoacetic acid		Iodate	Ketoacids
	Dibromoacetic acid		Bromate	Ketones
	Dibromoacetone cyanogens		Hydrogen peroxide	Carboxylic acids
	Bromide		Hyobromous acid	
			Epoxides	
		Ozonates		

In the contact process, ozone and oxygen mixture is dispersed through the water by diffusers at the bottom of a contact chamber to contact the pathogens and destroy them.

Ozone is the strongest disinfectant, which can also be used in wastewater treatment to control tastes and odors, color, and algae. Biocidal properties of ozone are not influenced by pH.

Despite these benefits, there are some disadvantages of ozonation, including high capital cost of production and lack of residual influence. These obstacles have made chlorination a more prevalent method in the world. Overall, ozonation is mostly followed with other disinfection methods like chlorination and chloramination, or it is combined with other disinfectants such as hydrogen peroxide, which can quicken the oxidation of some organics by two to six times relative to ozone by itself.

By-products are produced during the treatment of water by chemical agents. These by-products are summarized in Table 3.1 [25].

### 3.3.2 Physical Agents

Heat, light, and sound are physical disinfectants that can be used. Heat is currently used to destroy many bacteria in food and dairy industry. Heating water to the boiling point can be an effective way to disinfect water, but it is not a feasible strategy of disinfecting large quantities of water due to the high cost.

Sunlight is also a good disinfectant because of the UV radiation portion of the electromagnetic spectrum. Sunlight can decay microorganisms effectively because of exposure to the UV component and thermal heating of solar light.

#### 3.3.2.1 Ultraviolet Radiation Treatment

The disinfection of treated wastewater by implementation of UV radiation is a physical process, which mainly involves passing a film of wastewater within close proximity of a UV source. UV light penetrates the cell wall of the microorganism and is absorbed by the nucleic acid and enzymes of pathogens and inactivates them. Unlike other disinfectants, UV disinfection does not produce harmful by-products. UV disinfection does not result in a lasting residual in the wastewater, which is a disadvantage when water must be

**TABLE 3.2** Required UV-C Dose to Reach 90% of Inactivation for Different Microorganisms

Microorganism	[UV-C Dose] 90% (mW s c/m <sup>2</sup> )
Protozoa cysts	
<i>Giardia muris</i>	82
<i>Cryptosporidium parvum</i>	80
<i>Giardia lamblia</i>	63
Viruses	
Rotavirus SA 11	8
Poliovirus	15
Hepatitis A virus	3.7
Bacteria	
<i>Pseudomonas aeruginosa</i>	5.5
<i>Escherichia coli</i>	3
<i>Salmonella typhi</i>	2.5
<i>Shigella dysenteriae</i>	1.7
<i>Legionella pneumophila</i>	0.38

stored or piped over long distances or time. One of the problems of the UV treatment is high required costs, which can limit its application in some developing countries. The most commonly accessible wavelength of the UV light is 254 nm that is generated by a mercury vapor lamp, but the most effective wavelength is 265 nm. Effective dosage of UV differs from system to system with regard to the type of microbes and the quality of water. Currently, drinking water is mostly disinfected with UV dosage of 38–40 mJ/cm<sup>2</sup>. Higher dose of UV would contribute to better disinfection of water, but the treatment will become more expensive. The required UV doses to reach a 90% of inactivation with different pathogens are shown in Table 3.2 [2].

Some factors influence the effect of UV treatment. These factors are discussed in the following:

- Turbidity. UV treatment is more effective in clean water because turbidity shields pathogens against radiation. Therefore, water should be as clear as possible to make the transmittance of UV rays easier and water treatment more effective.
- Dissolved organic matter. As the dissolved organic matter is less in water, the treatment will be more effective because dissolved organic matter absorbs the UV rays and shields pathogens from radiation.
- Total dissolved solids. Solids deposit and foul the UV lamp; therefore, treatment will be more effective if dissolved solids are less in water.
- Depth of water. UV light can penetrate better through shallow water and the treatment would be more effective. Suggested depth of clear water for UV treatment is about 3–5 in.

### 3.3.3 Mechanical Tools

Pathogens are also partially removed by mechanical tools in water and wastewater treatment.

#### 3.3.3.1 Membrane Filtration

Filtration is the mechanical removal of specific sized particles from water by passing it through a porous medium. A membrane is a very thin paperlike structure that is capable of removing most of the contaminants. Membranes are divided into five groups:

1. *Microfiltration* membranes remove the particles bigger than 1  $\mu\text{m}$ , including *Cryptosporidium* oocysts, *Giardia* cysts, and all bacteria. Microfiltration membranes are the most numerous on the market and less expensive than other types of membranes.

2. *Ultrafiltration* membranes are similar to microfiltration membranes and function like a sieve. Their pore size ranges from 0.003 to 0.1  $\mu\text{m}$  and can remove all particles bigger than this pore size by 99.99%. Ultrafiltration membranes cannot remove salt or sugar.
3. *Nanofiltration* membranes have nanometer pore size and can remove all the particles above nanometer size such as viruses, cysts, and bacteria.
4. *Reverse osmosis* membranes are primarily used for desalination throughout the world. Currently, there are more than 100 reverse osmosis drinking water plants in the United States, and it is a very prevalent process in Middle Eastern countries to treat salty water for drinking purposes. These membranes exclude ions, but high pressure is needed to produce the deionized water.
5. *Electrodialysis* membranes use direct electric current to separate ionic components of a solution. The electric current will cause the collection of anions at the anode and cations at the cathode, after passing through the solution.

### 3.3.4 Radiation

Electromagnetic, acoustic, and particle are the main types of radiation. In this method, gamma rays are emitted from radioisotopes, like cobalt-60, and these rays are very strong to disinfect water and wastewater. Despite extensive studies in this field, there are no commercial devices or installations in operation yet [13].

## 3.4 Nanotechnology and Water Disinfection

---

Conventional methods of disinfection are dependent on chemical agents that are ineffective against cyst-forming protozoa such as *Giardia* and *Cryptosporidium*, and also these methods often produce harmful by-products. Therefore, there is a need to consider innovative strategies that boost the reliability of disinfection while preventing unintended adverse health effects. The advent of nano-engineered materials has spurred noticeable interest in the environmental applications that will improve technologies to protect the public health, including water treatment, groundwater remediation, and air quality control. Large specific surface area and high reactivity of nanomaterials are the main reason of their great application in different fields. The use of nanoparticles exhibiting the antimicrobial activity offers the possibility of an efficient removal of pathogens from wastewater. The main nanoparticles exhibiting antimicrobial activities are as follows:

### 3.4.1 Silver

Silver was used as a disinfectant for water in ancient Greek period [20]. In recent years with the developments in nanotechnology, silver has found the application in different fields like biomedical [10], catalysis [7], and water purification [6]. Several antimicrobial mechanisms of nanosilver are postulated, such as adhesion to cell surface changing the membrane properties, penetrating inside bacterial cell to damage DNA, and the release of antimicrobial  $\text{Ag}^+$  ions as a result of nanosilver dissolution. The inactivation of bacteria and viruses is also enhanced by silver nanoparticles in the presence of UV-A and UV-C irradiation. In general, silver nanoparticles ranging from 1 to 10 nm are more toxic to bacteria like *E. coli*. Nowadays, there are a lot of commercial products that use nanosilver as an antimicrobial agent including refrigerators, textiles, faucets, laundry additives, and nutrition supplements. Also some companies like Aqua Pure and Kinetico that manufacture home water purification systems are utilizing nanosilver to remove 99.99% of pathogens in water [12].

### 3.4.2 Chitosan

Chitosan is a type of natural polyaminosaccharide, which is a polysaccharide constituting mainly of unbranched chains of  $\beta$ -(1 $\rightarrow$ 4)-2-acetoamido-2-deoxy-*D*-glucose. After cellulose, chitin is the

most abundant polymer in nature. It can be obtained from crustacean shell such as prawns, crabs, fungi, and insects [23]. Chitosan nanoparticles are implemented in cosmetics, agriculture, and medical applications. It has been found that nanochitosan is effective against viruses, bacteria, and fungi. Nanochitosan exhibits more effective antimicrobial activity against viruses and fungi than bacteria [16]; within bacteria, chitosan exhibits a higher antimicrobial activity toward Gram-positive bacteria than Gram-negative bacteria [4]. Various antimicrobial mechanisms are suggested for chitosan. One mechanism includes positively charged chitosan particles interacting with negatively charged cell membranes, leading to more permeability of membrane and finally fracture and leakage of intracellular elements. In the other suggested mechanism, chitosan chelates trace metals, contributing to inhibition of activities of enzyme. Nanoscale chitosan is used in membranes and water storage tanks as an antimicrobial agent that is more effective than many other disinfectants. It is also used in water and wastewater treatment systems as a coagulant. Nanochitosan is less toxic toward humans and animals than the other nanoparticles.

### 3.4.3 Titanium Dioxide

Forty thousand tons of titanium dioxide nanoparticles were manufactured in the United States during 2006, and the annual production of nano titanium dioxide is estimated to reach 2.5 million tons in 2025 (Figure 3.1) [17].

Titanium dioxide nanoparticle is a widely used nanomaterial; only cosmetics and sunscreen products constitute 50% of titanium nanoparticle usage.  $\text{TiO}_2$  is the most prevalent semiconductor photocatalyst and is activated by UV-A (320–400 nm) irradiation [14].  $\text{TiO}_2$  is effective against both Gram-negative and Gram-positive bacteria. Depending on the size of the particles and the intensity and wavelength of the light used, a concentration between 100 and 1000 ppm can kill bacteria. The most promising property of  $\text{TiO}_2$ -based disinfection is basically its photoactivation by sunlight. A conducted experiment showed an initial bacterial concentration of 3000 cfu/100 mL was inactivated in 15 min by storing water in a plastic container that was coated inside with  $\text{TiO}_2$  and exposed to sunlight [5]. Doping  $\text{TiO}_2$  with other metals can improve its photocatalytic inactivation of bacteria and viruses.  $\text{Ag}/\text{TiO}_2$  is found to be one of the most promising photocatalytic materials due to its photoreactivity and visible light response [19].

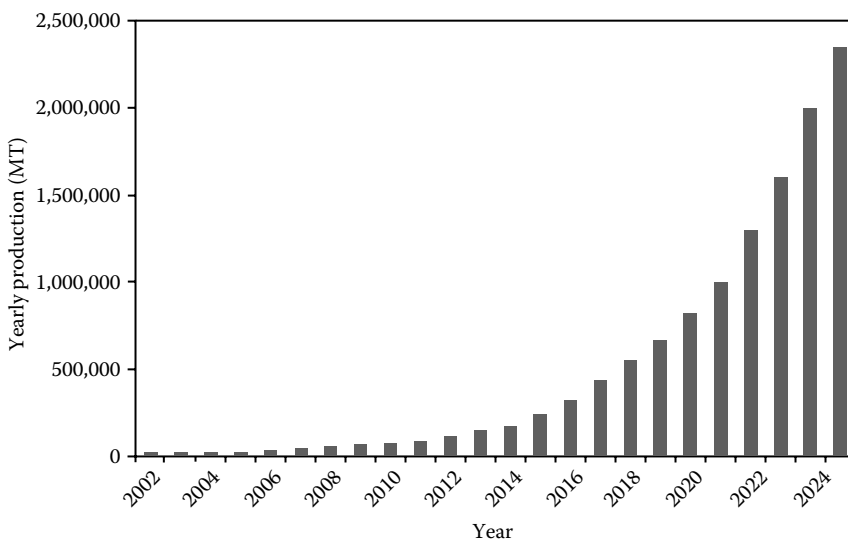


FIGURE 3.1 Prediction of titanium nanoparticles production in the United States (MT, metric tons).

### 3.4.4 Zinc Oxide

As an environment-friendly material, ZnO is used in catalyst industry, solar cells, gas sensors, and so on. Many characteristics of nano-sized ZnO are similar to TiO<sub>2</sub>. ZnO is used in sunscreens, coatings, and paints because of its high UV absorption efficiency and photocatalytic activity. The ZnO nanoparticles have exhibited a strong antibacterial effect on a vast range of bacteria [8]. The antibacterial mechanism of ZnO is still under study. One of the main mechanisms of photocatalytic degradation by ZnO is attributed to the generation of hydrogen peroxide within the cells, which oxidize the cell components. The membrane disruption is attributed to peroxidation of the unsaturated phospholipids. The predominance of the polysaccharides over the amide has charged the bacterial surface negatively. Therefore, bacteria are adsorbed easily on the ZnO powder and the nanoparticles might penetrate the cell. The bacterial growth will be inhibited as a result of cell membrane and the wall destruction in contact with ZnO nanoparticles [11]. In addition, binding Zn<sup>2+</sup> ion to the membranes of microorganisms will result in extended lag phase of the microbial growth cycle. ZnO is also used as an antimicrobial agent in some lotions and creams.

### 3.4.5 Fullerenes

Fullerenes are a sort of molecules composed totally of carbon. Fullerenes (C<sub>60</sub>, C<sub>70</sub>, etc.) have a low solubility in water, and therefore, they should be modified on the surface or combined with a stabilization agent to become soluble [21]. Fullerenes are known for their antimicrobial properties to inactivate viruses and bacteria and kill tumor cells. Fullerenes are not still used in commercial products as disinfectants because the knowledge of their properties and characteristics is limited. One of the main obstacles in the use of fullerol in water treatment is the difficulty in separating and recycling fullerol nanoparticles. Currently, there is no method to remove these small, light nanoparticles easily and cost-efficiently.

### 3.4.6 Carbon Nanotubes

Carbon nanotubes (CNTs) are made of graphene sheets that are rolled into a tube and probably capped by half a fullerene. CNTs are considered as the most extensively analyzed allotrope of carbon in this millennium. They have very dramatic and particular physicochemical properties that own immeasurable applications in the industry and affect society noticeably. CNTs are basically divided into two types: single-walled nanotubes (SWNTs) that are a single pipe with a diameter from 1 to 5 nm and multiwalled nanotubes (MWNTs) that are constituted of several nested tubes at lengths varying from 100 nm up to several tens of micrometers. CNTs are utilized in several ways for disinfection applications. First, SWNTs can be coated on filters and MWNTs can be made into hollow fibers [22]. One of the main problems in the use of CNTs is the difficulty of dispersing them in water. This obstacle is maybe the reason that has limited the research on antimicrobial activity of CNTs. In an experiment, SWNTs were immobilized on a membrane filter surface and 87% *E. coli* bacteria were killed in 2 h [9].

Antimicrobial nanoparticles can be used and combined with other disinfection methods to improve their abilities. For example, some pathogens are highly resistant to UV disinfection. Therefore, the combination of UV disinfection with photocatalytic nanoparticles can be helpful to overcome this problem.

Despite all numerous advantages of antimicrobial nanoparticles in disinfection of water, some challenges can limit their applications. One of the main barriers is dispersion and retention of nanomaterials. TiO<sub>2</sub> nanoparticles aggregate severely when they are added to the water. On the other hand, nanoparticles that are well dispersed in water cannot be separated easily because of their small sizes. The retention of nanoparticles can be expensive, and also these nanoparticles can be potentially harmful to human health and environment. Also the extensive use of nanoparticles can lead to leakage and

accumulation of them in the environment. These nanoparticles can destroy beneficial microbes that play an important role in bioremediation and nitrogen fixation for plant growth.

### 3.5 Case Study

The aim of this study that was conducted at the Microbiology Laboratory of Islamic Azad University of Shahreza is to observe the antibacterial activity of ZnO nanoparticles with different sizes against *E. coli* (ATCC 25922). All chemicals are analytical grade and are used as received without further purification. Double distilled water was used throughout the whole synthetic process. In a typical synthesis, (x) mL  $\text{NH}_3\cdot\text{H}_2\text{O}$  (28%) was added into 15.0 mL 0.5 M zinc nitrate aqueous solution to form a transparent solution under stirring. Then x (g) CTAB and 15.0 mL of absolute ethanol were added to the previously formed solution. After stirring at 60°C for 30 min, the mixture was then transferred into a 60.0 mL Teflon-lined autoclave and maintained at 140°C for 15 h. Subsequently, after the autoclave was cooled, the as-formed white precipitate was filtered, washed with absolute ethanol and double distilled water, and then dried at 80°C. Detailed conditions for other samples are summarized in Table 3.3.

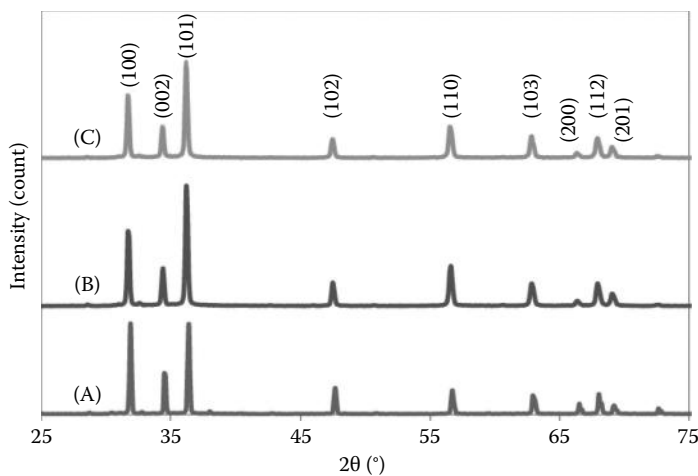
To determine the crystal phase composition of the prepared nanoparticles, x-ray diffraction (XRD) measurement was carried on a Bruker D8 ADVANCE XRD spectrometer with a  $\text{Cu K}\alpha$  line at 1.5406 Å and a Ni filter for an angle range of  $2\theta = 20^\circ\text{--}80^\circ$ . The XRD patterns of ZnO nanoparticles are shown in Figure 3.2.

All peaks of the obtained products were corresponding to the hexagonal wurtzite structure of ZnO with lattice parameters. No peak from either ZnO in other phases or impurities was observed. These results showed the ZnO nanoparticles were successfully synthesized by solvothermal reaction in all solvents.

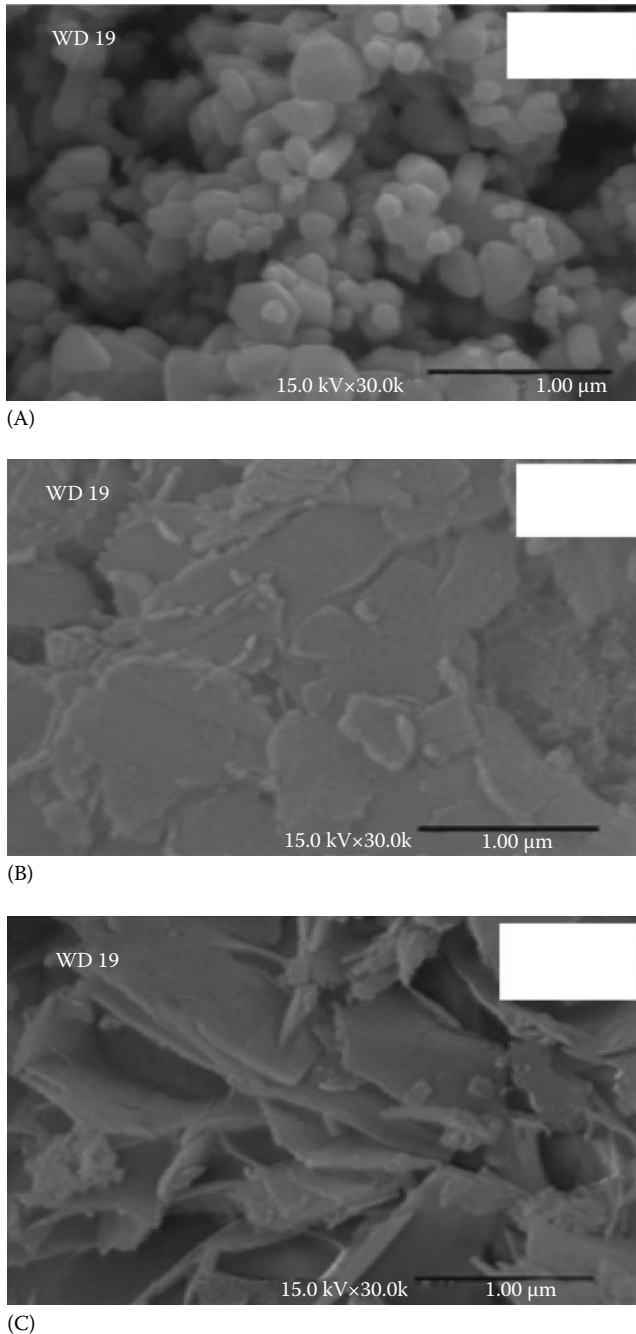
Philips XL30 scanning electron microscope (SEM) measurements were also used to investigate the morphology of the samples with an accelerating voltage of 17 kV. SEM micrographs of three samples

**TABLE 3.3** Starting Chemicals Used in the Solvothermal Syntheses

Expt. No.	0.5 M $\text{Zn}(\text{NO}_3)_2$ (mL)	CTAB (g)	28% $\text{NH}_3\cdot\text{H}_2\text{O}$ (mL)	$\text{H}_2\text{O}$ (mL)	EtOH (mL)
A	15	0	1.5	7.5	15
B	15	0.5469	1.5	7.5	15
C	15	0	6	3	15



**FIGURE 3.2** XRD patterns of ZnO samples.



**FIGURE 3.3** SEM images of ZnO nanoparticles.

with different mixtures of solvents are shown in Figure 3.3. The average particle sizes were about 85, 70, and 57 nm for A, B, and C samples, respectively.

The antibacterial efficiency of the synthesized ZnO nanoparticles is assessed using the macro-dilution (tube) broth method, determining the minimum inhibitory concentration (MIC) leading to inhibition of bacterial growth (National Committee for Clinical Laboratory Standards, NCCLS

**TABLE 3.4** Results of the Antibacterial Activity Performance Studies

Expt. No.	MIC (g/mL)	MBC (g/mL)
A	0.016	0.032
B	0.008	0.016
C	0.002	0.004

document M100-S12:NCCLS, Wayne, PA, 2000). Different concentrations of ZnO nanoparticles were prepared in sterilized Mueller–Hinton broth at final concentrations of 0.032, 0.016, 0.008, 0.004, 0.002, and 0.001 g/mL. Suspension of *E. coli* in sterile peptone water was adjusted to 0.5 McFarland. Then, 1 mL of *E. coli* suspension (0.5 McFarland) was added to each sample. The samples were kept in incubation at 37°C for 48 h. After incubation, samples were taken from tubes with no visible growth of bacteria and then were applied on nutrient agar (NA). After 24 h incubation, if one or two colonies were observed, this concentration was considered as MIC, but if no bacterial growth was observed, this concentration was recognized as minimum bactericidal concentration (MBC). The results of the antibacterial activity performance studies are collected in Table 3.4. It was found that the antibacterial activity of ZnO nanoparticles increased with decreasing particle size.

### 3.6 Summary and Conclusions

The quantity and quality of water is considered to be one of the critical issues for the coming decades. The control of microbial pathogens in water is one of the main problems that can limit available water resources. Different methods are implemented to disinfect water. Current methods of disinfection can form by-products that are harmful to the ecosystem. Also some pathogens are resistant to these methods. In recent years, the development of nanotechnology and antimicrobial agents that have little or no negative effect on the environment has become significant. Some nanoparticles can effectively inactivate and destroy these pathogens that are harmful to the health of humans. The action of nanoparticles is different against various microorganisms.

Despite high ability of some nanoparticles to inactivate pathogens, retention and suspension of nanoparticles can limit their application. Also some nanoparticles like silver can destroy beneficial microorganisms that are important for the environment. Overall, there is still a long way to go in order to study detailed characteristics of nanoparticles for the disinfection of water.

### References

1. Albrecht, M.A., Evans, C.W., and Raston, C.L. 2006. Green chemistry and the health implications of nanoparticles. *R. Soc. Chem.* 8: 417–432.
2. Bitton, G. 2005. *Wastewater Microbiology*. John Wiley & Sons, Hoboken, NJ.
3. Cooper, R.S. 2001. *Personal Communication*, BioVir Laboratories, Benicia, CA.
4. Don, T.M., Chen, C.C., Lee, C.K., Cheng, W.Y., and Cheng, L.P. 2005. Preparation and antibacterial test of chitosan/PAA/PEGDA bi-layer composite membranes. *J. Biomater. Sci. Polym. Ed.* 16: 1503–1519.
5. Gelover, S., Gomez, L.A., Reyes, K., and Leal, M.T. 2006. A practical demonstration of water disinfection using TiO<sub>2</sub> films and sunlight. *Water. Res.* 40: 3274–3280.
6. Jain, P. and Pradeep, T. 2005. Potential of silver nanoparticle-coated polyurethane foam as an antibacterial water filter. *Biotechnol. Bioeng.* 90: 59–63.
7. Jana, S., Pande, S., Panigrahi, S., Praharaj, S., Basu, S., Pal, A., and Pal, T. 2006. Exploitation of electrostatic field force for immobilization and catalytic reduction of o-Nitrobenzoic acid to anthranilic acid on resin-bound silver nanocomposites. *Langmuir* 22: 7091–7095.



8. Jones, N., Ray, B., Ranjit, K.T., and Manna, A.C. 2008. Antibacterial activity of ZnO nanoparticle suspensions on a broad spectrum of microorganisms. *FEMS Microbiol. Lett.* 279: 71–76.
9. Kang, S., Pinault, M., Pfefferle, L.D., and Elimelech, M. 2007. Single-walled carbon nanotubes exhibit strong antimicrobial activity. *Langmuir* 23: 8670–8673.
10. Kong, H. and Jang, J. 2008. Antibacterial properties of novel poly (methacrylate) nanofiber containing silver nanoparticles. *Langmuir* 24: 2051–2056.
11. Li, Q., Mahendra, S., Lyon, D.Y., Brunet, L., Liga, M.V., Li, D., and Alvarez, P.J.J. 2008. Antimicrobial nanomaterials for water disinfection and microbial control: Potential applications and implications. *Water Res.* 42: 4591–4602.
12. Maynard, A.D. 2007. Nanotechnology—Toxicological issues and environmental safety. In: *Project on Emerging Nanotechnologies*. Springer, the Netherlands.
13. Metcalf and Eddy, Inc. 2003. *Wastewater Engineering: Treatment and Reuse*. Revised by George Tchobanoglous, Franklin L. Burton, and H. David Stensel. McGraw Hill, New York.
14. Murray, C.A., Goslan, E.H., and Parsons, S.A. 2007. TiO<sub>2</sub>/UV: Single stage drinking water treatment for NOM removal? *J. Environ. Eng. Sci.* 6: 311–317.
15. Nelson, K. 2001. Personal communication, Department of civil and environmental engineering, University of California at Davis, Davis, CA.
16. Rabea, E.I., Badawy, M.E., Stevens, C.V., Smagghe, G., and Steurbaut, W. 2003. Chitosan as antimicrobial agent: Applications and mode of action. *Biomacromolecules* 4: 1457–1465.
17. Robichaud, C.O., Uyar, A.E., Darby, M.R., Zucker, L.G., and Wiesner, M.R. 2009. Estimates of upper bounds and trends in nano-TiO<sub>2</sub> production as a basis for exposure assessment. *Environ. Sci. Technol.* 43: 4227–4233.
18. Scheierling, S.M., Bartone, C.R., Mara, D.D., and Drechsel, P. 2011. Towards an agenda for improving wastewater use in agriculture. *Water Int.* 36: 420–440.
19. Seery, M.K., George, R., Floris, P., and Pillai, S.C. 2007. Silver doped titanium dioxide nanomaterials for enhanced visible light photocatalysis. *J. Photochem. Photobiol. A Chem.* 189: 258–263.
20. Smetana, A.B., Klabunde, K.J., Marchin, G.R., and Sorensen, C.M. 2008. Biocidal activity of nanocrystalline silver powders and particles. *Langmuir* 24: 7457–7467.
21. Spesia, M.B., Milanese, M.E., and Durantini, E.N. 2007. Synthesis, properties and photodynamic inactivation of *Escherichia coli* by novel cationic fullerene C(60) derivatives. *Eur. J. Med. Chem.* 43: 853–861.
22. Srivastava, A., Srivastava, O.N., Talapatra, S., Vajtai, R., and Ajayan, P.M. 2004. Carbon nanotube filters. *Nat. Mater.* 3: 610–614.
23. Wan Ngah, W.S. and Isa, I.M. 1998. Comparison study of copper ion adsorption on chitosan dowex A-1 and zerolit 225. *J. Appl. Polym. Sci.* 67: 1067–1070.
24. World Health Organisation (WHO) 2004. *Guidelines for Drinking Water Quality*. WHO, Geneva, Switzerland.
25. World Health Organisation (WHO) 1999. International Programme on Chemical Safety (IPCS), *Disinfectants and Disinfectant By-Products*, International Program on Chemical Safety (Environmental Health Criteria 216), Geneva, Switzerland.

# 4

## Environmental Engineering for Water and Sanitation Systems

---

4.1	Introduction .....	66
4.2	Sources of Water and Target Population.....	67
	Rain • Surface Water • Uses of Water	
4.3	Integrated Water Resources Management.....	72
	Principle of Integrated Water Management • Benefits of Integrated Water Resources Management • Challenges of Integrated Water Resources Management	
4.4	Water Supply Engineering.....	75
	Collection of Water • Conveyance of Water • Water Supply Treatment • Advanced Water Treatment	
4.5	Sanitary Engineering .....	78
	Layout of Sanitary Engineering Works	
4.6	Waste Water Systems.....	79
	Waste Water Treatment	
4.7	Summary and Conclusions .....	81
	Acknowledgment.....	81
	References.....	81

**Bosun Banjoko**  
*Obafemi Awolowo  
University*

### **AUTHOR**

**Bosun Banjoko** obtained his MSc, PhD in Biochemistry, and MPH in Environmental Health degrees from the University of Ibadan, Ibadan, Nigeria, MPA degree in Public Policy from Obafemi Awolowo University, Ile-Ife, Nigeria. He specializes in immunology, toxicology, environmental health, sustainable development, environmental ethics, and Diploma in International Environmental Law from UNITAR, Geneva, Switzerland. He is currently registered for the LLM Environmental and Human Rights degree program at Aberystwyth University, Aberystwyth, U.K and he is a senior lecturer in the Department of Chemical Pathology and head of the Environmental Health and Sustainable Development Unit at the Institute of Public Health, College of Health Sciences, Obafemi Awolowo University, Ile-Ife, Nigeria. He is an author of many articles and book chapters.

## PREFACE

Utilization of water is a global requirement, and appropriate technology in the context of provision of water for municipal and sanitation uses is one of the underpinnings of sustainable development. As the world population grows and in the advent of climate change, the need arises for an integrated approach to rational use of water. This chapter therefore discusses integrated water management as a requirement for sustainable water and sanitation systems.

## 4.1 Introduction

Environmental engineering is the application of science and engineering principles and techniques to improve the natural environment including air, water, and land resources. The scope extends to waste water management, remediation of polluted sites, air pollution control, water and material recycling, waste disposal, environmental impact assessment, radiation protection, industrial hygiene, and environment sustainability. All environmental-friendly technologies can be said to fall within the purview of environmental engineers.

Environmental engineers are responsible for the design of municipal water supply and industrial waste water systems. For the purpose of this chapter, however, the focus will be more on hydrology, sanitation, water resources management, and water treatment plant design. In environmental engineering, there are cross-activities between the disciplines of environmental science, ecology, biology, chemistry, civil engineering, chemical engineering, and agricultural engineering. The knowledge of these disciplines is therefore essential to environmental engineering specialty.

From historical perspectives, the practice of environmental engineering could be traced to the Harappan Civilization of the Indus Valley, in Punjab, Pakistan, dated 3000–1300 BC where archeological excavations revealed the presence of sewers [35]. The Romans were also known to have constructed aqueducts to prevent drought and create clean water supply for Rome metropolis. Furthermore, in the fifteenth century, the Bavarians created laws restricting the development and degradation of the Alpine country that constituted the region's water supply. However, modern environmental engineering could be traced to the nineteenth century when Joseph Bazalgette designed the first major sewerage system that reduced the incidence of waterborne diseases such as cholera in London [5]. This was followed by development of water treatment, sewage treatment, and recycling in industrialized and later the developing countries. Many of the world's health challenges can be traced to lack of safe drinking water and poor sanitation. Therefore, good management of water resources underpins abatement of most environmental challenges.

The World Health Organization/United Nations Children's Fund Joint Monitoring Program in its 2012 progress report on drinking water and sanitation ranked China, India, and Nigeria, respectively, with the largest population without access to improved drinking water [44]. The same program in its report, which covered between 1990 and 2010, noted that about 66 million Nigerians lacked access to drinking water while 34 million representing 20% of the country's population practiced open defecation. The other countries with large populations lacking access to potable water include China with 119 million people, India with 97 million people, Ethiopia with 46 million people, and Sudan with 18 million people. For open defecation, India topped the list with 626 million, followed by Indonesia with 63 million, Pakistan with 40 million, Ethiopia with 38 million, and Nigeria with 25 million.

Globally, the report noted that in 2010, 89% of the world's population, or 6.1 billion people, used improved drinking water sources, exceeding the Millennium Development Goal of 88%, while 92% are expected to have access in 2015. This means that 11% of the global population or 783 million people are still without access, while the WHO/UNICEF Joint Monitoring Program projects that 605 million will still not have access in 2015. Noting the disparity between rural and urban areas in access to improved

water supply, the report stated that an estimated 96% of the urban population globally used an improved water supply source in 2010 compared to 81% of the rural population [38,44].

## 4.2 Sources of Water and Target Population

Water may be abstracted for use from any one of a number of points in its movement through the hydrological cycle. The safe yield of the source must be sufficient to serve the population expected at the end of the design period, which may be between 10 and 50 years. The safe yield is the yield that is adequate 95% of the year. An ideal source of water must conform to two criteria, namely, (1) sufficient quantity and (2) acceptable quality. There are three main sources of water: they are (1) rain, (2) surface water, and (3) groundwater [42].

### 4.2.1 Rain

Rain is the prime source of all water. A part of the rainwater sinks into the ground to form groundwater (percolation or interflow), and part of it forms streams and rivers that flow ultimately into the sea (runoff). Some of the water in the soil is taken up by the plants and is evaporated in turn by the leaves (transpiration), and the remainder is lost to the atmosphere from the land and water surface due to the heat of the sun (evaporation). This chain of processes is called the hydrological cycle (Figure 4.1).

Rainwater is the purest water in nature. Physically, it is clear, bright, and sparkling; chemically, it is a very soft water, containing only traces of dissolved solids (0.005%). Microbiologically, rainwater is normally free from pathogenic agents; however, it becomes impure as it passes through the atmosphere where suspended impurities such as dust, soot, microorganisms and gases such as carbon dioxide, nitrogen, oxides, oxygen, and ammonia get picked up.

### 4.2.2 Surface Water

Surface water consists of all sources in which the water flows over the earth's surface. Examples of surface waters include rivers, lakes, seas, man-made reservoirs, and wadis (water source that is dry except in rainy season). The availability of surface water all year round depends so much on the level of rainfall. Surface water is prone to contamination from environmental, human, and animal sources. Therefore, it is not safe for consumption unless subjected to sanitary protection and purification.

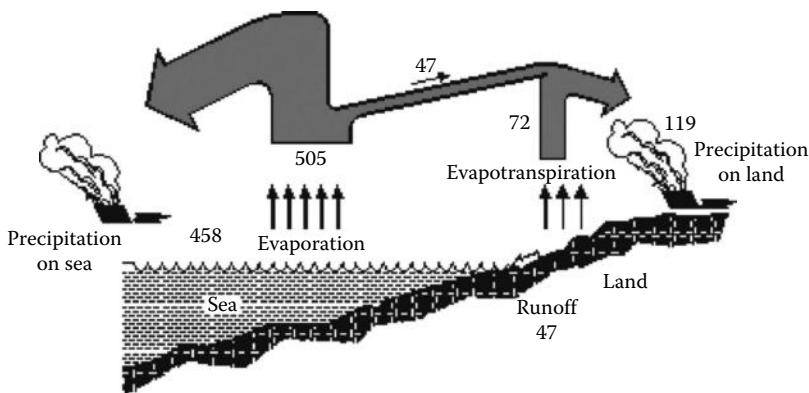


FIGURE 4.1 The hydrological cycle.

## **4.2.2.1 Types of Surface Water**

### **4.2.2.1.1 Impounding Reservoirs**

Storage or impounded reservoirs are created by construction of a solid barrier (i.e., dam, weir, or barrage) across a flowing river or stream at places where minimum area of land is submerged in the water and the reservoir basin remains cup shaped with a maximum depth of water. Impounding reservoirs are constructed across rivers, which are not able to provide the required quantity of water all year round. There are three essential parts of a reservoir: (1) a dam to hold the water back, (2) a spillway through which excess stream flow may discharge, and (3) gate chamber containing the necessary valves for regulating the flow of water from the reservoir. Impounding reservoirs generally provide a fairly good quality of water. The water is usually clear, soft, and palatable and ranks next to rainwater in purity. Contamination may occur from human and animal activities; therefore, the catchment area of an impounding reservoir should be free from human and animal intrusion [42].

### **4.2.2.1.2 Rivers and Streams**

Rivers provide a dependable supply of water and streams to a less extent. However, rivers and streams are easily prone to gross pollution and quite unfit for drinking unless properly treated for impurities and pathogens. The general belief that mountain streams are very pure water is often untrue. Even if there is no human habitation or cattle, there is a possibility of contamination from wild animals [25].

### **4.2.2.1.3 Tanks, Ponds, and Lakes**

Tanks are large excavations in which surface water is stored. They are common in developing countries where they are an important source of water supply. Tanks are prone to a high level of contamination except they are specially protected by construction of elevated platforms, which limit human and animal contacts. The tank can be subjected to sand filtration and some chlorination to improve their quality. Lakes and ponds arise when the depression of the earth's surface with impervious beds is filled with water. Lakes are formed when the size of the depression is very big and ponds are formed when the depression is small; while the former are generally formed in hilly areas, the latter are formed in plain areas. Ponds are also formed when soil is excavated for constructing earthen dams, embankments, and canals. The quantity of water in the lakes depends upon its basin capacity, soil properties, porosity, annual rainfall, and catchment area. For public supply, the quantity of water in lakes and ponds is very small and is only suitable for small towns in hilly areas. In some cases, due to the absence of other sources, large lakes become the main and permanent source of water supply. The quality of water in large lakes is better than that of small lakes. At high altitudes, the water available will be purer due to self-purification action of bleaching, removal of bacteria, and sedimentation of suspended matter. However, stagnation of the water promotes growth of algae, weed, and vegetables with resultant bad smell and taste and impurities.

### **4.2.2.1.4 Groundwater**

Groundwater results from rainwater percolating into the ground and constitutes the cheapest and most practical means of providing water to small communities. It has advantages over surface water due to the fact that the ground itself provides an effective filtration medium. In addition, groundwater is likely to be free from pathogenic agents, therefore usually requiring no treatment. The supply is almost certain even in dry season, but the yield might be reduced. Furthermore, it is less subject to contamination than surface water. Some disadvantages have been associated with groundwater and these include high mineral content like salts of calcium, magnesium, and iron, which renders it hard. It is also required for the water to be pumped for the purpose of access. The usual groundwater sources are wells and springs. Wells have been classified into (1) shallow and deep wells and (2) dug and tube wells. It is important to note that once groundwater is contaminated, it is difficult to restore.

#### 4.2.2.2 Aquifers

When rainwater percolates down through craves and pores of soil and rocks, it passes through a region called the unsaturated zone, which is characterized by the presence of both air and water in the spaces between soil particles. Water located in the unsaturated zone also called vadose water is not available for use. However, in the saturated zone, all spaces between the soil particles are filled with water, referred to as groundwater with a high yield. The upper boundary of the saturated zone is called water table. In addition, a transition region between the two zones called capillary fringe exists where water rises unto small cracks as a result of attraction between the rock surfaces.

An aquifer is a saturated geologic layer that sits atop of a confining bed or aquitard or aquiclude, which is relatively an impermeable layer that greatly restricts movement of groundwater [23]. In accessing groundwater, certain parameters are important. These include the flow rate and hydraulic gradient. How readily groundwater can move through rocks and soil is governed by permeability, but where and how rapidly it actually does flow is influenced by differences in hydraulic head also called potential energy from place to place. Groundwater flows from areas of higher hydraulic head to that of the lower. The height of the water table in an unconfined aquifer or of the potentiometric surface, that is, the confined aquifer, reflects the hydraulic head at each point in the aquifer. Furthermore, the greater the differences in the hydraulic head between two points, the faster the groundwater flow between them. In addition, flow rate is also dependent on the hydraulic conductivity. The hydraulic conductivity takes into account of both permeability of the rock and soil and the viscosity of the density of the flowing fluid. This phenomenon is equally applicable to other deep ground fluids like oils and gas whereby the conductivity ( $k$ ) varies.

The hydraulic gradient can be defined as the slope of the water table measured in the direction of the slowest rate of change. The groundwater flow is in the direction of the gradient at a rate proportional to the gradient.

Hydraulic gradient is thus calculated as

$$\text{Gradient } i = \frac{h_2 - h_1}{L} = \frac{\Delta h}{L} \quad (4.1)$$

where

$h$  is the hydraulic head or vertical distance from the datum plane (sea level) to the top of the water table

$L$  is the horizontal distance between two wells

#### 4.2.2.3 Darcy's Law

Darcy's law formulated by Henri Darcy in 1856 states that the flow rate of groundwater  $Q$  is proportional to the cross-sectional area  $A$  times the hydraulic gradient ( $dh/dl$ ):

$$\text{that is, } Q = KA \left( \frac{dh}{dl} \right) \quad (4.2)$$

where

$Q$  is the flow rate ( $m^3/day$ )

$K$  is the hydraulic conductivity or coefficient of permeability ( $m/day$ )

$A$  is the cross-sectional area ( $m^2$ )

$(dh/dl)$  is the hydraulic gradient

The application of Darcy's law is important in determining the yield of groundwater sources.

#### 4.2.2.4 Wells

Wells are important sources of water supply particularly in developing countries. Generally, wells are of two types, namely, (1) shallow wells and (2) deep wells. There are, however, varieties and modifications of these two:

1. Shallow wells: Tap water from the subsoil; therefore, the yield is not much and the potential for pollution is quite high.
2. Deep wells: Going several hundred meters into the ground to tap water from the aquifer is usually machine dug and provides a good source of water supply.
3. Artesian wells: Are a kind of deep wells in which water rises above the level of groundwater, because it is held under pressure between two impervious strata.
4. Sanitary wells: Sanitary wells are wells that are properly located, well constructed, and protected against contamination with a view to yield a supply of safe water. In essence, safe location means about 15 m from pollution sources like gutters. Usually there are platforms from the well and covering of the top to prevent it from contamination.
5. Tube wells: Tube wells are becoming quite successful in providing safe drinking water. The yield water is usually bacterially cheap. The tube well consists of a pipe made of galvanized iron sunk into the aquifer and flitted with a strainer at the end.
6. Deep tube well or borehole wells: Borehole required pressure drillings to reach the groundwater. Deep tube wells are more expensive to construct but provide better yields.
7. Tube wells generally can be fitted with solar-powered, electric pump, which may pump water into an overhead reservoir tank for better and safer drinking water.
8. Springs: Can be shallow or deep. Shallow springs have a tendency to dry up during summer, compared to deep springs, and are prove to contaminations particularly from wild animals. Well-built protective structures are required to safeguard water quality.

#### 4.2.3 Uses of Water

The usage into three categories, which include (1) environment–ecosystem, including forests, fisheries, and wildlife; (2) agriculture; and (3) water supply and sanitation, including domestic use, swimming pools, fire protection, power production from hydropower, and industrial use for production and cooling. The greatest use of water is for agricultural purpose through irrigation.

##### 4.2.3.1 Population Consideration

Population forecasting is germane to successful water supply scheme, which depends upon the quantity of water that is required. The first step is a decision on the design period, which may be from 10 to 50 years, and the per capita consumption of the people per day. The next step is to determine the population for the designated design period. Data on the present and past population may be obtained from census board while the department of statistics and health should give adequate information on birth and death rates. The future population also depends on migration, annexation, industrial, and trade expansions [1,35].

Therefore, the quantity of water required is obtained by multiplying future population and per capita consumption for a fixed design period. Standard methods for forecasting population include

1. Arithmetical increase
2. Geometrical increase
3. Incremental increase
4. Decreasing rate
5. Simple graphical
6. Comparative graphical
7. Master plan

#### 4.2.3.1.1 *Arithmetical Increase Method*

It is assumed for stable towns and cities that population growth is steady. Therefore, a constant increase in population is addressed periodically and the population at the required time is determined. The rate of change of population with time is constant, that is,

$$\frac{dp}{dt} = C \quad (4.3)$$

where

$dp$  is the change in population

$dt$  is the change in time

$$\text{by integration, } P_2 - P_1 = C (t_2 - t_1) \quad (4.4)$$

where

$P_1$  is the population at the time ( $t_1$ ) of first census

$P_2$  is the population at the time ( $t_2$ ) of last census

The population after an  $n$  decade can be calculated using the following formula:

$$P_n = P + n \times C \quad (4.5)$$

#### 4.2.3.1.2 *Geometrical Increase*

The geometrical increase method considers decade-to-decade increase in population:

$$P_n = P \left( 1 + \frac{I_c}{100} \right)^n \quad (4.6)$$

where  $I_c$  is the yearly or per decade percentage rate of increase in population growth. This method has a limitation in the sense that it is not applicable to young or newly established towns and rapidly advancing cities that have short-term expansion only.

#### 4.2.3.1.3 *Incremental Increase*

In this method, the average increase in population is found out as per arithmetical increase, and this is added to the average of the net incremental increase once for every future decade. This is an improvement of the two previously described methods and hence gives better accuracy.

#### 4.2.3.1.4 *Decreasing Rate of Growth*

This method is similar to geometrical increase method except that a changing rate of decrease is assumed rather than a constant rate of increase. The changing rate of large and old cities is generally considered to be a decreasing rate. The population figures predicted by this method are quite rational.

The average decrease in percentage increase is worked out and subtracted from the last percentage increase for each successive decade.

#### 4.2.3.1.5 *Simple Graphical Method*

In this method, a population time curve for a decade is plotted using simple graph. From the obtained curve, predictions can be forecasted.



#### 4.2.3.1.6 Comparative Graph Method

The census population of towns that were in similar conditions of development over 40–50 years is noted, and graphs of their population increase are plotted on the same graph paper. The future expected population of the town can be determined from this graph. The method is only possible when population and development data of the other cities or towns are available.

#### 4.2.3.1.7 Master Plan Method

Master plans are usually prepared for the development of the town and cities over 30–40 years. The population densities for the various zones of the towns are fixed for the future development. Now the water supply scheme for a particular zone can be designed very easily. On the basis of the master plan, it will also be very easy to design the future development of the various stages of the waterworks.

## 4.3 Integrated Water Resources Management

---

Integrated water resources management (IWRM) is a systematic process for the sustainable development, allocation, and monitoring of water resources used in the context of social economics and environmental objectives; it contrasts with the sectoral approach that applies in many countries whereby different agencies are responsible for drinking water, irrigation, and environment [3,11]. The lack of cross-sectoral linkage leads to uncoordinated water resource development and management, conflicts waste of funds and manpower, and unsustainable system [6,34]. It is against this backdrop that it is expedient to include this process in the modern water systems.

### 4.3.1 Principle of Integrated Water Management

The International Conference on Water and Environment in Dublin, Ireland, in January 1992 summarized water management under four principles. These are the following:

1. Freshwater is a finite and vulnerable resource, essential to sustain life, development, and the environment. Since water sustains life, effective management of water resources demands a holistic approach, linking social and economic development with protection of natural ecosystems. Effective management prorates rationale water usage across the whole catchment area of groundwater aquifer.
2. Water development and management should be based on a participatory approach, involving users, planners, and policy makers at all levels. The participatory approach involves raising awareness of the importance of water among policy makers and the general public; it means that decisions are taken at the lowest appropriate level with full public consultation and involvement of users in the planning and implementation of water projects.
3. Women play a central part in the provision, management, and safeguarding of water. The pivotal role of women as providers and users of water and guardians of the living environment has seldom been reflected in institutional arrangements for the development and management of water resources. Acceptance and implementation of this principle require positive policies to address women's specific needs and to equip and empower women to participate at all levels in water resources programs, including decision making and implementation in ways defined by them [14,15].
4. Water has an economic value in all competing uses and should be recognized as an economic good. Within this principle, it is vital to recognize first the basic right of all human beings to have access to clean water and sanitation at an affordable price. Past failures to recognize

the economic value of water have led to wasteful and environmentally damaging uses of the resources. Management of water as an economic good is an important way of achieving efficient and equitable use and of encouraging conservation and protection of water resources [10,18]. In essence, it is expedient to assemble the following in integrated water management as a group, agriculturists, environmental engineers, town planners, civil engineers, economists, environmental scientists, and policy makers [2].

### 4.3.2 Benefits of Integrated Water Resources Management

The benefits of IWRM are enormous. These benefits positively impact the different categories of water users including agriculture, water supply and sanitation, industry, environment, fisheries, tourism, energy, and transport. Each country has its priority developmental and economic goals set according to environmental, social, and political realities. Problems and constraints arise in each water use area, but the willingness and ability to address these issues in a coordinated way is affected by the governance structure of water. Recognizing the interrelated nature of different sources of water and also the interrelated nature and impact of the differing water uses is a major step in the understanding of the concept of IWRM [17].

The IWRM recognizes major users of water as follows: (1) environment–ecosystems, (2) water supply and sanitation, and (3) agriculture. Presently, despite the important nature of the environment in sustainable development, its needs are often not represented at the negotiating table. An ecosystem approach to water management focuses on several field-level interventions: protecting upper catchments (e.g., reforestation, good land husbandry, soil erosion control), pollution control (e.g., point source reduction, nonpoint source incentives, groundwater protection), and environmental flows (e.g., through reducing abstractions, special releases from reservoirs, river restoration) [27,28].

Agriculture is the single largest user of water and the major nonpoint source polluter of surface and groundwater resources. By bringing all sectors and stake holders into the decision-making process, IWRM is able to reflect the combined value of water to the society as a whole in difficult decisions on water allocations. This may mean that the contribution of food production to health, poverty reduction, and gender equity, for example, could override strict economic comparisons of rates of return on each cubic meter of water. Equally IWRM can bring into the equation the reuse potential of agricultural return flows for other sectors and the scope of agricultural reuse of municipal and industrial waste waters [19,30,32,41].

Furthermore, IWRM entails integrated planning use of water, land, and other resources in a sustainable manner. Specifically for the agricultural sector, IWRM seeks to increase water productivity (i.e., more crop per drop of water) within the constraints imposed by the economic, social, and ecological context of a particular region or country. A major shift in focus under IWRM is the concept of demand management (i.e., managing water demand rather than simply looking for the ways to increase supply) [20,21,26].

The water supply and sanitation sector stands to benefit from IWRM. Policies under the IWRM are likely to guarantee increased water security of domestic water supplies, reduced cost of treatment of waste water, and reduced conflicts between water users. Furthermore, IWRM will result in efficient usage, improved waste management, and good economic coverage [47].

For example, past sanitation systems often focused on removing waste from the areas of human occupation, thus keeping the human territories clean and healthy but replacing the waste with often detrimental environmental effects elsewhere. Introduction of IWRM will improve the opportunity for establishing sustainable sanitation solution that aim to minimize waste-generating inputs, reduce of waste outputs, and resolve sanitation problems as close as possible to where they occur [16] (Figure 4.2).

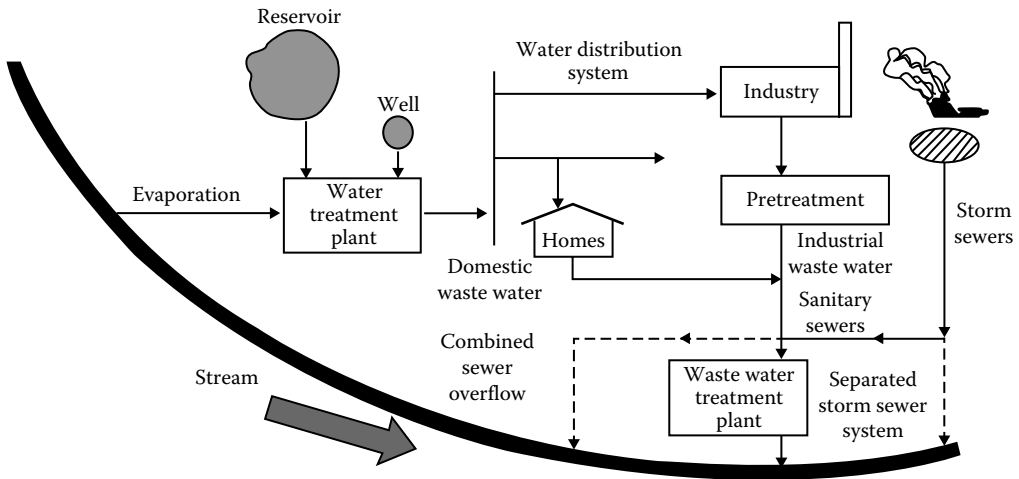


FIGURE 4.2 Schematic diagram of water, waste water, and storm water system.

### 4.3.3 Challenges of Integrated Water Resources Management

Despite the fact that there is so much good will with the concept of IWRM, it is beseeched with formidable barriers from all the three main categories of water usage. Some of these challenges include the following:

1. Lack of awareness among all water users especially in developing countries where the impacts of poor water management are just coming to the fore. Floods, pollution, and depleted rivers are beginning to get a bit of more public attention, but freshwater biodiversity is still outside the spheres of most interest groups.
2. Lack of political will to combat vested interest often, the interests of farmers and other water users prevail over the water needs of the ecosystems.
3. Lack of human and financial resources causes ecosystems not to be taken into account in planning and development.
4. Incompleteness in water management policy and legal and regulatory frameworks. This is particularly the case in developing countries where water policies are often rudimentary, and the regulatory mechanisms for implementing and enforcing them are weak.
5. Demographic pressures: Population growth, particularly in developing countries, linked to poverty and driving inappropriate nonsustainable agricultural practices and associated water utilization.
6. Lack of understanding of IWRM principles and practices: In many instances, only a few people at the helm of water management understand the concept of IWRM. In addition there is usually lack of technical support for its implementation.
7. Inadequate information and data on water consumption. Despite the recognized need for demand management, in many places, the data required for analyzing water use patterns in detail (e.g., temporal and spatial variation in quantities of water diverted and return flows) are lacking. Of all the sectors, agriculture is most often the one for which there is least quantitative information on exactly how much water is being used.
8. Lack of understanding of the interrelationships between biophysical and socioeconomic aspects of the system. Successful IWRM requires the integration of environmental, social, and economic factors, but in any specific situation, the relationships between biophysical and socioeconomic systems are often less well understood than the biophysical alone. Consequently, the social implications of management decisions are often impossible to predict [36].

9. Market failure: Despite the fact that water should be seen as an economic good, in many places, water is provided to the agricultural sector at very subsidized rates. This in part due to the unwillingness of governments of many nations to be self-sufficient in food production. The result is that there is little economic incentive for farmers to change long established agricultural practices.
10. Lack of tools and systems for integration: A lack of models of how to go about integration, unwillingness to change by various participants in water sector, particularly, water and sanitation professionals who are well used to decentralized system of operation. In addition, there is usually difficulty of getting the large, diffuse group represented by the water and sanitation (WATSAN) sector to interact meaningfully with the small, well-organized lobbyists of big agricultural and industrial interests.

## 4.4 Water Supply Engineering

---

An effective water supply engineering system involves determination of suitable source collection of the water from the primary source, conveyance through conduits adequate and canals, storage, treatment, and distribution through the pipe system. The complete design construction and maintenance of water supply system are dependent on good knowledge of civil engineering due to the requirement of hydraulic structures for efficient waterworks. Demand for more water for all uses equally brought upgrading of water supply systems with necessity to construct underground storage tanks elevated or overhead tanks (reservoirs).

The major aim of water supply systems is to supply adequate, safe, and wholesome water to the consumer. Therefore, water supply engineering entails planning, designing, construction, maintenance of waterworks, purification of water, and its distribution (Figure 4.3).

### 4.4.1 Collection of Water

Collection and conveyance of water from the primary source involve construction of intakes, which are structures placed in a surface water source to permit the withdrawal of water and then its discharge into a conduit through which it will flow into the waterworks systems.

Intakes consist of (1) conduit with protective works, (2) screens at open ends, and (3) gates and valves to regulate the flow. The intakes are classified into three types:

- Submerged or exposed intakes
- Wet or dry intakes
- Reservoir, lakes, river, or canal intakes

#### 4.4.1.1 Submerged or Exposed Intakes

These are intakes constructed wholly underwater; they are relatively cheap and do not obstruct the navigation. They cannot be damaged by trees and boats, but they create some measure of obstruction to the flow at the stream. In addition, they are difficult to maintain. On the other hand, exposed intakes are most suitable for collection at large quantities of water due to low potential of clogging of the intake. Operation and inspection is also easier than the submerged intakes.

#### 4.4.1.2 Wet or Dry Intakes

Wet intake tower is the type that is filled with water to the level of the source of supply; it is the most popular for waterworks. The dry intake tower contains no water. In this case, water enters through ports connected to the intake pipes, which convey it from the tower under pressure. The tower interior is accessible for the operation of valves and the inlet velocity is kept small.

#### 4.4.1.3 Reservoir, Lake, River, or Canal Intakes

These are thus classified based on the source of water. During summer, water levels are usually low; hence, storage reservoirs are constructed using a weir or dam across the rivers. The reservoirs may be earthen

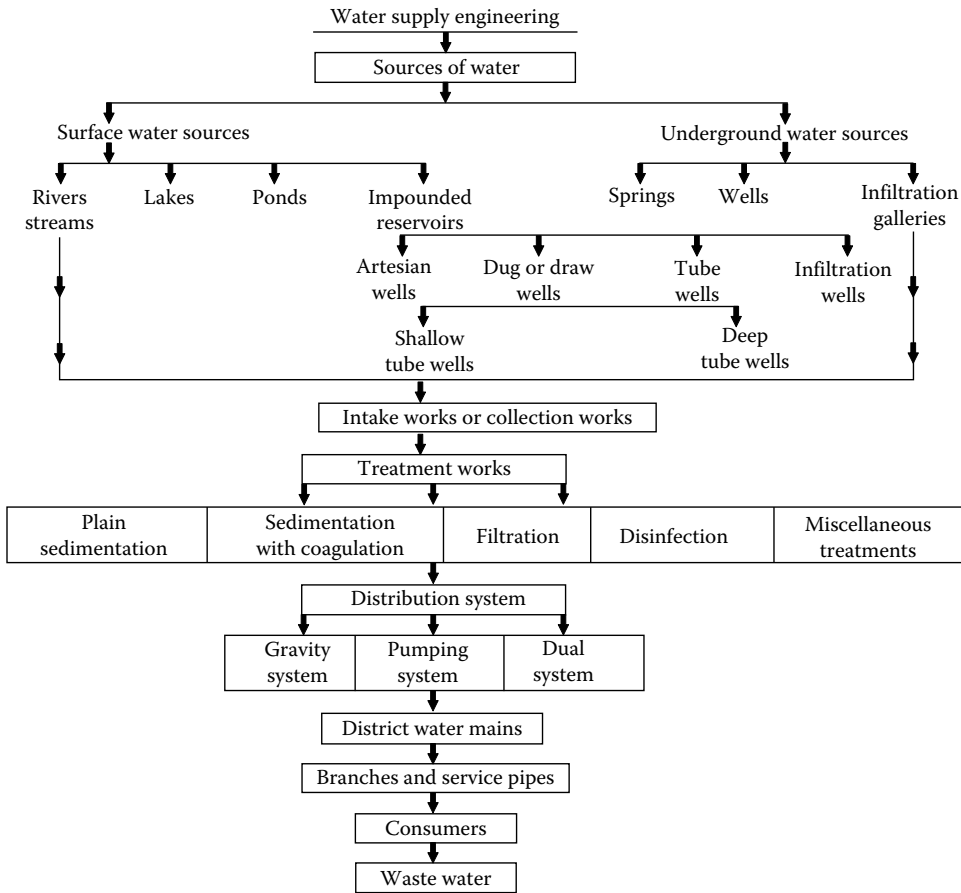


FIGURE 4.3 Flow diagram of a water supply scheme.

dam or concrete dam reservoirs. The intakes in concrete masonry dams consist of a concrete tower inside the body of the dam itself. The intake pipers with screens are provided at different levels to draw clear water near the surface in all seasons. All these inlet pipes are connected to one vertical pipe inside the intake way. Water from the vertical pipe is drawn by mass of a met pipe to the other side of the dam [39].

#### 4.4.2 Conveyance of Water

After water is drawn from intakes, the next step is conveyance to the treatment plant before destruction. The water is therefore conveyed for treatment by conduits. The methods of conveyance are dual:

1. When the source is at higher elevation than the treatment plant, the water will flow under the gravitational force; hence, open channel, aqueduct, or population is utilized.
2. When the source of water supply is underground, water is drawn by means of tube wells and pumped to the overhead reservoirs and thereafter distributed to the city under gravitational force. Water that can then be conveyed to the city using open channels, aqueducts, tunnels, flares, or pipes; Of all these means, use of pipe is most common. Pipes are made of cast iron, wrought iron, steel, cement, cement concrete, and timber. Pipes are laid generally on one side of the street deep below the ground to prevent damage during repairs on the road. Polyvinyl chloride (PVC) pipes

have been found to be particularly durable for waterworks and have been found to be cheap, durable, light in weight, free from corrosion, a good insulator of electricity, and easily pliable and have low hydraulic resistance.

#### 4.4.3 Water Supply Treatment

Treatment of raw water iron source purification to drinking quality depends on whether it is surface or groundwater. Large cities usually depend on surface waters, while small cities depend on groundwater. However, the practice in developing countries is more of convenient source. Due to poor planning and inadequacies in water systems, some large cities resort to groundwater. Surface water tends to have more turbidity and higher microbial contamination; hence, filtration is required. In contrast, groundwater is usually uncontaminated and has relatively little suspended solids hence requires no filtration. However, dissolved gases add ions like calcium and magnesium that gives it the hardness it needs to be removed. Generally the treatment plant in its simplicity involves the following (Figure 4.4):

1. Screening to remove relatively large floating and suspended debris, such as leaves, etc.
2. *Mixing with chemicals*: Which encourages suspended such to coagulate into large particulars and later settles at the bottom.
3. *Flocculation*: This is the process of mixing the water and coagulate allowing the formation of large particles to bind usually with alum ( $\text{Al}_2\text{SO}_4 \cdot 18\text{H}_2\text{O}$ ),  $\text{FeCl}_3$ ,  $\text{Fe}_2\text{SO}_4$ .
4. *Sedimentation*: Process whereby the flow is slowed enough so that gravity will cause the flow to settle.
5. *Filtration*: The process whereby the effluent is cleared. This is usually achieved using sand filled.
6. *Sludge processing*: Process in which the mixture of solids and liquids collected for the settling tank is dewatered and disposed of.
7. *Disinfection*: This is addition of chemicals like chlorine gas sodium hydrochloride ( $\text{NaOCl}$ ) to the liquid effluent (water) to ensure it is free of pathogens [4,9,13,24,29].
8. *Hardness removal*: Softening of water using lime soda, quicklime ( $\text{CaO}$ ), and hydrated lime [ $\text{Ca}(\text{OH})_2$ ] added to the water to raise the pH to 10.3 and converting the soluble bicarbonate ions ( $\text{HCO}_3^-$ ) into insoluble carbonate ions ( $\text{CO}_3^{2-}$ ). The bicarbonate then precipitates out as  $\text{CaCO}_3$ .

#### 4.4.4 Advanced Water Treatment

1. *Deep-Bed monomedium filtration*: It is usually advisable to use this method for direct filtration because they can remove more suspended particles than in this method; anthracite, sand, and gravel media are often used. The coarser media permits solids to penetrate into the beds for greater storage and depth and better efficiency [33].

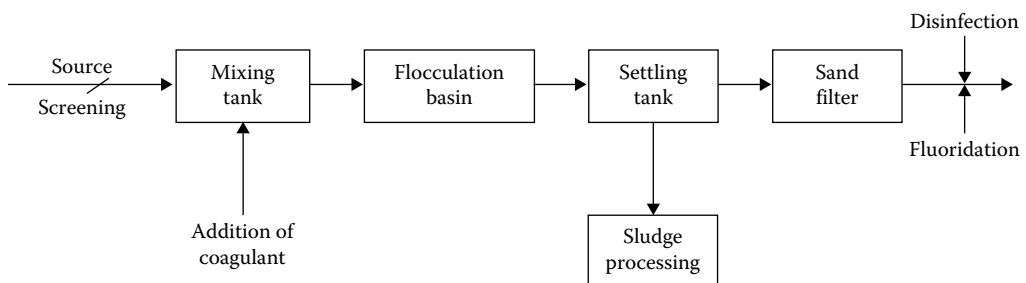


FIGURE 4.4 Schematic diagram of a surface water treatment plant.

2. *Granular aeration carbon*: This absorbs many compounds including toxic ones. Commonly used in municipal regions with organic contamination, taste, or odors. Many household water filters use activated carbon filters for water purification. When coated with silver nanoparticle, it prevents bacterial growth and decomposes toxic halo-organic compounds such as pesticides into nontoxic organic products.
3. *Membrane filtration*: Membrane filters are widely used for filtering both drinking water and sewage. For drinking water, membrane filters can remove all particles larger than 0.2  $\mu\text{m}$  including organisms like *Giardia* and *Cryptosporidium*. They are an effective form of tertiary treatment when it is desired to release water for industry, for limited domestic purposes or before discharging the water into a river that is used by towns further downstream.
4. *Ozonation*: Ozone is a very strong broad-spectrum disinfectant widely used in Europe. The gas is usually created on-site by passing oxygen through ultraviolet light or a cold electrical discharge.
5. *Air stripping desalination*: This is application to seawater whereby salt is removed from water. The process is usually expensive but required in some areas surrounded by seawater.

## 4.5 Sanitary Engineering

---

Sanitary engineering is the branch of public health engineering dealing with the removal and disposal of sewage to maintain healthy living conditions—principles that provide better living conditions are known as principles of sanitation, and these include collection, conveyance and disposal of waste products, availability of water, orientation of building for good aeration and light prevention of dampness, and disposal of sewage. There is a strong relationship between water supply engineering and sanitary engineering. This underpins the organization of this chapter. As a matter of fact, sanitary engineering commences at the end of water supply engineering. While water supply engineering entails collection, treatment, and supply, sanitary engineering involves collection, treatment, and disposal: in addition, the drainage system is equally important in this consideration.

### 4.5.1 Layout of Sanitary Engineering Works

#### 4.5.1.1 Collection Works

The collection works involve the network of sewers laid in the town to collect waste water. The collection works ensure rapid collecting of waste products usually sewage, which is transported to the treatment works. The system of collection works should be self-clearing, hydraulically tight, and economical so that even poor management will find it affordable.

#### 4.5.1.2 Treatment Works

The treatment works involve the treatment plant from sewage before disposal so as to avoid pollution of the air, land, and water and to promote public health.

#### 4.5.1.3 Disposal Works

The disposal works entails disposal of treated waste water whereby the effluent is discharged unto the sea and the dried sludge or solids products that are separated from treated water are taken to the landfill or farms to be used as manures.

#### 4.5.1.4 Drainage Works

The modern designs have separated drainage works from the collection works to prevent pollution of environment, which may arise due to flooding. Therefore, drainage works are designed to carry drainage directly to the river and seas. However, older cities or older areas of growing urban and

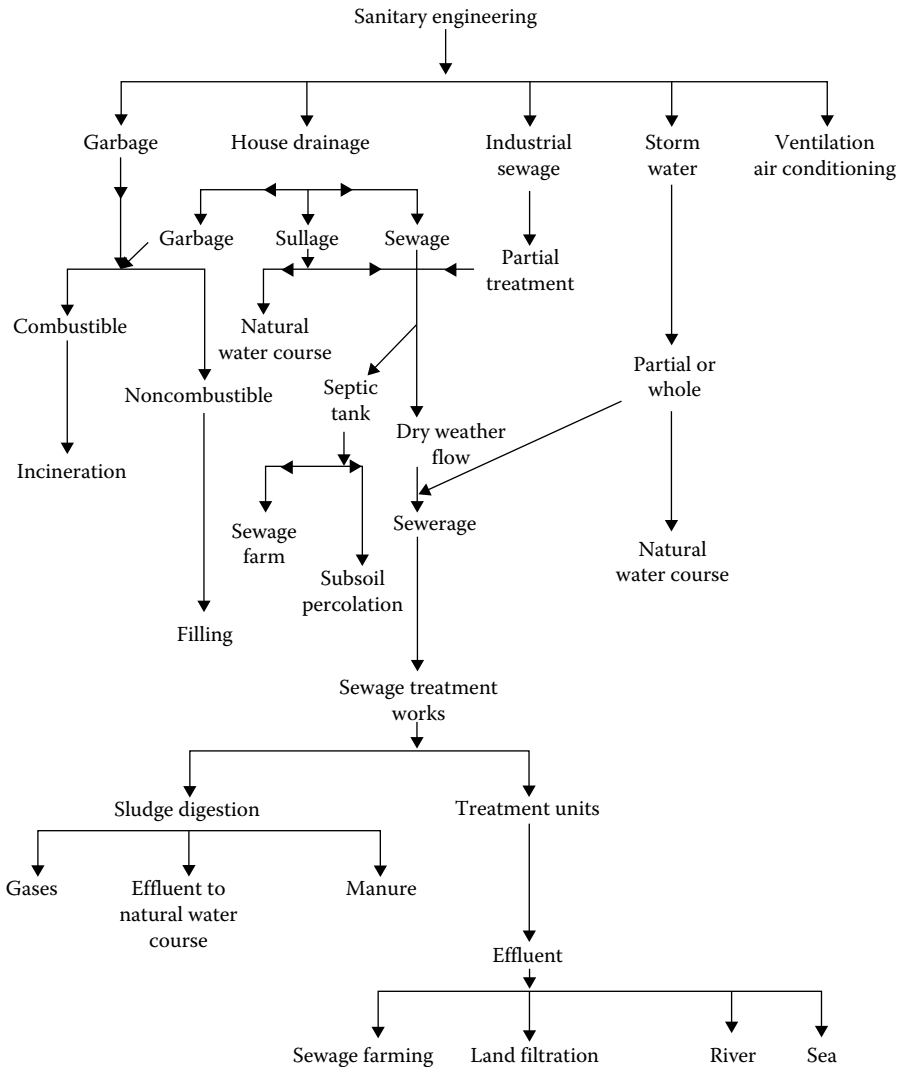


FIGURE 4.5 Flow diagram of a sanitary system.

peri-urban cities still have the old design and are therefore usually included in the plans and management (Figure 4.5).

## 4.6 Waste Water Systems

With reference to the principles of IWRM, it is expedient for government and communities to consider municipal and waste water system in tandem. Municipal water system involves the collection, treatment, and distribution to provide safe drinking water and for industrial use. It is expected that all nations have regulations, laws, and acts governing provision of drinking water, for example, the Safe Drinking Water Act of the United States of America (SDWA), Canada 2002, India, Nigeria, etc. Waste water system on the other hand involves collection and treatment of effluents from sewers before they are released back into the local stream, lake, estuary, or coastal waters. The primary responsibility of the two systems is to destroy pathogens before and after water is used [12].



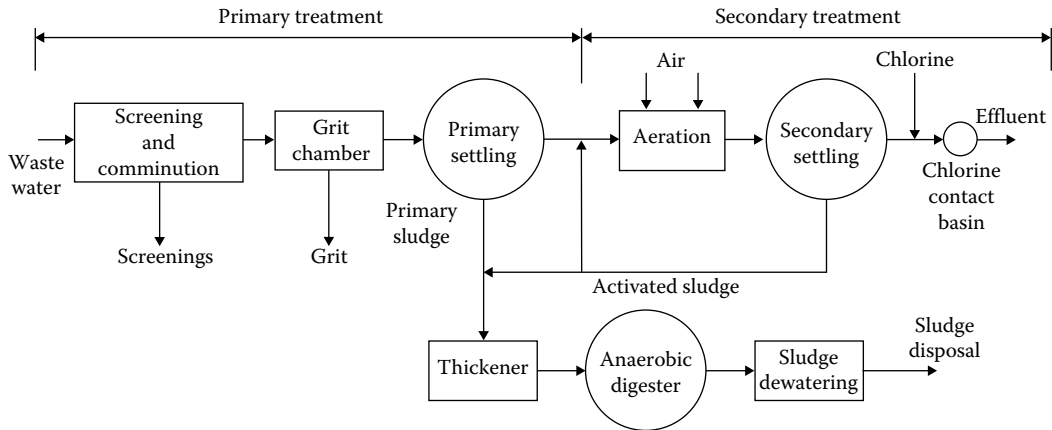


FIGURE 4.6 Schematic diagram of a waste water treatment plant.

## 4.6.1 Waste Water Treatment

The treatment of waste water involves two or three levels. These include primary, secondary, and tertiary treatments. Primary treatment involves simple screening by removing large floating objects such as leaves and sticks that may damage the pumps or clog small pipes. After screening, the waste water passes into a grit chamber for a few minutes (detention time) to allow sand, grit, and other materials to settle out. The waste water from the grit chamber thereafter passes to the primary settling tank where the flow speed is reduced enough to allow most of the suspended solids to settle out by gravity. The settled solids from this process called primary sludge are removed and chlorinated for disinfection and further processed to the thickener, to anaerobic digester, and later to sludge dewatering chamber for removal of water, and finally, the decontaminated sludge is disposed off.

The secondary treatment, also referred to as biological treatment, further removes more suspended solids beyond what is achievable by sedimentation. This is accomplished by three main methods utilizing the ability of microorganism to convert organic waste into stabilized low-energy compounds. These methods are (1) trickling filters, (2) activated sludge, and (3) oxidation ponds (Figure 4.6).

### 4.6.1.1 Trickling Filters

Trickling filters consist of a structure containing a rotating distribution arm that sprays liquid waste water over a circular bed of very small-size rocks or other materials. The spaces between the rocks allow air to circulate easily so that aerobic conditions can be maintained.

Individual rocks in the bed are covered by a layer of biological slimes that absorb and consume the waste trickling through the bed. The slime consists of mainly bacteria, fungi, algae, protozoa, worms, and larvae of insect. The accumulating slime periodically slides off the rocks and is collected at the bottom of the filter along with the treated waste water and passed on to the secondary settling tank where it is removed.

### 4.6.1.2 Activated Sludge

The aeration tank, that is the key biological unit in the activated sludge process receives effluent from the primary classifier and recycled biological organism from the secondary settling tank. Air or oxygen is pumped into the tank and the mixture thoroughly agitated to maintain aerobic conditions. After about 6–8 h of agitation, the waste water flows into the secondary settling tank, where the solids, mostly bacteria masses, are separated from the liquid by a portion of those solids that is relayed to the aeration tank to maintain proper bacterial population while the remainder are processed and disposed off.

The resultant mixture of solids and water after the liquid effluent has been released into a nearby body of water that is called sludge. The sludge is passed into two stages of anaerobic digester. The digested sludge is dewatered by pumping into large sludge drying beds. The digester and dewatered sludge can be used as a fertilizer or conveyed to a landfill.

#### 4.6.1.3 Oxidation Ponds

These are large, shallow ponds usually 2 m deep where raw or partially treated sewage is decomposed by microorganism. They are cheap to construct and maintain. Although they can be used to treat raw sewage, they are usually used as an addition to secondary treatment in which case they are called polishing ponds. Oxidation ponds are usually referred to as facultative ponds because the combined mechanism of aerobic digestion at the surface and anaerobic digestion at the near bottom of the pond [7,12,22,40].

## 4.7 Summary and Conclusions

---

Environmental engineering of the twenty-first century is quite broad with applications in water supply, sanitation, air pollution, and even transportation. While the principles of abstracting water from various sources remain the same, there is a considerable progress on how best to utilize available water. Some of the underpinnings of sustainable development include good environmental management and application of appropriate and sustainable technology in water supply and sanitation systems [37]. The principle of IWRM therefore holds the key to the successful and effective design and operation of sustainable water and sanitation systems. IWRM entails coordination of a cycle of water utilization from sources to usage, waste water treatment to storage and reuse. Such a management process requires adequate data on available volume of water, target population, rate of growth, types of uses in various degrees, funds, and ecological considerations. Furthermore, the climatic condition determines the types of technology to be deployed. It is therefore fashionable to involve various stake holders in planning water management. These include civil engineers, environmental engineers, sanitarians, town planners, architects, lawyers, agriculturists, industrialists, fishing companies, nongovernmental organizations, policy makers, economists, politicians, and the public.

## Acknowledgment

---

I wish to acknowledge the efforts of Bunmi Byron of Bunmi Byron and Associates, architects, for creating the artwork used in this chapter.

## References

1. Beck, U. 1992. *Risk Society: Towards a New Modernity*. Vol. 306. London, U.K.: Sage.
2. Boubecar, B., Crosby, C., and Touchains, E. 2002. *Intensifying Rainfed Agriculture: South African Country Profile*. Colombo, Sri Lanka: IWMI.
3. CapNet, Tutorial on basic principles of integrated water resources management, [www.cap.net.org](http://www.cap.net.org) (accessed May 15, 2012).
4. Chen, Y. and Regli, W.C. 2002. Disinfection practices and pathogen inactivation in ICR surface water plants. In *Information Collection Rule Data Analysis*. (eds.) McGuire, M.J., McLain, J.L., and Obolensky, A., pp. 376–378. Denver, CO: AWWA.
5. Cipolla, C.M. 1980. *Before the Industrial Revolution: European Society and Economy*. London, U.K.: W.W. Norton.
6. Conroy, R.M., Meegan, M.E., Joyce, T., McGuigan, K., and Barnes, J. 1999. Solar disinfection of water reduces diarrhoeal disease, an update. *Archives of Disease in Childhood* 81(4): 337–338.

7. Crittenden, J.C., Trussell, R.R., Hand, D.W., and Howe, K.J. 2005. *Water Treatment: Principles and Design*. 2nd ed., New York: Wiley.
8. Dawney, B. and Pearce, J.M. 2012. Optimizing solar water disinfection (SODIS) method by decreasing turbidity with NaCl. *The Journal of Water, Sanitation, and Hygiene for Development*, 2(2): 87–94.
9. Edzwald, J.K. 2011. *Water Quality and Treatment*. 6th ed., New York: McGraw-Hill.
10. European Commission. 1998. Towards sustainable water resources management—A strategic approach. Guidelines for water resources cooperation. 351, Brussels, Belgium: European Commission.
11. FAO. 1995. Irrigation in Africa in figures. Water reports #7, Rome, Italy: FAO.
12. FAO. 1997. Food production: The critical role of water. Technical document #7. Rome, Italy: FAO.
13. Gleick, P.H. 1993. *Water in Crisis: A Guide to the World's Freshwater Resources*. Oxford, U.K.: Oxford University Press.
14. Global Water Partnership. 2002. Toolbox, integrated water resources management. <http://www.gwp.ihe.nl> (accessed June 12, 2012).
15. Global Water Partnership. 2000. Integrated water resources management. TACs Background Papers, No. 4, 67pp. [www.gwpforum.org/gwp/library/Tacno4.pdf](http://www.gwpforum.org/gwp/library/Tacno4.pdf) (accessed June 10, 2012).
16. Groot, R.S. 1992. *Functions of Nature: Evaluation of Nature in Environmental Planning, Management and Decision-Making*, Groningen, the Netherlands: Wolters Noordhoff B.V.
17. Gumbo, B. and van der Zaag, P. 2001. Principles of integrated water resources management. Global water partnership Southern Africa, Southern Africa Youth Forum, September 24–25, 2001, Harare, Zimbabwe.
18. ICID. 2000. Strategy to implement ICID's concerns emanating from the vision for water, food and rural development. ICID, Cape Town. [www.icid.org/index\\_e.html](http://www.icid.org/index_e.html) (accessed April 20, 2012).
19. ICOLD. 1997. Dams and the environment. ICOLD position paper. <http://genepi.louis-jean.com/cigb/chartean.html> (accessed May 12, 2012).
20. IPCC. 2000. *Intergovernmental Panel on Climate Change. Land Use, Land-Use Change and Forestry*. Cambridge, U.K.: Cambridge University Press.
21. IUCN. 2000. Vision for water and nature. A world strategy for conservation and sustainable management of water resources in the 21st century. Gland, Switzerland, p. 52 [www.iucn.org/webfiles/doc/WWRP/Publicatinos/Vision/VisionWaterNature.pdf](http://www.iucn.org/webfiles/doc/WWRP/Publicatinos/Vision/VisionWaterNature.pdf). (accessed May 11, 2012).
22. Kawamura, S. 2000. *Integrated Design and Operation of Water Treatment Facilities*, 2nd edn. pp. 74–75, Vol. 104, New York: Wiley & Sons.
23. Masters, G.M., 1998. *Introduction to Environmental Engineering and Science*, 2nd ed. New Delhi, India: Prentice-Hall.
24. Neemann, J., Hulsey, R., Rexing, D., and Wert, E. 2004. Controlling bromate formation during ozonation with chlorine and ammonia. *Journal American Water Works Association* 96(2): 26–29.
25. Park, K. 2005. *Park's Preventive and Social Medicine*, 18th ed. pp. 519–573, Jabalpur, India: Banarsidas Bhanot.
26. Perreira, L.S., Cordery, I., and Lacovides, I. 2002. Coping with water scarcity. IHP-VI technical documents in hydrology, No. 58., Paris, France: UNESCO.
27. Postel, S.L., Daily, G.C., and Ehrlich, P.R. 1996. Human appropriation of renewable fresh water. *Science*, 271:785–788.
28. Rees, J.A. 2002. Risk and integrated water management. TAC background papers, Global water partnership, Stockholm, Sweden.
29. Reeves, T.G. 1986. *Water Fluoridation: A Manual for Engineers and Technicians*. Atlanta, GA: CDC.
30. Resiner, M. 2001. *Cadillac Desert: The American West and Its Disappearing Water*, London, U.K.: Punlico.
31. Rose, A., Roy, S., Abraham, V., Holmgren, G., George, K. et al. 2006. Solar disinfection of water for diarrhoeal prevention in southern India. *Archives of Disease in Childhood*, 91(2): 139–141.

32. Rosegrant, M. and Ringler, C. 1997. World food markets into the 21st century: Environmental and resource constraints and policies. *The Australian Journal of Agriculture and Resource Economics*, 41(3): 401–428.
33. Savage, N., Mamadou, S., and Diallo, M.S. 2005. Nanomaterials and water purification: Opportunities and challenges. *Journal of Nanoparticle Research*, 7(4–5): 331–342.
34. Savenije, H. 2002. Management arrangements; IHE Lecture Notes–Water Law and Institutions, Delft, the Netherlands: UNESCO-IHE.
35. Sharma, J.L. 1986. *Public Health Engineering*. 1st ed. pp. 8–194, New Delhi, India: Satia Prakashan.
36. Szollosi-Nagy, A., Najlis, P., and Bjorklund, G. 1998. Assessing the world's freshwater resources. *Nature and Resources*, 34: 8–18.
37. UN-ESA. 1992. Chapter 18–Agenda 21. <http://www.un.org/esa/sustdev/agenda21chapter18.htm> (accessed May 11, 2012).
38. United Nations. 2003. World water development report UNESCO. [www.unesco.org/water/wwap](http://www.unesco.org/water/wwap) (accessed May 11, 2012).
39. United States Environmental Protection Agency (EPA). 1990. Technologies for upgrading existing or designing new drinking water treatment facilities. Document No. EPA/625/4-89/023, Cincinnati, OH: EPA.
40. US EPA. Emergency disinfection recommendations. [www.epa.gov](http://www.epa.gov) (accessed June 3, 2012).
41. Waterhouse, J. 1982. *Water Engineering for Agriculture*. London, U.K.: Batsford.
42. WCD. 2000. *Dams and Development—A New Framework for Decision-Making*. Vol. 404, London, U.K.: Earthscan.
43. WHO. 2007. *Part 1: Combating Waterborne Disease at the Household Level*. Geneva, Switzerland: WHO.
44. WHO/UNICEF. 2005. *Water for Life: Making It Happen*. Geneva, Switzerland: WHO/UNICEF.
45. Wolff, P. and Stein, T.M. 1998. Water efficiency and conservation in agriculture opportunities and limitations. *Agriculture and Rural Development*, 17–20. [www.ewra.net/ew/pdf/Env\\_2004\\_5\\_6\\_05.pdf](http://www.ewra.net/ew/pdf/Env_2004_5_6_05.pdf) (accessed May 12, 2013).
46. Wood, S., Sebastian, K., and Scherr, S.J. 2000. *Pilot Analysis of Global Ecosystems: Agroecosystems*. Washington, DC: World Resources Institute.
47. World Bank Institute. 2003. *Integrated Water Resources Management: An Introduction*. Washington, DC: World Bank Institute.
48. World Bank. 1993. Water resources management—A world bank policy paper 140. Washington, DC: The World Bank.
49. Zagorodni, A.A. 2007. *Ion Exchange Materials: Properties and Applications*. Amsterdam, the Netherlands: Elsevier.



# 5

## Environmental Flows

---

Sara Shaeri Karimi  
*Dezab Consulting  
Engineers Company*

Mehdi Yasi  
*Urmia University*

Jonathan Peter Cox  
*Caribbean Institute  
for Meteorology and  
Hydrology*

Saeid Eslamian  
*Isfahan University  
of Technology*

5.1	Introduction .....	86
5.2	Environmental Flow Assessment Methods .....	87
	Hydrological Methods • Hydraulic Rating Methods • Habitat Simulation Methods • Holistic Methods	
5.3	Case Study: Typical Rivers in Urmia Lake Basin, Iran .....	88
	Data and Methodology • Results and Discussions	
5.4	Summary and Conclusions .....	100
	References.....	102

### AUTHORS

**Sara Shaeri Karimi** graduated in water engineering from Shahid Chamran University of Ahvaz, Iran. She gained her master's degree in hydraulic structures from Urmia University, Urmia, Iran. Currently she is working as a hydraulic engineer for the Irrigation and Drainage Division at Dezab Consulting Engineers Company, Ahvaz, Iran. Sara has collaborated in numerous national and international publications and has keen research interests in environmental flow, sustainable water resources management, and climatic change. In the future, she plans to compliment her professional career as an engineer with a doctorate in water resources.

**Mehdi Yasi** studied for his graduate degree in irrigation engineering at the University of Shiraz, Iran. He went on to specialize in river hydraulics and engineering, with a specific interest in the river groynes. He gained his PhD in this area from the Department of Civil Engineering, Monash University, Australia, in 1997. He was working on the modeling of the Danube River during his sabbatical at CEMAGREF, Lyon, France (2010–2011). He is a widely experienced engineer in river researches and has made significant contributions to engineering, especially on the development of Stream Restoration and Sediment Transport Manuals. He is currently an Associate Professor at the Department of Water Engineering, Urmia University, Iran.

**Jonathan Peter Cox** gained his PhD from the Department of Civil Engineering and Construction, University of Salford, Manchester, United Kingdom. He later took on a postdoctorate research position under the Mediterranean Desertification and Land Use (MEDALUS) Program of the European Community at the University of Murcia, Spain. In 1995, he was appointed as hydrologist for the Automatic Hydrological information System (SAIH) at the Confederación Hidrografica del Segura, Murcia, a post that he occupied for 15 years before transferring to the Comisaria of Aguas, Murcia, as the head of hydrometry and statistics. In parallel, Jonathan has developed a university lecturing career and, since 2001, is a member of the Department of Civil Engineering at the Catholic University of Murcia, Spain. In 2011, he initiated collaboration with the German hydrometry masters OTT, as a consultant for their Iberian office. Jonathan has recently taken up a position as senior lecturer in hydrology at the Caribbean Institute for Meteorology and Hydrology.

**Saeid Eslamian** received his PhD from the University of New South Wales, Australia, with Prof. David Pilgrim. He was a visiting professor in Princeton University, Princeton, New Jersey, and ETH Zurich, Switzerland. He is currently an associate professor of hydrology in Isfahan University of Technology. He is the founder and chief editor of *Journal of Flood Engineering* and *International Journal of Hydrology Science and Technology*. He has published more than 200 publications mainly in statistical and environmental hydrology and hydrometeorology.

## PREFACE

Humankind relies on rivers for an array of functions including biodiversity and conservation, irrigation, and domestic or industrial water supply. Water resources managers are required to maintain the highest possible quality in our rivers and streams to adequately comply with these functions. With the rising use of market forces as the basis of resource allocation, it is more complex but crucial to preserve the ecological requirements of river systems.

This task has become more difficult in recent years as ever-increasing demands for the allocation of water resources for off-stream uses has resulted in substantial changes in streamflow regimes in countless water courses around the globe, especially in arid and semiarid regions due to an inherent resource scarcity. These changes in streamflow regimes have contributed to compound environmental impacts on aquatic habitats and ecological systems.

Environmental flows (EFs) are defined as the discharge of water in streams and rivers, necessary to maintain equilibrium in aquatic ecosystems.

This chapter provides a practical guide as the first order of the estimation of EFs, where scarce or no information is available from the ecological perspective. The proposed potential EF values are suitable thresholds for EF requirements (EFRs) in rivers.

## 5.1 Introduction

Water resources management is a critical issue to development, because of its numerous links to poverty reduction, through health, agricultural productivity, and industrial and energy growth. Nevertheless, strategies to reduce poverty should not lead to the unsustainable degradation of water resources or ecological services [3].

The flows of the world's rivers are increasingly being modified through impoundments such as dams and weirs, abstractions for agriculture and urban water supply, drainage return flows, maintenance of flows for navigation, and structures for flood control [5].

Aquatic ecosystems provide a range of goods and services for humans, including fisheries, flood protection, wildlife, etc. To maintain these services, water needs to be allocated to ecosystems, as it is allocated to other users like agriculture, power generation, domestic use, and industry [28]. Increased understanding of the ecological importance of environmental variation has led to a concern that many regulated rivers lack the natural variations in flow required to maintain prerogulation communities. Furthermore, it is felt that existing streamflow management practice frequently overlooks the importance of natural streamflow variability in maintaining aquatic ecosystems [18]. Water that is allocated for maintaining aquatic habitats and ecological processes in a desirable state is referred to as instream flow requirement, EFs, EFR, or environmental water demand [3,5,30]. An environmental flow assessment (EFA) for a river may be defined simply as an assessment of how much of the original flow regime should continue to flow through the course and onto its floodplains in order to maintain specified valued features of the ecosystem [16,35].

More than 200 EFA methods for evaluating EF have been developed and range from relatively simple, low-confidence approaches to resource-intensive, high-confidence approaches [36].

Considering the differences among ecosystem structures, many EFR studies have been conducted for rivers, wetlands, estuaries, forests, and grassland ecosystems. Sun et al. developed a method for quantifying the EFs in estuaries, while integrating multiple ecological objectives. They proposed minimum, medium, and high EF levels and presented suggestions for water resources management of the Yellow River Estuary, Shandong province, China [33]. Yang et al. analyzed the EFRs for integrated water resources allocation in the Yellow River Basin. Based on the classification and regionalization of river system, various ecological needs and objectives were considered in the integrated analysis of EFRs considering both consumptive and nonconsumptive requirements [37]. Poff et al. described a new framework termed “the ecological limits of hydrologic alteration (ELOHA),” which is a synthesis of a number of existing hydrologic techniques and EFA methods that are currently being used to various degrees and that can support comprehensive regional flow management. They suggested that rivers of similar hydrological character respond to a particular type of flow regime change in a similar fashion [19].

The main goal of this chapter is to conduct a desktop assessment of EFs in the characteristic rivers in Iran and examine the current EF assessment methods in different regions subjected to a semiarid climate. The potential EF values in the river reach were evaluated using five hydrological methods. These methods include the FDC shifting, desktop reserve model (DRM), range of variability approach (RVA), Tennant and Tessman.

## 5.2 Environmental Flow Assessment Methods

---

As mentioned previously, there are several methods for the assessment of EFs. These methods are grouped into four categories: hydrological, hydraulic rating, habitat simulation, and holistic [36].

### 5.2.1 Hydrological Methods

There are at least a dozen frequently referenced, hydrology-based methods founded on available hydrological data, thereby inherently being region specific or context specific. One of the most frequently used EFRs is the Tennant method linking average annual flow to different categories of instream habitat condition.

Another method, denominated the flow duration curve analysis, makes use of historical discharge data to elaborate curves correlating the range of discharges and the percentage of time that each condition is equaled or exceeded. The design low-flow range of an FDC ranges between 70% and 99% [27]. The Q90% and Q95% are frequently used as indicators of low flow and have been widely used to set minimum EFs [21].

Two other significant hydrological EFRs are the RVA, developed for situations when the conservation of native biota and ecosystem integrity are the prime objectives in sustaining riverine ecosystems, and the 7Q10 method (7-day low-flow event over a 10-year period), frequently applied in eastern and south-eastern United States when water quality issues dominate. This flow rate clearly is far less than the minimum values calculated by alternate predictive methods. It appears to be compatible with perennial rivers with considerable base flows in humid areas, but does not seem to be well adapted to rivers characterized by significant flow variability in cold semiarid regions [26].

### 5.2.2 Hydraulic Rating Methods

Hydraulic rating methods are developed and specifically applicable for assessing aquatic habitats for riverine fish. They can be described as single river channel cross-section methods that use changes in various single hydraulic variables, such as wetted perimeter or maximum depth, as a substitute for habitat factors limiting biota, to build up a relationship between habitat and discharge for EF recommendations. Hydraulic rating methods represent the precursors of more sophisticated habitat



simulation methods that bring into play hydraulic data in addition to associated microhabitat and biological information.

### 5.2.3 Habitat Simulation Methods

Habitat simulation methods evolved out of the previous types of EFRs to create a superior perceptive of habitat requirements. These methods assess the instream habitat in terms of hydraulic variables, combined with information on the aptness of microhabitat conditions for particular species, life stages, or assemblages to predict the most beneficial discharges.

When this is terminated for a range of discharges, it is possible to perceive how an area of suitable habitat changes with flow. Habitat methods are widely considered to be more reliable and justifiable than assessments made by other methods. One of the most famous habitat methodologies is the instream flow incremental methodology developed by the Instream Flow Group of the U.S. Fish and Wildlife Service [36].

### 5.2.4 Holistic Methods

Holistic methods are all founded on the opinion that the complete riverine ecosystem is affected by the full-flow regime; therefore, an adequate depiction of these flows in terms of magnitude, duration, timing, and frequency and their incorporation in the regulated flow regime should permit the biotic characteristics and functional integrity of the river to continue. Comprehensive hydraulic and hydrological data are essential, for holistic methods, together with the data on biotic features and details on the needs of the local people, who depend on the river for their livelihood.

A handful of methods have become renowned, among which the South African building block methodology [15] and the Australian holistic approach [2] are considered the most important. Both methods rely on a bottom-up approach to construct a modified flow regime supported on month-by-month data and an element-by-element basis, where each element represents a well-defined feature of the flow regime. These methods are intended to achieve specific, well-motivated geomorphological, ecological, water quality, or social objectives within the modified riverine ecosystem.

## 5.3 Case Study: Typical Rivers in Urmia Lake Basin, Iran

---

The hypersaline Urmia Lake is the most important intracontinental environment in Iran, with distinctive geological, environmental, and biological characteristics [1]. The lake is situated between the Iranian provinces of East Azerbaijan and West Azerbaijan, west of the southern section of the similarly shaped Caspian Sea (Figure 5.1).

It is the largest lake in the Middle East and the third largest saltwater lake on the earth. The lake was declared a Wetland of International Importance by the Ramsar Convention in 1971 and designated a UNESCO Biosphere Reserve in 1976. The lake's environmental values depend largely on the inflow of the rivers in the basin. Nevertheless, lake water level has rapidly declined since the mid-1990s after having remained relatively stable over the 30 prior years. Construction of some 50 dams and diversion structures of surface water for agricultural use, along with reduced precipitation and warmer temperatures over the basin, coupled to a lesser extent with reduced inflow of groundwater is generally accepted as the cause [6,10,11].

The lake lies at around 1270 m above sea level, is up to 149 km long, and up to 60 km wide. This thalassohaline lake has a surface area of 6100 km<sup>2</sup>, a volume estimated at 29.4 km<sup>3</sup>, with a mean and maximum depth of 6 and 16 m respectively. Its drainage basin approaches 52,000 km<sup>2</sup> being the endorheic basin for a number of important streams and rivers. The watershed of the lake is an important agricultural region with a population of around 6.4 million people; an estimated 76 million people live within

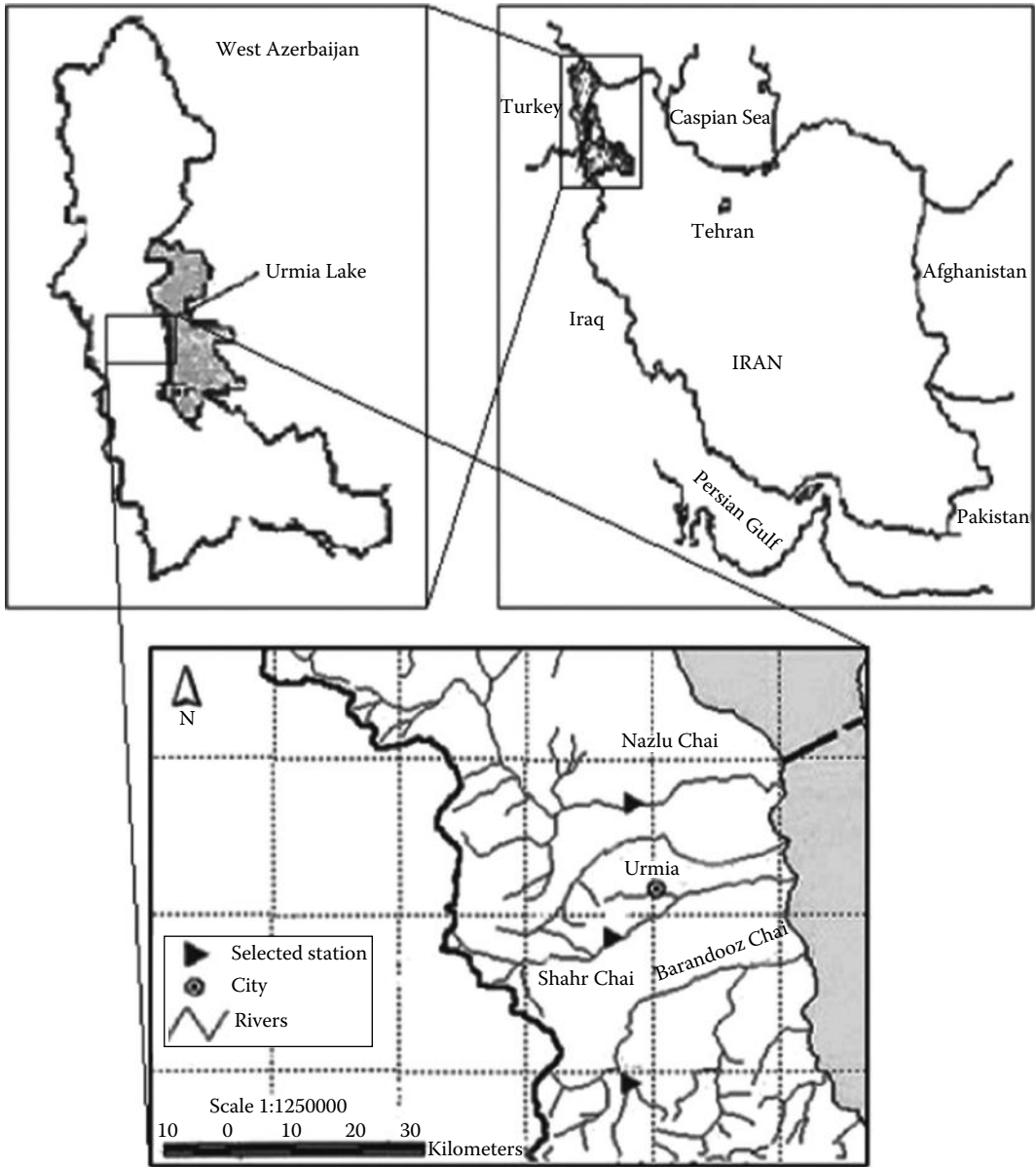


FIGURE 5.1 General map for study area.

a radius of 500 km [25]. The average annual rainfall within the basin from 1967 to 2006 was 235 mm, with a variation between 440 mm in 1968 to less than 150 mm in 2000. Annual inflow is optimistically estimated at  $6900 \times 10^6 \text{ m}^3$  by Ghaheri et al. [7]. Prominent perennial streams include the Zarrineh River (230 km long) entering from the south and draining part of the northern Zagros Mountains with a range in discharge of  $10\text{--}500 \text{ m}^3/\text{s}$ , with the Tata'u or Simineh River (145 km) as a major tributary. The saline Aji Chai River from the east drains the flanks of Sabalan Mountains at 4810 m ( $38^\circ 15' \text{N}$ ,  $47^\circ 49' \text{E}$ ) and Sahand Mountain at 3710 m ( $37^\circ 44' \text{N}$ ,  $46^\circ 27' \text{E}$ ). From the west, the smaller rivers denominated Nazlu Chai (85 km), Shahr Chai (70 km), and Barandooz Chai (70 km) [9] are the focus of this chapter.

Barandooz Chai, Nazlu Chai, and Shahr Chai rivers are among major perennial rivers from the Urmia Lake Basin. The construction of Shahr Chai Dam (commissioned 2005), Nazlu Dam (under construction), and Barandooz Dam (under construction), respectively, on the Shahr Chai, Nazlu Chai, and Barandooz Chai rivers in West Azerbaijan province, Iran, were the preliminary reason for these selections.

There are eight river gaging stations along these watercourses. Of these stations, Band (Shahr Chai River), Tepik (Nazlu Chai River), and Dizaj (Barandooz Chai River) gaging stations were selected to represent the potential inflows to the main stream of these rivers. Figure 5.1 shows the selected three gaging stations along the rivers, and they may be considered representative of the possible hydrological variability that could exist within the study area.

### 5.3.1 Data and Methodology

Hydrological EFA methods rely on the use of hydrological data, usually in the form of naturalized, historical monthly or daily flow records, for making EF recommendations. Gordon et al., Stewardson and Gippel and Smakhtin review many of the well-established hydrological and regionalization techniques used to derive the latter flow indices for gaged and ungaged catchments [8,27,32]. In this study, due to the lack of ecological information, five different hydrological methods were used to evaluate EF in the rivers under study.

Because the natural hydrological regime is to be related to the ecological rehabilitation of a river system, natural mean daily and monthly flow data were considered to eliminate the effect of reservoir operation on the natural flow regime of these three rivers downstream (Table 5.1).

The basis of the hypothesis of this study is that a hydrological regime can be related to the ecological condition of a river system [12,24,28,31,34]. The main features of these methods are described in Sections 5.3.1.1 through 5.3.1.5.

#### 5.3.1.1 FDC Shifting Method

The FDC shifting method is a relatively new hydrological method developed by Smakhtin and Anputhas. This method includes four subsequent steps to evaluate EF, as follows [28]:

*Step 1: Simulating reference hydrological conditions.* The first step is the calculation of a representative FDC for a desired river reach using a monthly time series. All FDCs in this method are represented by a table of flows corresponding to 17 fixed percentage points: 0.01%, 0.1%, 1%, 5%, 10%, 20%, 30%, 40%, 50%, 60%, 70%, 80%, 90%, 95%, 99%, 99.9%, and 99.99%. These points (1) ensure that the entire flow range is adequately covered and (2) are easy to use in the context of Steps 2–4.

*Step 2: Defining environmental management classes (EMCs).* Six EMCs are used in this method and are presented in Table 5.2. The EMCs (Table 5.2) are similar to those described in DWAF [4]. The higher EMCs require a higher allocation of water for ecosystem maintenance or conservation and a higher preservation of flow variability.

*Step 3: Establishing environmental FDCs from reference condition.* Environmental FDCs are determined by the lateral shift of the original reference FDC, that is, to the left along the probability axis. The 17 percentage points on the probability axis (Step 1) are used as steps in this shifting procedure. The procedure is graphed in Figure 5.2. A linear extrapolation is used to define the revised low flows at the lower tail of a shifted curve (see [28] for a detailed description).

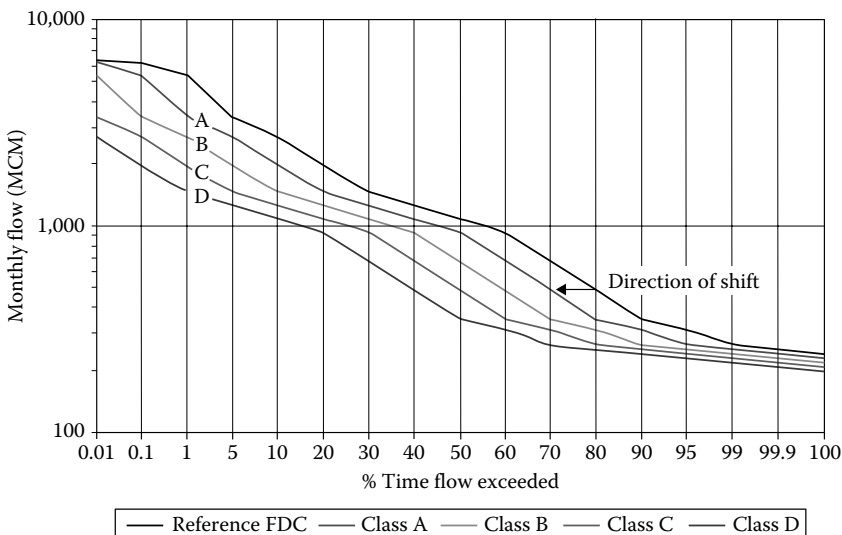
**TABLE 5.1** Details of Selected Observed Monthly Flow Data Sets

River	Station	Long. (°)	Lat. (°)	Elev. (m)	Area (km <sup>2</sup> )	Period
Barandooz Chai	Dizaj	45–03	37–23	1320	637	1956–2007
Nazlu Chai	Tepik	44–54	37–40	1450	1714	1985–2007
Shahr Chai	Band	45–01	37–30	1490	408	1949–2008

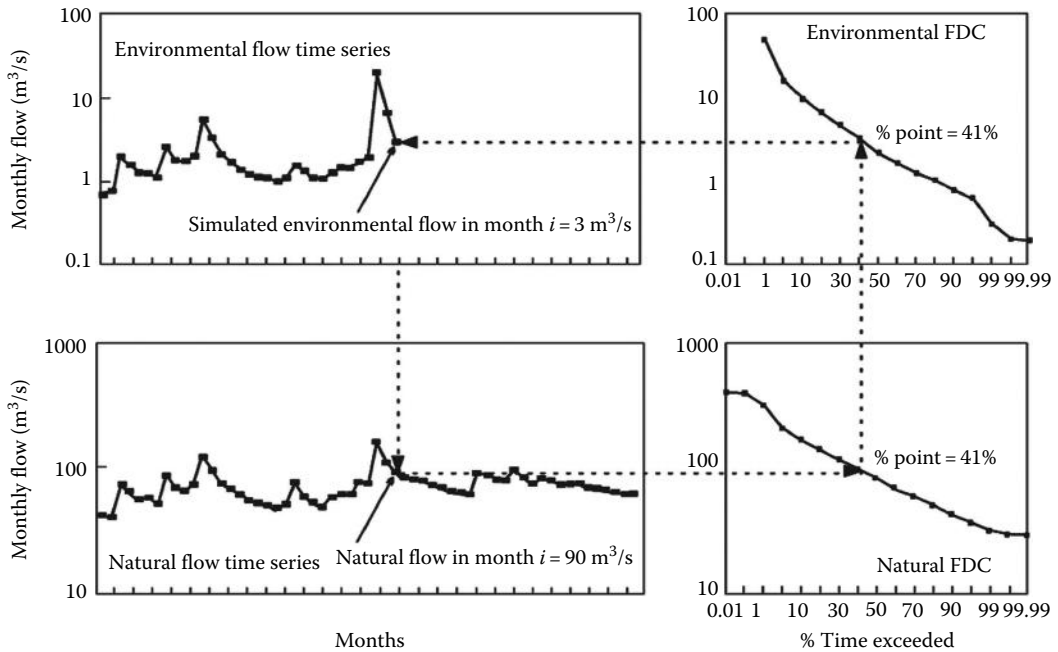
**TABLE 5.2** Environmental Management Classes (EMCs) Used in the FDC Shifting Method

EMC	Most Likely Ecological Condition	Management Perspective
A (natural)	Natural rivers with minor modification of instream and riparian habitat	Protected rivers and basins; reserves and national parks; no new water projects (dams, diversions) allowed
B (slightly modified)	Slightly modified and/or ecologically important rivers with largely intact biodiversity and habitats despite water resources development and/or basin modifications	Water supply schemes or irrigation development present and/or allowed
C (moderately modified)	Habitats and biota dynamics have been disturbed, but basic ecosystem functions are still intact; some sensitive species are lost and/or reduced in extent; alien species present	Multiple disturbances (e.g., dams, diversions, habitat modification, and reduced water quality) associated with the need for socioeconomic development
D (largely modified)	Large changes in natural habitat, biota, and basic ecosystem functions have occurred; species richness is clearly lower than expected; much lowered presence of intolerant species; alien species prevail	Significant and clearly visible disturbances (including dams, diversions, transfers, habitat modification, and water quality degradation) associated with basin and water resources development
E (seriously modified)	Habitat diversity and availability have declined; species richness is strikingly lower than expected; only tolerant species remain; indigenous species can no longer breed; alien species have invaded the ecosystem	High human population density and extensive water resources exploitation; generally, this status should not be acceptable as a management goal; management interventions are necessary to restore flow pattern and to “move” a river to a higher management category
F (critically modified)	Modifications have reached a critical level; ecosystem has been completely modified with almost total loss of natural habitat and biota; in the worst case, basic ecosystem functions have been destroyed and changes are irreversible	This status is not acceptable from the management perspective; management interventions are necessary to restore flow pattern and river habitats (if still possible/feasible) to “move” a river to a higher management category

Source: Smakhtin, V.U. and Anputhas, M., *An Assessment of Environmental Flow Requirements of Indian River Basins*, IWMI Research Report 107, International Water Management Institute, Colombo, Sri Lanka, 36pp, 2006.



**FIGURE 5.2** Estimation of environmental FDCs for different EMCs by lateral shift. (Adapted from Smakhtin, V.U. and Anputhas, M., *An Assessment of Environmental Flow Requirements of Indian River Basins*, IWMI Research Report 107, International Water Management Institute, Colombo, Sri Lanka, 36pp, 2006.)



**FIGURE 5.3** Illustration of the transformation procedure to generate a complete monthly time series of EF from the established environmental FDC. (From Smakhtin, V.U. and Eriyagama, N., *Environ. Modell. Softw.*, 23(12), 1396, 2008.)

*Step 4: Simulating continuous monthly time series of EF.* An environmental FDC can be converted into an actual environmental monthly flow time series using the spatial interpolation procedure (Figure 5.3) described in detail by Hughes and Smakhtin [14]. Generation of the EF time series completes the desktop EF estimation for a site. In this study, Global Environmental Flow Calculator (GEFC) software, version 1 [29], was used to analyze the data and estimate EFR.

### 5.3.1.2 Desktop Reserve Model

DRM is a hydrology-based, planning-type EFA methodology developed in South Africa by Hughes and Munster and further refined by Hughes and Hannart [12,13]. The main assumption of the DRM, which emerged from the analysis of the comprehensive reserve estimates, is that rivers with more stable flow regimes (a higher proportion of their flow occurring as base flow) may be expected to have relatively higher low-flow requirements in normal hydrological years.

Flow variability plays a major role in determining EFRs. Within the model, two measures of hydrological variability are used. The first is a representation of long-term variability of wet and dry season flows. The average coefficient of variation (CV) of flow for the three main months of both the wet and dry seasons is calculated, and the sum is the CV index. The second index is the base flow index, which is the proportion of total flow that can be considered to occur as base flow [12].

The DRM parameters have been determined empirically for South African rivers, and they must be modified for other conditions. In computing the results, the model assumes that the primary dry season months are June to August, and the primary wet season months are January to March, as occurs over much of South Africa. This assumption cannot be altered within the model. However, for the three rivers, the key months are April–June and September–November for the wet and dry seasons, respectively. To reflect these key months, the input data were shifted by 3 months (i.e., January became April and so forth) and the results were then readjusted, that is, the input data files were time stepped and then the output time stepped to reestablish the correct month assignment.

### 5.3.1.3 Range of Variability Approach

Richter et al. established the indicators of hydrologic alteration (IHA) method to assess hydrologic regime alteration, including 33 hydrological parameters, which jointly reflect different aspects of flow variability (magnitude, frequency, duration, timing, and rate of change) [23]. The IHA indicators can be divided into five groups: monthly flow indices, extreme flow indices, timing indices, high-flow and low-flow indices, and rising and falling indices. The basic premise of the IHA analysis is that the natural biotic composition, structure, and function of the aquatic ecosystem will be provided by protecting or restoring a natural hydrologic regime on a river.

Richter et al. developed the RVA method based on the IHA [24]. The objective of the RVA is to guide efforts to restore or maintain the natural hydrologic regime of a river, using the range of natural variability in 33 different ecologically relevant flow parameters as the basis for setting management targets. The RVA target range for each hydrologic parameter is usually based upon selected percentile levels or a simple multiple of the parameter standard deviations for the natural or preimpact hydrologic regime. The management objective is not to have the river attain the targeted range every year; rather, it is to attain the targeted range at the same frequency as occurred in the natural or preimpact flow regime [22].

The degree, to which the RVA target range is not attained, is a measure of hydrologic alteration. The hydrologic alteration index (HAI in percentage) is calculated by

$$\text{HAI} = \frac{N_{\text{observed}} - N_{\text{expected}}}{N_{\text{expected}}} \times 100 \quad (5.1)$$

where “ $N_{\text{observed}}$ ” and “ $N_{\text{expected}}$ ” are the number of years in which the corresponding observed and expected values of the hydrologic parameter fall within the targeted range, respectively. The HAI is equal to zero when the observed frequency of postimpact annual values falling within the RVA target range equals the expected frequency. A positive value of the HAI indicates that annual parameter values fall inside the RVA target range more often than expected; negative values indicate that annual values falling within the RVA target range less often than expected.

The Nature Conservancy developed the IHA software program to support hydrologic evaluations. The IHA software facilitates the analysis of variability and change in hydrologic parameter values over time by producing tabular summaries and graphical output [17]. Version 7 of the IHA software was used in this study to estimate EFRs in the Shahr Chai River.

### 5.3.1.4 Tennant Method

The Tennant method, sometimes called the Montana method, is the most frequent method applied worldwide and has been used by at least 25 countries [36]. Tennant used stream gaging records to calculate mean annual flow (MAF), and the established range of base flow conditions and an associated level of habitat protection on the basis of his qualitative assessment of habitat conditions generated by various flow regimes [34]. Tennant method reserves an amount of water for each of the seasonal periods of April–September and October–March (Table 5.3).

### 5.3.1.5 Tessman Method

Tessman (1980) as cited in Prairie Provinces Water Board adapted Tennant’s seasonal flow recommendations. These recommendations are based on mean monthly flows (MMFs) as well as MAF. The specific monthly Tessman’s recommendations are as follows [20]:

- If  $\text{MMF} < 40\% \text{ of MAF}$ , then minimum monthly flow equals the MMF
- If  $\text{MMF} > 40\% \text{ MAF}$  and  $40\% \text{ MMF} < 40\% \text{ MAF}$ , then minimum monthly flow equals  $40\% \text{ MAF}$
- If  $40\% \text{ MMF} > 40\% \text{ MAF}$ , then minimum monthly flow equals  $40\% \text{ MMF}$

Tessman also recommends a two-week period of  $200\% \text{ MAF}$  during the month of highest runoff for flushing flows.

**TABLE 5.3** Instream Flow for Fish, Wildlife, and Recreation in the Tennant Method

Description of Flows	Recommended Base Flow Regime (% of MAF)	
	October–March	April–September
Flushing or maximum	200	200
Optimum range	60–100	60–100
Outstanding	40	60
Excellent	30	50
Good	20	40
Fair or degrading	10	30
Poor or minimum	10	10
Severe degradation	<10	<10

Source: Tennant, D.L., *Fisheries*, 1, 6, 1976.

### 5.3.2 Results and Discussions

The potential EF values for the three rivers were evaluated by newly developed hydrological method (FDC shifting) using GEFC software. Monthly flow data were used to develop duration curves and to generate flow requirements at the three gaging stations of the rivers. Figure 5.4 shows the development of FDCs corresponding to six different EMCs (A–F) at the selected gaging stations in the rivers.

One characteristic feature of the estimated EFR is that higher the flow variability of a river (and therefore the steeper the FDC slope is), the lesser the EFRs are in all classes [28]. Barandooz Chai, which has the least variable regimes according to simulated flow records and corresponding duration curves, has therefore the highest EFR.

Nazlu Chai and Shahr Chai with the most variable flow regimes (and corresponding steeply sloping curves) have the lowest EFR in most of the classes.

Figure 5.5 illustrates the natural flow conditions at the selected gaging stations and the simulated EF time series for EMCs A and F. The simulated time series were obtained using the spatial interpolation procedure discussed in the previous section and illustrated in Figure 5.3. They retain most of the features of natural flow variability. The differences between the natural and environmental hydrographs at any particular time in desired EMC should ideally be considered as water available for other uses.

Estimation of the long-term EF as percent of natural MAF for different EMCs of the three rivers is presented in Table 5.4, using the FDC shifting method. The corresponding EF values clearly decrease progressively as ecosystem protection decreases. The results indicate that to maintain a river in the relatively high management class B, 44% of the natural MAF would be required with the exception of Barandooz Chai (an extreme case).

According to Table 5.4, more than 10% of the MAF rate must be allocated to maintain river life; lower than this value, the river would be considered to be a dead environment.

Table 5.5 presents the estimated EF from the DRM method. As shown in Table 5.5, the EFR for class D, which is sometimes perceived as the least acceptable level, is 15% of the natural MAF for all of the three rivers.

Comparative results from the FDC shifting and DRM methods are shown in Figure 5.6. Since the E and F classes are environmentally unacceptable (Table 5.2), they are not included in Table 5.5 and Figure 5.6.

The estimation from the FDC shifting method is consistently more conservative than the DRM method for all of the classes. The systematic underestimation of EF values from the DRM method could be related to necessary modifications of the empirical parameters used in the DRM. Currently, there are no scientific grounds (in terms of ecology, geomorphology, and hydraulic fields) for any such changes in the modeling of the three study river ecosystems.

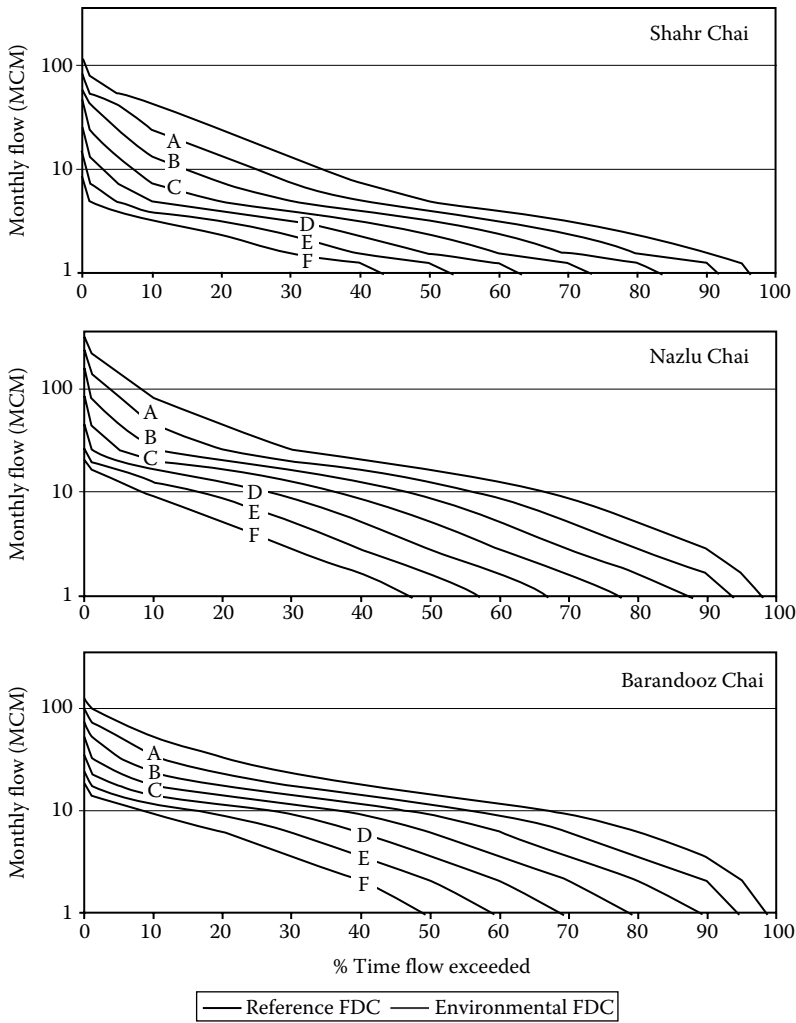
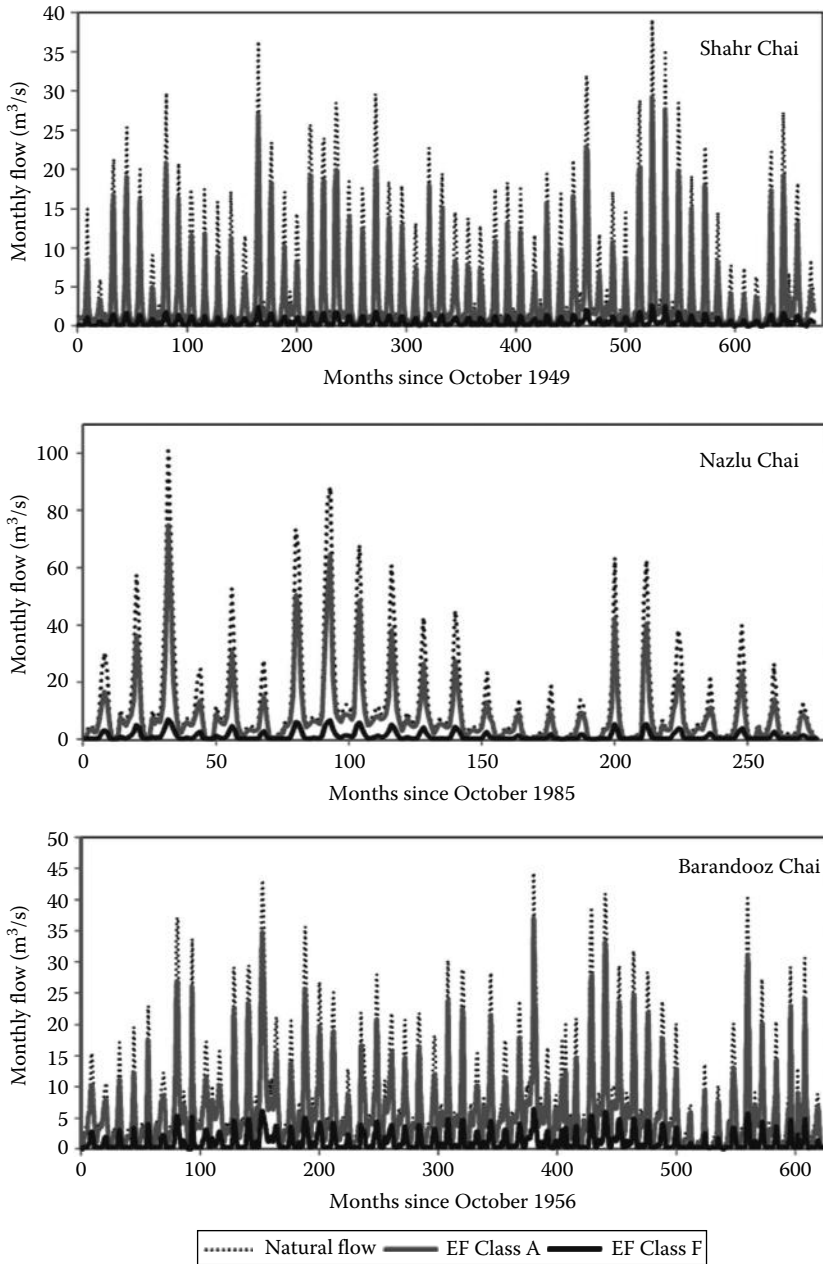


FIGURE 5.4 Environmental FDCs for Shahr Chai, Nazlu Chai, and Barandooz Chai rivers.

Due to the fact that the Barandooz and Nazlu dams are under construction, there are no regulated data for implementing the RVA method analysis in Barandooz Chai and Nazlu Chai rivers. Mean daily flow data of the Band Station (Shahr Chai River) from 1949 to 2008 was divided into pre-2005 and post-2005 data series. The annual mean values of 33 hydrologic parameters in the preimpact 56-year flow data series were calculated, then the annual mean values of those parameters in the postimpact 4-year series were calculated. In the absence of supporting ecological information,  $\pm 1$  standard deviation (SD) from the mean values of the predam parameters was used as the EF targets for each of the 33 IHA parameters. Finally, the HAI of the postimpact parameters against that of the preimpact parameters was computed (Table 5.6).

The negative HAI values of most parameters indicate that the annual values of these parameters fell within the RVA target range less often than expected. In summary, the hydrologic regime of the Band Station altered drastically after dam construction, especially for the high-flow-relevant parameters. High flow often occurs in wet seasons in a hydrological year. In wet seasons, irrigation water demand in the Shahr Chai River basin is lower than that in other seasons. Figure 5.7 illustrates an example of graphical output from the IHA software showing changes in monthly mean flows after the construction





**FIGURE 5.5** Observed (natural flow) and simulated (EF) monthly flow hydrographs in the Barandooz Chai, Nazlu Chai, and Shahr Chai rivers.

**TABLE 5.4** Estimation of EF as Percent of MAF for Different EMCs Using the FDC Shifting

River	MAF (m <sup>3</sup> /s)	Long-Term EF (% of MAF) at Different EMCs					
		Class A	Class B	Class C	Class D	Class E	Class F
Barandooz Chai	8.2	75.3	54.2	39.4	29.1	21.5	15.6
Nazlu Chai	12.2	67.4	43.6	29.3	20.4	14.4	9.9
Shahr Chai	5.2	68.8	44.1	28.2	18.9	13.4	10

**TABLE 5.5** Estimation of EF as Percent of MAF for Different EMCs Using the DRM

River	MAF (m <sup>3</sup> /s)	Long-Term EF (% of MAF) at Different EMCs			
		Class A	Class B	Class C	Class D
Barandooz Chai	8.2	56.7	37.1	23.9	15.4
Nazlu Chai	12.2	51.9	34.7	22.8	14.8
Shahr Chai	5.2	53.8	35.6	23.2	15

of Shahr Chai Dam on the Shahr Chai River. The RVA target for this hydrological parameter is also shown in Figure 5.7.

In the monthly mean flow data, except for November, the HAI values were relatively high. The April and May values of HAI reached 100%, the highest degree of deviation. In addition, from December to July, monthly mean flow was reduced after 2005. This may be because this period is considered to be the wet season in the Shahr Chai River basin, and water abstraction for irrigation is not necessary. Nevertheless, the values from August to November were greater than the predam values. It should be stated that it is very difficult to evaluate the results when there are no ecological data available to confirm or deny the suitability of the estimated environmental water requirement (EWR). Hence, the low RVA target was considered as the minimum monthly flow.

Using the Tennant method and based on national legislation, 10% of the MAF for the flows from October to March and 30% of the MAF for the flows from April to September were calculated in this study. Tables 5.7 through 5.9 present the EF estimations from the Tennant and Tesson methods for the Barandooz Chai, Nazlu Chai, and Shahr Chai rivers, respectively. Also, it is possible to produce actual monthly EFR distribution resulting from the application of the methods. Hence, comparisons of the monthly results of the methods are presented in Tables 5.7 through 5.9.

For better comparison of the differences among EF estimations of the applied methods, the results are summarized in Table 5.10. The RVA and Tesson methods, as presented in Table 5.10, estimated higher values than the others.

This study provides a useful guide as the first-order estimation of EFs where limited information is available on the ecology of the rivers. The proposed potential monthly EF values are to be used as a suitable threshold for EFRs in the three rivers. During wet and normal periods, it is possible to regulate the flow release from each of the three dams in order to satisfy human needs while sustaining the minimum EFR downstream. In drought periods, it is necessary to consider tradeoffs between agricultural and environmental water needs, resulting in solutions that reduce the risk of water shortages and minimize ecological integrity disturbances along the three rivers and toward Lake Urmia. However, the drought management approach requires the identification of real-time flow data and social tolerance of stakeholders downstream in order to achieve the optimum timing and magnitude of flow releases from each of the three dams. Optimizing the dam release rules for these three reservoirs is considered for future study.

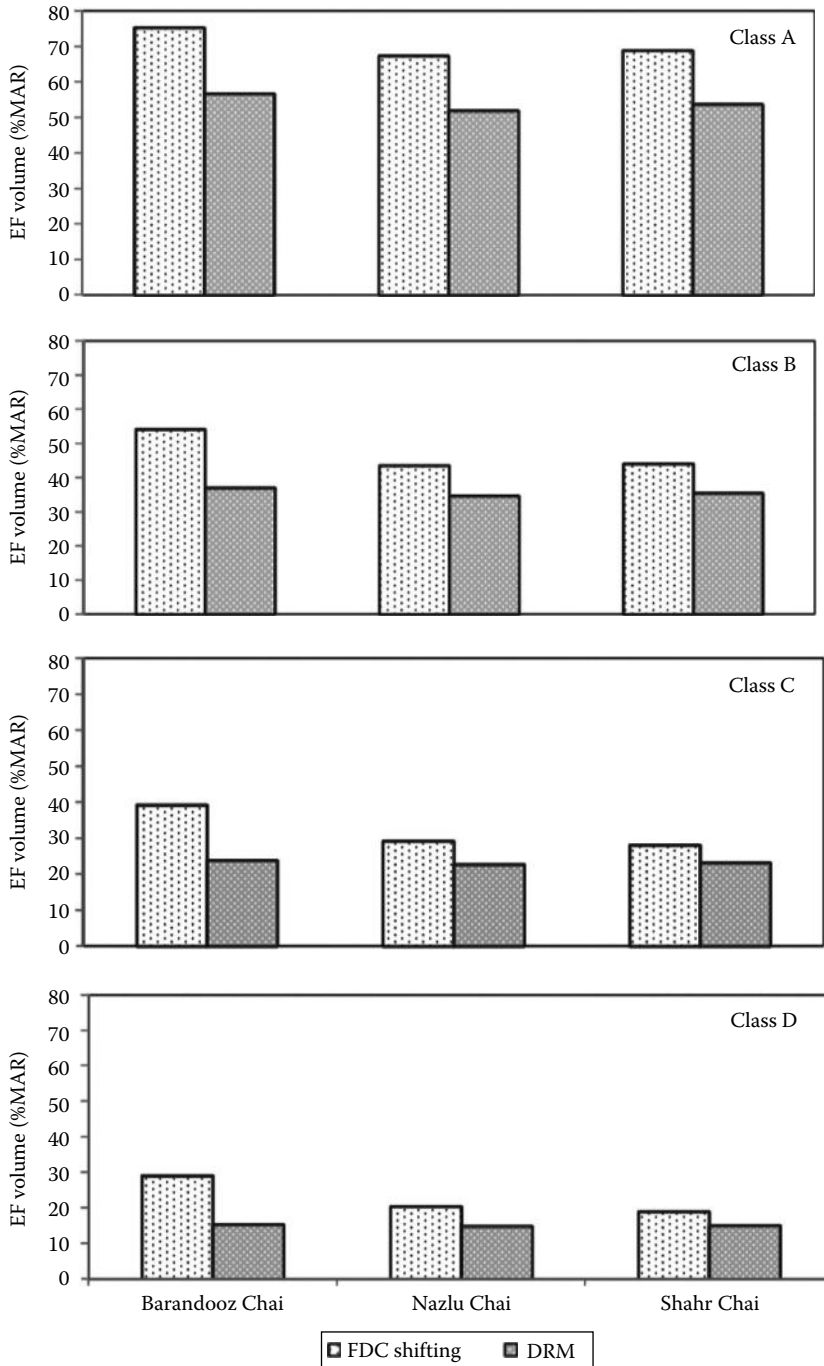


FIGURE 5.6 Comparison of EFRs estimated from FDC shifting method and DRM in different EMCs.

**TABLE 5.6** Alteration of 33 Hydrologic Parameters, Shahr Chai River

IHA Parameter Group	Predam: 1949–2004			Postdam: 2005–2008			RVA Boundaries		HAI <sup>a</sup> (%)
	Means	Min	Max	Means	Min	Max	Low	High	
<b>1. Monthly magnitude</b>									
October	1.1	0.1	5.7	3.1	0.4	8.2	0.5	2.1	-25.7 (L)
November	1.5	0.4	4.3	2.3	0.7	5.6	0.5	2.6	3.1 (L)
December	1.5	0.3	4.8	1.1	0.7	1.8	0.6	2.3	25 (L)
January	1.3	0.3	3.7	0.5	0	0.9	0.7	1.9	-34.5 (M)
February	1.4	0.4	3.4	0.5	0	0.8	0.8	2	-66.5 (M)
March	3.3	0.9	8.9	1.2	0.4	2.2	1.5	5	-69.4 (H)
April	10.8	3.3	23.4	1.5	0.8	2.8	6	15.6	-100 (H)
May	19.1	5.8	45.5	3.5	1.5	5	11.1	27.1	-100 (H)
June	15.4	2.5	35.3	5.4	3.5	8.6	8	22.8	-63.8 (M)
July	5.6	0.4	16.3	5.3	3.6	7.1	1.9	9.3	41 (M)
August	1.8	0	5.9	5.5	2.8	9.2	0.5	3.2	-64.7 (M)
September	0.9	0	2.4	4.5	1.1	9.6	0.3	1.4	-62.8 (M)
<b>2. Magnitude and duration of annual extremes</b>									
1-day minimum	0.3	0	1	0.1	0	0.3	0	0.5	-31.3 (L)
3-day minimum	0.3	0	1	0.2	0	0.5	0.1	0.6	-21.4 (L)
7-day minimum	0.4	0	1.1	0.2	0	0.6	0.1	0.7	-23.6 (L)
30-day minimum	0.6	0	1.4	0.3	0	0.7	0.2	0.9	-23.6 (L)
90-day minimum	1.1	0.1	3.4	0.5	0.3	0.8	0.5	1.7	-34.5 (M)
1-day maximum	47.1	10	170	12	10.9	12.9	10.8	83.4	17 (L)
3-day maximum	34	9.3	103.1	11	10.3	12.1	15.8	52.2	-100 (H)
7-day maximum	28.4	8.8	91.4	10.1	8.8	11.4	15	41.7	-100 (H)
30-day maximum	22.1	6.4	57.8	8	5.4	9.7	12.8	31.4	-100 (H)
90-day maximum	15.6	5	30.9	6.1	4.1	8.6	9.4	21.9	-100 (H)
Number of zero days	5.3	0	91	10	0	40	0	25.8	-20.7 (L)
Base flow index	0.1	0	0.3	0.1	0	0.2	0	0.1	-100 (H)
<b>3. Timing of annual extremes</b>									
Date of minimum	258.8	9	363	31	11	347	180.8	336.7	-100 (H)
Date of maximum	130.2	97	179	172.8	131	241	109.2	151.3	-60.7 (L)
<b>4. Frequency and duration of high and low pulses</b>									
Low pulse count	5.6	0	14	6.8	5	10	1.6	9.7	28.9 (L)
Low pulse duration	26.2	1	131	18.3	9.9	28.4	7.4	57.9	66.7 (H)
High pulse count	3.6	0	10	0	0	0	1.5	5.7	-100 (H)
High pulse duration	15.8	1	73						
The low pulse threshold		0.9							
The high pulse threshold		13.4							
<b>5. Rate and frequency of change in conditions</b>									
Rise rate	1.2	0.3	3.8	0.5	0.4	0.7	0.5	1.8	-37.5 (M)
Fall rate	-0.9	-2.5	-0.3	-0.4	-0.6	-0.3	-1.3	-0.4	-36.1 (M)
Number of reversals	106.5	16	154	107.3	92	120	77.3	135.6	31 (L)

<sup>a</sup> Hydrologic alteration index (HAI) is classified as high (H) > 67%, medium (M) = (34%–66%), low (L) < 33%.

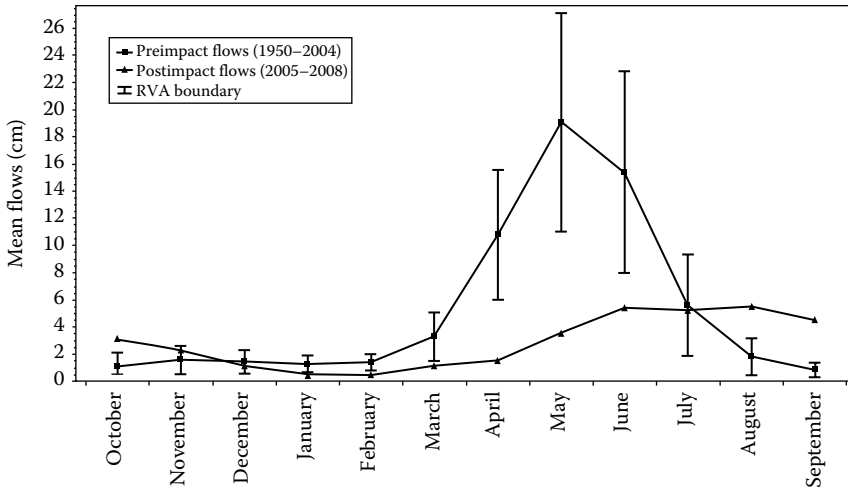


FIGURE 5.7 Illustration of changes in monthly mean flows after the construction of Shahr Chai Dam on the Shahr Chai River.

TABLE 5.7 Estimation of EF Values from Different Hydrological Methods, Barandooz Chai

Month	Mean Monthly Flow (m <sup>3</sup> /s)	Environmental Flow Requirement (m <sup>3</sup> /s)			
		FDC Shifting Class C	DRM Class C	Tennant (Fair)	Tessman
October	2.43	0.75	0.59	0.82	2.43
November	5.20	2.10	0.81	0.82	3.26
December	5.38	2.35	0.91	0.82	3.26
January	4.85	1.84	0.88	0.82	3.26
February	4.68	1.76	1.20	0.82	3.26
March	6.79	3.08	2.31	0.82	3.26
April	14.02	5.55	2.33	2.45	5.61
May	22.64	8.17	6.71	2.45	9.05
June	17.65	6.46	3.11	2.45	7.06
July	8.68	3.58	2.53	2.45	3.47
August	3.63	1.33	1.25	2.45	3.26
September	1.87	0.52	0.69	2.45	1.87

## 5.4 Summary and Conclusions

The proliferation of EFR current methods clearly indicates the present diversity and future requirements of this line of riverine system management. They reinforce the need for preserving downstream environments as a worldwide issue. No single EFR method is perfect under all conditions. Region- and climate-specific EFRs can require significant modifications before being applied in distinct zones.

The vast majority of methods tend to closely focus on the instream ecological features of riverine systems; nevertheless, holistic methods have the potential for the assessment of water requirements for nonflowing aquatic systems, such as floodplains, wetlands, including estuaries, and lakes.

**TABLE 5.8** Estimation of EF Values from Different Hydrological Methods, Nazlu Chai

Month	Mean Monthly Flow (m <sup>3</sup> /s)	Environmental Flow Requirement (m <sup>3</sup> /s)			
		FDC Shifting Class C	DRM Class C	Tennant (Fair)	Tessman
October	2.74	0.85	0.65	1.22	2.74
November	5.46	2.05	0.86	1.22	4.86
December	5.25	1.86	0.90	1.22	4.86
January	5.19	1.67	1.34	1.22	4.86
February	5.24	1.70	1.35	1.22	4.86
March	8.98	3.62	3.41	1.22	4.86
April	25.25	6.94	3.48	3.65	10.10
May	43.88	10.16	11.75	3.65	17.55
June	27.29	7.21	4.60	3.65	10.92
July	10.38	3.26	3.08	3.65	4.86
August	3.83	1.30	1.37	3.65	3.83
September	2.22	0.68	0.79	3.65	2.22

**TABLE 5.9** Estimation of EF Values from Different Hydrological Methods, Shahr Chai River

Month	Mean Monthly Flow (m <sup>3</sup> /s)	Environmental Flow Requirement (m <sup>3</sup> /s)				
		FDC Shifting Class C	DRM Class C	Low RVA	Tennant (Fair)	Tessman
October	1.10	0.37	0.30	0.54	0.53	1.10
November	1.54	0.60	0.38	0.53	0.53	1.54
December	1.46	0.59	0.37	0.63	0.53	1.46
January	1.28	0.51	0.35	0.65	0.53	1.28
February	1.41	0.53	0.38	0.79	0.53	1.41
March	3.26	1.04	1.39	1.51	0.53	2.11
April	10.83	2.01	1.56	6.03	1.58	4.33
May	19.08	4.42	5.06	11.09	1.58	7.63
June	15.40	4.19	2.71	8.02	1.58	6.16
July	5.59	1.58	1.97	1.86	1.58	2.24
August	1.81	0.78	0.88	0.45	1.58	1.81
September	0.87	0.36	0.38	0.29	1.58	0.87

**TABLE 5.10** Comparison of Environmental Flows from Different Hydrological Methods

Method	Environmental Flow Requirement					
	Shahr Chai		Nazlu Chai		Barandooz Chai	
	% of MAF	m <sup>3</sup> /s	% of MAF	m <sup>3</sup> /s	% of MAF	m <sup>3</sup> /s
FDC shifting (Class C)	28	1.48	29	3.52	39	3.18
DRM (Class C)	23	1.26	23	2.79	23	1.96
Tennant (March–August)	10	0.53	10	1.22	10	0.82
Tennant (September–February)	30	1.58	30	3.65	30	2.45
Tessman	50	2.65	53	6.38	49	4.02
Low RVA	51	2.69	—	—	—	—

In cases where ecological information is insufficient, hydrological indices can be used to provide an adequate estimation of environmental water requirements in rivers. This study tests several hydrology-based desktop EFA methods in the context of a developing country (where sufficient data on ecological features and the flow values of rivers are not available), using three rivers within the Urmia Lake Basin in Iran.

One of the major problems in EFA, effectively reflected in all of the methods used, is the elusive search for environmentally acceptable thresholds, below which there are some significant changes in the system [31].

The FDC shifting method enables rapid estimation of EFRs for different environmental classes if relevant hydrological data (i.e., monthly flow rates) are available. The DRM is developed for a specific country/region and needs to be tested and recalibrated for additional physiographic and climatic environments before it can be reliably applied. There is therefore a need to further develop, modify, and test the existing methods in specific river basins. The Tennant and Tessman methods are considered to be too simplistic and do not take into account the recent ecohydrological theories. The RVA was expressly designed for application in situations in which very little or no ecological information was available to support EF determination. However, despite the relatively advanced nature of the RVA, the number of parameters used is too large for the level of subjectivity associated with their selection [31].

The predictions of the EF rates for the three rivers from each of the five methods are compared and presented in Table 5.10. Comparative results indicate that in order to maintain the rivers at an acceptable ecological condition Class C, 23% of the natural MAF is required in the rivers from the selected gaging stations (downstream of the dams) toward Lake Urmia.

It seems that both methods of FDC shifting and DRM classify the flow environmentally better than the other methods. The reason for this perception is that in the FDC shifting method, variability of the flow regime would be maintained, and the DRM considers more complex parameters than the remaining methods.

## References

1. Amini, A., Shahosseini, M., Mohammadi, A., and Shahrabi, M., 2010. Sedimentological characteristics and origin of Urmia Lake deposits along the Shahid-Kalantari highway, *Scientific Quarterly, J. Geosciences*, 19(74), 57–68.
2. Arthington, A.H., King, J., O'Keeffe, J.H., Bunn, S.E., Day, J.A., Pusey, B.J., Bluhdorn, B.R., and Tharme, R., 1992. Development of an holistic approach for assessing environmental flow requirements of riverine ecosystems. In: *Water Allocation for the Environment*, pp. 69–76. The Centre for Policy Research, University of New England, Armindale, New South Wales, Australia.
3. Brown, C. and King, J., 2003. Environmental flows: Concept and methods. *Water Resources and Environment*, Technical Note C.1, World Bank, Washington, DC, 28pp.
4. DWAF, 1997. *White Paper on a National Water Policy for South Africa*. Department of Water Affairs and Forestry, Pretoria, South Africa.
5. Dyson, M., Bergkamp, G., and Scanlon, J., 2003. *The Essentials of Environmental Flows*. IUCN, Gland, Switzerland, 118pp.
6. Eimanifar, A. and Mohebbi, F., 2007. Urmia Lake (Northwest Iran): A brief review. *Saline Syst.* 3(5), 1–8.
7. Ghaheri, M., Baghal-Vayjooee, M.H., and Naziri, J., 1999. Lake Urmia, Iran: A summary review. *Int. J. Salt Lake Res.* 8(10), 19–22.
8. Gordon, N.D., McMahon, T.A., and Finlayson, B.L., 1992. *Stream Hydrology. An Introduction for Ecologists*. John Wiley & Sons, Chichester, U.K.
9. Günther, R.T., 1899. Contributions to the geography of Lake Urmia and its neighbourhood. *Geogr. J.* 14, 504–523.

10. Hassanzadeh, E., Zarghami, M., and Hassanzadeh, Y., 2011. Determining the main factors in declining the Urmia Lake level by using system dynamics modeling. *Water Resour. Manag.* 26(1), 129–145.
11. Hoseinpour, M., Fakheri Fard, A., and Naghili, R., 2010. Death of Urmia Lake, a silent disaster investigating causes, results and solutions of Urmia Lake drying. Paper presented at the *First International Applied Geological Congress*, Department of Geology, Islamic Azad University, Islamic Azad University, Mashad Branch, Iran.
12. Hughes, D.A. and Hannart, P., 2003. A desktop model used to provide an initial estimate of the ecological instream flow requirements of rivers in South Africa. *J. Hydrol.* 270(3–4), 167–181.
13. Hughes, D.A. and Munster, F., 2000. *Hydrological Information and Techniques to Support the Determination of the Water Quantity Component of the Ecological Reserve for Rivers*. Report to the Water Research Commission by the Institute for Water Research, Rhodes University, WRC Report No. 867/3/2000, Pretoria, South Africa.
14. Hughes, D.A. and Smakhtin, V.U., 1996. Daily flow time series patching or extension: A spatial interpolation approach based on flow duration curves. *Hydrol. Sci. J.* 41(6), 851–871.
15. King, J.M. and Louw, D., 1998. Instream flow assessments for regulated rivers in South Africa using the building block methodology. *Aquat. Ecosyst. Health Manag.* 1, 109–124.
16. King, J.M., Tharme, R.E., and Brown, C.A., 1999. *Definition and Implementation of Instream Flows*. Thematic Report for the World Commission on Dams, Southern Waters Ecological Research and Consulting, Cape Town, South Africa.
17. Mathews, R. and Richter, B.D., 2007. Application of the indicators of hydrologic alteration software in environmental flow setting. *J. Am. Water Resour. Assoc.* 43(6), 1400–1413.
18. Poff, N.L., Allan, J.D., Bain, M.B., Karr, J.R., Prestegard, K.L., Richter, B.D., Sparks, R.E., and Stromberg, J.C., 1997. The natural flow regime: A paradigm for river conservation and restoration. *Bioscience* 47, 769–784.
19. Poff, N.L., Richter, B.D., Arthington, A.H., Bunn, S.E., Naiman, R.J., Kendy, E., Acreman, M. et al., 2010. The ecological limits of hydrologic alteration (ELOHA): A new framework for developing regional environmental flow standards. *Freshw. Biol.* 55(1), 147–170.
20. PPWB (Prairie Provinces Water Board), 1999. *A Review of Instream Flow Needs Methodologies*. PPWB Report No. 145, Prepared by the Instream Flow Needs Committee, Canada. <http://www.ppwb.ca/uploads/document/files/ppwb-report-145-en.pdf>
21. Pyrcce, R., 2004. *Hydrological Low Flow Indices and Their Uses*. Watershed Science Centre, WSC Report No. 04, Trent University, Peterborough, Ontario, Canada, 33pp.
22. Richter, B.D., Baumgartner, J.V., Braun, D.P., and Powell, J., 1998. A spatial assessment of hydrologic alteration within a river network. *Regul. Rivers: Res. Manag.* 14(4), 329–340.
23. Richter, B.D., Baumgartner, J.V., Powell, J., and Braun, D.P., 1996. A method for assessing hydrologic alteration within ecosystems. *Conserv. Biol.* 10(4), 1163–1174.
24. Richter, B.D., Baumgartner, J.V., Wigington, R., and Braun, D.P., 1997. How much water does a river need? *Freshw. Biol.* 37, 231–249.
25. SEDAC, 2010. Gridded population of the world: Future estimates. Socioeconomic Data and Applications Center (SEDAC); collaboration with CIESIN, UN-FAO, CIAT. <http://sedac.ciesin.columbia.edu/gpw> (accessed December 14, 2011).
26. Shaeri Karimi, S., Yasi, M., and Eslamian, S., 2012. Use of hydrological methods for assessment of environmental flow in a river reach. *Int. J. Environ. Sci. Technol.* 9(3), 549–558.
27. Smakhtin, V.U., 2001. Low flow hydrology: A review. *J. Hydrol.* 240(3–4), 147–186.
28. Smakhtin, V.U. and Anputhas, M., 2006. *An Assessment of Environmental Flow Requirements of Indian River Basins*. IWMI Research Report 107, International Water Management Institute, Colombo, Sri Lanka, 36pp.
29. Smakhtin, V.U. and Eriyagama, N., 2008. Developing a software package for global desktop assessment of environmental flows. *Environ. Modell. Softw.* 23(12), 1396–1406.



30. Smakhtin, V.U., Revenga, C., and Doll, P., 2004. *Taking into Account Environmental Water Requirements in Global Scale Water Resources Assessments*. Research Report 2 of the CGIAR Comprehensive Assessment Program of Water Use in Agriculture, International Water Management Institute, Colombo, Sri Lanka, 24pp.
31. Smakhtin, V.U., Shilpakar, R.L., and Hughes, D.A., 2006. Hydrology-based assessment of environmental flows: An example from Nepal. *Hydrol. Sci. J.* 51(2), 207–222.
32. Stewardson, M. and Gippel, C., 1997. *In-Stream Environmental Flow Design: A Review*. Draft Report, Cooperative Research Centre for Catchment Hydrology, Department of Civil and Environmental Engineering, University of Melbourne, Victoria, Australia.
33. Sun, T., Yang, Z.F., and Cui, B.S., 2008. Critical environmental flows to support integrated ecological objectives for the Yellow River Estuary, China. *Water Resour. Manag.* 22(8), 973–989.
34. Tennant, D.L., 1976. Instream flow regimens for fish, wildlife, recreation and related environmental resources. *Fisheries* 1, 6–10.
35. Tharme, R.E. and King, J.M., 1998. Development of the building block methodology for instream flow assessments, and supporting research on the effects of different magnitude flows on riverine ecosystems. Water Research Commission Report No. 576/1/98.
36. Tharme, R.E., 2003. A global perspective on environmental flow assessment: Emerging trends in the development and application of environmental flow methodologies for rivers. *River Res. Appl.* 19(5–6), 397–441.
37. Yang, Z.F., Sun, T., Cui, B.S., Chen, B., and Chen, G.Q., 2009. Environmental flow requirements for integrated water resources allocation in the Yellow River Basin, China. *Commun. Nonlinear Sci. Numer. Simul.* 14(5), 2469–2481.

# 6

## Environmental Nanotechnology

---

6.1	Introduction .....	106
6.2	Production of Nanoparticles and Nanomaterials.....	106
	Top-Down Method • Bottom-Up Method	
6.3	Benefits of Nanotechnology for the Environment.....	107
	Environment Monitoring and Sensing • Remediation and Treatment • Sustainable Products and Resource Saving	
6.4	Risk of Nanotechnology .....	112
	Fate of Engineered Nanomaterials in Air • Fate of ENMs in Water • Fate of ENMs in Soil • Biodegradation and Chemical Transformation of ENMs	
6.5	Nanoparticles and Environment: Case Studies .....	114
	Application of Nanoparticles of Rice Husk Ash • Desalination of Water Using Nanoparticles of Husk Ashes in Sand Filter • Sulfate Ion Removal from Water Using Polysulfone Nanostructured Membrane	
6.6	Summary and Conclusions .....	116
	References.....	116

**Saeid Eslamian**

*Isfahan University  
of Technology*

**Raheleh Malekian**

*Isfahan University  
of Technology*

**Mohammad**

**Javad Amiri**

*Fasa University*

### AUTHORS

**Saeid Eslamian** received his PhD from the University of New South Wales, Australia, with Professor David Pilgrim. He was a visiting professor in Princeton University, United States, and ETH Zurich, Switzerland. He is currently an associate professor of hydrology in Isfahan University of Technology (IUT). He is the founder and chief editor of *Journal of Flood Engineering* and *International Journal of Hydrology Science and Technology*. He has published more than 200 publications mainly in statistical and environmental hydrology and hydrometeorology.

**Raheleh Malekian** received her PhD in Irrigation and Drainage from IUT in 2011. She received research scholarship from the University of Guelph in Canada in 2010. Her researches have been mainly about environmental issues. She has published more than nine peer-reviewed manuscripts and 12 conference papers from her research activities.

**Mohammad Javad Amiri** is a PhD student of IUT, Department of Water Engineering, Iran. He has published 10 international journal papers and 25 papers in scientific conferences mainly in surface and groundwater, soil, water, and plant relationship.

## PREFACE

Nanostructure science and technology is a broad and interdisciplinary area of research and development activity that has been growing explosively worldwide in the past few years. It plays a major role in the development of innovative methods to produce new products, to substitute existing production equipment, and to reformulate new materials and chemicals with improved performance resulting in less consumption of energy and materials and reduced harm to the environment as well as environmental remediation.

In this chapter, first the production of nanoparticles and nanomaterials are reviewed and then some benefits and risks of nanotechnology for the environment are described. At the end, three different case studies regarding nanoparticles and environment that have been conducted in Iran as a developing country with arid or semiarid zones are presented.

## 6.1 Introduction

Nanotechnology can be defined as the design, synthesis, characterization, and application of materials and devices on a length scale of approximately 1–100 nm in any dimension [46]. Nanotechnology is a result of convergence of traditional fields of physics, biology, and chemistry. Three types of nanoparticles can be considered: natural, incidental, and engineered. Clays, weathered minerals, organic matter, and metal oxides are the examples of natural substance [26,47]. Incidental nanoparticles are generated in a relatively uncontrolled manner and can originate as a by-product of fuel combustion, manufacturing, agricultural practices, vaporization and weathering, and release into the environment from nanoparticle production facilities [26]. Design and manufacture of engineered nanoparticles is intentionally with specific characteristics or compositions (e.g., shape, size, surface properties, and chemistry). These particles may be released into the environment through industrial or environmental applications [46].

Because of their unique properties, nanomaterials have novel electrical, catalytic, magnetic, mechanical, thermal, or imaging features that are highly worthy for applications in commercial, medical, military, and environmental sectors [46].

## 6.2 Production of Nanoparticles and Nanomaterials

Two basic strategies are used to produce nanoparticles: top-down and bottom-up. In the top-down strategy, source materials are mechanically crushed using a milling process. In the bottom-up strategy, structures are built up by chemical processes. The respective process for production of nanomaterials is selected based on the chemical composition and the desired features specified for the nanoparticles.

### 6.2.1 Top-Down Method

In this method, the material of the formed structure and base substrate is usually the same. The traditional mechanical–physical crushing methods for producing nanoparticles involve various milling techniques.

#### 6.2.1.1 Milling Processes

Mechanical attrition, which is applied in producing metallic and ceramic nanomaterials, is a typical example of top-down method. Because of its simplicity, the relatively inexpensive equipment needed,

and the applicability to essentially the synthesis of all classes of materials, this method has become popular. Possibility for producing nanomaterial in large quantity is the major advantage of this method. However, the contamination problem in this method is often a reason to dismiss the method. In this method, material is removed from the substrate, forming a cavity with certain geometries. The dimensions of the cavity depend on the travel path of the mill.

## 6.2.2 Bottom-Up Method

As the opposite of top-down method, in bottom-up methods, materials stack on top of a base component. This method is based on physicochemical principles of molecular or atomic self-organization.

### 6.2.2.1 Gas-Phase Processes

Gas-phase processes are of increasing interest in industry for producing nanomaterials in powder or film form. Examples include processes in flame-, plasma-, laser-, and hot-wall reactors, yielding products such as fullerenes and carbon nanotubes.

Nanoparticles are made from the gas phase by producing a vapor of the product material using chemical or physical methods. Initial nanoparticles, which can be in a liquid or solid form, are produced via homogeneous nucleation. Depending on the process, further particle growth involves condensation (transition from gaseous into liquid aggregate state), chemical reaction on the particle surface and/or coagulation processes, as well as coalescence processes (particle fusion) [39].

### 6.2.2.2 Liquid-Phase Processes

The most important liquid-phase processes in nanomaterial production are precipitation, sol-gel processes, and hydrothermal syntheses. The synthesis of nanomaterials in this process takes place at lower temperatures compared to gas-phase process.

#### 6.2.2.2.1 Sol-Gel Processes

The sol-gel process, which is the most established method in nanoparticle production, involves the evolution of inorganic networks through the formation of a colloidal suspension (sol) and gelation of the sol to form a network in a continuous liquid phase (gel). A metal or metalloid element surrounded by various reactive ligands is normally the precursors for synthesizing these colloids. The starting material is processed to form a dispersible oxide and forms a sol in contact with water or dilute acid. Removal of the liquid from the sol yields the gel. In this procedure, the sol/gel transition controls the particle size and shape.

The synthesis takes place under relatively mild conditions and low temperatures. The sol-gel process can be characterized by a series of distinct steps. The first step is the hydrolysis reaction in which the stable sol solution is formed. Then the sol starts to condense and polymerize, which leads to a growth of particles. This reaction is quite complex and involves many intermediate products. By agglomeration of the particles and increasing the viscosity of the solution, a wet gel will form. Aging of the gel during which the polycondensation reactions continue until the gel transforms into a solid mass is another step. Then, by removing water and other volatile liquids, the gel dries. Dehydration, during which surface-bound M-OH groups are removed, stabilizes the gel. Densification and decomposition of the gels at high temperatures is the step in which the pores of the gel network are collapsed and remaining organic contaminants are derived out.

## 6.3 Benefits of Nanotechnology for the Environment

---

The benefits of nanotechnology for the environment have been divided into three categories of sensing and detection, remediation and treatment, and sustainable products and resource saving.

### **6.3.1 Environment Monitoring and Sensing**

Environmental monitoring is crucial for policy makers. Using environmental monitoring, the data, which is needed for policy makers to understand and improve environment, would be provided, and nanotechnology offers improved analysis systems for environmental monitoring.

#### **6.3.1.1 Air Monitoring**

Analytical methods, such as mass spectrometry, gas chromatography, chemiluminescence, and infrared spectrometry, are precise methods for air composition analysis. But they are time-consuming, relatively expensive, and difficult to use for real-time field measurements.

The application of new, more flexible, and cost-effective systems that can operate at higher resolutions is required for air monitoring. Solid-state gas sensors (SGSs) that are able to analyze air samples faster, simpler, and less expensive than their conventional methods were developed based on this demand [40]. SGSs consist of one or more metal oxides of the transition metals (e.g., tin, aluminum, zinc, cobalt, and tungsten). Application of nanoparticles and thin films of metal oxides (<100 nm thick) in producing the sensors has considerable advantages compared to standard technology. By using this technology, the sensitivity of sensors increases and the response time of the devices reduces [21].

An important benefit of nanotechnology for air monitoring is that the integration of nano-sized materials in SGSs decreases the size of the sensors considerably, making them compact enough to be fitted anywhere. They can be integrated into a flexible, mobile, real-time monitoring system. By combining the sensors with a global positioning system (GPS), and connecting them via an intelligent sensor network, data can be transmitted from remote locations to a central service site, modeled, using geographic information system (GIS) software and published on the Internet [38].

#### **6.3.1.2 Water Monitoring**

Detection of a variety of contaminants with the acceptable accuracy was difficult to achieve with conventional water monitoring technologies. Nanotechnology has indicated potential to develop novel biosensor technologies, which are very promising to detect chemical pollutants in the environment. Because of the unique properties of nanomaterials, they can provide rapid, sensitive, simple, and low-cost detection.

A biosensor is an electronic device used to transform a biological interaction into an electrical signal. This device is based on the direct spatial coupling of the immobilized biologically active element, with a transducer that acts as detector and electronic amplifier. Different types of bioreceptors (enzymes, receptors, antibodies, DNA, or microorganisms) combined with electrochemical, optical, or mechanical transduction have been used for the elaboration of biosensors in view of water monitoring applications [6,41].

### **6.3.2 Remediation and Treatment**

Environmental remediation involves the removal of contaminants from soils, surface and groundwaters, and sediments that may pose a risk to human health and environmental receptors [46]. Novel nano-based remediation and treatment practices have been developed in recent years. More rapid and cost-effective cleanup of wastes is some of the advantages of these methods over the conventional technologies.

#### **6.3.2.1 Nanoscale Zero-Valent Iron**

Nanoscale zero-valent iron (nZVI) that can effectively remove a wide variety of common environmental contaminants, such as chlorinated methanes, chlorinated benzenes, pesticides, organic dyes, heavy metal ions, trihalomethanes, chlorinated ethenes, inorganic anions, and even radioactive elements, has been widely used for environmental remediation [52].

The zero-valent iron nanoparticles can remain reactive toward contaminants in soil and water for more than 4–8 weeks [52]. Field tests showed that nanoparticles can provide enormous flexibility for both in situ and ex situ applications. Nanoparticles can be transported by the flow of groundwater over 20 m distance. The particles react rapidly, when in situ applied and fast contaminant reduction rates are observed [52]. In cases of water or wastewater treatment, anchoring nanoparticles onto a solid matrix, such as activated carbon or zeolite, can prove extremely effective [52].

For effective application of nZVI, site-specific requirements must be met. Before nanoparticles are injected, adequate site characterization including information about site location; geologic, hydrogeologic, and subsurface conditions; and the concentration and types of contaminants is essential. The composition of the soil matrix, porosity, hydraulic conductivity, groundwater gradient and flow velocity, depth to water table, and geochemical properties (e.g., pH, ionic strength, dissolved oxygen, and concentrations of nitrate, nitrite, and sulfate) need to be evaluated to determine whether the particles can infiltrate the remediation source zone and whether the conditions are favorable for reductive transformation of contaminants [22].

Use of nZVI has received increasing amounts of attention and a fraction of the projects has been reported. For example, nanoremediation methods have been tested for site remediation in 44 sites in seven countries (including the United States) and in 12 US states. The sites include oil fields, manufacturing sites, military installations, private properties, and residences where pollutants include Cr(VI), nitrate, and chlorinated compounds of concern, such as PCE, TCE, or PCBs [22].

Bimetallic iron nanoparticles, such as iron/palladium, iron/silver, iron/nickel, iron/cobalt, and iron/copper, have been shown to be even more active and stable than nZVI [17]. Among them the palladized iron (Fe/Pd) has the fastest reaction kinetics, but it is not cost-effective for in situ applications.

Although nZVI represents a powerful means of groundwater and site remediation, there are some concerns that exposure to the nZVI particles can potentially give rise to environmental and health problems, caused by the particles themselves. To understand and quantify the potential risks, the mobility, bioavailability, toxicity, and persistence of manufactured nanoparticles need to be studied [35]. Also to be able to quantify the stability of nanoparticles in the environment, the stability of their suspensions and their tendency to aggregate and interact with other particles must first be determined [29].

### 6.3.2.2 Nanoscale Semiconductor Photocatalysts

Semiconductor photocatalysts (SPs) are catalysts, built from a number of materials, such as titanium dioxide ( $\text{TiO}_2$ ), zinc oxide ( $\text{ZnO}$ ), iron (II) oxide ( $\text{FeO}$ ), and tungsten trioxide ( $\text{WO}_3$ ), which obtain their activation energy from the absorption of light [34]. It was recognized that building SP materials from nanoparticles greatly enhances their photocatalytic activity. The ability of nanoparticulate SPs to degrade a great variety of inorganic and organic contaminants makes them very useful for environmental remediation.

The characteristics of  $\text{TiO}_2$ , such as low cost, low toxicity, and high reactivity, make the compound more popular than other SPs [47]. However, it is possible that the application of  $\text{TiO}_2$  nanoparticles can cause environmental problems. Currently, little data, regarding the human and environmental exposure to  $\text{TiO}_2$  nanoparticles, used for environmental remediation, are available and the associated risks are still largely unexplored.

### 6.3.2.3 Polymeric Nanoparticles

Polymeric nanoparticles have amphiphilic properties, which make them similar to the surfactant micelles. The amphiphilic polyurethane (APU) nanoparticles are polymeric nanoparticles, especially developed for remedial applications. A number of APU particles have been synthesized using (poly)urethane acrylate anionomer (UAA) and polyethylene glycol (PEG)-modified urethane acrylate (PMUA) as precursor chains [45]. APU nanoparticles can potentially replace the traditional surfactants, which are commonly used to facilitate the remediation of hydrophobic organic contaminants (HOCs).

HOCs often sorb strongly to soils or form nonaqueous phase liquid (NAPL) and cause a large problem for successful pump-and-treat remediation. Surfactants have been used to overcome this problem in pump-and-treat-systems [50]. However, surfactants that are chemically unstable can be easily lost in the process. The cross-linking of polymer chains within UAA particles makes them significantly more stable than surfactant micelles, while having similar desorption capabilities [45].

Suitability of the particles for treating various soil types should be investigated. Also toxicology of the polymeric nanoparticles designed for soil remediation and the development of a recovery and recycling process for the particles need to be studied.

#### **6.3.2.4 Ferritin-Encapsulated Metal Oxides**

Cage-shaped proteins can often function as controlled environments for the assembly and encapsulation of nano-sized materials. Ferritin, which is able to store iron, is a prime example of this occurrence. Ferritin is composed of 24 polypeptide subunits, which self-assemble into 3D, hollow complexes under certain conditions [24].

The metal ions then become bound to sites in the central cavity. The contribution of ferritin to the photoreduction of contaminants makes it helpful for remediation [24]. Despite that normally Fe (III) is able to carry out significant photochemical processes, the Fe (III)-bearing iron oxide quickly becomes photoreduced to Fe (II), which makes the catalyst inactive. The ferritin naturally converts Fe (II) to Fe (III), and the protein encapsulation of the iron oxide prevents its conversion back to Fe (II) without inhibiting the rate of decontamination [24]. Hexavalent chromium (Cr (VI)), a dangerous carcinogen, was reduced to the trivalent form Cr (III), which is ubiquitous and less toxic using ferritin [24]. This technology also offers potential remedial capabilities for aromatics, chlorocarbons, and nuclear contaminants.

No specific toxicity studies or safety concerns have been reported for ferritin. Since ferritin is naturally occurred, its application may cause little amount of toxicity for living animals, plants, and microbes. Concerns about ferritin should be focused on the ecological effects of its deployment in the environment.

#### **6.3.2.5 Single-Enzyme Nanoparticles**

The characteristics of enzymes make them more effective than synthetic catalysts in many areas of application. However, the lack of stability and relatively short life of enzymes is a cost-limiting factor for large-scale remedial purposes [25].

Single-enzyme nanoparticles (SENs) are a form of enzyme that is chemically stable and environmentally persistent [25]. SENs are resistant to extreme conditions such as high/low pH, high contaminant concentration, high salinity, and high/low temperature [25].

The type of enzyme employed for remediation is selected based on the contaminant. Peroxidases, polyphenol oxidases (laccase and tyrosinase), dehalogenases, and organophosphorus hydrolases are examples of applicable enzymes [4]. The large variety of applicable enzymes allows the potential remediation of an extremely broad class of organic contaminants.

There are no specific toxicity studies concerning the use of SENs as a remedial tool. Their enzymatic basis would point to its lack of toxicity. However, their potential persistence in the environment and/or in mammals if absorbed or ingested should be more clearly investigated.

#### **6.3.2.6 Self-Assembled Monolayers on Mesoporous Supports**

Self-assembled monolayers on mesoporous supports (SAMMS) were developed by the US Pacific Northwest National Laboratory (PNNL). SAMMS are a combination of mesoporous ceramics (with pore diameters between 2 and 50 nm) and self-assembled chemical monolayers. Both the monolayer and the mesoporous support can be functionalized to remove certain contaminants (e.g., Hg, Cd) [44].

SAMMS have higher removal capacity, faster adsorption, and better selectivity compared to other membrane and sorbent technologies such as ion exchange resins, activated alumina filters, and ferric oxide filters. This is because of the rigid, open-pore structure of SAMMS, which leaves all of the binding sites available to bind contaminant molecules [44]. The most famous type of SAMMS is the

thiol-SAMMS, which was specially developed for the removal of mercury from liquid media. SAMMS can also be used for the filtration of water.

This technology is still too expensive for everyday drinking water treatment applications. But it is expected to become cost-effective for this purpose in the near future [47].

### 6.3.2.7 Dendrimers

Dendrimers are highly branched, globular macromolecules, which represent a novel class of 3D and fall into a broader category deemed dendritic polymers. This category includes hyperbranched polymers, dendrigraft polymers, and dendrons. They consist of three major components: core, branches, and end groups [10]. The size of dendrimers ranges between 2 and 20 nm.

Poly(amidoamine) (PAMAM) dendrimers are the most common class of dendrimers, which was first used by Diallo et al. in 1999 [11]. Currently PAMAM dendrimers have been developed for use in the remediation of waste water and soil contaminated with a variety of transition metal ions such as copper (Cu(II)). Toxicity concerns are currently being researched for remedial dendrimers.

### 6.3.2.8 Nanocrystalline Zeolites

The term zeolite represents a very broad group of crystalline structures generally comprised of silicon, aluminum, and oxygen [42]. Because of the physicochemical properties of zeolites and their rigid 3D structures, they can offer superior sorption and hydraulic properties and have found use as molecular sieves and sorbents in wastewater treatment. Zeolites have been particularly useful in removing cationic species such as ammonium and some heavy metals from water [30]. Zeolites, and in particular clinoptilolites, have also been used to remove cationic radioactive species ( $^{137}\text{Cs}$ ,  $^{90}\text{Sr}$ ) from nuclear plant wastewaters and contaminated groundwaters [14]. In addition, surfactant-modified zeolite (SMZ) is capable of simultaneous sorption of anions, cations, and non-polar organic molecules from water [7].

Conventional synthesis methods produce zeolites on the scale of 1,000–10,000 nm. Decreasing the crystal size not only shortens the diffusion path lengths but also increases the fraction of the external surface area relative to the total surface area of the zeolite [28]. Nanocrystalline zeolites are porous nanomaterials with crystal sizes of less than 100 nm that possess unique external and internal surface reactivity. The ability to assemble nanocrystalline zeolites into thin films and other nanostructures facilitates the potential formation of separation membranes [42].

### 6.3.2.9 Carbon Nanotube Membranes

Nanotubes are engineered molecules most frequently made from carbon. They have a large surface area, high strength combined with light weight, and high electrical and thermal conductivity. Carbon nanotube membranes (CNMs) are able to remove almost all kinds of water contaminants, including bacteria, viruses, and organic contaminants. CMNs have also demonstrated potential for use in desalinating salty water [43].

Although the pores of CNMs are significantly smaller than the pores of other membranes, CNMs have shown the same, or even faster, flow rates. The reason behind that phenomenon is hidden in the smooth interior of the nanotubes, which walls are almost perfectly flat. Fast flow rate in CNMs reduces the amount of pressure needed to push the water through the membrane. This may result in reduction of desalination costs. Desalination using CNMs can be cheaper than reverse osmosis.

Nanotubes have also been made from titanium dioxide and can be successfully used as a photocatalytic degrader of chlorinated compounds [8].

## 6.3.3 Sustainable Products and Resource Saving

Sustainable development, which is the basis of the economic growth, ensures protection of the environment. Nanotechnology offers many innovative strategies to save resources through



improvements in the efficiency of renewable energy sources (such as solar cells, thermoelectric devices, fuel cells), energy storage (such as rechargeable batteries and supercapacitors, hydrogen storage), reduced consumption of materials (e.g., providing lighter and/or stronger construction materials or increasing the specific activity of functional materials), and the possibility of substituting alternative, more abundant materials for those that have limited availability (e.g., using nanostructured metal oxides instead of rare metals for catalysts). It also holds promise for improving the environment, by reducing waste and our dependence on nonrenewable natural resources, and in cleaning up existing pollution [31].

Carbon nanoparticles and nanofibers are examples of environmentally friendly materials, which are much more energy intensive compared to aluminum. Two recent studies, one on nanofibers and the other on nanoparticles, show that carbon nanofibers produced from a range of feedstock materials require 13–50 times the energy required for the production of primary aluminum on an equal mass basis [23], while the carbon nanoparticles study finds their energy intensity to be 2–100 times that of aluminum [27].

Nanoporous silicon is another example of resource-saving products. It has advantages as a material for solar cells, including its antireflection, light trapping, and surface passivation properties; the reduced thickness of the active layer due to the lower diffusion length for efficient charge collection; and a higher attainable voltage [5].

By application of materials with nano-sized features in the design of the electrodes, more and faster storage of energy in batteries becomes possible. By using these materials, batteries have become smaller and lighter. Among others, researchers are working on a battery that is based on carbon nanotubes. It may be expected that due to the large surface area of the carbon nanotubes, charging can become more or less instantaneous.

## 6.4 Risk of Nanotechnology

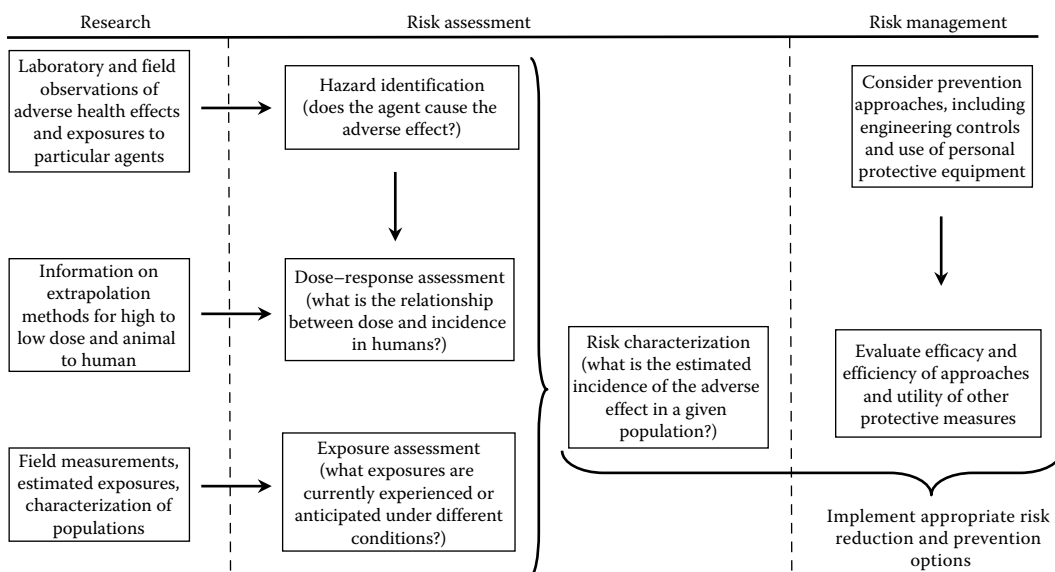
---

Occupational and environmental exposures to a limited number of engineered nanomaterials (ENMs) have been reported [33]. Little is known about health and environmental effects associated with exposure to ENMs. Therefore, some questions have been raised about potential risks from such exposures particularly in the past 5 years [12,13,32].

Some of the special properties that make nanomaterials useful are also properties that may cause some nanomaterials to pose hazards to humans and the environment, under specific conditions. The physicochemical properties of ENMs can cause the greater uptake and more biological activity of these materials compared to larger-sized particles of the same chemistry [20]. Some ENM characteristics that may influence their toxicity include size, shape, surface functionalization or coating, solubility, surface reactivity (ability to generate reactive oxidant species), association with biological proteins (opsonization), binding to receptors, and, importantly, their strong tendency to agglomerate [51]. The aspect ratio (length to diameter) of ENMs is another factor in their toxic potential. Fibers are particles with a length  $> 5 \mu\text{m}$  and aspect ratio  $\geq 3:1$  [48]. Inhaled asbestos containing high-aspect-ratio fibers is more toxic than lower-aspect-ratio fibers [51].

The risk assessment of chemicals, which originally described by the US National Research Council [36], has been put forward as the most relevant approach to understand and quantify the potential risks of ENMs [15]. The framework is depicted in Figure 6.1. This framework consists of a four-step process: (1) hazard identification, (2) dose–response assessment, (3) exposure assessment, and (4) risk characterization.

In order to determine the extent of environmental exposure to ENMs, their behavior in the environment should be understood. Until now, a very limited number of studies have been conducted on the environmental fate of ENMs, and fundamental mechanisms behind the distribution of most of them are still unknown [18].



**FIGURE 6.1** The risk assessment/risk management framework. (Modified from NRC, 1983, Risk Assessment in the Federal Government: Managing the Process, Committee on the Institutional Means for Assessment of Risks to Public Health, National Research Council: The National Academies Press, Washington, DC; Yokel, R.A. and MacPhail, R.C., *J. Occup. Med. Toxicol.*, 6, 1, 2011.)

### 6.4.1 Fate of Engineered Nanomaterials in Air

The fate of engineered nanoparticles (ENPs) in the air is determined by three main factors: (1) the duration of time particles remain airborne, (2) their interaction with other particles or molecules in the atmosphere, and (3) the distance they are able to travel in the air [3].

### 6.4.2 Fate of ENMs in Water

The fate of ENMs in water is controlled by several factors: (1) aqueous solubility or dispersibility, (2) reactivity of the ENMs with the chemical environment, and (3) their interaction with natural and anthropogenic chemicals [46].

Because of their lower mass, ENMs generally settle more slowly than larger particles of the same material. However, due to their high surface-area-to-mass ratios, ENMs can be readily sorbed to soil and sediment particles and consequently have the potential to remove from the water column [37]. Some ENMs can also be removed from water column by abiotic (hydrolysis and photocatalysis) and biotic degradation [9]. The fate of nano-sized particles in water/wastewater is strongly affected by pH. It is another variable that may affect sorption and settling of nanomaterials [46].

In contrast to the removal processes mentioned previously, some insoluble ENMs can be stabilized in aquatic environments. As an example, the aqueous stability of multiwalled carbon nanotubes for over 1 month in the presence of natural organic matter was investigated by Hyung et al. [19].

### 6.4.3 Fate of ENMs in Soil

The fate of ENMs in soil media can change, depending on the physical and chemical characteristics of the material. Because of their high surface areas, some ENMs can strongly sorb to the soil particles and become immobile [46]. On the other hand, if ENMs do not become trapped in the soil matrix, they

might fit into smaller spaces between soil particles and might therefore travel farther than larger particles. The size, chemical composition, and surface characteristics of ENMs will influence on their sorption strength to soil [46]. The types and properties of the soil and environment (e.g., clay versus sand) are also important factors in nanomaterial mobility [49].

#### **6.4.4 Biodegradation and Chemical Transformation of ENMs**

The biological processes can completely break down the ENPs and sometimes they can only change their physical structure or surface characteristics of the material. The potential for biodegradation is strongly dependent on the material properties. Most of the ENPs in current use are composed of not easily biodegradable materials, such as ceramics, metals, and metal oxides [46]. The biodegradation mechanisms of ENMs in the environment are not fully known, and therefore, much further researches are needed.

### **6.5 Nanoparticles and Environment: Case Studies**

---

In this section, three different case studies that have been conducted in Iran as a developing country with arid or semiarid zones that encountered with water deficit problem are introduced. In Iran, the 10 year strategic plan for nanotechnology development (Future Strategy) has been started since 2006. Water and environment is one of the five priorities in this plan. Studies and scientific researches in this field of technology is one of the effective tools for nanotechnology development.

#### **6.5.1 Application of Nanoparticles of Rice Husk Ash**

Existence of sulfate salts in soil, groundwater, surface water, and irrigation water threatens the concrete of hydraulic structures. One solution against sulfate salts is the utilization of anti-sulfate cement, ASTM Type 5 Portland cement, but it is more expensive than normal Portland cement (ASTM Type 1). Due to growing environmental concerns and the need to use less energy-intensive products, efforts are being made to find concrete replacement materials. In a study conducted at Isfahan University of Technology (IUT), the use of concrete incorporating nanoparticles of rice husk ash (RHA), as an agricultural waste, was investigated.

In order to burn the husks at a controlled temperature (from 550°C to 600°C for 2 h) and atmosphere, a special furnace was prepared. The experiments included 525 samples of cubical (70×70×70 mm) and cylindrical (50.8×101.6 mm) concrete, which were stored in different ages (7, 28, 60, 180 days) in three environment conditions (4% of the solutions of magnesium, calcium, and sodium sulfates), and 120 samples, which were stored in different ages (7, 28, 60, 180 days) in normal water environment conditions. The portions of RHA as cement replacement were 20 and 30 and 20% of RHA and 10% of silica fume. Also, 12 concrete canals incorporating different percentages of RHA were constructed in the field and their seepages were determined by ponding method. In order to increase the specific surface and pozzolanic activity, the RHA was milled by Los Angeles mill for 80 min (8 cycles of 10 min) and then passed through sieve number of 0.75 mm and that about 2% of RHA particles were less than 150 nm. The results showed that the concrete containing 20% RHA had higher compressive and tensile strengths up to 180 days compared with that of other treatments for the three sulfate solutions. The concrete containing RHA has better performance in the sulfated environments, so that loss of weight for the concrete containing normal Portland and anti-sulfate cements was three times of concrete containing 20% RHA. The magnesium sulfate had more corrosive effect on concrete, compared to sodium and calcium sulfates. The seepage from the concrete containing 20% RHA was about half of control concrete. The results are important especially for the hydraulic structures exposed to sulfated soil, groundwater, surface water, and irrigation water [1].

### 6.5.2 Desalination of Water Using Nanoparticles of Husk Ashes in Sand Filter

Desalination technology is a constant source to overcome the water shortage in arid and semiarid regions. In a study conducted at IUT, application of rice and almond husk ashes (AHAs), as agricultural by-products, in the sand filter of drip irrigation system was investigated. In order to produce ash from rice husk and almond husk, a special furnace was prepared [2]. RHA was produced at the temperature of 250°C–300°C after 30 min, and AHA was produced at the temperature about 700°C after 45 min. RHA and AHA were obtained in two sizes miliparticles and nanoparticles. Nanoparticles were produced with the Los Angeles Device during 1.5 h operation. Two volumes percent, 10 and 20, were considered for mixing the active carbon with sand filter. The saline water (EC= 12 dS/m) entered in to the sand filter container, under two flow rates of 3 and 6 m<sup>3</sup>/h. Sampling was completed in 50 min and was subjected to analysis for EC, sodium (Na<sup>+</sup>), calcium (Ca<sup>2+</sup>), carbonate (CO<sub>3</sub><sup>2-</sup>), bicarbonate (HCO<sub>3</sub><sup>-</sup>), chloride (Cl<sup>-</sup>), magnesium (Mg<sup>2+</sup>), sulfate (SO<sub>4</sub><sup>2-</sup>), hardness, sodium adsorption ratio (SAR), and pH. Comparing of the two ash particles, it seems that the particles of AHA are more effective on ion removal and reduction of water EC. Statistically, after using nanoparticles, there were a remarkable reduction in water EC, Mg, Na, Cl, CO<sub>3</sub><sup>2-</sup>, HCO<sub>3</sub><sup>-</sup>, SO<sub>4</sub><sup>2-</sup>, hardness, and SAR. It should be mentioned that, contrasting to miliparticles, nanoparticles could reduce the concentration of Ca<sup>2+</sup>; however, statistically it was not significant. The pH of outlet water from a sand filter containing AHA showed more variations compared to the pH of outlet water from a sand filter containing RHA. The amount of absorption increases with the increase of particle's contact time with absorbents. Based on this research, application of nanoparticles of RHA in drip irrigation systems, especially in case of saline water utilization, may result in reduction of emitter plugging.

### 6.5.3 Sulfate Ion Removal from Water Using Polysulfone Nanostructured Membrane

Modified polysulfone (PSf) nanofiltration membranes may be prepared from an ultrafiltration (UF) membrane through UV-graft modification for metal ion removal from water. Modification of UF membrane can be performed through either membrane material modification or membrane surface modification. In this study, which conducted at the Institute of Nanoscience and Nanotechnology, University of Kashan, both of these modifications were applied.

Original PSf membranes were prepared through phase inversion process using a homogeneous polymeric solution containing PSf (17% wt), polyethylene glycol (PEG) with molecular weight of 3000 g/mol (8% wt) and *N*-methyl-2-pyrrolidone (NMP) (75% wt). After achieving a homogeneous and transparent solution, dope solution was cast using an adjustable casting knife on a glass plate. Then the glass plate bearing PSf solution film was immersed into water coagulation. After about 1 min of phase inversion progress (solvent exchange between polymer and non-solvent), membrane was formed. During phase inversion process, dissolving PEG in water causes formation of porous PSf membrane. The obtained membrane belongs to UF category of membranes. After fabrication of PSf UF membrane via phase separation method, membrane modification by UV-assisted grafting polymerization in the presence of acrylic acid (AA) was performed. Also, the effect of grafting conditions including AA concentration and irradiation time on membrane performance properties as pure water flux and sulfate rejection was studied.

UV-induced grafting process increases membrane wettability and shifts membrane pore size distribution to a smaller size and makes NF membrane. Fourier transform infrared-attenuated total reflection (FTIR-ATR) and atomic force microscopy (AFM) were employed to characterize the chemical and structural changes on the modified membrane surface. Prepared PSf NF membranes succeeded in removal of sulfate ions such as Na<sub>2</sub>SO<sub>4</sub> (up to 96%) and MgSO<sub>4</sub> (50%) from water in a low operating pressure (300 kPa). Generally, modification processes make the NF membrane a possible candidate for water softening. As a result from the experiments, an increase in graft intensity (monomer concentration and

irradiation time) leads to decrease in pore size from 9.01 to 3.42 nm, which is accompanied by pure water flux decrease and sulfate rejection increase [16].

## 6.6 Summary and Conclusions

The environmental quality and human health are closely related to each other. Therefore, controlling the concentrations of contaminants in the environment reduces the probability of human exposure to them. Controlling pollution involves its monitoring and its reduction. Nanotechnology can provide new, more flexible, and cost-effective systems for environmental monitoring. It also offers effective remedial tools for the removal of contaminants. Remediation nanotechnologies remove contaminants from the environments in the different ways like photocatalyst oxidation, adsorption, or encapsulation. Despite the differences, however, the effective operation of most of them depends on their large and effective surface area. Although environmental technology benefits from nanotechnology, it needs to be studied further to assess the risk of exposure during manufacture or use of nanomaterials. Little is known about health and environmental effects associated with exposure to nanomaterials. So it is needed to carry out risk assessment in nanotechnology application by both developed and developing countries.

## References

1. Abedi-Koupai, J.A. and M.A. Fathi. 2003. Mechanical properties of concrete canal lining containing rice husk ash in sulfate environments. *JWSS-Isfahan Univ. Technol.* 7(2):13–27.
2. Abedi-Koupai, J. and E. Mohri. 2012. Desalination of water using nanoparticles of husk ashes in sand filter. In *Proceedings of the 4th International Conference on Nanostructures (ICNS4)*, Kish Island, Iran.
3. Aitken, R.J., S.M. Hankin, B. Ross, C.L. Tran, V. Stone, T.F. Fernandes, K. Donaldson, R. Duffin, Q. Chaudhry, and T.A. Wilkins. 2009. EMERGNANO: A review of completed and near completed environment, health and safety research on nanomaterials and nanotechnology Defra Project CB0409. Institute of Occupational Medicine Report TM/09/01, Edinburgh, U.K.
4. Alcalde, M., M. Ferrer, F.J. Plou, and A. Ballesteros. 2006. Environmental biocatalysis: From remediation with enzymes to novel green processes. *Trends Biotechnol.* 24(6):281–287.
5. Arico, A.S., P. Bruce, B. Scrosati, J.M. Tarascon, and W. Van Schalkwijk. 2005. Nanostructured materials for advanced energy conversion and storage devices. *Nat. Mater.* 4(5):366–377.
6. Badihi-Mossberg, M., V. Buchner, and J. Rishpon. 2007. Electrochemical biosensors for pollutants in the environment. *Electroanalysis* 19(19–20):2015–2028.
7. Bowman, R.S. 2003. Applications of surfactant-modified zeolites to environmental remediation. *Micropor. Mesopor. Mater.* 61(1–3):43–56.
8. Chen, Y., J.C. Crittenden, S. Hackney, L. Sutter, and D.W. Hand. 2005. Preparation of a novel TiO<sub>2</sub>-based p–n Junction nanotube photocatalyst. *Environ. Sci. Technol.* 39(5):1201–1208.
9. Colvin, V.L. 2003. The potential environmental impact of engineered nanomaterials. *Nat. Biotechnol.* 21(10):1166–1170.
10. Diallo, M.S., S. Christie, P. Swaminathan, J.H. Johnson Jr, and W.A. Goddard III. 2005. Dendrimer enhanced ultrafiltration. 1. Recovery of Cu (II) from aqueous solutions using PAMAM dendrimers with ethylene diamine core and terminal NH<sub>2</sub> groups. *Environ. Sci. Technol.* 39(5):1366–1377.
11. Diallo, M.S., L. Balogh, A. Shafagati, J.H. Johnson, W.A. Goddard, and D.A. Tomalia. 1999. Poly(amidoamine) dendrimers: A new class of high capacity chelating agents for Cu(II) ions. *Environ. Sci. Technol.* 33(5):820–824.
12. Dreher, K.L. 2004. Health and environmental impact of nanotechnology: Toxicological assessment of manufactured nanoparticles. *Toxicol. Sci.* 77(1):3–5.

13. European Commission, Community Health and Consumer Protection. 2004. Nanotechnologies: A preliminary risk analysis on the basis of a workshop organized in Brussels on March 1–2, 2004 by the health and consumer protection directorate general of the European commission. <http://www.certh.gr/dat/7CF3F1C6/file.pdf>
14. Gunter, M.E. and K.A. Zanetti. 2000. *Natural Zeolites for the Third Millennium*, eds C. Colella and F.A. Mumpton: De Frede Editore, Naples, Italy.
15. Hansen, S.F. 2009. Regulation and risk assessment of nanomaterials: Too little, too late?, Technical University of Denmark, Department of Environmental Engineering.
16. Homayoonfal, M. and A. Akbari. 2010. Preparation of polysulfone nano-structured membrane for sulphate ions removal from water. *Iranian J. Environ. Health. Sci. Eng.* 7(5):407–412.
17. Hristozov, D. and J. Ertel. 2009. Nanotechnology and sustainability: Benefits and risks of nanotechnology for environmental sustainability. *Forum der Forschung* 22:161–168.
18. Hristozov, D. and I. Malsch. 2009. Hazards and risks of engineered nanoparticles for the environment and human health. *Sustainability* 1(4):1161–1194.
19. Hyung, H., J.D. Fortner, J.B. Hughes, and J.H. Kim. 2007. Natural organic matter stabilizes carbon nanotubes in the aqueous phase. *Environ. Sci. Technol.* 41(1):179–184.
20. Jiang, J., G. Oberdörster, A. Elder, R. Gelein, P. Mercer, and P. Biswas. 2008. Does nanoparticle activity depend upon size and crystal phase? *Nanotoxicology* 2(1):33–42.
21. Jiménez-Cadena, G., J. Riu, and F.X. Rius. 2007. Gas sensors based on nanostructured materials. *Analyst* 132(11):1083–1099.
22. Karn, B., T. Kuiken, and M. Otto. 2009. Nanotechnology and in situ remediation: A review of the benefits and potential risks. *Environ. Health Perspect.* 117(12):1813.
23. Khanna, V., B.R. Bakshi, and L.J. Lee. 2008. Carbon nanofiber production. *J. Ind. Ecol.* 12(3):394–410.
24. Kim, I., H.A. Hosein, D.R. Strongin, and T. Douglas. 2002. Photochemical reactivity of ferritin for Cr (VI) reduction. *Chem. Mater.* 14(11):4874–4879.
25. Kim, J. and J.W. Grate. 2003. Single-enzyme nanoparticles armored by a nanometer-scale organic/inorganic network. *Nano Lett.* 3(9):1219–1222.
26. Klaine, S.J., P.J.J. Alvarez, G.E. Batley, T.F. Fernandes, R.D. Handy, D.Y. Lyon, S. Mahendra, M.J. McLaughlin, and J.R. Lead. 2009. Nanomaterials in the environment: Behavior, fate, bioavailability, and effects. *Environ. Toxicol. Chem.* 27(9):1825–1851.
27. Kushnir, D. and B.A. Sandén. 2008. Energy requirements of carbon nanoparticle production. *J. Ind. Ecol.* 12(3):360–375.
28. Larsen, S.C. 2007. Nanocrystalline zeolites and zeolite structures: Synthesis, characterization, and applications. *J. Phys. Chem. C* 111(50):18464–18474.
29. Mackay, C.E., M. Johns, J.H. Salatas, B. Bessinger, and M. Perri. 2006. Stochastic probability modeling to predict the environmental stability of nanoparticles in aqueous suspension. *Integr. Environ. Assess. Manage.* 2(3):293–298.
30. Malekian, R., J. Abedi-Koupai, S.S. Eslamian, S.F. Mousavi, K.C. Abbaspour, and M. Afyuni. 2011. Ion-exchange process for ammonium removal and release using natural Iranian zeolite. *Appl. Clay Sci.* 51(3):323–329.
31. Masciangioli, T. and W.X. Zhang. 2003. Peer reviewed: Environmental technologies at the nanoscale. *Environ. Sci. Technol.* 37(5):102–108.
32. Maynard, A.D. 2007. Nanotechnology: The next big thing, or much ado about nothing? *Ann. Occup. Hyg.* 51(1):1–12.
33. Maynard, A.D., P.A. Baron, M. Foley, A.A. Shvedova, E.R. Kisin, and V. Castranova. 2004. Exposure to carbon nanotube material: Aerosol release during the handling of unrefined single-walled carbon nanotube material. *J. Toxicol. Environ. Health, Part A* 67(1):87–107.
34. Nagaveni, K., G. Sivalingam, MS Hegde, and G. Madras. 2004. Photocatalytic degradation of organic compounds over combustion-synthesized nano-TiO<sub>2</sub>. *Environ. Sci. Technol.* 38(5):1600–1604.

35. Nowack, B. 2008. Pollution prevention and treatment using nanotechnology. In *Nanotechnology*: Wiley-VCH Verlag GmbH & Co. KGaA, Weinheim, Germany.
36. NRC. 1983. *Risk Assessment in the Federal Government: Managing the Process*, Committee on the Institutional Means for Assessment of Risks to Public Health. National Research Council: The National Academies Press, Washington, DC.
37. Oberdörster, G., E. Oberdörster, and J. Oberdörster. 2005. Nanotoxicology: An emerging discipline evolving from studies of ultrafine particles. *Environ. Health Persp.* 113(7):823.
38. Pummakarnchana, O., N. Tripathi, and J. Dutta. 2005. Air pollution monitoring and GIS modeling: A new use of nanotechnology based solid state gas sensors. *Sci. Technol. Adv. Mater.* 6(3):251–255.
39. Raab, C., M. Simko, U. Fiedeler, M. Nentwich, and A. Gazso. 2011. Production of nanoparticles and nanomaterials. *Nano Trust Dossier* 6:1998–7293.
40. Rickerby, D.G. and M. Morrison. 2007. Nanotechnology and the environment: A European perspective. *Sci. Technol. Adv. Mater.* 8(1):19–24.
41. Rogers, K.R. 2006. Recent advances in biosensor techniques for environmental monitoring. *Anal. Chim. Acta* 568(1):222–231.
42. Song, W., V.H. Grassian, and S.C. Larsen. 2005. High yield method for nanocrystalline zeolite synthesis. *Chem. Commun.* 2005 (23):2951–2953.
43. Srivastava, A., O.N. Srivastava, S. Talapatra, R. Vajtai, and P.M. Ajayan. 2004. Carbon nanotube filters. *Nat. Mater.* 3(9):610–614.
44. SAMMS Technical Summary. *Pacific Northwest National Laboratory (PNNL)* 2009. [http://samms.pnnl.gov/sammstech\\_summary.pdf](http://samms.pnnl.gov/sammstech_summary.pdf)
45. Tungittiplakorn, W., W. Leonard, C. Cohen, and J.Y. Kim. 2004. Engineered polymeric nanoparticles for soil remediation. *Environ. Sci. Technol.* 38(5):1605–1610.
46. U.S. Environmental Protection Agency. 2007. Nanotechnology White Paper. EPA 100/B-07/001. <http://www.nanowerk.com/nanotechnology/reports/reportpdf/report40.pdf>
47. Watlington, K. 2005. Emerging nanotechnologies for site remediation and wastewater treatment. U.S. Environmental Protection Agency. [http://83.cebed1.client.atlantech.net/download/studentpapers/K\\_Watlington\\_Nanotech.pdf](http://83.cebed1.client.atlantech.net/download/studentpapers/K_Watlington_Nanotech.pdf)
48. WHO/EURO. 1985. Technical Committee for Monitoring and Evaluating Airborne MMMF: Reference methods for measuring airborne man-made mineral fibres (MMMF), WHO/EURO MMMF Reference Scheme, monitoring concentration using a phase contrast optical microscope, determining size using a scanning electron microscope. In *Regional Office for Europe, Copenhagen*: World Health Organization, Regional Office for Europe, Copenhagen.
49. Wiesner, M.R., G.V. Lowry, P. Alvarez, D. Dionysiou, and P. Biswas. 2006. Assessing the risks of manufactured nanomaterials. *Environ. Sci. Technol.* 40(14):4336–4345.
50. Yeom, I.T., M.M. Ghosh, and C.D. Cox. 1996. Kinetic aspects of surfactant solubilization of soil-bound polycyclic aromatic hydrocarbons. *Environ. Sci. Technol.* 30(5):1589–1595.
51. Yokel, R.A. and R.C. MacPhail. 2011. Engineered nanomaterials: Exposures, hazards, and risk prevention. *J. Occup. Med. Toxicol.* 6(7):1–27.
52. Zhang, W. 2003. Nanoscale iron particles for environmental remediation: An overview. *J. Nanopart. Res.* 5(3):323–332.

# Formation of Ecological Risk on Plain Reservoirs

---

Svetlana Dvinskikh

*Perm State University*

Alexander Kitaev

*Perm State University*

Victor Noskov

*Perm State University*

Olga Larchenko

*Perm State University*

7.1	Introduction .....	120
7.2	Risks from Heat and Chemical Pollution .....	121
	Water Balance Method • Method of Chemical Balance • Heat Balance	
7.3	Thermal Pollution.....	134
7.4	Formation of Reservoirs Banks .....	139
	Role of Indented Coastline in the Formation of a Shore	
7.5	Summary and Conclusions .....	144
	References.....	144

## AUTHORS

**Svetlana Dvinskikh** has a doctorate in geographical sciences and is professor, head of the department of hydrology and water resources protection (faculty of geography, Perm State University, Russian Federation). Professor Dvinskikh is an academician of the International Academy of Ecology, Man and Nature Protection Sciences, and has won several academic and other awards, including the honour title of the Perm Region Person of the Year (2000) and honour title RF Merited Worker of the Higher School (2008). Professor Dvinskikh has more than 260 published works, including 12 monographs and manuals. In 2007, 2009, and 2011, she was the organizer of the international scientific and practical conference “Modern Problems of Reservoirs.” She has been successful in winning a number of research grants, for example, grant from RFBR for Systematization of the Environmental Risk Hydrological Conditions on Water Bodies of Different Genesis (in Perm region) (2006–2009); Theoretical Basis for the Complex Study of Reservoirs Areas Experiencing Significant Human Impact (2007–2010); Theoretical Justification of Sand and Gravel Deposit Management under Current State of Kama Reservoirs Aquatic Ecosystems (2010–2012). Professor Dvinskikh is a member of the Scientific and Technical Council of Perm Regional Environmental Department and Kama Water Basin Administration. Spheres of her scientific interests include (1) questions on assessment of pollution and protection of superficial water objects, and formation of hydrological risk, and (2) system methodology and its use in geo-ecology.

**Alexander Kitaev** is a candidate of geographical sciences and an associate professor at department of hydrology and water resources protection (faculty of geographical, Perm State University, Russian Federation). Alexander has more than 350 published works, including 13 monographs and manuals, reports, journal, and conference papers. He is also the chief editor of Geographical Bulletin (scientific journal) and Current Problems of Reservoirs and Their Spillways (Proceedings of International Scientific Practical Conference). Since 2009 he has been the corresponding member of the International Academy of Ecology, Man and Nature Protection Sciences. His main scientific direction is research on the formation of hydrodynamic and hydrochemical modes of natural and artificial superficial water objects.



**Victor Noskov** is a candidate of geographical sciences and an associate professor at department of hydrology and water resources protection (faculty of geography, Perm State University, Russian Federation). Victor has published a large number of scientific books, reports, journal, and conference papers. His research interests include climate parameter variability and climate changes in urban areas, impact of atmospheric processes on a thermal mode of reservoirs, and research on thermal pollution of reservoirs.

**Olga Larchenko** is a candidate of geographical sciences and an associate professor at department of hydrology and water resources protection (faculty of geography, Perm State University, Russian Federation). She is head of the annual inter-regional scientific and practical conference of students, masters, and graduate students "Questions of a Hydrology, Geo-ecology and Protection of Water Objects." Since 2009 she has been head of the laboratory for complex researches of reservoirs at the Natural Science Institute (NSI) of Perm State University. Her area of scientific interest involves research on river bad processes in natural and artificial water objects, and questions on hydrography of water currents and reservoirs. She is the author of 40 scientific works, including one monograph, manuals, reports, journal, and conference papers.

## PREFACE

In recent years, different natural disasters have raised the importance of research devoted to development patterns, risk forecast, and the management of these processes. These issues have become the object of different sciences related to human activity.

In the contemporary scientific literature, a risk is considered to be the result of different factors (natural, natural-technogenic, and technogenic) influencing natural components. Risk expresses the possibility of a disaster, accident, or further abnormalities in the existence and function of ecological systems. Unfortunately, common criteria for risk estimation have not been worked out yet.

Permissible mortality is considered to be a reliable criterion, but it does not suit water objects. The present research suggests estimating risk to water objects through the formation processes happening at them. Risk processes occur differently at water objects with different genesis even with the existence of similar factors. It is hard to research risks at reservoirs as they are characterized by disturbance of the natural regime.

The present chapter presents the authors' approach to the thermal and chemical conditions. The present approach is based on the water balance equation and its use for homogeneous morphometric areas.

Creation of big reservoirs has disturbed the existing course of exogenous geological processes and has caused the rough reorganization of a coastline relief. Immediate filling of a reservoir has activated geodynamic processes: erosion has been substituted by abrasion (where waves destroy reservoir banks). The present research argues that it is possible to estimate bank distraction with the help of the reservoir indented coastline coefficient, which may be used for long-range forecasting of coastline development.

## 7.1 Introduction

Rapid development of hydraulic engineering constructions and creation of large reservoirs, their cascades, and systems in river basins have been typical to the second half of the twentieth century. New water bodies have appeared and their number has increased in all countries and on all continents. Thus, a reservoir should be considered a global phenomenon. Artificial reservoirs themselves are not zonal

objects, that is, they are not typical to the natural areas in which they are created. It is a new water body, the formation of which is due to close interactions with the primeval nature. Changing this primeval nature causes the appearance of new geographic complexes and their territory is measured by thousands of square kilometers. The hydrological aspect of the problem is the basis for many of these processes. It determines the thermal and hydrochemical conditions of a reservoir, its bank formation, etc. Investigation of the conditions for the formation of hydrochemical regime of reservoirs, improvement of calculations, and forecast methods forms a relevant issue caused by the need to develop measures to protect water resources and improve water quality in artificial reservoirs. Identifying the role of the main hydrodynamic factors in the formation of the hydrochemical regime of artificial reservoirs allows us to improve the methods of assessing the peculiarities of the chemical composition and formation conditions of individual parts of water reservoirs. It also allows us to identify areas with unfavorable conditions from the water quality point of view in order to develop subsequent measures to limit pollution and, if possible, to for their complete removal.

## 7.2 Risks from Heat and Chemical Pollution

The balance method may be used to calculate the possibility of chemical and thermal risks. The calculation is based on the solution of the water balance equation.

### 7.2.1 Water Balance Method

The water balance method for estimating water flow at the boundaries of morphometric sections of reservoirs is based on the calculation of the balance in any section of a reservoir, but the section should be limited with input and output reservoir sections. The water balance equation of a morphometric section of a reservoir, over a period of time ( $t$ ), has the form:

$$V_t - V_{t-1} = \left( Q_1 \sum_{t-1}^t \tau - Q_2 \sum_{t-1}^t \tau \right) + W_{CI} + W_{GI} + W_P + W_{IMI} - (W_E + W_I + W_D) \pm H \quad (7.1)$$

where

$V_t$  and  $V_{t-1}$  are the volume of the water mass in the section in the final and initial time period, respectively

$Q_1$  and  $Q_2$  are the average second flow rate through the initial and final reservoir section, respectively

$\sum_{t-1}^t \tau$  is time period in seconds

$W_{CI}$  is the channel inflow into the section perimeter

$W_{GI}$  is the groundwater inflow

$W_P$  is the amount of precipitation on the reservoir surface

$W_{IMI}$  is the water entry due to ice melting and flooding in spring

$W_E$  is the evaporation from the reservoir surface in the reservoir floor and banks

$W_I$  is the removal of water for ice formation

$W_D$  is the ice dry-off during the winter draw-off

$\pm H$  is the residual balance

Currently, there are data from long-term observation of all components of water balance in reservoirs (see Equation 7.1). The only exception is the value of  $W_{CI}$  and  $W_I$ ; their observations are irregular and sometimes do not exist. A month period is considered to be the calculated period for solutions for the water balance for morphometric reservoir sections since this longer time interval is characterized by significant changes in water consumption levels, whereas a shorter time period will require

the consideration of the time during which the water level reaches the control station. This approach is typical to the practice of calculating monthly balances for reservoirs as a whole. The latter can be used as a criterion for a correct decision on the balance in reservoir sections. Solution of Equation 7.1 with the respect to the difference between the water flow through the starting and final reservoir sections in the calculated period of a calendar month allows us to proceed to the calculation of average monthly water consumption at the boundaries of the reservoir sections ( $Q_s$  and  $Q_f$ ).

The methods for calculating of the average monthly water flow through the closing reservoirs sections have been created at the Hydrology Department of Perm State University. This method is used for morphometric and channel basin reservoirs. The essence of these methods is the following:

1. The reservoir is consistently divided into sections along the length of the main and large reaches according to the peculiarities of the morphology and morphometry of the reservoir.
2. The volumes of water mass in the reservoir sections at the beginning and end of the calculated period (usually it is a month) are defined according to the known values of the water levels in the reservoir and by using curves of the volume of reservoir sections.
3. The difference in average monthly water flow between the final and starting reservoir sections is determined by solution of Equation 7.1:

$$\Delta Q = \frac{1}{\sum_{t-1}^t \tau} (V_{t-1} - V_t + W_{Cl} + W_{Gl} + W_P + W_{IMl} - W_E - W_I - W_D). \quad (7.2)$$

During reservoir draw-off, the volume of its water mass at the end of the calculated period will be less than the volume of the water mass in the reservoir sections in the beginning, that is,  $V_t < V_{t-1}$ , therefore,  $\Delta Q > 0$ , and during filling,  $V_t > V_{t-1}$  and, consequently,  $\Delta Q < 0$ ;

1. When the water flow in the starting reservoir section (the final river station) and the change in its amount between sections are known, the water flow at all reservoir sections are may consequently be calculated as follows:

$$Q_f = Q_s \pm \Delta Q \quad (7.3)$$

The method has been tested on the Kama and the Votkinsk reservoirs, and has produced satisfactory results. Below is an example of the calculation of the water balance components based on the morphometric sections of the main reach of the Kama reservoir. Its ultimate aim is to determine the average monthly water flow in the closing reservoir sections (Figure 7.1).

The procedure is as follows:

1. Determination of average monthly water levels in the reservoir sections against the location of the water measuring systems. They can be determined in two ways: first is when the location of the water gauge stations coincides with the boundaries of the selected morphometric reservoir sections and the second is when the location of the water gauge stations does not coincide with the boundaries of the reservoir sections. In the first case, the value of average monthly water levels for the starting and final range at the beginning and end of a month is taken according to the facts of the observation. According to these data, we calculate the average monthly water level for all the sections of the reservoir. This is the easiest way of calculation and error of calculation is minimal in this case. In the second case, an interpolation is used, which naturally increases errors. Since the location of the water gauge stations on the Kama reservoir does not coincide with the boundaries of the reservoir sections, the second way for determining the average monthly water flow is used. In the second case, calculation is as follows: (a) curves of the free surface are constructed at the beginning (first date) of each month. These curves are based on known values of all water levels available in the water gauge stations in the backwater zone; (b) the levels of water are read using the curves of the free surface at the beginning and end of the month for the entrance and

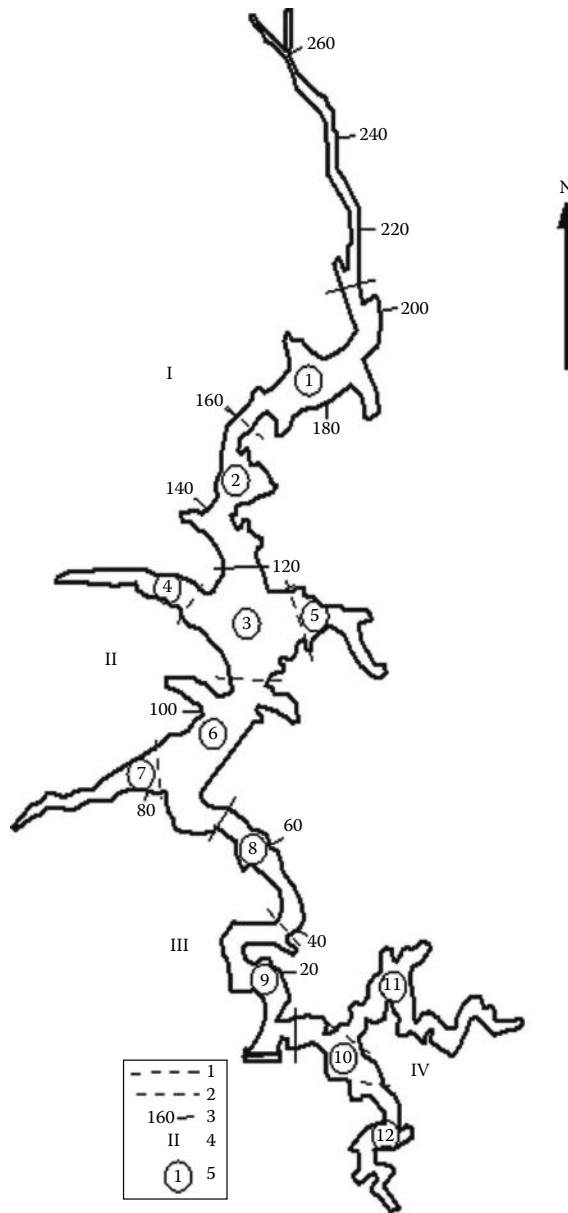


FIGURE 7.1 The scheme of the morphological taxa of the Kama Reservoir.

outlet of each reservoir section. The value of the water level at the beginning of January is read from the curve of this month and the value at the end of the month is read using the next curve (for February); for February, the value of water level is read using the February curve and in the end, using the March curve, and so on; (c) the average water level is defined as the normal at the entrance range and the outlet of each reservoir section at the beginning and end of a month.

2. Calculation of estimated water flow at the entrance range and the outlet of each reservoir section:
  - a. The volume of water mass in all reservoir sections is calculated from the Burmester curve of all reservoir sections according to certain water levels at the beginning and end of a month. The calculation is performed by using the following equation:

$$\Delta Q = \frac{1}{\sum_{t-1}^t \tau} (V_{t-1} - V_t); \text{ change in average monthly water level } (\Delta Q) \text{ at the fixed ranges.}$$

The water flow for the entrance range is calculated according to the known average monthly water flow in the entrance range of the first reservoir section. The water flow for all ranges of the reservoir sections is similarly calculated. The obtained values of water flow are specified by the amendment to the elements of the water balance.

3. Calculation of the amendment to the elements of the water balance. The data for all the water balance of the reservoir as a whole are used for the calculation:
  - a. The water balance components are differentiated by the reservoir sections depending their length or area. Thus, the channel inflow from the unrecovered observation area is determined according to the length of the coastline and the additional flow of water from ice melting, precipitation, and evaporation is estimated on the distribution of water area of the reservoir section. The channel flow from the covered observation area is taken into account in areas where this river flows into the reservoir. For example, in the third section, the river flow of Inva and Kosva is taken into account; on the sixth, of the Obva River; and on the 9th, of the Sylva and Chusovaya rivers. The water balance, mentioned in "Materials of the observations at lakes and reservoirs," includes the total channel inflow. To calculate the water flow from the unrecovered observation areas, the water flows of large rivers are subtracted from the general value of the channel inflow.
  - b. An amendment based on the results of the balance components of each of them is found when solving the equation of water balance for the reservoir sections (Equation 7.1).
  - c. The calculated water flow at the final ranges of the reservoir sections is obtained by adding the amendment to the previously calculated water flow.
  - d. The reliability of the obtained results is checked against the final range of the reservoir (hydroelectric power station), because its water flow is known. Calculation results obtained by the proposed method (in both Kamsky reservoirs over many years) have shown that error in determining the average monthly water flow is mainly about 5%–10%, that is, they are within the accuracy of hydrometric measurements.

Spatial and temporal changes in the water flow in the reservoirs' cascade and in their particular parts are determined by the nature of water body exploitation, that is, the nature and amount of water discharged through a hydroelectric power station dam. The latter is determined by the requirements of various sectors of the economy and, above all, energy. Changes in water flow on the Kama reservoir in space and time are also determined by the size and type of water entry from the main river (Kama) and most major tributaries (Chusovaya, Sylva, Inva, Kosva, Yayva, Obva). Since the Votkinsk reservoir is a lower component in the cascade, the water flow changes in it are determined by the volume of received water through the dam of the Kama hydroelectric power station, in addition to the discharge through the dam of the Votkinsk hydroelectric power station. Channel inflow into the Votkinsk reservoir is low. It constitutes up to 5%–6% of the incoming part of the water balance of the reservoir, and so it does not play a significant role in the change of the water flow as according to the length of the reservoir and time.

The within-year course of the average monthly values of water flow ( $Q$ ) at all areas of the Kama and Votkinsk reservoirs is characterized by distinct periods (phases): spring filled with maximum values of water flow, the summer–autumn period, and winter showing reservoir draw-off.

$Q$  in the last two periods is much lower than in spring (especially in high-water years); in the summer–autumn period, there is a possible increase in  $Q$  due to rain flooding. The nature of the within-year changes in the water flow in the different parts of the reservoirs' cascade is the same, and its extent is smaller in years with differences in the high-water component, although the amount of water flow in this case may significantly differ. For most years, summer is characterized by an excess of  $Q$  over the

winter period. This is particularly clearly observed for the Kama reservoir; at the Votkinsk reservoir, this tendency is also present, although the difference is appreciably smaller.

The most significant amplitude of the oscillation in water flow in a year is indicated in the upper parts of the reservoirs. It decreases as we move from the backwater pinch area to the dam of the hydroelectric power stations. A significant increase in amplitude is observed in the dam part of the Kama reservoir, which is associated with water entry from Sylvensk–Chusovoy reach within its limits. The Kama reservoir among all reservoirs' cascades is characterized by the maximum amplitude of oscillation in  $Q$ . The role of the natural factor in the change in water flow is much greater at this reservoir and besides it is the first unit of the cascade. For example, in the low-flow period (1967), in various parts of the Kama reservoir, amplitudes of annual oscillation in  $Q$  were as follows: Tyulkino, 2150 m<sup>3</sup>/s; Chermoz, 1700 m<sup>3</sup>/s; and Dobryanka, 1250 m<sup>3</sup>/s; the amplitudes of annual oscillation in  $Q$  in the various ranges of the reservoirs sections of the Votkinsk were as follows: Perm, 830 m<sup>3</sup>/s; Zhulanovka, 690 m<sup>3</sup>/s; and the Votkinsk hydroelectric power station, 280 m<sup>3</sup>/s [3]. The actual values of the amplitudes of oscillations in  $Q$  in the Votkinsk reservoir in high-water years may be a bit higher than those in the Kama reservoir. But the extent of excess water flow in spring over winter is much higher in the Kama reservoir even in high-water years (as well as in the medium- and low-flow periods). For example, the amplitude value in high-water 1965 in the central part of the Kama reservoir (Chermoz) was 4540 m<sup>3</sup>/s, which is slightly lower than a similar value in the central part of the Votkinsk reservoir (Zhulanovka), 4870 m<sup>3</sup>/s; but spring water flows were 15.6 times those in winter in the first case (4850 m<sup>3</sup>/s in May and 310 m<sup>3</sup>/s in March), whereas in the second case, spring water flows were 6.1 times those in winter (5830 and 955 m<sup>3</sup>/s). In the long-term perspective, the greatest amplitudes are observed in both the reservoirs in high-water years, the lowest ones being observed in the low-flow periods.

The changes in water flow along the length of the reservoirs' cascade are characterized by non-linearity: there is a wave of water flow, with different positions of the wave crest and a shallow wave gully during reservoir filling and draw-off. The water flows reduce from the area of the backwater pinch to the lower parts of the reservoir during the spring reservoir filling (usually in May). We observe a significant increase in  $Q$  at the dam site of the Kama reservoir due to the entry of large amounts of water from the Sylvensk–Chusovoy reach. In the summer–autumn period, we observe a slight increase in the water flow along the reservoir length.  $Q$  slightly increases at the Votkinsk reservoir during this period due to its small channel inflow. But it is significantly higher than at the Kama reservoir. This increase in the water flow is observed from the upper reservoir sections toward the dam during the winter reservoir draw-off. The most intense growth of  $Q$  in this period, as well as in summer, is marked at the Kama reservoir.

## 7.2.2 Method of Chemical Balance

The method of chemical balance research of artificial reservoirs according to their morphological taxa is a hydrodynamic approach to their solution [3]. It can be successfully used to solve the balance sheet at various stages of reservoir usage, and can be used in the preparation of forecasts for the next and distant (in the form of alternative calculations) prospects according to the planned water management activities in the basins of the investigated reservoirs.

The method of chemical balance research of valley reservoirs according to its districts and sections is based on the following procedure: a reservoir is divided into districts according to the peculiarities of its morphology and morphometry; the water balance of the reservoir sections is calculated according to the data observations of the hydrological regime; the most important role of the hydrodynamic factors in the formation of the hydrochemical regime of the reservoir sections is identified; the solution of the balance of the chemical balance in the reservoir districts and sections is estimated on the basis of field observations of the chemical composition of water. The calculation of the chemical balance of the reservoir sections and districts on the basis of total mineralization and the major components of the chemical water composition is based on the comparison of the income and outlay of the solutes across the initial

and final ranges of these taxonomic units. The equation of the mineral balance for the morphometric area can be written as follows:

$$S_t = S_{t-1} + S_I + S_{pr} + S_{ind.drain} + S_b + s_{g.w} - S_{fr} - S_{filtration} - S_e - S_{agr.needs} - S_{ac} \pm S_{ice} \quad (7.4)$$

where

$S_{t-1}$  and  $S_t$  are the amount of solute in the reservoir at the beginning and end of the calculated period, respectively

$S_I$  is the inflow of solutes to the initial range of the reservoir section

$S_{pr}$  is the inflow of solutes with precipitation to the reservoir surface

$S_{fr}$  is the removal of solutes through the final range of the reservoir section

$S_{agr.needs}$  is the solute removal during diversion flow for agricultural needs

$S_{filtration}$  is the solute outflow during filtration

$S_{ice}$  is the change in the income and outlay of dissolved substances due to ice formation and melting

$S_{ind.drain}$  is the flow of solutes into the reservoir with industrial drainage

$S_b$  is the salt entry into the reservoir with rocks by dissolution and leaching of karst collapse banks

$S_{g.w}$  is the flow of solutes with the groundwater

$S_e$  is the loss of salt by evaporation

$S_{ac}$  is the outflow of the dissolved substances in the ground floor of the reservoir, their accumulation in the bottom layer (less than a meter from the bottom), and in the dead volume of the reservoir

The presence of such components as  $S_{ind.drain}$  and  $S_b$  in the equation is determined by the fact that in some particular years, they can account 12%–26% and 5%–18%, respectively, of the total dissolved solids in the inflow of the Kama reservoir. All components of the Equation 7.4 can be divided into two groups depending on how the liquid water content of the year influences them. Such components as  $S_{pr}$ ,  $S_{ind.drain}$ ,  $S_{g.w}$ ,  $S_{filtration}$ ,  $S_e$ ,  $S_{agr.needs}$ ,  $S_{ac}$ , and  $S_{ice}$ , in contrast to the values of  $S_I$ ,  $S_b$ ,  $S_{fr}$ , and  $S_{t-1}$ , are more “stable,” that is, the liquid water content affects them much less and sometimes indirectly. In addition, calculation of the components of the first group of individual reservoir sections requires a large amount of facts, which are available in insufficient quantities or do not exist in some cases. When we calculate the balance of the chemicals in the reservoir sections based on the evidence of mineralization and the main components of the chemical composition of water, the components of the first group in Equation 7.4 is advisable to be used for calculation:

$$\sum S = S_{ind.drain} + S_b + S_{pr} + S_{g.w} - S_{filtration} - S_e - S_{agr.needs} - S_{ac} \pm S_{ice} \quad (7.5)$$

In this case, Equation 1.4 has the following form:

$$S_t = S_{t-1} + (S_I - S_{fr}) \pm \sum S \quad (7.6)$$

or

$$\sum S = S_{fr} - S_I + (S_t - S_{t-1}) \quad (7.7)$$

Calculation of balance in this equation is reduced to the determination of the total component of the balance ( $\sum S$ ), which can be either positive or negative. A positive value of  $\sum S$  indicates entry of additional minerals in the reservoir section, whereas a negative value means removal of substances from the water mass of the reservoir section. The absolute value of  $\sum S$  and its sign characterize the general orientation process.

Balance calculation based on the sum of the ions or major components of the chemical composition of water, in principle, involves prediction of the dissolved substances in the water mass in a reservoir ( $S_r$ ). The final goal of this forecast will be the calculation of mineralization size or the amount of major ions. This goal can be achieved if all balance components are either known or can be reliably determined. The greatest difficulties arise in the calculation of  $\Sigma S$ . Obviously, calculation of the balance for practical purposes must be preceded by the definition of this quantity for the entire period of the reservoir, its static analysis, and identification of its dependence on the formation of the major factors for each morphometric reservoir section. Since calculation of  $\Sigma S$  is very complex, it is necessary to determine its value from actual values of  $S_p$ ,  $S_{i-1}$ ,  $S_p$ , and  $S_f$  in the first stage of research on the chemical balance at the morphometric reservoir sections. The amount of mineral substances released into the starting range of the reservoir section ( $S_s$ ), and passing through its final alignment ( $S_f$ ), are, respectively, determined by

$$S_s = Q_s M_s \tau \quad (7.8)$$

and

$$S_f = Q_f M_f \tau \quad (7.9)$$

where

$Q_f$  and  $Q_s$  are the water flow at the starting and final reservoir sections  
 $M_s$  and  $M_f$  are their corresponding mineralization  
 $\tau$  is the calculated period

For the calculated period, as well as in calculating the water balance of the reservoir according to its areas and districts, it is advisable to use a calendar month. There are two possibilities to determine the mineralization at the boundaries of the reservoir sections: the first, when the places for sampling for chemical analysis coincide with the boundaries of the morphometric reservoir sections, and second, when the sampling points do not coincide with the boundaries of the reservoir sections. In the first case, the amount of mineralization (averaged along the effective cross-section) at the starting and final power sires is calculated according to its actual values. In the second case, the interpolation method is used.

At the Kama cascade of reservoirs, the sampling points often do not coincide with the boundaries of their morphometric sections for many years for various reasons. A similar pattern is observed in many other reservoirs of the country. Therefore, the second method is most commonly used. When the sampling points do not coincide with the boundaries of their morphometric sections, it is necessary to choose the base sites along the length of the reservoir, studying which a significant amount of hydrochemical data can be obtained. The water mineralization amounts averaged along the effective cross-sections are determined at these base sites. The need for such averaging is created by the fact that, first, the number of horizons at which water samples are collected for chemical analysis is more often different in different verticals, and, second, large differences in the values of mineralization have not been found in some verticals in the sites. To proceed from the mineralization values at the base sites to its value at the boundaries of the morphometric sections, it is necessary to plot a graph of the amount of ions along the length of the reservoir for each month of the studied years, and record the mineralization values at these section boundaries, which would later be used in the balance calculation. The quantity of actual data on the chemical composition of the reservoir waters is very limited. Besides, available data usually characterize only a few particular years and certain parts of a reservoir. In this case, it is necessary to determine the dependency of mineralization (or its major components) on the most important hydrodynamic characteristics (water flow, average velocity of channel current, water cycle coefficients, flowage coefficient) for all base sites or for all boundaries of the morphometric reservoir sections. The average monthly values of the characteristics of a reservoir's water mass dynamics and the isolated values of the reservoir's mineralization, averaged over the effective cross-section for the corresponding



period, are used while constructing the mentioned relationships. Lack of correspondence over the calculated period is primarily explained by the fact that data on the amount of ions are very limited. However, the dependencies between the characteristics of the reservoir dynamics and the characteristics of its hydrochemical regime for all base sites (or section boundaries) of the reservoir are sufficiently reliable. Apparently, the order of averaging (which equals a month for the hydrodynamic parameters) and an isolated measurement considered as an average over the effective cross-section for the hydrodynamic characteristics are similar. A characteristic feature of the reservoir is the tendency for mineralization decrease, with increase in hydrodynamic characteristics, and, accordingly, activation of mixing processes in it. For the navigation period, it is most advisable to use the dependency of mineralization on the coefficients of external water exchange, which has high degree (in comparison with other dependencies) accuracy in forecasting the deviation of the predictive values of the ion amounts from the actual amount of ions (10%–12% on average). For the period of the winter reservoir draw-off, the dependencies of the amount of ions on the volume of water received by the main river and the largest tributaries can be used, as well as the discharge of water over the dam of the hydroelectric power station. The first of these mentioned dependencies can be used for the area of the backwater wedging and the area nearest to its sections, whereas the second dependency can be used for the remaining parts of the reservoir.

To select the best way to determine reservoir mineralization on the borders of morphometric reservoir sections or in the base site, it is appropriate to use the dependency of the amount of ions on the various hydrodynamic parameters. The reservoir mineralization is determined on the basis of the finally accepted dependencies between the hydrodynamic parameters and the amount of ions for each of the base sites or the boundary of the morphometric reservoir sections for all months of the estimated number of years or the period that the reservoir existed. The reservoir mineralization corresponds to the average monthly values of the dynamics of the reservoir.

The quantity of dissolved substances in the water mass at the beginning ( $S_{t-1}$ ) and end ( $S_t$ ) of the calculated period is determined by the following relations:

$$S_{t-1} = M_{t-1}V_{t-1} \quad (7.10)$$

and

$$S_t = M_tV_t \quad (7.11)$$

where

$V_t$  and  $V_{t-1}$  are the volumes of the water mass in the section at the end and beginning of the calculated period, respectively

$M_t$  and  $M_{t-1}$  are the average mineralization in the reservoir section in the end and beginning of the calculated period

The volumes of the water masses in the reservoir sections are defined on the basis of Burmester curves according to the water levels at the beginning and end of each month. The total water mineralization in the reservoir sections is calculated as the arithmetic average of its values in the first and final reservoir sections. The possibility of such averaging is determined by the fact that very large “overfalls” in the change in ion amount (as well as individual components) are usually not observed along the reservoirs. The reservoir sections directly joined to the industrial complexes are the only exceptions. In this case, it is necessary to use the weighted average values of the water mineralization. When we have determined the average values of  $S_s$ ,  $S_p$ ,  $S_{t-1}$ , and  $S_t$ , we can directly proceed to the calculation of the balance of minerals in the reservoir based on the areas and districts according to Equation 7.4. The method of calculation of the chemical balance in the reservoirs based on the main components of the chemical composition (chlorides, sulfates, hydrogen carbonate, calcium, magnesium, etc.) is similar to the method for calculation of mineralization. The content of major ions in the border areas of the reservoir (or supporting

ranges) can be defined either by their dependence on the most important hydrodynamic characteristics of the reservoir or on their connection with the mineralization.

The suggested method of chemical balance research can be applied to the river reservoirs located in valleys. It allows us to calculate the chemical balance based on the mineralization and the major ions of the reservoir's chemical composition, and its morphometric sections for any, including typical (the high-flow, low-flow, and medium-flow periods), water-content year. In addition, it allows us to solve such important issues as calculation of the chemical balance in the reservoir during change of their operation modes.

It is possible to estimate the spatial temporal changes in the total component of the reservoir balance for any particular year of a multi-year period, as well as for any year with different water content. In our opinion, it is more suitable to estimate  $\Sigma S$  based on the mean multi-year values for each morphometric part of a reservoir. The total component of the balance of a reservoir is characterized (Table 7.1) by a very large-amplitude oscillation in the year and along the length of the reservoir. For example, at the second part of the reservoir,  $\Sigma S$  is maximum at  $+70.9 \times 10^3$  ton (July) and minimum at  $-39 \times 10^3$  ton (April), whereas at the sixth reservoir section, these values are  $+266 \times 10^3$  ton (June) and  $-225 \times 10^3$  ton (April), respectively. Despite differences in the values of the total component of the chemical balance ( $\Sigma S$ ), it is possible to notice some periodic phenomena in the within-year variability of all reservoir sections. The value of  $\Sigma S$  decreases by the end of winter to the beginning of spring and in April (in May for the ninth section of the reservoir), that is, at the beginning of spring reservoir-filling, this component of the chemical balance attains its minimum values (which are negative in almost all parts). Next begins an increase to maximum in July–August, with a subsequent decrease to minimum in September–October when most of the reservoir sections are characterized by negative values of  $\Sigma S$ , and a new increase in winter. These general features of the within-year course of the total balance component are absolutely typical for all sections of a reservoir [3]. Along with them, a number of sections have special features. Thus, for the river section of the reservoir, positive values of the components are typical throughout a year due to inflow of strongly mineralized water from Solikamsk enterprises. Negative values are absent because of its specificity (the area of backwater wedging determines the conditions close to the river). At the first reservoir section (Berezniki–Bustraya), positive  $\Sigma S$  values are observed for most of the year and only in the pre-spring period are there small negative values due to industrial pollution of the reservoir. The predominance of positive  $\Sigma S$  values of the total balance component on the part of the reservoir dam is determined by the entry of large volumes of the more mineralized waters (in comparison with Kama waters) of the Sylvensko–Chusovoy reach. Other reservoir sections are characterized by both positive and negative  $\Sigma S$  values. The prevalence of those or other values at each reservoir section allows us to assess their annual values. All morphometric reservoir sections are characterized by the positive values of the total component of the mineral balance in a year, that is, the volume of the additional substance flow into the reservoir section exceeds the volume withdrawn from the water masses. At the reservoir, the highest annual  $\Sigma S$  values are marked at the first of its two sections (river and the first). Determination of annual  $\Sigma S$  values for each section of a reservoir and the presence of their within-year variations allow us accurately show the most polluted areas of the reservoir.

While estimating within-year changes in the total component of the mineral balance of a reservoir, we should note that the increase in the volume of additional revenue of minerals during the summer months may be caused by additional surface inflow, which is not indicated by the values of income and outlay through the boundary cross-sections, groundwater supply, activation of the chemical interaction of water with the rocks forming the bed and shore of the reservoir, etc. The increase in positive values in winter, obviously, can be explained by the increased share of underground feed in the water balance in this period and, consequently, the entry of strongly mineralized waters. It is difficult to explain the process of removing minerals from the balance at the beginning of spring and autumn. We can assume that in spring it is due to the peculiarities of flow regulation. By the end of winter, as result of reservoir draw-off, the level is greatly reduced (7–8 m) and the most mineralized waters are accumulated in some particular parts of the bottom relief, flooded lakes, and holes beneath ice. According to the observations, there

**TABLE 7.1** Average Values of the Total of the Balance Mineralization ( $10^3$  ton) of the Kama Reservoir

Section	Month												Year
	I	II	III	IV	V	VI	VII	VIII	IX	X	XI	XII	
Tyulkino–Berezniki	50.0	42.5	38.7	3.60	119	150	191	210	193	164	182	69	1417
Berezniki–Bustraya	227	212	187	-74.8	-16.6	113	232	189	86.0	41.5	187	46.2	1430
Bustraya–Pozhva	32.2	-2.60	-35.0	-39.0	41.0	49.2	70.9	1.80	-19.5	-23.2	17.4	-24.2	69.0
Pozhva–Chyormoz	346	117	-48.8	-120	95.2	235	364	131	-25.7	-109	193	141	1320
Chyormoz–Sludka	134	-51.3	-80.7	-225	166	265	204	133	-9.30	-121	92.7	123	631
Sludka–Dobryanka	-9.80	-58.1	-137	-147	73.1	115	146	109	4.70	-71.0	96.9	38.3	159

has been repeated observation of very high mineralization at particular points on the bottom, and it has exceeded its average value several times. We may assume that one of the reasons for the increase in negative  $\Sigma S$  values in the pre-spring period is the biological processes in the reservoir (in this period there is the awakening of life in the reservoir, which requires large amounts of minerals). The same processes as well as, apparently, interaction of bed water with the under-channel flow allow us to explain a significant withdrawal of minerals from the water mass of the reservoir during fall. It is impossible to compare the findings as well as the expressed assumptions since there are no similar (or at least connected) works devoted to research on other reservoirs in the country. Interesting in this aspect are only works devoted to the issues of studying the salt balance and hydrobiology of the reservoirs. Thus, our hypothesis on the important role of the biological processes during pre-spring and autumn can be confirmed by the investigations at the Volgograd reservoir where only five most common species of bivalves filter about 840 km<sup>3</sup> of water during summer; at the same time, 29 million tons of sediment are precipitated and 36 million tons of sediments are disposed, and 811 ton of organic substance are mineralized. Undoubtedly, the Kama reservoir significantly differs from the Volgograd reservoir and all of the mentioned values will seem smaller, but the fact that hydrocoles play a very important role in the formation of the aquatic hydrochemical regime of water bodies is undeniable.

### 7.2.3 Heat Balance

The thermal state of the water mass is determined by its enthalpy, which continuously changes as a consequence of heat exchange over water surface, its lateral boundaries, and across the bottom. The radiation balance of the water table is created by short- and long waves of the solar radiation and includes all types of radiation heat exchange. When there is an interaction between the two environments (air and water) with different temperatures, turbulence, or contact heat exchange, occurs between them. Heat exchange also occurs in the process of evaporation and condensation when the water table, respectively, gains or loses heat from the surface layer of the surrounding air. The surface layer of water is heated or cooled as a result of these non-radiative forms of heat exchange. Then, by means of mixing this heat is extended to the bottom in a form of turbulent flow of heat. Insignificant heat exchange also occurs through the bottom: the heat current is directed from the water surface to the bottom during the period of summer heat and autumn cooling, and from the bottom to the water surface during the period of winter cooling. All of the aforementioned types of radiation and non-radiation heat exchange are members of heat balance.

*The radiation balance:* The factors determining the radiation balance can be divided into two groups: the first group includes factors, which do not depend on the properties of the underlying surface, such as the altitude of the sun, the length of a day, and cloudiness. The second group includes factors, which are determined by the properties of the underlying surface, such as the albedo (reflectivity) and emissivity of the surface, surface temperature, and temperature and humidity of the surrounding air (Table 7.2).

The radiation balance equation has the following form:

$$B = R(1 - A) - E \quad (7.12)$$

where

$B$  is the magnitude of radiation balance (kcal/cm<sup>2</sup> per month)

$R = (S_{\text{sinh}} + D)$  is the total solar radiation

$S$  is the direct radiation

$D$  is the diffused radiation

$h$  is the altitude of the sun

$E$  is the effective radiation

**TABLE 7.2** Radiation Balance of the Kama Reservoir in Comparison with Other Lakes and Reservoirs in Russia (kcal/cm<sup>2</sup>/Month)

No.	Month Impoundment	V	VI	VII	VIII	IX	X	Number of Years
1	Kama Reservoir	10.1	10.4	10.7	6.7	2.5	-0.5	14
2	Lake Kubenskoye	8.2	10.2	9.6	5.9	1.8	-0.6	25
3	Rubinsk Reservoir	8.4	10.4	9.5	6.6	2.6	0.3	8
4	Lake Ladoghs koye	10.0	12.0	11.4	6.4	2.4	-0.5	6
5	Lake Oneghs koye	8.9	10.7	10.2	5.5	1.9	-0.9	20
6	Volgogradsk Reservoir	—	12.4	11.9	9.3	5.8	1.7	5
7	Novosibirsk Reservoir	—	10.6	11.4	7.0	3.5	—	4

The total solar radiation is a stream of solar radiation consisting of direct and diffused radiation. Direct radiation is observed when there is cloudless sky and it depends on the water and dust content of the atmosphere. The part of diffused radiation that reaches the earth's surface is added to direct radiation.

Effective radiation is the difference between the long-wave radiation from the earth's (water) surface and atmospheric radiation. The emissivity of any body is quantitatively expressed by Stefan-Boltzmann law:

$$E = \delta\sigma T^4 \quad (7.13)$$

where

$E$  is the effective radiation (cal/cm<sup>2</sup> per min)

$\delta$  is the dimensionless characteristic of the emissivity of a body

$\sigma$  is the universal Stefan-Boltzmann constant, which is equal to  $0.814 \times 10^{-10}$  (cal/cm<sup>2</sup>/min)

$T$  is the temperature of the emitting surface in degrees Kelvin

The formula for determining the effective radiation from a reservoir's surface considering cloudiness has the form:

$$E = \delta\sigma T^4 (0.41 - 0.05e)(1 - cn) + 0.0034\Delta T - 0.0065 \quad (7.14)$$

where

$E$  is the effective radiation (kcal/cm<sup>2</sup> per min)

$\delta$  is the coefficient characterizing the emissivity of water ( $\delta = 0.91$ )

$\sigma$  is Stefan-Boltzmann constant

$T$  is temperature (Kelvin)

$e$  is humidity (mbar)

$n$  is cloudiness in parts of the unit

$c$  is the coefficient characterizing the influence of cloudiness on the effective radiation ( $c = 0.6$ )

$\Delta T$  is the temperature difference between water and air

### 7.2.3.1 Heat Exchange with Atmosphere by Evaporation

Evaporation is the second largest factor after radiation balance that causes the spring-summer heat and the first factor for autumn cooling. Evaporation causes significant loss of heat through water surface. Each gram of water evaporated carries away an amount of heat equal to the latent heat of vaporization:

$$LE = 607 - 0.7t, \quad [\text{cal/s}] \quad (7.15)$$

where  $t$  is temperature in degrees Celsius.

Each square centimeter of the water surface loses about 60 cal of heat during the evaporation of a water layer 1 mm in height. To calculate the heat loss during evaporation, it is necessary to calculate the amount of evaporation itself, which is determined by the formula:

$$E = 0.14n(1 + 0.72U_2)(e_0 - e_2) \quad (7.16)$$

where

$E$  is the height of the evaporated water layer in millimeters

$n$  is the number of days in the calculated period

$U_2$  is the wind speed at 2 m above the water surface

$e_0 - e_2$  is the difference in maximum vapor pressure, which is calculated from the temperature of the water surface and the actual elasticity of the water vapor in air at a height of 2 m above the water surface

### 7.2.3.2 Turbulent Heat Transfer with the Atmosphere

The formula for calculation of turbulent heat transfer with the atmosphere for the reservoirs is

$$P = 507n(1 + 0.72U_2)(t_0 - t_2), \quad [\text{cal/cm}^2\text{month}] \quad (7.17)$$

where

$P$  is the turbulent heat transfer with the atmosphere

$n$  is the number of days in the period

$t_0 - t_2$  is the temperature difference between water and air at a height of 2 m above the water surface

$U_2$  is the wind speed at 2 m above the water surface (m/s)

The magnitude of turbulent heat transfer through the reservoir water surface to the atmosphere can be either positive or negative since it depends on differences in temperature between the water and air. Heat flow is directed into the water if the air temperature is above the temperature of the water, in which case, the magnitude of the turbulent exchange is, conventionally, regarded as positive. If the water is warmer than air, the opposite pattern is observed.

### 7.2.3.3 Heat Inflow and Runoff

Heat inflow and runoff, as elements of the heat balance, are determined as follows:

$$Q_{\text{inflow,runoff}} = \frac{100Wt \times e \times \rho \times c}{F} \quad (7.18)$$

where

$Q$  is the quantity of heat (kcal/cm<sup>2</sup> per month)

$W$  is the average monthly inflow (runoff) of water (km<sup>3</sup>)

$t$  is the average temperature of the water

$\rho$  and  $c$  are the density and specific heat of water, which are both equal to one

$F$  is the reservoir surface area (km<sup>2</sup>)

**TABLE 7.3** Average Monthly Values of the Heat Balance Components of Kama Reservoir over a Period of Many Years

Month	$B$	$LE$	$P$	$Q_{\text{inflow}}$	$Q_{\text{runoff}}$	$Q_s$	$\Delta\Theta$	$\delta$	$\delta\%$
V	10.1	-2.72	1.24	7.01	-4.09	-0.87	7.00	3.67	14.0
VI	10.4	-4.88	-0.13	6.23	-5.74	-0.93	3.54	1.41	5.0
VII	10.7	-6.42	-0.77	3.94	-4.44	-0.71	1.32	0.98	3.6
VIII	6.89	-6.46	-1.39	2.69	-3.62	-0.21	-2.12	0.02	0.09
IX	2.48	-4.66	-1.58	1.95	-2.77	0.30	-4.09	-0.19	1.39
X	-0.47	-3.46	-2.40	0.89	-1.67	0.69	-5.57	-0.71	7.4
V-X	40.1	-28.6	-5.03	22.7	-22.3	-1.73	-0.08	5.22	4.4

### 7.2.3.4 Heat Balance of the Kama Reservoir

The heat balance equation includes the aforementioned components and has the following form:

$$B + Q_s - LE + P + Q_{\text{inflow}} - Q_{\text{runoff}} = \Delta\Theta + \delta \quad (7.19)$$

where

$B$  is the radiation balance

$Q_s$  is the heat exchange with the bottom soil

$LE$  is the heat loss by evaporation

$P$  is the turbulent heat exchange with the atmosphere

$Q_{\text{inflow}}$  and  $Q_{\text{runoff}}$  are heat inflow and runoff

$\Delta\Theta$  is change in the heat storage of water mass

$\delta$  is the residual heat balance

All values are expressed in kcal/cm<sup>2</sup> per month. Except the amount of heat loss by evaporation, which is always negative, all the other components can be either positive or negative. The direction of heat flow is determined by the sign: “+” means the heat flow is directed to water and vice versa. Mean annual values of heat balance of the Kama reservoir are shown in Table 7.3 [2].

The radiation balance is the main receipt component of the heat balance. The main component of the greatest heat balance expenditures is a term describing heat loss by evaporation. Turbulent heat exchange with the atmosphere is the next biggest member of heat balance. Heat exchange with the bottom soil is the smallest component of heat balance. The magnitude of the result of heat balance—change the heat storage of water mass—varies considerably both in time and space. Its biggest positive values are observed at the beginning of spring heat, that is, in May and in July there is a transition through zero and a maximum negative value is observed at the end of autumn cooling, that is, in October.

## 7.3 Thermal Pollution

The problem of thermal pollution is becoming increasingly serious due to intensive development of heat-and-power engineering in the world. Thermal pollution is a consequence of dumping of water heated by thermoelectric and nuclear power stations. Large thermoelectric power stations with 2.1–2.4 MW capacity use 70–90 m<sup>3</sup>/s of water to cool their units and require half as much again to cool the nuclear power stations themselves. Rise in water temperature up to 20°C–25°C has no negative impact on the life of hydrocoles. When water temperature rises up to 27°C–30°C, the vegetation period becomes longer and the amount of plankton increases. When water temperature rises up to 30°C–33°C, there is an oxygen shortage at the bottom of a reservoir; hydrogen sulfide zones are formed, which can cause death of hydrocoles, including fish. Thermal pollution leads to intense overgrowth in a reservoir. All these factors create an ecological risk in the reservoir [2].

Each country has its own norms of permissible heating temperatures of reservoir refrigerants. In the United States, for example, each state sets its own limits on water temperature increase. The maximum permissible excess on the most frequently recurring temperatures in most states is adopted for lakes, about 1.7°C, and reservoirs, 2.3°C, and for sea coasts and estuaries, 0.8°C. Some countries have different standards of acceptable reservoir heating. In England, France, and Germany, this temperature is 30°C, in The Netherlands, 32°C, and in Poland, 26°C. In Russia, the allowed reservoir water heating temperature in summer is 3°C, which is above the maximum natural temperature, and in winter, up to 5°C. In fact, in many reservoirs, water temperature exceeds the established norms because of dumping of warm waters and formation of zones of thermal pollution. Zones of thermal pollution are water areas where the observed temperatures exceed the natural temperature in the permissible norms. Development of heat-and-power engineering brings two major problems: (1) the problem of monitoring the areas around electric power companies, that is, development of systems and methods for monitoring the environment and state of the ecosystem as a whole, and (2) development of measures for utilization of the low-grade heat of the liquid waste of thermoelectric and nuclear power plants. It is necessary to know the extent of cooling of heated water injected into a reservoir when we design and construct thermoelectric and nuclear power plants. The second important factor is the achievement of a minimum temperature of water collected for cooling. The situation when the discharged water is cooled to the natural temperature is ideal. But in practice, usually the temperature of the collected water is above the natural water temperature and it affects the efficiency of the station: higher the temperature difference between the collected water and natural water, lower the efficiency of the station, and there is greater fuel consumption. This is why observation and forecast of the spread of warm waste water is important in connection with ensuring the best functioning of the station as well as to assess the impact of the heated water on the ecology of surrounding water bodies. Methods of mathematical modeling to calculate the temperature fields of thermal influence zones and thermal pollution play a very important role in solving this problem. In general, all models can be divided into two main groups: the first group includes models in which the hydrodynamic problem is solved irrespective of the heat problem. These mainly use analytical methods of calculation. The second group includes models based on the combined solution of equations of heat-mass transfer and hydrodynamics. The Perm State District Thermoelectric Power Station (Perm SDTPS) is the source of thermal pollution at the Kama reservoir. It is located on the left bank of the reservoir at a distance of 65 km from the dam at the Kama hydroelectric power station and has a capacity of 4,800,000 kW. The circulation water volume collected for cooling the turbine condensers changes according to season. It reaches 136 m<sup>3</sup>/s in autumn and winter, and 142 m<sup>3</sup>/s in spring and summer. The water supply of the stations is done with a once-through system. The tailrace closes with by means of a special construction designed to ensure normal operation of the channel in a period of significant change in water levels in the reservoir during a year and it reaches up to 7 m. To calculate the water temperature fields of thermal influence and pollution zones, we have proposed a mathematical model based on the equation of H. Reichardt (Schlichting) and the equation of thermal conductivity:

$$\frac{\partial Vx^2}{\partial x} = \Lambda(x) \times \frac{\partial^2 Vx^2}{\partial y^2} \quad (7.20)$$

$$\frac{Vx(X)\partial t}{\partial x} = \frac{D(X)\partial^2 t}{\partial x^2} - f(t) \quad (7.21)$$

where

$Vx$  is the velocity component along the  $x$ -axis

$\Lambda$  is the impulse transport coefficient

$X$  is the distance from the discharge point along the  $x$ -axis



$f(t) = \alpha'(t_0 - t_2)$  is a function, which depends on the temperature difference between the discharged water and natural water temperature  
 $\alpha'$  is a constant equal to  $0.16 \times 10^{-4}$

$$\Lambda = \frac{1}{2} k^2 X \quad (7.22)$$

where

$k$  is the empirical coefficient

$t$  is the water temperature at the calculated point

$D$  is coefficient of turbulent diffusion

$$D = \epsilon k^2 x \quad (7.23)$$

where

$\epsilon$  is Karman constant

Equation 7.20 was obtained by G. Reihard on the basis of his inductive theory of turbulence. He reduced the simple laws of turbulence to a simple system of formulas, which does not require searching solutions of differential equations. He assumed that the flow of impulses in the direction of the  $x$ -axis is proportional to the gradient of the impulses in the broadside direction. The law of impulse transfer is similar to the main law of thermal conductivity, according to which heat flux is proportional to the temperature gradient and the coefficient of heat transfer corresponds to the thermal conductivity coefficient, and Equation 7.20 is similar to the one-dimensional heat conduction equation. The latter was used to calculate the velocity distribution of the flow at the outlet of the channels. Equation 7.21 represents the thermal conductivity equation with an additional term  $f(t)$ , which implicitly takes into account the heat exchange between the water surface and atmosphere. Satisfactory convergence with field data was achieved by adjusting the empirical coefficients. The proposed model does not account for the action of crosswinds, but winds blowing toward or against the blowout stream are taken into account by increasing or decreasing the rate of the flowing stream by an amount corresponding to the wind speed. According to the data of the specialized observations at this part of the reservoir, the following empirical relationship has been established between the speed of the wind flow and wind speed:

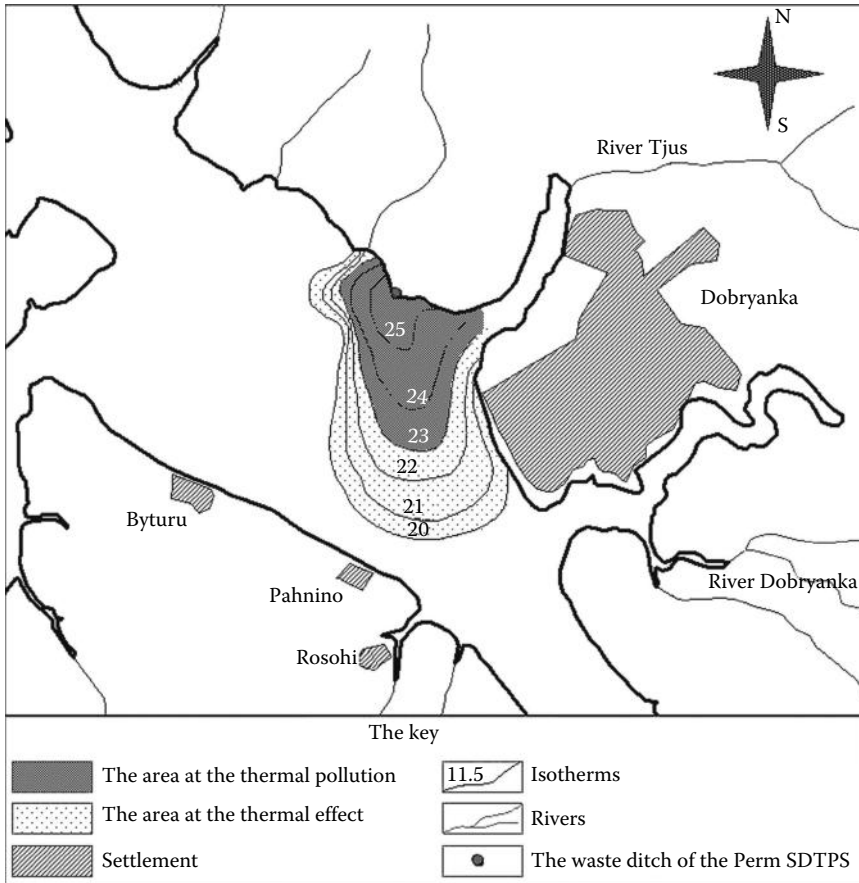
$$V_{\text{flow}} = 0.01 V_{\text{wind}} \quad (7.24)$$

where

$V_{\text{flow}}$  is the velocity of the wind flow (cm/s)

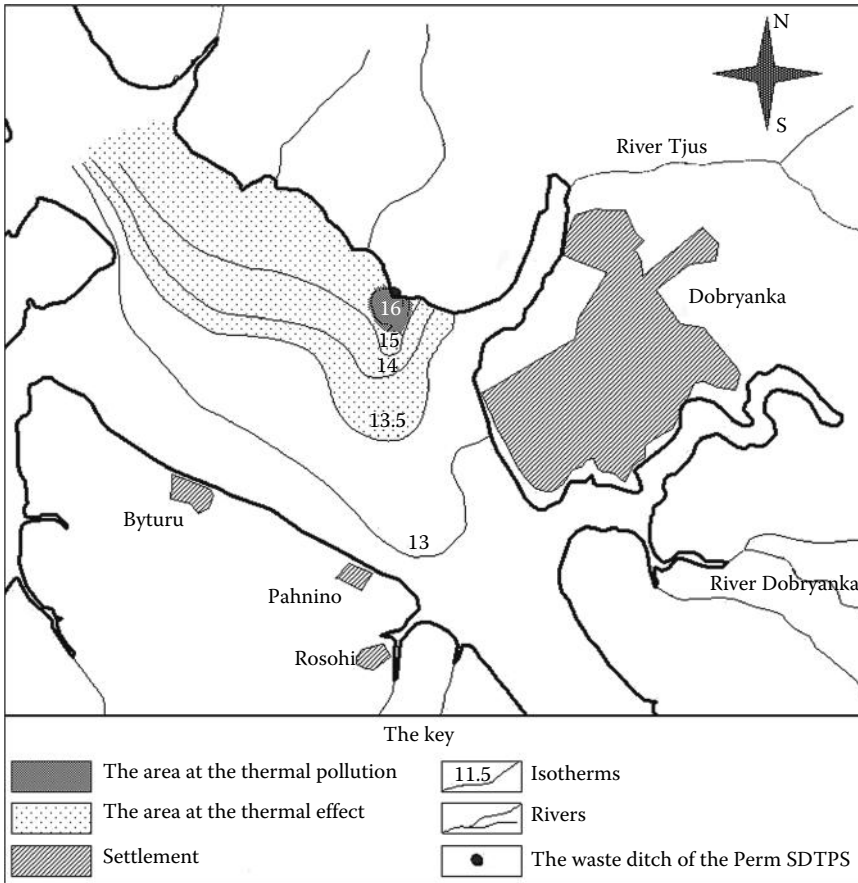
$V_{\text{wind}}$  is wind speed (m/s)

The model performs the two-dimensional task because the warm liquid waste, being lighter during a freezing-up period, spreads out in the upper half-meter layer. The comparative analysis has shown good convergence between the calculated and measured values of the area of thermal influence, and satisfactory convergence for the values of thermal pollution. An important indicator is the position of the lower boundary of the thermal influence zone as there is a part of a karstic bank 15 km below the discharge of warm water, and if the zone of thermal influence reaches this part, it may increase the intensity of the chemical abrasion of the banks and growth of karst holes in the zone of the heated water spread. The largest areas of thermal pollution zones are observed in the period of maximum water temperature because at this time, the temperature difference between the water and air is the least and the process of cooling is very slow. At the same time, the length of the zone of thermal influence is maximum during the ice-free period. The smallest areas of thermal pollution zones are observed at the end of



**FIGURE 7.2** Diagram of the temperature distribution field and zones of thermal pollution, and the thermal effects on the waters of the Kama Reservoir near the Perm SDTPS (July 30, 1991).

autumn cooling period when the temperature difference between water and air is the greatest. The area of the zone of thermal influence is mainly determined by the direction, speed, and duration of wind. Figures 7.2 and 7.3 show diagrams of temperature distribution and zones of thermal pollution, and the impact on the area of water, near Perm SDTPS according to a series of special observations in July and September 1991 [2]. In the first case, the largest area of the zone of thermal pollution has been recorded due to the high temperature of the collected water, the greatest difference between the temperatures of the discharged and collected water, and the brief wind activity in the western quarters. In the second case, the area of thermal influence was greatest as the whole day on September 14 and through the previous night, wind blew in the southern quarter. In this case, the zone of thermal influence spread up to the supply channel, which caused the penetration of warm waters into water intake facilities. This is undesirable because it can cause overheating of turbine condensers and reduce the efficiency of the station. Even more significant changes in the thermal and ice regime of the lower part of the reservoir occur during winter freeze-up. An ice hole is formed in the area of the discharge heated water, and its size and shape depend on air temperature, the regime level, and the morphometry of the reservoir section. The reservoir has increased flowage during the winter draw-off, which also affects the shape of the ice hole: during March–April it is situated downstream. Along the way from the Perm SDTPS to the dam of the Kama hydroelectric power station, the thickness and structure of ice changes: thickness of crystalline ice decreases to zero when melting from the bottom, but it is compensated by growth of snow ice on top.



**FIGURE 7.3** Diagram of the temperature distribution field and zones of thermal pollution, and the thermal effects on the waters of the Kama Reservoir near Perm SDTPS (September 14, 1991).

The temperature factor for the aquatic ecosystem is one of the most important among the abiotic components that affect the structure of the aquatic fauna as plankton, so benthos and fish fauna. Thus, any deviation from the natural rhythm of seasonal temperature dynamics, especially in the direction of increasing its level, is classified as thermal pollution. Observations made at the place of discharge of warm water, as well as above and below it, have shown that in the warm water discharge area, there is no tendency for decrease or increase in biomass. There have been some discrepancies between the seasons: the highest biomass has been found in the overheating water zone in months of minimum water temperature; then the differences have smoothed out in the warmer months. Therefore, the carried out observation has shown no significant thermal effects on the ground biocenoses in the area suffering from thermal pollution. The increased temperature background can be dangerous in terms of changing the dates of appearance and the number of generations of aquatic animals such as plankton, benthos, and fish. Besides, effects on the genetic structure of the populations are possible. There is controversy regarding when in conditions of high temperature may some positive effect be achieved (due to acceleration of maturity, changes in growing season, increase in the rate of growth). However, in an atypical thermal regime, rhythmic of physiological processes are destabilized, including those associated with reproduction, and the normal course of morphogenesis is also disturbed. The intense rhythm accelerates the mutation processes and leads to the increase in generic variation. Finally, this could lead to a reduction in genetic potential and a decrease in

the evolutionary flexibility of the species. Water temperature, which is outside the natural background, can be a powerful destabilizing factor, which may have a decisive impact on populations of fish and other aquatic organisms, transforming their genetic structure. This may have implications not only for the particular species, but also for the ichthyofauna and the entire ecosystem of a reservoir. Thus, thermal pollution, being the consequence of heated water dumping by thermal and nuclear power plants, is the most important anthropogenic factor influencing the thermal regime of reservoir refrigerants and their ecological systems, and creating conditions for the emergence of environmental risks.

## 7.4 Formation of Reservoirs Banks

*Current importance:* The existing course of exogenous geological processes was broken by the creation of large reservoirs. Rough reorganization of a coastal relief began, infilling of a reservoir occurred almost instantly, and as a result, geodynamic processes become more intense: erosion is substituted by abrasion (the process of bank reservoir destruction by waves), landslide activity, and karstic processes (if karst is present in a drainage basin), and internal erosion and other processes become more intense. Economic use of reservoirs is threatened by all these processes and some establishments have a risk of losing historical and cultural values.

*Peculiarities of the processes of bank reservoir formation:* Geodynamic processes at reservoirs influence, on the one hand, the present relief destruction and, on the other hand, the appearance of new forms (shoal). Earlier it was considered that the stage of processing should close with bank destruction fading; hence “the balance profile” should be established. But according to observations, the intensity of the processes still remains high, though eventually decreasing. Besides, the processes of bank destruction at reservoirs are complicated by the presence of variable backwater, that is, seasonal water level fluctuations.

While studying the river channel processes, the most attention is paid to the development of the channel itself and to the bottom of a plain, especially to its flood plain. As regards reservoirs, we are interested in plain slopes rather than bottom. The main features of plain slope formation (in comparison with rivers) are

1. The intensity of exogenous processes
2. The intensive formation of plain slopes
3. The “instant” (from the point of view of geological time) passage of geodynamic processes

A sophisticated analysis of Russian reservoirs research showed that it is possible to distinguish the following stages in bank formation:

- Destruction (the stage lasts for 5–20 years)
- Development—coastline formation is extensive and slow
- Attenuation—relative cessation development (relative as the balance profile cannot be created because of level regulation)

The complete idea of bank reservoir formation can be perceived by considering this process as a system. We distinguish progressive (factors, which contribute to the development of the system), regressive (factors, which prevent development), and neutral (factors, which do not participate in the development of the system) factors. The sum and interrelationship between these types of factors represent the system structure, the change in their amounts—its development, and the number of connections between them—its stability.

The system passes through three stages in its development (Figure 7.4) [3]:

1. First stage—system origin: This stage is determined by the existence of neutral and progressive factors, with the neutral ones prevailing.

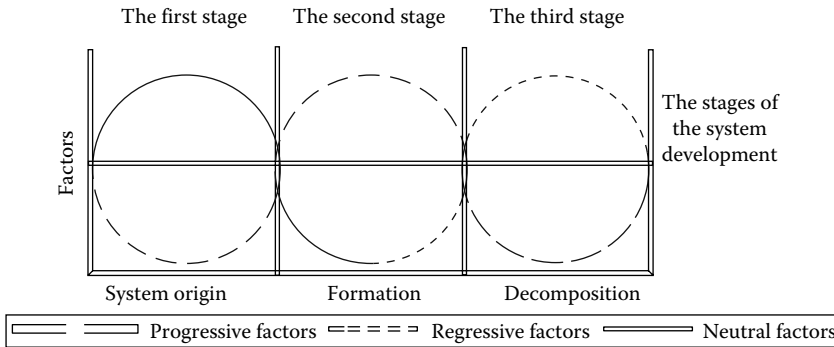


FIGURE 7.4 The scheme of geosystem development.

2. Second stage—system formation: This stage is determined by progressive, neutral, and regressive factors, with the progressive ones prevailing.
3. Third stage—system decomposition: This stage is determined by the aggregate of progressive and regressive factors, with the regressive ones prevailing. Factors located upward from the axis and at some point in time defining the development of the system are considered to be positive, whereas factors preventing the development of the system are considered negative.

The first stage—system origin—can be divided into two phases: the first phase begins when a reservoir is filled with water. Usually it lasts for several years. Water entry causes recovery of water level, which influences the bank slope. As a result, there is gradual water saturation and reduction of rock solidity. At this zero stage in the development process, there are micro-deformations in the bank rock structure. During this period, neutral qualities prevail as the process of coastline formation has not been defined yet. As a result, recovery of water level, which lasts for several years, determines the “shape” of a reservoir. The amount of progressive qualities (defining the geodynamic processes in the conditions of a river) decreases as there is still no order in the system development. However, as water recovers to normal headwater elevation (NHE) and attains a stable state, possibilities of formation of new forms of a relief (e.g., shoal) become more noticeable.

The intensity of the processes of bank destruction depends on the duration, character, and changes in the system at the present stage. New conditions of wind wave formation appear as water level rises and the total area of the water table extends. The development of the coastline advances to the second phase in the first stage. Wave formation exerts a powerful impact on banks by increasing the initial destructive effects connected with a reservoir infill. Wave energy is reflected, passed through, and partially absorbed by coastal systems, but nevertheless, most of this energy is spent in the destruction and removal of material from the coastal system, which increases the speed of processing at the first stage in the development process of bank formation. The duration of this stage depends on the time take by the water to recover to NHE. At the Kamskiy reservoirs, this period lasts for two years. At large reservoirs of Russia, which were filled up to two years, this period did not exceed two to seven years for banks in disperse incoherent caves and 10–16 years for banks formed by soluble and rocky layers.

The second stage—formation—also consists of two phases (Figure 7.5).

The first phase is characterized by intensive processes of formation. The fundamental change in a relief of initial river valleys begins. During this phase, the level of water in the reservoir, which defines its morphometry and morphology, continues to play the defining role. In its turn, the morphology and morphometry of both the above-water and underwater parts of a bowl aim to remain in conformity with the hydrological regime. But for all that, hydro- and geodynamic processes proceed differently in separate regions of the reservoir. There are highly complicated and contradictory “relationships” among these processes. It defines one of the features peculiar only to reservoirs—formation of a hydrological

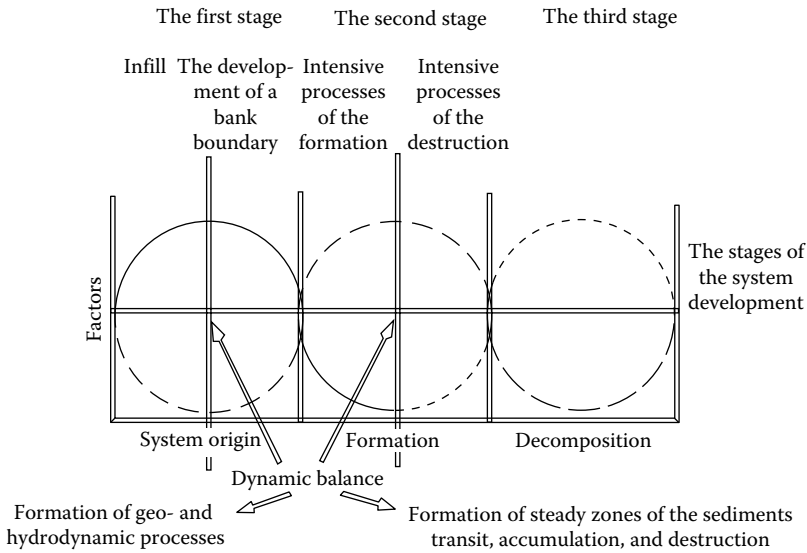


FIGURE 7.5 Temporary dynamics of a shore.

regime in the conditions of a reservoir bowl, which is being actively formed. As a result, morphometric indices can be changed considerably. At the same time, the formation of separate parts of the reservoir bowl is influenced by genetically diverse processes. For example, bank slopes and, partially, bank shoals are influenced by geodynamic processes, whereas hydrodynamic processes influence the shallow and deep-water zones. Both these processes are interconnected, that is, they develop in unity, which determines system integrity. At the same time, shift of the coastline deep into the adjacent territory, or toward the reservoir water area, is possible. During the processes of bank reformation, changes appear not only in the banks' profile, but also in their contours on the plan.

During the first years of reservoir existence, both processes (progressive and regressive) develop very intensively. It is explained by the fact that a reservoir and, in particular, its shore aspire to the condition of a dynamic balance. Clear distinctness in the formation of abrasive, accumulative, and neutral banks is typical to this condition (see the formation stage in Figure 7.4). Unfortunately, this condition is not permanent as the considered system is open and is influenced by a large number of factors. In fact, we have a constantly changing system in which the role of leading factors changes. For example, in the first phase of the filling of a reservoir, the formation of its bowl (morphology and a morphometry) is defined by hydrology and of its shore by geodynamics, but in the second phase of development, the hydrological regime is defined by the morphology and morphometry of the modified bowl, which leads to loss of the initial equilibrium condition (see the second stage in Figure 7.5). One equilibrium condition is substituted by another. It is explained by the fact that any geological process is the result of an equilibrium disturbance in a certain extent of the lithosphere, which is caused by changes (increase or reduction) in the external influences of this extent.

One feature is peculiar for the first phase of marginal erosion: destructive processes occur only within individual most vulnerable parts and then they quickly cover all new spaces, developing toward each other, merging, and forming large and, as a rule, linear zones of destruction.

The adaptation of the geological surroundings to the new influences of the hydrosphere is always connected, on the one hand, to the return of some part of the substance and, on the other hand, to the formation of additional systems from this substance. These additional systems are shoals protecting the main coastal system from external influences in a feedback negative loop and where along shore drift of sediments is possible. The mechanism of self-regulation of processing and further self-organization of the bank systems, which lead to gradual extension of both abrasive and

accumulative banks, and formation of steady zones of sediment destructions, transit, and accumulation, becomes more active at this stage.

In the second phase (the third and fourth stages), marginal erosion of banks and formation of coastlines of reservoirs are characterized by further strengthening of the mechanism of self-regulation and completion of the process of bank system self-organization. Theoretically, they should be steady in a certain interval of external influences. Modification of these influences leads to a new cycle of development of bank-forming processes according to the scheme characterized earlier.

The third stage of development—system decomposition—does not exist at reservoirs. It is connected with the artificial regulation of flow by a dam.

The length of the indented coastline determines the stage of bank system development.

### 7.4.1 Role of Indented Coastline in the Formation of a Shore

Study of shoal dynamics allowed us to draw the conclusion that practically all shoals aspire to be open (Figure 7.6). Change of the indented coastline is the indicator of this phenomenon. We suggest defining the indented coastline coefficient as a relation between the length of an ideal straight bank,  $L$  (to which all banks aspire), and the length of the existent coastline,  $L'$

$$\mathcal{K} = \frac{L}{L'} \quad (7.25)$$

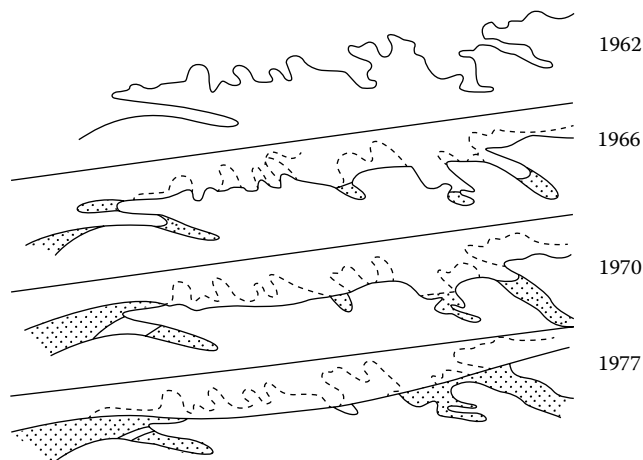
The value of this coefficient ( $\mathcal{K}$ ) cannot exceed 1. Values of the coefficient are given in Table 7.4.

A study of the role of an indented coastline in the process of bank destruction and shoal formation was conducted on the shoals of Chastuye, Elovo, and Babka villages (Votkinsk reservoir). The research showed that there is a close connection between the destruction volume ( $W$ ) and wind wave energy ( $E$ ):

$$W = B \sum E^a \quad (7.26)$$

where  $a$  and  $B$  are empirical factors.

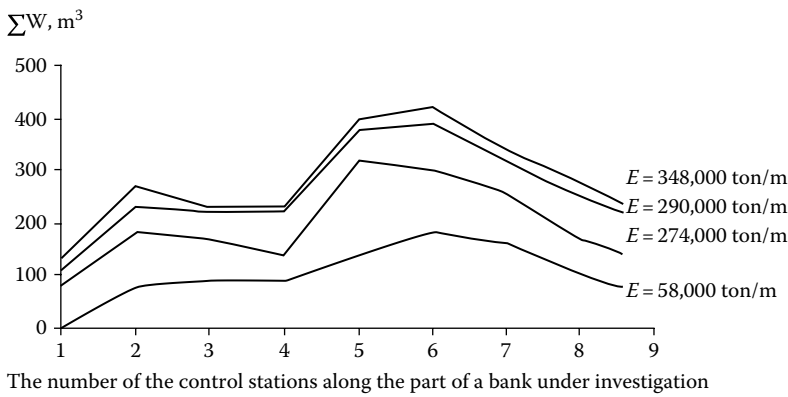
It has been established that factor “ $B$ ” changes in proportion with the amount of bank collapse and is defined by the morphometric features of the ground (Figure 7.7). For an even and slightly indented bank, it fluctuates from 0.1 to 1, whereas for a strongly indented bank, it may exceed 2. Factor “ $a$ ” is the



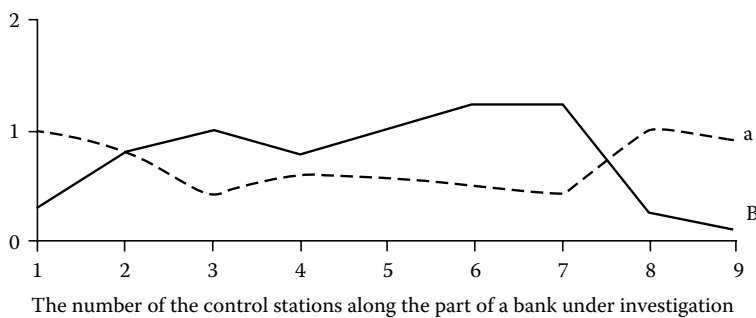
**FIGURE 7.6** Change in the indented coastline during the time 1962–1977 (Babka Village, Votkinsk Reservoir).

**TABLE 7.4** Values of Indented Coastline Coefficient ( $\mathcal{K}$ )

$\mathcal{K}$ Values	Bank Characteristic
$\mathcal{K} \leq 0.25$	First stage of development: The coast is strongly indented (there is intensive processing of the bank; its profile is not defined yet)
$\mathcal{K} = 0.50-0.25$	Second stage of development: The coast is middling indented (intensity of bank processing decreases; abrasion and accumulation zones start to form)
$\mathcal{K} = 0.75-0.50$	Third stage of development: The coast is indented (abrasion and accumulation zones are formed; the steady profile of the bank is developed)
$\mathcal{K} = 1-0.75$	Fourth stage of development: The coast is slightly indented (the processes of abrasion fade; marginal erosion of the bank is insignificant and is defined by a reservoir water-level rate)
$\mathcal{K} = 1$	The bank is straight, processing is almost stopped (it is allowed only for small parts of the coastal system)



**FIGURE 7.7** Change in the amount of bank collapse along bank length according to wave energy (Chastuye Village, Votkinsk Reservoir).



**FIGURE 7.8** Value of empirical factors  $a$  and  $B$  (Chastuye Village, Votkinsk Reservoir).

specular return of “ $B$ ” (i.e., when  $a$  increases, so does  $B$  and vice versa) (Figure 7.8). It characterizes the dissipation of wave energy and cannot exceed 1. Between the indented coastline coefficient and factors “ $a$ ” and “ $B$ ” are the following dependencies:  $a = 0.31$  indented coastline coefficient ( $\mathcal{K}$ ) ·  $B = 0.96$  indented coastline coefficient ( $\mathcal{K}$ ).

Therefore, it is possible to argue that the length of indented coastline really influences the bank destruction process (and so the formation of a shallow zone), being an integrated indicator (dissipation



of wave energy and morphometric features of shoals) of the internal description of the system, while the external description is represented by the energy of wind roughness.

In our opinion, the indented coastline coefficient of a reservoir can serve as an indicator of bank stability and can be used as an oriented factor in the long-term forecasting development of a bank zone (e.g., in the design of reservoirs and ponds).

Thus, in the first stage there is intensive development of geodynamic processes, and zones of destruction, transit, and accumulation begin to form. In the second stage, geodynamic processes are less intensive but are more defined (the process of self-organization of bank systems finishes) and the equilibrium condition of bank system is created. The third stage, typical to natural systems (decomposition), is absent, which is connected with artificial regulation of a drain.

After the achievement of an equilibrium condition, there is opinion that the bank system has reached a steady condition and it should be considered for its further economic use. But this opinion is mistaken: the bank system is a live organism and one equilibrium condition will be substituted by another (e.g., abrasion—by accumulation or transit, transit—by accumulation and so forth). If this factor is not taken into account, it can lead to risk (destruction of buildings, roads, the enterprises, etc.).

The nature of bank system development can be estimated with the help of satellite images characterizing quite considerable periods of observation (more than 20 years). If there is lack of monitoring data, the stage of bank system development can be characterized by the length indented coastline.

## 7.5 Summary and Conclusions

---

Building of reservoirs has led to the risk of chemical and thermal pollution, which are results of slowed water circulation and the use of a reservoir as a place, which is filled with (chemical and thermal) sewage. The balance method may be used to calculate the possibility of chemical and thermal risks. The calculation is based on the solution of the water balance equation for morphometry homogeneous parts of reservoirs.

Creation of reservoirs poses another type of risk—reservoir bank processing. The coefficient of indented reservoir coastline characterizes the intensity of reservoir bank processing. The mentioned coefficient can be used as an approximate one for long-term forecast of a bank zone development.

## References

1. Kitaev, A.B. 2006. The most important hydrodynamic characteristics of reservoirs (on example of Kama cascade). Perm State University, Perm.
2. Noskov, V.M. 2008. Study of the thermal regime and evaluation of thermal pollution in the low part of dam of the Kama reservoir. Perm State University, Perm. *Geographical Bulletin*, 1(7), 117–133.
3. Dvinskih, S.A. and Larchenko, O.V. 2012. Characteristics of reservoir shoreline. Kyiv Taras Shevchenko National University, Kyiv. *Physical geography and geomorphology*, 2(66), 35–41.

# Groundwater Vulnerability

---

8.1	Introduction .....	146
	Motivation • Definitions of Groundwater Vulnerability	
8.2	Conceptual Framework of Groundwater Vulnerability .....	147
8.3	Groundwater Vulnerability Modeling and Mapping Methods .....	149
	Overlay and Index Methods • Process-Based Methods • Statistical Methods • Uncertainty	
8.4	Climate Variability and Change.....	155
8.5	Summary and Conclusions .....	156
	References.....	157

**Jason J. Gurdak**  
*San Francisco State  
 University*

## AUTHOR

**Jason J. Gurdak** is an assistant professor of hydrogeology in the department of Earth and climate sciences at San Francisco State University, San Francisco, California, United States, where he leads the Hydrogeology and Water Resources Research Group. Prior to SFSU, he was a hydrologist for 11 years with the US Geological Survey (USGS) National Water-Quality Assessment Program. Dr. Gurdak has authored more than 30 peer-reviewed papers, books, and chapters on groundwater quality, vadose zone and soil-water processes, recharge and contaminant transport, groundwater vulnerability to contamination, including nonpoint source nitrate, and climate variability and change effects on water resources. He also helps lead two international programs in UNESCO and INQUA on global groundwater, climate change, and paleoclimate signals that advances science, education, and awareness of the effects of climate change on global groundwater resources.

## PREFACE

All groundwater resources are vulnerable to contamination. This chapter is motivated by the increasing interest to predict nonpoint source (NPS) contamination in groundwater as a response to widespread detection of such contaminants and the implications for human and aquatic health and resource sustainability. Although individual approaches differ, groundwater vulnerability assessments have the same fundamental goals of estimating the potential for NPS groundwater contamination, particularly in un-monitored aquifer locations. Readers of this chapter will gain a better understanding of the theory and application of groundwater vulnerability assessments and how to develop scientifically defensible models and maps to assist water-resource managers during decisions regarding groundwater protection, monitoring, remediation, or sustainable management. Researchers and students alike will also benefit from the chapter's outline of the current knowledge gaps and future research directions to improve groundwater vulnerability assessments. I thank my students and colleagues at SFSU and the USGS, especially Sharon Qi, for many thought-provoking discussions that have helped to shape this chapter.

## 8.1 Introduction

---

Groundwater resources supply fresh drinking water to more than 1.5 billion people globally and support streams, lakes, wetlands, aquatic communities, economic development and growth, and agriculture worldwide [3]. For example, groundwater in the United States provides drinking water for more than half the population and is the sole source of drinking water for many rural communities and some large cities [3]. However, all groundwater resources are vulnerable to contamination, and the physical environment may provide only some degree of protection to groundwater from natural and human impacts [95]. In response, groundwater vulnerability assessments have been developed to estimate the potential for nonpoint source (NPS) groundwater contamination, particularly in un-monitored aquifer locations, and provide scientifically defensible models and maps to assist water-resource managers during decisions regarding groundwater protection, monitoring, remediation, or sustainable management. This chapter provides a literature review of the various definitions and conceptualization of groundwater vulnerability, synthesizes the methods of modeling and mapping groundwater vulnerability to NPS contamination, discusses some recent advances in quantifying uncertainty and the effects of climate variability and change on groundwater vulnerability, and proposes future research directions to address the current knowledge gaps in groundwater vulnerability.

The increasing demand for safe drinking water has mandated policy and management decisions that protect and improve the availability and sustainability of clean groundwater resources. In the United States, recognition of the need to protect groundwater quality was established with the Nonpoint Source Management and Monitoring Programs [58] as part of the 1972 Clean Water Act. More recently in 1986, the Safe Drinking Water Act created the US Environmental Protection Agency (USEPA) source-water assessment program that has focused on assessing groundwater systems susceptibility to contamination [91]. The National Research Council [66] noted that in recognition of the need for effective and efficient methods for protecting groundwater resources from future contamination, scientists must develop techniques for predicting the relative likelihood that groundwater will become contaminated as a result of human activity or natural causes at the land surface.

### 8.1.1 Motivation

The single greatest and globally ubiquitous threat to groundwater quality is NPS contamination [24]. NPS contamination generally refers to spatially diffuse contaminants that are mobilized advectively in runoff and infiltration over large spatial extents of an aquifer. NPS contamination is often associated with land use or anthropogenic activities and includes pesticides from agricultural use, nitrogen from fertilizer and manure, or livestock-borne pathogens; road salts, oil, or grease; increased sediment erosion during land-use conversions; and atmospheric deposition of anthropogenic and natural chemicals [29]. The cumulative effect of NPS contaminant loading over large spatial extents of an aquifer potentially results in a greater threat to groundwater quality than those contaminants from point sources, such as from discharge pipes or leaking storage tanks [56].

Groundwater vulnerability has emerged as a subdiscipline of contaminant hydrogeology from the effort of scientists, water-resource managers, and policy makers to better understand and manage NPS groundwater contamination. The central objective of groundwater vulnerability assessment is to understand and predict the potential for NPS contamination of a groundwater resource. Federal, state, and local water-management programs use groundwater vulnerability assessments to identify areas most likely to have contamination and to make informed decisions regarding allocation of resources for groundwater protection and remediation. Groundwater vulnerability assessments have been used in policy analysis, selection of groundwater monitoring sites, prioritization of areas for enhanced protection or remediation, determining best management practices, and even as general information tools to improve education and awareness of a particular groundwater resource [92]. To meet these varied needs

toward the best resource management of groundwater availability and sustainability, accurate and scientifically defensible estimates of groundwater vulnerability are required across different spatial and temporal scales.

### 8.1.2 Definitions of Groundwater Vulnerability

The term *vulnerability* first appeared in the literature during the late 1960s [1] as a term and concept related to the understanding and protection of natural resources. Since its introduction, the definition and use of vulnerability as related to contamination of groundwater has widely varied. No universally accepted definition exists because groundwater vulnerability is not an absolute property but rather a relative concept and complex indicator of contamination [61]. Groundwater vulnerability assessments are made at a variety of scales, often incorporating the geology and hydrogeology of the aquifer, as well as the physiochemical characteristics of the NPS contaminant of interest. Assessments that focus on specific chemical properties of a contaminant or anthropogenic activity consider only the *specific vulnerability* of an aquifer [29]. The *intrinsic vulnerability*, or *aquifer susceptibility*, is assessed solely on the hydrogeologic characteristics of the aquifer without specifically addressing properties of that contaminant. Therefore, intrinsic susceptibility conceptualizes the inherent hydrogeologic properties of the groundwater flow system and the sources of water and stresses on the system, including infiltration and recharge rates, depth to water, hydraulic conductivity, transmissivity, thickness and characteristics of the unsaturated zone, confined/unconfined nature of the aquifer, and well discharge [21]. Groundwater vulnerability includes the concepts of intrinsic susceptibility, as well as the proximity and characteristics of sources of naturally occurring and anthropogenic contamination, factors that affect contaminant transport from land surface to a specific location within the groundwater flow system, and the in situ geochemical conditions [30,31].

Multiple definitions have been used for groundwater vulnerability. However, they all address the same underlying question: “What is the potential for [NPS] groundwater contamination?” [74]. Groundwater vulnerability is defined by the National Research Council [66] as “the likelihood for contaminants to reach a specified position in the groundwater system after introduction at some location above the uppermost aquifer.” This definition implies the relative and uncertain nature that is unavoidable; all groundwater is vulnerable and uncertainty is inherent in all groundwater vulnerability assessments [66]. Although the term groundwater vulnerability has been specifically reserved for the evaluation of NPS contamination, it can also address spatially extensive but similar point sources. The comprehensive definition of groundwater vulnerability used in this chapter considers controlling chemical properties and anthropogenic or natural processes associated with the NPS contaminant of interest, inherent hydrogeologic properties of an aquifer that control susceptibility, and quantification of associated uncertainty in an effort to express vulnerability as a tendency or likelihood of NPS occurrence.

## 8.2 Conceptual Framework of Groundwater Vulnerability

---

Assessments of groundwater vulnerability are often done on the watershed to subregional scale (~1,000 to 100,000 km<sup>2</sup>) and even regional [94] or national scale (>100,000 km<sup>2</sup>) [8]. Measured concentrations of the NPS contaminant in groundwater are sometimes available through various networks or programs of groundwater quality monitoring. However, the data required to completely characterize the spatial and temporal variability of factors responsible for NPS contamination, as well as those that characterize the hydrogeologic heterogeneity within large-scale aquifers, often are not available [29]. The data needs for such assessments are extensive, and many vulnerability assessments have been limited by only those data sets already collected and publicly available. A common criticism for such vulnerability assessments has been that it is unreasonable to apply complicated numerical computations across large-scale

systems, based on somewhat limited spatial data and unknown model uncertainty [98]. Although these limitations have presented a substantial challenge to quantitative groundwater vulnerability assessments, recent research has increased the use of computationally based methods with spatial data tools, such as geographic information system (GIS) [29].

Conceptualization of the target aquifer and potential NPS contaminant must incorporate an appraisal of purpose, intended audience, and willingness for trade-off between cost and gained understanding of groundwater vulnerability [21]. Selection of a vulnerability assessment method is resource and problem dependent [43] and must reflect the intended purpose and range of results, from purely scientific understanding to policy-driven water-resource management and protection. However, all methods are complicated by incomplete knowledge of contaminant loading and hydrogeologic factors important to groundwater vulnerability. Corwin and Wagenet [12] noted that “the greatest single challenge in cost-effective modeling of NPS pollutants is to obtain sufficient transport-parameter data to characterize the spatial distribution of the data with a knowledge of their uncertainty.” This inherent uncertainty must be reflected in a manner as to eliminate misrepresentation of groundwater vulnerability and to enable best-informed water-resource decisions. From a scientific standpoint, a properly calibrated and validated groundwater vulnerability assessment may prove valuable in advancing current hypotheses and contributing to improved understanding of the groundwater system in question.

Consideration of the groundwater flow system during conceptualization is important and is directly influenced by the hydrogeologic framework of the aquifer. For example, unconsolidated and unconfined aquifers are the most common aquifer systems assessed in the literature [31,98] and may require considerably different conceptualization than a highly heterogeneous and complex system, such as confined, fracture-flow, or karst systems [15,24]. Important factors for conceptualization of the groundwater flow system may include hydraulic conductivity, transmissivity, and direction of flow; water inputs, such as precipitation and irrigation rates; rates and mechanisms of infiltration and recharge (matrix or piston flow versus dual-porosity and preferential recharge); and outputs or discharge, such as groundwater pumping for consumptive uses or natural springs. A proper characterization of the groundwater flow system also forms the basis for understanding advective transport of NPS contaminants.

Vulnerability assessments must consider the specific chemical nature of the NPS contaminant of interest to properly characterize transport from surface loading to subsurface transport. For example, nitrate ( $\text{NO}_3^-$ ) is the most ubiquitous NPS contaminant of groundwater worldwide [9]. The predominance of vulnerability studies that assess the risk of groundwater contamination from  $\text{NO}_3^-$  parallels this serious groundwater quality issue. Nitrogen is available from a large number of natural and anthropogenic sources, particularly agriculture, and contributes to the widespread risk of  $\text{NO}_3^-$  contamination in groundwater [51]. More importantly, most natural and aqueous environments favor  $\text{NO}_3^-$  as the more stable, soluble, and conservative form of nitrogen. These characteristics promote relatively rapid advective transport of  $\text{NO}_3^-$ . Some processes temporarily remove  $\text{NO}_3^-$  from the groundwater system; denitrification is the only permanent sink [51].

Whereas  $\text{NO}_3^-$  is generally regarded as a more conservative solute (under oxic conditions), commercially available pesticides are considered reactive solutes. Although pesticides have similar agricultural sources as  $\text{NO}_3^-$ , (reactive) transport of pesticides is often retarded, due to such processes as adsorption, degradation, and volatilization. Groundwater vulnerability assessments considering pesticides are abundant in the literature [89,98] and address the reactive nature of pesticides in various approaches. This contrast of the two most commonly assessed NPS contaminants ( $\text{NO}_3^-$  and pesticides) illustrates the importance of proper conceptualization of the relevant chemical processes affecting contaminant transport. Attenuation of a potential NPS contaminant may take the form of dilution, sorption, ion exchange, solution/precipitation, hydrolysis, complexation, biochemical transformation, and volatilization. The surface and subsurface environments have varying capacities to promote attenuation processes.

Due to the immediate contact between potential surface-applied NPS contaminants and soil, the physical, chemical, and biological characteristics of the soil are important conceptual considerations for groundwater vulnerability assessments and for understanding NPS contaminant reactivity and attenuation. Soil properties and chemical conditions most relevant for vulnerability assessment are thickness, texture, permeability, available water capacity, pH, soil organic matter content, soil sorption, soil cation exchange, clay content, reduction–oxidation (redox) conditions, presence of hydric soils, soil acid neutralizing capacity, bulk density, and biological activity.

Beneath the soil zone, the remaining unsaturated (or vadose) zone is an important pathway for contaminant transport to the water table. However, most vulnerability assessments neglect the unsaturated zone or oversimplify its effect on contaminant transport [6]. Results of this oversimplification are most pronounced in arid environments and in systems with relatively thick and heterogeneous unsaturated zones. As technological advancements in subsurface characterizations are made, and more information is acquired about the unsaturated zone, vulnerability assessments must incorporate this important component into the conceptual model.

The final product of a vulnerability assessment is the identification of factors deemed most responsible for groundwater vulnerability. Spatial variability of these factors is most often displayed, often qualitatively, in the form of a vulnerability map [35,74,87]. Because these vulnerability maps often are used for decision-making concerning groundwater protection or monitoring, care must be taken by scientists to properly represent the spatial variability of groundwater vulnerability. This concern is relevant for maps that illustrate vulnerability as discrete values or risk levels, particularly in absolute terms. Uncertainty is inherent in all vulnerability assessments; models are always imperfect, limited by data and knowledge of the complexities of the system in question [35]. It is therefore the scientist's obligation to convey this knowledge of uncertainty regarding groundwater vulnerability by developing probabilistic methods or other measures of uncertainty within the final vulnerability model and map [35].

### 8.3 Groundwater Vulnerability Modeling and Mapping Methods

The first published methodological evaluation and mapping of groundwater vulnerability occurred during the late 1960s [98]. Since the mid-1990s, approaches have gradually shifted from subjective and opinion-based methods to more objective and scientifically defensible methods [29]. The previously described definitions and conceptualization of groundwater vulnerability and local-scale objectives are important in guiding which approach is most appropriate to scientifically estimate the potential for groundwater vulnerability [36]. Classification of groundwater vulnerability approaches are delineated by three general categories [37,41]: (1) overlay and index methods that are often subjective and biased because of predetermined controlling factors included in the index, (2) process-based methods consisting of mathematical modeling to approximate contaminant fate and transport, and (3) empirically based statistical methods that correlate groundwater chemistry and explanatory variables of the study area [99].

#### 8.3.1 Overlay and Index Methods

The overlay and index methods create indices based upon the aggregation, or overlay, of many variables or factors deemed important to groundwater vulnerability. Such methods are useful as initial screening or planning tools to measure potential groundwater contamination. An advantage to these methods is that much of the data needed for their implementation are generally available at the appropriate scale. However, overlay and index approaches are less rigorous than other approaches as a predictive model to estimate actual groundwater contamination. For example, the most widely used overlay and index method, DRASTIC [2], which is described in the succeeding text, uses professional judgment to weigh factors and create an aggregate point rating that is used to develop vulnerability maps [4,73].

The overlay and index methods are popular because they are widely applicable with GIS [17,45,48,53,65,72–74,86,87,95,96]. GIS-based groundwater vulnerability methods are commonly used

because of the following: (1) GIS can demonstrate the spatial variability of georeferenced independent, or explanatory, variables deemed important for the assessment; (2) GIS has the ability to incorporate georeferenced measurements of concentration of NPS contaminants in the groundwater and to calibrate and verify hydrologic and geochemical vulnerability models; and (3) digital display and data manipulation ability of GIS provides obvious advantages during vulnerability map making [29]. The more subjective, index half of the overlay and index approach has gradually been replaced by more objective, process-based, deterministic, and statistical models [29]. The commonly used DRASTIC, GOD, and EPIK overlay and index methods are described next. Witkowski et al. [95] provide details on additional overlay and index methods.

### 8.3.1.1 DRASTIC Model

DRASTIC [32] considers seven factors: **d**epth to water, **r**et recharge, **a**quifer media, **s**oil media, **t**opography, **i**mpact of unsaturated-zone media, and **h**ydraulic conductivity of the aquifer. Although DRASTIC is widely used [16,39], the seven factors of DRASTIC are subjectively estimated and based on the professional opinion of the modeler. Using DRASTIC, scores of 0–10 are assigned to each parameter; 0 means low risk of groundwater contamination and 10 mean high risk of groundwater contamination. The scores are multiplied by a parameter-specific weight, and then the weighted scores for the seven DRASTIC factors are added to produce the final vulnerability score [41]. Results from DRASTIC and other overlay and index methods are usually not calibrated to measured contaminant concentrations in the groundwater. Rupert [73] demonstrated that an uncalibrated DRASTIC model correlated poorly with measured  $\text{NO}_3^-$  concentrations in groundwater. Despite apparent disadvantages as predictive tools, other overlay and index methods exist. Gogu and Dassargues [24] provide additional background on the overlay and index method.

### 8.3.1.2 GOD Model

An alternative overlay and index approach is the GOD model, which considers the groundwater occurrence including recharge, overall lithology, and *depth* to groundwater [22]. Similar to DRASTIC, the GOD model also uses a somewhat subjective scoring system that is multiplied to yield a final score. Unlike DRASTIC, the GOD model enables consideration of fractures in the soil or overburden of the aquifer.

### 8.3.1.3 EPIK Model

The EPIK model [15] is a commonly used overlay and index approach for groundwater vulnerability assessments in karst aquifers. EPIK is an acronym for epikarst (E), protective cover (P), infiltration (I), and karst network development (K). EPIK is a multi-attribute weighting-rating method (i.e., overlay and index) that assesses groundwater sensitivity of karst terrain [19] and has been used successfully in a number of karst regions [5,25,52].

## 8.3.2 Process-Based Methods

The process-based methods typically use deterministic models that take advantage of process-based empirical equations and/or analytical solutions to model the physical and chemical processes of infiltration, recharge, contaminant attenuation, and flux in both space and time [11,43]. Connell and van den Daele [11] present analytical and semi-analytical solutions to the advection–dispersion equation and offer the potential for use in mapping aquifer vulnerability to surface-released contamination. Although the computer programs such as HYDRUS [79] and MODFLOW [40] are popular for simulating the fate and transport of contaminants in soil, vadose zone, and groundwater, computer models are not commonly used for groundwater vulnerability assessments due to their considerable data requirements and the expertise needed to develop the models at the spatial scales typical of groundwater vulnerability assessments [41]. Harter [41] suggests that computer models can be an economical tool for groundwater vulnerability modeling and mapping if (1) a localized analysis to a particular land use or contaminant is required, (2) if sufficient data are available or can be collected to properly calibrate the model, and (3) if a “what-if”

scenario is needed to evaluate complex, interdependent processes for making land-use planning decisions. Because of the extensive data required to represent subsurface processes, process-based assessments can be less rigorous at large-scale, regional systems and are best applied to local-scale phenomena [29].

Process-based vulnerability assessments have frequently targeted potential pesticide contamination at the field scale [54] and often incorporate loading and leaching of pesticides to simulate the transport and fate of pesticides in the near surface or soil. To account for spatial variability, these methods often use pesticide attenuation to calculate pesticide vulnerability indices [13,47,62,65,71,75,77,81]. One such pesticide vulnerability index (VI), the attenuation factor (AF) model [71], has correlated well with more complex unsaturated-zone numerical modeling results [55] and actual pesticide detection in groundwater [65,76].

Process-based pesticide vulnerability assessments range from complex to simple models. Complex models often include analytical solutions for 1D transport through the unsaturated zone to coupled, unsaturated–saturated, 2D or 3D models [66]. The pesticide root zone model (PRZM) [10] is one of the most commonly used complex models for pesticide vulnerability modeling. PRZM is a 1D, deterministic–empirical/conceptual model that simulates soil–water movement by using an empirical drainage algorithm and solute transport with the advection–dispersion equation. PRZM has two distinct advantages over simple index models for estimating pesticide leaching: (1) concentrations are estimated with reference to depth and time and (2) heterogeneity in the soil column and variability in recharge can be accounted for [57]. Other complex process-based models include the type transfer function (TTF), outlined by [83], the leaching estimation and chemistry model (LEACHM) [46], and the Monte Carlo simulations of deterministic models [80].

Advantages gained by the use of complex models are minimized by extensive data requirements, which have limited the use of complex models to local- or field-scale evaluations [37]. If data are unavailable, estimates are used that may introduce additional model uncertainty. Therefore, some types of error and possibly over model uncertainty can be reduced when using a simple method [75]. Simple index-based process models have been used more routinely for large-scale and regional pesticide vulnerability modeling. Process-based index models are first-order approximations of pesticide vulnerability and describe the relation between how fast the pesticide leaches and how fast it can be degraded. The net result of these two processes determines what fraction of soil-applied pesticides potentially reaches groundwater [70]. Index models are conceptually simplified and are typically valid only under steady-state flow within a uniform homogeneous ideal medium [37]. The models represent the important transport processes for pesticides, are most appropriately used as screening tools, and are intended for evaluation and comparison of pesticide behavior under constrained and limited conditions with the advantage of requiring few input data [78]. The following sections describe index process models that have routinely been used to evaluate groundwater vulnerability to pesticides.

### 8.3.2.1 Attenuation Factor

The AF [71] is a simple index of residence time and degradation rate of a pesticide that is equivalent to the fraction of applied pesticide mass that is likely to leach past a reference depth. This index is a simple solution to the 1D, advection-dominated transport equation and is defined as

$$AF = e^{\left( \frac{-0.693dRF\theta_{FC}}{qt_{1/2}} \right)} \quad (8.1)$$

where

$d$  is the distance from the land surface to groundwater (L)

$RF$  is the retardation factor, which accounts for pesticide sorption effects

$\theta_{FC}$  is the volumetric water content at field capacity ( $L^3 L^{-3}$ )

$q$  is the net groundwater recharge rate ( $L T^{-1}$ )

$t_{1/2}$  is the half-life for pesticide degradation (T)



RF is defined as

$$RF = \left( 1 + \frac{\rho_b f_{oc} K_{oc}}{\theta_{FC}} + \frac{\theta_g K_H}{\theta_{FC}} \right) \quad (8.2)$$

where

- $\rho_b$  is the soil bulk density ( $M L^{-3}$ )
- $f_{oc}$  is the fraction of soil organic carbon on a mass basis
- $K_{oc}$  is the organic-carbon sorption coefficient ( $L^{-3} M^{-1}$ )
- $\theta_g$  is the gas constant (unitless)
- $K_H$  is Henry's constant for pesticide of interest (unitless)

The AF ranges from zero to one, where zero corresponds to a minimal threat of applied pesticide leaching, and a value of one corresponds to all the applied pesticide mass reaching the groundwater [71].

### 8.3.2.2 Leaching Potential Index

Similar to the AF, the leaching potential index (LPI) [62] is derived from the advection–dispersion equation. The LPI is compound specific and includes information regarding adsorption and degradation parameters. The LPI is defined as

$$LPI = \frac{1000t_{1/2}V}{0.693RFd} \quad (8.3)$$

where  $V$  is the average linear vertical soil-water velocity ( $L T^{-1}$ ).

Greater LPI values correspond to a greater vulnerability to pesticide contamination. LPI is simply the inverse of the exponent of the AF in Equation 8.1 with a factor of 1000 arbitrarily included to increase the numerical values of the LPI [76]. Schlosser and McCray [76] conducted a sensitivity analysis by using the LPI to evaluate the relative importance of input-parameter variability on the model-predicted vulnerability and found that the calculated vulnerabilities were most sensitive to organic-carbon content, depth to groundwater, and vertical soil-water velocity.

### 8.3.2.3 Vulnerability Index

The VI [75] is a modified version of the LPI equation and is defined as

$$VI = \frac{200k\theta_{FC}}{d\rho_b(\%OM)} \left( \frac{t_{1/2}}{K_{oc}} \right) F_{DGW} \quad (8.4)$$

where

- $k$  is the decay constant ( $T^{-1}$ )
- $\%OM$  is the percentage of organic matter present in the soil
- $t_{1/2}/K_{oc}$  is the leachability ratio, which is the measure of the pesticide's propensity to biodegrade ( $t_{1/2}$ ) and to sorb to organic matter in the soil ( $K_{oc}$ )
- $F_{DGW}$  is a factor that accounts for the depth to groundwater

The VI model is a practical approach to assessing many pesticides simultaneously by incorporating the leaching potential. The VI uses the leachability ratio to account for the leaching potential of multiple pesticides with similar chemical properties. This method is a significant advantage over other index methods; by grouping pesticides according to their leachability ratio, vulnerability assessments are made for each group, rather than for each individual pesticide [75].

### 8.3.3 Statistical Methods

Statistically based methods of groundwater vulnerability often use regression analysis to develop relations between measured concentrations of the target constituent in the groundwater (dependent variable) and explanatory variables (independent variable), such as land-use activities, soil type, depth to water, precipitation, or hydrogeology. Multivariate and nonparametric statistical techniques, such as the posterior probability distribution method [97] and particularly logistic regression [36,67,72,82,86], and artificial neural networks (ANN) [14,18,33] have proven an effective statistical method for vulnerability at the subregional and regional scales. As with any statistical model, statistically significant relations do not represent causality [21]. Careful model design and experienced interpretation of results from statistical models is warranted, as the governing physical, chemical, and biological processes for water movement and chemical transport may be masked or even misrepresented using a purely statistical approach [29].

#### 8.3.3.1 Logistic Regression

Multivariate logistic regression has been used extensively in medical and epidemiological studies [59] and more recently has been widely used in groundwater vulnerability assessments because the binary response can be established using a threshold meaningful for specific management issues [31,67]. Unlike ordinary least squares (OLS) linear regression, (multiple) logistic regression is applicable for nonparametric and dichotomous (binary) data, both of which often characterize environmental and groundwater quality data. The response variable is established using a binary threshold, which is commonly set at a drinking-water standard, laboratory detection level, or relative background concentration. The odds ratio (8.5) defines the probability of being in a response category:

$$\text{Odds ratio} = \frac{P}{1-p} \quad (8.5)$$

where  $p$  is the probability of exceeding the established binary threshold value [44]. The log of the odds ratio, or logit, transforms a variable constrained between 0 and 1 into a continuous variable that is a linear function of the explanatory variables. The logit transformation is

$$\ln\left(\frac{P}{1-p}\right) = b_0 + bx \quad (8.6)$$

where

$b_0$  is the logistic regression constant

$bx$  is the vector of slope coefficients and explanatory variables

Predicted values of the response variable are converted back into probability units by using the logistic transformation, with the logistic regression model taking the form of

$$P = \frac{e^{(b_0+bx)}}{1 + e^{(b_0+bx)}} \quad (8.7)$$

where

$P$  is the probability of the binary response event

$e$  is the base of natural logarithm

Logistic regression-based groundwater vulnerability models have been successfully used across a range of systems, from aquifer scale [31,72] to national scale [67,69], and for a variety of NPS contaminants. Eckhardt and Stackelberg [17] developed logistic regression models to predict the probability of NPS

groundwater contamination from volatile organic compounds, pesticides, and inorganic constituents. Squillace and Moran [82] used logistic regression to estimate the likelihood of methyl tert-butyl ether (MTBE) occurrence in groundwater of the Northeast and Mid-Atlantic regions of the United States. Logistic regression has also been used to predict groundwater vulnerability to pesticides [74,86]. Twarakavi and Kaluarachchi [90] used ordinal logistic regression, which differs from (binary) logistic regression in that multiple thresholds were considered while estimating probabilities of exceedance, to predict the probability of heavy metal occurrence in groundwater.

Although logistic regression has been widely used for many types of contaminants,  $\text{NO}_3^-$  is the most common NPS contaminant evaluated using logistic regression [36,69,72,74,87]. Gurdak and Qi [31] developed logistic regression models and corresponding maps that predict the vulnerability of recently recharged groundwater in 17 principal aquifers (PAs) of the United States to NPS  $\text{NO}_3^-$  contamination. Gurdak and Qi [31] also identified the most important source, transport, and attenuation (STA) factors controlling NPS  $\text{NO}_3^-$  above relative background concentrations in recently recharged groundwater within each PA and described how those factors vary across the United States by climatic, environmental, and hydrogeologic settings. Dissolved oxygen in groundwater, crops and irrigated cropland, fertilizer application, seasonally high water table, and soil properties that affect infiltration and denitrification were the most important factors in predicting elevated  $\text{NO}_3^-$  concentrations. Findings from Gurdak and Qi [31] have important implications for management decisions that are based on more subjective modeling approaches that use predetermined controlling factors for all aquifers, such as the widely used DRASTIC model. Many DRASTIC factors were not important at the PA or national scale, and DRASTIC does not include DO, which is the most important controlling factor from the PA study [31]. Gurdak and Qi [31] recommend that DO be incorporated in groundwater modeling approaches whenever possible, especially for groundwater vulnerability assessments to  $\text{NO}_3^-$ .

### 8.3.3.2 GWAVA Model

The ground water vulnerability assessment (GWAVA) model is a nonlinear approach to groundwater vulnerability assessment that uses an additive linear submodel for NPS  $\text{NO}_3^-$  sources and multiplicative exponential terms that proportionally increase or decrease the amount of NPS contaminant transferred to and accumulated in groundwater [68]. The GWAVA model has the following form:

$$C_{\text{gwi}} = S_i T_i A_i + \varepsilon_i \quad (8.8)$$

where

$$\text{N sources: } S_i = \sum_{n=1}^N \beta_n X_{n,i} \quad (8.9)$$

$$\text{Transport: } T_i = \exp \left( \sum_{j=1}^J \alpha_j Z_{j,i} \right) \quad (8.10)$$

$$\text{Attenuation: } A_i = \exp \left( \sum_{k=1}^K -\delta_k Z_{k,i} \right) \quad (8.11)$$

$C_{\text{gwi}}$  is the observed mean ambient  $\text{NO}_3^-$  concentration in groundwater associated with monitoring network polygon i, mg/L

$X_{n,i}$  is the average nitrogen (N) load from source n in monitoring network polygon i

$Z_{j,i}$  is the average transport factor j in monitoring network polygon i

$Z_{k,i}$  is the average AF k in monitoring network polygon i

- $\beta_n$  is the coefficient for N source n
- $\alpha_j$  is the coefficient for transport factor j
- $\delta_k$  is the coefficient for AF k
- $\epsilon_i$  is the model error for monitoring network polygon I [68]

### 8.3.4 Uncertainty

The output from many types of groundwater vulnerability models can be displayed within a GIS when the explanatory variables within the model are represented in geospatial databases. Thus, the coupling of groundwater vulnerability models and GIS provides an efficient approach to create vulnerability maps that spatially represent the risk of NPS groundwater contamination. However, uncertainty is inherent in all groundwater vulnerability models and maps. Uncertainty can be considered any aspect of the data that results in less than perfect knowledge about the phenomenon being modeled [26]. Loague et al. [57] recommended that GIS-generated groundwater vulnerability maps would not be useful in the decision management arena until (1) model and data uncertainties were incorporated into the assessment and (2) nonsubjective criteria were established. Uncertainty analysis has received some attention and application within the field of groundwater vulnerability [23,35,43,60]. Uncertainty in vulnerability assessments has most commonly been addressed through the use of probabilistic methods, where the vulnerability or risk of contamination is expressed as a probability, as within the logistic regression method [67,74,86]. These methods have incorrectly ascribed all uncertainty within these calculated probabilities of vulnerability. Most frequently, data used to calculate these probabilities are imperfectly known because of spatial extrapolation techniques used within GIS to create spatially available explanatory data. Vulnerability probabilities that are calculated based on interpolated GIS data sets are inherently uncertain. If vulnerability maps are to be used for decision-making, the quality of the data, particularly from GIS, must be judged in terms of the reliability of the input data and the confidence limits that can be associated with the end product [42]. Groundwater vulnerability practitioners need easily accessible tools for quantifying errors and assessing their impact on the resulting groundwater vulnerability models and maps. Raster error propagation tool (REPTool) [32] is one example of a method to quantify uncertainty in GIS-based groundwater vulnerability maps and is briefly described next.

#### 8.3.4.1 REPTool

The REPTool [32] is a custom GIS tool to estimate error propagation and predict uncertainty in raster processing operations and geospatial modeling and has been successfully applied to quantify uncertainty in groundwater vulnerability models and maps [35]. REPTool uses Latin hypercube sampling [63], which is a stratified Monte Carlo method that is more computationally efficient to track error propagation in GIS data. REPTool enables users to create uncertainty maps that correspond to their groundwater vulnerability maps, which can be used to help decision-makers allocate limited resources for monitoring, protection, and remediation or to target areas to reduce errors and improve the confidence in the groundwater vulnerability models and maps [32].

## 8.4 Climate Variability and Change

Groundwater vulnerability is affected by human activities and climate change and variability in many complex ways [31]. Although climate change studies have only begun to quantify the effects on the quantity of groundwater resources, the quality of groundwater and groundwater vulnerability may be a limiting factor for some intended uses such as drinking or irrigation water supply and to the long-term sustainability of many groundwater resources worldwide [31].

Relatively few studies have evaluated the effects of climate variability and change on groundwater vulnerability [27,28,31,49]. The limited studies have primarily addressed seawater intrusion of coastal

aquifers, and some studies indicate that groundwater pumping is expected to have more of an effect than climate change and sea-level rise on groundwater vulnerability to seawater intrusion in some coastal aquifers [19,88]. The effect of climate change on air temperature may influence groundwater temperatures and dissolved oxygen concentrations [38,50], which have important implications for reaction rates and redox reactions that directly affect the nitrogen and carbon cycle in soil and groundwater, NPS and point source contamination, and the fate of many groundwater contaminants. Climate-induced changes that alter biogeochemical processes may potentially make groundwater less suitable for drinking [20]. Climate change that induces alterations to recharge rates may also increase the mobilization of pesticides and other pollutants and reduce groundwater quality [7,85]. In some semiarid and arid regions, climate change may mobilize naturally occurring salts, such as  $\text{NO}_3^-$  and chloride ( $\text{Cl}^-$ ) pore-water reserves, or promote enhanced denitrification and removal of  $\text{NO}_3^-$  from the unsaturated zone prior to recharge [34]. Interannual to interdecadal climate variability, such as from the El Niño/Southern Oscillation (ENSO), has affected the downward displacement of subsoil  $\text{Cl}^-$  and  $\text{NO}_3^-$  pore-water reservoirs in the High Plains aquifers that may have a substantial effect on groundwater vulnerability to NPS  $\text{NO}_3^-$  contamination [34]. Stuart et al. [84] noted that  $\text{NO}_3^-$  leaching to groundwater of the United Kingdom as a result of climate change is not yet well enough understood to make useful predictions without additional monitoring data. Studies on natural soil and agricultural processes in the United Kingdom report a range of  $\text{NO}_3^-$  leaching rates from a slight increase to possibly doubling  $\text{NO}_3^-$  concentrations in groundwater by 2100 because of climate change [84]. Additionally, a possible increase in surface water intrusion and flooding from climate change may pose a risk to groundwater quality because of contamination from bacteria and organic matter from wetlands [49]. It is critical for future studies to better understand the coupled effect of human and climate stresses on groundwater quality in other aquifers to best predict and manage future groundwater sustainability.

## 8.5 Summary and Conclusions

---

Continued concern about contamination of groundwater resources makes vulnerability assessments important tools for water-resource managers and policy makers. These concerns will drive the advancement of future assessments of NPS contamination to include a much broader scope of study and to include all potential groundwater contaminants that occur in a widespread and spatially variable fashion. Groundwater vulnerability practitioners should strive to develop the best available conceptual model, apply quantitative and scientifically defensible methods, and clearly state all limitations and uncertainty associated with the overall vulnerability estimation and map. The remaining critical questions that require additional research are adapted from Gurdak [29] and include but are not limited to:

Improvements in the field of groundwater vulnerability will occur by technological advancement, such as remote-sensing tools to characterize the subsurface and the continued application of quantitative and scientifically defensible groundwater vulnerability assessment methods.

Advanced quantitative methods are no substitute for a well-defined conceptual model that accurately represents the system. Therefore, important future research should strive for the best available conceptualization of the groundwater and unsaturated-zone systems of interest through the collection of descriptive data and storage in spatially integrated databases (GIS) that are well suited to make scale-appropriate evaluations.

Advancement will come from new groundwater vulnerability methods that address dual-porosity (preferential or fracture flow) or triple-porosity flow (karst systems).

To date, few groundwater vulnerability assessments have included mechanisms or processes that may act to short-circuit recharge as matrix or piston flow. Short circuiting, in the form of well-bore leakage, has been proposed to be a dominant mechanism for recharge and chemical transport in the High Plains aquifer [33].

Future groundwater vulnerability research must address temporal variability and the potential for the unsaturated zone to act as a chemical reservoir for some NPS contaminants. This is particularly worrisome for the vulnerability assessment of  $\text{NO}_3^-$  contamination. Recent studies have identified substantial

stores of  $\text{NO}_3^-$  within the unsaturated zone of major aquifers [64,93] that may increase the potential for groundwater contamination at some future date.

Groundwater vulnerability cannot be adequately addressed as a steady-state function because it changes over space and time. In particular, future research will benefit from an integration of data to better understand temporal variation in groundwater vulnerability.

Vulnerability maps, which are the most visible products from groundwater vulnerability assessment, are subject to inherent uncertainty [35]. Factors influencing NPS contamination are never completely realized, and thus spatial and the temporal representations (GIS data coverages) of these variables are subject to uncertainty. This uncertainty can be compounded and propagated through the analysis to the final mapped product, as Heuvelink et al. [42] and Gurdak et al. [35] have demonstrated. Consideration of error propagation is particularly relevant and should be addressed while using continuously distributed random variables within GIS-based vulnerability maps.

## References

1. Albinet, M. and J. Margat. 1970. Cartographie de la vulnérabilité à la pollution des nappes d'eau souterraine Orleans, France. *Bull BRGM 2eme Series* 4: 13–22.
2. Aller, L., B. Truman, J.H. Lehr, and R.J. Petty. 1985. DRASTIC—A standardized system for evaluating groundwater pollution potential using hydrogeologic settings, U.S. Environmental Protection Agency, EPA/600/2–85/018: 163pp.
3. Alley, W.M., R.W. Healey, J.W. LaBaugh, and T.E. Reilly. 2002. Flow and storage in groundwater systems. *Science* 296: 1985–1990.
4. Al-Zabet, T. 2002. Evaluation of aquifer vulnerability to contamination potential using the DRASTIC method. *Environmental Geology* 43: 203–208.
5. Awawdeh, M., and A. Nawafleh. 2008. A GIS-based EPIK model for assessing aquifer vulnerability in Irbid Governorate, North Jordan. *Jordan Journal of Civil Engineering* 2(3): 267–278.
6. Bekesi, G., and J. McConchie. 2000. Empirical assessment of the influence of the unsaturated zone on aquifer vulnerability, Manawatu Region, New Zealand. *Ground Water* 38(2): 193–199.
7. Bloomfield, J.P., R.J. Williams, D.C. Goody, J.N. Cape, and P. Guha. 2006. Impacts of climate change on the fate and behaviour of pesticides in surface and groundwater—A UK perspective. *Science of the Total Environment* 369: 163–177.
8. Burow, K.R., B.T. Nolan, M.G. Rupert, and N.M. Dubrovsky. 2010. Nitrate in groundwater of the United States, 1991–2003. *Environmental Science and Technology* 44(13): 4988–4997.
9. Canter, L.W. 1997. *Nitrates in Groundwater*. 263pp, New York: Lewis Publishers.
10. Carsel, R.F., C.N. Smith, L.A. Mulkey, J.D. Dean, and P. Howise. 1984. User's manual for the pesticide root zone model (PRZM), release 1. USEPA-600/3-84-109. U.S. Environmental Protection Agency, Washington, DC.
11. Connell, L.D., and G. van den Daele. 2003. A quantitative approach to aquifer vulnerability mapping. *Journal of Hydrology* 276: 71–88.
12. Corwin, D.L., and R.J. Wagenet. 1996. Applications of GIS to the modeling of nonpoint source pollutants in the vadose zone: A conference overview. *Journal of Environmental Quality* 25: 403–411.
13. Diaz-Diaz, R., J.E. Garcia-Hernandez, and K. Loague. 1998. Leaching potentials of four pesticides used for bananas in the Canary Islands. *Journal of Environmental Quality* 27: 562–572.
14. Dixon, B. 2005. Applicability of neuro-fuzzy techniques in predicting ground-water vulnerability: A GIS-based sensitivity analysis. *Journal of Hydrology* 309(1–4): 17–38.
15. Doerfliger, N., P.Y. Jeannin, and F. Zwahlen. 1999. Water vulnerability assessment in karst environments: A new method of defining protection areas using a multi-attribute approach and GIS tools (EPIK method). *Environmental Geology* 39: 165–176.
16. Ducci, D., 1999. GIS techniques for mapping groundwater contamination risk. *Natural Hazards* 20: 279–294.

17. Eckhardt, D.A., and P.E. Stackelberg. 1995. Relation of ground-water quality to land use on Long Island, New York. *Ground Water* 33(6): 1019–1033.
18. Eslamian, S., and L. Niloufar. 2009. Modelling nitrate pollution of groundwater using artificial network and genetic algorithm in an arid zone. *International Journal of Water* 5(2): 194–203.
19. Ferguson, G., and T. Gleeson. 2012. Vulnerability of coastal aquifers to groundwater use and climate change. *Nature Climate Change* 2: 342–345, doi:10.1038/NCLIMATE1413.
20. Figura, S., D.M. Livingstone, E. Hoehn, and R. Kipfer. 2011. Regime shift in groundwater temperature triggered by the arctic oscillation. *Geophysical Research Letters* 38: L23401, doi:10.1029/2011GL049749, pp. 1–5.
21. Focazio, M.J., R.E. Reilly, M.G. Rupert, and D.R. Helsel. 2002. Assessing ground-water vulnerability to contamination: Providing scientifically defensible information for decision makers. U.S. Geological Survey Circular 1224, 33pp.
22. Foster, S.S.D. 1998. Groundwater recharge and pollution vulnerability of British aquifers: A critical review. In *Groundwater Pollution, Aquifer Recharge and Vulnerability*, ed. N.S. Robins, pp. 7–22. London, U.K.: Geological Society, Special Publications 130.
23. Freissinet, C., M. Vauclin, and M. Erlich. 1999. Comparison of first-order analysis and fuzzy set approach for the evaluation of imprecision in a pesticide groundwater pollution screening model. *Journal of Contaminant Hydrology* 37: 21–43.
24. Gogu, R.C., and A. Dassargues. 2000. Current trends and future challenges in groundwater vulnerability assessment using overlay and index methods. *Environmental Geology* 39(6): 549–559.
25. Goldscheider, N. 2005. Karst groundwater vulnerability mapping: Application of a new method in the Swabian Alb, Germany. *Hydrogeology Journal* 13(4): 555–564.
26. Gottsegen, J., D.R. Montello, and M. Goodchild. 1999. A comprehensive model of uncertainty in spatial data. In *Spatial Accuracy Assessment: Land Information Uncertainty in Natural Resources*, eds. K. Lowell and A. Jaton, pp. 175–181. Chelsea, MI: Ann Arbor Press.
27. Green, T.R., M. Taniguchi, and H. Kooi. 2007. Potential impacts of climate change and human activity on subsurface water resources. *Vadose Zone Journal* 6(3): 531–532, doi:10.2136/vzj2007.0098.
28. Green, T.R., M. Taniguchi, H. Kooi, J.J. Gurdak, D.M. Allen, K.M. Hiscock, H. Treidel, and A. Aureli. 2011. Beneath the surface of global change: Impacts of climate change on groundwater. *Journal of Hydrology* 405: 532–560, doi: 10.1016/j.jhydrol.2011.05.002.
29. Gurdak, J.J. 2008. *Ground-Water Vulnerability: Nonpoint-Source Contamination, Climate Variability, and the High Plains Aquifer*, 223p. Saarbrücken, Germany: VDM Verlag Publishing, ISBN: 978-3-639-09427-5.
30. Gurdak, J.J., P.B. McMahon, and B.W. Bruce. 2012. Vulnerability of groundwater quality to human activity and climate change and variability. High Plains aquifer, USA. In *Climate Change Effects on Ground Water Resources: A Global Synthesis of Findings and Recommendations*, eds. H. Treidel, J.J. Martin-Bordes, and J.J. Gurdak, pp. 145–167. Boca Raton, FL: Taylor & Francis Group, 414 p.
31. Gurdak, J.J., and S.L. Qi. 2012. Vulnerability of recently recharged groundwater in principal aquifers of the United States to nitrate contamination. *Environmental Science and Technology* 46(11): 6004–6012.
32. Gurdak, J.J., S.L. Qi, and M.L. Geisler. 2009. Estimating prediction uncertainty from geographical information system raster processing—A user’s manual for the Raster Error Propagation Tool (REPTool): U.S. Geological Survey Techniques and Methods 11–C3, 71 p.
33. Gurdak, J.J., M.A. Walvoord, and P.B. McMahon. 2008. Susceptibility to enhanced chemical migration from depression-focused preferential flow. High Plains aquifer. *Vadose Zone Journal* 7(4): 1218–1230.
34. Gurdak, J.J., R.T. Hanson, P.B. McMahon, B.W. Bruce, J.E. McCray, G.D. Thyne, and R.C. Reedy. 2007a. Climate variability controls on unsaturated water and chemical movement. High Plains aquifer, USA. *Vadose Zone Journal* 6(2): 533–547.

35. Gurdak, J.J., J.E. McCray, G.D. Thyne, and S.L. Qi. 2007b. Latin hypercube approach to estimate uncertainty in ground water vulnerability. *Ground Water* 45(3): 348–361.
36. Gurdak, J.J., and S.L. Qi. 2006. Vulnerability of recently recharged ground water in the High Plains aquifer to nitrate contamination. Reston, VA: U.S. Geological Survey Scientific Investigations Report 2006–5050, 39pp.
37. Gurdak, J.J., and J.E. McCray. 2005. Groundwater vulnerability to pesticides: Statistical approaches. In *Water Encyclopedia: Volume 5: Ground Water*, eds. J.H. Lehr and J. Keeley, pp. 594–599. Chichester, U.K.: John Wiley & Sons Ltd.
38. Haldorsen, S., M. Heim, and M. van der Ploeg. 2012. Impacts of climate change on groundwater in permafrost areas—Case study from Svalbard, Norway. In *Climate Change Effects on Ground Water Resources: A Global Synthesis of Findings and Recommendations*, eds. H. Treidel, J.J. Martin-Bordes, and J.J. Gurdak, pp. 323–340. Boca Raton, FL: Taylor & Francis Group, 414p.
39. Hamza, M.H., A. Added, R. Rodriguez, and S. Abdeljaoued. 2007. A GIS-based DRASTIC vulnerability assessment in the coastal alluvial aquifer of Metline-Ras Jebel-Raf Raf (northeastern part of Tunisia). In *Groundwater Vulnerability Assessment and Mapping*, eds. A.J. Witkowski, A. Kowalczyk, and J. Vrba, pp. 103–113. London, U.K.: Taylor & Francis Group, 260 p.
40. Harbaugh, A.W. 2005. MODFLOW-2005, the U.S. Geological Survey modular ground-water model—The groundwater flow process: U.S. Geological Survey Techniques and Methods, Book 6, Chapter A16, Variously Paged.
41. Harter, T. 2005. Vulnerability mapping of groundwater resources. In *Water Encyclopedia: Volume 5: Ground Water*, eds. J. H. Lehr and J. Keeley, pp. 561–566. Chichester, U.K.: John Wiley & Sons Ltd.
42. Heuvelink, G.B., P.A. Burrough, and A. Stein. 1989. Propagation of errors in spatial modelling with GIS. *International Journal of Geographical Information Systems* 3(4): 303–322.
43. Holtschlag, D.J., and C.L. Luukkonen. 1996. Vulnerability of ground water to Atrazine leaching in Kent County, Michigan. Lansing, MI: U.S. Geological Survey Water-Resources Investigations Report 96-4198, 49p.
44. Hosmer, D.W., and S. Lemeshow. 1989. *Applied Logistic Regression*. New York: John Wiley & Sons, 373p.
45. Hrkal, Z. 2001. Vulnerability of groundwater to acid deposition, Jizerske Mountains, northern Czech Republic: Construction and reliability of a GIS-based vulnerability map. *Hydrogeology Journal* 9: 348–357.
46. Hutson, J.L., and R.J. Wagenet. 1992. Leaching estimation and chemistry model. Version 3, user manual. Research Series No 92–3. Department of Soil, Crop and Atmospheric Sciences. Ithica, New York: Cornell University.
47. Jury, W.A., D.D. Focht, and W.J. Farmer. 1987. Evaluation of pesticide groundwater pollution potential from standard indices of soil-chemical adsorption and biodegradation. *Journal of Environmental Quality* 16: 422–428.
48. Kinniburgh, D.G., P.L. Smedley, J. Davies, C.J. Milner, I. Gaus, J.M. Trafford, S. Burden, S.M. Ihtishamul, N. Ahmad, and K.M. Ahmed. 2003. The scale and causes of the groundwater arsenic problem in Bangladesh. In *Arsenic in Ground Water, Geochemistry and Occurrence*, eds. A.H. Welch and K.G. Stollenwerk, pp. 211–258. Boston, MA: Kluwer Academic Publishers.
49. Kløve, B., P. Ala-Aho, G. Bertrand, J.J. Gurdak, H. Kupfersberger, J. Kværner, T. Muotka, H. Mykrä, E. Preda, P. Rossi, C.B. Uvo, E. Velasco, M. Pulido-Velázquez. 2013. Climate change impacts on groundwater and dependent ecosystems. *Journal of Hydrology*, DOI: <http://dx.doi.org/10.1016/j.jhydrol.2013.06.037>
50. Kløve, B., P. Ala-aho, J. Okkonen, and P. Rossi. 2012. Possible effects of climate change on hydrogeological systems: Results from research on esker aquifers in northern Finland. In *Climate Change Effects on Ground Water Resources: A Global Synthesis of Findings and Recommendations*, eds. H. Treidel, J.J. Martin-Bordes, and J.J. Gurdak, pp. 305–322. Boca Raton, FL: Taylor & Francis Group, 414p.



51. Korom, S.F. 1992. Natural denitrification in the saturated zone: A review. *Water Resources Research* 28(6): 1657–1668.
52. Kovačič, G., and M. Petrič. 2007. Karst aquifer intrinsic vulnerability mapping in the Orehek area (SW Slovenia) using the EPIK method. In *Groundwater Vulnerability Assessment and Mapping*, eds. A.J. Witkowski, A. Kowalczyk, and J. Vrba, pp. 213–222. London, U.K.: Taylor & Francis Group, 260p.
53. Lee, S.M., K.D. Min, N.C. Woo, Y.J. Kim, and C.H. Ahn. 2003. Statistical models for the assessment of nitrate contamination in urban groundwater using GIS. *Environmental Geology* 44: 210–221.
54. Levy, J., G. Chesters, D.P. Gustafson, and H.W. Read. 1998. Assessing aquifer susceptibility to and severity of atrazine contamination at a field site in south-central Wisconsin, USA. *Hydrogeology Journal* 6: 483–499.
55. Li, Z.C., R.S. Yost, and R.E. Green. 1998. Incorporating uncertainty in a chemical leaching assessment. *Journal of Contaminant Hydrology* 29(3–4): 285–299.
56. Loague, K. 1996. The impact of land use on estimates of pesticide leaching potential: Assessments and uncertainties. *Journal of Contaminant Hydrology* 8: 157–175.
57. Loague, K., R.L. Bernknopf, R.E. Green, and T.W. Giambelluca. 1996. Uncertainty of groundwater vulnerability assessment for agricultural regions in Hawaii: Review. *Journal of Environmental Quality* 25: 475–490.
58. Lombardo, L.A., G.L. Grabow, J. Spooner, D.E. Line, D.L. Osmond, and G.D. Jennings. 2000. *Section 319 Nonpoint Source National Monitoring Program Successes and Recommendations*. NCSU Water Quality Group, Biological and Agricultural Engineering Department. Raleigh, NC: North Carolina State University.
59. Magder, L.S., and J.P. Hughes. 1997. Logistic regression when the outcome is measured with uncertainty. *American Journal of Epidemiology* 146(2): 195–203.
60. Madl-Szoni, J., and L. Fule. 1998. Groundwater vulnerability assessment of the SW Trans-Danubian Central Range, Hungary. *Environmental Geology* 35: 9–18.
61. Maxe, L., and P.O. Johansson. 1998. Assessing groundwater vulnerability using travel time and specific surface area as indicators. *Hydrogeology Journal* 6: 441–449.
62. Meeks, Y.J., and J.D. Dean. 1990. Evaluating ground-water vulnerability to pesticides. *Journal of Water Resources Planning and Management* 116: 693–707.
63. McKay, M.D., R.J. Beckman, and W.J. Conover. 1979. A comparison of three methods for selecting values of input variables in the analysis of output from a computer code. *Technometrics* 21: 239–245.
64. McMahon, P.B., K.F. Dennehy, B.W. Bruce, J.K. Böhlke, R.L. Michel, J.J. Gurdak, and D.B. Hurlbut. 2006. Storage and transit time of chemicals in thick unsaturated zones under rangeland and irrigated cropland, High Plains, United States. *Water Resources Research* 42, W03413, doi:10.1029/2005WR004417.
65. Murray, K.E., and J.E. McCray. 2005. Development and application of a regional-scale pesticide transport and groundwater vulnerability model. *Environmental and Engineering Geoscience* 11: 271–284.
66. National Research Council. 1993. *Ground Water Vulnerability Assessment, Predicting Relative Contamination Potential under Conditions of Uncertainty*. Washington, DC: National Academy Press, 210 p.
67. Nolan, B.T. 2001. Relating nitrogen sources and aquifer susceptibility to nitrate in shallow ground waters of the United States. *Ground Water* 39(2): 290–299.
68. Nolan, B.T., and K.J. Hitt. 2006. Vulnerability of shallow groundwater and drinking-water wells to nitrate in the United States. *Environmental Science and Technology* 40(24): 7834–7840.
69. Nolan, B.T., K.J. Hitt, and B.C. Ruddy. 2002. Probability of nitrate contamination of recently recharged ground waters in the conterminous United States. *Environmental Science and Technology* 36(10): 2138–2145.
70. Rao, P.S.C., and W.M. Alley. 1993. Pesticides. In *Regional Ground-Water Quality*, ed. W. M. Alley, pp. 345–377. New York: Van Nostrand Reinhold.

71. Rao, P.S.C., A.G. Hornsby, and R.E. Jessup. 1985. Indices for ranking the potential for pesticide contamination of groundwater. *Symposium of Soil and Crop Science Society of Florida* 44: 1–8.
72. Rupert, M.G. 1998. Probability of detecting atrazine/desethylatrazine and elevated concentrations of nitrate ( $\text{NO}_2 + \text{NO}_3 - \text{N}$ ) in groundwater in the Idaho part of the Upper Snake River Basin. U.S. Geological Survey Water-Resources Investigations Report 98–4203, 32p.
73. Rupert, M.G., 1999. Improvements to the DRASTIC ground-water vulnerability mapping method. U.S. Geological Survey Fact Sheet FS–066–99.
74. Rupert, M.G., 2003. Probability of detecting atrazine/desethyl-atrazine and elevated concentrations of nitrate in ground water in Colorado. Denver, CO: U.S. Geological Survey Water-Resources Investigations Report 02–4269, 35p.
75. Schlosser, S.A., and J.E. McCray. 2002. Sensitivity of a pesticide leaching-potential index model to variations in hydrologic and pesticide-transport properties. *Environmental Geosciences* 9: 66–73.
76. Schlosser, S.A., J.E. McCray, K.E. Murray, and B.A. Austin. 2002. A sub-regional scale method to assess aquifer vulnerability to pesticides. *Ground Water* 40(4): 361–367.
77. Shukla, S., S. Mostaghimi, V.O. Shanholt, M.C. Collins, and B.R. Ross. 2000. A county-level assessment of ground water contamination by pesticides. *Ground Water Monitoring and Remediation* 20: 104–119.
78. Shukla, S., S. Mostaghimi, V.O. Shanholtz, and M.C. Collins. 1998. A GIS-based modeling approach for evaluating groundwater vulnerability to pesticides. *Journal of the American Water Resources Association* 34: 1275–1293.
79. Simunek, J., M.T. van Genuchten, and M. Sejna. 2008. Development and applications of the HYDRUS and STANMOD software packages and related codes. *Vadose Zone Journal* 7(2): 587–600.
80. Soutter, M., and A. Musy. 1998. Coupling 1D Monte-Carlo simulations and geostatistics to assess groundwater vulnerability to pesticide contamination on a regional scale. *Journal of Contaminant Hydrology* 32: 25–39.
81. Soutter, M., and Y. Pannatier. 1996. Groundwater vulnerability to pesticide contamination on a regional scale. *Journal of Environmental Quality* 25: 439–444.
82. Squillace, P.J., and M.J. Moran. 2000. Estimating the likelihood of MTBE occurrence in drinking water supplied by ground-water sources in the Northeast and Mid-Atlantic regions of the United States. Rapid City, SD: U.S. Geological Survey Water-Resources Investigations Report 00–343, 10pp.
83. Stewart, I.T., and K. Loague. 2003. Development of type transfer functions for regional-scale nonpoint source groundwater vulnerability assessments. *Water Resources Research* 39: 1359–1371.
84. Stuart, M.E., D.C. Gooddy, J.P. Bloomfield, and A.T. Williams. 2011. A review of the impact of climate change on future nitrate concentrations in groundwater of the UK. *Science of the Total Environment* 409(15): 2859–2873.
85. Sugita, F., and K. Nakane. 2007. Combined effects of rainfall patterns and porous media properties on nitrate leaching. *Vadose Zone Journal* 6(3): 548–553.
86. Teso, R.R., M.P. Poe, T. Younglove, and P.M. McCool. 1996. Use of logistic regression and GIS modeling to predict groundwater vulnerability to pesticides. *Journal of Environmental Quality* 25: 425–432.
87. Tesoriero, A.J., and F.D. Voss. 1997. Predicting the probability of elevated nitrate concentrations in the Puget Sound Basin: Implications for aquifer susceptibility and vulnerability. *Ground Water* 35(6): 1029–1039.
88. Treidel, H., Martin-Bordes, J.J., and Gurdak, J.J. (eds.), 2012. *Climate Change Effects on Ground Water Resources: A Global Synthesis of Findings and Recommendations*. Boca Raton, FL: Taylor & Francis Group, 414p.
89. Troiano, J., J. Marade, and F. Spurlock. 1999. Empirical modeling of spatial vulnerability applied to a norflurazon retrospective well study in California. *Journal of Environmental Quality* 28: 397–403.
90. Twarakavi, N.K.C., and J.J. Kaluarachchi. 2005. Aquifer vulnerability assessment to heavy metals using ordinal logistic regression. *Ground Water* 43(2): 200–214.

91. U.S. Environmental Protection Agency. 1997. State source water assessment and protection programs guidance. Washington, DC: Final Guidance USEPA816-R-97-009, 127pp.
92. U.S. Environmental Protection Agency. 1993. A review of methods for assessing aquifer sensitivity and ground water vulnerability to pesticide contamination. Washington, DC: U.S. Environmental Protection Agency, EPA813-R-93-002, 196pp.
93. Walvoord, M.A., F.M. Phillips, D.A. Stonestrom, R.D. Evans, P.C. Hartsough, B.D. Newman, and R.G. Striegl. 2003. A reservoir of nitrate beneath desert soils. *Science* 302: 1021-1024.
94. Warner, K.L. and T.L. Arnold. 2010. Relations that affect the probability and prediction of nitrate concentration in private wells in the glacial aquifer system in the United States, Scientific Investigations Report 2010-5100; U.S. Geological Survey: Reston, VA, 73p.
95. Witkowski, A.J., A. Kowalczyk, and J. Vrba, (eds.). 2007. *Groundwater Vulnerability Assessment and Mapping*. London, U.K.: Taylor & Francis Group, 260p.
96. Witkowski, A.J., K. Rubin, A. Kowalczyk, A. Rozkowski, and J. Wrobel. 2003. Groundwater vulnerability map of the Chrzanow karst-fissured Triassic aquifer (Poland). *Environmental Geology* 44: 59-67.
97. Worrall, F. and D.W. Kolpin. 2003. Direct assessment of groundwater vulnerability from single observations of multiple contaminants. *Water Resources Research* 39: 1345-1352.
98. Zektser, I.S., A.P. Belousova, and V.Yu. Dudov. 1995. Regional assessment and mapping of groundwater vulnerability to contamination. *Environmental Geology* 25: 225-231.
99. Zhang, R., J.D. Hamerlink, S.P. Gloss, and L. Munn. 1996. Determination of non-point source pollution using GIS and numerical models. *Journal of Environmental Quality* 25: 411-418.

# Historical Development of Wastewater Management

---

Giovanni De Feo  
*University of Salerno*

Georgios Pericles Antoniou  
*Architect Engineer*

Larry Wesley Mays  
*Arizona State University*

Walter Dragoni  
*University of Perugia*

Hilal Franz Fardin  
*French Institute of Pondicherry*

Fatma El-Gohary  
*National Research Centre*

Pietro Laureano  
*IPOGEA*

Eleni Ioannis Kanetaki  
*Architect Engineer*

Xiao Yun Zheng  
*Yunnan Academy of Social Sciences*

Andreas Nikolaos Angelakis  
*Institute of Iraklio*

9.1	Introduction .....	166
9.2	Early Civilizations: Neolithic and Early Bronze Ages .....	167
	Neolithic Age • Mesopotamian Civilizations • Egyptians	
9.3	Indus Civilization .....	170
9.4	Minoan Civilization: Middle and Late Bronze Age .....	171
	Sewer and Drainage Systems • Bathrooms and/or Lustral Chambers • Toilets	
9.5	China and Other Southeast Asian Dynasties.....	176
9.6	Historical Times.....	178
	Etruscan Civilization (ca. 800–100 BC) • Classical and Hellenistic Periods (ca. 480–67 BC) • Roman Period (ca. 750–330 AD)	
9.7	Medieval Times.....	189
	Byzantine World • European Region	
9.8	From the Old World to Modernity (ca. Fifteenth Century to Eighteenth Century) .....	195
	European Technologies and Practices • Ottoman Practices (ca. 1453–1910 AD)	
9.9	Pre-Columbian American Societies .....	198
9.10	Modern Times.....	204
	Practices at the Industrial Revolution • Present Times (1900 to Present)	
9.11	Summary and Conclusions .....	209
	References.....	212

## AUTHORS

**Giovanni De Feo** is an assistant professor of sanitary and environmental engineering. Currently he teaches (1) environmental impact assessment and (2) environmental assessment procedures at the Faculty of Mathematical, Physical and Natural Sciences of the University of Salerno, Italy. He serves as referee for 34 international journals. He is an associate editor of (1) *Water Science and Technology* and (2) *Water Science and Technology: Water Supply*. He is a member of the editorial board of (1) *Energy and Environment Research*, (2) *Journal of Basic & Applied Sciences*, (3) *Environment and Pollution*, (4) *International Journal of Environmental Protection*, and (5) *Sustainability*. He is a member of the Management Committee of the Specialist Group on Water and Wastewater in Ancient Civilizations of the International Water Association (IWA).

**Georgios Pericles Antoniou** is an architect engineer specialized on buildings' conservation (MA UoYork, UK) and runs an independent architectural practice as well, focused on restoration and

anastylosis of historic buildings and monuments, including the restoration of the Ancient Theatre of Dodona in Epirus and the Roman Baths in Epidaurus. He is also—currently or formerly—adjunct at graduate and postgraduate courses at the Architectural Department of the University of Patras, at the Department of History of the Ionian University, at the Department of Restoration and Reuse of Buildings at the Advanced Technological Institute of Patras, etc. He was member in seven research programmes, either as part of his teaching duties or independently. He has participated in numerous international conferences and has published more than 40 scientific papers in conferences' proceedings, as articles in scientific magazines, or chapters in collective publications. Many of the publications refer on historic hydraulic constructions.

**Larry Wesley Mays** is a professor in the Civil, Environmental, and Sustainable Engineering Group in the School of Sustainable Engineering and the Built Environment at Arizona State University. He has published extensively his research in water resources engineering and has been the author, coauthor, or editor of 23 books. Two of these books are related to ancient water systems: *Ancient Water Technologies* (editor) published by Springer and *Evolution of Water Supply through the Millennia* (coeditor) published by the International Water Association. He has traveled to many ancient sites to photograph the water-related facilities. One of his major efforts is the study of ancient water systems and the relation that these systems could have on solving our problems of water resources sustainability using the concepts of traditional knowledge.

**Walter Dragoni** is a professor of hydrogeology and engineering geology at the Department of Earth Sciences (Dipartimento di Scienze della Terra), Perugia University, Perugia, Italy. He earned a degree in geological sciences at the University of Rome in 1969. Until 1977, he worked in the fields of mineral prospecting and applied geology for various private companies in Italy and abroad. From 1977 to 1988, he worked as a researcher at the CNR-IRPI. For a number of years, he taught hydrology and hydrogeology as a temporary professor at the University of Tuscia (Viterbo). On occasion, he teaches short courses on archaeology of water. Dragoni's scientific activities have been concerned mainly with hydrology and hydrogeology, modeling, limnology, karst phenomena, and erosion. In recent years, he has been occupied above all with the impact of climatic variations on water resources and the history of water management. He is external reviewer of the IPCC reports and member of the Management Committee of the IWA Specialist Group on "Water and Wastewater in Ancient Civilization." Dragoni's website address is <http://utenti.unipg.it/dragoni/denz/dragoeng.php>.

**Hilal Franz Fardin** is a PhD candidate in geography at the Ladys (University of Paris 8, France) and at the French Institute of Pondicherry (India). His doctoral study is about the values of constructed wetlands resources in southeast India, especially about the relation between pollution and society, culture, plant species, and techniques. Socioecological systems, economic botany, geohistory of water resources management, waste recycling, wetland services, and sustainable development are the major themes of his interest. He currently focuses on waste management ecotechniques, especially constructed wetlands, vegetation being the key link between the various aspects of his research work.

**Fatma El-Gohary** is a professor in the Water Pollution Control Research Department of the National Research Centre, Egypt. She graduated from Ain-Shams University. She was also awarded MSc degree from Ain-Shams University in Egypt and Dr.Eng. from the Faculty of Civil Engineering, Technical University, Hannover, Germany. Since then Prof. Dr. El-Gohary held several leading positions in the NRC including head of the Water Pollution Control Research Department, then the Head of the Environmental Research Division. On the international level, Prof. Dr. El-Gohary is an active member of the global research and development community through her contributions in international conferences, research projects, and expert group meetings. She published over 100 papers in scientific periodicals and supervised over 40 MSc and PhD candidates. She has been awarded the State Merit Prize for Advanced Sciences for the year 2002, the National Prize for scientific Excellency in the area of advanced Sciences for the year 1998, the Global 500 award from UNEP for the year 1988, the Eisenhower Fellowship for the year

1986 (USA), the National Research Centre Prize for Scientific Excellency, in the area of Environmental Science for the year 1985, and the State Prize Environmental Sciences for the year 1979.

**Pietro Laureano**, an architect and urban planner, is a UNESCO consultant for arid regions, water management, Islamic civilization, and endangered ecosystems. He has rebuilt the water systems of Petra, in Jordan, contributing to the UNESCO plan for “Greater Petra,” and restored canals and drainage systems in the monolithic town of Lalibela, Ethiopia, as team leader of the UNESCO and World Monument Fund (WMF) projects. He is the promoter of the recovery of the troglodyte city of the Sassi di Matera in southern Italy. He is founder and coordinator of Ipogea, Centre for Studies on Traditional Knowledge. He is part of the work group responsible for drafting the new UNESCO Landscape Convention. As Italian representative on the Technical-Scientific Committee of the United Nations Convention to Combat Desertification (UNCCD), and as Chairman of the Panel for Traditional Knowledge, he has promoted the creation of a World Bank of Traditional Knowledge and its innovative use ([www.tkwb.org](http://www.tkwb.org)). This initiative is being pursued with UNESCO through the creation of the International Traditional Knowledge Institute (ITKI), based in Florence.

**Eleni Ioannis Kanetaki** is an architect engineer (Faculty of Architecture, N.T.U. Athens), specialized in Restoration of Monuments (Università degli Studi di Roma La Sapienza). Her PhD thesis (Faculty of Architecture N.T.U. Athens) focused on a comparative study of 60 Turkish baths in Greece having concluded individual in situ research all over the country. She is the author of *The Ottoman baths in the Greek Territory*. Her freelance experience includes projects in Restoration and Rehabilitation of historical buildings, as well as in Architectural Surveys. Her teaching experience includes lecturing at the Patraso University, Faculty of Architecture, at the Technological Educational Institution of Pireus, Civil Engineering and Electrical Engineering Department and at the National Centre for Public Management in the thematic field *Cultural Heritage and Cultural Management*. Presently, she lectures as adjunct assistant professor at the Department of Architectural Engineering, Democritus University of Thrace (Xanthi). She is a member of ICOMOS Hellenic Section.

**Xiao Yun Zheng** is an anthropologist and historian in the field of environmental history and culture studies in China and an active scholar in the international academia. Current position includes professor and assistant president of Yunnan Academy of Social Sciences (YASS) and director of International Center for Ecological Culture Studies (YASS), China. Main Pluralism includes president of International Water History Association and vice president of China Senior Expert Committee for Water Culture (Chinese Ministry of Water Resource). His current studies include water history and culture in southwest China and Great Mekong Subregion countries, Japan, etc. Current research projects include urban water history of Southeast China, water history of Red River and Mekong basin, water history and culture cases study in Japan, etc., and water culture in the ethnic groups. He has published 130 research papers and 10 books in China and international academia.

**Andreas Nikolaos Angelakis** is a Water Resources Researcher at the National Agricultural Research Foundation, Institute of Iraklion, Greece. He received BS in Agricultural Sciences from the Agricultural University of Athens, Greece in 1962 and in Civil Engineering from University of California, Davis, CA, USA, in 1981. Also he received a MS in Water Resources and a PhD in Soil Physics from University of California, Davis, CA, USA, in 1977 and 1981, respectively. Scientific field of his interest are environmental engineering; aquatic wastewater management systems; water and wastewater management for small and decentralized systems; treated wastewater renovation and reuse; and water and wastewater technologies in ancient civilizations. He is author/coauthor of over 400 publications. He has over 1670 SCH citations and an h-index of 22. He also has participated in the organizing/scientific committee of more than 100 international Symposia. He is Fellow and Honorary member of IWA. Also, he is an IWA Strategic Council Member. In addition, he is President of IWA SG on water and wastewater in ancient civilizations and past president of EUREAU (Federation of European Water and Wastewater Services). For more on this, refer at <http://www.a-angelakis.gr/>.

## PREFACE

The rapid technological progress in the twentieth century created a disdain for the past achievements. Past water technologies were regarded to be far behind the present ones; signified major advances achieved in the twentieth century. There was a great deal of unresolved problems related to the management principles, such as the decentralization of the processes, the durability of the water projects, the cost effectiveness, and sustainability issues such as protection from floods and droughts. In the developing world, such problems were intensified to an unprecedented degree. Moreover, new problems have arisen such as the contamination of surface and groundwater. Naturally, intensification of unresolved problems led societies to revisit the past and to reinvestigate the successful past achievements. To their surprise, those who attempted this retrospect, based on archaeological, historical, and technical evidence, were impressed by two things: the similarity of principles with present ones and the advanced level of water engineering and management practices in ancient times.

Modern-day water technological principles have a foundation dating back 3000–4000 years ago. These achievements include technologies such as dams, wells, cisterns, aqueducts, baths, recreational structures, and even water reuse. These hydraulic works and features also reflect advanced scientific knowledge, which for instance allowed the construction of tunnels from two openings and the transportation of water both by open channels and closed conduits under pressure. Certainly, technological developments were driven by the necessities for efficient use of natural water resources in order to make civilizations more resistant to destructive natural elements, and to improve the standards of life. With respect to the latter, certain civilizations developed an advanced, comfortable, and hygienic lifestyle, as manifested from public and private bathrooms and flushing toilets, which can only be compared to our modern facilities which were reestablished in Europe and North America in the beginning of the last century [5].

The principles and practices in water management of ancient civilizations are not well known as well as other achievements of ancient civilizations, such as poetry, philosophy, science, politics, and visual arts. A lot is to be learned from ancient technologies and practices. Different remnants are available in various parts of the world allowing us to study the development of water technologies through centuries. To put in perspective the ancient water management principles and practices, it is important to examine their relevance to modern times and to harvest some lessons. Furthermore, the relevance of ancient works has to be examined in terms of the evolution of technology, technological advances, homeland security, and management principles. Finally, a comparative assessment of the various technologies among civilizations should be considered.

## 9.1 Introduction

A large amount of research and literature has focused on the historical development of water supply systems and the related hydraulic infrastructure in ancient civilizations; however, there is a lack of corresponding information on wastewater management in ancient civilizations. This is somewhat surprising since the lack of sanitation affects human development to the same or even greater extent as the lack of clean water. The purpose of this chapter is to trace the development of wastewater technologies of ancient civilizations. In addition, this chapter examines the continuation of the technological applications through centuries to more recent times.

The first successful effort in wastewater management known was the wastewater drainage of the early cities in the East. Evidence of the oldest known wastewater drainage was during the Neolithic Age around 6500 BC in El Kowm (or Al Kawm), located between the Euphrates River and the city of Palmyra in modern-day Syria. This location was one of the first places where domestic infrastructure for water

and wastewater was built. The early Mesopotamian cities at the end of the IV millennium BC to the beginning of the III millennium BC had networks of wastewater and stormwater drainage. Some of these cities included Habuba Kebira, Mari, Eshnunna, and Ugarit. Wastewater disposal facilities such as drainage facilities were available in the Late Urak Period (3300–3200 BC) at Habuba Kabira. Mohenjo-Daro in modern-day Pakistan in the Indus Valley is one example of an early Bronze Age civilization that had impressive water supply and effluent disposal systems. During the Bronze Age, wastewater management was practiced in several Minoan palaces and settlements in modern-day Crete including the four great palaces of Knossos, Phaistos, Mallia, and Zakros. In Knossos, which was the largest palace, there were bathing rooms, latrines, and wastewater drains, with one latrine having a flushing channel dug into the floor, fed by an outside reservoir. The ancient Egyptians followed sanitation practices according to their social status.

China has a long history of drainage, river management, irrigation, urban water supply, and wastewater management: the earliest event of water governance dates back around 2000 BC. Around 400 BC, the Greeks recognized the importance of water for the public health consequently organizing baths, toilets, and sewerage and drainage systems. The Etruscans were masters of hydraulics: the Romans, following their lessons, became masters in water and wastewater engineering constructing, in particular, the sewerage system of Rome developed around its main sewer (still preserved): the *Cloaca Maxima* (first developed around 600 BC). During the middle ages, epidemics raged through the majority of European cities, but the medieval world was more conscious of sanitation than the other renaissance civilizations. During the Byzantine period, the combination of several variables, such as the partial continuation of the ancient tradition and practices, the barbaric raids and their results, the social reformation due to the Christianity, etc., had a great influence on the development of lavatory and wastewater technologies. Sanitary installations such as toilets were incorporated in most Ottoman religious and secular buildings, such as mosques, medrese, türbe, hospitals, hammams, and baths. Lavatories were situated at a rather remote part of the complex, and squat toilets were placed adjacent to each other, and separated through partitions for privacy. Passing from the old world to the modern, one of the most revolutionary inventions in the sanitary field appeared for the first time, the water closet, and a vision of a new physical urban sanitation system to address concerns about disease transmission from exposure to waste began.

In the nineteenth century, there were diffuse outbreaks of cholera. Going against the mainstream view (“miasma theory”), in 1854 the British physician John Snow demonstrated that cholera epidemics were waterborne rather than airborne. The water closet gained tremendous popularity due to its ability to immediately remove human waste from the house, thus making cesspools no longer necessary. The twentieth century saw the development of wastewater treatment processes, with one of the main emphases and advances being the activate sludge process.

Significant developments relevant to the wastewater management are traced, including stormwater management and hygienic lifestyle in several ancient civilizations around the world. Special references to sanitary and wastewater structures, such as sewers, drains, bathrooms, and toilets, are made. Continuation of the technological applications through centuries is examined in an effort to trace a time line of wastewater management technologies, combined or not, with the social habits of each relevant era, and the abilities of each culture to adopt properly earlier technologies.

## 9.2 Early Civilizations: Neolithic and Early Bronze Ages

---

### 9.2.1 Neolithic Age

The first wastewater drainage of the early cities began in the East. Evidence of the oldest known wastewater drainage was in the Neolithic Age (*ca.* 10,000–3,000 BC) around 6500 BC in El Kowm (or Al Kawm), located between the Euphrates River and the city of Palmyra in Syria [21,104]. This location was one of the first places where domestic infrastructure for water and wastewater was built



[114,115]. El Kown has been explored by the French archaeologist Danielle Stordeur, who also published a detailed report [105]. El Kown had well-constructed and compartmented houses, many of which were built with drains for domestic wastewater. The houses also had lateral plaster-lined gutters between rooms, drainage holes through doorsteps or walls, or combined systems that drained water from room to room before discharging it outside through the wall [105]. In the middle of a street at El Kown, a 10 cm wide semicircular gutter was discovered that drained water from two adjacent houses [105]. According to Cauvin [22], and de Contenson and van Liere [26], similar drainage pipes have been discovered in Bourqras (Syria).

## 9.2.2 Mesopotamian Civilizations

The early cities in Mesopotamia at the end of the IV millennium BC or the beginning of the III millennium BC had networks of wastewater and stormwater drainage. Cities included Habuba Kebira, Mari, Eshnunna, and Ugarit. Wastewater disposal facilities such as drainage facilities were available in the Late Urak Period (3300–3200 BC) at Habuba Kabira, which is in modern Syria [106]. Habuba Kabira was a planned city built on elevated ground above the Euphrates River. The city had walls on three sides and the river on the fourth side. Cylindrical pipes (made of pottery) that obviously served as wastewater drainage pipes have been excavated.

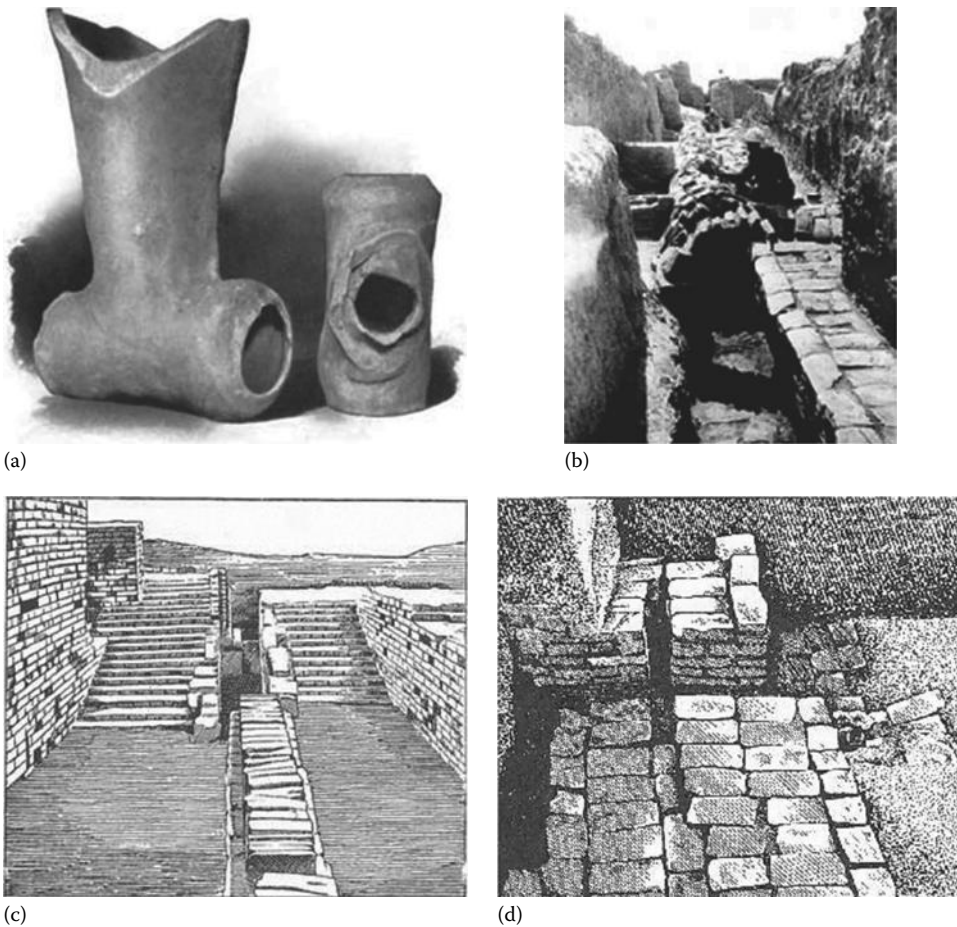
During the Akkadian times in southern Mesopotamia, drainage systems (Figure 9.1) were improved and elaborated. At the Akkadian palace in Eshnunna, drainage systems (Figure 9.1b) for disposing of both domestic and human wastes and rainwater during the monsoons were similar to those of Mohenjo-Daro in the Indus Valley (Figure 9.1c). All bathrooms and closets were arranged along the outer side of the building so that the drains discharged directly into a vaulted main sewer that was constructed along the length of the street and beyond. Figure 9.1d illustrates a toilet (closet) in the Akkadian palace at Eshnunna, Mesopotamia during the III millennium BC. The closets had a pedestal with the occasional refinement of a shaped bitumen seat [66]. The main sewer was constructed of baked brick, jointed and lined with bitumen. Also, open inspection chambers were located at the principal joints.

The Mesopotamian Empire states of Assyria and Babylonia marked great advances in civilization during the II millennium BC. The ruins from Mesopotamian cities contain well-constructed storm drainage and sanitary sewer systems. For example, the ancient cities of Ur and Babylon, located in present-day Iraq, had effective drainage systems for stormwater control [54]. The systems contained vaulted sewers and drains for household waste and gutters and drains specifically for surface runoff [72]. The material of choice was baked brick (clay) with an asphalt sealant. Figure 9.1a shows knee and t-joint made around 4000 BC that were found in the excavation of the Temple of Bel at Nippur, Babylonia. Babylonia is often referred to as the birthplace of pipe.

Rainwater was also collected for household and irrigation uses. The Babylonians were partially motivated to construct urban drainage systems by their desire to remain clean. The Babylonians, like other ancient civilizations, viewed uncleanness as a taboo, not because of the physical uncleanness, but the moral evil it suggested [92]. In retrospect, the Mesopotamians viewed urban runoff as a nuisance flooding concern, waste conveyer, and a vital natural resource.

## 9.2.3 Egyptians

In the ancient Egyptian city of Herakopolis (*ca.* 2100 BC), the average person treated their wastes much like those in Ur, they threw the wastes into the streets. However, in the elite and religious quarters, there was a deliberate effort made to remove all wastes, organic and inorganic, to locations outside the living and/or communal areas, which usually meant the rivers. The ancient Egyptians practiced sanitation, but in the widest sense of the word; however, they had what appears to have been a workable, viable sanitation system. The degree of sanitation available to certain individuals varied according to their social status.



**FIGURE 9.1** Wastewater management in Mesopotamia and Indus Valley: (a) knee and t-joint made around 4000 BC excavated at Temple of Bel at Nippur, Babylonia [111]; (b) main sewer of the Akkadian palace at Eshnunna, Mesopotamia, III millennium BC (US National Archives); (c) covered drain at Mohenjo-Daro, Indus Valley, III millennium BC (after Mackay, E.J.H., *Early Indus Civilization*, 2nd edition, Luzac, London, 1948 [70] as presented in [66] by D.E. Woodall); and (d) toilet (closet) at Akkadian palace at Eshnunna, Mesopotamia, III millennium BC (Frankfort 1934; cited in [66]).

Bathrooms were built right in their homes. There is evidence that in the New Kingdom the gentry had small bathrooms in their homes. In the larger homes next to the master bedroom, there was a bathroom that consisted of a shallow stone tub that the person stood in and had water poured over him. There is no evidence that the common people had bathrooms in their homes.

Actually, a “bathroom” was usually a small recessed room with a square slab of limestone in the corner. There the master of the house stood while his slaves liberally doused him with water. The wastewater ran into a large bowl in the floor below or through an earthenware channel in the wall where it emptied into still another bowl outside. Then that bowl was bailed out by hand. Remains of early earth closets, with limestone seats, have also been discovered. The disposal was evidently in the sandy soil.

By *ca.* 2500 BC, the Egyptians were pretty adept with drainage construction, accentuated by the significance that water played in their priestly rituals of purification and those affecting the burial of the kings. According to their religion, to die was simply to pass from one state of life to another. If the living required food, clothing, and other requirements of daily life, so did the dead. Thus, it is not surprising that archaeologists have discovered bathrooms in some tombs.

Excavators of the mortuary temple of King Suhura at Abusir discovered niches in the walls and remnants of stone basins. These were furnished with metal fittings for use as lavatories. The outlet of the basin closed with a lead stopper attached to a chain and a bronze ring. The basin emptied through a copper pipe to a trough below. The pipe was made of 1/16" beaten copper to a diameter of a little under 2". A lap joint seam hammered it tight. Also found within a pyramid temple built by King Tutankhamen's father-in-law at Abusir was a brass drain pipe running from the upper temple along the connecting masonry causeway to the outer temple on the river.

Excavators have discovered a tomb which supposedly contains the body of Osiris before he became a god. It contains the dividing line between life and death, that is, a deep moat containing water that surrounds all sides of the figure of the god on his throne. After *ca.* 5000 years, water still fills the canal through underground pipes from the River Nile.

### 9.3 Indus Civilization

---

Mohenjo-Daro, once a major urban center of the Harappa Culture or Indus Civilization, is an example of an early Bronze Age civilization that had impressive water supply and effluent disposal systems. Mohenjo-Daro is located about 400 km north of modern-day Karachi, Pakistan that was built around 2450 BC. According to Jansen [53], there were around 700 wells (with an average frequency of one in every third house) more than 15 m deep and often located houses that had bathing rooms and often latrines. Clay pipes drained wastewater from rooms. The pipes were constructed through walls to gutters covered with slabs. Wastewater then flowed into brick-covered channels that were dug under the walkways and then into larger collectors. Figure 9.1c illustrates the brick-covered drain at Mohenjo-Daro during the III millennium BC. Settling basins were also used to collect debris to prevent blockage (as described by Jansen [53] and Violett [115]). According to Jansen [53], the Harappan urban development "seems to have been accompanied by fully developed built-in water supply and effluent disposal systems, and evidence of these installations has turned up in every Mature Harappan settlement investigated to date."

Water management, and especially drainage, is considered as a key aspect of urban development in the history of South Asia [101]. The Harappan civilization (or Indus civilization) is the most ancient South Asian culture having implemented a complex and centralized wastewater management system. Indeed, one of the major characteristic of the Harappan culture is to have developed latrines, drainage and sewage systems [62]. This is during the Mature Harappan Period (or Urban Harappan Phase—*ca.* 2600–1900 BC) that sanitation appeared [53]. The most representative places of the Harappan culture of that very period are the sites of Harappa, Mohenjo-Daro, and Lothal. According to the current data, Mohenjo-Daro, considered as one of the capitals of the Harappan culture, can be considered as the most sophisticated place about wastewater management. Indeed, almost every habitation of this urban site (above 200 ha [65]) had its own bathroom [32] and was connected to the sewage system [119]. For each of the three main aspects of domestic wastewater management, namely bathroom, latrines, and sewage/drainage system, various techniques were used.

Most of the houses of Mohenjo-Daro were equipped with bathroom. Usually, bathrooms were located at the upper floor, and always on the street side of the house [36], making simpler the connection with the street drains. A typical Harappan bathroom consisted in raised platform surrounded by a row of bricks, in order to create a basin. The floor of the basin was sloped so that the water could flow to a corner or to the center of the basin, where the outlet pipe was located [53]. This vertical terracotta pipe was sometimes directly connected to the street drain, or in some other time to a jar. But, most of the time, the outlet was channeled into a soak-pit, playing the role of a sedimentation tank, which was probably cleaned from time to time. The soak-pit was connected to the street drain, where the "filtered" wastewater overflowed, which was not always the case for the jars.

Toilet facilities were quite rare in Mohenjo-Daro [119]. Latrines were adjacent to the bathroom, thus on the street side of the house. These latrines were of two types. Some were made of earthenware

bricks with a seat made of bricks or of wood [53]. The other type of toilet was a simple hole in the floor, as it is still frequently used in contemporary South Asia. Blackwater flowed through terracotta pipes, which joined most of the time a cesspit. The cesspit could be connected to street drains, where the overflow of the “purified” water could go into. In other cases, the cesspit consisted of an earthen jar [119], which could be carried into a specific place and then cleaned out, as it has been hypothesized about solid waste [53].

Wastewater of every private house of Mohenjo-Daro was managed. Main streets had one or two covered drains. In small lanes, the channels were open, while the “jar system” was used for the houses situated far from the drainage network [53]. But, another type of jar system was sometime in use. Indeed, some jars got holes at their bottom, so that the liquid could flow while the suspended solids were trapped inside the jar. Thus, because this kind of vessel was permanently fixed in the wall, it had to be cleaned out on the spot. When the domestic outlet was connected to the street drains, wastewater and rainwater were not separated. Besides collecting the rainwater from the streets, in some cases, the drains received the runoff of the roof through gutters [36].

The drains were U-shaped, situated 60 to 80 cm under the ground level, with a slope of an average of 2% [53]. There were covered up by bricks, stone, or wooden plank that could be easily removed for cleaning purposes [36]. In order to avoid the clogging of the drainage system, other cesspools were implemented at the junction of several drains, or where drain was extended on a long distance, and thus getting an important quantity of water [119].

In few cases, drains were located close to wells, which could cause a possible contamination, but most of the time drains were located far from wells [36]. It has been mentioned that the street drains flowed into the nearest river [27]; however, because of the presence of cesspits and “settling vessels,” the sewage systems can be considered as a sort of wastewater treatment, probably the first of the history [67].

Thus, the urban centers of the Harappan culture used various techniques in order to manage wastewater. Moreover, we have to keep in mind that there are other types of wastewater which we did not take into account in the present part. Wastewater from kitchen, laundry, agriculture, and industries was well managed too. During early South Asian history, wastewater has been managed in many other urban sites. According to contemporary situation, we can suppose that some rural areas had developed various ways to manage wastewater, as it is done in current Tamil Nadu villages [35].

## 9.4 Minoan Civilization: Middle and Late Bronze Age

---

Cultural advancements can be observed throughout the III and II millennia BC, when great progress was made in Crete, especially in the Middle Bronze Age (*ca.* 2100–1600 BC) when the population in its central and southern regions increased, towns were developed, the first palaces were built, and Crete achieved a prosperous and uniform culture. In the early phases of the Late Bronze Age (*ca.* 1600–1400 BC), Crete appears to have prospered even more, as evidenced by the larger houses and more luxurious palaces of this period [63]. At this time, the flourishing arts, improvements in metalwork along with the construction of better-equipped palaces, and an excellent road system, reveal a wealthy, highly cultured, well-organized society and government in Crete. However, one of the prominent characteristics of the Minoan civilization was the architectural and the hydraulic function of the sanitary systems and the stormwater drainage systems, including sewers, drains, bathrooms, and toilets [3].

### 9.4.1 Sewer and Drainage Systems

It is evident that during the Minoan civilization extensive systems and elaborate structures for water supply, irrigation, and drainage were planned, designed, and built to supply the growing population centers and agriculture with water [2]. Thus, in several Minoan palaces discovered by archaeologists in the twentieth century, one of the most important elements was the provision and distribution of water and the sewerage and drainage systems by means of sophisticated hydraulic systems.

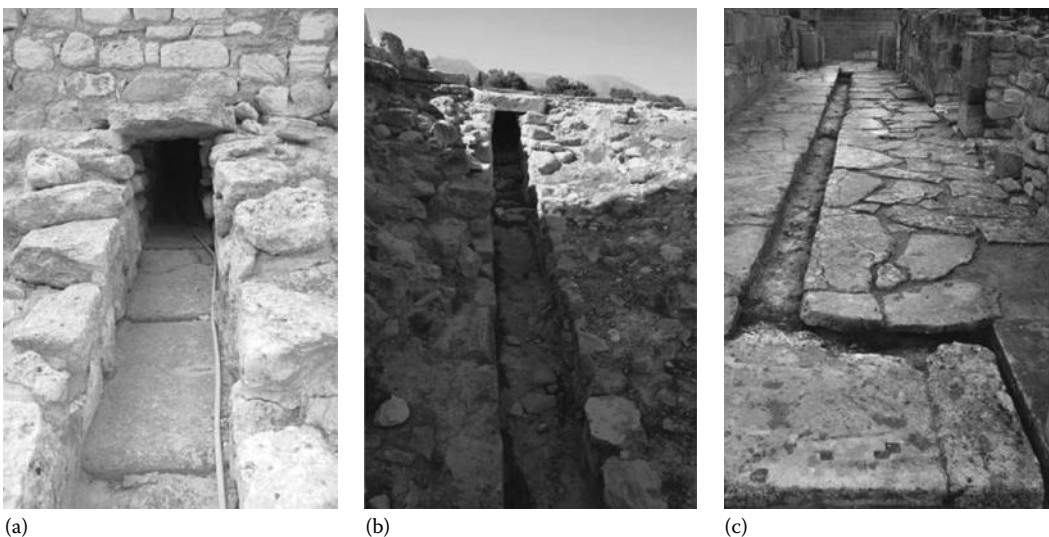
In several Minoan cities and palaces, there were well-established sewerage systems, which are in good functional condition even today. Stormwater from the flat roofs of the palace at Knossos was carried off by vertical pipes; one of these, located in the eastern wing, emptied into a stone sewer head from which a stone channel carried the flow of stormwater [33].

In the palace of Minos, surface water from a part of the Central Court was handled by a very capacious underground channel built of stone and lined with cement; it ran beneath the passage leading from the north entrance and received several flows from various quarters. The most fully explored part of the palace sewerage system is the portion which ran beneath the floors of the Residential Quarter. This formed a great loop with its high point located under the light well, next to the Grand Staircase, and emptied via a combined channel down the slope to the east of the palace [33]. In the area of the Hall of the Double-Axes and the Queen's Hall with its associated chambers, it received the wastewater of no less than five light wells; it also served a toilet on the lowest floor, and was connected with three vertical shafts. The sewer was built of stone blocks lined with cement and measured about 79 cm × 38 cm per section. The sewers, then, were large enough to permit men to enter them for cleaning or maintenance; in fact, manholes were provided for that purpose. Airshafts at intervals also helped to ventilate sewers [43].

Certainly, the plumbing arrangements and especially the sewers in the Minoan cities were carefully planned. Covered stone, slab-built sewerage systems in many cities to carry away sewage including stormwaters are evident. The remains at Knossos palace show clearly how rainwater was drained from the roof by way of light wells and used to flush out sewage from bathrooms and toilets.

Minoan palaces and cities were equipped with elaborate storm drainage and sewer systems. In fact, all palaces had applied strategies to dispose wastewater [69]. Open terracotta and stone conduits were used to convey and remove stormwater and limited quantities of wastewater. Pipes, however, were scarcely used for this purpose. Larger sewers, sometimes large enough for a man to enter and clean them, were used in Minoan palaces at Knossos and Phaistos (Figure 9.2). These large sewers may have led to the conception of the idea of the labyrinth, the subterranean structure in the form of a maze that hosted Minotaur, a hybrid monster [5].

The sewerage system of Zakros was quite dense and of high water-engineering standards [91], such as those found at Knossos and other Minoan cities. Zakros provides us with well-preserved remains of sophisticated networks in which descending shafts and well-constructed stone sewers, large enough to



**FIGURE 9.2** Minoan water sewerage and drainage systems: (a) Knossos (Photo courtesy of L.W. Mays), (b) Phaistos palace (Photo courtesy of L.W. Mays), and (c) Phaistos (Photo courtesy of A.N. Angelakis).

permit the passage of a man, play a part. Yet, there is evidence that the entire system was not effective in times of intense or extended storms. However, due to the privileged location of the site in a natural slope, the final disposal of wastewater and stormwaters at sea was easily attained. Platon [91] finds three basic types of conduits in the sewerage system of Zakros: a clay conduit in reversed n-shape, another built up with stones, and a third, narrow type, constructed with stones but open at the top.

One of the most advanced Minoan sanitary and storm sewer systems was discovered in Hagia Triadha (close to the south coast of Crete, few kilometers west of Phaistos). The Italian writer Angelo Mosso who visited the villa of Hagia Triadha in the beginning of the twentieth century and inspected the storm sewer system noticed that all the sewers of the villa functioned perfectly and was amazed to see stormwater come out of sewers, 4000 years after their construction. Farnsworth Gray [36] who relates this story and quotes Mosso adds the following statement: "Perhaps we also may be permitted to doubt whether our modern sewerage systems will still be functioning after even one thousand years."

#### 9.4.2 Bathrooms and/or Lustral Chambers

It should be noted that at the time, in addition to sewers, bathrooms were not considered necessary, merely convenient, and most palaces did not have them. Although the function of Minoan rooms is difficult to define, Evans (1921–1935), the famous archaeologist who discovered the Knossos palace, identified three rooms as bathrooms. The main type which resembles the bathrooms discovered at Phaistos and Malia is that found near the Queen's Hall in Knossos. However, there is a difference of it from those in Phaistos and Malia palaces. The point of distinction is that it is in the level of the floor and the consequent absence of steps. Evans [33] reports the last ones as "lustral chambers." Also, Graham [43] reported the assumption that a room which started out as a "lustral chamber" later became an ordinary bathroom. In fact, as a result of investigations by Platon [90] it must be assumed that this also happened twice in the houses at Tyliisos; and a careful investigation might show the same was true for the bathroom of the Queen's Hall in the palace of Minos [43]. Thus, it should have to suppose that Minoans in their latter days began putting cleanliness before godliness.

In Phaistos, a luxurious bathroom is located in southwest corner of King's megaron decorated with wall paintings and with usual steps descending into it. Also, its walls and floor are faced with alabaster slabs, with an attic on the east side. In the west side, an alabaster slab forming a step with a hole has been interpreted as a toilet.

Similar bathrooms have been reported in other Minoan sites. Platon [90] has provided us with some preliminary statistical data on Minoan cisterns, bathrooms, and other sanitary and stormwater and wastewater facilities. She concluded that, in terms of chronology, most of them should be placed in the Middle Minoan period; in regards to location, 16 are found next to domestic rooms, seven near holy altars, and two in palace entrances. In only two instances, various facilities for baths were found, seven were filled up with earth and two had been rebuilt and converted into bathrooms. Also, in 14 of these sites various holy objects were found, while in cement coats were indicated [90]. Graham [43] and Platon [91] have reported that water cisterns were used for the cleansing of both body and soul. Note also that most Minoan baths were connected to independent septic systems in the outside, a practice indicative of the advanced wastewater management and environmental techniques of that period [5].

In several bathrooms, clay tubs were used. A variety of such tubs have been discovered in Minoan sites. The clay tubs in the Minoan bathrooms must have been filled and emptied by hand rather than directly connected to the sewers. However, on the "Caravanserai," a rest house just south of palace, a footbath for the weary travelers, was supplied by a direct pipe, and the overflow discharged by another conduit; a branch of the water channel also served as a drinking trough [3].

At one of the most characteristic bathing facilities of the Mycenaean period, like the bathroom at the Mycenaean palace of Tiryns, there are evidences for attachment of wooden pieces (Figure 9.3). In that construction, the small holes found are for the fixing of a wooden coverage. However, it is not known if the research examined the case.

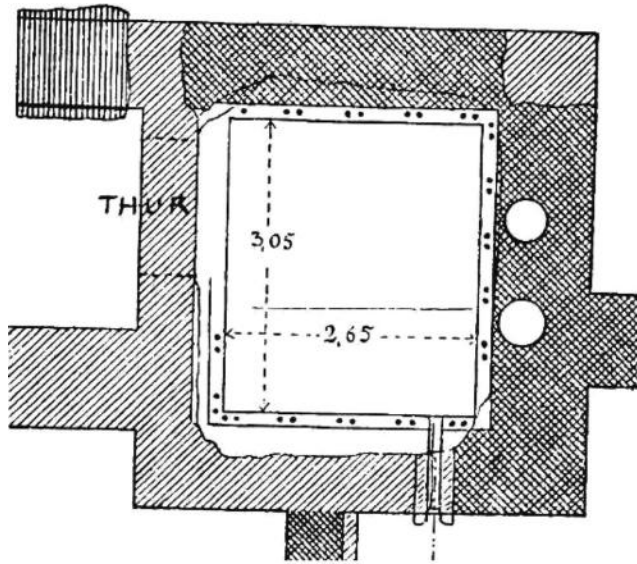


FIGURE 9.3 Bathroom in the palace of Tiryns. (From Doerpfeld, W., *Tiryns*, Leipzig, Germany, 1886.)

### 9.4.3 Toilets

In several of the Minoan houses, the toilet is quite clearly located in the private living rooms, and usually in as well removed a position as possible. In most cases, the evidence for the identification of a toilet is little more than the existence of a sewer at the floor level passing through the exterior wall and connecting with the outside central sewerage and drainage system. In some cases, there are traces of some sort of provision for a stone or wooden seat.

One of the most interesting rooms in the ground floor in the residential quarter of the Knossos Palace was identified as a toilet. Remains of a clay tube were found just outside the door of the room. Apparently, water was poured through a hole in the floor immediately outside the lavatory door; an under-floor channel linked the hole with the vertical clay pipe under the toilet seat [20]. The toilet could thus be flushed even during a rainless summer, either by an attendant outside the lavatory or by the user. This flushing toilet, probably the earliest in history, with a wooden seat and a small flushing conduit is shown in Figure 9.4 [43].

The toilet is similar in function to that of the so-called Queen's Hall and the toilets found in the Phaistos and Malia palaces and in some of Minoans cities and houses as well. A similar one found in the houses near the palace at Malia, known as Da. The house Da is a typical sample of Neopalatial Minoan architecture: it has a room with multiple doors, a megaron, a purified cistern, a stone toilet, etc. The toilet seat is in nearly perfect condition, since it was made not of wood, like the seat of the palace of Minos in Knossos, but of solid stone. This stone seat is 68.50 cm long by 45.50 cm wide front to back and its surface is 34–38 cm above the floor (Figure 9.4). It is built directly against an outside wall through which a large sewer passes. Like the Knossos find, the structure was evidently intended to be used as a seat rather than a stand; thus, it resembles the "Egyptian" toilet more closely than the so-called Turkish type found in the palaces at Mari and Alalakh in Syria [5]. However, there is a substantial difference of those toilets from the Minoan due to their flushing processes and their connections to the sewers. The toilet illustrated in Figure 9.4 is probably the earliest flush toilet in history. A similar toilet has been discovered in the west side of the so-called Queen's Apartment at Phaistos. It was connected to a closed sewer, part of which still exists. Another toilet sewer was discovered in House C at Tylissos [3]. In addition, most Minoan toilets were

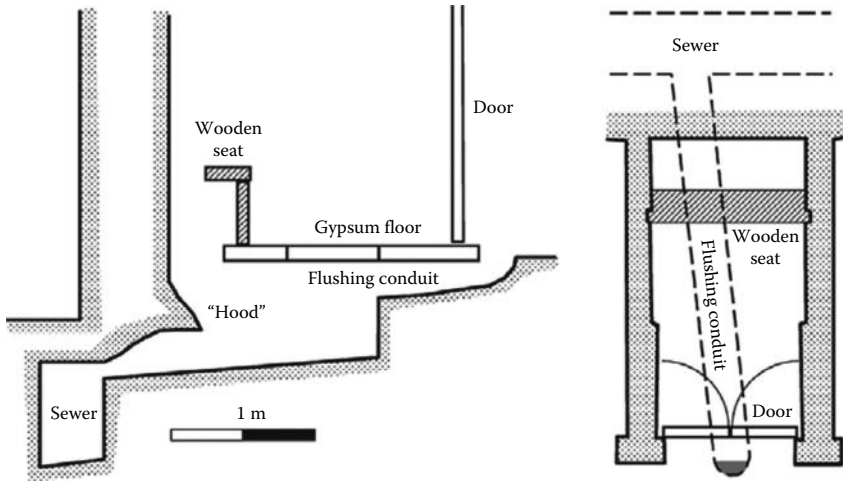


FIGURE 9.4 Section and plan of ground-floor toilet in the residential quarter of palace of Minos. (From Angelakis, A.N. et al., *Water Res.*, 39(1), 210, 2005.)

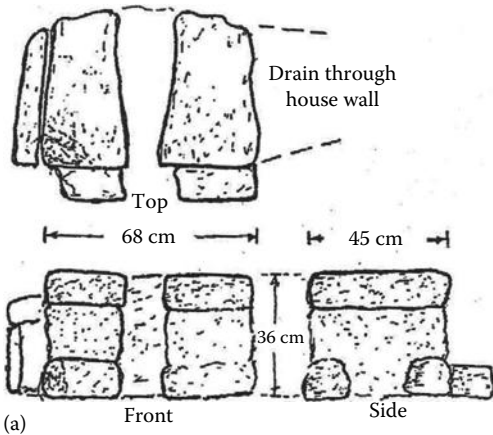


FIGURE 9.5 Toilet in the House Da, Malia: (a) layout of the house (Graham 1984) and (b) a recent photo of it. (Photo courtesy of A.N. Angelakis.)

located nearby or next to the bathrooms (e.g., that in Queen’s Hall in Knossos, Queen’s Apartment at Phaistos, and Da house in Malia) (Figure 9.5).

Some palaces had toilets with flushing systems operated by pouring water in a conduit [5]. However, the best example of such an installation was found in the island of Thera (Santorini) in the Cyclades. This is the most eloquent and best-preserved example belonging to *ca.* 1550 BC, in the Bronze Age settlement of Akrotiri, which shares the same cultural context with that of Crete [4].

At certain times of the year, the sewers in the palace of Minos may have been flushed out adequately by the rain that fell into the light wells; however, it appears that water was poured into the toilets to flush them. In fact, Evans noted the existence of sufficient space for placing a large pitcher at one end of the seat at Knossos and so concluded with evident delight [33]: “As an anticipation of scientific methods of sanitation, the system of which we have here the record has been attained by few nations even at the present day.”



## 9.5 China and Other Southeast Asian Dynasties

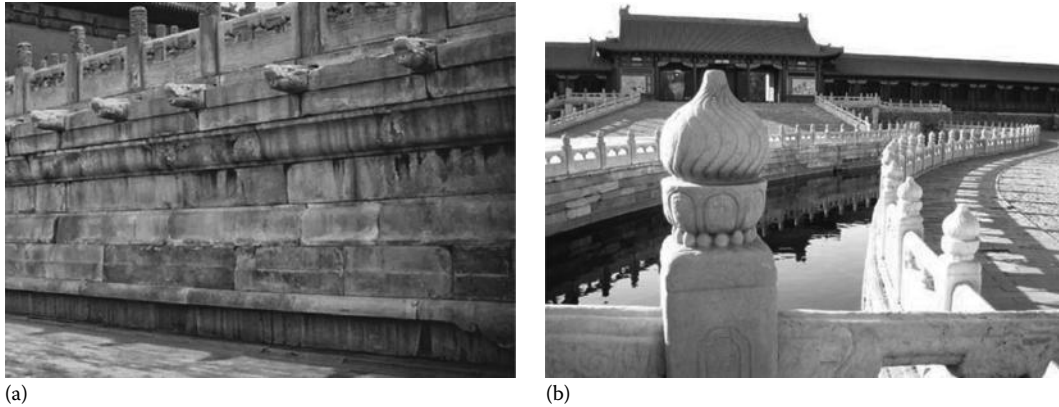
---

Archeological evidence shows that China has an old history of city drainage. According to the archaeological discovery, 2300 BC, the urban drainage facility had been built in various cities. Earliest drainage facilities were discovered in the old town Pingliangtai of the Henan province, where drainage pottery was used. Also earthen pipeline for drainage was found for an underground drainage system under the streets [48]. From *ca.* 10–15 BC century, in the Shan dynasty, urban development in center China was advanced in a golden age. Many large cities were formed near the Yellow River basin and urban drainage also improved accordingly. Archaeological discovery from Yanshixihaocheng which is today's Yan Shi city of the Henan province had a systematical drainage system that has built inside the city. According to the archaeological works, the city was around 1.9 million m<sup>2</sup>. There was an underground 800 m main urban drainage raceway from the East Gate to the palace and inside the palace there were branch down comers for drainage of rainwater and wastewater, which formed a well-designed drainage system. The underground raceway was 1.3 m in width and 1.4 m high, draining water from the palace and town into the City River [47].

From *ca.* 1100 to 221 BC, there were many kingdoms built in central China in the Yellow River basin and the Yangtse River lower basin. During this time along with the city development, drainage techniques in the cities also developed. Archaeological discovery shows that the urban drainage has developed on a high level in Ling Zi city, the capital city of Qi kingdom in today's Zi Bo city of Shandong Province. At that time, Ling Zi city had a population of 300,000 and an area of 15 km<sup>2</sup> in size. A complex water supply and drainage system was built combined with river, drainage raceway and pipeline, and the round-city river. The city built near the river and was linked with a canal around the city; there three raceway networks of drainage were built in the city, leading water from the rivers to supplying water to the city and gathering wastewater and stormwater by the drainage network into the round-city canal and again flowed into the lower reach of the river [80]. According to the archaeological digging, a large drainage station was found under the west wall around the city; the structure was constructed of stone, 43 m in length and 7 m in width. Water flowed from the city and cross the wall into the river. The aqueduct of the station had 15 outfalls that distributed in three floors and 5 outfalls per floor. The drainage system of Ling Zi city was the oldest and largest one in ancient China [34].

The Great Wall started during the Qin dynasty (*ca.* 220 BC), continued during the Han dynasty (*ca.* 206 BC–220 AD), and was completed during the Ming Dynasty (1368–1644). In order to drain precipitation on the wall in a timely fashion, workers built barrel drains at certain intervals. Rainwater could be drained to the outside of the wall through the mouth of the barrel drains which extended out from the wall about 1 yard. In addition, the drainage system has protected the Great Wall from the erosion of rainwater over a long period of time (Figure 9.6a).

The Han dynasty was a flourishing dynasty in Chinese history (founded in 206 BC), in the capital city near today's Xi An city in the Shan Xi province, called Chang An city. According to the archaeological discovery, a complex water system and drainage system was built in the city that combined functions with water supply, drainage, storage of water and ship transportation, round-city canal (length of 26 km) and a cross-city canal (9 km in length), and pools combined the main water system. Rainwater and wastewater gathering was by underground raceways, sluiceways, and channels from resident places of the city leading into the main system that combined a perfectly city drainage system. What is important is that this water system created a model of city drainage system to remain for many years in central China, especially for large cities. The model was for a city to be built with a canal around the city outside the town wall, with one or more canals cross inside the city and some pools that constructed a main structure of the water system, and then to building of subsystem of drainage with underground raceways, pipeline, channels, etc. to connect the main system with the resident places of the city. When the rainwater or wastewater was gathered, it was directed into the main system via the subsystem, and stored water in the pools or in the round-city canal. Outside the city, normally a canal was built from a river to direct water into the city for water supply, and built another channel to connecting the round-city canal



**FIGURE 9.6** Drainage systems of the Great Wall and the Forbidden City: (a) brick wall with drain and (b) inner Golden Water River forms the drainage system.

and river in the lower reach of the river for drainage. With this function, wastewater was usually to be cleansed in the pools and in the round-city canal, when the stormwater comes, it could also be led into the pools and the round-city river, later into the river, flooding usually could be effectively saved by this system and it is also with function of storing water in the dry season.

After Han dynasty, series of dynasties had been existed on Chinese history and built capital city in today's Xi An (Chang An, Tang dynasty), Kai Feng (Song dynasty), and Beijing (Yuan, Ming, Qing dynasties). The size of the cities was enlarged and drainage also developed in the cities to taking the functions of drainage of rainwater and wastewater, more and bigger drainage facilities were built to making accordance with city's population growth and construction, but the model of city water system designing almost follows the structure from Han dynasty, typically according to Chang An City. Drainage techniques also advanced to a highly level, a paradigm that is well known as Forbidden City, the palace where the emperors of Ming and Qing dynasties carried out their administration and lived. The inner Golden Water River was brought in from the moat outside the northeast corner of the imperial city and flowed from the palace through the southeast corner. Drainage was one of the reasons to dig out the river (Figure 9.6b). The construction of each palace considered the method of drainage, higher in the middle and north side of the courtyard. Rainwater flew through stone grooves, surface and underground water drains into the river.

Water and wastewater technologies in neighboring countries of China (e.g., Vietnam and Cambodia) were affected by the Chinese. A good paradigm is the drainage systems of the Ancient Angkor Temples in Cambodia. The major Temples were constructed from *ca.* 790 to 1307 AD. Khmer had strong characteristics of integrated architecture and hydraulic. Temples are still maintained under very wet conditions (of about 1300 mm atmospheric precipitation on an annual average basis). One of the earliest constructed Temples was that of Lolei. Lolei was an island temple in the middle of the Indratataka barry. In the center of the four brick towers, there are four stone drains. They face to all cardinal directions. Originally, the Brahmins used these drains to flow holy water for pilgrims to clean sin (Figure 9.7a). Also, outlet of drain in the lake is shown in Figure 9.7b.

Another paradigm is the Bayon Temple, which was built in the late twelfth and early thirteenth centuries during the reign of King Jayavarman VII. It is one of the most conspicuous buildings in the center of Angkor Thom of the ancient Khmer empire. Sokuntheary [102] concluded that the drainage system in the Bayon temple could be categorized into two types by their purpose. One would be the drains that function to evacuate rainwater from its center outward, and the other drains are found that made with special purpose to discharged sacred water used for rituals and religion ceremonies. Parts of the inner and outlet of drainage system of Bayon Temple are shown in Figure 9.8.



(a)



(b)

**FIGURE 9.7** Lolei temple drainage system: (a) inside drains and (b) outlet of a drain. (Photo courtesy of A.N. Angelakis.)



(a)



(b)

**FIGURE 9.8** Parts of the inner and outlet of drainage system of Bayon temple: (a) inside drain and (b) outlet of a drain. (Photo courtesy of A.N. Angelakis.)

## 9.6 Historical Times

### 9.6.1 Etruscan Civilization (*ca.* 800–100 BC)

The Etruscans (*ca.* 800–100 BC) settled in the area comprised among the Italian regions of Tuscany, Umbria, and Latium, up to the Adriatic coast, with branches reaching the Campania region, in Southern Italy. The Etruscan civilization is mainly remembered for their estimable building techniques as well as artworks production, as attested by the numerous and colorful grave frescos. They achieved their maximum splendor around the seventh century BC and had active relationships with Rome during the monarchy period [71,75]. Etruscan towns never did merge in a unitary state, but remained independent “city-states.” Many of the Etruscan cities on the Tyrrhenian coast based their power and wealth on mining and metallurgy, as part of their territory was rich in copper, iron, tin, lead, silver [9]. Each city had its own territory, providing the essential agriculture resources; the Etruscan territory, in antiquity famous for its fertility, was made rich by means of drainage, reclamation, and hydraulic works, in which the



**FIGURE 9.9** Etruscan tunnel of “Ponte Coperto” dug in the territory of Caere, Central Italy. (Photo courtesy of W. Dragoni.)

Etruscans were masters. As an example, Figure 9.9 (“Ponte Coperto”) shows an Etruscan tunnel, dug in the territory of Caere, in order to reclaim a swampy area of about 8 km<sup>2</sup> [12].

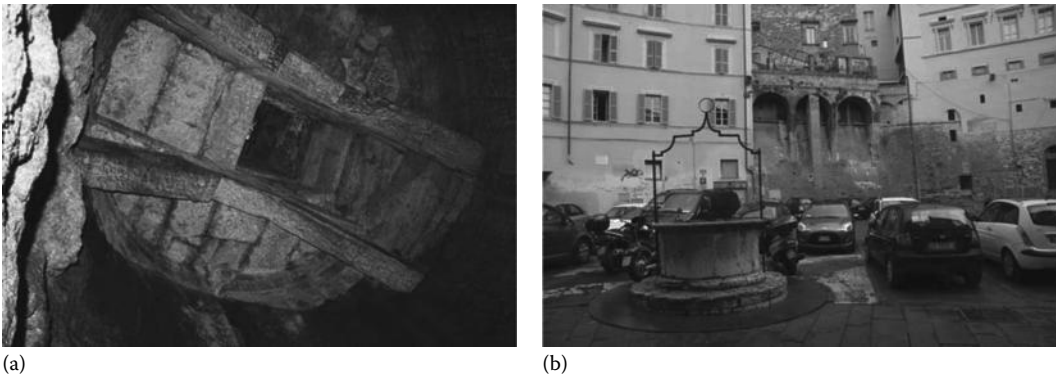
Typically the Etruscan cities were all defended by powerful walls, were located on top of flat hills, and were bounded by vertical or very steep slopes (Figure 9.10). Etruscans cities had runoff channels on the sides of streets. The ancient city of Marzabotto, located in Northern Italy, in the Po Valley, is usually reported as a typical example [95]. The system was based both on the natural slope of the plateau and on an artificial modification aimed at taking into account the special needs associated with water runoff, such as the need to avoid one of the two necropolis located between the urban area and the river Reno, where wastewater was usually discharged.

Another paradigmatic case study is the ancient city of Forcello, in the province of Mantova, in the Lombardy region. The drainage and discharge systems were based on two drains with the main function of the town sewer and certainly assuring the drainage of the entire area occupied by the houses [31]. It has to be emphasized that in the more ancient Etruscan towns the drainage network, always present, is not as ordered and regular as in the cases just mentioned. Such an ordered urban drainage network is present only in the late settlements outside of Etruria *strictu sensu*, in areas which can be considered Etruscan colonies, built *ex novo* following a rational plan, as in the case of Marzabotto and Forcello.

Drinking water was provided sometimes by means of aqueducts; however, more often water was supplied by numerous wells and cisterns, fed both by rainwater and drainage tunnels. In many cases, the water wells are works of rare beauty and ingenuity: one good example of this is the “Etruscan well” or “Sorbello well” in Perugia. It has a total depth of 35.5 m, a diameter of 5.6 m, and it is covered by a stone roof, standing on a truss made up by large stones (Figure 9.11a). It is noteworthy to say that this well, of a type which in Etruria is not unique, is located in a square of the modern city, and supports without problems the modern car traffic (Figure 9.11b), and this alone tells much about the engineering capabilities of Etruscans.



**FIGURE 9.10** Perugia, Central Italy: (a) Etruscan walls. The Etruscan walls are those made up with great gray travertine blocks. Medieval walls and houses are on the top of them; the palace in the background was made in the nineteenth century. On the left of the modern road, there are other medieval and modern buildings hiding the Etruscan City. (b) A little drain/sewer out of the Etruscan walls. (Photo courtesy of W. Dragoni.)



**FIGURE 9.11** “Etruscan well” or “Sorbello well” in Perugia, Central Italy: (a) inside view and (b) outside view. (Photo courtesy of W. Dragoni.)

The drainage tunnels (the so-called *cuniculi*, plural, or *cuniculus*, singular) are a peculiarity of the Etruscan construction technique. For instance, the city of Perugia is rich with *cuniculus*, which are mostly dug into the natural conglomerate, only a few have been excavated in the fill soil. The cross section is rather elongated and with an ogival vault; they are 1.7–1.8 m high and 0.7–0.8 m wide. They are similar to those in Orvieto and Todi [23]. According to Piro [89], most of the tunnels of Perugia had a drainage function. The tunnels were always placed in correspondence of contact between conglomeratic and silt-sandy soils or within the thickness of the filling soil. This condition allowed for a good efficacy of the drainage. Moreover, draining water allowed an improvement in the geomechanical characteristics of the soil and better conditions of stability of the soil embankments.

Orvieto, in the Umbria region, is another Etruscan laboratory. The peculiarity of Orvieto is that the cliff upon which it stands is composed by a thick layer of volcanic tufa, deposited on top of a clay-sandy formation, prone to sliding (Figure 9.12). The erosive action of the atmospheric factors and secondarily the anthropic activity shaped the cliffs, made it an impregnable fortress, site of an important Etruscan



**FIGURE 9.12** Panoramic view the cliff upon which stands Orvieto. (Photo courtesy of W. Dragoni.)

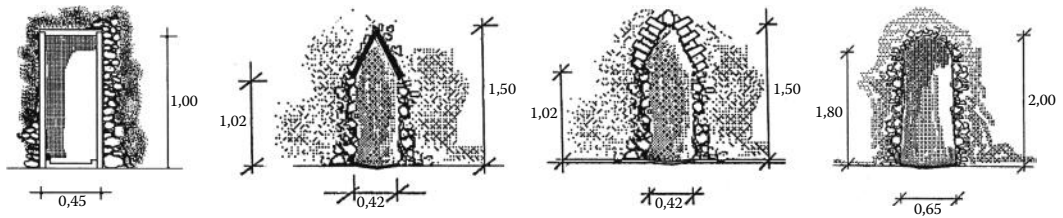
community. In the plateau, isolated on all sides, there are more than 600 artificial cavities, many materials attributable to the Etruscan Era, have been found [14,24]. Among these cavities, many *cuniculi* helped to drain the groundwater from the cliff, improving the stability of the hill.

The city of Todi, in Umbria, is located on an isolated hill near the confluence of the stream Rio with the Tiber River. The total number of wells, dug in the time span of more than 2000 years, is about 500, and the network of tunnels, dug at different altitudes, covers almost the entire urban area [73]. Bruschetti [17] describes the tunnels of the great bastion system, the so-called Etruscan bastion (Figure 9.13).

Behind the ramparts, there are several drainage channels. The main tunnel, located on the lower level, was first constructed to drain water into the ditch. Other tunnels, at higher altitudes, but all converging to the first through a well, drain and convey spring waters and rainwater that otherwise would be dispersed throughout the fill causing excessive pressure on the retaining wall structure. The tunnels have different sections: in all cases the walls are lined by blocks of limestone arranged in very regular



**FIGURE 9.13** Todi (Umbria region, Central Italy): the “Etruscan Bastion.” (Photo courtesy of W. Dragoni.)



**FIGURE 9.14** Sections of the “*fontana della Rua*” tunnel in Todi, Umbria region. (Bergamini, M., Todi: the tunnel “fountain of Rua” in the old hydraulic system, in *The Etruscans—hydraulic masters*, ed. M. Bergamini, Electa Publishers, Perugia, Italy, pp. 143–162, 1991.)

horizontal rows, the bottom is constituted of travertine slabs or tiles, not directly using the natural background because it is unreliable as a result of it being filled with soil. The coverage was obtained with slabs of travertine or with tiles placed to form a gabled roof. Bergamini [11] describes the tunnel known as “Fontana della Rua” (Rua’s fountain). This is a complex of tunnels, for various reasons being considered the most important of the entire water network in the city: it is the longest (about 350m), has a significant water regime, is in excellent condition, and has a variety of building types that denote its continued use over time (Figure 9.14).

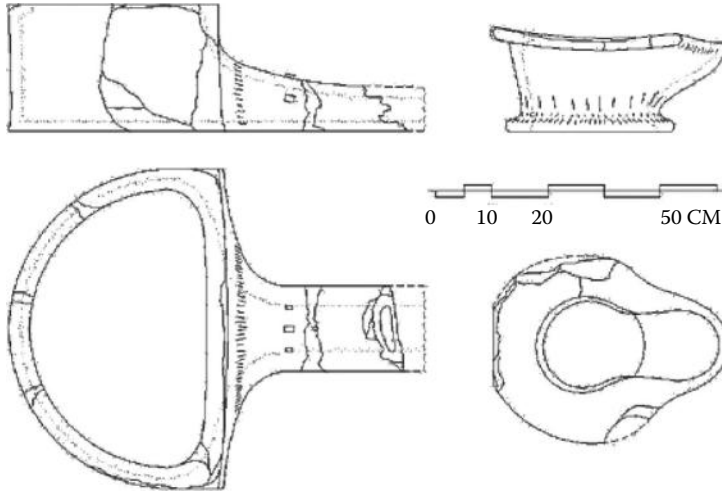
The Etruscan technical knowledge was adsorbed by the Romans, leading to the impressive works carried out during the flourishing of the Roman Empire [19,50].

### 9.6.2 Classical and Hellenistic Periods (ca. 480–67 BC)

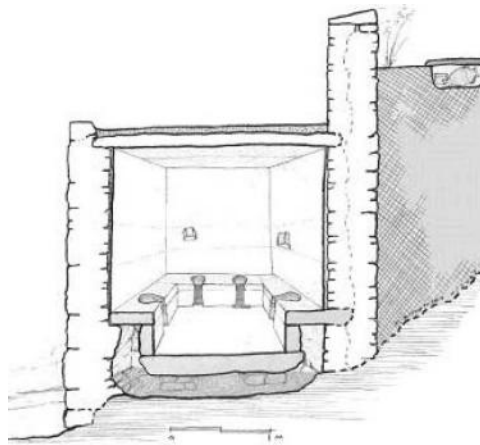
As far as it concerns the Geometric and Archaic periods, only few ruins can be attributed to sanitary structures. On the other hand, even though latrines were mentioned in many literal references any public or private well-formed lavatories dated in the Classical period (fifth–fourth centuries BC) have not been found, in agreement with researchers who have dealt systematically with that subject [85,112]. Despite the absence of flushing toilets in excavations from this time period, cesspits (*κοπρών*—*kopron*) have been found during the excavations by the American School of Classical Studies in houses of this period in Athens (specifically north of Areios Pagos). Similarly, on Rhodes small rectangular constructions under the streets just outside the houses are believed to be koprons [121]. The comedies of Aristophanes are the main ancient sources about the terminology of the sanitary structures in ancient Greece [127].

Except the well known after written sources containers of clay for defecation as the *κοπροδόχοι*—*koprodochoi*—(amides or skoramides from Athens), the archaeological finds of small cesspits and sewage ducts dated in the fifth century BC could be related with many traces of sanitary and purgatory structures found in *Olynthus* [93], a city destroyed by King Philipp II in 348 BC. There have been found not only small sewage ducts made of clay or led, but also well-formed sanitary clay vessels. All these clay utensils can be easily dated in the fifth century BC and are characterized by the efforts for achievement of anatomical shapes. In these seats, the absence of a base combined with the form of the lower edge (see Figure 9.15) suggests that they were either used over cesspits or along with some other mechanism for the collection and drainage of excrement.

It is evident that by that time the lavatory had still a private use, a fact that has survived in a way in the words used to call it (apochorisis, apopatos, afedron). The ancient terms mostly refer to a private type of use and the main term derives from the apochorisis (withdrawal) [6]. The typical ancient Greek lavatory on the other hand is being characterized by the use of more than one person at the same time (see Figure 9.16). The design of a typical lavatory in ancient Greece had been completed by the fourth century BC, and had incorporated all the preexisting design features of that type. Some documentation for similar installations in the Minoan and the Mycenaean period has already being discussed previously in this chapter.



**FIGURE 9.15** Earthen toilet seat and defecation vessel, Olynthos. (After Robinson, D., *Olynthos VIII*, Johns Hopkins Press, Baltimore, MD, 1938.)



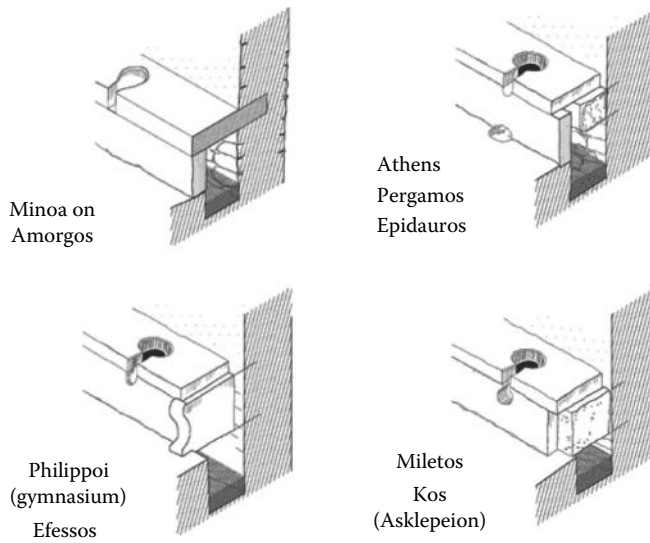
**FIGURE 9.16** Restored view of the lavatory at the “Gymnasium” on Amorgos. (Courtesy of G. Antoniou.)

The well-formed type of the ancient Greek lavatory was characterized by some typical features which remained more or less the same for all the lifetime of the structure. These features were (see Figure 9.16):

- Input water conduit
- Flushing duct below the floor level
- Bench-type seats with the keyhole-shaped defecation openings
- Front covers of the bench-type seats
- Sewage duct

Beside these, there were also other secondary constructions as the central shallow tank for cleaning the *sponghia* (out of sponge) the toilet paper of that period, the urine sewage conduit, small sedimentation tanks, etc. The seats’ supporting presents interesting differentiation and typology. Four types can be distinguished. All of them are cantilevered, mostly covered except the type in Philippoi [30] and Efessos (see Figure 9.17). More specifically, these are as the following:





**FIGURE 9.17** Formation and types of lavatory’s seats. (From Antoniou, G.P, Ancient Greek lavatories: Operation with reused water. In *Ancient Water Technologies*, ed. L.W. Mays, pp. 67–87, New York: Springer, 2010.)

1. Cantilevered stone slab protruding out of the wall
2. Freely supported slab over stone beams, cantilevered or not
3. Similar to the previous type where the stone joists protrude out the vertical plates and have been formed as neck moldings of benches and exedras
4. Type where the freely supported seat slab is also supported by stone cantilever beams which are shorter and less wide than the seat

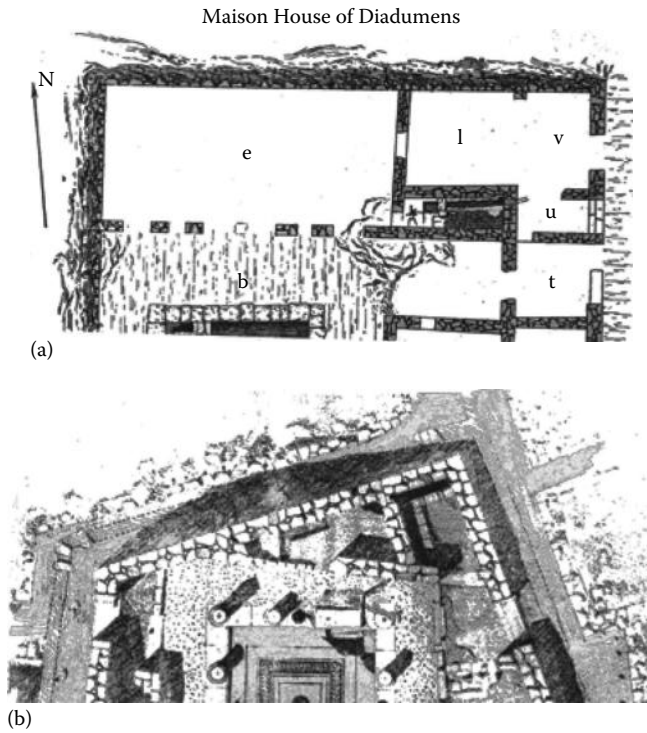
The element of the keyhole-shaped opening became a feature of the lavatory with some ornamental forms. Despite that it is obvious that the functionality was always very important. There is also some evidence that the covers for the openings were made out of clay. The seats in small domestic lavatories were just wooden benches, probably with similarly shaped openings.

The main difference between private and public toilets was their size and the number of users. On the other hand the method for the water supply differs sometimes, since the domestic lavatories require less water for the flushing. The public ones had usually supply with running water, reused [7] or not. The sewage used the ducts of the city running usually along the streets or beside the buildings. Sometimes in small residencies, there was no any sewage and the waste was running outside the house (i.e., in *Dystos* [51]).

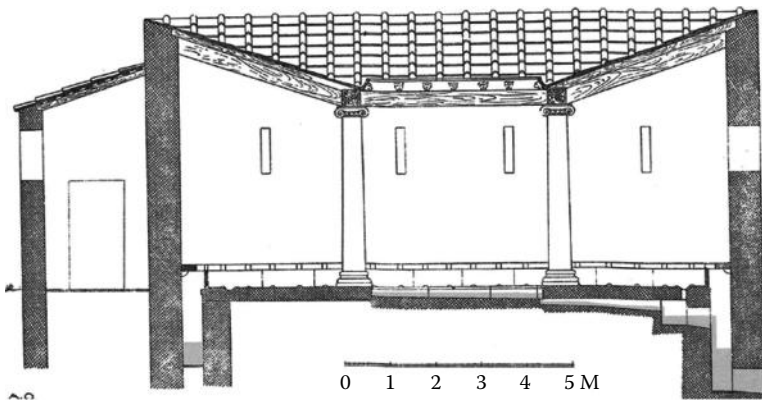
Many latrines dated to the second century BC have been preserved in residences (*Delos*, *Thira*, *Amorgos*, *Dystos*, *Kassopi*, and *Erythrai*) and in public buildings (especially Gymnasiums and Palestrae). The significance of *Delos* (see Figure 9.18) for the evolution of the typical layout of the ancient Greek lavatory is important [6], and the need for a more detailed historical investigation and presentation was recently fulfilled [109].

Lavatory capacity can be classified according to the number of the toilet seats, which correspond to the maximal number of users at any one time:

1. The very small domestic lavatories used by two or three people of the house (e.g., Figure 9.19) [51]
2. Moderate-sized domestic lavatories with more than four defecation seats
3. Small public lavatories with evidence for at least four users at a time (e.g., “Gymnasium” of *Minoa* in Figure 9.16 and in Palestrae on *Delos*) [25]
4. Large public lavatories used by more than 10 or 20 people. These were generally constructed during the Roman period



**FIGURE 9.18** Delos, houses' lavatories: (a) with flushing hole and (b) L shape. (From Chamonard, J., *Le Quartier du Theatre*, Collection Exploration archéologique de Délos, Paris, France, 1924.)



**FIGURE 9.19** The lavatory outside Roman Agora, Athens: restored longitudinal section. (From Orlandos, A., *The Role of the Roman Building Located Northern of Horologe of Andronikos Kiristos*, Paper presented at the Athens Academy, Athens, Greece, in Greek, 1940.)

Most of the ancient names for toilet mentioned at the beginning of this section refer to a private place (the part—*από*—*από*). Despite this, the excavation of many private lavatories clearly demonstrates evidence for their simultaneous use by more than one person. Even in residences where the inhabitants numbered 5–10 people, there were lavatories with two up to four defecation openings. In these cases, it is unclear whether there was a simultaneous usage by residents of different sexes. Public latrines were used by dozens of people simultaneously, and often more than 50 (Figure 9.19) [87]. This was a practice

which expanded during the Roman era and survived in many Byzantine and medieval lavatories of the Eastern Mediterranean area, including monasteries [82], baths [15] and castles such as *Mytilene* (at the sixteenth-century semisubterranean refuge).

### 9.6.3 Roman Period (ca. 750–330 AD)

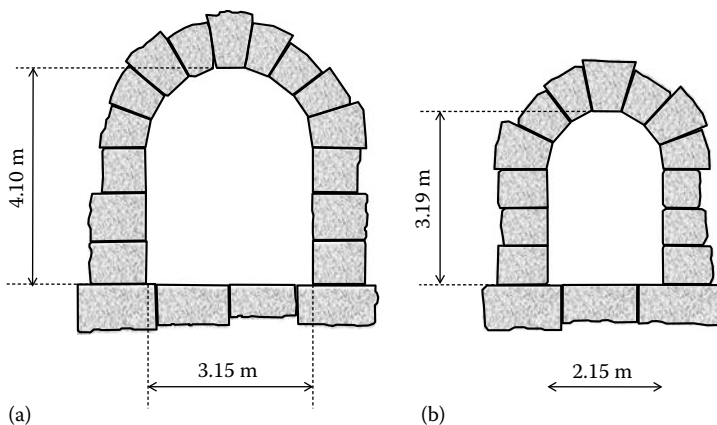
The Romans are usually cited for the magnificence of their aqueducts, but probably the most important hydraulic infrastructure that they realized is the sewerage system of Rome and its main collector: the *Cloaca Maxima*. Tradition ascribes its construction to Tarquinius Priscus, king of Rome 616–578 BC. The *Cloaca Maxima* combined the three functions of wastewater and rainwater removal and swamp drainage [28,29,50].

The *Cloaca Maxima* presumably follows the course of an old ditch, but soon it was insufficient to handle the flow of wastewater. Thus, it was enlarged in the next centuries, extended, and roofed over. Its line starts from near the *Forum Augustum* and flows into the Tiber near the *Ponte Palatino*. During the time of the emperors (31 BC to 193 AD), the canal could be traveled by boat and could be entered via manholes. The canal has a breadth up to 3.2 m and a height up to 4.2 m [64,117]. Figure 9.20 shows some sections of the wastewater collector of the *Cloaca Maxima* near the *Forum Augustum* and near the *Via del Velabro*.

Hopkins [52] emphasizes the fact that the *Cloaca Maxima* was built on 700 years of evolving hydraulic engineering and architecture. Moreover, Hopkins [52] underlines as it began as a monumental, open-air, freshwater canal, guiding streams through the newly leveled, paved, open space that would become the *Forum Romanum*.

The *Cloaca Maxima* was part of a sewerage system developed year by year with the addition of new stretches (*Cloaca Schiavonia*, *Cloaca Giuditta*, *Cloaca Circi*, *Naumachia Augusti*, etc.). Using gutters, located along the sides of the city streets, these drains collected rainwater, excess spillage from basins, and domestic rubbish and carried it out into the Tiber River [108]. Bianco [13], citing Livio, reports that the censors in 184 BC spent the sum of 24 million sesterces for the cleaning of the *Cloaca Maxima* and the creation of two new branches.

Different solutions were adopted in other known Roman cities such as *Pompeii* and *Herculaneum*, in nowadays Campania region, and *Ostia*, in nowadays Lazio region. As a matter of fact, cesspools were the most frequent solution attempted to manage wastewater in *Pompeii*, which extended



**FIGURE 9.20** Sections of the wastewater collector of the *Cloaca Maxima* in Rome: (a) near *Forum Augustum* and (b) near *Via del Velabro*.

over porous lava layers, able to easily absorb rain, urine, and feces. Cesspools were also used in *Herculaneum*, although much less frequently and were located on sites with steeper slopes and a compact subsoil of volcanic tuff. At *Ostia* the wastewater disposal system was mainly based on sewers rather than cesspools, because the aquifer ran just 2 m under the surface [67,103]. On the whole, the 11 Imperial Age Roman aqueducts had a total flow rate of  $1.13 \times 10^6$  m<sup>3</sup>/day and a total length of more than 500 km. Assuming a population of Rome of about 1 million of inhabitants, a mean specific discharge of around 1100 L/inhabitant/day was produced. This value is extraordinary if compared with the current specific water use of 200–300 L/inhabitant/day. The major part of this enormous quantity of water, together with waste in the street, went in the sewerage system and, finally, in the Tiber. Here we find not only the modernity of ancient Rome, but also why the other cities were pestilential. Building sewers was not sufficient to solve the waste problem, because without an enormous amount of water to throw inside, those channels would be turned into cesspits with stagnant and miasmatic sewage [88].

The Romans carefully planned road systems with properly drained surfaces. Along some roadways, they implemented curb and gutters to direct surface runoff to rock-lined open drainage channels. Many of the roadbeds were graded to direct the surface runoff from the streets toward the drainage channels [18].

Residents in populace areas of the Roman Empire took advantage of the constant flow in the open channels and underground sewers to transport their wastes away from their living areas. Although not by design, the Romans produced a linkage of urban water supply and urban drainage by way of the aqueduct overflow into the sewers. The Roman linkage of the urban water supply and drainage systems marks one of the earliest examples of establishing an urban water cycle [18].

Toilets had an important role in the Roman sanitation system. In particular, they can be divided into two groups: public (*foricae*), typically (but not necessarily) multiseat, and private (*latrinae*), typically (but not necessarily) single seat [49]. A public toilet was frequently built near to or inside a bath so that it was easily entered from both inside and outside of the bath. The abundance of water that was conducted to the bath could also be used to flush the toilet. Piped water for flushing private toilets seems to have been a rarity. Figure 9.21 is a photo of the public toilet near the Forum Baths at Ostia (Italy).

The Romans, however, lacked something similar to our toilet paper. They probably commonly used sponges or moss or something similar. In public toilets, the facilities were common to all. They were



**FIGURE 9.21** Public latrine near the Forum Baths at Ostia. (Courtesy of L.W. Mays.)

cramped, without any privacy, and had no decent way to wash one's hands. The private toilets most likely lacked running water and they were commonly located near the kitchens. All this created an excellent opportunity for the spreading of intestinal pathogens. In many cases, the private toilet was located near the kitchen. Hygienic conditions in both types of toilets must have been very poor, and consequently intestinal diseases were diffused. Dysentery, typhoid fever, and different kinds of diarrheas are likely candidates for diagnoses. Descriptions of the intestinal diseases in the ancient texts are unfortunately so unspecific that the identification of the causative agent is a very problematic venture. Studies of ancient microbial DNA might offer some new evidence for the identification of microbes spread by contaminated water [28,29,116].

Romans usually used chamber pots to collect the urine. These domestic facilities were then emptied in a vat placed under the well of the staircase. If tenement owners did not allow these vats to be placed in their building the tenant could empty their human waste into the nearest dung heap located in an alley, into the public latrines, or into the gutters that ran down the sides of the street. The obvious problem associated with these methods would have been a strong odor, attracting all kinds of insects and other creatures. Another alternative was to load human excrement into wagons, which passed through the streets during the day while other wheeled traffic was not allowed to be in the city. Those responsible for this duty were called *stercorarii* and they would take these cartloads of human waste and sell it to farmers as fertilizer [108].

Sewers would need to be regularly maintained as the buildup of rubbish and human waste would eventually clog the drains and create a fetid atmosphere. Floods caused by storms could also scour the sides of the drain creating the danger of collapse, both of the sewer walls and the buildings above. Cleaning the sewers did not necessarily include the removal of human waste from the public latrines, behind bushes, in alleys, and from the gutters. Perhaps, these duties fell upon the *stercorarii* as they passed through the city collecting human waste in their wagons. Rubbish thrown or dropped onto the Streets may have been the responsibility of building owners if it was in front of their property. Animals, insects, and birds would doubtless have removed some of this rubbish and human waste as well. The *stercorarii* could have also been employed for cleaning private facilities [108].

The Romans were well aware of the cleaning power of urine and also used it for washing clothing, developing in some towns and cities the logistics to collect larger volumes of urine. Fullers, who worked in laundries, would install amphoras in streets and alleys of towns to serve as public urinals, and would pass regularly to collect the urine, transporting it back to the laundry for washing [16,108]. Flohr and Wilson [37] stated that in the last century, the use of urine for fullers was overstated, because there is no reliable information about the quantities that were needed or about its dominance in the production process. In particular, they argued that in order to work with a more concentrated solution, the usual amount of liquid under the feet of the fuller was rather limited, thus contradicting the image of a fuller standing all day long in a fuller tub filled with water and urine. Moreover, Flohr and Wilson [37] stated that there is no evidence about the fact that fullers collected their urine by means of vessels in front of their workshops, as usually reported. Thus, it is not clear how Roman fullers collected and transported the urine they used.

Cooper [27] stated that the Romans knew of the need for clean water and the need to dispose off wastewater away from the source of drinking water. In the United Kingdom, they built their villas on the sides of hills where springs emerged from the hillside, and disposed off their wastewater to streams away from their villas. It has long been known that the Romans built brick-lined sewers in London (which they called *Londinium*). However, it has recently been discovered that these were preceded by wood-lined sewers which drained the water from the city to the River Thames. Pieces of the brick-lined sewers still exist [27].

Stormwater drainage systems were also used widely during the Roman times. These underground systems were used widely along streets and in areas where there was a large amount of impervious cover in the urban areas. Figure 9.22 shows a drainage inlet in Ostia near Forum Baths. Inlet designs varied throughout the Roman urban locations.



FIGURE 9.22 Drainage inlet in Ostia near Forum Baths. (Courtesy of L.W. Mays.)

## 9.7 Medieval Times

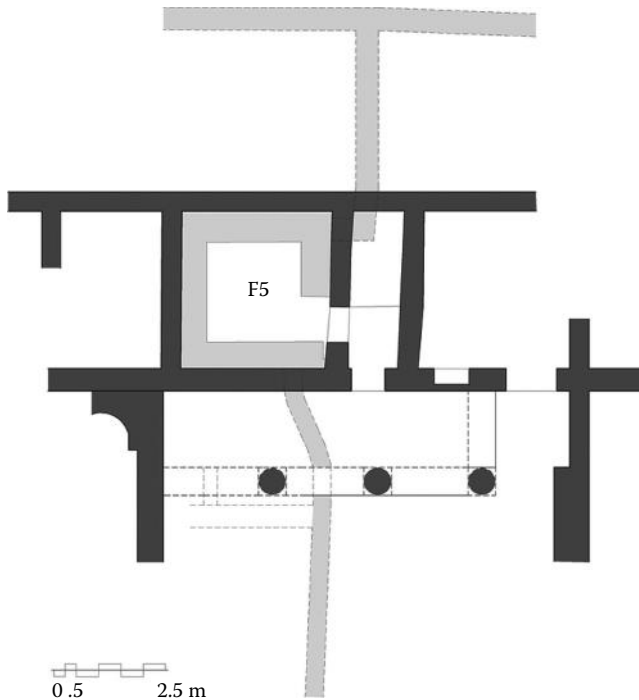
### 9.7.1 Byzantine World

The lavatory and wastewater technologies during the Byzantine period present interesting characteristics related mostly to a combination of various historical aspects, as the partial continuation of the ancient tradition and practices, the barbaric raids and their results, the social reformation due also to the Christianity, etc.

It is known that the Byzantine state—as it was named later on—after the ancient Byzantium had been situated at the Constantinople, was a continuation of the Roman Empire, adapting from its beginning not only administrative institutions but also the constructional and technical achievements of that preexisting empire. From the fifth century AD, due to the barbaric invasions the west part was lost and the Greco-Roman civilization which was inherited by the new state survived mostly in the eastern part. Therefore, the medieval characteristics of the east remained for quite long time!

Therefore, the lavatories and the wastewater technologies were typical of the ancient Greek and Roman facilities and can be traced to the eighth century. Typical toilets (Figure 9.23) can be found in baths of the first Byzantine centuries as in *Marea* (sixth to eighth century AD) [107] and the double bath at the pilgrimage complex of *Abou Mina* (end of sixth century AD) in Egypt [81]. In both cases the toilet is adjacent to the bath, but closer to the entrance or the disrobing hall or the entrance patio. This position complies with the written sources regarding life in the Byzantine era, which states that the users in the baths were visiting the toilet after undressing and before entering the bath. Moreover, it can most certainly be concluded out of the surviving remains that lavatories were used by many people simultaneously, despite their use three to four centuries after the official end of the ancient religion and the prevalence of Christianity which promoted privacy. Construction wise these toilets were supplied by water through pipes or the ditch system of the bath, possibly reusing water out of the main use of the bath as well. In *Marea*, an entry chamber (Figure 9.23) resembles similar plans found during the end of the Hellenistic period, that is, in *Athens* (see Section 9.6.2). Their placement at the outer zone of the building served as well for the sewage, like the way it was usually applied at the ancient lavatories, that is, in *Delos*, *Dystos*, *Kos*, etc. (see Section 9.6.2) [6].

It seems that the collective use, the connection or attachment to bathing facilities, and the semiperimetrical ditch, supplied by the bath water or separate stream water (as in *Aksaray Sultan Han*, and *Incir Han*), are characteristics that survived up to the twelfth to thirteenth century and are found at Selcuk—or *Rum Selcuk* according to Prof. Kiel—Hans-Caravansarais in *Anatolia* [120].



**FIGURE 9.23** Lavatory at Marea baths Egypt. Water ditches in gray. (Antoniou after Szymanska, H. and Babraj, K., *Le bain collectif en Egypte*, ed. M. Boussac et al., IFAO, Caire, 2009.)

Monastic lavatories with a collective character are not rare in the grater region of the eastern Mediterranean during the first Byzantine centuries. The row of the collective latrines at *St. Symeon* monastery in *Assuan*, Egypt [79] (see Figure 9.24, number 44) and their placement leads to the existence of a kind of sewage. On the other hand, a similar row at the great eastern tower (*ca.* sixth to seventh century AD) of *St. Catherine's* monastery at *Sinai* [82] had undoubtedly a collective use, but the waste was drained exactly outside the walls, via pipes through the thickness of the towers' wall.

Similarly the lavatories of the *Zygos* monastery in *Mt. Athos*, in Greece—dated *ca.* tenth century AD—have a similar layout, but placed outside the walls, attached to them [128]. On the other hand, it is not certain if it was operating as a collective toilet or not, forming just a row of toilets. The waste was also drained directly outside via inclined pipes (see Figure 9.25).

Despite the numerous examples of collective use lavatories, there are surviving structures of private or semiprivate toilets in monastic buildings. A characteristic case is the combination of private and semiprivate toilets in the *QR 195 hermitage* dated early seventh century [39,46]. There, a chair-type toilet was applied in single or twin layout.

The private toilet became part of the typical layout of the Byzantine Monastery and was constructed not only at the wings of the cells, but also in other buildings of the complexes, as the *Estiae* (Figure 9.26), *the Hospitals*, and the *Guest Houses*. In some cases—as in the *Hospital of Mega Meteoron* monastery—where a separating wall is absent, there was probably a wooden partition [126]. Doors resembled a kind of curtain, the so-called *velothyron* [126]. In many cases, there are pipes draining out the waste, inclined as in *Vrontiani* monastery in *Samos* (Figure 9.25), or vertical as at the lavatory of the *Mega Meteoron Hospital* (Figure 9.27). On the other hand, there are monastic literal references about cleaning or removing the waste “*σάρωσάτω τα λύματα ...*” [126]. This leads to the conclusion that there was not a sewage system in every case.

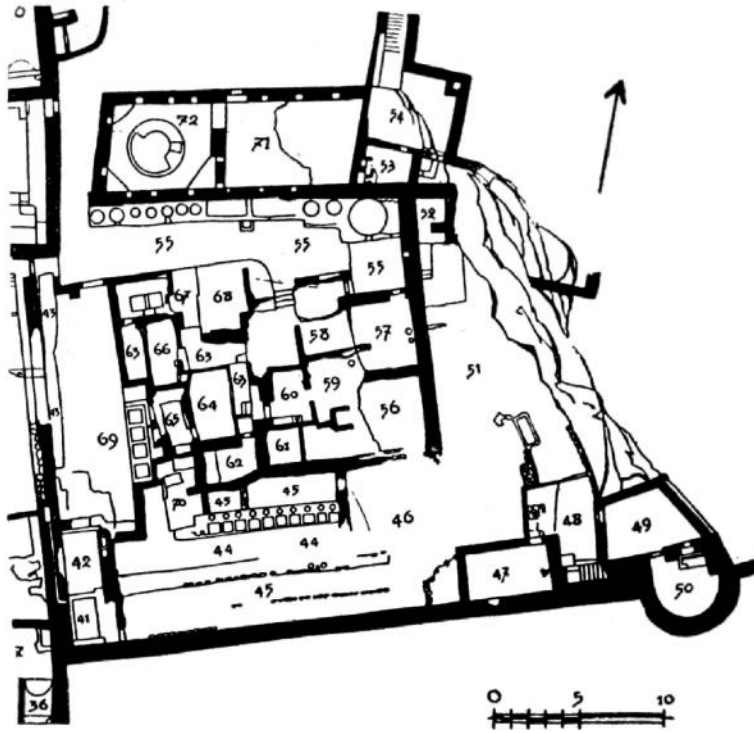


FIGURE 9.24 Collective lavatories # 44 St. Symeon Monastery, Egypt. (From Monneret de Villard, U., *Annales du Service de Antiques de l’Egypte*, Paris, France, in French, 1926.)

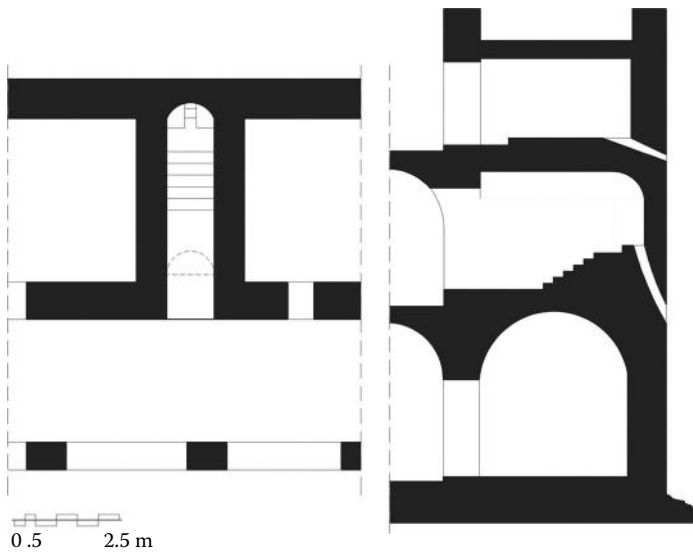


FIGURE 9.25 Toilets among monks’ cells. Samos Vrontiani. (Antoniou after Orlandos, A., *The Role of the Roman Building Located Northern of Horologe of Andronikos Kiristos*, Paper presented at the Athens Academy, Athens, Greece, in Greek, 1940.)



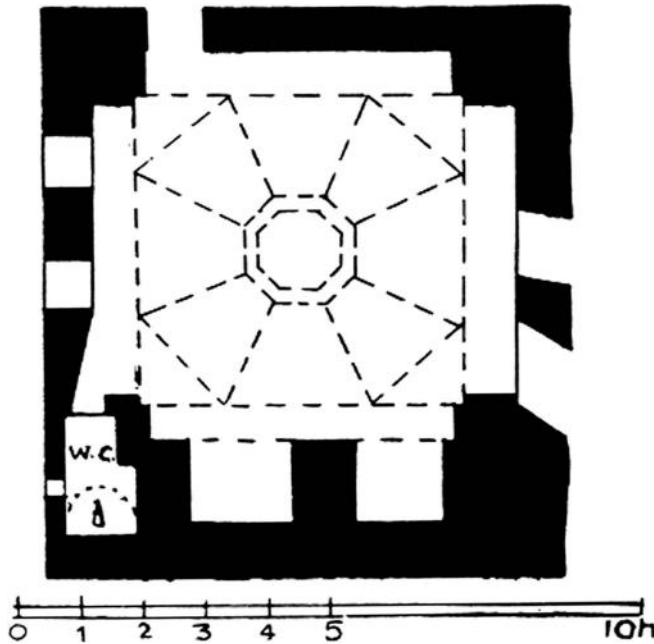


FIGURE 9.26 Estia—fireplace of Helandariou monastery. (From Ορλάνδος, Α., Μοναστηριακή Αρχιτεκτονική, (Monasteries' Architecture), 1st edn., Αθήνα, Εστία, in Greek, 1927.)

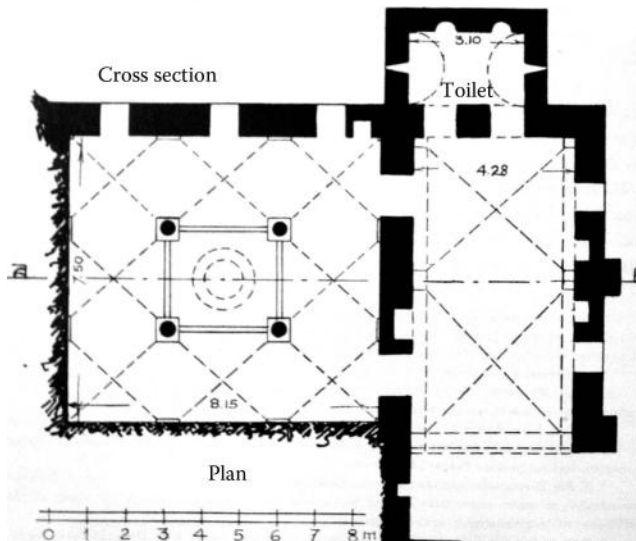
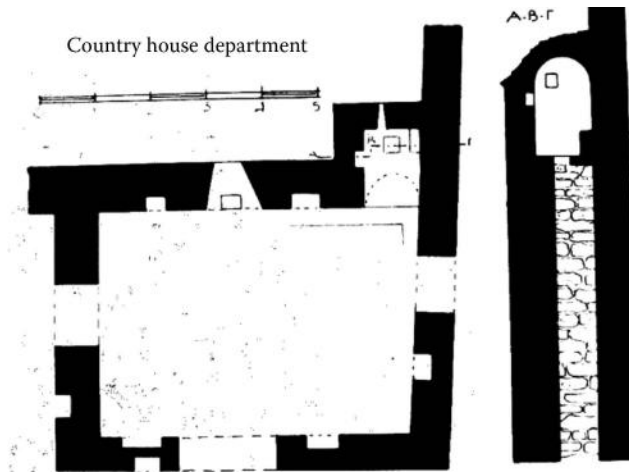


FIGURE 9.27 Hospital of the Mega Meteoron. (From Ορλάνδος, Α., Μοναστηριακή Αρχιτεκτονική, (Monasteries' Architecture), 1st edn., Αθήνα, Εστία, in Greek, 1927.)

In contradiction to the fact that there are some references of using water out of the monastery's cistern like in *Nea Moni in Chios* [126], not much information exists about the way the toilets were supplied with flushing water. In most cases, a bucket would have been used.

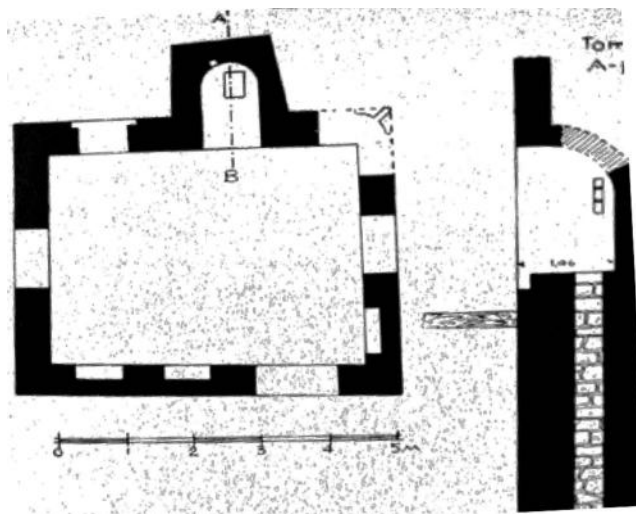
Most probably the residential toilets were flushed in a similar way. On the other hand many surviving structures, like the residences of *Mystras* in Greece, testify that a waste pipe network existed. It consisted



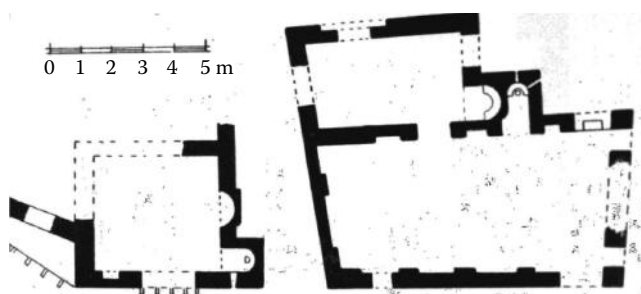
**FIGURE 9.28** Mystras. Chamber of mansion house with toilet. (From Ορλάνδος, Α., Τα παλάτια και τα σπίτια του Μυστρά, (Palaces and Houses of Mystras), in Αρχείο των Βυζαντινών Μνημείων της Ελλάδος, ν Γ' τ. 1 (Archive of Byzantine Monuments in Greece), Αθήνα, Ε.Α.Ε., Εστία, in Greek, 1937.)

not only of vertical pipes, but also of clay pipes under the streets [125]. These pipes coming from each house were centralized in a junction point, and were led to the town's sewage network. Moreover, the owners were responsible for the maintenance of the pipes up to the junction point [125] (Figure 9.28).

The residential byzantine toilet was protruding (Figures 9.29 and 9.30) and situated at the corner or side of the main chamber of *triclinion*, found often in each floor. Their usual semicircular edge, rather than their vaulted ceiling, was the reason of the term *exedra*, one of the names that had been given to the toilets by that time [125]. Traces testifying domestic twin or triple toilets are very limited, and in Salonika coexist with typical single toilet [122].



**FIGURE 9.29** Mystras. Chamber with toilet. (From Ορλάνδος, Α., Τα παλάτια και τα σπίτια του Μυστρά, [Palaces and Houses of Mystras], in Αρχείο των Βυζαντινών Μνημείων της Ελλάδος, ν Γ' τ. 1 [Archive of Byzantine Monuments in Greece], Αθήνα, Ε.Α.Ε., Εστία, in Greek, 1937.)



**FIGURE 9.30** Mystras. Chambers with toilets. Regular and mansion house. (From Ορλάνδος, Α., *Τα παλάτια και τα σπίτια του Μυστρά*, (Palaces and Houses of Mystras), in *Αρχαίο των Βυζαντινών Μνημείων της Ελλάδος*, τ. 1 (Archive of Byzantine Monuments in Greece), Αθήνα, Ε.Α.Ε., Εστία, in Greek, 1937.)

Similar protruding residential-type toilets—with or without a sewage pipe—dated in the mid- and late-Byzantine period survive in some monasteries of *Mt. Athos* [123]. Illumination was provided by oil lamps inside small niches on the walls. Written sources about 24 h burning oil lamps in monasteries’ *Typikon* refer also to the toilet oil lamps [126].

## 9.7.2 European Region

During the middle age, epidemics raged through the majority of European cities. By most accounts, the medieval world was more conscious of sanitation than the other renaissance civilization, but it did not prevent Europe succumbing to bubonic plague [74].

An official investigation into the state of the Fleet River in London in 1307 concluded that the main cause of pollution was tanning waste and butchers’ offal from Smithfield market [74]. In the same year, the Palace of Westminster installed a pipe connecting the King’s lavatory with another sewage pipe that had been constructed earlier to remove waste from the palace kitchen [74].

Rivers in London and Paris were open sewers. Waste leached into the groundwater and wells. Waste provided food for rats and although the Black Plague in 1347 was not directly caused by poor sanitation, it had to be an indirect cause. As a matter of fact, where there was good sanitation such as at the Christchurch Monastery in Canterbury, England, no one contracted the Black Plague. Around 1200, Phillippe Auguste had Parisian streets paved, incorporating a drain for wastewater in the middle. The first underground sewers were built in Paris in 1370 beneath Rue Montmartre and drained to a tributary of the Seine River [67].

In 1357, in London, a proclamation was issued forbidding the throwing of any sort of waste into the Thames or any other waterway. One of the responses by private citizens was the construction of cesspools. On private property, each cesspit had building regulations, which depended on the type of construction material used. If the cesspit was lined with stone, its mouth should be 2½ ft (75 cm) from the neighbor land; otherwise, it should be 3½ ft (105 cm) [27,108,118]. Other options for private houses in London were latrines. They were mainly present in larger houses and they had to be connected to large open sewers or ditches. On the contrary, some of the poorer citizens constructed latrines in their tenement building, connecting them to the gutters designed to carry excess rainwater from roofs and streets. Finally, people without cesspits and latrines often dumped wastewater which had been collected in chamber pots directly out of windows [108].

During the fifteenth century, Henry VI established a Commission of Sewers. The word “sewer” comes from old English and means seaward from the fact that the drains in London were open ditches which pitched toward the Thames River and then to the sea [68].

Pinna [88] tries to describe an Italian medieval toilet inspired by a tale, set in Naples, in the fifth story of the second day of the *Decameron* by Giovanni Boccaccio (1313–1375), written between 1350 and 1353:

a small room projecting from the walls of the building with a hole in the floor, where, without plumbing or water, feces and urine were dropped directly into an alley.

The wastewater, mingled with the liquid thrown from the windows contained in the pots, infiltrated into the not paved soil as well as polluted aquifers and artesian wells: the streets were washed only by occasional thunderstorms. Cesspits were sometimes connected to short sections of sewer. However, the cesspits were not always well sealed and then wastewater was often dispersed into soil. Moreover, the periodic emptying caused tipping and spreading of sewage, which could be sold as agricultural fertilizer, but only the solid part was traded. The liquid portion was considered a waste to discard. For example, in Tuscany in the seventeenth century, workers spilled sewage into the river Arno and other rivers, dirtying everything during the maneuvers. This activity was even ruled by judges of the Grand Duke, who provided detailed information on how and where to dispose off the sludge (in the river, where the current is stronger), from bridges and at what hours of the night [88].

From the thirteenth century, almost all municipalities in Central-Northern Italy promulgated sanitary laws and regulations with which even the launch from the window of the slurry was ruled: it could only happen at certain times of the night and after shouting “look, look, look.” Instead, the launch was free and without warning when it was raining [88].

## 9.8 From the Old World to Modernity (ca. Fifteenth Century to Eighteenth Century)

### 9.8.1 European Technologies and Practices

In this period one of the most revolutionary inventions in the sanitary field, still in use (in a modified version), appeared for the first time: the water closet. It might seem strange, but the first WC was invented by an English poet (any invention requires great creativity), in 1589: Sir John Harrington [74].

The Harrington’s invention was principally aimed at solving the problem of unpleasant odors produced by cesspools and latrines in use until then. It was mainly based on a temporary bowl-like vessel into which was run from a reservoir, or cistern (provided with an overflow pipe) water to a depth of 2 ft so as to cover all human excrement falling into it. If the supply of water was plentiful, this vessel was to be opened frequently from the bottom, so as to let all the filth flow down into the permanent cesspool, which was thus cut off from all but momentary contamination of the air of the privy. If, on the other hand, water was not plentiful, the vessel was to be opened and refilled at least once a day [94].

Harrington, a man fluent in Greek, Latin, and Italian, was quite familiar with contemporary medical theory on the role of air and smells on health. In fact, he published an English version of the medieval medical text *Regimen Sanitatis Salernitanum* in 1608 [55]. The *Regimen Sanitatis Salernitanum* is a medieval didactic poem in hexameter verse of the *Schola Medica Salernitana* (Salerno School of Medicine), dealing with domestic medical practice such as daily hygienic procedures and diet. The Salerno School of Medicine was founded in the eighth century and was the principal institution in Europe for the study of medicine, reaching its utmost splendor during the Middle Ages. The School marked an enormous step forward in the evolution of medical science and easily fitted into the city of Salerno, in Southern Italy, which had been thriving economically and culturally since it had been part of Magna Graecia. According to Schladweiler and McDonald [97], the *Regimen Sanitatis Salernitanum* was one of the driving forces of John Harrington’s invention (as documented in Harrington’s treatise *A New Discourse of a Stale Subject, called The Metamorphosis of Ajax*). However, the Latin version of *Regimen Sanitatis Salernitanum* actually only has two lines about air, which corresponds to “Let the air be pure, habitable, and bright, and let it be neither contaminated nor odorous with the stink of the sewer” [55].

Moreover, Jørgensen [55] suggests that although Harrington may have used the work for the political and social commentary discussed by other scholars, he also puts forward a vision of a new physical urban sanitation system to address concerns about disease transmission from exposure to waste. In fact,

his proposal includes both individually owned improved flushed privies and government-sponsored sewage systems, a hitherto overlooked element of his program.

The first WC was not immediately used principally due to the absence of sewerages. After, Alexander Cummings patented a WC in 1775 subsequently improved by other inventors [88]. For instance, in 1778, Joseph Bramah began marketing his own patented WC [74].

Writers in their works described how the unsupportable stench of city pollution was a common place throughout Europe during the Middle Ages. For instance, in 1711, Jonathan Swift published a lament on the distinguishing mix of detritus that oozed from London's drains during rainstorms. While, in 1772, Pierre Patte described how in cities such as Bordeaux, Lyon, and Toulouse, all manner of filth ran through the gutters before it reached the sewers [74].

Nevertheless, several advances were made in this period. In major European cities, in addition to stories of dirt and filth in the streets, sanitary technologies and practices can be found.

For instance, in the mediaeval London at least 13 public latrines were cited [94]. In particular, the latrines (also called "garderobes" or "privies") were built as follows [94]: (1) within the thickness of castle walls, as in London Tower; (2) within towers; (3) within turrets; (4) within chimneys; (5) within chambers corbelled out over the water of the moats; (6) within chambers on arches over the water; (7) with pipe drains to the moats; and (8) with cesspools to receive their filth.

The great fire of London in 1666, in itself a calamity of the first magnitude, did great good, indirectly, in many ways. After the fire, some attention was given to the construction of drains for removing the surplus waters of the city, which had hitherto been allowed to flow over the surface. These drains were very rude construction, and when covered were invariably of such a size that men could enter them and remove the deposits that were constantly collecting [36].

In 1579, in England, the Norwich assembly ordered the cleanup of leaky latrines as well as outlawed the practice of washing fabrics in the river because they caused great infection of the river [56].

In this period, we had the first occurrences of a primordial industrial pollution. As a matter of fact, the tanning process required significant amounts of water and generated highly noxious effluent. For this reason, most tanneries were located on a river or stream. For instance, York's tanners, in England, located their shops upstream of the town center on the Ouse River near its entrance into the town. Washing skins directly in the river from these locations was convenient for tanners, and wastewater vats contaminated with blood, flesh pieces, lime, and tannins could easily be emptied into the river. The York council was concerned about tanning liquids contaminating river water which was used for food preparation. Thus, tannery regulations were introduced to keep the water clean for use by butchers preparing puddings, but the same butchery was a source of river pollution [56].

In Berlin, the refuse heaps piled up in front of St. Peter's Church until in 1671 a law required every peasant who came to town to remove a load of filth when he returned home [36].

Paris in the Middle Ages was the metropolis of Europe and at least superficially the focus of refinement in living. But the streets were foul with filth. Parisians freely emptied chamber pots from their windows. The poorer classes defecated indiscriminately wherever most convenient. In 1531 a law required landlords to provide a latrine for every house, but it does not appear to have been well enforced [36]. In 1539, when plagues swept Europe, King Francois I ordered the homeowners of Paris to build cesspools for sewage collection in new houses. These continued to be used until the late 1700s [27]. On August 8, 1606, an order was given prohibiting any resident of the palace of Saint Germain from committing a nuisance therein. That same day, the King's son urinated against the wall of his room [36].

### **9.8.2 Ottoman Practices (ca. 1453–1910 AD)**

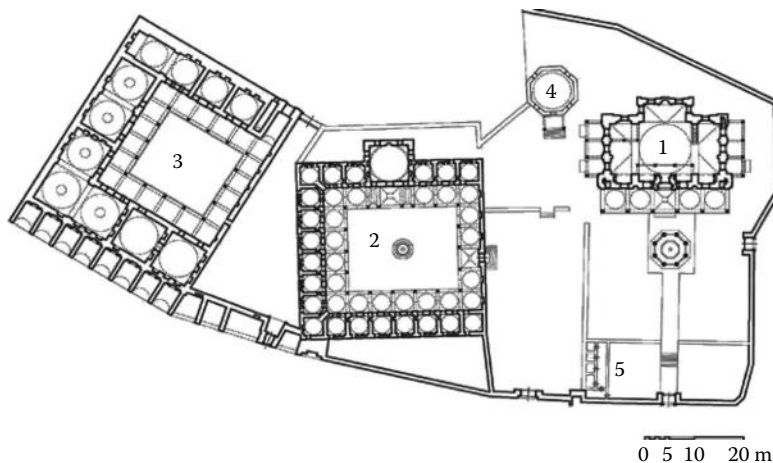
The practices applied by the Ottomans on latrine technology, wastewater and sewage networks were evidenced in the numerous buildings constructed by the Turkmen tribes, soon after they started conquering lands in western Turkey and in the Balkan peninsula, most possibly influenced by several preexisting examples. The urban infrastructure of the cities was enriched with various constructions

necessary for their society's basic needs [60] financed mostly by the institution of the Vakıf [61], such as (a) religious buildings; (b) secular ones (of social–public character and for domestic use, including commercial buildings); and (c) works of military architecture [58]. As Islam prescribes ablution before prayer [10] (the duty of washing is mentioned in the Kur'an: in Surah V, "... when you get ready for the worship, wash your face and hands up to the elbows ...") and the use of flowing water is indicated for ablution before prayers, as well as for total cleansing of the body; this encouraged them to the construction of fountains, public steam baths ("hammām" or "hamam"), as well as baths over thermal springs (*kaphca*) and water supplies, due to the lack of hygiene conditions during these times [59]. In addition lavatories (toilets), despite being secondary in terms of size, were necessary installations for the everyday life. Usually, they were situated somewhere outside the buildings and as they were often shedlike and weak constructions, most of them were ruined quickly. Nevertheless, numerous secular buildings and private residences preserve distinctive examples of well-survived toilets.

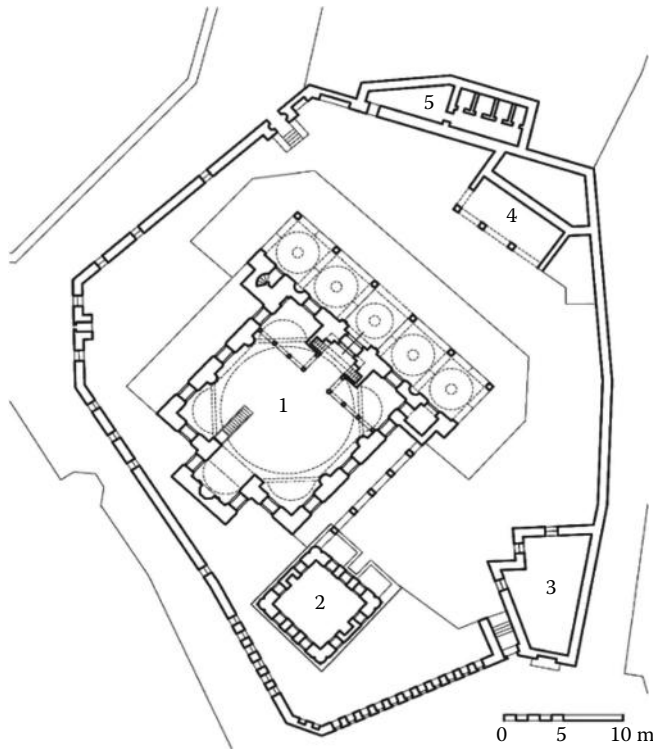
Sanitary installations (toilets) were incorporated in most Ottoman architectural types of religious and secular buildings, such as mosques (*cami*), medrese, türbe, hospitals (*darüşşifas*), hammams [57], thermal baths (*kaplica*), as well as grouped complexes of them (*külliyes*). Lavatories were situated at a rather remote part of the complex, and squat toilets were placed adjacent to each other (Figures 9.31 through 9.35), separated through partitions for privacy, in contradiction not only to the ancient Greek [6] and Roman lavatories' layout, but also to the Seljuk Hans (see also 9.7.1). An exception can be noticed in the case of the hammams, as a toilet (Figure 9.36) was incorporated in the disrobing hall of the building close to the depilation room, instead of being located outside of the building.

The paving of the latrines was usually layered with marble slabs which were also easier to clean, while a special keyhole-shaped monolithic marble structure was located in each compartment. That specially curved slab was adequately detached from the wall, in order that the user's body would not come in contact with the wall, while at the same time its vertical surface showed a convex profile, in order to avoid splashing by human waste (Figure 9.37). No flushing system has been traced, and the waste was removed from the toilet through ceramic pipes, placed under the keyhole-shaped slab. Usually openings set on the roof provided the necessary ventilation of the latrine.

Lavatories for public communal use were also evidenced earlier, in the Seljuk caravanserais [86] that are found along the Silk Road routes in Anatolia [120], dating from the beginning of the thirteenth century. They sometimes were attached to the bath and at the exception case of the Aksaray Sultan Han on the Konya-Aksaray Road, where the water installations run along the west exterior wall of the courtyard



**FIGURE 9.31** Muradiye Külliyesi, 1583-6, Manisa. (From Neçipoğlu, G., *The Age of Sinan: Architectural Culture in the Ottoman Empire*, Reaktion Books, London, U.K., 2005.)



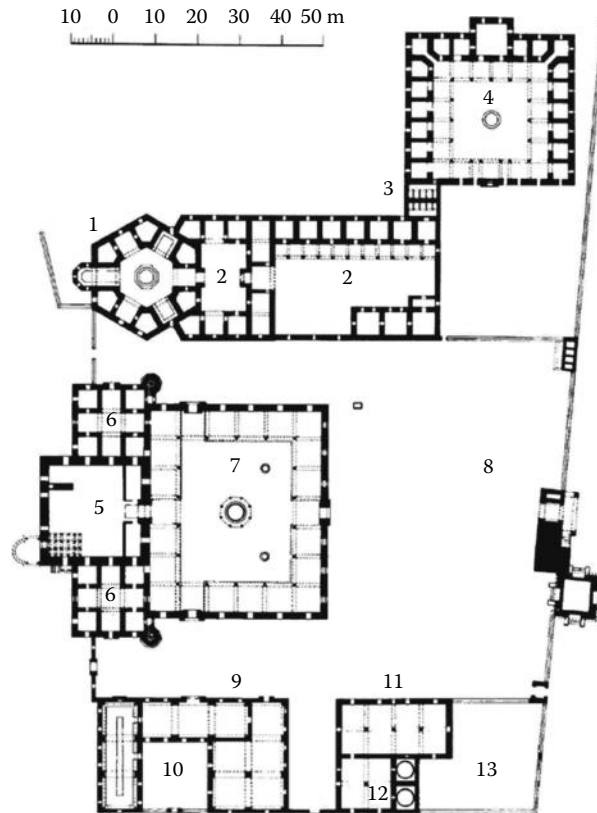
**FIGURE 9.32** Mehmet Ağa cami, 1584, Fatih-Istanbul. (From Neçipoğlu, G., *The Age of Sinan: Architectural Culture in the Ottoman Empire*, Reaktion Books, London, U.K., 2005.)

(Figures 9.38 and 9.39) and the collective lavatories are situated at the southwest corner. The channel that facilitates the sewage is still evident (Figure 9.40). Single toilets are also traced as private small cells in the baths (hammams) of the caravanserais.

According to the Muslim religion, ablution should be performed five times a day; therefore, residential buildings were equipped with a special area and facilities to perform total ablution (*Güsülhane*, ablution closet) [45]. As studied in the stone-built mansions with timber stories of *Safranbolu* and the nearby village of *Yürükköy* in Anatolia (Figure 9.40), washrooms (*Abdestlik*) and lavatories (*Hela* in Turkish, *toilet*) were located usually on the middle and upper floors, enclosed in one unity, and separated by a door, which assured a kind of privacy. Toilets are placed away from the rooms and there are small windows at the “blind” sides of the toilets for ventilation. The floor is of wood, while a triangular hole with raised edges is formed, connected to the sewage pit by means of a vertical drain or the space beneath the hole is empty and the waste matter falls into a pit, lower into the ground (this is why lavatories of the middle and upper floors are not situated one over the other) [45]. Occasionally, floors are paved by marble slabs and the defecation opening is keyhole-shaped, often flanked by footrests. A ewer of water in the *hela* is used for cleaning purposes. The variety of squat toilet types derived from the shape and the possible existence of three major components: the foot rest, the defecation hole, and the front part.

## 9.9 Pre-Columbian American Societies

A great deal has been published about water supply management in the pre-Columbian American Societies [76–78]; however, very little has been published concerning the wastewater management in these societies. Drainage systems have been discussed concerning societies in Mesoamerica. Mesoamerica includes Mexico



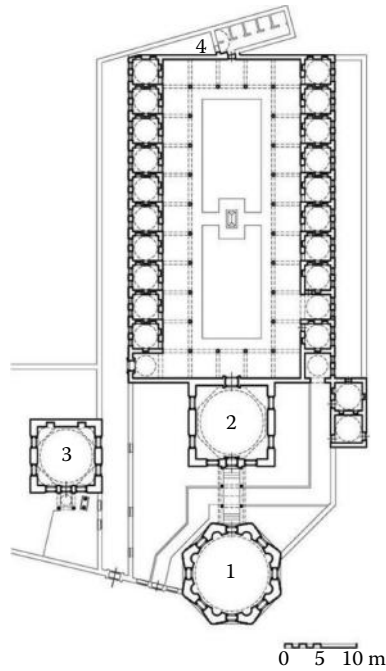
**FIGURE 9.33** Beyazid complex (darüşşifa, cami, imaret, etc.), 1484–1488, Edirne. (From Goodwin, G., *A History of Ottoman Architecture*, Thames & Hudson Ltd., London, U.K., 1971.)

and the northern Central America. The earliest Mesoamerican civilization, the Olmecs, evolved sometime before 1000 BC along the Gulf of Mexico. After about 800 BC, the Mesoamerican civilization exerted social and religious influence in an area extending from the Valley of Mexico to modern El Salvador.

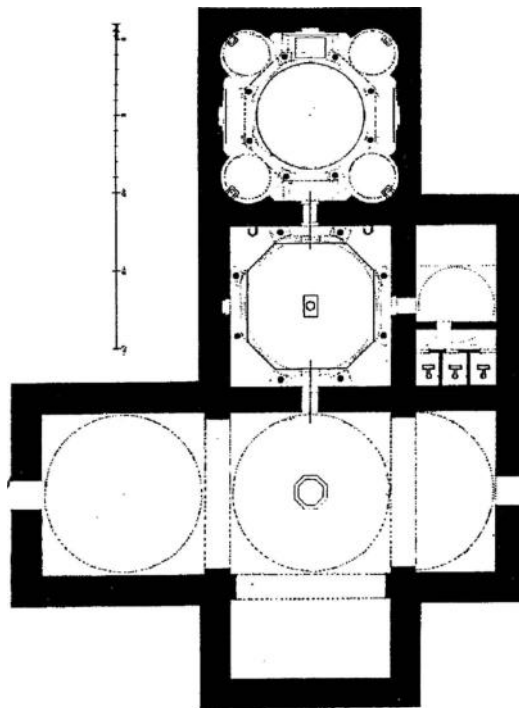
Xochicalco (in the place of the house of flowers) was located on hill top ~38 km from modern-day Cuernavaca, Mexico, and became one of the great Mesoamerican cities in the late classic period (650–900 AD). Rainwater was collected in the large plaza area and conveyed using drainage structures (see Figure 9.41a) and drainage ditches (Figure 9.41b) into cisterns and the excess was discharged elsewhere.

The ancient Maya lived in a vast area covering parts of present-day Guatemala, Mexico, Belize, and the western areas of Honduras and El Salvador. The Maya settled in the last millennium BC and their civilization flourished until around 870 AD. One excellent example of a large drainage system was at Cerrros (Cerros Mayo or Maya Hill) which was a late preclassic (400 BC to 250 AD) Maya community in northern Belize located on the shores of Bay of Chetumal (Corozal Bay), on a peninsula across from the modern-day town of Corozal. The drainage system consisted of a large canal perimeter (extending from one side of the peninsula to the other side) defining the core zone having a concentration of residential and civic architecture, with the area outside the perimeter as the periphery zone with primarily residential concentration [96]. This canal was constructed (between 250 and 50 BC) with a U-shaped cross section varying between 3.2 and 6.0 m in width and 1.6 m deep in the west to 2.10 m deep in the northeast [96]. This canal is referred to as the main canal with approximately seven lateral canals (basin canals) branching with the main canal. The major structures are shown on the northern part of the core zone located to the north of the canal. The area within the core zone is the plaza area and large structures and

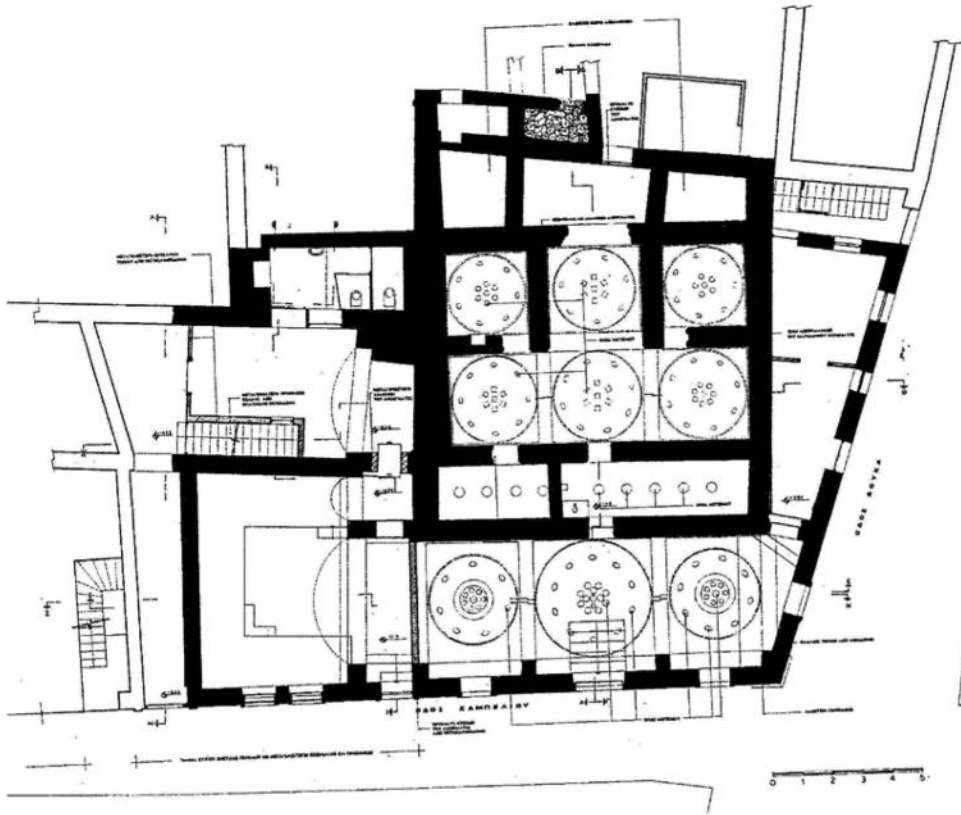




**FIGURE 9.34** Sokollu Mehmed Paşa Medresesi and Türbe, 1568–1569, Eyüp—Istanbul. (From Neçipoğlu, G., *The Age of Sinan: Architectural Culture in the Ottoman Empire*, Reaktion Books, London, U.K., 2005.)



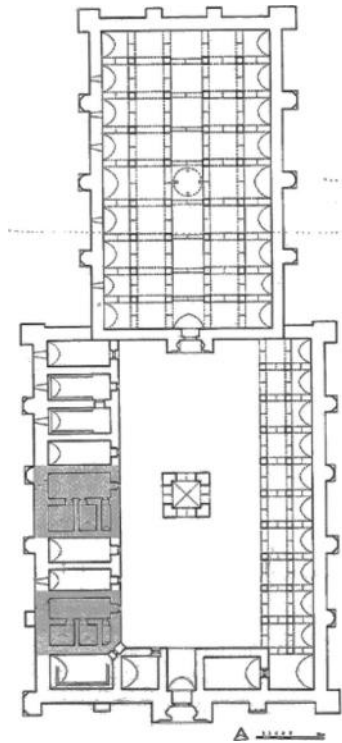
**FIGURE 9.35** Eski Kaplıca, 1389, Bursa. (From Glück, H., *Probleme des Wölbungsbaues I: Die Bäder Konstantinopels*, Arbeiten des Kunsthistorischen Instituts der Universität Wien, Band XII, Wien, Germany, in German, 1921.)



**FIGURE 9.36** Zampeliou and Douka str. hammam, Chania. (From Kanetaki, E., *Othomanika loutra ston elladiko xwro* (Ottoman baths in the Greek territory), Technical Chamber of Greece, Athens, Greece, 2004.)



**FIGURE 9.37** Karavangeli str. Hammam, Mytilene. (Courtesy of E. Kanetaki.)



**FIGURE 9.38** Plan of the Aksaray Sultan Han, 1229, Aksaray. (From Yavuz, A., *The Baths of Anatolian Seljuk Caravansarais*, in *Bathing Culture of Anatolian Civilizations*, ed. N. Ergin, *Ancient Near Eastern Studies Supplement* 37, Peeters, Leuven, Belgium, pp. 77–141, 2011.)



**FIGURE 9.39** Latrines placed one next to the other and the sewage hole in the Aksaray Sultan Han. (Courtesy of G. Antoniou.)



**FIGURE 9.40** Squat toilet in mansion at Yürükköy, Anatolia. (Courtesy of E. Kanetaki.)



(a)



(b)

**FIGURE 9.41** Components of drainage and rainwater harvesting system at Xochicalco: (a) drainage structure and (b) drainage ditch. (Courtesy of L.W. Mays.)

is well drained. The basin canals at Cerros were carved into limestone and are believed to be unique in the Maya lowlands. In the lower reaches of the basin canals, water was collected and not allowed to drain except during heavy rainfall the overflow was directed to the main canal and into smaller channels that connected to catchment areas.

## 9.10 Modern Times

### 9.10.1 Practices at the Industrial Revolution

#### 9.10.1.1 Sewage Collection Systems

A process of progressive technological and scientific innovation started in the beginning of the eighteenth century. The process began becoming mature around 1760, when it is usually considered the starting of the so-called industrial revolution. The period from 1760 to 1830 is cited as the first industrial revolution, involving particularly textile and metallurgical sectors. During the second industrial revolution (1870 to 1880), with the introduction of electricity, chemicals, and petroleum, a significant increase in population as well as a progressive urbanization occurred. For instance, the population of London increased from just under 1 million in 1801 to 2.8 million in 1861 [27]. Moreover, in 1851, in London more than 50% of the population lived in cities: this was extraordinary considering that, only in 2007, the United Nations has estimated that more than 50% of the world's population lived in cities rather than in the villages and countryside.

In the nineteenth century, there were diffuse outbreaks of cholera, and in the mid-1800s there was much debate about the origin. Despite much confusion surrounding the disease, the so-called miasma theory emerged as the prevalent account about cholera's cause. Going against this mainstream view, the British physician John Snow inferred several things about cholera's origin and pathology that no one else inferred [110]. In 1854, Snow demonstrated that cholera epidemics were waterborne rather than airborne. By mapping the disease outbreak, he identified a specific London water source, the Broad Street pump, as its proximate cause. Removal of the pump handle was temporally related to the end of the epidemic [41].

The water closet gained tremendous popularity in the 1800s because of its ability, once connected to the sewerage, to immediately remove human waste from the house, thus making cesspools no longer necessary. This improved the living conditions in homes but increased the pollution load into the River Thames. The water volume in the London drainage system almost doubled in the 6 years from 1850 to 1856 as a result of increased use of water closets (Halliday 1999) [27].

The presence of an efficient sewerage system is essential for the public health of all cities, especially for the biggest. The cases of London and Paris during the Industrial Revolution can be considered as paradigmatic case studies. Nowadays, separate sewerages are considered the standard with the separate collection of municipal wastewater and surface runoff. The principle advantage of such a system is preventing the overflow of sewer systems and treatment stations during rainy periods and the mixing of the relatively little polluted surface runoff with chemical and microbial pollutants from the municipal wastewater. The conveyance of sewage in a distinct system of sewers is believed to have been first suggested as early as 1842 by Mr. Edwin Chadwick [44].

Liernur's pneumatic sewerage system (*ca.* 1884) was invented by Captain Charles T. Liernur. This system was primarily used in Holland. It was designed as a separate system, with sewage and rainwater disposed off by separated systems. Pneumatic pressure delivered sewage through pipes to a collection station (see [44] for more details). Figure 9.42 shows the street reservoir design used in Amsterdam. Figure 9.43 shows the arrangement of Liernur's sewerage system in private houses (*ca.* 1884) that was developed for the proposed plan for a sewerage system for the city of Providence, Rhode Island in the United States.

Sir Edwin Chadwick (1800–1890) was appointed to the commission enquiring into the state of the Poor Law, which resulted in 1834 Poor Law report. According to Cooper [27], the principal recommendations of the Report on the Sanitary Conditions of the Labouring Population of Great Britain, in 1842, are the following:

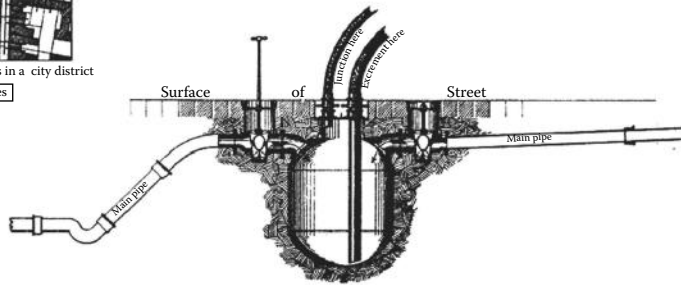


General plan of pneumatic system of pipes in a city district

■ Reservoirs — Pipes

Fig. 1

Details of parts of Liernur's sewerage system scale  $\frac{1}{40}$

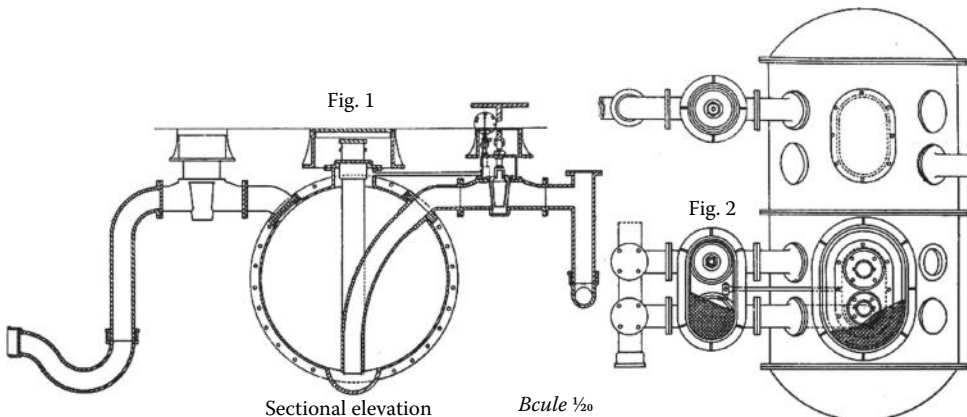


Street reservoir

Fig. 2

Plate V

(a)



Sectional elevation

Scale  $\frac{1}{20}$

Street reservoir of Liernur's sewerage system in use at Amsterdam, Holland

Plan

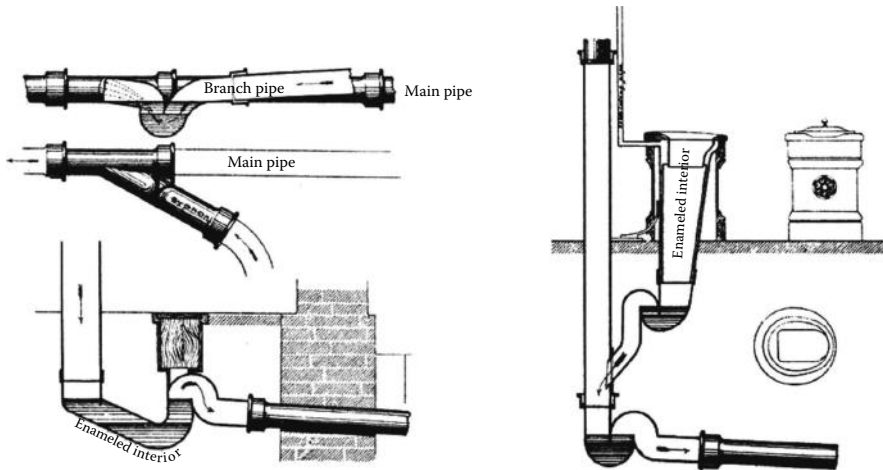
Plate VI

(b)

**FIGURE 9.42** Street reservoir for Liernur's sewerage system, ca. 1884: (a) street reservoir and (b) street reservoir used in Amsterdam, Holland. (From Gray, S.M., *Proposed Plan for a Sewerage System, and for the Disposal of the Sewage of the City of Providence*, Providence Press Company, Providence, RI, 1884.)

- Provision of water supply to every house
- Use of water closets over older systems (earth closets and privies)
- Discharge of domestic wastewater direct to sewer rather than to cesspools
- Sewers to also take solid refuse from streets
- Sewers, instead of discharging to watercourse, to convey sewage to an agricultural area away from town where its manorial value could be utilized

In 1856, Joseph Bazalgette was appointed chief engineer of the Metropolitan Board of Works in London. Bazalgette developed a massive project (from 1859 to 1867) aimed at collecting all the sewage of London in a hypogeum network of sewers: the first sewerage of London. His work is considered one of the great wonders of the nineteenth century. The key structure of the entire project was the 139 km of collectors passing on either side of the Thames. These were then linked to the 2100 km of sewers, built ex novo or renewed, passing beneath the streets of central London. Bazalgette constructed large underground sewers as well as the first underground railway along the banks of the Thames River in London [88]. The construction of the London sewerage system was usually cited because with it there was the first extensive use of Portland cement, which was patented in 1824 by Joseph Aspdin [38].



Diagrams showing arrangement of  
Liernur's sewerage system  
in private houses

Plate VII

**FIGURE 9.43** Arrangement of Liernur's sewerage system in private houses, ca. 1884. (From Gray, S.M., *Proposed Plan for a Sewerage System, and for the Disposal of the Sewage of the City of Providence*, Providence Press Company, Providence, RI, 1884.)

Compared to London, the industrial revolution in Paris was more gradual. From just under 600,000 inhabitants, the population of Paris was nearly 900,000 around 1850. The urban infrastructures were still those of the medieval city. The sewages were usually disposed off in cesspools. The sewerage system, although recently restored and enlarged after 1830 by the prefect of the Seine, Charles de Rambuteau, was insufficient and the scarcity of water available to the inhabitants (which was taken from the Seine in the middle of the city) was not able to assure a good operation. In 1853, Napoleon III appointed Georges Eugene Haussmann prefect of the Seine, who entrusted the hydraulic works to the engineer Eugene Belgrand. Construction included 600 km of new pipes and ducts, leaving only 15 km of the old sewerage built less than 20 years before. The sewers were 2.30 m high and 1.30 m wide, in order to collect both rain water, as well as domestic and industrial wastewater. In the main collectors, even larger (up to 4.40 and 5.60 m wide), rails for wagons for the cleaning of the channels were installed [88].

### 9.10.1.2 Wastewater Treatment Processes

The first wastewater treatment processes were developed in the nineteenth century.

Anderson [1], in a treatise about the "Elements of Agricultural Chemistry," describes the use of the sewage of towns as manure in the neighborhood of Edinburgh, in 1829. Anderson [1] complains that several attempts failed in converting the sewage manure into a solid form. In its liquid form, Anderson [1] stated that sewage manure was employed with the best possible effect in the cultivation of meadows.

A predecessor of the modern septic tank was developed by M. Mouras of France. As a matter of fact, in 1881 he patented a device he named the "Mouras Automatic Scavenger": it was a kind of a storage receptacle which was emptied periodically into a local sewer [98]. The term "septic tank" appeared for the first time in Great Britain, in 1895, used by Donald Cameron in order to describe the septic actions and processes within his patented device (Crites and Tchobanoglous 1997) [98].

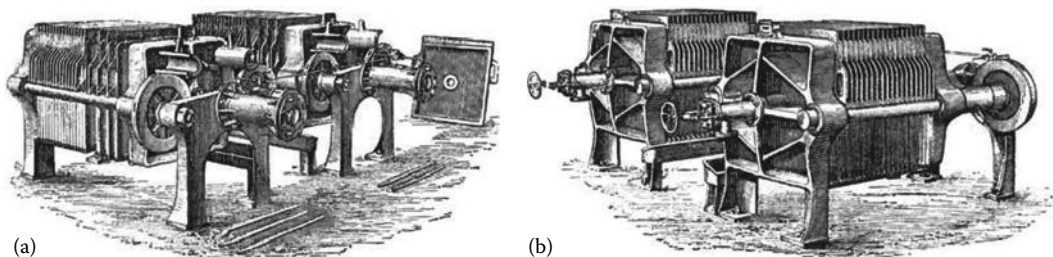
Slater [100] emphasized the importance of sewage by the number and "varied and contradictory character" of the patents relating to their treatment: "Freezing and heating, concentration and dilution, electrization and magnetizing, the addition of oxidizers and deoxidisers, of ferments and preventives of fermentation recommended, if not actually tried, show the want of any distinct and generally recognized

principle.” The first of 454 patents listed by Slater [100] for their chemical treatment of sewage, from 1846 to 1886 (around 1 patent per month), was by William Higgs and related to the “Precipitates with slaked lime, and brings the sewage gases evolved in contact with chlorine or hydrochloric acid gas.” Finally, in order to have an idea of the types of wastewater treatment in use at that time as well as the state of the art, the following are the titles of the chapters of the Slater’s book:

1. Nature and Composition of Sewage
2. How, When and Where is Sewage Injurious
3. Disposal and Treatment of Sewage
4. Water-Carriage in General
5. The Bazalgette System a Failure in London
6. Irrigation, its Principle and Conditions
7. Modifications of Irrigation
8. Filtration
9. Precipitation
10. Deodorising
11. Destruction
12. Promiscuous Methods
13. Self-Purification
14. Detection of Sewage Pollution in Rivers
15. Recognition of Purification in Sewage Tanks
16. Precipitation Mud, Methods of Drying
17. Sewage Manures
18. Sewage Legislation
19. Sewage Patents
20. Discussion on Dr. Tidy’s Paper, read before the Society of Arts May 5, 1886

Slater [100] also emphasized the importance of sludge (he used the term “mud”) management and, in particular, its dewatering since “the mud is a thin paste, containing, on an average, 90 percent, of water.” According to Slater [100], the best method of dealing with the mud was to run it into a filter press, similar to those shown in Figure 9.44, where the moisture present was reduced down from 50% to 40%, according to the pressure put on and the time allowed. The shape and the functioning of them are very similar to the modern filter presses: “the mud comes out on opening the presses in flat cakes, circular or rectangular, according to the make of the press, sufficiently coherent for handling” [100]. Moreover, as reported in Slater [100], at many sewage works some chemicals were added to the sludge in order to improve its ability to dewater. Thus the sludge conditioning was yet in use at that time.

Slater [100] highlighted the principal problem in the use of the filter press, and in general of the dewatering process: the management of the removed water. According to Slater [100], 100 tons of sludge contained around 91 m<sup>3</sup> of water, of which about 41 m<sup>3</sup> were squeezed out by the press. This liquid was



**FIGURE 9.44** Examples of filter presses (a, b) for the dewatering of sludge in use at the end of the nineteenth century. (From Slater, J.W., *Sewage Treatment, Purification, and Utilization*, Whittaker & Co., London, U.K., 1888.)



disposed passing back into the sewage or into the tanks, and was treated over again. This practice was judged “by no means judicious,” since “the press liquor is far harder to treat than fresh sewage, requiring an extra dose of chemicals, and even then, giving but a doubtful result. Press liquor, in fact, behaves very much like stale, putrid sewage.”

In 1869, Sir Edward Frankland began his groundbreaking study of filtration performance on raw London sewage by packing laboratory columns with various combinations of coarse gravel and peaty soil. This experiment was the first scientific proof that intermittent sand filtration is an effective treatment for wastewater. The concept of flowing wastewater across some natural material for treatment is the basis of attached growth processes, also referred to as fixed film [83].

In 1882, the English chemist, Robert Warrington, introduced the idea that the microorganisms contained in the sewage could be conveniently used for the treatment [27]. William Dibdin, an engineer for the municipal district of London (in 1885), clearly recognized the significance of using microorganisms to treat municipal wastewater [113].

In 1886, the development of standards for wastewater treatment began with the establishment of the Lawrence experimental station of the Massachusetts State Board of Health in United States [27,113]. In 1887, the first formal biological waste treatment unit, an intermittent sand filter, was tried at Medford, Massachusetts [113]. In 1890, the first trickling filter was commissioned (Stanbridge 1976) [27]. One of the earliest biological filters was used at Salford near Manchester in the United Kingdom [27].

### **9.10.2 Present Times (1900 to Present)**

The wastewater treatment processes were tremendously developed during the twentieth century. A detailed description of such a development is not the aim of this chapter, even because for the reader it is easier finding useful bibliographic references, in printed version and, especially, on the Internet. At the beginning of the century the first wastewater treatment plant appeared in the scene, and during the following decades becoming much larger and more articulated during the following decades.

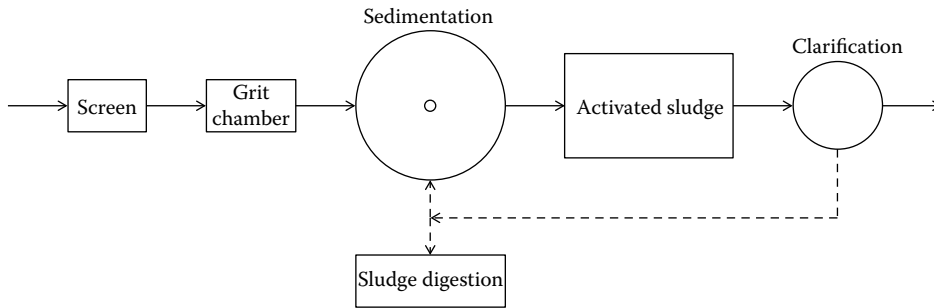
The Imhoff Tank, consisting of a cylindrical settling tank and a digestion tank directly underneath (the first two-storied facility), was patented in Germany, in 1906. In the process of sludge treatment, digestion was typically followed by dewatering on drying beds and transportation for agricultural purposes [99].

In the Unites States, the first trickling filter was placed in operation in 1901 (in Madison, Wisconsin); the first Imhoff tank was installed in 1909; liquid chlorine was first applied for plant-scale disinfection in 1914 [113]. Around 1913, the idea developed to increase the concentration of aerobic bacteria by sludge sedimentation after aerating the sewage in a bottle (protected from light) for several hours, to remove the solid-free water carefully and then add sewage again. Edward Arden and William T. Lockett from the River Committee of the Manchester Corporation in 1914 were the first persons to observe an increase in sludge by repeating this process several times. Over the following years, the first activated sludge batch process was converted to a continuous process using an aeration tank, a sedimentation tank, and sludge recycle system [117].

In terms of wastewater treatment, the twentieth century has surely to be considered the century of the activated sludge process, because its invention happened at the beginning of it as well as during the following decades this process reached full maturity. In fact, according to Cooper [27], we believe that the activated sludge process had the biggest impact of all processes upon environmental improvement in the past century.

The first activated sludge plant began operation in United States, in San Marco, Texas, in 1916 [113]. The first British city to fully apply the activated sludge process was Sheffield in 1920 [27]. The first use of the activated sludge process in Germany was at Essen-Recklinghausen in 1925 [99]. Figure 9.45 shows the flowchart of an activated sludge treatment plant as it appeared around 1930.

Two important steps toward the current state of wastewater treatment were the introduction of artificial sludge dewatering during the 1960s, and the addition of nitrogen and phosphorus removal to all



**FIGURE 9.45** Flowchart of an activated sludge (AS) plant around 1930. (Modified from Seeger, H., *Eur. Water Manage.* 2, 51, 1999.)

municipal sewage plants after the issuance of new target values for wastewater during the 1980s [99]. It can be observed that artificial sludge dewatering systems were already existing and operating at the end of the nineteenth century, as shown in Figure 9.45.

In the United States, primary treatment was the most common form of wastewater treatment until 1972 when the passage of the Clean Water Act mandated secondary treatment. As secondary treatment became common, public health and the environment improved significantly. By the mid-1980s, almost every treatment plant in the United States used some form of biological treatment [68].

## 9.11 Summary and Conclusions

Nowadays, when water is missing at our home (due to unforeseen breakage or planned maintenance to the aqueduct), we immediately complain. Whilst, usually we are not so interested if the wastewater treatment plant is out of service or even nonexistent unless we have a major backup of our bathrooms or toilets. The reasons behind this behavior are many, but the most important could be our “natural” aversion to human waste. As a matter of fact, when we do not want a baby to touch something, we usually say: “Don’t touch, it is shit!” So we need not wonder if there is a great lack of information about wastewater management throughout history. This is surprising if we consider that lack of sanitation and the consequential bacterial infections have killed more victims than armed conflicts. The limited written sources referring to relevant matters have a totally different main subject and the incorporation of lavatory’s, wastewater of sewage information is related with sarcastic comments as in Aristophanes comedies or directives as in Byzantine monastic *Typika*.

Studying the history of wastewater offers the possibility to study the history of mankind from a very unique perspective: it is as if you rummage in the waste bin trying to understand the habits of a family. In addition, the lavatory and sanitary constructions become quite often a field where the wealth and prosperity of a society is being presented and demonstrated, a fact that can be testified also during the older historic times.

It is obvious that technological improvements on wastewater management techniques have occurred during several historical periods. The presence of financial prosperity and cultural growth contributed without any doubt on these improvements and, on the contrary, improvements in wastewater management tremendously influenced human development. It is evident that the technological solutions have survived to political, cultural, and religious reformations. On the other hand, it seems that the barbaric raids and invasions diminished the continuation of the relevant technical practices.

Finally, in order to summarize the historical development of wastewater management, with Table 9.1 we have traced a timeline about historical development of sanitation and wastewater management, in some cases reaffirming the fundamental concepts presented in the paragraphs of this chapter, and in other cases providing additional details and points of view.

TABLE 9.1 Timeline for Historical Development of Sanitation and Wastewater Management

Period	Achievements	Comments
Around 6500 BC	A first successful effort in wastewater management was the wastewater drainage.	Oldest known at El Kown in present-day Syria
3300–3200 BC	Wastewater disposal facilities (drainage facilities) available.	At Hababa Kabira, which was a planned city, in present-day Syria
2100–1100 BC	Sewerage and drainage systems available in Crete Greece. Also, terracotta pipes drained to stone sewers and possibly the first “flushed” toilet was implemented at Knossos palace (Crete, Greece).	Minoan settlements (e.g., Knossos, Zakros, Agia Triada, and Tyllisos)
3000–67 BC	Well-constructed vaulted storm drains and sanitary sewer systems implemented. In Babylon, clay pipes led to cesspools. The Babylonians, like other ancient civilizations, viewed uncleanness as a taboo, not because of the physical uncleanness but the moral evil it suggested.	In Mesopotamia
2600–1900 BC	Earliest toilets and sewerage and drainage systems were developed in Mohenjo-Daro (Indus valley). Also, there is evidence of wastewater disposed to the agricultural lands.	In Mohenjo-Daro city located in modern Pakistan
1500–800 BC	The realization of the importance of pure water for people is evident already from the myths of ancient cultures. Religious cleanliness and water important in various ancient cults.	In various Mycenaean cities (in south Greece)
800–300 BC	The Etruscans were masters of hydraulics; the Romans, following their lessons, became masters in water and wastewater engineering. The Etruscans build a road system with properly drained surfaces. In particular, they realized a coordinated and comprehensive plan of the slopes of drainage channels on the sides of streets. They often constructed sewers and drains which further developed and improved by the Romans.	Etruscans region (in central Italy)
After 770 BC	The first well-organized drainage systems in temples and other religious structures appeared.	Early Dynasties in China and other areas of southeastern Asia
480–67 BC	Alcmaeon of Croton (floruit ca. 470 BC) was the first Greek doctor to state that the quality of water may influence the health of people. Also, Hippocratic treatise <i>Airs, Waters, Places</i> (ca. 400 BC) deals with the different sources, qualities, and health effects of water. Thus, the importance of water for the public health for first time was recognized and the first well-organized baths, toilets, and sewerage and drainage systems appeared. Also, the first public fountains were implemented. However, the first known epidemic of 430–426 BC, happened in Athens, caused the death of the great statesman, Pericles, decimated the population, and contributed significantly to the decline and fall of classical Greece. The enclave held 155,000 inhabitants out of the 400,000 total population of Attica. It is characteristic that during that time sanitary installations became a necessary space even for ordinary middle class houses (i.e., Olynthos, Delos, Dystos, etc.).	Greece, Turkey, south Italy, and northern African states

67 BC to ca. 330 AD	<p>The importance of water for the public health was widely recognized in several parts of the world. Pliny the Elder in the first century AD had in his works a long section concerning the different opinions on what kind of water is the best. Also, urban sewerage and drainage of large scale were recognized. In addition, the first baths and toilets both private and public of large scale appeared in several urban areas. The first sewerage network system in Rome connected to houses at ca. 100 AD. However, in public toilets facilities were common to all; they were cramped, without any privacy, and had no decent way to wash one's hands. The private toilets most likely usually lacked running water and they were commonly located near the kitchens. The rich had running water in their homes; the poor had to fetch their water from public fountains. Waterborne infections must have been among the main causes of death. Dysentery and different kinds of diarrheas must have played severe problems to the populations.</p>	<p>In eastern Mediterranean, Egypt, north Africa (modern Tunisia), the Apennine peninsula (modern Italy)</p>
ca. 330–1700 AD	<p>There was no improvement in methods of waste removal in Europe for many centuries. With the advent of the Dark Ages little progress was made for 1400 years, from the late fourth century. Baths, toilets and sewerage and drainage systems were further improved by Byzantines and Venetians. Medieval cities, castles and monasteries had their own wells, fountains or cisterns. Usually towns built a few modest latrines for the inhabitants, but these were mostly inadequate for the size of the population. The lack of proper sanitation increased the effects of epidemics in medieval towns in Europe. Also, in several Asian countries (e.g., China, India, and Vietnam) were implemented various types of drainage systems in the religious temples developed under several dynasties.</p>	<p>The transition from the ancient world is not certain.</p>
1700–1900 AD	<p>The great epidemics of cholera and typhoid fever occurred in England during 1830–1850 and their association with the pollution of water sources with raw wastewater made clear the need for sanitation and the protection of water resources and motivated health agencies to set sanitation rules and environmental policies to protect public health. Thus, the first large-scale projects of unintended, however, effluent reuse were set at the beginning of 1800s when “sewage farms” were developed as an attempt to protect public health and to control water pollution. This practice was mainly developed from 1840 to 1890 in England, while in the 1870s the first systems were appeared in the United States, France, Germany, and other European countries.</p>	<p>After the beginning of the Industrial revolution</p>
1900–present	<p>Decentralized waste management (DWM) concepts (e.g., privy vaults, cesspools, and dry sewage collection) were predominantly used in urban and rural areas up to the middle of the nineteenth century, mainly in the United States and in central Europe. Decentralized dry sewage systems were more common in Europe and Asia than in the United States because Europeans and Asians had more experience using human excrement as fertilizer and doing so cost effectively. On the other hand, an early attempt for centralized wastewater management in the United States was the construction of public and private combined sewers to transport the cumulative wastes from a city block or from several city blocks to a nearby water body. Afterward, the DWM systems became inadequate and were gradually replaced with centralized water-carriage sewer (CWM) systems. CWM systems remain the preferred wastewater management option in newly urbanizing areas since today. However, due to less-dense urban development patterns, DWM technologies have resurfaced as viable alternatives in several parts of the world. These new DWM technologies were entirely different than those used before including several small mechanical (e.g., attached and suspended biomass) and natural systems (e.g., wetlands, land application, and on-site) included recycling and reuse of wastewater.</p>	<p>From the globalization of the technological civilization of our times</p>

## References

1. Anderson, T. 1860. *Elements of Agricultural Chemistry*. Edinburgh: Adam and Charles Black.
2. Angelakis, A.N. and D. Koutsoyiannis. 2003. Urban water resources management in ancient Greek times. In *The Encyclopedia of Water Sciences*, eds. B.A. Stewart and T. Howell, pp. 999–1008. New York: Marcel Dekker.
3. Angelakis, A.N. and S.V. Spyridakis. 1996. The status of water resources in Minoan times: A preliminary study. In *Diachronic Climatic Impacts on Water Resources with Emphasis on Mediterranean Region*, eds. A.N. Angelakis and A.S. Issar, pp. 161–191. Heidelberg, Germany: Springer-Verlag.
4. Angelakis, A. N. and S. V. Spyridakis. 2012. A brief history of water and wastewater technologies in Bronze Age. *Water Sci. Technol. Water Supply* 13(3):564–573.
5. Angelakis, A.N., D. Koutsoyiannis, and G. Tchobanoglous. 2005. Urban wastewater and stormwater technologies in the ancient Greece. *Water Res.* 39(1):210–220.
6. Antoniou, G.P. 2007. Lavatories in ancient Greece. *Water Sci. Technol. Water Supply* 7(1):155–164.
7. Antoniou, G.P. 2010. Ancient Greek lavatories: Operation with reused water. In *Ancient Water Technologies*, ed. L.W. Mays, pp. 67–87. Dordrecht, The Netherlands: Springer.
8. Baker, M.N. 1948. *The Quest for Pure Water: The History of Water Purification from the Earliest Records to the Twentieth Century*. Denver, CO: American Water Works Association (AWWA).
9. Barker, G. and T. Rasmussen. 1998. *The Etruscans*. Oxford, U.K.: Blackwell Publishers Ltd.
10. Bearman, P.J., T. Bianquis, C.E. Bosworth, E. van Donzel, and W.P. Heinrichs, eds. 2001. *The Encyclopaedia of Islam*. Leiden, the Netherlands: Brill.
11. Bergamini, M. 1991. Todi: il cunicolo “fontana della Rua” nel sistema idraulico antico. In *Gli Etruschi maestri di idraulica*, ed. M. Bergamini, pp. 143–162. Perugia, Italy: Electa Editori (in Italian).
12. Bersani, P., A. Canalini, and W. Dragoni. 2010. First results of a study of the Etruscan tunnel and other hydraulic works on the Ponte Coperto stream (Cerveteri, Rome, Italy). *Water Sci. Technol.: Water Supply* 10(4):561–569.
13. Bianco, A.D. 2007. *Aqua Ducta, Aqua Distribuita*. Torino, Italy: Silvio Zamorano Editore (in Italian).
14. Bizzarri, C. 1991. Cunicoli di drenaggio ad Orvieto. In *Gli Etruschi maestri di idraulica*, ed. M. Bergamini, pp. 163–167. Perugia, Italy: Electa Editori (in Italian).
15. Boussac M.F., T. Fournet, and B. Redon. 2009. *Le bain collectif en Égypte*. Cairo, Egypt: IFAO.
16. Bracken, P., A. Wachtler, A.R. Panesar, and J. Lange. 2007. The road not taken: How traditional excreta and greywater management may point the way to a sustainable future. *Water Sci. Technol.: Water Supply* 7(1):219–228.
17. Bruschetti, P. 1991. Uso del sottosuolo per l’espansione urbanistica di Todi: sistemi idraulici e strutturali. I. In *Gli Etruschi maestri di idraulica*, ed. M. Bergamini, pp. 115–135. Perugia, Italy: Electa Editori (in Italian).
18. Burian, S.J. and F.G. Edwards. 2002. Historical perspectives of urban drainage. In *Global Solutions for Urban Drainage*, eds. E.W. Strecker and W.C. Huber, pp. 1–16. Portland, OR: American Society of Civil Engineers.
19. Castellani, V. and W. Dragoni. 1989. Opere idrauliche ipogee nel mondo romano: origine, sviluppo e impatto nel territorio. *L’universo, Ist. Geog. Milit.* LXIX(2):100–137 (in Italian).
20. Castleden, R. 1993. *Minoans: Life in Bronze Age Crete*. London, U.K.: Routledge.
21. Cauvin, J. 1994. Naissance des divinités. Naissance de l’agriculture: la révolution des symboles au Néolithique. *Paléorient* 20(2):172–174 (in French).
22. Cauvin, J. 1997. *Naissance des divinités, naissance de l’agriculture—La révolution des symboles au néolithique*. Paris, France: Editions du CNRS (in French).
23. Cencioli, L. 1991. Cunicoli di drenaggio a Perugia. In *Gli Etruschi maestri di idraulica*, ed. M. Bergamini, pp. 97–104. Perugia, Italy: Electa Editori (in Italian).
24. Cencioli, L. 1991. Cunicoli di drenaggio ad Orvieto. In *Gli Etruschi maestri di idraulica*, ed. M. Bergamini, pp. 169–176. Perugia, Italy: Electa Editori (in Italian).

25. Chamonard, J. 1924. *Le Quartier du Theatre*. Paris, France: Collection Exploration archéologique de Délos.
26. de Contenson, H. and W.J. van Liere. 1966. Premier sondage à Bouqras en 1965. Rapport préliminaire. *Annales archéologiques arabes syriennes* (in French).
27. Cooper, P.F. 2001. Historical aspects of wastewater treatment. In *Decentralised Sanitation and Reuse*, eds. P. Lens, G. Zeemann, and G. Lettinga, pp. 11–36. London, U.K.: IWA Publishing.
28. De Feo, G., L.W. Mays, and A.N. Angelakis. 2011. Water and wastewater management technologies in the ancient Greek and Roman civilizations. In *Treatise on Water Science*, Vol. 4, ed. P. Wilderer, pp. 3–22. Oxford, U.K.: Academic Press.
29. De Feo, G., P. Laureano, R. Drusiani, and A.N. Angelakis. 2010. Water and wastewater management technologies through the centuries. *Water Sci. Technol. Water Supply* 10(3):337–349.
30. Delorme, J. 1960. *Gymnasion: étude sur les monuments consacrés à l'éducation en Grèce, des origines à l'empire Romain*. Paris, France: De Boccard.
31. De Marinis, R.C. 1991. L'abitato etrusco del Forcello: opera di difesa e di drenaggio e importanza delle vie di comunicazione fluviale. In *Gli Etruschi maestri di idraulica*, ed. M. Bergamini, pp. 75–85. Perugia, Italy: Electa Editori (in Italian).
32. Doerpfeld, W. 1886. *Tiryns*. Leipzig, Germany.
33. Evans, S.A. 1921–1935. *The Palace of Minos at Knossos: A Comparative Account of the Successive Stages of the Early Cretan Civilization as Illustrated by the Discoveries*, Vols. I–IV. London, U.K.: Macmillan & Co. (reprinted by Biblo and Tannen, New York, 1964).
34. Fan, C.T. 1987. *The Space of Water Engineering*. No. 6, China.
35. Fardin, H.F., A. Hollé, E. Gautier, and J. Haury. 2012. Heritage of ancient civilizations wastewater management technologies: Examples from South Asia. Paper presented at the *3rd IWA Specialized Conference on Water & Wastewater Technologies in Ancient Civilizations*, March 22–24, 2012, Istanbul, Turkey.
36. Farnsworth Gray, H. 1940. Sewerage in ancient and medieval times. *Sewage Works J.* 12(5):939–946.
37. Flohr, M. and Wilson, A. 2011. The economy of Ordure. In *Roman Toilets: Their Archaeology and Cultural History*, eds. G.C.M. Jansen, A.O. Koloski-Ostrow, and E.M. Moormann, pp. 147–156. Leiden, Belgium: Babesch Supplement.
38. Gani, M.S.J. 1997. *Cement and Concrete*. London, U.K.: Chapman & Hall.
39. Gaubert, M. 2009. Bains et les Moines. In *Le bain collectif en Egypte*, eds. M. Boussac et al., pp. 297–303. Caire, Egypt: IFAO.
40. Glück, H. 1921. Probleme des Wölbungsbaues I: Die Bäder Konstantinopels, Arbeiten des Kunsthistorischen Instituts der Universität Wien, Band XII, Wien, Germany (in German).
41. Goldstein, B.D. 2012. John Snow, the broad street pump and the precautionary principle. *Environ. Develop.* 1:3–9.
42. Goodwin, G. 1971. *A History of Ottoman Architecture*. London, U.K.: Thames & Hudson Ltd.
43. Graham, J.W. 1987. *The Palaces of Crete*, Revised edition. Princeton, NJ: Princeton University Press.
44. Gray, S.M. 1884. *Proposed Plan for a Sewerage System, and for the Disposal of the Sewage of the City of Providence*. Providence, RI: Providence Press Company.
45. Günay, R. 2003. *Safranbolu Houses*. Istanbul: Yapi Yayin.
46. Henein, N.H. and M.W. Kellia. 2000. L'ermitage copte QR 195. I. Archéologie et architecture. Plans. Fouilles de l'IFAO 41. Caire, Egypt: Institut français d'archéologie orientale (in French).
47. HIACASS. 1985. Disentombment Brief Report of Yanshi Shi Xiang Gou Cheng. The Palace site. Henan group 2 of Institute for Archeology, Chinese Academy of Social Sciences. Archeology. No. 4, China.
48. HICR. 1983. Brief report of testing digging at long Shan culture old city site of Huai Yang Pingliangtai of Henan. Henan Institute for Cultural Relic. Cultural Relic. No. 3, China.
49. Hobson, B. 2009. *Latrinae et foricae. Toilets in the Roman World*. London, U.K.: Duckworth.
50. Hodge, A.T. 2002. *Roman Aqueducts & Water Supply*. London, U.K.: Gerald Duckworth.

51. Hoepfner, W. 1999. *Geschichte des Wohnens*. Stuttgart, Germany: Deutsche Verlags-Anstalt (in German).
52. Hopkins, N. 2007. The Cloaca Maxima and the monumental manipulation of water in archaic Rome. *Waters Rome* 4:1–15.
53. Jansen, M. 1989. Water supply and sewage disposal at Mohenjo-Daro. *World Archaeol.* 21(2):177–192.
54. Jones, D.E., Jr. 1967. Urban hydrology—A redirection. *Civil Eng.* 37(8):58–62.
55. Jørgensen, D. 2010. The metamorphosis of Ajax, jakes, an early modern urban sanitation. *Early English Stud.* 3:1–31.
56. Jørgensen, D. 2010. Local government responses to urban river pollution in late medieval London. *Water Hist.* 2:35–52.
57. Kanetaki, E. 2004. *Othomanika loutra ston elladiko xwro (Ottoman baths in the Greek territory)*. Athens, Greece: Technical Chamber of Greece.
58. Kanetaki, E. 2011. Bathhouses in the Former Ottoman Province of the Greek Lands: A contribution to the study of their history and architecture. Paper presented at the *Conference Bathing Culture*, 2007, Istanbul.
59. Kanetaki, E. 2012. The use of water in historic Balnear buildings of Greece. Paper presented at the *3rd IWA Specialized Conference on Water and Wastewater Technologies in Ancient Civilizations (IWA WWTAC 2012)*, Istanbul.
60. Kanetaki, E. 2012. Architectural and technical aspects regarding the construction of hammams in Ottoman Greece. Paper presented at the *2nd International Conference Balneorient: Βαλανεία, Thermae, Hammam*, 2009, Damaskus, Syria.
61. Kanetaki, E. 2012. The creation of historical cultural heritage in Greece during the Ottoman period. Paper presented at the *International Symposium on Historical Ottoman Artifacts and Foundations (AWQAF)* in the Balkans, Istanbul.
62. Kenoyer, J.M. 1991. The Indus Valley tradition of Pakistan and Western India. *J. World Prehist.* 5(4):331–385.
63. Koutsoyiannis, D., N. Zarkadoulas, A.N. Angelakis, and G. Tchobanoglous. 2008. Urban water management in Ancient Greece: Legacies and lessons. *ASCE, J. Water Resour. Plan. Manage.* 134(1):45–54.
64. Lamprecht, H.O. 1988. Bau und Materialtechnik bei antiken Wasserversorgungsanlagen. In *Geschichte der Wasserversorgung*, ed. Frontinus-Gesellschaft e.V., pp. 150–155. Mainz, Germany: Verlag Philipp von Zabern (in German).
65. Lawler, A. 2008. Boring no more, a trade-savvy Indus emerges. *Science* 320:1276–1281.
66. Lloyd, S. 1954. Building in brick and stone. In *A History of Technology, Volume I from Early Times to Fall of Ancient Empires*, eds. C. Singer, E.J. Holmyard, and A.R. Hall, pp. 456–490. New York: Oxford University Press.
67. Lofrano, G. and J. Brown. 2010. Wastewater management through the ages: A history of mankind. *Sci. Total Environ.* 408:5254–5264.
68. Lofrano, G., J. Brown, and G. De Feo. 2012. Water pathways through the ages: From early aqueducts to next generation of waste water treatment plants. In *Advances in Water Treatment and Pollution Prevention*, eds. S.K. Sharma and R. Sanghi, pp. 37–54. New York: Springer-Verlag.
69. MacDonald, C.F. and J.M. Driessen. 1990. The Storm Drains of the East Wing at Knossos. *Bulletin de Correspondance Hellénique, Supplément* 19:141–146.
70. Mackay, E.J.H. 1948. *Early Indus Civilization*, 2nd edn. London, U.K.: Luzac.
71. Magagnini, A. 2008. *Gli Etruschi. Storia e tesori*. Vercelli, Italy: Edizioni White Star.
72. Maner, A.W. 1966. Public works in ancient Mesopotamia. *Civil Eng.* 36(7):50–51.
73. Mariani, M. 1991. Uso del sottosuolo per l'espansione urbanistica di Todi: sistemi idraulici e strutturali. II. In *Gli Etruschi maestri di idraulica*, ed. M. Bergamini, pp. 137–141. Perugia, Italy: Electa Editori (in Italian).
74. Markham, A. 1994. *A Brief History of Pollution*. London, U.K.: Earthscan Publications Ltd.

75. Martini, P. and R. Drusiani, R. 2009. History of the water supply of Rome as a paradigm of water services development in Italic Peninsula. Paper presented at the *2nd IWA International Symposium on Water and Wastewater Technologies in Ancient Technologies*, Bari, Italy.
76. Mays, L.W. 2007. Water sustainability of ancient civilizations in Mesoamerica and the American southwest. *Water Sci. Technol.: Water Supply* 7(1):229–236.
77. Mays, L.W. 2010. *Ancient Water Technologies*. Dordrecht, the Netherlands: Springer Science and Business Media.
78. Mays, L.W. 2012. Water supply sustainability of ancient civilizations in Mesoamerica and the American southwest. In *Evolution of Water Supply Through the Millennia*, eds. A.N. Angelakis, L.W. Mays, D. Koutsoyiannis, and N. Mamassis, pp. 383–405. London, U.K.: IWA Publishing.
79. Monneret de Villard, U. 1926. *Annales du Service de Antiques de l’Egypte*. Paris, France (in French).
80. MQKOCs. 1988. The Drainage Network of Qi Kingdom Old City Site. The Museum of Qi Kingdom Old City Site of Ling Zi District. Archeology, No. 9, 1988, China.
81. Müller-Wiener, W. 1966. *Castles of the Crusades*. London, U.K.: Thames & Hudson.
82. Myriantheos, M. 1987. The Bastion at the SE side of the Sinai monastery wall. Paper presented at the *7th Symposium of Byzantine Archaeology and Art*, Athens, Greece (in Greek).
83. National Small Flows Clearinghouse. 2004. The Attached Growth Process—An old technology takes on new forms. *Pipeline* 15(1):1–8.
84. Neçipoğlu, G. 2005. *The Age of Sinan: Architectural Culture in the Ottoman Empire*. London, U.K.: Reaktion Books.
85. Neudecker, R. 1994. *Die Pracht der Latrine: zum Wandel öffentlicher Bedürfnisanstalten in der kaiserzeitlichen Stadt München*. Munich, Germany: Pfeil (in German).
86. Önge, Y. 1990. Toilets in Turkish Ottoman architecture. Paper presented at the *Seventh International Congress of Turkish Art*, Warsaw, Poland.
87. Orlandos, A. 1940. *The Role of the Roman Building Located Northern of Horologe of Andronikos Kiristos*. Paper presented at the Athens Academy. Athens, Greece (in Greek).
88. Pinna, L. 2011. *Autoritratto dell’immondizia*. Torino, Italy: Bollati Boringhieri (in Italian).
89. Piro, V. 1991. I cunicoli di drenaggio a Perugia. In *Gli Etruschi maestri di idraulica*, ed. M. Bergamini, pp. 105–113. Perugia, Italy: Electa Editori (in Italian).
90. Platon, M. 1990. New indications for the problems of purgatory cisterns and bathrooms in Minoan World. Paper presented at the *6th International Cretologic Congress*, Literary Association Chrysostomos, Chania, Greece (in Greek).
91. Platon, N. 1974. *Zakros, The New Minoan Palace*. Athens, Greece: The Athens Archaeological Society (in Greek).
92. Reynolds, R. 1946. *Cleanliness and Godliness*. New York: Doubleday and Company, Inc.
93. Robinson, D. 1938. *Olynthos VIII*. Baltimore, MD: Johns Hopkins Press.
94. Sabine, E.L. 1934. Latrines and cesspools of Mediaeval London. *Speculum* 9(3):303–321.
95. Sassatelli, G. 1991. Opere idrauliche nella città etrusca di Marzabotto. In *Gli Etruschi maestri di idraulica*, ed. M. Bergamini, pp. 179–207. Perugia, Italy: Electa Editori (in Italian).
96. Scarborough, V.L. 1983. A pre-classic Maya water system. *Am. Antiquity* 48(4):720–744.
97. Schladweiler, J.C. and J. McDonald. 2004. 1300’s—Late 1500’s: Sir John Harrington’s New Ajax (The True Roots of the Modern Day Flush Toilet) with Impetus Provided to John Harington by Queen Elizabeth, ‘The Schoole of Salerne,’ and ‘The Englishmans Doctor.’ [http://www.sewerhistory.org/articles/privbath/harrington/school\\_of\\_salernum.pdf](http://www.sewerhistory.org/articles/privbath/harrington/school_of_salernum.pdf) (accessed July 11, 2012).
98. Seabloom, R.W., T.R. Bounds, and T.L. Loudon. 2005. *Septic Tanks Text*. Fayetteville, NC: University of Arkansas.
99. Seeger, H. 1999. The history of German wastewater treatment. *Eur. Water Manage.* 2:51–56.
100. Slater, J.W. 1888. *Sewage Treatment, Purification, and Utilization*. London, U.K.: Whittaker & Co.
101. Smith, M.L. 2006. The archaeology of South Asian cities. *J. Archaeol. Res.* 14:97–142.



102. Sokuntheary, S. 2007. Study on the drainage system of the Bayon Temple in the Angkor Thom, Cambodia. PhD dissertation, Waseda University, Graduate School of Science and Engineering, Architectural History, Tokyo, Japan.
103. Sori, E. 2001. *La città e i rifiuti—Ecologia urbana dal Medioevo al primo Novecento*. Bologna, Italy: Il Mulino (in Italian).
104. Stordeur, D. 1989. El Kowm 2 Caracol et le PPNB. *Paleorient* 15(1):102–110.
105. Stordeur, D. 2000. *El Kowm 2: une île dans le désert—La fin du néolithique précéramique dans la steppe syrienne*. Paris, France: CNRS Editions (in French).
106. Strommenger, E. 1980. *Eine Stadt vor 5000 Jahren, Ausgrabungen der Deutschen Orient-Gesellschaft am Euphrat in Habuba Kabira*, Syrien, Mainz (in German).
107. Szymanska, H. and Babraj, K. 2009. Le bains de Marea. In *Le bain collectif en Egypte*, ed. M. Boussac et al. Caire: IFAO.
108. Taylor, C. 2005. The disposal of human waste: A comparison between ancient Rome and Medieval London. *Past Imperfect* 11:53–72.
109. Trümper, M. 2006. The Late-Hellenistic baths on Delos, I. The public baths in the theatre quarter. *Bulletin de correspondance hellénique* 130:143–229.
110. Tulodziecki, D. 2011. A case study in explanatory power: John Snow's conclusions about the pathology and transmission of cholera. *Stud. History Phil. Biol. Biomed. Sci.* 42:306–316.
111. United States Cast Iron Pipe & Foundry Co. 1914. *Cast Iron Pipe, Standard Specifications Dimensions and Weights*, p. 13. Burlington, NJ.
112. Vatin, C. 1976. Jardins et services voirie. *Bulletin de Correspondance Hellénique* 100:555–564.
113. Vesilind, P.A. 2003. *Wastewater Treatment Plant Design*. London, U.K.: Water Environment Federation, IWA Publishing.
114. Viollet, P.L. 2005. *L'hydraulique dans les civilisations anciennes—5000 ans d'histoire*. Paris, France: Presses de l'École Nationale des Ponts et Chaussées (in French).
115. Violet, P.L. 2007. Water engineering in ancient civilizations: 5,000 years of history (translation into English by Forrest M. Holly), International Association of Hydraulic Engineering and Research (IAHR), Madrid, Spain.
116. Vuorinen, H.S. 2010. Water, toilets and public health in the Roman era. *Water Sci. Technol. Water Supply* 10(3):411–415.
117. Wiesmann, U., I.S. Choi, and E.M. Dombrowski. 2007. *Fundamentals of Biological Wastewater Treatment*. Weinheim, Germany: Wiley-VCH Verlag GmbH.
118. Wolfe, P. 1999. History of wastewater. In *World of Water 2000—The Past, Present and Future*, ed. P. Wolfe, pp. 24–36. Tulsa, OK: WaterWorld and Water & Wastewater International.
119. Wright, R.P. 2010. *The Ancient Indus: Urbanism, Economy, and Society*. New York: Cambridge University Press.
120. Yavuz, A. 2011. The Baths of Anatolian Seljuk Caravansarais. In *Bathing Culture of Anatolian Civilizations*, ed. N. Ergin, Ancient Near Eastern Studies Supplement 37, pp. 77–141. Leuven, Belgium: Peeters.
121. Φιλήμονος, Μ. 2000. Τα αστικά απορρίμματα στην αγροτική παραγωγή. Η μαρτυρία της αρχαίας Ρόδου (Urban waste in agricultural production). Presented at the *Archaeology and Environment in Dodecanese. International Conference*, Ρόδος, Greece (in Greek).
122. Καρυδάς, Ν. 1999. Ανασκαφές στην οδό Γλαύκου (Excavations at Glaukos Street) AEMEΘ 13, (Archaeological Work in Macedonia and Thrace) Thessaloniki, pp. 370–374 (in Greek).
123. Κατσαρός, Θ. 2000. Ο Πύργος της Μεταμορφώσεως της Ι.Μ. Βατοπεδίου in Πύργοι του Αγίου Όρους (Towers of Mt Athos) Thessaloniki, pp. 45–49 (in Greek).
124. Ορλάνδος, Α. 1927. Μοναστηριακή Αρχιτεκτονική, (Monasteries' Architecture) 1st Edn. Αθήνα, Εστία (in Greek).

125. Ορλάνδος, Α. 1937. Τα παλάτια και τα σπίτια του Μυστρά, (Palaces and Houses of Mystras). In Αρχείο των Βυζαντινών Μνημείων της Ελλάδος, ν Γ' τ. 1 (Archive of Byzantine Monuments in Greece) Αθήνα, Ε.Α.Ε., Εστία (in Greek).
126. Ορλάνδος, Α. 1958. Μοναστηριακή Αρχιτεκτονική, (Monasteries' Architecture), 2nd Edn. Αθήνα ΒΑΕ (in Greek).
127. Ορλάνδος, Α. and Τραυλός, Ι. 1986. Λεξικό Αρχαίων Αρχιτεκτονικών Όρων (Dictionary of the Ancient Architectural Terms) Α. Ε. (in Greek).
128. Παπάγγελος, Ι. 2005. Αθωνική Μονή Ζυγού (Athonian Monastery of Zygos), Private edition, Thessaloniki, Greece (in Greek).



# 10

## Hydrofracturing and Environmental Problems

---

10.1	Introduction .....	220
10.2	Historical Perspectives .....	220
10.3	Global Perspectives .....	221
10.4	Principles of Hydrofracturing.....	222
10.5	Hydrofracturing Equipment, Instruments, and Materials.....	222
	Equipment and Instruments • Fracturing Fluid • Proppants • Chemical Additives	
10.6	Hydrofracturing Process.....	224
	Well Preparation	
10.7	Applications of Hydrofracturing.....	226
	Oil and Gas Well Fracturing • Fracture Monitoring • Hydrofracturing for Groundwater Well Stimulation • Wastewater Management • Regulation and Control	
10.8	Potential Environmental and Health Impacts.....	229
	Potential Environmental Impacts • Potential Health Impacts	
10.9	Benefits and Demerits.....	230
	Benefits of Hydrofracturing • Demerits of Hydrofracturing	
10.10	Summary and Conclusions.....	230
	Acknowledgment.....	231
	References.....	231

**Bosun Banjoko**  
*Obafemi Awolowo  
University*

### AUTHOR

**Bosun Banjoko** obtained his MSc, PhD Biochemistry, and MPH Environmental Health degrees from the University of Ibadan, Ibadan, Nigeria, MPA degree in Public Policy from Obafemi Awolowo University, Ile-Ife, Nigeria and Diploma in International Environmental Law from UNITAR, Geneva, Switzerland. He specializes in immunology, toxicology, environmental health, sustainable development, environmental ethics, and law. He is currently registered for the LL.M Environmental and Human Rights degree program at Aberystwyth University, Aberystwyth, U.K and he is a senior lecturer in the Department of Chemical Pathology and head of the Environmental Health and Sustainable Development Unit at the Institute of Public Health, College of Health Sciences, Obafemi Awolowo University, Ile-Ife, Nigeria. He is an author of many articles and book chapters.

## PREFACE

Hydrofracturing or hydraulic fracturing is a 1940s technology in which water, sand, and chemicals are pumped under very high pressure into a completed wellbore to create fissures in relatively impermeable geological formations such as shales. The fissures allow water, oil, or gas to flow into the well and the sand props the fissures open, preventing the resealing of the pathways. Hydrofracturing is becoming more popular with the global increasing demand for water, oil, and gas. There are, however, concerns about the seismic and environmental implications of the widespread usage of this process particularly on long-term basis. Obviously, there are developmental and economic benefits of fracking. However, necessity arises to examine the environmental and health impacts of its use in view of sustainable development, which is tied to sound environmental management. This chapter dealt with a global view of hydrofracturing including the components, benefits, challenges, and probable solutions with more specific examples in the United States where the practice is more common and frequently debated.

## 10.1 Introduction

Hydrofracturing, also called hydrofracking, is a method of induced hydraulic fracturing whereby fractures are propagated in a rock layer as a result of the action of a pressurized fluid through a wellbore drilled into reservoir rock formations. Some hydraulic fractures are naturally occurring and are referred to as “veins” or dikes and can create conduits along which gas and petroleum from source rocks migrate to the reservoir rocks [4].

Hydrofracturing as a process is currently a contentious issue worldwide. While proponents of its use dwell so much on the economic benefits with reference to better yield of oil, gas, or water, the protagonists are seriously concerned about the environmental impacts on short and long terms and the attendant health implications.

This chapter will therefore critically examine the technology vis-a-vis the pros and cons with the view of sustainable development, which is one of the underpinnings of millennium development goals (MDGs).

## 10.2 Historical Perspectives

Hydrofracturing has its origin in the United States as far as the 1860s when it was being experimented and utilized though at a small scale by oil industries in Pennsylvania, New York, Kentucky, and West Virginia using liquid and later solidified nitroglycerin to stimulate shallow, hard rock oil wells [18]. As time goes on, the same method was applied to water and gas wells. The development process of hydrofracturing witnessed the use of acid as a nonexplosive fluid in the 1930s. Due to acid etching, created fractures would not close completely and therefore productivity is enhanced. The same phenomenon was observed with water injection and squeeze cementing operations [18]. Floyd Farris of Stanolind Oil and Gas Corporation in the United States was credited for performing the first hydraulic fracturing experiment in 1947 at the Hugoton gas field in Grant County of Southwestern Kansas. Although the experiment did not provide appreciable increase in yield of gas, it however provided the basis for improved methods carried out by JB Clark in 1948.

A follow-up on the previous experiment resulted in Halliburton oil well cementing company being issued a patent and granted an exclusive license in 1949. The same company was subsequently credited for performing the first commercial hydraulic fracturing operation, first in Stephens County, Oklahoma, and later Archer County, Texas [18]. Since then, hydraulic fracturing has been used to stimulate approximately a million oil and gas wells worldwide [7]. The 1980s witnessed the use of hydrofracturing as a

well development process to increase the amount of water in existing dry and low-yield water wells and currently a popular method of choice to access groundwater in many developed countries, particularly the United States [6,15].

In Europe, Russia recorded first hydraulic fracturing practice in 1952. All other Western European countries however did not start until around 1977. Between 1977 and 1985, hydraulic fracturing was conducted at Rotliegend and carboniferous gas-bearing sandstones in Germany, onshore and offshore gas field in the Netherlands, and the UK sector of the North Sea.

Other European and some North African countries engaged in hydraulic fracturing include Norway, Poland, Czechoslovakia, Yugoslavia, Hungary, Austria, France, Italy, Bulgaria, Romania, Turkey, Tunisia, and Algeria [16].

### 10.3 Global Perspectives

---

Although hydrofracturing is most commonly used in the United States to extract natural gas from shale formations, it is becoming a practice widely utilized in Australia, South Africa, Canada, China, Denmark, Bulgaria, Poland, Ireland, New Zealand, and United Kingdom [21,24,26,28].

In many countries engaged in hydrofracturing, there are environmental and health concerns resulting in caution in licensing, temporary suspension, and in some instances outright ban due to public pressure [19,20].

In Australia, the procedure was conventionally limited to oil and gas wells in the Cooper Basin on a small scale. However, the vast majority of coal seam gas wells have good natural permeability and therefore require no hydraulic fracturing.

In Bulgaria, the government's decision to grant an approval to Chevron Corporation for possible shale gas extraction using hydrofracturing was reversed in January 2012 following widespread protests in the country.

Probably due to geographical proximity, Canada is another country besides the United States with a high degree of hydrofracturing practice. Although fracking has been in use in Canada at an industrial scale since the 1990s, recent concerns about the environmental implications has resulted in the practice being reviewed in New Brunswick and Nova Scotia, with Quebec temporarily suspending the practice pending an environmental review.

China is bound to be a big player in shale gas exploration having completed its first horizontal shale gas well in 2011. A global shale gas study by the US Energy Information Administration believed China's technically recoverable shale gas reserves to be almost 50% higher than that of the United States [8,9].

In Denmark, a preliminary study revealed an underground reserve of gas in North Jutland with potential for hydrofracking to be utilized. The news had since sparked off controversy and protests. In Lough Allen basin area of county Leitrim, in North Ireland, the potential hydrofracking license granted to Tamboran Resources company for gas exploration was met with a lot of protests. This gave birth to the protest group, "No fracking Ireland" who has been engaging the authorities on the issue.

In New Zealand, South Africa, and United Kingdom, hydraulic fracturing is part of petroleum exploration and extraction though on a smaller scale. Environmental concerns resulted in unofficial suspension of fracking in the United Kingdom, a review of the process in New Zealand, and a moratorium in South Africa's Karoo region [28].

Poland is a country that is aggressively developing its shale gas reserves, thought to be the largest in Europe. A Polish Geological Institute Study published in March 2012 concluded that while fracking may produce some amount of toxic wastes, the latter can be recycled without harming the environment [26].

This study particularly encouraged the Polish authorities to establish 22 gas wells. Furthermore, the economic implication is quite alluring since large-scale fracking would relieve some of the dependency on Russian gas by the European Union [22]. However, Poland, with a population of 38 million people and a large agricultural sector, would have to contend with the massive amount of water required for fracking that would reduce the amount of water available for other industrial and domestic use [28].

Although hydraulic fracturing is most commonly used in the United States to extract natural gas from shale formations, preliminary investigations had shown that the procedure does not significantly impact the environment negatively. This informed the exemption of hydraulic fracturing for the purpose of oil, natural gas, and geothermal production under the Safe Water Drinking Act (EPA 2011). The result of a 2004 EPA study on coal bed hydraulic fracturing was used to justify the passing of the exemption; however, EPA whistle-blower, Weston Wilson, and the Oil Gas Accountability Project found that critical information was removed from the report.

The fact that oil and gas exploration and production wastes are exempted from Federal Hazardous Waste Regulation under subtitle C or the Resource Conservation and Recovery Act (RCRA) and companies are still not required to provide the names of chemicals in “propriety” formula makes the lists incomplete and the whole “regulation” of hydrofracturing contemptuous. A cursory observation could indicate economic benefits as the main purpose of approval of the procedure. In view of these inconsistencies, there are serious concerns by environmentalists and such concerns are growing by the day. For example, in May 2012, Vermont became the first state of the United States to totally outlaw hydraulic fracturing.

Perhaps the main focus of current discussions on hydrofracturing in the United States is centered on the Marcellus shale. Also called the Marcellus formation, is a middle Devonian age, black, low-density, carbonaceous shale located in the subsurface beneath much of Ohio, West Virginia, Pennsylvania, New York, and some areas of Maryland, Kentucky, Tennessee, and Virginia. A US 2002 geological survey revealed that the Marcellus shale is estimated to contain 500 trillion cubic feet of natural gas located nearly a mile or more below the surface. The nature of the formation makes horizontal drilling and hydrofracturing a necessity to access the gas reserve. However, it is equally well known that the rock of the formation is radioactive. With land leasing agreements and government licensing and other economic activities in the area, debates on hydrofracturing are not likely to diminish very soon.

## 10.4 Principles of Hydrofracturing

---

The hydrofracturing process is based on Pascal’s law pronounced by the French mathematician Blaise Pascal based on the principle of fluid mechanics that states that “pressure exerted anywhere in a confined incompressible fluid is transmitted equally in all directions throughout the fluid such that the pressure ratio remains the same.” What this means in essence is that when high-pressure water is injected in an isolated section of a borewell, the hydraulic pressure acting is equal.

In hydrofracturing, forcing a mixture of water, sand, and chemical at high pressure down a wellbore and into the dense surrounding rocks will create small fractures that can cause the release of previously trapped reserves of gas, petroleum, or water. The technology enables the production of natural gas and oil from rock formations deep below the earth’s surface of a length of about 5,000–20,000 ft or 1,500–6,100 m; such depths do not allow sufficient permeability or reservoir pressure to allow natural gas and oil to flow from the rock into the wellbore at economic rates [11,12].

## 10.5 Hydrofracturing Equipment, Instruments, and Materials

---

### 10.5.1 Equipment and Instruments

Fracturing equipment operates over a range of pressures and injections rates and can reach up to 100 MPa (15,000 psi) and 265 L/s (100 barrels/min) [15]. Hydrofracturing equipment utilized in oil and gas usually consists of the following but not exclusively [5]:

1. Slurry blender: Equipment to finely mix the components of the fracturing fluid.
2. Monitoring units.
3. Fracturing tank.
4. Unit for storing and handling proppants.
5. High-pressure treating iron.

6. Chemical adding unit.
7. Low-pressure flexible losses.
8. Gauges, meters for flow rate, fluid density, and pressure motoring.
9. Packer: This is a tool that can be inflated or deflated hydraulically. A single or dual packer may be used but the latter is more popular. The packer seals the borewell but allows water to be pumped through a pipe passing through it. The packer is inflated hydraulically to seal the borewell at the desired depth or fracture zone. The depth of the casing pipe is less than 11 ft. The diameter of the packer is usually 6 in.
10. Hydraulic power pack: The hydraulic power pack is truck driven consisting of transfer gearbox, hydraulic relief valves, function/return line filters, and reservoirs.
11. High-pressure hydrofrac pump: Two-speed hydraulically driven pump with dual functions, that is, break and develop. In break function, the pump operates in low speed producing over 25,000 psi at 40 GPM, which is the pressure for fracking. In well developing function, the pump operates at high speed producing 500 psi at 80 GPM that develops the well allowing for optimal water flow.
12. Crane: Hydraulically operated with manual extension and of 8 tons capacity.
13. Winch: One ton capacity, hydraulically operated with a spooling capacity of 30 m/wire rope of 13 mm.
14. Hydraulic hand pumps: Dual displacement for packer inflation. The working pressure is 700 bar.
15. Carrier: Truck with engine capacity of about 110 bhp.
16. Fracturing pipes: Seamless of standard 15 ft length and diameter of 1½ in. with a tested and certified durability for 3000 psi.
17. Inflate hose: ¼ in. diameter with a working pressure of 700 bar.
18. Downhole TV camera: Waterproof video camera with travel capacity of 500 ft. Fitted at the other end with TV monitor, stand, connectors, and winch.
19. Generator: Air-cooled, three-phase, 415 VAC capacity for 7.5 KVA.
20. Submersible pump: 3 HP, three phase with electrical cable, cold control panel, and dry run preventer.

### 10.5.2 Fracturing Fluid

The fracturing fluid is typically a slurry of water, proppants, and chemical additives. The function of the fracturing fluid is to extend fractures and to carry proppants into the formation for it to stay there without damaging the formation or production of the well. The fracturing fluid can also contain gels, foams, compressed gases like nitrogen, carbon dioxide and air depending on the desire of the operators.

Typically of the fracturing fluid, over 98%–99.5% is water and sand with the chemicals accounting for about 0.5% of the whole fluid [13]. By implication, the total additives in the fracturing fluid constitute 0.5%–2%, while the remainder is water [13]. Hydraulic fracturing may use 1.2 and 3.5 million gallons of fluid per well, with large projects consuming up to 5 million gallons. Additional fluid is used when wells are refractured, and this may be done several times [13]. Obviously, water is by far the largest component of fracking fluids. The initial drilling operation itself may consume from 6,000 to 600,000 gal, that is, 23,000 to 2,300,000 L of fracking fluid.

### 10.5.3 Proppants

Proppants are fine materials delivered to the fractures through the fracturing fluid to keep them open for continuous flow of oil, gas, or water. Proppants are of various types and they include silica sand, resin-coated sand, and man-made ceramics. The choice of proppant to be used depends on the type of permeability or grain strength desired. Although the most commonly utilized proppant is silica sand, proppants of uniform size and shape such as a ceramic proppant is believed to be more effective. This is due to the fact that it ensures greater porosity within the fracture resulting in liberation of a greater amount of oil and natural gas [3,16].



### 10.5.4 Chemical Additives

Chemical additives are usually applied to tailor the injected material to the specific geological situation, protect the well, and improve its operation. They vary slightly based on the type of well. It is common knowledge that the composition of injected fluid is sometimes changed as the fracturing job proceeds. When the viscosity of the fracturing fluid is enhanced by some chemicals, it has to be reduced afterward using an oxidizer or an enzyme to enable the used fracturing fluid to be easily pumped out.

Examples of the chemical additives are as follows:

1. *Gelling agents/gels*: Conventional linear gels that are cellulose derivatives, namely, carboxymethyl cellulose, hydroxymethyl cellulose, guar, or its derivatives, that is, hydroxypropyl guar and carboxymethyl hydroxypropyl guar.
2. *Borate cross-linked fluid*: Guar-based fluid cross-linked with boron ions obtainable from borax/boric acid solution. These gels have higher viscosity at pH 9 onward and are used to carry proppants. After the fracturing job, the pH is reduced 3 or 4 with the aid of an acid so that the cross-links are broken and the gel is less viscous and can be pumped out.
3. *Organometallic cross-linked fluids*: These include zirconium, chromium, antimony, and titanium salts cross-linked with guar-based gels. The disadvantage of this mixture is that the cross-linking mechanism is not reversible. Once the proppant is pumped down along with the cross-linked gel, and the fracturing part is done, the gels are broken down with breakers.
4. *Aluminum phosphate ester oil gels*: Aluminum phosphate and ester oils are slurred to form cross-linked gel. These are one of the first known gelling systems. They are limited in use currently, because of formation damage and difficulty in cleanup process.
5. *Breakers—Oxidizers and enzymes*: Peroxydisulfate is one of the most common oxidizers used during hydraulic fracturing treatments for proppant pack cleanup. Ammonium persulfate is another oxidizer that allows a delayed breakdown of the gel polymer chains.
6. *Friction-reducing (slick water) additives*: Polyacrylamide and mineral oil are examples of additives that minimize friction between the fluid and the pipe.
7. *Surfactant*: Isopropanol used to increase the viscosity of the fracture fluid.
8. *Scale inhibitor*: Ethylene glycol prevents scale deposits in the pipe.
9. *pH modifier*: Sodium or potassium carbonate maintains the effectiveness of other components such as cross-linkers.
10. *Oxygen scavengers*: Ammonium bisulfite removes oxygen from the water and protects the pipes from corrosion.
11. *Iron control*: Citric acid prevents precipitation of metal oxides.
12. *Corrosion inhibitor*: N = n-dimethylformide prevents the corrosion of the pipe.
13. *Biocide*: Glutaraldehyde eliminates bacteria in the water that produce corrosive by-products.
14. *Diluted acid (15%)*: Hydrochloric acid helps dissolve minerals and initiate cracks in the rock.
15. *Potassium chloride*: Creates a brine carrier fluid.
16. *Surfactant*: Isopropanol used to increase the viscosity of the fracture fluid.

## 10.6 Hydrofracturing Process

---

The hydrofracturing process depends on the following:

1. Purpose, that is, whether for oil and gas or water
  2. Well type, that is, high-permeability reservoir or unconventional wells like tight gas and shale gas well
  3. Type of fracturing, that is, high-rate fracturing or high-viscosity fracturing
  4. Position of fracturing, that is, either vertical or horizontal or both
- The purpose of hydrofracturing will be discussed separately under applications.

#### 5. Types of wells

There are two main types of wells and they are the following:

- a. Conventional well or high-permeability reservoir for which low-volume hydraulic fracturing is required. This is the type in groundwater tapping.
- b. Unconventional well or tight gas and shale gas wells for which high-volume hydraulic fracturing is required. Unconventional wells are deeper and require higher pressure than conventional vertical wells.

#### 6. Types of fracturing

There are two main types of fracturing and are, namely, (a) high-rate fracturing and (b) high-viscosity fracturing:

- a. *High-rate fracturing (slick water)*: In the high-rate or slick water fracturing method, the fracturing fluid contains a limited amount of sand, friction reducer, and other chemical additives. To improve the efficiency of fracturing, the fluid is pumped at a high rate down the well through the perforations into the formation. The friction reducer is usually a polymer, which reduces pressure loss due to friction thus allowing the pumps to pump at a higher rate without generating a greater pressure on the surface.
- b. *High-viscosity fracturing*: Isopropanol is a common chemical used to increase the viscosity of the fracturing fluid. However, it requires a gelling agent like guar gum or cellulose for performance viscosity that enables proppants to be carried into the formation. The purpose of the high viscosity terminates after the fracturing job; therefore, when the well is producing, the need to reduce the viscosity arises. For this purpose, a chemical known as a breaker is pumped with a gel or cross-linked fluid to reduce the viscosity. This chemical also called an oxidizer or enzyme, reduces the fluid viscosity and ensured no proppant is pulled from the formation. Examples of such breakers are peroxydisulfate and ammonium persulfate. The rate of viscosity increase for several gelling agents is pH dependent, so that occasionally pH modifiers like sodium and potassium carbonate must be added to ensure viscosity of the gel [10,11,14].

#### 7. Position of fracturing: The hydraulic fracturing process can be for (a) vertical and (b) horizontal well drillings

- a. Vertical drillings: Are the conventional wellbore and are the ones common in groundwater stimulation. The pressure requirements in vertical wells are less than in horizontal drillings. A vertical well only accesses the thickness of the rock layer typically to a depth of 50–300 ft (15–91 m).
- b. Horizontal drillings: This is quite common in oil and gas exploration and involves wellbores where the terminal drill hole is completed as a lateral that extends parallel to the rock layer containing the substance to be extracted. For example, the lateral drillings extend from about 460 to 1500 m in the Barnett shale basin in Texas and up to 30,000 m in the Bakken formation in North Dakota.

Recent advances in drilling and completion technology have made drilling horizontal wellbores much more economical. Horizontal wellbores allow for far greater access to a formation than a conventional vertical wellbore. This is particularly useful in shale formations that do not have sufficient permeability to produce economically with a vertical well [2].

### 10.6.1 Well Preparation

It is common practice to pump some amount of dilute HCL (5%–25%) or acetic acid (5%–45%) to clean perforations or breakdown near wellbore and ultimately reduce pressure seen on the surface. Thereafter, the proppant is started and stepped up in concentration for the fracturing process to commence.

## 10.7 Applications of Hydrofracturing

The main industrial use of hydraulic fracturing is a stimulating production from oil and gas wells. Other applications include the following:

1. Stimulation of groundwater wells
2. Preconditioning or induction of rock in mining
3. Means of enhancing waste remediation processes, usually hydrocarbon waste or spills
4. Disposal of waste by injection into deep rock formations
5. A method of measuring the stress in the earth
6. Heat extraction for production of electricity in an enhanced geothermal system
7. Increasing the injection rates of geological sequestration of CO<sub>2</sub> [1,2,10,17]

However, for the purpose of this chapter, the focus of application will be on (a) oil and gas wells and (b) groundwater well applications.

### 10.7.1 Oil and Gas Well Fracturing

The technique of hydraulic fracturing as used in oil and gas wells is to increase or restore the rate at which fluids such as petroleum or natural gas can be produced from subterranean natural reservoirs. The reservoirs are typically porous sandstones, limestones, dolomite rocks, and sometimes coal beds or shale, which is a soft, finely divided stratified rock that splits easily consisting of consolidated mud or clay sediments [1,2].

#### 10.7.1.1 Procedure

A hydraulic fracture is formed by pumping the fracturing fluid into the wellbore at a rate sufficient to increase pressure down the hole to exceed that of the fracture gradient of the rock. The fracture gradient is the pressure increase per unit of the depth due to its density and it is usually pressurized in pounds per square inch bars per meter [23].

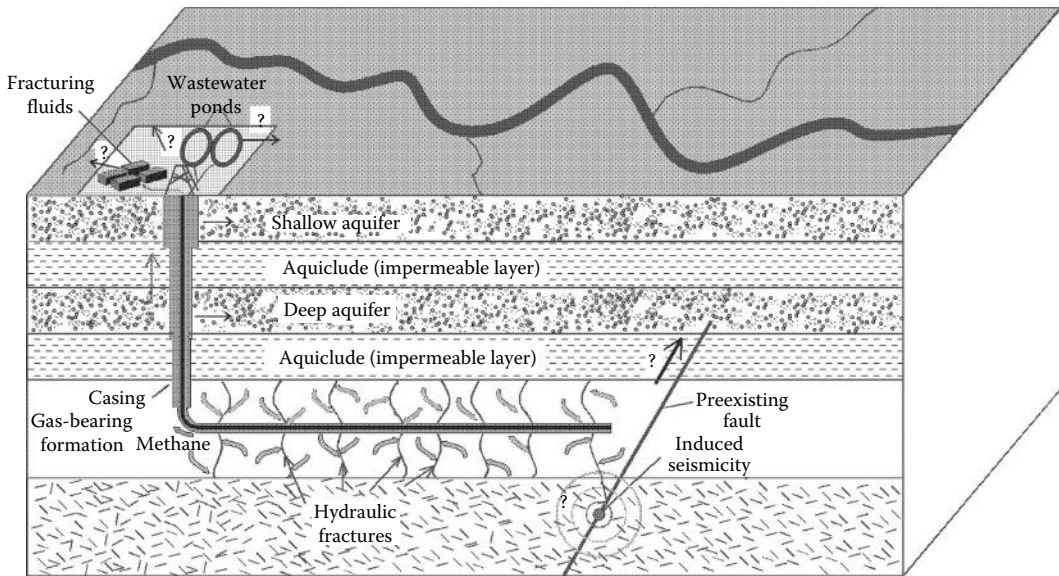
The rock cracks and the fracture fluid continues further into the rock extending the crack further on. The fracture width is maintained by introducing into the injected fluid proppants like grain sand, ceramics, and other particulates that will prevent the fracture from closing when the injection of fracturing fluids terminates and the pressure flow is reduced. The propped fracture is permeable enough to allow the flow of formation fluids to the well. The formation fluids include gas, oil, saltwater, freshwater, and fluids introduced to the formation during fracturing.

It is important to control leakage of fracturing fluid from the fracture channel into the surrounding permeable rocks. This may result in formation, matrix damage, adverse formation fluid interactions, or altered fracture geometry and thereby a decrease in production efficiency. Typically, hydraulic fracturing is performed in cased wellbores and the zones to be fractured are accessed by perforating the casing at those locations.

As the fracturing process proceeds, viscosity-reducing agents such as oxidizers and enzyme breakers are sometimes added to the fracturing fluid to deactivate the gelling agents and encourage flow back. At the end of the process, the well is commonly flushed with water sometimes blended with a friction-reducing chemical under pressure (Figure 10.1).

### 10.7.2 Fracture Monitoring

It is expedient to measure the pressure and rate during the growth of a hydraulic fracture as well as know the properties of the fluid and proppant being injected into the well. This provides the most common and simplest method of monitoring a hydraulic fracture treatment. These data, with knowledge of the underground geology, can be used to model information such as length, width, and conductivity of a propped fracture.



**FIGURE 10.1** Schematic of hydraulic fracturing in oil and gas exploration. (From Mike Norton 2012 (ed.) *HydroFrac2.svg*, Hydraulic Fracturing. [http://en.wikipedia.org/wiki/hydraulic\\_fracturing](http://en.wikipedia.org/wiki/hydraulic_fracturing) [accessed on November 24, 2013].)

Radiotracers like TC-99m and  $I^{131}$  are also used to measure flow rates, infection profile, and location of fractures created by hydraulic fracturing [25]. It is also possible to effect microseismic monitoring to estimate the size and orientation of hydraulically induced fractures using an array of geophones in a nearby wellbore. By mapping the location of any small seismic events associated with the growing hydraulic fracture, the approximate geometry of the determined [30,31].

### 10.7.3 Hydrofracturing for Groundwater Well Stimulation

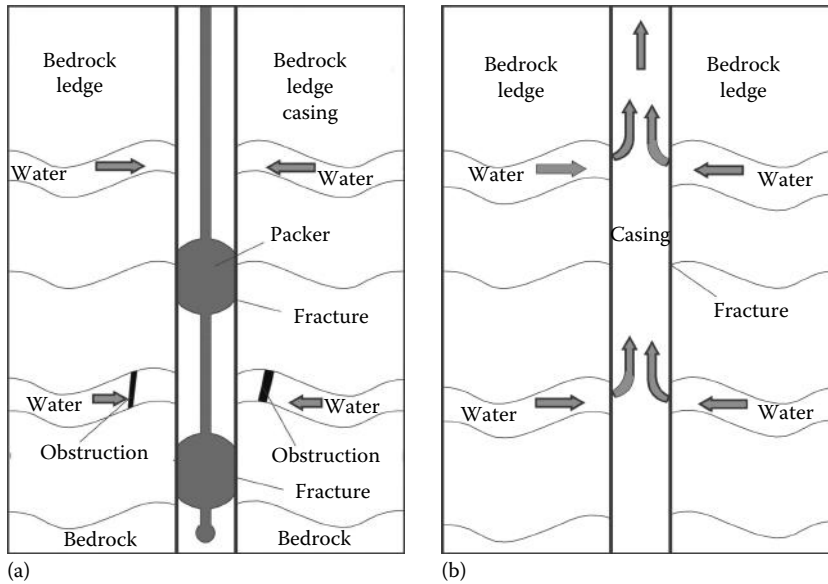
Hydrofracturing process in groundwater stimulation is a process by which water is forced into an existing borewell to pressurize, open out, and clean out non-water-producing veins in the earth strata thereby opening a clear path of water to flow into the well increasing the overall water yield.

The hydrofracturing process stimulates hydrogeological conditions of a borewell by

1. Initiating and propagating new fractures
2. Clearing of existing drainage channel of accumulated clay
3. Widening and smoothening of the pre-existing fractures
4. Improving smooth and free flow to and within conduit system

In a typical dry/low-yielding borewell, the waterborne fracture zones are identified and are subjected to high water pumping to initiate, propagate, widen, and extend the existing fractures. The water pumped into the borewell under high pressure up to 3000 psi breaks up fissures and fractures, cracks and cleans an array of mud and other impurities and blockages, and leads to contact with adjacent water-bearing fractures and bodies thereby improving the overall yield as the fracture is exposed to large extensive conduit system of fractures and aquifers (Figure 10.2).

Hydrofracturing is currently credited to be the most effective tool for groundwater recharging. The procedure for groundwater accessing includes initial general hydrogeological survey of the area of the selected borewell. This is followed by identification of fractures and fracture zone in the selected borewell by drillers' log, by downhole video inspection, or by geophysical logging.



**FIGURE 10.2** (a) Schematic of hydrofracturing process in groundwater well stimulation and (b) schematic of post-hydrofracturing process in groundwater well stimulation.

The hydrofracturing process proper involves two steps, namely, (1) packer setting and (2) high-pressure pumping:

1. *Packer setting*: A single or dual packer may be utilized. The packer that can be inflated or deflated hydraulically seals the borewell but allows water to be pumped through a pipe passing through the packer. The packer is generally set at 20–30 ft below the casing pipe or 70–80 ft from the ground level to around weathered zone if the depth of the casing pipe is less.
2. *High-pressure water pumping*: The high-pressure water pumping is carried out using a high-pressure hydrofrac pump capable of generating up to 3000 psi. Thereafter, water of appropriately 5000 gal is pumped into the borewell through the packer piping, thus forcing the water into existing fractures at a rate faster than the fracture can accept it, thereby opening and clearing the fracture paths. When the water is expended, the packer is dropped to a further depth of 70–80 ft and the process is repeated. Depending upon the depth of the borewell, normally, three hydrofracturing settings are carried out for good results.

Finally, a post-yield pumping test is carried out and a flow test is recorded to determine the overall improvement of the yield. The average hydrofracturing operational time is roughly 3–4 h per borewell; it should be observed that the procedure for water stimulation could be easier than that for oil and gas wells.

### 10.7.4 Wastewater Management

Although the concentrations of chemical additives used in hydrofracturing relative to the fracturing fluid are very low, the recovered fluid may be harmful due in part to minerals picked up from the formation. Over the life of a typical gas well, it is estimated that 100,000 gal of chemical additives would be used. Improved technology has ensured that wastewater containing injected fluid is recovered by underground injection, wastewater treatment and discharge, or recycling to fracture future wells.

### 10.7.5 Regulation and Control

Because of the sensitive nature of hydrofracturing, the practice for either oil and gas or hydrological purposes requires licensing. Nevertheless, the control should be made tighter due to potential adverse effects on the environment and health [25].

## 10.8 Potential Environmental and Health Impacts

---

Despite claims and counterclaims of safety and environmental pollution of hydraulic fracturing by proponents and opponents, expediency dictates caution for the good of the people. There are no doubts that there are environmental and health concerns [27,29]. This will thus be discussed.

### 10.8.1 Potential Environmental Impacts

1. *Water consumption:* Due to the large amount of water required for hydrofracturing, there are serious concerns of potential reduction in available water for industrial and domestic use particularly in arid areas such as Karoo in South Africa [28]. During periods of low stream flow, it may affect water supplies for power generation.
2. *Ecosystem:* High requirements of water for hydrofracking may affect aquatic life during periods of low stream flow.
3. *Wastewater management:* Fracturing fluid on flowing back through the well may consist of minerals and brine water. Furthermore, much of the wastewater is processed through public sewage treatment plants that are not equipped to remove radioactive material.
4. *Groundwater contamination:* Contamination of groundwater particularly by thermogenic methane will negatively impact water quality and cause well explosion in some instances. Other chemicals like ethylene glycol, isopropanol, and 2-butoxyethanol can also contaminate groundwater, and their products like benzene can be carcinogenic.
5. *Air pollution:* Methane is a gas well known to be released by hydrofracturing. The gas will eventually break down to carbon dioxide, a greenhouse gas, and contribute to global warming. The least studied of all the factors with potential danger are radioactive materials and heavy metals that might be released from the rocks. Radon gas that is odorless and colorless can cause emissions in residential areas surrounding hydrofracking sites with potential risk of lung cancer.
6. *Noise pollution:* Hydrofracturing possesses the capability of noise pollution with attendant health effects.
7. *Land pollution:* Residues of hydrofracturing fluid chemicals, heavy metals, and gases may negatively impact farm crops and animals.
8. *Seismic effects:* Hydrofracturing causes induced seismicity called microseismic events or micro-earthquakes. Although the magnitude is too small to be detected at the surface, the long-term effect may cause pronounced tremors [32].
9. *Environmental justice:* From all indications, economic considerations are currently overshadowing the environmental rights of the people where hydrofracturing practices are located. Principle 17 of the Rio Declaration states “Environmental Impact Assessment as a national instrument, shall be undertaken for proposed activities that are likely to have a significant adverse impact on the environment and are subject to a decision of a competent national authority.” Furthermore, the Convention on Access to Information, Public Participation in Decision Making, and Access to Justice in Environmental Matters makes it obligatory for the public to be involved in policies and decisions regarding hydrofracking.

## 10.8.2 Potential Health Impacts

1. *Psychosocial*: The fear of potential adverse effects on the environment that hydrofracking may cause will no doubt negatively impact the health of the people.
2. *Reduction in water supply*: Inadequate water supply may result in low availability of potable water and water for sanitation with associated risk of waterborne diseases.
3. *Radon and radio nuclides*: Radioactive gases have been implicated in having adverse health effects. Radon has been particularly implicated in the risk of developing lung cancers.
4. *Chemical toxicity*: A study on chemicals used in natural gas operations identified 632 chemicals with only 353 of these well characterized in the scientific literature. Many of these chemicals can affect the eyes, gastrointestinal, immune, and cardiovascular systems. In addition, some could be mutagenic or carcinogenic [6].
5. *Noise pollution*: Hydrofracturing can cause significant undesirable noise in people living around oil and gas formations where it is practiced. This can result in sleep disturbances, headache, and stress.

## 10.9 Benefits and Demerits

---

Many benefits and demerits of hydrofracturing have been identified and these are thus discussed.

### 10.9.1 Benefits of Hydrofracturing

1. *Provision of energy*: It is estimated that 80% or none of new oil and natural gas wells drilled in the United States will require hydraulic fracturing to enhance production. In other climes, Poland hopes to explore its verse reserve of gas that will boost supply to the European Union.
2. *Economic consideration*: The fact that there are oil and gas reserves to be assessed has caused provision for many. About 9.2 million US workers are supported by the oil and gas industry. In addition, there are revenues for local, state, and federal governments and lease royalties for landowners.
3. *Improved water access*: Hydrofracturing has proven to be the most effective tool for groundwater recharging.
4. *Control and environmental protection*: Current knowledge has not been able to show serious adverse environmental effects. This however does not remove their possibilities.

Furthermore, industry best practices and existing state regulations have proven relatively effective in protecting water resources from impacts related to hydrofracturing [25].

### 10.9.2 Demerits of Hydrofracturing

1. *Environment and health risks*: The potential environmental and health effects are the major concerns about hydrofracturing. The fear of the unknown long-term effect is justified. If, for example, groundwater is contaminated, remediation is costly and may not be total.
2. *Large water requirements*: Requirements of large amounts of water will affect water for other industrial uses, sanitation, recreation, and aquatic system [32].

## 10.10 Summary and Conclusions

---

Despite the huge controversy hydrofracturing has attracted, it is difficult to overlook its numerous benefits. However, the potential environmental and health dangers should not be discountenanced. Like all human endeavors, efforts should be made to closely monitor safe practices to protect groundwater in particular and the total environment in general.

From various scientific reports so far, hydrofracturing is relatively safe. However, the long-term seismic effect is unpredictable.

This underscores the requirement for more studies on environmental and health impacts of hydrofracturing, and such information should be made readily available to assuage the public particularly the environmentalists. Furthermore, best practices by industries should be emphasized. There should also be researches to modify or change some processes or chemicals that might be harmful in the use of the technology.

## Acknowledgment

I wish to acknowledge the efforts of Bunmi Byron of Bunmi Byron and Associates, architects, for creating the artwork used in this chapter.

## References

1. Banks, D., Odling, N.E., Skarphagen, H., and Rohr-Torp, E. 1996. Permeability and stress in crystalline rocks. *Terra Nova* 8(3): 223–235.
2. Bell, F.G. 2004. *Engineering Geology and Construction*. Taylor & Francis Group, Boca Raton, FL, p. 670.
3. CARBO ceramics. <http://www.carboceramics.com/> (Accessed June 10, 2012).
4. Charlez, P.A. 1997. Rock mechanics: Petroleum applications. Paris Edition, Technical Paper, Vol. 2, p. 239.
5. Chilingar, G.V., Robertson, J.O., and Kumar, S. 1989. *Surface Operations in Petroleum Production*. 2. Elsevier, New York, pp. 143–152.
6. Colborn, T., Kwiatkowski, C., Schultz, K., and Bachran, E., 2011. Natural gas operations from a public health perspective. *Human and Ecological Risk Assessment: An International Journal* 17(5): 1039–1056.
7. Energy Institute 2012. Fact-based regulation for environmental protection in shale gas development (Report), University of Texas at Austin. [http://energy.utexas.edu/image/ei\\_shale\\_gas\\_regulation\\_120215.pdf](http://energy.utexas.edu/image/ei_shale_gas_regulation_120215.pdf) (Accessed May 12, 2012).
8. EPA Regulation of hydraulic fracturing under the safe drinking water act EPA/31 October 011. <http://water.epa.gov/type/groundwater/uic/class2/hydraulicfracturing/index.cfm> (Accessed May 21, 2012).
9. EPA Treatment and disposal of wastewater from shale gas extraction. Environmental Protection Agency. <http://cfpub.epa.gov/npdes/hydrofracturing.cfm> (Accessed May15, 2012).
10. Frank, U. and Barkley N. 1995. Remediation of low permeability subsurface formations by fracturing enhancement of soil vapor extraction. *Journal of Hazardous Materials* 40(2): 191–201.
11. Gidley JL Holditech SA, Nierode DE. et al. 1989. *An overview of Fracturing: In Recent Advances in Hydraulic Fracturing* 12, Monograph series, SPE, Richardson, Texas.
12. Gill, R. 2010. *Ingenious Rocks and Processes: A Practical Guide*. John Wiley & Sons, New York, pp. 102–105.
13. Hartnett – White K 2011. The fracas about fracking, low risk, high reward but the EPA is against it, National Review Online, June 20, [www.nationalreview.com/articles](http://www.nationalreview.com/articles) (Accessed July 28, 2013).
14. Laubach, S.E., Reed, R.M., Olson, J.E., Lander, R.H., and Bonnell, L.M. 2004. Co-evolution of crack-seal texture and fracture porosity in sedimentary rocks: Cathodoluminescence observations of regional fractures. *Journal of Structural Geology* 26(5): 967–982.
15. Love, A.H. 2005. *Fracking: The Controversy over Its Safety for the Environment*. Lafayette, CA, Johnson Wright, Inc.
16. Mader, D. 1989. *Hydraulic Proppant Fracturing and Gravel Packing*. Elsevier, Amsterdam, the Netherlands, pp. 173–174; 202.
17. Miller, B.G. 2005. *Coal Energy Systems. Sustainable World Series*. Academy Press, Amsterdam, the Netherlands, p. 380.



18. Montgomery, C.T. and Smith, M.B. 2010. Hydraulic fracturing: History of an enduring technology *JPTOnline* (Society of Petroleum Engineers): pp. 26–41. <http://jgs.geoscienceworld.org/cgi/content/abstract/131/6/653> (Accessed June 8, 2012).
19. Patel, T. 2011. France to keep fracking ban to protect environment, Sarkozy says. *Bloomberg Businessweek*. <http://www.businessweek.com/news/2011-10-04/france-to-keep-fracking-ban-to-protect-environment-sarkozy-says.html> (Accessed June 22, 2012).
20. Patel, T. 2011. The French Public Says No to “Le Fracking.” *Bloomberg Businessweek*. [http://www.businessweek.commagazine/content/11\\_15/b4223060759263.html](http://www.businessweek.commagazine/content/11_15/b4223060759263.html) (Accessed June 1, 2012).
21. Penny, G.S., Conway, M.W., and Lee, W. 1985. Control and modeling of fluid leakoff during hydraulic fracturing. *Journal of Petroleum Technology (Society of Petroleum Engineers)* 37(6): 1071–1081.
22. Polish Report: 2012 Shale gas procedure produces toxic refuse but does not harm environment. Associated Press. Washington, DC. <http://www.washingtonpost.com/world/europe/polish-report-shale-gas-produce-produces-toxic-refuse-but-does-not-harm> (Accessed June 10, 2012).
23. Price, N.J. and Cosgrove, J.W. 1990. *Analysis of Geological Structures*. Cambridge University Press, Cambridge, U.K., pp. 30–33.
24. Ramanuja, K. 2012. Study suggests hydrofracking is killing farm animals, pets. *Cornell Chronicle*. <http://www.news.cornell.edu/stories/march12/FrackingAnimals.html> (Accessed March 9, 2012).
25. Reis, J.C. 1976. *Environmental Control in Petroleum Engineering*. Gulf Professional Publishers, Houston, TX.
26. Scislowska, M. 2012. Polish report: Shale gas extraction not harmful Associated Press. ABC.com. <http://abnews.go.com/Business/wireStory/policy-report-shale-gaextraction-harmful-15832525> (Accessed June 8, 2010).
27. Sumi, L. 2011. Our drinking water at risk what EPA and the oil and gas industry don't want us to know about hydraulic fracturing. Oil and Gas Accountability Project and Earthworks. <http://www.earthworksaction.org/pubs/DrinkingWaterAtRisk.pdf> (Accessed May 10, 2012).
28. Urbina, I. 2011. Hunt for gas hits fragile soil, and South Africans fear risks. *The New York Times*. <http://www.nytimes.com/2011/12/31/world/south-african-farmers-see-threat-from-fracking.html> (Accessed June 10, 2012).
29. USEPA, 2011. Regulation of hydraulic fracturing by the office of water. [http://water.epa.gov/type/groundwater/uic/class2/hydraulicfracturing/wells\\_hydroreg.cfm](http://water.epa.gov/type/groundwater/uic/class2/hydraulicfracturing/wells_hydroreg.cfm) (Accessed May 16, 2012).
30. Wan, R. 2011. *Advanced Well Completion Engineering*. Gulf Professional Publishing, Houston, TX, p. 424.
31. Zoback, M.D. 2007. *Reservoir Geomechanics*. Cambridge University Press, Cambridge, U.K., p.18.
32. Zoback, M., Kitasei, S., and Cpithorne, B. 2010. Addressing the environmental Risks from shale gas development report world watch institute. <http://efdsystems.org/Portals/25/Hydraulic%20FFracturing%20Paper%20-%20World%20Watch.pdf> (Accessed May 10, 2012).
33. Mike Norton. 2012. HydroFrac2.svg, Hydraulic Fracturing. [http://en.wikipedia.org/wiki/hydraulic\\_fracturing](http://en.wikipedia.org/wiki/hydraulic_fracturing) (Accessed on November 24, 2013).

# 11

## Modeling of Wetland Systems

---

11.1	Introduction .....	234
11.2	Hydrologic Modeling .....	234
	Hydrologic Model Components • Effect of Vegetation on Flow	
11.3	Water Quality Modeling.....	237
	Black-Box Models • Process-Based Models	
11.4	Uncertainty and Sensitivity Analyses .....	243
11.5	Knowledge and Data Needs .....	244
	Quantity and Quality Data Requirements • Design of Monitoring Systems • Accounting for Seasonality	
11.6	Summary and Conclusions .....	245
	References.....	245

Jennifer M. Olszewski  
*University of Maryland*

Richard H. McCuen  
*University of Maryland*

### AUTHORS

**Jennifer M. Olszewski** is currently a PhD candidate in civil and environmental engineering at the University of Maryland, College Park. She received both her undergraduate and Master of Science degrees in the same program at UMD, graduating with honors. Her MS research concentrated on comparing the hydrologic performance of a local bioretention cell with that of a nearby forested stream. After completing her MS degree, Jennifer worked with the US Department of Agriculture and a local wastewater treatment plant in analyzing the persistence of hormones and antibacterials in biosolids. She is currently developing a wetland model as part of her PhD project. The goal of this research is to formulate a process-based model that will enable engineers to design more efficient and more effective constructed wetlands.

**Richard H. McCuen** is currently the Ben Dyer Professor of civil and environmental engineering at the University of Maryland. He received his BSCE from Carnegie Mellon University (1967) and MSCE and PhD (1971) degrees from the Georgia Institute of Technology. Dr. McCuen has been involved in research related to storm water management, urban hydrology, flood frequency analysis, hydrologic modeling, and engineering ethics. He has been a faculty member at the University of Maryland for 42 years and served as Director of the Engineering Honors Program for more than 25 years. He is the author or coauthor of 25 textbooks, including *Hydrologic Analysis and Design* and *Modeling Hydrologic Change*, and approximately 275 journal publications and conference proceedings papers. He has served as editor or associate editor of leading journals including the *Journal of the American Water Resources Association*, the *ASCE Journal of Hydrologic Engineering*, the *Journal of Hydrology*, and the *AWRA Water Resources Impact*.

## **PREFACE**

A wetland is technically defined as a site underlain by hydric soils and more generally defined as an area with either permanently or seasonally saturated soil, which supports the growth of hydric vegetation. A constructed wetland is a man-made wetland used to treat municipal, industrial, and agricultural wastewaters, agricultural and urban runoff, landfill leachate, or acid-mine drainage waters. Additionally, a constructed wetland can also be used to promote wildlife benefits. These wetlands are purposefully built as buffers between man-made outflows and natural waterways, making them crucial components to reducing anthropogenic impacts on downstream ecosystems. Understanding how wetlands work will allow for better constructed wetland design and eventually healthier natural waterways. Wetland modeling is one method of understanding and designing these complex systems.

This chapter will evaluate different approaches to modeling wetland systems, including possible applications of wetland models as well as their limitations. The main objectives for wetland models are wetland design and optimization, evaluation of existing wetland efficiency, relevant policy development, and the assessment of the effects of nonstationarity on wetland performance. The benefits of modeling to each of these objectives will be highlighted. Because wetlands are complex, natural systems, a number of issues associated with modeling them have arisen, including data requirements, data uncertainty, knowledge uncertainty, and model user requirements. These uncertainties and limitations can adversely influence the functioning of a constructed wetland to the point where the wetland does not function as intended.

## **11.1 Introduction**

---

Accurate wetland models are crucial to better understand and to better design and restore wetlands. In order to develop such models, an in-depth understanding of wetland hydrology, chemistry, and biology is required. This chapter aims to provide a general overview of the most important wetland characteristics such as evapotranspiration (ET), nutrient transformations, and biological degradation processes as well as the current methods used to model these complex processes and their advantages and disadvantages.

## **11.2 Hydrologic Modeling**

---

Two main constructed wetland designs currently exist, surface-flow wetlands and subsurface wetlands. Surface-flow wetlands contain a permanent pool of water, while subsurface wetlands promote flow through a porous media such as sand or gravel. This section will concentrate on the hydrologic modeling of surface-flow wetlands.

### **11.2.1 Hydrologic Model Components**

Five model components can be used to represent the most important hydrologic processes of a surface-flow wetland: precipitation, precipitation excess (runoff), surface flow through wetland, infiltration, and ET. A number of methods can be used to model each component. It should be noted that, when developing a hydrologic model, all components should be chosen with comparable levels of complexity to ensure the greatest model reliability. This chapter will illustrate simplified model components for all five hydrologic processes based on wetland represented by three tanks in series.

While precipitation falls directly onto a wetland, it can also cause flow over the drainage area that contributes to surface runoff into a wetland. Depending on available data, required time step, and simulation duration, precipitation data can be obtained from a number of sources, especially government agencies responsible for the collection of such data. Because data records are often very limited or non-existent, models often use simulated rainfall data to test proposed wetland designs.

Precipitation excess or runoff dictates how much water will enter the wetland by means of overland flow from the contributing drainage area. A number of methods can be used to model runoff including the rational method and the natural resources conservation service (NRCS) runoff equation. The most appropriate runoff method is dependent on drainage area size, knowledge of drainage area characteristics such as media infiltration properties, slope, and land use properties. Simpler, empirical methods like the NRCS runoff equation are more applicable for drainage areas with less available data, while more complex, physically based methods can be used when more media data are available.

Flow through a wetland can be modeled using standard flow equations, such as the diffusive wave equations, the kinematic wave equations, the Muskingum method, and nonlinear reservoir equations (e.g., the continuity equation paired with Manning's equation). A thorough review of current hydrologic models and the equations used in each was done by Borah [1]. Again, the most appropriate flow-routing methods depend on the complexity of other wetland model components, as well as the time interval and flow velocity through the wetland. Manning's equation was used in the example surface-flow model component.

Infiltration can be modeled using various levels of complexity. Because surface-flow wetlands are generally designed to maintain a minimum water level, infiltration is characterized by saturated flow and is often minimal. Additionally, if wastewater is being treated, an impermeable layer may be required to avoid groundwater contamination, preventing infiltration all together. Darcy's equation can only be used if saturated flow is assumed. A Hortonian-derived equation was used to model infiltration in an example wetland flow simulation:

$$\hat{I} = A(1 - e^{-B \times D}) \quad (11.1)$$

where

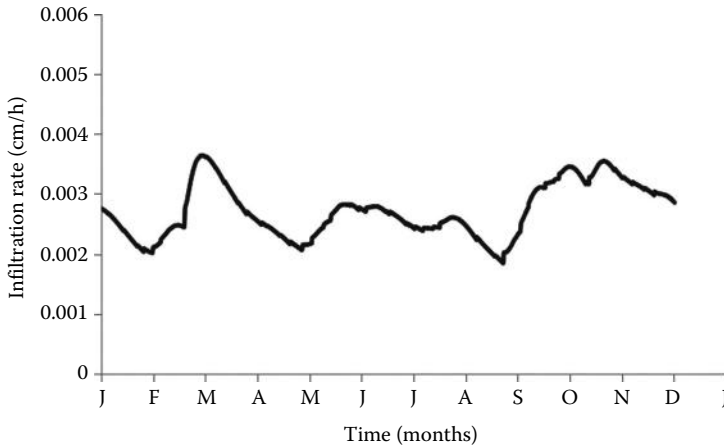
$\hat{I}$  is the infiltration depth rate (m/h)

$D$  is the water storage depth (m) within a wetland tank

$B$  and  $A$  are calibrated coefficients based on media hydraulic conductivity

In this simple example, infiltration rates are a function of water depth and the associated head. Therefore, as water depth decreases, infiltration rates exponentially decrease. Figure 11.1 shows model-generated infiltration rates over the course of a year. Infiltration rates increase with increasing rainfall in the spring months (March and April) as well as with increasing temperature in the fall and winter months due to decreased ET. During hotter, summer months, however, infiltration decreases because ET is at its peak.

Finally, ET has a significant impact on the water balance of a wetland. Depending on the required time increment of a given model, a number of different equations can be used to model wetland ET. The most detailed, physically based equations are the Penman and the Penman-Monteith equations, which relate ET to radiation, wind speed, relative humidity, air temperature, and vegetation properties. These equations can be used to accurately model hourly ET values. The Penman equations, however, are data intensive, requiring data that are often not available. Simplifications of the Penman equations can also be used to compensate for data gaps (e.g., approximating solar radiation using a sine curve). Other ET estimation methods include the temperature-based models, radiation-based models, monthly water balance methods including the Thornthwaite model, and pan evaporation methods [2]. A pan coefficient of approximately 0.80 is often multiplied by pan evaporation values to estimate corresponding wetland ET [3].



**FIGURE 11.1** Example infiltration rates (cm/h) over the course of one year. Infiltration fluctuates in response to water depth in the wetland, which, in turn, is a function of rainfall and subsequent wetland inflow as well as ET rates.

The example model also includes a simplified ET regime that follows a daily sinusoidal curve:

$$ET_d = \begin{cases} M + C \sin\left(\frac{2t\pi}{365} + \phi\right) & \text{for } P = 0 \\ 0 & \text{otherwise} \end{cases} \quad (11.2)$$

where

$ET_d$  is daily ET (mm/day)

$M$  is the mean daily ET value (mm/day)

$C$  represents the amplitude of the sinusoidal curve (mm/day)

$t$  is the day of year where January 1st is 1 (day)

$\phi$  represents the sine curve offset needed to align the sine curve zero point

This sinusoidal behavior gives seasonality to ET, making it higher in hotter, summer months and lower in colder, winter months. For a model that uses an hourly time interval, ET can be approximated by a distribution factor, such as the following:

$$ET_h = \begin{cases} 0 & \text{for } h \leq 11\text{h} \\ k(h)ET_d & \text{for } 12 \leq h \leq 19 \\ 0 & \text{for } h \geq 20\text{h} \end{cases} \quad (11.3)$$

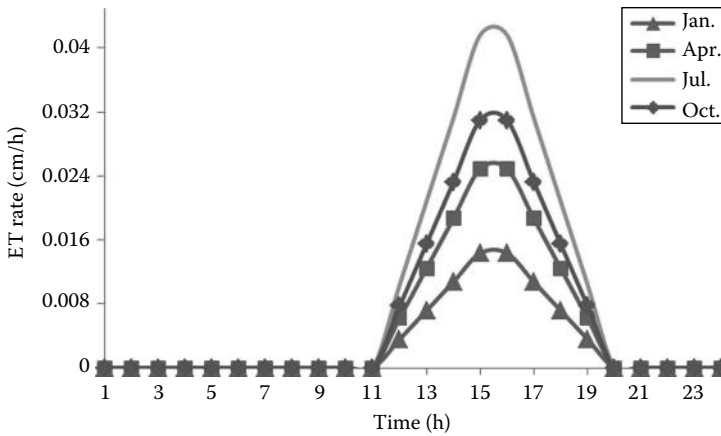
where

$ET_h$  represents the hour ET rate (mm/h)

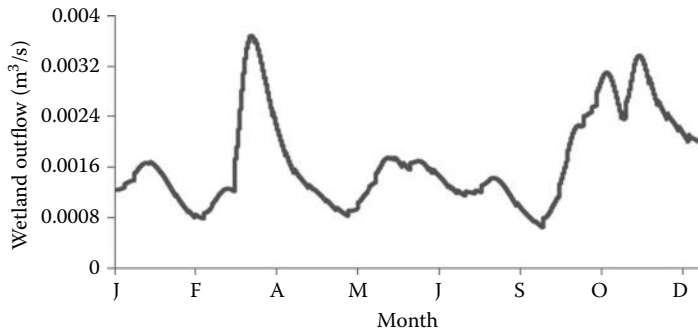
$h$  represents the hour in the day where midnight is 1 h and 11 p.m. is 24 h

$k(h)$  is the fraction of the daily  $ET_d$  depth allotted at hour  $h$

For this example,  $k(h)$  followed a triangular shape, peaking at the solar noon, which was estimated to be between 1 and 2 p.m. Figure 11.2 shows the hourly ET cycle for the first days of January, April, July, and October, which respectively represent the winter, spring, summer, and fall seasons. These curves were modeled using Equations 11.3 and 11.4. While fall and spring temperatures may be comparable, the April ET rates were low, which reflects the increased rainfall in spring.



**FIGURE 11.2** The daily ET cycle for the first day of January, April, July, and October. The summer and fall days have much greater ET rates than the winter and spring months.



**FIGURE 11.3** The predicted wetland outflow in m<sup>3</sup>/s over the course of one year.

Once all of the contributing flows are calculated in the wetland water balance, wetland outflow can be determined. Figure 11.3 shows the resulting wetland outflow over the course of one year as generated by the simple model explained earlier. Flow increases with increased rainfall and thus inflow to the wetland in the spring (flows reach almost 0.004 m<sup>3</sup>/s in April) as well as with decreased temperature during the winter months when ET is much smaller. Outflow is smallest during the summer months when ET rates are at their peak.

### 11.2.2 Effect of Vegetation on Flow

Vegetation in a constructed wetland can act as baffles, slowing flow and increasing the retention time [4–6]. As a result, an altered velocity profile may be necessary in order to accurately model flow through a vegetated wetland. The role of vegetation in flow alteration may also impact the flow-routing method required to model water flow through the wetland.

## 11.3 Water Quality Modeling

A number of studies have been devoted to both understanding and modeling the complex behavior of wetland chemistry and hydrology. The following section will focus on the current methods used to model constructed wetland water quality behavior as well as the data required to use them.

A review paper written by Kumar and Zhao [7] summarized the current modeling methods used to predict different constituent concentrations in constructed wetlands. The two main model types cited were black-box models and process-based models. Black-box models are calibrated using measured data that summarize the relationship between wetland inflow and outflow. Process-based models attempt to describe wetland behavior by quantitatively representing the actual processes within the wetland and are often calibrated using more extensive inputs such as wind speed and temperature data.

Currently, black-box models are most commonly used to model and design constructed wetlands. Black-box models that rely on first-order kinetics have often been cited as inadequate due to their oversimplification of wetland processes [8]. Process-based models, on the other hand, have the potential to more accurately mimic wetland behavior, but require detailed data that are often difficult to obtain.

### 11.3.1 Black-Box Models

Black-box models include regression models, first-order models, time-dependent retardation models, Monod models, tanks-in-series (TIS) models, neural networks, and statistical approaches. All black-box models depend on an empirical relationship between inflow and outflow concentrations of a given constituent.

Regression models relate inflow and outflow concentrations with the hydraulic loading rate with a number of empirically determined regression coefficients such as the following:

$$C_{out} = a C_{in}^b q^c \quad (11.4)$$

where

$C_{out}$  is the resulting outflow concentration (M/L<sup>3</sup>)

$C_{in}$  is the inflow concentration (M/L<sup>3</sup>)

$q$  is the wetland hydraulic loading rate (M/T)

$a$ ,  $b$ , and  $c$  are regression coefficients

The accuracy of estimates made with a black-box model transferred to a site not used in calibration is very often poor.

First-order models often use a rate coefficient  $k$  to relate inflow and outflow concentrations using an exponential decay equation. These models assume plug-flow behavior in the wetland. Plug-flow describes the overall wetland behavior, assuming pollutant concentrations change as water moves through the wetland. Therefore, pollutant concentrations should be greatest at the inflow and lowest at the outflow. The general form for a first-order, plug-flow transformation can be described by the following:

$$\frac{C_{out}}{C_{in}} = e^{-kt} \quad (11.5)$$

where

$k$  is the removal rate (M/T)

$t$  is the hydraulic retention time (T)

About 2 mg/L is a typical background concentration of TN, 1 mg/L of which is NH<sub>4</sub><sup>+</sup>-N [3,7].

Carleton et al. [9] used a plug-flow equation to model total phosphorus, ammonia (NH<sub>4</sub><sup>+</sup>), and nitrate (NO<sub>3</sub><sup>-</sup>) in 49 wetland systems. Outflowing concentrations were calculated accordingly [9,10]:

$$\frac{d(V_i C_i)}{dt} = QC_i - Q(C_i + dC_i) + r dV \tag{11.6}$$

where

- subscript “*i*” represents water entering the section of interest
- $dC_i$  is the concentration change within that section
- $dV$  is the water volume contained in the section

The transformation rate,  $r$  (M/L<sup>3</sup>T), is defined by both the Monod equation and first-order kinetics in the literature [11,12]. This rate can be used to describe the behavior of nitrogen, phosphorus, and BOD species.

A TIS model breaks the wetland into sequential completely mixed flow reactors (CMFR) along the flow path. Each tank is assumed to be completely mixed with first-order kinetics driving constituent degradation [3,7]. The overall expression relating influent and effluent concentrations in a wetland analyzed with TIS is as follows:

$$\frac{C_{out}}{C_{in}} = \frac{1}{(1 + k_{VRC} t/N)^N} \tag{11.7}$$

where

- $k_{VRC}$  is the first-order volumetric rate constant (T<sup>-1</sup>)
- $t$  is the total retention time in the wetland (T)
- $N$  is the number of tanks

In a study done by Kadlec [10], denitrification was modeled using a TIS first-order areal uptake equation, and dynamic nitrate balances were used to model the concentrations and flows of nitrate as a function of time. First-order rate constants were found to be much higher during simulated storm events ( $k_{20} = 107$ ) versus periods of steady state ( $k_{20} = 37$ ). Both event-based and dynamic equations were used to describe nitrate removal and transformations. Event-based mass removal was represented by

$$RE = \frac{\int(QC)_{in} dt - \int(QC)_{out} dt}{\int(QC)_{in} dt} \times 100 \tag{11.8}$$

where

- RE is removal efficiency (%)
- $Q$  represents flow rate (L<sup>3</sup>/T)
- $C$  is concentration (M/L<sup>3</sup>)
- $t$  is time

The dynamic mass balance for each wetland tank (based on TIS) is shown by the following:

$$\frac{d(V_t C_t)}{dt} = Q_{t-1} C_{t-1} - Q_t C_t + rV \tag{11.9}$$

where

- $V$  is the wetland tank volume (L<sup>3</sup>)
- $r$  is the transformation rate (M/L<sup>3</sup>/T)
- The subscript “*t-1*” is the water flowing into the tank
- “*t*” is the water in the tank and flowing out of the tank



Monod models estimate effluent concentrations based on bacterial growth rates and the available substrates for decomposition of a constituent. The general form of the Monod equation is shown as follows [12]:

$$u = \frac{u_{\max}S}{K_s + S} \quad (11.10)$$

where

- $u$  is the bacterial growth rate (1/T)
- $u_{\max}$  is the maximum growth rate (1/T)
- $S$  is the limiting substrate concentration (M/L<sup>3</sup>)
- $K_s$  is the concentration at  $0.5u_{\max}$  (M/L<sup>3</sup>)

Depending on the constituent being modeled and the available data, one model may be more appropriate than another. While a number of first-order removal rates have been computed based on actual constructed wetland behavior, Monod variables are generally taken from analogous wastewater treatment facilities [3,12]. The variation in the values reflects the degree of uncertainty in assessing a value for a specific wetland facility.

Artificial neural networks (ANNs) have also been used to model constructed wetlands [13]. These models imitate the structure of biological neural networks in order to establish a model that adapts rate constants and other parameters based on patterns recognized by the ANNs. Because these relationships are not based on physical processes within the systems, ANN models are considered black-box models.

### 11.3.1.1 Calibration of Black-Box Models

Black-box models are most often calibrated using linear or log-linear least squares, sometimes following a transformation of the relationship. The least squares method maximizes the explained variation, that is, the Pearson correlation coefficient, and provides an unbiased equation. Unfortunately, the empirical coefficients may not reflect the physical processes, which may limit the application of the model for other wetland sites. For black-box models, jackknifing verification should be made to provide some measure of accuracy of predictions.

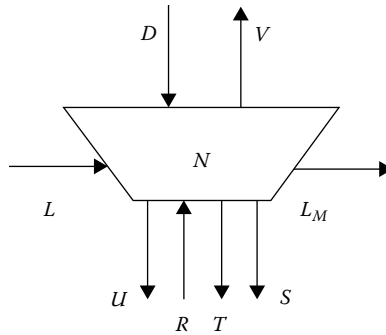
### 11.3.1.2 Advantages and Disadvantages

Calibrated black-box models generally can give reasonably accurate estimates of central tendencies, but prediction accuracy decreases when the model is used to estimate extreme conditions. The reduction in accuracy is often the result of the failure of the black-box model functional forms to reflect the physical processes at the extremes.

Black-box models are simple and require data only from the influent and effluent concentrations. However, because they are not physically based, black-box models calibrated with one set of data cannot be reliably transferred to different wetland systems without data from the new wetland. Therefore, black-box models have limited usefulness for design applications.

## 11.3.2 Process-Based Models

Process-based models use physically based equations to model the processes of a wetland and, as a result, can be very complex and data intensive. Existing constructed wetland process-based models and model environments include the FITOVERT model, the constructed wetland two-dimensional (CW2D) model, the structural thinking experimental learning laboratory with animation (STELLA) software, the 2D mechanistic model, and the constructed wetland model No. 1 (CWM1) [7]. The Hydrological Simulation Program–Fortran (HSPF) can also be used to model a constructed wetland environment. A number of studies have used such models to predict subsurface constructed wetland behavior. Fewer studies, however, have modeled water quality performance in surface-flow constructed wetlands.



**FIGURE 11.4** Schematic of nitrogen (org-N,  $\text{NO}_3^-$ , and  $\text{NH}_4^+$ ) mass balance in a wetland where  $D$  is atmospheric deposition,  $V$  is volatilization,  $U$  is plant uptake (represented by assimilation),  $R$  is resuspension,  $T$  represents all transformations (ammonification, nitrification, denitrification),  $S$  is sedimentation,  $L$  is the inflowing nitrogen load,  $L_M$  is the outflowing nitrogen load, and  $N$  represents the nitrogen levels in the wetland at the start of the time interval.

A process-based nitrogen model, for example, would include related equations for ammonification, nitrification, denitrification, and assimilation, which would in turn depend on additional wetland parameters such as pH, dissolved oxygen concentrations, and season. A representation of the nitrogen mass balance within a wetland is shown in Figure 11.4.

Individual processes within a process-based model can often be represented by functional forms that mimic the underlying physiochemical processes. The nitrogen model example given earlier, for example, could use Monod equations to model processes such as nitrification and denitrification, which in turn can be linked to each other as well as other limiting factors such as temperature and dissolved oxygen concentrations to create a larger, physically based model.

While process-based models have the potential to produce precise results, the lack of sufficient data for calibration and verification often limits their usefulness and accuracy. Where calibration data are limited, modelers generally try to increase the use of physically based theory in developing a model. The data versus theory trade-off has limits, as the theory is often inadequate without data fitting. Greater knowledge of these processes paired with more detailed and extensive data collection could lead to significantly more accurate process-based models. However, studies have shown that regardless of the database, accuracy may not increase after a certain level of complexity is reached.

### 11.3.2.1 Data Requirements for Fitting Process-Based Models

Process models attempt to reflect the most important wetland processes, with each model component generally requiring at least one fitting parameter. Conversely, black-box models use fewer parameters, thus requiring less calibration data. Black-box models are often narrowly focused on the design of a single component, while process-based models are used for both design of multiple components and measuring effects of the processes. To ensure that the model will provide a reasonable level of accuracy for prediction, design, and measuring effects, data requirements for both calibration and wetland design are extensive.

Process-based models generally allow for temporal process variation. As a result, these models require time-variant data streams including the following:

- *Rainfall*: The primary water forcing the watershed draining to a wetland
- *Temperature*: Relates to ET, vegetation activity, chemical reactions, etc.
- *Streamflow*: The primary outflow from the wetland system
- *Evaporation*: An outflow related to vegetation, soil moisture conditions, internal wetland water levels, etc.

- *Groundwater flow/gradient*: Important to baseflow and recharge as well as internal wetland water levels
- *Plant growth conditions*: Related to nutrient uptake by vegetation
- *Water quality data*: Important to assess effectiveness of wetland water quality components
- *Soil characteristics*: Important for estimating infiltration rates and soil nutrient retention

In most cases, model users are fortunate to have the first three data streams. The unavailability of the other data streams limits the ability to accurately calibrate many of the process-based model parameters. The length of the data streams (i.e., time period over which data were recorded) also plays a role in model accuracy.

Three other issues related to data requirements are (1) data for sufficient model start-up time, (2) time sampling variation, and (3) nonstationarity of hydrometeorological conditions. While the initial conditions of the system are rarely known, they can be very influential in prediction accuracy, especially for short record lengths. Very often, measured data for 1 year should be used before using predictions to assess accuracy. A one year start-up period generally ensures that fitted parameters will be insensitive to the assumed initial states of the system. It is generally accepted that rainfall characteristics in any one decade may differ from the characteristics of other decades. For example, recorded data on hurricane occurrence and magnitude suggest a significant time sampling variation. Parameters of a process-based model calibrated with a short record may not reflect precipitation conditions for other periods. Finally, it appears that hydrometeorological conditions are not temporally stationary. If projections of future conditions are available, the effect on fitted parameters should be assessed. This may require using data simulated to reflect future conditions.

### **11.3.2.2 Calibration of Process-Based Models**

Because process-based models are more complex than black-box models, the calibration process is generally more difficult, requiring more knowledge of calibration techniques. Models of intermediate complexity can be calibrated using nonlinear (numerical) least squares, while highly complex models require a trial-and-error procedure sometimes referred to as subjective optimization. For such models, it is common to use multiple fitting metrics rather than simply least squares. For example, goodness of fit may be judged on the basis of water balance volumes, the accuracy of both peak and low flows, the timing of discharges, rates of hydrograph recessions, and the accuracy of serial correlations. Failure to appreciate the complexity of fitting process models can produce models that are poor representations of the physical processes for which the model was formulated.

### **11.3.2.3 Advantages and Disadvantages**

Models are becoming more complex because decisions relevant to wetlands have more significance to society and the environment. When a wetland plays an important environmental role in a community, the model used to assess the functioning and efficiency of the facility must be able to show the effects of the physical elements of the wetland, better represent underlying physical processes, accommodate readily available data streams, address stakeholder issues, and quantify the array of metrics for each assessment criterion. Process-based models can meet these needs; however, it would be difficult for a black-box model to address each of these needs.

First, the use of a complex model requires greater user knowledge even when the model is already calibrated. The user must have knowledge of the physical processes and their interactions, calibration methods, model results assessment, the uncertainty of the measured data, and the proper way to use the model for design or prediction. If a wetland model is calibrated for a specific location, it must be recalibrated by the user when applied to different sites. As a result, the user must be able to understand the limitations imposed on the model by the calibration. This may require an understanding of the physical processes involved.

Second, while process-based models provide more information, they also require substantially more data, which are often difficult to find. Because calibration data are often limited, biases or a lack of

precision in the fitted parameters can result. The range of measured data, both for inputs and outputs, often is not representative of the full range of possible values. The available temperature data, for example, may range from 8°C to 26°C when values from 0°C to 40°C may be locally possible; the limited range of calibration data could distort the coefficients of the ET component. Additionally, other model coefficients can attempt to compensate for the limited range of data, which could distort the values of the other coefficients. Ultimately, data limitations affect the accuracy of predictions of any model output.

Third, it is a myth that continually increasing model complexity increases prediction accuracy. While adding model components to represent other physical or chemical processes will improve prediction accuracy for models with just a few parameters, at some level of complexity, studies have shown that further increases in complexity do not result in greater prediction accuracy. The added complexity may allow estimates of effects to be assessed, but the standard errors of the coefficients may actually increase, which would suggest that the fitted coefficients are less accurate than for a less complex version of the model.

Despite these drawbacks, the advantages of complex process models far outweigh the disadvantages. Process-based models provide more insight on the physical process that occurs within the wetland, allowing for more informed design decisions. Because these models are founded on physical, chemical, and biological processes, they have the potential to more accurately simulate actual wetland behavior than black-box models, which depend on empirical relationships.

## 11.4 Uncertainty and Sensitivity Analyses

The objective of an uncertainty analysis is to show the effects of errors in model inputs or calibrated parameters on the outputs or results of model predictions. Outputs can include hydrologic variables such as flow rates or rates of ET, concentrations or loads of water quality variables such as the predicted total suspended solids (TSS), trap efficiency of a wetland, or overall wetland habitat suitability.

Uncertainty analyses are often based on a truncated Taylor series as well as a term that accounts for correlation between input variables [14]:

$$u_c(y) = \sqrt{\sum_{i=1}^n \left( \frac{\partial f}{\partial x_i} \right)^2 u^2(x_i) + 2 \sum_{i=1}^{n-1} \sum_{j=i+1}^n \frac{\partial f}{\partial x_i} \frac{\partial f}{\partial x_j} u(x_i, x_j)} \quad (11.11)$$

where

$(\partial f / \partial x_i)$  and  $(\partial f / \partial x_j)$  are the partial derivatives of input variables and are referred to as the input variable sensitivity coefficients

$u_c(y)$  and  $u_c(x_i)$  are the respective uncertainties of the output and input variables

$u(x_i, x_j)$  is the covariance between the  $x_i$  and  $x_j$  terms

If input variables do not have significant correlation, the second term of Equation 11.12 can be set to zero.

A black-box model that uses a linear or power model to represent a physical process that is inherently exponential in form will yield derivatives that become increasingly inaccurate as the parameter deviates further and further from the central tendency. For small deviations, the derivative of the empirical function may not be too dissimilar from that of the more physically realistic form, but the effect of the functional form will be apparent in uncertainty estimates as the deviations increase. This is especially true for the parameters with large magnitude derivatives.

Uncertainty analyses for process-based model outputs should more accurately reflect input data uncertainty than analyses done for black-box models assuming that the process-based model accurately represents wetland water quality processes. If a poor physically based model is used, however, uncertainty analyses may also need to incorporate model error and uncertainty.

In addition to uncertainty analyses, sensitivity analyses can also be used to evaluate the importance of different input parameters such as ET and infiltration characteristics on wetland outputs such

**TABLE 11.1** The Effects of Variance of ET, Manning's  $n$ , and Infiltration Parameters on the Final Predicted Wetland Outflow Discharge

	True Values	ET (15%)		Manning's $n$ (25%)		Infiltration A (30%)		Infiltration B (30%)	
	—	-15%	+15%	-25%	+25%	-30%	+30%	-30%	+30%
Total outflow (m <sup>3</sup> )	53,700	54,700	52,800	55,100	52,400	54,700	52,700	54,400	53,100
Total infiltration (m <sup>3</sup> )	3,540	3,560	3,520	3,150	3,840	2,490	4,580	2,780	4,130
Total ET (m <sup>3</sup> )	6,340	5,390	7,290	6,340	6,340	6,340	6,340	6,340	6,340
Final wetland storage (m <sup>3</sup> )	5,370	5,420	5,430	4,310	6,350	5,420	5,320	5,400	5,350
Relative sensitivity	—	-0.124	-0.112	-0.104	0.097	0.062	0.062	0.043	0.037

Note: The final row shows the relative sensitivity of wetland outflow to each parameter.

as outflow rates and pollutant concentrations [15,16]. The following general equation can be used to calculate the relative sensitivity of an output parameter to a given input parameter:

$$S_x = \frac{\delta X/X}{\delta P/P} \quad (11.12)$$

where

$P$  is the input parameter

$S_x$  is the relative sensitivity with respect to  $P$

$X$  is the model output

Therefore, the sensitivity of a model with respect to a parameter is the ratio of the normalized change in the output over the normalized change in the input parameter. A higher  $S_x$  value indicates greater sensitivity to a given parameter. Table 11.1 shows example sensitivity values of wetland outflow with respect to ET, Manning's  $n$ , and infiltration parameters. Because wetland water balances depend heavily on ET, wetland outflow was found to be most sensitive to variance of ET inputs. Infiltration, on the other hand, is often a much smaller contributor to the water balance of a wetland and therefore has less impact on outflow rates.

## 11.5 Knowledge and Data Needs

### 11.5.1 Quantity and Quality Data Requirements

Most often, data needs exceed data supply. The lack of data implies that predictions with the calibrated model may not be accurate. Too often, data records are short and include extreme events, which can distort the importance of the calibrated model and the accuracy needed to meet the objectives of modeling. Unfortunately, data quantity and quality are often less than would be necessary to provide accurate predictions. This is true of both black-box and process-based models.

### 11.5.2 Design of Monitoring Systems

The use of process-based models could especially help scientists and engineers determine the data that would yield the most accurate models and ultimately the most effective designs. Monitoring of wetlands provides the data necessary to calibrate wetland models, assess the functioning of experimental wetlands, and contribute knowledge that can be transferred for use at other wetlands with similar properties. Poorly designed monitoring programs can limit the knowledge content of measured data. A model of a proposed wetland could permit an *a priori* assessment of the benefits of alternative proposed monitoring programs, thus maximizing the information content of the measured data. Simulation with a

wetland model can also be used to identify the most effective locations within and immediately outside of the wetland area to place monitoring instruments. A wetland model could also help determine the simulation duration necessary to experience the variety of conditions needed to characterize the long-term state of a wetland.

### 11.5.3 Accounting for Seasonality

The importance of different wetland physical processes varies with the seasons. Processes related to vegetation are generally less important during colder months. Seasonality is, therefore, an important factor in wetland design. Nutrient retention, for example, may be expected to increase during the warm growing season due to increased plant uptake and increased temperature-driven nutrient reaction rates. Wetland design should attempt to achieve optimum performance given such seasonal effects. Knowledge of the sensitivity of each design parameter to seasonal conditions is crucial to optimization. Each calibration statistic should be assessed on a seasonal basis, as well as on an annual basis. This increased complexity does, however, increase the calibration data requirements.

## 11.6 Summary and Conclusions

---

Knowledge, which can be loosely defined as “understanding the facts,” is very relevant to wetland design and calibration. Those involved in wetland model development must have a strong background in all relevant physical, chemical, and biological processes; in statistical analysis; and in model calibration (e.g., least squares, numerical response surface searching, and subjective optimization or fitting parameters largely based on experience and a thorough understanding of the processes). Modeling knowledge, such as model complexity, sensitivity analysis, verification practices, and the treatment of outliers, is also critical to successfully developing a wetland model as well as to successfully designing a wetland using a model. The design engineer should fully understand that the calibrated model may only be relevant to designs where the conditions are similar to the data used in calibration.

Many processes relevant to wetlands are not fully understood. Plant uptake of nutrients is one example of a poorly understood process. These instances of knowledge deficiencies can lead to model structures that poorly represent the underlying processes. As such, the fitted component may not lead to accurate wetland designs, and the fitted parameters may be inaccurate, which could lead to inaccurate designs. Additionally, if such a model is used for measuring the effects of changes in a design, the derivation may provide inaccurate indications of such design changes. Since models are often used to estimate values or effects under extreme conditions, a wetland model based on incomplete knowledge may yield especially poor results at the most important conditions.

## References

1. Borah, D.K. 2011. Hydrologic procedures of storm event watershed models: A comprehensive review and comparison. *Hydrological Processes*, 25(22), 3472–3489.
2. Dingman, S.L. 2002. *Physical Hydrology*, 2nd ed. Long Grove, IL: Waveland Press, Inc.
3. Kadlec, R.H. and Knight, R.L. 1996. *Treatment Wetlands*. Boca Raton, FL: CRC Press, Inc.
4. Jarvela, J. 2002. Flow resistance of flexible and stiff vegetation: A flume study with natural plants. *Journal of Hydrology*, 269(1–2), 44–54.
5. Righetti, A. and Armanini, A. 2002. Flow resistance in open channel flows with sparsely distributed bushes. *Journal of Hydrology*, 269(1–2), 55–64.
6. Wu, F.C., Shen, H.W., and Chou, Y.J. 1999. Variation of roughness coefficients for unsubmerged and submerged vegetation. *Journal of Hydraulic Engineering-ASCE*, 125(9), 934–942.
7. Kumar, J.L.G. and Zhao, Y.Q. 2011. A review on numerous modeling approaches for effective, economical and ecological treatment wetlands. *Journal of Environmental Management*, 92(3), 400–406.

8. Kadlec, R.H. 2000. The inadequacy of first-order treatment wetland models. *Ecological Engineering*, 15(1–2), 105–119.
9. Carleton, J.N., Grizzard, T.J., Godrej, A.N., and Post, H.E. 2001. Factors affecting the performance of stormwater treatment wetlands. *Water Research*, 35(6), 1552–1562.
10. Kadlec, R.H. 2010. Nitrate dynamics in event-driven wetlands. *Ecological Engineering*, 36(4), 503–516.
11. U.S. Environmental Protection Agency. 2000. *Constructed Wetlands Treatment of Municipal Wastewaters*. Cincinnati, Ohio. EPA/625/R-99/010.
12. Sykes, R. 2002. Biological wastewater treatment processes. In W.F. Chen and R.J.Y. Liew, *The Civil Engineering Handbook*, Chapter 11, CRC Press LLC, Boca Raton, FL.
13. Akrotos, C.S., Papaspyros, J.N.E., and Tsihrintzis, V.A. 2009. Artificial neural network use in ortho-phosphate and total phosphorus removal prediction in horizontal subsurface flow constructed wetlands. *Biosystems Engineering*, 102(2), 190–201.
14. Salicone, S. 2007. *Measurement Uncertainty: An Approach via the Mathematical Theory of Evidence*. New York: Springer Business Media, LLC.
15. van der Peijl, M.J. and Verhoeven, J.T.A. 1999. A model of carbon, nitrogen and phosphorus dynamics and their interactions in river marginal wetlands. *Ecological Modelling*, 118(2–3), 95–130.
16. Wang, N.M. and Mitsch, W.J. 2000. A detailed ecosystem model of phosphorus dynamics in created riparian wetlands. *Ecological Modelling*, 126(2–3), 101–130.

# 12

## Modifications in Hydrological Cycle

---

12.1	Introduction .....	248
12.2	Modifications in Hydrological Cycle.....	248
12.3	Methods of Quick Disposal of Floodwater.....	248
12.4	Spreading of Water for Leaching.....	248
12.5	Artificial Groundwater Recharge.....	249
12.6	Low-Impact Development.....	249
12.7	Case Study.....	250
	Effect of Floodwater Diversion • Effect of Modification in River Section • Combined Effect of Floodwater Diversion Modification in River Section • Effect of Artificial Recharge of Groundwater • Effect of Low-Impact Developments	
12.8	Summary and Conclusions.....	257
	References.....	259

**Jayantilal N. Patel**  
*Sardar Vallabhbhai  
National Institute  
of Technology*

### AUTHOR

**Jayantilal N. Patel** is presently working as a professor and the head of Civil Engineering Department at S.V. National Institute of Technology, Surat, India. He has a total experience of 28 years mainly in teaching and research. Dr. Patel has published 3 books and more than 12 research papers. He has guided three PhD scholars, completed four research projects, and more than 25 consultancy projects. He has also received nine awards and is a life member of nine technical societies. Dr. Patel has organized more than 25 conferences/workshops/training programs, etc. He is acting as an editorial board member/reviewer of more than 12 technical journals at international and national levels.

### PREFACE

The availability and the circulation of water on the earth and its atmosphere are generally represented by hydrological cycle inclusive of various components. Under certain circumstances, it is advisable to modify the cycle by man-made ways, so that more benefits can be availed from it. Such modifications add some advantages and reduce some disadvantages as regards the quality and quantity of usable water.

This chapter provides some of the ways to modify the hydrological cycle. The effect of such modifications on the quality and quantity of various components of the cycle is discussed in this chapter. The effects of modifications in hydrological cycle have been discussed in the selected study area.



## 12.1 Introduction

---

The hydrological cycle indicates the availability and the circulation of water on earth and its atmosphere. It can be modified from its natural behavior by man-made ways in certain circumstances. In the flood-prone areas, the floodwater can be diverted for purposes like artificial groundwater recharge through structures, spreading over an agricultural land for leaching, storage of water in detention reservoir, and disposing off the water to ocean through other drains [3,6]. By diverting the floodwater as indicated earlier, two advantages can be achieved, that is, reducing the depth of submergence due to floodwater and improving the quality of groundwater.

## 12.2 Modifications in Hydrological Cycle

---

The main components of hydrological cycle are precipitation, direct evaporation from precipitation, infiltration, evapotranspiration, surface runoff, and evaporation from water bodies. The modifications suggested in the normal hydrological cycle in flooded areas are as follows:

1. Diversion of water from flooded areas to saline land for leaching purpose
2. Diversion of water from flooded areas to other drains
3. Diversion of water from flooded areas to detention reservoir
4. Diversion of floodwater to artificial groundwater recharge structures
5. Providing low-impact development (LID) in the area
6. Enhancing the carrying capacity of main rivers

## 12.3 Methods of Quick Disposal of Floodwater

---

The effect of flood in a particular urban area can be minimized by providing suitable measures of quick disposal of water from the flood-affected area. It can be achieved by any one or a combination of the following measures [1–3]:

1. *Diversion of floodwater:* The floodwater can be diverted away from the affected area by means of artificial diversion canals. The water through such canals may be diverted to other drains, detention pond, ocean, saline land, etc., depending upon site situation and feasibility.
2. *Enhancing the carrying capacity of river:* The enhancement of carrying capacity of the existing river may be possible by adopting certain measures like modification in the cross section of river, removing unnecessary obstructions from river, etc.

## 12.4 Spreading of Water for Leaching

---

The floodwater can be diverted on saline land resulting in the spreading of water for leaching purpose [6]. In the leaching process, the rain water or floodwater of low salt concentration is applied to displace the high concentration of salts from the affected soil. The water passing through the soil strata pushes the salts below the root zone or to the tile drains provided for the purpose of drainage. Thus, it is useful for reclamation of saline soil. Leaching is also useful for maintaining the salt balance in the reclaimed or irrigated land. Excess rain water or the floodwater from the rivers and catchment area can be diverted to the agricultural fields where the soil has become saline. This water can be stored over the agricultural fields between soil bunds of required height for the removal of salts from the soil strata through natural leaching process. The leached water at the end either goes to groundwater bodies or can be disposed to drains by subsurface drainage systems depending upon the site conditions.

## 12.5 Artificial Groundwater Recharge

---

The artificial recharge to groundwater aims at augmentation of groundwater reservoir by modifying the natural movement of surface water utilizing suitable civil construction techniques. Artificial recharge techniques serve mainly the purposes like diversion of surface runoff to underground and improving the quality of groundwater. The artificial recharge projects are site specific and depend upon local conditions.

Techniques used for artificial recharge to groundwater can broadly be classified as direct methods, indirect methods, and combined methods. A particular method can be selected based on certain factors. Construction of artificial recharge well is the most suitable method for the purpose of modification in hydrological cycle. Following three different ways of artificial recharge of groundwater are designed and proposed for the purpose [6]:

1. Recharging the groundwater through existing open well or tube well
2. Recharging the groundwater through newly constructed tube well cum recharge well
3. Recharging the groundwater through recharge well in conjunction with storm water drainage system

## 12.6 Low-Impact Development

---

Low-impact development (LID) is a term that describes land planning and engineering design approach to manage storm water runoff. Conservation and use of on-site natural features to protect water quality are emphasized. This approach implements hydrological controls to replicate the predevelopment hydrological regime of watersheds through infiltrating, filtering, storing, evaporating, and detaining runoff close to its source on small scales. Conservation, minimization, runoff concentration, distributed integrated management, and pollution prevention are the basic steps in the design of LIDs. Some of the LID techniques are as follows [5]:

1. *Bioretention cell*: Bioretention cell captures and allows infiltration of storm water runoff from impervious surfaces to reduce water pollution and stabilize stream flows. Bioretention cells can be used in most settings including parking lots and residential areas where percolation is less. They use plants that can tolerate a wide range of moisture conditions. Native plants are generally used as they are deep rooted and help in maintaining soil quality and good percolation. The subdrain often outlets into the storm sewer or can discharge downgradient of the bioretention cell.
2. *Porous pavement*: Permeable pavement, also known as pervious or porous paving, is a type of hard surfacing that allows rainfall to percolate to an underlying reservoir base where rainfall is either infiltrated to underlying soils or removed by a subsurface drain. Porous pavement can be used instead of standard asphalt and concrete for surfacing sidewalks, driveways, parking areas, and many types of road surfaces. Pervious pavement allows water to infiltrate into layers of rock placed below the pavement and then into surrounding soils. The water is drained through perforated drain pipe.
3. *Infiltration trench*: Infiltration trenches are excavated into the ground either horizontally or vertically and filled with stone aggregate or brick bats to capture and allow infiltration of storm water runoff into the surrounding soils from the bottom and sides of the trench or well. This type of infiltration structure is used to remove pollutants and to infiltrate storm water back into the underground water table or aquifer. Pollutant removal is achieved through filtration.
4. *Vegetative swale*: Vegetated swales are open shallow channels with vegetation covering the side slopes and bottom that collect and slowly convey runoff flow to downstream discharge points. They are designed to treat runoff through filtering by the vegetation in the channel and infiltration into the underlying soils. Vegetative swales can be natural or man-made, and it can serve as part of a storm water drainage system.

## 12.7 Case Study

A study on the modification of hydrological cycle has been carried out. The area considered for the study is Surat City situated on the banks of River Tapi (India) near Arabian Sea. The study area is shown in Figure 12.1.

The city is frequently affected by flood. The city is also affected by seawater intrusion resulting in the deterioration of groundwater quality in the study area. In order to reduce the effect of flood and to improve the groundwater quality in the study area, modifications as discussed in Section 12.2 were suggested. The computed effects of the measures are discussed in the following text.

### 12.7.1 Effect of Floodwater Diversion

The proposed plan of diversion of floodwater from the study area by diversion canals [1,3] is shown in Figure 12.2.

The diverted water serves the purposes as shown in the following text:

1. Reduction in submergence due to flood
2. Recharge of groundwater
3. Leaching of saline soil
4. Transfer of floodwater to detention reservoir



FIGURE 12.1 Study area (Surat, India).

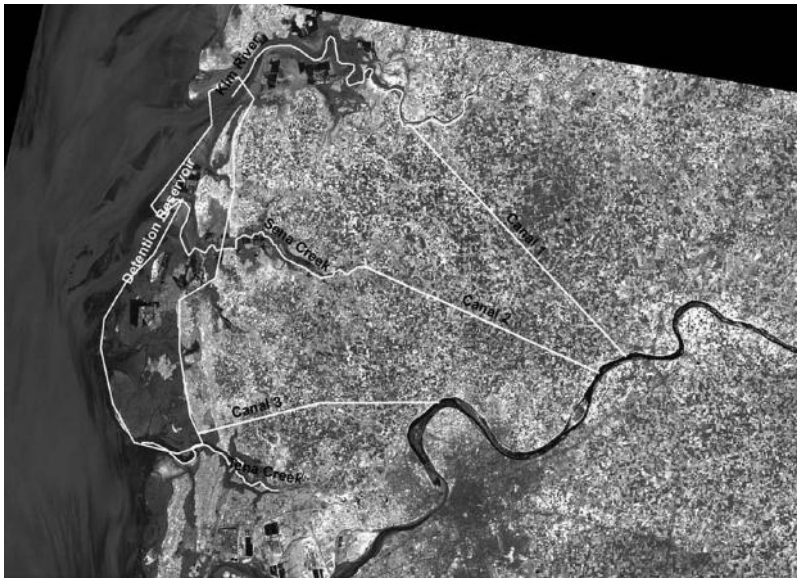


FIGURE 12.2 Scheme of diversion of floodwater from the study area.

TABLE 12.1 Comparison of Inundated Area after Floodwater Diversion

Flood Discharge (m <sup>3</sup> /s)	Total Area of Inundation (%)	Area of Inundation <2 M (%)	Area of Inundation 2–5 M (%)	Area of Inundation 5–8 M (%)	Area of Inundation 8–11 M (%)	Area of Inundation >11 M (%)
25,772 (without diversion)	100	19.54	58.09	12.58	4.71	5.08
25,772 (with diversion of 2,832 m <sup>3</sup> /s)	83.61	41.54	30.15	4.52	4.3	3.1

The reduction of flood inundation area due to diversion of floodwater was computed using geospatial technologies and hydraulic equations. The results are shown in Table 12.1. Figure 12.3 indicates the scenario of submergence area due to a flood of 25,772 m<sup>3</sup>/s without the diversion of floodwater and with existing carrying capacity (9,912 m<sup>3</sup>/s) of the river.

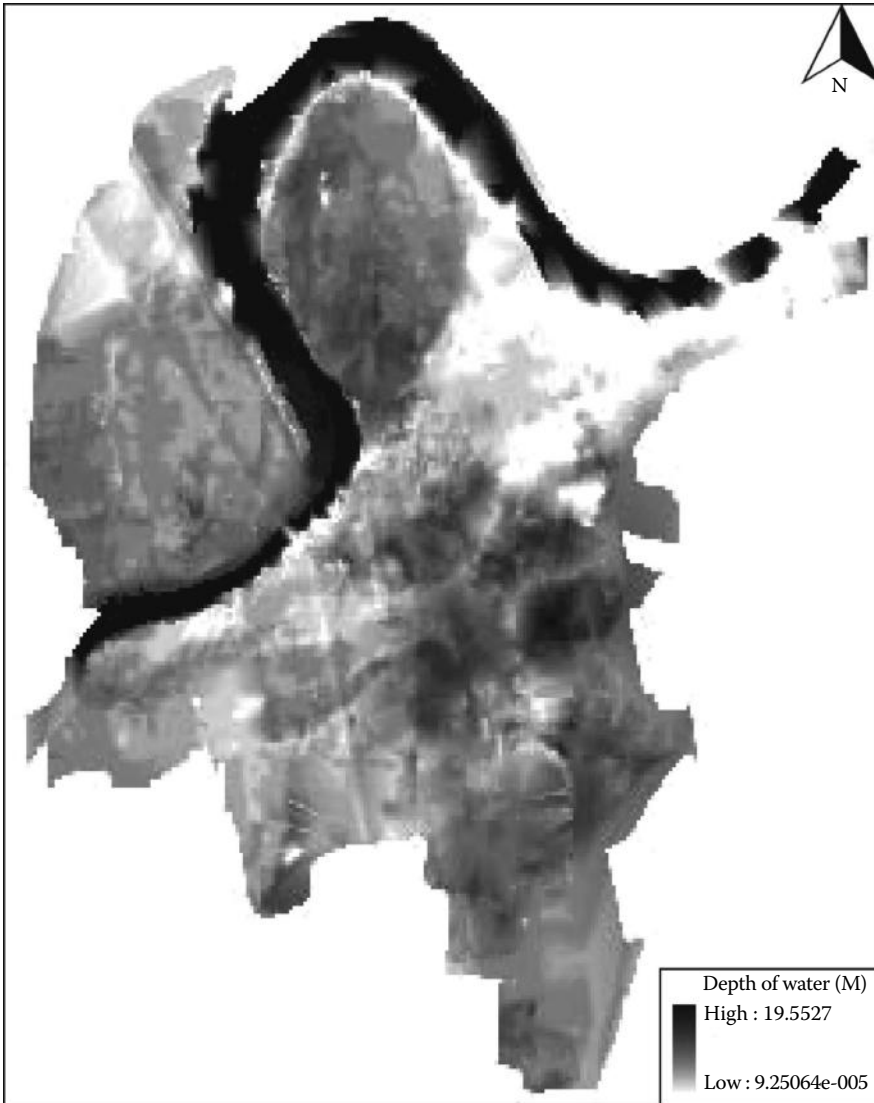
The reduced area of submergence due to diversion of floodwater (2832 m<sup>3</sup>/s) through canals is shown in Figure 12.4.

### 12.7.2 Effect of Modification in River Section

It is proposed to enhance the carrying capacity of river by modification in sections [2,3]. The effect of modification in river section and increasing the carrying capacity of river are shown in Table 12.2. The reduction in submergence area due to a flood of 25,772 m<sup>3</sup>/s and enhanced carrying capacity of river of 21,238 m<sup>3</sup>/s after modification in river section is shown in Figure 12.5.

### 12.7.3 Combined Effect of Floodwater Diversion Modification in River Section

The reduction in submergence area due to a flood of 25,772 m<sup>3</sup>/s and the combined effect of floodwater diversion of 2,832 m<sup>3</sup>/s and enhanced carrying capacity of river of 21,238 m<sup>3</sup>/s are shown in Figure 12.6 [3].



**FIGURE 12.3** Flood depth map of study area for flood flow of 25,772 m<sup>3</sup>/s.

### **12.7.4 Effect of Artificial Recharge of Groundwater**

Artificial groundwater recharge wells are proposed in the study area as shown in Figure 12.7.

The aspects of change in the quality of groundwater due to artificial recharge are computed [8,9] based on groundwater quality index up to year 2025. The results are shown in Figures 12.8 through 12.10. Comparison of change in the groundwater quality is shown in Table 12.3.

### **12.7.5 Effect of Low-Impact Developments**

The effect of LIDs is also studied in the study area. The computation of runoff, that is, inflow at a particular point of storm water drainage system without LID and with the combination of some of the LIDs, was carried out [5]. The results are shown in Figure 12.11.

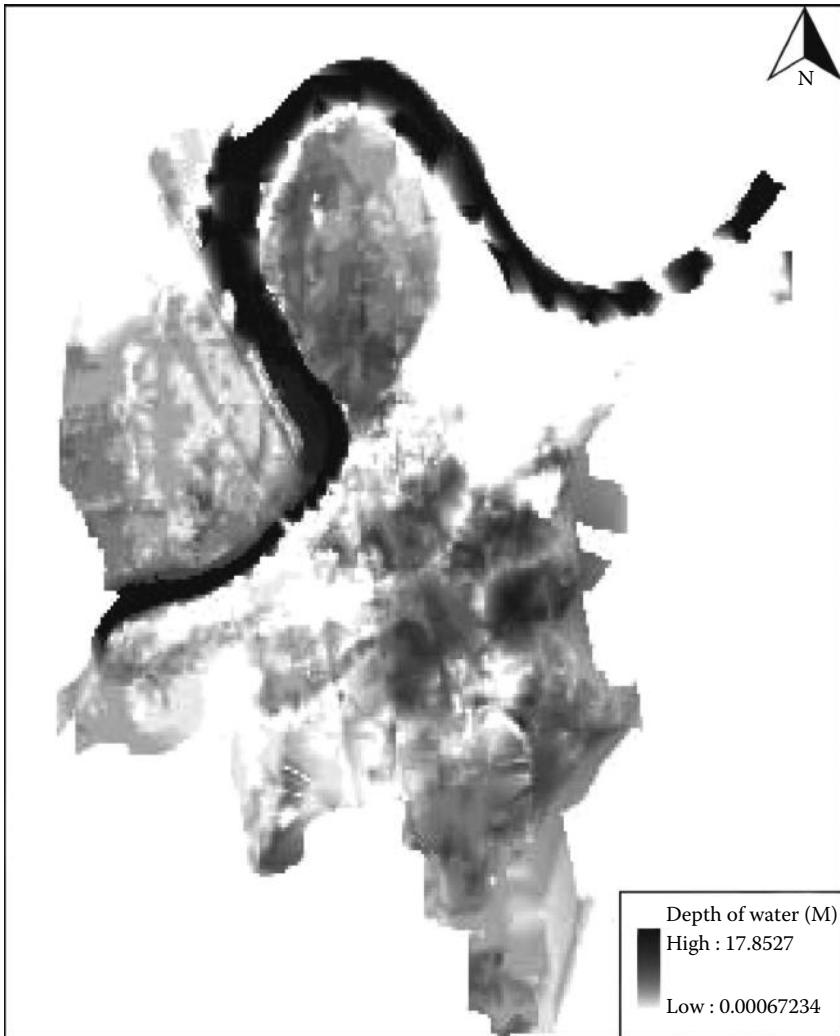
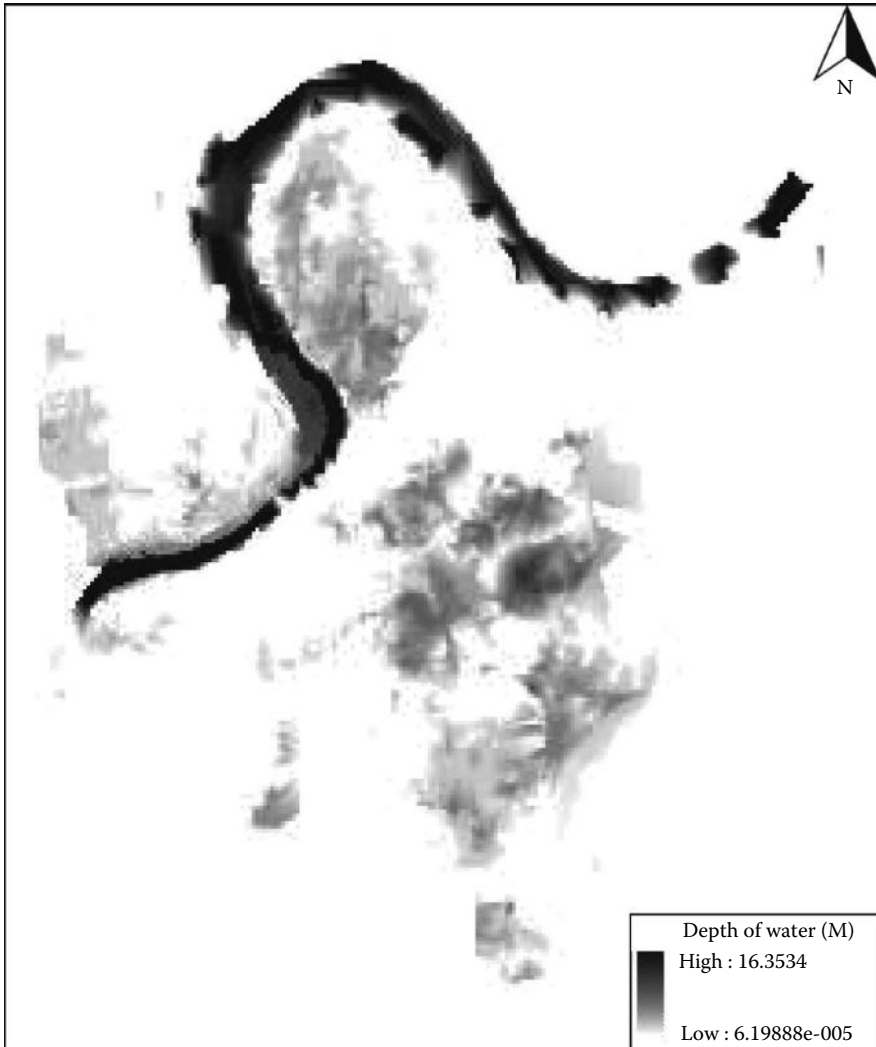


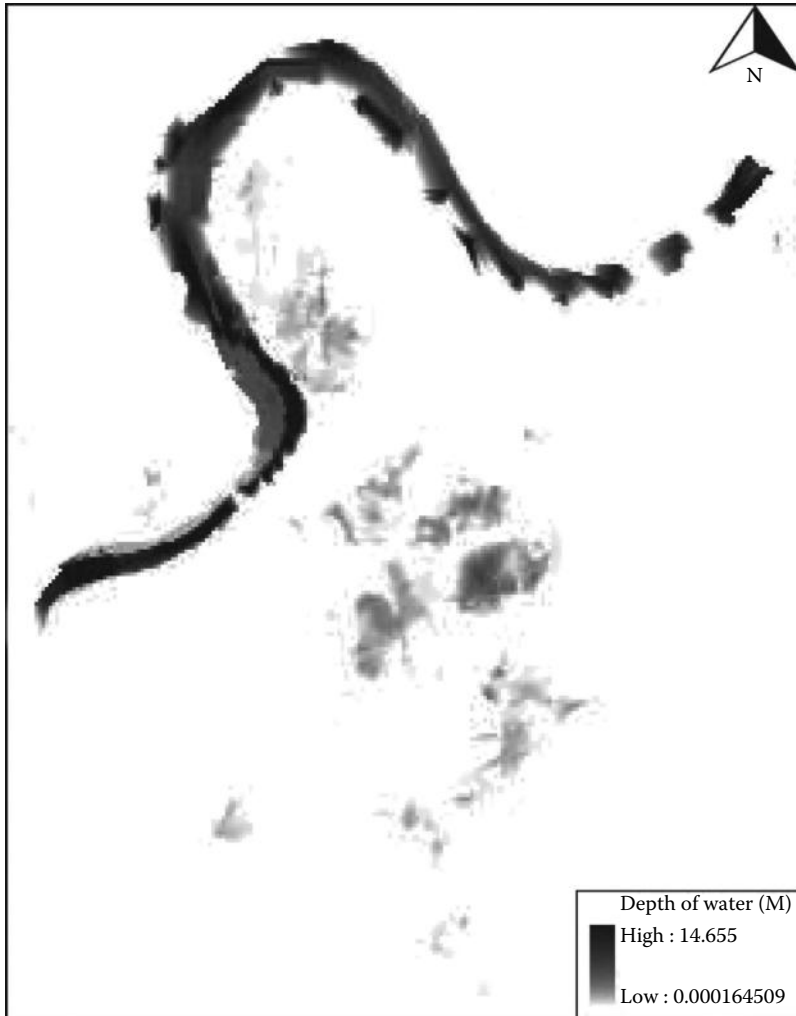
FIGURE 12.4 Flood depth map of study area after diversion of 2,832 m<sup>3</sup>/s of floodwater.

TABLE 12.2 Comparison of Inundated Area after Channel Modification

Modified Carrying Capacity (m <sup>3</sup> /s)	Total Area of Inundation (%)	Area of Inundation <2 M (%)	Area of Inundation 2–5 M (%)	Area of Inundation 5–8 M (%)	Area of Inundation 8–11 M (%)	Area of Inundation >11 M (%)
Existing (9,912)	100	19.54	58.09	12.58	4.71	5.08
11,327	82.42	42.24	28.48	4.44	4.24	3.02
12,743	80.04	43.04	26.00	4.32	4.18	2.86
14,158	75.44	42.44	22.05	4.21	4.11	2.63
15,574	69.91	41.77	17.64	4.40	3.62	2.49
16,990	66.54	40.51	15.74	4.52	3.46	2.31
18,406	62.23	38.96	14.24	4.64	3.25	2.14
19,822	59.97	37.50	12.67	4.75	3.06	1.98
21,238	52.76	32.26	10.90	4.95	2.82	1.84



**FIGURE 12.5** Flood depth map of study area after modified river capacity of 21,238 m<sup>3</sup>/s.



**FIGURE 12.6** Flood depth map of study area after modified river capacity of 21,238 m<sup>3</sup>/s and diversion of 2,832 m<sup>3</sup>/s of floodwater.



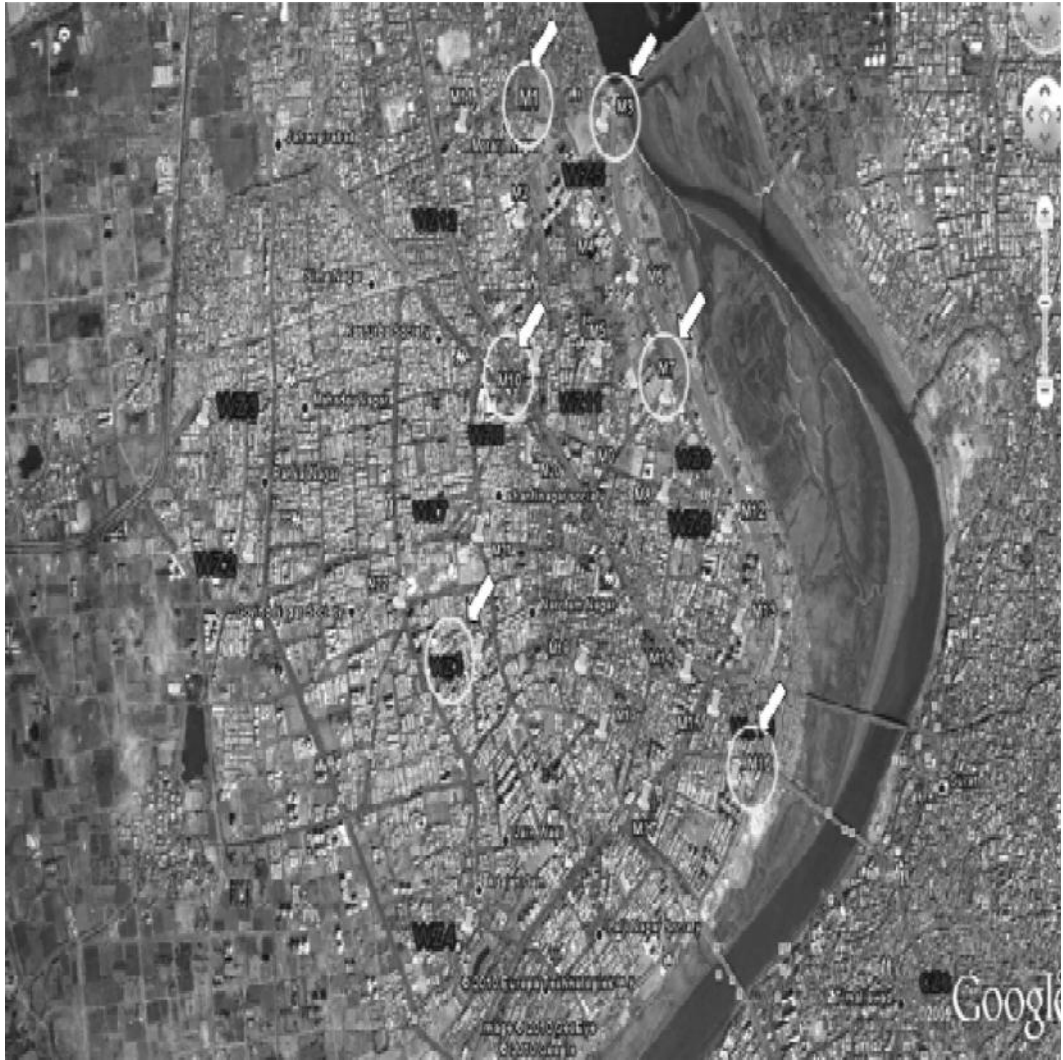


FIGURE 12.7 Location of groundwater recharge wells.

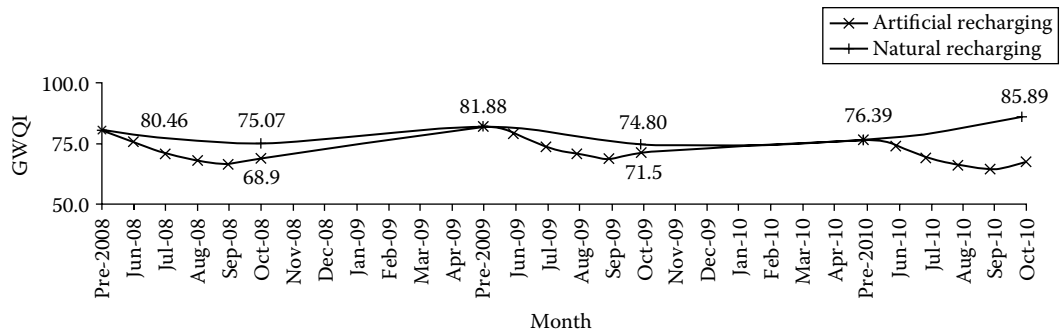


FIGURE 12.8 Trend of natural groundwater recharging vs. artificial recharging.

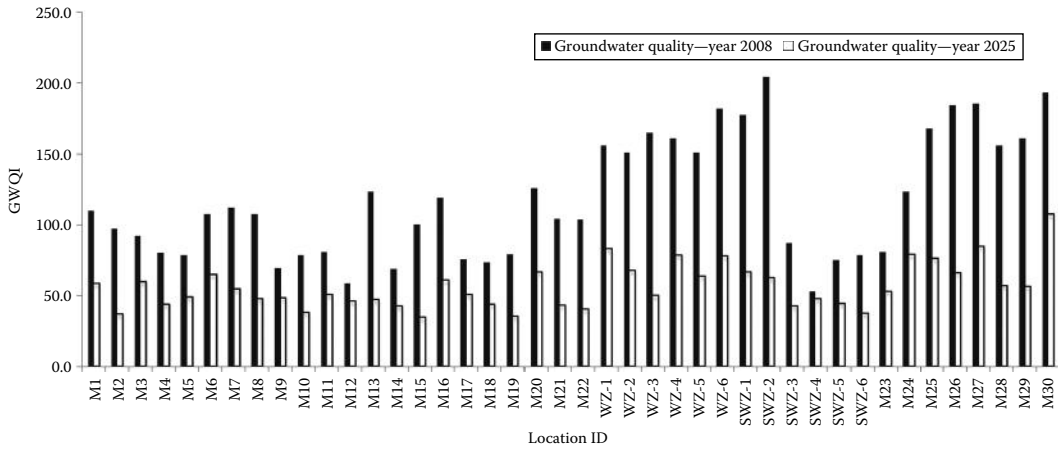


FIGURE 12.9 Comparison of groundwater quality in the years 2008 and 2025.

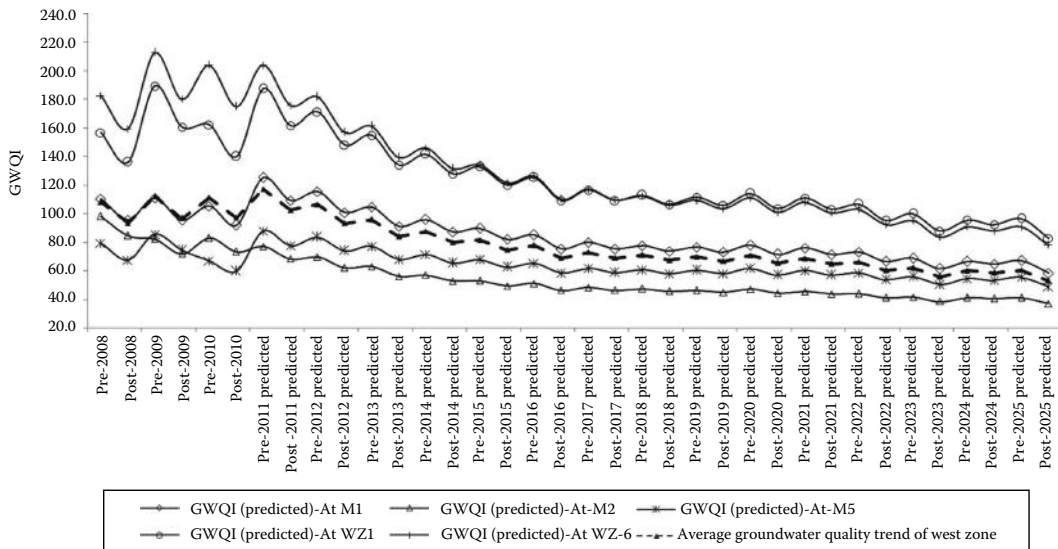


FIGURE 12.10 Predicted trend of groundwater quality in the year 2025.

## 12.8 Summary and Conclusions

Hydrological cycle can be modified by diverting floodwater away from the affected area and enhancing the carrying capacity of the river. The diversion of floodwater serves many purposes like reduction of the effect of flood in the affected area, reclamation of saline soil, increase in the storage of groundwater, storage of diverted water in detention reservoir, improvement in the quality of groundwater, control of seawater intrusion, etc. Providing LIDs results in the reduction in size of storm water drainage system up to some extent apart from improvement in the quality of groundwater. The results of modification in hydrological cycle in the study area, that is, Surat (India), are included in graphical and tabular forms in the chapter.

**TABLE 12.3** Comparative Groundwater Quality Indications for the Study Area

Location ID	Groundwater Quality Indication	
	Year 2008 (Actual)	Year 2025 (Predicted)
M1	Poor	Good
M2	Good	Excellent
M3	Good	Good
M4	Good	Excellent
M5	Good	Excellent
M6	Poor	Good
M7	Poor	Good
M8	Poor	Excellent
M9	Good	Excellent
M10	Good	Excellent
M11	Good	Good
M12	Good	Excellent
M13	Poor	Excellent
M14	Good	Excellent
M15	Poor	Excellent
M16	Poor	Good
M17	Good	Good
M18	Good	Excellent
M19	Good	Excellent
M20	Poor	Good
M21	Poor	Excellent
M22	Poor	Excellent
WZ-1	Poor	Good
WZ-2	Poor	Good
WZ-3	Poor	Good
WZ-4	Poor	Good
WZ-5	Poor	Good
WZ-6	Poor	Good
SWZ-1	Poor	Good
SWZ-2	Very poor	Good
SWZ-3	Good	Excellent
SWZ-4	Good	Excellent
SWZ-5	Good	Excellent
SWZ-6	Good	Excellent
M23	Good	Good
M24	Poor	Good
M25	Poor	Good
M26	Poor	Good
M27	Poor	Good
M28	Poor	Good
M29	Poor	Good
M30	Poor	Poor

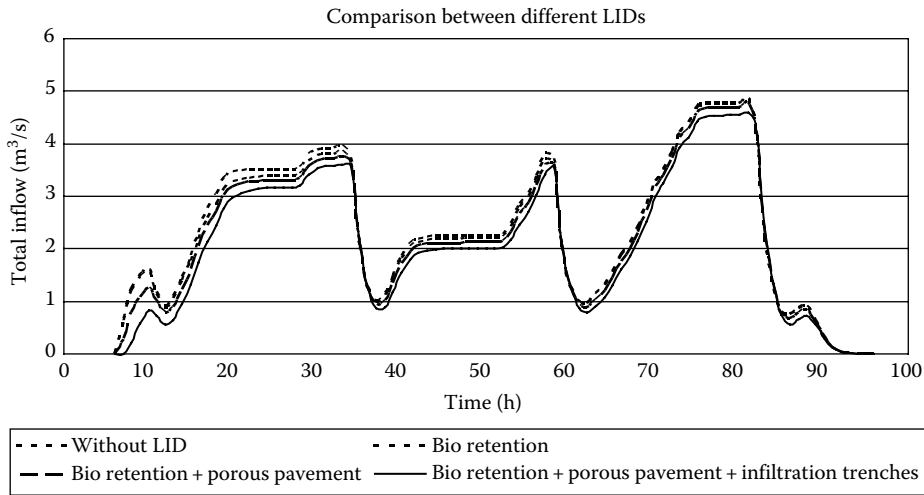


FIGURE 12.11 Effect of LIDs on the inflow at storm water drainage system.

## References

1. Agnihotri P.G. and Patel J.N. 2008, Preparation of flood reduction plan for Surat city and surrounding region (India), *WSEAS Transactions on Fluid Mechanics*, 3(2): 116–125.
2. Agnihotri P.G. and Patel J.N. 2011, Improving capacity of river Tapi (Surat, India) by channel modification, *International Journal of Advanced Engineering Technology*, 2(2): 231–238.
3. Agnihotri P.G. 2013, Flood mitigation plan for Surat city using geospatial technology, PhD thesis, S.V. National Institute of Technology, Surat, India.
4. Chow, Ven Te et al. 1988, *Applied Hydrology*, McGraw-Hill, New York.
5. Majmundar B.P. 2012, Application of SWMM for urban storm water management, M.Tech. thesis, S.V. National Institute of Technology, Surat, India.
6. Patel J.N. 2007, Application of GIS/GPS in rainwater harvesting and management, Report on R&D project, funded by Ministry of Human Resources Development, New Delhi, India.
7. Raghunath H.M. 2005, *Hydrology: Principles, Analysis, Design*, New Age International Publishers, New Delhi, India.
8. Sharma N.D. and Patel J.N. 2010, Evaluation of groundwater quality index of the urban segments of Surat city, India, *International Journal of Geology, NAUN*, 4(1): 1–4.
9. Sharma N.D. 2013, Improving ground water quality through artificial recharging, PhD thesis, S.V. National Institute of Technology, Surat, India.
10. Todd D.K. 1995, *Groundwater Hydrology*, 2nd edn., John Wiley & Sons, Singapore.



# 13

## Nonpoint Source and Water Quality Modeling

---

13.1	Introduction .....	262
13.2	Nonpoint Sources of Contamination, Hydrologic Transport, and Kinetic Reactions .....	263
	Nonpoint Sources of Contamination • Hydrologic Transport • Kinetic Reactions	
13.3	Watershed-Scale Nonpoint Source Modeling .....	268
	Lumped Parameter Watershed Models • Distributed Parameter Watershed Models	
13.4	Surface Water Quality Modeling .....	270
	1D Water Quality Models • 2D Water Quality Models • 3D Water Quality Models • Contaminant Transport, Transformation, and Fate Submodel	
13.5	Summary and Conclusions .....	295
	References.....	296

**Zhonglong Zhang**  
*U.S. Army Engineer  
Research and  
Development Center*

### AUTHOR

**Zhonglong Zhang** is a senior scientist at Badger Technical Services, Environmental Laboratory, U.S. Army Engineer Research and Development Center. In addition, he is an adjunct faculty member of the Civil and Environmental Engineering Department at both Mississippi State University and Jackson State University. Previously, he served as a principal environmental systems modeler with Concurrent Technologies Corporation in Bremerton, Washington, and as a project scientist and interim supervisor with the USEPA Center for Subsurface Modeling Support, Ada, Oklahoma. His PhD is from Clemson University. He has specialized in the development and application of mathematical models to watershed, river, reservoir, lake water quality problems. He has been involved in the development of a number of USACE watershed and water quality models in common usage. He was the lead developer of nutrient simulation modules (NSM) and contaminant transport, transformation, and fate (CTT&F) submodel for hydrologic and hydraulic models. He was the developer of a raster based landscape hydrology and chemical fate model. He developed new water quality and sediment diagenesis modules for CE-QUAL-W2 and supported the development of some multimedia transport/fate/risk assessment models for military installations. Recently his work has focused on the development of linked watershed (SWAT, HSPF) and riverine (HEC-RAS) modeling systems for total maximum daily load, biofuel development and environmental sustainability studies. He has also provided technical review and support of watershed, surface water, and groundwater models for FEMA, USACE Districts, and USEPA Regions.

## PREFACE

The identification of nonpoint source (NPS) problems and evaluation of an appropriate response rely on having numerical models that relate the sources of the contamination to impacted water bodies and predict water quality constituent concentrations of concern. NPS and water quality modeling tools are needed, which involve physical, chemical, and biological processes as well as the mathematical description of these processes. Rather than review a general description of this topic, the emphasis here is to present an NPS and water quality modeling framework and understanding of the transport and fate of NPS contaminants as well as practical aspects of modeling approaches. This chapter provides an overview of NPS contaminants, hydrologic transport and biogeochemical reactions, and types of watershed models to quantitatively estimate NPS loads. Generalized water quality transport and biogeochemical processes are introduced and followed by more specific detailed water quality models in 1D, 2D, and 3D. Most of the topics included in this chapter have been the main focus of my research and development work.

## 13.1 Introduction

Eutrophication and toxic contamination have been the main problems in impaired rivers, reservoirs, lakes, and estuaries. Of particular concern to human health and ecosystem function are elevated concentrations of nitrogen, phosphorus, and toxic chemicals and their degradates [24]. These water bodies are characterized by high contaminant loadings from adjacent watersheds. Loading of contaminants to surface waters and groundwater occurs via two primary routes: (1) point sources and (2) nonpoint sources (NPSs). As the name implies, point sources of contamination are identified by a well-defined point of entry where contaminants reach a water body. Typical examples are landfills and municipal and industrial treatment facilities. NPS of contamination has no easily identified point of entry where contaminants reach a water body. NPS contaminants originate from a wide variety of sources over a wide area, and they enter surface water and groundwater at many locations, by many processes. The water that carries NPS contaminants may originate from natural processes such as rainfall or snowmelt or from human activities such as agricultural practices. Any contaminant it picks up on its journey can become part of the NPS problem. Some of these contaminants are of natural origin, some are man-made contaminants. Surface runoff is the primary transport mechanism for many NPS contaminants including sediments, nutrients, pesticides, toxic chemicals, and pathogens. The US Environmental Protection Agency (USEPA) has reported that NPS pollution remains the nation's largest source of water quality problems. It is the main reason that approximately 40% of surveyed rivers, lakes, and estuaries are not clean enough to meet basic uses such as swimming and fishing. The top causes of water body impairments include pathogens, heavy metals, nutrients, sediments, oxygen depletion, and biological impairments [24].

Characteristically, NPS contaminants enter the environment over an extensive area and sporadic time frame, are related to certain uncontrollable meteorological events and existing geographic/geomorphologic conditions, and have the potential for maintaining a relatively long active presence [13]. Obviously, NPS pollution is much more difficult to identify, measure, and control than point sources. Models are needed for quantifying the transport and fate of NPS contaminants across the landscape and forecasting the response of water quality on stream and river, lake, and estuary ecosystems. Watershed-scale models are required to estimate NPS loadings and exports into water bodies. A water quality model that is customized for a specific water body is used to simulate the major physical, chemical, and biological processes that occur in the system and thus establishing quantitative relationships between the water quality response and external loadings including point sources and NPS. Water quality models are especially developed for predicting constituent concentrations of concern in a water body. These models have been useful in forecasting of the transport and fate of NPS contaminants; the assessment of water quality

conditions in rivers, lakes, or other water bodies; understanding the complex relationships regarding the environmental impact of contamination of concerns; and the prediction of the effectiveness of best management practices. The Total Maximum Daily Load (TMDL) program, established by the US Clean Water Act (CWA), drives US water quality policy and management today. Under the CWA, each state is required to establish water quality standards based upon a TMDL. NPS and water quality models, in combination with field monitoring data, are widely used when developing and implementing TMDLs.

This chapter addresses two particular areas related to the transport and fate of contaminants: NPS load modeling and water quality modeling. The discussion will be limited in certain ways; first, it provides a brief overview of NPS contaminants of concern, fundamental hydrologic transport, and biogeochemical reactions. Second, two types of watershed-scale models are introduced to characterize NPS and the transport and fate of contaminants across the landscape. Third, one-dimensional (1D), two-dimensional (2D), and three-dimensional (3D) surface water quality modeling methods are presented. It is concluded with a summary with estimating NPS loadings and predicting water quality concentrations. The gaps and limitations in NPS and water quality modeling are also discussed.

## 13.2 Nonpoint Sources of Contamination, Hydrologic Transport, and Kinetic Reactions

---

The amount of a contaminant of concern found at a given location in the aquatic environment depends on the contaminant's rate of accumulation. That, in turn, depends on the rates of contaminant loading and transport. Contaminant loading arises from an "input" (with respect to the water body), especially NPS materials. NPS and water quality modeling requires an understanding of sources of contamination and transport as well as biological, chemical, and biochemical reaction processes.

### 13.2.1 Nonpoint Sources of Contamination

As the water contacts and subsequently moves over the land surfaces, a wide range of contaminants may become dissolved or suspended in the resulting runoff. Contaminants from NPS may include nutrients, toxic contaminants, and chemical compounds including heavy metals, organics like polychlorinated biphenyls (PCBs) and polycyclic aromatic hydrocarbons (PAHs), and other substances [13,24,27]. The list of NPS contaminants that have been identified from surface waters and groundwater is long. Moreover, new contaminants continue to appear. Agricultural runoff is the single largest source of NPS pollution in the United States [24]. There are five primary classes of contaminants associated with agricultural activities: sediments, nutrients, pesticides, organic matter, and microorganisms. The most prevalent nutrient contaminants that originate from agriculture are nitrogen and phosphorus; however, metals can also be leached out of the soil [10]. Sediment may not be a major water contaminant by weight and volume but it also serves as a catalyst, carrier, and storage agent of other forms of natural and anthropogenic contaminants. As a sink, contaminants from many of the NPS become entrained in sediments, either by partitioning out of the water or via deposition of suspended solids to which they are adsorbed. Many contaminants and organic wastes discharged to aquatic systems eventually accumulate in sediments. As a source, contaminated sediments may release chemicals to water via desorption from organic ligands into surrounding interstitial water.

Water quality refers to the capacity of a water body to support certain uses or ecologic functions. Water quality is a reflection of the physical, chemical, and biological constituents that are suspended or dissolved in the water. Due to the large number of contaminants, water quality may be defined in terms of hundreds of parameters. The most common NPS contaminants of surface waters are sediments and nutrients (C, N, and P) [24]. These substances are washed into water bodies from agricultural land, small- and medium-sized animal feeding operations, construction sites, and other areas of disturbance. Other common NPS contaminants include pesticides, pathogens, toxic chemicals, and heavy metals. Although a range of water quality constituents may be of interest, a modeling exercise

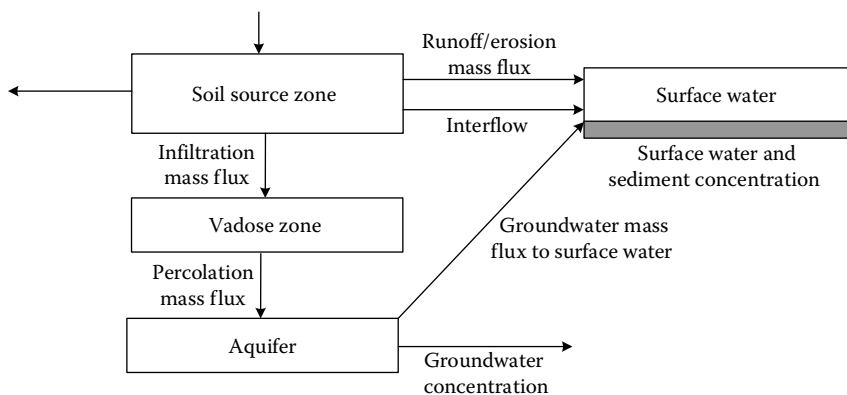


typically focuses on a small number such as nutrients, pesticides, and toxic chemicals. The following discussion will be limited on nutrients and toxic chemicals in NPS and water quality modeling.

### 13.2.2 Hydrologic Transport

NPS pollution is a water-driven process. Flowing water is the primary transport mechanism for movement of contaminants along the paths of the hydrologic cycle. To understand how contamination of surface water and groundwater occurs, it is necessary to understand the hydrologic cycle within a watershed. The hydrologic cycle and the related geophysical conditions determine the transport and fate of NPS contaminants. The hydrologic cycle begins with precipitation falling on the surface of the earth. As precipitation falls, some of it may evaporate directly into the atmosphere from bodies of water, and a portion may be intercepted by vegetation. The remainder reaches the ground where it can enter the soil through infiltration. Some of the infiltrating water remains near the soil surface and evaporates into the atmosphere. Another portion is extracted by plant roots and transported to leaves where it is lost to the atmosphere through transpiration. Water will infiltrate into the soil as long as the potential rate of infiltration exceeds the rate of precipitation. When the precipitation rate exceeds the infiltration rate, excess water builds on the soil surface and moves by overland surface runoff. Another portion of water that enters the soil can move vertically or laterally out of the plant root zone. Lateral movement of water through the soil is interflow. Downward movement of water through the soil is referred to as percolation. Percolating water eventually makes its way to a groundwater. Figure 13.1 schematically summarizes the hydrologic cycle and associated transport processes at the watershed scale. NPS contaminants from the surrounding land can reach streams and water bodies by direct surface runoff or subsurface or groundwater flow. Where groundwater enters the stream, contaminants are introduced into the stream.

Moving water can dissolve and mobilize contaminants in its path. These can include contaminants on the surface or in the subsurface of the earth. NPS loading is often separated into a dissolved phase, which moves with the flow of water, and a sediment-attached phase, which moves with the erosion of sediment. Water transport of a contaminant includes movement in the dissolved form in the subsurface and surface flows and in the particulate form with the sediment particles in the surface runoff. The transport and fate of NPS contaminants in watersheds are closely related to hydrological processes. Direct surface runoff may carry contaminants and sediment-associated contaminants into water bodies. The type and quantity of the NPS substances depend on the soil, vegetation, organic residue, management, and soil conservation practice. The sediment load depends largely on rainfall characteristics, topography, vegetation, soil type, and prevailing soil conservation practices. Three fundamental transport processes for moving and mixing contaminants within environmental media are advection, diffusion, and dispersion, which are common to surface water and groundwater. Advection is the transport of



**FIGURE 13.1** Watershed hydrologic cycle and transport processes.

contaminants along with the mean or bulk flow of water. Diffusion and dispersion signify the mixing of contaminants due to gradients in contaminant concentration [6,16,21–23].

### 13.2.2.1 Modeling Advection

In 1D flow system, the contaminant flux due to advection is calculated in terms of velocity and concentration by

$$J_a = u_x \cdot C_i \tag{13.1}$$

where

- $u_x$  is the depth-averaged  $x$ -direction (longitudinal) fluid velocity [L/T]
- $C_i$  is the concentration of species  $i$  [M/L<sup>3</sup>]

### 13.2.2.2 Modeling Diffusion and Dispersion

Diffusion moves contaminants from areas of high concentration to areas of low concentration. Although the physics are different, mathematically, dispersion and diffusion are treated identically in water quality modeling. Diffusion and dispersion can both be approximated with Fick’s laws in terms of contaminant concentration as

$$J_d = -D_x \frac{\partial C_i}{\partial x} \tag{13.2}$$

where  $D_x$  is diffusion or dispersion coefficient in 1D flow [L/T<sup>2</sup>].

### 13.2.2.3 Transport and Mass Balance Equation

The basis of NPS and water quality models to be discussed in this chapter is the principle of conservation of mass, which accounts for the production, loss, and accumulation of the contaminant within a specified control volume. The rate of accumulation of mass is balanced by the rates of production/consumption within the control volume, inflow from outside, and outflow across the boundaries:

$$\left[ \begin{array}{l} \text{Rate of accumulation} \\ \text{of contaminant per} \\ \text{unit volume} \end{array} \right] = \left[ \begin{array}{l} \text{Rate of contaminant} \\ \text{flow in} \end{array} \right] - \left[ \begin{array}{l} \text{Rate of contaminant} \\ \text{flow out} \end{array} \right] \pm \left[ \begin{array}{l} \text{Rate of contaminant} \\ \text{generation/consumption} \end{array} \right] \tag{13.3}$$

This equation must apply to all the state variables of the model. Once the appropriate transport mechanisms and kinetic reactions of the contaminant of concern are identified, this principle can be expressed mathematically as a time-dependent differential equation as follows:

$$\frac{\partial(V \cdot C_i)}{\partial t} = \text{Transport flux} \pm R(C_i) + S(C_i) \tag{13.4}$$

where

- $V$  is the control volume [L<sup>3</sup>]
- $R$  is the kinetic reaction term [M/T]
- $S$  is the boundary input [M/T]

The sources and sinks for each state variable involve the reaction kinetics of the variable being considered. The processes included in simulating NPS transport and fates of particular contaminants vary greatly. The hydrologic and hydraulic (H&H) and transport models must be properly coupled with

specific kinetic reactions. The H&H and transport models can be implicitly coupled or they can be run in series through an external linkage. If the H&H models are independent of the transport, hence, they can be run first and their output stored. Then, transport simulations can be run using the H&H output data without rerunning the H&H code. This approach does require a linkage processor. If the transport is coupled with the H&H model, then both models must be run together each time when conducting water quality assessment.

### 13.2.3 Kinetic Reactions

There are enormous numbers of chemical and biological processes that can affect water quality to some degree. The dynamics of chemical or biological reactions constitute what is referred to as kinetics. The kinetics or rate of such reaction is defined as production (or loss) of a given species of interest through chemical or biological processes. When no kinetic reaction occurs, the system is said to be conservative, and this characteristic is represented mathematically with the conservation of mass equation as

$$\frac{dM_i}{dt} = 0 \quad (13.5)$$

where  $M_i$  is the total mass of species  $i$  [M].

When kinetic reaction does occur, the system is called reactive, and, for a given species of interest, the system is no longer conservative. This characteristic is described mathematically as

$$\frac{dM_i}{dt} = S_i \quad (13.6)$$

where  $S_i$  is a source or sink term [M/T].

For reactive systems, rate equations are used frequently in water quality models to define kinetics of water quality constituents. The rate is also adjusted based on environmental conditions that affect the transformation. Since water quality models characterize concentration changes, reaction kinetics and derived kinetic rate laws for zero-, first-, and second-order types are briefly discussed. Kinetic mass is then added to the water quality model for two types of reactions. In the first case, the reaction becomes a source or sink term in the transport and mass balance equation in water quality modeling; in the second case, the reaction occurs at the boundary and becomes a boundary constraint on the governing equation.

Kinetic reactions are broadly categorized as either homogeneous or heterogeneous [20]. Homogeneous reactions occur everywhere within the fluid of interest. This means that they are distributed throughout the control volume; hence, they are represented as a source or sink term in the governing equation. By contrast, heterogeneous reactions occur only at fluid boundaries. They are not distributed throughout the control volume; hence, they are specified by source or sink boundary conditions. Some reactions have properties of both homogeneous and heterogeneous reactions. As an example, solids in water exist in two forms: either as particulate solids or as dissolved solids. The reaction is heterogeneous, but, the solid is suspended throughout the water column, the effect of the reaction is homogeneous in nature. Models that represent the reaction as heterogeneous are sometimes called two-phase, or multiphase, models. Models that simplify the reaction to treat it as a homogeneous reaction are called single-phase, or mixture, models. Knowledge of a contaminant's chemical form and of the chemical's ability to be sorbed, to precipitate, to dissolve, or to be degraded is necessary if the fate of the contaminant is to be modeled accurately.

#### 13.2.3.1 Sorption Processes

Sorption may be generally defined as the process in which a dissolved species becomes associated with a solid. Within natural waters, solutes may sorb to both inorganic and organic solids. Sorption is determined experimentally by measuring how much of a solute can be sorbed by a particular sediment, soil, or rock type. The capacity of a solid to remove a solute is a function of the concentration of the solute. If the

sorptive process is rapid compared with the flow velocity, the solute will reach an equilibrium sorption isotherm. The following three equilibrium sorption isotherms are often used in water quality modeling [6,23]:

### 13.2.3.1.1 Linear Sorption Isotherm

If there is a direct, linear relationship between the amount of a contaminant sorbed onto solid,  $C_p$ , and the concentration of the contaminant dissolved in water,  $C_d$ , the sorption isotherm of  $C_d$  as a function of  $C_p$  will plot as a straight line on graph paper. The resulting linear sorption isotherm is described by the following equation:

$$C_p = K_d C_d \quad (13.7)$$

where

$C_d$  is the dissolved concentration [L<sup>3</sup>/M]

$C_p$  is the sorbed concentration [M/M]

$K_d$  is the linear sorption coefficient [L<sup>3</sup>/M]

### 13.2.3.1.2 Freundlich Sorption Isotherm

A more general equilibrium isotherm is the Freundlich sorption isotherm. When  $C_d$  is plotted as a function of  $C_p$  on graph paper, the data will be curvilinear. This is defined by the nonlinear relationship

$$C_p = K_F C_d^n \quad (13.8)$$

where

$K_F$  is the Freundlich unit capacity factor

$n$  is the Freundlich exponent

### 13.2.3.1.3 Langmuir Sorption Isotherm

The Langmuir sorption isotherm describes the situation where the number of sorption sites is limited, so a maximum sorptive. The form of the Langmuir sorption isotherm is

$$C_p = \frac{\alpha\beta C_d}{1 + \alpha C_d} \quad (13.9)$$

where

$\beta$  is maximum amount of solute that can be sorbed

$\alpha$  is adsorption constant related to the binding energy (L<sup>3</sup>/M)

## 13.2.3.2 Homogeneous Reactions

According to the classification system described by Rubin [20], homogeneous reactions are ones that take place entirely within the liquid phase. If the reactions are reversible and proceed rapidly enough, the reaction can be described as being in local chemical equilibrium. If the reactions either does not reach equilibrium or is nonreversible, then it is treated as a homogeneous, nonequilibrium reaction. A few typical irreversible reactions in water quality modeling are discussed here.

### 13.2.3.2.1 Zero-Order Reaction

Some chemical reactions do not depend on the concentration of the contaminant but on other limiting factors, such as the available solid surface onto which the reactant can be adsorbed. This is referred to as zero-order reaction. The general rate equation for a zero-order reaction is given by

$$\frac{dC_i}{dt} = -k_0 \quad (13.10)$$

**13.2.3.2.2 First-Order Reaction**

The first-order rate of change of the amount of a contaminant is given by a constant times the amount of the contaminant. The general rate equation for a first order reaction is

$$\frac{dC_i}{dt} = -k_1 C_i \quad (13.11)$$

**13.2.3.2.3 Second-Order Reaction**

If the reaction follows the second order (rate constant is  $k_2$ ), then the rate of change of the amount of a contaminant becomes

$$\frac{dC_i}{dt} = -k_2 C_i^2 \quad (13.12)$$

where

$C_i$  is the amount of contaminant

$k_0, k_1, k_2$  are the zero-, first-, second-order rate constants in 1/unit time

In general, all rate units in the model are given in units of  $\text{day}^{-1}$ .

## 13.3 Watershed-Scale Nonpoint Source Modeling

Watersheds are the basic unit for management of water resources. Watershed-based knowledge of NPS transport and reaction processes is needed, including spatial and temporal variation to estimate the NPS input into a stream or river. NPS from the surrounding land can reach streams and rivers by direct runoff or subsurface or groundwater flow. In the infiltration area, nutrients that dissolve in the infiltrating water can reach the groundwater layer. Where groundwater enters the stream, contaminants are introduced into the stream. Models that describe watershed processes are classified according to several criteria. One of the most significant of these classifications is based on the spatial variability of the parameters that define the flow processes [1]. Spatially lumped models handle spatial variability by dividing a watershed into smaller geographical units; commonly used geographic units can be subbasins, terrain-based units, land cover classes, or elevation zones. Spatially distributed models divide watersheds into small, discrete units, usually based on grids or triangular irregular networks, enabling different model inputs or parameters to be used to represent spatial variability. The size of the grids should be determined by comprehensive consideration of the characteristics of topography, soil, land use, and vegetation in the watershed area. Compared with lumped models, distributed models take into account the variation of spatial heterogeneity and help modelers and decision makers better understand the spatial response to hydrologic and transport events. Figure 13.2 shows the classification of watershed models according to spatial discretization.

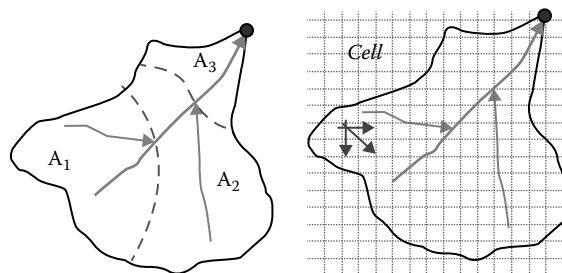


FIGURE 13.2 Lumped parameter versus distributed watershed model.

### 13.3.1 Lumped Parameter Watershed Models

Many lumped parameter watershed models have been developed and applied to estimate NPS loads. Some of the most popular models include hydrologic modeling system (HEC-HMS) [30], hydrologic simulation program – fortran (HSPF) [31], storm water management model (SWMM) [32], and soil and water assessment tool (SWAT) [33]. All of these models are public domain and come with a nice graphic user interface. The SWAT model was developed to assess the impact of land management and climate patterns on water, sediment, and agricultural chemical yields over long time periods in large watersheds. The watershed is partitioned into a number of subbasins. Each subbasin possesses a geographic position in the watershed and is spatially related to adjacent subbasins. Each subbasin is further divided into hydrological response units (HRUs) based on topography, land use, and soil. HRUs are the smallest computational units in SWAT with unique land use, soil type, and slope within a subbasin. Thus, SWAT can take two levels of the spatial heterogeneity into account. The first level (subbasin) supports the spatial heterogeneity associated with hydrology, and the second level (HRU) incorporates the spatial heterogeneity associated with land use, soil type, and slope class. Within a subbasin, SWAT does not retain the spatial location of each HRU. The loss of spatial information within the subbasin introduces a measure of unrealism and requires caution in interpreting model results. In SWAT, hydrologic, soil, and water quality and other processes are modeled within the subbasins through the use of HRUs. Flow generation, sediment yield, and pollutant loadings are summed across all HRUs in a subbasin, and the resulting flow and loads are then routed through channels, ponds, and/or reservoirs to the watershed outlet. SWAT typically produces daily results for every subbasin outlet, each of which can be summed to provide monthly and annual load estimates.

Major model components include climate, hydrology, nutrient cycle, pesticide, plant growth, and land management. For climate, SWAT uses the data from the station nearest to the centroid of each subbasin. The hydrology module simulates major hydrologic components and their interactions as simple responses using empirical relationships. The soil profile is subdivided into multiple layers that support soil water processes including infiltration, evaporation, plant uptake, lateral flow, and percolation to lower layer. A storage routing technique is used to calculate redistribution of water between layers in the soil profile. Lateral subsurface flow in the soil profile is calculated simultaneously with percolation. Groundwater flow contribution to total streamflow is simulated by routing a shallow aquifer storage component to the stream. Channel routing is simulated using either the variable storage method or the Muskingum method, both methods being variations of the kinematic wave model.

Erosion and sediment yield are estimated for each HRU with the modified universal soil loss equation [25]. The channel sediment routing uses a modification of Bagnold's sediment transport equation that estimates the transport concentration capacity as a function of velocity [2]. The model either deposits excess sediment or re-entrains sediment through channel erosion depending on the sediment load entering the channel. The delivery ratio is estimated for each particle size as a linear function of fall velocity, travel time, and flow depth.

SWAT simulates the complete soil nutrient cycle for nitrogen and phosphorus. The soil nitrogen cycle is simulated using five different pools; two are inorganic forms (ammonium and nitrate) while the other three are organic forms (fresh, stable, and active). Similarly, SWAT simulates six different pools of phosphorus in soil; three are inorganic forms and the rest are organic forms. Nitrate export with runoff, lateral flow, and percolation is estimated as products of the volume of water and the average concentration of nitrate in the soil layer. Organic nitrogen and organic phosphorus transport with sediment is calculated with a loading function developed by McElroy et al. [17] and modified by Williams and Hann [26] for application to individual runoff events. The loading function estimates daily organic nitrogen and phosphorus runoff loss based on the concentrations of constituents in the top soil layer, the sediment yield, and an enrichment ratio. The amount of soluble phosphorus removed in runoff is predicted using labile phosphorus concentration in the top soil layer, the runoff volume, and a phosphorus soil partitioning coefficient. In-stream nutrient dynamics in SWAT are simulated using the kinetic routines from the QUAL2E (Enhanced Stream Water Quality Model) in-stream water quality model [3].

### 13.3.2 Distributed Parameter Watershed Models

The US Army Corps of Engineer (USACE) Gridded Surface Subsurface Hydrologic Analysis (GSSHA) is one of physically based, distributed parameter hydrologic model that simulates the hydrologic response and sediment transport of a watershed subject to given hydrometeorological inputs [9]. The watershed is divided into grid cells that comprise a uniform finite difference grid. The model incorporates 2D overland flow, 1D stream flow, 1D unsaturated flow, and 2D groundwater flow components. The GSSHA model employs mass conservation solutions of partial differential equations and closely links the hydrologic components to assure an overall mass balance.

Within GSSHA, sediment erosion and transport processes take place both on land and within the channel. Nutrient water quality state variables included in GSSHA are transported by advection–dispersion processes. Conceptually, three hydrologic domains and associated nutrient pathways in the watershed are modeled: (1) subsurface soils, (2) overland flow, and (3) channel flow. Currently, GSSHA includes (1) subsurface soil nitrogen module, (2) subsurface soil phosphorus module, (3) soil plant dynamic module, (4) overland flow nitrogen module, (5) overland flow phosphorus module, (6) in-stream water quality module, and (7) contaminant transport, transformation, and fate modeling [28,29]. The soil nitrogen and phosphorus simulations in GSSHA were adopted from the SWAT model, which offers a robust accounting for the important processes in nitrogen and phosphorus cycles.

#### 13.3.2.1 Nitrogen Cycle

The nitrogen cycle represents one of the most important nutrient cycles found in terrestrial ecosystems that includes stores of nitrogen found in the atmosphere, where it exists as a gas (mainly  $N_2$ ), and other major stores of nitrogen including organic matter in soil and the oceans. Nitrogen in soil and water exists in organic or inorganic forms and in either dissolved or particulate forms. The inorganic forms of nitrogen include nitrate ( $NO_3^-$ ), nitrite ( $NO_2^-$ ), exchangeable ammonium ( $NH_4^+$ ), and fixed ammonium. The activities of humans have severely altered the nitrogen cycle. Some of the major processes involved in this alteration include the application of nitrogen fertilizers to crops and increased deposition of nitrogen from atmospheric sources. A schematic representation of the watershed nitrogen transport and transformation processes involved in the nitrogen cycle is given in Figure 13.3a.

#### 13.3.2.2 Phosphorus Cycle

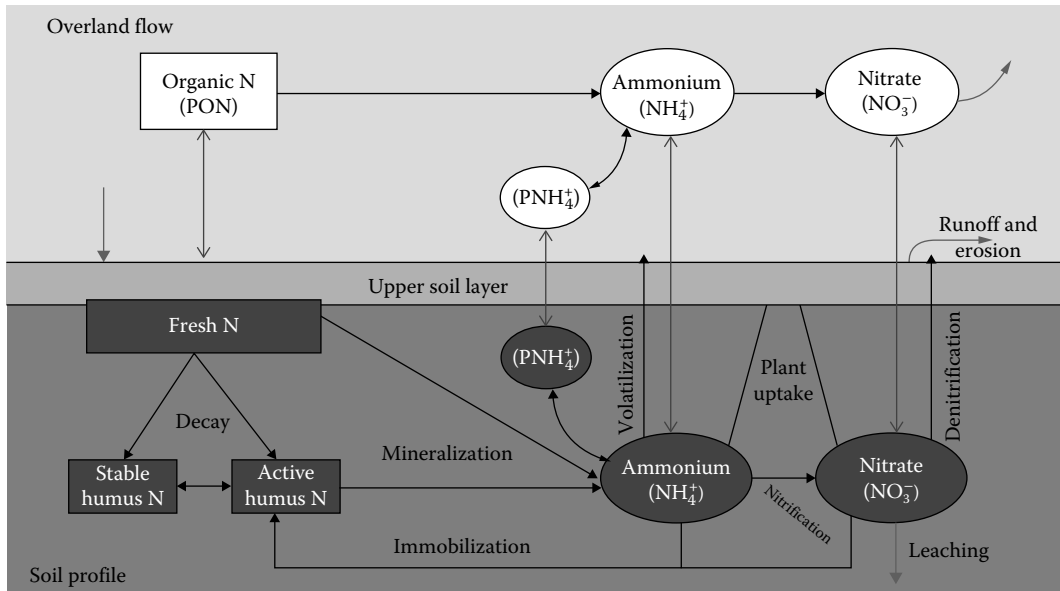
The phosphorus cycle differs from the other major biogeochemical cycles in that it does not include a gas phase. The largest reservoir of phosphorus is in sedimentary rocks. When it rains, phosphates are removed from the rocks via weathering and are distributed throughout both soils and water. Plants take up the phosphate ions from the soil. Phosphorus is not highly soluble, binding tightly to molecules in soil. Therefore, it mainly reaches waters by traveling with runoff soil particles. A schematic representation of the watershed phosphorus transport and transformation processes involved in the phosphorus cycle is given in Figure 13.3b.

#### 13.3.2.3 In-Stream Nutrient Water Quality

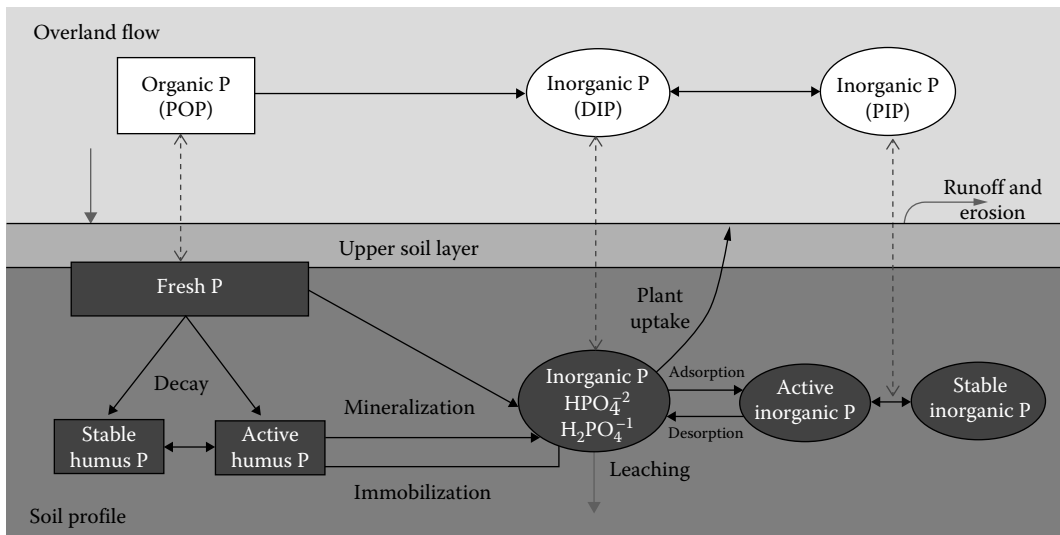
In-stream water quality kinetics computes algal biomass, organic and inorganic nitrogen and phosphorus species, carbonaceous biochemical oxygen demand (CBOD), and dissolved oxygen (DO). Currently, the in-stream water quality module includes a set of nutrient simulation modules that will be discussed in detail in 1D water quality modeling.

## 13.4 Surface Water Quality Modeling

Surface water quality modeling has a relatively long history. Surface water quality models have evolved over the course of time from the introduction of the classic Streeter–Phelps model for steady-state CBOD and DO in a stream in the 1920s. There has been more development over time. Model complexity



(a)



(b)

**FIGURE 13.3** (a) Schematic chart of GSSHA-NSM soil and overland flow nitrogen state variables and processes. (b) Schematic chart of GSSHA-NSM soil and overland flow phosphorus state variables and processes.

and size increased significantly in response to increasing complexity of NPS and management issues. In general, there are two types of surface water quality models: one is nutrient simulation model, the other one is toxic chemical simulation model. Nutrient models simulate the cycling of nutrients (C, N, P), the growth of algae, and DO dynamics. They are developed to assess water column levels of nutrients, algal biomass, and DO and are mainly applied to simulate the effects of point and NPS and management practices to abate eutrophication impacts. A number of nutrient models exist; typical public domain models developed and maintained by the US federal agencies are listed in Table 13.1. Some water quality state variables and biogeochemical processes are typical for these models, although the models differ in



**TABLE 13.1** Selected Surface Water Quality Models

Model	Reference	Dimensions	Components					
			DO	CBOD	Nutrients	Algae Group	Sediment Diagenesis	Chemicals
CE-QUAL-W2	[8]	2D	Yes	Yes	C, N, P	1–3	No	No
CE-QUAL-ICM	[4]	3D	Yes	No	C, N, P	1–3	Yes	Yes
CTT&F	[28]	1D, 2D	No	No	No	No	No	Yes
EFDC	[11,19]	3D	Yes	No	C, N, P	1–3	Yes	No
HEC-RAS-NSM	[29]	1D	Yes	Yes	C, N, P	1–3	Yes	No
OTEQ	[22]	1D	No	No	No	No	No	Yes
OTIS	[21]	1D	No	No	No	No	No	Yes
QUAL2E	[3]	1D	Yes	Yes	N, P	1	No	No
QUAL2K	[5]	1D	Yes	Yes	N, P	1	Yes	No
WASP	[27]	1D, 2D, 3D	Yes	Yes	N, P	1	Yes	Yes

the level of detail used in the process descriptions. All nutrient models include a simulation of DO as a state variable. In some models (e.g., QUAL2E, WASP), only one group of algae is simulated. In other models (e.g., HEC-RAS-NSM, CE-QUAL-W2, CE-QUAL-ICM, EFDC), multiple group of algal species are taken into account. Nutrient models are either based on a constant stoichiometric ratio of elements in algae (e.g., CE-QUAL-W2) or on variable element ratios (e.g., QUAL2K, WASP). In the latter case, the water column and the cellular element concentrations are based on separate mass balances which allow the simulation of luxury uptake of nutrients. In most models, internally, the algal biomass is expressed as carbon and converted to chlorophyll-a, using either a fixed or variable Chl/C ratio. Some models (e.g., CE-QUAL-W2, CE-QUAL-ICM) also include zooplankton, but the interaction between phyto- and zooplankton is often described in a fairly simple way by an external forcing function or an overall phytoplankton loss rate constant. Some models simulate dissolved organic carbon (DOC) and particulate organic carbon (POC) as well as the dynamics of these carbon pools (e.g., HEC-RAS-NSM, CE-QUAL-W2, CE-QUAL-ICM, EFDC). Other models lump them together and only simulate CBOD as a state variable (e.g., CE-QUAL-W2, QUAL2K, WASP). Some models include bed sediment diagenesis simulation and offer a full description of the exchange of nutrients across the sediment water interface, whereas in others, nutrient release fluxes have to be defined by the user as a boundary condition.

Reactions controlling chemical behavior are increasingly modeled, with some success, using a variety of geochemical modeling approaches. Chemical simulation models such as WASP, OTEQ, OTIS, and CTT&F in Table 13.1 describe the fate and distribution of contaminants in the surface water system. Their main objective is to assess chemical concentrations to allow comparison with water and sediment quality criteria. In contrast to nutrient and eutrophication models, toxic chemical modeling is complicated by the vast number of contaminants that are involved. Figure 13.4 gives an overview of the processes as they are included in the CTT&F [28]. The CTT&F is designed explicitly for organic chemicals. Important biogeochemical processes simulated are degradation, hydrolysis, oxidation, photolysis, volatilization, sorption, sedimentation, and resuspension. What processes to include in a model and the amount of detail necessary in their description should be determined by the problem and questions asked. Most chemical models are spatially explicit and focus on the abiotic environment, but sometimes, one or more biological compartments are included. Only few chemical models, for example, CTT&F, incorporate “three-phase partitioning,” the partitioning between solid particles (suspended or sediment), DOC, and water. The complexity of the model can be easily increased by enabling more state variables, parameters, and functions used for the simulation. Increasing the number of variables also increases the number of processes interacting between the variables for which additional parameters are required to control these processes.

A large number of textbooks cover the principles of surface water quality modeling such as [6,16,23], which include references to particular modeling tools. There is also a very large body of literature that

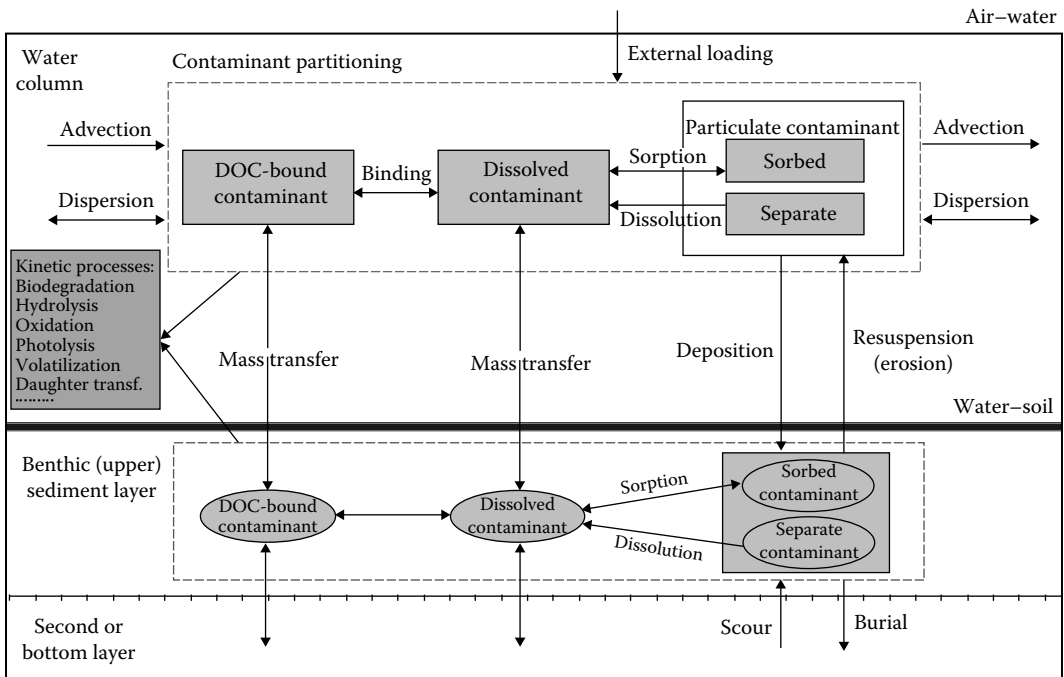


FIGURE 13.4 Schematic chart of general surface water contaminant modeling processes.

describes individual models and processes. Surface water quality models are usually grouped into categories based on the environment modeled or the number of “dimensions” considered. The environments modeled include streams, rivers, lakes, reservoirs, and estuaries. Constituent transport mechanisms depend on the type of water body simulated. The dimensions simulated by a particular model will provide information on both the complexity of a model and on its suitability to specific applications. A 0D model simply represents the volumes and concentrations assuming that the water body is completely and instantaneously mixed. A 1D model represents the water flow and the transport of constituents in one direction, and so the water body is assumed to be completely mixed across its width and depth. Most of riverine water quality models are 1D. Many water bodies exhibit significant multidimensional water quality variations caused by the interplay of hydrodynamics and biogeochemical processes. A 2D model will simulate transport of constituents across either the width or the depth of the water body, but not both. A width-averaged model is often used in simulating reservoirs. Depth-averaged models are useful when the river is broad and shallow such that stratification is limited, but transport across the width of the river is important. 3D models account for the water flows and transport in all directions. These models are highly sophisticated, and 3D water quality models are usually applied for large (i.e., deep and wide) estuaries where the mixing patterns are complex. The real world is inherently 3D, but with data limitation and current computational resources, surface water modeling and analysis are often limited to 1D and 2D models that approximate the real world. In general, as the model complexity increases, the number of parameters we use to describe the system and develop the model also increases. The more complex models we use, the more data we need to calibrate the model. The only test available to determine whether the model adequately reproduces natural system is to compare model output to data (measurements) taken from the system. Hence, the data requirements of a model are directly proportional to the model complexity. If very limited data are available, then complex models should be avoided because they cannot be adequately calibrated or validated.

A variety of federal government agencies in the United States have promoted the development and application of water quality models to solve environmental and ecosystem problems. The USACE has

been a long-standing leader in surface water quality modeling arena. In this chapter, water quality modeling and modeling approaches are introduced based on dimensions. Principles and processes are discussed through public domain 1D, 2D, and 3D models developed by USACE. Water quality models include two principal components: (1) a description of the flow system, which result in contaminant transport, and (2) a characterization of the chemical and biological reactions and transformations of contaminants. The contaminant transport and chemical and biological reactions must be coupled in order to describe the overall transport and fate of contaminants in aquatic environments. Furthermore, the water quality models discussed in this chapter are those that are capable of simulating at least DO, algae, and full nutrient (C, N, P) cycles in water bodies.

### 13.4.1 1D Water Quality Models

HEC-RAS is a 1D steady and unsteady flow hydraulics program capable of simulating a full network of open channels and hydraulic structures such as bridges, culverts, and weirs, with variable spatial discretization [30]. The HEC-RAS model has been expanded to include a water quality component which can simulate water temperatures and the movement of contaminants in rivers [29].

#### 13.4.1.1 Water Quality Transport and Mass Balance Equation

The physical processes of streamflow cause natural materials or contaminants to be transported and mixed, or exchanged, with other media. As illustrated in Figure 13.5, water quality constituents in a riverine system are simulated using a 1D transport model that accounted for physical processes including advection, dispersion, lateral inflow, and biogeochemical reactions:

$$\frac{\partial C_i}{\partial t} = -u_x \frac{\partial C_i}{\partial x} + \frac{1}{A} \frac{\partial}{\partial x} \left( A D_x \frac{\partial C_i}{\partial x} \right) + S_L + S_B + S_K \quad (13.13)$$

where

$C_i$  is the concentration of water quality constituent [M/L]

$A$  is the cross-sectional area of the channel [L<sup>2</sup>]

$D_x$  is the longitudinal dispersion coefficient of constituent [L<sup>2</sup>/T]

$S_L$  is the source/sink term representing direct and diffuse loading rate [M/L<sup>3</sup>/T]

$S_B$  is the source/sink term representing boundary loading rate including upstream, downstream, and benthic interaction [M/L<sup>3</sup>/T]

#### 13.4.1.2 Biogeochemical Reactions and Kinetic Sources/Sinks

A large number of reactions between chemicals and living organisms contribute to the dynamic change of water quality in riverine systems. Kinetic processes and corresponding time rates of change of the concentration due to biochemical reactions in HEC-RAS are determined from a series of nutrient simulation modules (NSM). The NSM was designed to simulate carbon, nitrogen, and phosphorus

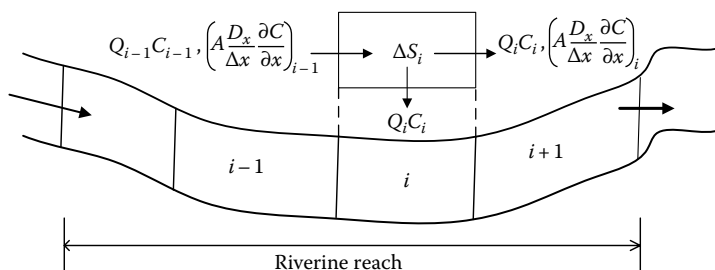


FIGURE 13.5 A conceptualization of the 1D river reach constituent transport and mass balance model.

**TABLE 13.2** List of HEC-RAS-NSM II Water Quality State Variables

No.	Name	Symbol	Unit
1	General Constituent	Ci	[mg/L]
2	Algae group	A <sub>p</sub>	[mg-A/L]
3	Nitrate–nitrite nitrogen	NO <sub>3</sub>	[mg-N/L]
4	Ammonium nitrogen	TNH <sub>4</sub>	[mg-N/L]
5	Dissolved organic nitrogen	DON	[mg-N/L]
6	Labile particulate organic nitrogen	LPON	[mg-N/L]
7	Refractory particulate organic nitrogen	RPON	[mg-N/L]
8	Total inorganic phosphorus	TIP	[mg-P/L]
9	Dissolved organic phosphorus	DOP	[mg-P/L]
10	Labile particulate organic phosphorus	LPOP	[mg-P/L]
11	Refractory particulate organic phosphorus	RPOP	[mg-P/L]
12	Dissolved inorganic carbon	DIC	[mol/L]
13	Labile dissolved organic carbon	LDOC	[mg-C/L]
14	Refractory dissolved organic carbon	RDOC	[mg-C/L]
15	Labile particulate organic carbon	LPOC	[mg-C/L]
16	Refractory particulate organic carbon	RPOC	[mg-C/L]
17	Dissolved oxygen	DO	[mg-O <sub>2</sub> /L]
18	Benthic algae	A <sub>b</sub>	[g-A/m <sup>2</sup> ]
19	Chemical oxygen demand	COD	[mg-O <sub>2</sub> /L]
20	Alkalinity	Alk	[mg-CaCO <sub>3</sub> /L]
21	Pathogen	PX	[cfu/100-mL]

cycling, DO dynamics, and phytoplankton and benthic algae production and loss. In order to understand or predict aquatic nutrient pollution, the biogeochemical simulation of nutrients is included in NSM at different levels for different applications. NSM level I and II only simulate the water column nutrient processes, they do not model the fate of those constituents once they are in the bed. Overall schematic representation of NSM I and NSM II biogeochemical kinetics is shown in Figure 13.6 (a) and (b) respectively. NSM level III conducts level II nutrient simulation coupling with a bed sediment diagenesis model. The sediment diagenesis model tracks the effects of organic matter decomposition on pore-water nutrients, and simulates sediment oxygen demand and the flux of nutrients from the pore waters to the overlying water column internally. The flexibility afforded by the NSM kinetics is unique. NSM permits the user to perform one, two, and three level water quality simulations; allows the specification of state variables; and tailored kinetic processes, all within the larger NSM modeling framework. NSM II is designed to model intermediate aquatic eutrophication described as in the following sections. The water quality state variables are listed in Table 13.2.

Terms for reaction sources and sinks of water quality constituents (e.g., decay and decomposition reactions) computed in NSM may be updated less frequently than hydraulics provided by HEC-RAS, allowing savings of computational time. This is consistent with the coarser time scales usually required to resolve biological/chemical processes as compared to hydraulics. Kinetic processes and rates of major water quality state variables simulated along with their source/sink terms are provided as follows.

### 13.4.1.3 Algae

Algae kinetics assumes a central role in nutrient cycles, affecting all other systems. Algae may be either floating (phytoplankton) or attached to the bed such as periphyton. Phytoplankton are subject to sinking and washout, while periphyton are subject to substrate limitation and scour by currents. NSM II allows for the configuration of several groups of phytoplankton. The kinetic equation employed in NSM for each algal group is the same; however, the choice of model coefficients is

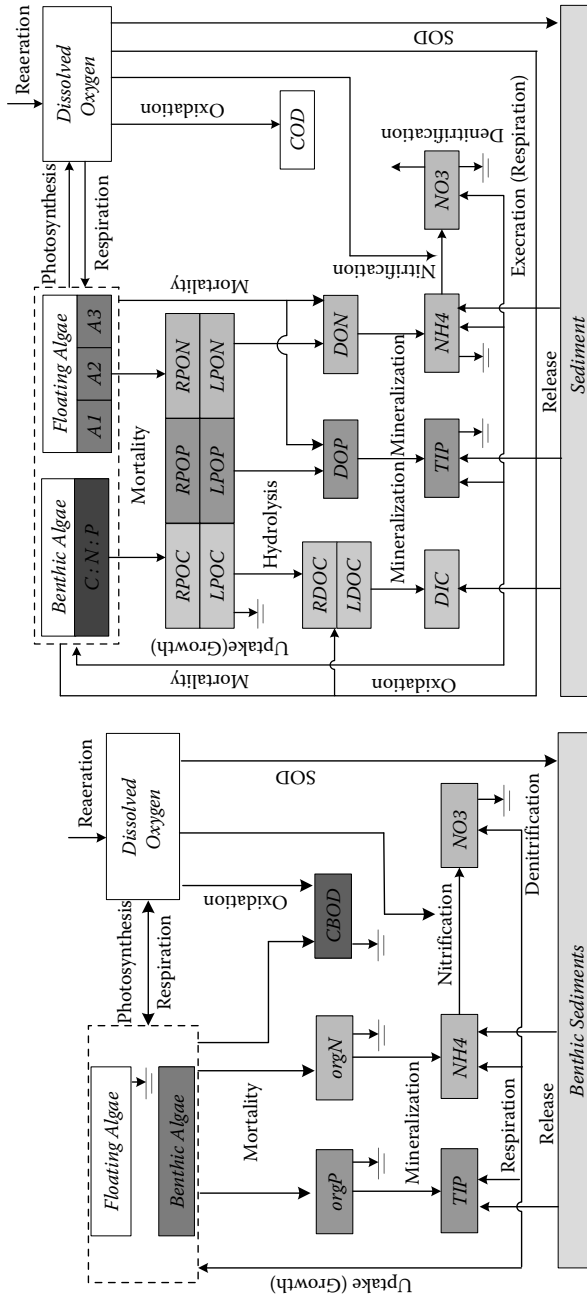


FIGURE 13.6 Schematic chart of (a) NSM I and (b) NSM II water quality state variables and processes.

different. The governing equation for algal biomass considers phytoplankton production and losses due to respiration, mortality, and settling:

$$\frac{dA_{pi}}{dt} = \left( -\frac{v_{sai}}{h} + \mu_{pi}(T) - F_{exp}k_{rpi}(T) - k_{dpi}(T) \right) A_{pi} \quad (13.14)$$

where

$i$  is the phytoplankton type

$A_{pi}$  is the biomass of phytoplankton  $i$  (mg-A/L)

$\mu_{pi}(T)$  is the temperature-dependent growth rate of phytoplankton  $i$  (day<sup>-1</sup>)

$k_{rpi}(T)$  is the temperature-dependent respiration rate of phytoplankton  $i$  (day<sup>-1</sup>)

$F_{exp}$  is the attenuation due to low oxygen for phytoplankton respiration

$k_{dpi}(T)$  is the temperature-dependent death rate of phytoplankton  $i$  (day<sup>-1</sup>)

$v_{sai}$  is the settling velocity of phytoplankton  $i$  (m/day)

The growth rate of a population of phytoplankton in a water body is a complicated function of the species of phytoplankton present and their differing reactions to solar radiation, temperature, and the balance between nutrient availability and phytoplankton requirements. For each phytoplankton group, phytoplankton growth rate is determined by the ambient temperature, by the availability of nutrients, and the intensity of light:

$$\mu_{pi}(T) = \mu_{mxpi} \phi_{Tpi} \phi_{Npi} \phi_{Lpi} \quad (13.15)$$

where

$\mu_{mxpi(T)}$  is the temperature-dependent maximum growth rate of phytoplankton  $i$  (day<sup>-1</sup>)

$\phi_{Tpi}$  is the effect of temperature on algal growth

$\phi_{Npi}$  is the algal nutrient attenuation factor (0–1)

$\phi_{Lpi}$  is the algal light attenuation factor (0–1)

*Temperature Limitation:* Phytoplankton growth temperature dependence has an optimum level and is modeled by a function similar to a Gaussian probability curve [3]:

$$\phi_{Tpi} = e^{-kt_{p1i}(T-T_{opi})^2} \quad T \leq T_{opi} \quad (13.16a)$$

$$\phi_{Tpi} = e^{-kt_{p2i}(T_{opi}-T)^2} \quad T > T_{opi} \quad (13.16b)$$

where

$T_{opi}$  is the optimal temperature for algal growth (°C)

$kt_{p1i}$  is the effect of temperature below  $T_0$  on algal growth (°C<sup>-2</sup>)

$kt_{p2i}$  is the effect of temperature above  $T_0$  on algal growth (°C<sup>-2</sup>)

*Light Limitation:* Light is the most limiting factor for algal growth, followed by nitrogen and phosphorus limitations. The effect of light on phytoplankton growth is assumed that light attenuation through the water follows the Beer–Lambert law. Three equations, half-saturation, Smith’s, and Steele’s equations combined with Beer–Lambert law, are used to quantify the impact of light on photosynthesis and compute the phytoplankton light attenuation coefficient.

Half-saturation equation

$$\phi_{Lpi} = \frac{1}{\lambda \cdot h} \ln \left( \frac{K_{Li} + I_0}{K_{Li} + I_0 \cdot e^{-\lambda \cdot h}} \right) \quad (13.17)$$

Smith's equation

$$\phi_{Lpi} = \frac{1}{\lambda \cdot h} \ln \left( \frac{I_0/K_{Li} + \left(1 + (I_0/K_{Li})^2\right)^{0.5}}{\left( (I_0/K_{Li})e^{-\lambda \cdot h} + \left[1 + \left( (I_0/K_{Li})e^{-\lambda \cdot h}\right)^2\right]^{0.5} \right)} \right) \quad (13.18)$$

Steele's equation

$$\phi_{Lpi} = \frac{2.718}{\lambda \cdot h} \left[ e^{-I_0/K_{Li} \cdot e^{-\lambda \cdot h}} - e^{-I_0/K_{Li}} \right] \quad (13.19)$$

Light extinction coefficient

$$\lambda = \lambda_0 + \lambda_s ISS + \sum \lambda_1 r_{chlai} A_{pi} + \sum \lambda_2 \left( r_{chlai} A_{pi} \right)^{2/3} \quad (13.20)$$

where

$\lambda$  is the light extinction coefficient ( $m^{-1}$ )

$\lambda_0$  is the background light extinction coefficient ( $m^{-1}$ )

$\lambda_s$  is the light extinction constant accounting for the impacts of inorganic suspended solids (L/mg/m)

$\lambda_1, \lambda_2$  are the light constants accounting for the impacts of chlorophyll (L/ $\mu gA/m$  and (L/ $\mu gA$ )<sup>2/3</sup>/m), respectively

*Nutrient Limitation:* The nutrient limitation on phytoplankton growth is determined by the single most limiting nutrient. It is assumed that phytoplankton follows Monod growth kinetics with respect to the important nutrients. The Monod method relates aquatic plants and algae growth rates with available nutrients dissolved in the water column. Since there are three nutrients, the Monod equation is evaluated for each nutrient, and the minimum value is chosen to reduce the saturated growth rate and compute the nutrient attenuation factor:

$$\phi_{Npi} = \min \left[ \frac{NH_4 + NO_3}{k_{sNpi} + NH_4 + NO_3}, \frac{DIP}{k_{sPpi} + DIP}, \frac{DIC}{k_{sCpi} + DIC} \right] \quad (13.21)$$

where

$k_{sNpi}$  is the half-saturation constant of phytoplankton photosynthesis for external  $N$  (mg-N/L)

$k_{sPpi}$  is the half-saturation constant of phytoplankton photosynthesis for external  $P$  (mg-P/L)

$k_{sCpi}$  is the half-saturation constant for phytoplankton photosynthesis for inorganic  $C$  (mol/L)

#### 13.4.1.4 Nitrogen Species

The nitrogen species commonly found in surface water are  $NO_3^-$ ,  $NO_2^-$ ,  $NH_4^+$ , DON, and PON. These forms are reactive in the framework of the nitrogen cycle. The nitrogen cycle includes the additional processes of denitrification, nitrification, and  $N_2$  fixation that are not in the carbon and phosphorus cycles. NSM II simulates five nitrogen cycle state variables: RPON, LPON, DON,  $TNH_4$ , and  $NO_3$ . The kinetic equations governing nitrogen cycling rates for these state variables in the water column are summarized as follows:

$$\frac{\partial RPON}{\partial t} = F_{rponp} r_{na} \sum_i^3 k_{dpi}(T) A_{pi} - k_{rpon}(T) RPON - \frac{v_{sr}}{h} RPON \quad (13.22a)$$

$$\frac{\partial \text{LPON}}{\partial t} = F_{lponp} r_{na} \sum_i^3 k_{dpi}(T) A_{pi} - k_{lpon}(T) \text{LPON} - \frac{v_{sl}}{h} \text{LPON} \quad (13.22b)$$

$$\frac{\partial \text{DON}}{\partial t} = S_{RPON,hn} + S_{LPON,hn} + (1 - F_{rponp} - F_{lponp}) r_{na} \sum_i^3 k_{dpi}(T) A_{pi} - F_{oxmn} k_{don}(T) \text{DON} \quad (13.22c)$$

$$\frac{\partial \text{NH}_4}{\partial t} = S_{DON,mn} + r_{na} F_{oxp} \sum_i^3 k_{rpi}(T) A_{pi} - r_{na} P_{Np} \sum_i^3 \mu_{pi}(T) A_{pi} - F_{oxna} \frac{\text{NH}_4}{k_{snh4} + \text{NH}_4} k_{nit}(T) \text{NH}_4 \quad (13.22d)$$

$$\frac{\partial \text{NO}_3}{\partial t} = S_{\text{NH}_4,nit} - r_{na} (1 - P_{Np}) \sum_i^3 \mu_{pi}(T) A_{pi} - (1 - F_{oxdn}) \frac{\text{NO}_3}{k_{sno3} + \text{NO}_3} k_{dnit}(T) \text{NO}_3 - \frac{v_{no3}(T)}{h} \text{NO}_3 \quad (13.22e)$$

where

$F_{rponp}$  is the fraction of phytoplankton mortality as RPON

$k_{rpon}(T)$  is the temperature-dependent hydrolysis rate of RPON ( $\text{day}^{-1}$ )

$v_{sr}$  is the refractory organic particle settling velocity (m/day)

$F_{lponp}$  is the fraction of phytoplankton mortality as LPON

$k_{lpon}(T)$  is the temperature-dependent hydrolysis rate of LPON ( $\text{day}^{-1}$ )

$v_{sl}$  is the labile organic particle settling velocity (m/day)

$k_{don}(T)$  is the temperature-dependent mineralization rate of DON ( $\text{day}^{-1}$ )

$F_{oxmn}$  is the attenuation due to low oxygen for DON mineralization

$k_{nit}(T)$  is the temperature-dependent nitrification rate ( $\text{day}^{-1}$ )

$F_{oxna}$  is the attenuation due to low oxygen for nitrification

$k_{dnit}(T)$  is the temperature-dependent denitrification rate ( $\text{day}^{-1}$ )

$v_{no3}(T)$  is the temperature-dependent sediment denitrification reaction velocity (m/day)

$F_{oxdn}$  is the enhancement of denitrification at low oxygen concentration

### 13.4.1.5 Phosphorus Species

In contrast to nitrogen and carbon, there is no gaseous atmospheric source. In surface water quality studies, the focus is often on the sediment-associated forms of phosphorus, as these tend to dominate the total phosphorus. Organic phosphorus is represented in NSM II with three state variables as dissolved organic phosphorus (DOP) and refractory and labile particulate organic phosphorus (RPOP and LPOP). NSM II simulates four phosphorus cycling state variables: RPOP, LPOP, DOP, and TIP. The kinetic equations governing phosphorus cycling rates for these state variables in the water column are summarized as follows:

$$\frac{\partial \text{RPOP}}{\partial t} = F_{rpoppp} r_{pa} \sum_i^3 k_{dpi}(T) A_{pi} - k_{rpop}(T) \text{RPOP} - \frac{v_{sr}}{h} \text{RPOP} \quad (13.23a)$$

$$\frac{\partial \text{LPOP}}{\partial t} = F_{lpoppp} r_{pa} \sum_i^3 k_{dpi}(T) A_{pi} - k_{lpop}(T) \text{LPOP} - \frac{v_{sl}}{h} \text{LPOP} \quad (13.23b)$$



$$\frac{\partial \text{DOP}}{\partial t} = S_{\text{RPOP},hp} + S_{\text{LPOP},hp} + (1 - F_{\text{rpop}} - F_{\text{lpop}}) r_{pa} \sum_i^3 k_{dpi}(T) A_{pi} - F_{\text{oxmp}} k_{dop}(T) \text{DOP} \quad (13.23c)$$

$$\frac{\partial \text{TIP}}{\partial t} = S_{\text{DOP},mp} + r_{pa} F_{\text{oxp}} \sum_i^3 k_{rpi}(T) A_{pi} - r_{pa} \sum_i^3 \mu_{pi}(T) A_{pi} - \frac{v_s}{h} f_{pp} \text{TIP} \quad (13.23d)$$

where

- $F_{\text{rpop}}$  is the fraction of phytoplankton mortality as RPOP
- $k_{\text{rpop}}(T)$  is the temperature-dependent hydrolysis rate of RPOP ( $\text{day}^{-1}$ )
- $F_{\text{lpop}}$  is the fraction of phytoplankton mortality as LPOP
- $k_{\text{lpop}}(T)$  is the temperature-dependent hydrolysis rate of LPOP ( $\text{day}^{-1}$ )
- $k_{\text{dop}}(T)$  is the temperature-dependent mineralization rate of DOP ( $\text{day}^{-1}$ )
- $F_{\text{oxmp}}$  is the attenuation due to low oxygen for DOP mineralization
- $F_{\text{oxmp}}$  is the attenuation due to low oxygen for DOP mineralization

### 13.4.1.6 Carbon Species

Organic carbon is represented in NSM II with four state variables as refractory and labile dissolved organic carbon (RDOC and LDOC) and refractory and labile particulate organic carbon (RPOC and LPOC). The dissolved inorganic carbon (DIC) is the sum of inorganic carbon species in a solution, which actually consists of several carbonate constituents: carbon dioxide ( $\text{CO}_2$ ), bicarbonate ( $\text{HCO}_3^-$ ), and carbonate ( $\text{CO}_3^{2-}$ ). The value of water pH is controlled by the carbonate system. Considering the mass associated with each biogeochemical process within a control volume, the kinetic equations governing carbon cycling rates for state variables (RPOC, LPOC, RDOC, LDOC, DIC) in the water column are summarized as follows:

$$\frac{\partial \text{RPOC}}{\partial t} = F_{\text{rpoc}} r_{ca} \sum_i^3 k_{dpi}(T) A_{pi} - k_{\text{rpoc}}(T) \text{RPOC} - \frac{v_{sr}}{h} \text{RPOC} \quad (13.24a)$$

$$\frac{\partial \text{LPOC}}{\partial t} = F_{\text{lpop}} r_{ca} \sum_i^3 k_{dpi}(T) A_{pi} - k_{\text{lpop}}(T) \text{LPOC} - \frac{v_{sl}}{h} \text{LPOC} \quad (13.24b)$$

$$\frac{\partial \text{RDOC}}{\partial t} = F_{\text{rdoc}} r_{ca} \sum_i^3 k_{dpi}(T) A_{pi} - F_{\text{oxmc}} k_{\text{rdoc}}(T) \text{RDOC} \quad (13.24c)$$

$$\begin{aligned} \frac{\partial \text{LDOC}}{\partial t} = & S_{\text{RPOC},hc} + S_{\text{LPOC},hc} + (1 - F_{\text{rpoc}} - F_{\text{lpop}} - F_{\text{rdoc}}) r_{ca} \sum_i^3 k_{dpi}(T) A_{pi} \\ & - F_{\text{oxmc}} k_{\text{ldoc}}(T) \text{LDOC} - r_{\text{cndn}} (1 - F_{\text{oxdn}}) \frac{\text{NO}_3}{k_{\text{snO}_3} + \text{NO}_3} k_{\text{dnit}}(T) \text{NO}_3 \end{aligned} \quad (13.24d)$$

$$\begin{aligned} \frac{\partial \text{DIC}}{\partial t} = & S_{\text{RDOC},mc} + S_{\text{LDOC},mc} + k_{\text{ac}}(T) (10^{-6} k_{\text{H}}(T) p_{\text{CO}_2} - F_{\text{CO}_2} \text{DIC}) \\ & + r_{\text{cca}} F_{\text{oxp}} \sum_i^3 k_{rpi}(T) A_{pi} - r_{\text{cca}} \sum_i^3 \mu_{pi}(T) A_{pi} \end{aligned} \quad (13.24e)$$

where

- $F_{rpocp}$  is the fraction of phytoplankton mortality as RPOC
- $k_{rpoc}(T)$  is the temperature-dependent hydrolysis rate of RPOC (day<sup>-1</sup>)
- $F_{lpocp}$  is the fraction of phytoplankton mortality as LPOC
- $k_{lpoc}(T)$  is the temperature-dependent hydrolysis rate of LPOC (day<sup>-1</sup>)
- $F_{rdocp}$  is the fraction of phytoplankton mortality as RDOC
- $k_{rdoc}(T)$  is the temperature-dependent mineralization rate of RDOC (day<sup>-1</sup>)
- $F_{oxmc}$  is the attenuation due to low oxygen for DOC mineralization
- $k_{ldoc}(T)$  is the temperature-dependent mineralization rate of LDOC (day<sup>-1</sup>)
- $r_{cca}$  is the carbon in mole to algal biomass (mol-C/mg-A)
- $k_{ac}(T)$  is the temperature-dependent CO<sub>2</sub> reaeration coefficient (day<sup>-1</sup>)
- $k_H(T)$  is the temperature-dependent Henry's constant (mol/L/atm)
- $p_{CO_2}$  is the partial pressure of carbon dioxide in the atmosphere (ppm)

### 13.4.1.7 Dissolved Oxygen

Six water quality state variables are involved in the DO mass balance: phytoplankton, benthic algae, ammonium, LDOC, RDOC, and COD. Kinetic processes simulated in NSM II include sources from atmospheric reaeration in the surface layer and algal photosynthetic production. Kinetic loss terms include algal respiration, nitrification, decomposition of DOC, oxidation of COD, and bottom layer consumption of oxygen from sediment oxygen demand. The kinetic reaction processes for DO are all temperature dependent. The kinetic rate equation governing the DO balance in rivers is formulated as follows:

$$\begin{aligned} \frac{dDO}{dt} = & k_a(T)(DO_s - DO) - k_{COD}(T)COD - \frac{SOD(T)}{h} + r_{ca} (r_{oca}P_{Np} + r_{ocn}(1 - P_{Np})) \sum_i^3 \mu_{pi}(T)A_{pi} \\ & - r_{ca}r_{oca}F_{exp} \sum_i^3 k_{rpi}(T)A_{pi} - r_{on}F_{oxna}k_{nit}(T)NH_4 - r_{oca}F_{oxmc}k_{rdoc}(T)RDOC - r_{oca}F_{oxmc}k_{ldoc}(T)LDOC \end{aligned} \quad (13.25)$$

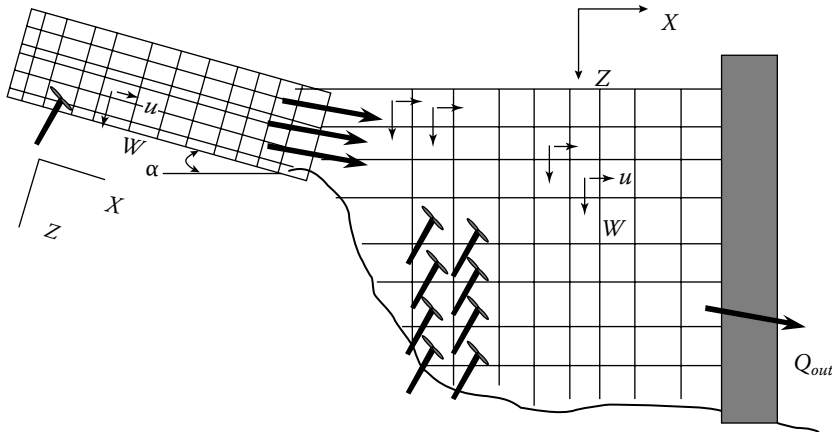
where

- $DO_s$  is the saturated DO concentration (mg-O<sub>2</sub>/L)
- $k_a(T)$  is the temperature-dependent oxygen reaeration coefficient (day<sup>-1</sup>)

### 13.4.2 2D Water Quality Models

2D water quality models are often used to predict longitudinal and vertical variations in stratified rivers, reservoirs, and estuaries, that is, in systems where vertical variations are significant. Numerous models of this type exist. CE-QUAL-W2 (W2) is a 2D (longitudinal-vertical) hydrodynamic and water quality model that was originally developed for deep, long, and narrow water bodies [8]. W2 simulates water level, flow, water temperature, and many water quality constituents in a water body, including total dissolved solids, nutrients, particulate and dissolved organic matter (DOM), DO, and algae. Most water quality process rates are modified by water temperature using the formulation of [23] to compute temperature rate multipliers for kinetic expressions. A typical model grid is shown in Figure 13.7.

The model presently can simulate up to 28 water quality state variables. In addition, the model calculates 20 derived constituents including pH and carbonate species concentrations. A partial listing of water quality constituents simulated in W2 is provided in Table 13.3.



**FIGURE 13.7** Schematic chart of typical CE-QUAL-W2 model grid. (From Cole, T.M. and Well, S.A. 2008. CE-QUAL-W2: A two-dimensional, laterally averaged, hydrodynamic and water quality model, version 3.6. Instruction report EL-08-1. U.S. Army Engineer Research and Development Center, Vicksburg, MS.)

**TABLE 13.3** Partial List of CE-QUAL-W2 Water Quality State Variables

No.	Name	Symbol	Unit
1	Temperature	Temp	[°C]
2	Inorganic suspended solids	ISS	[g/m <sup>3</sup> ]
3	Bioavailable phosphorus	PO <sub>4</sub>	[g-P/m <sup>3</sup> ]
4	Ammonium nitrogen	NH <sub>4</sub>	[g-N/m <sup>3</sup> ]
5	Nitrate-nitrite nitrogen	NO <sub>3</sub>	[g-N/m <sup>3</sup> ]
6	Dissolved silica	DSI	[g/m <sup>3</sup> ]
7	Particulate biogenic silica	PSI	[g/m <sup>3</sup> ]
8	Labile dissolved organic matter	LDOM	[g-A/m <sup>3</sup> ]
9	Refractory dissolved organic matter	RDOM	[g-A/m <sup>3</sup> ]
10	Labile particulate organic matter	LPOM	[g-A/m <sup>3</sup> ]
11	Refractory particulate organic matter	RPOM	[g-A/m <sup>3</sup> ]
12	Carbonaceous biochemical oxygen demand	CBOD	[g-O <sub>2</sub> /m <sup>3</sup> ]
13	Algae group	$\epsilon_a$	[g-A/m <sup>3</sup> ]
14	Epiphyton group	$\epsilon_e$	[g-A/m <sup>3</sup> ]
15	Macrophyte group	$\epsilon_{macro}$	[g-A/m <sup>3</sup> ]
16	Zooplankton group	$\epsilon_{zoo}$	[g-A/m <sup>3</sup> ]
17	Dissolved oxygen	DO	[g-O <sub>2</sub> /m <sup>3</sup> ]
18	Total iron	Fe	[g/m <sup>3</sup> ]
19	Alkalinity	Alk	[g/m <sup>3</sup> ]

#### 13.4.2.1 Water Quality Transport and Mass Balance Equation

The transport and mass balance equations compute the transport of constituents with their kinetic reaction rates expressed in source and sink terms. The sources/sinks for constituents are separated into two arrays: one contains boundary sources/sinks, the other one contains internal sources/sinks due to kinetic interactions. The internal source/sink term represents a mass rate of change of a constituent due to kinetic reactions. The kinetic reactions can be depicted graphically by considering each constituent as a compartment. Spatial averages across the lateral dimension of the channel of the turbulent time-averaged quantities can now be introduced:

$$\frac{\partial B \cdot C_j}{\partial t} + \frac{\partial U \cdot B \cdot C_j}{\partial x} + \frac{\partial W \cdot B \cdot C_j}{\partial z} - \frac{\partial (BD_x (\partial C_j / \partial x))}{\partial x} - \frac{\partial (BD_z (\partial C_j / \partial z))}{\partial z} = q_j B + S_j B \tag{13.26}$$

where

- $B$  is the control volume width(m)
- $U, W$  are the longitudinal and vertical velocities, respectively (m/s)
- $D_x$  is the longitudinal temperature and constituent dispersion coefficient (m<sup>2</sup>/s)
- $D_z$  is the vertical temperature and constituent dispersion coefficient (m<sup>2</sup>/s)
- $q_j$  is the lateral inflow or outflow mass flow rate of constituent per unit volume (g/m<sup>3</sup>/s)
- $S_j$  is the laterally averaged source/sink term (g/m<sup>3</sup>/s)

### 13.4.2.2 Biogeochemical Reactions and Kinetic Sources/Sinks

In order to solve the 2D advection–diffusion equation, the source/sink term,  $S_\Phi$ , must be specified. Kinetic processes and rates of major water quality state variables simulated in W2 along with their source/sink terms are provided as follows. Figure 13.8 illustrates major water quality constituents and their reaction processes included in W2.

### 13.4.2.3 Organic Matter

Organic matter in W2 is separated into four pools based on relative rates of decay (labile or refractory) and its physical status (particulate or dissolved). Particulate organic matter (POM) and DOM are designated as labile or refractory. The process of converting laboratory measurements into concentrations of LDOM, RDOM, LPOM, and RPOM for model input required several assumptions and insights based on data and experiments:

$$\begin{aligned} \frac{\partial \text{LDOM}}{\partial t} = & \sum K_{ae} \Phi_a + \sum (1 - P_{am}) K_{am} \Phi_a + \sum K_{ee} \Phi_e \\ & + \sum (1 - P_{em}) K_{em} \Phi_e - \gamma_{OM} K_{L\text{DOM}} \text{LDOM} - K_{L \rightarrow R} \text{LDOM} \end{aligned} \tag{13.27a}$$

$$\frac{\partial \text{RDOM}}{\partial t} = K_{L \rightarrow R} \text{LDOM} - \gamma_{OM} K_{R\text{DOM}} \text{RDOM} \tag{13.27b}$$

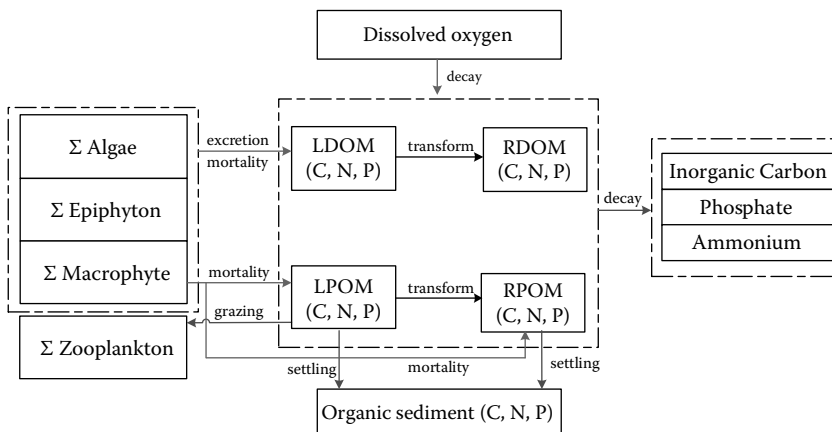


FIGURE 13.8 Schematic chart of CE-QUAL-W2 water quality state variables and processes.

$$\frac{\partial \text{LPOM}}{\partial t} = \sum P_{am} K_{am} \Phi_a + \sum P_{em} K_{em} \Phi_e - K_{LPOM} \gamma_{OM} \text{LPOM} - K_{L \rightarrow R} \text{LPOM} - \omega_{POM} \frac{\partial \text{LPOM}}{\partial z} \quad (13.27c)$$

$$\frac{\partial \text{RPOM}}{\partial t} = K_{L \rightarrow R} \text{LPOM} - \gamma_{OM} K_{RPOM} \text{RPOM} - \omega_{POM} \frac{\partial \text{RPOM}}{\partial z} \quad (13.27d)$$

where

$K_{ae}$  is the algal excretion rate,  $s^{-1}$

$\Phi_a$  is the algal concentration,  $g/m^3$

$P_{am}$  is the pattern coefficient for algal mortality

$K_{am}$  is the algal mortality rate,  $s^{-1}$

$K_{ee}$  is the epiphyton excretion rate,  $s^{-1}$

$\Phi_e$  is the epiphyton concentration,  $g/m^3$

$K_{em}$  is the epiphyton excretion rate,  $s^{-1}$

$\gamma_{OM}$  is the temperature rate multiplier for organic matter decay

$K_{LDOM}$  is the labile DOM decay rate,  $s^{-1}$

$K_{L \rightarrow R}$  is the labile to refractory DOM transfer rate,  $s^{-1}$

$K_{RDOM}$  is the refractory DOM decay rate,  $s^{-1}$

$P_{em}$  is the partition coefficient for epiphyton mortality

$K_{LPOM}$  is the labile POM decay rate,  $s^{-1}$

$\omega_{POM}$  is the POM settling rate,  $m/s$

Organic matter is difficult for laboratories to measure directly, so organic matter is not a standard water quality measurement. To determine the concentration of dissolved organic matter (DOM), measured dissolved organic carbon (DOC) concentrations are converted using the organic carbon to organic matter ratio. The concentration of particulate organic matter (POM) is derived from measured particulate carbon and the organic carbon to organic matter ratio since organic carbon is usually measured. Because of this limitation, the current W2 model (V3.71) has been modified to directly simulate carbon, nitrogen, and phosphorus cycles [34]. With these modifications, W2 has the capability of directly modeling organic carbon (POC, DOC), organic nitrogen (PON, DON), and organic phosphorus (POP, DOP). Revised W2 model also take into account variable algal stoichiometries, algal stoichiometries for carbon, nitrogen and phosphorus as separately defined variables.

#### 13.4.2.4 Algae

W2 gives the user complete freedom in how many and what kinds of algal groups can be included in the simulation through careful specification of the kinetic rate parameters that define the characteristics of each algal group. The kinetic rate equation for algal biomass is defined as follows:

$$\frac{\partial \Phi_a}{\partial t} = K_{ag} \Phi_a - K_{ar} \Phi_a - K_{ae} \Phi_a - K_{am} \Phi_a - \omega_a \frac{\partial \Phi_a}{\partial z} \quad (13.28)$$

where

$K_{ag}$  is the algal growth rate,  $s^{-1}$

$K_{ar}$  is the algal dark respiration rate,  $s^{-1}$

$\omega_a$  is the algal settling rate,  $m/s$

#### 13.4.2.5 Phosphate

Phosphorus is assumed to be completely available as orthophosphate ( $PO_4$ ) for uptake by phytoplankton. The kinetic rate equation for phosphate is as follows:

$$\begin{aligned}
 \frac{\partial \text{PO}_4}{\partial t} = & \sum (K_{ar} - K_{ag})\delta_{pa}\Phi_a + \sum (K_{er} - K_{eg})\delta_{pe}\Phi_e + K_{L\text{DOM}}\delta_{\text{POM}}\gamma_{\text{OM}}\text{LDOM} \\
 & + K_{R\text{DOM}}\delta_{\text{POM}}\gamma_{\text{OM}}\text{RDOM} + K_{L\text{POM}}\delta_{\text{POM}}\gamma_{\text{OM}}\text{LPOM} + K_{R\text{POM}}\delta_{\text{POM}}\gamma_{\text{OM}}\text{RPOM} \\
 & + \sum K_{\text{CBOD}}R_{\text{CBOD}}\delta_{\bar{p}\text{-CBOD}}\Theta^{T-20}\text{CBOD} + K_s\delta_{\text{POM}}\gamma_{\text{OM}}\Phi_s \\
 & + \text{SOD}\gamma_{\text{OM}}\frac{A_{\text{sed}}}{V} - \frac{\left(\sum \omega_{\text{ISS}}\text{ISS} + \omega_{\text{Fe}}\text{Fe}\right)P_p}{\Delta z}\text{PO}_4
 \end{aligned} \tag{13.29}$$

where

- $\delta_{pe}$  is the epiphyton stoichiometric coefficient for phosphorus
- $\delta_{pa}$  is the algal stoichiometric coefficient for phosphorus
- $\delta_{\text{POM}}$  is the organic matter stoichiometric coefficient for phosphorus
- $\delta_{\bar{p}\text{-CBOD}}$  is the phosphorus/CBOD stoichiometric ratio
- $K_{\text{BOD}}$  is the CBOD decay rate,  $s^{-1}$
- $R_{\text{BOD}}$  is the conversion ratio for 5-day CBOD to CBOD ultimate
- $\omega_{\text{ISS}}$  is the inorganic suspended solids settling velocity, m/s
- $\omega_{\text{Fe}}$  is the POM settling velocity, m/s
- $K_s$  is the organic sediment decay rate,  $s^{-1}$
- $\Phi_s$  is the organic sediment concentration,  $g/m^3$
- $\text{Fe}$  is the total iron concentration,  $g/m^3$

### 13.4.2.6 Ammonium

The kinetic rate equation for ammonium is as follows:

$$\begin{aligned}
 \frac{\partial \text{NH}_4}{\partial t} = & \sum K_{ar}\delta_{Na}\Phi_s - \sum K_{ag}\delta_{Na}\Phi_a P_{\text{NH}_4} + \sum K_{er}\delta_{Ne}\Phi_e - \sum K_{eg}\delta_{Ne}\Phi_e P_{\text{NH}_4} \\
 & + K_{L\text{DOM}}\delta_{\text{NOM}}\gamma_{\text{OM}}\text{LDOM} + K_{R\text{DOM}}\delta_{\text{NOM}}\gamma_{\text{OM}}\text{RDOM} + K_{L\text{POM}}\delta_{\text{NOM}}\gamma_{\text{OM}}\Phi_{L\text{POM}} \\
 & + K_{R\text{POM}}\delta_{\text{NOM}}\gamma_{\text{OM}}\text{RPOM} + K_s\delta_{\text{NOM}}\gamma_{\text{OM}}\Phi_s + \text{SOD}\gamma_{\text{OM}}\frac{A_{\text{sed}}}{V} \\
 & + \sum K_{\text{CBOD}}R_{\text{CBOD}}\delta_{\text{N-CBOD}}\Theta^{T-20}\text{CBOD} + K_{\text{NO}_x}\gamma_{\text{NO}_x}\text{NO}_x - K_{\text{NH}_4}\gamma_{\text{NH}_4}\text{NH}_4
 \end{aligned} \tag{13.30}$$

where

- $\delta_{Na}$  is the algal stoichiometric coefficient for nitrogen
- $\delta_{Ne}$  is the epiphyton stoichiometric coefficient for nitrogen
- $\delta_{\text{NOM}}$  is the organic matter stoichiometric coefficient for nitrogen
- $\delta_{\text{N-CBOD}}$  is the CBOD stoichiometric coefficient for nitrogen
- $P_{\text{NH}_4}$  is the ammonium preference factor
- $K_{\text{NO}_x}$  is the nitrate–nitrogen decay rate,  $s^{-1}$
- $K_{\text{NH}_4}$  is the ammonium decay rate,  $s^{-1}$
- $\gamma_{\text{NH}_4}$  is the temperature rate multiplier for nitrification
- $\gamma_{\text{NO}_x}$  is the temperature rate multiplier for denitrification

### 13.4.2.7 Nitrate–Nitrite

This compartment represents nitrate plus nitrite. The kinetic rate equation is as follows:

$$\begin{aligned} \frac{\partial NO_x}{\partial t} = & K_{NH_4} \gamma_{NH_4} NH_4 - K_{NO_x} \gamma_{NO_x} NO_x - \omega_{NO_x} \frac{\partial NO_x}{\partial z} - \sum K_{ag} \delta_{Na} \Phi_a (1 - P_{NH_4}) \\ & - \sum K_{eg} \delta_{Ne} \Phi_e (1 - P_{NH_4}) \end{aligned} \quad (13.31)$$

where  $\omega_{NO_x}$  is sediment transfer velocity, m/s.

### 13.4.2.8 Dissolved Oxygen

W2 includes both aerobic and anaerobic processes. Simulations can be used to identify possibilities for both metalimnetic and hypolimnetic oxygen depletion and its impact on various water control management alternatives:

$$\begin{aligned} \frac{\partial DO}{\partial t} = & \sum (K_{ag} - K_{ar}) \delta_{OM} \Phi_a + \sum (K_{eg} - K_{er}) \delta_{OM} \Phi_e + A_{sur} K_L (DO_s - DO) - K_{RPOM} \delta_{OM} \gamma_{OM} RPOM \\ & - K_{LPOM} \delta_{OM} \gamma_{OM} LPOM - K_{LDOM} \gamma_{OM} \delta_{OM} LDOM - K_{RDOM} \delta_{OM} \gamma_{OM} RDOM - K_s \delta_{OM} \gamma_{OM} \Phi_s \\ & - SOD \gamma_{OM} \frac{A_{sed}}{V} - \sum K_{CBOD} R_{CBOD} \Theta^{T-20} CBOD - K_{NH_4} \delta_{NH_4} \gamma_{NH_4} NH_4 \end{aligned} \quad (13.32)$$

where

$K_L$  is the interfacial exchange rate for oxygen, m/s

$\delta_{OM}$  is the oxygen stoichiometric coefficient for organic matter

$\delta_{NH_4}$  is the oxygen stoichiometric coefficient for nitrification

### 13.4.3 3D Water Quality Models

The CE-QUAL-ICM (ICM) model is a 3D eutrophication water quality model and was initially developed for application on Chesapeake Bay [4]. Since the initial development in the late 1980s, many refinements and additions to the model have been made. ICM model computes and reports concentrations, mass transport, kinetics transformations, and mass balances for up to 36 water quality state variables including physical properties; multiple forms of algae, zooplankton, carbon, nitrogen, phosphorus, and silica; and DO. ICM includes the ability to activate or deactivate model features, diagnostic output, and volumetric and mass balances. Each state variable may be individually activated or deactivated. ICM is generally recognized as the most comprehensive 3D water quality model in the world. In addition to its application in Chesapeake Bay, it has also been applied to Green Bay, New York harbor, Newark Bay, San Juan Bay, Long Beach harbors, Florida Bay, etc. Most ICM modeling studies have been aimed at improving water quality via reductions in nutrient and solid loads.

One of the features of the ICM model is that it is an unstructured grid finite volume model. Thus, mass is absolutely conserved. Its unstructured grid feature enables it to be linked with various hydrodynamic models, including CH3D and EFDC. This feature enables many simulations of the model to be made economically during model calibration since the hydrodynamics has to be simulated once. The ICM model used in one Chesapeake Bay application simulates up to 36 water quality state variables given in the following text (Table 13.4). The CH3D model was used to predict the hydrodynamics as a function of wind, tide, and salinity intrusion.

**TABLE 13.4** Partial List of CE-QUAL-ICM Water Quality State Variables

No.	Name	Symbol	Unit
1	Temperature	Temp	[°C]
2	Inorganic suspended solids (1–3)	ISS	[g/m <sup>3</sup> ]
3	Algae (1–3)	A	[g-C/m <sup>3</sup> ]
4	Zooplankton (1–2)	Z	[g-C/m <sup>3</sup> ]
5	Nitrate–nitrite	NO <sub>3</sub>	[g-N/m <sup>3</sup> ]
6	Ammonium	NH <sub>4</sub>	[g-N/m <sup>3</sup> ]
7	Dissolved organic nitrogen	DON	[g-N/m <sup>3</sup> ]
8	Labile particulate organic nitrogen	LPON	[g-N/m <sup>3</sup> ]
9	Refractory particulate organic nitrogen	RPON	[g-N/m <sup>3</sup> ]
10	Total inorganic phosphorus	TIP	[g-P/m <sup>3</sup> ]
11	Particulate inorganic phosphorus	PIP	[g-P/m <sup>3</sup> ]
12	Dissolved organic phosphorus	DOP	[g-P/m <sup>3</sup> ]
13	Labile particulate organic phosphorus	LPOP	[g-P/m <sup>3</sup> ]
14	Refractory particulate organic phosphorus	RPOP	[g-P/m <sup>3</sup> ]
15	Dissolved organic carbon	DOC	[g-C/m <sup>3</sup> ]
16	Labile particulate organic carbon	LPOC	[g-C/m <sup>3</sup> ]
17	Refractory particulate organic carbon	RPOC	[g-C/m <sup>3</sup> ]
18	Dissolved silica	DSI	[g/m <sup>3</sup> ]
19	Particulate biogenic silica	PSI	[g/m <sup>3</sup> ]
20	Dissolved oxygen	DO	[g-O <sub>2</sub> /m <sup>3</sup> ]
21	Chemical oxygen demand	COD	[g-O <sub>2</sub> /m <sup>3</sup> ]
22	Benthic algae	B	[g-C/m <sup>2</sup> ]

### 13.4.3.1 Water Quality Transport and Mass Balance Equation

The transport of water quality constituents in ICM is based on a 3D mass balance equation for a control volume. Control volumes correspond to cells on the model grid. ICM solves, for each volume and for each state variable, the equation

$$\frac{\partial V_j \cdot C_j}{\partial t} = \sum_{k=1}^n Q_k \cdot C_k + \sum_{k=1}^n A_k \cdot D_k \cdot \frac{\partial C}{\partial x_k} + \sum S_j \tag{13.33}$$

where

- $V_j$  is the volume of  $j$ th control volume (m<sup>3</sup>)
- $C_j$  is the concentration in  $j$ th control volume (g/m<sup>3</sup>),  $t$
- $x$  is the temporal and spatial coordinates
- $n$  is the number of flow faces attached to  $j$ th control volume
- $Q_k$  is the volumetric flow across flow face  $k$  of  $j$ th control volume (m<sup>3</sup>/s)
- $C_k$  is the concentration in flow across face  $k$  (g/m<sup>3</sup>)
- $A_k$  is the area of flow face  $k$  (m<sup>2</sup>)
- $D_k$  is the diffusion coefficient at flow face  $k$  (m<sup>2</sup>/s)
- $S_j$  is the external loads and kinetic sources and sinks in  $j$ th control volume (g/s)

An external hydrodynamic model is used to simulate hydrodynamics in the water body, and the resulting flow information were incorporated into the ICM to simulate the fate and transport of nutrients, algae, and DO.



### 13.4.3.2 Biogeochemical Reactions and Kinetic Sources/Sinks

Figure 13.9 illustrates major water quality constituents and their reaction processes included in ICM. The biogeochemical reactions and source/sink term for major water quality state variables are discussed as follows.

#### 13.4.3.3 Algae

Algal sources and sinks in the conservation equation include production, metabolism, predation, and settling. Generic equations for algal groups are presented as follows:

$$\frac{\partial A}{\partial t} = \left( G - BM - W_a \frac{\partial}{\partial z} \right) A - PR \tag{13.34}$$

where

- $A$  is the algal biomass, expressed as carbon (g C/m<sup>3</sup>)
- $G$  is the growth (day<sup>-1</sup>)
- $BM$  is the basal metabolism (day<sup>-1</sup>)
- $W_a$  is the algal settling velocity (m/day)
- $PR$  is the predation (g C/m<sup>3</sup>/day)
- $z$  is the vertical coordinate

#### 13.4.3.4 Organic Carbon

The carbon cycle in ICM (Figure 13.9) consists of the following elements: phytoplankton production and excretion, zooplankton production and excretion, predation on phytoplankton, dissolution of particulate carbon, heterotrophic respiration, denitrification, and settling. Algal production is the primary carbon source, although carbon also enters the system through external loading. Predation on algae by zooplankton and other organisms releases particulate and dissolved organic carbon to the water column. A fraction of the particulate organic carbon undergoes first-order dissolution to dissolved organic carbon.

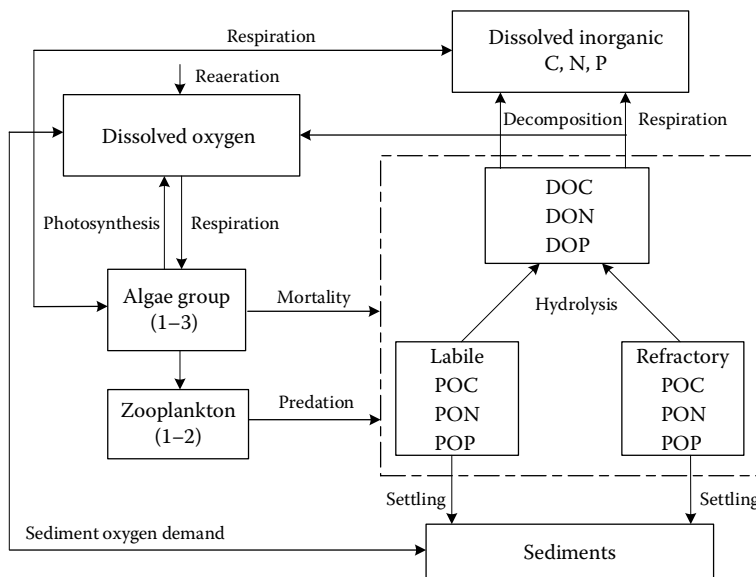


FIGURE 13.9 Schematic chart of CE-QUAL-ICM water quality state variables and processes.

Dissolved organic carbon produced by excretion, by predation, and by dissolution is respired at a first-order rate to inorganic carbon. Particulate organic carbon which does not undergo dissolution settles to the bottom sediments. Kinetics of the organic carbon state variables are described as follows:

$$\begin{aligned} \frac{\partial \text{DOC}}{\partial t} = & \text{FCD} \cdot R \cdot A + \text{FCDP} \cdot \text{PR} + \text{Klpoc} \cdot \text{LPOC} + \text{Krpoc} \cdot \text{RPOC} \\ & - \frac{\text{DO}}{\text{KHodoc} + \text{DO}} \cdot \text{Kdoc} \cdot \text{DOC} - \text{DENIT} \cdot \text{DOC} \end{aligned} \quad (13.35a)$$

$$\frac{\partial \text{LPOC}}{\partial t} = \text{FCL} \cdot R \cdot A + \text{FCLP} \cdot \text{PR} - \text{Klpoc} \cdot \text{LPOC} - \text{Wl} \cdot \frac{\partial \text{LPOC}}{\partial z} \quad (13.35b)$$

$$\frac{\partial \text{RPOC}}{\partial t} = \text{FCR} \cdot R \cdot A + \text{FCRP} \cdot \text{PR} - \text{Krpoc} \cdot \text{RPOC} - \text{Wr} \cdot \frac{\partial \text{RPOC}}{\partial z} \quad (13.35c)$$

where

FCD is the fraction of algal respiration released as DOC

FCDP is the fraction of predation on algae released as DOC

Klpoc is the dissolution rate of LPOC ( $\text{day}^{-1}$ )

Krpoc is the dissolution rate of RPOC ( $\text{day}^{-1}$ )

Kdoc is the respiration rate of DOC ( $\text{day}^{-1}$ )

FCL is the fraction of algal respiration released as LPOC

FCLP is the fraction of predation on algae released as LPOC

Wl is the settling velocity of labile particles ( $\text{m/day}$ )

FCR is the fraction of algal respiration released as RPOC

FCRP is the fraction of predation on algae released as RPOC

Wr is the settling velocity of refractory particles ( $\text{m/day}$ )

KHodoc is the half-saturation concentration of dissolved oxygen required for oxic respiration ( $\text{g O}_2/\text{m}^3$ )

DENIT is the denitrification rate ( $\text{day}^{-1}$ )

### 13.4.3.5 Phosphorus Species

The model phosphorus cycle includes the following processes: algal uptake and excretion, zooplankton excretion, predation, hydrolysis of particulate organic phosphorus, mineralization of DOP, settling, and resuspension. Dissolved phosphate is incorporated by algae during growth and released as phosphate and organic phosphorus through respiration and predation. DOP is mineralized to phosphate. A portion of the particulate organic phosphorus hydrolyzes to DOP. Kinetics of the phosphorus state variables are described as follows:

$$\frac{\partial \text{PO}_4}{\partial t} = \text{Kdop} \cdot \text{DOP} - \text{APC} \cdot G \cdot A + \text{APC} \cdot [\text{FPI} \cdot \text{BM} \cdot A + \text{FPIP} \cdot \text{PR}] \quad (13.36a)$$

$$\frac{\partial \text{DOP}}{\partial t} = \text{APC} \cdot (\text{BM} \cdot A \cdot \text{FPD} + \text{PR} \cdot \text{FPDP}) + \text{Klpop} \cdot \text{LPOP} + \text{Krpop} \cdot \text{RPOP} - \text{Kdop} \cdot \text{DOP} \quad (13.36b)$$

$$\frac{\partial \text{LPOP}}{\partial t} = \text{APC} \cdot (\text{BM} \cdot A \cdot \text{FPL} + \text{PR} \cdot \text{FPLP}) - \text{Klpop} \cdot \text{LPOP} - \text{Wl} \cdot \frac{\partial \text{LPOP}}{\partial z} \quad (13.36c)$$

$$\frac{\partial \text{RPOP}}{\delta t} = \text{APC} \cdot (\text{BM} \cdot \text{A} \cdot \text{FPR} + \text{PR} \cdot \text{FPRP}) - \text{Krpop} \cdot \text{RPOP} - \text{Wr} \cdot \frac{\partial \text{RPOP}}{\delta z} \quad (13.36d)$$

where

FPI is the fraction of algal metabolism released as dissolved phosphate

FPIP is the fraction of predation released as dissolved phosphate

FPD is the fraction of algal metabolism released as DOP

FPDP is the fraction of predation on algae released as DOP

Klpop is the hydrolysis rate of LPOP ( $\text{day}^{-1}$ )

Krpop is the hydrolysis rate of RPOP ( $\text{day}^{-1}$ )

Kdop is the mineralization rate of DOP ( $\text{day}^{-1}$ )

FPL is the fraction of algal metabolism released as LPOP

FPLP is the fraction of predation on algae released as LPOP

FPR is the fraction of algal metabolism released as RPOP

FPRP is the fraction of predation on algae released as RPOP

### 13.4.3.6 Nitrogen Species

The model nitrogen cycle includes the following processes: algal production and metabolism, predation, hydrolysis of particulate organic nitrogen, mineralization of dissolved organic nitrogen, settling, nitrification, and denitrification. Available nitrogen is incorporated by algae during growth and released as ammonium and organic nitrogen through respiration and predation. A portion of the particulate organic nitrogen hydrolyzes to dissolved organic nitrogen. The balance settles to the sediments. Dissolved organic nitrogen is mineralized to ammonium. In an oxygenated water column, a fraction of the ammonium is subsequently oxidized to nitrate + nitrite through the nitrification process. In anoxic water, nitrate + nitrite is lost to nitrogen gas through denitrification. Kinetics of the nitrogen state variables are described as follows:

$$\frac{\partial \text{NH}_4}{\delta t} = \text{ANC} \cdot [(\text{BM} \cdot \text{FNI} - \text{PN} \cdot \text{P}) \cdot \text{A} + \text{PR} \cdot \text{FNIP}] + \text{Kdon} \cdot \text{DON} - \text{NT} \quad (13.37a)$$

$$\frac{\partial \text{NO}_3}{\delta t} = -\text{ANC} \cdot (1 - \text{PN}) \cdot \text{P} \cdot \text{A} + \text{NT} - \text{ANDC} \cdot \text{DENIT} \cdot \text{DOC} \quad (13.37b)$$

$$\frac{\partial \text{DON}}{\delta t} = \text{ANC} \cdot (\text{BM} \cdot \text{A} \cdot \text{FND} + \text{PR} \cdot \text{FNDP}) + \text{Klpon} \cdot \text{LPON} + \text{Krpou} \cdot \text{RPON} - \text{Kdon} \cdot \text{DON} \quad (13.37c)$$

$$\frac{\partial \text{LPON}}{\delta t} = \text{ANC} \cdot (\text{BM} \cdot \text{A} \cdot \text{FNL} + \text{PR} \cdot \text{FNLP}) - \text{Klpon} \cdot \text{LPON} - \text{Wl} \cdot \frac{\partial \text{LPON}}{\delta z} \quad (13.37d)$$

$$\frac{\partial \text{RPON}}{\delta t} = \text{ANC} \cdot (\text{BM} \cdot \text{A} \cdot \text{FPR} + \text{PR} \cdot \text{FPRN}) - \text{Krpou} \cdot \text{RPON} - \text{Wr} \cdot \frac{\partial \text{RPON}}{\delta z} \quad (13.37e)$$

where

FNI is the fraction of algal metabolism released as  $\text{NH}_4$

PN is the algal ammonium preference

FNIP is the fraction of predation released as  $\text{NH}_4$

FND is the fraction of algal metabolism released as DON

FNDP is the fraction of predation on algae released as DON

Klpon is the hydrolysis rate of LPON ( $\text{day}^{-1}$ )

$K_{rpon}$  is the hydrolysis rate of RPON ( $\text{day}^{-1}$ )  
 $K_{don}$  is the mineralization rate of DON ( $\text{day}^{-1}$ )  
 FNL is the fraction of algal metabolism released as LPON  
 FNLP is the fraction of predation on algae released as LPON  
 FNR is the fraction of algal metabolism released as RPON  
 FNRP is the fraction of predation on algae released as RPON  
 $NT$  is the nitrification rate ( $\text{g N / m}^3 / \text{day}$ )

### 13.4.3.7 Dissolved Oxygen

Sources and sinks of DO in the water column include algal photosynthesis, atmospheric reaeration, algal respiration, heterotrophic respiration, nitrification, and chemical oxygen demand:

$$\begin{aligned}
 \frac{\partial \text{DO}}{\partial t} = & \text{AOCR} \cdot \left[ (1.3 - 0.3 \cdot \text{PN}) \cdot P - (1 - \text{FCD}) \cdot \text{BM} \right] \cdot A - \text{AONT} \cdot \text{NT} \\
 & - \frac{\text{DO}}{\text{KH}_{\text{odoc}} + \text{DO}} \cdot \text{AOCR} \cdot K_{\text{doc}} \cdot \text{DOC} - \frac{\text{DO}}{\text{KH}_{\text{ocod}} + \text{DO}} \cdot K_{\text{cod}} \cdot \text{COD} + \frac{K_r}{H} \cdot (\text{DO}_s - \text{DO})
 \end{aligned}
 \tag{13.38}$$

where

$\text{AOCR}$  is the oxygen-to-carbon mass ratio in production and respiration ( $=2.67 \text{ g O}_2/\text{g C}$ )  
 $\text{AONT}$  is the oxygen consumed per mass ammonium nitrified ( $=4.33 \text{ g O}_2/\text{g N}$ )  
 $\text{KH}_{\text{odoc}}$  is the half-saturation concentration of dissolved oxygen required for exertion of chemical oxygen demand ( $\text{g O}_2/\text{m}^3$ )  
 $K_r$  is the reaeration coefficient ( $\text{m/day}$ )

## 13.4.4 Contaminant Transport, Transformation, and Fate Submodel

1D, 2D, and 3D water quality models previously described address eutrophication problem and nutrient simulation in a water body. The objective of this section is to provide a brief overview of chemical transformations occurring in aquatic environment and contaminant modeling. The fate of contaminants in aquatic environments is in general driven by (1) dissolved contaminant transport by flow water, (2) particulate contaminant (absorbed by organic carbon and sediments) transport by flow water, (3) contamination dynamics in the upper layer of sediments, and (4) kinetic processes of contaminants. The CTT&F was developed for coupling with GSSHA, HEC-RAS, and CE-QUAL-W2 to simulate the contaminant transport, transformation, and fate in the water [28]. The CTT&F has the capability to simulate biodegradation, hydrolysis, volatilization, dissolution, and other transformation processes. An overview of processes in the CTT&F is presented in Figure 13.4, where the system is represented as two compartments: water column (runoff or surface water) and surface soil or sediment. Key processes taken into account in the CTT&F are described in the following sections.

### 13.4.4.1 Partitioning and Distribution of Contaminants

Partitioning is the process in which a substance is distributed among various dissolved and adsorbed species. Partitioning can and does occur in any environment, although the relative significance of partitioning in relation to other processes may vary. For purposes of realistic contaminant transport and fate modeling, three contaminant phases are considered: truly dissolved phase, phase bound to organic carbon (DOC, POC), and phase sorbed to sediments. CTT&F simulates the total concentration of a contaminant. The partitioning process calculates the dissolved and adsorbed species as fractions of the total concentration using equilibrium partitioning of mass among particulate (sorbed) phase, aqueous (dissolved) phase, and bound with DOC or other binding ligands or complexation agents. When the

partition coefficients and the concentrations of sediments and DOC are known, the partitioning fractions  $f_d$ ,  $f_b$ , and  $f_p$  in each compartment can be calculated as follows:

$$f_d = \frac{\phi}{\phi + k_b\phi\text{DOC} + k_p C_{ss}} \quad (13.39a)$$

$$f_b = \frac{k_b\phi\text{DOC}}{\phi + k_b\phi\text{DOC} + k_p C_{ss}} \quad (13.39b)$$

$$f_p = \frac{k_p C_{ss}}{\phi + k_b\phi\text{DOC} + k_p C_{ss}} \quad (13.39c)$$

where

$f_d$  is the fraction of total nonsolid contaminant in dissolved phase

$f_b$  is the fraction of total nonsolid contaminant in DOC-bound phase

$f_p$  is the fraction of total contaminant in sorbed phase associated with suspended solids

$k_b$  is the DOC binding coefficient ( $\text{m}^3/\text{g}$ )

$k_p$  is the distribution coefficient ( $\text{m}^3/\text{g}$ )

DOC is the DOC concentration ( $\text{g}/\text{m}^3$ )

$\phi$  is porosity of the benthic sediments ( $\phi = 1$  for water column)

$C_{ss}$  is the suspended solid concentration or bulk density of the benthic sediments ( $\text{g}/\text{m}^3$ )

Given the total concentration and the three-phase fractions in the water column, the dissolved, bound, and sorbed concentrations at equilibrium are determined as follows:

$$C_d = f_d C_T \quad (13.40a)$$

$$C_b = f_b C_T \quad (13.40b)$$

$$C_p = f_p C_T \quad (13.40c)$$

$$C_T = C_d + C_b + C_p \quad (13.40d)$$

where

$C_d$  is the concentration of truly dissolved phase ( $\text{g}/\text{m}^3$ )

$C_b$  is concentration of DOC-bound phase ( $\text{g}/\text{m}^3$ )

$C_p$  is the concentration of sediment sorbed phase ( $\text{g}/\text{m}^3$ )

$C_T$  is the total concentration of the contaminant ( $\text{g}/\text{m}^3$ )

#### 13.4.4.2 First-Order Decay

Any decay process is assumed to be governed by first-order decay. These mechanisms may include bacterial degradation, oxidation, and photolysis. The overall first-order decay rate is computed from rates for each contaminant phase (e.g., dissolved or particle sorbed) and the concentration of contaminant:

$$S_1 = K_1 C_T \quad (13.41)$$

where  $K_1$  is first-order decay rate ( $\text{day}^{-1}$ ).

When dealing with first-order biodegradation reactions, the use of a half-life rather than a rate is often convenient. If a half-life is specified for the transformation processes, then it is converted to first-order rate constant

$$K_1 = \frac{\ln 2}{t_{1/2}} \quad (13.42)$$

### 13.4.4.3 Second-Order Decay

The second-order reaction allows the user to simulate the effect of processes not considered. The second-order reaction depends upon a rate constant and an environmental parameter that may be taken to represent, for example, some reducing or oxidizing agent:

$$S_2 = K_2 E \cdot C_T \quad (13.43)$$

where

$K_2$  is the second-order decay rate ( $\text{day}^{-1}$ )

$E$  is the intensity of environmental property upon which the second-order reaction depends ( $\text{g}/\text{m}^3$ )

### 13.4.4.4 Hydrolysis

Hydrolysis is contaminant transformation by reaction with water. The hydrolysis rate is dependent on the pH. Chemicals in water may react with positively charged hydronium ions  $[\text{H}^+]$ , negatively charged hydroxide ions  $[\text{OH}^-]$ , or neutral water molecules. The reactions are first order for the neutral chemical and second order for the acidic or basic forms of the chemical:

$$S_{hyd} = K_{hyd} C_T \quad (13.44a)$$

$$K_{hyd} = k_{acid} [\text{H}^+] + k_{neutral} + k_{base} [\text{OH}^-] \quad (13.44b)$$

where

$K_{hyd}$  is the hydrolysis rate ( $\text{day}^{-1}$ )

$k_{acid}$  is the second-order acid hydrolysis rate ( $\text{m}^3/\text{g}/\text{day}$ )

$k_{base}$  is the second-order base hydrolysis rate ( $\text{m}^3/\text{g}/\text{day}$ )

$k_n$  is the first-order neutral hydrolysis rate

$[\text{H}^+]$ ,  $[\text{OH}^-]$  are concentrations of hydronium and hydroxide ions, respectively ( $\text{g}/\text{m}^3$ )

### 13.4.4.5 Volatilization

Volatilization is the gradient-driven transfer of a contaminant across the air–water interface. The rate at which volatilization occurs is dependent on the mass transfer coefficient at the air–water interface and the concentration of contaminants in the water column. The CTT&F assumes that only dissolved contaminants can be transported across the interface, and sorption to particulate or DOC reduces volatilization. Volatile contaminant concentrations in the atmosphere are often much lower than partial pressures equilibrated with water concentrations. In such case, volatilization reduces to a first-order process with a rate proportional to the conductivity and surface area divided by volume:

$$S_{vlt} = K_{vlt} f_d C_T \quad (13.45a)$$

$$K_{vlt} = k_v \frac{1}{h} = k_v \frac{A_s}{V_w} \quad (13.45b)$$

where

$k_v$  is the volatilization transfer coefficient across the air–water interface ( $\text{m}/\text{day}$ )

$V_w$  is the volume of the water column ( $\text{m}^3$ )

Volatilization is commonly modeled based on the well-known two-film theory of a gas–liquid transfer velocity. Equilibrium is assumed between the concentrations of the contaminant in the gas film and the liquid film according to Henry’s law. Only the free dissolved contaminant is available for volatilization. The two-resistance method assumes that two “stagnant films” are bounded on either side by well-mixed compartments. Concentration differences serve as the driving force for the water layer diffusion. Pressure differences drive the diffusion for the air layer. From mass balance considerations, it is obvious that the same mass must pass through both films, thus the two resistances combine in series, so that the conductivity is the reciprocal of the total resistance:

$$k_v = \left( K_L^{-1} + (K_H K_G)^{-1} \right)^{-1} \quad (13.46)$$

where

- $K_L$  is the mass transfer coefficient for the liquid film (m/day)
- $K_G$  is the mass transfer coefficient for the gaseous film (m/day)
- $K_{O_2}$  is oxygen reaeration rate (m/day)
- $K_H$  is dimensionless Henry’s constant

The liquid film mass transfer coefficient can be related to the oxygen transfer coefficient by the following:

$$K_L = K_{O_2} \left( \frac{32}{MW} \right)^{0.25} \quad (13.47)$$

where

- $K_{O_2}$  is the oxygen reaeration transfer coefficient (m/day)
- $MW$  is the molecular weight of chemical (g/mol)

For the gas film mass transfer coefficient, the following formula is provided by [18]:

$$K_G = 168u_w \left( \frac{18}{MW} \right)^{0.25} \quad (13.48)$$

where  $u_w$  is wind speed (m/s).

#### 13.4.4.6 Dissolution

Dissolution is the mechanism by which solid contaminants are transferred to the aqueous phase as dissolved contaminants. Once dissolved, the contaminant is available for redistribution and the full range of applicable transport and transformation processes. The maximum aqueous concentration that a solid phase contaminant can attain is defined by the solubility limit. Inclusion of contaminant aqueous dissolution improves model accuracy and has the potential to aid prediction of hazard persistence and assessment of remediation alternatives affected by dissolution of contaminants [14]. Dissolution of a solid particle in water can be described as a diffusion process [7,15] driven by the concentration gradient around a solid particle, which is expressed as follows:

$$S_{dsl} = K_{dsl} (S - f_d C_T) = \frac{k_{dsl} \alpha}{V} (S - f_d C_T) \quad (13.49)$$

where

- $V$  is the bulk volume (water and particles) (m<sup>3</sup>)
- $k_{dsl}$  is the dissolution mass transfer coefficient (m/day)
- $\alpha$  is the area available for mass transfer between the solid and liquid (m<sup>2</sup>)
- $S$  is the aqueous solubility of the contaminant (g/m<sup>3</sup>)

### 13.4.4.7 Reaction Yields

The contaminants simulated by CTT&F may be linked in sequences through reaction yields. When two or more contaminants are simulated, linked transformations that convert one chemical state variable into another may be implemented by specifying a reaction yield coefficient for each process. Reaction yields for transformation processes are useful in transport models to estimate the persistence of contaminants, including their degradation products

$$K_y = \sum_j k_{yj} Y_{kj} \quad (13.50a)$$

$$S_y = K_y C_T \quad (13.50b)$$

where

$k_{yj}$  is the reaction rate coefficient for reaction “ $k$ ” ( $\text{day}^{-1}$ )

$Y_{kj}$  is the effective yield coefficient from chemical “ $j$ ” undergoing reaction “ $k$ ” (g/g)

$K_y$  is the reaction rate coefficient for reaction “ $k$ ” ( $\text{day}^{-1}$ )

### 13.4.4.8 Source and Sink Terms

Kinetic reaction and transformation processes are represented as source or sink terms ( $\Sigma S_k$ ) as noted previously. In their most basic reaction rate form, they are represented as first-order processes that depend only on the concentration of the contaminant undergoing reaction. Transformations can also be described as second-order processes in conjunction with parameters to describe environmental conditions, such as oxidant or microorganism concentrations, pH, or solubility, allowing greater specificity with respect to contaminant phases and conditions controlling a reaction. In CTT&F, transformation algorithms of contaminants are handled in the same manner in the upper bed sediment as in the water column. The description of water column transformation algorithms provided also applies for transformation in the upper bed sediment. The total biochemical transformation fluxes can be computed as follows:

$$\Sigma S_s = (K_1 + K_2 + K_{hyd} + f_d K_{vlt} + f_d K_{dsl} + K_y) C_T \quad (13.51)$$

The transfer between water column and the upper layer of the bottom deposition is determined by adsorption–desorption and diffusion processes. Contaminant diffusion through interstitial water is a process which accounts for migration phenomena not related to sediment transport. Adsorption and desorption of a contaminant by the surface bed sediment are the main chemical exchange processes. The sedimentation of contaminated suspended sediments and the bottom erosion are also important pathways of the “water column–bottom” contaminant exchange.

## 13.5 Summary and Conclusions

This chapter introduced the concept of NPS and water quality modeling. Modeling approaches and models for estimating NPS loading exported from a watershed and predicting receiving water quality concentrations were concisely discussed. NPS and water quality models take many different shapes and sizes, with varying degrees of complexity and geographic coverage. One common type of model uses the principle of mass balance as a basis to predict the transport and fate of NPS contaminants. Mass balance is based on the principle that the entire mass of contaminant must be accounted for in the model. Many watershed-based NPS models have been developed, from the lumped parameter models to physically based distributed models. The lumped parameter watershed NPS model assumed there is no transport within the subbasin and used a simple transport algorithm in riverine system. A distributed NPS model is more complex than the lumped parameter model. In the future, watershed models based on the best



representation of physical processes will remain an essential part of understanding and modeling NPS contaminants. Greater efforts are needed to focus on algorithms that describe a mathematical relationship on how contaminants move from one compartment to another and computational techniques, including both new developments and enhancements of existing models.

Water quality models have been developed, aiming at describing spatial and temporal changes of contaminants of concerns in water bodies. Such models show different levels of complexity. They rely on watershed models to provide data on forcing functions, in particular NSP loads. An advantage of linked watershed and water quality models is that they can provide understanding of cause–effect mechanisms over large spatial scales that are impossible to derive solely from observed data. One limitation of this linkage is that current watershed models simulate less state variables compared with water quality models. The challenges faced in future NPS modeling have reflected the need to deal with spatial variability and the need to consider explicitly linkages among watershed models and water quality models. The need of expanding existing watershed model capabilities for additional state variables and processes has arose as a result of the augmentation of water quality objectives. To conduct a system-wide assessment of NPS contamination, the watershed and water quality models need to utilize a common water quality and contaminant kinetics to facilitate their linkage and application on a system-wide basis.

NPS and contamination of water bodies have been major problems in water quality and ecosystem management. Both problems have been subjected to extensive research and modeling. Water quality modeling for nutrient cycles is more advanced. Few models are available for modeling multiphase and multipathway chemical transport and fate at the watershed scale because of the vast number of chemicals and the inherent complexity of their behavior. For example, some chemicals can form soluble complexes with organic and inorganic ligands, sorb/bind with organic and inorganic particulates, and precipitate or dissolve. A chemical simulation model must compute ionic speciation for a given set of environmental conditions in order to predict these chemical behaviors correctly. The biogeochemical controls on chemical fate in environments involve complex linkages of biological and geochemical processes, which will affect their location, magnitude, and rate. Many more chemical types will need to be addressed, including metals and emerging contaminants. Existing chemical simulation models are limited in the range of chemical processes and contaminants they can represent. Water quality models must use the correct process mechanism and algorithm in order to make creditable concentration predictions.

Thus, a fundamental identification and mechanistic understanding of how these factors will drive the biogeochemistry of a particular contaminant is required. Modeling the fate of contaminants requires one to consider not only the biogeochemistry of these contaminants but also the other environmental factors such as pH, redox potential, and nature of the sediment particles and their reactive surfaces.

## References

1. Abbott, M.B. and Refsgaard, J.C. 1996. *Distributed Hydrological Modelling*. Kluwer Academic Publishers, Dordrecht, the Netherlands, 321p.
2. Bagnold, R.A. 1977. Bed-load transport by natural rivers. *Water Resour. Res.* 13:303–312.
3. Brown, L.C. and Barnwell, T.O. 1987. The Enhanced Stream Water Quality Models QUAL2E and QUAL2E-UNCAS: Documentation and User Manual, EPA-600/3-87/007. U.S. Environmental Protection Agency, Athens, GA.
4. Cerco, C.F. and Noel, M.R. 2004. The 2002 Chesapeake bay eutrophication model, EPA 903-R-04-004, U.S. Environmental Protection Agency, Annapolis, MD.
5. Chapra, S.C., Pelletier, G.J., and Tao, H. 2007. *QUAL2K: A Modeling Framework for Simulating River and Stream Water Quality, Version 2.07: Documentation and Users Manual*, Civil and Environmental Engineering Department, Tufts University, Medford, MA.
6. Chapra, S.C. 1997. *Surface Water Quality Modeling*. The McGraw-Hill Companies, Inc., New York.

7. Cussler, E.L. 1997. *Diffusion Mass Transfer in Fluid Systems*, 2nd edn. Cambridge Press, New York.
8. Cole, T.M. and Well, S.A. 2008. CE-QUAL-W2: A two-dimensional, laterally averaged, hydrodynamic and water quality model, version 3.6. Instruction report EL-08-1. U.S. Army Engineer Research and Development Center, Vicksburg, MS.
9. Downer, C.W. and Ogden, F.L. 2004. GSSHA: A model for simulating diverse streamflow generating processes. *J. Hydrol. Eng.* 9(3): 161–174.
10. Fergusson, J.E. 1990. *The Heavy Elements: Chemistry, Environment Impact and Health Effects*. Pergamon Press, Inc., New York.
11. Hamrick, J.M. 1996. A user's manual for the environmental fluid dynamics computer code (EFDC), The College of William and Mary, Virginia Institute of Marine Science, Special Report 331, 234pp.
12. Johnson, B.E., Gerald, T.K., and Zhang, Z. 2008. *System-Wide Water Resources Research Program–Nutrient Sub-Model (SWWRP-NSM)*. ERDC/EL-08-25, U.S. Army Engineer Research and Development Center, Vicksburg, MS.
13. Loague, K. and Corwin, D.L. 2005. Point and non-point source pollution. In: Anderson, M.G. (ed.) *Encyclopedia of Hydrological Sciences*. John Wiley & Sons, New York, pp. 1427–1439.
14. Lynch, J.C., Brannon, J.M., Hatfield, K., and Delfino, J.J. 2004. An exploratory approach to modeling explosive compound persistence and flux using dissolution kinetics. *Journal of Contaminant Hydrology* 66(3–4): 147–159.
15. Lynch, J.C., Brannon, J.M., and Delfino, J.J. 2002. Dissolution rates of three high explosive compounds: TNT, RDX, and HMX. *Chemosphere* 47: 725–734.
16. Martin, J.L. and McCutcheon, S.C. 1999. *Hydrodynamic and Transport for Water Quality Modeling*. Lewis Publishers, New York.
17. McElroy, A.D., Chiu, S.Y., Nebgen, J.W., Aleti, A., and Bennett, F.W. 1976. *Loading Functions for Assessment of Water Pollution from Nonpoint Sources*. Environmental Protection Technical Service, Washington, DC, EPA 600/2-76-151.
18. Mills, W.B., Dean, J.D., Porcella, D.B., Gherini, S.A., Hudson, R.J.M., Frick, W.E., Rupp, G.L., and Bowie, G.L. 1982. *Water Quality Assessment: A Screening Procedure for Toxic and Conventional Pollutants, Part I*, EPA-600/6-82-004a, Tetra Tech, Inc., Environmental Research Laboratory, U.S. Environmental Protection Agency, Athens, GA.
19. Park, K., Kuo, A.Y., Shen, J., and Hamrick, J.M. 1995. A three-dimensional hydrodynamic-eutrophication model (HEM-3D): Description of water quality and sediment process submodels (EFDC water quality model), Special Report in Applied Marine Science and Ocean Engineering No. 327, School of Marine Science, Virginia Institute of Marine Science, College of William and Mary, Gloucester Point, VA.
20. Rubin, J. 1983. Transport of reacting solutes in porous media: Relation between mathematical nature of problem formulation and chemical nature of reactions. *Water Resour. Res.* 19: 1231–1252.
21. Runkel, R.L. 1998. One-dimensional transport with inflow and storage (OTIS): A solute transport model for streams and rivers: U.S. Geological Survey Water Resources Investigations Report 98-4018, 73p.
22. Runkel, R.L. 2010. *One-Dimensional Transport with Equilibrium Chemistry (OTEQ): A Reactive Transport Model for Streams and Rivers*. U.S. Geological Survey Techniques and Methods Book 6, Chapter B6, 101p.
23. Thomann, R.V. and J.A. Mueller. 1987. *Principles of Surface Water Quality Modeling and Control*. Harper & Row Publishers, New York.
24. U.S. Environmental Protection Agency (USEPA). 2007. National Section 303(d) List Fact Sheet. U.S. Environmental Protection Agency, Retrieved June 13, 2007, [http://iaspub.epa.gov/waters/national\\_rept.control](http://iaspub.epa.gov/waters/national_rept.control).
25. Williams, J.R. and Berndt, H.D. 1977. Sediment yield prediction based on watershed hydrology. *Transactions of the ASAE* 20(6): 1100–1104.

26. Williams, J.R. and Hann, R.W. 1978. Optimal operation of large agricultural watersheds with water quality constraints. Texas Water Resources Institute, Texas A&M University, Technical Report No. 96.
27. Wool, T.A., Ambrose, R.B., Martin, J.L. and Comer, E.A. 2002. *Water Quality Analysis Simulation Program (WASP), version 6, User's Manual*. U.S. Environmental Protection Agency, Athens, GA.
28. Zhang, Z. and Johnson, B.E. 2011. The contaminant transport, transformation, and fate sub-model for predicting the site-specific behavior of distributed sources (munitions constituents) on U.S. Army training and testing ranges. Chappell, M.A., Price, C.L., and George, R.D. (eds.) *Environmental Chemistry of Explosives and Propellant Compounds in Soils and Marine Systems: Distributed Source Characterization and Remedial Technologies*, Vol. 1069. American Chemical Society, Chapter 14, pp. 241–272.
29. Zhang, Z. and Johnson, B.E. 2013. *Aquatic Nutrient Simulation Modules (NSM) Developed for Hydrologic and Hydraulic Models*. ERDC/EL-13-X, U.S. Army Engineer Research and Development Center, Vicksburg, MS.
30. HEC-HMS (Hydrologic Modeling System): <http://www.hec.usace.army.mil/software/hec-hms/>
31. BASINS (Better Assessment Science Integrating point & Non-point Sources): <http://www.epa.gov/waterscience/basins>.
32. SWMM (Storm Water Management Model): <http://www.epa.gov/nrmrl/wswrd/wq/models/swmm/>
33. SWAT (Soil and Water Assessment Tool): <http://swat.tamu.edu>
34. Sun, B., Zhang, Z. and Johnson, B.E. 2013. Improvement and Enhancement of 2D Hydrodynamic and Water Quality Model – CE-QUAL-W2. *Annual American Water Resources Conference*, Portland, OR.

# 14

## River Managed System for Flood Defense

---

14.1	Introduction .....	300
14.2	River System .....	300
14.3	Integrated River Management System .....	301
	Different Methods of River Management	
14.4	Flood Behavior .....	302
14.5	Flood Mitigation in River Basin .....	302
14.6	Flood Mitigation Methods in Regard to River Characteristics.....	303
	Structural Flood Mitigation • Nonstructural Methods in River Management	
14.7	Case Study.....	304
	Flood Defense in Iran • Integrated Golestan Flood Management	
14.8	Summary and Conclusions .....	313
	Acknowledgments.....	314
	References.....	314

**Akram Deiminiat**  
*KPM Consulting Engineers*

**Saeid Eslamian**  
*Isfahan University  
of Technology*

### AUTHORS

**Akram Deiminiat** was born on September 22, 1984, in Mashhad, Iran. She earned a bachelor's degree in water engineering at Birjand University of Iran. Then, she finished her studies in water structure engineering with a master's degree in 2007 from Urmia University of Iran. In 2007, she joined Kavosh Pay Mashhad Consulting Engineering Company. Her work experience runs to 6 years as an expert, designer expert, project manager, supervisor, and now as the head of River Engineering Department. Ms. Deiminiat, during her scientific activities, has published about 26 national and international papers and two chapters of an international *Handbook of Engineering Hydrology*. Also, she is a researcher and active member of Kavosh Water Resource Research Center having four research publications.

**Saeid Eslamian** received his PhD from the University of New South Wales, Australia, with Prof. David Pilgrim. He was a visiting professor in Princeton University, USA, and ETH Zurich, Switzerland. He is currently an associate professor of hydrology in Isfahan University of Technology. He is the founder and chief editor of *Journal of Flood Engineering* and *International Journal of Hydrology Science and Technology*. He has published more than 200 publications mainly in statistical and environmental hydrology and hydrometeorology.

## PREFACE

Flood occurs due to natural as well as man-made causes. Floodplains provide advantageous locations for urban and agricultural development. Unfortunately, the same rivers that attract development periodically overflow their banks causing loss of life and property damage. Therefore, there is a need for a catchment view of flood defense activities, integrated with environmental effects rather than a collection of unconnected individual measures. River management with a view to maximizing the efficient use of floodplains and to minimizing loss of life and property encourages the efficient use of the resources of the river basin as a whole, employing strategies to maintain or augment the productivity of floodplains, while at the same time providing protective measures against the losses due to flooding.

## 14.1 Introduction

Due to the position and value, the floodplains are the preferred places for investment and socioeconomic activities. Floods categorized as natural disasters, which may have both negative and positive impacts, and generally should not be considered a hindrance to economic development. Floods play a major role in replenishing wetlands, recharging groundwater and support agriculture and fisheries system, making floodplains preferred areas for human activities. Extreme demands on natural resources due to population growth have forced people and their property to move closer to rivers in many parts of the world. Further, flood control and protection measures have encouraged people to utilize newly protected areas extensively, thereby increasing flood risks and consequent losses [3].

Recurrent and extreme flooding, however, poses severe risks to development and has negative impacts on lives, livelihoods, and economical activities and can cause irregular disasters. Flood disasters result in the interaction between extreme hydrological events and environmental, social, and economic processes. These disasters have the potential to put development back by 5–10 years, particularly in the developing countries. The spiraling economic losses in developed countries have also given a rise to crucial concerns [19].

In the past decades, exposure to flood risks has been handled basically through structural measures. However, strategies that rely largely on structural solutions, for example, dams and reservoirs, embankments, and bypass channels, consequent to affect on the natural environment of the river, may result in loss of habitats, biological diversity, and ecosystem productivity. Further, structural approaches are bound to fail the moment an extraordinary or unforeseen event occurs. These traditional approaches, where the risks are merely transferred spatially, are likely to generate conflicts and inequities [3].

Environmental degradation is one of the potentials to threaten human security, including life, food, and health security. Therefore, considering river management issues with the goal of flood defense, which include investigation of both structural and nonstructural methods, is necessary.

## 14.2 River System

River is a narrow band of a basin. It is an environmental system and aquatic life. Sometimes, it is referred to as a riparian zone. It is a watercourse with two sections including main channel and floodplains. Rivers are founded in mountains or estuary. Totally, river is an immortal living system with different characteristics. Rivers change toward an equilibrium state.

Every river is the part of a large system called watershed. Actually, it is the land drained by a river and its tributaries. Rivers are the large natural streams of water flowing in channels and emptying into larger bodies of water such as lakes and seas.

The beginning of a river, which called headwaters, is the river source, which is located in mountains. The river source may be fed on by an underground spring or by a runoff from rain, snowmelt, or glacial melt. River includes tributaries, which are a smaller stream or river that joins a larger or main river, and the main river is the primary channel and course of a river. A developed floodplain is like a relatively flat land stretching from either side of a river. Built of materials deposited by a river, furthermore, the soil in floodplain is often rich in nutrients and ideal for growing food so there are some cultivation over there [16].

For much tourism, river is as a fishing, swimming, boating, and scenic beauty. But it is source and the backbone of a billion dollar economy indispensable to the daily lives of millions. There is some other use such as transferring by ships, producing power of electricity, constructing dam in order to reduce flood damage, and using as a recreational resource. While paying attention to different uses from rivers, river management and keeping it safe to provide us a safe drinking water and a healthy environment or aquatic life is necessary [16].

### 14.3 Integrated River Management System

---

Integrated river management (IRM) is a concept that addresses issue of human security against flood risks and sustainable development within a framework of integrated water resources management. Such an integrated approach to flood management can play an important role in the sustainable development and poverty reduction. IRM aims at minimizing the losses of lives due to the flooding while maximizing the net benefits derived from floodplains. As part of the approach, the reduction of flood risks is based on a judicious combination of measures dealing with the magnitude of the flood hazard and the community's exposure and vulnerability [19].

There are various constraints concerning physical, technical, economic, and political factors in all of the flood management approaches. Decision-making, societal values, perceptions of risks, and the trade-offs between development and environmental preservation differ among various stakeholders, but need to be taken into account [4].

Economic analysis not only helps to select the optimum level of adjustment to flood events on the basis of risk–safety trade-off decisions but also can help to realize an optimum combination of measures for the purpose.

There is a wide range of strategies for flood management comprising both structural and nonstructural measures including the option to live with flood. These options can provide maximum positive impact on people's welfare; and, can be evaluated through economic analysis [5].

The results of researches show the approaches that help to address socially relevance and its relation with environmentally friendly, economic analysis, targeting flood managers. However, there are no universal criteria to determine environmentally sensitive economic analysis in flood management. Therefore, adopting practices that show the particular circumstances in a given hydroclimate is very important [13].

#### 14.3.1 Different Methods of River Management

There are different methods for river management and flood defense in a river basin, which depend on different types of flood. There are several different types of flooding, and it is important to take into account of their characteristics in developing mitigation and alleviation measures.

In order to integrate river management in the main areas, the concerted action may be summarized as follows [13]: river basin modeling, river basin management, and flood mitigation.

River basin modeling models the river basin in order to determine the river basin characteristics, river flow, and rainfall and runoff. These parameters help us to manage the river basin with different structural and nonstructural measures. One of the most important issues in IRM is the flood management. Flood management helps us to reduce life and poverty damages induced by flood events.

Flood management divides into two main categories: flood structural management and nonstructural management, which when used simultaneously will be effective in reducing damages. The proper actions in order to reduce damages induced by flood called flood mitigation. There are different methods of flood mitigation, which depend on the kind of flood occurred, the characteristics of river basin, severity of flood, the kind of river, and especially financial issues. Usually methods that are effective to reduce flood will be selected after study on river basin and its modeling [5].

## 14.4 Flood Behavior

---

Flooding is a form of behavior therapy and is based on the principles of respondent conditioning. It is sometimes referred to as exposure therapy or prolonged exposure therapy. As a psychotherapeutic technique, it is used to treat phobia and anxiety disorders including posttraumatic stress disorder. It works by exposing the patient to their painful memories with the goal of reintegrating their repressed emotions with their current awareness.

Flooding is a psychotherapeutic method for overcoming phobias. This is a faster method of ridding fears when compared with systematic desensitization. In order to demonstrate the irrationality of the fear, a psychologist would put a person in a situation where they would face their phobia at its worst. Under controlled conditions and using psychologically proven relaxation techniques, the subject attempts to replace their fear with relaxation. The experience can often be traumatic for a person, but may be necessary if the phobia is causing them significant life disturbances. The advantage to flooding is that it is quick and usually effective. There is, however, a possibility that a fear may spontaneously recur.

Flooding is an effective form of treatment for phobias among other psychopathologies. It works on the principles of classical conditioning or respondent conditioning where patients change their behaviors to avoid negative stimuli.

From the viewpoint of hydrological and hydraulic issues, the meaning of flood behavior is how it forms when it starts, what is the severity of flood, and what sources are affected by flood. In order to flood management and reducing flood damage, predicting the flood behavior using flood experience and rainfall–runoff models is crucially important. Predicting flood behavior makes authorities ready to do early emergency actions for keeping people away from the flooded area and reducing their property damages.

## 14.5 Flood Mitigation in River Basin

---

Flood mitigation is one of the practical crucial methods in flood damage reduction. Although complete protection from flood disaster is not possible, a major part of damages can be reduced by mitigation plans. Mitigation action is taken before, during or after a disaster; and, it eliminates the disaster potential and the damage.

There are different mitigation plans, which should include one or more practical measures to reduce the flood damage. These practical measures involve two main methods such as the structural and non-structural methods of flood mitigation that have been categorized in the following text [1,10].

Normally, a flood mitigation plan should cover the following issues:

- The best implementation method to control the flood
- The most appropriate location to install the facilities
- The most suitable size for the facilities
- The best method for operation and maintenance of the facilities

Generally speaking, the selected method has to be an optimum plan. In order to determine the optimum alternative plan for mitigation, the location, the size of the structures, and operation condition of different alternatives should be presented. All methods will be evaluated by economic criteria of flood damage reduction and investment cost.

The most important items, which have to be mentioned excepting the other items, are the impact of flood risk on river system and the residents of danger zone.

Making necessary activities for flood mitigation is different in various situations before flood, during flood, and after flood in which the following items are included:

1. Preflood activities include
  - a. Flood risk management for all causes of flooding
  - b. Preparing flood hazard maps that indicate inundated and safe areas
  - c. Construction of physical flood defense infrastructure
  - d. Implementation of forecasting and warning systems
  - e. Land-use planning and management within the whole catchment
  - f. Discouragement of inappropriate development within the floodplains
  - g. Public communication and reduction of flood risk and actions to take in a flood emergency
2. Operational flood management before and during the flood
  - a. Predicting flood occurrence
  - b. Forecasting future river flow conditions from the hydrometeorological observations
  - c. Flood warning to the appropriate authorities and the public on the extent, severity, and timing of the flood
3. Performing the postflood activities with paying attention to the severity of the flood events may include
  - a. Identifying the inundated areas
  - b. Setting up appropriate camps for the stay of those affected by the disaster
  - c. Relief for the immediate needs of those affected by the disaster
  - d. Reconstruction of damaged buildings, infrastructure, and flood defenses
  - e. Setting up the equipments, which are needed by stricken people
  - f. Recovery of the environment and economic activities in the flooded area
  - g. Review of the flood management activities to improve the process and planning for future events in the area affected and, more generally, elsewhere [13]

## 14.6 Flood Mitigation Methods in Regard to River Characteristics

As mentioned in previous paragraphs, one of the important items in flood management is evaluating the utilization of possible methods for reducing flood damages to existing buildings and other facilities and reducing flood risk to permit additional growth. Two principal types of measures are considered: nonstructural measures and structural measures, which involve civil works in the floodplain and/or catchment. Nonstructural measures include zoning to limit the types of land uses permitted to those that may not be severely damaged by floods, protection of individual properties, flood warning system to evacuate residents and to move valuables, and flood insurance to recognize the risks of floods and to provide compensation when damages are not avoidable at acceptable cost [5].

The optimum flood mitigation master plan has to be determined by economic evaluation of the trade-off between the construction costs and expected value of damage reduction as the benefits. Totally, a flood mitigation plan has to be a complete plan with attention to different items in a river.

### 14.6.1 Structural Flood Mitigation

Structural river plans are traditionally known as the methods of flood mitigation, and these methods are used more in general flood management in the most flooded areas. Although recently the nonstructural measures have taken into consideration as effective methods of flood mitigation, they would not be more effective without attending to structural methods. Flood reduction will occur when the mitigation



methods reduce the magnitude of flood or vulnerability of the affected area. The flood mitigation study will identify the vulnerability potential of areas of flooding and determine the best methods to reduce damages. Also, it is necessary to carry out a cost/benefit analysis for the mitigation methods [5].

### 14.6.2 Nonstructural Methods in River Management

One of the flood mitigation measures that have been recently mentioned by scientists [8] is the non-structural measures, which include flood forecasting, flood warning and emergency planning, and providing flood insurance to affected people and poverty. The nonstructural measures such as flood forecasting and warning systems often inform about the development of a flood and play a crucial role in minimizing life and poverty damages caused by sudden floods. Also, the experiences show that the nonstructural plans are the most economic one than the structural plans. Therefore, the establishment of the following shall be indispensable to prevent the enormous losses against succeeding disasters and to secure the people's lives:

1. Flood hazard map, which indicates how floodwater extends during a flood in a certain area such as residents, office, schools, etc. It also shows the wide and deep changes of floodwater and that which lands will be safer and which direction should be taken for emergency evacuation.
2. Flood forecasting and warning system, which predicts the flooding before it occurs and warns the flood occurred to people and authorities.
3. Decision support system (DSS), which indicates the output data from flood forecasting and warning system. It helps decision-makers to do appropriate emergency action against the flood hazard. Often, it shall be established in an emergency room [2].
4. Early flood warning dissemination system, which establishes near the inundation areas in order to warn the residents and related offices using a telemetry and telecommunication system for early warning dissemination and keeping people away from the dangerous ones [18].

## 14.7 Case Study

---

In order to indicate a natural sample of integrated flood management, a case study and its experiments are shown in the following paragraphs.

### 14.7.1 Flood Defense in Iran

Iran is a country with many of the flooded areas, which is located near Caspian region from the north and Oman Sea from the south. Most of areas that are affected by flood every year are located in the north of Iran. The Caspian region, a northern part of Iran including provinces of Gilan, Mazandaran, and Golestan, has been frequently affected by the disasters of flood and debris flow.

In the Madarsoo River basin, which is one of the disaster-affected areas in this region, about 400 people and 50 people were killed due to the disasters of flood and debris flow during summertime in 2001 and 2002, respectively. Furthermore, thousands of livestock were lost, and a lot of infrastructures, such as bridges and roads, were washed out or destroyed.

In addition to the Madarsoo River basin, there are some rivers basins being composed of similar situations in hazardous topography and extreme climate in the region. For instance, about 50 people were killed by the disasters of flood and debris flow in the Nekka River basin in the Mazandaran Province [7].

Under such vulnerable situations suffering from flood and debris hazards in the Caspian region, effective countermeasures have not been carried out yet. Therefore, formulation of the master plan in the Madarsoo River basin and transfer of technologies, which are based on the study/research experiences and technical standards for similar basins, are urgently required in the Caspian region.

## 14.7.2 Integrated Golestan Flood Management

### 14.7.2.1 Golestan Province

Golestan Province with an area of 20,312 km<sup>2</sup> is situated in the southeast of the Caspian Sea, and it contains about 1.3% of total area of Iran. The province is located between 36° 44' and 38° 05' northern latitude and 53° 51' and 56° 14' eastern longitude of Greenwich meridian. It has an international border with Turkmenistan Republic on the north, and on the south, west, and east, it is situated in the vicinity of Semnan, Mazandaran, and Northern Khorasan provinces, respectively. The mountains Shahkuh, Siahmarzkuh, Chahbid, and the mountain chain of Kurkhud keep its southern and eastern parts with their limits. The most important townships of the province area are Gonad-e-Knaves with an area of 6856.8 km<sup>2</sup>, Minoodasht with an area of 6485.6 km<sup>2</sup>, and Gorgan with an area of 2848 km<sup>2</sup> (Figure 14.1).

This province combined two separate parts of flood initiator with an area of 9500 and flood affected with an area of 6800 km<sup>2</sup>. During 1992–2009, approximately 80 intensive raining occurred, which caused more than 250 heavy floods [7].

### 14.7.2.2 Golestan Flood

Golestan Province is located in the northern part of Iran and is very famous for agricultural production especially cotton. This area is faced with lots of flood-related problems and became the worst affected province as well as an interesting hydrological lab for related specialists. The August 2001 flood affected three provinces in northeastern Iran, resulted in many casualties, and damaged many forest areas and agricultural fields nearby.

Based on the information reported by UNDP (2001) about the flooding occurred in Golestan Province, the total number of people directly affected by the floods occurred following the region's worst flooding in 2001 years on August 10 was 217,796 out of which 10,000 are homeless although close to 1.2 million people have been directly or indirectly affected by the floods at varying degree. This flood occurred because of about 10 h rainfall having a depth of 170 mm. Furthermore, about 387 villages have been affected and 4000 buildings have sustained heavy damage. The deluge submerged around 15,000 ha of farmland and 10,000 ha of forest and pasture land. The damage was estimated to run into tens of millions of dollars. Due to waterlogging, malaria and diarrhea were of health concern in the affected areas. The number of deaths registered was around 600 in the province [12].

Another catastrophic flood also occurred on August 11, 2002, in the same region but in another watershed. The total damage of the second flood was comparatively much lesser because the susceptibility and vulnerability of the watershed area burden flood was less in comparison with the area inundated in the previous flood. The flood in August 2005 destroyed so many structures that were rehabilitated after the 2001 flood. Figures 14.2 and 14.3 show the flood disaster situation in 2005 flood along the Madarsoo River.

### 14.7.2.3 Experiences on River Management

Golestan Province has formulated the following aims to realize the rehabilitation, conservation, and regular exploitation of natural resources in watershed and to prevent the damage due to soil erosion, forest destruction, floods, drought, and sedimentation in dam reservoir [6].

1. Decreasing risks of natural and human disasters (flood and earthquake)
2. Protection and strengthening of production capacities with the performance of soil protection
3. Increasing national yields of capitals with the performance of improvement of farming and preventing from dam storage filling
4. Strengthening of underground water (aquifer) with flood spreading
5. Establishing occupation for rural and preventing migration from the villages to towns
6. Ratifying and legitimating exploitation sources in basins

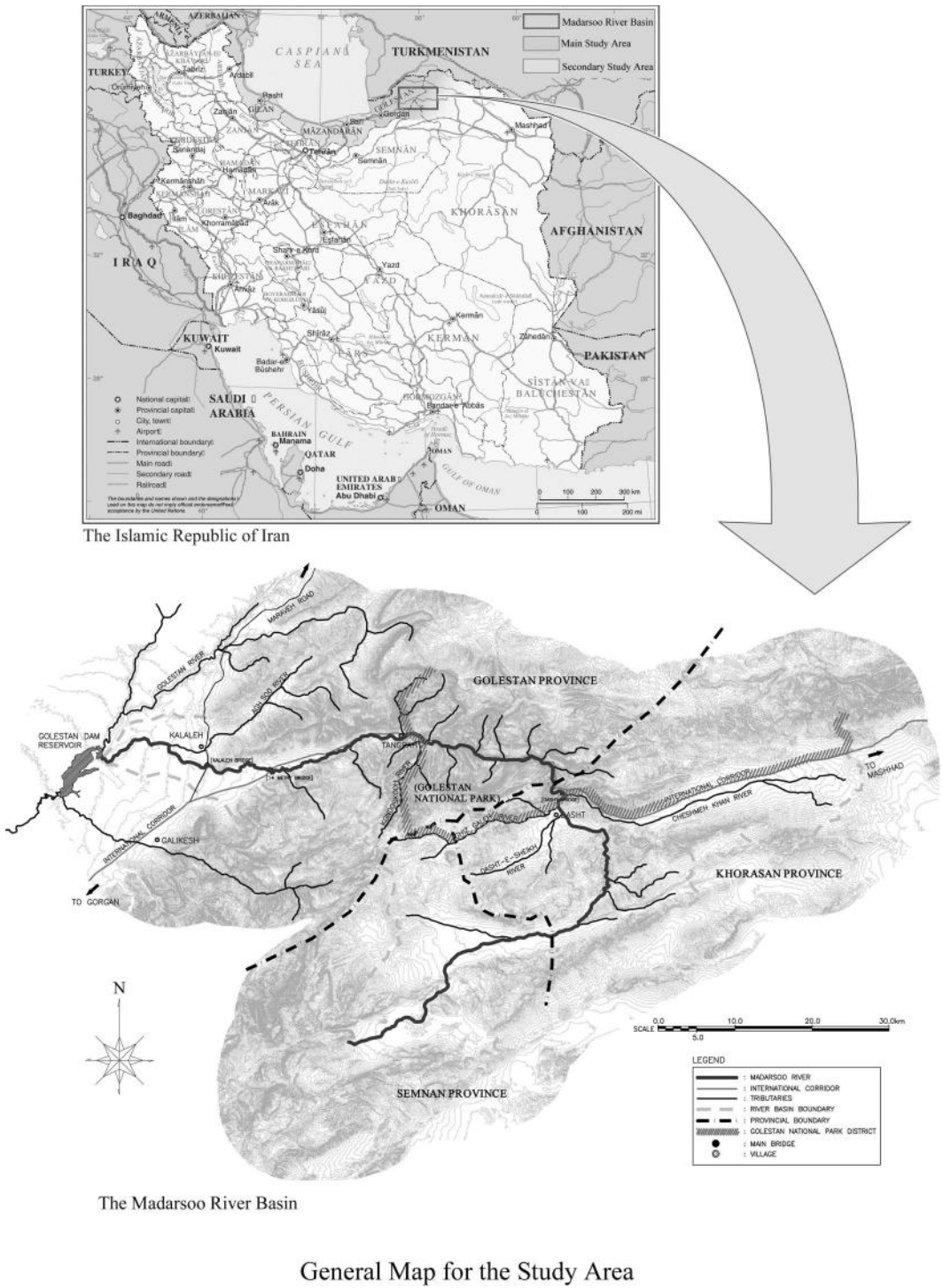


FIGURE 14.1 Geographical location of Golestan Province.



**FIGURE 14.2** Destruction of Kordkoy Bridge due to flood.



**FIGURE 14.3** Concrete dike near Loveh Village is washed away.

Performed activities can be divided into four groups to include rehabilitative manner of vegetation canopy, to establish reformation of the controlled reconstructions, to improve groundwater, to control flood, and to conduct watershed management:

1. Mechanical schemes  
Reducing flood destructive power and preventing the towns, villages, and farmlands from the damages of flood and sedimentation
2. Biological schemes

Rehabilitation of the canopy covers, reformation of the land use, increasing the crop yield, decreasing the runoff, and increasing the soil fertility

3. Combined management

Coordination between different activities, those that are available in watershed

4. Participatory application for people and finally life condition remediation

In this chapter, at first the mechanical plan (structure schemes) and, second, flood preparedness for people (nonstructural schemes) have been illustrated for flood control and management.

According to investigation [6], field surveys, and analysis regarding flood occurrence in the eastern part of the Golestan provinces, the following suggestion can be offered for flood mitigation, workable in immediate, short, and long terms:

1. With the effect of climate change and global warming, more and more floods are expected. We should therefore join our forces on prevention, mitigation, and preparedness. The most convincing argument is that why we should prevent, rather than respond to disasters.
2. Since the design and implementation of every flood control activity such as forecasting systems and engineering structures need the detailed and accurate data, equipping the watershed with pertinent climatologically and hydrometrical stations for collection of accurate data is necessary.
3. A comprehensive study is also very essential to prioritize different parts of watershed in flood generation as well as effective factors.
4. Design and reconstruction of appropriate and suitable structures such as ford instead of bridges, road cross drains, and selection of proper hydrologic design may be as another applicable technique for the prevention of flood damage in the watershed under study.
5. Structural measures such as dams may have a crucial role in flood impact controls as Golestan dam did in the case of occurrence of floods in August 2001 and 2002 in the study area through attenuating the flood peaks from 3000 and 600 m<sup>3</sup>/s to 300 and 0 m<sup>3</sup>/s, respectively, so extension of applying such techniques during a long time is advisable.
6. Beside international financial helps, the continuation of scientific meetings such as International Seminar of flash flood prevention and migration held in Gorgan, the province capital, on January 15, 2003, and January 16, 2003, and jointly organized by UNDP and Ministry of Interior of Iran was certainly helpful to find basic reasons of flood occurrence and the sound protection techniques as well [14].
7. Executive coordination between provinces, that have common watersheds viz. Golestan, Southern Khorasan, and Semnan in Golestan flood control, is also a must, which has to be kept in consideration.
8. In the study area, the torrent control through which the precipitated rainfall is controlled at the place is much preferable and economical than flood control.
9. Increasing the transportation capacity and training of the main river through cleaning, cutoff, debris collection, jetties, guide bank, and levees are other techniques approachable during time (Figure 14.4).
10. Public participation is another efficient approach that has to keep at the top of decision-making to let people share problem among them and find out the most desirable techniques for flood control in the area under consideration where many different communities and tribes exist.
11. The proposed river restoration plan aims to protect the human life. The proposed plan contains the main countermeasures to enlarge the flow capacity and to strengthen channel bed stability and bank protection of the existing rivers against a probable flood occurrence.

The proposed plans were the following:

- a. Enlarge the channel width using concrete block, gabion mattress, and revetment expanding in Gelman Darreh-Madarsoo River and Dasht-e-Sheikh River.
- b. Construct diversion channels, flood control dam, and sediment control dam in Ghiz Galeh River.



**FIGURE 14.4** Constructing a debris flow.

Despite implementing many of the earlier suggestions to control and manage the flood and, constructing and rehabilitating structures, the flood in August 2005 destroyed many structures that were rehabilitated.

In order to review the flood management activities, improve the process and planning, and recover and regenerate the environment and economic activities in the flooded area, more structures had restored again, and new nonstructural methods have been proposed. The nonstructural method that was suggested as an effective flood mitigation procedure in Golestan basin was an integrated system including a DSS, early forecasting and warning system, and preparedness plan.

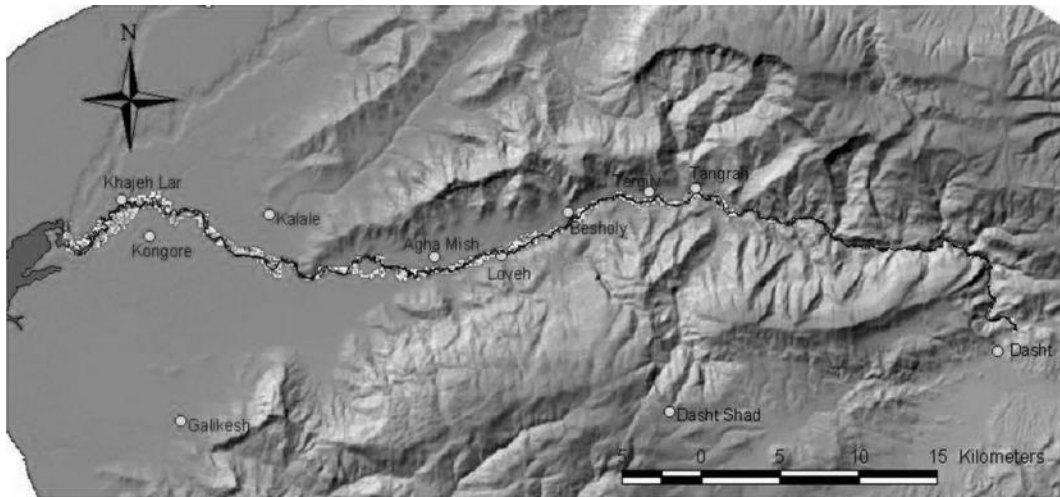
#### **14.7.2.4 Defining an Integrated System**

Establishing a viable flood forecasting and warning system for communities at risk requires the combination of data, forecasting tools, and trained forecasters. In the overall design of the integrated system, there are many factors that should be considered. These factors include basin characteristics (a record of such information over time is useful in establishing the dynamic relationship between rainfall and runoff), flood history, environmental factors (can help to shape future approaches to floodplain management and regulation, and can assist in the design and establishment of response actions), communities at risk (the basin characteristics and flood history of individual communities combined with damage estimates from previous floods will give some indication of the type of flood forecasting and warning system that may be most suitable for effective warnings), benefit and cost analysis, evaluating existing capabilities, identification of key users and collaborators, and determination of specific forecast system requirements [15,17].

#### **14.7.2.5 Flood Hazard Map**

Dissemination of the flood hazard map is broadly adapted in the world as one of the useful nonstructural flood mitigation measures. Through dissemination of the flood hazard map, the residents could be aware of the extent of the possible flood inundation area and available evacuation routes during floods.

The flood hazard map could also be the guidance for appropriate urban planning and land development. The flood hazard map, in general, contains the information on (1) the probable extent of flood inundation and (2) the evacuation sites and evacuation routes to be taken during floods. The extent of the probable flood inundation is delineated on the base map.



**FIGURE 14.5** Flood map calculated with MIKE 21 for 1600 m<sup>3</sup>/s constant discharges.

The available evacuation sites as well as evacuation routes for each unit of the local communities should be further selected by the relevant local government agencies based on the basic maps, and the flood hazard map should be finalized. The flood risk map thus prepared should be disseminated to the public through a bulletin, an information board, and other available information tools. Figure 14.5 shows the flood hazard and evacuation map.

#### 14.7.2.6 Flood Warning Decision Support System

The decision support tools are embedded in Golestan river basins. DSS provides a fully interactive environment where information is presented visually in an easy-to-understand plan. Flood-affected properties and population can be quickly identified during a flood event. They provide a clear visual presentation of where certain communities may be cut off and isolated, and which evacuation routes may be flooded. The DSS performs real-time flood predictions based on the real-time data provided by meteorology model. In general, the input to the DSS is the predicted water level. Figure 14.6 shows the layout of DSS for flood warning emergency management. It comprises three main elements: hydrological model, hydraulic model, and geographic information system (GIS) platform [9].

##### 1. Hydrological Element

Hydrological modeling components of this system are currently undertaken by the Bureau of Meteorology of Quebec University. The software platform for hydrological modeling is HEC-HMS model (U.S. Army Corps of Engineering). The model uses rainfall data in a region as input and generates flow hydrographs, which in turn will be used as input to the hydraulic models.

##### 2. GIS Element

Central to the DSS is a GIS user interface based on Arc GIS software platform. The flood surface is an input to the GIS tool, which can be generated in various methods (as explained in the following sections of the chapter). The output of GIS are answers to the flood emergency manager questions for decision-making, simulates flood levels. Also, it can generate the following information in the form of map, graph, or table [14]:

- a. Flood-level map
- b. Flood inundation map
- c. Evacuation route map

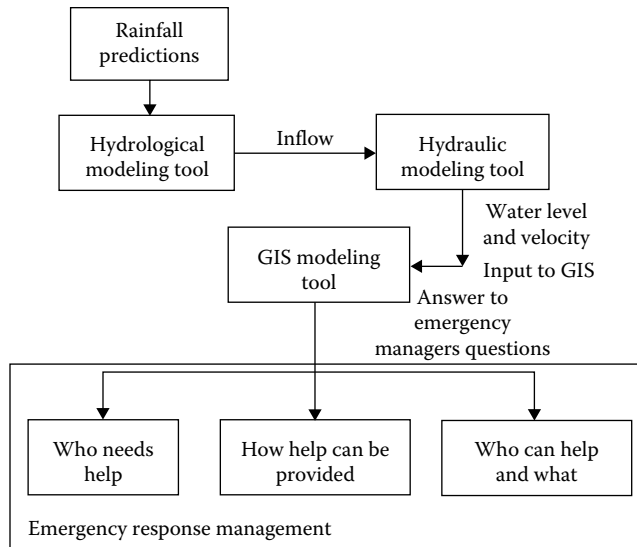


FIGURE 14.6 Flood warning decision support system layouts for river flooding.

- d. House-specific flood inundation information (for properties that have been surveyed)
- e. Hazard and vulnerability maps
- f. Flood flow velocity maps
- g. A report containing a list of inundated houses and vulnerable elements

The GIS data that are used for this system are mainly sourced from meteorology organization, survey organization, and local government.

### 3. Hydraulic Element

In this mode, a static link is established between the three main elements of the DSS such as hydrological, hydraulic, and GIS tools. The results of the hydrological modeling are provided for hydraulic modeling. Then, a multitude of outputs through the GIS element of the system is provided for hydraulic modeling. Finally, a multitude of outputs through the GIS element of the system are produced.

#### 14.7.2.7 Flood Preparedness Plan

##### 1. Flood Preparedness Requirements

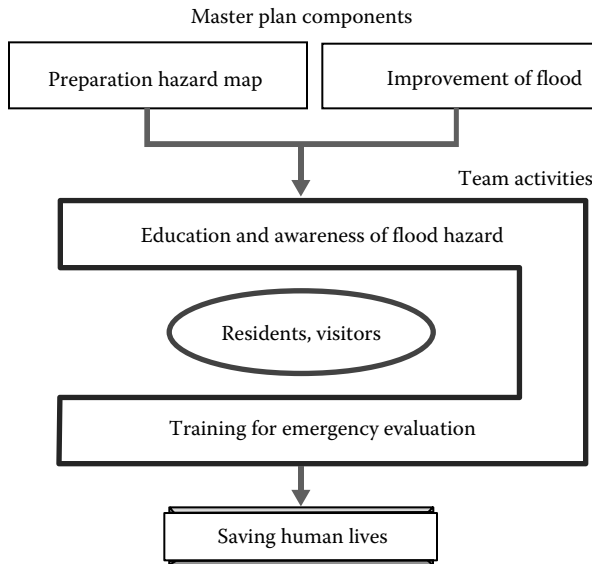
The flood preparedness is usually regarded as comprising measures that enable governments, organizations, communities, and individuals to respond rapidly and effectively to flood disaster situations. In general, flood preparedness measures are the following [6]:

- a. Provisions for emergency action, such as evacuation
- b. Provision of warning system
- c. Emergency communications
- d. Public education and awareness
- e. Training including exercises and tests

The flood preparedness is the most critical and important part in the entire disaster management, because it is the nearest and closest provision to residents who might be casualties in the floods. The relations between the master plan and flood preparedness are illustrated in Figure 14.7.

The warning system is used for issuing flood warnings after analyzing the model predictions. It is based on the results of the hydrological simulations resulting from the array of meteorological models or can also include other forecast systems such as radar technology. It allows visualization of flood warnings as a GIS map layer with descriptive station and marks.





**FIGURE 14.7** The base map master plan components and team activities in flood preparedness.

The process of complicated data transfers within the system that is automated by the developed telemetry system consists of a main station beside river, a repeater station located on elevation, and alarm stations located along river and crisis room. In order to link between stations, different telecommunication such as VPN, radio waves (VHF or UHF), and GPRS are used.

The analyzed data are transferred to receiver located in the main station using VPN, and then the data are transferred to repeater station as a frequency using radio wave. Repeater station transfers the frequency to alarm stations and crisis room. Simultaneous critical data are transferred to authorities using GPRS and mobile. Decision and warning are based on critical data that are determined by model base subsystem; also users can control all stations and subsystems, and they can discover any problem in the system. In this chapter, the flood warning system is based on local forecasting. This system consists of telemetry and DSS. Telemetry is defined to collect information from different stations and their monitoring. The data used by the modeling system include correct and useful data streams. The existing data collection system had to be expanded to provide sufficient and good quality data to support the forecasting system, which could be polled at regular and specific intervals in given case study. The system consists of rain gauges and river level gauges. Also, in order to establish a link between different stations and transfer information between them, telecommunication bed had been used. Figure 14.8 illustrates telecommunication between different parts of alarm stations located along Doogh River.

The target people who suffer from severe flood disaster damage include visitors and campers in the Golestan Forest Park. In particular, visitors and campers may have little knowledge and information concerning risks in the area. When a flood and debris flow disaster occurs, such people would easily panic resulting in a more severe damage, as witnessed in the 2001 flood. In this context, it is necessary to publicize the flood and debris flow hazard map to visitors and campers in the Golestan Forest Park as well as the local inhabitants to avoid such panic and to encourage for affording them

- To save their own lives
- To help each other
- To inform administrations

In relation to the hazard map, the following public information efforts are also effective for the disaster preparedness:

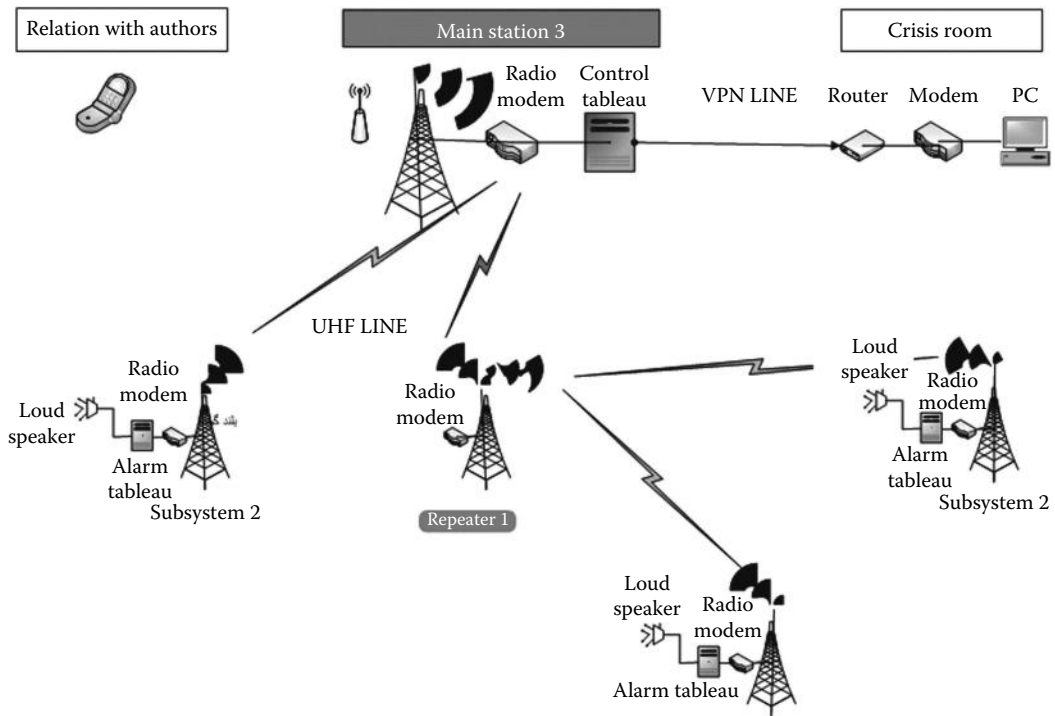


FIGURE 14.8 Telecommunication line between many parts of stations.

- Installation of signboards
- Distribution of leaflet/newsletter
- Dissemination of information through Internet

## 14.8 Summary and Conclusions

It is not possible to protect everyone, everywhere against flooding eventuality. Extreme or unpredictable events can happen. While the physical defenses may provide a low level of protection, they may be breached. As it is noticeable, the first step for the control and mitigation of flood disasters is performing integrated river basin management. The presentation of correct management methods and the production of a master plan with the goal of creation of good structural and nonstructural management plans against flood disasters are very necessary [5].

The experiences of using structural flood control method for flood defense in Golestan Province show that it is not always feasible to completely control or manage flood damages through structural measures due to economic, technological, environmental, and social constraints. In addition, structural approaches are bound to fail the moment an extraordinary or unforeseen event occurs. Once flooding overwhelms existing mitigation and early flood warning, computer- and telemetry-based method as a flood emergency management is the main tool for providing safety to the community and protects their life and property against huge flood. Finally, the results show that the nonstructural schemes had a close relationship with structural schemes in accordance with area characteristics. The nonstructural schemes such as creating flood hazard map which indicates how widely and deeply the floodwater extends during floods in certain probabilities, telemetry-based method to give suitable information to decision-makers for an announcement of flood warning and necessary actions had so important role than the structural schemes in mitigation of flood disasters, particularly financial losses which had been calculated.

## Acknowledgments

---

The information has been supported by Golestan Water Board; so, the authors would like to acknowledge this organization. The authors would also like to acknowledge the number of coworkers at KPM Consulting Engineers for providing proper information to do this study.

## References

1. Almeida, B., Ramos, C.M., Santos, M.A., and Viseu, T. 2003. *Dam Break Flood Risk Management in Portugal*, Lisbon, Portugal, LNEC, pp. 265.
2. Ahmad, S. and Simonovic, S.P. 2006. An intelligent decision support system for management of flood, *Water Resource Management Journal*, 20: 391–410.
3. APFM (2009). *Integrated Flood Management*, Geneva, Switzerland, World Meteorological Organization.
4. Bureau of Meteorology. 2010. Flood warning system for the Fitzroy river, Htm, Australian Government, Brisbane, Australia.
5. Heidari, A. 2009. Structural master plan of fl St mitigation measures, *Natural Hazards Earth System Sciences*, 9: 61–75.
6. JICA, 2006. Flood and debris flow in the Caspian coastal and focusing on the flood-hit region in Golestan province. Ministry of Jihad-e-agriculture, Golestan, Iran.
7. KPM, 2010. The integrated system for flood warning system and emergency action plan in Golestan River basin, A Report. Golestan Water Resource Co, Golestan, Iran.
8. National Flood Risk Advisory Group, 2008. Flood risk management in Australia. *The Australian Journal of Emergency Management*, 23(4): 20–27.
9. Patterson, B. 2007. Flood emergency decision support system development. Report for the Gold Coast City Council.
10. Plate, E. 1997. *Dam and Safety Management at Downstream Valleys*, Rotterdam, the Netherlands, A.A. Balkema, pp. 27–43.
11. Rosmayati, M. 2010. Decision Support System (DSS) in construction rendering processes, *International Journal of Computer Science Issues*, 7(2): 35–45.
12. Sadeghi, S.H. 2004. Study on consequent flood occurrence in a part of Northern Iran. *International Symposium, Interpraevent*, Iran, pp. 20–27.
13. Samuels, P.G. 1999. Integrated river management and flood risk. *Proceedings of the EuroConference on Global Change and Catastrophe Risk Management: Flood Risks in Europe*, England.
14. Simonovic, S.P. and Ahmad, S. 2005. Computer-based model for flood evacuation emergency planning, *Natural Hazards*, 34(1): 25–51.
15. Tate, E. and Cauwenberghs, K. 2005. An innovative flood forecasting system for the Demer basin: A case study, *International Journal of River Basin Management*, 3(4): 1–5.
16. Vanmierlo, M.C.L.M. 2007. Assessment of fl as risk accounting for river system behavior, *International Journal of River Basin Management*, 5(20): 93–104.
17. Wang, J. 2007. Development of a decision support system for flood forecasting and warning—A case study on the Maribyrnong River, A PhD Thesis: School of Architectural, Civil and Mechanical Engineering, Faculty of Health, Engineering and Science, Victoria University, Melbourne, Australia.
18. Water Resources Council Victoria (WRCV), 2005. Flood management and drainage strategy. A report, Port Philip and Westernport Region, Melbourne Water, Melbourne, Australia.
19. WMO, 2012. Zambezi River Basin Flood Forecasting and Early Warning System Strategy, USAID, Washington, DC.
20. WMO, 2011. Flood forecasting and warning, Publications Board, Geneva, Switzerland.

# 15

## Sediment Pollution

---

15.1	Introduction .....	316
15.2	Sediment and Sediment Pollution.....	316
15.3	Impact on the Nature of Water Source.....	317
	Sediment as a Physical Pollutant • Sediment as a Chemical Pollutant	
15.4	Control of Sediment Pollution.....	320
15.5	Remediation of Sediment Pollution.....	321
	Removal and Transport • Treatment Technology	
15.6	Modeling Pollution Transport in Sediment Bed .....	324
15.7	Summary and Conclusions .....	325
	References.....	325

**Qin Qian**  
*Lamar University*

### AUTHOR

**Qin Qian** has a PhD in civil engineering and is an assistant professor at the Department of Civil Engineering, Lamar University, Beaumont, TX, United States. Dr Qian joined the Lamar University in June 2008, immediately after completing her PhD study in civil engineering at the University of Minnesota. Her research interests are in hydrology, hydraulics, and water resources. Her research goal is to advance process-based knowledge to allow better informed land use planning, ecological restoration design, and preservation of aquatic ecosystems. The funded projects are (1) Assessment of the Impact of Airborne Particulate Pollutants on the Rio Grande Basin Watershed, (2) Hydraulic Performance of Rectangular Deck Drains, (3) Modeling the Solute Transport in the Interfacial Exchange Zone, and (4) Modeling the Sediment Transport in Rio Grande River. Dr Qian is a member of the American Society of Civil Engineers (ASCE), American Geophysical Union (AGU), Overseas Chinese Environmental Engineers and Scientists Association (OCEESA), Chi Epsilon Honor Society of ASCE, and Chinese American Water Resources Association (CAWRA). She served as National Science Foundation Panel reviewer for the Water Quality/Pollution Control Unsolicited Spring Panel (P091361), a committee member of the ASCE Groundwater Hydrology Committee, technical assistant of the Technical Advisory Panel for the Research Management Committee 5 (RMC-5) of the Texas Department of Transportation, and board member for the Gulf Coast Recovery and Protection District.

## **PREFACE**

Most of the sediments in rivers, lakes, and oceans have been contaminated by pollutants worldwide. Sediment pollution, caused by soil particles that enter the water as a result of erosion, threatens water supplies and recreations and causes harm to plant and fish communities. Some pollutants flow directly from industrial and municipal waste dischargers, known as point sources, while others, known as nonpoint sources, are from polluted runoff in agricultural lands, forest soils, and construction sites. Nonpoint source pollutants are difficult to control and typically involved public expenditure and have major economic as well as environmental impacts.

It is well known that the close and intricate relationship between soil erosion and nonpoint pollutant requires integrating water resource protection and land use planning at the watershed scale to provide effective resource management. The accelerated soil erosion can have negative impacts caused by sediment itself, such as turbidity and aquatic habitat destruction, and sediment-associated pollutants, such as pesticides and nutrients. The control approaches of sediment pollution are best management practices on agricultural lands, forest soils, and construction sites. The ex situ and in situ methods are applied to remediate the sediment pollution. The sediment pollution can also be quantified using 1-D vertical transport modeling with corrected diffusion and kinetic coefficients.

This chapter focuses on the issue of sediment pollution and associated impact on the nature of water resources. The main objective is to demonstrate approaches to control, remediate, and model the sediment pollution for the better water resource management.

## **15.1 Introduction**

Sediment not only functions as an important component of aquatic ecosystems for providing habitat for many aquatic organisms, it has also been described as the ultimate sink for pollutants and serves as a major repository for persistent and toxic chemical pollutants released into the environment [40]. Many of the sediments in rivers, lakes, and oceans have been contaminated by pollutants. Some of the pollutants were released years ago, while other pollutants enter water bodies every day. Some contaminants flow directly from industrial and municipal waste dischargers, while others are from polluted runoff in agricultural lands, forest soils exposed by logging, and construction sites [46]. The industrial and municipal contaminants, known as point source, are regulated and permitted under the Clean Water Act [47]; however, the polluted runoff, known as nonpoint source, is difficult to control due to weather conditions and may be eliminated through the application of the best available nonpoint source control practices. This chapter will focus on the sediment pollution from nonpoint source. Its impact on the nature of water source will be addressed. How to control, remediate, and model the sediment pollution will also be discussed.

## **15.2 Sediment and Sediment Pollution**

Sediment is defined as particles derived primarily from natural weathering of rock and is an assemblage of individual mineral grains, such as silt, sand, gravel, chemical precipitates, and fossil fragments that are transported and deposited by water, ice, or wind [9]. Sediment pollution is caused by soil particles that enter the water as a result of erosion [35]. Soil erosion and mineral depletion are major significance problems worldwide. The average global estimation of annual sediment load to the world oceans varies from 15 to 30 billion tons [42]. For example, the Mississippi River carries roughly 500 million tons of sediment into the Gulf of Mexico each year as shown in Figure 15.1 (NASA's terra satellite via



**FIGURE 15.1** Mississippi River sediment plume from NASA Earth Observatory.

direct broadcast on March 5, 2001, at 10:55 a.m. local time). Deposited sediment in rivers leads to physical disruption of the hydraulic characteristics of the channel. For example, Sao Francisco River Basin in Brazil has experienced serious disruption of river transportation and clogs hydraulic facilities that have been built to provide irrigation water from the main river channel [26]. It also reduces the storage capabilities of reservoirs and lakes; fills up storm drains, ditches, and catch basins; and increases the potential flooding risk.

To estimate and predict impacts of the sediment pollution in the aquatic system, it is necessary to understand the primary transfer mechanisms from land to water that are driven by hydrological cycle processes. Hydrological cycle is a global sun-driven process whereby water is transported from the ocean to the atmosphere, to the land, and back to the ocean by the physical processes of evaporation, precipitation, infiltration, runoff, and subsurface flow [54]. The precipitation and runoff are the key processes to understand the nature of sediment pollution. Figure 15.2 illustrates the pesticide transport in the hydrological cycle including its movement in and from sediment and aquatic biota within the stream.

Sediment pollution not only clogs the waterway and increases the flooding potential, it also causes water to be murky and unpleasant to look at, swim in, or drink, reduces the light available to underwater plants, and blankets food supplies and the nests of fish. Moreover, chemicals such as pesticides, phosphorus, and ammonium are transported with fine size sediments in an adsorbed state [20]. These chemicals decrease oxygen concentrations in the overlaying waters or develop anaerobic conditions in the sediment bed [24].

### 15.3 Impact on the Nature of Water Source

Sediment, as a physical pollutant, impacts the receiving water with high levels of sedimentation and turbidity; on the other hand, sediment, as a chemical pollutant, brings insoluble toxic pollutants into the

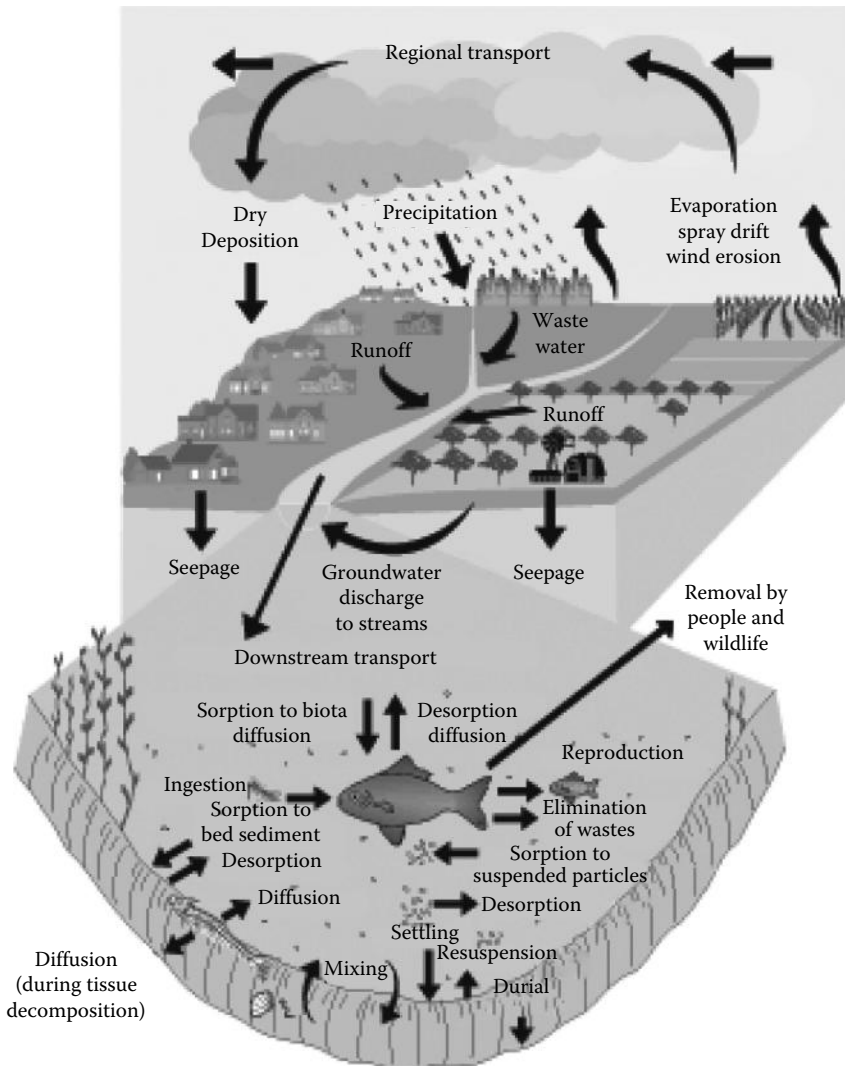


FIGURE 15.2 Pathways of pesticide movement in the hydrological cycle.

water [20]. In either case, the consequence is disruption of the aquatic ecosystem by destruction of habitat. Notwithstanding these undesirable effects, the eutrophication of many shallow lakes would give rise to immense growth of algae and rooted plants. This situation is undesirable for both aesthetic and economic. Therefore, it is urgent to seek means to reduce both turbidity and nutrient levels in aquatic ecosystem.

### 15.3.1 Sediment as a Physical Pollutant

Sediment as a physical pollutant is defined as “top soil loss and land degradation by gullying and sheet erosion and which leads both to excessive levels of turbidity in receiving waters, and to off-site ecological and physical impacts from deposition in river and lake beds” [26]. Turbidity is a measure of water clarity [43]. It is caused by the presence of suspended materials including soil particles (clay, silt, and sand), algae, plankton, microbes, and other substances. These materials are typically in the size range of 0.004 (clay) to 1.0 mm (sand). Turbidity can affect the color of the water and decrease the distance that light can

penetrate through the water for photosynthesis, which in turn causes a decrease in the number of aquatic organisms that feed on the primary producers in the ecosystem [35]. Kordi et al. [19] studied the correlation of chlorophyll with water turbidity in Mohammadabad Reservoirs and illustrated that there was a significant correlation between log chlorophyll-a and log Secchi disk ( $R_2 = 0.72$ ;  $y = -1.445x + 3.978$ ) as well as between log chlorophyll-a and water turbidity ( $R_2 = 0.60$ ;  $y = 0.027x + 1.074$ ). Higher turbidity also increases the water temperature since suspended particles absorb more heat. This, in turn, reduces the concentration of dissolved oxygen (DO) because DO decreases with increasing temperature [1]. Suspended materials can clog fish gills, reducing resistance to disease in fish, lowering growth rates, and affecting egg and larval development [1]. The study on the largemouth bass *Micropterus salmoides* suggests that greater turbidity levels reduce the ability of largemouth bass to capture prey and increase the time taken to locate and interact with prey. Thus, turbidity may impact individual fitness and management strategies [16]. In spawning rivers, gravel beds are blanketed with fine sediment, especially in slower waters, which inhibits or prevents spawning of fish and benthic macroinvertebrates [19]. Turbidity is closely related to stream flow velocity. Turbidity can increase dramatically with the heavy storm water runoff, especially in developed watersheds. It can also rise sharply during dry weather if earth-disturbing activities are occurring in or near a stream without erosion control practices in place [46].

Turbidity is generally measured by using a turbidity meter. A turbidity meter consists of a light source that illuminates a water sample and a photoelectric cell that measures the intensity of light scattered at a  $90^\circ$  angle by the particles in the sample. It measures turbidity in nephelometric turbidity units (NTUs) [46]. Instead of turbidity, another approach is to measure water clarity/transparency (an integrated measure of light scattering and absorption) using a Secchi disk, light meter, and sensors [10]. Secchi disks are widely used in lakes and reservoirs to measure transparency, but the method, although inexpensive and easy to use, usually is not practical in streams. The Secchi disk is typically an 8 in. diameter (20 cm) disk with alternating black and white quadrants. The disk is lowered into the water until the observer can no longer see it. The average of the depth of disappearance and reappearance is called the Secchi depth [7]. Light meters and underwater sensors can be used to obtain quantitative measurements of the photosynthetically active radiation available to the algal community [10].

### 15.3.2 Sediment as a Chemical Pollutant

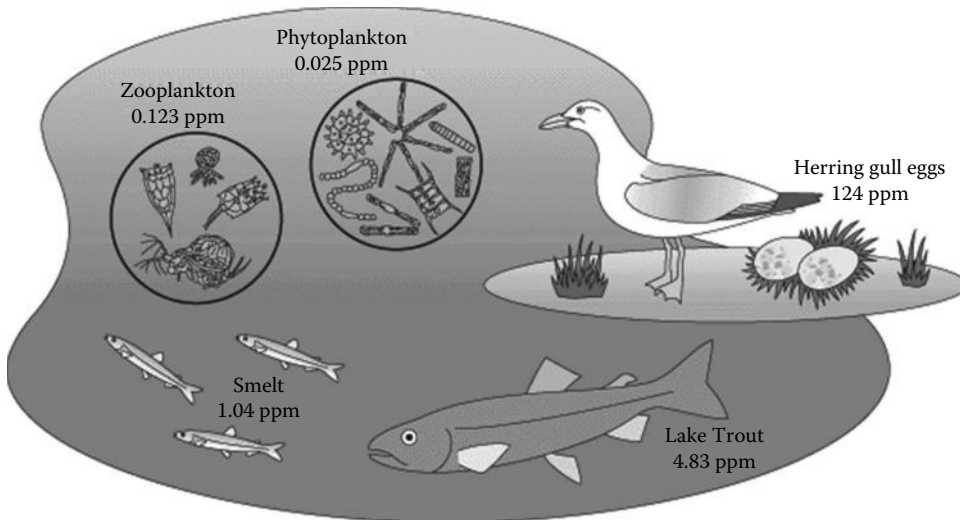
Sediment as a chemical pollutant is defined as “the silt and clay fraction (<63  $\mu\text{m}$  fraction), is a primary carrier of adsorbed chemicals, especially phosphorus, chlorinated pesticides and most metals, which are transported by sediment into the aquatic system” [26].

Five major types of sediment pollutants listed by US Environmental Protection Agency (USEPA) are as follows:

1. Nutrients, including phosphorous and nitrogen compounds such as ammonia
2. Bulk organics, a class of hydrocarbons that includes oil and grease
3. Halogenated hydrocarbons or persistent organics, a group of chemicals that is very resistant to decay such as DDT and PCBs
4. Polycyclic aromatic hydrocarbons (PAHs), a group of organic chemicals that includes several petroleum products and by-products
5. Metals, such as iron, manganese, lead, cadmium, zinc, and mercury, and metalloids such as arsenic and selenium

Higher concentration of phosphorous causes algae blooming and leads to decrease of DO in the water when the algae die and decay. Elevated level of ammonia can be toxic to organisms that inhabit the bottom of a water body, known as the benthic environment. Organics, PAHs, and heavy metals such as lead, chromium, zinc, and copper have serious consequences on humans, fauna, and flora when they are in excess of certain thresholds. The toxins in sediments can not only kill benthic organisms, reduce the food available to larger animals such as fish, and reduce the variety of organisms, that is, biodiversity,





**FIGURE 15.3** PCBs bioaccumulation and biomagnification in Great Lakes.

but also bioaccumulate in the benthic organisms and move up the food chain to increase concentrations in a process known as biomagnification [43]. When pollutants bioaccumulate in the food sources such as trout, salmon, and ducks, they pose a threat to human health. Figure 15.3 shows the degree of concentration in each level of the Great Lakes aquatic food chain for PCBs (in parts per million [ppm]). As a result, fish and shellfish, waterfowl, freshwater and marine mammals, and benthic organisms, as well as human being, are affected by sediment pollutions.

To determine the bioavailability of chemical pollutions in sediments, the particle size of sediment grains and the amount of particulate organic carbon associated with the sediment are two important factors [26]. Particle size is of primary importance due to the large surface area of very small particles, which carry more adsorbed nutrients and metals than larger size sediment. The affinity for particulate matter by an organic chemical is described by its octanol–water partitioning coefficient ( $K_{OW}$ ), which is the basis for predicting the environmental fate of organic chemicals. It is defined as a dimensionless concentration ratio whose magnitude expresses the distribution of a compound between equal volumes of two partially miscible solvents: *n*-octanol and water [55]. Chemicals with low values of  $K_{OW}$  are readily soluble, whereas those with high values of  $K_{OW}$  are described as “hydrophobic” and tend to be associated with particulates. For organic chemicals, the most important component of the sediment load appears to be the particulate organic carbon fraction that is transported as part of the sediment. Scientists have further refined the partitioning coefficient to describe the association with the organic carbon fraction ( $K_{OC}$ ) [47]. Unlike nutrients and metals, the transport and fate of sediment-associated organic chemicals is complicated by microbial degradation that occurs during sediment transport in rivers and in deposited sediment [26].

## 15.4 Control of Sediment Pollution

Soil erosion from agricultural lands, forest soils exposed by logging, overgrazed rangelands, strip mines, and construction sites are the sources of the sediment pollution; however, the bulk of sediment that is derived from these locations by water is believed to account for most of sediment supply to US waterways [20]. Therefore, controlling the soil erosion by water, that is, water erosion, is the key approach to limit the sediment pollution in water. Water erosion rates are affected by rainfall energy, soil properties, slope, slope length, vegetative and residue cover, and land management practices [47]. Rainfall impacts provide the energy that causes initial detachment of soil particles. Soil properties like particle

size distribution, texture, and composition influence the susceptibility of soil particles to be moved by flowing water. Vegetative cover and residue may protect the soil surface from rainfall impact or the force of moving water. These factors are used in the Revised Universal Soil Loss Equation (RUSLE), an empirical formula widely used to predict soil loss from agricultural fields, primarily crop land and pasture, and construction sites [15]. However, delivery of soil lost from a field to surface water is usually substantially less than 100%. Novotny and Olem [25] illustrated sediment delivery ratios, that is, percent of gross soil erosion delivered to a watershed outlet, are often on the order of 15%–40%. Watershed size, hydrology, and topography are the factors that influence the sediment delivery ratio.

A series of management measures along with best management practices to control nonpoint pollution from agriculture, urban areas, and forestry have been developed and addressed in detail [47–49]. The management measures involve reducing soil detachment and sediment transport and trapping sediment before it reaches water [47]. In addition, properly functioning natural wetlands and riparian areas can significantly reduce sediment pollution by settling, filtering, or storing sediment and associated pollutants [50]. More than one management practice system will be needed to provide effective control on multiple sources of sediment pollution. Each practice in a management practice system must be selected, designed, implemented, and maintained in accordance with site-specific considerations to ensure that the practices function together to achieve overall management goals. Site conditions, cost, and maintenance requirement areas also should be taken into consideration for practice selection. However, the basic erosion control measures do not always provide adequate control of nutrients, pesticides, or other sediment-attached pollutants. Many erosion control practices or structures may not effectively control the majority of pollutants that are attached to fine soil particles. If pollutants attached to soil particles are the primary concern, practices specifically designed to control fine sediments should be applied [47].

## 15.5 Remediation of Sediment Pollution

---

In terms of environmental impact, the most critical issue related to sediment pollutions is not necessarily the presence of relatively high concentrations of contaminants at a given point in time, but rather the progressive and long-term effects from sediment pollutions may cause an unacceptable risk to humans or to ecological receptors [20]. The need for remediating or managing sediment pollutions has become evident [2]. To manage sediment pollutions, a number of different approaches can be selected depending on site-specific conditions, sediment characteristics, mix of pollutions in the sediment, and local regulations. Sediment pollutions can be removed by dredging or excavating, and treated and disposed of *ex situ*, as appropriate. The sediments can also be managed in place, or *in situ*, such as monitored natural recovery, capping, and/or treatment by biological or chemical means. The main *in situ* and *ex situ* approaches or alternatives are listed in Table 15.1 [51].

*Ex situ* removing sediment pollutions often results in the least uncertainty about long-term effectiveness of the cleanup, minimizes the uncertainty associated with predictions of sediment bed or *in situ* cap stability and the potential for future exposure and transport of contaminants, and leaves the flexibility for future use of the water body [51]. However, the limitation of sediment removal can be significant because the implementation of dredging or excavation is usually more complex and costly than *in situ* approach. Sediment caps are typically immediate isolation of pollutants from potential receptors and result in relatively little environmental impact during and after placement. However, *in situ* cleanup methods such as MNR and capping frequently include institutional controls (ICs) that limit water body uses [51].

### 15.5.1 Removal and Transport

Dredging and excavation are the two most common means of removing contaminated sediment from a water body, either while it is submerged (dredging) or after water has been diverted or drained

**TABLE 15.1** List of the Major Remedial Approaches or Alternatives Available for Managing Risks from Contaminated Sediment

In Situ Approaches	Ex Situ Approaches
<i>In situ capping:</i> single-layer granular caps, multilayer granular caps, combination granular/geotextile caps	<i>Dredging:</i> hydraulic, mechanical, or combination/hybrid dredging and transport to shore; treatment of dredged sediment and/or removed water; disposal of dredged sediment or treatment residuals in upland landfill, confined disposal facility, or other placement; backfill of dredged area, as needed or appropriate
<i>Monitored natural recovery:</i> physical isolation or other processes, chemical transformation/sequestration, biological transformation/sequestration	
<i>Hybrid approaches:</i> thin-layer placement of sand or other material to enhance recovery via natural deposition	<i>Excavation:</i> water diversion or dewatering; excavation of sediment and transport to staging or processing; treatment of excavated sediment; disposal of excavated sediment or treatment residuals in upland landfill, confined disposal facility, or other placement; backfill of excavated area, as needed or appropriate
<i>Institutional controls:</i> fish consumption advisories, commercial fishing bans, waterway or land use restrictions, dam or other structure maintenance agreements	
<i>In situ treatment:</i> reactive caps, additives/enhanced biodegradation	

Source: <http://www.epa.gov/superfund/health/conmedia/sediment/pdfs/guidance.pdf>.

(excavation) [51]. They also frequently include treatment of water from dewatered sediment prior to discharge to an appropriate receiving water body. A primary concern during the removal and transport of contaminated sediments is the danger of introducing contaminants into previously uncontaminated areas. When considering dredging or excavation as a cleanup method, sediment removal, transport, staging, treatment (pretreatment, treatment of water and sediment, if necessary), and disposal (liquids and solids) are the key components to be evaluated [45].

The choice of dredging depends on the nature of the sediment, the types of contaminants, the depth to bottom, the thickness and volume of sediment, the distance to the next operation (e.g., disposal sites), and the available machinery [47]. Dredging involves mechanically grabbing, raking, cutting, or hydraulically scouring the bottom of a waterway to dislodge the sediment. Once dislodged, the sediment may be removed from a waterway either mechanically with buckets or hydraulically by pumping. Therefore, dredges may be categorized as either mechanical or hydraulic depending on the basic means of removing the dredged material. Some dredges employ pneumatic (compressed air) systems to pump the sediment out of the waterway [45]. However, these have not gained general acceptance on environmental dredging projects. The fundamental difference between mechanical and hydraulic dredging equipment is how the sediment is removed. Mechanical dredges offer the advantage of removing the sediment at nearly the same solids content and, therefore, volume as the in situ material. Mechanical dredges include clamshells, dippers, bucket ladder dredges, draglines, and conventional earthmoving equipment. Such techniques have been used extensively. Hydraulic dredges are usually barge-mounted systems that use centrifugal pumps to remove and transport the sediment/water mixtures. Pumps may be either barge-mounted or submersible. Standard hydraulic dredging commonly produces slurries of 10%–20% solids by wet weight. Economic operating depths range between 50 and 60 ft [44].

Excavation of contaminated sediment generally involves isolating the contaminated sediment from the overlying water body by pumping or diverting water from the area and managing any continuing inflow followed by sediment excavation using conventional dry land equipment such as sheet piling,

earthen dams, cofferdams, geotubes, and inflatable dams [51]. Typically, excavation is performed in streams, shallow rivers and ponds, or near shore areas, although site preparation for excavation can be more lengthy and costly than for a dredging project due to the need for dewatering or water diversion. Excavation equipment operators and oversight personnel can much more easily see the removal operation, and bottom conditions (e.g., debris) and sediment characteristics (e.g., grain size and specific gravity) typically require much less consideration.

Removed sediment is transported to a staging or rehandling area for dewatering (if necessary) and further processing, treatment, or final disposal. Transport links all dredging or excavation components and may involve several different modes of transport [45]. A wide variety of transportation methods, including pipelines, barges, railroads, and trucks, are available for moving sediment and residual wastes with unique physical and chemical attributes. In many cases, contaminated sediment is initially moved using waterborne transportation. Exceptions are the use of land-based or dry excavation methods. The feasibility, costs of transportation, and need for additional equipment are frequently influenced by the scale of the remediation project [45].

### 15.5.2 Treatment Technology

Treatment technologies for both in situ and ex situ involve the biological, chemical, or physical treatment of sediment pollution. The biological treatment is the process in which microbiological processes are enhanced by the addition of materials, such as oxygen, nitrate, sulfate, hydrogen, nutrients, substrate (e.g., organic carbon), or microorganisms, into the sediment or into a reactive cap to degrade or transform contaminants to less toxic or nontoxic forms. In recent years, it has been demonstrated as a technology for destroying some organic compounds in sediment [22,23]. The chemical treatment refers to processes in which chemical reagents, such as permanganate, hydrogen peroxide, or potassium hydroxide, are added to the dredging material or reactive capping for the purpose of contaminant destruction through oxidation and dechlorination processes. Contaminants may be destroyed completely or may be altered to a less toxic form [3]. The immobilization treatment refers to the processes of solidification, stabilization, or sequestering of contaminants by adding coal, coke breeze, portland cement, fly ash, limestone, or other additives to the sediment for encapsulating the contaminants in a solid matrix and/or chemically altering the contaminants by converting them into a less bioavailable, less mobile, or less toxic form [45].

The sediment from dredging and excavating can also be treated by extraction or washing, thermal (destruction or desorption), and particle size separation [51]. The primary application of extraction processes is to remove organic and metal contaminants from the sediment particles. The thermal technologies include incineration, pyrolysis, thermal desorption, sintering, and other processes that require heating the sediment to hundreds or thousands of degrees above ambient temperatures, are generally effective for destroying organic contaminants, but are also expensive and have significant energy costs. The particle size separation involves separation of the fine material from the coarse material by physical screening. A site demonstration of the Bergman USA process resulted in the successful separation of less than 45  $\mu\text{m}$  fines from washed coarse material and a humic fraction [45].

Sediment capping, either inactive or active, is the most commonly used alternative for the in situ remediation of sediments. Inactive sediment capping is the installation of a subaqueous covering or cap of clean, neutral material over contaminated sediment, thus producing a physical barrier that isolates sediment pollution from the surrounding environment and reduces pollution migration into the water column [44]. However, to prevent toxic contaminants releasing, the barrier is very thick, which is not suitable in shallow areas, under existing marine structures (e.g., docks, piers), and in sensitive habitats, such as marshes [18]. On the other hand, active or reactive capping involves the use of active capping materials that react with sediment pollutions to reduce their mobility, toxicity, and bioavailability [52,59]. Proposed active amendments have included bioaugmentation (addition of microorganisms),

biostimulation through the addition of amendments like oxygen or nitrate to stimulate organisms [37–39], the use of sequestration additives (granular activated carbon, organoclay, coke, apatite, organoclay, and biopolymers) [18,53], and the addition of hydraulic sequestration agents such as water-expanding clay [17,21,36,58]. Although a less mature technology, active capping holds great potential for a relatively permanent solution that avoids residual risks resulting from contaminant migration through the cap, and active capping can be applied in areas where more traditional thick inactive caps cannot.

## 15.6 Modeling Pollution Transport in Sediment Bed

Sediment pollutions are constituted with inorganic and/or organic chemical species. The exchange between overlying water and sediment at sediment/water interface plays an active role for important ecological and environmental processes and controls the distribution of solutes, colloids, dissolved gases, and biogeochemical reactions [8,13,14,27,28]. Dissolved nutrients that return from the sediment to the overlying water can be reused by the biological community; however, recycled metals from sediment can be toxic and deteriorate water quality. To estimate the solute exchange between the water and sediment, 1-D vertical diffusion model is commonly used and incorporated with microbial or chemical transformations or sorption kinetics [6]. It can be expressed as

$$\frac{\partial C}{\partial t} = \frac{\partial C}{\partial z} \left( D \frac{\partial C}{\partial z} \right) - kC \quad (15.1)$$

where

C is the concentration in the sediment ( $\text{kg}/\text{m}^3$ )

t is the time (s)

D is the diffusion coefficient ( $\text{m}^2/\text{s}$ )

k ( $\text{s}^{-1}$ ) is a first-order kinetic rate coefficient to estimate the sorption

The diffusion coefficient is considered to depend only on the geometry of the sediment, such as porosity, tortuosity, and pore size. It is also treated to be invariable with the depth from the sediment surface. However, natural water bodies are hardly ever motionless, even when they seem to be. Turbulence eddies, water surface waves, and bedforms are common features in the water bodies, and they can drive a flow through the sediment pore system [4]. Many experimental and numerical studies have been performed on the turbulent effects [5,11,12,24,34]. The turbulent boundary layer generates eddies that penetrate and survive best inside the sediment. It can enhance/augment significantly the diffusional mass transfer into and inside the sediment depending on the Schmidt number [11]. The flow through the sediment bed induced by oscillatory pressure perturbations along the water/sediment interfaces, due to bedforms [41] or surface water waves [29], adds an advection term into the mass transfer process and enhances the solute exchange between water and sediment [8,27,28,30–33]. The enhancement of mass transport by interstitial advective flow in the sediment pores is analyzed or modeled by introducing an “enhanced vertical dispersion coefficient  $D_E$ ” [30,31,33]. The enhanced dispersion coefficient ( $D_E$ ) was found to be several orders of magnitudes larger than the molecular diffusion coefficient and even the hydrodynamic dispersion coefficient [30]; the enhancement by progressive waves was less than that by standing waves. The enhanced dispersion coefficient and penetration depth can be estimated when the pressure wave characteristics and sediment bed parameters are available [31]. Sorption kinetics of hydrophobic organic chemicals to and from suspended sediment and soil particles was described by a radial diffusive penetration model modified by a retardation factor reflecting microscale partitioning of the sorbate between intra-aggregate pore fluids and the solids making up the aggregate grains [57]. It also can be estimated based on the tracer breakthrough curve (BTC) of the pollutants [56].

## 15.7 Summary and Conclusions

Sediment pollution is the most serious ongoing water quality problem. It reduces transport capacity, causes water to be murky reducing the light available to underwater plants, and blankets food supplies and nest of fish. Chemicals are transported with sediment in aquatic system to cause destruction of habitat. The factors to cause the sediment pollution include, but are not limited, to rainfall factor, soil erodibility factor, slope factor, crop factor, and supporting conservation practices. The management measure along with best management practices can control the sediment pollution. The remediate approaches of sediment pollution include ex situ method, that is, dredging and excavating, and in situ methods, that is, sediment capping. The sediment pollution can also be quantified using 1-D vertical transport modeling with corrected diffusion and kinetic coefficients.

## References

1. APHA, 1992. *Standard Methods for the Examination of Water and Wastewater*. 18th edn., American Public Health Association, Washington, DC.
2. Armitage, T.M. and K.J. Keating, 1997. EPA's national sediment quality survey: A report to congress on the incidence and severity of sediment contamination in surface waters of the U.S., *Proceedings of National Conference on Management and Treatment of Contaminated Sediments*, EPA/625/R-98/001.
3. Averett, D.E., B.D. Perry, E.J. Torre, and J.A. Miller, 1990. *Review of Removal, Containment, and Treatment Technologies for Remediation of Contaminated Sediments in the Great Lakes*, Miscellaneous Paper EL-90-25. U.S. Army Corps of Engineers Waterways Experiment Station, Prepared for U.S. Environmental Protection Agency—Great Lakes National Program Office, Chicago, IL.
4. Boudreau, B.P. and B.B. Jorgensen, eds., 2001. *The Benthic Boundary Layer: Transport Processes and Biogeochemistry*, Oxford University Press, Oxford, U.K., 404pp.
5. Dade, W.B., 1993. New-bed turbulence and hydrodynamic control of diffusional mass transfer at the sea floor. *Limnology and Oceanography*, 38(1): 52–69.
6. DiToro, D.M., 2001. *Sediment Flux Modeling*, Wiley & Sons, New York, 624pp.
7. Edmondson, W.T., 1980. Secchi disk and chlorophyll. *Limnology and Oceanography*, 25: 378–379.
8. Elliot, A.H. and N.H. Brooks, 1997. Transfer of non-sorbing solutes to a streambed with bed forms: Theory. *Water Resources Research*, 33(1): 123–136.
9. Fetter, C.W., 1988. *Applied Hydrogeology*, Macmillan Publishing Company, New York, p. 576.
10. Hambrook Berkman, J.A. and M.G. Canova, 2007. *Algal Biomass Indicators (ver. 1.0): U.S. Geological Survey Techniques of Water-Resources Chlorophyll a Investigations*. Book 9, Chap. A7, Section 7.4: 86, Columbus, OH.
11. Higashino, M. and H.G. Stefan, 2005. Oxygen demand by a sediment bed of finite length. *Journal of Environmental Engineering*, 131(3): 350–358.
12. Higashino, M., B.L. O'Connor, M. Hondzo, and H.G. Stefan, 2008. Oxygen transfer from flowing water to microbes in an organic sediment bed, *Hydrobiologia*, 614: 219–231.
13. Huettel, M., W. Ziebis, S. Forstr, and G.W. Luther, 1998. Advective transport affecting metal and nutrient distributions and interfacial fluxes in permeable sediments, *Geochimica et Cosmochim Acta*, 62(4): 613–631.
14. Huettel, M.H., R.E. Precht, and S. Ehrenhauss, 2003. Hydrodynamical impact of biogeochemical processes in aquatic sediments. *Hydrobiologia*, 494: 231–236.
15. Hudson, N.W., 1993. *Field Measurement of Soil Erosion and Runoff*, Issue 68. Food and Agriculture Organization of the United Nations. Rome, Italy, pp. 121–126. ISBN 9789251034064.
16. Huenemann, T.W., E.D. Dibble, and J.P. Fleming, 2012. Influence of turbidity on the foraging of largemouth bass, *Transactions of the American Fisheries Society*, 141(1): 107–111. doi: 10.1080/00028487.2011.651554.

17. Johnson, K.M., M.L. Smith, and G.V. Lowry, 2002. Sediment management in the Anacostia and Grasse river: Applying Fe(0)-based reactive sediment caps for in situ PCB destruction (Progress Report 9/1/02). <http://www.hsrrc-ssw.org/cap-amend1.pdf> (accessed on June 15, 2012).
18. Knox, A.S., M.H. Paller, and J. Robert, 2012. Active capping technology-new approaches for in situ remediation of contaminated sediments, United State Department of Energy, <http://www.osti.gov/bridge/purl.cover.jsp?purl=/1034750/> (accessed on June 15, 2012).
19. Kordi, H., S.A. Hoseini, M. Sudagar, and A. Alimohammadi, 2012. Correlation of chlorophyll-a with Secchi disk depth and water turbidity in aquaculture reservoirs, A case study on Mohammadabad reservoirs, Gorgan, Iran, *World Journal of Fish and Marine Sciences*, 4(4): 340–343.
20. Montgonyery C.W., 2000. *Environmental Geology*, 5th edn., McGraw-Hill Higher Education, New York.
21. Murphy, P., A. Marquette, D. Reible, and G.V. Lowry, 2006. Predicting the performance of activated carbon- coke- and soil-amended thin layer sediment caps. *Journal of Environmental Engineering-ASCE*, 132(7): 787–794.
22. Myers, T.E. and D.W. Bowman, 1999. Bioremediation of PAH-contaminated dredged material at the Jones Island CDF: Materials, equipment, and initial operations, DOER Technical Notes Collection (ERDC TN-DOER-C5), U.S. Army Engineer Research and Development Center, Vicksburg, Mississippi.
23. Myers, T.E. and C.W. Williford, 2000. *Concepts and Technologies for Bioremediation in Confined Disposal Facilities*, DOER Technical Notes Collection (ERDC TN-DOER-C11), U.S. Army Engineer Research and Development Center, Vicksburg, Mississippi.
24. Nakamura, Y. and H.G. Stefan, 1994. Effect of flow velocity on sediment oxygen demand: Theory. *Journal of Environmental Engineering*, 120(5): 996–1016.
25. Novotny, V. and H. Olem, 1994. *Water Quality Prevention, Identification, and Management of Diffuse Pollution*, Van Nostrand Reinhold, New York.
26. Ongley, E.D., 1996. Control of water pollution from agriculture-FAO Irrigation and Drainage paper 55, Food and Agriculture Organization of the United Nations, Rome, Italy.
27. Packman, A.I., N.H. Brooks, and J.J. Morgan, 2000. A physicochemical model for colloid exchange between a stream and a sand streambed with bed forms, *Water Resources Research*, 36(8): 2351–2361.
28. Packman, A.I., M. Salehin, and M. Zaramella, 2004. Hyporheic exchange with gravel beds: Basic hydrodynamic interactions and bedform-induced advective flows, *Journal of Hydraulic Engineering*, 130(7): 647–656.
29. Precht, E. and M. Huettel, 2003. Advective port-water exchange driven by surface gravity waves and its ecological implications, *Limnology and Oceanography*, 48(4): 1674–1684.
30. Qian, Q., V. Voller, and H. Stefan, 2008. A vertical dispersion model for solute exchange by underflow and periodic hyporheic flow in a stream grave bed, *Water Resources Research*, 44, W07422, doi:10.1029/2007WR006366.
31. Qian, Q., V. Voller, and H. Stefan, 2009a. Modeling of vertical solute dispersion in a sediment bed enhanced by wave induced interstitial flow, *Journal of American Water Resources Association*, 45(2): 343–354, doi: 10.1111/j.1752-1688.2008.00297.x.
32. Qian, Q., J.J. Clark, V. Voller, and H. Stefan, 2009b. A depth-dependent dispersion coefficient for modeling of vertical solute exchange in a lake bed under surface waves, *Journal of Hydraulic Engineering*, 135(3): 187–197.
33. Qian, Q., V. Voller, and H. Stefan, 2010. Can the “dispersion tensor model” for solute exchange in the sediment bed of a stream or lake be simplified? *Advances in Water Resources* 33: 1542–1550, doi:10.1016/j.advwatres.2010.09.001.
34. Rahm, L. and U. Svensson, 1989. On the mass transfer properties of the benthic boundary layer with an application to oxygen fluxes. *Netherlands Journal of Sea Research*, 24(1): 27–35.
35. Raven, P.H., L.R. Berg, and G.B. Johnson, 2010. *Environment*, Sunders College Publishing, Fort Worth, TX, p. 656.

36. Reible, D., D. Lampert, D. Constant, R.D. Mutch Jr., and Y. Zhu, 2006. Active capping demonstration in the Anacostia River, Washington, D.C. *Remediation: The Journal of Environmental Cleanup Costs, Technologies and Techniques*, 17(1): 39–53.
37. Rockne, K.J. and S.E. Strand, 1998. Biodegradation of bicyclic and polycyclic aromatic hydrocarbons in marine anaerobic enrichments. *Environmental Science & Technology*, 32(24): 3962–3967
38. Rockne, K.J., J.C. Chee-Sanford, B.P. Hedlund, R.A. Sanford, S.E. Strand, J. Leigh, and J.T. Staley, 2000. Anaerobic polycyclic aromatic hydrocarbon degradation by marine microbial isolates under nitrate-reducing conditions. *Applied and Environmental Microbiology*, 66(4): 1595–1601.
39. Rockne, K.J. and S.E. Strand, 2001. Anaerobic biodegradation of phenanthrene, naphthalene and biphenyl by a denitrifying enrichment culture. *Water Research*, 35(1): 291–299.
40. Salomons, W., N.M. De Rooji, H. Kerdijk, and J. Bril, 1987. Sediment as a source for contaminants? *Hydrobiologia*, 149: 13–30.
41. Thibodeaux, L.J. and J.D. Boyle, 1987. Bedform-generated convective transport in bottom sediment. *Nature*, 325: 341–343.
42. UNEP/GPA, 2006. *The State of the Marine Environment: Trends and Processes*, The Hague, the Netherlands.
43. US Environmental Protection Agency, 1991. *Volunteer Lake Monitoring: A Methods Manual*, EPA 440/4-91-002. Office of Water, US Environmental Protection Agency, Washington, DC.
44. US Environmental Protection Agency, 1993. *Selecting Remediation Technologies for Contaminated Sediment*, EPA 823/B-93/001. US Environmental Protection Agency, Washington, DC.
45. US Environmental Protection Agency, 1994. *Assessment and Remediation of Contaminated Sediments (ARCS) Program Remediation Guidance Document*, EPA/905/R-94/003. US Environmental Protection Agency, Washington, DC.
46. US Environmental Protection Agency, 1997. *Volunteer Stream Monitoring: A Methods Manual*, EPA 841-B-97-003, Washington, DC.
47. US Environmental Protection Agency, 2003. *National Management Measures to Control Nonpoint Pollution from Agriculture*, EPA 841-B-03-004. US Environmental Protection Agency, Washington, DC.
48. US Environmental Protection Agency, 2005a. *National Management Measures to Control Nonpoint Source Pollution from Urban Areas*, EPA-841-B-05-004. US Environmental Protection Agency, Washington, DC.
49. US Environmental Protection Agency, 2005b. *National Management Measures to Control Nonpoint Source Pollution from Forestry*, EPA 841-B-05-001. US Environmental Protection Agency, Washington, DC.
50. US Environmental Protection Agency, 2005c. *National Management Measures to Protect and Restore Wetlands and Riparian Areas for the Abatement of Nonpoint Source Pollution*, EPA 841-B-05-003. US Environmental Protection Agency, Washington, DC.
51. US Environmental Protection Agency, 2005d. *Contaminated Sediment Remediation Guidance for Hazardous Waste Sites*, EPA-540-R-05-012. US Environmental Protection Agency, Washington, DC.
52. Viana, P.Z., K. Yin, X. Zhao, and K.J. Rockne, 2006. Active capping: A low cost technology to contain and reduce the exposure risk of contaminated sediments. *7th Regional Conference of USA Inter-American Association of Sanitary Engineering and Environmental Sciences*, Chicago, IL.
53. Viana, P., K. Yin, X. Zhao, and K. Rockne, 2007. Active sediment capping for pollutant mixtures: Control of biogenic gas production under highly intermittent flows, *Land Contamination and Reclamation*, 15(4): 413–425, doi: 10.2462/09670513.879.
54. Viessman, W. Jr. and G.L. Lewis, 2003. *Introduction of Hydrology*, 5th edn. Pearson Education, Inc., New York, p. 612.
55. Witkowski, P.J., J.A. Smith, T.V. Fusillo, and C.T. Chiou, 1987. A review of surface-water sediment fractions and their interactions with persistent manmade organic compounds, US Geological Survey Circular 993.



56. Worman, A., A.I. Packman, H. Johansson, and K. Jonsson, 2002. Effect of flow-induced exchange in hyporheic zones on longitudinal transport of solutes in streams and rivers. *Water Resources Research*, 38(1), doi: 10.1029/2001WR000769.
57. Wu, S. and P.M. Gschwend, 1968. Sorption kinetics of hydrophobic organic compounds to natural sediments and soils, *Environmental Science and Technology*, 717–725.
58. Yin, K., P.Z. Viana, X.H. Zhao, and K.J. Rockne, 2007. A Monte Carlo simulation approach for active caps in mixed contaminant environments, Paper D-018. *Proceedings of the Fourth International Conference on Remediation of Contaminated Sediments*. Battelle Press, Columbus, OH.
59. Zhao, X., P.Z. Viana, K. Yin, and K.J. Rockne, 2007. Combined active capping/wetland demonstration in the Chicago River, *Proceedings of the Fourth International Conference on Remediation of Contaminated Sediments*, Savannah, GA. Battelle Press, Columbus, OH.

# 16

## Stormwater Modeling and Management

---

16.1	Introduction .....	330
16.2	Hydrologic Cycle.....	331
16.3	Rainfall Characteristics .....	331
16.4	Flood .....	332
16.5	Rainfall–Runoff Relationship .....	333
	Runoff Coefficient, Curve Number, and Time of Concentration ( $T_c$ ) • Peak Flow • Runoff Volume • Hydrograph • Unit Hydrograph Method	
16.6	Stormwater Modeling .....	337
	Data Collection • Stormwater Modeling Methodology • Modeling Result Analysis and Application	
16.7	Urban Drainage Design and Modeling.....	339
	Stormwater Collection and Conveyance • Stormwater Storage and Discharge	
16.8	Stormwater Quality Practice.....	341
	Stormwater Quality Introduction • Phosphorus Concern • CPP for Stormwater Quality Control and Phosphorus Removal as a Passive Unit Operation and Process	
16.9	Summary and Conclusion.....	343
	References.....	343

**Xuheng Kuang**  
*WRS Infrastructure and  
Environmental Inc.*

### AUTHORS

**Xuheng Kuang** received his PhD degree in 2005 while studying in the Department of Civil and Environmental Engineering, Louisiana State University (LSU) (Baton Rouge, LA, USA). His doctoral research focused on stormwater management, cementitious porous pavement, and low-impact development. Dr. Kuang earned his master's and bachelor of science degrees in fluid machinery and dynamic engineering from Wuhan University of Hydraulic and Electrical Engineering in 1997 and 1994, respectively.

Currently **Dr. Kuang** works with WRS Infrastructure & Environmental Inc. (FL, USA) as senior engineer and chief modeler. He has been in charge of projects worth hundreds of millions of U.S.-dollar under contract. Among them, the Comprehensive Everglade Restoration Plan (CERP) is the largest and most complicated water environmental protection project in US history. His cutting-edge technologies and findings in stormwater management and low-impact development have been widely applied in those projects.

**Dr. Kuang** has been active in academic research. He is the author of over 20 research articles published in authoritative journals such as the *Water Research*, the *Journal of Hydrology*, the *Water Science and*

*Technology*, the *ASCE Journal of Drainage and Irrigation*, and the *Transportation Research Record*. He has also been invited to give more than 40 presentations in international conferences and review technical articles for over 10 technical journals around the world. Dr. Kuang is a member of Sigma-Xi, ASCE, American Water Resources Association, and American Geographic Union.

## PREFACE

Significant urban growth in the twentieth and twenty-first century, combined with widespread introduction of impervious pavements around 1900, has made deleterious hydrologic, climate, and environmental problems due to increased peak flow, volume, and lag time of runoff; reduced underground water recharge; and degraded water quality. With urban growth, forests, farms, meadows, and pervious soils are being transformed into compacted soils, houses, shopping centers, roadways, and parking lots, resulting in a much higher degree of imperviousness. Compared with soils covered by vegetation, the highly impervious nature of disturbed soils and impervious pavements greatly reduces the infiltration capacity and the capability to recharge aquifers and maintain stream base flow and waterway health. As a result, this rainfall–runoff is lost as a resource for the long-term health of natural waters. Control of rainfall–runoff has become increasingly challenging with growth of urbanization and urban population across the world. Data from 47 small urban watersheds across the United States indicate that an approximately linear relationship exists when the volume-based runoff coefficient (“*C*”) is regressed against watershed imperviousness.

Recognizing the effects of urbanization on the hydrological environment, many communities have passed laws encouraging municipalities and developers to practice sound stormwater management on their properties. However, traditional stormwater management systems that collect, transport, and dispose of stormwater are not able to meet the requirements of the rapid land development and continuously increasing degree of imperviousness due to installation of streets, parking lots, and rooftops.

This present chapter first provides engineers with basic knowledge and the applicable tools of hydrology and stormwater management, and then presents the author’s approach for phosphorus removal from stormwater using cementitious porous pavement (CPP) since CPP is a highly effective low-impact development (LID) structure for stormwater management in both quality and quantity as a passive unit operation and process.

## 16.1 Introduction

With extreme urban growth in many countries, deleterious hydrologic, climate, and environmental problems associated with urban land development have become significantly serious due to increased peak flow, volume, and lag time of runoff; reduced underground water recharge; and degraded water quality [2,28,36,37,41]. With urban growth, forests, farms, and meadows are being transformed into houses, shopping centers, roadways, and parking lots, resulting in a much higher degree of imperviousness in such areas. Compared with soils covered by vegetation, the highly impervious nature of disturbed soils greatly reduces the infiltration capacity and the capability to recharge aquifers and maintain stream base flow and waterway health [5,9,24]. Stormwater management has become increasingly challenging with growth of urbanization and urban population across the world. Poor stormwater management causes many hydrologic, climate, and environmental problems [9,18,36], such as floods, increased erosion and sediment transport, water body contamination and eutrophication, and urban heat islands [2,6,40].

The first purpose of this section is to present engineers with basic knowledge and the applicable tools of hydrology and stormwater management, and the second purpose is to present the author’s approach for phosphorus removal from stormwater using cementitious porous pavement (CPP) since CPP is a highly effective low-impact development (LID) structure for stormwater management in both quality and quantity as a passive unit operation and process.

## 16.2 Hydrologic Cycle

Hydrologic cycle is defined as water circulation through different pathways and at different rates throughout the earth. The cycle begins with precipitation, which includes rain, snow, sleet, and hail from a storm. The precipitation either is absorbed into the ground or travels as surface water. Water absorbed by soil and vegetation will percolate to the water table or return to the atmosphere through evaporation and evapotranspiration. The cycle completes when water evaporates into the atmosphere. For stormwater modeling, the hydrologic cycle elements include precipitation, land use, soil type in terms of water absorption and storage, groundwater table, climatology, and the meteorology of the area of interest.

The water balance equation of the hydrologic cycle can be presented as follows:

$$\begin{aligned} \text{Total precipitation} &= \text{Net change in surface water} + \text{Net change in ground water} \\ &+ \text{Evapotranspiration} + \text{Interception evaporation} \end{aligned}$$

For the purpose of stormwater modeling, runoff is of the most interested. The total amount of water that is intercepted through evaporation and absorbed into groundwater before runoff begins is known as initial abstraction. After runoff begins, water still infiltrates into the soil until it becomes saturated.

$$\text{Runoff} = \text{Total precipitation} - \text{Initial abstraction} - \text{Infiltration} - \text{Evaporation} \tag{16.1}$$

For an area where water surface does not constitute a major portion, evaporation is usually not considered.

## 16.3 Rainfall Characteristics

Rainfall is the major form of precipitation and the major reason for flood issues. A storm hyetograph is the best way to present a storm event because it shows the instantaneous rainfall intensity measured in the storm duration. Figure 16.1 shows an example of a hyetograph. Intensity is defined as the rate of rainfall and is typically expressed in units of millimeters per hour. For hydrologic analysis, it is desirable to divide a storm across convenient time increments and determine the average intensity over each of the selected periods. These results are then plotted as rainfall hyetographs. Hyetographs provide greater

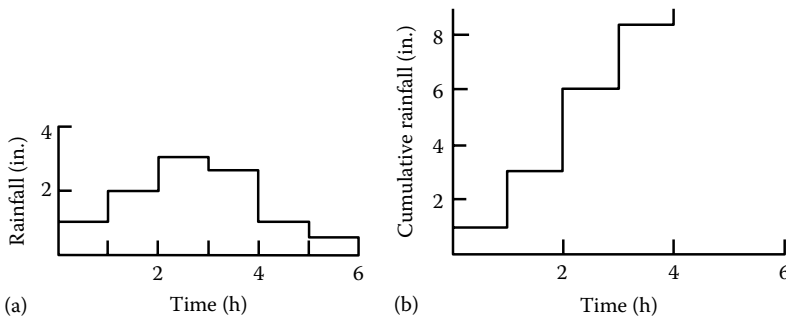
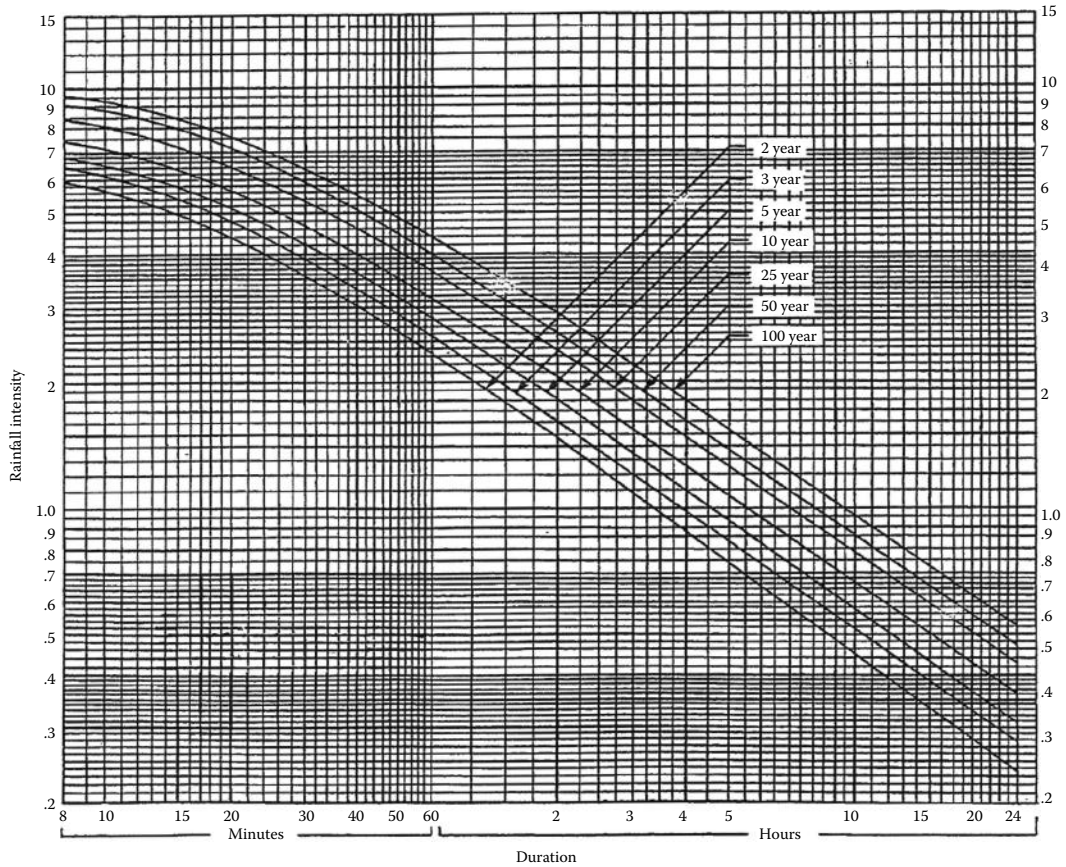


FIGURE 16.1 An example of a hyetograph. (a) Hyetograph. (b) Cumulative graph.



**FIGURE 16.2** An example of an IDF curve.

precision than constant rainfall intensity by specifying the precipitation variability over time and are used in conjunction with hydrographic (rather than peak flow) methods. Hyetographs allow the simulation of actual rainfall events, which can provide valuable information on the relative flood risks of different events and, perhaps, calibration of hydrographic models.

Although rainfall intensity varies during precipitation events, many of the procedures used to derive peak flow are based on a simplified constant rainfall intensity. Average precipitations are usually measured by rain gauges in many rain stations. Based on the precipitation data measured over long historic records, a standard Intensity–Duration–Frequency (IDF) curve can be developed for a specific area. An IDF curve provides a summary of a site’s rainfall characteristics by relating storm duration and exceedance probability (frequency) with rainfall intensity (assumed constant over the duration). Figure 16.2 shows an example of an IDF. With the IDF curve, rainfall depth and total rainfall volume can be calculated according to the area of interest. If IDF curves are not available, a designer needs to develop them on a project-by-project basis.

## 16.4 Flood

A flood occurs when water flow exceeds the capacity of the drainage system. In stormwater modeling, a standard flood or standard project flood is usually selected for rainfall–runoff calculation. A 100-year

storm event does not mean that kind of storm event occurs once every 100 years; instead, by definition, the possibility of that storm event occurring in a year is 1%.

The probability that a flood event in any year will equal a design basis flood with a recurrence interval  $F$  is

$$p\{F \text{ event occurs in 1 year}\} = \frac{1}{F} \quad (16.2)$$

## 16.5 Rainfall–Runoff Relationship

### 16.5.1 Runoff Coefficient, Curve Number, and Time of Concentration ( $T_c$ )

Both runoff coefficient ( $C$ ) and curve number (CN) provide a simplified relationship between rainfall and runoff based on local land use, soil storage and infiltration conditions (Tables 16.1 and 16.2).

**TABLE 16.1** Runoff Coefficient ( $C$ ) for the Rational Method

Drainage Area	Runoff Coefficient ( $C$ )
Business or commercial	
Downtown areas	0.70–0.95
Neighborhood areas	0.50–0.70
Residential	
Single-family neighborhood	0.30–0.60
Multi-units, detached	0.40–0.60
Multi-units, attached	0.60–0.75
Apartment dwelling areas	0.25–0.40
Suburban	0.50–0.70
Industrial	
Light areas	0.50–0.80
Heavy areas	0.60–0.90
Streets	
Asphalt	0.70–0.95
Concrete	0.80–0.95
Brick	0.70–0.85
Lawns	
Sandy soil	0.05–0.20
Heavy soil	0.13–0.35
Parks, cemeteries	0.10–0.25
Playground	0.20–0.40
Railroad yard area	0.20–0.40
Unimproved area	0.10–0.30
Drive and walks	0.75–0.95
Roof	0.75–0.95

*Source:* USDA (U.S. Department of Agriculture), U.S. Soil Conservation Service. Technical Release 55: Urban Hydrology for Small Watersheds, Available from NTIS (National Technical Information Service), NTIS # PB87101580, 1986; <http://www.evergladesplan.org>.

*Note:* Higher values are usually appropriate for steeply sloped areas and longer return periods.

**TABLE 16.2** Runoff CNs for Urban Areas (Average Watershed Condition,  $I_a = 0.2 S_r$ )

Land Use	Hydrologic Soil Group			
	A	B	C	D
<i>Fully developed urban area (vegetation established)</i>				
Good condition, grass cover 75% or more	39	61	74	80
Good condition, grass cover 50%–75%	49	69	79	84
Good condition, grass cover less than 50%	68	79	86	89
<i>Paved area (parking lots, driving way, roof, etc.)</i>				
Streets and roads	98	98	98	98
Paved with curbs and storm sewers	98	98	98	98
Gravel	76	85	89	91
Dirt	72	82	87	89
Paved with open ditches	83	89	92	93
<i>Average % impervious</i>				
Commercial and business area	89	92	94	95
Industrial districts	81	88	91	93
Row houses, town houses, and residential with lot sizes 0.05 ha or less	77	85	90	92
<i>Residential</i>				
1/4 acre	61	75	83	87
1/3 acre	57	72	81	86
1/2 acre	54	70	80	85
1 acre	51	68	79	84
2 acre	46	65	77	82
<i>Developing urban areas (no vegetation established)</i>				
Newly graded area	77	86	91	94
<i>Desert urban areas</i>				
Natural desert landscaping (pervious area)	63	77	85	88
Artificial desert landscaping	96	96	96	96
<i>Cultivated agricultural land—fallow</i>				
Straight row or bare soil	77	86	91	94
Conservation tillage poor	76	85	90	93
Conservation tillage good	74	83	88	90

Sources: Hvitved-Jacobsen, T. et al., *Sci. Total Environ.*, 146/147, 499, 1994; USDA (U.S. Department of Agriculture), U.S. Soil Conservation Service. Technical Release 55: Urban Hydrology for Small Watersheds, Available from NTIS (National Technical Information Service), NTIS # PB87101580, 1986.

Notes: *Group-A Soils*: High infiltration (low runoff). Infiltration rate > 0.3 in./h when wet.

*Group-B Soils*: Moderate infiltration (moderate runoff). Infiltration rate 0.15–0.3 in./h when wet.

*Group-C Soils*: Low infiltration (moderate-to-high runoff). Infiltration rate 0.05–0.15 in./h when wet.

*Group-D Soils*: Very low infiltration (high runoff). Infiltration rate 0–0.05 in./h when wet.

Time of concentration ( $T_c$ ) is also a synthesis parameter to favor stormwater modeling. It is defined as the time required for water to travel from the hydraulically most remote point of the basin to the point of interest.

### 16.5.2 Peak Flow

Peak flow is usually calculated to size drainage systems such as pipes, culverts, channels, and weirs, and is also used for selecting measures for erosion control. Peak flows are generally adequate for the design and analysis of conveyance systems such as storm drains or open channels.

### 16.5.2.1 Rational Method

The rational method has been the most commonly used method for calculation of peak flow for both urban and rural areas smaller than 80 ha since the 1900s [11]. This method assumes that peak flow occurs when the entire watershed is contributing to the flow, and rainfall intensity is the same over the entire drainage area and uniform over a time period equal to the time of concentration:

$$Q_p = \frac{f_a \cdot C \cdot I \cdot A}{360} \quad (16.3)$$

where

$Q_p$  is the peak flow (m<sup>3</sup>/s)

$f_a$  is the antecedent precipitation factor, which equals 1.0 for a storm return period of 2–10 years, and 1.1, 1.2, and 1.25 for return periods of 25, 50, and 100 years, respectively [32]

$C$  is the dimensionless runoff coefficient; no difference between recurrence probabilities

$I$  is the rainfall intensity (mm/h)

$A$  is the drainage area (ha)

Rainfall IDF curves are necessary for the rational method. If IDF curves are not available, they need to be developed case-by-case.

### 16.5.2.2 SCS Peak Flow Method

The US Soil Conservation Services (SCS) peak flow method calculates peak flow as a function of drainage basin area, potential soil storage, and time of concentration [11]. This rainfall–runoff relationship separates total rainfall into direct runoff, retention, and initial abstraction to yield the following equation for rainfall–runoff [11]:

$$Q_d = \frac{(P - 0.2S_r)^2}{P + 0.8S_r} \quad (16.4)$$

where

$Q_d$  is the runoff depth (mm)

$P$  is the depth of 24-h precipitation (mm), which could be obtained from the IDF curve

$S_r$  is the soil retention (mm), which could be obtained from

$$S_r = 25.4 \left( \frac{1000}{CN} - 10 \right) \quad (16.5)$$

Peak flow is then estimated from the following equation:

$$Q_p = q_u \cdot A \cdot Q_d \quad (16.6)$$

where

$A$  is the basin area (km<sup>2</sup>)

$Q_d$  is the runoff depth (mm)

$q_u$  is the unit peak flow (m<sup>3</sup>/s/km<sup>2</sup> mm) and can be calculated from the following equation:

$$q_u = 0.000431 \times 10^{C_0 + C_1 \log T_c + C_2 (\log T_c)^2} \quad (16.7)$$

where  $C_0$ ,  $C_1$ ,  $C_2$  are coefficients, which were developed based on the 24-h rainfall distribution type and the ratio of initial abstraction ( $I_a$ ) and rainfall depth ( $P$ ) [25].

This method is most accurate for areas with fairly homogeneous CN values, and the  $I_a/P$  ratio has to be between 0.1 and 0.5 [25].



### 16.5.2.3 Probabilistic Rational Method

The probabilistic rational method (PRM) is developed from observed data. The formula is similar to that in the rational method, but each parameter is determined by the recurrence interval as follows [30]:

$$Q(Y) = 0.278 C(Y) \cdot I(T_c, Y) \cdot A \quad (16.8)$$

where

$Q$  is the peak discharge ( $\text{m}^3/\text{s}$ )

$I$  is the average rainfall intensity ( $\text{mm}/\text{h}$ )

$A$  is the area ( $\text{km}^2$ )

$C$  is the runoff coefficient

$T_c$  is the time of concentration ( $\text{min}$ )

$Y$  is the average recurrence interval (ARI) (years)

The formula converts rainfall with an ARI of  $Y$  years derived from the design IDF data for a region into peak discharge with the same ARI. For the design purpose, the design rainfall are probabilistic values derived from frequency analyses.

The value of the runoff coefficient  $C$  is different for different values of  $Y$ . The probabilistic rational method is conceptually a form of regional flood frequency analysis, with rainfall intensity as one of the independent predictor variables. As rainfall intensity is one of the major determinants of the flood characteristics of a basin, this approach is an efficient form of regional flood frequency analysis, and is simple and familiar to most designers. With this probabilistic interpretation, accuracy of the time of concentration regarding travel time is much less important than the consistency and reproducibility of the derived  $C(Y)$  values [30].

### 16.5.3 Runoff Volume

Runoff volume is usually calculated for the retention/detention pond design for a small area. Equations 16.4 and 16.5 are commonly used to estimate the total runoff volume for storage facility design.

### 16.5.4 Hydrograph

A hydrograph is a simplified method describing the process of runoff during a storm event. In many places, a standard hydrograph (or unit hydrograph) has been developed for local stormwater modeling. Figure 16.3 shows a typical hydrograph. Hydrographic analysis is necessary for a complex stormwater drainage system, which usually includes detention/retention ponds, different flow conveyances, and pump stations. It can evaluate large storm drainage systems more precisely and reflect the conditions in each segment.

### 16.5.5 Unit Hydrograph Method

By assuming uniform rainfall intensity and duration over an entire watershed, a unit hydrograph could be developed for stormwater modeling. Basically, a unit hydrograph is defined as the direct runoff hydrograph that lasts for a unit duration of time, and has the same temporal and spatial distribution resulting from a rainfall event. The volume of direct runoff represented by the area under a unit hydrograph is equal to 1 mm of runoff from the drainage area. Unit hydrographs are recommended to be applied to drainage areas smaller than 2590  $\text{km}^2$  to overcome the limitations of uniform assumption.

When a unit hydrograph is not available for regional analysis, a synthetic unit hydrograph needs to be developed through analysis of a large number of natural hydrographs from across broad of geographic locations and hydrologic regions. Key parameters in the development of a synthetic

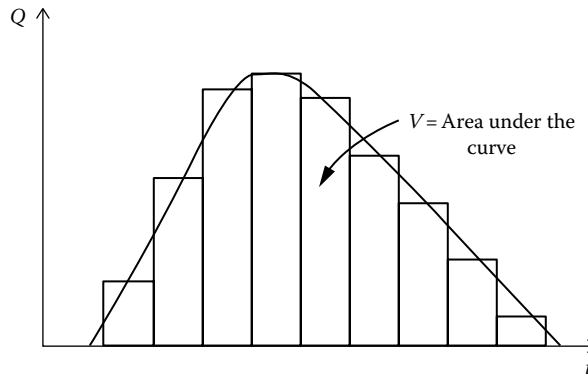


FIGURE 16.3 An example of a hydrograph.

unit hydrograph include lag time, unit hydrograph duration, peak discharge, and time to peak. A characteristic unit hydrograph could be sketched by using these points. The volume of this hydrograph equals 1 mm of runoff.

So far, the basic concept and parameters for stormwater modeling have been presented.

## 16.6 Stormwater Modeling

Stormwater modeling is used to understand the flow direction, flow rates, water elevations, pollutant loads, and contaminant concentrations at any location of interest during and after a specific storm event. The modeling results are usually then used for a master plan, storage and drainage design, or water treatment analysis.

### 16.6.1 Data Collection

The following data are usually needed for stormwater modeling:

1. Topographic information: A topographic survey is usually essential and is a basis for drainage basin delineation.
2. Soil characteristics: A geotechnical survey is needed to get information on soil infiltration and drainage properties. It is critical to determine the soil storage condition, hydraulic conductivity, density, infiltration rate.
3. Land use: Land use along with soil type determines rainfall infiltration properties. In stormwater modeling, land use and soil type (infiltration characteristics) determine the CN of a specific location.
4. Hydrologic and meteorology data, including rainfall data, base flow, seasonal high water table, temperature, evaporation rate in certain seasons (i.e., for a large storage surface area), historical low and high water levels, flood records, rain station records, developed hydrograph, etc. To obtain the design rainfall and hydrograph for a certain occurrence interval, frequency analysis is usually essential from historic record.
5. Local regulatory requirements, regulations, rules and laws, and design standards, including design storm event frequency and duration.
6. Existing drainage system, including all drainage facilities such as channels (creeks, rivers, ditches, canals, swales, low crossings), pipes, culverts, weirs, drop structures, ponds, pump stations, valves, gates, etc. Data include sizes, lengths, flow curves, inverts, materials, cross-sections, and stage–area curves that apply to the drainage facilities. As-built and/or new surveys usually are required to obtain all such information.

In many cases, some data listed above are not available or adjustments need to be made to use data collected from a number of locations. Double mass analysis is a commonly used data analysis approach for investigating the behavior of records of hydrological or meteorological data at many locations. It is used to determine whether there is a need for corrections to the data to account for changes in data collection procedures or other local conditions. Such changes may result from a variety of factors, including changes in instrumentation, changes in observation procedures, or changes in gauge locations or surrounding conditions. Double mass analysis for checking the consistency of a hydrological or meteorological record is considered to be an essential tool before using the record for analysis purpose. In addition, engineers are required to use their judgment to make sure all such information is reasonable as these data are to be used as input in stormwater modeling.

### 16.6.2 Stormwater Modeling Methodology

For a large drainage area with complex drainage routes, the basin–node–link (BNL) methodology is usually used for stormwater modeling. Many stormwater modeling software have been developed based on this methodology. In the BNL method, the drainage basin of interest is divided into a certain number of subbasins depending on the level of service. A node is then assigned to each subbasin. Water in each subbasin is assumed to accumulate to the node. Nodes are also assigned to each end of any conveyance sections. The nodes are connected by drainage links (such as pipes, channels, weirs, drainage structures, pumps, percolation, etc.). Figure 16.4 shows a typical BNL diagram for stormwater modeling [26]. The U.S. Environment Protection Agency (EPA) developed the most widely used stormwater modeling software (Stormwater Management Model [SWMM]) by utilizing the BNL methodology.

SWMM can be downloaded free of cost from the USEPA website. Many other stormwater modeling software have been developed based on the SWMM engine.

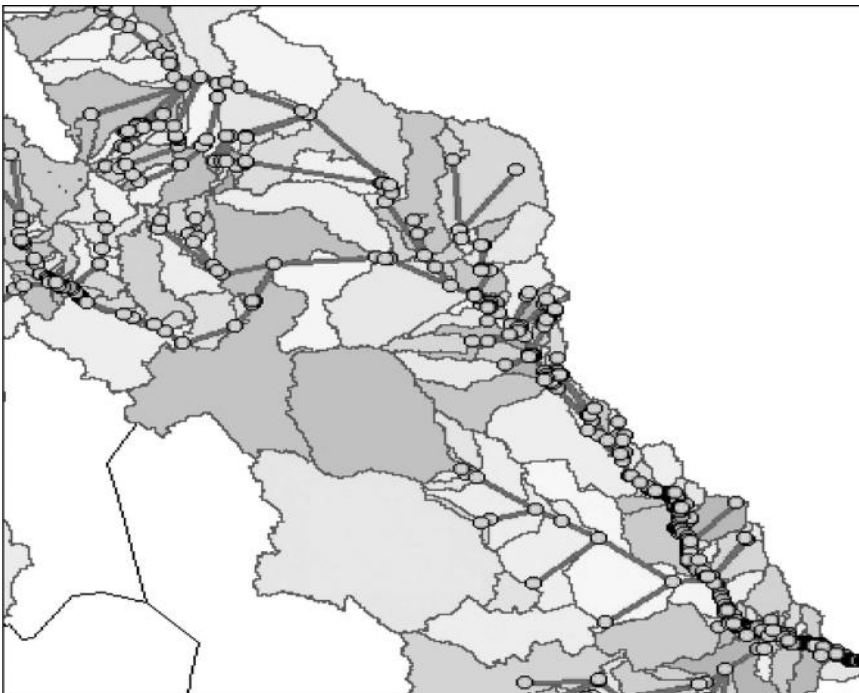


FIGURE 16.4 BNL diagram for stormwater modeling.

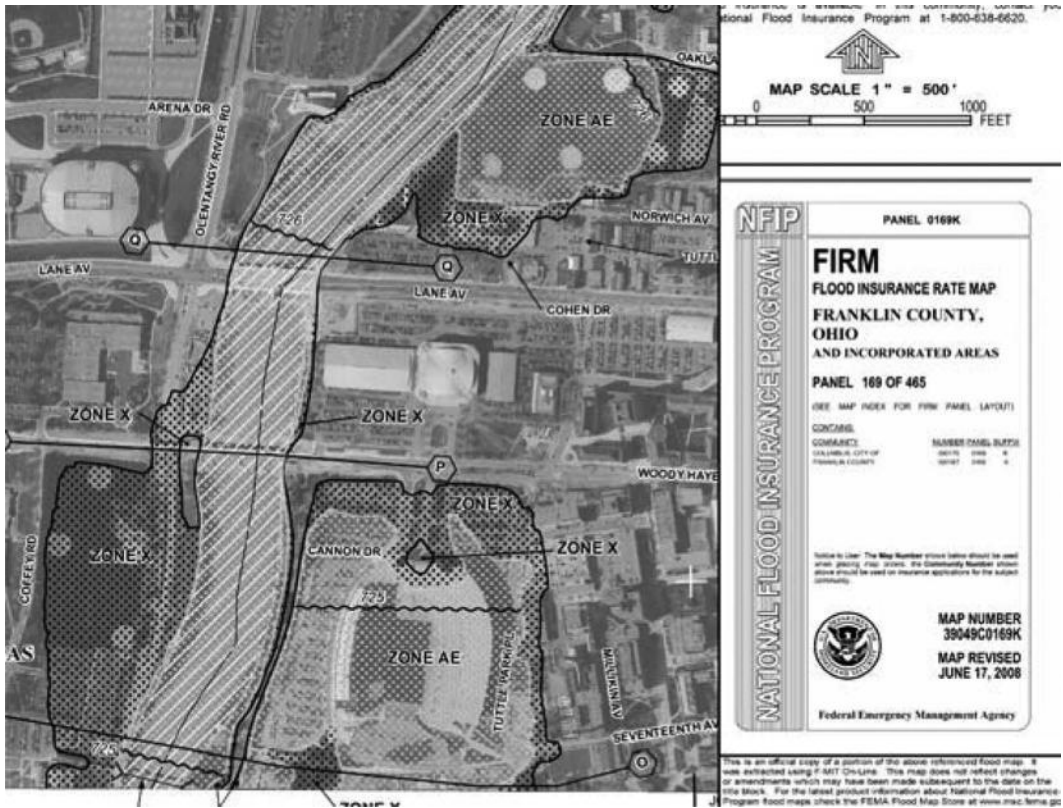


FIGURE 16.5 An example of a floodplain map.

SWMM and most SWMM-based software are one-dimensional. Two-dimensional software such as XPSWMM and TRUEFLOW are also available for spatially distributed hydraulic modeling.

### 16.6.3 Modeling Result Analysis and Application

Stormwater modeling results usually yield the stage (water level) at any point of interest, flow rate at any conveyance, and runoff volume in any basin at any time. The modeling results are then used as a basis for master planning, land development, and detail drainage design. Modeling results also form the basis for floodplain maps, which are produced to show inundated areas under a certain storm event. The U.S. Federal Emergency Management Agency (FEMA) 100-year floodplain maps are based on modeling results with approved model domains. The FERM 100-year floodplain map (called FIRM map) is the basis for mortgage lenders to claim flood insurance or not from property buyers. Figure 16.5 shows a flood zone map as an example [34].

## 16.7 Urban Drainage Design and Modeling

An urban drainage system consists of collection, conveyance, storage, and discharge components.

### 16.7.1 Stormwater Collection and Conveyance

In an urban area, stormwater is usually collected through sheet flow (rural area), gutters, and inlets (urban area), and delivered downstream.

Upon reaching the main storm drainage system, stormwater is conveyed to its discharge point via pipes, culverts, open channels, or natural ditches. In some situations, stormwater pump stations may also be required as a part of the conveyance system.

Manning's equation is commonly used to estimate the capacity of the collection system for both pipes and open channels:

$$v = \frac{0.379}{n} R^{2/3} S_0^{1/2} \quad (16.9)$$

where

$v$  is the velocity (m/s)

$n$  is the Manning's coefficient

$R$  is the wet perimeter (m)

$S_0$  is the slope of the energy grade line (m/m)

In application of this equation, the selection of Manning's  $n$  is critical and is based on the material, roughness of the surface, and vegetation growing conditions (open channels). Different surface materials in pipelines and different vegetation conditions in open channels will result in different Manning's  $n$  in the magnitude of tenth of times. As a result, great care needs to be taken and a sensitivity analysis is usually necessary to make sure the drainage system is designed with enough flow capacity.

## 16.7.2 Stormwater Storage and Discharge

Land development usually leads to more stormwater than the pre-development condition due to impervious surface increase such as road pavements and roofs. In addition, the increased runoff leads to more erosion and pollutant transport. On-site storage is an important measure to mitigate the impact of development. As a result, many local regulatory agencies require developers to treat the first few centimeters of stormwater (first flush) before it is allowed to be discharged off-site or downstream. Temporary storage facilities to store excess stormwater as a means of controlling stormwater quantity and quality are a fundamental principle in stormwater management. Storage of stormwater can reduce the frequency and extent of downstream flooding, soil erosion, sedimentation, and water pollution. Stormwater storage facilities can be classified by function as either detention or retention facilities. The primary function of detention is to store and gradually release stormwater runoff by way of a control structure. Retention facilities also store stormwater runoff, but release water only through evaporation or infiltration. In general, retention facilities provide more quality control than detention facilities [25].

Detention ponds are the most common detention facilities and are often designed to limit the post-development peak outflow rate so that it does not exceed the pre-development outflow rate in the same watershed. The peak flow and runoff volume can be estimated by using Equation 16.3 or 16.6.

Retention facilities provide dual functions of stormwater quantity and quality control. In addition, they may be used for water supply and groundwater recharge. Retention ponds should be designed with the capacity to mitigate peak flow following the same rules as detention ponds do. In addition, retention ponds will need to provide the capacity to retain a certain volume of stormwater, that is, 1–3 cm of "first flush" within a watershed.

Retention facilities can combine different water quality-control measures. For example, a bio-retention area is a mix of functional attenuation, retention, and vegetation absorption, each performing different functions in the removal of pollutants and attenuation of stormwater runoff [8,25].

## 16.8 Stormwater Quality Practice

---

### 16.8.1 Stormwater Quality Introduction

With rapid urban development, there has been a significant shift from interest solely in water quantity issues, such as flood control and water supply, toward a more balanced concern for both the quantity and quality aspects of the water environment [4]. Particulate matter, metal elements, nutrients, organics, and major pollutants are present in runoff, which is discharged to and contaminates the water environment. Nutrient pollution mainly including phosphorus and nitrogen pollution is a major environmental concern in many countries and attracts increasing attention from many scholars and governmental officers.

To predict the impact of land development on a watershed, pollutant loadings can be estimated for both pre- and postdevelopment scenarios. Several methods and models are currently available, which employ algorithms for pollutant loading estimation. A simple method is an aptly named empirical method, which is intended for use in sites smaller than 2.5 km<sup>2</sup>. It assumes that average pollutant concentration is multiplied by the average runoff to yield an average loading estimate. Many comprehensive stormwater management models, such as the SWMM and the Storage, Treatment, Overflow, Runoff Model (STORM), have the ability to generate pollutant loads and the fate and transport of the pollutants [3,7].

Many best management practices (BMPs) have been developed to improve stormwater quality and mitigate the impacts on the receiving water bodies. Commonly used BMPs include infiltration trenches, infiltration basins, grassed swales, detention and retention ponds, wetlands, water quality inlets, and porous pavements. An important parameter in BMP design is the runoff volume treated. This initial flush of runoff is known to carry the most significant nonpoint pollutant loads [3,8,25]. Definitions for this first flush vary case-by-case, but it is most commonly defined as the first 13–25 mm of runoff per hectare of impervious area. In general terms, the greater the volume treated, the more the pollutants will be removed [7]. However, treating volumes in excess of 25 mm (1.0 in.) per hectare (acre) of catchment area result in only minor improvements in pollutant removal efficiency [7].

### 16.8.2 Phosphorus Concern

Phosphorus (P) has been extensively input into rivers, lakes, and oceans, and other small-size water bodies from over-fertilization of urban and right-of-way areas, industrial, and municipal sources (such as detergents) [5]. Because it is an essential nutrient for growth of organisms, phosphorus is a major cause of eutrophication in most ecosystems, subsequently followed by massive algal blooms, fish suffocation, and other undesired effects [5]. Phosphorus in the elemental form is particularly toxic and is subject to bioaccumulation in much the same way as mercury [5].

Phosphorus in natural waters is divided into two component parts: dissolved phosphorus (DP) and particulate phosphorus (PP) [16], and the sum of DP and PP is termed total phosphorus (TP). DP and PP are differentiated by whether or not they can pass through a 0.45- $\mu$ m membrane filter [14]. It was found that 60%–80% of the phosphorus in road runoff had been associated with particulates [20]. Phosphorus removal from stormwater occurs by either adsorption or precipitation. Bio-system removal is usually applied in rural areas, whereas CPP is high in efficiency in phosphorus removal in urban areas as a passive unit operation and process [24,37].

The critical concentration of phosphorus, above which growth of algae and other aqueous plants is accelerated, is suggested to be 0.01 mg/L for dissolved phosphorus and 0.02 mg/L for total phosphorus [35]. In comparison, dissolved phosphorus in South Florida (USA) can be as high as 1.0 mg/L and total phosphorus can be as high as 3.0 mg/L as an event mean concentration. Excess release of phosphorus into surface water has caused severe environmental and ecologic problems in the Everglade area in

South Florida (USA). The federal government passed the Water Resources Development Act (WRDA) in 2000 with the goal to preserve water resources and restore the environment and ecosystem in Central and South Florida. The act approved the so-called Comprehensive Everglades Restoration Plan (CERP), which covers 16 counties over an 11,520,000-acre area. It will take more than 30 years to construct and the estimated investment in October 2007 dollars was \$10 billion. It has been the largest and most complicated water environmental protection project in US history and more than 10 federal and state agencies have been involved in [42].

### 16.8.3 CPP for Stormwater Quality Control and Phosphorus Removal as a Passive Unit Operation and Process

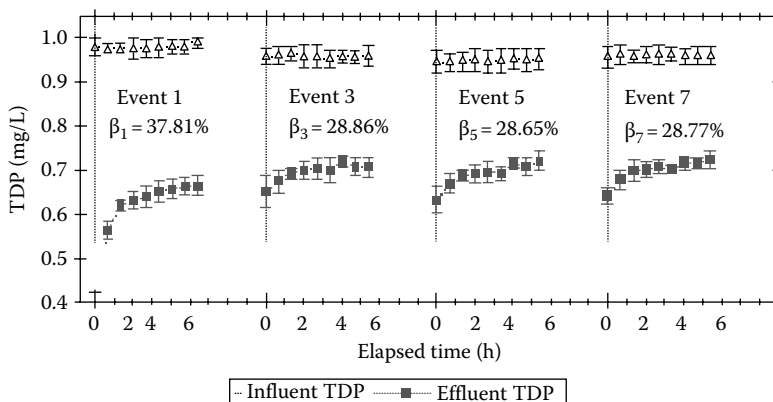
Lot of researchers have demonstrated that a porous pavement is a very effective tool for stormwater management in both quantity and quality control [6,15,18,19,23,24,33,36,37]. A porous pavement not only reduces runoff volume, facilitates groundwater and interflow recharge [10,21,31], and mitigates temperature increases [22,38], but also improves runoff quality by removing particulate matter, metals, mineral oils, soluble, and anthropogenic pollutants from the runoff [12,13,29]. Compared with an asphalt porous pavement, CPP has outstanding advantages for water environmental benefits [13]. For example, research also found that CPP is very effective in phosphorous removal. Park and Tia [27] showed in their research that total phosphorous removal efficiency was up to 66% (14 days) to 96% (seven days) for fresh-made CPP. Through its filtration function, CPP retains particles on its surface and the particulate-associated phosphorous removal is obvious since 60%–80% of the phosphorous in road runoff is associated with particulates [5,17], and CPP particle removal efficiency is as high as 90% [18,24,36].

Researchers have also demonstrated that CPP is also effective in phosphorous removal as a passive unit operation and process. Figures 16.6 and 16.7 show DP and TP removal by CPP specimens, which had been exposed to rainfall–runoff for three years before used for experiments in examining phosphorous removal efficiency. Removal efficiency  $\beta$  can be calculated as

$$\beta = \frac{[P] - [P]_0}{[P]_0} \times 100\% \quad (16.10)$$

In the expression,  $[P]_0$  = Phosphorous concentration in the influent.

Results show that CPP as a passive unit operation and process is capable of removing 50% of the TP. It is reasonable to believe that fresh CPP will have even higher efficiency of phosphorous removal.



**FIGURE 16.6** DP removal by CPP specimens (CPP specimens have been exposed to rainfall for three years before used for the study).

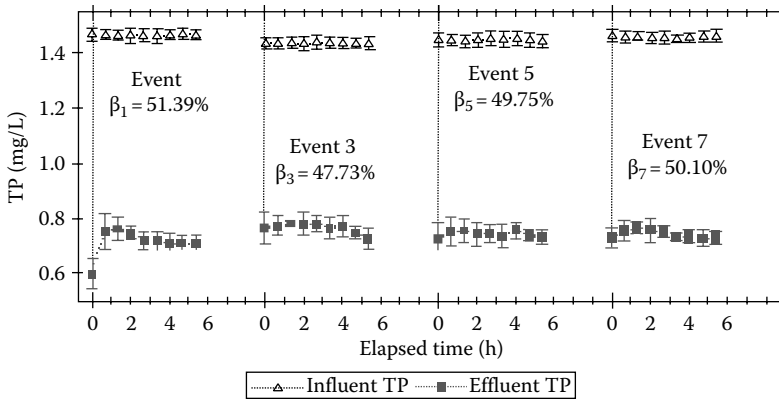


FIGURE 16.7 TP removal by CPP specimens (CPP specimens have been exposed to rainfall for three years before used for the study).

## 16.9 Summary and Conclusion

Stormwater management, including both quantity and quality control, is a matter strongly related to the safety and health of public lives and properties, and is critical for urban sustainable development. This chapter introduces the basic theories and knowledge of hydrology and hydraulics for stormwater modeling and management. It includes the introduction of the hydrology cycle, rainfall characteristics, rainfall–runoff relationship, stormwater modeling, urban drainage design and modeling, and water quality practice. The chapter also provides the author’s latest research results on phosphorus removal from stormwater using CPP. The results demonstrate that CPP serves an effective LID structure for stormwater management through phosphorus removal as a passive unit operation and process. A 3-year-exposed CPP still functions well in terms of phosphorus removal, with efficiency as high as 50%.

## References

1. American Society of Civil Engineers. 1960. *Design Manual for Storm Drainage*. New York: American Society of Civil Engineers.
2. Andersen, C.T., Foster, I.D.L., and Pratt, C.J. 1999. The role of surfaces (permeable pavement) in regulating drainage and evaporation: Development of a laboratory simulation experiment. *Hydrological Processes*, 13, 597–609.
3. Asaeda, T. and Ca, V.T. 2000. Characteristics of permeable pavement during hot summer weather and impact on the thermal environment. *Canadian Building and Environment*, 35, 363–375.
4. Balades, J-D., Legret, M., and Madiec, H. 1995. Permeable pavements: Pollution management tools. *Water Science and Technology*, 32(1), 49–56.
5. Bäckström, M. 2000. Ground temperature in porous pavement during freezing and thawing. *Journal of Transportation Engineering, ASCE*, 126(5), 375–381.
6. Bäckström, M. and Bergström, A. 2000. Draining function of porous asphalt during snowmelt and temporary freezing. *Canadian Journal of Civil Engineering*, 27, 594–598.
7. Carlson, R.E. and Simpson, J. 1996. *A Coordinator’s Guide to Volunteer Lake Monitoring Methods*. Madison, WI: North American Lake Management Society, p. 96.
8. EPA. 2000. *Low Impact Development (LID): A Literature Review*. United States Office of Water (4203) EPA-841-B-00-005, Environmental Protection Agency, Washington, DC, October.



9. Fach, S., Geiger, W.F., and Dierkes, C. 2002. Development of an assessment procedure for porous pavements. *Ninth Conference on Urban Drainage 2002*, Portland, OR.
10. Field, R., Masters, H., and Singer, M. 1982. Status of porous pavement research. *Water Research*, 16, 849–858.
11. Field, R., Masters, H., and Singer, M. 1982. Porous pavement: Research; development; and demonstration. *Journal of Transportation Engineering*, ASCE, 108, 244–258.
12. Ghafoori, N. and Dutta, S. 1995. Pavement thickness design for no-fine concrete parking lots. *Journal of Transportation Engineering*, ASCE, 121(6), 476–484.
13. Hogland, W., Niemczynowicz, J., and Wahlman, T. 1987. The unit superstructure during the constructive period. *Science of the Total Environment*, 59, 411–424.
14. Hvitved-Jacobsen, T., Johansen, N.B., and Yousef, Y.A. 1994. Treatment systems for urban and highway run-off in Denmark. *The Science of the Total Environment*, 146/147, 499–506.
15. Jackson, T.J. and Ragan, M. 1974. Hydrology of porous pavement parking lots. *Journal of the Hydraulics Division*, 145(9), 1739–1752.
16. Kim, Y.-J., Geohring, L.D., and Steenhuis, T.S. 2003. Phosphorus removal in vegetative filter strips receiving milkhouse wastewater and barnyard runoff. ASAE Paper # 03-2075, American Society of Agricultural Engineers, St. Joseph, MI, 11pp.
17. Kobayashi, T., Kagata, M., Kodama, T., and Ito, M. 2002. Development of the environment-friendly hybrid permeable concrete. *Transactions of the Japan Concrete Institute*, 23, 65–76.
18. Kuang, X., Kim, J., Gnecco, I., Raje, S., Garofalo, G., and Sansalone, J.J. 2007. Particle separation and hydrologic control by cementitious permeable pavement. *Transportation Research Record: Journal of the Transportation Research Board*, 2025, 111–117.
19. Kuang, X. and Sansalone, J. 2011. Cementitious porous pavement in stormwater quality control: pH and alkalinity elevation. *Water Science and Technology*, 63(12), 2992–2998.
20. Kuang, X., Sansalone, J., Ying, G., and Ranieri, V. 2011. Pore-structure models of hydraulic conductivity for permeable pavement. *Journal of Hydrology*, 399(3–4), 148–157.
21. Kuang, X. and Fu, Y. 2013. Coupled infiltration and filtration behaviours of concrete porous pavement for stormwater management. *Hydrological Processes*, 27, 532–540.
22. Kuennen, T. 2003. A new era for permeable pavement. *Road Science—Better Road*, 28–32.
23. Maidment, D.R. 2002. *Arc Hydro: GIS for Water Resources*. Redlands, CA: ESRI Press.
24. Malhotra, V.P. and Normann, J.M. 1994. *Best Management Practices Computer Model, SDN Water Resources*.
25. McCuen, R.H., Johnson, P.A., and Ragan, R.M. 2002. *Highway Hydrology, Hydraulic Design Series No. 2*, 2nd ed., Publication No. FHWA-NHI-02-001, Federal Highway Administration, Washington, DC.
26. Oke, T. 1982. The energetic basis of urban heat island. *Quarterly Journal of the Royal Meteorological Society*, 108, 1–24.
27. Park, S.B. and Tia, M. 2004. An experimental study on the water-purification properties of the porous concrete. *Cement and Concrete Research*, 34, 177–184.
28. Pilgrim, D.H. 1989. *New Directions for Surface Water Modeling, Proceedings of the Baltimore Symposium*, IAHS Publ. No. 181, Regional methods for estimation of design floods for small to medium sized drainage basins in Australia, Baltimore, MD.
29. Pratt, C.J. 1999. Use of permeable, reservoir pavement constructions for stormwater treatment and storage for re-use. *Water Science and Technology*, 39(5), 145–151.
30. Ranieri, V. 2002. Runoff control in porous pavement. TRB 1789, Paper No. 02-3476, 46–55.
31. Rigler, F.H., 1973. A dynamic view of the phosphorus cycle in lakes. *Environmental Phosphorus Handbook*, Griffith, E.J., Beeton, A., Spencer, J.M., and Mitchell, D.T. New York: John Wiley & Sons.
32. Sansalone, J., Kuang, X., and Ranieri, V. 2008. Permeable pavement as a hydraulic and filtration interface for urban drainage. *ASCE Journal of Irrigation and Drainage*, 134(5), 666–674.
33. Sansalone, J., Kuang, X., Ying, G., and Ranieri, V. 2012. Filtration and clogging of permeable pavement loaded by urban drainage. *Water Research*, 46(20), 6763–6774.

34. Shueler, T.R. 1987. *Controlling Urban Runoff: A Practical Manual for Planning and Designing Urban BMPs*. Washington, DC: Metropolitan Council of Governments.
35. Spivakov, B.Y., Maryutina, T.A., and Muntau, H. 1999. Phosphorus speciation in water and sediments. *Pure and Applied Chemistry*, 71(11), 2161–2176.
36. Stotz, G. and Krauth, K. 1994. The pollution of effluents from pervious pavement of an experimental highway section: First results. *The Science of the Total Environment*, 146/147, 465–470.
37. Teng, Z. and Sansalons, J.J. 2004. In situ partial exfiltration of rainfall runoff. II: Particle separation. *Journal of Environmental Engineering, ASCE*, 130(9), 1–13.
38. USDA (U. S. Department of Agriculture). 1986. Urban Hydrology for Small Watersheds, TR-55.
39. USDA (U.S. Department of Agriculture). 1986. U.S. Soil Conservation Service. Technical Release 55: Urban Hydrology for Small Watersheds. Available from NTIS (National Technical Information Service), NTIS # PB87101580.
40. Wright-McLaughlin Engineers. 1969. *Urban Storm Drainage Criteria Manual*, Vol. 2. Prepared for the Denver Regional Council of Governments. Denver, CO: Wright-McLaughlin Engineers.
41. <http://buildipedia.com/at-home/design-remodeling/how-to-read-flood-zone-maps>
42. <http://www.evergladesplan.org/>



# 17

## Stormwater Modeling and Sustainable Management in Highly Urbanized Areas

---

17.1	Introduction .....	348
17.2	Modeling Approaches .....	349
	Published Pollutant Yield Data • Buildup and Washoff Modeling • Regression Modeling • Flow Data Modeling • Estimating Concentrations and Loadings • Deterministic Modeling	
17.3	Stormwater Packages for Sustainable Management.....	356
	MUSIC • SUDSLOC • SUSTAIN • WinSLAMM	
17.4	1D–2D Modeling .....	359
17.5	Summary and Conclusions .....	361
	References.....	361

J. Bryan Ellis  
*Middlesex University*

Christophe Viavattene  
*Middlesex University*

### AUTHORS

**J. Bryan Ellis** is an emeritus professor at the Urban Pollution Research Centre (UPRC), Middlesex University in London, United Kingdom. He has over 380 publications in the field of urban drainage and is currently involved in work on sustainable drainage system modeling for both flood and water quality risk management. He is a past member and chair of the International Water Association/International Association Hydraulic Research (IWA/IAHR) Joint International Committee on Urban Drainage. Professor Ellis was a past director of science and training at the UK Natural Environment Research Council (NERC). He has recently been involved in a number of UK government working parties on urban diffuse pollution, urban water management, highway outfalls, and pharmaceuticals in urban receiving waters.

**Christophe Viavattene** is a research fellow at the Flood Hazard Research Centre (FHRC), Middlesex University in London, United Kingdom. He gained his PhD at the École Nationale Supérieure des Mines de Paris, France, before joining HFRC with research interests spanning the engineering, social, and economic interfaces. His research is mainly focused on understanding how society can better manage water resources and their associated risks, for example, floods, drought, and pollution. Much of his work has focused on EU-funded projects utilizing agent-based modeling and GIS-based approaches. His recent work has been concerned with the development of GIS-based decision support system (DSS) modeling techniques for best management practice/sustainable drainage systems (BMP/SUDS) implementation.

## PREFACE

The assessment and prediction of urban surface water runoff has become a core issue for urban stormwater management across the world and has generated an ever-increasing interest in modeling tools for risk assessment and best management practice (BMP) mitigation measures. While hydraulic modeling approaches for stormwater flows and sewer conveyance are now well developed and tested, the modeling basis for nonpoint urban water quality is still somewhat rudimentary. This chapter focuses on statistical and numerical approaches that have been developed to quantify pollutant concentrations and loadings associated with stormwater runoff and to evaluate the performance effectiveness of BMP controls for sustainable water management in highly urbanized areas.

There has been a widespread application of simple, first-order screening techniques primarily based on regression and probabilistic analysis. These are now being supplemented by generic GIS and process-based modeling techniques frequently employing coupled 1D–2D dual-drainage methodologies. In general, it is alleged that the simpler metamodeling approaches if appropriately calibrated and verified can match the predictive outcomes from the more deterministic process-based methods. A brief review is also provided of some commercially available software packages intended to support decision making for sustainable stormwater management.

## 17.1 Introduction

Existing approaches to modeling impermeable stormwater discharges range from simple application of basic hydraulic/hydrologic procedures to highly complex surface runoff and groundwater models. In the case of diffuse urban pollution, both lumped and distributed approaches have been used. Models can be both stochastic and deterministic and treat the watershed, or a significant part of it, as one unit. Distributed models divide the catchment into smaller spatial units assumed to be homogeneous and described individually by a set of differential mass balance equations.

Despite their questionable accuracy and reliability, simple first-order screening procedures and reactions have wide applications in the field of urban hydrology and frequently are incorporated into more complex mathematical models [25,29]. Such simple procedures provide rapid assessment techniques enabling preliminary and early identification of “active/hotspot” areas generating runoff and nonpoint pollution. However, the performance effectiveness of alternative and sustainable management measures based on such simplified screening procedures must be viewed with considerable caution. It is also clear that as the scientific understanding of the sources, conveyance, and behavior of both runoff and pollutants has increased, the capacity to move from simple empirical models to deterministic, process-based models capable of robust scenario assessment and prediction of future changes has also been enhanced [23].

The various inputs, outputs, and pathways followed by nonpoint runoff and diffuse pollutants from both “natural” and anthropogenic sources within urban catchments are now generally well categorized [14,48]. Although the principal external inputs to the drainage system may be identified as dustfall and precipitation, the primary volumes and loads are derived from impermeable roof and highway surfaces. Further pollutant sources are generated through biochemical reactions that occur within the deposited sediments of the belowground system and that are (re)-suspended during storm flows and flushed through to the receiving waterbody. The magnitude and characteristics of the output loadings are a combined and complex function of atmospheric quality, urban land use activity and intensity, surface composition and condition, traffic type and intensity, local municipality cleaning practice, and stormwater controls, as well as a function of the specific storm event properties [33]. Illicit connections and cross-connections at various points in the surface water system can also lead to mixing of sanitary wastewater with stormwater in the separate sewer pipe.

There has been considerable application of statistical techniques to the presentation and analysis of monitored runoff and quality data for nonpoint urban discharges and in data interpretation [1,43]. The use of probability distribution functions, standardized parallel plots, and regression functions in the US EPA/ASCE International BMP database illustrates such applications ([www.bmpdatabase.org](http://www.bmpdatabase.org)) and this statistical approach has been widely adopted [14]. However, the mathematical modeling of the water quality processes and associated characteristics of surface water drainage systems and BMP source control devices has been largely confined to the analysis of pollution variability within selected systems such as ponds, wetlands, and infiltration systems [7] and essentially focused on greenfield low impact development (LID) rather than highly urbanized inner city locations.

Over the last 5 years however, there has been a growing interest in the development of generic process-based modeling techniques for the analysis and prediction of BMP (or sustainable drainage systems, SUDS) water quality. This is partly related to the criticisms arising from lack of long-term performance data, potential impacts upon receiving waterbody quality targets, as well as a need to extend knowledge of dominant interactive processes such as water–sediment reactions. Such analysis also requires a detailed methodological consideration of the driving conveyance flows. In response to such demands, a number of proprietary 1D, 2D, and even 3D GIS-based models are appearing, many of which are still under development or remain largely untested to any great extent.

Most established modeling techniques “force-fit” parameters due to inbuilt inflexibilities in the pre-calibrated runoff algorithms. Making a model “agree” with measured field data encourages user changes to input data that often conflict with flow survey information. It could be argued that the verification process may not be so critical these days given it is much easier to obtain validating catchment data and input areas can be supplied in digital form for direct use in models. However, few if any of the water quality modeling approaches fully consider the dynamic interactive processes of flocculation or biochemical transformation involved in pollutant production, preferring to use fixed potency factors and/or partitioning coefficients.

One major issue relates to the high number of parameters used in most water quality models for which only limited data is available. While the modeling procedures do provide default values for various parameters, these must be used with extreme caution as differing models derive vastly different outcomes for the same parameter input values [2]. In addition, water quality modeling is highly dependent on the initial conditions prior to the storm as well as to the model input data. Therefore, long time series data are required to obtain acceptable results, which is normally in conflict with the event-based framework on which these modeling approaches are constructed. While design storm events may be a very useful basis for hydraulic design, their application for water quality modeling purposes is much more fragile.

## 17.2 Modeling Approaches

### 17.2.1 Published Pollutant Yield Data

A crude first-order screening procedure for the estimation of cumulative catchment yield from diffuse nonpoint sources can be derived from relating basic urban land use types to pollutant runoff concentrations ( $\text{mg L}^{-1}$ ) and accumulation rates ( $\text{kg}^{-1} \text{ha}^{-1} \text{year}^{-1}$ ). A yield approach suitable for planning level decisions within urban catchments of less than 2000 ha incorporates a crude hydrologic estimate based on the annual average stormwater runoff volumes generated by differing impermeable land use types. The derived  $Q_{\text{year}}$  volumes are then multiplied with an appropriate event mean concentration (EMC) value to derive a total pollutant loading rate ( $\text{kg}^{-1} \text{m}^3 \text{year}^{-1}$ ) for the catchment. Appropriate EMC land use values can be obtained by reference to summarized data such as available in the US EPA/ASCE BMP database ([www.bmpdatabase.org](http://www.bmpdatabase.org)) or other sources [9,21,30]. One particular issue with this approach is the application of lumped average values and the estimation of initial losses such as depression storage. In addition, these databases focus on inflow and outflow data to urban BMP/SUDS devices rather than

on specific loadings associated with differing urban land use activities. The procedure is best suited to long-term loading estimates rather than the analysis of individual short-term storm events.

The aforementioned yield data approaches can be improved by providing some measure of uncertainty or error in the estimates. This can be done by reference to the ranges of area loading and EMC values estimating the maximum, minimum, and mean (or median) loading values and then evaluating to determine if the measured uncertainty or error would change the conclusions. This is essentially the basis for models such as the Swedish StormTac approach ([www.stormtac.com](http://www.stormtac.com)). In many instances, uncertainty would make little difference in catchment pollution management strategies if the objective, for example, was to identify critical pollutant source areas and if one (or more) specific land use activity was dominant. Although such yield data approaches appear crude with “land use” being too broad a term to accurately characterize the runoff and pollutant-generating capacity of an area, the estimates from such basic empirical approaches frequently bound estimates made independently by more complex mechanistic modeling and can produce the same ultimate management conclusions [45]. Such simple methods are also amenable to implementation in useful spreadsheet formulations.

### 17.2.2 Buildup and Washoff Modeling

Pollutant accumulation and washoff modeling from impervious urban surfaces has a well established history with most “buildup” models based on semiempirical formulations in which the antecedent dry period is often the principal independent variable. The most widely used functional form is the exponential relation developed from the classic baseline studies of Sartor et al. [38] with surface accumulation approaching asymptotic values with elapsed time since sweeping or storm washoff. The rate of pollutant removal from the surface over time is then assumed to be linearly proportional to rainfall intensity with the limiting surface load assuming a complete removal of solids following a cleaning (storm or sweeping) event. As the available field data used to calibrate model parameters have large uncertainties, the choice of the accumulation model depends more on numerical fitting than on physical reasons.

It should be noted, however, that various studies [3,13] have shown little dependence of storm runoff loads on preceding days, which would imply a dependence on the buildup limit and not on the functional form. This would certainly seem to be the case for trunk road/motorway situations where surface materials tend to stabilize around a constant level in a state of discontinuous suspension due to turbulent eddies caused by traffic. Therefore, a better and more linear fit is produced if allowance is made for residual loads rather than assuming complete removal. In addition, there has been considerable discussion on the validity of using a constant supply term ( $k$ ) value and particularly whether this  $k$  value can be assumed to be independent of particle size.

One of the simplest formulations for pollutant buildup is that for total solids (TS) developed for the US Federal Highway Administration [18] and that is based on average daily traffic (ADT) density ( $\text{vehicles}^{-1} \text{day}^{-1}$ ). Other solids-associated pollutants, for example, heavy metals and hydrocarbons, are then predicted by linear regression using “potency” factors. Typically, the steady-state loadings predicted by this formulation vary between 2 and 50  $\text{g}^{-1} \text{m}^{-1}$  of curb length. While such crude empirical procedures can only be used as screening approaches and would need checking against field data, they nevertheless provide rapid, first-order estimation techniques. A similar modeling approach has been adopted by the UK Highways Agency for prediction of surface water runoff and water quality discharging from motorways and major highways [22] and allowing comparison with receiving water quality standards and available dilution capacities under baseflow conditions. The modeling approach develops a stochastic solution based on long-term rainfall time series to predict EMCs, rather than deterministic modeling of buildup and washoff.

A primary difficulty with the buildup/washoff formulation is the assumption of proportionality between rainfall intensity and removal rates that means that concentrations can only decrease with time during the storm event. This causes difficulty in calibrating the quality portion to observed runoff data, which often show increases in concentration during a storm event as runoff rate increases.

An “availability” exponent ( $b$ ) obtained from calibration to the rainfall intensity parameter would overcome the problem permitting concentrations to increase as the exponent increases, as long as the initial losses ( $b$ ) are greater than 1. Concentrations that decrease as flow increases, such as might occur for soluble constituents, may also be simulated by setting  $b < 1$ . It should be noted that the application of these procedures for soluble pollutant assessment provide a highly conservative estimate of likely water quality impacts downstream of a surface water outfall (SWO).

For urban runoff discharges to ground, the annual loading is likely to be of greater importance than instantaneous or event-based volumes and concentrations (except for spillages and fissure flow conditions). A preliminary assessment of the effects of surface runoff on groundwater quality can be made using annual pollutant buildup rates and assuming that all of this loading is washed into the aquifer. The procedure assumes that no dilution is available and that the groundwater is static, that is, worst-case conditions.

It must be stressed that these rapid assessment procedures for both surface and groundwater discharges only yield a preliminary, precautionary estimate and the results of such estimating procedures should not be used by themselves to justify the choice of any specific mitigation techniques.

### 17.2.3 Regression Modeling

Various workers have advocated the use of regional multiple regression equations for the estimation of runoff volumes and pollutant concentrations and loadings expressed as a function of various independent variables, with standard errors providing uncertainty bounds to the predicted values [6,21]. These empirical equations tend to be site specific, with the principal controlling variables being cumulative runoff volume, time elapsed since commencement of the storm, total rainfall depth, 5 min rainfall intensity, and antecedent dry weather period [13]. The use of such regression equations for conditions and locations outside the original data set is always ill advised. In addition, when applying such regression techniques, it must be remembered that an increase in the standard error of the estimate by inclusion of another variable indicates that the additional information given by the extra variable is offset by the loss in degrees of freedom, that is, the regression is better without the extra variable. There are also problems of parameter normalization involved in regression analysis in that the sum of squares F ratio values can be influenced by unbalanced parameter selection. For example, if the regression utilizes a large number of rainfall variables, it should not be surprising if these variables appear dominant in the analysis. There are further questions relating to the degree to which many of the chosen variables can be said to be truly independent variables. However, some review studies have concluded that once calibrated, the outcomes of regression equations for modeling estimates of event pollutant loads are as good as, if not better than, process-based approaches [45].

### 17.2.4 Flow Data Modeling

Site-specific loading estimates can be derived empirically for planning level decisions using the assumed EMC lognormal distribution as interpreted within the US EPA/ASCE national BMP database and as confirmed in many other studies [8,29]. Depending on the availability of local data, the calculations can be performed in various ways. The best situation is to have continuously recorded local flow data and a series of representative local EMC values for a range of storm events. Assuming a lognormal distribution of EMCs, the mean of the record of EMC values is derived. The natural log of the EMC values is first taken and the mean and variance of the natural logs computed. A site (or local) flow record can be consulted to obtain the total flow volume for the loading estimate period. This volume is then multiplied by the upper and lower confidence limits (CL) to obtain the estimate bounds. If a flow record is not available, recourse should be made to a standard hydrological model. Figure 17.1 illustrates this probabilistic methodology that evaluates the influent and effluent EMCs to determine if differences in incoming and outgoing BMP/SUDS concentrations are statistically different. In this case, the untreated



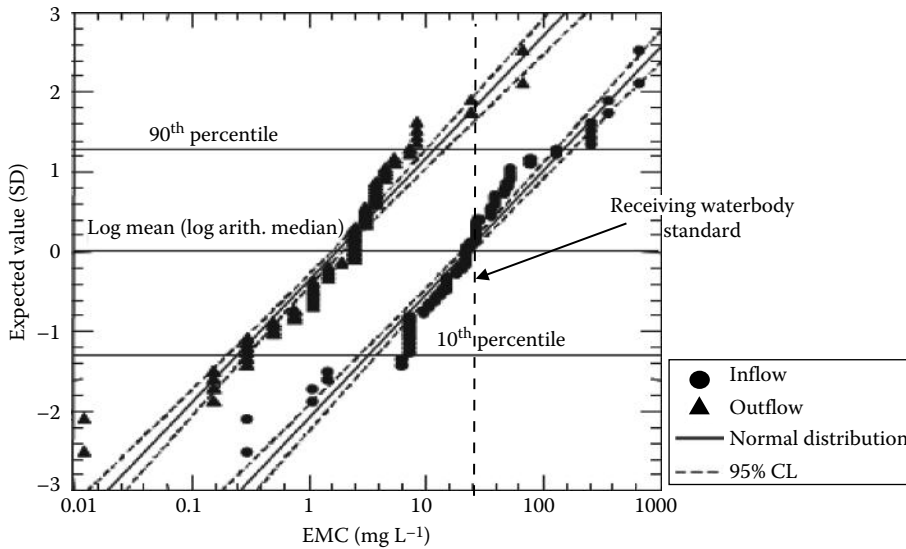


FIGURE 17.1 Stormwater runoff EMC normal probability plot.

runoff concentrations would exceed the  $25 \text{ mg L}^{-1}$  receiving water quality standard at least 50% of the time, but on passage through the BMP/SUDS facility (a wet retention pond), the standard is only exceeded some 5% of the time. The method highlights those ranges in influent values that yield the greatest percentage removal rates.

A simple dilution ratio determination based on the ratio of receiving water flow to the surface water peak discharge flow rate can be used for assessing the impact of key oxygen demanding parameters such as BOD and  $\text{NH}_4\text{-N}$ . This provides a simple screening tool to assess the acceptability of nonpoint discharges enabling an estimate to be made of whether the watercourse is large enough to safely receive the nonpoint discharge. The dilution methodology is based on a mass balance of the river flow and surface water discharge that is matched against the downstream river quality equal to the 95 percentile class limit (at minimum  $Q_5$  flow) to indicate the minimum dilution required to avoid exceedance of the class limit [36].

One GIS methodology based on official UK government land use categorization (covering 11 land use types) and census output data has been developed that combines impermeable surface runoff modeling for specific urban land use activities with probabilistic EMC distributions for the determination of catchment unit area loads (UALs) [12,31]. The methodology can be extended to include receiving water hazard/risk predictions (against set environmental quality objective or EQO targets) as well as catering for extreme flow ranges and ecological status based on biological diversity scores for differing land uses [11,12]. The runoff volume algorithm used to determine the percentage runoff (PR) in the methodology is based on the Wallingford modified rational method. EMC urban land use values (and their assumed lognormal distributions) as identified from the various databases can be multiplied by runoff volume to derive annual load estimates of sufficient accuracy to inform urban drainage planning at a catchment scale. It is therefore possible to utilize the UAL distribution to identify source areas carrying the highest nonpoint pollutant loads. Further averaging techniques based on microcatchment topography using a digital elevation model (DEM) have been developed that defines surface runoff paths [30]. Given the assumed lognormal distribution of the EMC data and the availability of rainfall time series data, an EMC value can be determined for any probability of occurrence, for example, 1:10 and 1:100, to assess the effect of extreme events or future climate change on resulting diffuse loadings.

There are additional issues related to the limitations of the selected runoff algorithm and that are common to most surface runoff modeling approaches. There is, for example, a fundamental difficulty

relating to seasonal conditions with differing parameters requiring to be separately set for winter and summer conditions in order to obtain a model that fits. In addition, outcomes will be different when control systems have had insufficient time to drain down before being subjected to a follow-on storm event. Rainfall–runoff modeling based on a 5 ha area (at 2–5 min intervals) is necessary for optimum resolution and data on this spatial/temporal scale is rarely available with the same being true for extreme event data. Improvements to the runoff model have come forward [47], including revisions to depression storage and initial loss as well as adjustments to the derivation of percentage imperviousness and catchment wetness parameters, mainly to take better account of paved and pervious surface contributions. Further consideration should also be given to depression storage by examining the benefits of micro (surface roughness), meso (surface puddles), and macro-storage (total connectivity to the drain) subdivisions that can add substantially to initial losses in the modeling process.

Limitations still exist, however, in terms of consideration of the activation of connected runoff as a storm cell expands over a subcatchment and to contributions of the so-called “permeable” surfaces located in urban areas such as parks and open spaces. The restricted hydraulic design (<1:20/1:30 Return Interval: RI) of surface water sewer pipes also means that extreme storm events (>1:30 RI) generate exceedance flows that bypass the storm drains and route overland flow directly to nearby open ground or to the receiving water channel. Under such exceedance flows, it is difficult to accurately determine either flow volumes or flow quality; the contribution of saturated or “sealed” permeable areas compounds this difficulty. Increased wetness and surface “sealing” during a storm event is also an important consideration in terms of generating delayed runoff from “pervious” surfaces.

A further important issue relates to urban land use types, as the likely runoff and associated quality is highly dependent on the nature, age, and condition of the surface component. While runoff modeling and routing based on a more detailed scale would certainly provide a more robust and accurate determination of runoff volumes and timing, it is doubtful if it would provide a more accurate estimation of pollution loading.

### 17.2.5 Estimating Concentrations and Loadings

The use of volume–concentration formulations provides a useful starting point for simple semi-distributed stochastic modeling of pollution loads and has been widely used [8,19,29]. The performance of such volume–concentration models has been tested by various workers against annual load estimates derived from deterministic multiparameter hydrologic methods such as SWMM and have been found to either match or even outperform the more complex modeling algorithms [44]. As site EMC is not correlated with annual runoff volume, this means that the approach can be applied to a wide range of pollutants. Neither does EMC appear to be related to catchment size or impermeable surface area. In addition, it enables probabilistic methods to assess the uncertainty in the loads estimation technique and can be applied at the required catchment scale. However, EMC data at the extreme discharge range are limited and national databases rarely disaggregate inflow quality data based on specific land use activity.

There are also questions regarding the long-held assumption of lognormal distribution for surface water runoff pollutant EMCs. It has been argued that BMP effluent and soluble outflows appear to have a more normal distribution [44], while others [20] have also proposed a mixture of normal distributions based on unit operating processes (UoPs) for urban runoff. Irrespective of these issues, probabilistic pollutant distributions remain the commonly adopted data format for expressing urban runoff EMCs for varying urban land uses and provide the basis of the MOUSE modeling approach, for example.

Given the inherently random nature of rainfall, runoff, and diffuse pollutant events in urban catchments, it would seem statistically appropriate to analyze water quality outputs and impacts within a stochastic framework. Estimating the probability of concentrations can theoretically be used to estimate maximum (or any other level) but is usually restricted to the EMC. In order to accurately estimate even the EMC, an extended data time series is needed to establish the underlying probability distribution for a specific location. Alternatively, an assumption can be made of the distribution and a reduced

local data record can be set to fit the distribution. However, it has been extensively shown that nonpoint urban runoff concentrations conform to a lognormal probability distribution, that is, their logarithms are normally distributed.

The statistical consistency of this lognormal distribution provides for a simple probabilistic modeling of nonpoint urban runoff quality [8,29,43] as illustrated in Figure 17.1. For any particular location, graphical lognormal plots for each pollutant of interest would need to be determined, which requires in turn local data on the mean and coefficient of variation of rainfall runoff and concentrations in order to have a reliable prediction. The reciprocal of the probability can be used to determine the concentration return periods so that exceedance values for ecological criteria can also be derived [10,11]. It has been shown that where the rainfall runoff model is robust and accurate, the effects of modeling uncertainty become minimal with differing analytical techniques yielding very similar probability distributions of model parameters and prediction intervals [5].

### 17.2.6 Deterministic Modeling

There are a large number of complex, physically based simulation models now available linking surface flows, pollutant generation, and conveyance in urban drainage systems [23,34] and that have become standard models for urban drainage modeling. The prime driving objective of such mechanistic modeling has been to evaluate the impact of sewer discharges upon receiving water flows and quality although more recently there has been a focus on integrated system modeling and management. Table 17.1 provides a comparative summary of the functionality of some of these modeling approaches.

One of the oldest and best known is the generic, event-based US Environmental Protection Agency's Storm Water Management Model (SWMM) [37]. SWMM5 now provides an integrated graphical environment for editing catchment input data and flow routing at single-event and long-term (continuous) scales together with first-order water quality simulations. This most recent version also incorporates optional BMP simulation for LID. The integration within SWMM5 of dual-drainage capabilities and belowground hydrological and hydraulic computations also offers substantial conceptual modeling improvements although the hydraulic engine may be rather unstable by comparison to other common simulation engines. SWMM5 provides a very flexible simulation of water quality process in surface runoff flows (the RUNOFF block uses washoff coefficients as earlier described) but has more limited capability for simulating in-sewer sediment and pollutant behavior (in the TRANSPORT block). The use of the "add-on" full-solution EXTRAN block does enable experienced users to successfully address water quality processes in both surface water and combined sewer systems. However, SWMM5 remains essentially an analytical tool rather than an automated design tool and cannot be used with highly aggregated data, for example, daily rainfall data. The introduction of a spatial decision support dimension within PCSWMM5 does also provide a high-performance, scalable GIS engine to the modeling capabilities for stormwater management [4].

Mike Urban CS is a GIS-based model data management software package (formerly known as MOUSE) developed by the Danish Hydraulic Institute ([www.dhigroup.com](http://www.dhigroup.com)) with the stormwater module powered by the fully dynamic SWMM5 software. A pollution and sediment transport module is incorporated into the main package, and simulation provides analysis of return periods, sewer loadings, sediment deposition rates and locations, and peak outflow concentrations.

Consideration of surface water runoff, pollutant generation, and transport are also included within various proprietary European models such as HYDROWORKS-DM and MOUSETRAP [39]. Water quality processes are considered as conservative processes with pollutants being in either dissolved or sediment-associated phases with the latter form adopting potency factors. They adopt 1D advection-dispersion terms with an empirically derived dispersion coefficient.

The momentum toward fully physically based deterministic models must be questionable given the complexity of both surface and in-sewer process phenomena as well as the relative significance of acute and chronic impacts on the recipient ecosystem. The mechanistic modeling also needs to offer options for

TABLE 17.1 Comparison of Model Functionality

	MIKE URBAN CS/ MOUSE	InfoWorks CS 2D	SUSTAIN (Incl SWM5 and HSPF)	MUSIC	WinSLAMM	SUDSLOC (with STORM)
Hydrology	Runoff: conceptual, curve nos., etc. Runoff: generation algorithms Baseflow/infiltration Routing: sewer/network Routing: source control devices Hydraulic routing 1D/2D capabilities Inlet controls	✓ ✓ ✓(RDII) ✓ ✓ ✓ ✓ ✓ ✓ ✓	✓ ✓ ✓(RDII) ✓ ✓ ✓ ✓ ✓ ✓ ✓	✓ X ✓ X ✓ X X X X ✓	X X X X ✓ X X X X ✓	✓ ✓ ✓(RDII) ✓(Upstream) ✓ X ✓ ✓ ✓ ✓
Temporal resolution	Lumped (daily, annual, event) average	✓	✓			
GIS capability	Distributed: subhourly, continuous Land use, DEM ✓(Not site/plot scale)	✓	✓	✓	X	✓
Optimization	User-defined decision variables, uncertainty analysis	✓	Marginally suitable	X	X	✓
Water quality	Pollutant build up/washoff Advection, dispersion, mixed reactor BMP/SUDS treatment Biofiltration Permeable paving, green roof technology	✓ ✓ ✓ Marginally suitable Permeable paving only	✓ ✓(Advection) ✓ Marginally suitable Marginally suitable	X ✓(Plug flow) ✓ ✓ X	X X ✓ Marginally suitable X	✓ ✓(Mixed reactor) ✓ ✓ ✓
Uses	Planning/screening level Preliminary design Detailed design Site layout Decision support; multi-criteria analysis Research tool	✓ ✓ Marginally suitable Marginally suitable X ✓	✓ ✓ Marginally suitable Marginally suitable ✓	✓ ✓ X X X ✓ X	✓ X X X X ✓ X	✓ ✓ X Marginally suitable Marginally suitable Marginally suitable ✓ ✓

long-term simulation studies. The severe difficulties of reliable measurement and representation of “real” field processes and their extreme temporal and spatial variability may ultimately and fatally predicate the achievement of truly comprehensive, deterministic modeling. Deterministic models include so many functions and parameters that a stringent calibration is virtually impossible; thus, there is a dependence on default values. Such complex approaches will always be appropriate as research tools but the simpler, meta-models may offer more robust planning and management tools particularly for transient, urban runoff pollution events and especially where a good database is available. Characterizing the impact of urban runoff and pollutant loadings on receiving waterbodies is critical for the risk assessment that any regulatory agency requires for effective and sustainable drainage management.

However, the real challenge is to go beyond the prediction of runoff volumes and pollutant loadings and to provide a risk assessment of the explicit economic and social costs of the modeling outcomes. There is a need to link mechanistic models to biological response models and then to economic models and thus provide “real world” sustainable modeling and this is particularly the case for highly urbanized areas. The high-resolution spatial data now becoming available to modelers through GIS and techniques such as spectral and remote imaging is opening up a complete new set of modeling and risk assessment approaches incorporating decision support systems (DSSs), full life costing, neural networks, and generic algorithms that may address this issue. Aside from the technical problems of model coupling, the development of integrated meta-models is further and severely challenged by institutional issues associated with stakeholder collaboration and acceptability. Additionally, there are major challenges associated with validation of a fully integrated urban catchment management modeling approach [27].

## 17.3 Stormwater Packages for Sustainable Management

---

A variety of generic, integrated stormwater modeling approaches have become commercially available for both flow and quality analysis and that incorporate BMP/SUDS performance and decision support options. Table 17.1 provides a comparative summary of the water quality functions and uses included in some of the more common modeling packages.

### 17.3.1 MUSIC

The *Model for Urban Stormwater Improvement Conceptualisation* (MUSIC) is a widely used software package developed in Australia by CRC for catchment hydrology (now eWater CRC). Version 3.0.1 was issued in 2005 with patch 3.0.2 added in August 2007 and is available via the eWater Ltd. product website ([www.toolkit.net.au](http://www.toolkit.net.au)). It is essentially a DSS to evaluate the conceptual design of stormwater management drainage systems in terms of water quality outflows and receiving water objectives. It is applicable at a range of temporal and spatial scales and for catchments varying between 0.1 and 100 km<sup>2</sup> with modeling time steps ranging from 6 min to 24 h. Outputs include time series cumulative frequency graphs and a life cycle costing module is also available in the software. The modeling capability extends to water reuse analysis of treatment facilities having a permanent pool allowing simulation of stored stormwater for household uses such as garden irrigation or toilet flushing.

MUSIC does not have capabilities for detailed sizing of stormwater facilities and omits any hydraulic or ecosystem response analysis. A number of assumptions are built into the algorithms including in particular those relating to the rationale for selecting default parameters. The modeling routine depends on default mean and standard deviation values to derive stochastic pollutant concentration distributions, and thus, there is a need for independent calibration of the results based on local flow and pollution concentration data. This becomes a particular issue when considering extreme storm events. The 3.0.2 patch to v.3.0.1 allows the application of time steps less than 6 min for flow routing to control devices having small storage volumes and subject to rapidly varying flows.

One issue is that the use of average statistics means that inflow concentrations will always be lower than outflows due to the background concentration  $C^*$  value, despite new default  $C^*$  and  $k$

(treatment or decay rate) values being added to v.3 in May 2005. There is also a need for users to remove all zero flow time periods from the analysis and only include effective storm flows to achieve a more appropriate measurement of concentration reductions across the BMP/SUDS facility. The observations of settling rates in BMP/SUDS facilities are typically much less than theoretically predicted by the model. Thus, smaller devices where the  $k$  decay factor dominates, predict less treatment efficiency. Background  $C^*$  concentration values are also frequently lower than theoretically predicted, thus apportioning better treatment efficiency to larger devices where  $C^*$  is the dominant factor. These differences appear to be applicable to all structural BMP/SUDS devices and the revised May 2005 defaults to v.3 were applied on this basis. It should be noted that filtration systems do not use  $k$  or  $C^*$  values, so modeling depends on multiple regression of detention time against filter particle size. However, this relationship can be highly variable both between devices and between storm events. In addition, the modeling analysis does not consider the effects of evaporation/transpiration losses from pond/wetland systems that can be significant over protracted dry weather conditions. A further problem in the analysis is that no initial or exfiltration losses are considered.

The use of a first-order kinetic decay (or treatment)  $k$  rate implies that the rate of change of pollutant concentration with time is proportional to the concentration, and the use of plug flow implies that stormwater entering the pond/wetland “reactor” flows as a coherent body along the length of the device. The change in concentration during the retention time is therefore dependent solely on processes occurring within the plug flow. Therefore,  $k$  is a lumped parameter representing a deposition rate in the case of solids and bacteria, a biodegradation rate for organics (BOD), and a reaction rate in the case of nutrients, metals, and hydrocarbons. Thus, the value of  $k$  really depends on the relevant operating “treatment” process and is normally expressed as a synthesized index value combining the different removal processes. Any factor such as hydraulic retention time that influences these processes can indirectly affect the final  $k$  value. Rainfall will cause dilution and shorten retention times, and such “augmentation” can lead to errors by as much as a factor of four in the determination of rate constants for a first-order reaction. The  $k$ - $C^*$  two-parameter model also does not account for adaptation trends in a wetland system as it matures or the effects of pH and dissolved oxygen as well as other factors that are known to affect the fate of pollutants in treatment systems.

### 17.3.2 SUDSLOC

SUDSLOC is a decision support tool for selecting appropriate BMP/SUDS mitigating controls and locating them optimally within identified critical drainage zones of highly urbanized areas [15]. The tool is a stand-alone application developed with the ESRI ArcGIS engine platform. The central data integration and communication GIS tool facilitates knowledge transfer and discussion between stakeholders involved in urban surface water management and drainage infrastructure provision and serves as a precursor to analytical modeling. The end users can optimize the location and design of the BMP/SUDS devices by automatically investigating all the potential locations within an urban catchment based on a comparative site-by-site approach. Ranking procedures developed on scientific and engineering criteria facilitate the comparison of BMP/SUDS performances using multi-criteria analysis and specific pollutant unit removal potentials. SUDSLOC allows both the design of mitigating controls and their integration into an existing drainage network and can also export the results for further integration into a 1D model such as STORM. STORM is a hydrologic model devised as a planning tool for the management of stormwater runoff with rainfall runoff generation conceptualized either as linear cascade storages or as time-surface functions; the hydraulic modeling of the belowground sewer system utilizes MOUSE [24]. The model contains conventional sewer drainage elements as well as BMP/SUDS elements including infiltration and green roof technologies with outcomes focused on peak flow rates, storage volumes, overall water balances, and BMP/SUDS performance. A time step of between 5 and 15 min is used in the analysis, and like MUSIC, this raises problems for small storage devices subject to high and/or rapidly varying flows.

The 1D STORM model output can also be coupled with a 2D non-inertia model such as FloodArea and used within an ArcGIS extension to identify and quantify exceedance overland flooding and assess the spatial flow paths, distribution, and depths of flooding in the urbanized area [46]; animated outputs facilitate stakeholder understanding and discussion. Such modeling integration represents a move toward total flood risk management and helps to avoid gaps that can result from separate approaches formulated at different stages and by differing agencies in the flood risk assessment planning cycle.

### 17.3.3 SUSTAIN

The US EPA System for *Urban Stormwater Treatment and Analysis Integration (SUSTAIN)* model [16] is essentially a decision support tool for the optimized selection and placement of BMPs within urban catchments primarily on the basis of user-defined cost and performance effectiveness criteria. It uses an ArcGIS-based template with MS Excel and Access interfaces for land use and catchment data with an optimized SWMM5 algorithm for flow and pollutant generation and routing, with sediment algorithms adapted from HSPF. BMP effectiveness is modeled on the basis of UoPs that predicts performance as a function of biochemical processes, physical configuration, and storm/catchment properties. Pollutant removal is considered as a first-order function with pollutant routing assumed to be fully mixed. The modeling approach can use either instantaneous or kinematic overland wave flow routing with the latter having a pollutant decay/delay function. The BMP module allows the choice of distributed (stand-alone) or aggregated (multiple) configuration and the postprocessor provides both animated graphical and tabular outputs.

Cost-effectiveness in the modeling approach refers to individual pollutants, whereas in reality, urban runoff is a “cocktail” of interacting multiple pollutants. Minimizing cost also requires that the user sets target percentage reductions in pollutant loadings based on annual average concentration and loading values. It is not clear how far the model can be applied to toxic pollutants or in assessing stormwater permitting requirements. The internal simulation model has not been used extensively to date and needs considerable local verification. It has been suggested that peak flow and BMP TSS performance predictions can be subject to 11%–45% error for urban catchments exceeding 40–50 ha [26]. There are also possible issues relating to output file management and selection of output directories. Irrespective of these reservations, the modeling approach is beginning to be used quite widely within the United States particularly as a basis of estimating cost-effectiveness of BMPs in terms of TDML implementation.

### 17.3.4 WinSLAMM

*Source Loading and Management Model for Windows (WinSLAMM)* was developed to evaluate urban nonpoint source pollution loadings based on small storm hydrology, that is, storms less than 1:1 RI with a total rainfall depth less than 12–15 mm. This approach assumes that urban stormwater quality is primarily associated with the more frequent rainfall events. It uses individual storm event data to estimate runoff volumes and pollutant loadings for 6 differing urban land use categories and 14 source area types. The averaged output values are then used to estimate BMP removal performance for the storm series; a costing analysis is included in the performance evaluation.

There are no theoretical processes considered in the modeling with performance being assessed on the basis of observed or referenced data and computed flow duration probability curves. Stochastic analysis procedures are used to represent input parameter uncertainty especially for pollutant EMC values. The model calibrates mass balances for flow and quality derived from differing development characteristics (based on NRCS curve numbers) and rainfall events and it is only intended as a screening planning level tool. In principle, this modeling structure is very similar to that of the Australian *Urban Volume and Quality (UVQ)* model that simulates alternative catchment scale urban water cycle scenarios based on daily runoff and pollutant fluxes [32]. The UVQ model uses a quasi-distributed spatial representation of the catchment and treatment processes.

Without calibrated data, model results should be considered as only being relative rather than absolute predictions. WinSLAMM is beginning to be used quite extensively by municipalities within the United States to assess potential stormwater management options and potential drainage infrastructure provision for LID proposals [35]. No baseflow conditions are simulated within the model, and it only incorporates routing analysis for controls and components where it is considered that hydrograph effects are likely to be important. Modeling in-series requires the user to ensure that no “double counting” of particulate pollutant removal occurs within the algorithms; wet storage basins also require a setting to the design outlet elevation. Scour and sediment resuspension is not considered in the modeling processes and sediment storage depth does not count toward the permanent pool depth. Site construction runoff and associated sediment deposition is not considered and runoff volume at full build-out needs to be accounted for in calculating treatment efficiency; such considerations need multiple WinSLAMM model runs. Porous paving is not given credit as water quality filters in the modeling approach although belowground storage can be modeled as a biofilter device (allowing 100% removal by infiltration).

## 17.4 1D–2D Modeling

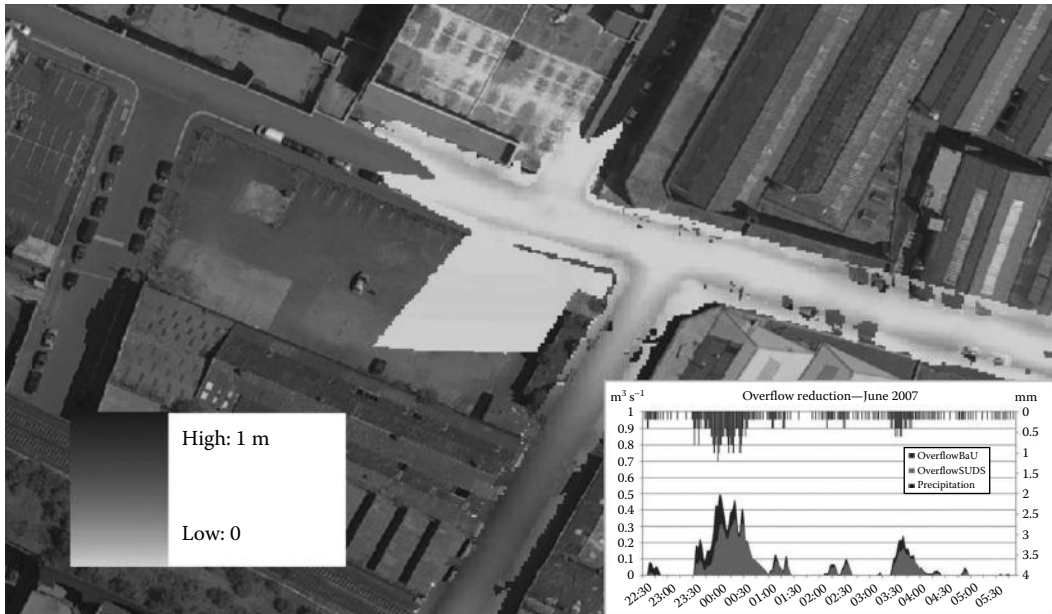
It has become increasingly apparent that a high proportion (30%–40%) of urban flood damages are attributable to surface water pluvial flooding combining sewer surcharging with impermeable surface overland flow rather than due to river floodplain overtopping. Strategic flood risk assessment of surface water flows has become fundamental in guiding urban flood risk management for highly urbanized areas as specified, for example, in the EU Floods Directive. Such regulation requires local flood authorities to define and map “hotspot critical drainage areas” liable to surface water pluvial flooding in terms of flood distribution, depths, and flow velocities. In addition, such flood definition and quantification should be accompanied by appropriate mitigating measures.

Such specifications can only be satisfied by reference to coupled 1D–1D and 1D–2D dual-drainage modeling frameworks delivered within a GIS template to accurately represent the detailed microtopography, urban land use, and building distributions. Dual drainage research and development has a history going back several decades with an early recognition of the significance of major (surface) and minor (sewered) system flooding [42]. The last decade has seen a steady progression on the coupling of surface and sewered storm flows and that are now beginning to realize their full potential through their integration with GIS-based tools and the use of detailed terrain survey techniques using LiDAR and satellite imagery. This coupled integrated approach now provides a methodology for systematic and consistent analysis of the sources, pathways, and distribution of urban pluvial flooding and as a reliable basis to the selection and location of mitigating management controls in highly urbanized areas.

Such coupled modeling can be readily used for both operation and design and involves a lower degree of averaging of the fundamental hydraulic and hydrologic equations and thus provides a more realistic description of flood flow conditions. Some of the superiority of 1D–2D models derives from the lack of predefined flow routes as well as the animation of results on a GIS platform making it more convenient for hazard, flood damage and water quality mapping and for public communication. Figure 17.2 illustrates the 1D–2D simulation of extreme event flooding in central Birmingham, the second largest city in England that provides detailed information on the spatial distribution and depth of surface water exceedance flooding in this highly urbanized environment. Such animated outputs offer a temporal visualization of flood flow paths and velocities that can be used as a basis for emergency preparations as well as for flood mitigation. The insert to Figure 17.2 illustrates the overall 30% reduction in flow volume that can be obtained following implementation of upstream BMP/SUDS control facilities (green roof and porous paving) as predicted from the SUDSLOC model.

There has been a considerable response in software development to meet such rigorous demands with a number of 1D–2D modeling approaches now being available to enhance the interaction between sewer and surface systems under conditions of surcharge and overflow. They open up an entirely new physically based approach to urban stormwater modeling. They include MIKEFLOOD ([www.dhisoftware.com](http://www.dhisoftware.com)) that





**FIGURE 17.2** 1D–2D flood visualization in a highly urbanized area.

integrates MIKE11 and MIKE21, InfoWorks CS 2D ([www.innovyze.com](http://www.innovyze.com)), SOBEK ([www.deltaressystems.com](http://www.deltaressystems.com)), and TUFLOW ([www.bmtwbm.com.au](http://www.bmtwbm.com.au)). InfoSWMM 2D ([www.innovyze.com](http://www.innovyze.com)) incorporates LID modeling features with a 2D mesh as well as enhanced water quality functions (v.12) to provide a fully integrated smart network technology for urban drainage management.

However, these models are essentially developed for river overbank flooding rather than exclusively for impermeable surface pluvial flooding. All the models have some issues in relation to the potential contribution of pervious areas during exceedance conditions. There is an assumption that such areas will be noncontributing, which is unrealistic for heavily trafficked urban situations where open spaces, parks, etc., can have compacted surfaces that will contribute effective runoff during extreme events. As previously argued, there are also issues relating to the quantification of initial losses and depression storage as well as accounting for downstream roadside inlet and gully inflows to the belowground drainage system during a storm event.

In addition, the DEM of street microtopography is too frequently based on coarse grid sizes (typically >2 m) derived from aerial laser LiDAR survey or other imagery that fails to capture the detail of street curbs, surface cambers, alleys, walls, fences, etc., all of which are major constraints on accurate definition of flood flow paths and depths. The  $\pm 150$  mm error in vertical resolution derived from aerial survey can also lead to substantial errors in the exchange volumes between raster cells. For accurate quantification of flood flow paths and depths, a spatial resolution of 0.25–1.0 m and vertical resolution of 2–5 cm is required that can only be satisfied utilizing mobile terrestrial LiDAR survey [15,17]. The greatest inaccuracies in these modeling approaches lie in the treatment of street channels that are normally characterized by 1D flow even where surface water may be flowing in opposite directions each side of the road. The local storm flow geometry at street intersections is also highly problematic. Once the roadside curbs are overtopped, the 1D flow assumption no longer holds. Even 1D–2D modeling having coarse grid cells fails to accurately compute the joining surface water channels that depend on microtopographic storage levels [17].

A number of 1D–2D research-type models have also been developed that refine the dual-drainage processes and offer alternative automated fine-scale DEM approaches such as SIPSON/UIM [28],

STORM/SUDSLOC [46], and other coupled simulation approaches [40]. All 1D–2D modeling approaches currently have difficulties in terms of specification of initial losses, contribution of permeable areas, and simulation of roof runoff and roof gully connections. However, the research-type approaches are attempting to address these issues as well as enabling user definition of spatially distributed friction mapping and the use of hybrid modeling [41] to give a better representation of overland flow dynamics and to reduce simulation run times.

## 17.5 Summary and Conclusions

---

A large number of models capable of simulating urban stormwater quantity and quality that employ a variety of structural approaches are available, many of which have either evolved or been upgraded as both knowledge and technology have improved. The large majority are planning or screening level models and capable of both continuous- and single-event simulation. Buildup and washoff of pollutants as well as adsorption characteristics are normally based on assumed first-order kinetic reactions with overland flow routing considered by linear storage methods. Numerical solutions for advection–diffusion as well as diffusion and kinetic wave considerations for pressurized and backwater effects present serious problems for most modeling approaches primarily due to the highly dynamic and transient nature of sewered and overland flow under extreme storm flow conditions. There is a trend toward the adoption of hydraulic routing for stormwater drainage infrastructure analysis as a modeling option, and 1D–2D-linked modeling is becoming a standard approach for highly urbanized situations. The applicability of high-resolution 2D modeling for small-scale flood and associated pollution events needs further evaluation especially for full St. Venant equation–based numerical models. This will enable consideration of the interactions between surface and subsurface flooding and water quality in stormwater drainage networks.

## References

1. Barrett, M.E. 2008. Comparison of BMP performance using the international BMP database. *Am. Soc. Civil Eng. J. Irrig. Drain. Eng.*, 134 (5), 556–562.
2. Bouteligier, R., Vaes, G., and Berlamont, J. 2004. Urban drainage water quality modeling software: The practical use of InfoWorks CS and MouseTrap. In Chocat, B. (ed.): *Sustainable Techniques and Strategies in Urban Water Management, Proc. NOVATECH04*, Graie, Villeurbanne, Lyon, France. pp. 423–430. ISBN 2950933769.
3. Butler, D. and Clark, B.P. 1995. *Sediment Management in Urban Drainage Catchments*. Report 134, Construction Industry Research and Information Association (CIRIA), London, U.K., ISBN 9780860174097.
4. CHI. 2012. *Urban Drainage Modeling Workbook*. Computational Hydraulics Institute (CHI), Guelph, Ontario, Canada.
5. Dotto, C.B., Manning, G., Kleidorfer, M., Vezzaro, L., Henricks, M., McCarthy, D.T., Freni, G., Rauch, W., and Deletic, A. 2012. Comparison of different uncertainty techniques in urban stormwater quantity and quality modeling. *Water Res.*, 46 (8), 2545–2558.
6. Driver, N.E. and Troutman, B.M. 1989. Regression models for estimating urban storm runoff quality and quantity in the United States. *J. Hydrol.*, 109, 221–236.
7. Elliott, A.H. and Trowsdale, S.A. 2007. A review of models for low impact urban stormwater drainage. *Environ. Modell. Softw.*, 22(3), 394–405.
8. Ellis, J.B. 1986. Probabilistic modelling of urban runoff quality. In *Proceedings of Water Quality Modelling in the Inland Natural Environment*, Bournemouth, June 10–15. British Hydrodynamics Research Association, Cranfield, Bedfordshire, U.K., pp. 551–558.
9. Ellis, J.B. 1989. The management and control of urban runoff quality. *J. Inst. Water Environ. Manage.*, 3(2), 116–124.

10. Ellis, J.B. 2000. Risk assessment approaches for ecosystem responses to transient pollution events in urban receiving waters. *Chemosphere*, 41, 85–91.
11. Ellis, J.B. and Mitchell, G. 2006. Urban diffuse pollution: Key data information approaches for the water framework directive. *Water Environ. J.*, 20(1), 19–26.
12. Ellis, J.B. and Revitt, D.M. 2008. Quantifying diffuse pollution sources and loads for environmental quality standards in urban catchments. *Water Air Soil Poll.*, 8(5/6), 577–585.
13. Ellis, J.B., Harrop, D.O., and Revitt D.M. 1986. Hydrological controls of pollutant removal from highway surfaces. *Water Res.*, 20(5), 589–595.
14. Ellis, J.B., Marsalek, J., and Chocat, B. 2005. Urban water quality. In Anderson, M.G (ed.): *Encyclopedia of Hydrological Sciences*. John Wiley & Sons Ltd., Chichester, U.K., Chapter 97, Vol. 2, pp. 1479–1491. ISBN 0471491039.
15. Ellis, J.B., Viavattene, C., Chlebek, J., and Hetherington, D. 2012. Integrated modeling for urban surface water exceedance flows. *Water Manage.*, 165 (WM10), 543–552.
16. EPA. 2009. SUSTAIN: A framework for placement of best management practices in urban watersheds to protect water quality. Report EPA/600/R-09/095. US Environment Protection Agency, Office of Research & Development, Washington, DC.
17. Fewtrell, T.J., Duncan, A., Sampson, C.C., Neal, J.C., and Bates, P.D. 2011. Benchmarking urban flood models of varying complexity and scale using high resolution terrestrial LiDAR data. *Phys. Chem. Earth*, 36, 281–291.
18. Gupta, M.K, Agnew, R.W., and Kreutzberger, W.P. 1978. Highway runoff constituents. Report DoT-FH-8600, Envirex Inc., Springfield, VA.
19. Harremoës, P. 1988. Stochastic models for estimation of extreme pollution from urban runoff. *Water Res. Bull.*, 22, 1017–1026.
20. Hall, M.J., Ellis, J.B., and Brizio, M. 1990. On the statistical distribution of event mean concentrations of pollutants in stormwater runoff. In Iwasa, Y. and Sueshi, T. (eds.): *Drainage Models and Quality Issues. Proceedings of the 5th International Conference on Urban Storm Drainage*. Osaka, Japan, IWA Publishing, Vol. 1. pp. 317–323.
21. Hemain, J.C. 1986. Statistically based modelling of urban runoff quality. In Marsalek, J., Torno, H.C., and Desbordes, M. (eds.): *Urban Runoff Pollution*. NATO Technical Series No. 10, Springer-Verlag, Berlin, Germany, pp. 277–304. ISBN 3540160906.
22. HMSO. 2012. *Road Drainage and the Water Environment*. Vol. 11, Section 3, Part 10: *Design Manual for Roads and Bridges (DMRB)*. Highways Agency, Her Majesty's Stationery Office (HMSO). London, U.K. ([www.dft.gov.uk/ha/standards](http://www.dft.gov.uk/ha/standards)).
23. Huber, W.C. and Strecker, E.W. 2008. Urban stormwater modeling: Status in 2008. In Babcock, R. and Walton, R (eds.): *Proceedings of World Environmental and Water Resources Congress*, July 2007. American Society of Civil Engineers, Reston, VA. ISBN 9780784409763.
24. IPS. 2008. *STORM User Manual*. Ingenieurgesellschaft Prof. Dr. Sieker (IPS), Berlin, Germany.
25. Jenkins, A., Ellis, J.B., and Ferrier, R.C. 2000. Modelling diffuse pollution. In D'Arcy, B.J., Ellis, J.B., Ferrier, R.C., Jenkins, A., and Dils, R. (eds.): *Diffuse Pollution Impacts*. Terence Dalton Publishers, Suffolk, U.K. Chapter 13, pp. 123–133. ISBN 1870752465.
26. Lai, F., Zhen, J., Riverson, J., Alvi, K., and Shoemaker, L. 2007. SUSTAIN: An EPA BMP process and placement tool for urban watersheds. *Proceedings of Conference TMDL2007*. Bellevue, WA. pp. 24–27 June 2007. Water Environment Federation, Alexandria, VA.
27. Lerner, D.N., Kumar, V., Holzkamper, A., Surridge, B.W.J., and Harris, B. 2011. Challenges in developing an integrated catchment management model. *Water Environ. J.*, 25, 345–354.
28. Maksimovic, C., Prodanovic, D., Boonya-aroonnet, S., Leitao, J.P., Djordjevic, S., and Allitt, R. 2009. Overland flow and pathway analysis for modeling urban pluvial flooding. *J. Hydraul. Res.*, 47(4), 512–523.
29. Marsalek, J. 1991. Pollutant loads in urban stormwater. *Water Resour. Bull.*, 27(2), 283–291.

30. Mitchell, G. 2001. The quality of urban stormwater in Britain and Europe. Unpublished Report, School of Geography, University of Leeds, Leeds, U.K.
31. Mitchell, G. 2005. Mapping hazards from urban diffuse pollution: A screening model to support sustainable urban drainage planning. *J. Environ. Manage.*, 74, 1–9.
32. Mitchell, V.G. and Diaper, C. 2006. Simulating the urban water and contaminant cycle. *Environ. Modell. Softw.*, 21, 129–134.
33. Murrell, K.N. and Crabtree, R.W. 1994. Mike 11 application guide for intermittent discharges. R and D Note 190. National Rivers Authority, Bristol, U.K.
34. Nix, S.J. 1994. *Urban Stormwater Modelling and Simulation*. Lewis Publishers, Boca Raton, FL. ISBN 0873715276.
35. Pitt, R. and Voorhees, J. 2004. The use of WinSLAMM to evaluate the benefits of low impact development. *Proceedings of the Low Impact Development Conference: Putting the LID on SWWM*. College Park, MD, pp. 21–23.
36. Richards, K. 1993. Surface water outfalls: Quality and environmental impact management. Report No. UM 1400, Water Research Centre, Swindon, U.K.
37. Rossman, L.A. 2007. *Storm Water Management Model User's Manual*. EPA/600/R-05/040. Environment Protection Agency, Cincinnati, OH.
38. Sartor, J.D., Boyd, G.B., and Agardy, F.J. 1974. Water pollution aspects of street surface contaminants. *J. Water Poll. Control Fed.*, 46 (3), 459–467.
39. Schutze, M.R., Butler, D., and Beck, B. 2002. *Modelling, Simulation and Control of Urban Wastewater Systems*. Springer, London, U.K. ISBN 9781852335533.
40. Seyoum, S., Vojinovic, Z., Price, R.K., and Weesakul, S. 2012. Coupled 1D and non-inertial 2D flood inundation model for simulation of urban flooding. *J. Hydraul. Res.*, 138(1), 23–34.
41. Simoes, N., Leitao, J.P., Ochoa, S., SaMarques, A., and Maksimovic, C. 2011. Urban drainage models for flood forecasting; 1D/1D, 1D/2D and hybrid models. *Proceedings of the 12th International Conference Urban Drainage (ICUD12)*. September 2011. Porto Alegre, Brazil. CD-ROM. IWA Publishing Ltd., London, U.K.
42. Smith, M.B. 2006. Comment on analysis and modeling of flooding in urban drainage systems. *J. Hydrol.*, 317, 355–363.
43. Strecker, E.W., Quigley, M.M., Urbonas, B., and Jones, J. 2004. Analyses of the expanded EPA/ASCE International BMP database and potential implications for BMP design. In Sehike, G., Hayes, D.F., and Stevens, D.K. (eds.): *Proceedings of World Water & Environmental Congress*. June 27 to July 1, 2004. Salt Lake City, Utah. American Society of Civil Engineers, Reston, VA. ISBN 0784407371.
44. Van Buren, M.A., Watt, W.E., and Marsalek, J. 1997. Application of the log-normal and normal distributions to stormwater quality parameters. *Water Res.*, 31(1), 95–104.
45. Vaze, J. and Chiew, F.H.S. 2003. Comparative evaluation of urban stormwater quality models. *Water Resour. Res.*, 39 (10), 1280–1290.
46. Viavattene, C., Ellis, J.B., and Chlebek, J. 2011. A GIS-based integrated modelling approach for the identification and mitigation of pluvial urban flooding. In Savic, D., Kapelen, Z., and Butler, D. (eds.): *Proceedings of Conference Computing and Control for the Water Industry (CCWI2011)*. Centre for Water Systems, University of Exeter, Exeter, U.K., pp. 271–276. ISBN 0953914054.
47. WaPUG. 2009. *Integrated Urban Drainage Modelling Guide*. Ref. V01-00. Chartered Institution of Water and Environmental Management (CIWEM), London, U.K. ([www.ciwem.org/groups/standards](http://www.ciwem.org/groups/standards)).
48. Zoppou, C. 2001. Review of urban stormwater models. *Environ. Modell. Softw.*, 16(3), 195–231.



# 18

## Integrated Water Resource Management and Sustainability

---

18.1	Introduction .....	366
	Background • Need for Sustainable Water Resource Management • Aim and Scope of the Chapter	
18.2	Concept of Sustainable Development.....	367
	Background • Challenges in Achieving Water Resource Sustainability • Introducing Dominant Approaches of Sustainability • Systemic Internalization Approach • Sustainability and IWRM	
18.3	Concept of IWRM and Its Associated Principles.....	371
	Introduction to IWRM • Timeline of IWRM and Sustainable Development • Main Principles of IWRM • Main Challenges of IWRM • IWRM Modeling	
18.4	A Case Study: Implementing IWRM without Considering a Conflict Resolution Perspective.....	377
	Environmental and Managerial Challenges of the Case Study • Conflict Resolution Analysis: The Need to Implement IWRM at the Lake Urmia Basin • Discussion	
18.5	Summary and Conclusions .....	382
	Acknowledgments.....	382
	References.....	382

**Husain Najafi**

*Tarbiat Modares University*

**Ehsan**

**Tavakoli-Nabavi**

*Australian National University*

### AUTHORS

**Husain Najafi** earned his MSc in water resources engineering from Tarbiat Modares University (Tehran, Iran). Under the supervision of Dr. Ali Bagheri and Dr. Kaveh Madani, his graduate study focused on the application of a non-cooperative game theory approach to shared water resource management. He was a visiting scholar at University of Central Florida in 2011. His main research interests are integrated water resource planning and management, and conflict resolution methods, in addition to application of systems analysis tools in water resources systems.

**Ehsan Tavakoli-Nabavi** is a PhD scholar in environmental and resource management at Research School of Social Sciences (RSSS), Australian National University (ANU). He has both BSc and MSc degrees in civil engineering. His research and publications particularly during his master's career at Isfahan University of Technology (IUT) were focused on sustainable development, integrated water resource management, systems thinking, artificial intelligence, and decision theory.

## **PREFACE**

Years after the publication of the Brundtland commission report, the way to handle the sustainability of resources is, nevertheless, still the focal point of attention for the scientific community. In fact, an important and controversial key concept regarding the sustainability paradigm is how to align human activities with the environment in such a way that sustainable development of resources would be achieved. To put this in practical use, understanding different changes in terms of the social, political, environmental, and economic landscapes is critical for effectively managing the current complex water resource systems. This calls for an integrated approach taking into account the interaction between physical and socioeconomic considerations. Integrated Water Resource Management (IWRM) provides a holistic framework for facilitating policy makers to successfully plan and manage water resources, as well as to gain insights into how the fragmented management of such resources can be prevented. This chapter aims to familiarize the readers with the sustainability approach in addition to categorizing the main school of thoughts for the term, providing the basic principles in IWRM, and representing the advanced methods applied for integrated water resource modeling.

## **18.1 Introduction**

### **18.1.1 Background**

Nowadays, water scarcity and water quality issues have been recognized as major key concerns threatening freshwater resource availability across the globe. Added to all mismanagements caused by governance crisis as well as complexities associated with social nested systems are uncertainties embedded in ecological systems and the role of climate change which have made policymaking a real challenge for all involved actors in recent years.

Faced with this situation, the need for adaptation to change and implementation of a holistic methodology, which takes both socio-economic and natural processes into account all at once, has become so evident than ever before that policy makers are gradually realizing the fact that most water resource challenges are as a result of pressures outside of the water box, considerably in terms of social and economic changes. Therefore, escalating awareness has been attached to the subject addressing dilemmas, which water managers have encountered. On the other hand, remarkable advances have been made outside of the field of water resources during the past few decades. These improvements are mainly as a result of rapid technological breakthroughs, which have also enabled authorities to take multidisciplinary water problems into account. For example, emerging new disciplines such as hydro-informatics have helped water managers to deal with the interdisciplinary nature of the challenges by providing appropriate foundations for water resource assessments and applying new tools such as decision support systems (DSSs) [30].

Along with innovative technological improvements, new paradigms such as the concept of sustainability have also been put forward, which has significantly impacted the course in which natural resources over a broad context, and to be more specific, water resources, are being approached. As long as developing such new paradigms is concerned, the aim was mainly to support planners and decision makers to address global issues on spatiotemporal scales. In fact, all these developments were as a means of changing the way resources have been managed, especially for the case of water, from proactive single-sector water development projects to developments through a more holistic and sustainable approach.

## 18.1.2 Need for Sustainable Water Resource Management

In most cases, successful and effective water resource management is rare despite the numerous efforts, which have been made in order to fulfill this goal. This is primarily because water resource management is often fragmented and has suffered from a wide range of mismanagement practices, consequently threatening the sustainability of the water resources. Such mismanagement practices include, but are not limited to, a lack of thorough understanding of the issues within the system, governance crisis; excessive emphasis on supply-oriented policies rather than demand management; ignorance toward long-term impacts in terms of water management practices; failure to consider the interaction between system components; and, not taking into account, a comprehensive trade-off between the social, environmental, and economic considerations in the decision-making process. An actual example of such mismanagement was seen in the Lake Urmia disaster, which occurred in Iran and the Aral Sea [47,65].

## 18.1.3 Aim and Scope of the Chapter

The aim of this chapter is to familiarize the readers with the two important paradigms of sustainability and Integrated Water Resource Management (IWRM). While these two concepts are closely related to each other, this has been done by a comprehensive introduction of the different school of thoughts considering the sustainability concept in Section 18.2 followed by discussing the timeline of sustainability and IWRM at the start of the third section of the chapter. The fundamental principles of IWRM have been addressed in Section 18.3 along with a discussion of the application of different modeling approaches for successful implementation of IWRM. After introducing the basic theoretical aspect of each term in Sections 18.2 through 18.4 will present a real case study, the Lake Urmia disaster in Iran, which is an actual example of a water resource system failed to take into account various challenging aspects pertinent to the sustainability paradigm. For addressing complexities associated with implementing integrated water resources management for the Lake Urmia basin, the non-cooperative game theory approach has been introduced based on the work done by Najafi et al. [51] to show the role of conflict resolution methods to help with a better understanding of why and how sectorial management at provincial scale would lead to unsustainable agricultural and water resource development. The final section will then review the chapter.

## 18.2 Concept of Sustainable Development

---

### 18.2.1 Background

The term “sustainable development” and the closely related term “sustainability” are now on their paths to ensure the best for “Our Common Future” as suggested by WCED [67] as well as to remind the “future we want.” It is now featured on 45,500,000 web pages compared with 8,720,000 web pages in 2005. The results of this web search illustrate dramatic growing alertness toward the socio-environmental impacts at a global scale and a sharp decrease in reliability on conventional development paradigms.

Sustainable development has been used for different purposes in a diverse range of scientific realms after the release of the Brundtland report in October 1987. Since then, researchers, experts, and anyone involved in the subject have articulated their own definition and re-applied classifications to fit their purposes. Although the rate of critiques to such a wide range of definitions and perspectives toward sustainable development has grown significantly, each definition and essay on the subject will open a new window for promoting a sustainability dialog. Currently, there is no particular or generally accepted definition, but the most frequently quoted definition is clarified in the Brundtland report:

Sustainable development is development that meets the needs of the present without compromising the ability of future generations to meet their own needs.



It contains two key concepts:

- The concept of *needs*, in particular the essential needs of the world's poor, to which overriding priority should be given
- The idea of *limitations* imposed by the state of technology and social organizations on the environment's ability to meet present and future needs

In brief, sustainable development can be defined in simple words as follows: It is the pattern of permanent use of resources.

## 18.2.2 Challenges in Achieving Water Resource Sustainability

Human's experiences to control nature and particularly water through successive supply-oriented projects (e.g., constructing dams, developing trans-boundary water projects) has resulted in significant socio-environmental costs during the past century (e.g., frequent droughts, depletion of aquifers, growing water stresses and their consequent effects on the society such as health problems, etc.). Although there have been many efforts to address such issues by developing the concept of sustainability, goals, which are set to reach it, as well as attempts for measuring it, the results obviously can be seen as a particularly high rate of action-failure in water systems and various environmental catastrophes around the world. The question is of course, what has caused such a deviation from the sustainability path, locally and globally, and how can one make the concept more practical?

The answer is there is a need for a paradigm shift in "looking" as well as "thinking." In order to do so, this paradigm shift must be internalized among researchers, practitioners, and, foremost, the society. To achieve this paradigm shift and take advantage of its implementation, two main strategies need to be adopted, which are detailed in the following sections.

### 18.2.2.1 Back to the Main Path by Interdisciplinary Research

First of all, in order to return to the main path, we need to know where we are, why we are here, and how we can change our path to reach the targets, which we had first established. In this regard, both *knowledge* and *creativity* in new forms of multidisciplinary research can help us to answer these questions. Critical examination of the driving forces behind the basic issues underlying the sustainability path deviation will improve overall system sustainability. In other words, water systems need bridging among various disciplines for removing barriers between engineering science and humanities rather than focusing on each of them.

According to [18]

Key contributions for the analysis of long-term and foundational issues come from 'interdisciplines,' such as human ecology and environmental politics; social sciences such as sociology and institutional theory; and disciplines within the humanities, such as history and philosophy.

### 18.2.2.2 Developing Internalized Frameworks for Ensuring Sustainable Actions

Although developing a number of sustainable development indicators (SDIs)<sup>wp\*</sup> might help us to improve subsystem efficiency, they could not be solely effective to ensure the sustainability of a system as a whole. In fact, without having a conceptual framework, which can ensure the integrity of all aspects of the system, relying on both using and developing indicators would be impractical and sometimes counterproductive. In order to achieve sustainability, constructing conceptual frameworks is essential, frameworks that foster a profounder understanding of the dynamics associated with complexity of systems. Therefore, analytical frameworks enable decision makers to reduce the number of indicators

---

\* Quantitative tools developed to address the need for integrating different aspects of the term sustainability.

to the real need so that they are capable of using minimum number of indicators but with maximum degree of strategic perspective.

In addition, frameworks can act like maps, which can give coherence to our problem definitions, goals, techniques, data collection, and finally any thorough analysis. Using conceptual frameworks, they can help us in prioritizing issues in the systems context so that strategic management can be facilitated. Examples of SDI frameworks are the Driver–Pressure–State–Impact–Response (DPSIR) framework, system-based approaches, and System of Integrated Environmental and Economic Accounting (SEEA) (see [20]).

To conclude, in order to ensure that our actions are sustainable, it is essential to re-examine dominant approaches for addressing sustainability issues in water resource planning and management. As Loucks also highlighted [38]:

It has become evident that many of our water resource developments and management practices implemented during the past century should be re-examined.

### 18.2.3 Introducing Dominant Approaches of Sustainability

Different philosophies, school of thoughts, methodologies and techniques, have been developed to achieve sustainability in water resource systems. Examinations in water resource sustainability show that different approaches might generally embrace within three categories of: normalization, optimization, and internalization.

#### 18.2.3.1 Normalization

The normalization realm implies direct connection to norms, principles, goals, and so forth for detecting the state of sustainability. In this approach, all attempts are being made to “measure” the sustainability of systems and the “state” of a system in different time intervals, and consequently, one can have a sound sense about the sustainability of the system [8,62]. It endorses sustainability’s changing nature, but focus is more on quantifying the sustainability aspect of a system through developing statistical metrics by using massive information as well as developing numerous indicators.

Many supporters of this thinking realm believe in the idea “the more the better” in using indicators rather than to have a strategic perspective to create indicators. Another common feature of this school of thought is its reliance on systems thinking. Built on the systems thinking idea, it is believed that one can solve and analyze problems by breaking the system under study down to its elements, isolate each in order to understand the whole system’s performance, and then analyze each of them [11,17,32]. Most simple and one-dimensional statistical sustainability indicators could be classified into this category. In this approach, economy, society, and environment will be on a sustainable trajectory if the developed indicators are maintained in the range of defined thresholds.

The major deficit of being solely involved in this realm is the ignorance of dynamic interactions, consequences, side effects, and recognition of disruptive mechanisms responsible for the problem, which can be well explained by command-and-control linear management. In addition, although measuring sustainability dimensions at points over time can give evidence of whether the existing development path is in line with societal goals at that particular aspect of sustainability, they are unable to detect the impacts of problems or even probable side effects in a holistic way. Therefore, it allows more sustainability path deviation without making an effective contribution to closing the gap.

#### 18.2.3.2 Optimization

Optimization includes finding the “best” obtainable values of sustainability goal functions in a defined domain over a static time period. This may include a variety of different types of objectives and constraint functions. Over past decade, there have been many attempts for achieving sustainability in water resource modeling by applying numerous mathematical optimization techniques [14,44,57,58].

The main problem associated with this approach is the sensitivity of the target values. It means any little change in the socio-political features of the problem would make the optimal solution inefficient; one of the main reasons is that sustainability of water resources is more a socio-political than a technical challenge by nature.

Additionally, in spite of countless dilemmas in structuring a unanimous analytical framework, defining the goal functions for the sustainability of a region based on its socio-political situation is a tricky task. Optimization relies on many assumptions, losing control over each of which may lead to a more apparent deviation in the system's sustainability path. Therefore, effective optimization for reaching sustainability needs accurate knowledge, massive information, and profound insight regarding what is going to be optimized.

### **18.2.3.3 Internalization**

The third category of sustainability approaches can be called attempts for "internalization." Most recent efforts in finding a way of going back to the sustainability path could be classified into this school of thought. This implies the evolutionary process, which transforms the sustainability values into moral behavior. For internalization, the system needs to be managed into an integrated perspective and then internalized by the values of sustainability through the process of "learning." Considering internalization approaches, they seek adaptive alternatives through a systemic and strategic framework.

In this approach, when the ability for systemic learning is developed and systems are managed in an integrated perspective, positive and negative consequences will affect upcoming planning through innovative interpretation of different sets of processes. Thus, the system will encounter new changes, which will have resulted from the learning process.

Supporters of this approach address sustainable development as a moving target or a dynamic ideal rather than a static state of a system to be measured by indicators developed in the normalization realm [3,5,13,31]. Emphasis in such an approach is on the impacts of the core of humanity rather than any mathematical innovation; process rather than performance; effectiveness rather than efficiency; and basically "navigating" rather than "measuring."

## **18.2.4 Systemic Internalization Approach**

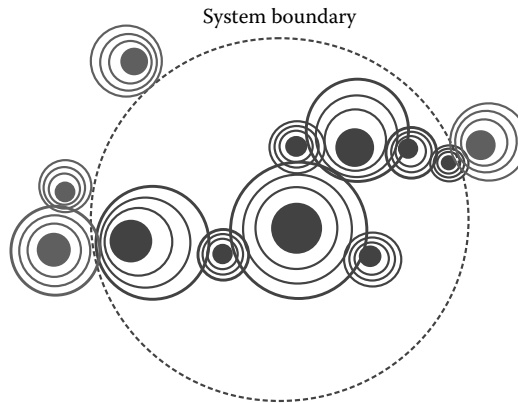
All definitions of sustainable development require seeing the world as a system, including all its temporal and special features. By accepting this basic notion, internalization commences its processes by adaptive learning over time.

Hence, sustainable development is not a fixed goal but rather a process of ongoing changes by which a system boosts its developmental trajectory with minimum deviation from sustainability values. To practice effective planning for a system, it is substantial to adopt methodologies, which enable articulating as integrating the whole.

Having understood the implications of this matter, it is clear that the concept of sustainable development is embraced in systems thinking. Systemic internalization approach acknowledges the importance of holism in perspective and complexity of understanding, as well as placing emphasis on the relationship between the components of a system rather than the properties of the components themselves. Figure 18.1 shows how sustainability as a feature of a system reminding a system's openness may be in interaction with the external components of the real world. Applying this approach enabled researchers to track trends and obtain deeper understanding of the system under study for monitoring sustainability rather than measuring it [4,5,31,61].

## **18.2.5 Sustainability and IWRM**

Having defined the principles of sustainability, the challenges, and its associated schools of thoughts to check the system's progress, there is a need to place them into a practical platform, align human



**FIGURE 18.1** An open system: a system which constantly interacts with its environment.

activities with the environment, and modify the way policy makers have been dealing with challenges by using our improved insight of sustainability. Once this is achieved, it may lead us to sustainable development of resources. In the context of water, which is of course the key driver for economic and social developments, it will play a substantial role through its function in sustaining the environment. Sustainable development could avoid bearing countless pressures, which exceed the carrying capacity of natural resources and, the socio-economic challenges approaching sustainability.

As we mentioned, development will move in a sustainable trajectory if it accounts for major shifts, particularly in the water sectors. In this regard, IWRM can help policy makers to develop sustainable platforms, and implement development objectives and goals in terms of managing the world's limited water resources in a holistic way. In addition, IWRM seeks to manifest environmental sustainability as one of the eight development goals of the millennium.

While it has been accepted that conventional water resource management poses huge pressures on environmental sustainability, IWRM can successfully address the issue of sustainability path deviation by dealing with the sustainability criteria, the three E-pillars of ecological sustainability, social equity, and economic efficiency.

### 18.3 Concept of IWRM and Its Associated Principles

IWRM, therefore, is not only an option; it is a must. We have to embrace it and align our practices to it. However, there are as many obstacles standing in the way of the realization of IWRM as there are opportunities in support of it [66].

Considering IWRM as the practical aspect of the sustainable development concept, the aim of this section is to discuss the fundamental aspects of IWRM and show how the concept can address the new challenges current complex water resources systems are faced with.

#### 18.3.1 Introduction to IWRM

While conventional water resource management mostly failed at reaching sustainable water resource development [43], many researchers addressed the need for an alternative methodology to address issues that occurred as a result of unsustainable developments and their further impacts on environmental considerations as well as socio-economic challenges [7,25,53,54]. As discussed before, this is mainly as a result of fragmented management and consequent supply-oriented policies rather than considering both supply and demand management [26], and due to various governing crises such as inadequate and

ill-suited legal frameworks, causing degradation of both surface and groundwater resources. In fact, the new paradigm and methodology should address efficient use of water collectively, with equity in access to water for all water users, environmental sustainability, and involvement of all sectors and groups of people from the society, characteristics, which have not been considered in conventional water management.

IWRM was officially developed about four decades ago by the International Water Resources Association (IWRA) [10]. Many researchers have attempted to address the IWRM concept and facilitate its implementation at local, regional, and national scales, but undeniably, GWP's efforts in terms of publishing different guidelines and attempts to develop a practical methodology for implementing IWRM have been remarkable at the global scale. Perhaps, the most agreed definition of IWRM has been suggested by the Technical Assistant Committee of Global Water Partnership, which is as follows:

A process that promotes the coordinated development and management of water, land and related resources, in order to maximize the resultant economic and social welfare in an equitable manner without compromising the sustainability of vital ecosystems [26].

In order to recognize the importance of IWRM, one should notice that IWRM has been adopted by many countries in the world and globally accepted as a way of achieving sustainable water resource management [28,45,49,63]. The next section details the chronological evolution of both the IWRM and sustainable development paradigms with respect to their interactions. The chronological evolution can provide an appropriate foundation for our further arguments for IWRM by reviewing some remarkable events, which have significantly influenced both paradigms.

### **18.3.2 Timeline of IWRM and Sustainable Development**

To begin with, while the earliest evidence of land and water governance may date back millennia ago, starting in the last century, however, serious efforts for addressing river basin development and management (in its modern form) were made at the end of the nineteenth century [48]. This can mainly be assumed as a result of population growth and various pressures on water resources. In the 1930s, one of the earliest versions of comprehensive water resource management had been started to be developed by the Tennessee Valley Authority (TVA) [15]. After the Second World War, there was much international focus on water and its related subjects as challenges to water had become more inescapable and environmental issues had not been taken into consideration. After such sporadic efforts, which continued until the second half of the twentieth century, there was an increase in consensus to bring those concerns to public policies. At that time, the United Nations (UN) realized that there was also a heavy degradation of human capital and natural resources. Therefore, through establishing many commissions and conferences on the elusive sustainability term, the UN paved a way for new research and practices to impede development from moving on its unsustainable path. In fact, UN agencies were instrumental in the globalization of both sustainability and IWRM so that many conferences were held on the issues of water, environment, and sustainable development starting with the 1972 UN Conference on the Human Environment in Stockholm.

In the context of water resources, the 1970s was a genuine turning point in the paradigm shift from subsectoral water resource management to a more holistic and integrated approach. For instance, in 1977, the basic concepts of IWRM started to be developed as an important achievement of the Mar del Plata International Conference, which has been recognized as one of the most influential events in the history of IWRM in the scientific water community [2,9,56].

Later at that time and influenced by the published report entitled "Our Common Future" by the World Commission on the Environment and Development [2], which addressed sustainable development, emphasis was also put forward on freshwater resources as a finite and vulnerable resource, which should be managed in an integrated manner, in the Dublin Conference [33]. It is now well accepted that the Dublin Conference with its four principles was a gradual shift from traditional engineering approaches, which have been water supply-oriented, toward an integrated approach. The Dublin

principles, which asserted both “ecological” and “institutional” aspects of water, as well as the role of “gender” and “instruments,” have profoundly influenced the development of the IWRM concept [71].

In June 1992, not long after the Dublin Conference, the conference on sustainability referred to as the Rio Conference succeeded in raising awareness toward the necessity of integration of all different sectors from societies. Despite being the first experience of its kind, it had impressive outcomes, including incorporation into Agenda 21 and the climate change convention, which later led to Kyoto the protocol and biological diversity convention. Many other conferences were held on the issues of water, environment, and sustainable development such as the International Conference on Freshwater in Bonn and the second and third World Water Forums in The Hague and Kyoto [9,34,56,69] as shown in Table 18.1.

**TABLE 18.1** Timeline of Remarkable Events of IWRM and Sustainable Development

Year	Place	Event	Major Achievements
Beginning of twentieth century	Many regions across the world	—	Sporadic efforts to manage water in a participatory and institutional way
1972	Stockholm	The UN Conference on the Human Environment	Laying the foundations for the international law and defining the terms of the global debate on environment and development [60]
1977	Mar del Plata	The Mar del Plata Conference	Establishing global water activities related to water
1987	Brundtland	The World Commission on Environment and Development (Brundtland Commission)	Re-examination of the critical issues of environment and development based on the Stockholm Conference, define sustainable development
1992	Dublin	The International Conference on Water and Environment	Addressing water as the main element of sustainable development, introducing Dublin principles as one of the main fundamentals of IWRM
1992	Rio de Janeiro	The UN Conference on Environment and Development (UNCED)	Incorporating the Dublin's principles into Agenda 21
2000	New York	The UN Summit of 2000	Introducing the millennium development goals
2000	The Hague	The Second World Water Forum Conference	Including IWRM in the political agenda, a start point in the birth of GWP
2001	Bonn	The World Conference on Fresh Water Resources	Addressing the gap between policy development and practical implementation
2002	Johannesburg	The World Summit on Sustainable Development (Rio + 10)	Setting 2005 as a target for worldwide IWRM implementation
2003	Kyoto	The Third World Water Forum	Establishing multistakeholder dialogue (MSD) for the first time
2006	Mexico city	The Fourth World Water Forum	Addressing the increasing awareness of global water issues and political mobilization <sup>a</sup>
2009	Istanbul	The Fifth World Water Forum	Confirming the importance of the institutional and cultural dimensions of water resource management
2012	Marseille	The Six World Water Forum	Bringing water up on all political agenda
2012	Rio de Janeiro	The World Summit (Rio + 20)	Renewing the political commitment to sustainable development, emphasis on reaffirmation of previous action plans

<sup>a</sup> Available at <http://www.worldwatercouncil.org/index.php?id=6> (last accessed on November 10).

Ten years after the Rio Conference, leaders from different governments, businesses, and NGOs participated in the World Summit on Sustainable Development held in Johannesburg (also known as Rio + 10) in order to reach an agreement on a set of measures for the same goal: accepting sustainable development as an all-embracing goal for all institutions on all scales. Moreover, the Johannesburg Declaration, which was built on the Stockholm Conference in 1972, the Rio Conference, as well as the international call for helping to achieve millennium development goals (MDGs) are among other conference outcomes. In fact, through introducing three pillars of sustainable development, namely economic efficiency, social equity, and environmental sustainability, the definition of sustainability was modified to “development in economy and humanity, and protecting the environment.” After Johannesburg, due to greater emphasis on human development compared with economic development, global concerns were raised and academic research on “humanity,” “social justice,” and “equity,” as well as “poverty alleviation,” were grounded.

In 2012, two decades after the Rio Conference, the world is still concerned about sustainability’s vague future and the need to prepare a thorough agenda for the next 20 years. This is essentially important as a means for re-examining the international political commitment to the dimensions of sustainable development and the goals established in Rio de Janeiro.

The primary result of Rio + 20 was a 49-page paper entitled “The Future We Want” in which governments of 192 countries renewed their political commitment to sustainable development. By studying the document, it became clear that it put forth a huge reaffirmation of previous action plans such as Agenda 21. The interesting point is that the word “reaffirm” had been used more than 50 times in the final published document to show the degree of importance of reaffirmation. In fact, it is needed to reaffirm the achievement of sustainable development, economic stability, and strengthening of international cooperation repetitively.

In the past few decades, efforts toward improving water management have changed dramatically, ranging from water supply-oriented methods to demand management, from relying solely on engineering methods to considering the environmental landscapes, and from sectoral management to more participatory and cross-sectorial management. Finally, through implementation of these changes, IWRM has become as a dominant water resource management paradigm.

### **18.3.3 Main Principles of IWRM**

There are some fundamental aspects of IWRM, which has been widely accepted across the global scientific water management community. These aspects can be expressed as the four principles of the Dublin Conference (also referred to as Dublin–Rio principles), which later that time, as it was discussed, were incorporated into Agenda 21 and have also been accepted at the UN Conference in Rio de Janeiro [64] (see Section 18.3.2).

Of these principles, the first one places emphasis on freshwater as a finite and vulnerable resource, which is essential to sustain life, development, and the environment. This principle addresses the need for integrating different elements of the social, environmental, and economic aspects of water resource systems, which should be taken into account to achieve integrated and holistic water resource management.

The central point of the second principle is the institutional frameworks and participatory aspect of each water resource project. Above and beyond, stakeholder participation is another key factor, which is an integral part of IWRM. Multi-stakeholder participation at different levels is the cornerstone of any IWRM plan [28] as it facilitates a sustainable decision-making process. In fact, effective stakeholder participation is essential for implementing IWRM because of its role in conflict resolution when there are different interest groups, where it can help “to address local issues in a coordinated and integrated manner” [43]. The third principle demonstrates the role of “gender,” more specifically, the role of women who play a central part in the provision, management, and safeguarding of water, while the last principle is “instrument,” which places emphasis on water as an economic good, which has an economic value in all its competing uses.

In addition to the four principles outlined in the Dublin Conference, which function as a basis for the IWRM concept, different water experts have attempted to describe IWRM in different ways but in-line with each other. For instance, in a systems approach to implement IWRM, consider a water resource system consisting of three main interacting components, including the natural (environmental), institutional, and socio-economic subsystems, where the trade-offs between the components make IWRM possible [39]. Savenije and Van der Zaag [59] suggested IWRM to have four dimensions of water resources, water users, spatial, and temporal scales, which should be taken into account as long as appropriate legal, institutional, and financial arrangements are concerned. Nevertheless, as Section 18.2 opened with a statement by Savenije and Van der Zaag, which addressed the importance of IWRM [59], there still are challenges associated with the paradigm among the scientific community.

### 18.3.4 Main Challenges of IWRM

IWRM has been hotly debated by many researchers regarding its conceptualization as well as its implementation method [28,45]. Regardless of much effort, which has been put to make the concept practicable, there are many who criticize IWRM by addressing the types of challenges regarding the definition, implementation, and methodological framework, as well as what should be integrated.

#### 18.3.4.1 Challenges Related to the Definition

As mentioned before, GWP's definition is now globally accepted as one of the most cited quotes. However, one should consider that there is no specific definition and IWRM should not be considered as a blueprint as different people have suggested different definitions for IWRM. For instance, Jonker [36] defined IWRM as "Managing people's activities in a manner, which promotes sustainable development (improving livelihoods without disrupting the water cycle)," or Merrey et al. [46] suggested addressing poverty to the definition. Moreover and according to Funke et al. [19], the importance of IWRM's definition "lies in the fact that it tempts water resource managers to carry on as before and simply label existing practices as IWRM, assuming that this is what they have always been engaged in." Such examples show the variety even in the definition as well as the aspects, which should be covered by the IWRM term.

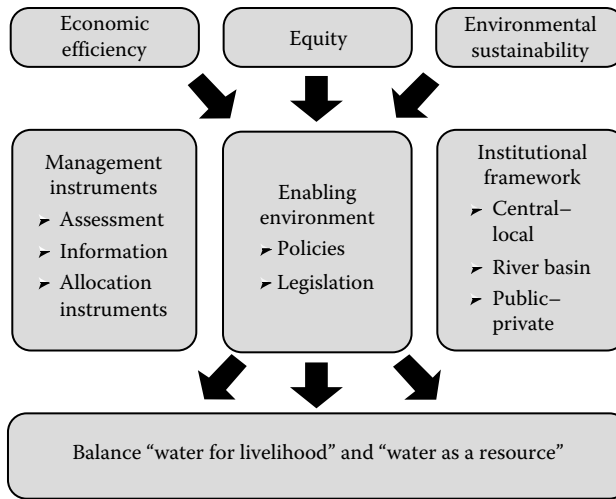
#### 18.3.4.2 Implementation and Scope Challenges

A challenge, which some researchers such as Allan [1] point to, is the difficulty of implementing IWRM. They assume that IWRM is essentially a political process and once this would be understood, IWRM could be implementable. Another important aspect, which should be considered, is the proper scope when it comes to speak about IWRM implementation. Hashemi [28] asserts that IWRM can be interfaced with different levels of decision-making, including policy, organizational, and operational, and thus it can be extended beyond the watershed boundaries. As watershed is the basic unit for analyzing hydrological water resource issues and is an appropriate scale for decision-making at the operational level, a river basin is widely accepted as a unit for implementing IWRM. However, water resource strategies are almost entirely decided outside of watershed boundaries; hence, there should be a move toward extending the watershed into the "problemshed," a concept, which has developed by Mollinga [50]. In this regard, Hashemi [28] developed the concept of "politicized IWRM," that is, to make politics central to the implementation of the concept since IWRM is essentially a political process. It is also concluded that

Lack of implementation has been attributed to the gap between policy decisions and technical outcomes has been attributed associated with lack of implementation. Hence, there has been a shift from technical toward socio-technical approaches [28].

In addition, governance crisis is also another aspect of importance when we speak about the implementation problems in IWRM. It has been shown that lack of good governance and effective institutional setups can be assumed as the main obstacles to implementing IWRM [28,70]. Supporting the





**FIGURE 18.2** Three pillars of the IWRM concept. Adapted from GWP-TAC (Global Water Partnership—Technical Advisory Committee). 2004. *Integrated Water Resources Management (IWRM) and Water Efficiency Plans by 2005. Why, What and How?* TAC Background Papers No. 10. GWP, Stockholm, Sweden.)

idea of a substantial role of effective institutional setups in implementing IWRM, Matondo [43] conducted a comparison between conventional and IWRM, and asserted that institutional framework is a key factor in successful implementation of both conventional and IWRM. This is why “strong institutional orientation” has been referred to as one of the most important aspects of IWRM [35]. GWP also developed a toolbox including different instruments and tools to develop the concept more practically as well as to be more implementable; these tools include (see Figure 18.2) [27]

1. Enabling the environment: To move toward establishing different policies and legislations in order to achieve sustainable water resources management.
2. The institutional roles, which address the need to build organizational frameworks as well as capacity-building.
3. Management instruments, which include different economic and regulatory instruments, water resource assessments, conflict resolution to address the different challenges associated with water management.

#### 18.3.4.3 Challenge Related to the Term “Integrate”

Biswas is undoubtedly one of the most important researchers in the field of IWRM who has criticized the IWRM concept. He noticed that it is difficult to implement IWRM since according to the definition, what should be integrated is not clearly defined and, further, different people consider different range of issues to be integrated. In other words, he criticized the normative package of IWRM by bringing up questions such as “What has to be integrated and how?” and in this regard, he supported his idea by presenting a list of more than 30 sets of dimensions and issues, which had been addressed by different authors in order to be integrated into the terms of IWRM [9]. On the other hand, as we quoted from Van der Zaag [66], one should consider IWRM as a “must,” to which we should align our practices.

#### 18.3.5 IWRM Modeling

Modeling approaches are appropriate tools for helping decision makers gaining insights about water resource systems by means of simulating underlying processes within the system and optimizing the

systems main objectives. In fact, policy makers require modeling techniques for improving and facilitating decision-making not only as part of a learning process, but also as a tool for predicting the state of water resources and its possible evolutions. In addition, models are useful tools to represent how the different points of views of stakeholders can be a part of management based on its effects on socioeconomic conditions as well as natural processes. Therefore, by modeling IWRM, decision makers are supported so that they can gain valuable insights in terms of evaluating alternatives, comparing the impacts of various water management scenarios, followed by choosing an appropriate action plan within the system in a holistic way.

Mirchi et al. [47] presented a chronological synthesis of watershed modeling techniques and illustrated the application of physically based modeling approaches, hydroeconomic, multicriteria decision-making, as well as conflict resolution models in integrated watershed modeling. Likewise, Hashemi and O'Connell [29] also provided a historical account of the development of both hydrological and water resource DSSs. Both studies suggested that the 1960s was a real turning point in water resource modeling with the advent of digital computers; more recently, in the 1990s, there have been attempts to develop integrated modeling systems linking various components of the water resource system together at the watershed scale [29,47].

As long as the appropriate model addressed the interactions between various system components as well as the trade-offs between natural characteristic, social, and economic elements, various researchers attempted to build such models based on different modeling approaches (e.g., multicriteria decision analysis, system dynamics, agent-based modeling approaches). To exemplify, Table 18.2 summarizes some examples illustrating the applicability of modeling approaches as well as specific developed DSSs on regional or national scales. Such tools can be useful for addressing the multi-disciplinary, multi-criteria, multi-sectoral, multi-dimensional aspects of IWRM.

While there has been a varying degree of success in IWRM modeling, nevertheless, some DSSs have not been able to integrate all the components of the IWRM (e.g., Basin [3,16] and RIBASIM [68] cited in [29]). Georgakakos [21] discusses that there can be lack of integration with respect to disciplines as well decision levels. Also, it was discussed that the process of integration is marred by “technological barriers and scientific information gaps” [28]. It is also asserted that they have not fulfilled all the “criteria of comprehensiveness,” which have five desirable features [29]:

- A GIS/graphical user interface and geo-database management system
- Scenario analysis with multi-criteria analysis or statistical techniques for strategy evaluation (expert systems)
- Socio-economic assessment tools/indicators
- Institutional assessment tools (e.g., water pricing)

Although not included in the scope of this chapter, it is worth mentioning that conceptual frameworks can also be useful tools to guide water managers and policy makers through integrated assessment by identifying main root problems helping to build more efficient models. In this regard, IWRM conceptual frameworks can be linked to sustainability assessment frameworks such as the DPSIR framework (see Section 18.2) so that a thorough analysis of water resource systems could be achieved.

## 18.4 A Case Study: Implementing IWRM without Considering a Conflict Resolution Perspective

In this section, we exemplify a case of IWRM implementation at a watershed which has faced with an environmental disaster caused by unsustainable developments at provincial scale. The section can help with a better understanding of the need for using appropriate conflict resolution approaches as an important management instruments for integrated watershed management as suggested by Mirchi et al. [47]. Relying on the work done by Najafi et al. [51], noncooperative game theory is suggested as an appropriate tool for explaining the potential conflicts associated with regional policymaking when IWRM plans has been implemented. On other words, an attempt is made to show why implementing

**TABLE 18.2** Example Applications of IWRM Modeling at the Watershed Scale

Objective(s)	Location	Modeling Approach/ Name	Modeling Description	Citation
To evaluate the potential and limitations of parsimonious hydrological and social models, assess the role of a conceptual integrated model in facilitating stakeholder debates	France	Socio-hydrosystem DSS	The DSS includes a river and aquifer module; a soil module to compute daily water budget; and three modules of canal management, winegrower, and canoe-renting	[37]
Developing a model within the policy context of the European Water Framework Directive	Local and EU-wide case studies	Integrated basin-wide DSS (mDSS/MULINO approach)	Using the DPSIR framework, the developed model is capable of modeling interactive social, economic, and environmental systems by multi-criteria analysis	[23,24]
Assessing cost/benefits for various water development projects, environmental, and socio-economic assessments	Nile Basin (which includes 10 countries)	The Nile Decision Support Tool	The model comprises databases and interfaces, a river simulation and management module, agricultural planning, and hydrologic and remote sensing modeling components	[22]
Linking physical process with socio-economic activities	Canada	Systems approach (system dynamics simulation)	The integrated model has two components of a continuous hydrological model as well a socio-economic one. Using the systems approach, the model addressed well the interaction between different parts by using the concept of feedback loops	[55]
Providing multi-actor simulation modeling for treating the socio-economic part of the water cycle in a process-based approach (developed within the framework of the large-scale research project GLOWA-Danube)	Germany	Object-oriented techniques (DeepActor)	The model comprises a coupled simulation system of global change impacts, which allows parallel interactive simulation of the physical and socio-economic components of water	[6]
Introduction of IWRM principles for implementing IWRM at the basin scale and addressing water conflict sources, and supporting stakeholders to manage their water resources	Bolivia	Multicriteria decision analysis (MCDA)	Developing environmental, social, and economic criteria to implement the administration instruments by use of the AHP method	[12]
Supporting integrated water resource management in Daegu City	South Korea	Web-based DSS	The developed model considers the effects of climate change, addresses hydrological processes, forecasts water demand, and has an optimized water allocation model; however, socio-economic aspects are not taken into consideration	[72]

IWRM at watershed scale even in presence of developed institutional frameworks can be unattainable when there are potential conflicts over managing water at provincial scale. One should notice that a comprehensive analysis of how IWRM should be implemented or suggesting any action plans for the case study is out of the scope of this section.

### 18.4.1 Environmental and Managerial Challenges of the Case Study

Lake Urmia, which is the largest enclosed body of water in Iran, is shared between three provinces, namely, Kurdistan, Eastern Azerbaijan, and Western Azerbaijan. The lake is valuable not only in terms of environmental and ecological services, but also in terms of providing social benefits such as eco-tourism and recreational facilities (Figure 18.3). Lake Urmia is now faced with serious environmental and water resource challenges in terms of both water quantity and water quality mainly due to unsustainable agricultural developments and lack of holistic approaches to plan and manage its water resources. Therefore, environment and water resources are faced with excessive pressure, which consequently have caused serious challenges for the lake to survive. Over the past years, the lake’s surface area has declined dramatically (to near one-third of its normal area), which subsequently has resulted in water quality issues. Water quality degradation has also had serious ecological and socio-economic impacts. For example, exceeding salt concentration beyond the threshold of 240 g/L has threatened the viability of a unique population of brine shrimp, *Artemia urmiana*, which consequently has resulted in the collapse of the lake’s food chain and loss of many of migratory bird populations [65].

In fact, increasing economic activity together with increasing population growth and a further need for food production has significantly increased the cultivated area by more than 200% over the past three decades, which consequently has declined the total amount of water released at the upstream of the lake. Consequently, ecological and environmental considerations had been ignored in the basin as a result of unsustainable developments. On the other hand, due to the declining lake level and further

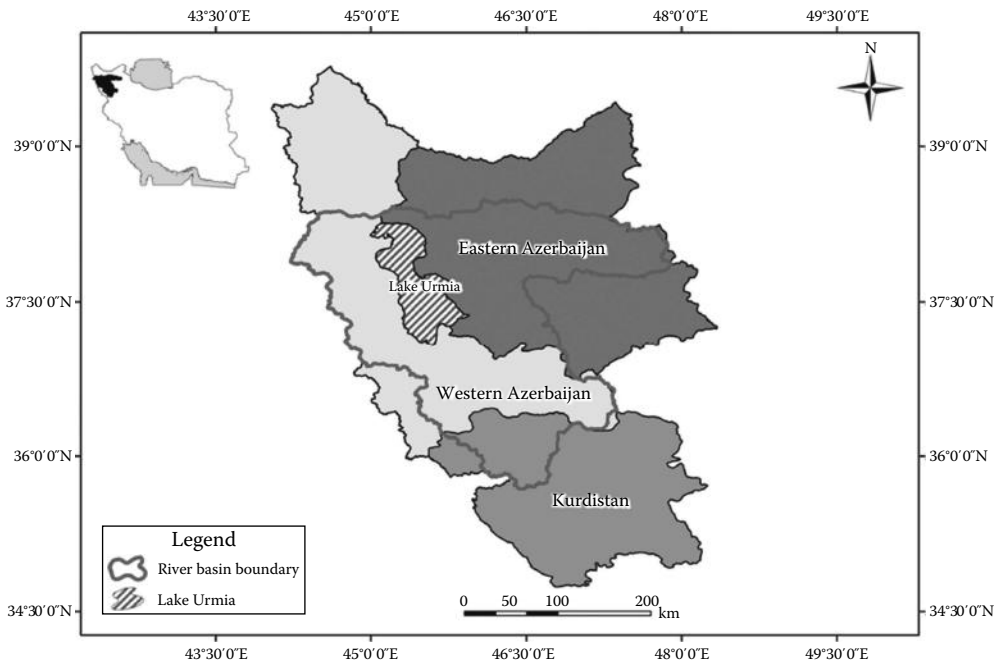


FIGURE 18.3 Location of the Lake Urmia.

increasing salt flats areas, occurrence of “salt storms” is now more likely, a disaster, which was also seen in the case of the Aral Sea. Likewise, if occurred, it would result in a reduction of agricultural production and various socio-economic challenges (see UNEP [65]).

Hashemi provides a thorough analysis of the national outlook of water resource management in Iran. Specifically, for the case of the Lake Urmia basin, a historical analysis was presented showing different time periods of attempts to implant IWRM at the basin scale. Addressing the Lake Urmia challenges, Hashemi [28] concludes that

- Water resources are governed by a prevailing top-down framework at the national level wherein all levels of stakeholders (e.g., farmers) are not getting involved in the decision-making process
- Using a DPSIR-IAD assessment, current institutional arrangements have failed to address pressures from increasing water demand well
- There is a lack of cooperation between regional water authorities

Addressing such challenges, and by considering the current institutional setups, one can conclude that governance crisis still can be considered one of the most important reasons of failure to reach sustainable and integrated water resource management for the Lake Urmia river basin. In this regard, the next section provides insights into Lake Urmia water resource management at the operational level in which regional water authorities are the main players.

#### **18.4.2 Conflict Resolution Analysis: The Need to Implement IWRM at the Lake Urmia Basin**

There have been numerous bodies of research that have attempted to address the problems in Lake Urmia basin with the aim of analyzing as to what extend the underlying driver forces impact the lake water level drop. Although valuable insights into the main causes of water level drop are provided, most of the researches rely heavily on technical tools failing to take into account other aspects which are of utmost importance as well (e.g., socioeconomic considerations and the role of institutional framework). Applying such tools solely cannot support policy makers to carefully plan for and manage the problems associated with the Lake Urmia water quality and quantity issues. This implies the need for applying an integrated framework, and an all-embracing approach that takes all aspects, including hydrological, socioeconomic and environmental, into consideration. In a broader context, Hashemi [28] presents a thorough analysis of the national outlook of water resource management in Iran, and, more specifically, the case of Lake Urmia basin. In addition, he provides a historical analysis showing the different time periods of attempts made to implement IWRM at the Lake Urmia basin. Addressing the challenges related to the lake, Hashemi [28] concludes that

- Water resources are governed by a prevailing top-down framework at the national level wherein all levels of stakeholders (e.g., farmers) are not getting involved in the decision-making process
- Using a DPSIR-IAD assessment, current institutional arrangements have failed to address pressures from increasing water demand at basin scale
- There is a lack of cooperation between regional water authorities

The third conclusion, of course, points to the importance of taking conflict resolution methods into account when implementing IWRM. Although such approaches can provide valuable insights into integrated multidisciplinary water resources modeling [47], very little information is available in the literature to analyze the Lake Urmia problems from the point of view of conflict resolution. As discussed before, Mirchi et al. [47] believe that conflict resolution methods are an integral part of integrated multidisciplinary water resources modeling; however, projects and research studies that have been done as of today at the Lake Urmia basin have mainly been focused on all suggested modeling approaches by the mentioned reference except the last one. This is probably one of the main reasons and a stumbling block in implementing IWRM at the Lake Urmia basin.

Using the lake example presented by Madani [40] in addition to water resources management at the Lake Urmia basin, a recent research by Najafi et al. [51] has illustrated how managing the lake may represent a conflict between involved provinces by using a game theory approach. Game theory can be useful when there are different actors having a variety of strategies in decision-making process. More specifically, the method is capable of addressing challenges associated with environmental management as well as the way water resources are managed when there are potential conflicts among stakeholders, sometimes having oppositional interests [41,42]. In the Lake Urmia conflict, the main stakeholders at the basin are regional water authorities, environment protection agencies, as well as agricultural jihads, which authorize agricultural activities, of the three provinces. In fact, the conflict may be assumed as a game between the involved provinces (as players of the game) where each may choose from the set of strategies whether to cooperate, which means to release the specific amount of water by each province for the lake's survival, or to not cooperate, which means not to release the specific amount identified for each province and to divert and consume water for agricultural demands upstream of the lake [51,52]. Considering the minimum ecological requirement of the lake as the basic concept [28], different scenarios may take place depending on the amount of water to be released by each province. Such scenarios are introduced by Najafi et al. [51] using noncooperative game theory.

Using the topology of  $2 \times 2$  games, prisoner's dilemma (PD) has been suggested as the most likely structure for the Lake Urmia conflict [51,52]. Therefore, not surprisingly, it is very likely that each province attempts to choose the strategy of "Don't Cooperate" (DC), not providing the minimum ecological requirement but rather consuming water for the agriculture sector, which consumes nearly 97% of the available water resources in Iran. This, in fact, has resulted in an unsustainable development of resources and demonstrates the need to implement IWRM.

Addressing such challenges, and by considering the current institutional setups, one can conclude that governance crisis and the failure of implementing appropriate conflict resolution approaches can still be considered the most important reasons as to why sustainable and integrated water resource management for the Lake Urmia river basin may fail at the operational level.

### 18.4.3 Discussion

As of the eight development goals of the millennium, environmental sustainability can be achieved for the outcome (C, C) in cases where the two provinces provide the total environmental demand in the long run. In such a situation, the outcome (C, C) is one of the three Pareto-optimal outcomes in the PD game. Using the game theory approach, and more specifically, ordinal  $2 \times 2$  games, can be very useful to show what is happening at the basin scale, how sectoral management can affect the sustainability of the lake, and the extent to which regional water authorities can participate in ensuring the lake's sustainability by using the cooperation or non-cooperation strategies of the players. Although the processes, which have occurred at the basin, can be found to be very complicated, using  $2 \times 2$  noncooperative games can describe the real situation in a simple but powerful way.

The lack of an integrated approach to water resource planning and management results in unsustainability of water management if the resources are not governed by a cross-sectoral institute. For the case of Lake Urmia, analyzing the conditions for implementing water resources suggests that supply-oriented policies in providing water for upstream agricultural activities resulted in governance crisis, which can be well explained by the Pareto-inferior outcomes of the PD game. For this game, the unique Nash Equilibrium outcome of (DC, DC) is expected to be as the final outcome of the conflict. On the other hand, the choice of a cooperation strategy by each province is equal to participatory management of the basin, which can ensure sustainability of its water resources, thereby preventing governance crisis. However, to reach the Pareto-optimal outcome of (C, C), which ensures sustainability of water resources at the basin scale, there is a need to raise consensus among policy makers by participatory approaches; For instance; it has been suggested that by

explaining the game to players or other methods which improve the level of trust between parties, both players would attempt to cooperate when the PD game prevails [51]. Moreover, in the context of IWRM, achieving the outcome (C, C) is the likely outcome when new legal frameworks as well as proper institutional frameworks are established.

## 18.5 Summary and Conclusions

---

This chapter mainly aims at introducing the basic concepts of IWRM, sustainability of water resources, and the main discussions, which already exist for both paradigms. As the way water resources are managed has been significantly revolutionized during recent decades, complex water-related challenges have now been well addressed by improved modeling techniques, attempts, which have been made for more participatory approaches, and introduction of new paradigms such as the concept of sustainable development. Such outcomes can be assumed as major key drivers affecting the way water resources can be effectively and successfully managed.

Presenting the timelines of sustainable development and IWRM, it was shown that the two concepts are closely related to each other. In fact, addressing social, environmental, and economic considerations is central in the concept of IWRM so that one can consider it as the practical aspect of sustainable water resource developments.

Illustrating the real example of Lake Urmia, noncooperative game theory has been introduced as a valuable tool for assessing the lake's problem and how it can provide insights for sustainable water resource planning and management. The Lake Urmia illustration depicts how lack of considering an appropriate conflict resolution method in implementing IWRM at watershed scale may lead to provincial water resource conflict and consequent environmental and socioeconomic problems. Therefore, although agreed with Savenije and Van der Zaag, who believe in IWRM as a must [59], there still are challenges associated with the paradigm when it comes to implement at regional/national and watershed scales.

## Acknowledgments

---

The authors wish to express their gratitude to Dr. Ali Bagheri and Dr. Mukhtar Hashemi for critical and useful comments, guidance, and suggestions during the writing of the chapter. Also, comments from Mr. Seyed Sajed Motevallian and Ms. Fatemeh Zare are appreciated.

## References

1. Allan, T. 2003. IWRM/IRWAM: A new sanctioned discourse? Occasional Paper 50. SOAS Water Issues Study Group, School of Oriental and African Studies, Kings College London, University of London, London, U.K.
2. Amezaga, J.M. 2005. Inter-institutional links in land and water management. In Anderson, M.G. and McDonnell, J.J. (eds.). *Encyclopaedia of Hydrological Sciences (3003–3012)*, 5-Volume Set. John Wiley & Sons, West Sussex, U.K.
3. Ammentorp, H.C. 2001. Application of MIKE BASIN to Nakanbé catchment. Paper presented at the 4th DHI Software Conference, June 6–8, Helsingør, Denmark.
4. Bagheri, A., M. Darijani, A. Asgary, and S. Morid. 2010. Crisis in urban water systems during the reconstruction period: A system dynamics analysis of alternative policies after the 2003 earthquake in Bam—Iran. *Water Resources Management*, 24(11): 2567–2596.
5. Bagheri, A. and P. Hjorth. 2007. A framework for process indicators to monitor for sustainable development: Practice to an urban water system. *Environment, Development and Sustainability*, 9(2): 143–161.
6. Baron, J.S., N.L. Poff, and P.L. Angermeier. 2002. Meeting ecological and societal needs for freshwater. *Ecological Applications*, 12(5): 1247–1260.

7. Barthel, R., S. Janisch, N. Schwarz, A. Trifkovic, D. Nickel, C. Schulz, and W. Mauser. 2008. An integrated modelling framework for simulating regional-scale actor responses to global change in the water domain. *Environmental Modelling and Software*, 23: 1095–1121.
8. Bender, M.J. and S.P. Simonovic. 1997. Consensus as the measure of sustainability. *Hydrological Sciences Journal*, 42(4): 493–500.
9. Biswas, A.K. 2004. Integrated water resources management: A reassessment—A water forum contribution. *Water International*, 29(2): 248–256.
10. Braga, B.P.F. 2001. Integrated urban water resources management: A challenge into the 21st century. *International Journal of Water Resources Development*, 17(4): 581–599.
11. Bruce, J.P. 1992. *Meteorology and Hydrology for Sustainable Development*. World Meteorological Organization No. 769, Secretariat of the WMO, Geneva, Switzerland.
12. Calizaya, A., O. Meixner, L. Bengtsoon, and R. Berndtsson. 2010. Multi-Criteria Decision Analysis (MCDA) for Integrated Water Resources Management (IWRM) in the Lake Poopo Basin, Bolivia. *Water Resource Management*, 24: 2267–2289.
13. Cashman, A. 2006. A watery form of sustainability. *Water and Environment Journal*, 20(1): 2–6.
14. Cetinkaya, C., O. Fistikoglu, N. Harmancioglu, and K. Fedra. 2008. Optimization methods applied for sustainable management of water-scarce basins. *Journal of Hydroinformatics*, 10(1): 69–95.
15. Cook, B.R. and C.J. Spray. 2012. Ecosystem services and integrated water resources management: Different path to the same end? *Journal of Environmental Management*, 109: 93–100.
16. Danish Hydraulic Institute (DHI). 1997. *MIKE BASIN: Operating Manual and Description*. Danish Hydraulic Institute, Hørsholm, Denmark.
17. Falkenmark, M. 1988. Sustainable development as seen from a water perspective. In *Perspectives of Sustainable Development*. Stockholm Studies in Natural Resources Management, No. 1, Stockholm, Sweden, pp. 71–84.
18. Fischer, J., A.D. Manning, A.D. Steffen, W. Rose, D.B. Daniell, K. Felton et al. 2007. Mind the sustainability gap. *Trends in Ecology and Evolution*, 22(12): 621–624.
19. Funke, N., S.H.H. Oelofse, J. Hattingh, P.J. Ashton, and A.R. Turton. 2007. IWRM in developing countries: Lessons from the Mhlatuze catchment in South Africa. *Physics and Chemistry of the Earth*, 32: 1237–1245.
20. Genuiux, G., S. Bellon, C. Deverre, and B. Powell. 2006. Sustainable development indicators frameworks and initiatives. System for Environmental and Agricultural Modelling; Linking European Science and Society (SEAMLESS) project. Report No. 49, France.
21. Georgakakos, A.P. 2006. Decision support systems for Water Resources Management: Nile Basin applications and further needs. *CPWF: Proceedings of the Working Conference*, Nazareth, Ethiopia.
22. Georgakakos, A.P. 2007. Decision support systems for integrated water resources management with an application to the Nile Basin. *Topics on System Analysis and Integrated Water Resource Management*. Castelletti, A. and Soncini-Sessa, R. (eds.). Elsevier, Oxford, U.K.
23. Giupponi, C. 2007. Decision support systems for implementing the European Water Framework Directive: The MULINO approach. *Environmental Modelling and Software*, 22: 248–258.
24. Giupponi, C., J. Mysiak, A. Fassio, and V. Cogan. 2004. MULINO-DSS: A computer tool for sustainable use of water resources at the catchment scale. *Mathematics and Computers in Simulation*, 64(1): 13–24.
25. Gleick, P.H. 2003. Global freshwater resources: Soft-path solutions for the 21st century. *Science*, 302(5650): 1524–1528.
26. GWP. 2000. Integrated water resources management. Global Water Partnership—Technical Advisory Committee Background Paper No. 4, Stockholm, Sweden. Available online at: <http://www.gwpforum.org/gwp/library/Tacno4.pdf>
27. GWP-TAC (Global Water Partnership—Technical Advisory Committee). 2004. Integrated Water Resources Management (IWRM) and Water Efficiency Plans by 2005. Why, What and How? TAC Background Papers No. 10. GWP, Stockholm, Sweden. Available online at: [http://www.gwp.org/Global/GWP-CACENA\\_Files/en/pdf/tec04.pdf](http://www.gwp.org/Global/GWP-CACENA_Files/en/pdf/tec04.pdf) (accessed September 25, 2013).



28. Hashemi, M. 2012. A socio-technical assessment framework for Integrated Water Resources Management (IWRM) in Lake Urmia basin, Iran. PhD thesis, Newcastle Institute for Research on Sustainability, Newcastle University of Technology, Newcastle, U.K.
29. Hashemi, M. and P.E. O'Connell. 2011. Historical perspectives: From hydrological models to Decision Support Systems (DSSs). In Gasmelseid, T. ed. *Handbook of Research on Hydroinformatics: Technologies, Theories and Applications*. Hershey, PA, IGI Global.
30. Hashemi, M. and P.E. O'Connell. 2011. Science and water policy: An integrated methodological framework for Developing Decision Support Systems (DSSs). In *Handbook of Research on Hydroinformatics: Technologies, Theories and Applications*. Gasmelseid, T. (ed.). IGI Global, Hershey, PA.
31. Hjorth, P. and A. Bagheri. 2006. Navigating towards sustainable development: A system dynamics approach. *Futures*, 38(1): 74–92.
32. Huang, G.H. and J. Xia. 2001. Barriers to sustainable water-quality management. *Journal of Environmental Management*, 61: 1–23.
33. ICFW. 2001. Brief conference report including ministerial declaration, the Bonn keys and Bonn recommendations for action. Available online at: <http://www.un.org/esa/sustdev/sdissues/water/BonnConferenceReport.pdf> (accessed September 25, 2013).
34. ICWE. 1992. The Dublin statement on water and sustainable development. Available online at: <http://www.unesco.org/science/waterday2000/dublin.htm> (accessed on June 22, 2004).
35. Imperial, M.T. 2009. Paradoxes, possibilities, and the obstacles to IWRM: Lessons from the Institutional Rational Choice Literature. Paper presented at the *International Symposium on Society and Resource Management (ISSRM)*, Vienna, Austria.
36. Jonker, L. 2002. Integrated water resources management: Theory, practice, cases. *Physics and Chemistry of the Earth*, 27: 719–720.
37. Lanini, S., N. Courtois, F. Giraud, V. Petit, and J.D. Rinaudo. 2004. Socio-hydro-system modelling for integrated water-resources management—The He'rault catchment case study, southern France. *Environmental Modelling and Software*, 19: 1011–1019.
38. Loucks, D.P. 2000. Sustainable water resources management. *Water International*, 25(1): 3–10.
39. Loucks, D.P. and E. Van Beek. 2005. *Water Resources Systems Planning and Management: An Introduction to Methods, Models and Applications*. UNESCO, Paris, France.
40. Madani, K. 2010. Game theory and water resources. *Journal of Hydrology*, 381: 225–238.
41. Madani, K. and K. Hipel. 2011. Non-cooperative stability definitions for strategic analysis of generic water resources conflicts. *Water Resources Management*, 25: 1949–1977.
42. Madani, K. and J.R. Lund. 2012. California's Sacramento-San Joaquin Delta Conflict: From Cooperation to Chicken. *Water Resources Planning and Management*, 138(2): 90–99.
43. Matondo, J.I. 2002. A comparison between conventional and integrated water resources planning and management. *Physics and Chemistry of the Earth*, 27: 831–838.
44. McPhee, J. and W. Yeh. 2004. Multiobjective optimization for sustainable groundwater management in semiarid regions. *Journal of Water Resources Planning and Management*, 130(6): 490–497.
45. Merrey, J.D. 2008. Is normative integrated water resources management implementable? Charting a practical course with lessons from Southern Africa. *Physics and Chemistry of the Earth*, 33: 899–905.
46. Merrey, J.D., P. Drechsel, F.W.T Penning de Vries, and H. Sally. 2005. Integrating “livelihoods” into integrated water resources management: Taking the integration paradigm to its logical next step for developing countries. *Regional Environmental Change*, 5(4): 197–204.
47. Mirchi, A., D.W. Watkins Jr., and K. Madani. 2010. *Modeling for Watershed Planning, Management, and Decision Making, Watersheds: Management, Restoration and Environmental Impact*. Vaughn, J.C. (ed.). Nova Science Publishers, Hauppauge, New York.
48. Molle, F. 2006. Planning and managing water resources at the river-basin level: Emergence and evolution of a concept. Comprehensive assessment of water management in agriculture research, Report 16. IWMI, Colombo, Sri Lanka.

49. Molle, F., P.P. Mollinga, and R. Meinzen-Dick. 2008. Water, politics and development: Introducing water alternatives. *Water Alternatives*, 1(1): 1–6.
50. Mollinga, P.P. 2008. Water, politics and development: Framing a political sociology of water resources management. *Water Alternatives*, 1(1): 7–23.
51. Najafi, H., A. Bagheri, and K. Madani. 2013. The topology of generic shared water resources games: Insights for the Lake Urmia disaster. *Proceedings of the 6th International Conference in Water Resources and Environmental Research (ICWRER)*, Koblenz, Germany.
52. Najafi, H., K. Madani, and A. Bagheri. 2011. Game theory and shared water resources management. Presented at *2011 Fall Meeting, AGU*, San Francisco, CA, December 5–9.
53. Niemczynowicz, J. 2000. Present challenges in water management: A need to see connections and interactions. *Water International*, 25(1): 139–147.
54. Postel, S.L. 2000. Entering an era of water scarcity: The challenges ahead. *Ecological Applications*, 10(4): 941–948.
55. Prodanovic, P. and S.P. Simonovic. 2007. Integrated water resources modelling of the Upper Thames River Basin. *18th Canadian Hydrotechnical Conference on Challenges for Water Resources Engineering in a Changing World*. Winnipeg, Manitoba, Canada.
56. Rahaman, M.M. and O. Varis. 2005. Integrated water resources management: Evolution, prospects and future challenges. *Sustainability: Science, Practice, and Policy*, 1(1): 15–21.
57. Rao, Z., B. Potter, D. Webb, and R. Parkin. 2009. Sustainable water resources management: River basin modeling and decision support framework. *Wuhan University Journal of Natural Sciences*, 14(6): 543–551.
58. Safavi, H.S. and M.A. Alijanian. 2011. Optimal crop planning and conjunctive use of surface water and groundwater resources using fuzzy dynamic programming. *Journal of Irrigation and Drainage Engineering*, 137(6): 383–397.
59. Savenije, H.H.G. and P. Van der Zaag. 2008. Integrated water resources management: Concepts and issues. *Physics and Chemistry of the Earth, Parts A/B/C*, 33(5): 290–297.
60. Seyfang, G. and A. Jordan. 2002. The Johannesburg summit and sustainable development: How effective are environmental mega-conferences? *Yearbook of International Cooperation on Environment and Development*, 2002/2003: 19–26.
61. Shahbazbegian, M. and A. Bagheri. 2010. Rethinking assessment of drought impacts: A systemic approach towards sustainability. *Sustainability Science*, 5(2): 223–236.
62. Simonovic, S.P., D.H. Burn, and B.J. Lence. 1997. Practical sustainability criteria for decision-making. *The International Journal of Sustainable Development and World Ecology*, 4(4): 231–244.
63. Swatuk, L.A. 2004. Political challenges to sustainably managing intra-basin water resources in Southern Africa: Drawing lessons from cases. Paper presented at the *5th WaterNet/WARFSA Symposium, Integrated Water Resources Management and the Millennium Development Goals: Managing Water for Peace and Prosperity*, Windhoek, Namibia, November 2–4.
64. UNCED. 1992. Agenda 21: The Rio declaration on environment and development. *Earth Summit, United Nations Conference on Environment and Development (UNCED)*, Rio de Janeiro, Brazil, June 3–14, 1992. Available online at: <http://habitat.igc.org/agenda21/index.htm>
65. UNEP and GEAS. 2012. The drying of Iran's Lake Urmia and its environmental consequences. *Environmental Development*, 2:128–137. Available online at: [http://na.unep.net/geas/getuneppagewitharticleidsript.php?article\\_id=79](http://na.unep.net/geas/getuneppagewitharticleidsript.php?article_id=79) (accessed September 25, 2013).
66. Van der Zaag, P. 2005. Integrated water resources management: Relevant concept or irrelevant buzzword: A capacity building and research agenda for Southern Africa. *Physics and Chemistry of the Earth*, 30: 867–871.
67. WCED. 1987. *Our Common Future*. Oxford University Press, Oxford, NY.
68. WL Delft Hydraulics. 2005. RIBASIM documentation. Available online at: <http://www.wldelft.nl/soft/ribasim/doc/index.html> (accessed October 4, 2013).

69. WWC. 2000. Final report. *Second World Water Forum and Ministerial Conference. Vision to Action*. World Water Council, Marseilles, France.
70. WWDR. 2009. Water in a changing world. The United Nations World Water Development Report 3, UNESCO, Earthscan, London, U.K.
71. Xie, M. 2006. *Integrated Water Resources Management (IWRM)—Introduction to Principles and Practices*. World Bank Institute (WBI), pp. 1–15, Washington, DC. Available online at: <http://www.pacificwater.org/userfiles/file/IWRM/Toolboxes/introduction%20to%20iwrM/IWRM%20Introduction.pdf> (accessed September 25, 2013).
72. Zeng, Y., Y. Cai, P. Jia, and H. Jee. 2012. Development of a web-based decision support system for supporting integrated water resources management in Daegu city, South Korea. *Expert Systems with Applications*, 39: 10091–10102.

# 19

## Sustainable Wastewater Treatment

---

19.1	Introduction .....	388
19.2	Sustainability.....	388
	Environmental Sustainability • Economic Sustainability • Social Sustainability • Trade-Offs and Balancing	
19.3	Systems View .....	391
19.4	Indicators and Assessment Methods.....	392
	Indicators of Sustainable Wastewater Treatment • Assessment Methods	
19.5	Sustainable Wastewater Management Strategies.....	395
19.6	Summary and Conclusions .....	396
	References.....	396

Erik Grönlund  
*Mid Sweden University*

### AUTHOR

**Erik Grönlund** has a PhD in environmental engineering from Luleå University of Technology, where his research focused on wastewater treatment with microalgae. He is currently a senior researcher and lecturer at Mid Sweden University, with a focus on sustainability assessment methods and systems analysis and modeling of the environmental–economic interface in watersheds related to the European Union Water Framework Directive. He has an interdisciplinary background from ecotechnology, systems ecology, geology, and economy.

### PREFACE

For a long time, wastewater needed only to be carried away from the human settlement into a nearby river, lake, sea, or groundwater. However, with increasing population and industrial activity, the volume and composition of the wastewater needed some mechanical, biological, or chemical treatment before discharge. In this chapter, wastewater treatment is placed into the context of sustainable development, with its main aspects of environmental, economic, and social concerns, both for future and current generations. The wide spectra of indicators and assessment methods that are used to assess the sustainability of the wastewater treatment methods are presented. The theme throughout the chapter is a systems view that shows us that sustainability cannot be assessed only at the scale of the wastewater treatment facility. The fence or walls of the treatment plant are a too narrow scope for a proper sustainability assessment as we will see.

## 19.1 Introduction

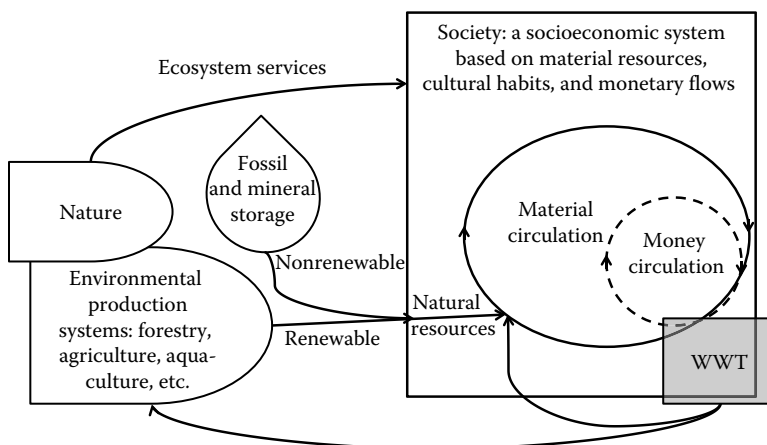
Sustainability and sustainable development are important concepts more and more used; however, currently, there is no full consensus of these concepts. In this chapter, three different viewpoints will be taken. First there are aspects of sustainability for which there is almost full consensus. Second, this chapter will give an overview of what approaches have been used so far regarding sustainability assessment of wastewater treatment. Third, to give perspective on sustainability, a systems approach covering several of the important aspects identifiable in the context of sustainability and wastewater treatment will be used. This systems approach is not proven better than other approaches, but will work as a relative viewpoint.

## 19.2 Sustainability

There is almost complete consensus that sustainability has three aspects: environmental, economic, and social sustainability. Another important feature is the intergenerational equity aspect, expressed by the famous World Commission on Environment and Development [79] as “development that meets the needs of the present generation without compromising the ability of future generations to meet their own needs.”

The three aspects—environmental, economic, and social sustainability—are often referred to as the three pillars of sustainability or the “triple bottom line” [75]. Goodland [25] depicted the three sustainability aspects with three rings and sustainable development defined as the area where all three rings overlap. As pointed out by Giddings et al. [23], the problem with this model is that it gives the picture of a separation between environmental, economic, and social aspects, while a probably more true model is that they are interconnected to a large extent [64]. A good overview of this sustainability discussion can be found in Palme [68].

The objection by Giddings et al. [23] was further processed by Grönlund and Carlman [28] (see Figure 19.1). To the left in the picture are the productive systems of the environment: the forests, agricultural land, lakes and oceans, wetlands, and more that provides the population of humans on planet earth with natural resources, the natural systems that, even if untouched by human activities, provide us with ecosystem services as scenery, biodiversity, the hydrological cycle, etc. [56], and the geological storage of fossil fuels and minerals produced by historical, biological, and geological systems that are used by the human population as nonrenewable natural resources.



**FIGURE 19.1** Systems connections with relevance to environmental, economic, and social sustainability. WWT, wastewater treatment. (Modified from Grönlund E and Carlman I, 2013.)

To the right in the picture are the societies. Human populations or settlements forming socioeconomic systems based on natural resources, cultural habits, or capital, and almost all of them characterized by monetary flows within the systems. The human settlements are also characterized by energy use (not shown in Figure 19.1) and a circulation of material. Some of the materials are sent back to the environment as solid waste, gaseous waste, and liquid waste. In the picture, the flow of liquid waste is depicted, leaving the settlement through the wastewater treatment system (WWT). The material from the WWT is fed back to the lakes, rivers, or oceans, or as sludge or irrigation to land systems as forests or agriculture land. These systems can either handle the discharge and reuse it as a resource again available to the settlement, or may cause damage to the environmental system, which often gives trouble also to the human settlement. A special case here is sludge delivered to a solid waste dump. In the long run, solid waste facilities must be considered belonging to the environmental systems either as forests or meadows, unless we hope that they will be transformed to the fossil and mineral storage pool. For example, Günther [31] describe how solid waste dumps deliver collected leachate to a wastewater treatment plant from which sludge is delivered back to the solid waste dump as a hampered effluent accumulation process system only delaying phosphorus on its way to the recipient.

The WWT square is placed partly outside the society square. Wastewater treatment facilities can be viewed as an interface or a so-called ecotone between the society and the environmental systems as often described in ecological engineering [27,57]. The interface can be a constructed wetland, different types of aquatic ponds, or irrigation of agricultural or forest land. Even activated sludge or compost can be considered to be in the interface between society and the environmental systems.

### 19.2.1 Environmental Sustainability

Environmental sustainability can be viewed as the fact that our societies are depending on natural resources and other ecosystem services like, for example, “nature” as a provider of aesthetic services (Figure 19.1). The systems conditions or socioecological principles of Azar et al. [5] and Holmberg et al. [40] give a good view of how this sustainability aspect must develop over time to be sustainable. The conditions can have a scope of local, regional, or global, and are stated as follows:

1. No systematic increase in concentrations of substances extracted from the earth’s crust
2. No systematic increase in concentrations of substances produced by society
3. No systematic degradation of the physical conditions for the long-term production capacity in the ecosphere or the diversity of the biosphere

From these conditions, almost all of our environmental problems can be viewed:

- a. Greenhouse gas emissions violate condition 1 with a systematic increase in fossil carbon dioxide. Other important greenhouse gases produced by society, as CFCs,  $N_2O$ , ozone, and methane, violates condition 2. The contribution to greenhouse gas emissions from large-scale deforestation of rainforest violates condition 3.
- b. Eutrophication substances as phosphorus fertilizer violates condition 1, and nitrogen fertilizer captured from gaseous nitrogen violates condition 2. The high electricity use for the conversion of nitrogen gas to nitrogen fertilizer probably also violates condition 1 if the electricity is produced from coal, oil, or fossil natural gas.
- c. Acidification: the sulfuric acid originates from oil or coal and violates condition 1; the nitric acid originates from conversion of nitrogen gas in combustion engines and violates condition 2. The recently recognized problem of ocean acidification is caused by fossil fuels producing fossil carbon dioxide.
- d. Toxic substances: the increase stems either from extraction from the earth’s crust violating condition 1 (e.g., mercury, lead, cadmium, and other heavy metals), or from society’s production violating condition 2 (e.g., DDT, PCB, dioxin, or other problematic organic compounds).

- e. Biodiversity: the major part of the biodiversity loss is caused by violation of condition 3, where mainly rainforest areas are systematically decreased. The biodiversity loss caused by changed management methods in the landscape, as is the case in agriculture and forestry, is one of the few aspects that are not captured by the conditions.

Environmental sustainability is sometimes also labeled ecological sustainability. An important aspect of ecology is that it is almost always place dependent. From this follows that it is impossible to give general answers to what is sustainable or not. For example, if groundwater in the region is scarce and the withdrawal is larger than what is regenerated by the hydrological cycle, a low value of a water use indicator can be nonsustainable, while a much higher indicator valued in a groundwater-rich region is sustainable. The same reasoning is valid for discharges of nutrients as phosphorus and nitrogen. If the capacity of the recipient, local or regional, to incorporate the higher nutrient load without disturbance is high enough decides if it is environmental sustainable or not. In principle, the same reasoning is also valid for energy use, which is an indicator often compared between different wastewater treatment methods. If the energy is produced in such a way that the emissions are incorporated to the environment without disturbance, it is sustainable, otherwise not. For example, the properties of the regional soil and bedrock together with the predominant wind directions decide what level of acidification discharges from coal or oil burning is sustainable (on the other hand, the carbon dioxide discharges have a global context in this example).

### **19.2.2 Economic Sustainability**

Economic sustainability is often assessed by the economic costs for the wastewater treatment, and this is often appropriate. Economy can, however, be viewed from a larger, and older, perspective: how people make their living, which is not necessarily measured only by monetary flows. In anthropology, how different tribes make their living is discussed, meaning how their local economy is composed. Also in the science of ecology, sometimes the term “the economy of nature” is used [70], meaning how different populations or communities (meaning several species living together) make their living regarding food and nutrients. In most modern societies, though, the major part of peoples living is mirrored by monetary flows. The point made here is that from a sustainability point of view, economy is not equal to monetary assessment, even though money is often a good estimator of the economy.

Balkema et al. [7] stated that “economic sustainability implies paying for itself, with costs not exceeding benefits.” From the reasoning provided earlier, this is a good rule of thumb. However, as seen in Figure 19.1, the monetary flow is just a subsystem supporting the wanted outcome of a long-term sustained society. This means that some subsectors of the society can have higher costs as long as the system as a whole is sustained. Not only food and water supply are such examples, but also wastewater treatment can be argued having this position, since inappropriate wastewater treatment threatens the long-term environmental supporting systems to the society.

Balkema et al. [7] also indicate that economy is larger than just the monetary flows: Economic sustainability should mainly “... focusing on increasing human well-being, through optimal allocation and distribution of scarce resources, to meet and satisfy human needs. This approach should, in principle, include all resources: also those associated with social and environmental values (e.g. in environmental economics). However, in practice most analyses include only the financial costs and benefits.” To this can be added that ecological economics is the scientific economy branch including a systems perspective in the spirit of Figure 19.1, rather than environmental economics [29].

### **19.2.3 Social Sustainability**

Society needs to be maintained, which is the overarching (anthropocentric) goal in Figure 19.1. This goal is to a large extent already covered by the environmental and economic sustainability aspects.

In this perspective, the aspect of social sustainability is sort of a residual aspect. Remaining cultural or social aspects are found here. In wastewater treatment, this is often aesthetic questions around the wastewater treatment plant: smell or fitness of the plant in the landscape. But it can also be the work environment within the wastewater treatment plant. Balkema et al. [7] chose to call this dimension “sociocultural” and highlight aspects as “... human morality ... — ... human relations, the need for people to interact, to develop themselves, and to organize their society.”

### 19.2.4 Trade-Offs and Balancing

Balkema et al. [7] and others identify that there is often a trade-off regarding the three aspects of environmental, economic, and social sustainability and that sustainability is a balancing act: “The forthcoming risks for the environment and for the economy will have to be balanced.” The message from Figure 19.1 is that we cannot claim that an activity is sustainable if it is a result from a negotiation between contradicting environmental and economic demands [81]. Sometimes we can consider such results as being on the path to sustainability, but we must always consider the probable outcome of a created environmental debt, which needs to be taken care of (or paid for) later on our path to sustainability [30,71–73].

Another aspect of the sustainability balancing is the hierarchical level in focus. Many papers regarding wastewater treatment and sustainability focus on details in the wastewater treatment plant. But in the context of Figure 19.1, the appropriate level is rather the city or the municipality level, at least for the economic sustainability aspects.

## 19.3 Systems View

---

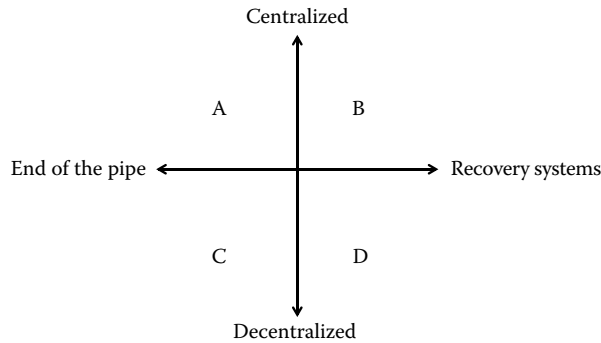
Figure 19.1 shows a systems view on wastewater treatment, but it does not show details within the society, which includes three main parts: (1) the collection system, (2) the treatment system, and (3) the delivery system back to the environmental systems. These components are needed for all types of wastewater regardless of small or large scale: domestic, industrial, and storm water.

The wastewater treatment solutions currently available can be organized in a two-dimensional diagram (Figure 19.2) with the axes of centralized versus decentralized and end-of-the-pipe versus recovery system (end-of-the-pipe is a common denominator for solving environmental problems after they have arisen with different types of filters or other capture mechanisms, in opposition to the solution where the system is designed to cause as little problems as possible). This arrangement creates four compartments where different solutions to WWTs can be placed as provided in the following text:

- A. Centralized mechanical, chemical, and biological treatment plants, or different combinations of them, where the produced sludge is delivered to a solid waste dump or stored at the treatment plant. This is the most common solution for cities around the world.
- B. Same as in A, with the exception that there is a recovery system for the rest of the products. This can be chemical phosphorus recovery from sludge, application of the sludge on agriculture land, irrigation of agriculture and forest land, or aquaculture systems. This is more common for smaller cities or villages with close connection to agricultural land. For example, Kärroman [46,47] showed that the distance to agricultural land was crucial for the sustainability assessment.
- C. Single houses or a few houses together with a separate wastewater treatment facility. Septic tanks in combination with infiltration or sand beds are of this type.
- D. Dry solutions or urine separating solutions are often of this type, where the urine is applied on nearby green areas or agricultural land, and the feces is composted or dried and burned with the ash, then used as a fertilizer.

Kärroman [45,46] found it very difficult to compare different types of wastewater treatment, since there are so many possible combinations of collection systems, treatment methods, size and age of the existing





**FIGURE 19.2** The two current main dimensions in wastewater treatment design.

facility, and the many possibilities to reuse the outflows from the facilities as, for example, biogas or irrigation. Balkema et al. [7] also pointed out the choice between centralized and decentralized WWT as the probably most important question to address. A key component for this is whether to use water or not as a transportation media to a centralized treatment plant. Balkema et al. [7] pointed out the dilution as a problem since it makes the cost higher of both money and resources as energy and material, space, expertise, and to treat pathogens and toxic compounds as heavy metals and organic substances of different types. Another key component is the mixing of different wastewater streams that makes it difficult to recirculate or recover resources from the wastewater. Günther [32] referred to this as the MIFSLA approach: “mix first, separate later.”

In light of Figure 19.1, end-of-the-pipe solutions cannot be considered sustainable in the longer run. On the other hand, they may be the only current realistic choice from other practical reasons (technical, economic, social), which is a well-known situation for the engineer.

## 19.4 Indicators and Assessment Methods

There are many factors to consider regarding sustainability, as can be seen from the earlier-provided presentation of what sustainability is. Crucial is also our ability to assess sustainability or assess our position in relation to the sustainability goals we want to achieve. Indicators of sustainability are important. In this section, we will look in the toolbox available to assess sustainability and sustainable development. It turns out that there is no strict border between indicators and assessment methods, rather a circular continuum from indicators, indicators in frameworks, assessment methods, and indicators produced by assessment methods.

### 19.4.1 Indicators of Sustainable Wastewater Treatment

Sustainability indicators have been frequently discussed in the literature (see [52]). Bakkes et al. [6] defined an indicator as a piece of information with a wider significance than its immediate meaning. Lundin [52] concludes that all indicators are part of frameworks “... based on different perceptions of Sustainable Development” and that there is “... no superior framework ...” among them.

Examples of wastewater system indicators connected to frameworks are the sustainable development records (SDRs) developed by Nilsson and Bergström [61]. SDRs are always expressed as ratios, for example, an indicator of “sewage treatment quality” is expressed as *acceptable samples per all samples*, an SDR of energy use is *number of people per energy used*, and a recycling SDR can be *phosphorus to farmland per phosphorus to sewage system*. OECD [66] developed a framework called pressure–state–response (PSR) where examples of indicators are *withdrawal of freshwater* (pressure),

*phosphorus content in river* (state), and *public expenditures on wastewater treatment* (response). The socioecological conditions or principles [5,40] mentioned in Section 19.2.1 can also be used as indicators. For example, the first principle can have indicators as *accumulation of cadmium compared to natural content in soil* or *anthropogenic flows of nitrogen compared to natural flows*; the second principle: *production of persistent substances*; the third principle: *area of wetlands* or *nonrenewable water use per total freshwater use*. There is also a fourth principle focusing on efficient and fair resource use for which indicators can be stated as *recycling of phosphorus per total input* or *percentage of population with access to potable water and sanitation*. An example of a framework formalized as a modeling tool is the ORWARE model [15,16] including 43 indicators related to chemical compounds, such as BOD, metals, nutrients, and solids. The model was developed for evaluation of the environmental impact of waste management in different geographical areas, especially focusing on the return of nutrients to arable land.

Lundin [52] pointed out an interesting development path for wastewater-related sustainable development indicators giving the example from Bossel [12] of a systems analytical framework. To overcome the risk of specific expertise bias, Bossel [12] focused on the subsystems relation and contribution to the overall system, or the goals that are desirable for the society. Bossel's [12] attempt suggested over 200 indicators, of which many were difficult to collect data for. Lundin [52], however, found that "... the approach is interesting in that it starts by addressing the question of human needs and how different sectors can contribute to Sustainable Development."

In the wastewater sector, there have been some frameworks developed for sustainability indicators. Among them, an SDR-type system called the METRON project [43] developed for European metropolitan areas. Two similar projects have been developed in Sweden, "Sustainable Urban Water Management" [38,55], and Great Britain, the SWARD project, "Sustainable Water Industry Asset Resources Decisions" [3,4,20].

## 19.4.2 Assessment Methods

There is a whole set of tools available in the so-called environmental assessment toolbox. An overview was given by, for example, Wrisberg et al. [82]. They distinguished between analytical and procedural tools, where the analytical tools produce the indicators and the procedural tools show us how to use them in a systematic and successful way. In the following, a set of tools is shortly presented.

### 19.4.2.1 Life Cycle Assessment

Life cycle assessment (LCA) is a common assessment method for wastewater treatment (see Balkema et al. [7] for an overview). The main application for LCA is to assess different environmental impacts during a product's lifetime, for which it produces an inventory of environmental aspects based on mass and energy balances. These environmental aspects are then categorized in impact categories, such as global warming potential, depletion of resources, ozone depletion, acidification, ecotoxicity, eutrophication, landscape degradation, etc. These categories can be normalized and weighted against each other for a final decision support for which choice is the best from an environmental point of view. The main advantages of LCA are that it is well described and standardized [42] and that it can be applied to a wide range of products and services including wastewater treatment. The drawbacks of LCA is that the assessment of a complete life cycle requires a large quantity of data and that it limits itself to a restricted set of technical and environmental aspects, meaning it must be complemented for a full sustainability assessment.

There are many examples where LCA have been used in the wastewater treatment sustainability assessment, for example, Benetto et al. [8], Bengtsson et al. [9], Dennison et al. [17], El-Sayed Mohamed Mahgoub et al. [18], Fuchs et al. [21], Lee and Tansel [49], Lim and Park [50], Lundin [52], Lundin and Morrison [53], Lundin et al. [54], Muñoz et al. [59], Renou et al. [69], and Zhang et al. [83].

### 19.4.2.2 Exergy Analysis

The main advantage of exergy analysis is that the whole assessment is based on a single quantifiable indicator: exergy [7]. This advantage is at the same time its limiting factor, since exergy analysis measures only the efficiency of processes but not different environmental impacts.

Hellström [34–37] used exergy analysis and concluded, for example, that urine separation systems are interesting alternatives if nitrogen removal is considered important. He also pointed out that large flows of exergy are following the handling of organic matter, thereby providing an opportunity to retain exergy through the production of methane.

### 19.4.2.3 Economic Analysis

There are two main branches of economy in the environmental context. The major one, environmental economics, suggests a single indicator, where all aspects of sustainability are expressed in monetary terms (internalization of them into the economy). The main environmental economic tools are cost-benefit analysis (CBA), life cycle costing (LCC), and total cost assessment [7]. In environmental economic theory, all kinds of costs and benefits can be included; however, in practice, these tools mostly incorporate only financial costs and benefits. This is because most social and environmental costs are difficult to quantify.

In CBA, the relevant costs and benefits are identified, those with no functioning market mechanism are estimated with various methods, and finally the costs and benefits are summed up and possible to compare with other examined alternatives. Cost-effectiveness analysis is a version of CBA where the benefits are set fixed, similar to a functional unit in LCA. For example, Birol et al. [10], Ko et al. [44], and Molinos-Senante et al. [58] evaluated WWTs with CBA.

If CBA or cost-effectiveness analysis is applied in a life cycle perspective, it is called life cycle costing (LCC) [82]. The most problematic part in LCC is the valuation of emission and other costs far out in the life cycle chain. For example, Lim et al. [51] used LCC to investigate the environmental and economic feasibility of a total wastewater treatment network system.

The second minor branch of economy, ecological economy, is a diverse approach but with a common feature of not trying to internalize all costs and benefits in monetary terms, but rather let them keep their integrity in other ecological or social measures [29]. The ecological economics approach rather “internalize” indicators for decision support from other methods as LCA, energy measures, or toxicity measures. Conversion to a single indicator exists, but is then rather different types of point systems than money.

### 19.4.2.4 Emergy Analysis

Emergy analysis (or emergy synthesis) has become a more and more popular method the last decade. It is one of the most holistic methods available relying on systems science and thermodynamics. The interest for the method comes from that it includes not only energy and material flows but also economic flows within the same theoretical framework [62,64,65]. This is a very unusual position in the sustainability assessment toolbox (shared only with the extended exergy approach [76]), and the method has met criticism from both natural scientists [33] and economists [41].

Emergy analysis has been especially popular in the ecological engineering branch of the wastewater treatment field, not surprisingly since the field has its roots in systems ecology with H.T. Odum as one of the major pioneers in the 1960s [57,63].

Emergy analysis has been applied to wastewater treatment by, for example, Almeida et al. [1], Arias and Brown [2], Björklund et al. [11], Chen et al. [14], Geber and Björklund [22], Grönlund et al. [30], Nelson [60], Siracusa and La Rosa [77], Vassallo et al. [78], Zhang et al. [84], and Zhou et al. [85].

### 19.4.2.5 Environmental Risk Assessment

Environmental risk assessment (ERA) examines the risk that threatens ecosystems and society related to substances, processes, or technology in either a quantitative or qualitative way [82].

Risk assessments vary widely in scope and application. Models are used since the task requires large leaps of simplification regarding differences in toxicological endpoints, spatial and temporal scales, complexity of exposure, and several others [82]. ERA investigations for wastewater have been performed by, for example, Escher et al. [19], Ginebreda et al. [24], Gros et al. [26], Hernando et al. [39], and Verlicchi et al. [80].

## 19.5 Sustainable Wastewater Management Strategies

---

In the previous sections, we have seen that even though there is consensus to some extent regarding the rough lines of what sustainability and sustainable development is, there is no consensus on an operational basis how to assess it. In light of this situation, it is not strange that the current sustainability discussion in the wastewater treatment sector is a little bit rough and sometimes apparently contradicting. It is not surprising either that many authors, especially from the engineering field, land on the practical solution of increasing sustainability by focusing on reducing obvious nonsustainability. In the following, some examples will be presented based on this philosophy.

Butler and Parkinson [13] focusing on urban drainage concluded that sustainability in this respect is an unattainable goal. Instead they put their focus on reducing nonsustainability, which could be carried out by separate handling of industrial waste to not contaminate the sludge fraction in order to make it possible to reuse, separate handling of storm water, and reduce inappropriate use of potable water as a carrying medium in sewers. Management strategies for this could be focused on water conservation, small-scale recycling of rainwater and graywater, storage of storm water, and local treatment of the blackwater.

Otterpohl et al. [67] suggested for urban areas: (1) separation of feces and urine with vacuum toilets and treatment with other biological waste in biogas plants, (2) decentralized aerobic treatment of graywater in constructed wetlands, and (3) infiltration of storm water to completely avoid a centralized sewage system.

Kärrman [47] and Kärrman and Jönsson [48] estimated the wastewater treatment sectors' proportional contribution to different environmental problems, in order to focus the management on the right problems. They found that for Swedish conditions, discharge of nitrogen, cadmium, mercury, and lead, as well as heavy metal flows to arable soil contributed more than 10% to the separate environmental problems. Discharge of phosphorus and copper to receiving waters, energy use, air emissions causing acidification, photooxidants, and global warming, and flows of cadmium to landfills contributed 0.1%–10%. For the Netherlands, Roeleveld et al. [74] found similar results: discharge of nitrogen and phosphorus contributed to more than 10% of the impact.

Kärrman [47] suggested a four-point strategy for sustainable wastewater management:

1. Handle nutrient-rich flows separately from other waste flows. Highest in nutrients are urine, and lowest graywater and storm water. It is beneficial from both energy and environmental perspectives to not mix these flows.
2. Recycle nutrients and use energy efficiently. The main factors to consider are the settlement density and the distance to the agricultural land. Digestion or composting is good treatment alternative before application. The graywater fraction can be infiltrated or used for irrigation.
3. Avoid contamination of wastewater flows. The pollution will end up in the food production.
4. Put unavoidable pollution on landfill. Most likely, this is ashes after sludge incineration. The largest proportion of heavy metals will be found in the nutrient-poor flows, which should be captured in the sludge of a treatment facility.

Kärrman's [47] suggested strategy fits well into the framework presented earlier in this chapter (Figure 19.1). The weak points from a long-term sustainability view are the last point of accepting temporary land-fill solutions and if the energy use for building, maintenance, and transportation can be covered by sustainable energy sources.

## 19.6 Summary and Conclusions

---

In this chapter, we have seen that there is consensus to some extent regarding the broad outlines of what sustainability and sustainable development is, with its main aspects of environmental, economic, and social concerns, together with concerns for the needs of future generations as well as our own generation. However, in our toolbox of indicators and methods for assessing sustainability and sustainable development, there is no consensus on an operational basis what tools to use. Rather the sustainability of wastewater treatment has been assessed with very different methods and indicators, giving different answers. For wastewater management strategies, this can be interpreted as that we know approximately in what rough direction we must go, but we do not have a precise roadmap. The current sustainability discussion in the wastewater treatment sector is often characterized by the practical solution of increasing sustainability by focusing on reducing obvious nonsustainability.

A systems approach has shown us that sustainability cannot be discussed and assessed only at the scale of the wastewater treatment facility. Rather the treatment of wastewater must be seen in its larger context, where it is an embedded part of the society and always connected to the environmental systems via the effluent, the sludge or ashes, or the fumes from incineration. What society delivers to the environmental systems via the wastewater treatment sector must be in a form that the environmental systems can handle and reuse, otherwise the risk of environmental problems will increase systematically. The economic and social sustainability aspects are highly interconnected, and from a systems point of view, we cannot claim that a wastewater treatment solution is sustainable if it is coming out of a negotiation between contradicting environmental and economic demands. Rather a sustainable solution must ensure that the society and its economy are compatible and possible to embed in the environmental systems of nature, agriculture, forestry, aquaculture, etc.

## References

1. Almeida CMVB, Borges D Jr., Bonilla SH, Giannetti BF. 2010. Identifying improvements in water management of bus-washing stations in Brazil. *Resources, Conservation and Recycling* 54: 821–831.
2. Arias ME, Brown MT. 2009. Feasibility of using constructed treatment wetlands for municipal wastewater treatment in the Bogotá Savannah, Colombia. *Ecological Engineering* 35: 1070–1078.
3. Ashley R, Hopkinson P. 2002. Sewer systems and performance indicators—Into the 21st century. *Urban Water* 4: 123–135.
4. Ashley R, Blackwood D, Butler D, Jowitt P. 2004. *Sustainable Water Services—A Procedural Guide*. London, U.K.: IWA Publishing. [www.iwapublishing.com](http://www.iwapublishing.com).
5. Azar C, Holmberg J, Lindgren K. 1996. Socio-ecological indicators for sustainability. *Ecological Economics* 18: 89–112.
6. Bakkes JA, van den Born GJ, Helder JC, Swart RJ, Hope CW, Parker JDE. 1994. *An Overview of Environmental Indicators: State of the Art and Perspectives*. Nairobi, Kenya: Environmental Assessment Sub-Programme; UNEP. Report no. UNEP/EATR.94-01; RIVM/402001001.
7. Balkema AJ, Preisig HA, Otterpohl R, Lambert FJD. 2002. Indicators for the sustainability assessment of wastewater treatment systems. *Urban Water* 4: 153–161.
8. Benetto E, Nguyen D, Lohmann T, Schmitt B, Schosseler P. 2009. Life cycle assessment of ecological sanitation system for small-scale wastewater treatment. *Science of the Total Environment* 407: 1506–1516.
9. Bengtsson M, Lundin M, Molander S. 1997. *Life Cycle Assessment of Wastewater Systems. Case Studies of Conventional Treatment, Urine Sorting and Liquid Composting in Three Swedish Municipalities*. Gothenburg, Sweden: Technical environmental planning. Report no. 1997:9.
10. Birol E, Koundouri P, Kountouris Y. 2010. Assessing the economic viability of alternative water resources in water-scarce regions: Combining economic valuation, cost-benefit analysis and discounting. *Ecological Economics* 69: 839–847.

11. Björklund J, Geber U, Rydberg T. 2001. Emergy analysis of municipal wastewater treatment and generation of electricity by digestion of sewage sludge. *Resources, Conservation and Recycling* 31: 293–316.
12. Bossel H. 1997. Deriving indicators of sustainable development. *Environmental Modelling and Assessment* 1: 193–218.
13. Butler D, Parkinson J. 1997. Towards sustainable urban drainage. *Water Science and Technology* 35: 53–63.
14. Chen B, Chen ZM, Zhou Y, Zhou JB, Chen GQ. 2009. Emergy as embodied energy based assessment for local sustainability of a constructed wetland in Beijing. *Communications in Nonlinear Science and Numerical Simulation* 14: 622–635.
15. Dalemo M, Sonesson U, Jönsson H, Björklund A. 1998. Effects of including nitrogen emissions from soil in environmental systems analysis of waste management strategies. *Resources, Conservation and Recycling* 24: 363–381.
16. Dalemo M, Sonesson U, Björklund A, Mingarini K, Frostell B, Jönsson H, Nybrant T, Sundqvist JO, Thyselius L. 1997. ORWARE—A simulation model for organic waste handling systems. Part 1: Model description. *Resources, Conservation and Recycling* 21: 17–37.
17. Dennison FJ, Azapagic A, Clift R, Colbourn JS. 1998. Assessing management options for wastewater treatment works in the context of life cycle assessment. *Water Science and Technology* 38: 23–30.
18. El-Sayed Mohamed Mahgoub M, van der Steen NP, Abu-Zeid K, Vairavamoorthy K. 2010. Towards sustainability in urban water: A life cycle analysis of the urban water system of Alexandria City, Egypt. *Journal of Cleaner Production* 18: 1100–1106.
19. Escher BI, Baumgartner R, Koller M, Treyer K, Lienert J, McArdell CS. 2011. Environmental toxicology and risk assessment of pharmaceuticals from hospital wastewater. *Water Research* 45: 75–92.
20. Foxon TJ, McKelkeny G, Gilmour D, Oltean-Dumbrava C, Souter N, Ashley R, Butler D, Pearson P, Jowitt P, Moir J. 2002. Sustainability criteria for decision support in the UK water industry. *Journal of Environmental Planning and Management* 45: 285–301.
21. Fuchs VJ, Mihelcic JR, Gierke JS. 2011. Life cycle assessment of vertical and horizontal flow constructed wetlands for wastewater treatment considering nitrogen and carbon greenhouse gas emissions. *Water Research* 45: 2073–2081.
22. Geber U, Björklund J. 2002. The relationship between ecosystem services and purchased input in Swedish wastewater treatment systems—A case study. *Ecological Engineering* 19: 97–117.
23. Giddings B, Hopwood B, O'Brien G. 2002. Environment, economy and society: Fitting them together into sustainable development. *Sustainable Development* 10: 187–196.
24. Ginebreda A, Muñoz I, de Alda ML, Brix R, López-Doval J, Barceló D. 2010. Environmental risk assessment of pharmaceuticals in rivers: Relationships between hazard indexes and aquatic macroinvertebrate diversity indexes in the Llobregat River (NE Spain). *Environment International* 36: 153–162.
25. Goodland R. 1995. The concept of environmental sustainability. *Annual Review of Ecology and Systematics* 26: 1–24.
26. Gros M, Petrović M, Ginebreda A, Barceló D. 2010. Removal of pharmaceuticals during wastewater treatment and environmental risk assessment using hazard indexes. *Environment International* 36: 15–26.
27. Grönlund E. 2004. Microalgae at wastewater pond treatment in cold climate—An ecological engineering approach. Doctoral thesis 2004:61. Luleå University of Technology, Luleå, Sweden.
28. Grönlund E, Carlman I. 2013. A systems ecology view on wastewater treatment sustainability. Department of Engineering and Sustainable Development, Mid Sweden University, Östersund, Sweden.
29. Grönlund E, Hedin D, Eriksson P-O. 2009. Is emergy best suited for ecological economics, environmental economics, or with an economic context of its own? pp. 41–48 In: Brown MT, ed. *Emergy Synthesis 5: Theory and Applications of the Emergy Methodology. Proceedings from the 5th Biennial Emergy Research Conference*, Gainesville, Florida, January, 2008. Gainesville, FA: The Center for Environmental Policy, University of Florida.

30. Grönlund E, Klang A, Falk S, Hanaeus J. 2004. Sustainability of wastewater treatment with micro-algae in cold climate, evaluated with emergy and socio-ecological principles. *Ecological Engineering* 22: 155–174.
31. Günther F. 1998. Phosphorus management and societal structure. Hampered effluent accumulation process (HEAP) in different areas of the Swedish society. *Vatten* 554: 199–208.
32. Günther F. 2000. Wastewater treatment by greywater separation: Outline for a biologically based greywater purification plant in Sweden. *Ecological Engineering* 15: 139–146.
33. Hau JL, Bakshi BR. 2004. Promise and problems of emergy analysis. *Ecological Modelling* 178: 215–225.
34. Hellström D. 1997. An exergy analysis for a wastewater treatment plant—An estimation of the consumption of physical resources. *Water Environment Research* 69: 44–51.
35. Hellström D. 1998. Nutrient management in sewerage systems: Investigations of components and exergy analysis. Doctoral thesis 1998:02. Luleå University of Technology, Luleå, Sweden.
36. Hellström D. 1999. Exergy analysis: A comparison of source separation systems and conventional treatment systems. *Water Environment Research* 71: 1354–1363.
37. Hellström D. 2003. Exergy analysis of nutrient recovery process. *Water Science and Technology* 48: 27–36.
38. Hellström D, Johansson E, Grennberg K. 1999. Storage of human urine: Acidification as a method to inhibit decomposition of urea. *Ecological Engineering* 12: 253–269.
39. Hernando MD, Mezcua M, Fernández-Alba AR, Barceló D. 2006. Environmental risk assessment of pharmaceutical residues in wastewater effluents, surface waters and sediments. *Talanta* 69: 334–342.
40. Holmberg J, Robèrt K-H, Eriksson K-E. 1996. Socio-ecological principles for a sustainable society. In: Costanza R, Olman S, Martinez-Alier J, eds. *Getting Down to Earth. Practical Applications of Ecological Economics*. Washington, DC: International Society of Ecological Economics, Island Press.
41. Hornborg A. 1998. Towards an ecological theory of unequal exchange: Articulating world system theory and ecological economics. *Ecological Economics* 25: 127–136.
42. ISO 14040. 2006. *Environmental Management—Life Cycle Assessment—Principles and Framework (ISO 14040:2006)*. Geneva, Switzerland: International Organization for Standardization.
43. Kallis G, Coccossis H. 2000. *Metropolitan Areas and Sustainable Use of Water—Indicators for Urban Water Use*. Athens, Greece: Commission of the European Communities, Environment and Climate RTD Programme.
44. Ko J-Y, Day JW, Lane RR, Day JN. 2004. A comparative evaluation of money-based and energy-based cost-benefit analyses of tertiary municipal wastewater treatment using forested wetlands vs. sand filtration in Louisiana. *Ecological Economics* 49: 331–347.
45. Kärrman E. 1996. Evaluation of wastewater systems, methods and applications. pp. 103–116 In: Thofelt L, Englund A, eds. *Ecotechnics for a Sustainable Society*. Mid Sweden University Östersund, Sweden.
46. Kärrman E. 2000. *Environmental Systems Analysis of Wastewater Management*. Gothenburg, Sweden: Chalmers University of Technology.
47. Kärrman E. 2001. Strategies towards sustainable wastewater management. *Urban Water* 3: 63–72.
48. Kärrman E, Jönsson H. 2000. Normalising impacts in an environmental systems analysis of wastewater management. pp. 276–284 In: *Book 5 Water Resources and Waste Management, Conference Pre-Prints of the 1st World Water Congress of the International Water Association (IWA)*, July 3–7, 2000, Paris, France.
49. Lee M, Tansel B. 2012. Life cycle based analysis of demands and emissions for residential water-using appliances. *Journal of Environmental Management* 101: 75–81.
50. Lim S-R, Park JM. 2009. Environmental impact minimization of a total wastewater treatment network system from a life cycle perspective. *Journal of Environmental Management* 90: 1454–1462.
51. Lim S-R, Park D, Park JM. 2008. Environmental and economic feasibility study of a total wastewater treatment network system. *Journal of Environmental Management* 88: 564–575.

52. Lundin M. 2003. *Indicators for Measuring the Sustainability of Urban Water Systems—A Life Cycle Approach*. Gothenburg, Sweden: Chalmers University of Technology.
53. Lundin M, Morrison GM. 2002. A life cycle assessment based procedure for development of environmental sustainability indicators for urban water systems. *Urban Water* 4: 145–152.
54. Lundin M, Molander S, Morrison GM. 1999. A set of indicators for the assessment of temporal variations in the sustainability of sanitary systems. *Water Science and Technology* 39: 235–242.
55. Malmqvist P-A, Heinicke G, Korrman E, Stenstrom T, Svensson G. 2006. *Strategic Planning of Sustainable Urban Water Management*. London, U.K.: IWA Publishing. www.iwapublishing.com.
56. MEA. 2005. *Ecosystems and Human Well-Being: Synthesis*. Washington, DC: Millennium Ecosystem Assessment (MEA), Island Press.
57. Mitsch WJ, Jørgensen SE. 1989. *Ecological Engineering: An Introduction to Ecotechnology*. New York: Wiley.
58. Molinos-Senante M, Hernández-Sancho F, Sala-Garrido R. 2010. Economic feasibility study for wastewater treatment: A cost–benefit analysis. *Science of the Total Environment* 408: 4396–4402.
59. Muñoz I, José Gómez M, Molina-Díaz A, Huijbregts MAJ, Fernández-Alba AR, García-Calvo E. 2008. Ranking potential impacts of priority and emerging pollutants in urban wastewater through life cycle impact assessment. *Chemosphere* 74: 37–44.
60. Nelson M. 1998. Limestone wetland mesocosm for treating saline domestic wastewater in Coastal Yucatan, Mexico. Gainesville, FA: University of Florida.
61. Nilsson J, Bergström S. 1995. Indicators for the assessment of ecological and economic consequences of municipal policies for resource use. *Ecological Economics* 14: 175–184.
62. Odum HT. 1983. *Systems Ecology: An Introduction*. New York: John Wiley & Sons.
63. Odum HT. 1989. Ecological engineering and self-organization. In: Mitsch WJ, Jørgensen SE, eds. *Ecological Engineering: An Introduction to Ecotechnology*. New York: Wiley.
64. Odum HT. 1994. *Ecological and General Systems—An Introduction to Systems Ecology*. Niwot, CO: University Press of Colorado.
65. Odum HT. 1996. *Environmental Accounting. Emergy and Environmental Decision Making*. New York: John Wiley & Sons, Inc.
66. OECD. 1998. *Towards Sustainable Development—Environmental Indicators*. Paris, France: OEDC.
67. Otterpohl R, Grottker M, Lange J. 1997. Sustainable water and waste management in urban areas. *Water Science and Technology* 35: 121–133.
68. Palme U. 2007. *The Role of Indicators in Developing Sustainable Urban Water Systems*. Gothenburg, Sweden: Environmental Systems Analysis, Department of Energy and Environment, Chalmers University of Technology.
69. Renou S, Thomas JS, Aoustin E, Pons MN. 2008. Influence of impact assessment methods in wastewater treatment LCA. *Journal of Cleaner Production* 16: 1098–1105.
70. Ricklefs RE. 2008. *The Economy of Nature*. New York: Freeman.
71. Robèrt K-H. 2000. Tools and concepts for sustainable development, how do they relate to a general framework for sustainable development, and to each other? *Journal of Cleaner Production* 8: 243–254.
72. Robèrt K-H, Daly HE, Hawken P, Holmberg J. 1997. A compass for sustainable development. *International Journal of Sustainable Development and World Ecology* 4: 79–92.
73. Robèrt K-H, Schmidt-Bleek B, Aloisi de Lardere J, Basile G, Jansen JL, Kuehr R, Price Thomas P, Suzuki M, Hawken P, Wackernagel M. 2002. Strategic sustainable development—Selection, design and synergies of applied tools. *Journal of Cleaner Production* 10: 197–214.
74. Roeleveld PJ, Klapwijk A, Eggels PG, Rulkens WH, van Starckenburg W. 1997. Sustainability of municipal wastewater treatment. *Water Science and Technology* 35: 221–228.
75. Rogers PP, Jalal KF, Boyd JA. 2008. *An Introduction to Sustainable Development*. London, U.K.: Earthscan.
76. Sciubba E. 2003. Extended exergy accounting applied to energy recovery from waste: The concept of total recycling. *Energy* 28: 1315–1334.



77. Siracusa G, La Rosa AD. 2006. Design of a constructed wetland for wastewater treatment in a Sicilian town and environmental evaluation using the emergy analysis. *Ecological Modelling* 197: 490–497.
78. Vassallo P, Paoli C, Fabiano M. 2009. Emergy required for the complete treatment of municipal wastewater. *Ecological Engineering* 35: 687–694.
79. WCED. 1987. *Our Common Future*. Nairobi, Kenya: World Commission on Environment and Development (WCED), United Nations Environment Programme.
80. Verlicchi P, Al Aukidy M, Galletti A, Petrovic M, Barceló D. 2012. Hospital effluent: Investigation of the concentrations and distribution of pharmaceuticals and environmental risk assessment. *Science of the Total Environment* 430: 109–118.
81. Westerlund S. 2000. Sustainable balancing. In: Vihervuori P, Kuusiniemi K, Salila J, eds. *Erkki J. Hollo 1940-28/11-2000: Juhlajulkaisu*. Helsinki, Finland: Lakimiesliiton kustannus.
82. Wrisberg N, Udo de Haes HA, Triebswetter U, Eder P, Clift R, eds. 2002. *Analytical Tools for Environmental Design and Management in a Systems Perspective—The Combined Use of Analytical Tools*. Dordrecht, the Netherlands: Kluwer Academic Publishers.
83. Zhang QH, Wang XC, Xiong JQ, Chen R, Cao B. 2010a. Application of life cycle assessment for an evaluation of wastewater treatment and reuse project—Case study of Xi'an, China. *Bioresource Technology* 101: 1421–1425.
84. Zhang X-H, Deng S, Wu J, Jiang W. 2010b. A sustainability analysis of a municipal sewage treatment ecosystem based on emergy. *Ecological Engineering* 36: 685–696.
85. Zhou JB, Jiang MM, Chen B, Chen GQ. 2009. Emergy evaluations for constructed wetland and conventional wastewater treatments. *Communications in Nonlinear Science and Numerical Simulation* 14: 1781–1789.

# 20

## Tourism and River Environment

---

20.1	Introduction .....	402
20.2	Water Viability and the Tourism Industry .....	403
20.3	River Environmental Hydrology.....	404
20.4	River Ecology.....	404
20.5	River System and the Tourism Perspective.....	404
20.6	Link between River and Tourism.....	405
20.7	Ortkand River Tourism Region in Iran: A Case Study .....	406
	Characteristics of Ortkand River Basin • River Tourism Attractions	
20.8	Developing Tourism Potential in Ortkand River .....	412
	Enhancement of Facilities and Services • Facilitating Transfer between Tourism Zones	
20.9	Summary and Conclusions .....	418
	Acknowledgments.....	419
	References.....	419

**Akram Deiminiat**  
*KPM Consulting Engineers*

**Hassan Shojaee Siuki**  
*KPM Consulting  
Engineering Co.*

**Saeid Eslamian**  
*Isfahan University  
of Technology*

### AUTHORS

**Akram Deiminiat** earned her bachelor's degree in water engineering from Birjand University (Iran). She completed her studies on water structure engineering, with a master's degree in 2007 from Urmia University (Iran), following which she joined Kavosh Pay Mashhad (KPM) Consulting Engineers. Her work experience as head of the River Engineering Department spans across 6 years. She is also experienced in the field of international affairs and has published nearly 30 papers in national and international journals. She is also a researcher and active member of the Kavosh Water and Soil Management Research Center, with four research publications.

**Hassan Shojaee Siuki** received his PhD in geology science from the University of Varsho (Poland). His thesis was on geotourism and geoparks in Iran. He is the director manager of KPM Consulting Engineers Company, with about 25 years experience in the field of engineering. He was an assistant professor in Ferdowsi University (Mashhad) for several years. He is currently also the president of Kavosh Water and Soil Management Research. He has more than 50 papers published mainly in conferences and journals. He was recently the representative of FCIC in Iran.

**Saeid Eslamian** received his PhD from the University of New South Wales, Australia, along with Professor David Pilgrim. He was a visiting professor in Princeton University, United States, and ETH Zurich, Switzerland. Currently, he is an associate professor of hydrology in the Isfahan University of Technology. He is the founder and chief editor of the *Journal of Flood Engineering* and the *International Journal of Hydrology Science and Technology*. He has more than 200 papers published mainly on statistical and environmental hydrology, and hydrometeorology.

## 20.1 Introduction

---

There are different aspects of tourism and its relation with natural sources such as ecotourism, geotourism, and the recently defined river-based tourism, which defines the different uses of rivers by tourists.

Rivers have had an important place in human history since we began our lives and expanded it by civilization. Rivers have played a critical role in human survival, modernization, and, more recently, economic development. In ancient times, rivers facilitated long- and short-distance travel, trade, and hunting. Rivers allowed the great civilizations of the past to flourish. In the modern world, cities and their cultural landscapes can be classified according to the fabric of river life to create unique urban environments [1].

On one hand, rivers allow deserts to bloom with agricultural products and the creation of recreational opportunities; on the other hand, rivers are the major spatial elements of a landscape and constitute a significant tourism resource. Rivers also serve as political boundaries for municipal, regional, state, and international entities. They also make use of the many transportation innovations throughout the world today. As is obvious, the use of rivers by people is increasing from different points of view. However, using rather than abusing rivers and wasting water is important, and will become an increasingly important issue in the future.

Natural resources and rivers are very sensitive toward the way they are used. Sometimes human interventions have an adverse effect on rivers and change the natural behavior of a river as they are considerably stressed by irrigation, catchment clearing, pollution, dam construction, tourist consumption, and other forms of human intervention. Therefore, managing the way humans use natural resources such as rivers is very important. Also, identifying and surveying the above factors is very essential to improve river systems and develop tourism activities. Sometimes the widespread consumption of river water causes a gradual decrease in resources, which in turn creates many environmental problems. From the above introduction, it is obvious that rivers have a large effect on human life. Yet rivers assign themselves to many of the ecosystems. In addition to providing water to urban growth, transport of goods, and agriculture, many other rivers provide tourism aspects such as waterfalls, water parks, and scenery. In cities, a lots of hotels are located beside rivers as riverside hotels in which people do shopping, swimming, playing, and recreational activities. In natural areas, rivers offer the opportunity for viewing the beautiful scenery, boating, fishing, surfing, and other forms of recreational activities [11].

Besides the above mentioned potentials of rivers in river tourism, they have a number of significant direct and indirect effects on the tourism industry. Direct effects of rivers including direct uses of river's places, its scenery, transporting, agriculture, boating, fishing, and supplying for agricultural and drinking water. Indirect effects include flood supply, support for manufacturing and industrial activities, use in hydroelectricity production, and disposal of human and industrial waste. Therefore, rivers have complex ecosystems, which have an effect on human activities, and, as a paradox, are noticeably influenced by many human activities, including tourist and recreation.

Paying attention to the different uses of rivers, they can be classified based on the type of use. A distinction has to be made between tourism beside a river and tourism on the river. Tourism beside a river uses the riverside setting as a tourist resource. This kind of use is related to rivers indirectly. Humans only use rivers' aspects such as physical morphology, beautiful landscape, interesting history, trade, etc. In this type of use, humans indirectly affect the river situation and also have the most economic effect on the river. On the river, which has the major activity the activities include cruising, sailing and white rafting, surfing, transportation, drinking, domestic water, etc. In this kind of use, people have a direct relation with the river water. River and humans are always in interaction with each other. River water is necessary to grow many agricultural products and generate electricity, which is needed to sustain tourism in all regions of the world.

Some forms of river tourism, such as river cruising, are found only in specific locations, for instance, Mississippi River, Ganges River in India, the Sugar Island of the Sundarbans; white water rafting along one long river stretch starts at the highest point where river rafting is possible in the world. The best places for water rafting are mountainous regions, which offer other associated forms of adventure tourism. In addition, some river systems are rich in natural heritage, especially bird migration, penguins, and various beautiful natural landscapes.

In addition, one can also see rivers that do not have any water and have run dry. If water is not available in its natural state, artificial public forms, including beautiful scenery and landscaping, which include artificial waterfront parks, national parks, nature preserves, fountains, ponds, swimming pools, and artificial waterfalls, are provided to appeal to tourists. Sometimes the potential of rivers is greater than ever, which can be developed by changing the scenery, landscape, facilities, etc. Developing the potential of rivers for river tourism depends on an extensive literature review of different factors that have some influence on them. Some of these factors, such as hydrological, spatial, and biological factors; recreational use; environmental concerns; safe location for stay; and management, which include irrigation, land use, transportation, industrial use, and tourism uses of rivers, appear to overlap or have little relevance to tourism [4].

## 20.2 Water Viability and the Tourism Industry

---

As there is an attempt to meet the water use needs of a growing population and the need for tourism activities, issues of water quality and quantity will gain increasing significance in the years to come. Droughts, for example, are natural phenomena that can cause water shortage. But human activities can cause water availability problems as well.

Researchers have studied tourism's influence on the environment from different perspectives, for example, biological/ecological, behavioral, planning and design, and political. This chapter looks at the sustainability of cycling tourism based on cycling tourists' impact on nature and resource consumption, as well as their assessment of the environmental awareness level of the destination. It is important to note, however, that to achieve complete evaluation of cycling tourism's environmental sustainability, it is necessary to also study other consequences of cycling tourism. The effect of tourism on the environment can be criticized from many points of view such as biological/ecological, behavioral, planning, design, and political [10].

As the demand for water has increased in some countries, because of increased urbanization, industrialization, and agriculture, and because of the need to reduce the seasonal cycles of abundances and deficiencies, many water-capture schemes using dams have been implemented throughout the world. While increasing the availability of fresh water for human use, dams have had a significant impact on river ecosystems, ocean runoff, evaporation, and sediment flow. Driven by the hydrological cycle, the water available for human consumption recycles rapidly, usually through annual cycles of rainfall driven by the seasons. In recent decades, a mismatch has emerged between the total demand for fresh water and its availability. The demand includes the following:

- Farming, including irrigation, and animal watering
- Domestic use
- Public use such as for gardens and recreation
- Navigation (e.g., canals and locks)
- Environmental use (maintenance of river- and lake-related ecosystems)
- Hydroelectricity generation
- Flood mitigation

In the past, the availability of water for recreational purposes created few conflicts with other uses. However, with the industrialization of water supply as an input for factory production commencing with the industrial revolution, the easy coexistence between recreation and other uses such as food

production, transportation, and industrial use has changed, and today recreational users of water must compete with other consumers. In many jurisdictions, this is unlikely to cause problems, but as the demand for water grows and the cost of water supply for human and industrial use increases, this may change. In sensitive riverine ecosystems, the growing popularity of nature-based tourism may create problems with sustainability and capping visitation may become necessary [12].

### **20.3 River Environmental Hydrology**

---

River environmental hydrology is described as a system called the river system. The river system includes different aspects of rivers' characteristics such as environmental hydrology, hydraulic, geology, and morphology. From the environmental hydrology perspective, river basins are characterized by size, shape, geology, topography, climate, and ecosystem, which define the hydrological characteristics of a river. There is a reality that the environmental hydrology of rivers can affect tourism and associated potentials.

Generally, the above attributes constitute a river system. These govern all the basic characteristics of a river such as shape, slope, and flow. Furthermore, these include geology, climate, and water volume. Hydrology is a water treatment in a river basin and makes it as a water resource of a basin. Clearly, hydrology is the key driving force for river systems. Human intervention, through land clearing for agriculture or through construction of dams, or even as a tourist, can directly affect river hydrology and requires careful management [7].

### **20.4 River Ecology**

---

Ecology in rivers depends on the aquatic and terrestrial systems, which are affected by the downstream river situation, for transferring nutrients and energy. Other items, which affect river ecology, are the position of the basin, its shape, area, slope, river flow, and capacity of sediment transportation. This behavior of river constitutes the river's ecology.

There are different aspects of ecology in a river system. Also, there are different kinds of river flow. Certainly when there is fresh water at high velocity, river ecology is better than when there is slow-moving water such as in lakes and ponds, or in the worst condition, wetlands in which the soil remains saturated or inundated during some parts of a year. Each situation forms a different ecosystem. Turbulent and fresh water at high velocity have more oxygen and are able to form a complex ecosystem. Slower moving water often lacks oxygen and creates less biodiversity in an ecosystem. One of the key factors in maintaining an ecosystem and facilitating the deposition of sediment and nutrient, which support plant communities in river flood plains, is flooding. Human intervention affects river ecosystems by reducing river flow, water quality, sediments, and nutrients. Therefore, the level of withdrawal has a direct correlation with the extent of impact on the downstream ecosystem, where reducing these communities sometimes has adverse effects on the ecosystem and sometimes has a destructive effect.

The various components of the environment of a river system include the river itself, the right and left banks of the river, and the flood plains. Flood plains are also subject to other nonriver bodies. Actually the primary, secondary, and tertiary components relate with each other to build a river system and are affected by each other. Development of the parts of a river for agriculture or other uses such as irrigation will have a direct effect on secondary variables such as flow regime, channel forms, and land use. River-based ecology is also of especial interest for ecotourists and geotourists. In different seasons, flooded wetlands along many rivers present beautiful landscapes, and rare flora and fauna [6].

### **20.5 River System and the Tourism Perspective**

---

As mentioned in the previous section, human interventions affect rivers and the environment, and sometimes cause problems. Sometimes they gradually reduce water resources. Managing rivers is an important factor in creating opportunities for tourists to use water resources sufficiently, especially in

the developing tourism industry. Five main forms of human intervention are setting up canals, irrigation network, construction dams, flood control structures, drainage, and transportation. Certainly, since changes in one part of a river system will cause changes in other parts, effective river management is difficult and not all changes are predictable. In the past, the situation was different than what has been in recent years. There was a special concern for the water managers to provide human welfare through intervention in river systems via processes such as dams; nowadays, river managers often have difficulty adopting the obvious perspective from river systems, although where there is use of rivers by tourists, the ability of the river to being used by tourists is very crucial for the tourism industry [2].

Generally, from the point of view of a river manager and the tourism industry, the state of the different issues of a river system, such as economic issues (agriculture, navigation, recreation, and urban use), ecosystem issues (habitats, swamps, flora, and fauna), ecosystem services entitled as the health of the regional economy and the health of the environment, is very important in order to provide facilities, security, and a healthy environment for tourists, and to develop the tourism industry beside rivers. Furthermore, the need for a typology for river systems is obvious through the increasing use of rivers as tourism resources either as an attraction, a transport corridor, or a source of water. Therefore, sustainability of river systems as a tourism resource is important, but sufficient research on this issue is not available. As it is obvious, the direct and indirect roles of rivers in tourism include [9] the following:

- As locations for activities and places of tourist interest
- As a transportation medium, including cargo barges and river cruising
- As a medium providing recreational activities, including water sport, fishing, and biking
- As a source of drinking water

Indirect roles include the following:

- As a food source, either directly through supply of fish and other food sources or indirectly through the agriculture that the river supports
- As a support for manufacturing activities
- For disposal of human and industrial waste
- For provision of hydroelectricity

As a case study for developing tourism industry beside rivers, there are several case studies on rivers, which show a zoning scheme that divides area into preservation, economic, recreation, and cultural zones and a range of factors that affect tourism potential of the river.

As was mentioned earlier, river management is very important in order to provide a healthy and sufficient resource especially where there is rapid population growth. Due to the increasing use of water for industrial, agricultural, and human purposes, residential effluent and industrial waste have put enormous pressure on rivers. Therefore, attention toward sustainability of a river system is important as is the need for tourism to compete with other river users.

## 20.6 Link between River and Tourism

The developed typology of a river system is based on different factors, which affect tourism over a long period of time. It shows itself with various perspectives. Table 20.1 illustrates factors affecting rivers, which have direct or indirect relevance with tourism. River systems support extensive tourism, but also exhibit considerable differences in many of the factors outlined in Table 20.1. Some of these factors may have an effect on the different sectors of a river and have consequences on riverine tourism [3].

To sum up, there are several direct relationships between tourism and rivers. The first relationship is the physical morphology, fluvial systems, and the different forms of rivers, which present beautiful landscapes and a wealth of attractions. These appear to be unique venues in some parts of the world. Sometimes rivers present the beautiful and interesting history of a place and attract a large number of tourists for recreational activities and viewing its cultural heritage from far away.

**TABLE 20.1** Factors That Affect Tourist Use of River Systems

Factors	
Biological factors	Recreational use
Political factors, including borders	Transportation use
Management	Environmental concerns
Land use adjacent to the river	Industrial use of the river

The second relationship is direct use of rivers, which is oriented toward the environmental situation, such as for drinking and domestic water, recreational activities (golf course, as a pool, surfing), and special uses in arid regions where one attempts to get greater benefits from the river flow for tourism uses. They give their own water to tourism. The third relationship is rivers as transportation corridors. Large navigable rivers in countries especially border rivers provide the situation for transporting materials and goods between countries or even between continents. There are large ships, which are specially built for transferring oil. So, some rivers even have an economic role. Also, some ships carry travelers between islands, continents, etc. In most developed countries, rivers play an additional role in commerce and trade compared with transporting tourists on sightseeing cruises.

As it is obvious, river systems with complex ecosystems have an important role in supplying human uses from different perspectives, including tourism, recreation, and human activities. Use over a long period of time and continuous activity has an adverse effect on rivers. So use of river systems from different points of view must be mentioned and managed by authorities in order to preserve the natural and cultural wealth of this ecosystem for the present and future generations. As the effect of tourism on the rivers is difference on nature and water resources, this issue has to be considered by managers. The majority of river tourism destinations are located beside rivers and they are used only in transferring, cruising, rafting, and sailing which have a very weak effect on the rivers from the viewpoint of reducing the rivers' resources [8].

To sum up, rivers are one of the most significant elements of tourism destinations and recreation in addition to their commercial uses. Rivers constitute locations for travel, cultural heritage, recreational activities, and sports, have other uses for the local residents. Tourists choose their destinations by considering their demands from a river. Consequently, managers must provide a descriptive concept map of the main aspects of the potential of river tourism in rivers. It facilitates choosing selected rivers and can be applied to increasing their potential in river tourism as destinations.

## 20.7 Ortkand River Tourism Region in Iran: A Case Study

There is a unique and beautiful fall alongside Kalat town, which has a longitude of  $59^{\circ}39'6.39''$ – $59^{\circ}50'31.49''$  and latitude of  $36^{\circ}46'11.63''$ – $36^{\circ}52'35.24''$ . The Ortkand resort area is one of the areas of the Kalat resort and an attraction for foreign and Iranian tourists due to its beautiful falls, mountains, water caves, and the historical and ancient places located in Kalat and the roads around it. This community is located 110 km from Mashhad on the Mashhad–Kalat route and is located in Ghaleno village next to Zavin area, which is 18 km from the main road. The road is divided into two parts on the way to Ortkand fall: the lower part leads to a cave of 15 km length. Formations can sometimes be observed in this cave and damages can be seen in some of the older parts of the cave. Thus, the reliefs of Ortkand are very attractive for climbing. Figure 20.1 shows the Ortkand River basin located in Iran.

### 20.7.1 Characteristics of Ortkand River Basin

The characteristics of a region can be defined by its physiographic, hydrological, geological features, and environmental aspects. The regional characteristics of the Ortkand restored area are specific due to

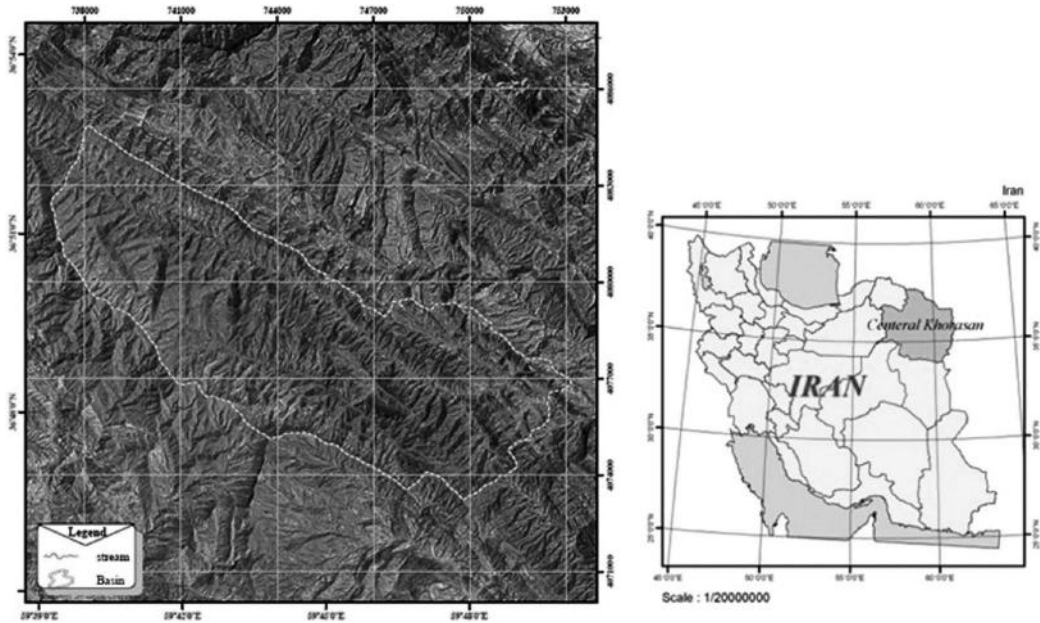


FIGURE 20.1 The situation of Ortkand River basin in the Razavi Khorasan province, Iran.

its geographic location, surrounding mountains, and weather conditions. Ortkand River has an area of 79 km<sup>2</sup> and is 45.5 km in perimeter. The region has an average temperature of 10°C and yearly average rainfall of 366 mm. Average runoff in this basin is about 4 million cubic meters.

Ortkand region has sedimentations of Mozduran formation such as oolitic limestone and shale dating back to the last Jurassic period, and Shurijeh dating back to the Upper Cretaceous period, which include red and brown shale gypsum and sandstone; Tiregan formation with the pre-Cretaceous including oolitic lime stone and minor marl. Tiregan formation in the form of conformity and inter finger is located on top of the Shurijeh formation; and, the cover is in the form of gradual and conformity with progressive condition on the Shurijeh sedimentation.

### 20.7.2 River Tourism Attractions

The main feature of river tourism is water, which is one of the most popular natural settings for rest and recreation. Even short periods near water are claimed to have a beneficial soothing effect on most people. This observation explains why tourist destinations promote water features in various forms of existing rivers, lakes, waterfalls, hot springs, and beaches. If water is not available in a natural state, artificial landscapes, including fountains, ponds, swimming pools, and artificial waterfalls, are created to appeal to the tourist. The potential attractiveness of rivers is even greater, which is a consequence of the changing scenario, and the potential for natural and urban settings along riverbanks. But this is not the only attraction of rivers. Rivers are equally as important for their religious value. Rivers and canals are valued for their relaxing way of supporting travel and associated riverbank activities, and for the exceptional scenery and culture they traverse. Sometimes river tourists have the opportunity to interact with local communities, shop, engage in sightseeing, and take up any activity that might help them to enjoy on holidays.

In order to attract tourism into a region, existing whole aspects, which are further introduced, are necessary. In areas, which do not have enough potential for tourism, these can be enhanced to increase the potential tourism attractions. Some of the most significant tourist attractions along the banks of the



Ortkand River are the natural landscapes, geological aspects, topography, historical heritage, and relic places located around/in the Kalat Township. These tourism attractions are categorized into several aspects, which have been detailed in the following.

### 20.7.2.1 Outdoor Recreational Activities

There are different items of natural heritage, especially aquaculture, various natural landscapes, fresh weather, green forests beside the river, and the mountains alongside Ortkand River. In addition, there are locations such as bower, which are used as markets by natives for selling handicraft and native bread. The area is poor in other recreational activities such as waterfall parks, natural preserves, and natural trails. Figures 20.2 through 20.5 show the natural attractions in the Ortkand River.

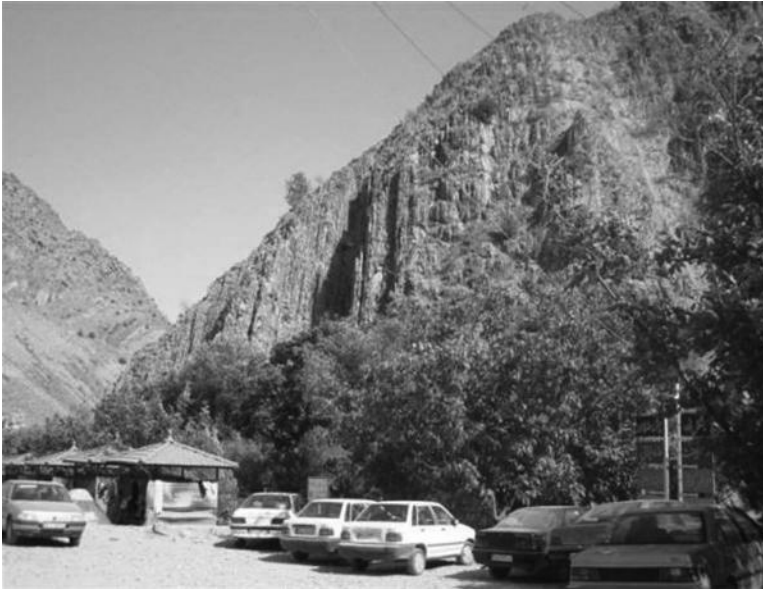
### 20.7.2.2 Geological Landscapes

The geological and geomorphological attractions in the Kalat region can be categorized into falls, water caves, geysers (Laguna), natural castles originated from synclinals located in Kopeh Dagh, and a vertical wall made of lime stones, which has surrounded the city like a high fence. The Ortkand fall, water caves, and geysers are located in the Ortkand restored area through these geological aspects. The Kalat area, which is a natural castle originated from synclinals located in Kopeh Dagh, has other attractions. In this area, limestones are present as vertical walls and blades with sharp crest lines. This is the way in which this phenomenon surrounds this beautiful city like a great high fence along with the King Nader Sun Castle. In other words and in scientific terms, the Kalat fence is a multimoving synclinal and because of revering erosions at the middle of this synclinal, its bottom is very deep and is shaped like a natural castle. Kalat formation with the lime substances has formed a beautiful high-elevation fence. The only way of entry and exit from this castle is through the river path, which has cut this great wall and has made it possible to enter this community.

The average height of the Ortkand fall from the sea level is 1400 m and average rain is recorded at 247 mm a year. From the geomorphological point of view, this fall resembles Gharesu falls and alternations of hard carbonate formation, such as Tiregan, Mozduran, and Shurijeh detrital, along



**FIGURE 20.2** The beautiful natural scenery in Ortkand.



**FIGURE 20.3** Parking located in entry of Ort kand.



**FIGURE 20.4** The Nur Forest in the beginning part of Ort kand.

the length of the Kopeh Dagh Mountain are the main causes for such a natural phenomenon. In fact, one can say that this fall is like a karst fall, which has been formed by karstification by considering the folding of the above mentioned formations and the type of lithology, and the past power flow in the form of Antes, which slipped these mountains and created a lot of gaps. Figures 20.6 through 20.9 show the most important geological aspects of the Kalat restored area and the natural aspects around it as a destination for tourism.



**FIGURE 20.5** The beautiful scenery in Ortland.



**FIGURE 20.6** Natural lane and lime walls among vertical layers of shale and lime.



FIGURE 20.7 Lime shapes in cave erosions.



FIGURE 20.8 Collapsed old part of a rock.

### 20.7.2.3 Historical Heritage and Ancient Places

In addition to geological attractions, the city of Kalat is unique in that it has many tourism places together with a beautiful natural setting, which attracts many geotourists from around the world. It is more common for tourists to visit places where history actually occurred rather than to



**FIGURE 20.9** Lime walls originating from vertical shale layers and natural lanes.

spend time in modern museums detailing that history, and overall, adventure and other forms of environment-based tourism remain much less important than cultural tourism. The historic heritage and ancient places such as Naderi epigraph, Naderi's dam, the Sun Palace, Gabri houses, and the Gonbad Kabood mosque, because of their antiquity, which dates back to the King Nader era, as well as their fantastic architecture, attract most of the tourism in the Kalat region to itself. These places are shown in Figure 20.10.

## 20.8 Developing Tourism Potential in Ortkand River

Tourism development is an amalgamation of the two concepts of tourism and development, and can be defined in different ways and viewed from different perspectives. Pearce [5] described it as the provision or enhancement of facilities and services to meet the needs of tourists. Additionally, tourism may also be seen as a means of development in a much broader sense: the path to achieving some end state or condition. Generally, the purpose of developing remoter areas for tourism is twofold: to provide sustainable economic activity for the populations in such areas and to reduce the pressure of tourist visits on established destinations, which furthermore increases the tourism potential in other regions to be destinations for tourists. Other studies of regional development have noted the complexity of tourist destination locations and the need for leadership to both identify appropriate ways ahead and to ensure cohesive approaches among the many stakeholders. There is also the need to facilitate movement of tourists between the main tourism zones [7].

In the Ortkand area, besides its beautiful natural landscape, interesting morphology, fantastic geological features, and ancient places, which are located around the Kalat region, there are issues in attracting tourists, which include insufficient lighting, insufficient security in the caves, lack of safety tools on the way to the falls and falling stones and objects, insufficiently wide road for the traffic to travel to and from the falls, and an insufficient number of restaurants at the location. These are indicated in Figures 20.11 through 20.14. With the aim to provide and develop tourism potential in the Ortkand River basin, some solutions considering the issues noted earlier are proposed in the following sections.





**FIGURE 20.11** An existing old restaurant.



**FIGURE 20.12** An existing unsafe place for rest.

### **20.8.1 Enhancement of Facilities and Services**

The Ort kand area is faced with certain problems from the viewpoint of facilities and services such as suitable access road, locations to rest, cafe shop, locations for shopping, and sufficient lightning especially at night. In order to improve the convenience of tourists in the Ort kand River area, some schemes have been proposed. These schemes are divided into two parts: access roads into the site and infrastructural facilities, which include the following plans:



FIGURE 20.13 Available across road into Ort kand.



FIGURE 20.14 Destroyed river banks.

1. Access roads
  - a. Fixing parts of roads, which have been washed away due to river flow
  - b. Paving earthen access roads into the site
  - c. Setting up guidance tableaus in on the way to indicate tourism sites
2. Developing infrastructure in the region
  - a. Setting up locations, which are safe and comfortable to stay for tourism and mountain climbing
  - b. Setting up restaurants to serve fresh food and local food especially to foreign tourists



- c. Setting up cafe shops to sell cold and hot beverages, especially tea, to foreign tourists
- d. Creating local markets for native people to sell handicraft and local products
- e. Setting up a clinic, sanitary center, and ambulance for critical situations
- f. Setting up a cultural amphitheater for local celebrations
- g. Fixing the lighting beams and replacing with proper lighting

Figures 20.15 through 20.18 show the appropriate locations to develop some schemes.



**FIGURE 20.15** Setting up a camp for resting.



**FIGURE 20.16** Setting up a cultural amphitheater.



FIGURE 20.17 Setting up a restaurant and river bank.



FIGURE 20.18 Setting up a café shop and local marketing.

Also, in order to increase safety and ensure a healthy atmosphere for tourists, some plans have been proposed. These plans can be implemented by engineers after doing necessary studies:

- Securing old structures such as walls and drops by using a rock bolt and gabion net
- Securing places where solar cells for heating water are kept
- Removing loose large stones from the way
- Mounting a flood alarm system

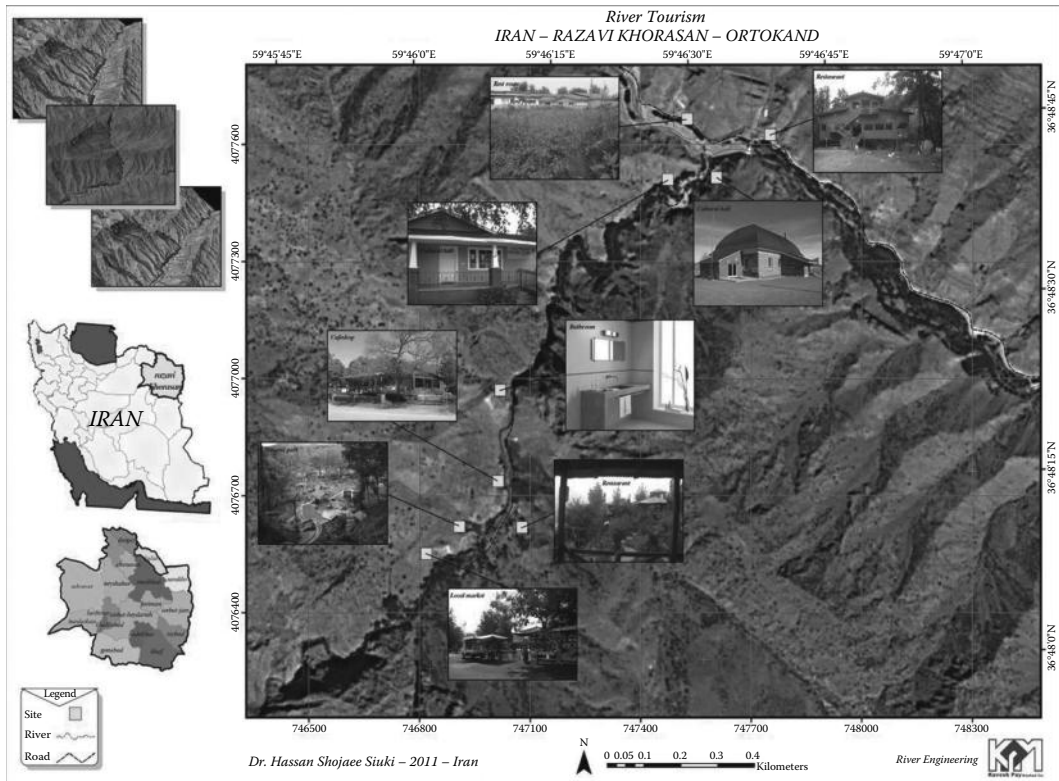


FIGURE 20.19 Some proposed tourism attractions in the Ortokand River.

Finally, a garbage basket should be kept along the way to ensure a healthy environment for visitors. Figure 20.19 shows increasing potential for tourism in Ortokand.

### 20.8.2 Facilitating Transfer between Tourism Zones

In regions where multiple tourism sites are located within short distances from one another, it is necessary to have existing facilities for easy movement from one site to another. It can be done by using buses, vans, and, more conveniently, by cable cars. A careful study of further information on Karat's tourism sites shows the existence of several tourism sites in different parts of the Kalat region, which indicates the necessity of using cable cars. It helps tourists to view better the geological and geomorphological aspects, and the natural castle around the Kalat region from above.

## 20.9 Summary and Conclusions

River systems are complex ecosystems that are noticeably influenced by human activities, including tourism and recreation. As there are both negative and positive impacts of tourism on the local ecology, it leads to the overconsumption, pollution, and the decline in resources. However, from the ecological point of view, tourism is often more acceptable and preferable than any other industrial activity as it is environmentally friendlier. In this specific type of tourism, continuous use of the world's rivers by tourists must be monitored and well managed to be able to conserve the natural and cultural wealth of these unique ecosystems, and to increase tourist attractions for the present and future generations. Besides, in many regions, tourism is the main source of income.

As an example, there are many aspects in/of the Ortkand River, Iran, which attract tourists especially in the pleasant, fresh weather months (spring and summer). But there are insufficient facilities. In order to increase facilities and to reach a wide range of tourists, several action plans in the view of existing problems have been proposed; furthermore, the expenses of implementing these plans and direct and total sales, the income, and the employment effects of the expenditure by tourists have also been estimated.

## Acknowledgments

---

The authors would like to acknowledge the Cultural Heritage, Handicrafts, and Tourism organization for supporting this work. They would also like to acknowledge their coworkers at KPM Consulting Engineers for providing the required information for performing the study.

## References

1. Dowling, R.K. 2006. *Cruise Ship Tourism*. CAB International, Wallingford, U.K.
2. Hulme, P. and Young, T. 2002. Introduction. In: Hulme, P. and Youngs, T. (eds.) *The Cambridge to Travel Writing*. Cambridge University Press, Cambridge, U.K., pp. 1–16.
3. Martin-Vide, J.P. 2001. Restoration of an urban river in Barcelona, Spain. *Environmental Engineering and Policy*. 2(3): 113–119.
4. McKean, J.R., Johnson, D., Taylor, R.G., and Johnson, R.L. 2005. Willingness to pay for non angler recreation at the lower Snake River reservoirs. *Journal of Leisure Research*. 37(2): 178–194.
5. Pearce, D. 1989. *Tourism Development*. Longman Scientific, Harlow, U.K.
6. Postel, S. and Carpenter, S. 1997. Freshwater ecosystem services. In: Daily, G.C. (ed.) *Nature's Services: Societal Dependence on Natural Ecosystems*. Island Press, Washington, DC, pp. 195–214.
7. Prideaux, B. and M. Cooper. 2009. *River Tourism*. CAB International, Wallingford, U.K.
8. Siebentritt, M.A., Ganf, G.G., and Walker, K.F. 2004. Effects of an enhanced flood in riparian plants of the River Murray, South Australia. *River Research and Applications*. 20(7): 765–774.
9. Whitehead, B. 2002. South America/Amazonia: The forests of Marvels. In: Hulme, P. and Youngs, T. (eds.) *The Cambridge to Travel Writing*. Cambridge University Press, Cambridge, U.K., pp. 122–138.
10. Xie, L.Q., Xie, P., and Tang, H.J. 2003. Enhancement of dissolved phosphorus release from sediment to lake water by *Microcystis* blooms—An enclosure experiment in a hyper-eutrophic, subtropical Chinese lake. *Environmental Pollution*. 122(3): 391–399.
11. Young, W., Schiller, C., Roberts, J., and Hillman, T. 2001. The rivers of the basin and how they work. In: Young, W. (ed.) *Rivers as Ecological Systems: The Murray Darling Basin*. Murray Darling Basin Commission, Canberra, Australia.
12. Zhang, Z., Huang, J., Yu, G., and Hong, H. 2004. Occurrence of PAHs, PCBs and organochlorine pesticides in the Tonghui River of Beijing, China. *Environmental Pollution*. 130(2): 249–261.



# 21

## Transboundary River Basin Management

---

21.1	Introduction .....	422
21.2	Rules for International Rivers.....	423
	Helsinki Rules • Dublin Principles • Kyoto Protocol	
21.3	Hydrologist's Role.....	425
21.4	Case Study: Africa .....	426
21.5	Trading Water Rights.....	428
21.6	Environmental Impact of Dams.....	429
	Downstream Aquatic Ecosystems and Biodiversity • Social and Economic Implications of Dams	
21.7	Watershed Management.....	430
	Pollution Control	
21.8	Summary and Conclusions.....	431
	References.....	431

**David Stephenson**  
*University of Botswana*

**Eva Sbrana**  
*PDNA and Associates*

### AUTHORS

**David Stephenson** is a professor emeritus at the University of the Witwatersrand and an adjunct professor at the University of Botswana. He was a visiting professor at the University of Stuttgart, Tokyo Institute of Technology, and McMaster. He is the author of 11 books and over 200 papers in water resources. He is the advisor to governments in Africa on water projects and consults internationally in water development and hydraulic structures.

**Eva Sbrana** is a civil engineer, currently working for a civil engineering consulting firm in Botswana. She graduated at the University of Botswana in 2008 and did her final year research project in international waters. She is experienced in road design, civil, and environmental engineering.

### PREFACE

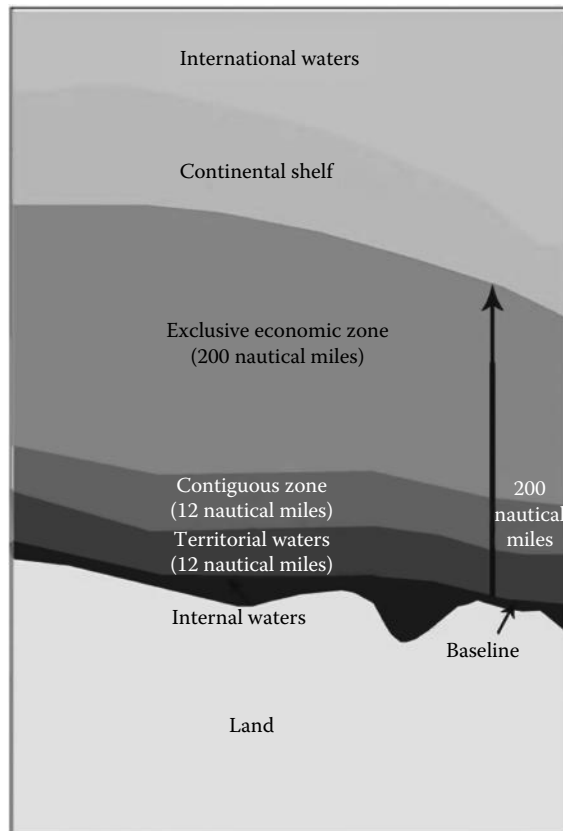
Water rights are difficult to establish especially for rivers that flow between or across multiple countries. Being a valuable resource, especially in African countries, there is a need to determine practical and efficient ways to share and respectfully use these waters without negatively impacting users downstream, or at least provide some sort of compensation. Watershed management is another way of protecting the water bodies they drain into. Management of catchments is difficult because they too can be split between different countries. This chapter takes a closer look at the different available options to better manage shared rivers.

## 21.1 Introduction

Sharing and managing international shared waters is of interest to most countries. Offshore water limits are well defined (Figure 21.1). Rivers are more complex because they can pass through or by a number of countries. The quality of the water is generally usable, and the potential for creating hazards or benefits is more prevalent. A number of attempts have been made to create laws and treatise, but these are not easy to enforce. A suitable formula for sharing international rivers, particularly in developing areas, is sought [1,4,10].

It is becoming acknowledged that water is likely to be the most pressing environmental concern of the next century [14,15]. Difficulties in river basin management are exacerbated only when the resource crosses international boundaries [20]. An aid in the assessment of international waters has been the Register of International Rivers. As global populations and economies continue to grow exponentially, and as environmental change threatens both the quantity and quality of the world's freshwater resources, attention has increasingly focused on the state and management of those resources.

Rivers are the life sources for many communities. They provide water for irrigation, navigation, drinking, and washing as a source of mechanical energy and have many other uses [18]. Different countries may share rivers, and cooperative management may not always be executed [28,29]. A government, or an individual, may try to make use of the river for its own benefit without considering the other users.



**FIGURE 21.1** Hydro-space offshore.

### Definitions

- An international river is defined as one crossing or bounding more than one country.
- A watershed is the boundary between adjacent drainage basins.
- A border is a line between countries.

In some situations, rivers act as natural political borders. However, this gives rise to conflicts in the use of the river. Responsibility for management (storage, pollution control, watershed management) is complicated and may give rise to disputes. The natural position for a border is the watershed. Then catchment management will be the simplest. Arguments over pollution, abstraction, and misuse are minimized.

The worst position for a national border from the catchment management point of view is the river. However, this is a convenient natural barrier, reducing illegal immigration and transport of illicit goods, that is, a river is best as a barrier not border. Many countries at war with each other welcome rivers or other natural boundaries.

There are over 260 international rivers in the world, covering 45% of the land surface of the earth and accounting for approximately 80% of global river flows. For various reasons, populations have settled along these rivers. Maybe the river was used to separate feuding communities. As populations and economies grow, the essential water resources will be put under increasing pressure to meet the needs and fulfill the aspirations of 90% of the world's population who currently live in the countries sharing these rivers [26]. Unfortunately, in developing countries, it is often the poorer people who live along the river, and they are helpless to move. They become subject to feuds, drought, flood, and pollution in various localities.

The overarching challenge in managing international rivers is to do so equitably and in an environmentally, socially, and economically sustainable manner—in the absence of an authority or binding agreement. All international rivers, without exception, create some degree of tension among the societies that they bind or separate. There are consequences of these tensions and of the cooperative or noncooperative responses they elicit, which can reach far “beyond the river.” Recognizing that international waters are key natural resources for future prosperity and security, it is important to identify mechanisms and instruments to support the use of water as a catalyst for regional cooperation rather than a source of potential conflict. Cooperatively managing and developing these rivers requires great skill, robust institutions, significant investment, and strong cross-boundary cooperation [5].

One of the worst affected countries is Bangladesh, where 58 rivers cross from India and other countries. The flooding and sedimentation problems have no solution in sight.

## 21.2 Rules for International Rivers

---

International treaties and agreements have to be followed through to enable the rivers to be managed properly. The World Bank and other organizations are assisting in capacity-building in some of the countries, whereas the Southern African Development Community [21] committees monitor operation of dams and water resource projects in general. The Zambezi River, on the other hand, which affects eight countries, has its own management structure. The question arises as to what influence the smaller countries have in controlling the flows. They are generally at the mercy of upstream controllers and must make do with leftover water, whatever the good intentions. Release from structures is subjective whether it be controlled manually or automatically and therefore holds the risk of flooding downstream. Therefore, a more stable management structure is required. This would include management of floods, embankments, and channelization. Peasants even often ignore the barriers that are erected to indicate the dangerous zones. So flood control structures and automatic releases are seen to be the answers.

Apart from hydroelectric power generation in the major rivers, for example, Zambezi, there are abstractions for agriculture and urban use, the latter being the most economically important. Other uses, including fishing, recreation, and navigation, are limited.



The following rules have been suggested for the use of waters of international rivers:

- Absolute territorial sovereignty [2]
- Absolute territorial integrity [27]
- Communal/integrated basin development [8]
- Equitable utilization (Helsinki rules) [12]

### **21.2.1 Helsinki Rules**

An international drainage basin is a geographical area extending over two or more states determined by the watershed limits of the system of waters, including surface and underground waters, flowing into a common terminus.

- Each basin state is entitled, within its territory, to a reasonable and equitable share in the beneficial uses of the waters of an international drainage basin.
- A basin state may not be denied the present reasonable use of the waters of an international drainage basin to reserve a future use of such waters for a cobasin state.
- Consistent with the Charter of the United Nations, states are under an obligation to settle international disputes as to their legal rights or other interests by peaceful means in such a manner that international peace and security and justice are not endangered.

### **21.2.2 Dublin Principles**

The question of how to apply these rules arises. It is suggested that the answer may lie in the Dublin principles [7]:

1. Freshwater is a finite and vulnerable resource essential to sustain life, development, and the environment.
2. Water development and management should be based on a participatory approach, involving users, planners, and policy makers at all levels.
3. Women play a central part in the provision, management, and safeguarding of water resources.
4. Water has an economic value in all its competing uses and should be recognized as an economic good.

The rules provided earlier have not solved all problems and are yet to be condensed into something useful [22]. The environment is not properly accounted for [25]. It is suggested that the ideas of the Kyoto accord [13] for managing carbon emissions could be applied in water resources. Thus water rights could be traded as an economic good. This will require a lot of work in identifying values, for example, water resources, flood control, and pollution costs. The real difference with regard to water is that we will be selling a useful commodity not a right. It may therefore be appealing to developing as well as developed countries.

### **21.2.3 Kyoto Protocol**

The Kyoto Protocol is an agreement made under the United Nations Framework Convention on Climate Change. Countries that ratify this protocol commit to reducing their emissions of carbon dioxide and five other greenhouse gases (GHGs) or engaging in emissions trading if they maintain or increase emissions of these gases. The Kyoto Protocol now covers more than 170 countries globally and more than 60% of countries in terms of global GHG emissions. As of December 2007, the United States and Kazakhstan were the only signatory nations not to have ratified the act. This treaty expires in 2012, and international talks began in May 2007 on a future treaty to succeed the current one. Kyoto is underwritten by governments and is governed by global legislation enacted under the UN's aegis.

Governments are separated into two general categories: Developed countries are referred to as Annex I countries, which have accepted GHG emission reduction obligations and must submit an annual GHG inventory. Developing countries, referred to as non-Annex I countries, have no GHG emission reduction obligations but may participate in the Clean Development Mechanism.

Through to 2012, Annex I countries have to reduce their GHG emissions by a collective average of 5% below their 1990 levels. While the average emission reduction is 5%, national limitations range from an 8% average reduction across the European Union (EU) to a 10% emission increase for Iceland, but since the EU's member states each have individual obligations, much larger increases (up to 27%) are allowed for some of the less developed EU countries. Countries that pollute less are allowed to emit higher concentrations of carbon dioxide.

Kyoto includes "flexible mechanisms" that allow Annex I economies to meet their GHG emission limitation by purchasing GHG emission reductions from elsewhere. These can be bought either from financial exchanges or from projects that reduce emissions in non-Annex I economies.

In practice, this means that non-Annex I economies have no GHG emission restrictions, but when a GHG emission reduction project (a "Greenhouse Gas Project") is implemented in these countries, the project will receive carbon credits, which can then be sold to Annex I buyers.

These Kyoto mechanisms are in place for two main reasons: there were fears that the cost of complying with Kyoto would be expensive for many Annex I countries, especially those countries already home to efficient low GHG emitting industries, and high prevailing environmental standards. Kyoto therefore allows these countries to purchase cheaper carbon credits on the world market instead of reducing GHG emissions domestically, and this is seen as a means of encouraging non-Annex I developing economies to reduce GHG emissions through sustainable development, since doing so is now economically viable because of the investment flows from the sale of carbon credits.

All the Annex I economies have established Designated National Authorities to manage their GHG portfolios under Kyoto. Countries including Japan, Canada, Italy, the Netherlands, Germany, France, Spain, and many more are actively promoting government carbon funds and supporting multilateral carbon funds intent on purchasing carbon credits from non-Annex I countries. These government organizations are working closely with their major utility, energy, oil and gas, and chemical conglomerates to try to acquire as many greenhouse gas certificates as cheaply as possible.

## 21.3 Hydrologist's Role

---

There is a wealth of legal opinion on the problems of international rivers [6,9], but scientific solutions lag. The following problems need solutions:

- What is the cross border minimum and average flow?
- What are the benefits of international cooperation, that is, scale, economics, or multipurpose?
- What is the cost of use, direct and indirect?
- What is the cost of storage and evaporation, in financial and socioeconomic terms?
- What are the consequences of pollution and changing ecosystem?
- Is development affecting the sustainability of the river system?

Scientists' analytical and modeling abilities facilitate decision making, but hydrologists seem to be content to stay with our answers instead of communicating to decision makers. Knowledge of hydrology goes a long way to solving problems, and together with groundwater analysis and water quality management, most problems can be solved.

In developed countries, the environmental aspects are receiving more attention. In-stream requirements, hydrological regimes, wetlands, and sustainability receive more attention than that in developing countries. An accord like the Kyoto protocol is needed for water resources sharing and problem solving. A water accord could enable sale of water rights, and pollution permits, storage, and flood management to be sold between countries.

If hydrological risk can be reduced, cost will reduce, development will proceed, and cooperation will improve. Despite the problems being so different from developed to undeveloped countries, sale of rights may bring countries together.

## 21.4 Case Study: Africa

Africa has more international rivers than any other continent (see Figures 21.2 and 21.3) and more international feuding. Rivers form borders in many cases. But illegal crossing of borders is common, for social, economic, or refuge reasons. The rivers are largely uncontrolled, so crossing may be dangerous. And international treaties are few. So development is hindered. Many people have proposed water as a dynamic binding force, that is, joint development projects. The reality is that war and economic uncertainty make international development difficult. And that is where the politics are so difficult, and dispute resolution is a problem. Politics poses a barrier to mutual development in many countries or even the lack of legal infrastructure to adopt laws. On the other hand, Southern Africa Development Community have drafted laws on international use of rivers, which are being tested by some Southern African countries. The Nile River has been the subject of extensive negotiation [16].

Although they are not the major rivers of Africa, the rivers flowing into the Indian Ocean east of Africa pose the most problems [17]. On the west coast are the major rivers of the Congo and Zaire, the Niger, and the Volta. Development on these rivers is relatively local, and the controversy regarding usage is minimal. Of the major river flowing to the north of Africa, the Nile is the most controversial. Because it passes through many countries, its development is likely to be hampered by politics.

The rivers flowing to the east of Africa are generally limited in length between the African rift valley and mountains. It is only further south that one encounters transcontinental rivers such as the Zambezi, Limpopo, and Komati rivers. The Zambezi and Limpopo rivers rise in Angola and the arid country of Botswana to the west. They then flow to the more humid country of Mozambique. The problems are therefore diverse along these rivers. Arid countries are water-scarce and try to dam as many of the tributaries and major rivers as possible, whereas in Mozambique, the major problem is flooding. At this stage, there is no bulk shortage of water in Mozambique, only spatial distribution problems and flooding.

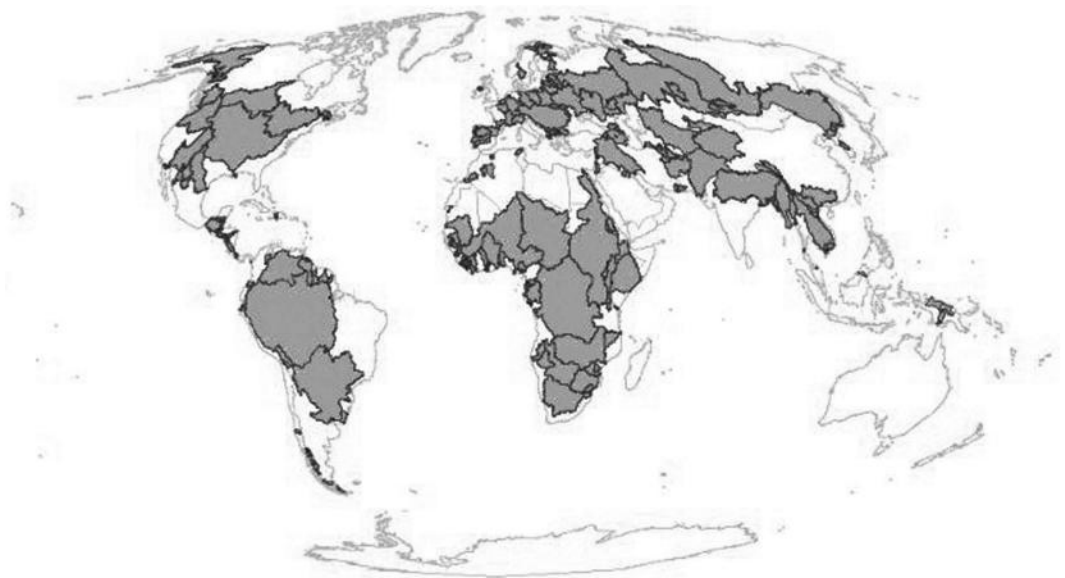


FIGURE 21.2 International river basins of the world.

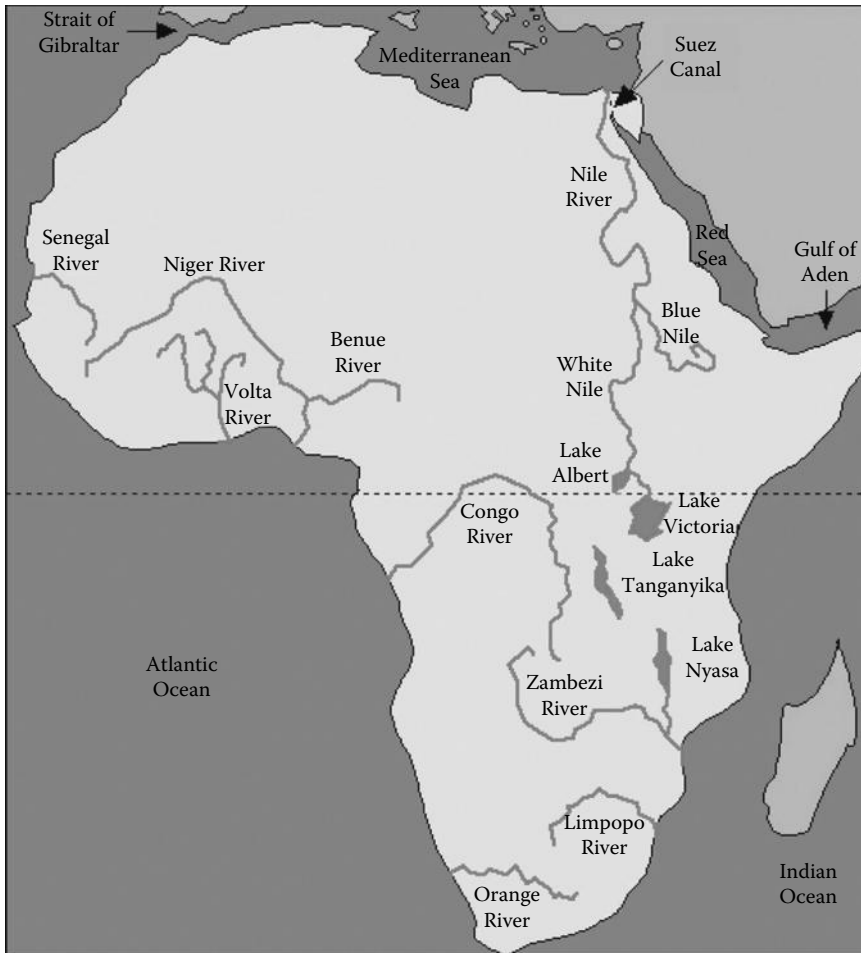


FIGURE 21.3 Africa's international rivers.

The Zambezi River has a catchment area of 1.3 million km<sup>2</sup> and a length of 3500 km [3]. Recently, a flood of 22,000 m<sup>3</sup>/s occurred, while low flow can be less than 500 m<sup>3</sup>/s and the mean flow is 3,400 m<sup>3</sup>/s. The Limpopo River has a catchment area of 30,000 km<sup>2</sup> and a considerably lower flow. The low flow is very sensitive to abstraction by dams to the west, but at this stage, this has not been of concern to Mozambique.

The Komati River has a catchment area of 20,000 km<sup>2</sup> at the border with Mozambique and a total catchment area of 50,000 km<sup>2</sup> by the time it reaches the Indian Ocean. The mean flow is 110 m<sup>3</sup>/s, but there is a low flow of less than 1 m<sup>3</sup>/s in the dry months across the border into Mozambique. It is the Komati River that has the most problems in the country of Mozambique with regard to the allocation of the water resources. There are 12 major dams on the upper Komati River and its tributaries. These dams will prevent water from reaching Mozambique, particularly during low flows. Uncoordinated abstractions and increased evaporation loss from reservoirs compound the problem to the east. This will force Mozambique to construct dams to catch surplus floodwater to store it for the dry seasons for urban and agricultural purposes. Although there is an international treaty regarding the water use, operators and in-stream abstractions are not always in accordance with these treaties.

The Limpopo [11] and its western tributaries are highly regarded by the arid country Botswana, and most of the tributaries in Botswana are dammed or are in the process of being dammed for water,

which is vital for urban use. The question of in-stream releases needs close attention in the case of arid countries. The rivers are usually completely dry for over 90% of the time, and the only in-stream water available in these periods occurs in the form of groundwater or bed water in the sandy beds of the rivers. A completely different approach to releases is therefore required. That would include the process of recharging of the river bed aquifers during spill from the dams. Dams are generally not manned, and as such there is no downstream release or overflow during dry periods. It is only after heavy rains and flood that there is spill, which is carried down the Limpopo River through South Africa and Zimbabwe to Mozambique. The question therefore arises of whether the dams serve any value in flood control. On the contrary, downstream bank dwellers are inclined to become blasé about floods on dammed rivers, since the low flows are so low. Therefore, when floods do occur, they are more unexpected than in the case of a natural flowing river.

Botswana is a landlocked country with three river borders, namely, the Limpopo, Molopo, and Zambezi. These rivers have varying degrees of protection or are, to a different extent, boundaries. The Zambezi is a big river—defying crossing other than by boat or bridge. It is therefore a deterrent to illegal immigration (from North to South). The Limpopo is more amenable to human crossing, but there is less incentive to cross from one stable country to another (South Africa). The Molopo is dry most of the time and is therefore not a deterrent except that it traverses arid country.

The shortage of water in Botswana could be corrected by purchasing water rights from the Zambezi. However, negotiation has been difficult with the neighboring Zimbabwe. The nearest to cooperative development has been the construction of a hydropower station on the Zambian bank. Attempts to build the Batoka Gorge Dam have been thwarted by lack of cooperation and environmental objections. On the other hand, the Kariba Dam and to a lesser success the Cahora Bassa Dam on the Zambezi have been successful in spurring economic regional development.

The most contentious river for Botswana is the Okovango, which rises in Angola's highlands and feeds an internationally acclaimed wetland in Botswana. Abstractions in Angola and Namibia could starve the Okovango, changing its course and width once again. Previous diversions were caused by tectonic movement and Aeolian deposits. In fact, the river once flowed into the Orange River and may in future flow into the Zambezi.

Hydroelectric power offers an economic incentive to cooperate. For example, a third power station is contemplated on the River Zaire for supplying countries throughout Africa. In addition, Angola's water resources could benefit from diversion from the Zaire. And in turn Angola would not dam the Okovango, which is the source of the Okovango wetland.

## 21.5 Trading Water Rights

---

Initially, normal water flows and rights should be established from hydrological study and socio-economic principles.

Then international payments should be calculated. If an upstream country wishes to sell water to downstream countries, it should do so at an agreed tariff. Similarly, a downstream country should be compensated if upstream users overdraw their share. Pollution passed downstream should be fined. Flood increase should also be fined, whereas attenuation of floods should be rewarded.

A tariff structure could be based on costs, for example,

- Water supply \$/m<sup>3</sup>
- Pollution \$/kg
- Flood reduction \$10/(m<sup>3</sup>/s)

In developed countries, the environmental aspects are receiving more attention. In-stream requirements, hydrological regimes, wetlands, and sustainability receive more attention than that in developing countries. A water accord could enable sale of water rights, and pollution permits, storage, and flood management to be sold between countries.

**TABLE 21.1** Major Environmental Impacts of Dams

---

Imposition of a reservoir in a river valley (loss of habitat)
Changes in downstream morphology of riverbed, delta, coastline due to altered sediment load (increased erosion)
Changes in downstream water quality: effects on river temperature, nutrient load, turbidity, dissolved gases, concentration of heavy metals, and minerals
Reduction of biodiversity due to restricting the movement of organisms (e.g., salmon) and because of the aforementioned changes

---

**TABLE 21.2** Impacts of Dam Operations

---

Changes in downstream hydrology
a. Change in total flows
b. Changing seasonal flow (e.g., different flood periods)
c. Short-term fluctuations in flows (sometimes hourly)
d. Change in extreme high and low flows
Changes in downstream morphology by altered flow pattern
Changes in downstream water quality by altered flow pattern
Reduction in riparian and floodplain habitat diversity, especially because of elimination of floods

---

## 21.6 Environmental Impact of Dams

---

Frequently, arguments develop on building dams across international rivers. It is generally upstream development, which impacts on downstream river environments. Seldom is there an upstream impact except if the dam is built close to a border. Then flooding can be an issue.

Tables 21.1 and 21.2 outline the general environmental drawbacks of dams.

### 21.6.1 Downstream Aquatic Ecosystems and Biodiversity

Changes in downstream morphology of riverbed and banks, delta, estuary, and coastline due to altered sediment load may occur such as along the Nile. Much of the impact of dams on downstream habitats is through changes in the sediment load of the river. All rivers carry some sediment as they erode their watershed. When the river is held in the reservoir behind a dam for a period of time, sediment will be trapped in the reservoir, and settle to the bottom, so that water released by the dam will be clearer, with less sediment than it had once had. For example, before the High Aswan Dam, the Nile carried an average of 124 million tons of sediment to the sea each year and deposited another 9.5 million tons on the floodplain; now, 98% of the sediment goes to the bottom of the Nasser Reservoir. Eventually, all the easily erodible material on the riverbed below the dam could be eroded away, leaving a rocky streambed and a poorer habitat for aquatic fauna. Erosion may also increase along the coast beyond the mouth of the river, as observed, for example, downstream of the Akosombo Dam in Ghana. Over time, the downstream river will also tend to become narrower and deeper, which will also reduce the diversity of animal and plant life that it can support.

The impacts of these changes are magnified by changes in the flow pattern of rivers downstream that is caused by normal operation of dams. These changes, whether in total streamflow, in seasonal timing, or in short term, even hourly fluctuations in flows, generate a range of impacts on rivers. This is because the life of rivers is usually tightly linked to the existing flow patterns of rivers. Any disruption of those flows, therefore, is likely to have substantial impacts.

### 21.6.2 Social and Economic Implications of Dams

Table 21.3 summarizes the main social and economic impacts in dam construction.

**TABLE 21.3** Social and Economic Impacts of Dams

Relocation of communities	Impacts on health, and economic, social, and cultural well-being
Loss of community control over water	Transfer of control from local level to central government or corporate control
Diseases	Encouraged by dam projects (creating habitat for parasites, e.g., mosquitoes)
Increasing cost of dams	Problems encountered (e.g., sedimentation) Cost of social, environmental impacts Losses due to evaporation, abstraction Delays

## 21.7 Watershed Management

Watershed management is a way of looking at relationships between people, land, and water. It requires an integrated approach between landowners, land use agencies, stormwater management experts, environmental specialists, water use purveyors, and communities. It is an approach to stewardship of our natural resources, compliance with regulation and resources management. Experts in watershed management recognize watersheds as systems within which resources are connected and strive toward efficient, sustainable, and intelligent solutions to watershed issues. These issues include water supply, water quality, drainage, stormwater runoff, water rights, and the overall planning and utilization of watersheds. International boundaries across watersheds cause disruption in monitoring and management.

### 21.7.1 Pollution Control

Watersheds feed local and shared water bodies. There are a number of human and natural processes that affect the runoff quality and consequently the use of the extracted water from water bodies. Different locations, climates, vegetation, and settlements create different watersheds.

In mountain upland areas, there are unique blends of climate, geology, hydrology, soils, and vegetation shaping the landscape, with waterways often cutting down steep slopes.

In trying to solve environmental problems or prevent them from happening, water quality standards have been set: local water supply antidegradation goals, natural heritage conservation goals, etc. These goals and standards are usually set by programs within government agencies. Multiple indicators (chemical, biological, and physical) can help indirectly gauge overall system integrity.

Management agencies and organizations are realizing that effective resource management is never ending, involves those affected by decisions, and reflects their integrated nature. Watersheds are practical for integrating these efforts. The emerging watershed framework builds on existing management programs and resources but has as its goal watershed system integrity. When focusing on the watershed's integrated system, it is important to consider common goals.

Different communities vary in the benefits they want from their watersheds. Moreover, watersheds change through time. Eastern watersheds cleared of their forests in the first half of the twentieth century had specific management needs during regrowth in the second half of the century, but management needs will likely change again in the twenty-first century. Changes can even occur on more immediate time scales, due, for example, to the appearance of a serious forest pest or disease, a change in water use patterns, or the arrival of a new community industry or enterprise. Watershed management is a dynamic and continually readjusting process that is built to accommodate these kinds of changes [19].

## 21.8 Summary and Conclusions

---

International rivers are controversial from the points of view of water rights, impacts, and change. They affect ecology, humanity, and politics. Rivers are of use as a barrier against migration and therefore politically important. But basin management is hindered by the division of international river catchments into different countries. A possibility for economic development in poor countries is the development and use of rivers [23,24], but financiers are put off by political instability and lack of financial infrastructure. So unless politics are stable, there will be ad hoc development, with little attention to sustainability. Ways of stimulating development include multipurpose water resources projects. A way of achieving international sustainability is by issuing water rights, for usage, pollution, storage, and flood control. The rights of developing countries underexploiting their rivers could be traded from developed countries.

## References

1. Agreement on the Cooperation for the Sustainable Development of the Mekong River Basin, 1995. ILM, 34, p. 864
2. Berber, B. 1959. *Rivers in International Law*, Stevens, London, U.K.
3. Bourgeois, S., Kocher, T., and Schelander, P. 2003. *Case Study: Zambezi River Basin*, ETH Zurich: *Seminar on Science and Politics of International Freshwater Management*, Working Paper, Zurich, Switzerland.
4. Bourne, C.B. 1965. The right to utilize the waters of international rivers. In: *Canadian Yearbook of International Law*, Kluwer Law International, The Hague, the Netherlands, pp. 187–265
5. de Chazoumes, L.B. ed. 2010. *International Watercourses—Enhancing Cooperation and Managing Conflict. Proceeding of the World Bank Seminar*, World Bank Technical Paper No. 414, Washington, DC, p. 27.
6. Convention on the Law of Non-Navigational Uses of International Watercourses, May 21, 1997.
7. Dublin Principles, 1992. *International Conference on Water and the Environment (ICWE)*, Dublin, Ireland.
8. Dubrovnic Convention, 1956. *Report of the 47th Conference of the International Law Association*. London, U.K.
9. Gleick, P. 2002. Fresh water resources and international security. In: Wolf, A. ed. *Conflict Prevention and Resolution in Water Systems*, Edward Arnold, London, U.K., p. 148.
10. Görgens, A.H.M. and Boroto, R.A. 1997. Limpopo River: Flow balance anomalies, surprises and implications for integrated water resources management. *Proceedings of the 8th South African National Hydrology Symposium*, Pretoria, South Africa.
11. Helsinki Rules on the Uses of the Waters of International Rivers, 1966.
12. Kyoto Accord, 1998. *United Nations Framework Convention on Climate Change*.
13. Laylin, J. and Bianchi, R. 1959. The role of adjudication in international river basins. *American Journal of International Law*, 53: 30–49.
14. McCaffrey, S.C. 2003. *The Law of International Watercourses*, Oxford Monographs in International Law, Oxford University Press, New York.
15. McCaffrey, S.C. 1998. *The UN Convention on the Law of the Non-Navigational Uses of International Watercourses*, United Nations Audiovisual Library of International Law, New York.
16. Ministry of Water Resources, 2010. *Agreement on the Nile River Basin Cooperative Framework*, Boundary and Transboundary Rivers Affairs Department, Ethiopia.
17. Nakayama, M. 2003. *International Waters in Southern Africa*, United Nations University Press, Tokyo, Japan.
18. *Non-Navigational Uses of International Watercourses to the EU and Its Member States*, BYB of International Environmental Law, Oxford University Press, New York, pp. 923–925.



19. Redgwell, C. 2008. National implementation. In: Bodansky, D. et al. eds. *The Oxford Handbook of International Law*, Oxford University Press, New York, pp. 923–925
20. Salman, S.M.A. and Boisson de Rieu-Clarke, A.S. 2008. *The Role and Relevance of the UN Convention on the Law*.
21. Southern African Development Community (SADC), 2000. *Revised Protocol on Shared Water*, ILM40, 321.
22. Subedi, S. 2003. *Resolution of International Water Disputes: Challenges for the 21st Century*. International Bureau of the Permanent Court of Arbitration, Kluwer Law International, The Hague, the Netherlands, p. 47.
23. Tanzi, A. and Arcari, M. 2001. *A Framework for Sharing. UN Convention on the Law of the Non-Navigational Uses of International Watercourses*, Kluwer Law International, The Hague, the Netherlands.
24. UNECE, 1997. *Convention on the Protection and Use of Transboundary Watercourses and International Lakes*.
25. United Nations Agenda 21, 1992. A program for action for sustainable development. In: *Report of the United Nations Conference on Environment and Development*, Annex II, U.N. Doc., A/Conf. 151/26 (Vol. II), Rio de Janeiro, Brazil.
26. United Nations, 2010. *The Human Rights to Water and Sanitation*, General Assembly Resolution, Preamble, paragraph 5, UN Doc. A/RES/64/292, August 3.
27. Utton, A.E. 1973. International water quality law. *Natural Resources Journal*, 13(2): 282–314.
28. Wolf, A.T. 1998. Conflict and cooperation along international waterways. *Water Policy*, 1: 251–265.
29. Wouters, P.K. 2003. *Universal and Regional Approaches to Resolving International Water Disputes: What Lessons Learnt from State Practice?* International Bureau, Kluwer Law International, The Hague, the Netherlands.

# 22

## Transboundary Water Resource Management

---

22.1	Introduction .....	434
22.2	Hydrological Interdependence .....	435
	Competition for a Finite Supply of Water • Impacts on Water Quality • Timing of Water Flows	
22.3	The Conflict–Cooperation Problematique .....	436
22.4	Transboundary Water Resources as Drivers of Development.....	437
22.5	Integrated Approaches to Transboundary Water Management and the Preponderance of “Water Silos” .....	438
22.6	Role of Multiple Actors in Transboundary Water Management.....	438
	Institutional and Legal Development • Private Sector • Individuals	
22.7	Summary and Conclusions .....	440
	References.....	441

**Inga Jacobs**  
*Water Research Commission*

**Anthony Richard Turton**  
*University of Free State*

### AUTHORS

**Inga Jacobs** is an executive manager of Business Development, Marketing, and Communications at the Water Research Commission (WRC), South Africa. She is a political scientist by training and specializes in regional and international water governance in Africa and, specifically, cooperative governance in shared river basins in the Southern African and East African regions. Inga completed her PhD degree in International Relations at the University of St. Andrews, Scotland, in 2010. She also holds a Master of Arts in International Studies from the University of Stellenbosch and a Bachelor of Arts (BA) in International Relations from Grinnell College, Iowa, in the United States. Within her professional capacity at the WRC, Inga is responsible for the strategic monitoring of research trends in the water sector, as well as providing direction and leadership on the impact of water R&D in South Africa and other metadata research.

**Anthony Richard Turton** is a professor at the Centre for Environmental Management, University of Free State, South Africa. Anthony is a transboundary water resource management specialist. He teaches at the University of Free State but is also a founding trustee of the Water Stewardship Council of Southern Africa. He is a director of TouchStone Resources (Pty) Ltd, a company that works into the mining sector where water is a major strategic risk to greenfield operations. He holds a DPhil degree from the University of Pretoria in which he developed a conceptual framework for transboundary water resource management under conditions of strategic risk in a region that is fundamentally water constrained.

## PREFACE

The management of rivers that are shared between different countries is characterized by complex and interconnected factors and challenges, most of which have competing demands on the resource. This chapter outlines several core principles and practices of transboundary water management most notably: the ability of transboundary rivers to act as hydrological “connectors” of people, politics, and economies; the ways in which conflict and cooperation are negotiated in shared resource domains; the role of transboundary water resources as drivers of economic development; and the role of major stakeholders involved in transboundary water governance. By providing this overview, we provide a synopsis of the way in which the field of transboundary water management is currently approached. The chapter also focuses on one particular region, the Southern African Development Community (SADC), comprising of 15 sub-Saharan African states, to illustrate the complex interactions of transboundary basins and the way in which water is linked to other important sectors, such as energy and food. International rivers form part of a complex landscape comprising of actors, institutions, policies, as well as a wide range of biophysical, socioeconomic, and sociopolitical characteristics that are constantly interacting to negotiate rights and access to the resource. We emphasize that not only do national and international institutions affect the management of transboundary rivers but so too do organizations, non-state actors, and also individuals.

## 22.1 Introduction

Water is the foundation of economic development and social stability, and when it is shared, issues of strategic importance such as state survival become interlinked. The management of an international river basin\* also implies the management of competing demands on the resource [20]. These demands will continue to intensify as a result of increasing water scarcity, degrading water quality, rapid population growth, urbanization and industrialization, and uneven levels of economic development [7]. According to the World Resources Institute (WRI) [41], roughly 3.5 billion people may live under conditions of water stress by 2025. Environmental pressures have also increased with virtually one-third of the world’s watersheds losing more than 75% of their forest cover [21].

Throughout the world, there are 263 lake and river basins shared between two or more countries. This makes up approximately 60% of the global freshwater flow, with the surrounding area providing a home to two in every five people in the world today [38,40]. In addition, there are numerous transboundary aquifers, that is, groundwater bodies, which serve as drinking water sources for over 2 billion people.

This chapter outlines several core principles and practices of transboundary water management most notably: the ability of transboundary rivers to act as hydrological “connectors” of people, politics, and economies; the ways in which conflict and cooperation are negotiated in shared resource domains; the role of transboundary water resources as drivers of economic development; and the role of major stakeholders involved in transboundary water governance. In so doing, we sketch the development trajectory of key trends in transboundary water management over time and explore the way in which the field is currently approached.

---

\* The term international rivers is used to refer to freshwaters (surface and groundwater) whose basins are situated within the borders of more than one sovereign state as well as the lakes and wetlands through which some of these flows may pass. The term transboundary rivers is also used to refer to rivers which cross or flow along international state (and therefore political) boundaries.

In this chapter, we also investigate the SADC,\* a region with 15 major transboundary rivers, an uneven distribution of water resources across the region, and a considerable backlog with regard to water access [23]. In jointly managing, utilizing, and preserving the huge resource potential of international river basins in terms of agriculture, energy production, and other sectors, benefits can be reaped that are geared to support sustainable development trajectories.

## 22.2 Hydrological Interdependence

The degree of hydrological interdependence experienced is often illustrated by the number of countries that share a particular basin. The Danube River Basin, for example, traverses along 19 riparian countries; while the Nile and Niger River Basins are shared by 11 countries each; and the Amazon, Zambezi, and Rhine River Basins are all shared by nine countries each. This results in hydrological linkages across political boundaries oftentimes elevating shared water resources to an issue of national security.

However, no region better demonstrates the realities of hydrological interdependence than Africa as a result of political demarcations drawn up at conferences in Berlin, Lisbon, London, and Paris more than a century ago [38]. These arbitrary political borders left over 90% of all surface water in the region in transboundary river basins harboring more than three-quarters of its people [38]. The continent of Africa contains 63 river and lake basins, resulting in each African state sharing at least one freshwater body with its neighbors, which has at times resulted in hostile relations among riparian states [28]. Another interesting aspect of African transboundary rivers is that there are more basins than sovereign states, and around 10% of these rivers do not flow into the ocean by virtue of the fact that they are endorheic [35].

Additionally, the hydropolitical climate in Africa is characterized by a diversity of local configurations, including a multitude of biophysical, sociocultural, and political contexts that contribute to Africa's hydropolitical fragility. These include, but are not limited to, a range of domestic policy variance between riparian states. There is also a great deal of variability in economic development between states and a broad spectrum of social, economic, and cultural institutions, as well as the highly varied spatial and temporal precipitation and the (mal)-distribution of water. In Southern Africa alone, some of the most economically developed states such as South Africa and Botswana have limited water resources, which may constrain future economic development [2,31,32,34].

According to the 2006 Human Development Report (HDR) [38], one country's water use transmits effects to other countries through one of three mechanisms.

### 22.2.1 Competition for a Finite Supply of Water

Countries often depend on the same transboundary source of water to support their national environments, sustain livelihoods, and generate in-country growth. However, the use in one place (oftentimes upstream) restricts availability in another (usually downstream). For example, the retention of water upstream for irrigation or power generation in one country restricts flows downstream.

### 22.2.2 Impacts on Water Quality

Upstream uses oftentimes also affect the quality of water that arrives in a downstream country. Dams developed in uncoordinated ways cause silting in reservoirs, preventing the rich sediment from reaching low-lying plains [38]. Industrial or human pollution can also be transported through rivers to people in other countries. In Southern Africa, a unique spatial development pattern exists where several large cities

---

\* The SADC comprises 15 member states: Angola, Botswana, the Democratic Republic of the Congo (DRC), Lesotho, Madagascar, Malawi, Mauritius, Mozambique, Namibia, Seychelles, South Africa, Swaziland, Tanzania, Zambia, and Zimbabwe.

or centers of economic development (such as Johannesburg, Pretoria, Harare, Bulawayo, Francistown, Gaborone, and Windhoek) are located not on rivers, lakes, or seafronts but on the continental or watershed divide [35,36]. This is directly as a result of the development of key mining areas and, subsequently, the formation and rise of key urban areas and later cities. This translates into a dependency on water that has to be pumped uphill for urban use and, subsequently, results in sewage return flows as these rivers are additionally burdened with transporting waste material, most of which enters downstream water storage reservoirs.

### 22.2.3 Timing of Water Flows

The timing and volume of water flows by upstream users have crucial implications downstream. For example, agricultural users in one country may need water for irrigation at the same time as another country needs it for hydropower generation. In cases such as this, challenges cannot be solved by individual countries acting in isolation. Instead, they can be at times exacerbated when countries act in isolation. For example, a sub-Saharan country like Malawi gets most of its energy supply from hydropower plants on the Shire River, an outlet of Lake Malawi that flows into the Zambezi River. However, Malawi's hydropower supply is greatly influenced by the flood season on the Zambezi River, into which the Shire River flows. When the Zambezi is in flood, the large volume of Zambezi River water pushes water in the smaller Shire backward. This effectively slows down generation along the Shire, with further pressure having the ability to bring the process to a standstill. The problem is at its worst when floodgates at the Kariba Dam, far upstream on the Zambezi, are opened. On the other hand, controlled release of that water is necessary for both flood control and to avoid damage to the dam. This example illustrates that silo approaches to resource management not only produce suboptimal deployment of resources but could negatively affect other resources that are closely related [11].

All these issues will affect and be affected by the way in which we are able to effectively and sustainably manage our transboundary waters. The now notoriously popular phrase taken from a United Nations (UN) Report rings true throughout the world: "Governance issues form the central obstruction to sound and equitable water sharing and management" [37]. Not only will the integrated development of transboundary waters contribute substantially to the socioeconomic development of the riparian countries sharing them, it could also promote and enhance economic integration in Southern Africa. Such an integrated development of resources for the benefit of all requires enhanced cooperation among the riparian countries sharing them in addition to non-state actors that also play an influential role in determining how shared water resources are used.

## 22.3 The Conflict–Cooperation Problematique

---

The conflict–cooperation problematique is also an ever-present notion in transboundary water resource management. Upstream use determines downstream options in water management, which may set the stage for dispute or cooperation, particularly when combined with notions of water scarcity and competing uses. Particularly among countries with highly developed irrigation systems such as Egypt, Iraq, Syria, Turkmenistan, and Uzbekistan, the dependence on rivers flowing from neighboring countries is so significant that it amounts to roughly two-thirds of in-country water use [38]. Any change in water use patterns in upstream countries therefore has serious adverse affects on the agricultural systems and rural livelihoods downstream [38]. The Tigris–Euphrates Basin, for example, provides water to Iraq, Syria, and Turkey, with a combined population of 103 million. Turkey's Southeast Anatolia Project has therefore raised major concerns since the creation of 21 dams and 1.7 million hectares of irrigated land could reduce flows in Syria by about a third, creating winners and losers within the basin area.

Indeed, there are also those who focus on the conflict potential of accelerating environmental problems such as drought and seawater rise, hypothesizing a linear relationship between population growth and scarcity. Falkenmark's characterization of "water scarcity indicators" postulates that as populations

increase, so too does water scarcity, which leads to competition and potentially conflict [5]. This type of theorization has led other authors to conclude that the inherent linkages between water scarcity and violent conflict predicted the inevitable occurrence of water wars in the twenty-first century.

Homer-Dixon, the most prominent author on the subject of scarcity and conflict, outlines three major sources of environmental scarcity and their interaction [10]. Firstly, supply-side scarcity describes how the depletion and pollution of resources reduce the total available volume. Secondly, demand-side scarcity explains how changes in consumptive behavior and a rapidly growing population can cause demand to exceed supply. And thirdly, structural scarcity occurs when some groups receive disproportionately large slices of the resource pie, leaving others with progressively smaller slices [29]. Homer-Dixon does, however, acknowledge that environmental scarcity is never a conflict determining factor on its own and is usually found in conjunction with other more detrimental causes [10]. As such, environmental scarcity can aggravate existing conflict and make it acute. In Southern Africa, this plays out when marginalized communities are forced to migrate and settle on contested land, thereby bringing these incoming communities into conflict with people who are already struggling to survive. Migrations away from the Kalahari toward the panhandle of the Okavango Delta and migration toward Windhoek in Namibia are two such examples.

Today, the field of transboundary water governance acknowledges that in any given transboundary water basin, localized conflicts and cooperation occur simultaneously and therefore necessitate the continuous negotiation and renegotiation of interests of those that compete and cooperate over its use.

## 22.4 Transboundary Water Resources as Drivers of Development

International river basins are also critically important development drivers in other sectors, and their impact in agriculture and energy production is well known [11]. The interdependence between resources illustrates, for example, how demand for one resource can drive the demand for another and, similarly, how the cost of one resource can determine the efficiency of production of the other. In essence, food production requires water; water extraction, conveyance, treatment, and distribution require energy; and energy production requires water. Environmental pressures and climatic changes, as well as economic and population growth accompanied by increasing urbanization, intensify the interactions between the three systems. The policies related to different sectors of the economy could intensify or attenuate these interdependencies or, worse, ignore the impact of one on the other and adversely impact the overall water–energy–food nexus.

Despite these and many other inherent interlinkages, traditionally, water, energy, and/or food security have been managed in silos, paying little, if any, attention to their linkages. These interconnections are often ignored when policy-makers devise partial responses to problems affecting one particular sector without acknowledging the impact on other resources. Other barriers to integrated resource management are linked to the increasing institutional complexity between shared basins and the potential challenges this poses to regional economic integration. However, existing institutional complexity also presents opportunities for the water sector to increasingly integrate with other sectors in terms of decision making in agriculture, energy, industry, and urban development in particular [11]. International river basins are therefore part of an increasingly complex landscape of policies, trading relations, and sectoral demands.

The importance of scale (spatial and temporal) is also critical to our understanding of transboundary water governance and the solutions we propose [19]. Depending on the most appropriate level of scale, different management capacities and skills are required [30]. At the regional economic community (REC) level, for instance, there is a need for system level analysis and outlook. Specifically, there is a need to understand the role of transboundary waters in promoting regional integration by providing valuable services such as energy production, primary products, industry and domestic water use, and ecosystem services [11]. An important discussion to have in this regard relates to the type of institutions that are most appropriate to serve this. Are water-centric institutions such as river basin organizations

in fact the most appropriate vehicle through which to channel development strategies? While they are an important piece (of many) of the puzzle in dealing with natural resource governance and development, they will have to work with other sectors and multi-level institutions to address root causes of problems and issues [11].

## **22.5 Integrated Approaches to Transboundary Water Management and the Preponderance of “Water Silos”**

---

Despite these inherent linkages and the common logic of managing shared resources in an integrated way, historically, the water sector’s approach to problem solving, socioeconomic development, and overall water management has been segmented. Additionally, the water sector experienced a high degree of supply-driven scientific and hydrological engineering innovation based on sound empirical, technically driven expertise that relied heavily on notions of objectivity, quantification, accuracy, verification, and linearity [11].

Sometimes referred to as “hard science,” this positivist scientific paradigm has been seen as the preferred and most reliable type of knowledge to base decisions regarding water management, thus reinforcing the natural and technical science preponderance [11]. This tradition has also produced several limiting consequences to the integrated management of transboundary waters. Firstly, it resulted in the construction of governance “silos” or the development of separate governmental departments of energy, mining, and water. Secondly, it resulted in the formation of legal and institutional “silos”—separate legal and institutional frameworks to govern these sectors. And finally, this tradition has also contributed to the development of knowledge “silos”—separate specialists that have acquired domain-specific expertise to study any one of these issues, often in isolation [11].

The societal response to the “silo” paradigm has therefore been to perpetuate this reality by creating “silo” teaching of university curricula, a lack of social scientists involved in the so-called technical issues, funding agendas that tend to favor natural science methodology and thus support less social science research, an organizational bias favoring natural scientists and technical experts in research organizations, and high-level political decision makers relying on technical experts for the information they need [11].

However, in South Africa, this model and related mindset slowly started to change in the 1980s [14]. New and emerging challenges and complexities, such as climate change, eutrophication, acid mine drainage, skills flight, and social inequality, are demanding more integrated levels of ingenuity and expertise from a diverse set of transdisciplinary backgrounds and a wide spectrum of actors (e.g., scientists, government actors, civil society). No amount of technical and scientific ingenuity is adequate if the solutions generated are not relevant, digestible, and acceptable to the specific sociopolitical and socioeconomic contexts of our time.

## **22.6 Role of Multiple Actors in Transboundary Water Management**

---

### **22.6.1 Institutional and Legal Development**

Sharing a critical and strategic resource also requires strong and robust institutions and a multiplicity of stakeholders, as well as sound legislation to ensure harmony and alignment between states. Over the last few decades, a significant number of formal institutions in the context of interstate diplomacy have emerged to govern transboundary rivers such as international basin committees or transboundary river basin commissions [16]. However, informal processes of institution building have also gained momentum, for example, transnational actor networks that seek to address selected water management challenges. From a legal perspective, cooperation on transboundary water resources often comes in the form of treaty arrangements, in which sovereign states enter into legally binding contractual obligations to

exercise their sovereign authority, with the aim of controlling specific kinds of environmentally harmful behavior on the part of their contractual partners [13].

The roles of institutions in transboundary river basin management often include the provision of a common arena for member states to meet and discuss water management issues, the promotion of information sharing among the various riparians, and the joint production of information [39]. Additionally, the development of coordinated water resources development and management schemes is considered one of the core activities of international river basin institutions [16]. More recently and largely as a result of donor requirements, transboundary watercourse institutions are confronted with an enlarged catalogue of requirements, including the management or at least recognition of linkages to other sectors, understanding and addressing the effects of climate change on water resources management [6], as well as the promotion of participatory approaches and stakeholder engagement [3,12].

However, most international commissions suffer severe capacity constraints and/or are limited by the sovereignty of states in fulfilling mandates beyond information exchange and stakeholder coordination. Very many commissions are understaffed and have only limited scientific capacity to support joint decision making at the international level [16]. Other challenges include the development of relational capital, that is, the ability to forge trustful relationships between riparian states, due to the time it takes for this to be acquired [15,24]. Capacity limitations are also exacerbated by the lack of political will and commitment of governments of the riparian countries to support the tasks of such commissions [16].

In the legal context of transboundary water management, international conventions, most prominently the 1997 UN Convention on the Law of the Non-Navigational Uses of Internationally Shared Watercourses, prescribe how such arrangements should ideally be constructed. The 1997 UN Convention on the Non-navigational Uses of International Watercourses is the only international treaty governing shared freshwater resources that is universally applicable [17,18]. It therefore offers much value as a guiding framework since it shows which countries have committed themselves in theory to the principles of transboundary cooperation such as equitable utilization, the no harm doctrine, ecosystem protection, and prior notification, among others. The principle of “equitable and reasonable utilization” is one of the cornerstones of international water law and, consequently, is enshrined in the International Law Association’s (ILA) Helsinki Rules of 1966 as well as in the UN Convention and the Revised Water Protocol [22].

The UN Convention is not yet in force but guides the development of watercourse agreements at the regional level, most notably the 2000 Revised Protocol on Shared Watercourses of SADC, a legally binding agreement guiding the management of transboundary rivers in the SADC region [9]. An interesting characteristic of the SADC region is that while SADC states (with the exception of South Africa and Namibia) have not ratified the UN Convention, they have all accepted the SADC protocols and, in so doing, have indirectly adopted the principles of the UN Convention (such as equitable and reasonable utilization, no harm doctrine, prior notification, and information exchange).

### 22.6.2 Private Sector

The private sector also plays an important role in national water management, not only in terms of its impact on water quality and quantity but also due to its influence on shaping public policy [16]. Similar mechanisms also occur at the international level, although modes of interaction are less institutionalized than in well-defined national contexts [16]. Businesses are likely to seek to exert their influence through the respective riparian national government of an international river basin, while at the same time, individual governments have considerably less influence to regulate corporate involvement at the transboundary level [16].

However, other industries are also greatly affected by water resources and therefore have an interest in how it is managed. In the South African mining sector, for example, water resources are increasingly becoming contested to the point that capital raising for greenfield projects is at risk [33]. The unintended consequence of this process is that foreign direct investment is being reduced, which can have



a debilitating impact on economic development by virtue of driving a loss of investor confidence in a region. Investors are unable to distinguish between water scarcity as an issue that can be managed and general confidence in a national economy to the level where they feel comfortable enough to invest. This is driving innovation in the private sector where a range of new initiatives are becoming available, suggesting that this sector has a significant role to play in the economic development of areas that are mineral rich but water constrained.

### 22.6.3 Individuals

Apart from collective entities such as institutions and private companies, the importance of individuals to the success or failure of effective environmental governance is also critically important, and various scholars investigated their role in different ways [11]. Andonova and Mitchell investigated the role of individuals in the transformation of informal activist movements to large-scale transnational networks because of their ability to mobilize other individuals against socially destructive environmental abuses [1]. Some notable individuals including Al Gore, Wangari Matthai, Chico Mendes, and Ken Saro Wiwa have assisted in the rescaling of environmental problems from the local level to the international or transnational levels [1]. But it is not only the actions of prominent individuals that have helped to shape the transnational environmental landscape but also the collective action of thousands of largely unknown individuals that contribute to environmental behavioral changes. These individuals, often the targets of transnational networks, either as consumers or as members of households, communities, or professional groups, contribute to environmental degradation (e.g., through the excessive use of aerosols, smoking habits) but also environmental protection (e.g., through the increase in the demand for carbon offsets). They therefore form part of the complex multi-actor landscape that defines transboundary water governance.

In terms of water management specifically, Swatuk [26,27] argues that water governance in Southern Africa (as is the case in other regions) comprises of differently empowered actors who negotiate and renegotiate roles and rights to access water resources. Sometimes these interactions lead to positive outcomes where a close-knitted community of technical experts based on trusting relationships is formed, resulting in a wealth of knowledge and experience in the water sector [11]. Other times, it may result in negative outcomes such as power asymmetries and an epistemic community that acts as a discursive elite, who control what is or is not acceptable practice in the water sector and potentially delegitimizing minority interests. Either way, key individuals work toward persuading their constituencies of the moral appropriateness of specific codes of conduct relating to transboundary water governance and have played a significant role in shaping normative standards of behavior and best practice [11]. The clarity with which legal and institutional frameworks are drafted and implemented is similarly influenced by an individual dimension.

## 22.7 Summary and Conclusions

---

This chapter has sought to provide an overview of the core principles and practices of transboundary water management. Using the SADC region to illustrate complex interactions in the context of transboundary basins, we have demonstrated the crucial need for integrated and adaptive management approaches in order to successfully link water management to other important sectors, such as energy and land management to ensure the overall sustainable socioeconomic development of the riparian countries but also the promotion of regional and subregional cooperation for economic cooperation [11]. International rivers form part of complex landscapes of actors, institutions, policies, and biophysical, socioeconomic, and sociopolitical characteristics, always interrelated and at times also conflicting. We emphasized that not only do national and international institutions affect the management of transboundary rivers, but so too do organizations and actors beyond the riparian states play an increasingly important role.

## References

1. Andonova, L. and B. Mitchell. 2010. The rescaling of global environmental politics. *Annual Review of Environment and Resources* 35: 255–282.
2. Ashton, P.J., D. Hardwick, and C. Breen. 2008. Changes in water availability and demand within South Africa's shared river basins as determinants of regional social and ecological resilience. In *Exploring Sustainability Science: A Southern African Perspective*, eds. M.J. Burns and A.V.B. Weaver, Stellenbosch, South Africa: Stellenbosch University Press.
3. Bruch, C. 2005. Evolution of public involvement in international watercourse management. In *Public Participation in the Governance of International Freshwater Resources*, eds. C. Bruch, L. Jansky, M. Nakayama, and K. Salewicz, pp. 21–72, Tokyo, Japan: United Nations University Press.
4. Eckstein, G. 2002. Development of international water law and the UN watercourse convention. In *Hydropolitics in the Developing World: A Southern African Perspective*, eds. A.R. Turton and R. Henwood, Pretoria, South Africa: African Water Issues Research Unit.
5. Falkenmark, M. 1989. The massive water scarcity now threatening Africa: Why isn't it being addressed? *Ambio* 18(2): 112–118.
6. Falkenmark, M. and A. Jägerskog. 2010. Sustainability of transnational water agreements in the face of socioeconomic and environmental change. In *Transboundary Water Management—Principles and Practice*, eds. A. Earle, A. Jägerskog, and J. Öjendal, pp. 157–170, London, U.K.: Earthscan.
7. Giordano, M. and A. Wolf. 2002. The world's freshwater agreements: Historical developments and future opportunities. In *Atlas of International Freshwater Agreements*. Nairobi, Kenya: United Nations Environment Programme.
8. Granit, J. and M. Claassen. 2009. A path towards realising tangible benefits in transboundary river basins. In *Getting Transboundary Water Right: Theory and Practice for Effective Cooperation*, eds. A. Jägerskog and M. Zeitoun, pp. 21–26, Stockholm, Sweden: Stockholm International Water Institute.
9. Hiddema, U. and G. Erasmus. 2007. *Legislation and Legal Issues Surrounding the Orange River Catchment*. Orange River Integrated Water Resources Management Plan. Pretoria, South Africa: WRP Consulting Engineers.
10. Homer-Dixon, T. 1994. Environmental scarcities and violent conflict: Evidence from cases. *International Security* 19(1): 5–40.
11. Jacobs, I.M. and S. Nienaber. 2011. Waters without borders: Transboundary water governance and the role of the 'transdisciplinary individual' in Southern Africa. *Water SA* 37(5): 665–678.
12. Jansky, L., D.M. Sklarew, and J.J. Uitto. 2005. Enhancing participation and governance in water resources management. In *Enhancing Participation and Governance in Water Resources Management: Conventional Approaches and Information Technology*, eds. L. Jansky, and J.I. Uitto, Tokyo, Japan: United Nations University Press.
13. Karkkainen, B.C. 2005. Transboundary ecosystem governance: Beyond sovereignty? In *Public Participation in the Governance of International Freshwater Resources*, eds. C. Bruch, L. Jansky, M. Nakayama, and K. Salewicz, pp. 73–87, Tokyo, Japan: United Nations University Press.
14. King, J., C. Brown, and A. Sabet. 2003. A scenario-based holistic approach to environmental flow assessments for rivers. *River Research and Applications* 19: 619–639.
15. Kranz, N., T. Menniken, and J. Hinkel. 2010. Climate change adaptation strategies in the Mekong and Orange—Senqu basins, what determines the state-of-play? *Environmental Science and Policy* 13(7): 637–648.
16. Kranz, N. and I. Jacobs. 2012. Leadership capacity in transboundary basins: The interface between institutions and individuals. In *Environmental Leadership: A Reference Handbook*, eds. D. Gallagher, N. Christensen, and P. Andrews, New York: SAGE Publications.
17. McCaffrey, S. 2001. The contribution of the UN Convention on the law of non-navigational uses of international watercourse. *International Journal of Global Environmental Issues* 1(3/4): 250–263.

18. McCaffrey, S. 2001. *The Law of International Watercourses*, Oxford, U.K.: Oxford University Press.
19. Molden, D. and D. Merrey. 2002. Managing water from farmers' fields to river basins: Implications of scale. In *Hydropolitics in the Developing World: A Southern African Perspective*, eds. A.R. Turton and R. Henwood, pp. 141–155, Pretoria, South Africa: African Water Issues Research Unit (AWIRU).
20. Postel, S. 1999. *Pillars of Sand: Can the Irrigation Miracle Last?* New York: W.W. Norton & Company.
21. Revenga, C., S. Murray, J. Abramavotz, and A. Hammond. 1998. *Watersheds of the World: Ecological Value and Vulnerability*. Washington, DC: World Resources Institute.
22. SADC, 2000. *Revised Protocol on Shared Watercourses*. Gaborone, Botswana: Southern African Development Community.
23. SADC, 2011. *Regional Strategic Action Plan on Integrated Water Resources Development and Management (2011–2015) RSAP III*. Gaborone, Botswana: South Africa Development Community.
24. Salamé, L. and P. Van der Zaag. 2010. Enhanced knowledge and education systems for strengthening the capacity of transboundary water management. In *Transboundary Water Management—Principles and Practice*, eds. A. Earle, A. Jägerskog, and J. Öjendal, pp. 171–186, London, U.K.: Earthscan.
25. Savenije, H. and P. van der Zaag. 2000. Conceptual framework for the management of shared river basins, with a special reference to the SADC and EU. *Water Policy* 2: 9–45.
26. Swatuk, L. 2002. The new water architecture in Southern Africa: Reflections on current trends in the light of 'Rio+10'. *International Affairs* 78(3): 507–530.
27. Swatuk, L. 2005. Political challenges to implementing IWRM in Southern Africa. *Physics and Chemistry of the Earth* 30: 872–880.
28. Toepfer, K. 2005. Preface. In *Hydropolitical Vulnerability and Resilience along International Waters: Africa*. Nairobi, Kenya: United Nations Environment Programme.
29. Turton, A. 2000. Water wars in Southern Africa: Challenging conventional wisdom. In *Water Wars: Enduring Myth of Impending Reality*, eds. H. Solomon, and A.R. Turton, African Dialogue Lecture Series, Monograph Series No. 2., Durban, South Africa: Accord.
30. Turton, A.R. 2002. The expanded concept of hydropolitics: Towards a new research Agenda for Southern Africa. In *Hydropolitics in the Developing World: A Southern African Perspective*, eds. A.R. Turton and R. Henwood, pp. 239–245, Pretoria, South Africa: African Water Issues Research Unit (AWIRU).
31. Turton, A. 2003. The hydropolitical dynamics of cooperation in Southern Africa: A strategic perspective on institutional development in international river basins. In *Transboundary Rivers, Sovereignty and Development: Hydropolitical Drivers in the Okavango River Basin*, eds. A. Turton, P. Ashton, and T. Cloete, Pretoria, South Africa: AWIRU and Green Cross International.
32. Turton, A. 2008. The Southern African hydropolitical complex. In *Management of Transboundary Rivers and Lakes*, eds. O. Varis, C. Tortajada, and A.J. Biswas, Berlin, Germany: Springer-Verlag.
33. Turton, A.R. 2013. Can water governance deepen democracy in South Africa? Towards a new social charter for mining. In *International Journal of Water Governance* 1(–2): 65–87.
34. Turton, A. and P. Ashton. 2008. Basin closure and issues of scale: The Southern African hydropolitical complex. *International Journal of Water Resources Development* 24(2): 305–318.
35. Turton, A.R., P.J. Ashton, and I. Jacobs. 2008. The management of shared water resources in Southern Africa. CSIR Report No. CSIR/NRE/WR/ER/2008/0400/C. IMIS Contract No. 2009UNA073263853111. Lusaka, Zambia: United Nations Economic Commission for Africa—Southern Africa (UNECA-SA).
36. Turton, A.R., M.J. Patrick, and R. Rascher. 2008. Setting the scene: Hydropolitics and the development of the South African economy. *International Journal of Water Resource Development (Special Edition)* 24: 319–323.

37. United Nations. 2006. Water a shared responsibility. UN World Development Report 2. UNESCO and Berghahn Books, Paris, France.
38. United Nations Development Programme and United Nations Development Programme. 2006. Human Development Report, Chapter 6: Managing transboundary waters. In *Beyond Scarcity: Power, Poverty and the Global Water Crisis*, pp. 201–231, United Nations Development Programme, New York: Palgrave Macmillan. <http://www.loc.gov/catdir/enhancements/fy0801/2007382796-t.html>.
39. Van Ginkel, H. 2005. Implications of the information society on participatory governance. In *Public Participation in the Governance of International Freshwater Resources*, eds. C. Bruch, L. Jansky, M. Nakayama, and K. Salewicz, pp. 88–97, Tokyo, Japan: United Nations University Press.
40. Wolf, A.T., A. Kramer, A. Carius, and G. Dabelko. 2005. Managing water conflict and cooperation. In *State of the World*, Washington, DC: World Watch Institute.
41. World Resources Institute, United National Development Programme, United Nations Environment Programme, and World Bank. 2000. *World Resources 2000–2001: People and Ecosystems: The Fraying Web of Life*, Washington, DC.



**Olga Eugenia Scarpati**  
*National Research Council  
 La Plata National  
 University*

**Eduardo Kruse**  
*National Research Council  
 La Plata National  
 University*

**Marcela Hebe Gonzalez**  
*National Research Council  
 Buenos Aires University*

**Alberto Ismael Juan Vich**  
*National Research Council  
 Cuyo National University*

**Alberto Daniel Capriolo**  
*National Research Council*

**Ruben Mario Caffera**  
*Uruguayan State University*

# Updating the Hydrological Knowledge: A Case Study

---

23.1	Introduction .....	446
23.2	Pampean Plain (Argentina Republic).....	446
23.3	Extreme Hydrological Events in Buenos Aires Province, Argentina .....	449
23.4	Oriental Republic of Uruguay.....	450
23.5	Andes Mountain Range (Argentine Republic).....	452
	Fluvial Regime • Detecting Gradual and Abrupt Changes in Runoff	
23.6	Comahue Region (Argentine Republic) .....	456
	Study of the Rainfall in Comahue Region	
23.7	Summary and Conclusions .....	458
	References.....	458

## AUTHORS

**Olga Eugenia Scarpati** is a researcher at the Center of Pharmacological and Botanical Studies of the National Research Council and professor of Physical Geography I (Climatology) at the Geography Department of La Plata National University, Argentina. Member of the Steering Committee, Commission for Water Sustainability of International Geographical Union. Main themes: agrohydrology and climatology.

**Eduardo Kruse** is a researcher at the National Research Council and a professor of general hydrology in Faculty of Natural Sciences, La Plata National University, Argentina. He has published many papers dealing with flatland hydrology, interaction of surface water and groundwater, and hydrochemistry. Main themes: hydrological and hydrogeological processes in coastal areas.

**Marcela Hebe Gonzalez** is a researcher at the Center of Atmospheric Sciences at the National Research Council and a professor of general meteorology in the Department of Atmospheric and Oceanic Sciences of Buenos Aires University, Argentina. Main themes: statistical seasonal rainfall forecasting in Argentina.

**Alberto Ismael Juan Vich** is a researcher at Argentine Institute of Snow, Glaciology and Environmental Sciences of National Research Council. He is a professor and the director of Environmental Studies and Natural Resources Institute belonging to Cuyo National University, Argentina. Main themes: hydrology and water resources.

**Alberto Daniel Capriolo** is a researcher at the Center of Pharmacological and Botanical Studies National Research Council, Argentina. He has achieved numerous computing programs of hydrological models. Main themes: scientific computation and software, agrohydrology, and climatology.

**Ruben Mario Caffera** works in Environmental System Unit, School of Agronomy, Uruguayan State University, Uruguay. He is a member of the staff, Multi-country Study on Eco-Bio-Social Research on Dengue and Chagas Diseases in Latin America and the Caribbean UNICEF/UNDP/World Bank/WHO. His main themes are meteorology and climatology.

## PREFACE

In this chapter, the hydrology of the southern region of South America is updated. The study region belonging to Argentina and Uruguay Republics has a surface of 3,110,223 km<sup>2</sup>. It presents high diversity in its environments, a large Atlantic coast, important mountain masses, vast plains of temperate climate, watersheds of great potential for multiple use, different types of climate, and high availability of natural resources that are associated with the natural basis of the settlement and national economic activities, although some are not sufficiently valued and have been degraded by uncontrolled human intervention. The location and size of both the countries determine a diversity of landscapes and several water regimes. This situation is exacerbated by the high irregularity in the distribution of annual precipitation. The Andes Range and the air masses from the Atlantic and Pacific Oceans are the main regulator of the water cycle.

An important surface of Argentina and almost whole Uruguay belong to Del Plata basin, one of the biggest of the world with 3,200,000 km<sup>2</sup> and which includes other basins of secondary order as those of Paraná, Uruguay, Paraguay, and Bermejo y Pilcomayo Rivers and some of the third order as Iguazú, Entre Ríos province rivers, Pasaje–Juramento–Salado and Carcarañá Rivers. All of them complete the system cited earlier in the considered countries.

The rivers are of pluvial regime with annual precipitations varying from 2000 mm at east of La Plata Basin to 700 mm at its northwestern area. Seventy-five percent of Argentine and Uruguayan populations live there and develop the main productive activities.

This very important region has an important problem: According to a study completed in 1996, the density of hydrological and meteorological stations is low compared with WMO standards. This remarks that there is need for more information to increase the hydrological knowledge.

## 23.1 Introduction

The aim of this chapter is showing some advances realized in some areas of Argentina and Uruguay, concerning climate variability and its influence over the hydrology of the region. The different Argentine regions analyzed are Pampean Plain with a special study of extreme hydrological events (EHEs) in Buenos Aires Province (BAP) and the behaviors of the rivers of the Andes Mountain Range and those of Comahue.

Water use is dominated by agriculture, and the irrigated areas are growing according to the development in the whole region, so water sustainability is a major theme to be considered in the future.

## 23.2 Pampean Plain (Argentina Republic)

From a hydrological perspective, large flatlands occurring in humid climates are characterized by a predominance of vertical water movements (i.e., evapotranspiration and infiltration) over horizontal ones (i.e., runoff), and by a strong interrelationship between surface water and groundwater. Such is the case of the Pampean Plain in Argentina and the territory of Uruguay (Figure 23.1). Both of them are almost totally included in La Plata Basin.

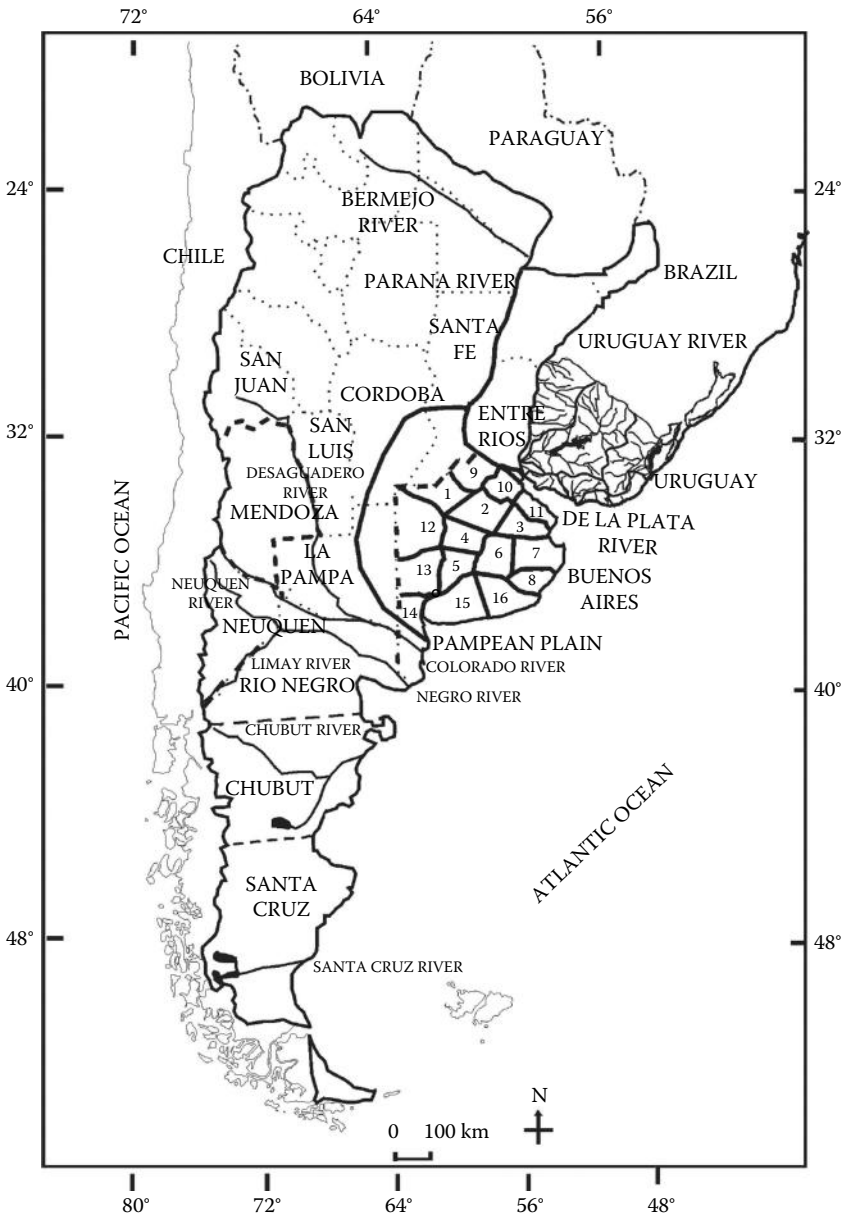


FIGURE 23.1 Southern region of South America.

The Pampean Plain covers approximately 500,000 km<sup>2</sup>, with predominant heights below 200 m above mean sea level. It is covered by Quaternary sediments, predominantly silty (loess), which overlie several sedimentary basins of different ages and geological origins.

The landscape is characterized by low topographic slopes (on the order of 1 per 1000 and even below 0.5 per 1000), low drainage density, and the presence of relatively permeable materials on the surface.

The climate is temperate, with a mean annual temperature of 17°C. The mean annual rainfall is on the order of 1000 mm, decreasing toward the west and south. Dry and rainy seasons, which may modify significantly the hydrological conditions, can be observed.



The terms of the hydrological balance in the Pampean Plain have a relevance different from an area with steeper slopes. Such slight slope causes a decrease in surface runoff, which implies a longer period of contact between the water and the surface, increasing infiltration and evapotranspiration. The vertical transport of water and the storage occurring in depressions, the unsaturated zone (USZ), and the saturated zone (SZ) stand out. Besides, there is an influence of interception storage in cultivated areas, depending on their areal coverage and growth stages. Temporary or permanent depression storage is also a significant component, and therefore the simulation models must consider them.

Water movement in the USZ, which connects the surface and subsurface hydrological processes, is a primary objective in the study of the plain.

The combination of geomorphological and climate factors determines hydrological systems ranging from an integrated drainage network to a lack of drainage. In the former case, there is local surface runoff toward the watercourses and regional runoff toward a final point of discharge. In other cases, the lack of watercourses causes that, when precipitation occurs, water fails to have enough energy to run off toward a specific point of discharge.

The slight slope favors the moderating influence of depression storage. Frequently, a drainage basin cannot be determined, as transferences between its divides occur, and in certain cases, there is a plurality of drainage exit points. The drainage network is not a reflection of the weather, and in general, it is modified by anthropogenic activities, such as channelizations or hydraulic works, which seriously distort the natural drainage network. Often, the concept of self-similarity, which expresses the similarity in hydrological response between a portion and the totality of the system, cannot be applied.

In the subsoil, there is local and regional groundwater flow [5]. Locally, groundwater flow is active, and once it has covered a certain stretch, it is discharged into streams or lakes, becoming their base flow. Regionally, groundwater flow is passive and extremely slow, which in a vast plain is caused by the difference between the input and output volumes of local groundwater flow and which must be related to the sedimentary thicknesses of the subsoil in the plain.

The characteristics mentioned earlier and the presence of a shallow water table cause the water in streams and lakes as well as groundwater to be directly related, which is why they should be treated as a single unit.

Possible behaviors may be considered for different areas of the Pampean Plain, taking into consideration whether they occur under dry or wet hydrological conditions. Under wet conditions, input is higher than output. The degree of difference causes a decrease in groundwater storage capacity (rise in the water table) and/or depression storage capacity (increase in flooded areas). Under dry hydrological conditions, output is higher than input. The deficit is compensated for by geological storage, increasing the groundwater storage capacity (deepening of the water table) and/or depression storage capacity (decrease in water level in lakes).

Thus, in order to become acquainted with the hydrological situation, it is relevant to assess the rainfall variations, the influence of evapotranspiration, and the evolution of the water tables and of the areas covered by surface water [6].

Given the hydrological processes that characterize the Pampean Plain, it is necessary to define which are the most relevant elements to be measured, and how and where to do so, once a conceptual model to represent the behavior of the system has been defined.

Measuring the terms of the balance and the vertical exchange of water is necessary, as the latter predominates in the processes occurring in plains. In order to do so, apart from carrying out conventional measurements, depression storage should be assessed by means of accurate topographic surveys.

In the USZ, soil moisture content and potential, from the surface to the water table, including the hydraulic properties of the unsaturated porous media, should be measured.

In the SZ, the variations in the water table and the piezometric level of the underlying aquifers should be recorded.

By means of remote sensing (i.e., aerial photography and satellite imaging), systematic assessments may be carried out concerning the variations in time of the percentage and type of plant coverage, surface storage, soil moisture, rainfall field, heat flow, and areal evapotranspiration, among other variables.

The objective of quantifying the hydrological processes in the Pampean Plain must contribute toward improving the use of water and natural resources in general. This requires not only the knowledge of the current situation, but also the prediction of possible system behavior under different conditions, extreme or not, natural or induced. Such a simulation should try to represent the peculiarities of plain systems, which is why the available conceptual models developed within the framework of classical hydrology are difficult to apply and sometimes even inadequate. It is necessary to adapt or develop simulation models that are adequate for plain hydrology. Even though it is advisable for hydrological models to be developed on the basis of physical parameters, in certain cases, when confronted with uncertainties or heterogeneities, it is convenient to make adjustments in order to achieve a better identification between the model and the prototype.

During the calibration of models adequate to run simulations in plains, it has been proved that groundwater processes (e.g., observable in the system by means of the water tables) and surface hydrological processes (e.g., observable by means of the runoff volume) are highly sensitive compared to the parameters characterizing the USZ. This highlights the key role of the USZ in water table recharge and infiltration, which are the processes interconnecting surface and groundwater hydrology.

In the development of the different stages of calibration, the impossibility of making partial adjustments to the parameters governing surface and groundwater hydrology becomes evident, so a global calibration is necessary, including all of the parameters as a whole. The objective function should contemplate a reliable prediction of surface runoff, groundwater recharge, and water tables, as well as their evolutionary tendencies in time.

### 23.3 Extreme Hydrological Events in Buenos Aires Province, Argentina

---

BAP is located in the main rain-fed region of Argentina, the Pampean Plain, and presents a lot of cities of different importance and population. The main soil uses are crops (maize, wheat, and soybean) and livestock for meat or milk production. EHEs are a constant in BAP, and their impacts mainly over the agriculture have been studied with different scales and point of views.

The analysis of the disasters database in Argentina during the period 1974–2002 shows the prevalence of floods, not only because more than 60% of the records correspond to this type of disaster but also because they are the most recurrent and with high negative impact in terms of social and economic effects. The other one is drought, which was very important during 2008 and the summer 2011–2012.

Soil moisture is a significant hydrological variable related to floods and droughts and plays an important role in the process of converting precipitation into runoff and groundwater storage and controls the interaction of the land with the atmosphere.

BAP is a large plain with elevations below 300 m and its surface 307,571 km<sup>2</sup>, and it presented significantly increased precipitation during the last decades [3].

The El Niño–Southern Oscillation (ENSO) remote influence on the climate variability of such region has been extensively documented, and there is some evidence that El Niño events have been stronger in recent decades. They appear to be both a giver and a taker in climate change [4,7].

The drainage system of the BAP can be divided into 16 sectors according to their basins [1] and can be seen in Table 23.1 and in Figure 23.1.

The spatial and temporal variabilities of soil water storage were examined using Thornthwaite and Mather soil water balance method, daily precipitation data, and normal daily mean reference evapotranspiration estimated by the Penman–Monteith formula and with soil hydrologic constants—field capacity and permanent wilting point—calculated by means of soil data measured *in situ*.

**TABLE 23.1** Sectors of the Drainage Areas Studied

Sector	Name
S1	Northwestern area of the Salado River basin
S2	Central area of the Salado River basin
S3	Salado River mouth
S4	Southern area of the Salado River basin and northern area of Vallimanca River basin
S5	Southern area of the Salado and Vallimanca river basins
S6	Western Channels area at south of the Salado River basin
S7	Channels area at south of the Salado River
S8	Southeastern basin and streams
S9	Arrecifes River basin
S10	Northeastern stream basins
S11	Drainage basin of the La Plata River at the South of Samborombon River
S12	Region without surface drainage
S13	Lagoon area at the southwest
S14	Small rivers and streams with Atlantic drainage
S15	Basins and streams of south (to west)
S16	Basins and streams at south (to east)

The results of the soil water balance, soil water deficit (SWD), and soil water surplus (SWS) were considered triggers of EHE in the BAP. Their temporal and spatial distributions were analyzed using the nonparametric test Mann–Kendall and then an Excel template—MAKESENS—for detecting and estimating trends in the time series of annual values of soil water components.

Tables 23.2 shows the trends and temporal distributions of SWS for different periods.

The resulting trends are not at all statistically significant. During the total studied period (1969–2008), trends are not important; almost all sectors remain stable. SWS trends have three  $\alpha = 0.1$  and one  $\alpha = 0.05$ , and the SWD trends present four  $\alpha = 0.1$ , three  $\alpha = 0.05$ , and only one  $\alpha = 0.01$ .

The EHEs always have different areal distribution, but according to these tables, some patterns can be seen. During 1969–1988, there was a humid period of increasing soil water trends with the exception of Sector 16, mainly during 1969–1978, since 1989 SWDs are increasing in almost all sectors.

## 23.4 Oriental Republic of Uruguay

Uruguay has as striking physiographic feature and a relatively low landscape too. Situated in a climate transitional zone, the Uruguayan territory shows peculiar patterns. There is not a proper dry season in the area. Nevertheless, westward in the “Litoral,” there are two rain maxima centered in spring and autumn jointly with a steep winter minimum. But in the South Eastern portion of the country (Merin Lagoon and Atlantic watersheds), the double peak is shifted forward in a way that the main maximum is during winter and the beginning of spring, the second one lying in late summer (February–March), with the more steep minimum starting late spring (November) and lasting deep into summer (December–January). These patterns persist after the early signs of climate change occurring mainly in the 1980s. These changes imply a general increase in the precipitation regime mainly in central and southern regions of the Rio de la Plata Basin. On an annual basis, the significance of this trend in the Uruguayan territory is referred to the 1948–2000 period. However, from 2004, a number of vacillations in the precipitation patterns occur, with severe droughts (2004, 2008) and big floods (2002), the time length being too short to confirm a new shift in trend of the climatic system in the area. That is why it is common to find that the former annual rainfall values, lying from

**TABLE 23.2** Trends and Temporal Distribution of Soil Water Surplus (mm)

Sector	Period				
	1969–2008	1969–1978	1979–1988	1989–1998	1999–2008
S1	=	=	↑	=	↓
S2	=	↑	↑	=	↓
S3	=	↑	↑	↓	↓
S4	=	↑	↑	↑	↓
S5	=	=	↑	=	↓
S6	=	↑	=	↓	↓
S7	=	↑	↑	↑	↓
S8	=	=	↓	=	↓
S9	=	↑	↑	=	↓
S10	↓	↑	↑	↓	↓
S11	↑	↑	=	↓	↓
S12	=	↓+	↑*	↑	↓+
S13	=	↑	=	=	↓+
S14	=	↑	↓	=	=
S15	=	=	↓	=	↓
S16	=	=	=	=	↓

Notes: ↓ diminution, ↑ increase, and = no variation, + significant trend at level  $\alpha = 0.1$ , \*  $\alpha = 0.05$ .

near 1400 mm northeastward and near 1000 mm in the southeastern bottom, increased by 12%–20% for the period 1982–2003.

But the more typical feature in the Uruguayan precipitation regime is its variability. Conceivably because of the transitional climate features, the variability in monthly precipitation regimes is quite high along the year where March and September are the more stable months in the year, February and April being the more variables.

The seasonal variability, taking into account by the coefficients of variation of 26 raingauges for a long period (1948–2008), is not stable in the decennial timescale. An attempt to deal with new trends shows a decrease in monthly variability roughly in the whole country in October and in April—although this month remains one of the more variable between years—and an increase in variability in the southern part of the country in March and notably in the north in December. These trends are not outlined in the mean flow patterns in the hydrological outlooks cited later. It is to mention that even with these changes, multiannual monthly isohyets remain meridional in the winter months and zonal during summer, with transitional regimes in the intermediate seasons.

In spite of the absence of a proper dry season, the summer “thermal efficiency” of the Köppen Classification implies very high values of evapotranspiration during summer almost tripling those of the winter and determining water deficits in soils in the middle of the warm season. For official and practical purposes, the country has been divided into six “macro-watersheds” Rio Uruguay River (45,750 km<sup>2</sup>), de la Plata River (12,400 km<sup>2</sup>), Atlantic Ocean (8,600 km<sup>2</sup>), Merin Lagoon (28,700 km<sup>2</sup>), Negro River (68,350 km<sup>2</sup>), and Santa Lucia River (13,250 km<sup>2</sup>).

Four of these water bodies are shared with neighboring countries, while the Santa Lucia River pertains entirely to the Uruguayan territory and the Negro River has only a very small portion in Brazil. The Merin Lagoon is currently connected in the Brazilian territory to the Los Patos Lagoon by a canal. The Atlantic “macro basin” discharge is mainly indirectly through coastal lakes (from west to east: José Ignacio, Garzón, Rocha, Valizas, and Negra) with an intermittent surface flow to the sea. Most of the streams discharging in La Plata River and in the Atlantic Ocean show a sandy bar, but even so, salty

waters penetrate several kilometers into each of them because of the intermittent river flow intensity and steady favorable wind conditions.

On the other hand, the entire Uruguay River is the second tributary of the big La Plata Basin, with different precipitation regimes. Particularly important are the precipitation originated by summer season mesoscale convective complexes, and winter synoptic activity, producing mostly liquid precipitation. The low-level jet east of the Andes that supplies moisture from tropical South America to the La Plata Basin is observed throughout the year (with some changes in the core's height), supplying moisture and heat from warmer regions at all times of the year, favoring precipitation during both the warm and cold seasons [2]. The entire Uruguay River has a basin of 365,000 km<sup>2</sup> and a mean flow of about 4,500 m<sup>3</sup>/s. It shows a varied relief along its 1500 km length, with many small valleys and short water courses. The terrain slope is 0.104 m/km and the fluvial one 0.086 m/km. The longitudinal gradient of the basin is small, while the transverse section of the basin is comparatively narrow, so the lag between river discharge and rainfall is small. This discharge is related to ENSO events more accurately in the Uruguay River than in the river basins belonging to the Uruguayan country. Both are related strongly with the cold phases (La Niña) pronouncing ebbs and, in a weaker way, with the warm phases with high discharges.

For the Uruguayan territory [8,9], different parameters of the main basins can be seen in Tables 23.3 and 23.4.

### 23.5 Andes Mountain Range (Argentine Republic)

The Andes Mountain Range is the main water cycle regulation system at the continental level. All human activities in the Andes are associated with the mountain range hydrologic cycle. There is evidence that important changes such as the retreat of ice sheets affect the magnitude and seasonality of runoff [10]. The runoff regimes of the main rivers rising in the eastern slope of the Andes in the Argentine Republic are studied in the following text, and special emphasis is laid on the detection of jumps and long-term trends.

The Andes Mountain Range contours the Pacific Ocean coast for 7500 km. It extends from Panama (11°N latitude) down to its southern end (56°S latitude), where it sinks into the Atlantic east of island Isla de los Estados (Argentina). It was formed at the end of the late Cretaceous period as a result of the Nazca plate subduction underneath the South American plate. The tectonic forces brought on by this collision have shaped the configuration of the present relief: high mountains, extensive high plateaus (high cold plateau), deep longitudinal valleys, and transverse valleys in Argentina and Chile.

**TABLE 23.3** Summary of Averaged Seasonal Values for Regionalized Gauged Basins

Regions	Precipitation (mm/Month)				Thornthwaite ETP (mm/Month)			
	Annual	April– July	August– November	December– March	Annual	April– July	April– July	December– March
Northern Litoral	114	113	103	126	70	43	43	107
North central	121	128	102	134	71	45	45	109
Northeast	131	133	119	140	69	44	44	105
Southern Litoral	103	87	94	127	67	41	41	105
Southwest	97	88	93	109	66	43	43	100
South central	106	108	104	107	65	42	42	99
East central	121	131	116	117	67	44	44	102
East	118	126	109	120	65	43	43	99
Southeast	106	112	103	102	63	43	43	94

*Note:* Quarterly and annual precipitation and potential evapotranspiration calculated by Thornthwaite method (1980–2004).

**TABLE 23.4** Summary of Averaged Seasonal Values for Regionalized Gauged Basins

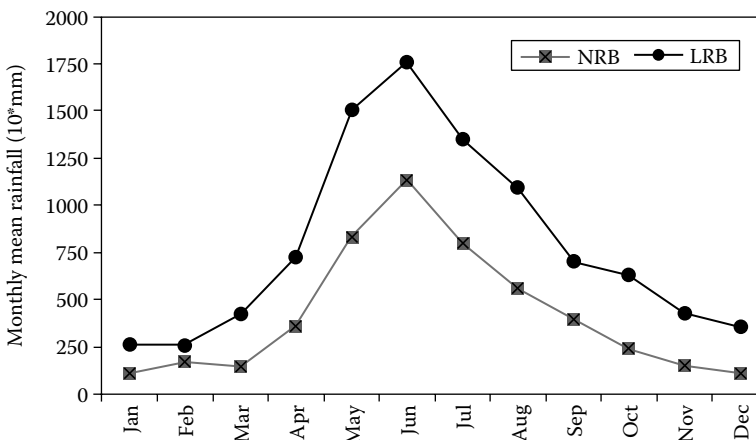
Regions	Runoff Coefficient			Runoff Sheet (mm/Month)				
	Annual	April–July	August–November	December–March	Annual	April–July	April–July	December–March
Northern Litoral	0.35	0.49	0.32	0.16	40	61	36	24
North central	0.38	0.52	0.33	0.20	46	73	35	30
Northeast	0.43	0.54	0.45	0.20	56	76	56	35
Southern Litoral	0.31	0.40	0.33	0.19	32	37	32	26
Southwest	0.21	0.26	0.23	0.10	20	24	23	13
South central	0.34	0.41	0.37	0.13	36	49	41	17
East central	0.37	0.47	0.40	0.15	45	67	48	21
East	0.41	0.46	0.51	0.18	49	63	57	26
Southeast	0.35	0.40	0.41	0.15	37	48	45	17

Note: Quarterly and annual runoff coefficient and runoff sheet (1980–2004).

The Andes range regulates the flow of air masses from the Atlantic and the Pacific and shapes the fluvial regime of the rivers originating on its slopes. The area under study is the basins on the eastern slope of the Andes northwest of Argentina and Patagonia along a wide latitudinal gradient that extends practically all over the national territory. The Andes are known by different names along their strike (Figure 23.2).

The hydrological year runs from September to August for the rivers in the north of Argentina (Cordillera Oriental, Sierras Subandinas, and Sierras Pampeanas); from July to June, for the rivers corresponding to the Cordillera Frontal, Principal, and Precordillera, including the Colorado River; and from April to March for the Patagonian rivers (Cordillera Principal, Patagónica, Antecordillera, and Sierras Patagónicas), with the exception of the Santa Cruz River for which the hydrological year runs from September to August. The fluvial regimes are classified according to the seasonal variations in the volume of water, using Parde’s classification.

The Arid Diagonal, which traverses the South American continent from the north of Peru to the Patagonian coast, could be considered as the boundary of the Atlantic and Pacific influences on the Andes. This area with little rainfall is the boundary between the quasi-monsoon (Atlantic) and Mediterranean (Pacific) climates on the slopes of the Cordillera. There are seasonal, annual, and long-term fluctuations that respond, among other factors, to latitudinal variations in the pressure fields of



**FIGURE 23.2** Mean annual cycle of rainfall in NB (gray, square points) and LB (black, circle points).

South America. From December to February, the Atlantic influence is stronger on the eastern slope of the Andes between 22°S and 35°S latitude, while the Pacific influence is stronger in winter. This atmospheric dynamics gives rise to different rainfall patterns. More than 50% of the total annual rainfall is concentrated north of 28°S, with a quasi-monsoon rainfall pattern and heaviest rains occurring between December and February. In the Cordillera Principal, rainfall originates in the Pacific and occurs from May to August. In the Patagonia, with a Mediterranean climate regime, rainfall originates in the Pacific and occurs in winter; summers are dry. South of 45°S–47°S, rainfall is mainly of Pacific origin and is evenly distributed year round.

### 23.5.1 Fluvial Regime

The Bermejo River basin straddles Bolivia and Argentina. The river rises in the eastern slopes of the Cordillera Oriental and Sierras Subandinas. The basin collects surplus water from the mountain front between 21°S and 25°S. The area is characterized by intensive erosion processes and heavy summer floods. Precipitation seasonality and intensity in the upper basin affect erosion rates on bare soils and on the steep relief. The Sierras Pampeanas receive more than 1800 mm/rainfall per year on the eastern slope. The Sali-Dulce endorheic basin originates in a mountain arch (heights up to 5000 m) between 26°S and 28°S and discharges into the Mar Chiquita lake system. The river headwaters have a very dense natural drainage network, significant flows, and marked seasonality; the Las Cañas River is representative of this part of the Sali-Dulce basin. The Bermejo and Las Cañas rivers have a tropical rainfall regime with rainfall concentrated in the summertime and extending beyond it to give rise to a characteristic hydrologic regime.

The central-western part of Argentina, between 28°S and 33°S, is drained by the vast hydrographic system of the Desaguadero–Salado–Chadileuvú River. From north to south, it includes the Bermejo River and the Jachal, San Juan, Mendoza, Tunuyán, Diamante, and Atuel rivers that rise in the Cordillera Frontal, Precordillera, and Cordillera Principal. After leaving those elevations, the rivers become allochthonous, and in the plains, they are used for irrigation purposes, and the rest of their flows is lost by infiltration. The Pincheira River, with a significant specific water flow, is a small affluent of the Malargüe River and an inlet to the Bañados de Llancanelo (wetlands, endorheic basin).

There are different hydrological regimes in the area. One of them is the mountain nival regime, in which the orographic effect of the cordillera contributes to a more lasting source of water. The melting period is more or less prolonged and not too marked due to the altitude gradient in the basin. This leads to decreases in temperature and evaporation and to increases in the fraction of solid precipitation. The sequence of occurrence of high flows results in two subtypes. The first one, the nival–glacial subtype (December, January, February, and November), which is characteristic of the Mendoza and Diamante River basins, receives water from snowmelt accumulation; snowmelt proceeds upward and is regulated by temperature increases during the warm months. The second is the purely nival regime subtype (December, January, November, and February), which is characteristic of the San Juan River basin: snow accumulates from April to September and melts completely during the warm months from November to February.

Due to their latitude and altitude, the Cordillera Frontal and Cordillera Principal have a significant glacier-covered area, so that water contributions to the basin are the product of glacier ablation and snowmelt. This regime, which differs from the others in the flooding period, also has two subtypes. The classic glacial subtype (January, February, and December), characteristic of the Mendoza River basin, and the glacial atténué subtype, with high waters occurring earlier than that in the former subtype and a sequence of maxima in January, December, and February. Surface glacier ablation causes great and outburst floods depending on the magnitude of the rise in temperature. Continuous in-depth melting ensures minimum water flows in winter. The regime of the Tunuyán and Atuel rivers is of the glacial atténué subtype. The Pincheira River has a purely nival regime with maximum water flows occurring in December, January, November, and February.

The Colorado is an allochthonous river formed by the confluence of the Grande and Barrancas rivers. It drains the Cordillera Principal between 35°S and 37°S along a 270 km front. In its medium reach, it sometimes receives very limited flows from the Desaguadero–Chadileuvú–Curacó system. The Grande River is the largest of all Andean rivers in the Cuyo region. The regimes in the basin are of the nival *atténué* or transitional snow type with a greater influence of the pluvial component. The purely nival regime in the upper basin is the result of the combined regimes of its affluents. The pluvial component is greater downstream and leads to a fluvial regime of the nival–pluvial type; spring rains anticipate flood peaks.

The Negro River, formed by the Limay and Neuquén rivers, collects rainwater and snow- and ice-melt water from an important mountain front located between 37°S and 41°S on the Cordillera Patagónica and from the mountain range Patagónides. The complex drainage system of the Limay has 40 glacier lakes of significant size and depth. The Neuquén River differs from the Limay in rainfall pattern: rains are much less abundant, they tend to be seasonal, and there are practically no lake basins. The Chubut River basin extends from 41°S to 44°S. Its headwaters receive numerous tributaries from the mountain range Patagónides, and it becomes allochthonous downstream as it runs through the Patagonian plateau. The regimes in the basins are the result of a mixture of solid (snow and ice) and liquid (rain) contributions from the upper basins. Their main characteristic is that there are two flood peaks and two low-water-level periods, though not always clearly marked. The upper basins are characterized by snow-melt and glacier ablation and by high water levels in the spring, which are rapidly depleted. Rainfall occurs in winter and gives rise to a nival–pluvial Mediterranean regime, while in the lowlands, it results in a pluvial–nival Mediterranean regime. These regimes are regulated by numerous lakes that act as natural reservoirs. Flood waves caused by snowmelt and rains are similar and lead to a flow with two maxima (July and November).

The Santa Cruz is the second most important river in Patagonia after the Negro River. Its headwaters lie in the Southern Patagonian Ice Fields between 49°S and 51°S. It is the outlet for lakes Viedma and Argentino, which are connected by the La Leona River. The waters of both lakes originate from snow-melt and glacier ablation. The Santa Cruz is an allochthonous river up to the point where it discharges into the Argentine Sea. It is a typical example of a glacier-melt fed river, with glacier-melt contributions from lakes Argentino and Viedma. It has one peak flow event in March and one low-flow event in September. The abrupt changes in the Santa Cruz River levels are due to sudden flood waves triggered by ice calving on the Perito Moreno Glacier.

### 23.5.2 Detecting Gradual and Abrupt Changes in Runoff

In order to detect gradual and abrupt changes in fluvial regime, several tests were conducted at 30 sites (gauging stations) to assess the maximum daily flow; the daily flow exceeded 355 days in a year and the annual flow series. Changes in trend were detected in 28% of the series, mostly during low water periods. Annual flows show a positive trend only in the Bermejo, Las Cañas, Tupungato, Mendoza, and Atuel rivers. The maximum daily flow tends to be higher in the Bermejo, Mendoza, Salado, Atuel, and Neuquén rivers, but it probably decreases in the Limay River. The maximum daily flow occurs earlier in the Las Cañas River and later in the Los Patos River. In both cases, the magnitude does not change. According to hydrologic records, the minimum daily flow tends to be higher in most of the sites under study except in the Neuquén, Limay, and Chubut rivers, where the minimum flow is likely to be lower. Only the Bermejo and Mendoza rivers show statistically significant trends in most hydrological variables.

The methods for determining abrupt changes in the hydrological variable series yield relatively different results. This is so because in most cases, the basic assumptions for the tests are not met and give rise to a significant degree of uncertainty. The break point occurs in the 1970s, when there is evidence of changes in the annual and minimum daily flow hydrological variables at most of the gauging stations included in the study. Changes in the Patagonian rivers Limay, Chubut, and Santa Cruz are negative (Table 23.5). Since different methods have been used, a restrictive criterion was adopted based on the fact that in order to accept the condition under analysis, none of the methods should reject the null hypothesis.



**TABLE 23.5** Trends and Jumps in Some Variables of the Rivers

Basin	South Latitude	West Longitude	Trend			Jumps		
			Q <sub>max</sub>	Q <sub>355</sub>	Q <sub>YEAR</sub>	Q <sub>max</sub>	Q <sub>355</sub>	Q <sub>YEAR</sub>
Bermejo	22°43'	64°22'	ns	+	+	ns	1978 (+)	1972 (+)
	23°06'	64°13'	+	+	+	1974 (+)	1980 (+)	1973 (+)
Las Cañas	27°24'	65°59'	ns	+	+	ns	1975 (+)	1972 (+)
Los Patos	31°57'	69°42'	ns	+	ns	ns	1978 (+)	1977 (+)
	31°53'	69°41'	ns	+	ns	ns	1978 (+)	1945 (-)
San Juan	31°20'	69°06'	ns	ns	ns	ns	1982 (+)	Ns
	31°32'	68°53'	ns	+	ns	ns	1978 (+)	1945 (-)
Vacas	32°61'	69°46'	ns	ns	ns	1972 (+)	1972 (+)	1972 (+)
Cuevas	32°51'	69°46'	ns	+	ns	1977 (+)	1978 (+)	1972 (+)
Tupungato	32°51'	69°46'	ns	ns	+	1978 (+)	1979 (+)	1977 (+)
Mendoza	32°51'	69°16'	+	+	+	1977 (+)	1978 (+)	1977 (+)
Tunuyan	33°47'	69°25'	ns	+	ns	ns	1979 (+)	1972 (+)
Diamante	34°40'	69°19'	ns	ns	ns	ns	1980 (+)	ns
Atuel	35°05'	69°36'	ns	ns	ns	ns	ns	ns
	35°04'	69°07'	ns	ns	ns	ns	ns	ns
	35°02'	68°52'	+	+	ns	1972 (+)	1978 (+)	1978 (+)
Salado	35°13'	69°46'	+	ns	ns	1977 (+)	1952 (-)	1972 (+)
Pincheira Grande	35°31'	69°48'	+	ns	ns	1982 (+)	1978 (+)	1978 (+)
	35°19'	70°18'	ns	+	ns	1987	1991	1987
	35°52'	69°53'	ns	ns	ns	ns	ns	ns
Valenzuela	35°19'	70°18'	ns	-	ns	ns	ns	ns
Chico	35°48'	70°05'	ns	ns	ns	?	?	?
Poti Malal	35°52'	69°57'	ns	ns	ns	ns	1985	ns
Colorado	37°06'	69°44'	?	?	ns	?	?	1977 (+)
Neuquén	38°32'	69°25'	+	ns	ns	1971 (+)	1967 (-)	1913 (+)
Limay	40°32'	70°26'	ns	-	ns	Ns	1940 (-)	1952 (-)
Chubut	42°06'	71°10'	ns	-	ns	1983 (-)	1991 (-)	1985 (-)
	43°51'	68°30'	ns	ns	ns	ns	1966 (+)	1985 (-)
Santa Cruz	50°16'	71°54'	ns	+	ns	ns	1994 (+)	ns

Notes: ns, non significance at level  $\alpha=0.05$ ; +, positive trend at level  $\alpha=0.05$ ; -, negative trend at level  $\alpha=0.05$ ; ?, no data.

## 23.6 Comahue Region (Argentine Republic)

The Comahue region is located in the area of the Andes Mountain Range, between 38°S and 43°S encompassing the Argentinean provinces of Neuquén, which limits with Neuquén River in the north and Limay River in the south. There, the low-level flow prevails from the west, and moist air can enter the continent from the Pacific Ocean because the height of the Andes mountain rainfall falls from 3000 to 1500 m south of 38°S. Most of the energy resources of Argentina come from hydroelectric stations operating in the region. Neuquén River Basin (NB) is the main affluent of Negro River and occupies an area of 49,958 km<sup>2</sup>. Limay River Basin (LB) covers an area of 23,600 km<sup>2</sup>, and its mean flow is 734 m<sup>3</sup>/s. The hydroelectric dams of Alicurá, Piedra del Águila, Pichi Picún Leufú, and El Chocón are on this river. The interannual variability of rainfall influences the flow of both rivers and, therefore, the power generation, the water schedule release, the probability of flooding, and high drainage level from irrigated valleys; for that reason, the study of rainfall is relevant and so the use of some predictors for seasonal rainfall.

### 23.6.1 Study of the Rainfall in Comahue Region

Mean monthly rainfall in LB and NB for the period 1975–2007—using data of high quality and selected stations—is depicted in Figure 23.3. The low-frequency variability of the annual precipitation series was analyzed using a linear trend method of minimum squares, and statistics significance was tested using Student test.

To improve the detection of rainfall extreme periods that could produce significant consequences in dams operation, the standardized precipitation index (SPI) using 6 month period was calculated to quantify deficit or excess of precipitation.

The computation of the SPI involves fitting a gamma probability density function to a given frequency distribution of precipitation totals for LB and NB. The parameters of the gamma distribution were estimated for each 6 month accumulated rainfall series. SPI value greater (lower) than zero indicates water excess (deficit). A wet (dry) period according to the SPI is defined as the period during which the SPI is continuously positive (negative). The magnitude of the index allows classifying the 6 month accumulated rainfall in categories that go from extreme drought to extreme excess (extremely dry, severe dry, moderate dry, normal, moderate wet, severe wet, and extremely wet).

The main feature is a defined annual cycle with a peak in late autumn and winter over both basins and that rainfall in LB exceeds the NB all along the year. Rainfall decreases in both basins, 2.4 mm/year in NB and 3.2 mm/year in LB. However, trends are not statistically significant since correlation coefficient is near 0.13 in both cases because of the number of years considered. Statistical significant rainfall trends were detected only in a few stations very near the Andes Mountain Range [4].

SPI using 6 month period was calculated in order to be representative of accumulated rainfall over the whole 6 month period. In order to describe extreme events, the maximum positive (minimum negative) SPI in each year is detected in order to be representative of extreme excess (drought) event. The maximum and minimum series are adjusted using a Gumbel distribution, which is well suited for modeling extreme hydrologic events. The fitted Gumbel distributions to annual maximum SPI at LB and NB will be used later to illustrate some of the results concerning the recurrence period for wettest and driest SPI. The recurrence period for SPI >1.5 (severe or extreme excess) is approximately 7 years and for SPI < -1.5 (severe or extreme drought) is approximately 5 years in both, LB and NB. SPI calculated with

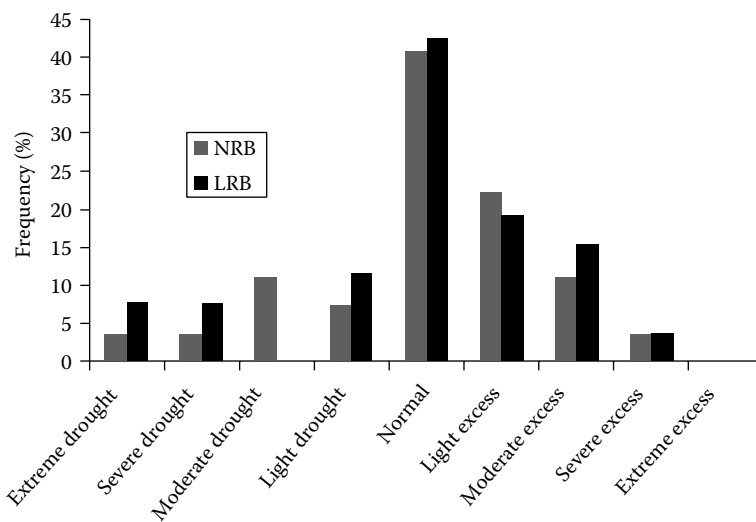


FIGURE 23.3 Percentage of different categories for Sset for the period 1980–2007 in NB (gray bars) and LB (black bars).

accumulated rainfall since April to September (Sset) is representative of the most quantity of rainfall as the annual cycle shows that winter is the typical rainfall season (Figure 23.2). Figure 23.3 shows the percentage frequency of different categories of Sset. It can be noted that there are more cases of excess than droughts: 37% of the years has excess meanwhile 25.9% has droughts in NB, and these values are 38.5% and 26.9% respectively for LB.

There is some indication that wet (dry) cases tend to occur in warm (cold) phase of ENSO. Therefore, correlation between sea surface temperature in EN34 region and SPI is 0.38 in LB and 0.37 in NB, both significant at 95% confidence level. Although better response is detected from July to February, with maximum signal in late spring (correlation of 0.47 in November in LB and 0.46 in October in NB), meanwhile no significant relation is present in autumn.

## 23.7 Summary and Conclusions

The natural hydrological system of the Pampean Plain and Uruguay is characterized by its fragility and its fluctuations from droughts to floods, which frequently produce negative effects on human activities. In general, anthropogenic alterations have intensified such effects, which become evident in the greater severity of droughts and floods, pollution, and decrease in freshwater reserves. Advances in the understanding of these atypical hydrological conditions have been based on the readaptation of technological tools developed for more rugged environments.

There is a deficiency in the field concerning the measurement of hydrological variables all over the countries and the development of appropriate models to simulate the involved processes.

Adequate assessment and monitoring of the hydrological processes become more important every day, not only to provide efficient water use management, but also to prevent any qualitative and quantitative alterations in the water resources of Southern South America.

As in future years a significant increase in water-related problems is foreseeable, preventive measures to avoid inadequate water use and any possibility of contamination and to foster an increase in water reserves must be taken.

To provide effective water management and promote the sustainable development of natural resources, there is a lack of basic data and in-depth knowledge of the physical medium that would make it possible to achieve a global understanding of hydrological behavior.

Risk assessment in general is hampered by lack of records as well as climate change and climatic variability.

## References

1. Argentina National Water Resources. 2002. Atlas digital de los recursos hídricos superficiales de la República Argentina. Buenos Aires, Argentina, Available at: <http://www.hidricosargentina.gov.ar/CartAct.html#1> (accessed on January 18, 2011).
2. Berbery, E. and V. Barros. 2002. The hydrologic cycle of the La Plata basin in—South America. *Journal of Hydrometeorology*, 3: 630–645.
3. Forte Lay, J.A., O.E. Scarpatti, and A.D. Capriolo. 2008. Precipitation variability and soil water content in Pampean flatlands (Argentina). *Geofísica Internacional*, 47(4): 341–354.
4. González, M.H. and C.S. Vera. 2010. On the interannual winter rainfall variability in Southern Andes. *International Journal of Climatology*, 30: 643–657. DOI: 10.1002/joc.1910.
5. Kruse, E., J.A. Forte Lay, J.L. Aiello, A. Basualdo, and G. Heinzenknecht. 2001. Hydrological processes on large flatlands. *IAHS Publication*, 267: 531–536.
6. Kruse, E. 1992. Estimación de escurrimientos subterráneos en la cuenca del Ao. Azul (Buenos Aires). *Situación Ambiental de la Provincia de Buenos Aires: II*: 15 (1–12). CIC, La Plata, Argentina.

7. Scarpati, O.E., L.B. Spescha, and A.D. Capriolo. 2002. The impact of the heavy floods in the Salado River basin, Buenos Aires province, Argentina. *Mitigation and Adaptation Strategies for Global Change*, 7(3): 285–301.
8. Torres and Chao. 2012a. Ciclos anuales y estacionales de parámetros hidrológicos. Depto. de Hidrología, DINAGUA, MVOTMA, Uruguay. Available at: <http://www.mvotma.gub.uy/biblioteca/documentos-de-agua/item/10003085-ciclos-anuales-y-estacionales-de-parámetros-hidrológicos> (accessed on April 9, 2012).
9. Torres and Chao. 2012b. Regionalización y correlaciones de parámetros hidrológicos. Depto. de Hidrología, DINAGUA, MVOTMA, Uruguay. Available at: <http://www.mvotma.gub.uy/biblioteca/documentos-de-agua/item/10003084-regionalización-y-correlación-de-parámetros-hidrológicos> (accessed on April 9, 2012).
10. Villalba, R., J.C. Leiva, S. Rubulis, J. Suarez, and L. Lenzano. 1990. Climate, tree rings and glacier fluctuations in the Frías valley, Río Negro, Argentina. *Arctic and Alpine Research*, 22: 150–174.



# 24

## Water Governance

---

24.1	Introduction .....	462
	What Is Governance? • Why Is Governance Difficult?	
24.2	Challenges of Governance.....	463
	Change • Conflict	
24.3	How Does Governance Work?.....	467
	Power • Rules	
24.4	What Might Be Asked of a System of Rules? .....	470
24.5	Can You Redefine the Rule Systems?.....	471
	Bridging	
24.6	Tasks of Governance .....	472
	Provisioning • Managing	
24.7	Changing Individual Behavior .....	477
24.8	Summary and Conclusions .....	477
	References.....	479

**Colin Green**  
*Middlesex University*

**Saeid Eslamian**  
*Isfahan University  
of Technology*

### AUTHORS

**Colin Green**, seen as an international authority on flood risk management, acted as a specialist advisor on water management to the House of Commons Environment, Food, and Rural Affairs select committee for a number of their inquiries into flooding, the Floods and Water Bill, and the most recent price and quality round for the water industry in England and Wales. He is a member of the Core International Experts group for the hazard and risk science base at Beijing Normal University, one of China's "111" projects. Colin sees a strong virtuous circle between theory and practice and has worked extensively for national agencies in both Europe and global countries, including Argentina, China, Egypt, South Africa, and Bangladesh. He was elected to the International Academy of Water in 2000. He is a frequent commentator on television and radio and likes to believe that when the US government complained to the British government about media coverage of Hurricane Katrina they were complaining about.

**Saeid Eslamian** received his PhD from the University of New South Wales, Australia, with professor David Pilgrim. He was a visiting professor in Princeton University, United States, and ETH Zurich, Switzerland. He is currently an associate professor of hydrology in Isfahan University of Technology. He is the founder and chief editor of *Journal of Flood Engineering* and *International Journal of Hydrology Science and Technology*. He has published more than 200 publications mainly in statistical and environmental hydrology and hydrometeorology.

**PREFACE**

This chapter deals with different aspects of water governance, definition, challenges, tasks, and changing individual behavior. In both practice and analysis, governance is difficult because it matters. It is about what social relationships are functionally most appropriate, the most effective in changing either the world or the behavior of particular groups.

**24.1 Introduction****24.1.1 What Is Governance?**

The most frequently cited functional definition of governance is the following:

Governance comprises the complex mechanisms, processes, and institutions through which citizens and groups articulate their interests, mediate their differences, and exercise their legal rights and obligations [103].

Thus, governance concerns on how we make collective decisions, who makes those decisions, how those decisions are implemented, and how the resources are supplied to implement those intended actions. So, governance involves process; self-evidently it is also done by people. Governance is social relationships in action; it is the expression of what are the existing social relationships, it is undertaken through a process of social interaction, and the results either express current social relationships or create new social relationships. “Water” thus becomes a means of articulating social relationships. What economists term “property rights” should be understood instead as a set of social relationships [22,67,111], things creating or expressing these social relationships.

What the previous definition also emphasizes is that governance is a struggle by the individuals and interest groups to promote their interest while simultaneously preserving the gains each receives from being part of a wider community. Sprey [98] similarly defined a household as being a zone of cooperative conflict, the different parties having different individual interests but the household surviving provided that there are net gains to each individual from being part of that household.

Social relationships are involved in the process of decision-making, and decisions produce social relationships either directly or indirectly by changing our relationship with the physical world. In the past, interventions were generally directed primarily to changing the physical world, such as building a canal or sewerage system. More recently, the emphasis has shifted to changing ourselves, changing the behavior of individuals or groups, and so acting directly in terms of social relationships. In either approach, an essential commonality is that the purpose of governance is action.

Governance is done by people interacting through different symbolic systems, notably language [28,81], individuals, and groups sharing a common interest seeking to shape the outcome of the process through these interactions. Thus, the different individuals and groups seek to frame the discourse [10] in a way that reflects their interests and understanding, the use of language being one form of power. In turn, they offer contested definitions of governance and “good” governance in particular [70]. Those interactions, the use of different forms of power to influence others or the self, are governed by informal and formal rules: institutions [74,92,104].

**24.1.2 Why Is Governance Difficult?**

Governance both in practice and in analysis is difficult because it matters. Discussions of governance immediately evoke the use of concepts, which are themselves problematic such as authority [8],

legitimacy [54,56], accountability [63], community [15], and justice [81]. Analytically, the problem is that these essential concepts involved stand in relation to each other as dualities in the form of multidimensional Yin–Yangs. Thus, one concept cannot be understood except in relation to the other. One such obvious duality is that between the individual and community, but other key dualities are between power and rules, between justice and legitimacy, and between stability and change. Equally, these different concepts then have to be turned into actions, which demonstrate accountability, legitimacy, and so forth.

In practice, governance is difficult because it is about what social relationships are functionally most appropriate, the most effective in changing either the world or the behavior of particular groups. But simultaneously, it is about what those relationships ought to be, the problem of justice [42]. At the same time, humans are fallible. While we may seek to be rational, we are not very good at it; we also make mistakes and lack the appropriate skills. The challenge in governance is to develop systems, which perform better over the long run than the individuals who make it up.

## 24.2 Challenges of Governance

---

The form of governance adopted is a mirror of the interpretation of reality that is adopted; governance can be no more successful than that interpretation provides a useful insight into the nature of reality. In particular, that interpretation has to reflect the nature of water [40], the inherent nature of decisions [39], and the prevailing or desired forms of social relationships.

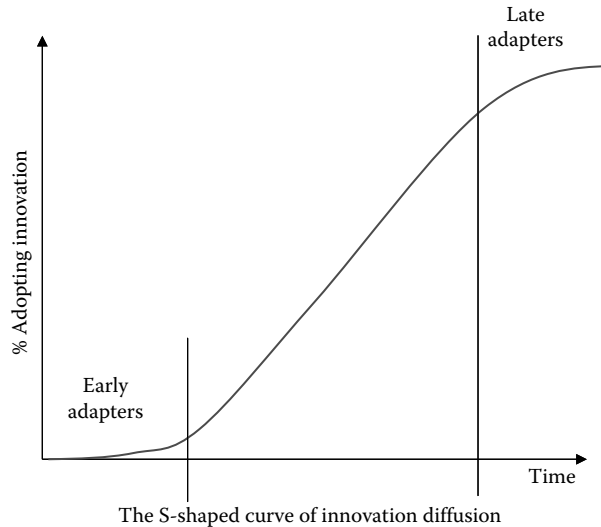
### 24.2.1 Change

We have to do more with less in order to switch onto a path of sustainable development [75], where to develop is to change. Hence, we have to make change and doing more with less requires that we discover and invent means of making more efficient uses of resources. In turn, we have to promote the rapid diffusion of successful innovations [109]. So, governance requires that we become better and faster at learning where much learning is from each other [36]. Since nearly all of human activity is now undertaken through organizations, part of the problem is how organizations can learn [5] and how they can learn from each other [51].

We have to make change in the face of change. Water management has always been about reacting to the inherent variability of the meteorological cycle, the variations over the year and between years of precipitation, and consequently the flows in rivers and the stocks in aquifers. Hence, our systems have to be able to cope with this variation; we want them to be resilient [50], specifically in the face of sudden shocks such as droughts and floods including the extremes of such cyclical patterns as ENSO. We are dealing with systems, which, by definition, are dynamic and subject to different rates and degrees of change. Social relationships are themselves dynamic; for example, equality is inherently a balancing point. There are trend changes over time, not only climate change but also changes in economic structure, demographics, and so forth. In the case of the MICs and LICs, the rates of economic growth and urbanization are unparalleled in human history. Consequently, we need our governance systems to have adaptive capacity [72], to be able to adjust to, and to make adjustments in the face of changes in water availability and demand. These governance systems have to match the rates of the changes with which we have to cope. In understanding change, the reasons why change did not occur are as important as those why change occurred [88].

The change we want is purposive and successful. Not all change is desirable; the shift to diets higher in meat content poses extreme problems for water management because of the much greater amounts of water required to provide such a diet [67]. Equally, we simultaneously desire change and stability; social changes are particularly challenging so some societies place a strong emphasis upon the importance of social harmony [16]. A totally unpredictable world, one in which there was no stability but all was in flux, would be very disturbing. So, two problems of governance are which changes to promote and how much change to adopt and how quickly.





**FIGURE 24.1** Change and innovation.

It may be argued that we have treated the whole concept of change quite superficially, unacceptably so when a concern for change is at the center of governance. The conventional model of innovation [87], the adoption of change, is the S-shaped curve shown in Figure 24.1. If we are seeking to induce a reduction in water consumption, questions that might reasonably be asked include the following:

- Who do we want or anticipate will change? In the case of domestic consumers, is it the large families, the old or the young, those living in apartments or in single-family dwellings who will reduce consumption?
- How much will they change? So, do we anticipate that a few will change a lot or that nearly all will change a bit?
- How will the change occur? Will it be the result of changes in behavior (e.g., taking shorter showers, not brushing teeth under running taps, not always flushing the toilet after use), by changing technology (e.g., fitting low-flow shower heads, press release taps, low flush toilet cisterns)?
- How fast will the change occur? Overnight or will it take many years? Does it matter?

The nature of the desired change depends upon the diagnosis of the present; the desire for change may be driven either by the belief that there is a specific problem at present or in the pursuit of an objective that is not currently being achieved. In the narrow sense of resource efficiency, there may be three problems (Figure 24.2):

- Water is inefficiently allocated. For example, in agriculture, irrigation water may currently be used on crops where the returns to water are low (e.g., rice) when there is unmet demand for water for crops, which have a high return to water (e.g., flowers, fruit, and vegetables).
- Water users fail to achieve the current efficiency frontier. Some of the users may fail to achieve what is currently technologically possible; for example, globally, crop yields are below those that are possible [100].
- There is a need to drive the efficiency frontier nearer to the limits defined by the rules of physics, chemistry, and biology. For instance, the introduction of dwarf varieties of crops increased the efficiency of water use [67].

The choice of the intervention strategy will depend upon the current interpretation of reality.

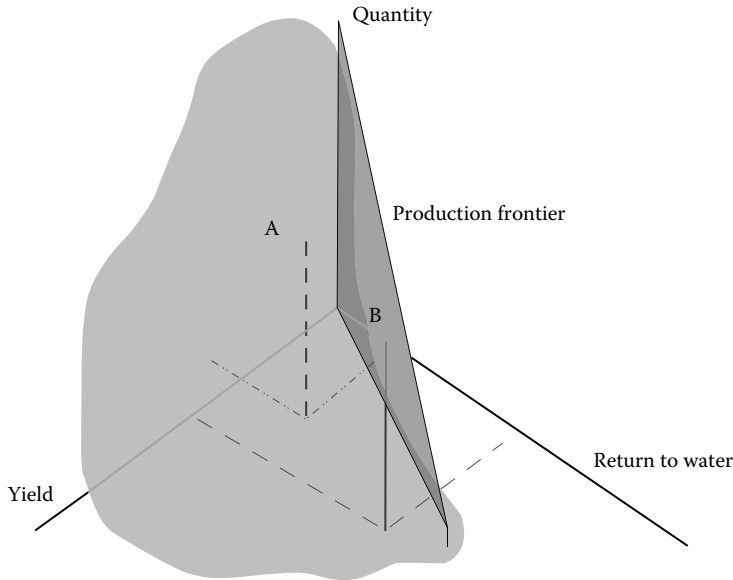


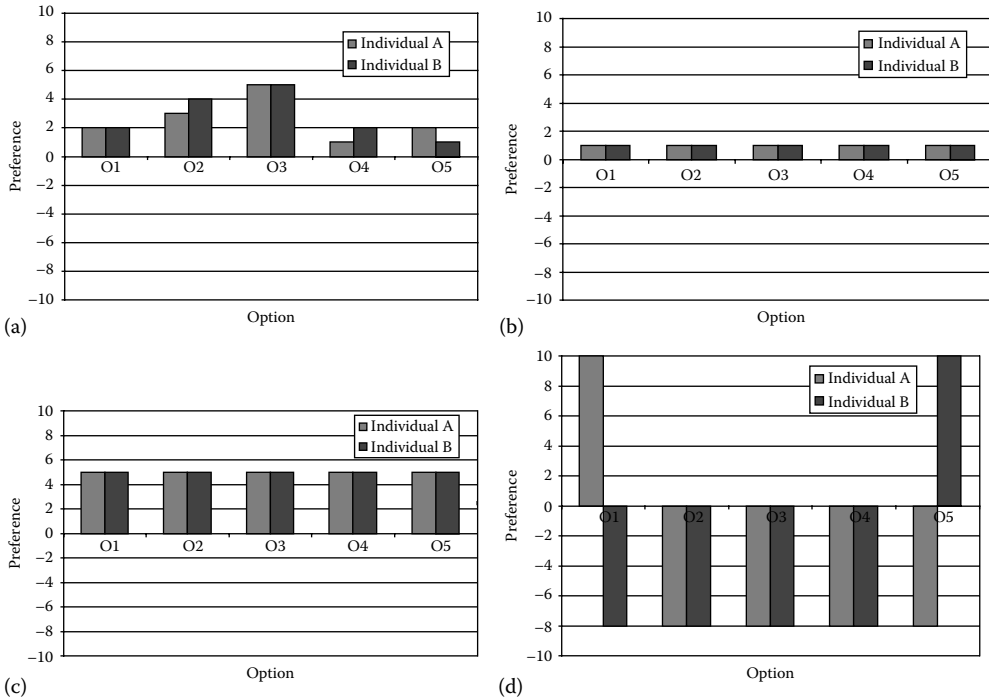
FIGURE 24.2 Frontiers: the problems in the narrow sense of resource efficiency.

That we have to make desirable change in the face of change has two consequences for governance. That the future is one of change creates innate uncertainty and governance requires taking action in the face of that uncertainty. Two diametrically opposed interpretations of this uncertainty exist: the first holds that uncertainty can be treated in probabilistic terms; the second holds that probability and uncertainty are two entirely different things [58,59]. How we decide on what action to take depends upon which interpretation of uncertainty is adopted.

Secondly, the definition of power is that it is the capacity to induce change [65]. Hence, the success of governance is rooted in whether the appropriate powers exist to match the reality that is confronted. This is the functional aspect of power. But to speak of power immediately raises the normative question of who should be able to use what powers for which purposes [41]. Euphemisms, such as influence, can be emotionally less charged terms to use than power.

### 24.2.2 Conflict

A decision is only required if there exist at least two possible and mutually exclusive courses of action and doubt as to which course of action to adopt [39]. Thus, decision-making is a learning process that involves seeking to resolve the conflicts that make the decision necessary and to become confident that one option ought to be preferred over all others. The simplest possible case of decision is where one person can make and implement the choice; for example, today, would I prefer to eat pasta, rice, or potatoes? As soon as there are two people involved who must make a joint decision, it becomes necessary to also resolve the differences between the people involved. So, a couple have to decide where to eat together if there are three restaurants, which have, respectively, pasta-, rice-, and potato-based menus. The difficult in resolving that conflict then depends how different are their initial preferences between the options. In Figure 24.3, in case (a), as soon as the options are identified, the choice is resolved as both people prefer option 3. In cases (b) and (c), there are no differences between individuals A and B, but in case (b), neither really knows what their preferences are, and in case (c), they are indifferent between the options; neither cares which option is adopted. Given more knowledge about the consequences of the options, differences in preferences between the options might emerge in case (b). Case (d) is the simplest



**FIGURE 24.3** Conflict: (a) The choice is resolved as both people prefer option 3. (b) There are no differences between individuals A and B; neither really knows what their preferences are. (c) There are no differences between individuals A and B; they are indifferent between the options. (d) The simplest example of Arrow's impossibility theorem.

example of Arrow's impossibility theorem [6]. That simply demonstrates that if there is no agreement in the rank order of preferences between options across individuals, there is no rule that can be used to decide which option to adopt. At its extreme, it appears to imply that unless individuals are identical, collective decisions cannot be made.

However, the practical limitation of Arrow's theorem is that it assumes that the participants cannot negotiate and have nothing to negotiate about. The two practical methods of approaching the disagreement are firstly to look to invent or discover another option, one about which a measure of agreement can develop. The process through which such a measure of agreement can be created has been framed in many different ways: negotiation [29,86], conflict resolution [19,97], or mediation [1]. What is generally true is that we only need agreement that one option should be adopted; we do not require a consensus. Indeed, it is unlikely to be the case that there is a course of action that all can agree is the best possible outcome. That is, the agreement need only be limited to the acceptability of the process and need not extend to the outcome. Equally, the agreement need only extend to which option to adopt; there need to be no agreement as to the rank of preference over the remaining options.

The second approach is to chain decisions together, making several decisions conditional on each other. In the latter case, an individual or group can sacrifice their preferred option now in the reasonable expectation that the collective will take account of their sacrifice in the specific choice in making a decision either in parallel to or subsequent to the current decision. The challenge is to devise a means by which decisions can be chained together in such a way that individuals or groups are prepared to make a sacrifice in one case in the expectation that their sacrifice will be taken into account in future decisions. Trust [52,64,89] has been found to be an important condition for groups of stakeholders to be able to reach agreement, but the concept of trust is somewhat nebulous [69]. What does seem to be indicated is that the stakeholders must come to see themselves as a community rather than as adversaries, various techniques

being used to build up such a feeling [1,13,108]. Secondly, the emphasis on agreement as to the acceptability of the process is to argue for the importance of procedural justice [101], which forms of power may be used for what purposes by whom [42]. Thirdly, the lesson from studies of the performance of juries in criminal cases is that it is important to focus on the issues rather than to personalize the debate, to start by asking what are the critical issues rather than to ask for votes on which option should be preferred [111]. Closely aligning specific options with specific groups or individuals is not the way to generate agreement.

The alternative way to make decisions where there is no agreement is for one party in isolation or in coalition to use their greater power to enforce their choice upon the other parties. For example, the choice of restaurants by parents with children is commonly largely dictated by the preferences of the children either because children who did not get their preference will express their displeasure or because of the parents' desire to make their children happy. But children have a privileged position; their use of power is seen as legitimate (unless they become "spoiled," they fail to learn that they cannot always get their own way). Unless the use of power is seen as legitimate [56], then the consequence is the search for countervailing power that ultimately includes violence.

## 24.3 How Does Governance Work?

---

The duality at the center of governance is that of power and rules. Governance needs to functionally produce appropriate change in the relationship between the human and physical worlds and to deliver on our collective objectives including social relationships, to deliver "well-being" [99]. This duality may be entered from either direction but commonly is approached from rules [78]. But since the function of rules is to delimit power, it is more logical to start with power.

### 24.3.1 Power

Functionally, power is the capacity to induce (or inhibit) change [65]. Consequently, anything that gives the capacity to induce or inhibit change is a form of power and so there are many different forms of power. Those forms of power obviously include income or wealth, physical capacity, and political influence but also knowledge and skills, including reasoning itself. Those forms of power are differently distributed. What differs between forms of power is their domain of effectiveness and their strength.

A broad categorization of those domains is as follows:

- Over the physical world: Historically, water management involved direct changes to the physical world, and the forms of power required were those that would enable successful physical intervention—the capacity to build reservoirs, to channelize rivers, or to construct reticulated distribution networks. Ultimately all sustainable water management involves some change in the relationship between an individual or group and the physical world, a change in policy being effective to the extent to which it results in a change in behavior and consequent change in interactions with the environment.
- Over the self: One way of defining human rights is in terms of the specific domains over which the individual ought to have personal power. Sen's [94] concept of capabilities is thus essentially about power; what are the domains to which the individual should be entitled to power?
- Over others: The ability to influence the behavior of others either directly or indirectly. Sustainable water management typically involves seeking to change the behavior of others; for example, prices may be used in order to drive down water consumption, promote the use of sustainable drainage systems (SuDS), or reduce the pollution loads in wastewater discharged to the environment. Indirect effects include the incidence of costs since increasing someone else's expenditure necessarily limits those other activities they can undertake that incur expenditure.

Seeking to change the behavior of others is obviously the most problematic aspect, and it is argued in the following discussion that justice is centered on the proper uses of power. The previous classification

also illustrates that power is in part organized hierarchically, any individual or organization while having “powers to” is subject to “powers over” those limitations to what it can do that are created by the rule structure. The power to set rules for others is thus, at least superficially, a particularly useful form of power. However, there are many forms of power and those subject to the power of another will logically strive to find a countervailing form of power if they cannot subvert the power over them. For example, Alinsky [3] sought to develop power strategies for those communities apparently without power, as did Gandhi before him. So, while power may appear to be hierarchically arranged, the reality is more complex and power is as much given as obtained. If the application of power to one group by another is not to be resisted by the first, there must be consent, an agreement that the particular use of power is legitimate.

The duality of rules and power is shown in the continuum of power (Figure 24.4) ranging from a requirement to do something, the power to require, to a prohibition against taking certain actions, the power to forbid [42]. At the center of this continuum exist incentives, encouragements to either take some action or not take specified actions; prices, charges, and subsidies are examples of such incentives.

An important feature of power is that power creates power and so it is cyclical: power is involved in the decision as to what to do and also how to implement that decision, while the consequence of what decision is taken and how the decision is implemented is likely to be a redistribution of power. Consequently, the balance of power in future decisions is potentially different from the current balance of power. So, for example, if there is a shift from municipal provision to market-based provision, there is a corresponding shift in power and this shift in power will influence the outcome of future decisions. Therefore, the interest is not simply in the immediate consequences of a decision but in the future of power and what that means for future decisions.

To be effective, power can be argued to have three necessary components [42]:

1. To provide a signal as to what change or what behavior is intended
2. To provide an incentive sufficient to overcome the barriers to making that change or adopting that behavior
3. To have some means of establishing compliance with the intentions

To be effective, the signal must stand out from the background of other stimuli and be interpreted in favor of the desired behavioral change. It must be first recognized as a signal and then interpreted as having a particular meaning and having a meaning, which implies that a particular behavior would be an appropriate response to that signal. But simply sending a signal does not mean that it will be necessarily received and, if received, that it will be either believed or interpreted as having the intended meaning [45].

To work, the strength of the incentive provided must be greater than that of the barriers to change. The strength of those barriers can depend upon the way in which change can be implemented and commonly varies between the different groups within the target population. For example, the tenants of properties are more restricted in the changes they can make to their property than are owner-occupiers of property. Again, since power is organized hierarchically, it may be easier to target one level of the power hierarchy than another. The strength, the effectiveness, of a form of power is thus a composite of these three components. Therefore, an essential question is:

- Which forms of power work in which circumstances? And why or how?

Economists have made the lazy assumption that prices always work and nothing else does. Hence, they have generally not studied how power works or of which forms of power are most effective in which circumstances. Unfortunately, in the case of water, prices appear to be relatively ineffective in inducing



**FIGURE 24.4** The continuum of power.

change, with the necessary caveat that the change may be taking place so slowly that the full extent of the change has not yet taken place. For example, meta-analyses of the response of household consumption to water prices, on average, show a price elasticity of  $-0.1$  to  $-0.2$  so that prices have to be doubled to induce a reduction of 10%–20% [20]. In industry and commerce, where water consumption is metered, it is routine to discover that companies are using more water than would maximize profitability [86], commonly by a factor of 15%–30% [25]. Finally, in agriculture, the price increases necessary to decrease demand are sometimes very large indeed [17]. The same issues of effectiveness arise with regulatory approaches. Hence, a key question is

- How effective is each form of power singularly or in combination with other forms of power?

Different forms of power may well be differentially effective both in reaching the intended targets and in inducing change depending upon what are the anticipated answers to these questions. Unless everyone can change a bit, then a shotgun approach is unlikely to be as effective as a more targeted approach and is likely to involve higher costs. So, for example, a strategy targeted specifically at vehicle washing installations to promote the adoption of water reuse might well be more effective, at a lower cost, than a blanket strategy aimed at promoting water reuse or simply increasing the charges for water.

Attempting to exert power also has two costs: to the exorter and on the target. The exorter incurs costs both in reaching the target and in seeking to influence their behavior. The incentive to the target to make the change has to exceed the costs of so doing, including the costs of determining what is the appropriate action to take. One absolute scarcity is of attention so that human perception is designed to prioritize for attention by selecting out that which is probably not sufficiently significant to require attention. Looking at the continuum of power model (Figure 24.3), the discretionary actions are more demanding of attention. The advantage of requirements not to do something or to do something is thus that they minimize the costs to the consumer of deciding what to do. Rees [86], for example, concluded that a reason why companies use water inefficiently is that the input costs of water are too low a proportion of production costs to be worthy of management attention.

So, the two apparent approaches are either to increase the costs of water so as to justify attention or to cut the costs of attention. For example, if top-loading and the more water-efficient front-loading washing machines [82] are both available on the market, the consumer has to spend time and effort determining which type and which model to buy. Hence, banning top-loading washing machines may significantly reduce the attention costs to the consumer and be more effective than increasing the costs of water.

The functional questions are: who has power, how effective are those powers, and what incentives do they have to use those powers? This, coupled to the need to define the boundaries to those powers, is “institutional mapping” [43,77]. But the recognition of who has power now immediately raises the normative question: who ought to have power? Stakeholders in decision-making are thus those who have the necessary powers now and those that are considered ought to have power but until now have been excluded from an appropriate share of power. In turn, justice can be understood in the procedural terms as being one who can use which forms of power over whom for which purposes. Importantly, in these terms, what is important is which forms, circumstances, and uses are explicitly excluded [41], the question of rules.

### 24.3.2 Rules

The function of rules, the standard definition of an institution [104], is to set limits to power. Rules may be formalized, as in legislation, or informalized as in the form of social norms. In turn, rules are unnecessary in the absence of power or the need to set limits to power. Thus, rules chase evolving power. Almost universally aquifers are overexploited because in the absence of a low-energy cost method of abstracting water from them, there was no need to set limits to that power, and so they were left as an open-access resource.

North [74] defined institutions as the rules of the game and organizations as the players of the game. Organizations are organized: that is, they are groups of people who are acting to achieve some organizational purpose in addition to satisfying their personal goals. Organizations are governed by the institutional framework in which they exist but also create their own internal rule framework to promote the achievement of the purpose of the organization. Those internal rules include a way of framing the world and the role of the organization and its members [91].

Since the purpose of rules is to set limits to power, rules create boundaries. Those boundaries are geographic, functional, and temporal [42]. As the basis for intervening in the world, institutions are interpretations of the world, the nature of the organizations reflecting the predominant interpretation of reality. Thus, the name of the ministry in which responsibility for water management is located indicates the basic interpretation being used; a Ministry of Water Resources can be expected to approach water management differently from a Ministry of Sustainable Development or a Ministry of Agriculture, Water and Forestry.

As boundary makers, potential problems with systems of rules then include the following:

- A mismatch between the boundaries of the problem and the boundaries to power created by the rules [35,72,115]. The obvious example of such a mismatch between the problem and administrative boundaries is the common practice of setting administrative boundaries along the helweg of a river. In turn, all water management can be said to be transboundary; it is only the nature of those boundaries that differ. Transnational river catchments present only one extreme of the general problem.
- There are sometimes gaps between the boundaries created by the rules, areas, or issues where no organization has the appropriate powers to intervene.
- There are ambiguities in the boundaries; for example, prior to the 1918 Land Drainage Act, there were over 80 bodies with responsibilities for land drainage and flood defense on the river Ouse in England, but it was not clear which, if any, had any responsibilities for flood defense on the tidal section of the Ouse [96].
- The boundaries are based explicitly or implicitly upon the use of a now obsolescent technology or otherwise upon past conditions so that the system is not adaptive to change conditions. For example, the legislative definition of a “public sewer,” essentially as a pipe, has been held to be one of the reasons for the slow adoption of SuDS in England.

If we can choose where the boundaries would be, where should the boundaries be created? Practical problems are that as both individuals and organizations, there are limits to the degree of complexity, which can be handled. Increase the task complexity and error rates increase [85]. Disciplines had to be invented because as knowledge increased, no individual was any longer capable of knowing everything. Again, specialization of labor was found to increase efficiency. So, the world had to be broken up into manageable pieces. Even in an ideal world, the result would be a compromise between two considerations, which are unlikely to coincide. The first is that boundaries should be along natural fracture lines: where there is the lowest degree of connection between different issues, areas, or problems. The second is at the point where organizational economies of scale or scope give way to diseconomies. The arguments for economies of scope, including Integrated Water Resource Management [44], result in increasingly high degrees of connectivity, and so fracture points are less apparent.

## **24.4 What Might Be Asked of a System of Rules?**

---

Functionally, the ideal system of rules might be one where

- The system of rules should be adaptive to changing circumstances, for example, changes in both the availability of water and the demands for water

- It should both enable and promote learning and the associated innovation; consequently it should be capable of adjustment in the light of that learning. This requires avoiding being over specific and particularly avoiding the assumption of a particular technological approach
- The rules should be clearly written and easily understood
- The rules have to make it clear which differences ought to be taken into account and which differences ought to be ignored
- Be efficient in achieving objectives in terms of the use of resources
- A secondary purpose of rules is to reduce uncertainty as far as possible, making it clear what is and what is not permitted. However, this is a secondary purpose

The traditional English system of common law, law built up through case law [34], may be argued both to have been adaptive and to have promoted learning [36] and so to have some advantages over code-based legal systems [114], such as that in Germany.

The requirement of adaptivity also suggests that it is those rule systems that have survived in highly variable environments for long periods of time that need to be examined for the lessons they provide. Notably, Islamic water law [107], developed in arid climates over centuries, is likely to be a good place to start.

A disadvantage of an adaptive, learning system is obviously that it does change both as conditions change and as learning takes place. This does create uncertainty: what were understood to be the rules may no longer be the rules. Conversely, by allowing incremental change, it allows progressive adaptation rather than requiring substantive changes later. But the problem in either approach is to adapt at the rate at which conditions are changing.

## 24.5 Can You Redefine the Rule Systems?

If it is possible to define what the ideal rule system should be, is it possible to invent an appropriate system of rules? Thus, to change the rules of the game? If rules could be changed very easily and so were frequently changed then, this would obviate the advantages of having a rule system in the first place because it would require the power to readily change rules and hence the absence of rules over that power. In turn, there are quite different models of how rule systems develop; Ostrom [77] argues that rules can be designed, while Putnam [83], for example, argues that rules are emergent [90] and path dependency constrains the way in which rules evolve and develop. Cleaver's [14] concept of "bricolage" is perhaps the ultimate concept of emergence, alternative rule systems competing with each other for authority, for recognized power. The requirement to be adaptive to change in circumstances implies that rule system will evolve as conditions change.

Quite obviously, some sets of rules are intentionally made more difficult to change than others. For example, in Germany, the responsibility for water management is defined in the basic law, the formal constitution, as resting with the individual provinces, the land. In the United States, police powers are constitutionally reserved to the individual provinces, the states.

A more problematic area is the informal rule systems and how far these either naturally change, can be changed, or should be changed. Equally, what will happen when the formal system conflicts with the informal system? In some cases, the informal system precludes the formal system delivering success; for example, some irrigation systems have been designed upon the assumption that female labor will be available to the male household members [113]. The advantage of informal rule systems is that they are largely internalized and it might be argued, therefore, that formal rules systems should be organized so as to reinforce or use informal rule systems wherever possible. For example, in Morocco, the informal rules of hospitality are used to ensure that payments are made for water supply. If someone declines to pay their share of the costs of water, the village water committee drops in on them for dinner, and the cost of the necessary hospitality exceeds the bill for water [21].

Change in informal rule systems should be anticipated to be slow since informal rule systems are argued to be the basis for cultural identity [33]. This would imply both that informal rule systems will



be very difficult to change and that it is very dangerous to try to do so because of the possible unintended consequences. On the other hand, changes in the informal rules creating gender have, in terms of human history, changed quite rapidly in the past few decades.

### 24.5.1 Bridging

The necessary fracturing of our response to the interpreted reality, creating a mosaic of organizations delimited by rules, creates the need to form two kinds of bridges across those divides. The first is for the transmission of information, knowledge, and innovation across those boundaries. The second is so that organizations can act so as to deliver integrated action when their powers are fragmented. Individuals interacting with each other perform these bridging functions, as is all governance.

There is an increasing literature on the role of individuals in the transfer of knowledge and innovation across organizations [51,80] and the role of networks in transmission [73]. But the important question is: what those individuals do and the skills and techniques they use to do it? We need to identify what are the transferable skills and techniques that they use. We need to adopt more effective social skills. A difficulty here is that in the context of organizations, individuals are simultaneously representatives and symbols of those organizations as well as individuals.

The second requirement is that the necessarily fragmented organizations act together to deliver an integrated approach, for example, the development of groups for catchment management [18,54,73] and learning alliances [12]. A question here is whether there are significant cultural differences in success and whether such approaches are more successful in cultures that stress social harmony or social solidarity than in cultures that stress competition.

## 24.6 Tasks of Governance

---

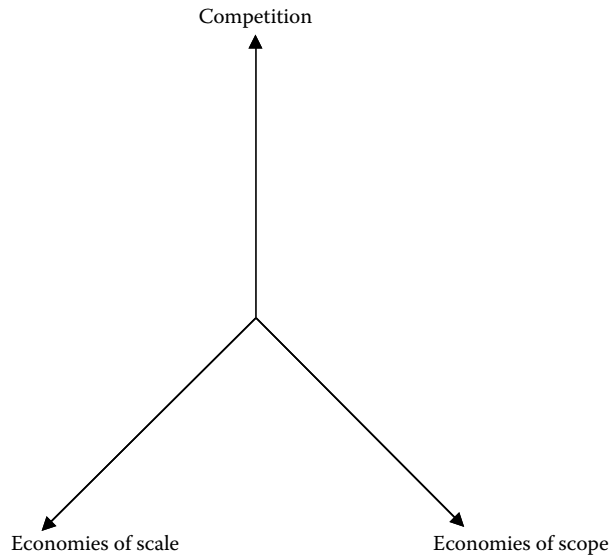
### 24.6.1 Provisioning

The organizational form of water service provision became the most hotly contested framing in water governance, being reduced to the “market” versus the “state.” This reduction to ideological sloganization resulted in the avoidance of such questions as: What is the problem? What is a “state” [23]? What is a “market” [61]? How does each work? In what circumstances does each work? The result was a lot of failures both in state provision and also in privatization. Moreover, it neglected the richness of alternative forms of water service provision, including various composite forms such as the *stadtwerke* and concession [11], as well as the widespread historical dependence upon Water User Associations [26,107]. Reducing the argument to a dichotomy also eliminated the scope for innovation in arrangements, including combinations of competition and cooperation.

The twin problems of provisioning can be said to be to deliver the service efficiently and to resolve the conflicts created in doing so. In the case of water, efficiency in the use of resources may be generated in three ways (Figure 24.5); unfortunately, competition is mutually incompatible with the other two means. In particular, economies of scale result in monopoly provision instead of competition.

So, the issue of the appropriate organizational form that is most likely to result in efficiency depends partly upon the interplay of the three factors shown in Figure 24.5. In turn, a useful distinction is between four basic forms of provision:

- Competition. Created through a market under some conditions.
- Cooperation. The action of several individuals or organizations acting together for a single purpose: the Water User Associations that have played such a significant role in the history of water management [105].
- Collaboration. Where two or more individuals or organizations act together for a number of different purposes. In water management, the obvious example is the municipalities that in Europe took the central role in providing wastewater and water management [48].



**FIGURE 24.5** Efficiency generation in the use of water resources.

- Coordination. Where two or more individuals or organizations are compelled by superior power to act together for one or more different purposes.

Where there are significant economies of scale, then second model has often been adopted, with economies of scope promoting the adoption of the third model. The final model is perhaps particularly associated with periods of intense settlement, such as the United States in the nineteenth century and in colonial development.

One way of looking at the challenges raised by the different forms of provision is in terms of the overlaps between five groups affected by the quantity and quality of the service provided:

- The providers of capital
- The providers of labor
- The providers of the revenues to fund the provision
- The consumers of the service
- Those who are affected by the means by which the service is provided (e.g., those who live by a river that runs dry because of over-abstraction)

The list given previously is a simplification because they are usually major subdivisions in interest and power within each of the categories, for example, between the interests of shareholders and bond holders or between senior executives and manual laborers.

Those different groups have different interests that are in conflict; providers of capital want to obtain a good return to capital relative to the risk taken, providers of labor to have good employment conditions, the providers of revenue to pay the lowest possible amount, the consumers to have the best possible service, and the others to be affected only positively by the means employed to provide the service. Examining the degree of overlap or separation, the number of people who are members of two or more groups, between five populations in a specific approach to service delivery, exposes the differences between different forms of provision. Doing shows marked differences between, for example, the German *stadtwerke* model of municipal provision and the English privatization model.

Where there is a high degree of overlap between the populations, then those people will have to resolve their internal conflict of interests, and this might be expected to reduce the risk that the power of one interest will simply overwhelm that of another. Where the populations are largely distinct, then

there is a potential requirement for a third party to intervene to ensure that the powers of the different parties reflect their interests. So, in the nineteenth century, preventing extortionate returns to capital was a problem in privatized water service supplies [47].

None of the four forms can be regarded as inherently stable. Faced with competition, any profit-maximizing supplier rationally seeks a monopoly. Where that cannot be achieved, the next best option is to form a cartel: to cooperate with those who would otherwise compete. Conversely, those who cooperate or collaborate may seek a short-term advantage from other members, to compete with them. Thus, where competition is desired, the problem is to stop participants from cooperating; where cooperation or collaboration is desired, then the problem is to prevent competition breaking out. Josephson's [55] history of the great industrial cartels of the nineteenth-century United States illustrates the cycle between cooperation and competition as the cartels formed, broke up, and reformed. Josephson's history illustrates another point that for cooperation to be practiced, the individual parties have to expect to gain more from cooperation than they can from acting independently.

A key practical difference then between competition and cooperation or collaboration is that in the competitive approach, conflict is channeled to the collective interest, whereas both cooperation and collaboration depend upon conflicts between the parties involved being resolved in such a way as to allow cooperation or collaboration. A market depends upon conflict between a sufficiently large number of competing suppliers to create efficiency [31]. In the market model, lack of conflict, lack of competition between competing suppliers, destroys efficiency; a practical problem is then that innovation destroys competition by giving one firm an advantage over others. Conversely, the lack of competition reduces the incentive to innovate. But in the cooperative model, competition between the parties is likely to destroy efficiency.

The four practical management problems are thus as follows:

1. In the specific circumstances, which factor is most likely to generate efficiency?
2. What are the conditions for that form of provision?
3. Where the present situation differs from the desired, can and how can the change be made?
4. How are we going to manage the conflicts that are not internalized to the organizational form adopted?

If the different functions and activities that are involved in water management are then mapped onto the space defined in Figure 24.5, then the different functions and activities are likely to fall into different regions. For example, small-scale entrepreneurial water supply is common where aquifers are an available water resource [97]. Water vendors are an obvious example of apparent competition, but the economies of scale are such that water vendors cannot compete with other forms of provision when this becomes available. Conversely, the economies of scale from reservoir-supported abstraction and supply are sufficient to overwhelm any potential gains from competition except at the margin, as was discovered in the nineteenth century in London [37].

For the larger consumers, such as retail or leisure chains as well as large single premises, water management companies (WaMCos) offer the possibility of introducing competition [38]. Chains of businesses can let out, through competitive tender, contracts to WaMCos to manage the water services for tranches of property. While the potable water supply would largely continue to be taken from the water supply utility's network and wastewater be discharged to the wastewater utility's network, the role of the WaMCo would be to minimize those total costs to the chain by maximizing the efficiency of water usage within each tranche of property.

Given the capital intensity of water management, the introduction of competition in capital raising would seem a logical option. However, loans are the cheapest forms of capital and competition raises the revenue risk and hence the cost of borrowing money. So, while introducing effective competitive capital, markets should reduce the costs of raising capital; the revenue risk problem suggests that competition in the actual use of capital may be counterproductive by raising the required return to capital.

**TABLE 24.1** Problems and Organizational Forms of Provision

Problems	Organizational Forms of Provision			
	Competition	Cooperation	Collaboration	Coordination
Conflicts	Between consumer and producer, over costs imposed upon others	Between different parties, negotiation over short term	Between different parties, negotiation over long term	Technical decision-making providing what the public are considered to need, or political process
Who makes decisions	Entrepreneurs on behalf of self; executives on behalf of shareholders	Stakeholders	Stakeholders	Scientific bureaucrats or politicians
Incentives	Making profit either for executives or for shareholders	Best combination of service and cost for self	Best combination of service and cost for self	Varyingly public service ethos, corruption, political expediency
Constraints	Competitors	External conditions	External conditions	Bureaucrats: administrative framework Politicians: need for public support

Furthermore, an underlying problem is that saving takes place for multiple purposes [57,58] where those purposes result in different time commitments together with different degrees of risk acceptance and hence desired rates of return to capital. The problem is consequently to maintain the dynamic balance between the different forms of savings and the different investment opportunities. Using a surplus of savings seeking short term, high returns to fund water management is unlikely to result in water efficiency in the long term. Conversely, an abundance of savings wanting secure, and therefore relatively low returns, over the long term is unlikely to provide the investment necessary for innovation.

These different forms can then be distinguished on the basis of (Table 24.1) the following:

- How are the inherent conflicts between different parties managed?
- Who makes the decisions and how those decisions are made?
- What are the incentives to the supplier?
- What are the constraints under which the supplier operates?

### 24.6.2 Managing

In a system, action at any point and time will necessarily have consequences elsewhere and later, the economists’ “externalities.” Externalities are the inherent and necessary consequences of any action at one point in a system since a system is defined by interconnections. The greater the degree of inter-connectiveness, the more common and larger are the externalities. Local optimal action then can be suboptimal from the perspective of the system as a whole, for example, the dike raising wars on the Mississippi in the nineteenth century where local communities sought to deflect floods onto others [46]. Now, KPMG [60] estimated that externalities equal an average of 49% of turnover in 12 industrial sectors, so they argue the real return on investment to a wide spectrum investor is substantially reduced. For every €100 million invested across the 12 sectors, the real return to the investor is equivalent to that from only €51 million of that investment.

A catchment is a highly coupled system, what happens at any one time and place depending upon what happened earlier and upstream. Water availability is then determined by meteorology and land-form and is also time and spatially varying to varying degrees. The problem is one of allocation between competing or alternative uses so as to maximize the performance, in the widest sense, of the catchment as a whole. This is the argument, coupled to usual existence of economies of scale and scope in water management, for the adoption of Integrated Water Resource Management [44]. The problem then is to do it. What is desired is that sum and interactions of individual actions result in the maximum performance of the system as a whole.

Three possible approaches are then as follows:

- To provide incentives to individuals so that they act in ways that result in an overall optimum.
- To instruct individuals to act in specific ways and not in others.
- The community acts collectively to create a shared vision and plan of action.

Combinations of these approaches are possible and each strategy has its limitations and weaknesses. The general problem is that of providing requisite variety [7]; if the system it is desired to manage can take  $n$  states, then the management system must provide  $n$  responses. If there are  $P$  individuals in the catchment and each can take  $R$  different actions, then there are possibly  $R^P$  different catchment states to which the management system must be able to respond. Reduce the potential variety of the system to one, and there is neither the capacity for innovation nor adaptation. Conversely, not all individual innovation is desirable from a system perspective; individual players may seek to game the system for individual gain. A classic example of the latter is the attempt to rely upon a market system to provide electricity in California; gaming by individual suppliers had disastrous consequences [27]. So, the problem is to allow efficient innovation while excluding the destructive.

The traditional approach to catchment management has been the second, define what must be done or must not be done: the variety in the system has been dramatically reduced. There is now considerable interest in making greater of prices as a coordinating mechanism for two reasons:

1. To take ecosystem services into account [2]
2. To take advantage of differences in the cost of adaptation

Some activities provide positive externalities, the environment providing both provisioning (e.g., fisheries) and regulating (e.g., flood alleviation) services [2]. Providing a means for paying to maintain these services is obviously desirable as a means of preserving those services.

The classic economic argument for the use of prices or subsidies instead of regulation is that the latter force the same standard on everyone when action by some could meet that standard at a lower total cost than action by all. If a price mechanism is used then, everything else being equal, there is the possibility that those with the lowest costs will make the change so that the environmental standard will be achieved at lowest total cost. A practical problem is that prices have to be set, and, in the absence of omniscience, the likelihood has to be that they will involve less variety than what actually exists and will not reflect the “real” costs; those which would be calculated were omniscient. In addition, in a situation where many externalities are not priced, introducing pricing in one area may add a further distortion: the “second-best” problem [62].

The argument for adaptive management in ecosystems is that we have incomplete understanding of how natural ecosystems work [49]. The same logic can be applied to economies, so pricing should be framed from an adaptive management perspective. This suggests the use of limited experiments and also testing out the effects of different price regimes until the most effective regime is discovered. Irreversible changes should be avoided. Hypothecating the charges, using the revenue to provide investment to reduce the externalities on which the charge is levied, may also be useful [4].

The added complexity is that it is not sufficient to do it for the present; it is necessary to build in the capacity to adapt to changes over time. One strategy for providing such adaptive capacity is the use of varying forms of tradable entitlement or obligation. For example, the use of tradable entitlements to irrigation water has been quite successfully implemented in Australia, but developing a successful system has taken many years of learning and adaptation [110]. A similar system in Chile has been markedly less successful because the system adopted did not allow the same scope for learning and adaptation [9]. Some long-term experience in trading is given in some of the Spanish irrigation orchard that experience may be said to have been mixed [32].

For an effective and practical system of trading, there has to be something, which both can be clearly defined and is desirable, to be traded. There also have to be gains to both parties to the potential trade from making the trade; there have to be differences between the two parties, which create the potential

gain. Water carriers were the earliest system of urban water distribution in almost all cities, including London [30]; the modern equivalent is bottled water in which there are some highly competitive markets. If bottled water is compared to irrigation water, then the difficulties of inducing markets in irrigation water are apparent. Bottled water is supplied in a form of storage, in a quantity as required, at the time required, and of the quality desired and is delivered at or near the point of demand. Doing the same thing for irrigation water is more difficult and depends upon the capacity of a system for storage and transfer. Because water pollution is not a single pollutant, and hence a clearly defined good, but rather a multiplicity of different chemical compounds entrained in the water column, attempts at introducing markets in water pollutants have so far had limited success [93]. The scope for both forms of trading is also limited by the inherent spatial and temporal dynamics of a catchment, particularly for irrigation water that is inherently a consumptive use of water and where the salts introduced in the return water reduce its value for downstream use.

Both these two approaches depend upon there being some organization with the power either to set rules or create prices across the entire catchment. Where powers are fragmented, the cooperative approach is a way of building a coherent management strategy, one that will in turn result in either rules or prices being used in its implementation. Ostrom [77] has defined the overarching set of rules necessary for such management to be effective. An added argument for the cooperative approach is the fragmentation of knowledge and the consequent need for social learning, partly as a community-building process [18,54].

## 24.7 Changing Individual Behavior

---

We try to change either the world or our relationship to it, for instance, to build an additional reservoir or to adopt demand management. Changing our relationship to the world involves a much more diffuse set of actions being taken by a much larger number of people than the traditional approach of changing the world. So, how to change large numbers of individuals' behavior has become a key issue. Thus, the question is: which forms of power in isolation or in combination are most effective in achieving the desired change?

In seeking to induce change, there are obvious questions as to who will change, how they will change, and how long will that change take? The classic curve for the adoption of innovation [87] was shown in Figure 24.1; conventionally, some people are early adopters and others very late in adopting the innovation. In this case, it is differences in populations that determine how quickly the change takes place. For example, if it is farmers who wish to exit farming who are most likely to trade water, then it is which farmers wish to exit farming, and the numbers so doing, which will determine rate and extent of the change that occurs. Similarly, if the introduction of SuDS is limited to new buildings, then adoption of SuDS will be limited to the rates at which new and redevelopment take place and to the locations where this takes place. Thus, the comparative ineffectiveness of prices in inducing changes in water usage [20,69] may simply indicate areas where change can only be made slowly. The corollary to considering how change may take place is the barriers to change; for example, tenants are less able to change buildings than the owners of the buildings. Rather more work is needed to understand how change takes place in water management; for example, which companies in which industries have driven the gains in the efficiency of water usage seen in Germany [102]? More work is also needed to understand which powers are most effective in inducing change; for example, what has induced the fall in domestic water consumption in some countries to 110 l/p/d [24]?

## 24.8 Summary and Conclusions

---

The centroid of governance is that it is about people and it is done by people. It is about what should be the social relationships between people, and it is undertaken through the then existing sets of social relationships. Social relationships are consequently the lens by which different implementations of

governance should be viewed. This is also to stress processes over structure; that what is important about a plan, for example, is the process by which it was developed and the social relationships developed in that process rather than the document itself. To extend the military aphorism that a plan never survives first contact with the enemy, it is then the relationships and understanding built up in developing the plan that enable a successful adaptive response to battle conditions, coupled to the social relationships built up through training. Similarly, water management is the process of planning and social relationships built up through the planning process that is important rather than the plan as a blueprint.

The military metaphor also provides a further insight: when can structures and rules replace skills? A challenge of governance is to distinguish between those problems that can be engineered out and those problems that are simply innate. The former problems are potentially susceptible to institutional redesign [77]; the latter can only be addressed by skills. Rather than trying to design an ideal institutional framework for water management, it is probably more useful to focus on the skills and techniques necessary to deliver cooperation across the boundaries.

If the centroid of governance is social relationships, then the central questions are as follows:

- What is the nature of social relationships?
- What ought to be those social relationships? Both the functional question of what relationships are most efficient in achieving sustainable use of resources and the normative question of justice.
- What are the skills and techniques for successful social relationships?

Consequently, thinking usefully about governance means discussing two things about which we are usually reluctant to talk:

- Conflict: how to resolve the conflicts between each other
- Power: specifically the power to influence other people

Failing to address these issues, seeking to find technical expressions to replace them, does not mean that they will go away, but only that they will be hidden and addressed, at best, indirectly. For example, arguments about privatization have a dimension of power: the power of a vote being replaced by the power of income or wealth. Equally, treating a problem as simply a technical problem will leave untested the probably haphazard accretion of power by those who have accrued it. But critically, these are the two areas where we have to focus our efforts at improving performance.

This is to discuss the “how” of governance; the interpretation of reality now that we seek to address is that of making face in the face of change. Hence, we have to learn both from the present and also from the past, both from what appears to work and what has failed in some circumstances. What we do next has to be adaptable in the face of changing futures, so while it is desirable to seek to optimize in the present, that present optimization cannot be bought at the cost of a loss of adaptability to the future. Hence, we need to avoid making irreversible changes. What we do now also has to provide resilience in the inevitable shocks, such as floods and droughts.

We have to innovate but to avoid clutching at panaceas. The purpose of innovation is to learn and the danger of panaceas is that innovations, which work well in some circumstances, are deployed in all circumstances. The twin dangers are failing to innovate at all versus simply adopting the latest panacea. At the same time, some innovations will necessarily fail, the only absolute failure being the failure to innovate. So failure is acceptable provided that it does not have irreversible consequences and lessons are learned from that failure. Hence, innovation needs to be treated as an experiment, one that can be reversed if it is unsuccessful, and to provide scope for adaptation to future changes as well as to learning from practice.

In short, as a species, our childhood has been one of great success in changing the environment, but now it is time to put away childish things and learn how to live and work with each other: to focus upon social relationship requirements and skills, to focus upon changing ourselves.

## References

1. Acland, A.F. 1990. *A Sudden Outbreak of Common Sense: Managing Conflict Through Mediation*, Hutchinson, London, U.K.
2. Alcamo, J. et al. (eds.) 2003. *Ecosystems and Human Well-Being: A Framework for Assessment*, Island Press, Washington, DC.
3. Alinsky, S. 1971. *Rules for Radicals*, Random House, New York.
4. Andersen, M.S. 1994. *Governance by Green Taxes*, Manchester University Press, Manchester, U.K.
5. Argyris, C. and Schon, D.A. 1996. *Organizational Learning II*, Addison-Wesley, Reading, MA.
6. Arrow, K.J. 1963. *Social Choice and Individual Values*, 2nd edn., Wiley, New York.
7. Ashby, W.R. 1964. *An Introduction to Cybernetics*, Methuen, London, U.K.
8. Barry, N.P. 1989. *An Introduction to Modern Political Theory*, Macmillan, Basingstoke, England.
9. Bauer, C.J. 2008. The experience of Chilean water markets, Paper given at *ExpoZaragoza*, Zaragoza, Spain.
10. Berger, P. and Luckman, T. 1967. *The Social Construction of Reality*, Penguin, Harmondsworth, England.
11. Blokland, M., Braadbaart, O., and Schwartz, K. (eds.) 1999. *Private Business, Public Owners: Government Shareholdings in Water Enterprises*, The Ministry of Housing, Spatial Planning, and the Environment, Nieuwegein, the Netherlands.
12. Butterworth, J., McIntyre, P., and da Silva Wells, C. 2011. *SWITCH in the City: Putting Urban Water Management to the Test*, IRC International Water and Sanitation Centre, The Hague, the Netherlands.
13. Chambers, R. 2002. *Participatory Workshops*, Earthscan, London, U.K.
14. Cleaver, F. 2001. Institutional bricolage, conflict and cooperation in Usangu, Tanzania, *IDS Bulletin*, 32(4), 26–35.
15. Cohen, A.P. 1985. *The Symbolic Construction of Community*, Routledge, London, U.K.
16. Consedine, J. 1999. *Restorative Justice*, Ploughshare, Lyttelton, New Zealand.
17. Cornish, G., Bosworth, B., Perry, C., and Burke, J. 2004. *Water Charging in Irrigated Agriculture: An Analysis of International Experience*, FAO, Rome, Italy.
18. Craps, M. (ed.) 2003. Social learning in river basin management, HarmoniCOP WP2 reference document. Available at: [www.harmonicop.info](http://www.harmonicop.info) (accessed on April 2, 2013).
19. Creighton, J.L., Dunning, C.M., Priscoli, J.D., and Ayres, D.B. 1991. Public involvement and dispute resolution: A reader on the second decade of experience at the Institute for Water Resources, Institute for Water Resources, U.S. Army Corps of Engineers, Alexandria, VA.
20. Dalhuisen, J.M., Florax, R.J.G.M., de Groot, H.L.F.M., and Nijkamp, P. 2001. Price and income elasticities of residential water demand, TI 2001-057/3, Tinbergen Institute, Amsterdam, the Netherlands.
21. Dalton, G.M. 2007. Financing potable water supply services in rural areas: Challenges, approaches and lessons from the PAGER experience in Morocco, Unpublished PhD thesis, SOAS, London, U.K.
22. Davies, M. 2007. *Property*, Routledge-Cavendish, Abingdon, England.
23. Dunleavy, P. and O'Leary, B. 1987. *Theories of the State*, Macmillan, London, U.K.
24. Environment Agency. 2009. *International Comparisons of Domestic per Capita Consumption*, Environment Agency, Bristol, U.K.
25. Envirowise. 2005. *Cost-Effective Water Saving Devices and Practices—For Commercial Sites*, Envirowise, Didcot, U.K.
26. Fagan, B. 2011. *Elixir: A Human History of Water*, Bloomsbury, London, U.K.
27. Federal Energy Regulatory Commission. 2003. Final Report on price manipulation in western markets, Docket No. PA02-2-000, Federal Energy Regulatory Commission, Washington, DC.



28. Figueroa, M.E., Kincaid, D.L., Rani, M., and Lewis, G. 2002. Communication for social change: An integrated model for measuring the process and its outcomes, Communication for Social Change Working Paper Series No. 1, Rockefeller Foundation, New York.
29. Fisher, R. and Brown, S. 1989. *Getting Together*, Business Books, London, U.K.
30. Flaxman, T. and Jackson, T. 2004. *Sweet and Wholesome Water: Five Centuries of History of Water-Bearers in the City of London*, E W Flaxman, Cottisford, U.K.
31. Frank, R.F. 2006. *Microeconomics and Behavior*, McGraw-Hill, Boston, MA.
32. Garrido, S. 2011. Governing scarcity: Water markets, equity and efficiency in pre-1950s eastern Spain, *International Journal of the Commons* 5(2), 513–534. <http://www.thecommonsjournal.org/index.php/ijc/rt/> (accessed on May 3, 2013).
33. Geertz, C. 1993. *The Interpretations of Cultures*, Fontana, London, U.K.
34. Getzler, J. 2004. *A History of Water Rights at Common Law*, Oxford University Press, Oxford, U.K.
35. Gibson, C., Ostrom, E., and Ahn, T.-K. 1998. Scaling issues in the social sciences, IHDP Working Paper No. 1 (Part 1), IHDP (International Human Dimensions Program), Bonn, Germany.
36. Goldstein, H. 1981. *Social Learning and Change*, Tavistock, London, U.K.
37. Graham-Leigh, J. 2000. *London's Water Wars*, Francis Boutle, London, U.K.
38. Green, C. and Anton, B. 2012. Why is Germany 30 years ahead of England, *International Journal of Water*, 6(3), 195–212.
39. Green, C.H. 2003. *Handbook of Water Economics*, John Wiley & Sons, Chichester, U.K.
40. Green, C.H. 2008. The current crisis in water economics, in Strosser P., Le Roux, J., Rouillard, J., and Badger, R. (eds.) *Conference on Considering the Role of Costs and Benefits in Supporting Regulatory Actions*, Scottish Environment Protection Agency, Edinburgh, U.K.
41. Green, C.H. 2009. Procedural equity, SWITCH Project Report. Available at: <http://www.switchurbanwater.eu/> (accessed on April 2, 2013).
42. Green, C.H. 2010. The practice of power: Governance and flood risk management, in Pender, G. and Faulkner, H. (eds.) *Flood Risk Science and Management*, Chapter 17, Blackwell, Oxford, U.K.
43. Green, C.H., Parker, D.J., and Johnson, C. 2007. Institutional arrangements and mapping for the governance of sustainable urban water management technologies. SWITCH Project Report. Available at: <http://www.switchurbanwater.eu/> (accessed on April 2, 2013).
44. GWP (Global Water Partnership Technical Advisory Committee). 2000. Integrated Water Resources Management, TAC Background Paper 4, Global Water Partnership, Stockholm, Sweden.
45. Hall, S. 1997. The work of representation, in Hall, S. (ed.) *Representation: Cultural Representations and Signifying Practices*, pp. 13–74, Sage, London, U.K.
46. Harrison, R.W. and Mooney, J.F. 1993. *Flood Control and Water Management in Yazoo-Mississippi Delta*, Social Science Center, State University, Starkville, MS.
47. Hassan, J.A. 1985. The growth and impact of the British water industry in the nineteenth century, *Economic History Review*, 38(4), 531–547.
48. Hietala, M. 1987. *Services and Urbanization at the Turn of the Century*, Studia Historica 23, Finnish Historical Society, Helsinki, Finland.
49. Holling, C.S. (ed.) 1978. *Adaptive Environmental Assessment and Management*, Wiley, Chichester, U.K.
50. Holling, C.S. 1973. Resilience and stability of ecological systems, *Annual Review of Ecology and Systematics*, 4, 1–23.
51. Huitema, D. and Meijerink, S. 2010. Realizing water transitions: The role of policy entrepreneurs in water policy change, *Ecology and Society*, 15(2), 26. <http://www.ecologyandsociety.org/vol15/iss2/art26/> (accessed on April 2, 2013).
52. Imperial, M.T. and Hennessey, T. 2000. *Environmental Governance in Watersheds*, National Academy of Public Administration, Washington, DC.
53. Ison, R.L., Steyaert, P., Roggero, P.P., Hubert, N., and Jiggins, J. 2004. Social learning for the integrated management and sustainable use of water at catchment scale, SLIM Final Report, Open University, Milton Keynes, U.K.

54. Johnson, C., Dowd, T.J., and Ridgeway, C.L., 2006. Legitimacy as a social process, *Annual Review of Sociology*, **32**, 53–78.
55. Josephson, M. 1982. *The Robber Barons: The Great American Capitalists 1861–1901*, Harcourt, Brace and Jovanovich, San Diego, CA.
56. Jost, J.T. and Major, B. (eds.) 2001. *The Psychology of Legitimacy: Emerging Perspectives on Ideology, Justice and Intergroup Relations*, Cambridge University Press, Cambridge, U.K.
57. Katona, G. 1975. *Psychological Economics*, Elsevier, New York.
58. Keynes, J.M. 1936. *The General Theory of Employment, Interest and Money*, reprinted, Royal Economics Society/Macmillan, London, U.K.
59. Knight, F.H. 1921. *Risk, Uncertainty and Profit*, Houghton Mifflin, Boston, MA.
60. KPMG. 2012. Expect the unexpected: Building business value in a changing world. [www.kpmg.com/sustainability](http://www.kpmg.com/sustainability) (accessed on April 2, 2013).
61. Lane, R.E. 1991. *The Market Experience*, Cambridge University Press, Cambridge, U.K.
62. Lipsey, R.G. and Lancaster, K. 1956–1957. The general theory of second best, *Review of Economic Studies*, **24**, 11–32.
63. Lloyd, R., Oatham, J., and Hammer, M. 2007. *Global Accountability Report*, One World Trust, London, U.K.
64. Lubell, M., Schneider, M., Scholz, J.T., and Mete, M. 2002. Watershed partnerships and the emergence of collective action institutions, *American Journal of Political Science*, **46**(1), 148–163.
65. Lukes, S. 1974. *Power*, Macmillan, London, U.K.
66. Macpherson, C.B. (ed.) 1978. *Property*, Basil Blackwell, Oxford, U.K.
67. Molder, D. (ed.) 2007. *Water for Food, Water for Life*, Earthscan, London, U.K.
68. Molle, F. and Berkoff, J. (eds.) 2007. *Irrigation Water Pricing: The Gap Between Theory and Practice*, CAB, Wallingford, U.K.
69. Möllering, G. 2001. The nature of trust: From Georg Simmel to a theory of expectation, interpretation and suspension, *Sociology*, **35**(2), 403–420.
70. Moretto, L. 2005. Urban governance and informal water supply systems: Different guiding principles amongst multilateral organisations, Paper given at the *Conference on the Human Dimension of Global Environmental Governance*, Berlin, Germany.
71. Moss, T. 2003. The governance of land use in river basins: Prospects for overcoming problems of institutional interplay with the EU Water Framework Directive, *Land Use Policy*, **21**(1), 85–94.
72. Mysiak, J., Henrikson, H.J., Sullivan, C., Bromley, J., and Pahl-Wostl (eds.) 2010. *The Adaptive Water Resource Management Handbook*, Earthscan, London, U.K.
73. Nesta, L. and Mangematin, V. 2004. The dynamics of innovation networks, SEWPS Paper No. 114, SPRU, Sussex University, Brighton, U.K.
74. North, D.C. 1990. *Institutions, Institutional Change and Economic Performance*, Cambridge University Press, Cambridge, U.K.
75. OECD. 2011. *A Green Growth Strategy for Food and Agriculture*, OECD, Paris, France.
76. OECD. 2011. Water governance in OECD countries: A multi-level approach, *OECD Studies in Water*, OECD, Paris, France.
77. Ostrom, E. 1990. *Governing the Commons: The Evolution of Institutions for Collective Action*, Cambridge University Press, New York.
78. Ostrom, E. 2005. *Understanding Institutional Diversity*, Princeton University Press, Princeton, NJ.
79. Panos London. 2007. *The Case for Communication in Sustainable Development*, Panos London, London, U.K.
80. Partzsch, L. and Ziegler, R. 2011. Social entrepreneurs as change agents: A case study of power and authority in the water sector, *International Environmental Agreements*, **11**, 63–83.
81. Pettit, P. 1980. *Judging Justice: An Introduction to Contemporary Political Philosophy*, Routledge, London, U.K.

82. Pugh, C.A. and Tomlinson, J.J. 1999. *High-Efficiency Washing Machine Demonstration, Bern, Kansas*, Paper given at *Conserv 99*, Oak Ridge National Laboratory, Knoxville, TN.
83. Putnam, R.D. 1993. *Making Democracy Work: Civic Traditions in Modern Italy*, Princeton University Press, Princeton, NJ.
84. Raiffa, H. 1982. *The Art and Science of Negotiation*, Belknap/Harvard University Press, Cambridge, MA.
85. Reason, J. 1990. *Human Error*, Cambridge University Press, Cambridge, U.K.
86. Rees, J. 1969. *Industrial Demand for Water: A Study of South-East England*, Weidenfeld & Nicolson, London, U.K.
87. Rogers, E.M. 1962. *Diffusion of Innovation*, Free Press, Glencoe, Scotland.
88. Sabatier, P.A. (ed.) 2007. *Theories of the Policy Process*, Westview, Boulder, CO.
89. Sabatier, P.A., Focht, W., Lubell, M., Trachtenberg, Z., Vedlitz, A., and Matlock, M. 2005. *Swimming Upstream: Collaborative Approaches to Watershed Management*, MIT Press, Cambridge, MA.
90. Sawyer, R.K. 2005. *Social Emergence: Societies as Complex Systems*, Cambridge University Press, Cambridge, U.K.
91. Scott, W.R. 1987. The adolescence of institutional theory, *Administrative Science Quarterly*, **32**(4), 493–511.
92. Scott, R.W. 1995. *Institutions and Organizations*, Sage, London, U.K.
93. Selman, M., Greenhalgh, S., Branosky, E., and Guiling, J. 2009. Water quality trading programs: An international overview, WRI Issue Brief No. 1, World Resources Institute, Washington, DC.
94. Sen, A.K. 1992. *Inequality Re-Examined*, Clarendon, Oxford, U.K.
95. Shamir, Y. 2002. *Alternative Dispute Resolution Approaches and Their Application*, IHP-VI Technical Documents in Hydrology No. 7, UNESCO, Paris, France.
96. Sheail, J. 2002. Arterial drainage in inter-war England: The legislative perspective, *Agricultural History Review*, **50**(II), 253–270.
97. Solo, T.M. 1998. *Competition in Water and Sanitation: The Role of Small-Scale Entrepreneurs*, Public Policy for the Private Sector Note No. 165, World Bank, Washington, DC.
98. Sprey, J. 1969. The family as a system in conflicts, *Journal of Marriage and Family*, **31**, 699–706.
99. Stiglitz, J.E., Sen, A., and Fitoussi, J.-P. 2009. Report by the Commission on the Measurement of Economic Performance and Social Progress, Paris, Commission on the Measurement of Economic Performance and Social Progress. [www.stiglitz-sen-fitoussi.fr](http://www.stiglitz-sen-fitoussi.fr) (accessed on April 2, 2013).
100. Thiam, A., Bravo-Ureta, B.E., and Rivas, T.E. 2001. Technical efficiency in developing country agriculture: A meta-analysis, *Agricultural Economics*, **25**, 235–243.
101. Thibaut, J. and Walker, L. 1975. *Procedural Justice: A Psychological Analysis*, Erlbaum, Hillsdale, NJ.
102. Umwelt Bundes Amt. 2007. *Environmental Data for Germany*, Umwelt Bundes Amt, Berlin, Germany.
103. UNDP (United Nations Development Programme). 1997. *Governance for Sustainable Human Development*, UNDP, New York.
104. Uphoff, N. 1986. *Local Institutional Development: An Analytical Sourcebook with Cases*, Kumarian, West Hartford, CT.
105. Wagret, P. 1967. *Polderlands*, Methuen, London, U.K.
106. Weisbord, M.R. and Janoff, S. 1995. *Future Search*, Berrett-Koehler, San Francisco, CA.
107. Wilkinson, J.C. 1990. Muslim land and water law, *Journal of Islamic Studies*, **1**, 54–72.
108. Worthington, S. 2003. *Equity*, Clarendon, Oxford, U.K.
109. Young, H.P. 2009. *Innovation Diffusion in Heterogeneous Populations: Contagion, Social Influence, and Social Learning*, Center on Social and Economic Dynamics, Brookings Institution, Washington, DC.
110. Young, M. 2011. The role of the unbundling water rights in Australia's Southern Connected Murray Darling Basin, in EX-POST Case Studies Paper by D. Zetland (Wageningen University), WP6 IBE, EPIWATER.
111. Young, O., Agrawal, A., King, L.A., Sand, P.H., Underdal, A., and Wasson, M. 1999. Institutional dimensions of global environmental change, IHDP Report No. 9, IHDP, Bonn, Germany.

112. Young, W., Cameron, N., and Tinsley, Y. 1999. Juries in criminal trials part 2—A summary of the research findings, Preliminary Paper 37, Vol. 2, Law Commission, Wellington, New Zealand.
113. Zwartveen, M. 1997. A plot of one's own: Gender relations and irrigated land allocation policies in Burkina Faso, Colombo, International Irrigation Management Institute, Colombo, Sri Lanka. <http://www.cgiar.org/iimi> (accessed on April 2, 2013).
114. Zweigert, K. and Kotz, H. (translated Weir T) 1992. *An Introduction to Comparative Law*, Clarendon, Oxford, U.K.



# 25

## Water Pollution Control Using Low- Cost Natural Wastes

---

**Faezeh Eslamian**

*Isfahan University  
of Technology*

**Saeid Eslamian**

*Isfahan University  
of Technology*

25.1	Introduction .....	486
25.2	Pollutants .....	486
25.3	Adsorption .....	487
25.4	Adsorbent.....	487
25.5	Natural and Low-Cost Wastes as Adsorbents.....	488
	Heavy Metal Removal • Dyes	
25.6	Case Study.....	494
25.7	Summary and Conclusions .....	495
	References.....	496

### AUTHORS

**Faezeh Eslamian** received her BS degree in civil engineering and master's degree in environmental engineering from Isfahan University of Technology (IUT), Iran, and currently is an expert engineer in environmental engineering. In addition to English language, she also has an official degree in French language from the University of Neuchatel, Switzerland. Faezeh has published more than five papers on natural solid waste management, remote sensing, and groundwater and surface water interaction.

**Saeid Eslamian** received his PhD from the University of New South Wales, Australia, with Prof. David Pilgrim. He was a visiting professor in Princeton University, USA, and ETH Zurich, Switzerland. He is currently an associate professor of hydrology in IUT. He is the founder and chief editor of *Journal of Flood Engineering* and *International Journal of Hydrology Science and Technology*. He has published more than 200 publications mainly in statistical and environmental hydrology and hydrometeorology.

## PREFACE

Nowadays, the great development in science, technology, and industries has induced a huge and growing threat to the environment, natural resources, as well as the human health. The wastewater from industries such as mining, refining ores, tanneries, batteries, textile, printing, paper industries, and pesticides normally contains high contents of toxic materials that pose major concerns to the health and aesthetic aspects of these precious bodies of water if left untreated. This chapter mainly focuses on the water pollution caused by the two essential toxic pollutants, namely, heavy metals and dyes.

Among various removal methods, adsorption is proven to be the most effective for this case owing to its design simplicity and high efficiency. Furthermore, the abundant and numerous types of adsorbent contribute greatly to the priority of this method. However, activated carbon, which is the most common and efficient adsorbent due to its high adsorption capacity, is considered to be rather expensive. Therefore, many research has been conducted to find a promising alternative. Natural and low-cost wastes such as chitosan, natural zeolites, clay, and even agriculture wastes have shown to be effective adsorbents for dye and heavy metal removal.

In the current chapter, an introduction to these kinds of adsorbents as well as a review of the researches carried out by several researchers is presented here. At the end of this chapter, a case study regarding the removal of several textile dyes by walnut shell wastes is described in detail.

The potential use of these natural wastes as an alternative adsorbent for removal can tremendously contribute to the environment as they are recycled and reused for water pollution control and majorly decrease pollutants.

## 25.1 Introduction

---

In the recent years, water pollution has become a major concern for the environment as well as the human health. Natural surface water resources such as lakes, rivers, seas, and oceans are often contaminated through the direct or indirect discharge of effluents and, therefore, lead to water pollution. With the growth of technology and increase in demand, the number of industries is considerably augmenting. However, the wastewater from industries such as mining, refining ores, tanneries, batteries, textile, printing, paper industries, and pesticides normally contains high contents of toxic materials that pose serious threats to the health and aesthetic aspects of these precious bodies of water if left untreated. Therefore, it is essential to treat the wastewater from these industries prior to discharge to the environment so that they meet the standard and guidelines.

## 25.2 Pollutants

---

The wastewater from industries often contains two major types of pollutants: heavy metals and dyes.

Toxic heavy metal ions are introduced to the surface waters by means of various industrial activities. The major toxic metal ions hazardous to humans as well as other living creatures are Cr, Fe, Se, V, Cu, Co, Ni, Cd, Hg, As, Pb, Zn, etc. These heavy metals are of specific concern due to their toxicity, bioaccumulation tendency, and persistency in nature [64]. Even small concentrations of these toxic ions could threaten health and damage the ecosystem equilibrium.

On the other hand, dyes are also hazardous chemical compounds widely used in industries such as textile, plastics, leather, food, cosmetics, and printing. Not only are dyes of aesthetic concern but also possess complex molecular structures forming stable structures that are nonbiodegradable. Similar to heavy metals, wastewaters containing dyes need to be treated to meet the standards, prior to entering the bodies of waters.

Various removal techniques are used for dyes and heavy metals among which the most important are as follows: precipitation and sedimentation, membrane technologies, photochemical oxidation, electrochemical treatment, ion exchange, and adsorption. However, adsorption is considered to be the most effective in this case owing to its lower cost and demand for energy, and also its simple design and operation. Another advantage of adsorption over other procedures is its capability to use natural wastes as adsorbents.

## 25.3 Adsorption

The term adsorption refers to a process through which a gas or liquid solute accumulates on the surface of a solid or a liquid (adsorbent), forming a molecular or atomic film (the adsorbate). Adsorption differs from absorption where the substance diffuses into a liquid or solid, forming a solution. However, the term sorption comprehends both processes, whereas desorption represents the reverse process [30].

Depending on the type of bonding formed between the adsorbent and the adsorbate, adsorption is classified as either physisorption or chemisorption. When the adsorbent adheres to the adsorbent's surface by weak intermolecular Van der Waals interactions, the process is called physical adsorption or in other terms physisorption, whereas a molecule adhering to a surface through the formation of a chemical bond is called chemical adsorption or chemisorption.

Adsorption is normally described by means of isotherms, the most important of which are Langmuir isotherm, Freundlich isotherm, and BET isotherm. An isotherm is a function or in other words a mathematical model that connects the amount of adsorbate on the adsorbent with its concentration (if liquid) or pressure (if gas).

## 25.4 Adsorbent

One of the most important and effective factors in an adsorption process is the type of adsorbent. Adsorbent is a substance to the surface of which the adsorbate adheres and consequently the adsorption process is achieved. An adsorbent should have a high resistance against abrasion, high thermal stability, and small pore diameters. Therefore, the most essential feature of a good adsorbent is its porous structure that results in a higher surface area. The quantity, size, and shape of its pores determine the overall adsorption capacity of the adsorbent for a special substance. Adsorbents are classified according to the diameter of their pores (Table 25.1) [26].

The common commercial adsorbents are basically categorized into three groups as follows:

1. Oxygen-based compounds: usually polar and hydrophilic compound such as silica gel, zeolites, and alumina
2. Carbon-based compounds: normally nonpolar and hydrophobic compounds such as activated carbon and graphite
3. Polymeric compounds

**TABLE 25.1** Classification of the Pore Size in Adsorbents

Pore Diameter (d), nm	Type
$d > 50$	Macropores
$2 \leq d \leq 50$	Mesopores
$d < 2$	Micropores
$d < 0.7$	Ultramicropores

Source: Gupta, V.K. and Ali, I., *J. Colloid Interf. Sci.*, 271, 321, 2004.



Activated carbon is the most popular and oldest adsorbent used in water and wastewater treatment processes owing to its high adsorption capacity. Activated carbon can be generated from a wide range of material from charcoal to wood and nuts.

The commercial adsorbents mentioned earlier are expensive and often call for a regeneration process. Therefore, throughout the years, many efforts have been made to replace them with other convenient and low-cost adsorbents.

Natural adsorbents can be an alternative for the expensive commercial ones. They are often agricultural or industrial wastes or wood industry by-product. The main advantages of natural and low-cost adsorbents over the commercial adsorbents are that they are cheap, abundant, easily available, disposable without regeneration, and are often usable without the need for any previous complex thermal or chemical process. These low-cost adsorbents are not only cheap but also more effective in some cases. Their processes have a simple design and operation and being less toxic, environment friendly, and biodegradable, they contribute considerably to the further protection of the environment. Natural and low-cost adsorbents are divided into two separate categories based on their nature: natural organic adsorbents and natural mineral adsorbents.

## 25.5 Natural and Low-Cost Wastes as Adsorbents

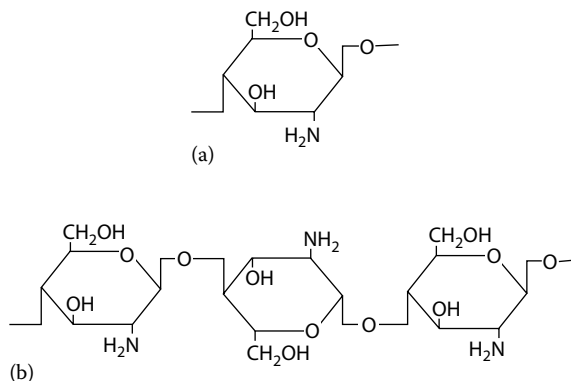
In this section, the potential application of natural and low-cost wastes as adsorbents is discussed separately based on the type of pollutant they can remove.

### 25.5.1 Heavy Metal Removal

In the recent years, much attention has been given to natural and low-cost adsorbents having metal-bonding capacities. The following substances discussed here possess heavy metal removal capacities in addition to being easily available and abundant making them low-cost adsorbents.

#### 25.5.1.1 Chitosan

Chitosan is one of the most abundant natural biopolymers having a molecular structure similar to that of cellulose. Chitosan has superior metal-bonding capacities due to its high content of amino groups. Therefore, it has the ability to serve as an adsorbent for heavy metals. Chitosan is produced from alkaline *N*-deacetylation of chitin, which is widely found in the exoskeleton of shellfish [9]. The chemical structure of chitosan chain with the molecular formula of  $(C_6H_{11}NO_4)_n$  ( $n = 1$  and  $3$ ) is shown in Figure 25.1 [74].



**FIGURE 25.1** The chemical structure of chitosan chain  $(C_6H_{11}NO_4)_n$  for (a)  $n = 1$  and (b)  $n = 3$ .

**TABLE 25.2** Adsorption Capacities of Chitosan for Various Heavy Metals

Reference	Adsorption Capacity (mmol/g)						
	Cr <sup>3+</sup>	Ni <sup>2+</sup>	Pb <sup>2+</sup>	Hg <sup>2+</sup>	Zn <sup>2+</sup>	Cu <sup>2+</sup>	Cd <sup>2+</sup>
Udaybhaskar et al. [68]	2.96	—	—	—	—	—	—
Juang et al. [31]	—	—	—	—	—	2.85	—
Ng et al. [49]	—	—	0.56	—	—	2.83	—
Wu et al. [74]	—	1.13	1.15	3.06	4.42	3.13	3.4
Wan et al. [70]	—	—	—	—	—	2.36	—
Hu et al. [29]	—	—	—	—	—	2.12	—
Lima and Airoldi [35]	—	0.37	—	—	0.21	—	—
Saiano et al. [55]	—	0.1	0.68	—	—	0.21	0.26
Paulino et al. [53]	—	1.1	0.72	—	0.14	—	—
Sankararamkrishnan et al. [56]	3.0	—	—	—	—	—	0.76
Alexandre et al. [4]	—	0.42	—	—	—	1.59	—

In Asian countries such as Thailand, Japan, and China, fishery wastes such as shrimp, lobster, and crab shells have been considered a promising alternative for producing chitosan. Chemical modification of chitosan overcomes its dissolution in acidic media and enhances its adsorption capacity. However, only the various researches done on pristine chitosan are discussed in this chapter. Adsorption capacities of chitosan for various heavy metals are summarized in Table 25.2.

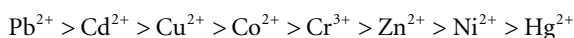
### 25.5.1.2 Natural Zeolites

Natural zeolites are hydrated aluminosilicate minerals with microporous structures that have valuable characteristics owing to their unique structure. The honeycomb structure of natural zeolites is negatively charged, hence positively charged ions (cations) such as heavy metals are able to be attached to it. Therefore, natural zeolites could be utilized as natural adsorbents for heavy metals. Furthermore, natural zeolites are often called as molecular sieves. The natural channels existing in zeolite structure selectively screen molecules according to size, and hereby, molecules too large to pass through the entry channel are excluded [72].

There are many natural zeolites identified. Clinoptilolite, mordenite, phillipsite, chabazite, stilbite, analcime, and laumontite are very common forms, whereas offretite, paulingite, barrerite, and mazzite are much rarer. Among the various kinds of zeolites, clinoptilolite is the most abundant natural zeolite and is widely used around the world [72]. The general chemical formula of zeolites is  $M_{x/n}[Al_xSi_yO_{2(x+y)}] \cdot pH_2O$  where M is (Na, K, Li) and/or (Ca, Mg, Ba, Sr), n is cation charge,  $y/x = 1-6$ , and  $p/x = 1-4$ .

The adsorption capacity of the most common zeolite, namely, clinoptilolite, for various heavy metals is summarized in Table 25.3.

Natural zeolites are important low-cost materials for water and wastewater treatment. As mentioned previously, due to their cation exchange capability, natural zeolites show high performance in the adsorption of cations in aqueous solution such as heavy metals. However, zeolites exhibit varying ion selectivity and competitive adsorption for a multicomponent system [9]:



As shown earlier, natural zeolites (Clinoptilolite) have the most capability to remove  $Pb^{2+}$ .

Overall, natural zeolites are promising adsorbent of heavy metal from aqueous solution and can serve as a natural and environment-friendly substitute of commercial adsorbents such as activated carbon.

**TABLE 25.3** Adsorption Capacities of Zeolite (Clinoptilolite) for Various Heavy Metals

Reference	Adsorption Capacity (meq/g)							
	Cr <sup>3+</sup>	Ni <sup>2+</sup>	Pb <sup>2+</sup>	Mn <sup>2+</sup>	Zn <sup>2+</sup>	Cu <sup>2+</sup>	Co <sup>2+</sup>	Cd <sup>2+</sup>
Alvarez-Ayuso et al. [6]	0.237	0.068	—	—	0.106	0.186	—	0.082
Gedik and Imamoglu [24]	—	—	—	—	—	—	—	0.145
Sprynskyy et al. [61]	—	0.222	0.134	—	—	0.405	—	0.0375
Erdem et al. [19]	—	—	—	0.153	0.268	0.282	0.448	—
Turkman et al. [67]	—	—	0.222	—	0.734	—	—	0.0053
Cincotti et al. [16]	—	—	0.735	—	0.1	0.34	—	0.12
Oter and Akacy [51]	—	0.095	0.501	—	0.180	0.125	—	—
Al-Haj-Ali and Al-Hunaidi [5]	—	—	0.290	—	—	—	—	—

**TABLE 25.4** Adsorption Capacities of Clay for Various Heavy Metals

Clay Type	Reference	Adsorption Capacity (mg/g)				
		Cd <sup>2+</sup>	Cr <sup>6+</sup>	Pb <sup>2+</sup>	Zn <sup>2+</sup>	Cu <sup>2+</sup>
Montmorillonite	Srivastava et al. [62]	0.72	—	0.68	—	—
	Undaybeytia et al. [69]	4.78	—	—	4.98	—
	Lin and Juang [36]	—	—	—	13.277	—
Kaolinite	Singh et al. [59]	—	—	—	1.25	—
	Srivastava et al. [62]	0.32	—	0.12	—	—
	Chantawong et al. [14]	—	—	1.41	—	—
	Gupta and Bhattacharyya [77]	9.27	—	11.52	—	—
Bentonite	Bhattacharyya and Gupta [13]	—	—	—	—	4.3
	Khan et al. [33]	11.41	0.57	—	5.45	—
	Mellah and Chegrouche [40]	—	—	—	52.91	—
	Naseem and Tahir [48]	—	—	20	—	—
	Kaya and Hakan Oren [32]	—	—	8.27	—	—

### 25.5.1.3 Clay

Similar to zeolites, clay is an important inorganic compound in soil. Having high surface area and ion exchange capability, clay minerals have high adsorption capacities as well. There are three basic species of clay: smectites (such as montmorillonite), kaolinite, and micas, out of which montmorillonite has the highest cation exchange capacity [9]. An adsorption capacity of clay for various heavy metals is presented in Table 25.4.

### 25.5.1.4 Industrial and Agricultural Waste

Another group of natural and low-cost adsorbents to which attention has been driven lately is the by-products or wastes of industries or agricultural processes. These biomaterials usually contain cellulose showing high capacity for adsorption. The major advantages of biosorption over conventional treatment methods include low cost, high efficiency, minimal chemical or biological sludge generation, no additional nutrient requirement, and the possibility of metal recovery [64]. The basic components of the agricultural waste material biomass involve hemicellulose, lignin, extractives, lipids, proteins, simple sugars, water hydrocarbons, and starch containing variety of functional groups that facilitate metal adsorption [76].

Various researches have proven these economic and environmental-friendly agricultural wastes to be a promising adsorbent for heavy metals from aqueous solutions. Up to now, mainly, agricultural wastes such as rice bran, rice husk, wheat bran, wheat husk, sawdust of various plants, bark of

**TABLE 25.5** Removal Efficiency of Agricultural Wastes for Various Heavy Metals

Natural Waste	Reference	Removal Efficiency (%)						
		Cr <sup>3+</sup>	Cr <sup>6+</sup>	Pb <sup>2+</sup>	Zn <sup>2+</sup>	Cd <sup>2+</sup>	Zn <sup>2+</sup>	Ni <sup>2+</sup>
Sugarcane bagasse, maize corn cob	Garg et al. [23]	97	—	—	—	—	—	—
Bagasse fly ash	Gupta and Ali [26]	—	97	—	—	90	—	90
	Srivastava et al. [63]	—	—	—	—	65	—	42
	Mohan and Singh [42]	—	—	—	—	93	93	—
Coconut shell fibers	Mohan et al. [43]	—	>80	—	—	—	—	—
Wheat bran	Farajzadeh and Monji [21]	—	>82	—	—	—	—	—
Eucalyptus bark	Sarin and Pant [57]	—	100	—	—	—	—	—
Rice bran	Oliveira et al. [50]	—	45	—	—	—	—	45
	Montanher et al. [44]	—	—	>80	>80	>80	>80	—
Tea waste	Ahluwalia and Goyal [2]	—	—	92	—	—	84	73
	Malkoc and Nuhoglu [37]	—	—	—	—	—	—	86
Peels of peas, fig leaves	Benaissa [12]	—	—	—	—	75	—	—
Hazelnut shell	Kurniawan et al. [34]	—	—	>85	—	>85	>85	>85
Various sawdust	Sciban et al. [58]	—	—	—	—	—	80	80
	Taty-Costodes et al. [66]	—	—	96	—	98	—	—
	Yu et al. [75]	—	—	85	—	—	—	—
	Acar and Malkoc [78]	—	100	—	—	—	—	—

the trees, groundnut shells, coconut shells, black gram husk, hazelnut shells, walnut shells, cottonseed hulls, waste tea leaves, maize corn cob, sugarcane bagasse, apple, banana, orange peels, soybean hulls, grape stalks, water hyacinth, sugar beet pulp, sunflower stalks, coffee beans, and cotton stalks have been studied [11]. A summary of the works done on these agricultural wastes as adsorbent for metal ions is given in Table 25.5.

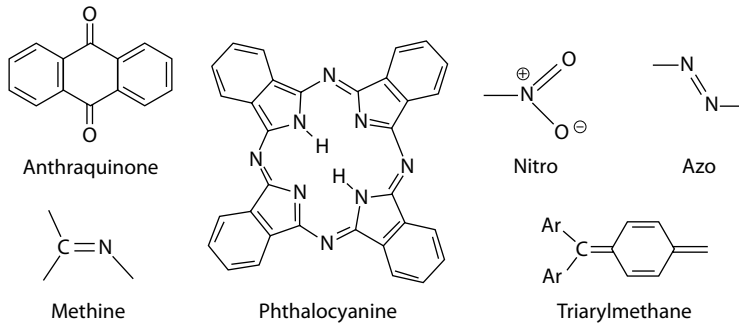
As it can be concluded from Table 25.5, agricultural wastes have high removal efficiency for the various kinds of metal ions.

A wide range of low-cost adsorbents has been studied worldwide for heavy metal removal. It is evident that inexpensive and locally available materials could serve as convenient alternative for the commercial activated carbon, which is expensive. However, it should be mentioned that in order to improve removal efficiencies and adsorption capacities of some natural and low-cost material, chemical modifications and small adjustments could be carried out in a way that the overall procedure cost would be yet less than that of the commercial adsorbents. Nonetheless, the capability to reuse these natural unwanted wastes is itself considered a step forward for a better forthcoming environment.

### 25.5.2 Dyes

Dyes have a wide diversity in structure. Dyes are classified based on either their molecular structure or application type.

- *Chemical structure:* According to this classification, dyes are categorized based on available chromophore groups in their structures. Some of the most important chromophore groups are illustrated in Figure 25.2. This type of classification is widely used since the chromophore group in the dye structure can reveal many characteristics and features of the dye, by which it can be identified or applied [1]. For instance, azo dyes are strong and cheap, while anthraquinone dyes are weak and expensive. Azo dyes are considered the most popular and include approximately 70% of the dyes [25].



**FIGURE 25.2** Several common chromophore groups in organic dyes. International Agency for Research on Cancer (IARC), 2010. IARC Monographs on the evaluation of carcinogenic risks to humans, General introduction to the chemistry of dyes, Volume 99. Available at: <http://monographs.iarc.fr/ENG/Monographs/vol99/index.php>

- Application:* In this type, the dyeing process, approach, and application are the basics of the classification and are, therefore, analyzed merely from this point of view. In color index, the dyes are categorized due to their application method, and each dye is given an application number, for instance, C.I. Acid Red 88. This is very helpful, since the consumers are often interested in the application of the dye. There is a structural similarity among the dyes with the same application; however, no specific relation is identified, and the same particular dye can be found more than once and for various applications.

Dyes are categorized into two groups based on their solubility: acidic, basic, direct, and reactive dyes that are soluble in water, and azoic, disperse, sulfuric that are insoluble in water.

Acid dyes are soluble anionic dyes, which are often applied to silk, wool, nylon, and acrylic fiber in a neutral-to-acidic dye bath. Most acid dyes are the salts of sulfonic acid or carbocyclic acids possessing complex structures with interlinked aromatic ring. Acid dyes have good water solubility in comparison to other dyes [76]. The major chemical groups in their structures include azo, anthraquinone, azin, and nitro [25].

Basic dyes are soluble cationic dyes often applied to acrylic fibers. However, they are also used to dye silk, wool, and paper. Acid acetic is normally added to the dye bath in order to increase the cohesion between the fiber and the dye. Basic dyes have brilliant and transparent appearances. These dyes produce cations when dissolved in water.

Direct dyes are soluble anionic dyes that are directly applied to a neutral or rather basic dye bath without the need of any fixing additives. Direct dyes are often applied to cellulosic fibers such as cotton, rayon, paper, and leather. Furthermore, they have large molecular structure due to the Van der Waals interactions between the fiber and dye molecules.

Similar to heavy metals, it could be stated that the most effective treatment method for the removal of dyes is adsorption, and activated carbon is considered to be the most common adsorbent. However, other low-cost and natural adsorbents have proven to be applicable and in some cases even more effective. The possibility of the use of various low-cost and natural adsorbents as an alternative has been studied by many researchers. A brief review of the work in the form of tables is presented here to justify the feasibility of their use and the environmental step forward. Since different groups of dyes exhibit different characteristics and hereby have different effective adsorbents and adsorption capacities, they are presented here based on the dye type. The adsorption capacities of low-cost and natural wastes for the removal of the most common dye types such as acidic, basic, and direct are presented in this chapter in Tables 25.6 through 25.8, respectively.

As it can be seen in Tables 25.6 through 25.8, some of these low-cost and natural adsorbents, including agricultural wastes and clay, have an excellent removal capacity for the studied dyes. Among natural materials, clay occupies a prominent position being low cost, abundant, and having high adsorption

**TABLE 25.6** Adsorption Capacity for the Removal of Acid Dyes by Low-Cost Natural Adsorbents

No.	Low-Cost Natural Adsorbent	Dye	Adsorption Capacity (mg/g)	References
1	Wood	Acid Blue 25	9.5	Poots et al. [54]
2	Bagasse	Acid Red 114	22.9	McKay et al. [38]
3	Banana pith	Acid Brilliant Blue	4.42	Namasivayam et al. [47]
4	Orange peel	Acid Violet 17	19.88	Sivaraj et al. [60]
5	Bagasse	Acid Blue 25	17.5	Chen et al. [15]
6	Orange peel	Acid Orange 52	20.5	Annadurai et al. [7]
7	Banana peel	Acid Orange 52	21	Annadurai et al. [7]
8	Chitosan	Acid Red 73	728.2	Wong et al. [73]
9	Chitosan	Acid Red 18	693	Wong et al. [73]
10	Pine sawdust	Acid Yellow 132	398.8	Ozacar and Sengil [52]
11	Hazelnut shell	Acid Blue 25	60.2	Ferrero [22]
12	Walnut sawdust	Acid Blue 25	36.98	Ferrero [22]
13	Cherry sawdust	Acid Blue 25	31.98	Ferrero [22]
14	Raw clay	Acid Red 88	1133.1	Akar and Uysal [3]
15	Leaf powder	Acid Orange 52	10.5	Deniz and Saygideger [17]
16	Walnut shell	Acid Red 88	24.6	Eslamian [20]
17	Walnut shell	Acid Blue 113	15.42	Eslamian [20]

**TABLE 25.7** Adsorption Capacity for the Removal of Basic Dyes by Low-Cost Natural Adsorbents

No.	Low-Cost Natural Adsorbent	Dye	Adsorption Capacity (mg/g)	References
1	Sunflower stalk	Basic Blue 9 <sup>a</sup>	205.3	Sun and Xu [65]
2	Rice husk	Basic Blue 9	312	McKay et al. [39]
3	Bagasse	Basic Red 2	838	McKay et al. [39]
4	Clay	Basic Blue 9	300	Bagane and Guiza [10]
5	Bagasse pith raw	Basic Red 22	75	Chen et al. [15]
6	Zeolite	Basic Red 22	14.91	Meshko et al. [41]
7	Orange peel	Basic Violet 10 <sup>b</sup>	14.3	Annadurai et al. [7]
8	Banana peel	Basic Violet 10	20.6	Annadurai et al. [7]
9	Hazelnut shell	Basic Blue 9	76.9	Ferrero [22]
10	Walnut sawdust	Basic Blue 9	59.1	Ferrero [22]
11	Cherry sawdust	Basic Blue 9	39.84	Ferrero [22]
12	Jackfruit peel	Basic Blue 9	285.71	Hameed [27]
13	Spent tea leaves	Basic Blue 9	300.05	Hameed [28]
14	Pistachio shell	Basic Blue 9	389	Moussavi et al. [45]

<sup>a</sup> Methylene Blue.<sup>b</sup> Rhodamine-B.

capacity. As described before, there are various types of clays, the adsorption capacity of which results from a negative recharge. In addition, industrial and agricultural wastes are another low-cost alternative for the removal of dyes, which has shown to be as effective as commercial adsorbents if not more. Ferrero [22] has investigated several nut shells as dye removal adsorbents. According to his studies, the adsorption capacity of hazelnut shell was observed to be even higher than that of commercial activated carbon. The author explained the reason for such behavior due to the presence of polar functional

**TABLE 25.8** Adsorption Capacity for the Removal of Direct Dyes by Low-Cost Natural Adsorbents

No.	Low-Cost Natural Adsorbent	Dye	Adsorption Capacity (mg/g)	References
1	Sunflower stalk	Direct Red 28 <sup>a</sup>	37.78	Sun and Xu [65]
2	Rice hull ash	Direct Red 28	171	Chou et al. [80]
3	Orange peel	Direct Red 28	14	Annadurai et al. [7]
4	Banana peel	Direct Red 28	18.2	Annadurai et al. [7]
5	Coir pith	Direct Red 28	6.8	Namasivayam and Kavitha [46]
6	Orange peel	Direct Red 23	10.72	Arami et al. [8]
7	Orange peel	Direct Red 80	21.05	Arami et al. [8]
8	Soybean hull	Direct Red 80	178.6	Arami et al. [81]
9	Chitosan	Direct Red 28	81.23	Wang and Wang [71]
10	Almond shell	Direct Red 80	22.4	Doulati Ardejani et al. [18]
11	Walnut shell	Direct Blue 15	11.3	Eslamian et al. [20]

<sup>a</sup> Congo Red.

groups in hazelnut shell. Furthermore, the thermal activation causes a highly microporous structure that is inaccessible to the large number of dye molecules and adversely destroys the functional groups on the surface area while contributing to the adsorption mechanism [22].

It should be noted that various factors, namely, pore size distribution of the adsorbent, dye molecule size, functional groups on the adsorbent, initial concentration of dye, adsorbent dose and particle size, solution pH and temperature, and agitation speed and time, often effectively impact the adsorption capacity of the dye removal process by natural waste. Therefore, the maximum adsorption capacity can be optimized by varying the contributing factors. A cost–benefit analysis is recommended as well in order to minimize the cost in comparison to that of commercial adsorbent and to justify the approach.

## 25.6 Case Study

The main goal of this case study was to evaluate walnut shells as a low-cost and agricultural adsorbent for the removal of textile dyes from aqueous solutions, which was carried out by Eslamian et al. in 2012. For this purpose, the batch adsorptions of three dyes, namely, Acid Red 88, Acid Blue 113, and Direct Blue 15, onto walnut shells were investigated. The effect of three most effective factors on dye removal such as the initial dye concentration in four levels (25, 50, 100, and 150 mg/L), adsorbent dosage in four levels (5, 10, 20, and 35 g/L), and pH in three levels (4, 6, and 8) were evaluated by means of full factorial experiment design.

The solution containing Acid Red 88 reached equilibrium after 90 min of contact with the adsorbent, while the other two dyes reached equilibrium after 120 min. Adsorption isotherm experiments were conducted, and it was found that the maximum adsorption capacity of walnut shells for the removal of Acid Red 88, Acid Blue 113, and Direct Blue 15 is 24.6, 15.4, and 11.3 mg/g, respectively.

Later, the effect of the three most important chosen factors (initial dye concentration, adsorbent dosage, and pH) in dye removal by walnut shells was studied. A total of 288 tests were done, out of which 70% of the data showed removal efficiency in the range of 70%–100%. This can be better understood by the histogram illustrated in Figure 25.3. The maximum dye removal efficiency for Acid Red 88, Acid Blue 113, and Direct Blue 15 was reported as follows: 96.6%, 96.4%, and 87.4%.

The results obtained from the analysis of variance (ANOVA) determined that the adsorbent dosage has the most contribution to the process of dye removal by walnut shells (49%). As illustrated in Figure 25.4, the augmentation in the amount of adsorbent from 5 to 35 g/L considerably increases the dye removal efficiency from approximately 40% to 100%.

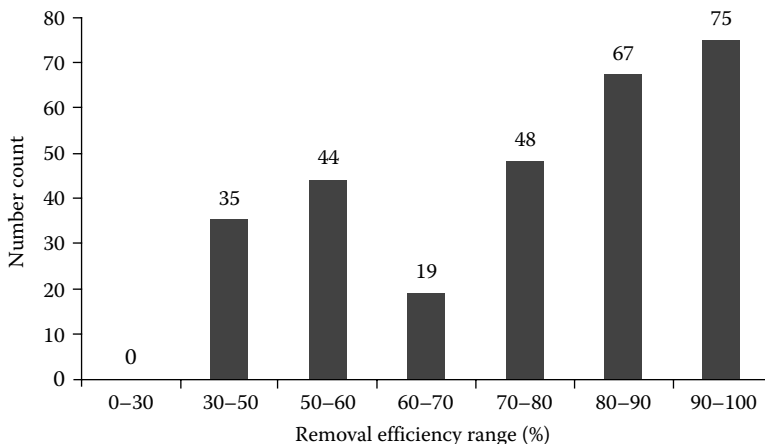


FIGURE 25.3 Histogram of the data for the dye removal by walnut shell.

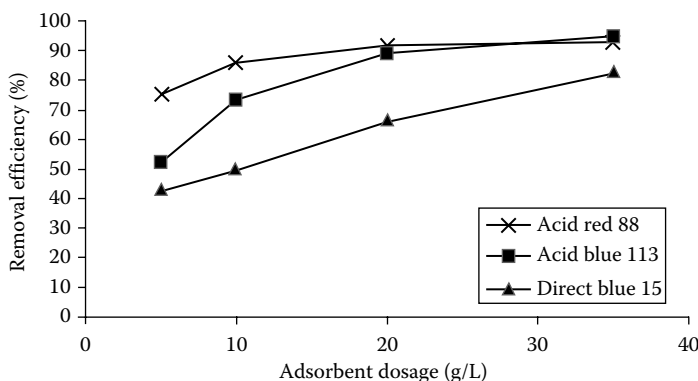


FIGURE 25.4 The effect of adsorbent dosage on the removal of dyes by walnut shells.

However, by increasing the initial dye concentration, the removal efficiency slightly decreased, and as for this case, the change in the pH of the solutions did not significantly affect the adsorption process.

The optimum condition for the maximum removal efficiency of the three investigated dyes was found as follows: initial dye concentration of 25 mg/L, adsorbent dosage of 35 g/L, natural pH, contact time of 120 min, agitation speed of 160 rpm, and lab temperature of  $(25 \pm 2)$ .

The dye removal efficiency of walnut shells for the three dyes was compared to that of activated carbon in the optimum condition. Based on the results obtained, walnut shells have more capacity in removing Acid Blue 113 and Direct Blue 15 in comparison with activated carbon, whereas the adsorbent showed similar results for Acid Red 88. Due to the high cost of activated carbon in relevance with walnut shells, and by taking into consideration its high removal efficiency and availability, walnut shells as adsorbent are preferable for the case of these three dyes.

## 25.7 Summary and Conclusions

Water pollution is one of the major concerns of today’s societies with the inefficiency of water resources in most region especially arid regions making it even worst. Therefore, many efforts have been carried out to control the pollution of these valuable natural resources. It is essential that



wastewaters be sufficiently treated to meet the required quality standards prior to discharge. The two most toxic and hazardous pollutant groups are heavy metals and dyes. Adsorption was suggested to be the efficient removal approach for these pollutants, and the feasibility of the use of an alternative adsorbent was discussed in this chapter. According to the studies presented here, nonconventional adsorbents, namely, low-cost and natural wastes can be applied as an alternative adsorbent that has proven to possess promising adsorption capacities. The use of these natural and low-cost wastes can be optimized and further studied so that they could replace the commercial adsorbents. Since these natural adsorbents are easily available, cheap, and environmentally friendly, they tremendously contribute to the environment as they are recycled and reused for water pollution control and majorly decrease pollutants.

## References

1. Abrahart, E.N., 1977. *Dyes and Their Intermediates*, New York: Chemical Publishing, pp. 1–12.
2. Ahluwalia, S.S. and Goyal, D., 2005. Removal of heavy metals from waste tea leaves from aqueous solution, *Eng. Life Sci.*, 5: 158–162.
3. Akar, S.T. and Uysal, R., 2010. Untreated clay with high adsorption capacity for effective removal of C.I. Acid Red 88 from aqueous solutions: Batch and dynamic flow mode studies, *Chem. Eng. J.*, 162: 591–598.
4. Alexandre, A.T., Santos, L.B., and Nozaki, J., 2008. Removal of Pb<sup>2+</sup>, Cu<sup>2+</sup>, and Fe<sup>3+</sup> from battery manufacture wastewater by chitosan produced from silkworm chrysalides as a low-cost adsorbent, *React. Funct. Polym.*, 68: 634–642.
5. Al-Haj-Ali, A. and Al-Hunaidi, T., 2004. Breakthrough curves and column design parameters for sorption of lead ions by natural zeolite, *Environ. Technol.*, 25: 1009–1019.
6. Alvarez-Ayuso, E., Garcia-Sanchez, A., and Querol, X., 2003. Purification of metal electroplating waste waters using zeolites, *Water Res.*, 37: 4855–4862.
7. Annadurai, G., Juang, R.-S., and Lee, D.-J., 2002. Use of cellulose-based wastes for adsorption of dyes from aqueous solutions, *J. Hazard. Mater.*, 92: 263–274.
8. Arami, M., Limaee, N.Y., Mahmoodi, N.M., and Tabrizi, N.S., 2005. Removal of dyes from colored textile wastewater by orange peel adsorbent: Equilibrium and kinetic studies, *J. Colloid Interf. Sci.*, 288: 371–376.
9. Babel, S. and Kurniawan, T.A., 2003. Low-cost adsorbents for heavy metals uptake from contaminated water: A review, *J. Hazard. Mater.*, B97: 219–243.
10. Bagane, M. and Guiza, S., 2000. Elimination d'un colorant des effluents de l'industrie textile par adsorption, *Ann. Chim. Sci. Mat.*, 25: 615–625.
11. Bailey, S.E., Olin, T.J., Bricka, R.M., and Adrian, D.D., 1999. A review of potentially low-cost sorbents for heavy metals, *Water Res.*, 33(11): 2469–2479.
12. Benaissa, H., 2006. Screening of new sorbent materials for cadmium removal from aqueous solutions. *J. Hazard. Mater.*, 132: 189–195.
13. Bhattacharyya, K.G. and Gupta, S.S., 2006. Kaolinite, montmorillonite, and their modified derivatives as adsorbents for removal of Cu(II) from aqueous solution, *Sep. Purif. Technol.*, 50(3): 388–397.
14. Chantawong, V., Harvey, N.W., Bashkin, V.N., and Asian, J., 2001. Adsorption of lead nitrate on Thaikaolin and ball clay, *Energ. Environ.*, 1: 33–48.
15. Chen, B.N., Hui, C.W., and McKay, G., 2001. Film-pore diffusion modeling and contact time optimization for the adsorption of dyestuffs on pith, *Chem. Eng. J.*, 84: 77–94.
16. Cincotti, A., Mameli, A., Locci, A.M., Orru, R., and Cao, G., 2006. Heavy metals uptake by Sardinian natural zeolites: Experiment and modeling, *Ind. Eng. Chem. Res.*, 45: 1074–1084.
17. Deniz, F. and Saygideger, S.D., 2010. Equilibrium, kinetic and thermodynamic studies of Acid Orange 52 dye biosorption by *Paulownia tomentosa* Steud. leaf powder as a low-cost natural biosorbent, *Bioresour. Technol.*, 110: 5137–5143.

18. Doulati Ardejani, F., Badii, Kh., Yousefi Limaee, N., Shafaei, S.Z., and Mirhabibi, A.R., 2007. Adsorption of Direct Red 80 dye from aqueous solution onto almond shells: Effect of pH, initial concentration and shell type, *J. Hazard. Mater.*, 151: 730–737.
19. Erdem, E., Karapinar, N., and Donat, R., 2004. The removal of heavy metal cations by natural zeolites, *J. Colloid Interf. Sci.*, 280: 309–314.
20. Eslamian, F., 2012. Evaluation of walnut shells as an adsorbent for dye removal from solutions containing textile dyes, Master thesis, Department of Civil Engineering, Isfahan University of Technology, Isfahan, Iran.
21. Farajzadeh, M.A. and Monji, A.B., 2004. Adsorption characteristics of wheat bran towards heavy metal cations, *Sep. Purif. Technol.*, 38: 197–207.
22. Ferrero, F., 2007. Dye removal by low cost adsorbents: Hazelnut shells in comparison with wood sawdust, *J. Hazard. Mater.*, 142: 144–152.
23. Garg, U.K., Kaur, M.P., Garg, V.K., and Sud, D., 2007. Removal of hexavalent Cr from aqueous solutions by agricultural waste biomass, *J. Hazard. Mater.*, 140: 60–68.
24. Gedik, K. and Imamoglu, I., 2008. Affinity of clinoptilolite-based zeolites towards removal of Cd from aqueous solutions, *Sep. Sci. Technol.*, 43: 1191–1207.
25. Gupta, V.K. and Suhas, S., 2009. Application of low-cost adsorbents for dye removal—A review, *J. Environ. Manage.*, 90: 2313–2342.
26. Gupta, V.K. and Ali, I., 2004. Removal of lead and chromium from wastewater using bagasse fly ash—A sugar industry waste, *J. Colloid Interf. Sci.*, 271: 321–328.
27. Hameed, B.H., 2009a. Removal of cationic dye from aqueous solution using jackfruit peel as non-conventional low-cost adsorbent, *J. Hazard. Mater.*, 162: 344–350.
28. Hameed, B.H., 2009b. Spent tea leaves: a new non-conventional and low-cost adsorbent for removal of basic dye from aqueous solutions, *J. Hazard. Mater.*, 161: 753–759.
29. Hu, K.J., Hu, J.L., Ho, K.P., and Yeung, K.W., 2004. Screening of fungi for chitosan producers and copper adsorption capacity of fungal chitosan and chitosanaceous materials, *Carbohydr. Polym.*, 58: 45–52.
30. Inglezakis, V.J. and Pouloupoulos, S.G., 2006. *Adsorption, Ion Exchange and Catalysis*, 1st edn., Amsterdam, the Netherlands: Elsevier Ltd.
31. Juang, R.S., Wu, F.C., and Tseng, R.L., 1999. Adsorption removal of copper(II) using chitosan from simulated rinse solutions containing chelating agents, *Water Res.*, 33: 2403–2409.
32. Kaya, A. and Oren, A.H., 2005. Adsorption of zinc from aqueous solutions to bentonite, *J. Hazard. Mater.*, 125(1): 183–189.
33. Khan, S.A., Rehman, R., and Khan, M.A., 1995. Adsorption of chromium(III), Chromium(IV) and Silver(I) on bentonite, *Waste Manage.*, 15: 271–282.
34. Kurniawan, T.A., Chan, G.Y.S., Lo, W.H., and Babel, S., 2006. Comparison of low-cost adsorbents for treating wastewater laden with heavy metals, *Sci. Total Environ.*, 366: 409–426.
35. Lima, I.S. and Airoidi, C., 2004. A thermodynamic investigation on chitosan–divalent cation interactions, *Thermochim. Acta*, 421: 133–139.
36. Lin, S.H. and Juang, R.S., 2002. Heavy metal removal from water by sorption using surfactant modified montmorillonite, *J. Hazard. Mater.*, 92: 315–326.
37. Malkoc, E. and Nuhoglu, Y., 2005. Investigation of Ni II removal from aqueous solutions using tea factory waste, *J. Hazard. Mater.*, B127: 120–128.
38. McKay, G., El-Geundi, M., and Nassar, M.M., 1997. Equilibrium studies for the adsorption of dyes on bagasse pith, *Adsorp. Sci. Technol.*, 15: 251–270.
39. McKay, G., Porter, J.F., and Prasad, G.R., 1999. The removal of dye colours from aqueous solutions by adsorption on low-cost materials, *Water Air Soil Poll.*, 114: 423–438.
40. Mellah, A. and Chegrouche, S., 1997. The removal of zinc from aqueous solutions by natural bentonites, *Water Res.*, 31: 621–629.
41. Meshko, V., Markovska, L., Mincheva, M., and Rodrigues, A.E., 2001. Adsorption of basic dyes on granular activated carbon and natural zeolite, *Water Res.*, 35: 3357–3366.

42. Mohan, D. and Singh, K.P., 2002. Single- and multi-component adsorption of cadmium and zinc using activated carbon derived from bagasse-an agricultural waste, *Water Res.*, 36: 2304–2318.
43. Mohan, D., Singh, K.P., and Singh, V.K., 2006. Chromium (III) removal from wastewater using low cost activated carbon derived from agriculture waste material and activated carbon fabric filter, *J. Hazard. Mater.*, B135: 280–295.
44. Montanher, S.F., Oliveira, E.A., and Rollemberg, M.C., 2005. Removal of metal ions from aqueous solutions by sorption onto rice bran, *J. Hazard. Mater.*, B117: 207–211.
45. Moussavi, G. and Khosravi R., 2011. The removal of cationic dyes from aqueous solutions by adsorption onto pistachio hull waste, *Chem. Eng. Res. Des.*, 89: 2182–2189.
46. Namasivayam, C. and Kavitha, D., 2002. Removal of Congo Red from water by adsorption onto activated carbon prepared from coir pith, an agricultural solid waste, *Dyes Pigments*, 54: 47–58.
47. Namasivayam, C., Prabha, D., and Kumutha, M., 1998. Removal of direct red and acid brilliant blue by adsorption on to banana pith, *Bioresour. Technol.*, 64: 77–79.
48. Naseem, R. and Tahir, S.S., 2001. Removal of Pb(II) from aqueous/acidic solutions by using bentonite as an adsorbent, *Water Res.*, 35: 3982–3986.
49. Ng, J.C.Y., Cheung, W.H., and McKay, G., 2002. Equilibrium studies of the sorption of Cu(II) ions onto chitosan, *J. Colloid Interf. Sci.*, 255: 64–74.
50. Oliveira, E.A., Montanher, S.F., Andnade, A.D., Nobrega, J.A., and Rollemberg, M.C., 2005. Equilibrium studies for the sorption of chromium and nickel from aqueous solutions using raw rice bran, *Process Biochem.*, 40: 3485–3490.
51. Oter, O. and Akcay, H., 2007. Use of natural clinoptilolite to improve, water quality: Sorption and selectivity studies of lead(II), copper(II), zinc(II), and nickel(II), *Water Environ. Res.*, 79: 329–335.
52. Ozacar, M. and Sengil, I.A., 2005. Adsorption of metal complex dyes from aqueous solutions by pine sawdust, *Bioresour. Technol.*, 96: 791–795.
53. Paulino, A.T., Guilherme, M.R., Reis, A.V., Tambourgi, E.B., Nozaki, J., and Muniz, E.C., 2007. Capacity of adsorption of Pb<sup>2+</sup> and Ni<sup>2+</sup> from aqueous solutions by chitosan produced from silkworm chrysalides in different degrees of deacetylation, *J. Hazard. Mater.*, 147: 139–147.
54. Poots, V.J.P., McKay, G., and Healy, J.J., 1976. The removal of acid dyes from effluent using natural adsorbents—II wood. *Water Res.*, 10: 1067–1070.
55. Saiano, F., Ciofalo, M., Cacciola, S.O., and Ramirez, S., 2005. Metal adsorption by *Phomopsis* sp. biomaterial in laboratory experiments and real wastewater treatments, *Water Res.*, 39: 2273–2280.
56. Sankaramakrishnan, N., Sharam, A.K., and Sanghi, R., 2007. Novel chitosan derivative for removal of cadmium in the presence of cyanide from electroplating wastewater, *J. Hazard. Mater.*, 148: 353–359.
57. Sarin, V. and Pant, K.K., 2006. Removal of chromium from industrial waste by using eucalyptus bark, *Bioresour. Technol.*, 97: 15–20.
58. Sciban, M., Klasnja, M., and Skrbic, B., 2006. Modified hardwood sawdust as adsorbent of heavy metal ions from water, *Wood Sci. Technol.*, 40: 217–227.
59. Singh, A.K., Singh, D.P., and Singh, V.N., 1988. Removal of Zn(II) from water by adsorption on china clay, *Environ. Technol. Lett.*, 9: 1153–1162.
60. Sivaraj, R., Namasivayam, C., and Kadirvelu, K., 2001. Orange peel as an adsorbent in the removal of Acid violet 17 (acid dye) from aqueous solutions. *Waste Manage.*, 21: 105–110.
61. Sprynskyy, M., Buszewski, B., Terzyk, A.P., and Namiesnik, J., 2006. Study of the selection mechanism of heavy metal (Pb<sup>2+</sup>, Cu<sup>2+</sup>, Ni<sup>2+</sup>, and Cd<sup>2+</sup>) adsorption on clinoptilolite, *J. Colloid Interf. Sci.*, 304: 21–28.
62. Srivastava, S.K., Tyagi, R., and Pal, N., 1989. Studies on the removal of some toxic metal ions, part II. *Environ. Technol. Lett.*, 10: 275–282.
63. Srivastava, S., Ahmed, A.H., and Thakur, I.S., 2007. Removal of chromium and pentachlorophenol from tannery effluent. *Bioresour. Technol.*, 98: 1128–1132.

64. Sud, D., Mahajan, G., and Kaur, M.P., 2008. Agricultural waste material as potential adsorbent for sequestering heavy metal ions from aqueous solutions—A review, *Bioresour. Technol.*, 99: 6017–6027.
65. Sun, G. and Xu, X., 1997. Sunflower stalk as adsorbents for color removal from textile wastewater. *Ind. Eng. Chem. Res.*, 36: 808–812.
66. Taty-Costodes, V.C., Favdvet, H., Porte, C., and Delacroix, A., 2003. Removal of cadmium and lead ions from aqueous solutions, by adsorption onto saw dust of *Pinus sylvestris*. *J. Hazard. Mater.*, B105: 121–142.
67. Turkman, A.E., Aslan, S. and Ege, I., 2004. Treatment of metal containing wastewaters by natural zeolites, *Fresen. Environ. Bull.*, 13: 574–580.
68. Udaybhaskar, P., Iyengar, L., and Rao, A.V.S.P., 1990. Hexavalent chromium interaction with chitosan. *J. Appl. Polym. Sci.*, 39: 739–747.
69. Undaybeytia, T., Morillo, E., and Maqueda, C., 1996. Adsorption of Cd and Zn on montmorillonite in the presence of a cationic pesticide, *Clays Clay Miner.*, 31: 485–490.
70. Wan Ngah, W.S., Kamari, A., and Koay, Y.J., 2004. Equilibrium and kinetics studies of adsorption of copper (II) on chitosan and chitosan/PVA beads, *Int. J. Biol. Macromol.*, 34: 155–161.
71. Wang, L. and Wang, A., 2007. Adsorption characteristics of Congo Red onto the chitosan/montmorillonite nanocomposite, *J. Hazard. Mater.*, 147: 979–985.
72. Wanga, S. and Pengb Y., 2010. Natural zeolites as effective adsorbents in water and wastewater treatment, *Chem. Eng. J.*, 156: 11–24.
73. Wong, Y.C., Szeto, Y.S., Cheung, W.H., and McKay, G., 2004. Adsorption of acid dyes on chitosan—equilibrium isotherm analyses, *Process Biochem.*, 39: 695–704.
74. Wu, F.C., Tseng, R.L., and Juang, R.S., 2010. A review and experimental verification of using chitosan and its derivatives as adsorbents for selected heavy metals, *J. Environ. Manage.*, 91: 798–806.
75. Yu, B., Zhang, Y., Shukla, A., Shukla, S., and Dorris, K.L., 2001. The removal of heavy metals from aqueous solutions by sawdust adsorption—Removal of lead and comparison of its adsorption with copper, *J. Hazard. Mater.*, 84: 83–94.
76. Zollinger, H., 2003. *Color Chemistry. Synthesis, Properties and Applications of Organic Dyes and Pigments*, 3rd edn., Weinheim, Germany: Wiley-VCH.
77. Gupta, S.S. and Bhattacharyya, K.G., 2008. Immobilization of Pb (II), Cd (II) and Ni (II) ions on kaolinite and montmorillonite surfaces from aqueous medium, *J. Environ. Manage.*, 87: 46–58.
78. Acar, F.N. and Malkoc, E., 2004. The removal of chromium (VI) from aqueous solutions by *Fagus orientalis* L, *Bioresour. Technol.*, 94: 13–15.
79. International Agency for Research on Cancer (IARC), 2010. IARC Monographs on the evaluation of carcinogenic risks to humans, General introduction to the chemistry of dyes, Volume 99. Available at: <http://monographs.iarc.fr/ENG/Monographs/vol99/index.php>
80. Chou, K.S., Tsai, J.C., and Lo, C.T., 2001. The adsorption of Congo red and vacuum pump oil by rice hull ash, *Bioresour. Technol.*, 78: 217–219.
81. Arami, M., Limaee, N.Y., Mahmoodi, N.M. and Tabrizi, N.S. 2006. Equilibrium and kinetics studies for the adsorption of direct and acid dyes from aqueous solution by soy meal hull, *J. Hazard. Mater.*, 135, 171.



# 26

## Water Resources Assessment in a River Basin Using AVSWAT Model

---

26.1	Introduction.....	502
26.2	Background.....	503
26.3	Stages in Water Resources Assessment .....	503
26.4	Role of GIS in Water Resources Assessment .....	504
26.5	Role of DEM in Water Resources Assessment .....	507
26.6	Brief Description of SWAT and AVSWAT .....	509
26.7	Description of the Study Region.....	511
26.8	Data Used in the Study.....	512
26.9	Application of AVSWAT Model .....	513
26.10	Summary and Conclusions .....	516
	Abbreviations .....	517
	Acknowledgment.....	517
	References.....	517

**Aavudai Anandhi**  
*Indian Institute of Science*  
*Kansas State University*

**V.V. Srinivas**  
*Indian Institute of Science*

**D. Nagesh Kumar**  
*Indian Institute of Science*

### AUTHORS

**Aavudai Anandhi** is working as an assistant professor for research in the Department of Agronomy, Kansas State University, Manhattan, United States, since October 2011. Earlier she worked as a research associate (December 2008–August 2011) in Hunter College, CUNY University, New York, United States, studying the impacts of climate change in New York City water supply. For about eleven months, she worked as a postdoctoral fellow in the Indian Institute of Science, Bangalore, India, after she obtained her PhD from the same institute in 2008. Earlier to 2002, she has worked in state government agencies and a nongovernmental organization (NGO) in India handling projects relating to remote sensing and GIS applications to water resources and agriculture and soil and water conservation. Her areas of research include the following: climate change impacts, adaptation and mitigation on water, agriculture, and energy nexus, extreme event analysis, downscaling, global climate model evaluation; agroecosystems and hydrological modeling, model sensitivity and uncertainty analysis, reliability and vulnerability assessments, life cycle analysis; and remote sensing and GIS applications in water resources and agriculture. She has published about 20 papers in leading international journals and about 40 in conference proceedings.

**V.V. Srinivas** is working in the Department of Civil Engineering, Indian Institute of Science, Bangalore, since July 2002. Earlier he has worked at Purdue University, United States (2001–2002), as a postdoctoral

research associate. Dr Srinivas obtained his PhD (Engg) from the Indian Institute of Technology Madras, Chennai, India, in 2001. His research interests include stochastic surface water hydrology and climate hydrology. He is a recipient of Young Engineer Award of the Indian National Academy of Engineering (INAE) in 2006, Better Opportunities for Young Scientist in Chosen Areas of Science and Technology (BOYSCAST) Fellowship of Government of India in 2007, Jacques W. Delleur Award (2002) and VICS Fellowship (2007) of Purdue University, United States, and recognition as Outstanding Reviewer from American Society of Civil Engineers (ASCE) for the year 2010. He has published more than 40 papers in leading international journals and conferences in his research fields. He has coauthored a textbook titled *Regionalization of Watersheds: An Approach Based on Cluster Analysis* published by Springer. He is an associate editor for *Journal of Earth System Science*, published by Indian Academy of Sciences and Springer, since 2008. Further, he has reviewed more than 70 papers for various international journals.

**D. Nagesh Kumar** is working in the Department of Civil Engineering, Indian Institute of Science, Bangalore, since May 2002. Earlier he worked in IIT, Kharagpur (1994–2002) and NRSC, Hyderabad (1992–1994). Dr Kumar obtained his PhD (Engg) from Indian Institute of Science, Bangalore, India in 1992. He visited Utah State University, United States, in 1999 for six months on BOYSCAST Fellowship and Ecole Nationale Supérieure des Mines de Saint-Etienne, France, as visiting professor for four months in 2012. His research interests include climate hydrology, water resources systems, ANN, evolutionary algorithms, fuzzy logic, MCDM, and remote sensing and GIS applications in water resources engineering. He has published more than 140 papers in leading international journals and conferences in his research fields. He has coauthored two textbooks titled *Multicriterion Analysis in Engineering and Management* published by PHI, New Delhi, and *Floods in a Changing Climate: Hydrologic Modeling*, published by Cambridge University Press, United Kingdom. He has received IBM Faculty Award for 2012. He is an associate editor for *ASCE Journal of Hydrologic Engineering*. He is in the editorial board of *Open Hydrology Journal*, *ISH Journal of Hydraulic Engineering*, and *Journal of Applied Computational Intelligence and Soft Computing*.

## PREFACE

GIS with its data, topological, network, and cartographic modeling, map overlay, and geostatistics techniques is a very effective tool for water resources assessment (WRA). Digital elevation modeling (DEM) is useful for extracting topographic information such as slope properties, drainage basin delineation, drainage divides, and drainage networks that are required for hydrological modeling for WRA. The role of GIS and DEM in the different stages of WRA is demonstrated through a case study of rainfall–runoff simulation in Malaprabha reservoir catchment of India using Arc View Soil and Water Assessment (AVSWAT) model. GIS and DEM were useful in providing necessary input to AVSWAT model that performed fairly well in predicting runoff. The results pertaining to the parameters plant uptake compensation factor (EPCO)=0.75, soil evaporation compensation factor (ESCO)=0.4, and available water capacity (AWC)=0.04, for which  $R^2$  value of 0.95 is obtained during validation, are selected. In addition to investigating the water balance issues of each subbasin in Malaprabha catchment, AVSWAT was developed to predict the impact of land management practices on water displacement of sediment and agricultural chemical yields.

## 26.1 Introduction

Water as a source of life has become more important in this century due to increase in its consumption owing to the population explosion, unprecedented rise in standard of living, enormous industrial development, and technological advancements. At the global scale, between 1970 and 1990, the amount

of freshwater resources available per capita decreased by a third (See page 12 in Chapter 1 of [20]). Also, water crisis is predicted to take place by mid-twenty-first century. Hence, water management continues to be a high priority issue in international agendas. The 19th special session of the UN General Assembly concluded that water would become a major limiting factor in socioeconomic development and the seriousness of the situation calls for the highest priority to be given to the freshwater problems [19]. However, the holistic integrated and environmentally sound sustainable management of our water resources is intimately linked to our ability to adequately assess them. Hence, water resources assessment (WRA) has become more essential than ever for meeting the world's water needs. WRA is defined as the determination of the sources, extent, dependability, and quality of water resources for their utilization and control. Here, water resources are defined as the water available, or capable of being made available, for use in sufficient quantity and quality at a location and over a period of time appropriate for an identifiable demand [16].

The past experience suggests that it is easier to assess the water resources of the area in a river basin or aquifer framework when compared to jurisdictional and economic regions [17]. WRA of a region involves a detailed study of the surface and subsurface water. Integration of the entire surface and subsurface data requires thousands of man-hours. However, it would increase the scope and scale of problems that can be addressed by WRA. This predicament makes the geographic information system (GIS) software a powerful tool for developing solutions in building hydrological information systems that synthesize geospatial and temporal water resources data to support hydrological analysis and modeling for WRA.

## 26.2 Background

---

The earliest need for WRA of the world was stressed in Mar del Plata Action Plan announced in 1977. Fifteen years later, in 1992, Rio Summit (Chapter 18 in Agenda 21 of United Nations Conference on Environment and Development) emphasized the need for the establishment of inventory of water resources, development of interactive databases, use of GIS, and sharing of appropriate knowledge and technology. Further, the World Water Assessment Programme (WWAP) was established by United Nations Water (UN Water) in 2000 for assessment of freshwater resources throughout the world. The WWAP publishes its output/recommendations in United Nations World Water Development Reports (WWDRs) that are published triennially [20,21] to enhance the WRA capacity of countries. The current interest in WRA has been emphasized by the World Water Council (WWC), the Global Water Partnership (GWP), and the World Commission on Water for the twenty-first century, to promote a World Water Vision for the year 2025.

## 26.3 Stages in Water Resources Assessment

---

Based on WRA: *Handbook for Review of National Capabilities* [18], following three stages are identified in the WRA:

1. The first or basic stage of WRA involves collection, processing, and inventorying hydrological, hydrometeorological, hydrogeological, physiographic, and auxiliary data on the water cycle components and water use projects for the creation of water resources information system. Depending on the characteristics of the available water resources, current and future needs of the users, the requirements of data for WRA are different for different regions and countries.
2. The second stage is to interpret the collected data in the form of technical information for the water resources information system. This stage involves assessing the state of water resources, forecasting of water-related natural disasters (such as droughts and floods), and using various techniques. The selection of a technique (such as hydrological modeling) depends on the availability of data and the objectives for WRA. Also, in this stage, further detailed investigations in meeting the requirements of water resources development projects may be carried out according to the requirement.



3. The final stage is to interpret and evaluate the data and technical information (provided by the previous stages) and convert them into knowledge, for making appropriate decisions. Some of the decisions at this stage could be on prioritizing watersheds, zoning of land within watersheds, riparian buffers, and management and mitigation of floods and droughts. Also, this stage adopts appropriate management strategies to avoid adverse environmental effects and reconcile conflicts between users for a sustained economic and social development in the region. The decisions depend on the specific task/objectives in WRA, while keeping in view the overall objective of integrated, sustainable management of water resources.

The primary objective of this chapter is to demonstrate the use of GIS and digital elevation model (DEM) in the various stages of WRA through a case study of rainfall–runoff simulation. Catchment of Malaprabha reservoir in Karnataka state of India is chosen for demonstration. It is one of the major lifelines for the arid regions of north Karnataka and possibly the largest arid region in India outside the Thar desert. Several rainfall–runoff simulation models are in use and each has its strengths and limitations, and there are no established criteria by which the superiority of any particular model can be clearly established. The Soil and Water Assessment Tool (SWAT) is selected for rainfall–runoff prediction, as this model has been widely used in hydrology and as the extensive data required for the model could be readily obtained for the study region from different sources. Details of this case study are presented in this chapter.

## 26.4 Role of GIS in Water Resources Assessment

GIS is not only a computer-based spatial database system, capable of gathering, storing, manipulating, analyzing, and disseminating geographic data, but also, in its widest definition, a data system to manage the environment for sustainable development.

GIS has been able to capture the synergy between the time series data on hydrological, hydrometeorological, and hydrogeological variables describing water properties and the geospatial data on water environment describing the water resources feature of the landscape for a better WRA. Hence, GIS can play an important role in all the three stages of WRA (Figure 26.1).

The first stage of WRA involves collection, processing, and inventorying of existing hydrological, hydrometeorological, hydrogeological, physiographic, and auxiliary data. The data required in WRA vary in space and time. Examples of data that vary in both space and time include that on

1. Variables such as temperature, wind speed, humidity of air, precipitation, runoff, evaporation, streamflows, soil moisture, and hydraulic conductivity of soil
2. Water bodies such as glaciers, rivers, lakes, oceans, and groundwater
3. Physiographical attributes such as land use and land cover

Examples of data that vary only in space include topography, geology, geomorphology, and soil of the region. The data that are collected from various sources such as conventional network of measurement devices, remote sensing (aerial surveys, satellites, and radars), DEMs, topographic maps, and satellite images can be classified into three groups, namely, historical data, real-time data, and special survey data.

GIS could be used to integrate and relate any data with a spatial component, regardless of the source of the data. The techniques in GIS useful in this stage of WRA are data creation, relating data from different sources, data representation, and handling nonspatial data. Through digitization (the most common method of data creation), geographic data are extracted from hardcopy map or survey plan and transferred into a digital medium for further use. Further, relating data from several sources in many different forms is useful. For example, relating information on soil moisture measurements obtained from tensiometers in a region to satellite images of the region might be useful for drawing inferences about soil moisture status in the region at various times of the year.

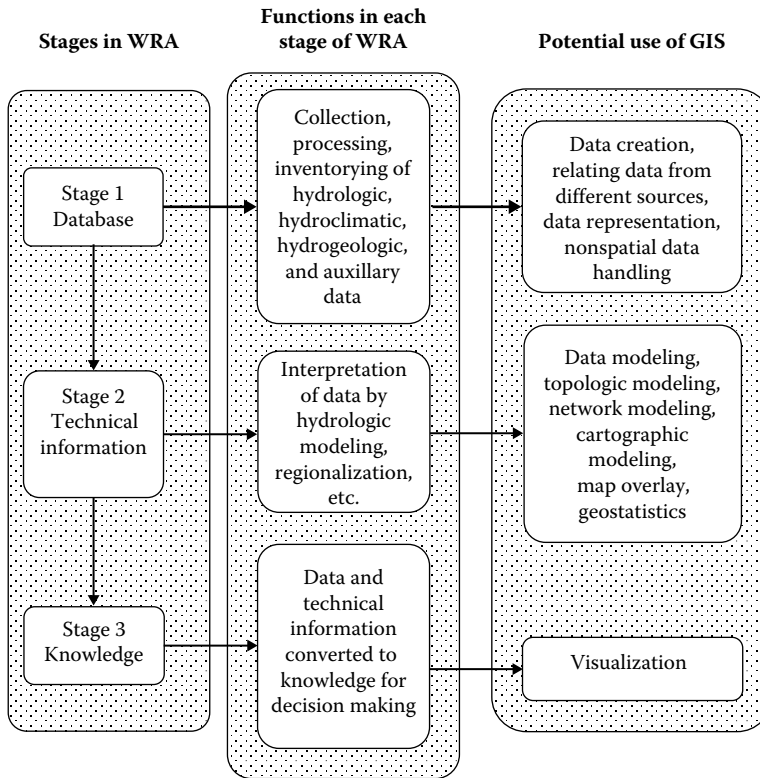


FIGURE 26.1 Use of GIS in the components of WRA.

GIS facilitates conversion of existing digital information (such as digital satellite images generated through remote sensing or DEMs), which may not yet be in map form, into forms that can be recognized and used (e.g., maplike layer of digital information about vegetative covers, drainage network). Furthermore, real-world data objects are represented by dividing them into two abstractions: discrete objects (e.g., dam and spillway) and continuous fields (e.g., rainfall amount and elevation) to be stored as raster and vector forms. Additionally, nonspatial data can also be stored besides the spatial data represented by their spatial coordinates. For example, rainfall data can be converted to maplike layer of thematic information in GIS, based on rain gauge location data, or instead stored as attribute information to spatial data such as inventory of land use and land cover. The digital maps at different scales undergo manipulations such as projection and coordinate conversions to integrate in GIS.

The second stage of WRA involves application of techniques such as hydrological modeling and regionalization to extract technical information for the water resources information system. Availability of spatially distributed data and the ability to manipulate such data are essential to the techniques for assessing the state of water resources, forecasting of water-related natural disasters, detailed investigations for water resources development projects, etc.

The most commonly used technique is the estimation of water balance in river basins by modeling the various components of the water cycle based on a number of existing methods/models. The selection of a particular method/model depends on the available data, the characteristics of the water resources in the region, the current and future needs of the users, the finance allocated for the assessment, requirement of a stationary or changing climate, etc. The readers may refer to the various review articles [13–15,23] for a historical perspective of mathematical modeling of watershed hydrology, steps in developing watershed models, new developments and challenges, and analysis of risk and reliability in model selection.

A major impediment to progress in hydrological modeling is the inability to explicitly consider the spatial variation of model parameters [5]. This task has always been the most time consuming and therefore costly component of hydrological modeling requiring high computational power. This impediment has since been overcome to some extent by the rapid development of computer systems and creation of advanced software.

GIS with its features such as data, topological, network, and cartographic modeling, map overlay, and geostatistics is a useful tool in the second stage of WRA. The *data modeling* can be used to depict 2D and 3D characteristics of the Earth's surface, subsurface, and atmosphere from information points, for example, modeling point rainfall measurements to generate a 2D isohyetal map of a region and surface modeling of point elevation measurements to generate a 3D DEM of a region. *Topological modeling* can be used to analyze and recognize the spatial relationships that exist within digitally stored spatial data to perform complex spatial modeling. Examples of spatial relationships include adjacency (what adjoins what), containment (what encloses what), and proximity (how close something is to something else). In *network modeling*, GIS can simulate the routing of streamflow along a river. Incorporating information such as slope, speed limit, and channel dimensions is useful in representing the flow more accurately. *Cartographic modeling* refers to a process where several thematic layers of the same area are produced, processed, and analyzed. Operations on map layers can be combined into algorithms and eventually into simulation or optimization models. In *map overlay*, the two separate spatial datasets (points, lines, or polygons) are combined to create a new output vector dataset. These overlays may be a union, intersect, symmetric difference, clip, or mask. *Geostatistics* is a point-pattern analysis that produces field predictions from data points using techniques such as interpolation in order to predict the behavior of points and locations that are not directly measurable. DEMs, triangulated irregular networks, edge-finding algorithms, Thiessen polygons, kriging, spline, and trend surface analysis are all mathematical methods to produce interpolative data. Thus, GIS offers new opportunities for hydrological modeling and upon integration with hydrological models provides the capabilities to account for the spatial variability of hydrological processes by several sets of customized and user-friendly tools.

Three major integration architectures are summarized from a range of approaches that has been proposed and implemented for integrating GIS with hydrological models [1]. The first approach is a simple two-component architecture, which allows for one-way data transfer between two independent systems (e.g., a GIS and a hydrological model). It promises low cost of implementation but low usability as well. The second approach is "embedded" two-component architecture that extends capabilities of a master component by using functions of an embedded agent component. Depending on the capabilities of the model and its output requirement, GIS can be the master component (when GIS calls a model) or agent component (when model calls a GIS application). While the third approach has many-component architecture consisting of two or more master components that share common agent components such as a database management system and/or an end-user interface. This option provides a single external scheme for the integrated system, yet retains the independence of each master component. The cost of this architecture tends to be high, but it is desirable when the component systems are complex. This third type of architecture is used in the hydrological model considered for this study.

In the final stage of WRA, GIS is used to extract and organize model output data for charting and display. This is useful for better visualization of the technical information and for analyzation of results for making appropriate decisions. The outputs from the methods/models selected for the study provide information about the characteristics of the existing water resources, stress on the water resources if any, and problems due to natural, man-induced factors, mismanagement, etc. Mapping the changes in land use, land cover, and variables such as streamflow and rainfall in a region is useful to anticipate future conditions of water, to decide on a course of action, or to evaluate the results of an action or policy [3]. For example, mapping finds use in studying impact of land development on water quality and ecological resources.

Previous studies [6,7] reported incapability in representing continuous-time component in hydrological modeling as one of the major limitations of integrating GIS with hydrological models. This problem

has been overcome in environmental modeling using a generic environmental modeling language integrated into a GIS, which supports spatial-temporal operators [12].

## 26.5 Role of DEM in Water Resources Assessment

A high-resolution DEM can be used as the basic spatial data source for defining the hydrography of the region. Studies have demonstrated the feasibility of extracting topographic information such as slope, drainage basin delineation, drainage divides, drainage networks, and morphometric properties of drainage basins (e.g., area and perimeter of drainage basins). These information extracted are faster to access and provide more precise and reproducible measurements than traditional manual techniques applied on topographic maps. Further, these techniques find more use in extracting information from large watersheds (greater than 10 km<sup>2</sup>), where manual determination of drainage network and sub-watershed features is tedious, time-consuming, error-prone, and often highly subjective process.

From the DEM (Figure 26.2), data of several features describing the hydrology of Malaprabha catchment have been derived, among which the following have been used:

- A raster dataset with the flow direction of the DEM (for each square-shaped cell of the DEM, it is assumed that the water flows toward the cell having least elevation out of its eight neighboring cells)
- A raster dataset with the flow accumulation of the DEM (each cell is assigned a value equal to the number of cells upstream of the cell; this dataset has been derived from the flow direction dataset)
- A vector dataset with drainage network (this dataset is derived based on combined information from the flow accumulation and flow direction datasets) (Figure 26.3)
- A vector dataset with probable outlets of drainage subbasins in the drainage network (Figure 26.4)
- A vector dataset with delineated drainage subbasins (this dataset is derived from the drainage network in combination with the dataset of outlets of drainage basins) (Figure 26.5)
- A vector dataset with longest streams in the delineated subbasins (Figure 26.6)

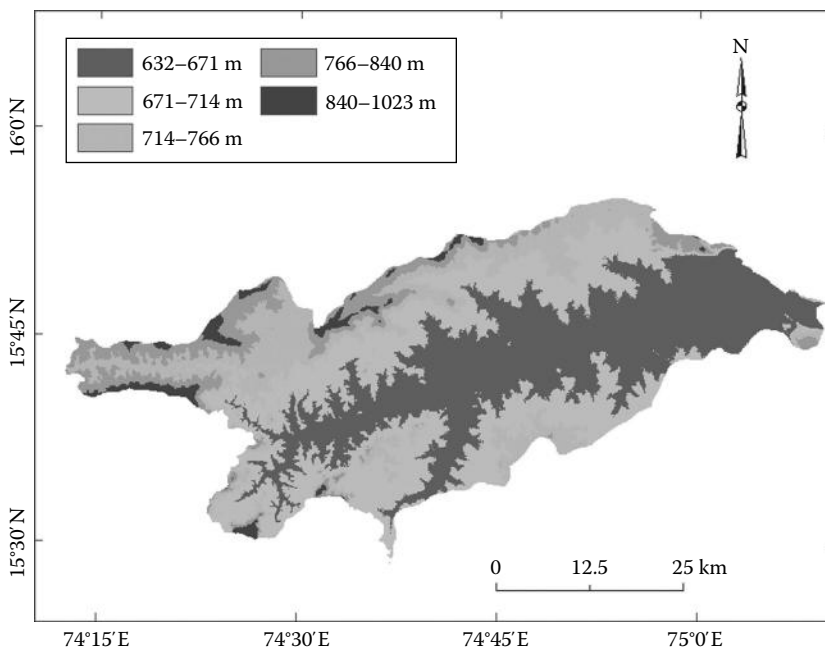
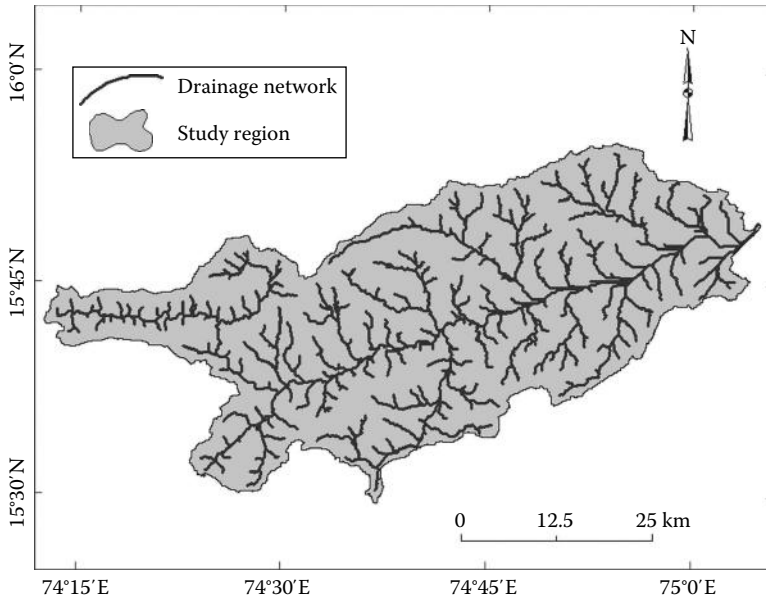
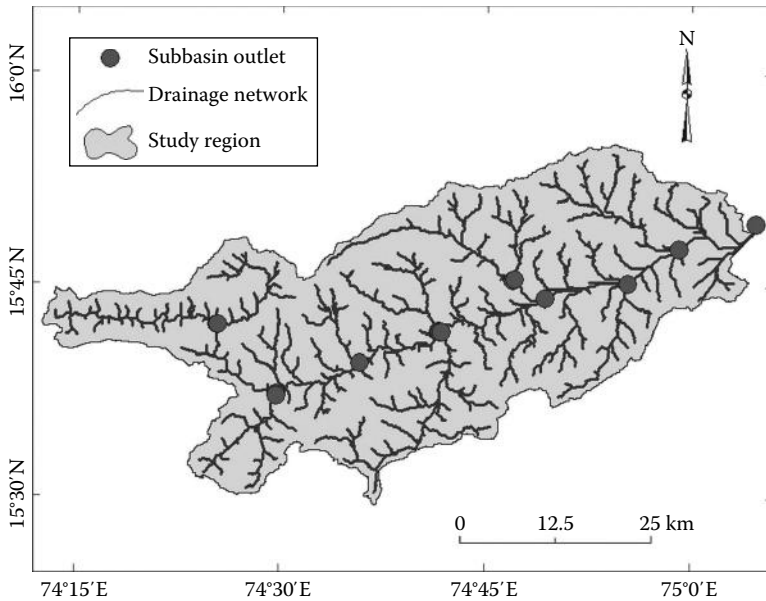


FIGURE 26.2 DEM of the catchment of Malaprabha reservoir.



**FIGURE 26.3** Stream network in the catchment of Malaprabha reservoir obtained from AVSWAT model using DEM.



**FIGURE 26.4** Drainage subbasin outlets, which are specified in the catchment of Malaprabha reservoir to form drainage subbasins obtained from AVSWAT model.

In the present study, the available information was processed through a GIS-based model to provide, at the scale of the river basin, a comprehensive picture of the streamflow simulation. This approach makes the best use of the scattered information and makes it possible to extrapolate point data or data available at river basin level to develop a credible picture of the situation of the river basin's water use and its impact on water resources.

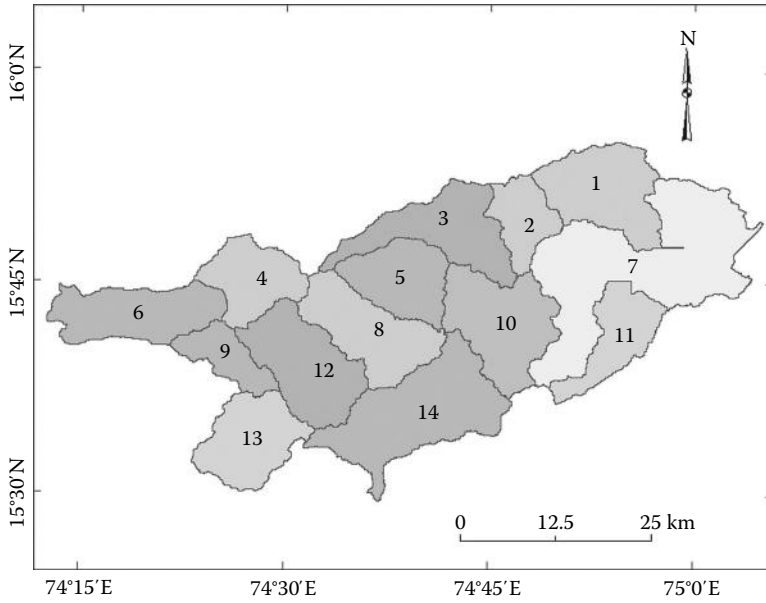


FIGURE 26.5 Subbasins formed by AVSWAT for the selected outlets in the catchment of Malaprabha reservoir.

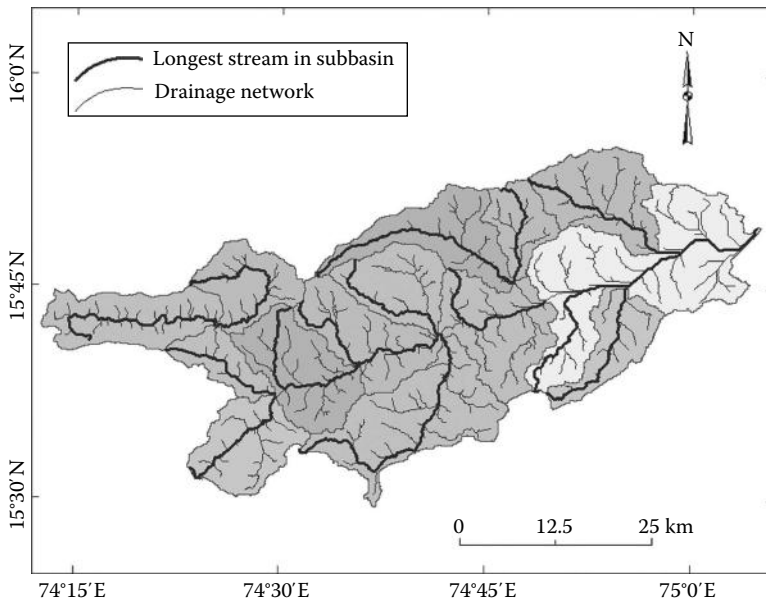


FIGURE 26.6 Longest stream in each subbasin obtained from AVSWAT model.

## 26.6 Brief Description of SWAT and AVSWAT

SWAT is the acronym for Soil and Water Assessment Tool. It is a river basin scale model developed by Dr. Jeff Arnold for the US Department of Agriculture (USDA) Agricultural Research Service [9]. It can predict the impact of land management practices on water, sediment, and agricultural chemical yields in large complex watersheds with varying soils, land use, and management conditions over long periods of time. SWAT is a physically based, distributed, continuous-time model that operates

on a daily time scale. Physical processes associated with water movement, sediment movement, crop growth, nutrient cycling, etc. are directly modeled by SWAT [2].

For modeling purposes, a watershed is partitioned into a number of subbasins, which are then further subdivided into hydrological response units (HRUs). The use of subbasins in a simulation model is particularly beneficial when different areas of the watershed are dominated by land uses and soils dissimilar enough in properties to impact hydrology. Input information of each subbasin is grouped into several categories: climate, HRUs, ponds/wetlands, groundwater, and the main channel or stream draining the subbasin. The HRUs are the aggregated land areas within the subbasin that comprise of unique land cover, soil, and management combinations.

Simulation of the hydrology of a watershed is separated into two major parts in SWAT. The first part deals with the land phase of the hydrological cycle that considers amount of water, sediment, nutrient, and pesticide loadings in each subbasin. The second part deals with the routing phase that considers movement of water and sediments through the channel network to the outlet.

AVSWAT-2000 (version 1.0) [4] is an ArcView extension and a graphical user interface (GUI) of the SWAT model. The two systems, ArcView and SWAT, are dealt with as two independent master components in the integration system. The conceptual design of the integration system includes an add-on external user interface and a shared internal database to couple the two systems (Figure 26.7). The integration begins with the external user interface, where the end user initiates a new database or activates an existing one. Arc macro language (AML) scripts are activated via the interface to prepare input parameters for SWAT in the GIS environment. The data transition from GIS to the SWAT model is automated through the internal database shared by both the GIS and the hydrological model. User-friendly data entry and editing is part of the functionality of the external GUI, where users can interactively enter and modify model input files and parameters, including nonspatial parameters. The internal database stores the input data and transfers it into a SWAT compatible format. As the last step, the execution of SWAT is activated through the external user interface.

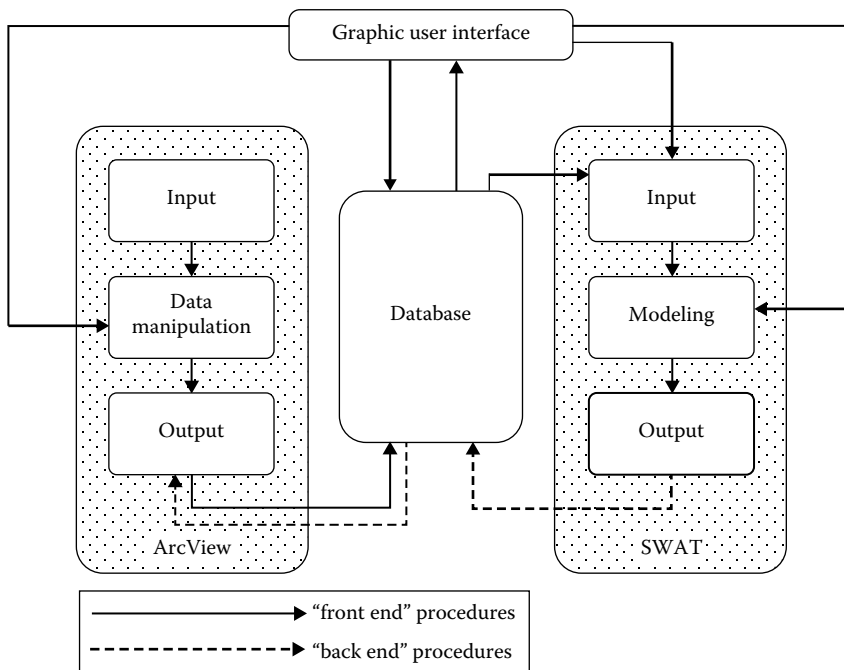
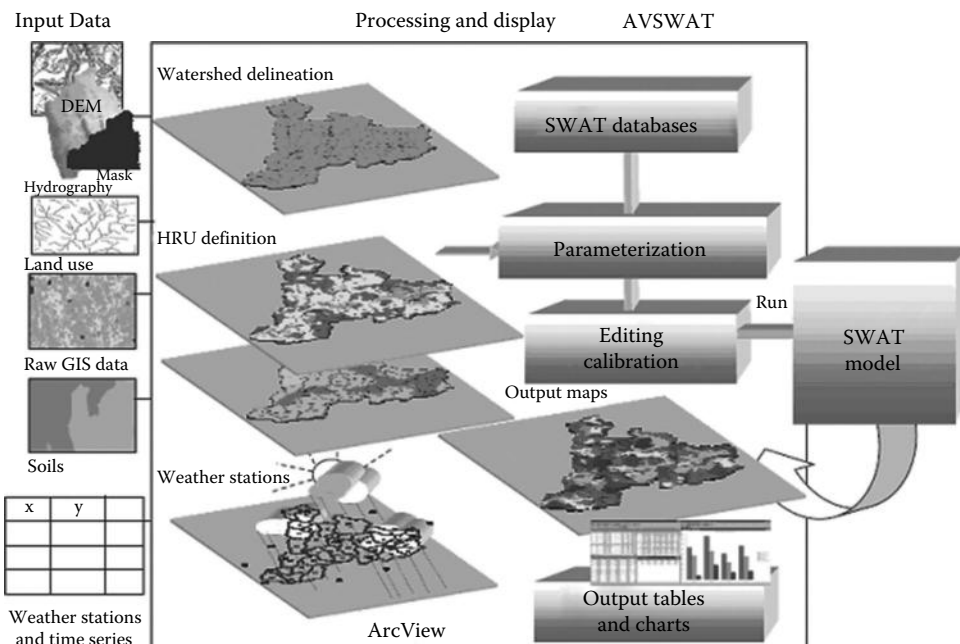


FIGURE 26.7 Architecture of the interface system coupling ArcView and SWAT.



**FIGURE 26.8** Schematic of AVSWAT (From Di Luzio, M. et al., Soil and water assessment tool. ArcView GIS interface manual: Version 2000, GSWRL Report 02–03, BRC Report 02–07, Published by Texas Water Resources Institute TR-193, College Station, TX, 346 pp, 2002).

AVSWAT (Figure 26.8) is organized in a sequence of several linked tools grouped into eight modules:

1. Watershed delineation
2. Definition of HRU
3. Definition of the weather stations
4. AVSWAT databases
5. Input parameterization, editing, and scenario management
6. Model execution
7. Read and map-chart results
8. Calibration tool

The basic map inputs required for the AVSWAT include digital elevation maps, soil maps, land-use/land-cover maps, hydrography (streamlines), and time series on weather variables with their locations.

## 26.7 Description of the Study Region

The study region is the catchment of Malaprabha river, upstream of Malaprabha reservoir. It has an area of 2093.46 km<sup>2</sup> situated between latitude 15°30'N–15°56'N and longitude 74°12'E–75°8'E. It lies in the extreme western part of the Krishna river basin in India and includes parts of Belgaum, Bagalkot, and Dharwad districts of north Karnataka.

The Malaprabha river is one of the main tributaries of the river Krishna. The river originates at Kankumbi near the Chorla Ghats in the Western Ghats at an altitude of 793 m, 16 km from Jamboti village in Khanapur taluk. The Malaprabha dam was constructed by 1974 near the famous “Naviluteertha” or peacock gorge near Manoli in Parasgad taluk of Belgaum district. The Malaprabha irrigation project comprises of a masonry dam of height 145.53 m and length 40.23 m. The dam has a gross storage capacity of 37.73 (1000 million cubic feet) TMC (~1070 Mm<sup>3</sup>) and live storage capacity



of 29.32 TMC ( $\sim 830 \text{ Mm}^3$ ). The area to be irrigated by right bank canal (RBC) is 202,708 ha and that by left bank canal (LBC) is 41,364 ha [22].

Analysis of temporal variation of rainfall showed that, in general, the climate of the subbasin is dry, except in monsoon months. Isohyetal map prepared for the study region showed considerable variation in spatial distribution of annual rainfall. Heavy rainfall (more than 3000 mm) is recorded at gauging stations in the upstream reaches of the Malaprabha catchment, which forms a part of the Western Ghats. In contrast, the rainfall recorded at the Malaprabha dam is around 400 mm.

The mean monthly maximum temperatures in the catchment vary from  $25^\circ\text{C}$  to  $34^\circ\text{C}$  and the average of the mean monthly maximum temperatures is  $28^\circ\text{C}$ . The mean monthly minimum temperature ranges from  $17^\circ\text{C}$  to  $21^\circ\text{C}$ . The day temperatures rarely fall below  $25^\circ\text{C}$ . The hottest months are April and May with mean maximum temperature of  $34^\circ\text{C}$ . December and January are the coldest months with mean minimum temperature of  $17^\circ\text{C}$ . On annual basis, the diurnal difference between the maximum and the minimum temperatures is  $8^\circ\text{C}$ – $13^\circ\text{C}$ .

The wind speeds are high during the monsoon season (June to September) and low during November, December, and January months. The mean monthly wind speed is 9.6 km/h during the peak monsoon (July), while in non-monsoon months, the mean monthly wind speed varies from 3 to 6 km/h.

The subbasin has a wide variety of soils such as medium black soil, deep black soil, mixed red and black soils, red sandy soil, and red loamy soil [11], which can be broadly classified into three textures, namely, clay, skeletal clay, and loam. Further, among the soils in the subbasin, the black soil is predominant.

## 26.8 Data Used in the Study

---

In this study, contemporaneous daily rainfall records of 11 gauging stations in the catchment of Malaprabha reservoir are considered. The rainfall data, from January 1971 to December 2000, are procured from the Directorate of Economics and Statistics (DES), Bangalore, India. The record of daily streamflows at Malaprabha dam, from January 1978 to December 2003, is collected from the files of the Water Resources Development Organization (WRDO), Bangalore. Further, the records of meteorological parameters such as daily maximum, minimum, and mean temperatures, wind velocity, and relative humidity, for the period from January 1978 to December 2000, for Gadag station are procured from the India Meteorological Department. The available information on rainfall and runoff for the study region allows comparison of the SWAT model simulated runoff with that observed at the Malaprabha dam for the period from January 1978 to December 2000. A thematic layer showing the locations of the hydro-meteorological gauging stations is prepared using their spatial coordinates. Attributes such as rainfall, temperature, and wind speed in meteorological data files are assigned to each gauging station. Later, hydrometeorological data are assigned to each subbasin based on its proximity to the gauging station.

The Shuttle Radar Topography Mission (SRTM) DEM data modified for the study region are procured from the International Water Management Institute (IWMI), Hyderabad, India. The SRTM DEM presents the elevation of the land surface with a resolution of 90 m ( $3 \text{ arc s} \times 3 \text{ arc s}$ ). The SRTM obtained the elevation data on a near-global scale to generate the most complete high-resolution digital topographic database of the Earth. SRTM consisted of X-band and C-band radar interferometry that flew onboard the space shuttle Endeavour during an 11-day mission in February of 2000. SRTM is an international project spearheaded by the National Geospatial-Intelligence Agency (NGA), the National Aeronautics and Space Administration (NASA), the Italian Space Agency (Agenzia Spaziale Italiana; ASI), and the German Aerospace Center (Deutschen Zentrum für Luft- und Raumfahrt [DLR]).

Soil, land-use, and land-cover information obtained by interpretation of satellite images and data on hydroclimatic attributes are provided as input to SWAT model.

The runoff curve numbers (CNs) considered for selected land use, land cover, and soils in the Malaprabha subbasin were adapted from [8]. The available water content, also referred to as plant available water or AWC, is calculated by subtracting the fraction of water present at permanent wilting point from that present at field capacity.

The basin attributes are obtained using a given basin layer. The SWAT–ArcView interface calculates area, resolution, and geographic coordinate boundaries for the basin and for each subbasin. The length of the longest stream and the proportion of each subbasin within the basin are also estimated.

## 26.9 Application of AVSWAT Model

The main source of hydrological input to a catchment is rainfall. Therefore, assessment of its spatial and temporal variation in the study region is necessary before developing a hydrological simulation model. Average rainfall over the catchment of Malaprabha reservoir is estimated at monthly and annual time scales by the SWAT model using the records of the selected rain gauges in the study region. To check the general validity of the estimated rainfall from the SWAT model, the representative rainfall provided by SWAT and that obtained by adopting Thiessen polygon method, which is a common method for computing average rainfall over an area, are compared. GIS was used for estimation of the areas of the Thiessen polygons. The average rainfall at monthly time scale for the study region, computed using SWAT model and Thiessen polygon method, are found to be correlated to each other fairly well.

Temporal variation of average rainfall in the catchment of Malaprabha reservoir and its relationship with the streamflows recorded at the reservoir site is studied. Results show that peak flows noticed at reservoir correspond to heavy rainfall in the catchment.

The runoff from the catchment was simulated using SWAT model with ArcView interface. The ArcView interface is useful to create databases necessary for the SWAT model. First, ArcView map themes and database files, which provide necessary information about the watershed, are prepared. The ArcView map themes required for the interface include those of DEM data, land cover, land use, and soil. The database files necessary for the interface include [4] the following:

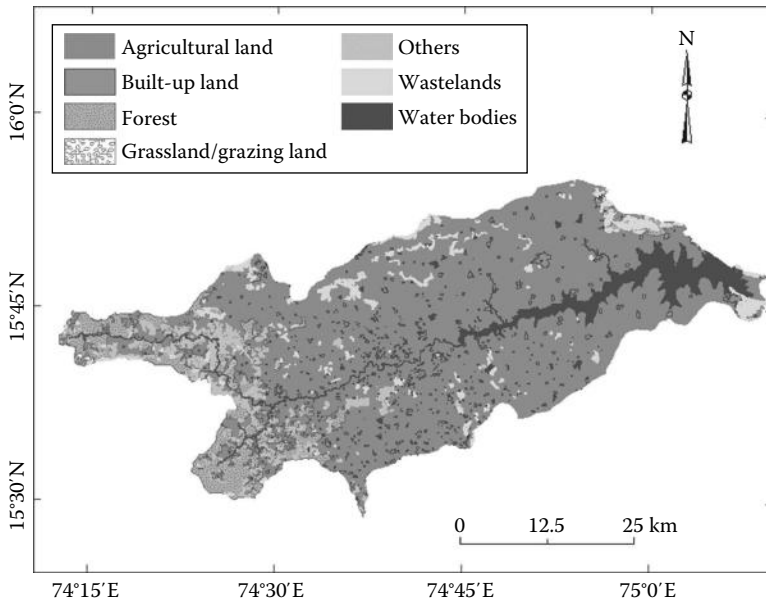
1. Location tables of subbasin outlet, watershed inlet, gauging stations of precipitation, temperature, solar radiation, wind speed, and relative humidity
2. Look-up tables of land use and soil
3. Data tables for precipitation, temperature, solar radiation, wind speed, relative humidity, point discharge (annual, monthly, and daily loadings), reservoir inflow (monthly and daily if available), and potential evapotranspiration (if available)

The DEM data were preprocessed using ArcView interface of SWAT model, to obtain stream network in the catchment of the Malaprabha reservoir (shown in Figure 26.3). For this purpose, the minimum watershed area (critical source area) was specified as 210 ha. Subsequently, the stream network was reviewed and drainage basin outlets are fixed through screen interactive option of the SWAT model (see Figure 26.4). The SWAT model was run forming 14 drainage subbasins in the Malaprabha reservoir catchment (Figure 26.5), and the physiographic characteristics of the subbasins are noted.

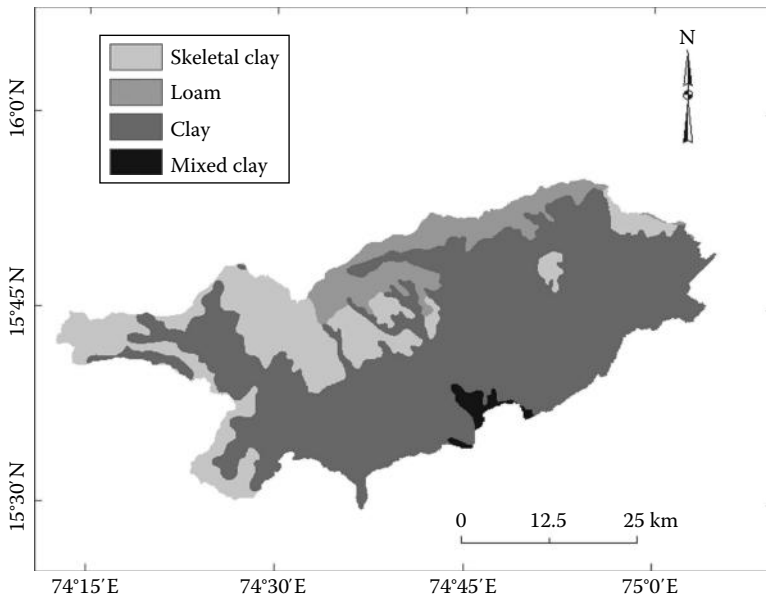
The land-use/land-cover and soil maps of the Malaprabha reservoir catchment (shown in Figures 26.9 and 26.10) are overlaid on each other to identify HRUs. The information about the type of land use/land cover and soil in each HRU and the number of HRUs in each drainage subbasin is documented. The SWAT model allows user to edit databases containing parameters of soils, weather stations, land cover/plant growth, fertilizer, pesticide, tillage, and urban land type.

The data tables prepared of weather variables are fed into the SWAT model and it was run. The development of the SWAT model involves calibration and validation phases. Traditionally, the first 70% of the available record is selected for training and the remaining 30% is used for validation. In the current study, the data for the period from January 1978 to December 1993 were considered for model calibration, and that for the period from January 1994 to December 2000 were considered for model validation.

The SWAT model provides amount of water in the land phase of the hydrological cycle, sediment, nutrient and pesticide loadings in each subbasin, and sediment routed through the channel network to the outlet as outputs. However, only the runoff generated by SWAT was considered for validation.



**FIGURE 26.9** Land-use/land-cover theme of the Malaprabha reservoir catchment.



**FIGURE 26.10** Theme showing classified soils in the Malaprabha reservoir catchment.

In calibration phase, the runoff simulated by SWAT model at monthly time scale was compared with that observed at the Malaprabha reservoir. In general, the model overpredicts or underpredicts the runoff. In a few cases, the model may not simulate intermittent peak flows, possibly due to loss of information because of nonuniformity in spatial distribution of the available rain gauges in the study region.

The SWAT model estimates the water yield from an HRU for a time step, using Equation 26.1. The water leaving an HRU contributes to streamflow in the reach:

$$\text{WYLD} = \text{SURQ} + \text{LATQ} + \text{GWQ} - \text{TLOSS} - \text{Pond abstractions} \quad (26.1)$$

where surface runoff (SURQ), lateral flow (LATQ), and groundwater flow (GWQ) represent contribution to streamflow in the reach from SURQ, LATQ, and GWQ, respectively, during the time step. TLOSS refers to the amount of water lost from tributary channels during transmission. The groundwater is primarily contributed by shallow aquifers. The area-weighted values of rainfall, SURQ, GWQ, and streamflow in the reach (WYLD) for the Malaprabha catchment estimated from the corresponding values of the variables at the 14 drainage subbasins in the catchment are some of the outputs from this model.

In the present study, the SWAT model is found to overpredict the runoff. To overcome the problem, possible options include decreasing the CN and increasing AWC of soil, EPCO, and the ESCO [10].

Soil moisture depletes from various depths in the soil layer(s) to meet its evaporative demand. The parameter ESCO allows user to specify contribution from different depths of soil in meeting the soil-evaporative demand. The default setting in SWAT causes 50% of the soil-evaporative demand to be met from the top 10 mm of soil and 95% of the same to be met from the top 100 mm. When ESCO approaches 0, the SWAT model allows more water to be extracted from the lower layers of soil to meet the evaporative demand. On the other hand, as ESCO approaches 1, the model allows less variation from the default setting, indicating a situation in which evaporative demand is met primarily from the top layer of soil.

Further, plant uptakes water from its root zone to meet its transpiration requirements. The parameter EPCO allows user to specify the vertical distribution of plant water uptake within the root zone. The default setting in SWAT allows plant to uptake 50% of water demand from the upper 6% of the root zone. When EPCO approaches 1.0, the SWAT model allows more of the water uptake demand to be met by lower layers in the soil. On the other hand, as EPCO approaches 0, the model allows less variation from the default setting, indicating that plant water uptake occurs primarily within upper root zone.

With a view to examine the sensitivity of the result from the SWAT model to variation of parameters, sensitivity analysis is performed by varying each of the model parameters within its permissible range. The values of EPCO and ESCO are varied from 0.1 to 1.0 with an increment of 0.1, whereas the value of AWC is varied from  $-0.04$  to  $+0.04$  with an increment of 0.01. For each combination of the chosen parameters, the runoff simulated by the SWAT model is compared with that observed at the Malaprabha dam for the calibration period, in terms of model performance indicators. Results pertaining to the parameters  $\text{EPCO} = 0.75$ ,  $\text{ESCO} = 0.4$ , and  $\text{AWC} = 0.04$  are selected from the calibration phase. Even after calibration, the magnitude of error in simulating streamflows is found to be high because of consistent overprediction of runoff from the Malaprabha catchment. The overprediction of runoff by the SWAT model could be attributed to the combined effect of considerable amount of retention storage in Malaprabha catchment, which goes unaccounted for in estimating inflows into Malaprabha reservoir every water year as well as the possible underestimation of evapotranspiration in the region. Even though SWAT models these two components, investigations towards their estimation are constrained by the paucity of data. Hence, for each month, the retention storage and plausible error in estimation of evapotranspiration are lumped together as one parameter and estimated in the calibration period. Parameters thus obtained are used for the model validation. Streamflows simulated by SWAT model for the validation period after accounting for the combined effects of retention storage and evapotranspiration are shown in Figure 26.11. It can be seen from the figure that the model performs fairly well with a  $R^2$  value of 0.95 during the validation period (January 1994–December 2000).

Information pertaining to temporal variation of storage in all the prominent surface water bodies existing in the subbasin (such as lakes/tanks) is necessary to arrive at a reasonable estimate for the retention storage. However, for the Malaprabha catchment, records pertaining to filling and emptying of prominent surface water bodies are not maintained. Moreover, accurate estimation of volume of surface water contributing to retention storage requires understanding interaction of surface and groundwater in the subbasin, possibly by using advanced techniques such as isotope hydrology, which is beyond the scope of the present work.

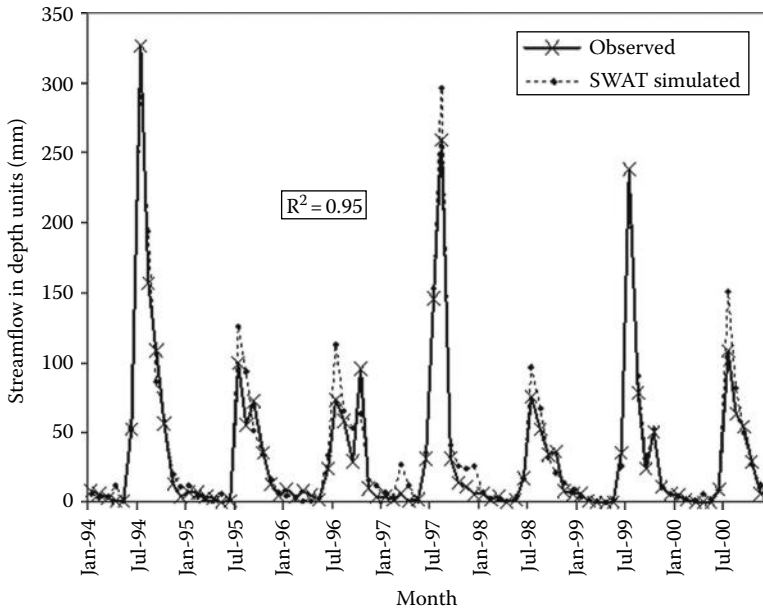


FIGURE 26.11 Observed and simulated monthly streamflows at Malaprabha dam site for the validation period.

## 26.10 Summary and Conclusions

GIS has been used to capture the synergy between the time series data on variables describing water properties and the geospatial data on water environment for a better WRA. A high-resolution DEM can be used as the basic spatial data source in defining the hydrography of the study basin for WRA. GIS and DEM make the best use of scattered information and facilitate extrapolating point data or data available at river basin level to develop a credible picture of the situation of the water use in the river basin and its impact on water resources. Thus, GIS and DEM are useful in the first stage of WRA.

GIS with its data, topological, network, and cartographic modeling, map overlay, and geostatistics techniques is a useful tool for hydrological modeling in the second stage of WRA. DEM used for extracting topographic information such as slope properties, drainage basin delineation, drainage divides, and drainage networks is useful for hydrological modeling in the second stage of WRA.

The use of GIS and DEM in the different stages of WRA is demonstrated through a case study of rainfall–runoff simulation in Malaprabha reservoir catchment of India using SWAT model. The GIS and DEM were useful in providing necessary input to SWAT model that performed fairly well in predicting runoff. The results pertaining to the parameters  $EPCO = 0.75$ ,  $ESCO = 0.4$ , and  $AWC = 0.04$ , for which  $R^2$  value of 0.95 is obtained during validation, are selected.

Recently, there is growth in consensus that global climate is changing. The climate change could introduce nonstationarity in time series of hydrological and hydroclimatic variables such as streamflow and rainfall. If there is evidence of nonstationarity in data, it has to be accounted in modeling hydrology of river basin. However, longer records are necessary to prove the assertion of nonstationarity. For the Malaprabha catchment, investigations in this direction are constrained by paucity of data on hydroclimatic variables.

In this study, in addition to investigating the water balance issues of each subbasin in Malaprabha catchment, SWAT was developed to predict the impact of land management practices on water displacement of sediment, and agricultural chemical yields. This information may be used in the final stage of WRA for integrated management of water resources in the basin.

## Abbreviations

---

AML	Arc macro language
ASI	Italian Space Agency
AVSWAT	ArcView Interface of Soil and Water Assessment Tool
AWC	Available water content
CN	Curve number
DEM	Digital elevation model
DES	Directorate of Economics and Statistics
DLR	German Aerospace Center
EPCO	Plant uptake compensation factor
ESCO	Soil evaporation compensation factor
GIS	Geographic information system
GUI	Graphical user interface
GWP	Global Water Partnership
GWQ	Groundwater flow
ha	Hectare
HRU	Hydrological response unit
IWMI	International Water Management Institute
LATQ	Lateral flow
LBC	Left bank canal
Mm <sup>3</sup>	Million cubic meters
NASA	National Aeronautics and Space Administration
NGA	National Geospatial-Intelligence Agency
NIH	National Institute of Hydrology
PIR	Project Identification Report
RBC	Right bank canal
SRTM	Shuttle Radar Topographic Mission
SURQ	Surface runoff
SWAT	Soil and Water Assessment Tool
TMC	Thousand million cubic feet
TLOSS	Amount of water lost from tributary channels during transmission
USDA	US Department of Agriculture
WRA	Water resources assessment
WRDO	Water Resources Development Organization
WWAP	World Water Assessment Programme
WWC	World Water Council
WWDR	World Water Development Report
WYLD	Streamflow in the reach

## Acknowledgment

---

The authors acknowledge support from Ministry of Earth Sciences, Government of India, through project no. MoES/ATMOS/PP-IX/09.

## References

1. Abel, D.J., Kilby, P.J., and Davis, J.R. 1994. The systems integration problem. *International Journal of Geographical Information Systems*, 8(1), 1–12.

2. Akhavan, S., Abedi-Koupai, J., Mousavi, S.F., Afyuni, M., Eslamian, S.S., and Abbaspour, K.C. 2010. Application of SWAT model to investigate nitrate leaching in Hamadan–Bahar Watershed, Iran, agriculture. *Ecosystems and Environment*, 139, 675–688.
3. Alemaw, B.F. and Chaoka, T.R. 2003. A continental scale water balance model: A GIS approach for Southern Africa. *Physics and Chemistry of the Earth. Parts A/B/C*, 28(20–27), 957–966.
4. Di Luzio, M., Srinivasan, R., Arnold, J.G., and Neitsch, S.L. 2002. Soil and water assessment tool. ArcView GIS interface manual: Version 2000. GSWRL Report 02–03, BRC Report 02–07, Published by Texas Water Resources Institute TR-193, College Station, TX, 346 pp.
5. Maidment, D.R. 1993. GIS and hydrologic modeling. In: *Environmental Modeling with GIS*, Goodchild, M.F., Parks, B.O., and Steyaert, L.T. (eds.), Oxford University Press, New York, 147 pp.
6. McDonnell, R.A. 1996. Including the spatial dimension: Using geographical information systems in hydrology. *Progress in Physical Geography*, 20(2), 159–177.
7. Meijerink, A.M.J. et al. 1994. *Introduction to the Use of Geographic Information System for Practical Hydrology*, International Hydrological Programme, UNESCO and ITC. Enschede, the Netherlands.
8. Mishra, S.K. and Singh, V.P. 2003. *Soil Conservation Service Curve Number (SCS-CN) Methodology*, Water Science and Technology Library, Vol. 42, Kluwer Academic Publishers, Dordrecht, the Netherlands, 513 pp.
9. Neitsch, S.L. et al. 2002a. Soil and water assessment tool—Theoretical documentation: Version 2000, Texas Water Resources Institute (TWRI) Report TR-191, College Station, TX.
10. Neitsch, S.L. et al. 2002b. Soil and water assessment tool—User’s manual: Version 2000, Texas Water Resources Institute (TWRI) Report TR-192, College Station, TX.
11. NIH. 1989. Hydrological year book for 1988–89, Malaprabha sub-basin, Technical Report (TR-150), National Institute of Hydrology, Roorkee, India.
12. Pullar, D. 2005. Incorporating level set methods in Geographical Information Systems (GIS) for land-surface process modeling. *Advances in Geosciences*, 4, 17.
13. Singh, V.P. and Frevert, D.K. (eds.). 2002a. *Mathematical Models of Large Watershed Hydrology*, Water Resources Publications, LLC, Highlands Ranch, CO, 914 pp.
14. Singh, V.P. and Frevert, D.K. (eds.). 2002b. *Mathematical Models of Small Watershed Hydrology and Applications*, Water Resources Publications, LLC, Highlands Ranch, CO, 972 pp.
15. Singh, V.P. and Woolhiser, D.A. 2002. Mathematical modeling of watershed hydrology. *Journal of Hydrologic Engineering*, ASCE, 7(4), 270–292.
16. UNESCO/WMO. 1992. *International Glossary of Hydrology*, 2nd edn. UNESCO and WMO, Geneva, Switzerland, 413 pp.
17. UNESCO/WMO. 1997a. *Comprehensive Assessment of the Freshwater Resources of the World*. Report by the UN, UN Development Programme, UN Environment Programme, FAO, UNESCO, WMO, World Bank, WHO, UN Industrial Development Organization and Stockholm Environment Institute. World Meteorological Organization, Geneva, Switzerland.
18. UNESCO/WMO. 1997b. *Water Resources Assessment—Handbook for Review of National Capabilities*, Geneva, Switzerland, 153 pp.
19. United Nations General Assembly. 1997. *Programme for the Further Implementation of Agenda 21*, United Nations General Assembly Special Session, United Nations, New York.
20. World Water Development Report. 2003. *The United Nations World Water Development Report 1: Water for People, Water for Life*. UNESCO Publishing/Berghahn Books, Oxford, U.K., 576 pp.
21. World Water Development Report. 2006. *The United Nations World Water Development Report 2: Water—A Shared Responsibility*. UNESCO Publishing/Berghahn Books, Oxford, U.K., 600 pp.
22. WRDO. 1986. Malaprabha project—project identification report, Irrigation Department, Bangalore, India.
23. Xu, C.Y. and Singh, V.P. 2004. Review on regional water resources assessment models under stationary and changing climate. *Water Resource Management*, 18(6), 591–612.

# 27

## Water Scarcity

---

27.1	Introduction .....	520
27.2	Water Scarcity: Conceptual Background.....	520
27.3	Water Scarcity: Issues and Contemporary Challenges.....	521
27.4	Global Water Scarcity .....	523
	Regional and National Scenario	
27.5	Causes of Water Scarcity .....	525
	Climate Change and Water Scarcity • Natural System and Water Scarcity (Uneven Distribution of Rainfall) • Impact of Climate Change and Variability on Scarcity • Population Growth and Water Scarcity • Utilization, Demand, and Water Scarcity • Water Deficit and Pollution	
27.6	Water Scarcity Indices .....	530
	Crop Water Stress Index • Water Supply Stress Index • Falkenmark Water Stress Indicator (Resources to Population Index) • Water Availability Index • Water Poverty Index • Social Water Stress Index • Watershed Sustainability Index • Water Resources Vulnerability Index • IWMI Water Scarcity Assessment	
27.7	Water Scarcity Mitigation .....	532
	Dryland Agriculture and New Irrigation Systems • Traditional Knowledge Systems • Wastewater Reuse	
27.8	Water Governance for Scarcity Management .....	536
	Engineering Responses and Structures for Water Scarcity Mitigation • Social Engineering and Community Initiatives for Revival of Local Water Bodies • Equitable Demand and Supply Management	
27.9	Summary and Conclusions .....	540
	References.....	541

**R.B. Singh**  
*University of Delhi*

**Dilip Kumar**  
*University of Delhi*

### AUTHORS

**R.B. Singh** (PhD) is the head of the Department of Geography, Delhi School of Economics, University of Delhi, Delhi, India. He is presently the vice-president, International Geographical Union (ICSU-IGU); managing editor, *Journal of the NAGI*; member, Indian National Science Academy-IUGG-IGU Joint National Committee; and an IAHS National Representative. Dr. Singh has supervised 27 PhD and 63 MPhil students. He has to his credit 37 research volumes/books and more than 175 research papers published in journals related to land use, water resources, climate change, disaster management, and urban environment.

**Dilip Kumar** (PhD) is associated with Shaheed Bhagat Singh (E) College, University of Delhi, as an assistant professor in geography. He is teaching and conducting research on the application of remote sensing and GIS in resource management. Dr Kumar is the life member of Indian Society of Remote



Sensing, Association of Geographical Studies, and National Association of Geographers, India. He has more than 10 research papers published in international journals and book related to land and water resources management, remote sensing, and GIS applications.

## **PREFACE**

Water is one of the basic natural resources of the earth surface, which constitutes only 3% of the world's freshwater, which is unevenly distributed. The increasing demand–supply gap and mismanagement of freshwater pose the condition of scarcity in terms of quality and quantity. The sustainable development of human being requires the proper assessment of freshwater resources. The present chapter deals with the concept, methods, issues, contemporary challenges, and causes of water scarcity at global level. There are various methods to assess the water scarcity by different indices such as crop water stress index (CWSI), water supply stress index (WaSSI), Falkenmark's water stress index, water availability index (WAI), water poverty index (WPI), and many others. The assessment of water scarcity is required for mitigation and judicious use of water resources. It involves the physical and social parameters such as dryland agriculture, irrigation deficit technique, traditional knowledge systems, wastewater reuse, and good governance for water scarcity management, which also includes the water education and policies for the sustainable development of water resource.

## **27.1 Introduction**

Earth is known as the “blue planet” due to the abundance of water covering three-fourth part of the earth, and it is fundamental for life on earth. Water is one of the basic natural resources of the earth. Human beings depend on water for drinking, cooking, and washing together with the demand for travel, agriculture, industry, mining, and energy. Only 3% of the world's water is fresh, and 99% of it is locked in ice caps and glaciers or flow or is stored underground. As a result, 1% is readily available for use. Earlier, it was thought that water is present in sufficient quantity on the earth surface because it was renewed and balanced between availability and demand. But today, water becomes scarce not only in arid and semi-arid regions but also in the regions where rainfall is relatively abundant. The pressure on water resource intensifies, leading to tensions, conflicts among users, and excessive pressure on the environment. The increasing stress on freshwater resources brought about by ever-rising demand and profligate use, as well as by growing pollution worldwide, is of serious concern. The concept of scarcity not only is related to the quantity but also includes the quality of the water. It is also estimated that people need a minimum of about 100 L/day water for drinking, cooking, and washing in order to maintain adequate health. Nearly 900 million people have no choice but to use unsafe water [60]. There are real imbalances in the amount of water used in different countries. In western countries, 300 L/day is flushed, but in developing countries like India, it is very low about 25 L/day approximately. It is also estimated that one-third of the world's inhabitants live in countries with severe water problem or water scarcity. About 400 million children (one in five from the developing world) have no access to safe water; 1.4 million children will die each year from lack of access to safe drinking water and adequate sanitation [58]. Without improved water resources management, the progress toward poverty reduction targets, the millennium development goals, and sustainable development in all its economic, social, and environmental dimensions, will be jeopardized [67].

## **27.2 Water Scarcity: Conceptual Background**

Water resources are an essential component of the earth's hydrosphere and an indispensable part of all terrestrial ecosystems. The water environment is characterized by the hydrological cycle, including floods and droughts, which in some regions have become more extreme and dramatic in their consequences [46].

Even though sufficient rainfall occurs on most arable agricultural land, periodic floods and droughts continue to limit the yields in diverse areas throughout the world. The objective should be to make available adequate supplies of water of good quality. Innovative technologies, including the improvement of indigenous technologies, are needed to fully utilize limited water resources and to safeguard those resources against pollution.

Water resource assessment constitutes the practical basis for their sustainable management and a prerequisite for the evaluation of the possibilities for their development. There is, however, a growing concern that more precise and reliable information is needed about water resources, especially information on groundwater and water quality. Major impediments are the lack of financial resources for water resources assessment, the fragmented nature of hydrological services, and the insufficient numbers of qualified staff. At the same time, the advancing technology for data capture and management is increasingly difficult to access for developing countries. Establishment of national databases is, however, vital to water resources assessment and to mitigate the effects of floods, droughts, desertification, and pollution.

Most of the regions of the world are affected from problems of loss of potential sources of freshwater supply, degraded water quality, and pollution of surface and groundwater sources. Major problems affecting the water quality of rivers and lakes arise in variable order of importance according to different situations from inadequately treated domestic sewage, inadequate controls on the discharges of industrial wastewaters, loss and destruction of catchment areas, ill-considered siting of industrial plants, deforestation, and poor agricultural practices. There is a widespread lack of perception of the linkages between the development, management, use, and treatment of water resources and aquatic ecosystems. A preventive and appropriate approach is crucial to avoid the subsequent costly measures to rehabilitate, treat, and develop new water supplies [48].

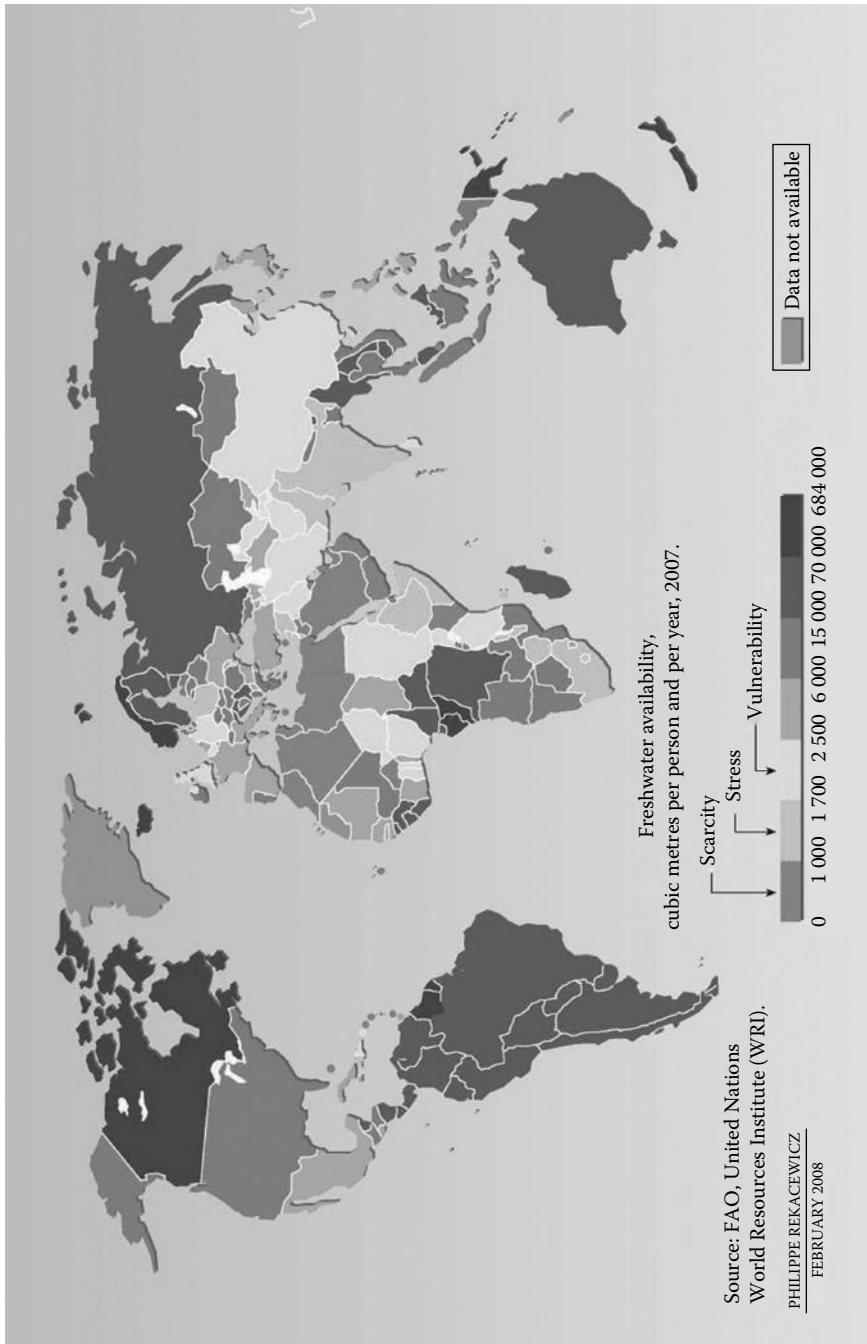
In order to maintain the availability of water, all needful efforts are being made in the field of research and development to meet the demand for drinking water, irrigation, and industrial uses; reliable information on water depletion for agricultural production is needed when freshwater resources are getting scarce. Remote sensing can help water policy makers and agronomists to achieve that goal. The hydrological cycle is greatly influenced by changing land use and land cover. The large-scale deforestation may cause significant changes in regional and global climate. The rainfall variability in both time and space makes water availability and plant productivity quite uncertain. Recent studies indicate degradation of water resource in the Himalaya resulting from erosion, flooding, and scarcity of water and degrading water quality [45,47]. Multitemporal satellite data provide spatially distributed information on irrigated area, cropping pattern, and paddy yield through application of geographic information system techniques [40]. Water Utilization Index defined as an area irrigated per unit volume is a measure of water delivery performance and constitutes one of the important spatial performance indicators of an irrigation system [2].

### 27.3 Water Scarcity: Issues and Contemporary Challenges

---

Water scarcity is an imbalance between availability and demand of water. Water scarcity can be determined by both the availability of water and its consumption patterns. It also occurs when the amount of water withdrawn from lakes, rivers, or groundwater is greater than its supply and is no longer adequate to satisfy all human or ecosystem requirements, resulting in increased competition between water users and other demands. It is pertinent to mention a few following facts about the water scarcity [68]:

- Water scarcity occurs even in areas where there is plenty of rainfall or freshwater.
- Water scarcity affects one in three people on every continent of the globe. The situation is getting worse as need for water is rising along with population growth, urbanization, and increases in household and industrial uses.
- Almost one-fifth of the world's population (about 1.2 billion people) lives in areas where the water is physically scarce. One quarter of the global population also lives in developing countries that face water shortages due to a lack of infrastructure to fetch water from rivers and aquifers (Figure 27.1).



**FIGURE 27.1** Freshwater scarcity.

- Water scarcity forces people to rely on unsafe sources of drinking water.
- Poor water quality can increase the risk of diseases such as cholera, typhoid fever, and dysentery, and other water-borne infections.
- Water scarcity encourages people to store water in their homes. This can increase the risk of household water contamination.
- A lack of water has driven up the use of wastewater for agricultural production in poor urban and rural communities. More than 10% of people worldwide consume foods irrigated by wastewater that can contain chemicals or disease-causing organisms.
- Millennium development goal number seven, target 10, aims to halve, by 2015, the proportion of people without sustainable access to safe drinking water and basic sanitation. Water scarcity could threaten progress to achieve this target.
- Water is an essential resource to sustain life. As governments and community organizations make it a priority to deliver adequate supplies of quality water to people, individuals can help by learning how to conserve and protect the resource in their daily lives.

One of the basic principles of social justice is that all citizens should have access to resources, sufficient to meet their basic needs, and live a dignified life. Clean water is part of the social minimum, with 20 L/person each day as the minimum threshold requirement. While basic needs vary, the minimum threshold is about 20 L a day. Most of the 1.1 billion people categorized as lacking access to clean water use about 5 L a day—1/10th of the average daily amount used in rich countries to flush toilets. Dripping taps in rich countries lose more water than that is available each day to more than 1 billion people. Some 1.1 billion people in the developing world do not have access to a minimal amount of clean water. Coverage rates are lowest in sub-Saharan Africa, but most people without clean water live in Asia [52,53].

## 27.4 Global Water Scarcity

---

About one-third of the world's population lives in countries with moderate-to-high water stress, defined by the United Nations as water consumption that exceeds 10% of renewable freshwater resources. By this measure, some 80 countries, constituting 40% of the world's population, were suffering from water shortages by the mid-1990s [9,59]. By 2020, water use is expected to increase by 40%, and 17% more water will be required for food production to meet the needs of the growing population. According to another estimate from the United Nations, by 2025, 1.8 billion people will be living in regions with absolute water scarcity, and two out of three people in the world could be living under conditions of water stress [52]. In the early 2000s, total global withdrawals of water were approximately 3700 km<sup>3</sup>/year, a tiny fraction of the estimated stock of 35 million km<sup>3</sup> of water [19].

### 27.4.1 Regional and National Scenario

Regional water scarcity is a significant and growing problem although there are many different (and often inconsistent) measures and indicators of water scarcity [20]. In some regions, water use exceeds the amount of water that is naturally replenished every year. The balance between water demand and availability has reached a critical level in many areas of Europe, the result of overabstraction and prolonged periods of low rainfall or drought. Reduced river flows, lowered lake and groundwater levels, and the drying up of wetlands are widely reported, alongside detrimental impacts on freshwater ecosystems, including fish and bird life. Where the water resource has diminished, a worsening of water quality has normally followed because there is less water to dilute pollutants. In addition, saltwater increasingly intrudes into overpumped coastal aquifers throughout Europe. Climate change will certainly exacerbate these adverse impacts in the future, with more frequent and severe droughts expected across Europe. The European Commission [12] estimated that at least 11% of Europe's population and 17% of its territory are affected by water scarcity.

In South America, the Chacaltaya glacier in Bolivia, which used to be the world's highest ski run, has been reduced to just a few small pieces of ice. Scientists in Bolivia are attributing the disappearance to the effects of climate change. Furthermore, the World Bank estimated that many of the Andes's tropical glaciers will disappear within the next 20 years. If the World Bank's prediction is correct, the water supply of around 80 million people would be threatened. Water scarcity can lead to conflict and hinders local agriculture and industry. Also, if the local population is forced to store water, then there is a chance that much of it could become contaminated, thus making it unsafe to drink [62].

The first signs of diminishing water availability in Australia appeared somewhere between 1993 and 1996 when the rate of water resource capture and use started to exceed the rate of stream flow supply. Australia is the driest inhabited continent in the world, and climate variability has always had a profound impact on its history and development. In recent decades, climate change has transformed a difficult water management challenge into a water crisis. Average annual rainfall in most of the countries has dropped by a third since 1980 [69].

India is considered rich in terms of annual rainfall and total water resources availability; however, the uneven distribution of the resource causes regional and temporal shortages. India's average annual rainfall equivalent of about 4000 billion cubic meters (BCM) is unevenly distributed both spatially and temporally. The annual per capita utilizable resource availability varies from 18,417 m<sup>3</sup> in the Brahmaputra valley to as low as 180 m<sup>3</sup> in the Sabarmati Basin [7]. Even in the Ganga Basin, the annual per capita availability of water varies from 740 m<sup>3</sup> in the Yamuna [48] to 3379 m<sup>3</sup> in the Gandak. Levels of precipitation vary from 100 mm annually in western Rajasthan to over 9000 mm in the northeastern state of Meghalaya [11]. With 75% of the rainfall occurring over the 4 monsoon months and the other 1000 BCM spread over the remaining 8 months, our rivers carry 90% of the water between June and November. Thus, only 10% of the river flow is available during the other 6 months. The rapid increase in the country's population, from about 343 million at the time of independence to over 1000 million in 2000, accompanied by growth of agriculture, rapid urbanization, economic growth, and improved access to basic services has resulted in an increase in the demand for water. A requirement of 629 BCM against the availability of 1122 BCM indicates surplus at the national level; however, spatial and temporal variations give rise to shortages in some regions. The western plains, the Kachchh region, and some pockets in the northern plains face acute water shortages. The country's total water requirement is projected to grow to 1180 BCM by the year 2050 as against 629 BCM in 1997–1998. The widening gap between demand and supply has led to a substantial increase in the share of groundwater consumption by the urban, agricultural, and domestic sectors. The quality of water sources is threatened because of inadequate provisions for the treatment of wastewater [64]. More than 90% of rural and nearly 30% urban population are dependent on groundwater sources for meeting their drinking and domestic water requirements. It also forms the major source of irrigation accounting for more than 50% of the total irrigation potential created so far in the country. As the population is increasing, the stress on natural resources is also increasing. Not only the stress is increasing due to the increasing population but pressure is also increasing due to the continuous increase demands by level of development. The uneven distribution of groundwater, coupled with its overexploitation and quality problems, has ultimately resulted in the scarcity of potable water [31]. By 2030, demand in India will grow to almost 1.5 trillion m<sup>3</sup>, driven by domestic demand for rice, wheat, and sugar for a growing population. Against this demand, India's current water supply is approximately 740 BCM. As a result, most of India's river basins could face severe deficit by 2030 unless concerted action is taken, with some of the most populous areas—including the Ganga, the Krishna, and the Indian portion of the Indus, facing the biggest absolute gap [1]. Delhi, the capital of India, is facing the water scarcity due to the phenomenal growth in population. It has crossed the figure of about 13 million in 2001 census. This has put tremendous pressure on the existing civic services including supply of drinking water. The present demand for water in Delhi is around 800 MGD, whereas the supply from all the available sources is about 650 MGD. The gap between demand and supply is partly being met by extraction of groundwater through wells, tubewells, and deep bore hand pumps [63].

About 66% of Africa is arid or semiarid, and more than 300 of the 800 million people in sub-Saharan Africa live in a water-scarce environment. Arab countries, which cover about 10% of the area of the world, receive only 2% of the world's average annual precipitation and contain as little as 0.3% of the global annual renewable water resources. Although the average annual rainfall in the Arab region is about 250 mm, large areas of the region are very dry, with an annual rate of precipitation that does not exceed 5 mm. Consequently, by 2015, almost all Arab countries are predicted to be below the level of severe water scarcity defined as less than 500 m<sup>3</sup>/capita/year, with nine countries below 200 m<sup>3</sup> and six below 100 m<sup>3</sup> [10]. By 2025, only Lebanon and Iraq are expected to remain above the water scarcity level. Mauritania, Algeria, Morocco, Tunisia, Egypt, Sudan, Iraq, Lebanon, and Syria further rely on river flows supplemented by limited groundwater sources, while many others depend mainly on shallow and deep groundwater sources supplemented by surface runoff during floods. Surface water resources in Arab countries are estimated to be about 224 BCM/year of which 77% comes from outside the region. Groundwater sources in the Arab region are quite limited, not exceeding a total of 50 BCM/year [24]. Desalinated seawater is further the main source of drinking water across Gulf Cooperation Council (GCC) countries, due to limited groundwater availability, with the overall capacity of new and existing desalination facilities being more than 3.4 BCM on an average. Demographic growth and economic and social development across Arab countries have contributed considerably to significant increases in water demand producing around 10.85 BCM/year of domestic wastewater. Approximately 83 million people in the Arab region do not currently have access to safe drinking water, and about 96 million people need access to sanitation services. Average per capita domestic water consumption in the Arab region is about 200 L/day (compared to a reported 525 L/day in the United States), but varies significantly among the countries of the region. Domestic water consumption in the Arab region escalated from about 12,000 million m<sup>3</sup> in 1995, to about 16,000 million m<sup>3</sup> in 2002. This represents more than a 30% increase in water consumption in less than a decade, a trend expected to persist in the Arab region in the future. Currently, domestic water consumption represents about 7% of the total water used in Arab countries. Domestic water consumption in the GCC countries however ranges from 300 to 750 L/capita/day, some of the highest in the world.

## 27.5 Causes of Water Scarcity

---

Basically, water scarcity is caused by two reasons. One belongs to the natural phenomenon including biophysical conditions such as low rainfall, high temperature, soil characteristics, and vegetation cover. Another results from the man-made activities such as attitude and their poor water management system. Both reasons affect both quality and quantity of the water resources, as well as human factors over stress the water scarcity.

### 27.5.1 Climate Change and Water Scarcity

The major climatic parameter such as temperature and rainfall affect the water availability of any region. The variations in such parameters increase the frequency and severity of floods and droughts, loss in snowpack and acceleration of snowmelts in mountainous areas, and sea-level rise; and disrupt ecosystems that maintain water quality [67]. People living near a shoreline will be affected more, as they are most susceptible to sea-level rise and increased salinity of coastal potable water sources. Many of these factors will increase both water demand and water scarcity, affecting human and ecosystem health. Climate change will alter the geography of traditional crop areas, which may impact on the world's capacity to provide enough food thus increasing the water demand. Ongoing climate change will mean that the water supply for human communities will become more and more uncertain. The Intergovernmental Panel on Climate Change (IPCC) has stated that between 2000 and 2005 in the northern hemisphere, climate change accelerated faster than predicted, with the consequence that the water cycle could change in an unpredictable way, leading to the possibility of increasing

extreme weather. The fear is that with all these changes, even if the quantity of water in the world does not change, the level of accessibility of the theoretically available water may significantly change [66]. Global climate change and atmospheric pollution could also have an impact on water resources and their availability and, through sea-level rise, will lead intrusion of sea water into groundwater affecting the freshwater availability in low-lying coastal areas.

### **27.5.2 Natural System and Water Scarcity (Uneven Distribution of Rainfall)**

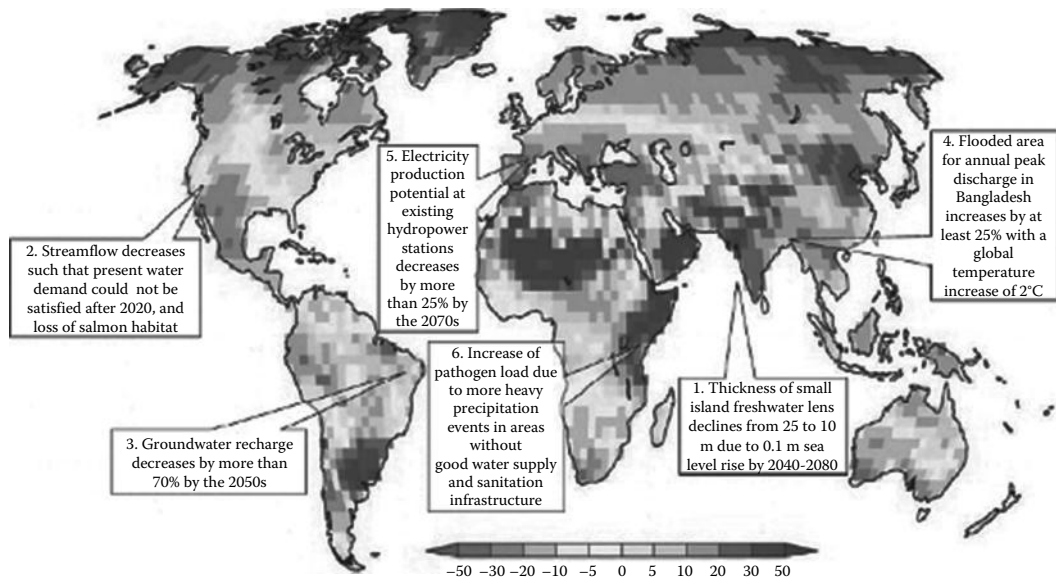
The water resources are not evenly distributed or easily accessible to everyone. Water availability basically depends on the precipitation and the temperature of particular area that leads to the evaporation of the moisture. The precipitation quantity and pattern can also vary in similar climatic conditions. The amount of rainfall varies seasonally as well as annually. If the evaporation is more than precipitation, then there will be scarcity. In semiarid and arid regions, the rainfall is irregular and the temperature is very high leading to long dry period. Evaporation and evapotranspiration from vegetation, soil, groundwater, lakes, river, and wet surface also increase the water scarcity in the semiarid and arid regions. For an example, in the Arabian countries where climate is warm and dry, low precipitation and high evaporation lead to water scarcity, and in contrast, nations such as Scandinavian countries, where precipitation levels are higher than the evaporation, have abundance of water. The areas having high runoff also affect the hydrological condition of an area. The runoff is determined by not only the precipitation regime but also the vegetation cover, soil, geology, topography, and relief, which make groundwater recharge and increased water availability of an area. River flow is the sum of surface runoff, subsurface water, and groundwater flows. In the mountainous terrain, steep slope leads to the high runoff and provides more water directly to the river than the subsurface and groundwater flows, which leads to water scarcity in that region in the dry period. Infiltration and subsurface flow make water available in the foothills for some period. The riverbeds are normally the areas through which most of the recharge takes place.

### **27.5.3 Impact of Climate Change and Variability on Scarcity**

In its most recent report, the IPCC concludes that water and its availability and quality will be the main pressures on, and issues for, societies and the environment under climate change [3]. Climate-related impacts on water resources are already being documented. In all corners of the world, there is growing empirical evidence of increased severe weather events, flooding, and diminished ice cover, all of which can be attributed to climate change. Numerous scientific studies [44] also show increases in the intensity, duration, and spatial extent of droughts, higher atmospheric temperatures, warmer sea surface temperatures, changes in precipitation patterns, and diminishing glaciers and snowpack. In the future, climate change will affect water supply, quality, and demand in the following ways.

Climate change will affect water scarcity and sustainable supply. It will bring changes as follows:

- Increase in water shortages due to changes in precipitation patterns and intensity. In particular, the subtropics and midlatitudes, where much of the world's poorest populations live, are expected to become substantially drier [27]. Reduced precipitation in some arid regions could trigger exponentially larger drops in groundwater tables [5].
- Decrease natural water storage capacity from glacier/snowcap melting and subsequently reduce long-term water availability for more than one-sixth of the world's population that lives in glacier- or snowmelt-fed river basins, including major regions of China, India, Pakistan, and the western United States.
- The capacity and reliability of water supply infrastructure due to flooding, extreme weather, and sea-level rise will be affected. Furthermore, climate change will concentrate snowmelt and precipitation into shorter time frames, making both water releases more extreme and drought events more sustained. Current infrastructure often does not have the capacity to fully capture



**FIGURE 27.2** Future climate change impacts on freshwater by world regions. (Grey-coding signifies estimated percent change in annual runoff by the end of the twenty-first century under IPCC scenario A1). (From Intergovernmental Panel on Climate Change, *Climate change 2007: Impacts, adaptation and vulnerability, Contribution of Working Group II to the Fourth Assessment Report of the Intergovernmental Panel on Climate*, Geneva, Switzerland, 2007.)

this larger volume of water and therefore will be inadequate to meet water demands in times of sustained drought.

- Impair nonconsumptive water uses, including transportation on inland waterways such as the Mississippi River in the United States and Rhine River in Europe, where freight transport has already been disrupted due to floods and droughts [38]. Tourism sectors that are dependent on the availability of water or snow are also vulnerable to water scarcity due to climate change. Freshwater fisheries, many of which supply food to the world's poorest populations, also depend on abundant, high-quality water resources to remain productive.

The impacts of climate change on the water cycle will vary regionally (Figure 27.2). While some areas will benefit from having more water, these benefits are tempered by the negative effects of increased precipitation variability and seasonal runoff shifts on water supply, water quality, and flood risks. Overall, the report IPCC concludes, “the negative impacts of climate change on freshwater systems outweigh the benefits.”

Climate change will increase water demand. It will

- Increase water demand for agriculture, primarily for irrigation, due to prolonged dry periods and severe drought. Some research estimates an over 40% increase in land needing irrigation by 2080 [15]
- Increase water demand for hydration needs for billions of farm animals due to higher atmospheric temperatures
- Increase quantities of water needed for industrial cooling due to increased atmospheric and water temperatures [49]

### 27.5.3.1 Climate Change and Water Scarcity in India

According to the assessment of the IPCC on the vulnerability of India to climate change, key challenges are most likely to be surface warming, a rise in sea level, decreasing water availability due to glacial



retreat, significant reduction in crop production, and a loss of flora and fauna [27]. Among the key forecasts are the following:

- Climate projections indicate increases in both maximum and minimum temperatures over the region south of 25°N. The maximum temperature is projected to increase by 2°C–4°C during the 2050s. In the northern region, the increase in maximum temperature may even exceed 4°C. Model projections also indicate an increase in minimum temperature by 4°C [21]. Even relatively small climatic changes can have a huge impact on water resources, particularly in arid and semi-arid regions such as northwest India [23].
- In India, decreasing monsoon seasonal rainfall has been observed over east Madhya Pradesh, northeast India, and some parts of Gujarat and Kerala (–6% to 8% over the last 100 years) [22].
- Glaciers form the main source of water for key perennial rivers such as the Indus, Ganga, and Brahmaputra. Almost 67% of the glaciers in the Himalayan mountain ranges have retreated in the past decade and will continue to retreat, diminishing flows of the aforementioned rivers and leading to severe water shortages as well as potential food insecurity and energy security (hydro-power generation) [21].
- The frequency and intensity of extreme weather events, such as heat waves, droughts, and floods, have increased over the past two decades and will increase further due to climate change. The observed rate of sea-level rise along the Indian coast has been estimated between 1.06 and 1.75 mm/year. The highest recorded rise has been along the coast of West Bengal. A sea-level rise of 0.4–2.0 mm has been recorded along the Gulf of Kutch. Rising sea levels will lead to salt intrusion into coastal freshwater sources and thus threaten water availability [25].
- Overuse of groundwater forces the water table lower and increases the arsenic content of groundwater. Future climate change will ostensibly exacerbate this problem [32]. The per capita availability of freshwater in India is expected to drop from around 1820 m<sup>3</sup> currently to below 1000 m<sup>3</sup> by 2025 as a result of the combined effects of population growth and climate change [28].

### **27.5.3.2 Climate Variability and Its Impact on Water Resources in Togo**

There is a decreasing trend in rainfall and increase in temperature in Oti Plain (north of Togo) over 51 years. The temperature has increased all over the area. The spatial analysis of decadal rainfall showed a shift of isohyets from north to south. This climatic variability has been correlated to Oti River discharge, which decreased with a coefficient of 0.717. After 1969, the average of river discharge decreased by 36.92%, 27.63% for groundwater volumes, while the depletion coefficients have increased by 29.57%. This leads to rapid draining of aquifers. Field investigation showed drying up of rivers and wells and an accentuation of the difficulties in water supply for majority of local population who depends on these sources. The climate change is real at local level and is having great impacts on water resources [33].

### **27.5.4 Population Growth and Water Scarcity**

Hydrologists typically assess scarcity by looking at the population–water equation. As noted, the convention is to treat 1700 m<sup>3</sup>/person as the national threshold for meeting water requirements for agriculture, industry, energy, and the environment. Availability below 1000 m<sup>3</sup> is held to represent a state of “water scarcity” and below 500 m<sup>3</sup>, “absolute scarcity” [42]. Today, about 700 million people in 43 countries live below the water stress threshold. With average annual availability of about 1200 m<sup>3</sup>/person, the Middle East is the world’s most water-stressed region; only Iraq, Iran, Lebanon, and Turkey are above the threshold. Palestinians, especially in Gaza, experience some of the world’s most acute water scarcity of about 320 m<sup>3</sup>/person. Sub-Saharan Africa has the largest number of water-stressed countries of any region. Globally, there is more than enough water to go round, but the problem is that some countries get a lot more than others. Almost a quarter of sub-Saharan Africa’s population lives in a water-stressed

country today, and that share is rising. With many of the most water-stressed countries experiencing very high population growth rates, per capita availability is shrinking fast. With 1950 as a benchmark, the distribution of global population growth has dramatically reshaped the per capita availability of water. While availability stabilized in rich countries in the 1970s, the decline continued in developing countries, especially in arid developing countries. By 2025, more than three billion people could be living in water-stressed countries and 14 countries will slip from water stressed to water scarce [53].

### **27.5.5 Utilization, Demand, and Water Scarcity**

There are three major sectors viz. domestic, agriculture, and industries, which utilize the major part of the water resources. The agricultural sector is the largest consumer of water resources, and variability in water supply has a major influence on health and welfare in poor areas. With water scarcity and extreme weather events expected to increase under climate change, water security could decline significantly in rural areas. Consequently, it is important to understand the impacts of global change on agriculture. Agriculture is the sector that has by far the highest demand for water. Withdrawals for irrigation may increase by six times from 1900 to 2025, and related water consumption is foreseen to increase by seven times, since technologies help to decrease the nonconsumed fraction of water use. However, the demands for industrial and domestic water uses are increasing much faster than that for irrigation: Withdrawals for industry are foreseen to increase in the same period by nearly 30 times and those for domestic uses by more than 26 times [39].

### **27.5.6 Water Deficit and Pollution**

Pollution is one of the major causes of global water scarcity. Water pollution occurs when large amount of a material is added to or dumped in water. There are basically two sources of water pollution, that is, point source and nonpoint source. The point sources of water pollution include effluent outfalls from factories, refineries, drain or sewer line, and waste treatment plants. The nonpoint source of water pollution is agricultural field where over irrigation or via rainwater, pollute the surface and underground water supply sources like rivers and lakes causes highly toxic and poisonous water create the scarcity leading to various diseases such as typhoid and dysentery. Water pollution adds enormously to existing problems of water scarcity by contaminating large volumes of available water, thus making it unsuitable for use. This situation is worst in third world countries, where human health is gravely damaged by accelerating contamination of water supplies by eutrophication, heavy metals, persistent organic pollutants, acidification, and sewage pollution.

For example, in the city of Varanasi in India, the Ganga River is severely polluted with sewage (fecal coliform levels range from 50,000 cfu/100 mL to over 5,000,000 cfu/100 mL). Inadequate treatment of the city's sewage has also caused severe contamination of groundwater, resulting in high nitrate, heavy metal, and fecal coliform levels.

Water deficit can lead to low water discharges and dehydration events, which can affect the concentration of nutrients and contaminants. Dehydration events will cause the cessation of microbial activity, which results in an accumulation of nutrients such as nitrogen and phosphates. Biological degradation of toxicants can also be slowed down or stopped. Furthermore, periods of low discharge can cause an increase in the concentration of harmful substances, which can have negative effects on the water quality and aquatic organisms. The bioavailability of heavy metals can change due to extreme weather events. The behavior of heavy metals is complex and is determined by several parameters, such as pH, concentration of organic matter, and minerals [8].

Water scarcity can also lead to the salinization of surface waters. In general, it is expected that climate change will reduce the physiochemical water quality. An increased occurrence of low flows will lead to decreased contaminant dilution capacity and thus higher pollutant concentrations, including pathogens. In areas with overall decreased runoff (e.g., in many semiarid areas), water quality deterioration will be even worse.

## 27.6 Water Scarcity Indices

There are various methods to quantify the stress on the water resources based on water requirement for human being. Freshwater scarcity is commonly described as a function of available water resources and human population.

### 27.6.1 Crop Water Stress Index

The CWSI is the most often used index, which is based on canopy temperature to detect crop water stress. The calculation of CWSI relies on two baselines: the nonwater-stressed baseline, which represents a fully watered crop, and the maximum stressed baseline, which corresponds to a nontranspiring crop (stomata fully closed). According to the Idso's definition [26], the CWSI can be expressed as

$$\text{CWSI} = \frac{[(T_c - T_a) - D2]}{[D1 - D2]} \quad (27.1)$$

where

D1 is the maximum canopy and air temperature difference for a stressed crop (the maximum stressed baseline)

D2 is the lower limit canopy and air temperature difference for a well-watered crop (the nonwater-stressed baseline)

T<sub>c</sub> is the measured canopy surface temperature (°C)

T<sub>a</sub> is the air temperature (°C)

### 27.6.2 Water Supply Stress Index

McNulty et al. [34] proposed this technique to quantitatively assess the relative magnitude of water supply and demand at the eight-digit USGS hydrological unit code level, known as WaSSI, and calculated by the following formula:

$$\text{WaSSI} = \frac{\text{WD}}{\text{WS}} \quad (27.2)$$

Water demand is WD, water supply is WS, and x represents either historic or future water supply and/or demand from environmental and anthropogenic sectors. The WaSSI highlights water-stressed areas that are typically overlooked in assessments of larger scales. WaSSI is unique from other water availability measurement tools as it considers factors of anthropogenic water demand.

### 27.6.3 Falkenmark Water Stress Indicator (Resources to Population Index)

Falkenmark [13] water stress indicator is one of the most commonly used indicators. Based on the per capita usage, the water conditions in an area can be categorized as no stress (>1700 m<sup>3</sup>/capita/year), stress (1000–1700 m<sup>3</sup>/capita/year), scarcity (500–1000 m<sup>3</sup>/capita/year), and absolute scarcity (<500 m<sup>3</sup>/capita/year). Originally, the indicator is based on the estimation that a flow unit of one million cubic meters of water can support 2000 people in a society with a high level of development, using Israel as a reference by calculating the total annual renewable water resources per capita. Water availability of more than 1700 m<sup>3</sup>/capita/year is defined as the threshold above which water shortage occurs only irregularly or locally. Below this level, water scarcity arises in different levels of severity. Below 1700 m<sup>3</sup>/capita/year, water stress appears regularly; below 1000 m<sup>3</sup>/capita/year, water scarcity is a limitation to economic development and human health and well-being; and below 500 m<sup>3</sup>/capita/year, water availability is a main constraint to life.

The another method is developed by Gleick on the basis of ability to meet all water requirements for basic human needs such as 5 L/person/day for drinking water for survival; 20 L water for human hygiene, sanitation services, and waste disposal; 15 L for adequate bathing; and 10 L of water for modest household needs for preparing food. This proposed water requirement for meeting basic human needs gives a total demand of 50 L/person/day. International organizations and water providers are recommended to adopt this overall basic water requirement as a new threshold for meeting these basic needs, independent of climate, technology, and culture [18]. Both Falkenmark and Gleick developed the “benchmark indicator” of 1000 m<sup>3</sup>/capita/year as a standard that has been accepted by the World Bank [14,17].

#### 27.6.4 Water Availability Index

Meigh et al. [35] developed the index that includes surface water as well as groundwater resources and compares the total amount to the demands of all sectors, that is, domestic, industrial, and agricultural demands. The month with the maximum deficit or minimum surplus respectively is decisive. The index is normalized to the range -1 to +1 (Equation 27.3).

When the index is zero, availability and demands are equal.

$$WAI = \frac{(R + G - D)}{(R + G + D)} \quad (27.3)$$

where

R is the surface runoff

G is the groundwater resources

D is the sum of demands of all sectors

The surface water availability is calculated as 90% reliable runoff. The groundwater availability is estimated either as the potential recharge that is calculated from the monthly surface water balance, or as the potential aquifer yield, and the lower figure is considered in the calculation.

#### 27.6.5 Water Poverty Index

WPI [50], developed by the Centre for Ecology and Hydrology, shows the connection between water scarcity issues and socioeconomic aspects. It ranks countries according to the provision of water, combining five components, which are resources, access, use, capacity, and environment. Each of these components is derived from two to five indicators, which are normalized to a scale from zero to one.

In case of an equal weighting, the subindex and component values are then calculated as a simple average of the corresponding indicators, and this value is multiplied by 20. The overall index is generated as a sum of the component values so that the value is between 0 and 100. A value of 100 is possible only if a country ranks best in all of the five components.

#### 27.6.6 Social Water Stress Index

Building on the Falkenmark indicator, Ohlsson [37] integrated the adaptive capacity of a society to consider how economic, technological, or other means affect the overall freshwater availability status of a region. Ohlsson argued that the capability of a society to adapt to difficult scenarios is a function of the distribution of wealth, education opportunities, and political participation. The UNDP Human Development Index is a widely accepted indicator used to assess these societal variables.

### 27.6.7 Watershed Sustainability Index

Chaves, Henrique, and Alipaz [6] proposed index that incorporates hydrology, environment, life, and policy, each having the parameters pressure, state, and response. The watershed sustainability index (WSI) is structured to be watershed or basin specific and intended for a maximum area of 2500 km<sup>2</sup>; larger areas would need to be broken down into smaller sections. The WSI (0–1) is the average of four indicators (Equation 27.4); H is the hydrological indicator (0–1); E is the environmental indicator (0–1); L is the life (human) indicator (0–1); and P is the policy indicator (0–1). Each parameter is given a score of 0, 0.25, 0.50, 0.75, or 1.0.

$$\text{WSI} = \frac{H + E + L + P}{4} \quad (27.4)$$

All indicators are equal in weight, although parameters may vary from basin to basin and should be chosen by consensus among stakeholders [6]. However, the use of the model depends on available information specific to watersheds, which may be varying in nature. Application of this on a global scale may not be feasible.

### 27.6.8 Water Resources Vulnerability Index

It is the ratio of total annual withdrawals to available water resources. A country is considered water scarce if annual withdrawals are between 20% and 40% of annual supply and severely water scarce if withdrawals exceed 40% [41].

### 27.6.9 IWMI Water Scarcity Assessment

The International Water Management Institute [29] used water scarcity assessment for the larger scale across the entire globe. They considered the portion of renewable freshwater resources available for human requirements (accounting for existing water infrastructure), with respect to the main water supply. The analysis labeled countries as *physically water scarce* when more than 75% of river flows are withdrawn for agriculture, industry, and domestic purposes. This implies that dry areas are not necessarily water scarce. Indicators of physical water scarcity include acute environmental degradation, diminishing groundwater, and water allocations that support some sectors over others [36]. Countries having adequate renewable resources with less than 25% of water from rivers withdrawn for human purposes, but needing to make significant improvements in existing water infrastructure to make such resources available for use are considered “economically water scarce” [43].

## 27.7 Water Scarcity Mitigation

---

There are various issues while dealing with the mitigation of water scarcity. Mitigation involves the technical parameters, as well as social parameter includes physical structures for collecting, storing, and distribution. The social factor such as tradition and attitude are much more important than the physical parameters.

### 27.7.1 Dryland Agriculture and New Irrigation Systems

The mitigation and adaptation strategy for agriculture and animal husbandry should include cropping strategies for aberrant weather conditions, cropland management techniques, improving access to information, and enhanced role of biotechnology and risk management in agriculture. Apart from ensuring sustainability in agriculture, government also needs to invest in programs that aim at increasing livestock production and enhancing livelihood support in rural areas. There is also a need to

enable increased participation of Self Help Groups, Producers Cooperatives, Breeding Associations, and Village Committees through which extension knowledge, technologies, and skills can be made accessible to local communities.

In order to enhance the productivity from drylands and secure agriculture-based livelihoods, specific areas of action include the following:

- a. Promotion of dryland agriculture techniques such as low/zero tillage, in situ soil moisture conservation, raised bed, ridge furrow, mulching, etc.
- b. Watershed development and management.
- c. Development of efficient irrigation infrastructure to ensure judicious utilization of water.
- d. Soil improvement through reclamation of alkaline and saline soil.
- e. Green manuring and organic farming can help reduce emissions from agriculture and promote judicious use of resources such as water.

### 27.7.1.1 Cropping Strategies for Reducing Water Demand

Crop production strategies for aberrant weather conditions are being developed for the Indian arid region. Selection of short-duration varieties is an important strategy to combat droughts. Pearl millet (varieties such as MH-179, CZP-9401, ICMV-155, CZH-859), mung bean (varieties such as S-8, K-851, P-9075), clusterbean (varieties such as Maru, JDM 1, FS 277), moth bean (varieties such as Maru, Jadia, CZM 79), and sesame have been found to be drought-tolerant and are grown in the region. Intercropping of pearl millet and grain legume also helps in overcoming drought. Mid-season corrections like reducing plant population (thinning), transplanting pearl millet, and spraying antitranspirants like kaolin, weeding, and creating soil mulch are some of the strategies used to reduce the effects of drought. Cropping strategies under favorable conditions such as the early onset of monsoon might include pearl millet with high-density planting followed by a leguminous/fodder crop. Under normal monsoon rainfall conditions, cropping strategies might be pearl millet with a reduced population followed by a legume/fodder crops. One interculture after 25 days of planting is required to control weeds and soil compaction. Sometimes mixed cropping is adopted as insurance against total crop failure.

### 27.7.1.2 Runoff Farming

Runoff farming is an age-old practice used by farmers for successful crop production in arid regions. There are two types of runoff farming. In the first, on gentle sloping lands, bunds are constructed across the prevailing slope to intercept the runoff. The water thus harvested remains stored in soil profile and is available to the crop during the dry period. Alternately, the field is divided into a series of micro-catchments/ridge and furrows. The water harvested from micro-catchments/ridge is used by the crop grown in furrows. This practice is recommended for areas with adequate soil depth. Field trials over two decades showed successful crop production with this technique.

### 27.7.1.3 Sprinkler and Drip Irrigation

Sprinkler and drip irrigation have been introduced in the highly undulating and sandy tracks of the dry region. In dry areas, sandy soil with high infiltration rate and deep percolation lead to enormous amount of scarce water. In this method, water is sprayed in the air and allowed to fall free on the crop and surface. Differential size of nozzles/pipes is used to spray the water. With careful selection of these nozzles and sprinkler spacing, the amount of irrigation water required for sustaining root zone can be increased efficiently. With the help of sprinkler irrigation method, light and frequent irrigation for good germination is provided to crops. Water flows in this method through micropores than macropores, which is more water efficient. Water in dry regions is very scarce, and by this method, efficient water management is possible. In comparison to conventional irrigation methods such as open or *Nali*, the area coverage is more in this method as about 38% area is more irrigated with the same volume of water. Government is also supporting this technique in dry region. The provision of subsidy is made on



**FIGURE 27.3** Sprinkler irrigation method.

purchasing pipes specially designed for sprinkler irrigation. In this method, water can be transported through pipes to quite distant places without wastage. In undulating sandy plains, open or *nali* method is not efficient. A nozzle is set on the joint of pipes that moves round with water pressure (Figure 27.3).

#### **27.7.1.4 Irrigation Deficit Technique**

Deficit irrigation technique is one of the methods to conserve irrigated water in the agricultural field. In this method, plants are exposed to certain levels of water stress during either a particular growth period or throughout the whole growth season, without significant reduction in yields. Deficit irrigation is one way of maximizing water use efficiency for higher yields per unit of irrigation water. Among field crops, groundnut, soybean, common bean, and sugarcane show proportionately less yield reduction than the relative evapotranspiration deficit imposed at certain growth stages. Crops such as cotton, maize, wheat, sunflower, sugar beet, and potato are well suited for deficit irrigation applied either throughout the growing season or at predetermined growth stages. In order to ensure successful deficit irrigation, it is necessary to consider the water retention capacity of the soil. Under deficit irrigation practices, agronomic practices may require modification, for example, decrease plant population, apply less fertilizer, adopt flexible planting dates, and select shorter-season varieties [30].

Water supplies are also under pressure from agricultural users and saving of water resources and increasing agricultural productivity. Strategies to improve water productivity under water scarcity include

1. Cultivation of plants with high water-use efficiency or plants with greater drought tolerance
2. Investment in water-efficient technologies for growing plants as in deficit irrigation techniques  
This includes the following [16]:
  - a. Regulated deficit irrigation (RDI) method is based on the observation that photosynthesis and fruit/grain growth are less sensitive to water stress induced by drought, than transpiration, so consequently water use efficiency is increased. However, deficit irrigation can also reduce yield, and for optimal application of RDI, plant and soil water status must be monitored in order to maintain a plant–water regime within certain degree of water stress that could not limit yield.
  - b. Partial root drying (PRD) irrigation is switched from one side of the root to the other side of the roots to keep it in dry soil alive and fully functional and sustain the supply of root signals. The treatment is then reversed, allowing the previously well-watered side of the root system to dry down while fully irrigated previously dry side. The frequency of the switch is determined according to soil type, genotypes, or other factors such as rainfall and temperature. In most of the experimental data, the PRD cycle includes 10–15 days. The principle behind PRD is that irrigating part of the root system keeps the leaves hydrated.

### 27.7.2 Traditional Knowledge Systems

Rainwater has been used since ancient times, and evidence of roof catchment systems dates back to early Roman times. Roman villas and even whole cities were designed to take advantage of rainwater as the principal water source for drinking and domestic purposes since at least 2000 BC. In the Negev Desert in Israel, tanks for storing runoff from hillsides for both domestic and agricultural purposes have allowed habitation and cultivation in areas with as little as 100 mm of rain per year. According to an archaeological encyclopedia, “The first cisterns were dug in the middle and late bronze age (2200–1200 BC). The rainwater that collected in them during the short rainy season would be enough for at least one dry season. In some parts of Palestine cisterns were the main (sometimes even the only) source of drinking water in peacetime as well as in wartime. In the early Iron Age (1200–1000 BC) the sides of cisterns began to be covered with watertight plaster, which considerably prolonged the time for which water could be stored. It was this important innovation that made it possible to extend the areas of settlement into the mountainous parts of the country” [56]. Water has been harvested in India since ancient times; our ancestors were perfect in the management and conservation of water resources. They harvested the rain drop directly. From rooftops, they collected water and stored it in tanks built in their courtyards. From open community lands, they collected the rain and stored it in artificial wells. They harvested monsoon runoff by capturing water from swollen streams during the monsoon season and stored it in various forms of water bodies. They harvested water from flooded rivers. Various traditional methods were applied in different parts of the countries such as kul, Zing, Naula, dongs, ahars-pynes, baolis, kunds, khadins, cheruvu, bandh, etc. [65].

### 27.7.3 Wastewater Reuse

The wastewater reuse for agriculture and irrigation is emerging as an established water management practice in several water-scarce regions in the world. In areas where water is scarce, treated wastewater provides an alternative source of water for irrigating crops. Depending upon the level of treatment, it can be relatively nutrient rich, reducing the need for additional applications of inorganic fertilizer. Reclaimed water has various advantages such as reduction of surface water pollution, nutrients in treated wastewater, saving of high-quality freshwater, and greater water security. For example, Egypt, since 1980, is interested in the use of treated wastewater as a substitute for freshwater in irrigation. The capacity of wastewater treatment plants has increased by more than six times in the last two decades with current capacity estimated at 12 million m<sup>3</sup>/day. At present, 323 wastewater treatment plants exist across India. The length of wastewater collection networks increased from 28,000 km in 2005 to 34,000 km in 2010. They are using wastewater irrigation to combat desertification. An innovative afforestation scheme includes the *Jatropha Curcas* plantation in the Luxor Desert, which is irrigated by treated wastewater from Luxor City and produces crops used for biofuel. The yearly yield per hectare is up to 5 tons of seed, which can produce up to 1.85 tons of oil. In Algeria, 15,770 ha are being irrigated with treated wastewater. And as climate change has proven to have increasingly adverse impacts on the regularity of freshwater supply, demand for treated wastewater has increased. In Spain, 20% of water used across all sectors is supplied from treated wastewater, including the irrigation of 5000 ha of tomatoes and 2500 ha of banana plantations. Wastewater use for urban and peri-urban agriculture in south Delhi part is an emerging priority. It can reduce water scarcity and provide a reliable source of water, improve agriculture productivity, reduce pollution, and create livelihood opportunities for urban households [61]. For instance, the experience of Sao Paulo investing billions of U.S. dollars to build treatment plants along the Tiete River. They have developed 500 million USD Guarapiranga Water Quality and Pollution Control project, which included sewerage connections, slum upgrading of 200,000 poor urban dwellers, and wastewater treatment to protect one main source of drinking water for the city.



## 27.8 Water Governance for Scarcity Management

---

Governance is a complex process that considers multilevel participation beyond the state, where decision making includes not only public institutions, but also the private sector, civil society, and society in general. Good governance frameworks refer to new processes and methods of governing and changed conditions of ordered rule on which the actions and inactions of all parties concerned are transparent and accountable. It embraces the relationships between governments and societies, including laws, regulations, institutions, and formal and informal organizations. Water governance can be perceived, in its broadest sense, as comprising all social, political, economic, and administrative organizations and institutions, as well as their relationships to water resources development and management. It is concerned with how institutions operate and how regulations affect political actions and societal concerns through formal and informal instruments [51]. United Nations Development Programme [52] considers water governance to include political, economic, and social processes and institutions through which governments, private sector, and civil society make decisions about how best to use, allocate, develop, and manage water resources.

### 27.8.1 Engineering Responses and Structures for Water Scarcity Mitigation

Rainwater harvesting provides the long-term answers to the problem of water scarcity. Rainwater harvesting offers an ideal solution in areas where there is sufficient rain but inadequate groundwater supply, and surface water resources are either lacking or are insufficient. Rainwater harvesting system is particularly useful in remote and difficult terrain as it has the ability to operate independently. The whole process is environment friendly. There are a number of ways in which water harvesting can benefit a community. Water harvesting enables efficient collection and storage of rainwater, makes it accessible, and substitutes for poor quality water. Water harvesting helps to smooth out variation in water availability by collecting the rain and storing it more efficiently in closed stores or in sandy riverbeds. In doing so, water harvesting assures a continuous and reliable access to water [55]. In urban areas, scarcity and accelerating demand of water is a major problem, and it can be reduced by rainwater harvesting, using various existing structures like rooftops, parking lots, playgrounds, parks, ponds, flood plains, etc., to increase the groundwater table, which saves the electric energy to lift the groundwater because one meter rise in water level saves 0.40 kWh of electricity. Subsequently, it can also reduce storm drainage load and flooding in city streets. The Panchsheel Cooperative Group Housing Society, New Delhi, India, has implemented rainwater harvesting project and harvesting each drop of rain in the urban environment. The plan has been prepared in association with the Council for Scientific and Industrial Research, which will provide the bacteria to purify the water. Initially, the pilot project will have the capacity to treat about 20,000 L/day, and the project will involve not more than \$2000. The treated water will be used for irrigation purposes in the colony and major portion of it will also be used in the Society office and Panchsheel Club, including use in the flush [57]. In rural areas, different measures applicable to runoff zone, recharge zone, and discharge are available. The structures commonly used are bench terracing, contour bunds, gully plugs, *nala* bunds, check dams, and percolation ponds, etc.

#### 27.8.1.1 Farm Ponds

Farm ponds are made either by constructing an embankment across a water course or by excavating a pit or the combination of both within individual farms having flat topography with low soil permeability. The main objective is to provide water storage for life-saving irrigation in a limited area and drinking water for livestock and human beings (Figure 27.4).

#### 27.8.1.2 Nala Bunds and Percolation Tanks

*Nala* bund and tanks are structures across *nallas* (streams) where the slope of the *nala* should not be more than 2%, as far as possible, and the catchment of the *nala* bund should not be less than 40 ha. There should be adequate soil permeability or good fracture development to facilitate good groundwater

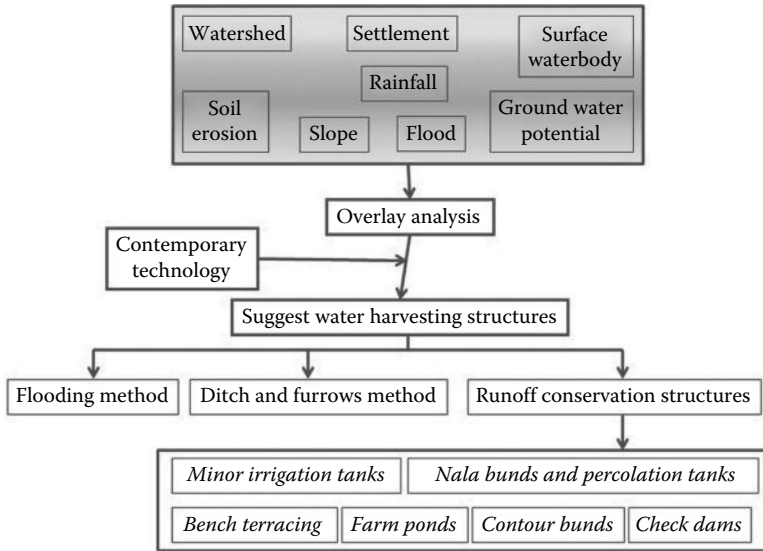


FIGURE 27.4 Decision-making methodology for locating engineering structures.

recharge. *Nala* bunds are less expensive, smaller in dimension, and constructed using locally available material, whereas percolation tanks are larger and more expensive. The main objective is to impound surface runoff coming from the catchment to hold the silt flow and to facilitate percolation of stored water into the soil substrata with a view to raise groundwater level as well as improve soil moisture regime in the zone of influence of the *nala* bund/percolation tank.

**27.8.1.3 Contour Bunds**

Contour bunding involves construction of narrow-based trapezoidal embankments or bunds along contours across the slope of the land to impound water behind them, which infiltrates into the soil and ultimately supplements groundwater recharge. This technique is generally adopted in low-rainfall areas where rainfall normally less than 800 mm and gently sloping agricultural lands with very long slope lengths are available with the permeability of the soils.

**27.8.1.4 Bench Terracing**

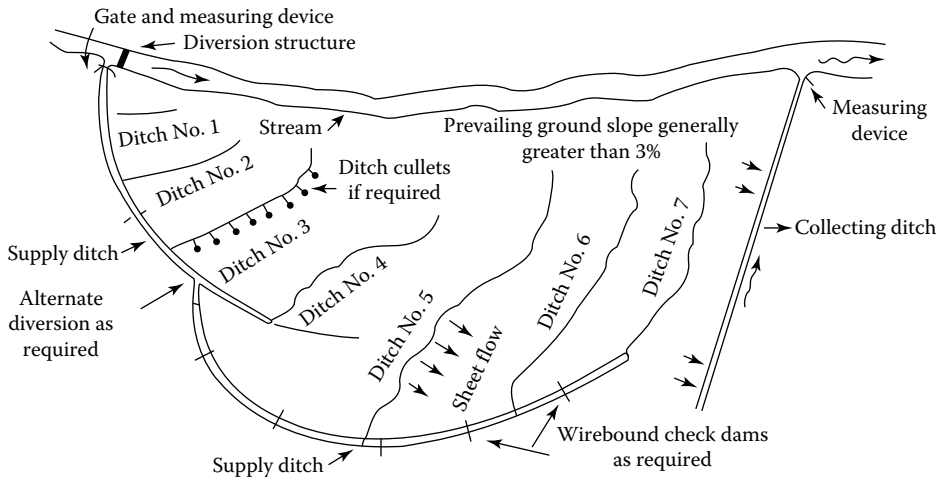
Bench terracing involves leveling of sloping lands with surface gradient up to 8% and having adequate soil cover for bringing them under irrigation. It also helps in soil conservation and holding runoff water on the terraced area for longer durations, leading to increased infiltration and groundwater recharge.

**27.8.1.5 Check Dams**

In general, they are constructed across the lower stream order (up to third order) with medium slopes, where the water table fluctuation is very high and the stream is influent or intermittently effluent. There should be some irrigation wells in the downstream of the proposed structure to recharge.

**27.8.1.6 Ditch and Furrow Method**

This method involves construction of shallow, flat-bottomed, and closely spaced ditches or furrows to provide maximum water contact area for recharge from source stream or canal. The ditches should have adequate slope to maintain flow velocity and minimum deposition of sediments. The collecting ditch to convey the excess water back to the source stream or canal is also provided, though this technique involves less soil preparation when compared to recharge basins and is less sensitive to silting [4] (Figures 27.5 and 27.6).



**FIGURE 27.5** Schematics of ditch and furrow recharge system. (From Central Ground Water Board, *Manual on Artificial Recharge of Ground Water*, Central Ground Water Board, Ministry of Water Resources, Government of India, New Delhi, India, 2007.)

### 27.8.2 Social Engineering and Community Initiatives for Revival of Local Water Bodies

In dry regions, water availability is limited to a period of the year. Rainfall is received for 3–4 months of rainy season, while for the rest of the year, people have to depend on stored water. Local people have their own methods of rainwater storage as ponds and natural lakes, were created and maintained by local rural communities over long historical periods for various purposes as irrigation, domestic use, etc. But now these local water bodies declined in number as well as in importance, and the initiatives and responsibility of irrigation and maintenance of these local water bodies passed on from local communities to government. It resulted in reduced accessibility of local communities to safe water, which was used to depend on tanks and which did not benefit from expansion of canal and well irrigation.

In dry areas, these water bodies were used to maintain by local communities, but at the time from when government took the control of these resources, both their quality and quantity deceased. In the lack of proper maintenance and care, these water bodies are either dried or become the waste and garbage site. For combating climate change in dry regions, these water bodies are being revived. They have multifunctional aspects as for irrigation, drinking purposes, and other domestic activities. Runoff storage by applying traditional methods such as *Johads* is another aspect of conserving these water bodies (Figure 27.7).

### 27.8.3 Equitable Demand and Supply Management

The water scarcity can be reduced by the proper management in the utilization of freshwater. It includes the proper distribution system. In the urban environment, the distribution of tap water is unevenly distributed as in high-income localities, where water supply is 250–300 L/person/day, and in low-income locality settlement, it is less than 100 L/person/day, and in some places, it is supplied by the tanker (Figure 27.8). The utilization of the reverse osmosis system in the household, where treated water is supplied within the permission limit, should be stopped because it can waste more than 50% of the freshwater. There should be utilization of treated rainwater for the sanitary use, cleaning, and washing the cars or vehicles for the water conservation.

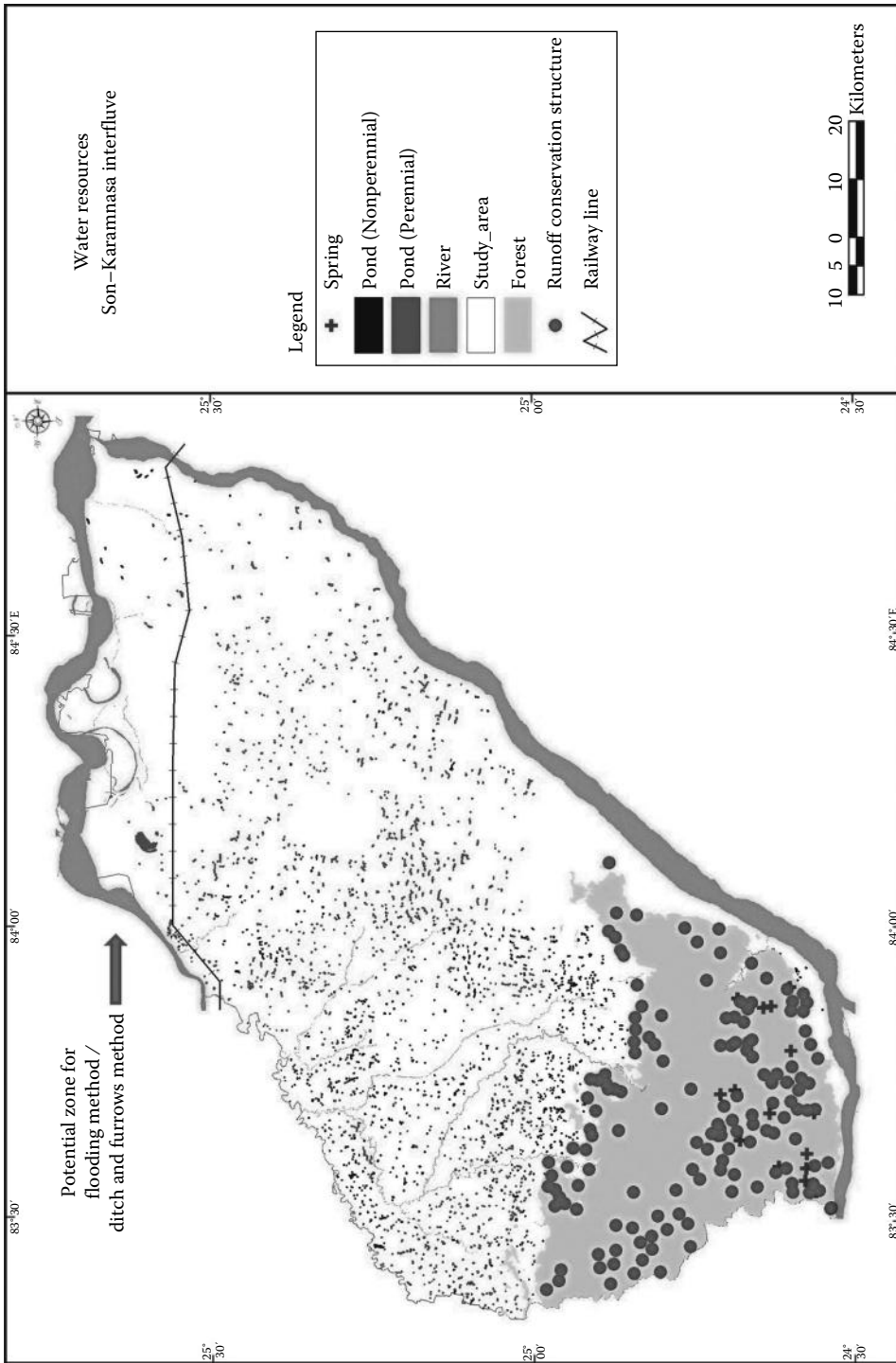


FIGURE 27.6 Runoff conservation techniques.



**FIGURE 27.7** Local water bodies as *Johad*, the base of rural livelihood.



**FIGURE 27.8** Water scarcity in National Capital Territory of Delhi.

## 27.9 Summary and Conclusions

Water is essential for all the socioeconomic development activities and for maintaining healthy ecosystems. As population increases, development calls for increased allocations of groundwater and surface water for the domestic, agriculture and industrial sectors. Water is essential for the environment, food security, and sustainable development. All the known civilizations (Harappa, Sindhu Valley, and Mohan Jodharo) have flourished along water sources, and it is true in the present context too. Water scarcity is one of the major problems faced by not only the human society but also the flora and fauna of the world. It is true that water is a renewable resource and it cannot become extinct, but the rapid growing population and their development process have put enormous pressure on the water resources especially on the freshwater by raising their demands, leading to the water scarcity in the world. This problem is not only confined to the arid and semiarid regions but also observed in the water-abundant regions. To meet the growing need for water by building dams and diverting rivers is one of the solutions, but it also creates ecological problems. There is a need for proper water management and planning to improve the overall productivity of water use and their efficiency, innovative new technologies, and the strong participation of communities and local water users in decision making. The improvement of the efficiency of the water use in different sectors can enable reduction of water

scarcity. Value-based water education is an innovative approach to water education that not only seeks to impart information on water but also inspires and motivates learners to change their behavior and adopt attitudes that promote the wise and sustainable use of water.

## References

1. 2030 Water Resources Group. 2009. *Charting Our Water Future*. 2030 Water Resources Group, Nestle S.A., Vevey, Switzerland.
2. Babu, A.V.S., V.V. Rao, and I.V. Muralikrishna. 2007. Satellite remote sensing derived spatial water utilisation index (WUI) for benchmarking of irrigation system. *Journal of the Indian Society of Remote Sensing* 35:81–91.
3. Bates, B.C., Z.W. Undzewicz, S. Wu, and J.P. Palutikof. 2008. Climate change and water. Technical Paper VI of the intergovernmental panel on climate change. IPCC Secretariat, Geneva, Switzerland.
4. Central Ground Water Board. 2007. *Manual on Artificial Recharge of Ground Water*. Central Ground Water Board, Ministry of Water Resources, Government of India, New Delhi, India.
5. Chandler, D. 2008. *Water Supplies Could Be Strongly Affected by Climate Change: Changes in Rainfall Can Be Amplified, Up or Down, in Changes to Aquifers*. Massachusetts Institute of Technology News, Cambridge, MA.
6. Chaves, M., L. Henrique, and A. Suzana. 2007. An integrated indicator based on basin hydrology, environment, life, and policy: The watershed sustainability index. *Water Resource Management* 21:883–895.
7. Chitale, M.A. 1992. *Population and Water Resources of India*. Umesh Communications, Pune, India.
8. Claessens, J. and A. Van der Wal. 2008. Verkenning effecten hoogwaterstanden op de bodemkwaliteit” in *hetlandelijk en stedelijk gebied*. Briefrapport RIVM 607050003/2008.
9. Commission on Sustainable Development. 1997. *Comprehensive Assessment of the Freshwater Resources of the World*. Report of the Secretary-General. United Nations Economic and Social Council, New York.
10. El-Ashry, M., N. Saab, and B. Zeitoon, eds. 2010. *Arab Environment Water: Sustainable Management of a Scarce Resource*. Arab forum for Environment and Development, Beirut, Lebanon.
11. Engleman, R. and P. Roy. 1993. *Sustaining Water: Population and the Future of Renewable Water Supplies*. Population and Environment Programme, Population Action International, Washington, DC.
12. European Commission. 2007. Communication from the Commission to the European Parliament and the Council on addressing the challenge of water scarcity and droughts in the European Union Commission, 414.
13. Falkenmark, M. 1989. The massive water scarcity threatening Africa: Why isn't it being addressed. *Ambio* 18:112–118.
14. Falkenmark, M. and C. Widstrand. 1992. *Population and Water Resources: A Delicate Balance*. Population Bulletin, Population Reference Bureau, Washington, DC.
15. Fischer, G. et al. 2007. Climate change impacts on irrigation water requirements: Effects of mitigation, 1990–2080. *Technological Forecasting and Social Change* 74:1083–1107.
16. Food and Agriculture Organisation. 2010. *Deficit Irrigation Methods: Management Practices for Horticulture and Viticulture*. Faculty of Agriculture, University of Belgrade, Belgrade, Serbia.
17. Gleick, P.H. 1995. Human population and water: To the limits in the 21st Century. *Human Population and Water, Fisheries, and Coastal Areas*. American Association for the Advancement of Science Symposium, Washington, DC.
18. Gleick, P.H. 1996. Basic water requirements for human activities: Meeting basic needs. *Water International (IWRA)* 21:83–92.

19. Gleick, P.H. 2006. *Freshwater Withdrawal, by Country and Sector. The World's Water 2006–2007*. Island Press, Washington, DC.
20. Gleick, P.H., E.L. Chalecki, and A. Wong. 2002. Measuring water well-being: Water indicators and indices. In: *The World's Water 2002–2003*, ed. P.H. Gleick, pp. 87–112. Island Press, Washington, DC.
21. Government of India. 2004. Initial national communication to the UNFCCC (NATCOM). <http://unfccc.int/resource/docs/natc/indnc1.pdf> (accessed October 24, 2011).
22. Government of India. 2008. National action plan on climate change (NAPCC). <http://pmindia.nic.in/Pg01-52.pdf> (accessed October 24, 2011).
23. Government of India. 2009. State of environment report. [http://moef.gov.in/soer/2009/SoE%20Report\\_2009.pdf](http://moef.gov.in/soer/2009/SoE%20Report_2009.pdf) (accessed October 24, 2011).
24. Government of UAE. 2011. *Water Use in the Arab World: From Principle to Practice*. A Summary of Proceedings Expert Consultation Wastewater Management in the Arab World, Government of UAE, May 22–24, 2011, Dubai, United Arab Emirates.
25. Gupta, A., S. Chauhan, and P.K. Gautam. 2009. *Security Implications of Climate Change for India*, pp. 167–177. Institute for Defence Studies and Analyses (IDSA), New Delhi, India.
26. Idso, S.B., R.D. Jackson, Jr. P.J. Pinter, R.J. Reginato, and J.L. Hatfield. 1981. Normalizing the stress degree day for environmental variability. *Agricultural Meteorology* 24:45–55.
27. Intergovernmental Panel on Climate Change. 2007. Climate change 2007: Impacts, adaptation and vulnerability. *Contribution of Working Group II to the Fourth Assessment Report of the Intergovernmental Panel on Climate*. Geneva, Switzerland.
28. Intergovernmental Panel on Climate Change. 2008. *Climate Change and Water*. Geneva, Switzerland.
29. International Water Management Institute. 2008. Areas of physical and economic water scarcity. UNEP/GRID-Arendal Maps and Graphics Library. [http://www.grida.no/graphicslib/detail/areas-of-physical-and-economic-water-scarcity\\_1570](http://www.grida.no/graphicslib/detail/areas-of-physical-and-economic-water-scarcity_1570)
30. Kirda, C. 2000. *Deficit Irrigation Scheduling Based on Plant Growth Stages Showing Water Stress Tolerance*. Deficit irrigation techniques, Report No. 22, FAO, Rome, Italy.
31. Kumar, D. 2008. Land and water resource management in Son-Karamnasa interfluvium in Bihar, PhD Thesis, Department of Geography, University of Delhi, Delhi, India.
32. Leadership Group on Water Security in Asia. 2009. Asia's next challenge: Securing the region's water future. <http://asiasociety.org/files/pdf/WaterSecurityReport.pdf> (accessed March 24, 2011).
33. Maleki, B.H., H. Koffi, A.S. Abide, W. Kperkouma, and E.S. Kodjovi. 2012. Climate variability and its impact on water resources in Oti Plain. *Proceeding of International Conference on Climate, Water and Policy (ICCWP) 2012, Exploring Climate Application Series I*, Busan, Republic of Korea.
34. McNulty, S., G. Sun, J.M. Myers, E. Cohen, and P. Caldwell. 2010. Robbing Peter to Pay Paul: Tradeoffs between ecosystem carbon sequestration and water yield. *Proceeding of the Environmental Water Resources Institute Meeting*, Madison, WI.
35. Meigh, J.R., A.A. McKenzie, and K.J. Sene. 1999. A grid-based approach to water scarcity estimates for eastern and southern Africa. *Water Resources Management* 13:85–115.
36. Molden, D. 2007. *A Comprehensive Assessment of Water Management in Agriculture*. International Water Management Institute, Colombo, Sri Lanka.
37. Ohlsson, L. 2000. Water conflicts and social resource scarcity. *Physics and Chemistry of the Earth* 25:213–220.
38. Parry, M. ed. 2000. *Assessment of Potential Effects and Adaptations to Climate Change in Europe: The Europe Acacia Project*. Report of concerted action of the environment program of the Research Directorate General of the Commission of the European Communities, Jackson Environmental Institute, University of East Anglia, Norwich, U.K.
39. Pereira, L.S., I. Cordery, and I. Iacovides. 2009. *Coping with Water Scarcity-Addressing the Challenges*. Springer, Dordrecht, the Netherlands.

40. Rao, V.V. and A.K. Chakraborty. 2000. Water balance study and conjunctive water use planning in an irrigation command area: A remote sensing perspective. *International Journal of Remote Sensing* 21:3227–3238.
41. Raskin, P., P. Gleick, P. Kirshen, G. Pontius, and K. Strzepek. 1997. *Water Futures: Assessment of Long-Range Patterns and Prospects*. Stockholm Environment Institute, Stockholm, Sweden.
42. Rijsberman, F.R. 2004. Water scarcity: Fact or fiction? New directions for a diverse planet. *Fourth International Crop Science Congress*, September 26–October 1, Brisbane, Australia, [www.crop-science.org.au](http://www.crop-science.org.au).
43. Seckler, D., D. Molden, and R. Barker. 1998. *Water Scarcity in the Twenty-First Century*. IWMI Water Brief 1, International Water Management Institute, Colombo, Sri Lanka.
44. Sen Roy, S., R.B. Singh and M. Kumar. 2011. An analysis of local spatial temperature patterns in the Delhi metropolitan area. *Physical Geography* 32:114–138.
45. Singh, R.B. 2004. Impact of climate change on water resources sustainability in the Himalayan-Gangetic region. *India: Annals of the National Association of Geographers* 14:32–39.
46. Singh, R.B. and S. Singh. 2011. Rapid urbanization and induced flood risk in Noida, India. *Asian Geographer* 28:147–169.
47. Singh, R.B. and S. Kumar. 2011. Mountain risks in downstream water resource management in Upper Bhagirathi basin, Indian Himalayas. *IAHS Red Book* 347:49–54.
48. Singh, R.B. and V. Chandana. 2011. Spatial analysis of the Yamuna water quality in pre and post monsoon periods. *IAHS Red Book* 348:8–13.
49. Smith, B.T. et al. 2005. Climate and thermoelectric cooling linkages. *Potential Effects of Climate Change in Thermoelectric Cooling Systems*. Oak Ridge National Laboratory, Oak Ridge, TN.
50. Sullivan, C. and J. Meigh. 2002. Application of the water poverty index at different scales: A cautionary tale. *Water International* 31:412–426.
51. UNDESA, UNDP, and UNECE. 2003. Governing water wisely for sustainable development. In: *United Nations, World Water Development Report: Water for People, Water for Life*, pp. 369–384. UNESCO, Paris, France.
52. United Nations Development Programme. 2004. *Water Governance for Poverty Reduction: Key Issues and the UNDP Response to Millennium Development Goals*. United Nations Development Programme, New York.
53. United Nations Development Programme. 2006. *Human Development Report-Beyond Scarcity: Power, Poverty and the Global Water Crisis*. United Nations Development Programme, New York.
54. United Nations Environment Programme. 2007. *Global Environmental Outlook 4: Environment for Development*. United Nations Environment Programme, Malta.
55. UN-HABITAT. 2005. *Rainwater Harvesting and Utilisation, Blue Drop Series, Book 1: Policy Makers*. UN-HABITAT, Mtwapa, Kenya.
56. UN-HABITAT. 2005. *Rainwater Harvesting and Utilisation, Blue Drop Series, Book 2: Beneficiaries and Capacity Builders*. UN-HABITAT, Mtwapa, Kenya.
57. UN-HABITAT. 2005. *Rainwater Harvesting and Utilisation, Blue Drop Series, Book 3: Project Managers and Implementing Agencies*. UN-HABITAT, Mtwapa, Kenya.
58. UNICEF. 2004. *The State of the World's Children, 2005: Childhood under Threat*. UNICEF, New York.
59. United Nations/World Water Assessment Program. 2003. World water development report: Water for people, water for life. [www.unesco.org](http://www.unesco.org).
60. World Bank. 2010. *World Bank Annual Report 2010: Year in Review*. The World Bank, Washington, DC.
61. Susanne, M., Scheierling, C. Bartone, D. Duncan, D. Mara and P. Drechsel. 2010. *Improving Wastewater Use in Agriculture, An Emerging Priority*. The World Bank, Water Anchor, Energy, Transport, and Water Department. <http://elibrary.worldbank.org/doi/pdf/10.1596/1813-9450-5412> (accessed on December 28, 2013).



62. <http://www.ammado.com/nonprofit/46496/articles/8036> (accessed on December 28, 2013).
63. [http://www.delhi.gov.in/wps/wcm/connect/doi\\_djb/DJB/Home/About+Us](http://www.delhi.gov.in/wps/wcm/connect/doi_djb/DJB/Home/About+Us) (accessed on December 28, 2013).
64. <http://envfor.nic.in/divisions/ic/wssd/doc2/ch7.html> (accessed on December 28, 2013).
65. <http://www.rainwaterharvesting.org/Rural/Traditional.htm> (accessed on December 28, 2013).
66. <http://www.unep.org/dewa/vitalwater/rubrique12.html> (accessed on December 28, 2013).
67. [http://www.unwater.org/downloads/WWD2012\\_climate\\_change.pdf](http://www.unwater.org/downloads/WWD2012_climate_change.pdf) (accessed on December 28, 2013).
68. <http://www.who.int/features/factfiles/water/en/index.html> (accessed on December 28, 2013).
69. <http://web.worldbank.org/WBSITE/EXTERNAL/TOPICS/EXTSDNET/0,contentMDK:22845098~menuPK:64885113~pagePK:7278667~piPK:64911824~theSitePK:5929282,00.html> (accessed on December 28, 2013).

# 28

## Water Security: Concept, Measurement, and Operationalization

---

**Chansheng He**  
*Lanzhou University*  
*Western Michigan*  
*University*

**Lanhui Zhang**  
*Lanzhou University*

**Xifeng Zhang**  
*Lanzhou University*

**Saeid Eslamian**  
*Isfahan University*  
*of Technology*

28.1	Introduction .....	546
28.2	Water Security: An Evolving Concept.....	547
	Water Availability • Water Vulnerability • Water Accessibility • Water Sustainability	
28.3	Measurement of Water Security.....	548
	Water Quantity • Water Quality • Water Safety for Humans • Water for Ecosystems • Water for Sustainable Development	
28.4	Operationalization of Water Security .....	550
28.5	Climate Change and Water Security .....	550
28.6	Water Security and Preparedness .....	551
28.7	Threats and Opportunities.....	551
28.8	Summary and Conclusions.....	551
	Acknowledgments.....	552
	References.....	552

### AUTHORS

**Chansheng He** is a professor in the Department of Geography at Western Michigan University. He received both his BS and MS in agronomy from Northwestern Agricultural University in China and his PhD in resources development from Michigan State University with a minor in system science. His academic interests are in water resources management, watershed hydrology, nonpoint source pollution modeling, hydrology of the Great Lakes watersheds, water resources issues in China, and comparative analysis of Sino-US water resources policies. He has published over 100 articles in leading national and international journals. A GIS-nonpoint source pollution modeling interface (ArcView Nonpoint Source Modeling or AVNPSM) he developed has been used in 12 countries. During the past decade, a distributed large basin runoff model (DLBRM) he has jointly developed with the NOAA Great Lakes Environmental Research Laboratory has been applied in North America's Great Lakes Basin and other countries. He serves on several editorial boards, including *Science China Earth Sciences*, *Journal of Resources and Ecology*, and *Chinese Geographical Science* (English edition). He served as the chair of the Association of American Geographers (AAG) Water Resources Specialty Group and is a member of the AAG Publication Committee, and a member of the Steering Committee of Commission for Water Sustainability, International Geographical Union (IGU). As a Fulbright Specialist, he is also an adjunct professor of Lanzhou University, Shanghai Jiao Tong University, and The Chinese Academy of Sciences, Institute of Geographic Sciences and Natural Resources Research.

**Lanhui Zhang** received her BS and MS in computer science and her PhD in meteorology, all from Lanzhou University. Her research interest focuses mainly on climate change and water resources in arid regions. Currently, she is working on the impacts of climate change on hydrological processes in arid regions of northwestern China, mainly through the coupling of the regional climate model and the hydrological model.

**Xifeng Zhang** received her BS in geography from Lanzhou University and is currently a PhD student at the university. Her research interest mainly focuses on water security and water resources management in arid region. Her present research project analyzes the impacts of climate change and human activities on water resources in arid and semiarid regions of Northwestern China.

**Saeid Eslamian** received his PhD from the University of New South Wales, Australia, with Prof. David Pilgrim. He was a visiting professor in Princeton University, USA, and ETH Zurich, Switzerland. He is currently an associate professor of hydrology in Isfahan University of Technology. He is the founder and chief editor of *Journal of Flood Engineering* and *International Journal of Hydrology Science and Technology*. He has published more than 200 publications mainly in statistical and environmental hydrology and hydrometeorology.

## PREFACE

Since the 1990s, water security has assumed an increasingly prominent position in the international water resources arena to tackle the intensifying global water crisis. Despite its increasing use in water resources research and policy documents, the concept of the water security remains largely multidimensional and unstandardized. This chapter reviews the definitions, measurement, and operationalization of the water security, to bring a parallel paradigm to the integrated water resources management. Water security provides a framework to achieve end goal—water security for both human society and ecosystems, with quantifiable thresholds. Successful implementation of water security in any community or geographic region must address the seven common elements: (1) whose values are to be secured, (2) for which values, (3) how much security, (4) from what threats, (5) by what means, (6) at what cost, and (7) at what time period.

## 28.1 Introduction

Rapid population growth, fast urbanization, increasing economic expansion, drastic land cover alterations, and climate change have resulted in a global water crisis [49]. Worldwide, approximately 2.6 billion people lack access to safe drinking water supply and improved sanitation, and water-associated diseases cause serious illness of over 300 million people each year [50,51], and by 2025, over 3.5 billion people will have water shortages [25,45,46]. The World Economic Forum [46] defines water supply crisis as one of the top five crises facing the globe in the next 10 years.

To address the water crisis, researchers, practitioners, and decision makers have developed a number of water resources concepts and programs during the past decades, such as supply management, demand management, and integrated water resources management (IWRM), and water security [5,18,21,22,30]. Traditionally, supply management has played a major role in meeting the increasing demands for water, through extending the withdrawals of the total amount of raw water or increasing the production and delivery of purified water to meet the multiple demands in a region [18]. Demand management emphasizes managing demands for water by institutional approaches and water-saving technology such as water pricing, water market, conservation, efficiency improvement, etc. [18,22]. The IWRM, defined as a systematic consideration of water supplies and water demands, natural and human systems, and upstream

and downstream linkages in development and implementation of water resources policies and decisions, as well as stakeholder participation in water resource management processes, has been accepted globally [14,37]. Since the 1990s, water security has assumed an increasingly prominent position in the international water resources arena [7]. Despite its increasing use in water resources research and policy documents, the concept of the water security remains largely multidimensional and unstandardized [7]. This chapter reviews the definitions, measurement, and operationalization of the water security, to bring a parallel paradigm to the IWRM.

## 28.2 Water Security: An Evolving Concept

---

Traditionally, security is more concerned with the safety (political independence and territorial integrity) of nations or states from external military threats. More recently, multiple forms of security have been widely used, often taking the form of proposals (or policy agendas) for giving high priority to certain issues, such as food security, environmental security, and energy security [2].

The terms “food security” and “energy security” generally refer reliable access to sufficient supplies of food or energy, respectively, to meet basic needs of individuals, regions, societies, or nations for human welfare and national prosperity [16,24]. For example, the United Nations (UN) Food and Agricultural Organization [11] defines that food security is a situation where all people, at all times, have physical, social, and economic access to sufficient, safe, and nutritious food that meets their dietary needs and food preferences for an active and healthy life. As water is an essential input of food production and agriculture is the largest consumptive water user, researchers have also analyzed both global food and water systems in the context of “water for food,” stating that political power, social, and gender relations are major factors that contribute to insecurities surrounding water and food [1,34]. Energy security refers to maintaining uninterrupted availability of energy sources at an affordable price to meet economic developments and environmental needs [3,24]. Unlike the concepts of energy security and food security, there has been no generally agreed-upon definition of water security since its emergence in the 1990s. In their comprehensive review, Cook and Bakker [7] thoroughly analyzed the multiple definitions of and approaches to water security. They reported that the definitions of water security used in the 1990s were linked to specific human security issues, such as military security and food security [7]. The Global Water Partnership [14] first defined water security as an overarching goal where “every person has access to enough safe water at affordable cost to lead a clean, healthy and productive life, while ensuring the environment is protected and enhanced.” Grey and Sadoff [16] defined water security as “the availability of an acceptable quantity and quality of water for health, livelihoods, ecosystems and production, coupled with an acceptable level of water-related risks to people, environments and economies.” In the United States, water security focuses on the consequences of terrorist attacks on the nation’s water supply to public health, national security, and the nation’s economic services [31,42].

While multiple themes/elements have been proposed from different perspectives, the core themes of the water security seem to include water availability, vulnerability, accessibility, and sustainability [4,7,14,16].

### 28.2.1 Water Availability

Water security is often linked to water availability, which is defined as the amount of annually renewable water per person or per unit area in a given area, region, or country [38]. Traditionally, precipitation minus evapotranspiration over land is a measure of the maximum available renewable freshwater resource (the total discharge from all the rivers and groundwater to the sea, also called blue water, estimates between 40,700 and 45,500 km<sup>3</sup>) [33,35]. Globally, approximately 3800 km<sup>3</sup>/year is currently withdrawn by human beings, and evapotranspiration (green water) from cropland and grassland

(roughly 7,600 and 14,400 km<sup>3</sup>/year, respectively) accounts for one-third of the total terrestrial evapotranspiration [33]. However, due to its uneven distribution over space and time, the amount of renewable freshwater available for human use is much smaller in a region or country.

### **28.2.2 Water Vulnerability**

Water security also links to water vulnerability as water also has a power to destroy lives and livelihoods through disastrous events such as floods, hurricanes, and droughts [7,39]. Water vulnerability refers to the degree to which a region or water system is susceptible to the physical threats such as hazards or adversarial actions (e.g., vandalism, terrorist attack) and the capacity of people and communities to cope with those threats [31,39,42]. For example, the vulnerability of a water supply system to pollution is the water system's capacity to absorb, spread, or mitigate the effects of a polluting fluid that might jeopardize the quality of waters both spatially and temporally [39,48,50]. Vulnerability assessments help the communities or water systems evaluate their susceptibility to potential threats and identify corrective actions that can reduce or mitigate the consequences from such threats [31,42]. The value of vulnerability is generally expressed in a range between 0 (no loss or damage) and 1 (total loss).

### **28.2.3 Water Accessibility**

Water accessibility refers to the rights or the ability of individuals or households to have an access to adequate quantities of affordable and safe drinking water and basic sanitation [7,50,51]. Water security requires guaranteed access to water as Norman et al. [32] define water security as “sustainable access, on a watershed basis, to adequate quantities of water, of acceptable quality, to ensure human and ecosystem health.” As to the ecological system, the lowest water requirement should be guaranteed to ensure the health of the ecological systems and the provision of ecosystem services.

### **28.2.4 Water Sustainability**

Water security seeks to achieve water sustainability. While there is no generally agreed-upon definition of water sustainability, Gleick [12] defines it as “the use of water that supports the ability of human society to endure and flourish into the indefinite future without undermining the integrity of the hydrological cycle or the ecological systems that depend on it.” He further specifies seven criteria to evaluate the sustainability of water systems: to maintain human health; to restore and maintain the health of ecosystems; to meet certain minimum standards of water quality; to maintain the long-term renewability of freshwater stocks and flows; to make data on water resources availability, use, and quality to all parties; to set up institutional mechanisms to prevent and resolve conflicts over water; and to foster and implement democratic and participatory water planning and decision making. His definition and criteria are quite similar to the definition of water security by Global Water Partnership [14].

## **28.3 Measurement of Water Security**

---

Measurement of water security, while diverse, may focus on the quantity, quality, safety, ecosystems, and sustainability of water resources in a geographic region.

### **28.3.1 Water Quantity**

Since sufficiency of water supply for humans and ecosystem is the primary gauge of water security, quantity and availability of water are often used to assess water security [7].

A water scarcity index is often used to assess the water availability in a region, which is defined as the ratio of the product of total water withdrawal minus the amount of desalinated water to the renewable freshwater resources in the region [33]. A region is considered highly water stressed if the index is higher than 0.4. For example, Northern China, the area on the border between India and Pakistan, the Middle East, and the middle and western areas of the United States are experiencing water stresses [33].

Another index of water shortage measures the number of people that have to share each unit of blue water resource in a region or country [7,10].

### **28.3.2 Water Quality**

Water quality refers to the relative ability of the water to satisfy a particular need and is a central indicator of water security. While various water quality standards are available for different water uses, including drinking water supply, irrigation, recreation, and ecosystem services, globally about 3.3 billion people don't have access to clean water due to water contaminations [25]. At the watershed scale, the US Environmental Protection Agency has developed a set of indicators to measure the water quality of the nation's watersheds [40,41], including physical, chemical, and biological indices. Examples of such indices are ambient water quality, wetland loss index, aquatic/wetland species at risk, fish and wildlife consumption advisories, indicators of source water condition for drinking water systems, rivers and lakes, occurrence of chemicals in surface and groundwaters that are regulated in drinking water, hydrologic modification caused by dams, estuarine pollution susceptibility index, etc. [17,47].

### **28.3.3 Water Safety for Humans**

Water safety is a major theme of water security. It refers to the management of the water resources to ensure the welfare of people. This includes access to clean, safe drinking water supply, wastewater treatment facilities, and recreational water environments [48]. It also encompasses minimizing disruption of the normal functioning of a community or region from both natural (e.g., floods and droughts) and human-induced hazards (e.g., water pollution, dam failures, and land subsidence from overpumpings) [49,50]. Measurement of water safety often includes system assessment, operational monitoring, and rehabilitation of the water systems [47,49,50].

### **28.3.4 Water for Ecosystems**

Freshwater ecosystems provide human society many economically valuable commodities and ecological services, defined as "the conditions and processes through which natural ecosystems, and the species that make them up, sustain and fulfill human life" [9]. Such services include flood control, transportation, recreation, purification of human and industrial wastes, habitat for plants and animals, and production of fish and other foods and marketable goods [9]. Five environmental factors that regulate much of the structure and functioning of any aquatic ecosystem are (1) the flow pattern, (2) sediment and organic matter inputs, (3) temperature and light characteristics, (4) chemical and nutrient conditions, and (5) the plant and animal assemblage [9]. At the landscape scale, researchers have proposed the index of biotic integrity, which integrates attributes of fish and plant assemblages to evaluate the ecological quality of a freshwater system [17].

### **28.3.5 Water for Sustainable Development**

Water for sustainable development should achieve the following: sustainable access to adequate quantities of water, of acceptable quality, at affordable prices to meet the needs of human society, while maintaining the integrity of the hydrological cycle and the associated ecosystems [7,12,13,15,49,50].

Jones [26] pointed out that water management should minimize the interference with nature and maximize the benefits for nature, and at the same time, the environment management should minimize the adverse impacts on and maximize benefits for water resources. Thus, measurement of sustainable use of water, while still a challenge, should be comprehensive, encompassing hydrological, biological, social economic, and intergenerational factors.

## 28.4 Operationalization of Water Security

---

In his review of the concept of security, Baldwin [2] identifies seven common elements in various conceptions of security: (1) whose values are to be secured, (2) for which values, (3) how much security, (4) from what threats, (5) by what means, (6) at what cost, and (7) at what time period [2].

As water security concerns are broad and diverse, these questions will vary geographically and must be thoroughly addressed when operationalizing water security.

In the United States, for example, the main water security concern is the protection of the nation's drinking water and wastewater infrastructure from terrorist attack, and a "Water Security Research and Technical Support Action Plan" has been developed to address the pressing issues associated with this concern [31,41].

In China, the water security research emphasizes safety (e.g., flooding) and pollution in southern China, while focusing on both availability and quality in northern China [6,7,18–20,50,51]. A number of water resources programs have been implemented in recent years to enforce the cap for total water withdrawals, to improve water use efficiency, and to control waste discharge into the nation's waters [22].

In the sub-Saharan Africa, the main water security is on the degradation of ecosystems and water-related diseases, and environmental assessment programs have been set up to address the public health problems [50]. At the community scale, through international aid, thousands of African villages have installed play pumps to provide access to clean and safe drinking groundwater and to manage water-borne diseases, thus successfully addressing the two main water security concerns of those villages [26,27].

The primary water security issue in Europe is on the health of the water environment. The European Water Framework Directive mandated the member countries to bring all water bodies into "good ecological status" and "good chemical status" by 2015, by interpreting and implementing the rules consistently at the watershed scale [26].

Vörösmarty et al. [44] have developed a spatially cumulative threat framework to consider multiple stressors to human water security and biodiversity simultaneously at the global scale. The framework may be adapted to prioritize policy and management responses to threats to water security for both humans and freshwater biodiversity at other scales.

## 28.5 Climate Change and Water Security

---

Climate change will alter the pattern of hydrological cycle over space and time, leading to increased extreme weather events such as floods, droughts, and hurricanes, affecting water demands for all uses, including food production, industrial development, urban water supplies, recreational activities, and ecosystem services, and exacerbating competition and conflicts over water at regional, national, or international scales [28,36,43]. Developing countries—most of Africa, large areas in central Asia, and countries including China, India, Peru, or Bolivia—will experience large increases in water demand and scarcity, thus facing greater threats to water security [43,44]. Climate change projections show decreasing groundwater resources, increasing drought risk or flash floods, advancing sea-level rise, and their impacts on the regional economies in the Mediterranean region [28]. Immerzeel et al. [23] studied the impacts of climate change on snow and glacial melt in the Tibetan plateau and adjacent mountain ranges, and reported that climate change is likely to reduce upstream water supply in the Indus, Ganges,

Brahmaputra, and the Yangtze rivers. The reduced water availability will threaten food security of over six million people in these basins [23].

To adapt to climate change, water security plans must take into account the effects of climate change and variability on both water supply and demands to improve the preparedness of water systems, communities, and regions [50].

## 28.6 Water Security and Preparedness

---

Climate change adaptation and preparedness strategies should be formulated and implemented at international, national, regional, and local levels to achieve water security of these regions and peoples [48]. Public awareness needs to be increased through training programs and informal education such as seminars, workshops, brochures, and newspapers. All stakeholders including central and local authorities, NGOs, and academia need to be actively engaged in developing water security preparedness strategies through a participatory approach. Through international and national financial and technology assistance programs, multilevel environmental and water observation systems need to be established for timely assessing the state of the water and environmental systems. Early disaster warning systems and emergency response mechanisms need to be developed at national, regional, and local levels. Key water infrastructures need to be well maintained with efficient water use and water-saving technologies. Wherever feasible, innovative technologies on wastewater reuse and desalination should be promoted as alternative water resources. Last but not least, an integrated approach should be developed as part of national, regional, and local development plans to ensure water security of these systems [49].

## 28.7 Threats and Opportunities

---

Multiple threats exist to water security. Climate change and resulting extreme weather events intensify the variability of hydrological systems over space and time. Rapid population growth, increasing demand for food supply, fast industrial development, and drastic urbanization represent exacerbating competitions for water between humans and nature [4].

Despite these threats, multiple opportunities are available toward achieving water security at different scales. (1) Water-saving technologies: Globally, at least half of the water withdrawn for irrigation is wasted [4]. If the wasted water is fully used by crops, doubling the current global food production could be achieved without additional water withdrawals. (2) Urban water systems: By 2050, 70% of the world's 10 billion people is projected to live in cities, and this increasing urban population provides opportunities for improvements in water supply and sanitation with the deployment of more efficient technical solutions [4]. (3) Global water trade: As an embedded ingredient of food and other products ("virtual water"), water circulates in the global economic system [4]. Water-scarce countries may supplement their water need by importing water-intensive commodities from other countries [4]. (4) Good water governance: Since water crisis is a crisis of governance [50], improved water governance is the key toward water security. While there are multiple forms of good governance, its core components should include "polycentric governance, effective legal frameworks, reduced inequalities, open access to information, and meaningful stakeholder participation [4]."

## 28.8 Summary and Conclusions

---

Over the past two decades, IWRM has become a globally dominant water management paradigm through the promotion of the various UN and UN-related bodies involved in water [26]. During the same period, the concept of water security has gained increasing attention and evolved significantly [7]. While the two concepts are similar, IWRM emphasizes human requirements and governing process, less on attention to protection of the environment [26]. Water security provides a framework to achieve



end goal—water security for both human society and ecosystems, with quantifiable thresholds [7]. Some scholars criticize the concept of water security as potentially disruptive of the water resources negotiations in the Nile River Basin [29], and hydropolitics should be considered within the definition of security and within the field of security studies [8]. Proponents of water security paradigm believe that it provides a parallel move to IWRM [7]. Even overlapping with IWRM, water security can be considered as an alternative paradigm in water resources management. Successful implementation of water security in any community or geographic region must address the seven common elements raised by Baldwin [2]: (1) whose values are to be secured, (2) for which values, (3) how much security, (4) from what threats, (5) by what means, (6) at what cost, and (7) at what time period.

## Acknowledgments

Partial support for this research is provided by the National Natural Science Foundation of China (Grant No: 91125010), and Department of Geography, Scherer Endowment Fund of Western Michigan University.

## References

- Allouche, J. 2011. The sustainability and resilience of global water and food systems: Political analysis of the interplay between security, resource scarcity, political systems and global trade. *Food Policy*, 36: S3–S8.
- Baldwin, D.A. 1998. The concept of security. *Review of International Studies*, 23: 5–26.
- Biswas, A.K. and K.E. Seetharam. 2008. Achieving water security for Asia, *International Journal of Water Resources Development*, 24: 145–176.
- Bogardi, J.J., D. Dudgeon, R. Lawford, E. Flinkerbusch, A. Meyn, C. Pahl-Wost, K. Vielhauer, and C. VÖrÖsmarty. 2012. Water security for a planet under pressure: Interconnected challenges of a changing world call for sustainable solutions. *Current Opinion in Environmental Sustainability*, 4: 35–43.
- Brady, D.J. 1996. The watershed approach. *Water Science and Technology*, 33(4–5): 17–21.
- Chinese Academy of Sciences (CAS). 2009. *Water Sciences and Technology in China: A Roadmap to 2050*. Strategic Research Group of the CAS. Science Press, Beijing, China.
- Cook, C. and K. Bakker. 2012. Water security: Debating an emerging paradigm. *Global Environmental Change*, 22: 94–102.
- Dinar, S. 2002. Water, security, conflict, and cooperation. *SAIS Review*, XXII(2): 229–253.
- Ecological Society of America. 2003. Sustaining healthy freshwater ecosystems, *The Issues in Ecology Series*, 10: 1–16. [http://www.esa.org/sbi/sbi\\_issues/](http://www.esa.org/sbi/sbi_issues/) (accessed January 12, 2013).
- Falkenmark, M. and D. Molden. 2008. Wake up to realities of river basin closure. *International Journal of Water Resources Development*, 24: 201–215.
- FAO. 1996. *Declaration on World Food Security*. *World Food Summit*, FAO, Rome, Italy.
- Gleick, P.H. 1996. Basic water requirements for human activities: Meeting basic needs. *Water International*, 21: 83–92.
- Gleick, P.H. 1998. *The World's Water 1998–1999. The Biennial Report on Freshwater Resources*. Island Press, Washington, DC.
- Global Water Partnership (GWP). 2000. *Towards Water Security: A Framework for Action*. Global Water Partnership, Stockholm, Sweden.
- GWP. 2004. Catalyzing change: A handbook for developing integrated water resources management (IWRM) and water efficiency strategies. [http://www.gwptoolbox.org/images/stories/gwplibrary/catalyzing%20change\\_english.pdf](http://www.gwptoolbox.org/images/stories/gwplibrary/catalyzing%20change_english.pdf) (accessed May 6, 2012).
- Grey, D. and C. Sadoff. 2007. Sink or swim? Water security for growth and development. *Water Policy*, 9(6): 545–571.

17. He, C., S.B. Malcolm, K.A. Dahlberg, and B. Fu. 2000. A conceptual framework for integrating hydrological and biological indicators into watershed management. *Landscape and Urban Planning*, 49(2): 25–34.
18. He, C., S. Cheng, and Y. Luo. 2005. Desiccation of the Yellow River and the south water northward diversion project. *Water International*, 30(2): 261–268.
19. He, C., S. Cheng, and Y. Luo. 2007. Water diversions and China's water shortage crisis. In Robinson, P.J., T. Jones, and M-K. Woo (eds.). *Managing Water Resources in a Changing Physical and Social Environment*. IGU Home of Geography Publication Series, Società Geografica Italiana, Rome, Italy, pp. 89–102.
20. He, C., X. He, and L. Fu. 2010. China's South-to-North water transfer project: Is it needed? *Geography Compass*, 4/9: 1312–1323. doi 10.1111/j.1749-8198.2010.00375.x.
21. He, C. and T.E. Croley II. 2010. Hydrological resource sheds and the U.S. Great Lakes applications. *Journal of Resources and Ecology*, 1(1): 25–30.
22. He, C. 2012. Watershed science and water resources management. *Advances in Earth Science*, 27(7): 705–711 (in Chinese).
23. Immerzeel, W.W., L. Van Beek, and M. Bierkens. 2010. Climate change will affect the Asian water towers. *Science*, 328: 1382–1385.
24. International Energy Agency. 2013. Energy security. <http://www.iea.org/topics/energysecurity/> (accessed January 31, 2013).
25. Johnson, N., C. Revenga, and J. Echeverria. 2001. Managing water for people and nature. *Science*, 292: 1071–1072.
26. Jones, J.A.A. 1999. Climate change and sustainable water resources: Placing the threat of global warming in perspective. *Hydrological Sciences Journal*, 44(4): 541–557.
27. Jones, J.A.A. 2010. *Water Sustainability: A Global Perspective*. Hodder Education, London, U.K.
28. Ludwig, R., R. Roson, C. Zografos, and G. Kallis. 2011. Towards an inter-disciplinary research agenda on climate change, water and security in Southern Europe and neighboring countries, *Environmental Science and Policy*, 14: 794–803.
29. Mekonnen, D.Z. 2010. The Nile Basin Cooperative Framework Agreement negotiations and the adoption of a 'water security' paradigm: Flight into obscurity or a logical cul-de-sac? *The European Journal of International Law*, 21(2): 421–440.
30. National Research Council (NRC). 1999. *New Strategies for America's Watersheds*. National Academies Press, Washington, DC.
31. NRC. 2003. *A Review of the EPA Water Security Research and Technical Support Action Plan: Parts I and II (Free Executive Summary)*. National Academies Press, Washington, DC. <http://www.nap.edu/catalog/10772.html> (accessed January 13, 2013).
32. Norman, E.S., K. Bakker, and G. Dunm. 2011. Recent developments in Canadian water policy: An emerging water security paradigm. *Canadian Water Resources Journal*, 36(1): 53–66.
33. Oki, T. and S. Kanae. 2006. Global hydrological cycles and world water resources. *Science*, 313: 1068–1072.
34. Pinstrip-Andersen, P. 2009. Food security: Definition and measurement. *Food Security*, 1: 5–7.
35. Postel, S.L., G.C. Daily, and P.R. Ehrlich. 1996. Human appropriation of renewable fresh water. *Science*, 271: 785–788.
36. Ruettinger, L., A. Morin, A. Houdret, D. Taenzler, and C. Burnley. 2011. Water, crisis and climate change assessment framework (WACCAF). The Initiative for peacebuilding—Early warning analysis to action (IFP-EW). <http://www.ifp-ew.eu> (accessed January 17, 2013).
37. Snellen, W.B. and A. Schrevel. 2004. IWRM: For sustainable use of water, 50 years of international experience with the concept of integrated water management. Ministry of Agriculture, Nature and Food Quality, Amsterdam, the Netherlands.
38. Shiklomanov, I.A. and J.C. Rodda. 2003. *World Water Resources at the Beginning of the 21st Century*. Cambridge University Press, Cambridge, U.K.

39. United Nations Environment Programme (UNEP). 2002. *Global Environment Outlook 3: Past, Present and Future Perspectives (GEO-3)*. Earthscan Publications, London, U.K.
40. US Environmental Protection Agency (USEPA). 1996. Environmental indicators of water quality in the United States, EPA 841-R-96-002. Office of Water, Washington, DC.
41. USEPA. 1997. The index of watershed indicators, EPA 841-R-97-010. Office of Water, Washington, DC.
42. USEPA. 2004. *Water Security Research and Technical Support Action Plan*. EPA/600/R-04/063. Office of Water, Washington, DC.
43. Vörösmarty, C.J., P. Green, J. Salisbury, and R. Lammers. 2000. Global water resources: Vulnerability from climate change and population growth. *Science*, 289: 284–288.
44. Vörösmarty, C.J., P.B., McIntyre, M.O. Gessner, D. Dudgeon, A. Prusevich, P. Green, S. Glidden et al. 2010. Global threats to human water security and river biodiversity. *Nature*, 467: 555–561.
45. World Commission on Dams (WCD). 2000. *Dams and Development*. Earthscan Publications Ltd., London, U.K.
46. World Economic Forum. 2013. Global risks 2013 eighth edition CH-1223 Cologny/Geneva, Switzerland. [www.weforum.org](http://www.weforum.org) (accessed January 31, 2013).
47. World Health Organization (WHO). 2005. Water safety plans: Managing drinking-water quality from catchment to consumer. [http://www.who.int/water\\_sanitation\\_health/](http://www.who.int/water_sanitation_health/) (accessed January 31, 2013).
48. World Water Council (WWC). 2009. Istanbul declaration of heads of states on water. Outcomes of the 5th world water forum, Istanbul. [www.worldwatercouncil.org](http://www.worldwatercouncil.org) (accessed January 14, 2013).
49. World Water Assessment Programme (WWAP). 2003. *The United Nations World Water Development Report: Water for People and Water for Life*. UNESCO, Paris, France.
50. WWAP. 2012. *The United Nations World Water Development Report 4: Managing Water Under Uncertainty and Risk*. UNESCO, Paris, France.
51. Xia, J., L. Zhang, C. Liu, and J. Yu. 2007. Towards better water security in North China, integrated assessment of water resources and global change—A North-South analysis. *Water Resources Management*, 21(1): 233–247.

# 29

## Water Supply and Public Health and Safety

---

29.1	Introduction .....	556
	Historical Perspective: Water and Infectious Diseases	
29.2	Physical and Chemical Properties of Water .....	558
29.3	Criteria for Selection and Acquisition of a Water Supply.....	560
29.4	Sources of Potable Water and Associated Quality Issues.....	560
29.5	Contaminants in Potable Water .....	561
	Why We Worry about Water Quality • Pathogens • Sediment and Turbidity • Dissolved Matter: Salt (NaCl) and Total Dissolved Ions • Heavy Metals in Potable Water	
29.6	Municipal Water Treatment.....	565
	General Issues • Coagulation and Filtration • Water Disinfection • Special Case for Developing Countries	
29.7	Case Studies: Potable Water Quality and Safety Issues in Eastern Massachusetts .....	570
	Description of the System • Infectious Hepatitis Outbreak • Disinfection System Breakdown • Threats against a Water Supply	
29.8	Water Quality and Climate Change .....	573
29.9	Summary and Conclusions .....	574
	References.....	575

Theodore  
C. Crusberg  
*Worcester Polytechnic  
Institute*

### AUTHOR

**Theodore C. Crusberg** received his BA from the University of Connecticut in 1963, his MS from Yale University in 1964, and his PhD from Clark University (Worcester, MA) in 1968, all in chemistry. After spending a year at Tufts University School of Medicine (Boston, MA) in the Department of Biochemistry, he joined the chemistry faculty of Worcester Polytechnic Institute and was instrumental in the formation of the new Life Sciences Department, which in time became the Department of Biology and Biotechnology. As professor emeritus he occasionally teaches courses in environmental science and microbial physiology and carries out research dealing with water quality and other environmental issues.

## PREFACE

In terms of volume, water is an impressive natural resource on planet Earth, yet potable water is but a small portion of the total that is in fact available for human consumption. To insure its potability (which means that humans may safely consume it), natural freshwater must in many cases be first subject to a variety of treatment processes, some of which may produce other potentially harmful substances. In many countries water is subject to well-defined regulatory controls to insure its safety, but for millions worldwide, safe drinking water is unavailable or prohibitively expensive. This review will discuss public health and safety issues related to water destined to be consumed by humans directly or in some cases indirectly through the consumption of irrigated agricultural products. Firsthand case studies will relate how public works and public health managers must maintain constant vigilance to thwart any intentional or unintentional threat against their water supply.

## 29.1 Introduction

One could say that water by any name has importance in virtually any religion and is mentioned in many ancient religious texts. The ancients recognized the need for clean water and developed technologies to channel it from source to place of need. In humid environments water was extracted directly from nearby water sources, but in arid environments water had to be both imported and protected from evaporation. This was done by moving water from sources at higher elevations to populations living at lower elevations by means of what are known as *kanats* [10]. These dug tunnels, found mostly in the Middle East but also in other arid regions of the world, captured water usually from a mountain stream or aquifer and diverted it underground to fertile lands where it could be used in agriculture for domestic purposes. Tunnels over 100 km long with shafts over 100 m deep were used for water delivery and retrieval, and evaporation of course was prevented until the water was brought up to the surface. To the ancients dating back as far as six millennia, water quality was mostly based upon aesthetic concerns such as turbidity and odor [28].

### 29.1.1 Historical Perspective: Water and Infectious Diseases

Probably the most sophisticated water management program was the water supply system of ancient Rome. Beginning almost two and a half millennia ago, aqueducts were constructed to supply the people of Rome with a constant supply of water from sources outside the city, at first underground for security and then above the surface as the city became walled and enemies realized that military challenge would not be fruitful. The nine aqueducts, the water supplies from which they were drawn, and various issues related to the distribution system that had been built by the Christian year 97 were documented by Sextus Julius Frontinus in his two volumes he titled *De Aquis Urbis Romae*, water supply of the city of Rome [14]. Frontinus had impressed Emperor Nerva and was appointed *curator aquarum* or water commissioner after a short military career, managing a system that provided 38 million gallons a day (144 million liters) to the estimated one million residents (citizens and slaves) who lived within the walls of the city. Water quality as described by contemporaries Vitruvius and Pliny was deemed “good” if it served well in cooking vegetables, leaving no sediment or deposits after boiling, with no foul odor or taste, and if those consuming it also seemed to them to look healthy then it was potable. Roman water in fact was high in lime for the most part and sometimes small rounded stones would enter an aqueduct for which sedimentation ponds were constructed near the sources, and what appears to be some kind of ancient filter has been found in the museum

of Naples. Viewing the volumes of water transported into Rome according to the data in Frontinus' books, one has to assume that at least half of the water that originated at the sources was lost before it even got to the walls of the city by a combination of leaks and intentional diversion, that is, theft. Although additional aqueducts were constructed after the time of Frontinus by the Christian year 1000, the people of Rome had to depend on the filthy Tiber for water as the ancient system collapsed due to failure to maintain it as the city was abandoned as a seat of government.

Water quality was of course an issue as we now understand from the records of the members of the Mayflower party, which left Southampton, England, in the late 1620 with a goal of arriving at least one nautical degree south of their final destination, what is now Plymouth, Massachusetts. Instead of water, a large quantity of a product known as "ships beer" was brought for general consumption, much safer than water, and preserved by boiling. A landing party that went ashore at the first sight of Cape Cod found a spring (now immortalized as "Pilgrim Springs" in Cape Cod National Seashore) from which some feel they "dared to drink," and not to mention their find of a cache of Indian corn that they took for their own use.

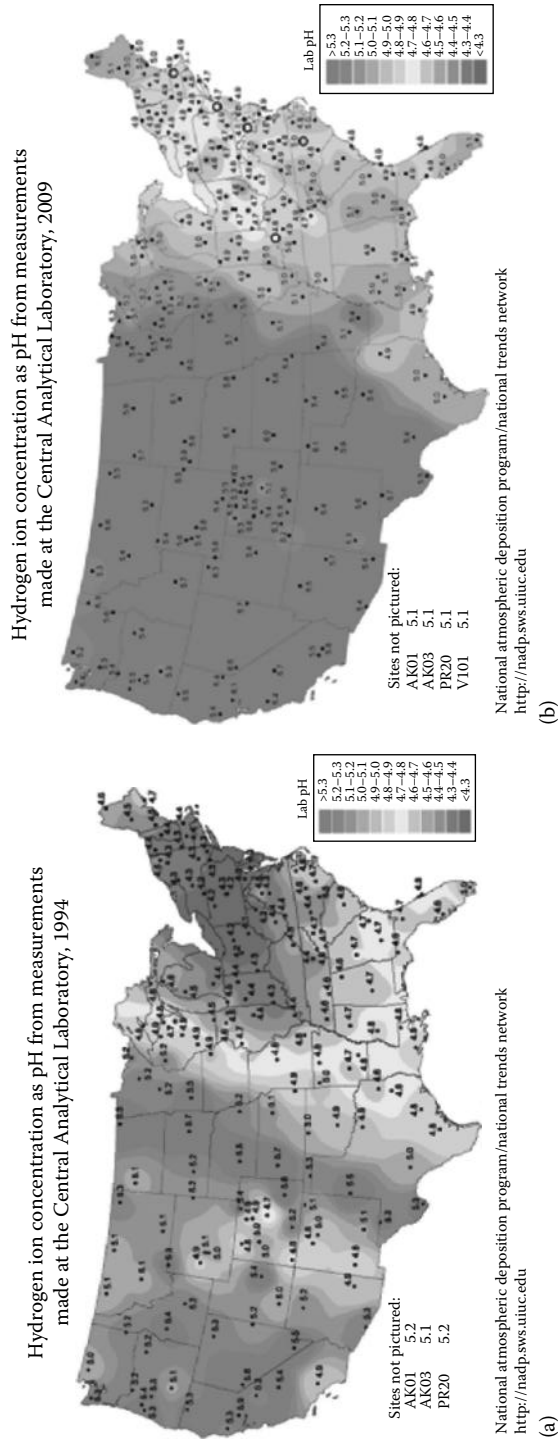
Although in 1840 Professor of Anatomy Jacob Henle at the University of Göttingen published his belief that infectious diseases were caused by living, parasitic organisms, it wasn't until the London cholera epidemic of 1854 when John Snow, M.D., carried out a double-blind controlled prospective study and established the relationship between contaminated water and that disease, although at that time disease was thought to be due to what was termed a "miasma," and it wasn't until Robert Koch's (who had in fact worked with Henle early in his career) seminal work using the anthrax bacillus to prove conclusively in his 1878 paper that bacteria caused disease. In 1873, Massachusetts native the young Dr. Austin Flint, to eventually become a prolific writer on a number of medical issues, reported how an outbreak of typhoid fever that he actually investigated three decades prior, in North Boston, NY, in a community of only 43 people living in a half dozen closely spaced homes was most likely passed from person to person in contaminated groundwater, an event that resulted in 28 cases of disease and 10 deaths [11]. Flint noted that those not affected by the disease lived a distance of around 80 m from a tavern at which a traveler also from Massachusetts had died three weeks earlier from fever, nor had they or were they allowed to use water from the well owned by the tavern. Actually it was probably Dr. William Budd's relentless work on typhoid in England and a similar publication the same year (1873) that sealed the relationship between contaminated water and disease. Finally, in 1880, *Salmonella typhi* was shown to be the agent causing typhoid fever. In colonial America, freshwater for human consumption was easy to obtain, from streams, rivers, springs, and groundwater supplies as the population extended from the cities westward. Following the first recorded use of chlorine in Belgium in 1902 and three years later in both Lincoln, United Kingdom and in Jersey City, NJ (the seventeenth largest city in the United States) the first "disinfection revolution" began when calcium hypochlorite was added to municipal drinking water to eliminate bacterial pathogens and protect consumers. By 1914, the "coliform standard" was established so that water providers could evaluate the microbiological safety of drinking water, and since that time coliform assays in one form or another have proven to be reliable indicators of the safety of potable water. By 1912, liquid chlorine was first used for water treatment in Niagara Falls, NY, and by 1941, 85% of all water treatment plants in the United States employed chlorination disinfection. At the outbreak of World War II, the US government required that all surface water supplies be chlorinated to hopefully prevent sabotage by our enemies. Water treatment facilities involved a number of technologies that usually included some sort of filtration prior to disinfection yet many large municipal drinking water providers often relied solely on chlorine disinfection to remove pathogens, and little evidence was presented to demonstrate that chlorine alone could protect the water consumer against viruses, but really not against certain protozoans, especially *Cryptosporidium parvum* and *Giardia lamblia*, unless large amounts of chlorine or long contact times were employed. Unfortunately the once pristine water sources often became seriously polluted. By 1909, for example, the Fairmount Water Works, built 90 years earlier on the banks of the Schuylkill River in Philadelphia, Pennsylvania, was abandoned once it became evident that the water was the

origin of disease. In the 1880s in the United States, typhoid deaths numbered around 50 per 100,000 population annually, falling to around 5 per 100,000 in 1928, and drinking water was virtually eliminated as a course of typhoid by 1940 (reviewed in [17]).

## 29.2 Physical and Chemical Properties of Water

The physical properties of pure water include a high surface tension (73 dyn/cm at 20°C); a high heat capacity (1 cal/g or 4.22 kJ/kg); a high dielectric constant, also known as the relative permittivity (78.54 D at 25°C); and a density of 1 g/cc at 4°C. It is the dielectric constant that gives the solvent its ability to dissolve many ionic and nonionic solids. Water however in natural settings is anything but pure. As rain falls from the sky, raindrops interact with the local atmosphere collecting airborne particulate matter and dissolving gasses on its way to Earth. Typical gasses in air that are soluble in water at 25°C include nitrogen (.0175 mg/g), carbon dioxide (1.45 mg/g), oxygen (0.04 mg/g), and sulfur dioxide (90 mg/g). Raindrops then descend to the surface and, if over land, travel over or through that surface changing properties as it joins other drops and moves until it reaches a receiving body, a surface stream or lake or takes up residence in the soil or groundwater. We know that the pH of pure water is 7.0 at 25°C, but as it absorbs atmospheric acid gasses such as carbon dioxide and sulfur dioxide/trioxide, the pH can be drastically reduced. As rain lands on the surface, it can then take up other materials present on the surface such as organic acids, and in addition it can dissolve soluble materials that make up the ground surface, or it can react with the substance that is the surface, for example, if one of its constituents is calcium carbonate. Typically, rainfall that dissolves just carbon dioxide acquires a pH of around 5.65, slightly acidic, but if substantial sulfur dioxide is present in any quantity, the pH can fall significantly to below 5. The partial pressure of CO<sub>2</sub> in the atmosphere is 0.000335 atm and the Henry law constant  $[CO_2]_{(aq)}/P_{CO_2} = 2 \times 10^{-3}$  so the concentration of H<sub>2</sub>CO<sub>3</sub> in rainwater at equilibrium is  $1.2 \times 10^{-5}$  M. Low pH precipitation (rain, snow, or ice) is termed “acid precipitation” and has proven to be a serious problem in areas where high sulfur coal and oil fuels are in extensive use. Where sulfur ores Cu<sub>2</sub>S (chalcocite), CuS (covellite), and CuFeS<sub>2</sub> (chalcopyrite) are mined and then heated in a smelter that converts the metal sulfur compounds to metal oxides, the result is the atmospheric release of sulfur dioxide. For every kg of copper produced, 1.5 kg of slag and 2 kg of sulfur dioxide are also produced as waste products. The use of lower sulfur fuels and scrubbers to remove sulfur dioxide has resulted in a rise in precipitations pH and correspondingly lower sulfate levels. The National Atmospheric Deposition Program (in the United States) has produced maps for many components found in atmospheric deposition throughout the United States from 1995 to 2009. Figure 29.1 shows the laboratory measured pH values for all areas across the United States, and the reduction of acidity and rise in pH is evident for this time period, and it is attributed to reduction of acid gasses such as SO<sub>x</sub> (both SO<sub>2</sub> and SO<sub>3</sub>, anhydrides of sulfurous acid and sulfuric acid, respectively) [19].

Water pH and composition affect what is often called the aggressiveness or corrosivity of water, and this means that we have to be able to assess this property, and to do this we employ the Langelier saturation index or SI. The Langelier saturation index is a means of evaluating water quality data to determine if the water has a tendency to form a chemical scale at one extreme or to cause the piping of the distribution system to actually erode or dissolve away at the inner walls. In order to use this index, the following laboratory analyses are needed: pH, total dissolved solids, alkalinity, and total hardness (usually [Ca<sup>2+</sup>]), and temperature is also needed. In manipulating the data, the actual pH of the water is compared to the theoretical pH (pH<sub>s</sub>) based on the chemical analysis. The saturation index = SI = pH – pH<sub>s</sub>. If pH<sub>s</sub> = pH<sub>actual</sub>, the water is said to be in balance and will not corrode piping nor will scale build up inside the pipe. On the other hand, if pH<sub>s</sub> < pH<sub>actual</sub>, the SI = a positive number, and water may form scale that is usually a carbonate residue, and this decreases the effective inner diameter of the piping, and if pH<sub>s</sub> > pH<sub>actual</sub>, then the SI = a negative value and the water is not at all scale forming, but rather it may be aggressive, dissolving the substrate of the piping itself. If copper or lead from solder joints is stripped from the inner substrate of the piping, a public health issue may prevail.



**FIGURE 29.1** pH values for atmospheric deposition for the years 1994 (a) and 2009 (b), measured in the laboratory after sample retrieval. (<http://nadp.sws.uiuc.edu/maplib/archive/NTN/>).



## 29.3 Criteria for Selection and Acquisition of a Water Supply

---

Municipalities and individuals need more water from time to time and must seek out a proper drinking water supply, which sounds simple but it most certainly always isn't. In a later section, a well water supply that was saved for emergency use during drought turned out to be subject to serious contamination and will be discussed. Of course the most important issues for a water manager are water availability and water quality. The supply may be on the earth's surface in the form of a river or lake or even a salty sea; it may be a groundwater supply near the surface or in a deep aquifer. Engineering studies will most assuredly be done to determine if the quantity of water will be worth the expense of developing the source, and laboratory work will determine its potability. Protection of watershed is another issue, certainly for surface supplies and hopefully also for groundwater supplies as well. It is important to determine how seasons will affect both water quantity and quality. For example, in the northern United States, sodium levels in water rise after winter deicing operations using rock salt (NaCl). An outbreak of cryptosporidiosis caused by the protozoan pathogen *C. parvum* in the Milwaukee (WI) population in 1993 was attributed by some researchers to runoff from agricultural lands entering the city's water supply intakes following a period of wet weather. Aerial photography can be used to identify potential problems such as junkyards where old cars are collected for their parts and for recycling as well as gasoline/petrol stations that may have leaky underground tanks that are not registered with the local government or other commercial or industrial operations that may use hazardous materials that may be inadvertently released into the local environment. Water resources that depend on a nearby river have to take into account various potential contamination sources upstream including roadways and railways on which cars and trucks can travel carrying hazardous materials that can escape into the river during an accident. In these cases redundancy may have to be built into water treatment facilities. It may be more prudent to collect water from the river or nearby well and store it temporarily in a tank or cistern at the front end of the treatment process. From there it can be treated by conventional methods. Should a possible issue such as gasoline truck accident occur in the vicinity, it may be easier to cease providing water by shutting a valve on a tank to the treatment train than to inject contaminated water directly into the distribution system. On August 6, 1988, in Brewster, Massachusetts, a small town on Cape Cod, a gasoline tanker overturned on busy Route 6 spilling approximately 5,000 gallons (approximately 20,000 L) of petrol into the ground causing the municipal water pumps to be shut down and the highway closed for days. In December 1977, a leak was discovered at a gasoline/petrol station in North Truro, Massachusetts, near the tip of Cape Cod, resulting in the release of between 2000 and 3000 gallons of petrol, causing the Provincetown wellfield (which was located in Truro) to be shut down and requiring that the abutting community find an alternate water supply. Falmouth, Massachusetts, also on Cape Cod, experienced a substantive groundwater pollution problem due to improper disposal of munitions and hazardous materials on the Massachusetts Military Reservation over the past century, threatening town wells. Certainly, hundreds more of these kinds of instances could be described here, but these few are mentioned only to demonstrate how water supplies thought to be in well-protected landscapes could be suddenly put at risk or, worse, lost. In other words, no matter how well defined the source water may be at the time it is put into use as a water supply, unforeseen circumstances can render that source at risk.

## 29.4 Sources of Potable Water and Associated Quality Issues

---

While over 75% of the earth's surface is covered in water, two billion people worldwide reside in water-stressed countries, defined areas in which human activity is constrained by the scarcity of water resources. Unfortunately, freshwater accounts for a mere 3% of the global water supply, and most of this is locked up in glaciers and ice caps. Drinking water or potable water sources as discussed previously include surface and subsurface supplies. Surface waters, which make up only 0.3% of the world's total water in industrial countries, have for the most part been fully developed and exploited. Cities near large lakes and rivers extract those waters and subject them to treatment. Large reservoirs have been

built to store water when it is available for those times when it is needed. The strategy for surface water supply protection in the northeastern United States in the past was to identify and exploit well-protected upland sources, and this was done in many cases by the public officials developing and overseeing our water supplies a century or more ago. At the time of their development, large tracts of inexpensive land were also acquired around the water sources to provide protection; however, communities have been built in those surface reservoir areas and human encroachment is now widespread. As a result, water supplies have been threatened by casual inadvertent spillage with resulting contamination of that water and in some cases with the need to take those sources off-line for various amounts of time. Very large water sources such as the Colorado River have been totally utilized. Government projects in the American southwest now can store a 3 year supply of freshwater behind a series of dams allowing water to be provided to users in times of drought and during periods of low river flow once the spring runoff from the Rocky Mountain snowpack ends by midsummer. By treaty Mexico receives 10% of Colorado River water, and there it too is utilized to its fullest extent and only rarely does any flow into the Gulf of Cortez. Rivers running across international boundaries such as the Mekong in Southeast Asia present serious diplomatic issues and can be the source of conflict between nations. Surface waters are considered the most vulnerable to contamination since they receive runoff directly from agricultural lands as well as the storm water runoff from roadways, parking lots, and rooftops of nearby cities and towns and from industrial and wastewater treatment plant discharges. Agricultural runoff often is rich in pathogenic organisms and nutrients such as nitrate ions, which pose threats to human health. Groundwater on the other hand is usually considered safer since sand, clays, and gravels that make up aquifers serve to filter water percolating or moving both vertically and horizontally through the subsurface. Problems do of course occur in the subsurface, and there are many instances of excessive arsenic of a magnitude that it poses a public health significance in countries considered both rich and poor. Also, as discussed elsewhere in this review, the subsurface is not free of trouble when hazardous materials are inadvertently or intentionally discharged on the land surface and then allowed to percolate into nearby aquifers. New technologies even allow the oceans and seas of the world to serve as drinking water sources. Energy-intensive reverse osmosis (RO) of saline waters will provide about 38 billion m<sup>3</sup> of potable water by the year 2016 [9].

## 29.5 Contaminants in Potable Water

---

### 29.5.1 Why We Worry about Water Quality

The purpose of most of the chapters is to provide in-depth insights to mechanisms of finding water, getting it to a user, treating it if necessary, and protecting it from degradation. This chapter deals of course with water quality issues. Certainly we, like our predecessors, are concerned over the aesthetic nature of what we personally consume. The aesthetics of our drinking water, its appearance and palatability, is important to us personally, but we know that water potability—meaning its safety in terms of our own health—is also very important. Edward Abbey, noted American essayist, novelist, and activist who dealt with the most basic of environmental issues, related in *Desert Solitaire* how to determine the potability of water in the desert southwest (primarily in Utah, United States) by noting the presence of living things such as insect larvae or other living animals (this author has seen tadpoles, immature frogs, in the waters of Capitol Reef National Park in Utah). If those animal species could live in the water, then we humans could drink it—hopefully after treating it to remove pathogens. What he was telling us was that such water probably contained nothing poisonous like arsenic, often found in springs in the Utah desert. In *Desert Solitaire*, he mentions that there are only two spring-fed creeks flowing in the Arches National Park area, one too salty and the other too poisonous for humans to use. We do indeed have much to worry about when we drink our required gallon (about 4 L) of water each day. This chapter will try to summarize those natural and unnatural substance we often find in water that we must control in order to make our water potable, that is, safe for human consumption. Worldwide, polluted water

affects the health of 1.2 billion people every year and contributes to the death of 15 million children under 5 every year. There are several kinds of contaminants that have to be considered as well as ways to remove or in some cases change them to make them less harmful, if at all possible. First, inorganic substances pose important health issues. Suspended matter is often an issue of aesthetics, making water very visibly unattractive, and in some cases the small particles themselves may prove to protect pathogens integrated or adsorbed within them or to serve as surfaces to which toxic material can adsorb. Other inorganic constituents include a wide array of heavy metals found as cationic species, including anionic arsenic species, as noted by Abbey previously. Organic constituents found in water suitable for drinking include a very wide variety of compounds classified as natural, usually harmless decomposition products of vegetation commonly found in a river or stream or in water entering the groundwater aquifer that can be tapped for use as shallow or deep wells. However, hundreds and possibly thousands of what are called anthropogenic (meaning “man-made”) organics from industrial, agricultural, and even domestic sources are also found in water. Some compounds are even produced when a disinfectant used to kill pathogens from a water source reacts with the naturally occurring organics forming compounds of special public health concern. Very important in considering the safety of a water supply is the pathogen content. Pathogens are grouped into various categories, for example, bacteria, viruses, fungi and yeasts, protozoans, and even some nematodes (roundworms). Also present are many harmless biological entities of those same categories. It is important that before water is consumed by humans that it be analyzed for those potentially harmful entities, but this is not always either possible or desirable even by those who will consume the water. These assays are expensive requiring in many cases very sophisticated technologies. And even if analyses are performed and problems found, there may be few or even no other water sources that could substitute for the one at hand.

### 29.5.2 Pathogens

Most of the effort and expense for water treatment is directed at killing or inactivating pathogens and these include a myriad of microorganisms and viruses. Waterborne pathogens are mostly organisms and viruses that are spread via the fecal–oral route causing diarrheal diseases and severe dehydration of an infected individual and are most serious when contracted by children. Infected individuals are prone to use poor sanitary practices, which lead to the spread of the disease to others. Commonly employed water treatment technologies can reduce the numbers of pathogenic bacteria and viruses in drinking water significantly; however, eukaryotic single-cell pathogens such as *G. lamblia* cysts and *C. parvum* oocytes need more sophisticated methods to realize a complete kill. Surprisingly we do not routinely test for any bacterial, viral, or protozoan pathogens in the water we treat or drink. Such testing is expensive and takes quite a bit of time. Rather, we have selected a few organisms that we are confident will be present in fecal matter, and if they are in source or treated water, then we are also confident that such water might harbor real pathogens. An accepted surrogate for fecal-derived pathogens in water is the bacterium *Escherichia coli* and other organisms having very similar biochemistries, which we call the coliform group. It is true that many organisms that are termed “coliforms” are not derived from fecal matter but are present in the natural environment and are associated with decaying vegetation. However, our tests that we use to find these organisms are based on the presumption that their presence in water may be due to the presence of real fecal matter and that those charged with community public health are expected to error on the side of safety over convenience [17].

### 29.5.3 Sediment and Turbidity

Sediment refers to the presence of particulate matter in water and turbidity is a measure of the clarity or if present the cloudiness of water. Turbidity in water can be due to several environmental factors: (1) runoff from the land, especially from agricultural lands being farmed; (2) algae growing naturally in a body of water; (3) industrial discharges and discharges from municipal wastewater treatment plants;

(4) high iron concentrations that form a rust-colored water; and (5) certain decomposition products of plants such as humic acids. A measure of turbidity is used to indicate water quality and filtration effectiveness (e.g., whether disease-causing organisms are present). Higher turbidity levels are often associated with the potential for the water to carry higher levels of disease-causing microorganisms such as viruses, parasites, and some bacteria. Sediment can protect adsorbed bacteria and viruses from disinfection by hiding pathogens within the structure of the sediment particles, allowing them to be eventually ingested by consumers. Sediment can even react with those same disinfectants reducing their concentrations to levels that will be inadequate to protect the water from pathogens that would have been normally inactivated by the disinfectant chemicals.

Turbidity is quantifiable since it is a principal physical characteristic of water because the particulate matter will cause light to be scattered and absorbed rather than be transmitted in straight lines through a water sample. The technology used to quantify turbidity uses the nephelometric, turbidimeter, or nephelometer (from the Greek word *nephelè*, meaning clouds or cloudiness in this case), which determines turbidity by the light scattered at an angle of 90° from an incident beam and has been adopted by *Standard Methods* as the preferred means for measuring turbidity because of its sensitivity, precision (reproducibility), and applicability over a wide range of particle size and concentration and is stated in terms of nephelometric turbidity units or NTU. Removal of turbidity from drinking water has been shown to correlate with pathogen removal [13]. Handheld commercial turbidity meters cost in the vicinity of \$1000. It is common to install a continuous monitoring turbidimeter at the entry to drinking water distribution systems should a reference be needed for any particular hour or day of any week.

#### 29.5.4 Dissolved Matter: Salt (NaCl) and Total Dissolved Ions

Note that the term used here is “constituents” and not “contaminants.” That is because contaminant refers to the introduction of constituents through human action of some kind. Salt or sodium chloride, that is, NaCl, is a natural constituent of almost every water source and is a very soluble component of native rocks and soils. As water percolates over rock faces or through the soils of the subsurface, salt naturally is released and dissolves in the water as sodium cations (Na<sup>+</sup>) and chloride (Cl<sup>-</sup>) anions. Rocks, even those of granitic origins, are slowly, over millennia, decomposed by symbiotic lichens on their surfaces liberating a variety of salts, many of which are used by nearby plants for some of the nutrients required for their growth. During such decomposition, many metallic elements are liberally released and, if soluble, can enter nearby water sources. Salt in drinking water is also derived from natural salt deposits, seawater infiltration into aquifers, as well as infiltration of sewage and industrial wastes, agricultural chemicals applied to fields and in areas of the temperate world salt applied to roads for deicing purposes, and salt storage facilities for road salt. Private and municipal wells located along major interstate highways are often impacted by road salt that can exceed 240 pounds of salt (108.7 kg) per lane mile during a snow or ice storm. Although Boston, Massachusetts, obtains its potable water supply from distant well-protected upland reservoirs, there are several surface reservoirs in the greater Boston area that serve smaller communities, and with the density of the population and major highways that have been built around the city, the smaller surface supplies are seriously impacted by winter salt use. Concern over salt is based not only on taste but on its effect on cardiac health. We can taste salt concentrations above around 0.015 M (876 mg/L NaCl or 532 mg/L Cl ion) in water [4], but health professionals and many governmental regulatory bodies suggest (usually not require) that we drink water that tests under 20 mg/L NaCl, a level too often unable to be met. Only 1%–2% of the 4000–6000 mg that we ingest daily is actually derived from drinking water. The value of 20 mg/L is actually derived from the fact that some individuals on salt-restricted diets should only ingest 500–1000 mg/day of sodium, and this allows them no more than 40 total mg from their drinking water. Adding insult to injury is the fact that several water treatment technologies add salt to drinking water especially if sodium fluoride is employed to ward off tooth decay in children served

by that water supply and in the use of sodium hypochlorite as a disinfectant when the use of chlorine gas is for one reason or another not feasible. Even water-softening devices add sodium, which is used to replace magnesium and calcium ions that are constituents that give water a hardness factor (by making it hard for soap to clean clothes). Many states in the United States that use deicing salts on their roadways during winter months have reduced the amount used per lane mile, and some states now substitute calcium or magnesium chloride, but the latter does crystallize in a way on a windshield from the melted snow or ice spray while driving on the highway that can impede vision of the road ahead (author's observation). Salt storage piles on department of public works yards are now covered to protect them from rain and snow; although when salt is mixed into sand, which is also applied to roadways, these piles of sand/salt mixtures are often left uncovered (author's personal observations). The state of New Hampshire, in fact, has replaced a number of road salt-contaminated private wells found to have salt levels that exceeded 250 mg/L and where highway desalting impact has been proven. In other communities it was found to be less expensive to connect impacted residences to nearby municipal drinking water distribution systems and remove them from their private wells. RO technology is the only practical way to remove or reduce salt dissolved in water, and residential units can be quite costly, yet the technology is scalable, and large municipal operations are common and can be used for the desalination of seawater. The technology involves the application of high pressure on one side of a device holding a membrane, causing mainly water molecules and some sodium and chloride ions to permeate the membrane, retaining most of the salt and for that matter most every other particle on the high-pressure side. One problem with RO however is that the water from the higher-pressure side of the membrane is usually very high in salt concentration and must be disposed of locally, usually in a sanitary sewer or septic system on the property or in some cases allowed to evaporate in surface ponds. Even small household systems that produce from 10 to 50 L of potable water a day produce a fair amount, up to 10 times the volume of useful water, of effluent that has to be disposed of. For large municipal RO systems, deep well injection may be favorable, and for seawater desalination, of course direct discharge back into the sea is the way to minimize costs. Electrical power consumption for water carrying a salt load of between 600 and 700 mg/L would require around 1.4 kWh/1000 gal or 0.37 kWh/1000 L. Desalination of 35,000 mg/L dissolved solids seawater requires perhaps 7–10 times this amount of energy per unit of potable water produced [2]. Membrane replacements also have to be considered since membrane fouling may at times occur and small household units may incur annual costs of between \$100 and \$200.

Salt levels of rivers used extensively for agriculture are found to increase as fertilizers dissolve into irrigation waters and as water evaporates naturally on the way to the sea. Although measuring the concentration of NaCl in water can be done, it is usually inferred using a simple electronic device known as a conductivity meter rather than carrying out wet chemical analyses. Chloride anions can of course be determined by titration using a standard silver nitrate solution and potassium chromate indicator, which gives a red-colored silver chromate precipitate as soon as all of the chloride is consumed by the silver ions forming insoluble AgCl, the so-called end point of the titration. Chloride-specific ion electrodes are also available but are subject to interferences and are used in conjunction with a standard pH meter. Sodium ions can be determined analytically using a selective sodium ion electrode coupled to a standard pH meter. It is true that the electrode does not measure concentration but activity of the ion, which is defined as 1 at infinite dilution. Usually salt and the term total dissolved ions (TDI) are used synonymously since in most cases (but not always) TDI is mostly salt (NaCl), and since ions can carry current, one usually measures TDI using a conductivity meter. The basic unit is called an inverse-ohm/cm or mho/cm also called 1 siemen (Si). Normally we work with values of one thousandth (milli-) or one millionths (micro-) of it for natural waters (1000 millimhos and 1,000,000 micromhos). Good potable water and freshwater streams have conductivities between 20 and 1500  $\mu$ Si. A solution of 0.01 M (584 mg/L) NaCl would produce a reading of 1156  $\mu$ Si/cm. Commercial meters for accurate measurements are available for around \$350, but much cheaper less accurate units can be purchased for around \$60.

## 29.5.5 Heavy Metals in Potable Water

Plating operations in industrialized nations in the past have liberated huge quantities of chromium, silver, and copper, and other processes have liberated mercury much of which can now be found in the sediments of the rivers and lakes into which they were discharged, even accumulating in benthic sediments offshore as the rivers deliver their bounty to the seas.

Naturally occurring arsenic is found worldwide in two predominant forms in water, as the more toxic arsenite anion ( $\text{AsO}_3^{-3}$ ) and the less toxic arsenate anion ( $\text{AsO}_4^{-3}$ ). In Massachusetts, Reitzel [21] identified arsenic in deep rock wells, and although the origin of that arsenic was originally thought to be the result of arsenic from nonnatural sources leaching into the well water, only recently has the US Geological Survey provided evidence that the arsenic source is in fact the natural bedrock in an area that bisects the state via a fault that runs north–south through the state. The US Environmental Protection Agency (USEPA) has recently reduced the maximal contaminant level or MCL from 50 to 10  $\mu\text{g}/\text{L}$ . Of special concern is that arsenic is known to cause a variety of serious diseases including several kinds of cancer, and even at the lower MCL it is thought to possibly contribute to an increased cancer incidence, but it is not sensible to legislate a level of “0,” which would be impossible for many water utilities to meet. Many Third World countries also are plagued by groundwater arsenic including Bangladesh where perhaps as many as 20% of its population is threatened by high levels of this metal. The need for expensive treatment technologies as well as the expense of analytical testing for the metal makes those remediation methods difficult to implement in developing countries. Bangladesh also has the problem of the bioconcentration of arsenic, which in groundwater is used for irrigation. The arsenate anion is often mistaken for phosphate by the transport systems of roots, and in fact the arsenate in irrigation water becomes part of the crop, which is then consumed by humans who then integrate the anion into their body tissues putting them at increased risk for its adverse health effects [16].

## 29.6 Municipal Water Treatment

---

### 29.6.1 General Issues

No drinking water source should be assumed to be completely safe, especially those that serve large numbers of people, which we term public drinking water systems, and these systems use various methods of water treatment to provide safe drinking water for their communities. Generally, a municipal water treatment plant employs several processes in series beginning with coagulation and flocculation of the incoming raw water using alum or ferric chloride to form a precipitate, followed by sedimentation to remove the floc and any other incoming particulate matter. Coagulants are relatively inexpensive cationic salts that react with negatively charged particles forming larger particles called floc, which can be more easily removed when this water mass is passed through a sand, gravel, or charcoal filter. Bacterial populations are usually reduced by around 90% using this form of technology, and it is a proven method for removal of the human pathogen protists *C. parvum* and *G. lamblia*, and even arsenic can be removed to below its maximum contaminant level of 10  $\mu\text{g}/\text{L}$ . *C. parvum* is an intracellular parasite that infects cells of the bowel, and the pathogenicity of *G. lamblia* occurs because this organism that also infects the bowel does so by attaching to the outside of cells preventing water reabsorption. Some water sources prove difficult to manage by more traditional technologies and require state-of-the-art filtration technologies such as membrane microfiltration, RO, and adsorption. Filtered water is then passed into a large tank where a chemical disinfectant is added. After a period of time (known as the contact period) to insure that the chemicals have inactivated pathogens, the water is released into the distribution system for delivery to the consumers. Disinfection kills or inactivates viruses and bacteria that are potentially harmful, but the process is not designed to provide sterile water and some bacteria can escape unharmed. Typical disinfectants are gaseous chlorine ( $\text{Cl}_2$ ), calcium or sodium hypochlorite ( $\text{CaOCl}_2$  and  $\text{NaOCl}$ , respectively), and

ozone (O<sub>3</sub>), which must be produced on-site (*in situ*) using electrical discharge in a pure oxygen environment, but other disinfectant chemicals may be chosen for specific reasons. The USEPA's Public Drinking Water Systems web page (<http://water.epa.gov/drink/>) discusses water treatment strategies and lists the 90+ contaminants EPA regulates and why (<http://water.epa.gov/drink/contaminants/index.cfm>). Somewhat controversial is the use of sodium fluoride in drinking water to prevent tooth decay in children, which introduces not only fluoride but some sodium into drinking water as it leaves the treatment plant. Fluorosis or the mottling of teeth is often noted in children taking in excessive amounts of fluoride. The recommended level of total fluoride is 1 mg/L.

### 29.6.2 Coagulation and Filtration

Coagulation using alum and ferric chloride is used effectively for the reduction or removal of turbidity, organic matter, color, and even arsenic. Alum (Al<sub>2</sub>[SO<sub>4</sub>]<sub>3</sub>·18H<sub>2</sub>O) and ferric chloride (FeCl<sub>3</sub>) are two examples of chemicals, which when added to raw drinking water form the precipitates aluminum hydroxide (Al[OH]<sub>3</sub>) and ferric hydroxide (Fe[OH]<sub>3</sub>), respectively. After formation, the hydroxides react with negatively charged colloidal material in the water forming a floc, which is removed by rapid sand or gravel filtration. The precipitates are prevented from travelling through the filter and accumulate on the surface, and at some point the precipitates must be removed from the top of the filter by reversing the flow of water (backwashing), and the resulting slurry of water and precipitates must be disposed of in a municipal sewer system. Alternative chemicals include the inorganic polymer aluminum chlorohydrate and even diatomaceous earth as a filter aid.

### 29.6.3 Water Disinfection

Filtered water is then subject to chemical disinfection using chlorine gas (mostly in North America) and ozone (mostly in Europe). The effectiveness of a disinfectant is quantified by its ability to inactivate a population of bacteria by a factor of 10 (90% reduction in number) in a certain period of time, and this is called the log inactivation, defined as

$$\text{Log inactivation} = \text{Log} \frac{N_0}{N_t} \quad (29.1)$$

where

$N_0$  is the initial (influent) concentration of viable microorganisms (actually quantified as colonies growing on a specific medium under certain growth conditions) in raw water

$N_t$  is the concentration of surviving microorganisms, and log is to base 10

#### 29.6.3.1 Chlorine and Hypochlorite

Chlorine gas has been used as a disinfectant for decades. It has the benefit of inactivating pathogens and providing what is called a "residual" as water travels through the pipes to the consumers at the very end of the distribution system. Residual chlorine is important should pathogens survive the initial burst of chemical at the chlorinator or if pathogens are introduced inadvertently within the system via a temporary cross-connection. Pathogens could survive the initial high concentration of chlorine, for example, if they were integrated in sediment that escaped filtration and some communities only rely on chlorination and do not filter raw water. Chlorine does react with a variety of natural chemicals found in raw water including organic matter and free ammonia and amines. This loss of chlorine is called *chlorine demand*, which removes chlorine that would have been the disinfectant, and as a result additional chlorine must be added to make up for this loss. Reaction of chlorine with organic matter forms trihalomethanes, thought to be carcinogens, and therefore it is necessary to balance the total chlorine added

with THM produced. The active species for chlorine disinfection is free hypochlorous acid (HOCl) formed when chlorine gas reacts with water:



and HClO is a stronger oxidant than chlorine gas or the anion of HOCl, hypochlorite ( $\text{OCl}^-$ ) under standard conditions with an  $E^\circ = +1.63$  V. Hypochlorous acid is a weak acid with a  $\text{pK}_a$  of 7.5 at  $20^\circ\text{C}$  thus when the  $\text{pH} = \text{pK}_a$  50% of the acid is in the free acid while the other half is in the anion hypochlorite form. A lower pH, such as a pH of 6.5 would result in 90% free hypochlorous acid and 10% the disinfectant of lesser capability, the hypochlorite anion. The mode of action of chlorine was contentious until 1981 when it was reported that cellular inactivation precedes the loss of respiration in bacterial cells capable of respiring, which failed to divide after exposure to HOCl [1]. It is important to note that cell inactivation is dependent upon many factors including the presence of organic chemicals and various types of sediment in the water, which can react quickly with and thus deplete the HOCl concentration, the temperature of the water, the pH, and the time in which the bacteria are in the presence of HOCl, also called the contact time. Reducing the pathogen population by 90% at a particular concentration of disinfectant in mg/L (a factor of 10) multiplied by the contact time (in minutes) needed for such inactivation is called the CT value (concentration X time in minutes). Table 29.1 shows the CT values for the indicator organism *E. coli* and for cysts of the enteric pathogen *G. lamblia* and viruses using four different disinfectants at  $5^\circ$  and  $20^\circ$ .

Chloramine is produced when  $\text{Cl}_2$  reacts with ammonia ( $\text{NH}_3$ ) in water to produce monochloramine ( $\text{NH}_2\text{Cl}$ ), which as seen in Table 29.1 is really a poor disinfectant for any of the organisms listed. On the other hand, chlorine dioxide ( $\text{ClO}_2$ ) and ozone ( $\text{O}_3$ ) have excellent disinfection capability. Most people today think that ammonia addition to produce chloramines in drinking water was done to provide a residual (the chloramine molecule) for disinfection of inadvertent entry of pathogens in the distribution systems such as those caused by cross-connections. However, chloramines really had nothing to do with disinfection but with aesthetics. When chlorine was added to water entering a distribution system in the early 1900s, the disinfectant reacted rapidly with any phenols, chemicals that were rampantly discharged as wastes from industrial processes that were indeed present. Ammonia addition at the intakes forms chloramines rather than chlorophenols, which present medicinal tastes to the water and in the past resulted in complaints by consumers.

**TABLE 29.1** Comparison of CT Values for 90% Inactivation of Microorganisms at  $5^\circ\text{C}$  and  $20^\circ\text{C}$

Organism	Free Chlorine ( $\text{Cl}_2$ ) (pH 6–7)	Chloramines ( $\text{NH}_2\text{Cl}$ ) (pH 8–9)	Chlorine Dioxide ( $\text{ClO}_2$ ) (pH 6–7)	Ozone ( $\text{O}_3$ ) (pH 6–7)
<i>E. coli</i> bacteria	0.034–0.05	95–180	0.4–0.75	0.02
Viruses	2.0 at $5^\circ$	857 at $5^\circ$	2.8 at $5^\circ$	0.3 at $5^\circ$
	1.0 at $20^\circ$	321 at $20^\circ$	1.0 at $20^\circ$	0.125 at $20^\circ$
<i>G. lamblia</i> cysts	35–50 at $5^\circ$	1470 at $5^\circ$	17 at $5^\circ$	0.62 at $5^\circ$
	15–21 at $20^\circ$	735 at $20^\circ$	10 at $20^\circ$	0.24 at $20^\circ$

Source: [http://www.hc-sc.gc.ca/ewh-semt/pubs/water-eau/escherichia\\_coli/treatment-traitement-eng.php](http://www.hc-sc.gc.ca/ewh-semt/pubs/water-eau/escherichia_coli/treatment-traitement-eng.php).

Note: *Guidance Manual for Compliance with the Filtration and Disinfection Requirements for Public Water Sources* [25] and Health Canada Guidelines for Canadian Drinking Water Quality: Guideline Technical Document. *E. coli*. Federal-Provincial-Territorial Committee on Drinking Water of the Federal-Provincial-Territorial Committee on Health and the Environment Health Canada Ottawa, Ontario, February 2006. CT = concentration of disinfectant in mg/L multiplied by time in minutes required for one log (90%) inactivation.



Addition of ammonia with the formation of chloramines reduced such complaints but resulted in water of questionable public health safety [17]. Chlorine dioxide can be produced *in situ* by the reaction of sodium chlorite and chlorine forming the gas  $\text{ClO}_2$ . This disinfectant has a number of disadvantages, especially its cost, which is from 5 to 10 times that for chlorine gas, and ozone is still better for recalcitrant pathogens like giardia cysts as seen in Table 29.1.

### 29.6.3.2 Ozone

Ozone must also be generated on-site and involves the discharge of a high voltage between two electrodes in an atmosphere of pure oxygen. The  $\text{O}_2$  molecule dissociates under those conditions and the resulting atomic oxygen (O) reacts with other oxygen molecules forming ozone ( $\text{O}_3$ ). Ozone serves as an excellent disinfectant as shown in Table 29.2, but its cost is 2–3 times that for chlorine gas, and it leaves no residual in the distribution system as its lifetime is short. Chlorine still must be added subsequently to provide that residual disinfectant. An ozone/chlorine combination is used widely in Europe but only rarely in the United States. One notable exception in the United States is the Massachusetts Water Resources Authority, which began disinfection using ozone at its treatment plant located 25 km from downtown Boston in 2005, adding chloramine for residual protection. In this case, treated water travels a long distance through an underground tunnel before reaching the city center, and although the CT for chloramines is large, so is the time needed to deliver water to the 2.2 million residents in 44 cities and towns that form the authority.

### 29.6.3.3 Ultraviolet Light

Ultraviolet (UV) light has been used for disinfection for industrial purposes for decades. High-quality water used in the electronics, medical, and biotechnology sectors usually places a UV device at the back end of their processes to insure that there is minimal likelihood of survival of any pathogen that will be used in product manufacture. UV light kills organisms by causing a reaction of adjacent thymine bases on the organism's DNA (its genome) forming what is known as thymine–thymine dimers. If enough of these dimers form in the DNA, the molecule cannot replicate and neither then can the organism. UV lamps need a quartz window since glass absorbs light of those wavelengths and works by high-voltage ionization of mercury atoms in the vapor inside the bulb, which emit UV light when the electrons return to their ground state. The use of UV for inactivation of both giardia and cryptosporidium spp. will be an important technology for New Yorkers once the system installed on the new Croton Aqueduct [24,25] is in operation. On a more personal scale, it is common for visitors from the United States who visit, study, and work in countries that cannot provide safe drinking water to their population often use the new commercial battery-operated UV water purifiers to provide safer drinking water for themselves and their families and colleagues (as per the author's discussions with scientist-colleagues who regularly visit Brazil).

**TABLE 29.2** Disinfection By-Products Regulated by the USEPA

Disinfectant By-Product	Causes	Maximum Contaminant Level
Trihalomethanes—chloroform, bromodichloromethane, dibromochloromethane, and bromoform	Reactions of chlorine with organic matter in source water	80 $\mu\text{g/L}$
Haloacetic acids—monochloroacetic acid, dichloroacetic acid, trichloroacetic acid, monobromoacetic acid, and dibromoacetic acid	Reactions of chlorine with organic and inorganic matter in source water	60 $\mu\text{g/L}$
Bromates	Reactions of ozone with bromides in source water	10 $\mu\text{g/L}$
Chlorite	Reaction of $\text{ClO}_2$	1 $\mu\text{g/L}$

Source: [http://www.epa.gov/enviro/html/icr/gloss\\_dbp.html](http://www.epa.gov/enviro/html/icr/gloss_dbp.html).

### 29.6.3.4 Disinfection By-Products

When certain disinfectants react with bromide or natural organic matter (i.e., decaying vegetation) present in the source water, harmful by-products can be formed. Disinfection by-products that are regulated by the USEPA include trihalomethanes, haloacetic acids, bromate, and chlorite. Table 29.2 lists the four classes of disinfection by-products and how they are formed at the USEPA maximum contaminant levels that are permitted.

Another parasite of great concern is the enteric parasite *C. parvum*, a pathogen that infects the cells of the lumen of the bowel and is present in most cattle herds, especially in the newborn calf population and in humans causes serious diarrhea and dehydration. This pathogen was associated with a serious public health emergency in Milwaukee (WI) in 1993, where Lake Michigan serves as source water. Thousands of residents most likely contracted the disease and many theories for the outbreak have been offered, but none has been confirmed. In a laboratory study challenging mice with 10,000 oocytes of *C. parvum*, Peeters et al. [20] showed that ozone at 1.11 mg ozone/L was required to inactivate all oocytes in a contact period of six min but 0.4 mg/L ClO<sub>2</sub> per liter reduced but did not inactivate all oocytes. Chlorine is not considered a suitable method for disinfection of *C. parvum* in drinking water source water. Those who are immunologically compromised have difficulty fighting an infection.

How do we know that water directed to consumers is free of pathogens? It is difficult to actually test for the presence of viable viruses and protozoans such as giardia or cryptosporidium species. For this reason it is customary to use an indicator of the presence of pathogens and the bacterium *E. coli*, present in most warm-blooded animals, has been chosen to serve in this capacity. In the early 1900s, the presence of this bacterium in water was determined in a cumbersome laboratory test known as the most probable number test, which measured gas produced in a test tube when a volume of water was added to a fermentation broth that supported the growth of *E. coli* and the evolution of gas as a metabolic product. A simpler method was developed that used a specific medium originally developed in 1904 but improved at the Lawrence Experiment Station in Lawrence, Massachusetts (United States), for the group of lactose-fermenting bacteria that we call “coliforms,” which have their origin in both the gut tract of warm-blooded animals and in decaying organic matter. The bacteriological medium became known as mEndo-LES, and coliforms are identified after overnight incubation by a green metallic sheen on colony surfaces, the result of small crystals of basic fuchsin forming on those surfaces. The USEPA redefined the medium in 2002 and called the new test “Method 1604” [26]. This method utilizes two chromogenic dyes to identify total coliforms and especially *E. coli* in the sample. In the new method, a 100 mL sample of aseptically collected water is passed through a 0.45 μm membrane filter, and the filter transferred to a suitable culture dish to which was added 5 mL of the growth medium and incubated at 35° for 24 h. Total coliforms are viewed under UV light (366 nm), and *E. coli* colonies appear blue under room light. In the United States, the EPA has developed the standard for *E. coli*, and coliforms found as “0” and if found the same sampling site must be retested. No more than 5% of all samples tested must have evidence of these organisms, which is clear evidence that these viable organisms have survived disinfection.

The consumer of the water provided by the municipality should feel confident that he or she is obtaining a safe and aesthetically appealing product so it is imperative for the water manager to maintain vigilance over the entire system, testing both source water and water from sampling sites within the distribution system for various parameters that are reliable indicators of water quality. Should the community begin to experience some form of enteric disease outbreak as recorded in medical facilities and clinics, the water manager working with local public health personnel should try to seek answers that may implicate or hopefully demonstrate that drinking water is not at fault.

### 29.6.4 Special Case for Developing Countries

Special attention must be paid to drinking water available to households in the developing world since well-protected supplies coupled with efficient distribution systems employing adequate water treatment to insure safe water for consumers are often not possible. In the developing world, unsafe drinking

**TABLE 29.3** Household (Point-of-Use) Water Treatment and Storage Options for Developing Countries

Method of Water Treatment	Log Bacterial Reduction	Cost per Annum per Person	Comments
Free chlorine (hypochlorite)	3	\$0.66	Cost and availability issues.
Combined free chlorine and coagulation (alum)	7	\$4.95	Cost and availability issues.
SODIS	3	\$0.63	Efficacy dependent on many factors such as oxygenation, time allowed for treatment and use of non-SODIS water.
Porous ceramic filter	2	\$3.03	Products are variable as to pore size, tortuosity of channels, and chemical treatment (Ag impregnation).
Slow biosand filter	1	\$60 (one time cost)	High compliance requires maintenance, posttreatment disinfection recommended.

Source: Sobsey, M.D. et al., *Environ. Sci. Technol.*, 42, 4261, 2008; UNICEF, Promotion of household water treatment and safe storage in UNICEF water programmes, [http://www.unicef.org/wash/files/Scaling\\_up\\_HWTS\\_Jan\\_25th\\_with\\_comments.pdf](http://www.unicef.org/wash/files/Scaling_up_HWTS_Jan_25th_with_comments.pdf), 2008. (Accessed June 20, 2012).

Note: All methods require a learning component by a trained educator.

water coupled with poor sanitation and hygiene contribute to perhaps as many as 4 billion cases of diarrheal disease annually, causing more than 1.5 million deaths, mostly among children under 5 years of age [29]. Still there are 1.1 billion people in the world without access to safe drinking water [30]. Circumstances often require members of a family to seek water from distant sources where its quality is usually not certain. This water must be returned to the home where it should be subject to some form of household water treatment and storage (HWTS) to insure its potability and safety. In fact, a recent study did indeed show that HWTS was effective in preventing diarrheal disease [6]. The same kinds of strategies used in the developed world on a large municipal scale to protect the safety of drinking water are also scalable downwards to the household level as shown in Table 29.3. Clasen [6] stated that the use of point-of-use household treatment was more effective than having to rely on improved wells and communal standpipes. Boiling of water is not recommended because fuel, usually wood, is already in short supply in many of these same areas of the world. Of course there are issues related to each of these methods that can compromise the method. For example, it is common to fail to leave bottles used for solar disinfection (SODIS) in the sunlight for a sufficient time, and each method requires an “in-service” training session by a trained educator. In most countries, households can rely on obtaining the initial hardware for their selected water treatment method as a donation or a subsidy from a governmental or nongovernmental organization (NGO).

Figure 29.2 is a schematic of a biosand (slow sand) filter to remove sediment and around 90% (1 log removal) of bacteria that are poured with water into the top of the device. The top 1–2 cm of biofilm takes around a month to develop once use is initiated, and the next 10 cm of the filter provides the active biological zone where incoming bacteria are removed by competition with other organisms on the biofilm that forms on the sand grains. Disinfection using SODIS or chlorination is still recommended since only one log removal is normal for this kind of system.

## 29.7 Case Studies: Potable Water Quality and Safety Issues in Eastern Massachusetts

### 29.7.1 Description of the System

This author has had the opportunity to directly witness a number of events and instances that could testify to the attitude that society in general had about its lack of concern for its potable water supplies during that period of history. One good reason that well-protected upland supplies were important

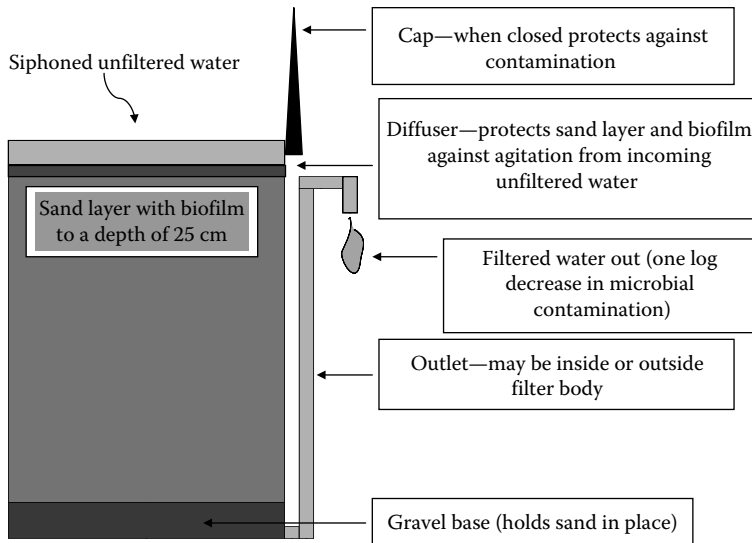


FIGURE 29.2 Schematic of a biosand (slow sand) filter.

in the eastern United States was that for decades industry required a free water supply for many of its functions, for water power certainly, but especially for disposal of liquid waste materials. In the city of Worcester (MA), the author joined with the city Departments of Public Health and Public Works and the City Manager's office to form the Water Quality Resource Study Group of the Worcester Consortium for Higher Education. The purpose of the study group was to tackle drinking water problems facing the city, which was served by several upland reservoirs and two wells in addition to a connection to a reservoir serving Greater Boston. Twenty-four million gallons (91 million liters) are provided on average daily to about 200,000 people delivered through almost 600 miles (780 km) of piping. Until a modern treatment plant was constructed during the 1990s, chlorination was the sole disinfection technology.

### 29.7.2 Infectious Hepatitis Outbreak

In 1969–1970, the city of Worcester experienced a serious outbreak of infectious hepatitis (hepatitis A), an enteric viral disease passed via the fecal–oral route. The outbreak made national news and was featured in *Life Magazine*, and the scientific findings were later reported in peer-reviewed publications [8,18]. Briefly, many members of the Holy Cross College football team (American football—not what in the United States is called soccer) experienced the disease due to a point source introduction of a sizable virus load when several seemingly unrelated situations occurred. That period of the late summer was very hot in the city, and children from a nearby multifamily home discovered that they could obtain relief from the heat by scaling a fence onto college property and bathing in the small pools created by the irrigation system in the practice field. It appears that some of the irrigation system valves were left slightly open to the city water distribution system. A fire in a retail property perhaps a km or two to the west was fought using water forced by pumper trucks capable of delivering 200,000 L of water per hour, but to do this, water must be drawn through the piping from all directions including the water in the standing pools on the Holy Cross college campus, which were inadvertently left open creating what is known as a “cross-connection.” It appears that one or more of the children using the pools had active hepatitis A, and instead of returning home to find relief, the child simply defecated near or in the pool. This highly polluted water was drawn into the distribution system of the college during the fire, and when the football team, tired and hot, entered a maintenance shed near the field to satisfy their thirst, they had no idea that they were consuming water that would sicken most of the team and effectively end

the football season for the college. A backflow preventer most likely would have prevented this kind of event. During that same year, the city of Worcester itself experienced an outbreak of the same disease, the incidence of which was shown to correlate not only with socioeconomic conditions of city inhabitants but with certain water and sewer system parameters [15], especially water system type (high- or low-pressure system) and water and sewer pipe ages.

### **29.7.3 Disinfection System Breakdown**

Another instance was an outbreak of diarrheal disease in Worcester that was traced to one of the wells that were put into service in the east side of the city during a period of drought. In this case the Coal Mine Brook well rated at 2.9 million gallons of water per day supplemented the 40 million gallons of water used daily for domestic, commercial, and industrial purposes. Many adult students taking a weekend photography course at a hotel served by this well became sickened, initially blaming the hotel's food preparation. However, further investigations showed that there was possible negligence by one city employee whose job was to ascertain that the liquid chlorine (as sodium hypochlorite) feed that was metered into the water pumped directly into the city distribution system was operating improperly. The disinfectant was contained in a tank and the tank was positioned onto a scale, and the employee was supposed to check to insure that the sodium hypochlorite was being metered out properly. Although he clearly noted in his mind that the pump had apparently malfunctioned as none of the hypochlorite solution had left the tank, he failed to report the incident at the time and as a result presumably contaminated water entered the distribution system. It was later found that nearby Coal Mine Brook was highly contaminated and that the distance between well and brook was insufficient to filter out harmful pathogens and the well was permanently taken off-line.

### **29.7.4 Threats against a Water Supply**

Water supply managers have to contend with constant surveillance of the water they provide to consumers (or customers) to insure safety and public health. Natural phenomena can create havoc such as when a lightning strike disabled a treatment process. Such an event did occur in Worcester, MA, but an audible alarm in the chlorinator minimized the time required to react to the problem and make repairs. However, from time to time human intervention can occur, such as a hazardous material or waste spill occurring in a watershed, especially if in proximity to the intake to a distribution system. What might happen should a credible threat be made against a surface water supply since most are somewhat accessible to illegal entry by a determined person?

Perhaps a minor example occurred on June 15, 2011, when a man was observed urinating in the Mt. Tabor reservoir in Portland, OR, forcing the city to discard the entire 7.8 million gallons of drinking water to waste, an amount valued at about \$36,000 including a \$7,000 disposal fee for the water. This event seems trivial and except for the psychological element of consuming water containing a trivial amount of urine, there was no scientific need to take such drastic actions. No one seems to have minded the presences of birds and animals in the vicinity of this distribution reservoir as it was left open to nature in general until the incident discussed previously.

However, some issues must be dealt with employing utmost urgency. In particular, one such incident that was quickly and quietly dealt with was one that today would be termed a case of "domestic terrorism." One evening in the mid-1970s, the Water Quality Resource Study Group received a phone call from the assistant director of the Worcester Department of Public Health, and he remarked that we needed to come up with a plan immediately to deal with a threat to an unnamed public water supply in Massachusetts. We were told that the Jackson Gang (actually known initially as the Sam Millville/Jonathan Jackson Gang, changing its name to the United Freedom Front, a very small leftist prison reform group) had dumped cyanide into a drinking water source, and our services were requested to aid the Health Department in the dealing with the matter immediately. The threat, allegedly by the Jackson

Gang, was taken seriously since it was their *modus operandi* to inform the public prior to carrying out an action, reducing the likelihood of civilian casualties. A bottle of potassium cyanide from the university chemical stock room was picked up and brought to the Worcester Public Health Laboratory. Once at the laboratory, a colleague at nearby Clark University known to be interested in environmental chemistry and who may have been able to help select an analytical procedure was called upon. Surprisingly, that colleague had just purchased a new cyanide analytical tool, an Orion cyanide electrode, which although not as able to give a sensitivity as good as that of the *Standard Methods* chemical procedure, it would provide us with the speed needed to get our set of assays done. Using the electrode was also not a method validated by any agency at the time for water analysis, but this was one of the special moments that demanded immediate action. After standardizing the electrode, which used a pH/millivolt meter, cyanide levels were measured in raw water samples taken by state and municipal public health personnel at the intakes of many of the central Massachusetts reservoirs. By the time all 22 samples were assayed at 2 AM, no cyanide had been found, and it was learned that the state environmental laboratory in Lawrence had not yet even begun to carry out their assays, and they had to resort to the standard chemical assay, which had a long preparation time since they did not yet possess a cyanide electrode. To the public's knowledge, there was never a positive assay that could be directed at any single surface supply, but Mr. Bernard Borci, the Public Health laboratory manager, who was very familiar with using cyanide in plating baths in the city, assured us that depending on how anyone might add a cyanide salt to cold reservoir water, it would take a rather long time for it even to dissolve. Fortunately, the event was noted only on an inside page of the local newspaper the following day. How a community might in fact react to such an event today is of course up for debate, but it is likely that a decision to minimize the possible consequences of such an event as was made then, by minimizing public attention of the issue would not be suitable today.

## 29.8 Water Quality and Climate Change

---

The climate of the world is changing. It has been doing so in one way or another since the last glacial maximum around 23,500 years ago, but there are indicators that it is changing faster now than anytime in current human history. A multitude of data all show temperature trends that are in the positive direction, and this phenomenon has been attributed to the accumulation of certain gasses emitted due to human activity. It is not the purpose of this chapter to explain these changes but to assess the impact temperature rise will have on water quality and public health and safety associated with climate change. Foster and Rahmstorf [12] examined five prominent time series of global temperature for the period 1979–2010, and all showed a temperature anomaly of from 0.141°C/decade to 0.175°C/decade. No one really knows how climate change will affect drinking water security, but several studies point to those issues water managers will have to consider in the coming decades. The most vulnerable people are those living in the developing world where access to safe drinking water and proper sanitation are important issues. A water-stressed region is one where precipitation runoff has been determined to be less than 1000 m<sup>3</sup> per person per year, and in 1995 it was estimated these areas were home to a population of 1.4 billion [7]. Climate change may change the patterns of human immigration with cities such as Delhi (India) facing population increase that will bring the census to as many as 30 million and even today water must be imported from as far away as 300 km to satisfy needs of the people. Computational models attempt to predict how climate change will affect precipitation patterns across large areas including continents, but none of these has yet been tested or can be. One-sixth of the Earth's population lives in areas dependent on meltwater from mountain glaciers and snowpack, and there is evidence that glacial retreats are in progress and that highest flow rates in catchments are in fact arriving earlier in the year as temperatures in the spring rise a little earlier than they once did exacerbating dry season water availability [5]. Since we have based our water security planning activities on the historic record of drought and precipitation, water managers must now try at least to plan for the unexpected brought about by climate change. Computational models based on past climate records help somewhat, but these models must be

improved and new data sets as they are generated year by year used to fortify their results and providing a better look into the future. Although the developed world has learned how to exploit virtually any water resource, there is still hope for many countries of the developing world since many resources are still untapped. For example, only 4% of Africa's groundwater resources are in current use, and the availability of engineering and hydrology competent human resources will be of great benefit. It also may be wise to consider novel water storage technologies such as aquifer recharge when excess water is already or if it becomes available. In Pima County, Arizona, some of the water delivered from the Colorado River 500 km away via an aqueduct known as the Central Arizona Project is allowed to infiltrate local aquifers for use during drought years in the likely event it be needed in the coming decades and that area is already using reclaimed municipal wastewater for irrigation and the greening of local golf courses and municipal parks. A significant long-term temperature increase due to climate change with associated evaporation of the Colorado River as it winds its way southwestward is likely to lead to increased salinity of river water as it travels into Mexico, which could violate a treaty that specifies just how much salinity in river water is acceptable. Climate scientists warn that increasing global temperatures will likely bring more intense and unpredictable climatic events such as harsher floods and droughts. Analyzing 18 watersheds in the US Wolock and McCabe [27] compared two computational models, the Canadian Climate Model and the Hadley Climate Model for runoff, and neither was consistent with the other demonstrating the need for further research. A decade and a half has passed since the 1997 publication of the American Water Works Association's recommendations for water managers who will have to deal with problems associated with climate change issues in the future, but little more can be said about them since there is still very limited if any relevant experience [3]. In other words, the increasing global temperatures that the world has in fact seen since the early 1970s have not yet done sufficient "damage" to allow anyone to be able to predict negative events with any certainty. The "take-home message" from all of these studies is that water resources planning and related public health and safety issues should be considered during all phases of the planning process, just as is done now when water managers try to foresee and take preventative measures on a routine even daily basis. Information technology allows water managers everywhere to communicate with one another and with personnel of other governmental personnel at all levels and in the end keep as vigilant as possible in hopes of averting a disaster should there be one in anyone's future.

## **29.9 Summary and Conclusions**

---

Drinking or potable water security refers to both safety and public health issues, which must be addressed in order for consumers to feel confident about their water supply. Availability of safe drinking water is very site specific and ranges from many people in the developing world having to walk great distances from their home to obtain it and then to return to the home for drinking and food preparation, often on a daily basis, to others simply turning on a tap in their home for what seems an infinite supply and never having to worry about the matter. Those who provide their own water usually from a well must be aware that there is usually no one to offer periodic inspection and analysis of their water and they themselves must insure its safety, and this usually involves a fee for a laboratory to perform proper analysis. Many foreign governmental agencies and NGOs now provide financial and educational assistance for those in the developing world to help with the cost and setup of on-site point-of-use but simple treatment systems. Cities and town that provide water to many residents and businesses have planning agencies, which maintain vigilance of the present water supply and distribution systems by assessing water quality and quantity and are also looking forward to insure both supply and quality for the future. New technologies are used to obtain water from unlikely sources such as domestic wastewater and the oceans and seas of the world. The immediate development of untapped groundwater supplies in Africa, for example, could solve many problems on that continent. The most important issues however are for both those dealing with their own water supply and those working in municipal agencies who are in charge of water for masses of people, are to always be alert and aware of the sources of their raw water, and are

to be ready to react should something unexpected happen that might threaten the supply in some way. Once lost, a water supply is difficult to replace. To do what seems to be too much to provide protection of a water supply is nonsense. It is always better to error on the side of safety!

## References

1. Albrich, J.M., McCarthy, C.A., and Hurst, J.K. 1981. Biological reactivity of hypochlorous acid: Implications for microbicidal mechanisms of leukocyte myeloperoxidase. *Proc. Natl. Acad. Sci. USA* 78: 210–214.
2. Alexander, K.L. 2008. Desal in the west: Opportunities and challenges. *Southwest Hydrology* (March/April), 7, 26–30. [http://swhydro.arizona.edu/archive/V7\\_N2/feature6.pdf](http://swhydro.arizona.edu/archive/V7_N2/feature6.pdf) (accessed September 27, 2013).
3. American Water Works Association (AWWA). 1997. Climate change and water resources: Committee report of the AWWA public advisory forum. *J. Am. Water Works Assoc.* 89: 107–110.
4. Bartoshuk, L.M. 1974. NaCl thresholds in man: Thresholds for water taste or NaCl taste? *J. Comp. Physiol. Psychol.* 87: 310–325.
5. Bates, B.C., Kundzewicz, Z.W, Wu, S., and Palutikof, P. (eds.). 2008. *Climate Change and Water*. Technical paper of the intergovernmental panel on climate change. Geneva, Switzerland: IPCC Secretariat.
6. Clasen, T., Roberts, I., Rabie, T., Schmidt, W., and Cairncross, S. 2006. Interventions to improve water quality for preventing infectious diarrhoea (a Cochrane Review). In: *The Cochrane Library*, Issue 3, Oxford, U.K.: Update Software.
7. Costello, A., Abbas, M., Allen, A. et al. 2008. Managing the health effects of climate change. *The Lancet* 373: 1693–1733.
8. Crusberg, T.C., Burke, W., Reynolds, J.T., Morse, L.J., Reilly, J., and Hoffman, A.H. 1978. The reappearance of a classical epidemic of infectious hepatitis in Worcester, Massachusetts. *Am. J. Epidemiol.* 107: 545.
9. Elimelech, M. and Phillip, W.A. 2011. The future of seawater desalination: Energy, technology and the environment. *Science* 333: 712–717.
10. English, P.W. 1968. The origin and spread of qanats in the old world. *Proc. Am. Phil. Soc.* 112: 170–181.
11. Flint, A. 1873. Relation of water to the propagation of fever. *Public Health* 1: 164–172.
12. Foster, G. and Rahmstorf, S. 2011. Global temperature evolution 1979–2010. *Environ. Res. Lett.* 6: 044022. <http://iopscience.iop.org/1748-9326/6/4/044022> (accessed June 20, 2012).
13. Fox, K.R. 1995. Turbidity as it relates to waterborne disease outbreaks. *Presentation at M/DBP Information Exchange*. Cincinnati, OH: AWWA Whitepaper.
14. Frontinus, S.J. 1973. *The Two Books on the Water Supply of the City of Rome, AD97*, Translated by C. Herschel, Boston, MA: New England Water Works Association.
15. Hoffman, A.H., Crusberg, T.C., and Savelonis, B. 1979. Statistical correlations between infectious hepatitis and water and sewerage system parameters. *Arch. Env. Health.* 34: 87–91.
16. Lubin, J.H., Beane-Freeman, L.E., and Cantor, K.P. 2007. Inorganic arsenic in drinking water: An evolving public health concern. *J. Nat. Can. Inst.* 99: 906–907.
17. McGuire, M.J. 2008. Eight revolutions in the history of U.S. drinking water disinfection. *J. Am. Water Works Assoc.* 98: 123–148.
18. Morse, L.J, Bryan, J.A, and Hurley, J.P. 1972. The Holy Cross College football team hepatitis outbreak. *J. Am. Med. Assoc.* 219: 706–708.
19. NADP. 2007. National atmospheric deposition program archives. <http://nadp.sws.uiuc.edu/maplib/archive/NTN/> (accessed June 20, 2012).
20. Peeters, J.E., Mazás, E.A., Masschelein, W.J., Villacort, W.J., de Maturana, I., and Debacker, E. 1989. Effect of disinfection of drinking water with ozone or chlorine dioxide on survival of *Cryptosporidium parvum* oocysts. *Appl. Environ. Microbiol.* 55: 1519–1522.



21. Reitzel, N.M. 1984. Arsenic in rock wells in central Massachusetts. In Crusberg, T.C., Cheetham, R.D. and Hoffman, A.H. (eds.). 1985. *Water Quality and the Public Health, Proceeding of a Conference*. Worcester Consortium for Higher Education: Worcester, MA, pp. 116–126.
22. Sobsey, M.D., Stauber, C.E., Casanova, L.M., Brown, J.M., and Elliott, M.A. 2008. Point of use household drinking water filtration: A practical, effective solution for providing sustained access to safe drinking water in the developing world. *Environ. Sci. Technol.* 42: 4261–4267.
23. UNICEF. 2008. Promotion of household water treatment and safe storage in UNICEF water programmes. [http://www.unicef.org/wash/files/Scaling\\_up\\_HWTS\\_Jan\\_25th\\_with\\_comments.pdf](http://www.unicef.org/wash/files/Scaling_up_HWTS_Jan_25th_with_comments.pdf) (accessed June 20, 2012).
24. U.S. Environmental Protection Agency. 1996. *Ultraviolet Light Disinfection Technology in Drinking Water Application—An Overview*. Washington, DC: Office of Water. EPA/811-R-96-002.
25. U.S. Environmental Protection Agency. 1999. EPA guidance manual: Alternative disinfectants and oxidants (Chapter 8). [http://water.epa.gov/lawsregs/rulesregs/sdwa/mdbp/upload/2001\\_01\\_12\\_mdbp\\_alter\\_chapt\\_8.pdf](http://water.epa.gov/lawsregs/rulesregs/sdwa/mdbp/upload/2001_01_12_mdbp_alter_chapt_8.pdf) (accessed June 20, 2012).
26. U.S. Environmental Protection Agency (Office of Water). 2002. Method 1604: Total coliform and *Escherichia coli* in water by membrane filtration using a simultaneous detection technique (MI medium). EPA 821-R-024, Washington, D.C. <http://www.epa.gov/microbes/documents/1604sp02.pdf> (accessed September 26, 2013).
27. Wolock, D.M. and McCabe, G.J. 1999. Simulated effects of climate change on mean annual runoff in the conterminous United States [abstract], In Adams, D.B., ed., *Proceedings of Specialty Conference on Potential Consequences of Climate Variability and Change to Water Resources of the United States*, May 10–12, 1999, Atlanta, GA: American Water Resources Association, pp. 161–164.
28. World Health Organization (WHO). 2003. *Emerging Issues in Water and Infectious Diseases*. Geneva, Switzerland: World Health Organization.
29. World Health Organization (WHO). 2005. Progress towards the millennium development goals, 1990–2005. [http://unstats.un.org/unsd/mi/goals\\_2005/goal\\_4.pdf](http://unstats.un.org/unsd/mi/goals_2005/goal_4.pdf) on 15 November 2005 (accessed June 20, 2012).
30. World Health Organization (WHO). 2006. *Mortality Country Fact Sheet 2006: Ethiopia*. Geneva, Switzerland: World Health Organization.

# Handbook of Engineering Hydrology

## Environmental Hydrology and Water Management

While most books examine only the classical aspects of hydrology, this three-volume set covers multiple aspects of hydrology and includes contributions from experts comprising more than 30 countries. It examines new approaches, addresses growing concerns about hydrological and ecological connectivity, and considers the worldwide impact of climate change.

It also provides updated material on hydrological science and engineering, discussing recent developments as well as classic approaches. Published in three books, **Fundamentals and Applications; Modeling, Climate Change, and Variability; and Environmental Hydrology and Water Management**, the entire set consists of 87 chapters and contains 29 chapters in each book.

The chapters in this book contain information on

- The anthropogenic aquifer, groundwater vulnerability, and hydrofracturing and environmental problems
- Disinfection of water, environmental engineering for water and sanitation systems, environmental nanotechnology, modeling of wetland systems, nonpoint source and water quality modeling, water pollution control using low-cost natural wastes, and water supply and public health and safety
- Environmental flows, river managed system for flood defense, stormwater modeling and management, tourism and river hydrology, and transboundary river basin management
- The historical development of wastewater management, sediment pollution, and sustainable wastewater treatment
- Water governance, scarcity, and security
- The formation of ecological risk on plain reservoirs, modification in hydrological cycle, sustainable development in integrated water resources management, transboundary water resource management, and more

Students, practitioners, policy makers, consultants, and researchers can benefit from the use of this text.