

**ADVANCES IN
DRUG RESEARCH**

Volume 30



ACADEMIC PRESS

ADVANCES IN
DRUG RESEARCH

VOLUME 30

This Page Intentionally Left Blank

ADVANCES IN
DRUG RESEARCH

Edited by

BERNARD TESTA

*School of Pharmacy, University of Lausanne,
Lausanne, Switzerland*

and

URS A. MEYER

*Department of Pharmacology,
Biocentre, University of Basel, Basel,
Switzerland*

VOLUME 30



ACADEMIC PRESS

Harcourt Brace & Company, Publishers

SAN DIEGO LONDON BOSTON NEW YORK
SYDNEY TOKYO TORONTO

This book is printed on acid-free paper.

Copyright © 1997 by ACADEMIC PRESS

All Rights Reserved

No part of this publication may be reproduced or transmitted in any form or by any means electronic or mechanical, including photocopy, recording, or any information storage and retrieval system, without permission in writing from the publisher.

Academic Press
525 B Street, Suite 1900, San Diego, California 92101-4495, USA
[http:// www.apnet.com](http://www.apnet.com)

Academic Press Limited
24-28 Oval Road, London NW1 7DX, UK
[http:// www.hbuk.co.uk/ap/](http://www.hbuk.co.uk/ap/)

ISBN 0-12-013330-X

A catalogue record for this book is available from the British Library

Typeset by Keyset Composition, Colchester, Essex
Printed in Great Britain by Hartnolls Ltd, Bodmin, Cornwall

97 98 99 00 01 02 EB 9 8 7 6 5 4 3 2 1

CONTENTS

CONTRIBUTORS	vii
PREFACE: FAREWELL	viii

The Concept of Emergence–Dissolvement in Drug Research

BERNARD TESTA AND LEMONT B. KIER

1 Introduction	1
2 The Synergetic Process in the Formation of Complex Systems.	2
3 The Concept of Dissolvement	4
4 Dissolvement at the Molecular Level.	5
5 Dissolvement at the Biological Level.	7
6 Dissolvement at the Pharmacological Level.	9
7 Conclusion	13
References	14

Sense and Non-sense in Toxicity Assessment of Medicinal Products

A. G. RAUWS, E. J. DE WAAL AND J. W. VAN DER LAAN

1 Introduction	16
2 Cases of Sense or Non-sense in Toxicity Assessment	19
3 Reflection and Discussion	53
References	62

The Concept of Chiral Conformers and its Significance in Molecular Pharmacology

MIKLÓS SIMONYI

1 Introduction	73
2 Ring Conformers	76
3 Conformers of Flexible Molecules	86
4 Conclusion	105
References	106

Combinatorial Compound Libraries for Enhanced Drug Discovery Approaches

EDUARD R. FELDER AND DIETER POPPINGER

1 Introduction	112
2 Historical Background	113

3	Basic Principles of Combinatorial Technologies	114
4	Current Topics	139
5	Discussion	180
	References	183
	Appendix	196

Reversal of Chloroquine Resistance in Malaria: A New Concept of
Chemotherapy

SANJAY BATRA AND AMIYA P. BHADURI

1	Introduction	202
2	The Mechanism of Action of Chloroquine	203
3	Current Status of Chloroquine Resistance	208
4	The Mechanism of Chloroquine Resistance in <i>Plasmodia</i>	210
5	Strategies for the Development of Chloroquine Resistance Reversal Agents	214
6	Conclusion	226
	References	227
SUBJECT INDEX		233
CUMULATIVE INDEX OF AUTHORS		243
CUMULATIVE INDEX OF TITLES		247

CONTRIBUTORS

S. BATRA, *Medicinal Chemistry Division, Central Drug Research Institute, Lucknow 226 001, India*

A. P. BHADURI, *Medicinal Chemistry Division, Central Drug Research Institute, Lucknow 226 001, India*

E. R. FELDER, *Core Drug Discovery Technologies, Ciba-Geigy AG, CH-4002 Basel, Switzerland*

L. B. KIER, *Department of Medicinal Chemistry, Virginia Commonwealth University, Richmond, VA 23298, USA*

J. W. VAN DER LAAN, *Preclinical Assessment Group of the Medicines Evaluation Board, National Institute of Public Health and the Environment, NL-3720 BA, Bilthoven, The Netherlands*

D. POPPINGER, *Computer-Assisted Research, Ciba-Geigy AG, CH-4002 Basel, Switzerland*

A. G. RAUWS, *Preclinical Assessment Group of the Medicines Evaluation Board, National Institute of Public Health and the Environment, NL-3720 BA, Bilthoven, The Netherlands (retired)*

M. SIMONYI, *Central Research Institute for Chemistry, Hungarian Academy of Sciences, H-1525 Budapest, POB 17, Hungary*

B. TESTA, *School of Pharmacy, BEP, University of Lausanne, CH-1015 Lausanne, Switzerland*

E. J. DE WAAL, *Preclinical Assessment Group of the Medicines Evaluation Board, National Institute of Public Health and the Environment, NL-3720 BA, Bilthoven, The Netherlands*

PREFACE: FAREWELL

Good players know that they should leave the game while the fun still lasts. This is a thought that has been in our mind for some years. Aware that the day of our resignation as editors of *Advances in Drug Research* would inevitably come, we were all the more motivated to devote our energy to this task. Now the day has come indeed, and the volume you hold shall be the last under our editorship.

With a total of 18 volumes bearing one or both of our signatures, we have been privileged during these 14 years to create and maintain cordial and enriching relations with innumerable colleagues in many countries. Yet impermanence is the only permanent thing in our world. Philosophers from Heraclitus of Ephesus to Henri Bergson have stressed that everything is in flux and constant change (Young, 1993). Our decision was therefore a natural one taken in the percipience of simply following the way of motion and alternance (Watts, 1992).

To conclude our editorship on a harmonious and long-lasting note, particular attention was paid to selecting topics of interest, significance and appeal. As a result, the present volume comprises four chapters of quite broad and general character, and a more specialized one.

In the first chapter, Testa and Kier build on a chapter they published in volume 26. Having presented complex systems and emergent properties, they now go on to propose dissolvence as the complement of emergence and show that this phenomenon can be recognized at all levels of complexity of interest in drug research. The concept is a provocative one awaiting applications, but it certainly allows the formation of complex systems to be seen in a fresh perspective.

The second chapter is entirely oriented towards toxicology. Indeed, Rauws and his colleagues condense much common sense and many sobering insights into their text on 'sense and non-sense in toxicity assessment of medicinal products'. This topic is obviously a sensitive and difficult one, and it is treated here in a laudably constructive manner.

The next two chapters treat broad and timely topics in drug design. Simonyi, a pioneer in medicinal stereochemistry, offers what is a primer on the significance of chiral conformers in molecular pharmacology. The importance of configurationally stable chiral compounds is well known to all drug researchers and was treated in a previous volume. However, Simonyi's chapter brings something quite different to the awareness of readers, namely the fact that very rapidly interconverting enantiomers are an invaluable tool to understand molecular recognition and specificity in ligand-receptor interactions.

The same can be said about the chapter on combinatorial compound libraries. This is at present one of the hottest fields in drug discovery, and we are grateful to two highly active and creative experts for sharing their knowledge and enthusiasm. While the pace of progress in combinatorial chemistry and high throughput screening is fast enough to outdate any factual text by the time it appears in print, Felder and Poppinger have achieved a unique overview that will remain valuable in years to come due to its synthetic and conceptual character.

And finally, Batra and Bhaduri present the reversal of chloroquine resistance as a new concept in the chemotherapy of malaria. This is again a far-reaching text which blends findings and hypotheses in a stimulating manner.

For all authors of *Advances in Drug Research*, preparing a chapter was a distinct step in their scientific life. For the undersigned, editing these volumes was a long-lasting commitment to serve drug research not only as educators and investigators, but also by helping others to find context, knowledge and inspiration. All we scientists march together on the road of discovery and creation. We enter this peregrination as students and leave it when the time has come. But whatever our contributions, and this is the editors' final conclusion, we '... should never regard [our] discoveries as more than steps along the infinitely long road to perfect knowledge. There is no ultimate certainty at any stage.' (Taylor, 1993.)

BERNARD TESTA
URS A. MEYER

References

- Taylor, J. (1993). 'When the Clock Struck Zero', p. 115. Picador, London.
Watts, A. (1992). 'Tao – The Watercourse Way.' Penguin Books, London.
Young, L. B. (1993). 'The Unfinished Universe.' Oxford University Press, Oxford.

This Page Intentionally Left Blank

The Concept of Emergence–Dissolvement in Drug Research

BERNARD TESTA¹ and LEMONT B. KIER²

¹*School of Pharmacy, BEP, University of Lausanne, CH-1015 Lausanne,
Switzerland*

²*Department of Medicinal Chemistry, Virginia Commonwealth University,
Richmond, VA 23298, USA*

1	Introduction	1
2	The Synergetic Process in the Formation of Complex Systems	2
3	The Concept of Dissolvement	4
4	Dissolvement at the Molecular Level	5
4.1	Molecules	5
4.2	Macromolecules	6
4.3	Molecular Aggregates	7
5	Dissolvement at the Biological Level	7
5.1	Molecular Machines and Membranes	8
5.2	Organelles and Cells	8
5.3	Tissues, Organs and Organisms	9
6	Dissolvement at the Pharmacological Level	9
6.1	The Targets	9
6.2	Molecular Aggregations	10
6.3	Drug–organism Transactions	11
6.4	Drug–drug Interactions	12
7	Conclusion	13
	References	14

*'He escapes from his ego by this merger and acquires an impersonal immortality
in the association; his identity dissolving into greater identity.'*

H. G. Wells, J. S. Huxley and G. P. Wells (1934) (bold added).

1 Introduction

To date, the description of complex systems is focused mainly on the emergence of new properties and behaviour (Goodwin, 1995; de Vree 1996; Waldrop, 1992). This applies to complex systems in any realm of scientific inquiry, including drug research (Kier and Testa, 1995a). Emergent behaviour is spoken of in the same breath as complexity and rightly deserves

the designation of a hallmark. But what of the behaviour of ingredients caught up in the process of synergy, of the parts that form a system of a higher level of complexity? What is left behind in terms of properties when the form and function of complex components become subsumed in a higher order? The reality and the attributes of this 'lost chord' is a neglected but essential aspect of the understanding of complexity. Here, we explore in this light some complex systems of relevance to drug research (Kier and Testa, 1995a).

2 The Synergetic Process in the Formation of Complex Systems

A system, M , destined to become an ingredient in a higher order complex system, $M + 1$, has a form (or structure) and exhibits a pattern of behaviour called function (or properties). Form and functions fluctuate (Prigogine, 1978; Cramer, 1993), thus generating a number of formal and functional states. These states are snapshots of the system at a given moment in time, and they are characterized by a definable form and by a definable function. In other words, any property exhibited by a system will have a different value for each state occupied by that system.

Obviously, form and function can only fluctuate within limits, implying that the number of formal and functional states a system can occupy is limited. The ensemble of all possible states of this system will span a range of values which delineates a property space, which can also be viewed as the basis of attraction of all possible states of a given system. It is through the functional states, or rather through their properties (the observables) that a system is accessible to an observer. How many discrete and distinct states can be recognized for a given system depends, of course, on its intrinsic nature, and also on the criteria of discrimination applied by the observer.

We now consider the synergetics of complex systems interacting and becoming integrated to create complex systems of higher levels. First, we imagine a number of systems of level M that coexist independently and without interaction but are synergistic in their potential to merge to form a system of level $M + 1$. When systems of level M acquire the ability from information processing to engage each other in weak interactions, an embryonic higher level system $M + 1$ emerges in a nascent state. This is schematized in Figure 1 for two systems of level M . At this stage, system $M + 1$ is characterized by a small, partial blending of property spaces with concomitant loss of identity characteristic of the primordial M systems. We call such a loss, a process of dissolvement. This concept of dissolvement is the central argument of the paper. At the early stage described in Figure 1, there is limited emergence and limited dissolvement. The limited property space emerging at the level $M + 1$ co-mingles with the remaining property spaces of the conservative M level systems.

The possibility of increasing interactions from more extensive information

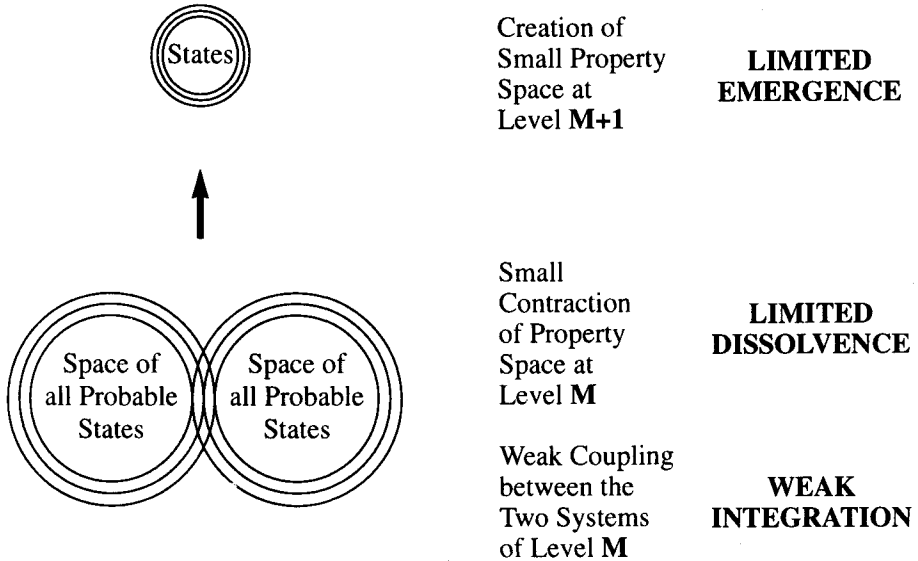

FIG. 1. Schematic representation of weak coupling among sub-systems, resulting in limited emergence of new properties, and limited dissolvement of their property space.

processing among level M systems brings a further change in the architecture of the evolving $M + 1$ level system. Moderate interactions produce progressively higher degrees of dissolvement and emergence of property space, resulting in a more integrated system, as portrayed in Figure 2. The process underway here is reversible, the temporal course being dependent upon the robustness of the two levels of complexity.

At certain points in the course of the increasing synergy among M -level systems, the system may reverse its progress, collapsing to a lower level of synergy; possibly even reverting back to the field of conservative M -level systems. Alternatively, the balancing of internal information with synergetic stability may produce a metastable complex system bearing the hybrid character of M and $M + 1$ level systems. A third possibility is for the progress to continue from the generated information and to evolve towards a higher level of synergy with strong interactions between the components. The concomitant development of extensive emergence and dissolvement defines a higher level of stability in the highly organized and integrated $M + 1$ complex system. Such a complex system is schematized in Figure 3.

To summarize at this point, we have presented a hierarchy of system types starting with isolated systems, M , which evolve to a $M + 1$ system of increasing integration of its constituents (Figures 1-3). It is assumed that this evolution is driven and controlled by an internal information exchange (Fleissner and Hofkirchner, 1996).

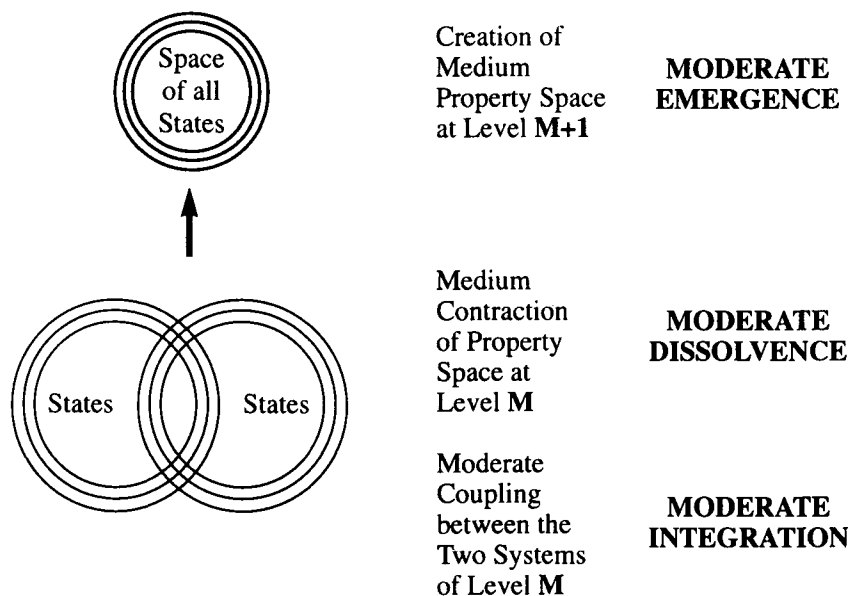

FIG. 2. Schematic representation of moderate coupling among sub-systems, resulting in moderate emergence of new properties, and moderate dissolution of their property space.

3 The Concept of Dissolvence

The creation of a complex system at level $M + 1$ is accompanied by the emergence of properties (Figures 1–3). These emergent properties define the property space of the new system. Simultaneously however, we observe that the interaction, coupling and integration of the systems of level M is accompanied by a reduction in their property space. At this stage of the discussion, such a reduction is presented as a postulate to be exemplified and evidenced below. Here, we reflect on possible characteristics of the phenomenon in order to focus awareness and help recognize it in complex systems of relevance to drug research.

The phenomenon we call dissolvence is viewed as a reduction in the number of probable states of a system as it engages in coupling and synergy with fellow systems to form a system with a higher level of complexity. In other words, a system merging into a higher system experiences a progressive (but partial) loss of choice, options and independence. The partially lost properties do not disappear, they dissolve into the higher system, to use the words of H. G. Wells, J. S. Huxley and G. P. Wells quoted above. To speak of dissolution would be trivial and too material. For reasons of parity with emergence, the word dissolvence is used.

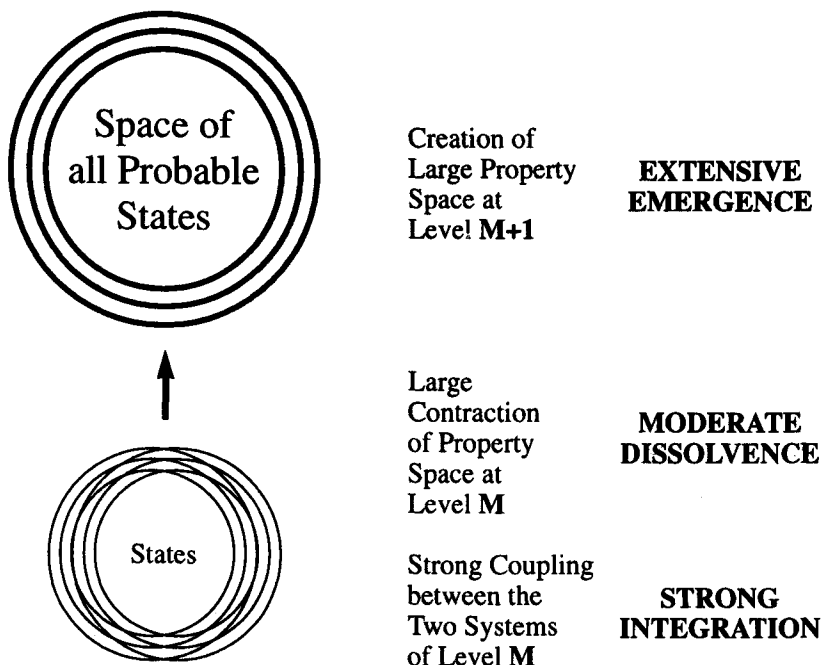

FIG. 3. Schematic representation of strong coupling among sub-systems, resulting in extensive emergence of new properties, and extensive dissolvement of their property space.

Dissolvement is an aspect of the formation of a complex system that has received little if any attention. We submit here that emergence and dissolvement are the two sides of the same phenomenon, namely the formation of a complex system. However, emergence and dissolvement do not involve the same properties. The properties lost during dissolvement are not the same as those arising in the emergence process. We now turn our attention to well-recognized occurrences of emergence in some complex systems and examine whether dissolvement can also be identified as a natural phenomenon, concomitant with emergence.

4 Dissolvement at the Molecular Level

4.1 MOLECULES

The union of atoms to form molecules is a pervasive phenomenon in nature; think of water, the air we breathe, and the many inorganic molecules that form the lithosphere. The merging of atoms to form molecules gains paramount significance in the biosphere. This is affirmed by the observation that most of matter in the biosphere is formed by highly complex, functional

molecules with only a small part existing as 'unbound' elements. In the biosphere, the formation of molecules from atoms is just one step, albeit an essential one, in the open-ended ladder that leads to macromolecules, membranes, organelles, cells, tissues, organs, organisms, societies, and beyond (Kier and Testa, 1995a; Testa and Kier, 1995). The biological levels are examined in the next section.

A molecule is a complex system (Primas, 1981). It can be viewed as a system of level $M + 1$ (Figures 1–3), whereas the ingredient atoms are level M systems. When the synergy of atoms occurs to form molecules, there is a well-known emergence of molecular properties that do not exist in isolated atoms. Such emergent properties and structural attributes include, among others, molecular topology, stereoisomerism, conformational freedom and flexibility. In other words, emergence in molecules involves their form, function and fluctuation.

But what about the constituting atoms? Many of the properties characteristic of isolated atoms are lost in molecules. The simplest possible example is the hydrogen atom (one proton and one electron, i.e. the hydrogen radical H^\bullet). This species is so reactive that it has a very strong propensity to react with another H^\bullet to form H_2 in a highly exothermic reaction. When H^\bullet is formed in biological systems (e.g., by high-energy radiations), it may cause significant biological damage. Clearly, H^\bullet loses its intrinsic reactivity when incorporated into H_2 , or for that matter into any molecule.

The above is just a small yet significant example of dissolvement at the molecular level. In more general terms, the dissolvent properties of atoms when forming molecules are those associated with their external layers of electrons, the so-called valency electrons. These electrons no longer belong to the atom but form the molecular orbitals which account for so many emergent molecular properties and structural attributes (Primas, 1981). These properties and attributes are those outlined in previous writings (Kier and Testa, 1995a; Testa and Kier, 1995), to which one can add chemical reactivity and wavelengths of absorption of electromagnetic radiations. The latter property is particularly illustrative, since it determines the colour that a chemical compound appears to our eyes.

The synergetic process accompanying molecular formation is thus accomplished through electron sharing among the constitutive atoms, thereby destroying their conservative state and producing a dissolvement of their properties, together with a concurrent emergence of molecular properties.

4.2 MACROMOLECULES

The molecules that react to form macromolecules are known as monomers prior to the reaction and as residues once they are incorporated into polymers. This difference in names is in itself a revealing terminology,

indicating that chemists are well aware of the changes in chemical properties that accompany the monomer-to-residue transformation. Macromolecules can be natural (e.g., nucleic acids) or of synthetic origin, and they may contain a single or different types of residues (e.g., cellulose and proteins, respectively). In previous writings, we have discussed in some detail the emergent properties of biomacromolecules (Kier and Testa, 1995a; Testa and Kier, 1995). We now examine the coordinate changes in the properties of the monomeric units as they are incorporated into macromolecules. Chemists know all too well that when monomers are incorporated, they undergo chemical alterations, losing for example -H and -OH (in macromolecules formed by a reaction of dehydration, e.g. proteins and polysaccharides).

However, the formation of macromolecules can also be discussed in a different perspective. Monomers as free molecules behave as any other chemical compound, possessing a property space defined by their form and function and their fluctuations. As residues, they experience numerous changes in their properties. For example, their conformational space is controlled mostly by the macromolecule, while the lipophilicity and ionization of their side-chains are strongly influenced by the macromolecular fields. In other words, residues differ from their monomeric precursors not only by small chemical changes, but also by major restrictions (i.e., dissolvement) in form, function and fluctuation.

4.3 MOLECULAR AGGREGATES

Another example of the coupled processes of emergence-dissolvement is the transformation of a disparate group of amphipathic molecules into a complex system such as a micelle (Testa and Kier, 1995). The amphiphiles exhibit a set of molecular properties (e.g. great conformational freedom) which face dissolvement when the molecules interact to form the new architecture of the higher level complex system.

Macroscopic aggregates in the form of condensed states of matter can lead to similar considerations. A liquid, for example, has many emergent properties that are meaningless at the level of its individual molecules (e.g. freezing point, boiling point, viscosity and density). These molecules preserve their individual existence in the condensed state but due to strong intermolecular coupling they experience restricted motion and conformational freedom, and a much reduced capacity for additional intermolecular interactions. This decrease in property space again exemplifies dissolvement.

5 Dissolvement at the Biological Level

Biological systems offer a vast and perhaps infinite repertoire of emergent properties. The simplest biological systems are considered to be

biomacromolecules, whose functionalities, adaptability, resilience and high propensity to enter higher-level systems make them the essential building blocks of living systems (Testa and Kier, 1995; Kier and Testa, 1995b). Some of these levels will be examined here for the revelation of coupled emergence–dissolvement.

5.1 MOLECULAR MACHINES AND MEMBRANES

Observations of emergence–dissolvement can be made with the aggregation of protein molecules to form functional aggregates (the molecular ‘machines’) such as many enzymes, ion channels, and receptor systems with their transduction units. The haemoglobin molecule is an example of such a system. Four haemoproteins combine through a variety of forces to become a functioning tetramer with emergent properties that optimize the transport and delivery of O₂. Each macromolecule of haemoglobin exhibits dissolvement as the synergy occurs. This manifests itself as occlusion of certain side-chain functionalities, hydration patterns, and so forth. In general terms, biomacromolecules are regulated (‘enslaved’) in their form, function and fluctuation by the functional aggregates of which they are subsystems.

Another eloquent example of simultaneous emergence–dissolvement is offered by biological membranes. The emergent properties of these multifunctional systems are compartmentalization, the control of transport processes, coupled or hypercyclic enzymatic activities, and transmission of information, to name some of the most important functions. All membrane constituents (phospholipids, cholesterol, various functional proteins and glycoproteins) experience marked limiting (i.e. dissolvement) in their property space. Thus, their conformational space is restricted, whereas their functions are subordinated to higher-level regulation.

5.2 ORGANELLES AND CELLS

Organelles are of particular significance in the present context, being units endowed with specialized, emergent functions, and separated by a membrane from the rest of the cell. Examples include nuclei, mitochondria, lysosomes, chloroplasts, and the endoplasmic reticulum with its ribosomes. Organelles are incapable of surviving or even functioning outside the cell, where they find the medium to which they adapted, or outside artificial media that very closely mimic these intracellular conditions. Inside the cell they receive the energy and material to operate and the information to regulate their functions, while they export their products and wastes. One telling example of dissolvement is that of mitochondria, the organelles whose major function is to supply energy to the cell in the form of ATP. The fact that mitochondria

retain the genetic information coding for some of their proteins has led to the conclusion that they are distant descendants of independent micro-organisms which evolved to become enslaved cellular constituents.

Thus, organelles are open systems whose survival and functioning depend entirely on higher-level systems (cells) via a permanent influx and efflux of information, material, energy, products and wastes. Thereby, they participate in the synergetics forming the cell, and in so doing lose some of their form, function and fluctuation.

5.3 TISSUES, ORGANS AND ORGANISMS

At higher levels of biological complexity, the eukaryotic cells become participants in the synergy leading to tissues, organs, and organisms. At each level emergence is manifested by a variety of specific properties – but what about dissolvement?

Cells belonging to pluricellular organisms do not have the capacity for independent survival and multiplication, in contrast to prokaryotic cells (e.g. bacteria) which possess these essential functions but only in a few species associate to form pluricellular organisms. Like an organelle, a eukaryotic cell is an open system whose survival and functioning are entirely dependent on and controlled by higher-level systems via a permanent influx and efflux of information, material, energy, products and wastes. This total dependence for survival, this control and subjugation, are all expressions of dissolvement. The same control and regulation by higher levels is apparent in tissues and organs, and is also interpretable as dissolvement.

In summary, organisms are highly complex systems whose form, function and fluctuation emerge from a hierarchy of subsystems that have surrendered some of their properties.

6 Dissolvement at the Pharmacological Level

6.1 THE TARGETS

We have traced the hierarchy of complex systems from molecules through macromolecules, aggregates, organelles, cells, tissues, organs and organisms. In a pharmacological perspective, all these complex systems are the targets of drugs, and at all these levels events occur which are the focus of attention of medicinal chemists, biochemists and pharmacologists. The main point of the present argument is that any of these targets, when interacting with a drug or another active agent, forms a system of higher order displaying properties present neither in the target alone nor in the drug. In other words, the properties of the drug–target complex are much more than the mere

addition of the specific properties of the two partners (Kier and Testa, 1995b).

These emergent properties can be seen at the level of macromolecular targets (receptors, enzymes, ion channels and other molecular machines, all grouped here under the label of effectors), up to the level of organisms (animals and humans). Here, chemical manipulation by drugs leads, hopefully, to desired phenomena such as symptom palliation, pain relief, circulatory normalcy, and a host of other clinical objectives. All of these are emergent attributes arising from the interactions and transactions of ingredients of a lower level of complexity.

Our perceptions of these emergent pharmacological attributes are recorded as measured responses exhibited by other complex biological systems, or even as sensations within ourselves. The latter comprise the emergent states that we call health, fitness or well-being – in other words, the mission of medicine and drug research (Testa, 1996). At this organismic level of emergence we do not have a continual sense of the cellular or subcellular phenomena antecedent to the measurements and awareness of the health state. These antecedents, these ingredients of emergence experience dissolution as they become part of the manifold of changes in tissues and organs that collectively constitute our state of health.

6.2 MOLECULAR AGGREGATIONS

If we now look more closely at these systems, antecedent to perceived health parameters, we find numerous examples of the emergence–dissolution couple within the hierarchical range of interest in pharmacology. At the level of molecular aggregation we identify the complex combination of ligand–water–effector as the molecular trigger initiating a cascade of events leading to a measurable pharmacological effect. The generation of an action from an efficacious union of these ingredients is the emergent property. Accompanying the union of these ingredients is a significant degree of dissolution for the partners. For the ligand molecule, this is identified with a loss of mobility and a restriction of conformational and electronic spaces. For water in the immediate vicinity of the complex, dissolution is identified with a reduction in randomness. And for the macromolecular target, complex formation results, among others, in focused conformational and electronic changes (Figure 4).

These processes of dissolution are prerequisite to the emergence of action, i.e. the functioning of the complex. By limiting the choices of states of the ingredients within the complex there is created a number of possible states of the complex. Options of action and reaction are channelled. These limitations force certain reactions with higher probabilities. The inevitability of certain responses, including a fitness-evolved response of this system, is

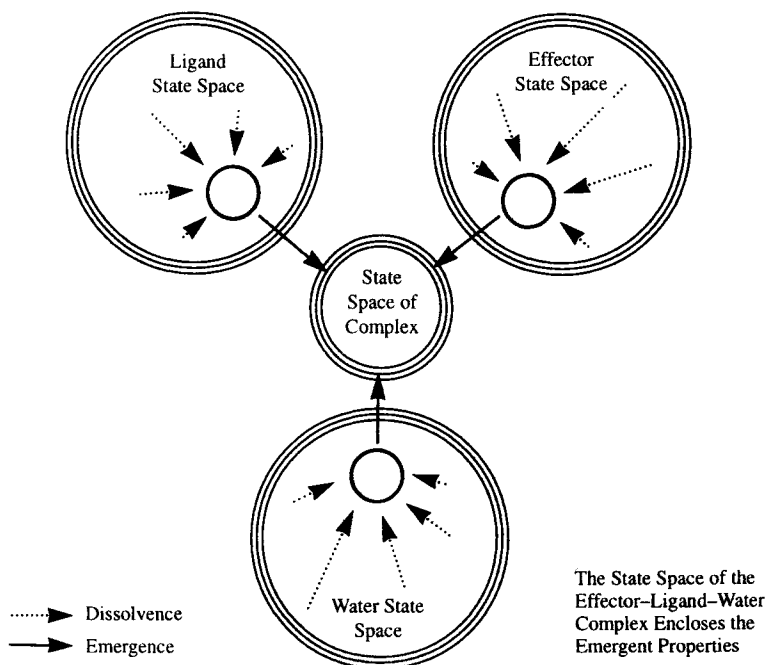

FIG. 4. Schematic representation of the formation of ligand-effector-water complex system, resulting in the emergence of new, functional properties. This is accompanied by a decrease (dissolvement) in the space of probable states of the ligand, effector and water.

thus established. This limiting and channelling of possibilities is an outcome of the dissolvement or elimination of many other reactions possible in the pre-union states of the ingredients. Kier and Testa (1995a, 1995b) have referred to this as a probabilistic advantage. Allegorically, we may say that the phoenix of emergence arises from the ashes of dissolvement. In drug research this concept might generate new questions and suggest fresh experimental approaches.

6.3 DRUG-ORGANISM TRANSACTIONS

In a broader sense we may view the interaction of a ligand with an organism where the ensemble exhibits a series of mutual changes in the partners. This is a type of interaction called transaction (Capra, 1983). The consequences of transaction are the emergence of unique properties not linearly related to the properties of the ingredients. Two facets of transaction emerge from these pairings, the pharmacodynamic and the pharmacokinetic effects. The pharmacodynamic effects have been shown to be a classification embracing

all of the effects of a drug on a biological system, whereas the pharmacokinetic effects are those which can be ascribed to the influence of a biological system on the drug.

Pharmacodynamic effects invariably result in profound channelling of function and states in the effector, as in the cases of receptor activation or inhibition, receptor sensitivity change, and enzyme inhibition or induction. Each of these phenomena arises from the consequence of dissolvence of pre-transaction states and function profiles, as discussed above.

The pharmacokinetic effect is a consequence of the context of the drug; it is a function of the biological environment acting upon the molecule. This results in a manifold of states adopted by the drug molecule to conform to conditions imposed by membrane barriers, seductive plasma proteins beckoning the passing drug to abide awhile, enzymes waiting to metabolize, and excretion routes bidding farewell to the intruder. Each event produces a series of restricting conditions on the drug molecule so that conformity is enforced and many options of state are no longer accessible. In other words, there is much dissolvence as the drug experiences its pharmacokinetic fate.

6.4 DRUG-DRUG INTERACTIONS

Each drug exhibits a profile of phenomena including distribution pattern, metabolic fate, clinical activity and side-effects. These collectively constitute the rubric of a drug, influencing its selection for the treatment of a patient. This rubric lists the attributes of a drug which manifests itself in the patient as a set of conditions referred to as the status of health and well-being. This set of conditions are emergent properties from the myriad of molecular encounters and cellular transformations, all experiencing dissolvence at each level.

At first glance, we may anticipate that a second and even a third drug would add to the benefits experienced with the first choice of medication. Improved treatment, reinforced attack on a malfunctioning organ, enhanced receptor response, might be possible under this additive expectation. However, this synergy is not always verified, and sometimes interactions occur such that one drug may influence unfavourably the response of another drug. The activity of one drug may be reduced, masked or obliterated as a result of the interaction. Well-known examples of drug-drug interactions include heteroinduction or inhibition of metabolizing enzymes. Where each drug by itself may be a substrate to the enzyme capable individually of producing a favourable clinical outcome, together they are a pair of competitive inhibitors to each other. This is also an emergent phenomenon accompanied by a loss of properties of the individual partners. Stated differently, the specific pharmacodynamic effects of the drug-drug-organism trio is accompanied by the dissolvence of the individual effects of the interacting drugs.

When the health status outcomes of the co-mingling of two drugs are favourable, we refer to such a regimen as combination therapy. Here, we have evaluated the loss of individual drug properties, the dissolvement, and have accepted as desirable the emergent properties of the combination. The combined drugs are chosen for their ability to partially mask or to accentuate each other in the emergence-dissolvement paradigm. Recognition of the dissolvement is the key to the successful crafting of such combinations or to the avoidance of them in adverse situations.

7 Conclusion

In this text, the creation of some complex systems of relevance to drug research, and the emergence of their specific properties, have been viewed from an unexplored perspective. Specifically, we have examined the property space of the components as they come together and enter coupling and synergy to create a complex system. What has been found is that the number of formal and functional states of the components decreases during this creation. This phenomenon we call dissolvement, and it can in fact be recognized in the formation of complex systems at all levels of size and complexity. Table 1 again summarizes the main aspects of this paradigm.

TABLE 1
Relations between coupling of components, dissolvement of their properties, and emergence of properties at the higher level

	Level M	Level M + 1
Weak coupling	Limited loss of properties Small decrease in number of states Small contraction of property space	A few emergent properties A few emergent states Creation of small property space
	→	→
	Limited <i>Dissolvement</i> in Properties	Limited <i>Emergence</i> in Properties
Strong coupling	Large loss of properties Large decrease in number of states Large contraction of property space	Many emergent properties Many emergent states Creation of large property space
	→	→
	Extensive <i>Dissolvement</i> in Properties	Extensive <i>Emergence</i> in Properties

Dissolvement must not be viewed as a destruction or a loss, but rather as a creative process, generating the information that allows the nascent system to appear and evolve to higher states of organization and emergence. Thus, the concept of dissolution should be recognized as the inseparable counterpart of emergence. Both the emergence and the dissolution of properties can help understand how complex systems are formed, behave and evolve. In the field of drug research, the emergence–dissolution paradigm might allow researchers to observe under a different angle the transactions between ligand and target, the formation of the functional complex, and the emergence of new properties. This is true in all systems discussed above, be they chemical, biological or pharmacological. If this view allows new phenomena to be recognized and new questions to be asked, it will prove its worth and be taken up by others. We offer this preliminary writing with the hope that it may be a source of insight and inspiration.

References

- Capra, F. (1983). 'The Turning Point. Science, Society and the Rising Culture', pp. 285–332. Fontana Paperbacks, London.
- Cramer, F. (1993). 'Chaos and Order. The Complex Structure of Living Systems', p. 108. VCH, New York.
- de Vree, J. K. (1996). A note on the information, order stability and adaptability. *Biosystems* **38**, 221–227.
- Fleissner, P. and Hofkirchner, W. (1996). Emergent information – Towards a unified information theory. *Biosystems* **38**, 243–248.
- Goodwin, B. (1995). Emergent form: evolving beyond Darwinism. *Complexity* **1**, 11–15.
- Kier, L. B. and Testa, B. (1995a). Complexity and emergence in drug research. In 'Advances in Drug Research, Vol. 26' (Testa, B. and Meyer, U. A., eds), pp. 1–43. Academic Press, London.
- Kier, L. B. and Testa, B. (1995b). Complex systems in drug research. II. The ligand–active site–water confluence as a complex system. *Complexity* **1**(4), 37–42.
- Prigogine, I. (1978). Zeit, Struktur und Fluktuationen (Nobel-Vortrag). *Angew. Chem.* **90**, 704–715.
- Primas, H. (1981). 'Chemistry, Quantum Mechanics and Reductionism.' Springer, Berlin.
- Testa, B. (1996). Missions and finality of drug research: A personal view. *Pharmaceutical News*, **3**(6), 10–120.
- Testa, B. and Kier, L. B. (1995). 'Complex systems in drug research. I. The chemical levels.' *Complexity* **1**(4), 29–36.
- Waldrop, M. M. (1992). 'Complexity: The Emerging Science at the Edge of Order and Chaos.' Simon & Schuster, New York.
- Wells, H. G., Huxley, J. S. and Wells, G. P. (1934). 'The Science of Life', p. 1475. The Literary Guild, New York (quoted by Louise B. Young (1993) In 'The Unfinished Universe'. Oxford University Press, New York).

Sense and Non-sense in Toxicity Assessment of Medicinal Products

A. G. RAUWS, E. J. DE WAAL and J. W. VAN DER LAAN

*Preclinical Assessment Group of the Medicines Evaluation Board, National
Institute of Public Health and the Environment, NL-3720 BA, Bilthoven,
The Netherlands*

1	Introduction	16
1.1	Historical Background	16
1.2	Development of Modern Toxicology	18
2	Cases of Sense or Non-sense in Toxicity Assesment	19
2.1	Pronethalol	20
2.1.1	Introduction	20
2.1.2	History	20
2.1.3	Comment and Conclusion	22
2.2	Withdrawal of the Antidepressants Zimeldine, Nomifensine and Indalpine	23
2.2.1	Introduction	23
2.2.2	History	23
2.2.3	Comment and Conclusion	24
2.3	The Tamoxifen Discussion	25
2.3.1	Introduction	25
2.3.2	History	26
2.3.3	The Genotoxicity Debate	26
2.3.4	The Toremifene Alternative	29
2.3.5	Risk Assessment	29
2.3.6	Comment and Conclusion	30
2.4	The Noscipine Genotoxicity Scare.	30
2.4.1	Introduction	30
2.4.2	History	31
2.4.3	Noscipine Pharmacokinetics	31
2.4.4	<i>In vitro</i> Genotoxicity Studies	32
2.4.5	<i>In vivo</i> Mouse Oocyte Study	33
2.4.6	Comment and Conclusion	33
2.5	Cyproterone Acetate: is it Really a Liver Carcinogen?	34
2.5.1	Introduction	34
2.5.2	History	34
2.5.3	Genotoxicity Revisited	35
2.5.4	Alternatives to Cyproterone Acetate.	37
2.5.5	Epidemiology	38
2.5.6	Comment and Conclusion	38
2.6	Acitretin and the Pregnancy Postponement Problem	39
2.6.1	Introduction	39
2.6.2	History	39

2.6.3	Etretinate Formation From Acitretin	41
2.6.4	Reflection and Discussion	42
2.6.5	Epidemiology	44
2.6.6	Comment and Conclusion	45
2.7	Is Oxazepam Carcinogenic?	45
2.7.1	Introduction	45
2.7.2	History	46
2.7.3	Reflection and Discussion	48
2.7.4	Comment and Conclusion	52
3	Reflection and Discussion	53
3.1	Introduction	53
3.2	'Unity of Life' Paradigm	55
3.3	Protocol Toxicology	56
3.4	<i>In Vitro</i> Versus <i>in Vivo</i> Toxicology	57
3.5	Integrative Toxicology	58
3.6	Conclusion	60
3.6.1	Weakness	60
3.6.2	Strength	61
	References	62

1 Introduction

1.1 HISTORICAL BACKGROUND

Toxicology is the science of chemically induced harmful effects to humans, to their domestic animals or plants, or to the web of nature at large. Toxicology is a subdiscipline of natural science and as such should ideally not beget non-sense. Yet the title of this essay will, in many biomedical colleagues, evoke feelings of recognition. The reason is that toxicity assessment is more than toxicology alone: it is the judicious assembly and interpretation of the results of toxicity tests, to conceive a coherent, consistent picture of the health effects of the substance under investigation. Here, the scientist can demonstrate his or her human fallibility and inadequacies.

In this essay we limit our discussion to active substances used in human medicine. Although fundamentally and technically there is only one toxicological science, the assessment procedures for human medicinal products differ from those for pesticides and other products potentially producing residues in food or in the environment.

To understand the present, one should study the past. The meaning of the ancient Greek word 'farmakon' was originally 'magic' or 'spell'. By way of 'magic potion' its main meaning became 'medicine'. From this denotation the term 'farmakon toxikon' was derived: the 'arrow poison' ('toxikon' means 'bow and arrows'), later generalized to 'poisonous substance' (Muller, 1933). To avoid the use of the ambiguous word 'drug', bioactive substances in this review will be denoted by the term 'pharmakon' (plural: 'pharmaca').

From prehistoric times until the renaissance, no distinction was made

between the sciences of materia medica and poisons. The Chinese and the Indians used an extensive but confusing body of materia medica. The Egyptians however succeeded in codifying their materia medica and putting dosage on a quantitative basis (Leake, 1975). In Greek and Roman antiquity pharmaca played only a small role in the practice of medicine compared with diet and other regimens of life (Leake, 1975). However, a large body of empirical knowledge on poisons developed that was readily used for private or public purposes. Strikingly, there was little need for experimental animals, despots having opponents, slaves and criminals, convicted or not, available for trying out poisons (Ackerknecht, 1977; Gallo and Doull, 1991; Milles, 1994).

Biomedical use of animals as experimental models for the human, taking the 'unity of life' for granted, only started in the seventeenth century with, e.g. Harvey (sheep, blood circulation), and developed further in the eighteenth century with, e.g. Spallanzani (birds, digestion) and Galvani (frog, electrophysiology). Orfila, in his embracing study of toxic substances published in 1814 and 1815, sacrificed 4000 dogs to study toxicity to humans (Holmstedt and Liljestrand, 1963). One can detest this mass sacrifice, but as a model for the human in acute studies it was a good choice. Moreover, sticking to one species allowed comparison of substance toxicities.

Buchheim and Claude Bernard seem to have been the first to give thought to use of animals to predict pharmacological or toxic effects in humans. Bernard, whose *Introduction à l'Étude de la Médecine Expérimentale* (1865) is still a treasury of fundamental biomedical wisdom connects basic considerations with practical advice regarding design as well as conduct and evaluation of experiments (Bernard, 1946). (Fortunately for non-francophones there is an excellent English translation of this fundamental textbook (Bernard, 1957).) Moreover Bernard developed the idea of the 'milieu intérieur', the constancy of which was the condition for life for higher animals. ('La fixité du milieu intérieur est la condition de la vie libre, indépendante', cited from Bell *et al.*, 1959.) In the 20th century this was extended by Cannon to 'homeostasis' (Cannon, 1963), an important concept, because symptoms of toxicity indicate potentially irreversible disturbance of homeostasis in the organism.

Buchheim, in his *Lehrbuch der Arzneimittellehre* (1853–1856) accepts the use of animals despite differences between the human and animals known to him. He especially recommends study of a substance in several animal species to unravel the essentials of its mechanism of action in the human (Buchheim, 1856) and considers comparative pharmacology as essential for understanding human pharmacology.

In several old books on toxicology (Herrmann, 1874; Lewin, 1899; Meyer and Gottlieb, 1911), or in books on the history of medicine or pharmacology (Holmstedt and Liljestrand, 1963; Hastings, 1974; Ackerknecht, 1977) no arguments are found for explicitly accepting animals as experimental models

for the human. Only much later this point was taken up again, e.g. by Calabrese (1984). So one has to assume that toxicology, amongst other biomedical sciences, has largely bluffed its way into animal experimentation, unmistakably with quite some success.

One milestone in the development of toxicology still has to be mentioned. There has been, probably throughout the ages, a notion of a dose-response relationship: 'More poison is worse'. It was, however, the renaissance physician Paracelsus who grasped the essence of toxicity when he wrote: '. . . Alle Dinge sind Gift und nichts ohn Gift. Allein die dosis macht, dass ein Ding kein Gift ist. . .' (Deichmann *et al.*, 1986), which translated in English corresponds with 'All substances are poisons and nothing (is) without poison(ousness). Only the dose makes that a substance is not a poison . . .'. This revolutionary view has been shorthanded to the Latin adagium 'Dosis solum facit venenum' (the dose only makes the poison). With this insight the quantitative basis for toxicology was laid.

That this basic insight nevertheless still has to be hammered again and again into the heads of pharmacotherapists – professionals or amateurs – is illustrated by the misuse of megadoses of pyridoxine (vitamin B₆), not to mention Pauling's use of L-ascorbic acid in this context. Applied without really supporting evidence in a variety of neuropsychiatric conditions (cf. Schaumburg *et al.*, 1983) it has caused neurotoxicity. This is the more amazing because there is a body of literature on pyridoxine neurotoxicity from 1942 until well into the 1980s at least (Antopol and Taylor, 1942; Cohen and Bendich, 1986). These data have been disregarded by enthusiastic empirists. A regrettable lack of 'Good Literature Search Practice' shown in many empirical therapies.

1.2 DEVELOPMENT OF MODERN TOXICOLOGY

Since the nineteenth century, toxicology has developed like other life sciences along positivist lines and with an increasing speed. Especially in the last half of this century, it grew in response to requirements of industrial hygiene and of industrial production of synthetic raw materials and pharmaca. So toxicology started to share responsibility for the social implications (industrial medicine, public health) of the expansion of chemical industry and of the use of its products.

This responsibility materialized in the development of predictive sub-disciplines of toxicology, such as the assessment of chronic toxicity and carcinogenicity. Herein the concept of 'unity of life' was less simply applicable than in acute studies and species differences increasingly became a limitation to prediction. Herein toxicology necessarily became dependent on the growth of other sciences for its development (e.g. analytical chemistry, clinical chemistry, histopathology) which had to provide methods to support the

interpretation of slowly developing symptoms of toxicity. So toxicology has become a superscience based upon a multitude of basic sciences, such as physiology, cell biology and biochemistry, and upon auxiliary sciences, such as analytical chemistry, statistics and laboratory animal science.

The social role of toxicology, although being an important stimulus for its growth, has not been without drawbacks. In the second half of this century, the development of regulatory toxicology introduced an element of formalism, leading to 'cookbook toxicology'. So, expressed in an exaggerated way there grew a dichotomy between flexible scientific toxicology and a more rigid industrial/regulatory practice of toxicology. The latter was a consequence of the responsibilities looming large over both innovating industry and regulatory authorities. Where the weight of responsibility alone might induce rigidity, this property was further stimulated in reaction to incidents when eager young scientists, seeking for social relevance in their work, started crying 'Wolf!' without sufficient supporting data. In such cases, as has happened often with sciences with social implications, the boundaries of responsible science were transgressed. For political reasons, under pressure by the media or for opportunistic motives, results have been published which did not satisfy the requirements of an integrated approach to potential toxicity.

Indeed, the present structure of toxicology, with its numerous sub-disciplines, carries the danger of shortcuts. As an example, an *in vitro* genotoxicity experiment can only identify a hazard, and is inadequate as evidence for a risk of toxicity if not accompanied by *in vivo* genotoxicity studies, toxicokinetic studies in the laboratory animal species used and in the human, and finally integrated into a benefit/risk assessment. Disquieting results, leaked to the general press, may have irreversible social or economical consequences. Later nuancing of the results mostly cannot reverse the course of events. It will only add to the feelings of insecurity of the general public not knowing whom and what to believe.

A toxicology book for the general public has been written by Zbinden (1985), which, unfortunately, is only accessible for readers well versed in German. Such a book in English would greatly improve the public understanding of the trial-and-error process in toxicity assessment.

So now we have reached the point where we can discuss not only the sense of toxicity assessments, but also their occasional non-sense. This discussion, on the basis of illustrative examples, also should show us the way to prevent production and spread of occasional non-sense.

2 Cases of Sense or Non-sense in Toxicity Assessment

Below, a number of exemplary cases of pharmaca will be discussed, showing use of sense or, regrettably, appearance of non-sense in toxicity assessment.

They are arranged in a roughly chronological order. Roughly because several cases overlap in time and can therefore not be exactly arranged in sequence.

2.1 PRONETHALOL

2.1.1 Introduction

Pronethalol (Alderlin®) was developed in the late 1950s/early 1960s as a β -blocker to treat hypertension. It received widespread use in several countries, but no approval in the United States, because it was reported to produce cancer in mice. The fate of pronethalol has to be seen in the light of the knowledge at that time. At present, many compounds are still on the market despite tumour findings in rats or mice. The decision ultimately to withdraw the compound was derived from suggestions from other structural analogues. Direct testing appeared to be difficult. Because of lack of knowledge the worst-case scenario was applied, leading to the decision in 1963 to stop further development.

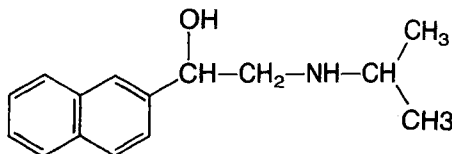

Pronethalol hydrochloride

2.1.2 History

Pronethalol (up to 200 mg kg⁻¹) caused lymphomas (most commonly thymic in origin) and reticulum cell sarcomas (especially of the uterus and liver) in mice (Paget, 1963). No details were given about the strain. The earliest tumours in the thymus appeared within 3 months of commencing administration. The data in Table 1 are derived from the report of Howe (1965).

No tumours are observed after 2 years' administration to rats and 1 year to dogs (Paget, 1963). It is not clear from the publications whether in the publications of Howe (1965) and Paget (1963) the same data are mentioned. According to M. J. Tucker (personal communication, 1996) it is probable that these authors refer to the same study.

Further reports on carcinogenic effects of β -blockers were not published in the open literature until 1980 (for a review see Jackson and Fishbein, 1986). Apparently, other compounds from the same pharmacological class have been shown to be tumorigenic in laboratory animals since regulatory

TABLE 1
Pronethalol. Incidence of thymic tumours in a mice study (Howe, 1965)

% Pronethalol in diet	Thymic tumours male mice	Thymic tumours female mice
0.2	1/25	2/25
0.1	3/25	4/25
0.05	0/25	3/25
0 (control)	1/25	0/25

authorities for pharmaceuticals have required that evaluation of carcinogenic potential for β -blocking agents be carried out in life-span studies in rats and mice prior to extensive clinical trials (see Faccini *et al.*, 1981).

The study of Alcock and Bond (1964) confirmed the appearance of tumours early in life after the administration of pronethalol. The authors reported that after only 10 weeks' treatment with pronethalol tumours of the thymus began to appear. This early development of thymic tumours led to the suggestion that specific metabolites with reactivity towards DNA might be formed in mice. The major metabolites were however found to be similar in rats and mice (Hathway, 1970). So, it was unlikely that these metabolites were causative agents of the tumorigenicity.

Theoretically, formation of a minor metabolite, an ethyleneimine-derivative, a class of compounds known to be carcinogenic, is possible. Howe (1965) showed, in mice, the formation of an ethyleneimine from a structural analogue of pronethalol, the β -chloroethylamine derivative. This β -chloroethylamine derivative induced in male mice a much higher incidence of thymic tumours (20/25 in male mice fed with 0.2%, after 2 months reduced to 0.15%; no tumours in the male control group). In female mice the incidence (4/25) was the same in the control group and the treated group. However, no evidence was found in mice *in vivo* that the ethyleneimine derivative was a minor or transient metabolite of pronethalol. Furthermore, ethyleneimine formation is also possible for labetalol and sotalol, which were found to be negative in carcinogenicity tests (for references see Faccini *et al.*, 1981).

Pronethalol has been subjected to a number of mutagenicity tests, both *in vitro* and *in vivo*. Cintokai *et al.* (1978) reported a negative result in the dominant lethal test in mice up to a dose of 250 mg kg⁻¹. On the other hand, the β -chloroethylamine derivative, the ethyleneimine-forming analogue mentioned above, was positive in this test. No effect of either chemical (with and without microsomal activation) was seen on Chinese hamster bone

marrow cell chromosomes and pronethalol was negative in the Ames test using *Salmonella typhimurium* strains TA1535 and TA1537. Similar results were reported in the micronucleus test in mice (Okine *et al.*, 1983).

The tumorigenic effect in mice could not be reproduced in Carworth CF/1 mice in a dose of $150 \text{ mg kg}^{-1} \text{ day}^{-1}$ (Newberne *et al.*, 1977). While a high incidence of lymphoreticular tumours was observed, there was a higher incidence in controls than in pronethalol-treated animals. The authors suggest that the earlier findings of carcinogenicity of pronethalol were possibly fortuitous or related in some manner to the strain of mouse used. Unfortunately, it remains unclear which mouse strain was used by Paget (1963).

Cooper *et al.* (1985) cited a publication of Tucker (1968) describing that pronethalol induces in rats leukaemia (reticulum cell, lymphatic and myeloid) which show periportal (lymphatic) and generalized (myeloid) infiltrations of the liver. Mammary tumours would have been produced also. A weak promotor-like effect in the rat as the induction of ethoxyresorufin de-ethylase was described by Ioannides *et al.* (1979). However, M. J. Tucker (personal communication, 1996) has written that no tumour findings were present in rats and that the citation was wrong.

The amount of tumours induced by pronethalol as described in the first study by Howe (1965) appeared to be low. Taking into consideration the second study with β -chloroethylamine, the incidence in the female group was not enhanced at all. Also in the male mice the incidence remained in the lower range, at least in comparison with the incidence after β -chloroethylamine (20/25).

2.1.3 Comment and Conclusion

According to the state of the art in the 1960s, the withdrawal of pronethalol from the market may be considered as appropriate. Ashby (1996) stresses that in that period (before 1978) all carcinogenic effects were thought to be caused by DNA damage, i.e. by a genotoxic action. The development of the tests for genotoxicity and the recognition of non-genotoxic carcinogenesis only started in that period. Moreover, in 1965 the regulatory authorities (especially in Europe) had only a short experience in evaluation of carcinogenicity. Also, knowledge about species specificity in carcinogenesis was hardly present. The carcinogenicity data were published as a short letter to the Editor of the British Medical Journal. In the same issue, the results of three new clinical trials were published but the company decided to confine its use to established life-threatening conditions.

The present knowledge on carcinogenesis would have allowed another choice to be made.

2.2 WITHDRAWAL OF THE ANTIDEPRESSANTS ZIMELDINE, NOMIFENSINE AND INDALPINE

2.2.1 Introduction

Post-marketing surveillance concerns the assessment of the cause of adverse events occurring with newly marketed pharmaceuticals. This is an essential component of the identification of safety issues after, and in addition to animal toxicity testing and the monitoring of adverse events in the context of clinical trials in selected patient populations. The last two modes of studying the safety profile of a new chemical entity often lack sufficient sensitivity to predict rare toxicities in large patient populations to be treated after registration. In the past, several efficacious pharmaceuticals have been withdrawn from the market owing to serious adverse events in patients that had not been detected in premarketing toxicity screening, neither in laboratory animals nor in humans. This obviously is the toxicologist's nightmare. It can be exemplified by considering some rather recent antidepressants.

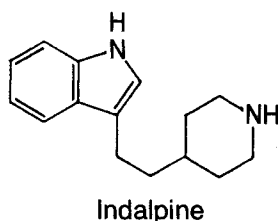
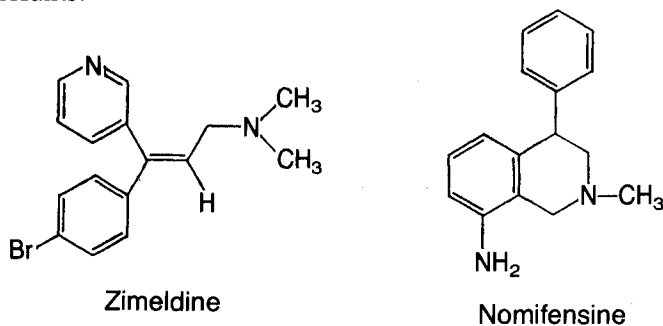

2.2.2 History

In the 1980s, three antidepressants were withdrawn from the market because of unexpected, probably immunologically mediated, toxicities: zimeldine, indalpine, and nomifensine (Henry and Martin, 1987). The benefits of using these pharmaceuticals no longer outweighed the risks. Zimeldine, a pyridylallylamine, was the first selective neuronal serotonin inhibitor to be used in

clinical practice. It was introduced in 1982, but had unfortunately to be withdrawn world-wide in 1983. A hypersensitivity reaction was noted in a small percentage of zimeldine-treated patients, which, in most cases, regressed with no specific treatment. These patients showed febrile reactions in connection with liver function disturbance (Kristofferson and Nilsson, 1989). In rare cases, however, these reactions were complicated by the development of a serious neurological disorder resembling the Guillain-Barré syndrome (Anonymous, 1983, 1985b; Nilsson, 1983; Henry and Martin, 1987). The involvement of the immune system was indicated by positive reactions to zimeldine *ex vivo* seen with lymphocytes from patients who developed severe hypersensitivity reactions upon zimeldine treatment and from a few exposed factory employees who became allergic to the compound (Kristofferson and Nilsson, 1989). The risk of developing the invalidating and sometimes life-threatening Guillain-Barré syndrome was increased about 25-fold among patients receiving zimeldine compared with the natural incidence of the disorder (Fagius *et al.*, 1985). Some years later, statistical research revealed that zimeldine indeed was the cause of at least nine cases of Guillain-Barré reported in the literature, confirming the rationale of removing zimeldine from the market (Naranjo *et al.*, 1990).

Indalpine (a dopamine/noradrenaline reuptake inhibitor) and nomifensine (another serotonin reuptake inhibitor) were also withdrawn from medical practice for reasons of immunotoxicity. Indalpine appeared to be associated with the occurrence of agranulocytosis, particularly in elderly patients (Henry and Martin, 1987). Nomifensine was withdrawn because of the induction of immune haemolytic anaemia and intravascular haemolysis (anonymous, 1985b; anonymous, 1986; Henry and Martin, 1987).

2.2.3 *Comment and Conclusion*

The withdrawals of zimeldine, indalpine and nomifensine indicate that the animal toxicity studies routinely performed upon request of the regulatory authorities in the premarketing phase are not adequate to detect the immunostimulatory potential of pharmaceuticals underlying systemic hypersensitivity and autoimmune phenomena. This being so, zimeldine, in particular, has become a model compound for the development of new reliable animal test systems, although the mechanism by which it induces immunotoxicity has been elucidated only in part. Zimeldine was shown to induce a strong and persistent response in the popliteal lymph node assay in mice (Thomas, 1989; Thomas *et al.*, 1989, 1990). In this assay, local popliteal lymph node reactions are measured after injection of the test agent into the foodpad of mice. Of course, many other pharmaceuticals found to induce unexpected autoimmune-like diseases in man have also been employed in validating the assay (Bloksma *et al.*, 1995). Today, the popliteal

lymph node assay in mice is considered the most promising animal test to detect allergenic and autoimmunogenic pharmaceuticals, although a major drawback is the limited opportunity for drug metabolism in this assay (Bloksma *et al.*, 1995). This nicely illustrates how a certain pharmaceutical that shows unexpected toxicity in the human may be put to good use as a tool in developing methods to detect this toxicity. Such new tests may subsequently be employed as additional safeguard.

2.3 THE TAMOXIFEN DISCUSSION

2.3.1 Introduction

Tamoxifen (Nolvadex®) is a nonsteroidal anti-oestrogenic agent used therapeutically as a first-line drug in the treatment of oestrogen receptor-positive advanced breast cancer since the 1970s (Anonymous, 1985a). It is a triphenylethylene drug, which is structurally related to diethylstilbestrol (DES). Tamoxifen exerts both anti-oestrogenic and oestrogenic effects, depending on the species and target tissue. It is a well-tolerated compound with a low level of short-term adverse effects, particularly when compared with cytotoxic anticancer agents (Catherino and Jordan, 1993). This opinion on the safety of tamoxifen has existed for a long time, although detailed toxicological studies (particularly chronic ones) were not available until the beginning of the present decade.

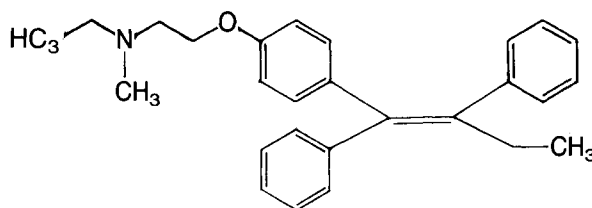

Tamoxifen

For several years now, a discussion has continued about the prophylactic use of tamoxifen in otherwise healthy pre- and post-menopausal women being at increased risk for developing breast cancer (Jordan, 1995; Smith and White, 1995). A major concern with this long-term preventive use of tamoxifen of course is the question whether it will cause more health problems than it will prevent (King, 1995; Williams *et al.*, 1993). This prompted a reconsideration of the toxicology of tamoxifen, particularly in view of its analogy to DES (King, 1995).

2.3.2 History

A series of independent rodent carcinogenicity studies were initiated in the late 1980s, which were all published in 1993 (Greaves *et al.*, 1993; Hirsimäki *et al.*, 1993; Williams *et al.*, 1993). These experiments showed that tamoxifen induces hepatocellular adenomas and carcinomas in rat liver of both sexes. However, regulatory authorities were ahead of the scientific community in already being aware some years earlier of still unpublished carcinogenicity studies documenting that tamoxifen is a hepato-carcinogen in female rats. They also possessed confidential reports by the company documenting the lack of carcinogenic potential in mice.

Early tests indicated the absence of genotoxic activity of tamoxifen *in vitro*. These tests were an Ames bacterial gene mutation assay, a mammalian cell gene mutation assay, a human lymphocyte chromosome aberration assay and an unscheduled DNA synthesis (UDS) assay in HeLa cells (all mentioned by Tucker *et al.*, 1984). Initially, tamoxifen was thought to induce rat liver tumours due to its oestrogenic effects. As it did not induce liver tumours in mice (Tucker *et al.*, 1984), it was first classified as a rat specific, non-genotoxic liver carcinogen. This was considered to pose no risk regarding the therapeutic use of tamoxifen in breast cancer patients. However, the rapidity of development of malignant tumours in the rat carcinogenicity assay in a manner suggestive of DNA-reactive compounds was pivotal in the company's initial decision not to proceed with the use of tamoxifen in the treatment of non-life-threatening conditions (Greaves, 1996).

In the late 1980s, several case reports were published of endometrial abnormalities in women receiving tamoxifen therapy in breast cancer. These include endometrial hyperplasia, polyps and cases of endometrial carcinoma (Catherino and Jordan, 1993; King, 1995). Together with the proposed use of tamoxifen in non-life-threatening preventive indications, these potentially alarming findings caused a rush of toxicological publications on the presumed carcinogenicity of tamoxifen and its mechanism of action, which has not abated yet. The increased incidence of endometrial tumours in women given tamoxifen may be mediated by genotoxic or hormonal factors (i.e. partial oestrogen receptor agonism) or a combination of both. The elucidation of the mechanism of action is pivotal in risk assessment, because it will provide important information about the question whether or not a safe threshold level may be postulated.

2.3.3 The Genotoxicity Debate

The classification of tamoxifen as a non-genotoxic rat carcinogen proved to be questionable when the first reports of the presumed genotoxicity of tamoxifen were published in 1992. First, tamoxifen was shown to induce covalent DNA adducts in female rats. Male rats have received little attention in this respect.

In female Sprague Dawley rats, two liver DNA adducts were formed after a single intraperitoneal injection of 20 mg kg^{-1} body weight tamoxifen. Adduct levels increased five- to seven-fold and 10- to 15-fold after three and six injections, respectively (Han and Liehr, 1992). Second, the genotoxic potential of tamoxifen was studied in several rat test systems. In female Fischer F344/N rats, tamoxifen caused a time-dependent increase in the level of adducts after 7 days of dosing. A dose-response relationship was demonstrated over the range of $5\text{--}45 \text{ mg kg}^{-1}$ body weight per day. Adducts were not detected in uterus DNA (White *et al.*, 1992). In the same publication, the investigators showed that exposure of rat hepatocytes to tamoxifen *in vitro* resulted in the induction of unscheduled DNA synthesis, when preparations from rats were used that had been pretreated with tamoxifen *in vivo* (White *et al.*, 1992). There was no response in the standard UDS test without predosing of the animals. Apparently, the adducts were subject to repair. Another conclusion from these experiments is that tamoxifen needs to be activated metabolically before it can exert its presumed genotoxic action. The lowest dose level associated with adduct formation was 5 mg kg^{-1} ; this is about 10-fold higher than the human therapeutic dose ($0.3 \text{ mg kg}^{-1} \text{ day}^{-1}$). However, in rats a four- to five-fold higher dose of tamoxifen needs to be given to achieve serum levels similar to those observed in humans (Robinson *et al.*, 1991), and human therapy continues for many years particularly where tamoxifen is taken prophylactically. The major difficulty in interpreting these animal findings is that while DNA adduct formation is evident, adduct formation alone provides no convincing evidence that it results in DNA damage.

Direct evidence of genotoxicity (i.e. DNA damage exceeding the capacity of DNA repair) is scarce. First, experiments have been performed in human lymphoblastoid cell lines transfected with various inducible human cytochromes P450 being able to metabolize tamoxifen. In these cells, tamoxifen induces an increase in micronucleus formation in a dose-dependent manner (White *et al.*, 1992). Again, these results stress that metabolic conversion of tamoxifen is a prerequisite for inducing genotoxicity. Second, tamoxifen induced karyotypic instability including aneuploidy, improper mitotic spindle formation and chromosome aberrations in rat hepatocytes *ex vivo* (Sargent *et al.*, 1994). This clastogenic action of tamoxifen may be associated with malignant conversion of tumours. Third, evidence of genotoxicity is manifest in the presence of a high frequency of *p53* tumour suppressor gene mutations in hepatocellular carcinomas from rats treated with tamoxifen (Vancutsem *et al.*, 1994). The *p53* gene is the most commonly mutated gene in human neoplasms (Holstein *et al.*, 1991).

Apparently, tamoxifen is capable of initiating tumour induction through a genotoxic mechanism in rat liver. The contribution of its hormonal action in the pathogenesis is unclear, although the mitogenic potential of tamoxifen may contribute to tumour formation. While the previously mentioned

publications highlight the genotoxic properties of tamoxifen in rats, an abstract presented at a scientific meeting documented the failure of tamoxifen to induce increased liver DNA adduct formation in breast cancer patients compared with controls following 2 months to 3 years of exposure to tamoxifen (Martin *et al.*, 1994). Unfortunately, this study involved only seven livers of human patients being treated with tamoxifen. Another interesting study was performed by Phillips and co-workers (1996a) comparing the amount of DNA adducts formed in primary cultures of rat and human hepatocytes upon incubation with tamoxifen or *o*-hydroxytamoxifen, the principal intermediate in the metabolic activation of tamoxifen, presumably leading to the formation of the proximate carcinogen in the rat. Whereas DNA adducts were readily detected in rat hepatocytes treated with tamoxifen, they were not found in tamoxifen-treated human hepatocytes. Furthermore, treatment of human hepatocytes with *o*-hydroxytamoxifen resulted in DNA adduct formation at levels about 300-fold lower than those in rat hepatocytes. This suggests that the metabolite is either detoxified more rapidly or activated less readily in human hepatocytes than it is in rat cells (Phillips *et al.*, 1996a). It is unclear at present to what extent the same differences would be expected *in vivo*, particularly after prolonged administration.

These seemingly reassuring *in vitro* findings do not preclude that tamoxifen administration results in DNA adduct formation in human tissues other than the liver, such as the uterine endometrium. It is well known from studies with other carcinogens that different organs are susceptible in different species. Recent data, however, strongly suggest that tamoxifen lacks genotoxic properties in human endometrium as no DNA adducts were detectable in this tissue in 18 patients undergoing long-term treatment with tamoxifen (Carmichael *et al.*, 1996). Additional *in vitro* experiments with human endometria exposed in organ culture revealed DNA adducts upon incubation with *o*-hydroxytamoxifen, whereas no adducts were detectable from treatment with high concentrations of tamoxifen itself. Although the genotoxic metabolite *o*-hydroxytamoxifen is generated in human endometrial tissue, the levels attained in women are apparently too low to give rise to detectable DNA adducts (Carmichael *et al.*, 1996). Furthermore, therapeutic doses of tamoxifen do not form detectable DNA adducts *in vivo* in white blood cells of breast cancer patients or in healthy volunteers. Unfortunately, the latter findings were obtained in a fairly limited number of subjects (i.e. seven patients and three female controls) (Phillips *et al.*, 1996b). Individual susceptibility to tamoxifen treatment with respect to carcinogenicity is probably influenced by the efficiency of DNA repair and the extent of cell proliferation. Therefore, it still cannot be excluded that, due to genetic polymorphism, in a small number of women given tamoxifen over long periods of time, sufficient DNA damage will be produced resulting in cancer in the liver or in any other tissue (Smith and White, 1995).

2.3.4 *The Toremifene Alternative*

The concerns about the long-term use of tamoxifen, especially for non-cancer indications, have led to an interest in developing equally effective compounds with a better safety profile. Interestingly, the structurally related triphenylethylene anti-oestrogen toremifene, having similar oestrogenic effects on the rat liver as tamoxifen (Kendall and Rose, 1992), does not induce liver tumours in female rats after 52 weeks of treatment in contrast to toremifene at equimolar dose levels (Hirsimäki *et al.*, 1993). Toremifene treatment yields a lower level and a more limited spectrum of DNA adducts in female rat liver than tamoxifen. This would suggest that the hormonal action of tamoxifen is not sufficient for the induction of hepatocellular carcinomas in rat liver. However, toremifene does possess genotoxic activity (although less than tamoxifen) in a human lymphoblastoid cell line expressing selected human P450s (Styles *et al.*, 1994). Furthermore, toremifene induces hepatic aneuploidy *in vivo* to a similar extent as tamoxifen in female rats (Sargent *et al.*, 1996). No further data on the genotoxic potential of toremifene have been published.

2.3.5 *Risk Assessment*

In a recent review of the current literature, it is confirmed that tamoxifen treatment is associated with an increased incidence of proliferative and neoplastic changes in the human endometrium. There is a 1.3–7.5 relative risk of developing endometrial carcinoma in tamoxifen-treated patients. The authors correctly conclude, however, that despite the increased risk of developing endometrial cancer in breast cancer patients receiving tamoxifen, the net benefit of the treatment greatly outweighs the risk. Further studies are required to assess the long-term benefit and adverse effects of possible prophylactic tamoxifen programmes (Daniel *et al.*, 1996).

The International Agency for Research on Cancer (IARC) is about to publish a review on the evidence on the potential carcinogenicity of tamoxifen. Three major conclusions resulted from the evaluation process. First, there is conclusive evidence that tamoxifen reduces the risk of contralateral breast cancer in women with a previous diagnosis of unilateral breast cancer. Second, there is sufficient evidence in humans for the carcinogenicity of tamoxifen in increasing the risk of endometrial cancer. In addition, it was concluded that there is inadequate evidence in humans that tamoxifen affects the risk of other cancers. Third, there is sufficient evidence in experimental animals for the carcinogenicity of tamoxifen. The IARC does not take a formal position on the underlying mechanism of endometrial tumour formation, whether it is genotoxic or not.

It is clear that the presence of a growing body of evidence for a genotoxic

action of tamoxifen, together with its carcinogenic potential in rats and presumed carcinogenic action in humans make tamoxifen a poor choice for the chronic preventive therapy of breast cancer. If a non-genotoxic mechanism were to be proven in humans, it still is debatable whether there would exist a satisfactory margin of safety.

2.3.6 Comment and Conclusion

The tamoxifen story is a good example of sense in toxicology: the preclinical research was initiated and progressed simultaneously with the development of new clinical applications. At least in part, this had to do with the great interest of academia and cancer research institutions in tamoxifen. This created a rapid outburst of scientific publications on the so-called 'tamoxifen controversy': tamoxifen being a clinically promising preventive agent as well as a rat carcinogen (Pitot, 1995).

2.4 THE NOSCAPINE GENOTOXICITY SCORE

2.4.1 Introduction

Noscapine or narcotine was discovered in 1817 as an accompanying alkaloid in opium. For decades it was considered to be devoid of any observable biological activity; only in the course of this century was its antitussive action detected. It is now the active substance in many 'over the counter' antitussive products. In the USA, noscapine in 1987 was classified as a non-monograph substance, which implies that for new products containing noscapine a complete 'new drug application' has to be submitted (Gatehouse *et al.*, 1991). In 1988, Ishidate, a Japanese investigator, reported a high level of polyploidy in *in vitro* tests with noscapine. The results of Ishidate were considered disputable by Gatehouse *et al.* (1991), because he had used a cell line with an abnormally large number of chromosomes in the diploid state in the

Noscapine

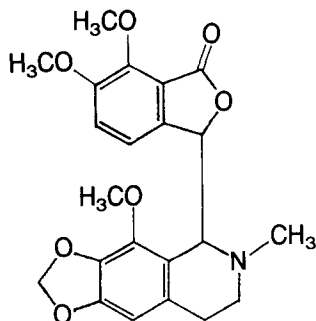

control groups; Gatehouse *et al.* repeated these studies with another cell line.

2.4.2 History

In September 1989, the European medicines authorities were informed by a pharmaceutical manufacturer that studies on noscapine, carried out by other manufacturers, had shown genotoxicity. In fact, effects were limited to a clear-cut increase in polyploidy: in the Chinese hamster cell line V79 after incubation *in vitro* with noscapine concentrations of 15–60 mg l⁻¹ during 24 and 48 h and in human lymphocytes after incubation *in vitro* to 120 mg l⁻¹ during 24 h. All in all, in 1989, it concerned isolated observations, reported summarily as posters (Carlton *et al.*, 1990; Gatehouse *et al.*, 1990) and not yet supported by *in vivo* animals tests nor by toxicokinetic and human pharmacokinetic data. So, that time, it was impossible to put the results into perspective. The pharmaceutical industry and trade were duly informed by some national authorities. Sloppy use of terminology – confusing genotoxicity with mutagenicity – added to feelings of insecurity within industry, trade and other authorities.

Between the authorities in Europe there were large differences in perception of the risk to the patient ensuing from the above observations. This impeded the development of a concerted policy. So several authorities did not dare to take the slightest risk, whereas other ones – taking into account the record of this old pharmacon – refused to take action on this meagre basis without additional supporting evidence. New results from an *in vitro* chromosome aberration test with human lymphocytes and an *in vivo* bone marrow metaphase test in rats did not suggest genotoxic or mutagenic effects.

2.4.3 Noscapine Pharmacokinetics

Data on the human pharmacokinetics of noscapine had already been published in the open literature (Dahlström *et al.*, 1982) and confirmed the expected rather low plasma concentrations. Noscapine is almost completely absorbed and is distributed well in tissue (V_{area} : 4.7 ± 0.91 kg⁻¹). The binding to proteins is extensive: about 95% to plasma albumin (large capacity) and to α_1 acid glycoprotein (large affinity). *In vitro* there is an equilibrium between noscapine and noscapine acid, i.e. the product of lactone ring opening (Karlsson and Dahlström, 1990). Noscapine exhibits presystemic elimination (Cl_p : 1.30 ± 0.16 l kg⁻¹ h⁻¹) resulting in a systemic availability of 0.30 ± 0.07 (Karlsson *et al.*, 1990). A dose dependence of clearance has been found after administration of supra-therapeutic doses,

presumably by saturation of presystemic elimination. Decrease of clearance after repeated doses suggests a product inhibition mechanism. Excretion occurs largely as biotransformation products via the urine. Noscapine is excreted in breast milk only in very small amounts (Olsson *et al.*, 1986). Unfortunately, in 1989 mostly old data on the fate of noscapine in animals were available (Nayak *et al.*, 1965; Idänpään-Heikkilä, 1967, 1968), moreover largely focused on biotransformation and macro-autoradiography. More recent biotransformation studies by Tsunoda and Yoshimura (1979, 1981) do not give clues for metabolic activation of noscapine.

2.4.4 In Vitro Genotoxicity Studies

In the course of 1991 the studies referred to above were published in full (Gatehouse *et al.*, 1991; Mitchell *et al.*, 1991). In their studies, Gatehouse and collaborators (1991) showed the occurrence of polyploidy in Chinese hamster V79 cells from 30 and 15 mg l⁻¹ onwards (incubation for 24 and 48 h, respectively) and in human peripheral lymphocytes from 60 mg l⁻¹ onwards (incubation 24 and 48 h, respectively). Spindle damage, considered to lead to polyploidy, was caused by similar concentrations in V79 cells and human fibroblasts *in vitro*. The results from an aneuploidy assay in hybrid human/mouse R3-5 cells were positive in the same concentration range. In their discussion, Gatehouse *et al.* (1991) link these effects via literature citations with possible tumour production, malignancy, spontaneous abortion and birth defects. It was already known at that time that an *in vivo* micronucleus test was negative (Furukawa *et al.*, 1989). Human pharmacokinetic data indicated low systemic noscapine concentrations (about 100 µg l⁻¹) during therapy (Dahlström *et al.*, 1982). Gatehouse *et al.* (1991) acknowledged that a systemic hazard might not therefore exist, but pointed to the possible contact of buccal and gastro-intestinal mucosa with high concentrations of noscapine. In doing this, they neglected the short duration of these contacts compared with the long incubation time (24 and 48 h) of the substance needed to induce polyploidy *in vitro* (cf. Mitchell *et al.*, 1991). Mitchell *et al.* (1991), in parallel with Gatehouse *et al.*, studied noscapine-induced polyploidy *in vitro*, using human lymphocytes. They also reported careful methodical studies and showed that incubation for 4 h was not sufficient to induce polyploidy. In addition, they showed that incubation of noscapine with a microsomal preparation from livers of Aroclor-treated rats abolished the capacity to induce polyploidy. Their sober conclusion is that the capacity of noscapine to induce polyploidy *in vitro* is unlikely to produce a hazard in the therapeutic use of noscapine.

Porter *et al.* (1992) observed morphological transformation and changes in chromosome number in cultures of 'immortal' Syrian hamster skin fibroblasts, incubated in media containing noscapine in concentrations of

30–120 mg l⁻¹ for 24 and 48 h. From these limited *in vitro* results and without any reference to toxicokinetic considerations the authors jumped to the conclusion that noscapine ‘may be considered a potential carcinogen’.

In 1992 toxicokinetic data on noscapine in mice became internally available to the regulatory authorities. Later, they were published in full in the open literature (Tiveron *et al.*, 1993). These data resulted from satellite groups of a study of aneugenic activity on mouse oocytes. Comparing the human therapeutic AUC¹ values (0.2 mg h l⁻¹) and the AUC values in the negative mice genotoxicity test (233 mg h l⁻¹ at 400 mg kg⁻¹) there is a difference of a factor of about 1000. It is also possible to calculate an AUC value as a measure for exposure in the *in vitro* tests: concentration times duration of exposure. For the Chinese hamster V79 cell line at 15 and 90 mg l⁻¹ this results in 360 and 2160 mg h l⁻¹ respectively, during 24 h of incubation. In other *in vitro* experiments the calculated exposure is in the same range. Thus, *in vitro* also there is a large difference in the human exposure.

2.4.5 In Vivo Mouse Oocyte Study

The main part of the mouse oocyte study of Tiveron *et al.* (published in full in 1993) showed that noscapine has no aneugenic activity in mouse oocytes. The authors carried out their study of mouse metaphase II oocytes after exposure of the animals to 20, 120 and 400 mg kg⁻¹ (maximum tolerated dose). No genotoxic effects were found. At the highest dose there was only a decrease of the mean number of oocytes harvested per female. The authors conclude that *in vivo* in the mouse, showing pharmacokinetics similar to that in the human, at doses producing about 1000 times larger exposure than during therapeutic use, no effects on chromosome physiology are found.

At the end of 1992, based upon the sum of published results (Dahlström *et al.*, 1982; Furakawa *et al.*, 1989; Gatehouse *et al.*, 1991; Mitchell *et al.*, 1991, Porter *et al.*, 1992; Tiveron *et al.*, 1993) it was officially concluded that there was no danger of genotoxicity in the therapeutic use of noscapine as an antitussive if taken in accordance with the instructions for use.

2.4.6 Comment and Conclusion

From a scientific point of view this episode was a storm in a teacup, but actually it almost killed a familiar ‘over the counter’ antitussive, produced uncertainty for consumers and industry and cost considerable money,

¹AUC is the area under the plasma concentration/time curve. It is an important pharmacokinetic characteristic.

time and effort in correcting premature conclusions and suggestions. Moreover, abandoning the use of noscapine meant, ironically, increased use of dextromethorphan, a substance pharmacologically not strictly comparable with noscapine (Karlsson *et al.*, 1988). Dextromethorphan has been associated with CNS side-effects and psychological dependence (Hinsbergen *et al.*, 1992; Wolfe and Caravati, 1995), although it is generally considered to be safe (Bem and Peck, 1992). Unfortunately, a dependable comparison of the safety of both substances is not available.

At the time it was disconcerting to witness how many experts rushed into the 'safety' of restrictive measures (which often appear to be irrevocable) on the basis of only a few isolated results which were uninterpretable without supporting *in vivo* animal, toxicokinetic and human pharmacokinetic data. Scarce resources had to be reallocated to produce the additional data needed to allow a more balanced picture of the toxicity of noscapine.

2.5 CYPROTERONE ACETATE: IS IT REALLY A LIVER CARCINOGEN?

2.5.1 Introduction

The synthetic steroid cyproterone acetate (CPA) was first synthesized in 1961. The compound has both anti-androgenic and progestational activity. CPA was introduced in the clinic in 1973 and has since been widely used as an active component in anti-androgenic and contraceptive drugs.

2.5.2 History

Since 1967, CPA was known to the regulatory authorities to increase the incidence of hepatomas in a rat carcinogenicity assay at the intermediate and high doses (i.e. 50 and 250 mg kg⁻¹ day⁻¹, respectively) in a dose-dependent manner, particularly in female animals (unpublished data). The term 'hepatoma' as used by the investigators comprised various stages of neoplastic transition from hyperplasia to adenoma, but seemed not to include malignancy. At the 10 mg kg⁻¹ day⁻¹ dose level, no proliferative lesions were seen

Cyproterone acetate

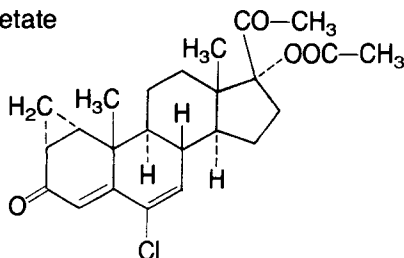

in the liver. The 50 and 250 mg kg⁻¹ day⁻¹ dose levels employed caused a dramatic loss of body weight, were severely hepatotoxic and considerably exceeded the therapeutic dose levels in humans, which range from approximately 0.02 to 5 mg kg⁻¹ day⁻¹. If allometric scaling based on interspecies differences in basal metabolic rate is applied, the apparent margin in rat versus human dose levels will be reduced four- to five-fold (Davidson *et al.*, 1986). A second rat carcinogenicity study employing lower dose levels (i.e. 0.04–2 mg kg⁻¹ day⁻¹) was negative. A summary of this study was published by Schuppler and Günzel in 1979. An unpublished carcinogenicity study in mice was negative at the same dose levels as the second rat study. Only recently, a carcinogenicity study in CPA-treated mice has been published. In this study, hepatocellular tumours developed in 44% of males and 22% of females dosed with CPA, compared with none in the controls. No conclusion could be drawn, however, on any sex preference, because of premature deaths in the females. In addition, 85% of both sexes dosed with CPA developed adenomatous polyps of the pyloric antrum and pancreatic islet cell hyperplasia (Tucker *et al.*, 1996).

Early reports indicated that CPA is negative in the Ames test with or without metabolic activation (Lang and Redmann, 1979). At that time unpublished reports were available to regulators demonstrating that CPA is negative in the hypoxanthine–guanine phosphoribosyl transferase (HGPRT) test with V79 cells and the *in vitro* chromosomal aberration assay in human lymphocytes irrespective of the presence of metabolic activation (Lang and Reimann, 1993). Further studies in the 1980s revealed that CPA is a potent mitogen and enzyme inducer in rat liver (Schulte-Hermann *et al.*, 1980, 1988; Schulte-Hermann and Parzefall, 1980), which are properties thought to be associated with tumour promotion. A liver foci assay for tumour-initiating activity in male rats, however, showed negative results (Schuppler *et al.*, 1983).

The body of evidence available in the 1980s was interpreted as that the CPA-associated increase in tumour formation was caused by a tumour-promoting activity being related to some non-genotoxic mechanism of no relevance to humans. The carcinogenic response in rats only occurred at high dose levels compared with the human therapeutic dose, leaving a satisfactory margin of safety. The animal data therefore were not considered to be prohibitive for the administration of CPA to humans. Moreover, the broad therapeutic use since 1973 gave no grounds to expect an increase of proliferative liver lesions in humans after administration of CPA.

2.5.3 Genotoxicity Revisited

In the early 1990s, the human safety of long-term CPA treatment was suddenly questioned as new findings were reported on the involvement of

DNA damage in the pathogenesis of CPA-mediated liver tumour formation casting doubt on the 'safe threshold' concept. Neumann and coworkers (1992) showed that CPA stimulates DNA repair synthesis *in vitro* in rat hepatocytes, suggesting that CPA is a DNA-damaging compound with possible tumour-initiating potential. The increase in DNA repair synthesis indeed may be possibly, but not necessarily, related to tumour-initiating potential. Being anxious about the potential impact of their experimental findings, the investigators stressed that the findings in rat liver were of unknown relevance to human liver (Neumann *et al.*, 1992). Nevertheless, this literature report caused a burst of subsequent publications further documenting the presumed genotoxic properties of CPA.

The compound was shown to generate DNA adducts in rat hepatocytes both *in vitro* and *in vivo* after single oral dosing, yielding approximately 100-fold higher DNA adduct levels in females (CPA 0.1–30 mg kg⁻¹) compared with males (CPA 3–100 mg kg⁻¹) (Topinka *et al.*, 1993). No adducts were detectable by ³²P-postlabelling in extrahepatic rat tissues (Topinka *et al.*, 1993). From these reports, it could not be excluded that the elevation in rat DNA adduct levels is not specific as it was unknown whether they were directly caused by CPA. A prerequisite for proper hazard assessment would therefore be a further characterization of the chemical composition of the CPA-associated DNA adducts (in order to see whether CPA itself is the substrate of DNA adduct formation). Furthermore, these investigations do not elucidate whether the adducts observed after CPA treatment are an essential prerequisite for the tumour formation anyway.

Deml *et al.* (1993) re-examined whether CPA had any tumour-initiating activity by employing an initiation-promotion model with female rats, which is based on a different protocol from the initiation-promotion model in male rats by Schuppler and coworkers (1983) mentioned before. A female model was thought to be more relevant than a male one in view of the gender difference in carcinogenic response in rats. In female rats, a positive response was seen only at high dose levels that were hepatotoxic in the long-term rat carcinogenicity assay (Deml *et al.*, 1993).

In 1994, a poster was presented at a national congress of Italian pharmacologists claiming genotoxic effects of CPA (expressed as an increase in DNA repair activity) in cultured human hepatocytes from surgical liver biopsies of three female donors; cells from one male donor showed no response at all (Martelli *et al.*, 1994). This poster, and also the published rat data, prompted the German regulatory authorities to classify CPA as a possible genotoxic hepatic carcinogen of trans-species relevance. They published their concern over suspected genotoxic carcinogenicity in a 'rapid alert' in August 1994 and initiated a procedure to reconsider the current marketing approvals for CPA-containing products in Germany (Press release of the Commission of the European Communities, 1994). At the European level, the German authorities requested an opinion of the Committee for

Proprietary Medicinal Products (CPMP). This of course urged the other authorities in the European Union to assess rapidly the apparently alarming news also. After ample contemplation, the CPMP concluded that no regulatory action was necessary regarding presumed genotoxic and carcinogenic potential of CPA. The companies concerned were requested by the CPMP to incorporate a short summary of the animal findings in the Summary of Product Characteristics (SmPC) concluding that their clinical relevance is uncertain and that there is no clinical experience supporting an increased incidence of liver tumours in CPA-treated humans (Press release of the Commission of the European Communities, 1994).

Since then, several further studies have been published. In 1995, the preliminary human data by Martelli and coworkers mentioned before were somewhat extended to seven donors and published in a scientific journal. CPA was shown to induce DNA repair synthesis in hepatocyte preparations derived from two males and four out of five females. Only a very slight enhancement in DNA fragmentation was found at fivefold higher concentrations. In view of the discussion described above, the authors' conclusion (Martelli *et al.*, 1995), that CPA is genotoxic in human hepatocytes and that the striking sex difference in the genotoxicity of CPA in rat hepatocytes is not observed in human ones, is rather speculative.

Further genotoxicity studies were performed by scientists employed by the German regulatory agency to investigate whether CPA-induced DNA adducts have the potential of being transformed into mutations (Kasper *et al.*, 1995). In their hands, CPA did not induce gene mutations or chromosomal aberrations in Chinese hamster ovary cells co-cultivated with female rat hepatocytes as the metabolizing system. Some indications were found of a micronucleus-inducing potential of CPA in an *in vitro* micronucleus assay with proliferating female rat hepatocytes. It could not be determined whether the slight increase in micronucleus formation after CPA exposure indicates a clastogenic potential or whether it was just a consequence of the mitogenic potential of CPA. The authors conclude that their findings do not establish a clear genotoxic potential (Kasper *et al.*, 1995).

To ascertain whether the CPA-induced adducts, as detectable by the [³²P]DNA postlabelling technique in female rat liver, represent CPA-specific DNA adducts, Topinka and colleagues (1996) explored the adduct structure. They confirmed that the CPA-induced DNA adducts do contain CPA or CPA metabolites.

2.5.4 Alternatives to Cyproterone Acetate

To acquire further information on the activities of CPA, some authors have published comparative studies with structurally related sex steroids. Long-term toxicity studies in dogs and monkeys (6 and 10 years, respectively)

showed no proliferative lesions in these species after chronic administration of steroids, some of which (e.g. the structural CPA analogues chlormadinone acetate and megestrol acetate) also induce DNA adduct formation in rat liver, albeit to a lesser extent than CPA (Topinka *et al.*, 1995). Martelli and co-workers (1996a) compared the clastogenic and tumour-initiating activities of chlormadinone acetate and megestrol acetate in female rats. In a micronucleus test in rat hepatocytes, the clastogenic properties of these compounds were about 1/3 to 2/3 of that of CPA. The tumour-initiating activity of chlormadinone acetate and megestrol acetate in the rat liver foci assay was seven- to ten-fold lower than that of CPA. These studies demonstrate that CPA, chlormadinone acetate and megestrol acetate are characterized by different profiles of genotoxic activity in female rat liver. The difficulties, however, in extrapolating these findings to humans is stressed by a study of Martelli and co-workers (1996b). They found that the rate of DNA repair in primary human hepatocytes exposed to CPA, chlormadinone acetate and megestrol acetate *in vitro* is similar, irrespective of donor gender. Under the same experimental conditions, substantial differences were observed in the amounts of DNA repair elicited by the three steroids in primary hepatocytes from female rats, CPA having the greatest potency. The three compounds failed to induce DNA repair in hepatocytes from male rats (Martelli *et al.*, 1996).

2.5.5 Epidemiology

To date, the published literature only documents a very low number of cases of liver tumours among CPA users (Ohri *et al.*, 1991; Watanabe *et al.*, 1994; Rüdiger *et al.*, 1995). A recent literature review by German clinicians on the genotoxicity, hepatotoxicity and carcinogenicity of CPA concludes that in the last two decades since the introduction of CPA into therapy, no observations have been made which could point to a particular hazard from CPA with regard to proliferative liver change (Rabe *et al.*, 1996). As in the case of CPA, the epidemiological data on the incidence of liver tumours in women who had taken drugs that contain chlormadinone acetate or megestrol acetate are very limited. Consequently, it is impossible to establish to what extent these pharmaceuticals play a role in human liver carcinogenesis (Martelli *et al.*, 1996a).

2.5.6 Comment and Conclusion

The firm German regulatory action in 1994 may be considered to have been too hasty in retrospect. The alarm at that time obviously was based on a 'worst case scenario' assuming a serious human health issue, which was based

on scanty experimental evidence. It is, however, taken for granted that it is very difficult to decide, as a health authority, on the potential human health consequences of some unproven hazard flagged by incomplete experimental data. One might argue that authorities should be on the safe side of the spectrum of possible restrictive actions to be taken. On the other hand, science should not be violated. In that respect, the CPMP's decision to put a warning into the Summary of Product Characteristics of CPA-containing products is a wise compromise. The uncertainty present in 1994 still exists as no final conclusion can yet be drawn as to whether the presumed genotoxic properties of CPA (if any) have any relevance in terms of long-term safety in humans.

2.6 ACITRETIN AND THE PREGNANCY POSTPONEMENT PROBLEM

2.6.1 Introduction

Acitretin and its ethyl ester etretinate are aromatic retinoids developed in the 1970s for the treatment of psoriasis and other hyperkeratotic skin conditions. Etretinate seemed a better candidate for registration, because as an ester it was expected to show a higher and less variable bioavailability than the much less lipophilic acitretin. Of an intravenous dose, about equal parts are excreted by the urinary and biliary routes (Wiegand and Jensen, 1991). Paravicini (1981, cited by Grønhøj Larsen *et al.*, 1987) found that about 60% of a dose of etretinate was recovered unchanged in the faeces. As may be expected, etretinate is better absorbed in the fed than fasting state. According to Wiegand and Jensen (1991), in the fed state and assuming linear pharmacokinetics, on average 60% of an oral acitretin dose is absorbed (range 36–95%). For [¹⁴C]acitretin, Rubio *et al.* (1994) reported a cumulative urinary excretion of about 20% of the radioactivity after 240 h in psoriatic patients. These results document incomplete absorption of both substances, acitretin generally being absorbed less than etretinate.

2.6.2 History

Owing to their retinoid nature, both substances were expected to be highly teratogenic. This hazard indeed was identified and characterized in animal experiments. Etretinate was studied by Hummler and Schüpbach (1981) and found to be teratogenic in mouse, rat and rabbit after dosing for about 12 days in pregnancy. Lowest teratogenic doses were mouse 4 mg kg⁻¹ day⁻¹, rat 2 mg kg⁻¹ day⁻¹ and rabbit 2 mg kg⁻¹ day⁻¹. Malformations were found in the skeleton and in soft tissues (CNS, cleft palate, kidney malformations), similar to those caused by retinoic acid. Acitretin was also shown to be

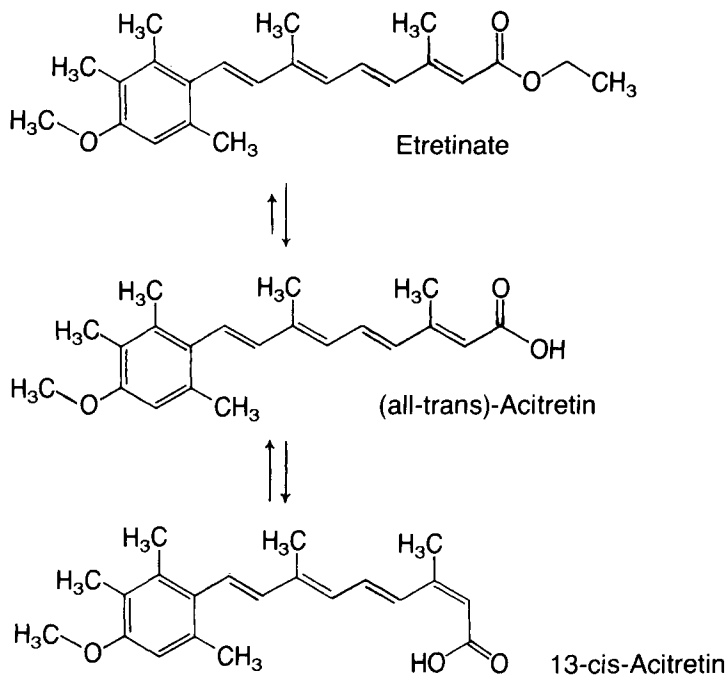

teratogenic (Kistler and Hummler, 1985) in the mouse, rat and rabbit after dosing during days 7–19 post coitum. Here, the rabbit was most sensitive (lowest teratogenic dose $0.6 \text{ mg kg}^{-1} \text{ day}^{-1}$), the rat least ($15 \text{ mg kg}^{-1} \text{ day}^{-1}$). These findings were confirmed and extended by studies *in vitro* (Kistler, 1987; Kochhar *et al.*, 1989; Löfberg *et al.*, 1990). Etretinate as such appeared to be not teratogenic, but had to be hydrolysed to acitretin to display its effect.

Correspondingly, recommendations were strictly given to prevent pregnancy during therapy with these substances and to postpone a desired pregnancy for a period long enough to assure well-nigh complete (i.e. >99%) elimination of etretinate and its biotransformation products. The teratogenicity of acitretin and etretinate nevertheless was regrettably confirmed by the outcomes of several pregnancies having inadvertently been started during therapy (Happle *et al.*, 1984). A recent and useful commenting overview of outcomes of pregnancies begun under or shortly after retinoid treatment is given by Geiger *et al.* (1994).

During long-term administration of etretinate, it became apparent that the strong lipophilicity of the substance enabled it to fill a large deep compartment, in fat depots and other lipid-rich tissues (Masarella *et al.*, 1985; Grønhøj Larsen *et al.*, 1988). This caused the terminal elimination half-life to be very long (about 100 days), which means that, taking a waiting period of 7 half-lives (>99% eliminated), a future mother would have to wait for

2 years before beginning a 'safe' pregnancy (Geiger *et al.*, 1994). Under such conditions etretinate was registered in the European Community in the 1980s. It is understandable that a pregnancy postponement period as long as 2 years was unfavourable for the application of etretinate in therapy.

Acitretin, the corresponding free acid was much less lipophilic and was reasonably expected to be much more rapidly eliminated than etretinate; so the drawback of comparably low and variable bioavailability of acitretin was offset by the benefit of its larger rate of elimination in steady state. For acitretin, with a half-life of about 50 h, a waiting period of 2 months was agreed upon. This seemed sufficient to assure well-nigh elimination of acitretin from the body of the prospective mother (Berbis *et al.*, 1988). Acitretin was submitted for registration with this advantage in comparison with etretinate and was duly accepted in 1989 in the member-states of the European Union.

2.6.3 *Etretinate Formation from Acitretin*

Some years later, during studies with acitretin in women, an unknown substance was detected in their plasma (Wiegand and Jensen, 1991; Lambert *et al.*, 1992). The substance was subsequently identified as etretinate. This esterification *in vivo* was unexpected. Nevertheless, not long before the introduction of acitretin, a similar esterification reaction with retinoic acid was described (Miller and DeLuca, 1985). The esterification of acitretin was studied *in vitro* with rat and human microsomes and *in vivo* in the rat (Chou *et al.*, 1991), as well as with liver preparations from several other species (Laugier *et al.*, 1994) with and without addition of ethanol. Moreover, it could be shown to occur also without the addition, respectively administration, of ethanol (Chou *et al.*, 1991). In the rat, esterification was strongly increased above basal values by simultaneous administration of ethanol (Chou *et al.*, 1992). In human pharmacokinetic studies, the formation of etretinate from acitretin was shown to be positively related (Jensen *et al.*, 1992) and even correlated with administration of ethanol (Grønhøj Larsen *et al.*, 1993), as can be calculated from their data, producing a correlation coefficient of 0.96. It is clear that use of alcoholic beverages during acitretin use may result in an increasing etretinate load in the patient's fat depots.

These findings were an extremely unpleasant surprise because etretinate with its long elimination half-life can act as a very efficient depot for the strongly teratogenic acitretin, prolonging its apparent elimination half-life (Grønhøj Larsen *et al.*, 1993). For this reason, the waiting period before starting a pregnancy after stopping acitretin was extended to two years in the official 'labelling' in Europe. Moreover, it was recommended to refrain from ethanol-containing beverages during acitretin therapy and also until 2 months after stopping acitretin intake.

Worse was yet to be found: in 1994, pharmacoepidemiologists reported that the persistence of measurable concentrations of acitretin, 13-*cis*-acitretin and etretinate in plasma of women having been treated with acitretin might be longer than 2 years (Sturkenboom *et al.*, 1994). Moreover, if these concentrations would at last decrease below the limit of detection, appreciable quantities of these substances still might be present in the subcutaneous fat tissue and other fat depots. In women who had never been treated with etretinate, etretinate fat:plasma concentration ratios of several hundreds were found during acitretin therapy (Sturkenboom *et al.*, 1994). The authors concluded that pregnancy after acitretin treatment could only be safe when no etretinate could be detected in subcutaneous fat tissue. A plasma concentration of these retinoids below the limit of quantification – in their perception – was not enough to assure safety for the conceptus.

2.6.4 Reflection and Discussion

It is here that integration of toxicodynamic, toxicokinetic and human pharmacokinetic knowledge becomes crucial. Without sound toxicological reasoning it is the lower limit of detection – in plasma or in fat – which becomes the irrelevant determinant in safety assessment. However, sound reasoning may perhaps not provide the quick answer policy makers or breakers may look for but may well show the way to be followed to find the answers needed.

Acitretin, not etretinate, is the proximate teratogenic substance (Kistler, 1987; Reiners *et al.*, 1988; Kochhar *et al.*, 1989). Etretinate is dangerous as a depot for supplying acitretin and maintaining a continuous – possibly teratogenic – concentration of acitretin at the site of action. Likewise 13-*cis*-acitretin is only considered teratogenic as supplier of acitretin by isomerization (Geiger and Brindley, 1988). At the moment, unfortunately, we do not know the relationships between etretinate in any subcutaneous fat depot, plasma etretinate and 13-*cis*-acitretin concentrations and plasma acitretin concentrations on one hand, or acitretin concentrations at the active site, within the growing and differentiating embryo on the other.

Let us try and take a pharmacokinetic view of the situation as it exists, at the end of a series of acitretin doses in an organism with a newly developing embryo (Figure 1A). Metabolic elimination, more rapid than in the case of etretinate, is an important acitretin sink. Residual acitretin, in the central compartment, is in exchange with two important compartments: slowly with the lipid compartment and, more rapidly, with the embryo. Furthermore, there is a quasi-equilibrium, far to the acitretin side, with etretinate in the central and embryo compartments.

Etretinate, if formed at all, is slowly carried to and dissolved in the lipid compartment, a practically bottomless pit for lipophilic substances. Etretinate

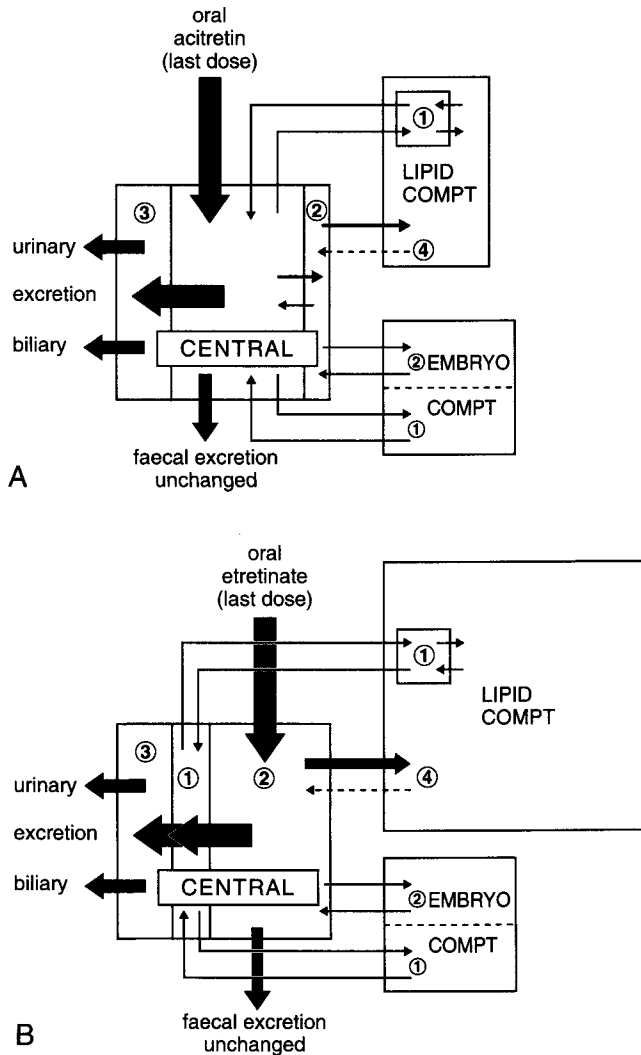

FIG. 1. Compartment models of acitretin and etretinate pharmacokinetics after acitretin (A) and etretinate (B) administration respectively. The numbers refer to the pharmaca and derived substances: 1, acitretin; 2, etretinate; 3, biotransformation products (chain shortening, conjugation); 4, etretinate sequestered in lipid depots (immobilized, unless fat mobilization occurs).

concentrations in the plasma and embryo will be kept low by hydrolysis to acitretin. Acitretin itself will be eliminated relatively rapidly. Provided that no lipids are mobilized to satisfy metabolic needs, most of the etretinate formed will remain sequestered in the lipid compartment. Mobilization of etretinate and subsequent hydrolysis to acitretin, has meanwhile been shown in the fasting rat (Sturkenboom, 1995). The expectation that sequestration as etretinate would markedly reduce circulating acitretin is not directly supported by experiments with lean and obese Zucker rats (McNamara and Blouin, 1990). Unfortunately, these experiments were carried out only with bolus doses, not during steady state. The formation of etretinate from acitretin can be limited by ethanol abstinence of the organism, or person, in question during the treatment period and, where necessary, thereafter. In comparison, Figure 1B shows the analogous situation with etretinate administration: the main difference will be in the long-lasting release of etretinate from its large depot in the fat compartment.

Unfortunately, at the moment, we cannot quantify this largely qualitative picture as we do not know the global human nor the exact animal pharmacokinetics of acitretin in this situation (although the latter is accessible to an experimental approach). Relevant animal data would give at least an idea of an order of magnitude of a plasma threshold concentration for teratogenesis. In their comment, Geiger *et al.* (1994) suggest that synthetic teratogenic retinoids show a teratogenic potential similar to that of the natural ones. Physiological retinoid concentrations lie between 2 and 4 ng ml⁻¹, so lower concentrations of retinoids would be considered safe (Geiger *et al.*, 1994). We consider this as wishful thinking, unless it is proven experimentally that natural and synthetic teratogenic retinoids show similar threshold concentrations for teratogenicity. This should preferably be proven in several animal species and be supported by *in vitro* studies in limb bud cell cultures. An important step in this direction has been made by Nau and coworkers using etretinate (Löfberg *et al.*, 1990), but appears not to have been followed up in later years with acitretin, or other retinoids.

2.6.5 Epidemiology

Now we will have to help ourselves with human data on acitretin pharmacokinetics during steady state and after discontinuation of administration, and with the favourable or unfavourable results of inadvertent administration of acitretin during pregnancy. Wiegand and Jensen (1991) have reported on a group of 22 current acitretin users, four of whom exhibited plasma concentrations of etretinate in the range 5–62 ng ml⁻¹, seven showed traces of it, while 11 did not show detectable etretinate in plasma (lower limit of quantification: 5 ng ml⁻¹). Sturkenboom *et al.* (1994) mention 10 prior or current acitretin users not having ever used etretinate, seven of which did

not show detectable etretinate plasma concentrations (lower limit of quantification: 0.1 ng ml^{-1}) and three showed levels of $0.4\text{--}1.2 \text{ ng ml}^{-1}$. According to the authors, etretinate concentrations in subcutaneous fat varied from undetectable to 1029 ng g^{-1} (!) in this group.

Until 1994 no typical malformations, which might have been caused by acitretin, had been brought to the attention of the pharmaceutical company (Geiger *et al.*, 1994). In 1995, one possible case was reported in the Netherlands (Die-Smulders *et al.*, 1995). The craniofacial, ear and heart malformations were suggestive of retinoid embryopathy, whereas, strikingly, the severe limb deformations were not.

2.6.6 *Comment and Conclusion*

The lesson in the acitretin case and for future cases is that during development more attention should be given to the connection between systemic and organ concentrations, and effects in animal toxicology. This is especially important if toxicity, as in this case teratogenicity, is suspected and the target sites are already known. Subsequently, the results should be linked to systemic, and possibly biopsy, concentrations in the human. The acquisition of such data appears to be more a matter of organizational effort and resource management than of much extra studies.

In this case, a conclusion in the form of a risk assessment at the moment is impossible because of lack of (published) data linking animal teratogenicity and human exposure.

2.7 IS OXAZEPAM CARCINOGENIC?

2.7.1 *Introduction*

The International Agency for Research on Cancer (IARC) initiated in 1969 a programme to evaluate carcinogenic risks to humans and to produce monographs on chemicals in the widest sense of the word. The evaluation of the IARC represent a hazard identification step, for which evidence of carcinogenicity in humans and in experimental animals, as well as other relevant data in experimental systems and in humans are taken into account.

In the final evaluation an agent is judged to be causally associated with cancer in humans only when there is sufficient evidence from relevant, valid epidemiological studies. If this is the case data on carcinogenicity studies in experimental animals are given less weight. However, in the absence of adequate human data the IARC recommends regarding agents for which there is sufficient evidence of carcinogenicity in experimental animals as if

they represent a carcinogenic risk to humans (IARC, 1990). The compounds are assigned in this way to five groups: group 1, carcinogenic to humans; group 2A, probably carcinogenic to humans; group 2B, possibly carcinogenic to humans; group 3, not classifiable as to carcinogenicity to humans; group 4, probably not carcinogenic to humans.

In a review published some years ago 20 out of 200 compounds evaluated were conclusively considered carcinogenic to humans, and 52 probably or

Oxazepam

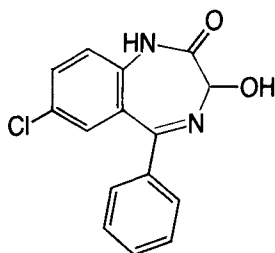

possibly carcinogenic (Marselos and Vainio, 1991). Very recently the IARC has published the evaluation of 14 compounds, some of which had been evaluated before (IARC, final draft 1996).

For the present discussion on 'Sense and non-sense in toxicity assessment' the most interesting discussion is on oxazepam. Oxazepam was labelled by the IARC after evaluation in 1977 as well as in 1987 as 'not-classifiable' (IARC, 1977, 1987). Now after reevaluation oxazepam is labelled as possibly carcinogenic to humans (group 2B) (IARC, 1996). This labelling is the consequence of the process of the IARC evaluation, which, however, can be criticized in view of the scientific state of the art, as will be shown below.

2.7.2 History

The first report on carcinogenic effects of oxazepam appeared in 1974. Three groups of 14 male and 14 female Swiss-Webster mice received oxazepam in the diet from 3 to 12 months of age at concentrations of 0.05 or 0.15%, or were given a control diet. At 12 months of age all mice received the control diet for a further 2 months; all surviving animals were then killed. Liver tumours described as liver-cell adenomas were found in 3/12 (25%) males receiving the lower dose and in 8/13 (61%) males and 5/8 females receiving 0.15% oxazepam. No liver tumours were seen in 13 male and 10 female surviving controls (Fox and Lahcen, 1974).

Other benzodiazepines were also related to an increased risk of cancer, as diazepam was described to enhance the growth of mammary tumours in rats (Karmali *et al.*, 1979). However, in life-time feeding studies (2 years) diazepam and also prazepam have been reported not to cause elevated

tumour incidence in either Wistar rats or CF1 mice, even though in that study the incidence of malignant liver tumours was significantly increased in male mice fed diazepam (De La Iglesia *et al.*, 1981).

The NTP has repeated the carcinogenicity studies (NTP, 1993). Long-term carcinogenicity studies were carried out in two mouse strains: in the Swiss-Webster strain during 57 weeks and in the B6C3F₁ strain for 2 years. Studies with oxazepam in rats were not started initially because adequate studies were carried out by the manufacturer of oxazepam, Wyeth Laboratories, in Sprague-Dawley rats. Because of the marked neoplastic findings in mice in the NTP report under discussion, the NTP decided to start 2-year studies of oxazepam with Fisher 344/N rats. Furthermore, adequate rat studies for diazepam and temazepam (both leading to exposure to oxazepam by metabolism of the parent compound) were published (De La Iglesia *et al.*, 1981; Robinson *et al.*, 1984).

The outcome of the NTP study in the B6C3F₁ mice is given in Table 2.

TABLE 2
Oxazepam. Incidences of neoplasms in livers and thyroid glands of B6C3F₁ mice in the 2-year study (overall rate) (NTP, 1993)

	dose (p.p.m.)			
	0	125	2500	5000
<i>Male</i>				
Dose (mg kg ⁻¹ day ⁻¹)	0	20	390	890
Hepatoblastoma	0/49	2/50	21/50	13/50
Hepatocellular adenoma	17/49	18/50	34/50	32/50
Hepatocellular carcinoma	9/49	5/50	45/50	50/50
All liver tumours	23/49	19/50	50/50	50/50
Thyroid follicular cell adenoma	0/49	1/50	1/50	1/50
<i>Female</i>				
Dose (mg kg ⁻¹ day ⁻¹)	0	26	450	920
Hepatoblastoma	0/50	1/50	8/50	8/50
Hepatocellular adenoma	25/50	35/50	35/50	36/50
Hepatocellular carcinoma	9/50	5/50	49/50	44/50
All liver tumours	28/50	36/50	50/50	47/50
Thyroid follicular cell adenoma	0/50	4/50	5/50	6/50

The increase in the individual types of liver tumours is both for males and for females statistically significantly dependent on the dose ($P < 0.001$). For the different dosage groups the effects in the 125 p.p.m. group were not significant, but with the other dosages the effects were highly significantly increased ($P < 0.001$). The increase in thyroid follicular cell adenoma was only significant for the females in the two highest dose groups ($P < 0.02$).

For the study with the Swiss-Webster mice, three groups (60 animals of either sex) were used, i.e. 0, 2500 or 5000 p.p.m. The animals were fed during 57 weeks. Only hepatocellular adenomas and carcinomas (no thyroid tumours) were observed with a combined overall rate in the highest dose group of 87% for males and 80% for females.

The conclusion of the NTP is that, under the conditions of these feed studies, there was clear evidence of carcinogenic activity of oxazepam in male and female Swiss-Webster mice based on hepatocellular adenoma and carcinoma. There was also clear evidence of carcinogenic activity of oxazepam in male and female B6C3F₁ mice based on increased incidences of hepatoblastoma and hepatocellular adenoma and carcinoma. Increased incidences of hyperplasia of thyroid gland follicular cells in male and female B6C3F₁ mice and of follicular cell adenomas in female B6C3F₁ mice were also related to oxazepam exposure. The proportion of neoplasms with an activated *H-ras* gene decreased under the influence of oxazepam, indicating that the effect is related to a promoting action of oxazepam. The report compares oxazepam with phenobarbital.

2.7.3 Reflection and Discussion

The labelling of oxazepam as 'possibly carcinogenic to humans' by the IARC is 'non-sense' because of the reasons discussed in the paragraphs below.

2.7.3.1 Tumour findings. The increased thyroid follicular cell adenomas in female mice is probably related to the induction of hepatic microsomal enzymes and altered thyroid function leading to hyperplasia. A hypothesis has been developed for rats to account for these findings (McClain, 1989), which is likely to be applicable for mice also. This involves induction of the glucuronidation activity in the liver for thyroxine, causing enhanced biliary excretion. This leads to a persistent increase in thyroid-stimulating hormone levels, which fosters increased thyroid follicular cell hyperplasia (only this stage was seen in male mice) and neoplasia. It was shown that glucuronidation is a major metabolic pathway for oxazepam, and induction of this activity occurs with repeated dosing.

The increase in hepatocellular adenomas and carcinomas induced by chemicals in rodents, especially in mice, has been addressed by many authors (Goodman *et al.*, 1991). The susceptibility of mice to hepatocarcinogenicity

varies markedly with age, gender and strain. The genetic basis for the inter-strain susceptibility in mice is now being clarified, and is largely accounted for by a genetic locus Hcs (hepatocarcinogen sensitive) locus (Drinkwater and Ginsler, 1986). Sensitive strains have a high incidence of spontaneously mutated H-*ras* oncogenes and are defective in their control of DNA methylation (Counts and Goodman, 1994). H-*ras* oncogenes appear to have a negligible role in human cancer where, instead, mutations in the *p53* tumour suppressor gene are critical (Ozturk, 1991). The NTP has included a screening for the *ras* oncogene. Liver neoplasms are commonly seen in B6C3F₁ mice in 2-year studies, occurring with a typical incidence of 30–40% in control males and 10–20% in females. Chemically induced liver tumours in mice have a high frequency of proto-oncogene activation, particularly by point mutations of *ras*-type oncogenes (Barbacid, 1987). In the NTP study relevant mutations in the H-*ras* gene were detected in 13/37 (35%) of the hepatocellular tumours from the 125 p.p.m. group compared with 58% of the neoplasms in control mice, only one neoplasm (2.5%) in the 2500 p.p.m. group, and none in the 5000 p.p.m. group of mice. The mutation spectrum of the 13 cases with the activated *ras* gene was similar to that detected in liver tumours in the control mice bearing an activated H-*ras* gene. Oxazepam treatment thus stimulated the formation of tumours not bearing activated H-*ras* genes. Also, in a study with phenobarbital-induced liver neoplasms detection of H-*ras* gene mutations was significantly lower than that detected in neoplasms in control animals (Fox *et al.*, 1990).

Another similarity between oxazepam and phenobarbital is the induction of hepatoblastoma. Hepatoblastoma are malignant liver tumours which occur in children under 3–4 years of age and have a morphological structure completely different from that of the hepatocellular carcinoma which will occur at an older age (Frith *et al.*, 1994). The increase of hepatoblastoma in the oxazepam-fed groups was alarming because of its uncommon character. Even in the 125 p.p.m. group two males and one female had a hepatoblastoma, whereas none was found in the controls of this study, and historically, none was found in 1366 control male mice and only one was found in 1363 female control mice. However, the similarity between human and mouse hepatoblastoma is only histopathological, and apparently not related to the aetiology of the carcinogenic response. Whereas in humans hepatoblastoma is observed as an early and single tumour response, hepatoblastomas in mice are described mainly in conjunction with the hepatocellular adenomas. The histogenesis of hepatoblastomas is clearer from the studies of Diwan *et al.* (1994) as large numbers of these tumours accumulated in their studies with phenobarbital, DDT and Arochlor-1254. The preponderance of evidence is that they generally evolve from preneoplastic or neoplastic hepatocytes in foci of hepatocellular tumours. The susceptibility of mice to induction of hepatoblastomas is further related to strain differences, as has been clearly shown by Diwan *et al.* (1989) using reciprocal F₁ hybrid males (B6D2F₁

versus D2B6F₁ mice). In summary, it can be concluded that the induction of hepatoblastoma in the B6C3F₁ mice by oxazepam does not contribute really to the carcinogenic risk in humans.

2.7.3.2 Mechanisms. Oxazepam, and other benzodiazepines, are known to be negative in a variety of *in vitro* bacterial and mammalian genotoxicity tests (Balbi *et al.*, 1980; Swierenga *et al.*, 1983; NTP, 1993). In a study of 14 weeks' duration parallel with the carcinogenicity study in B6C3F₁ mice a search was done for micronuclei in peripheral blood cells with a negative result (NTP, 1993) confirming an earlier study using lower dosages applied five times weekly *i.p.* (Degraeve *et al.*, 1985). Other references, however, indicate that oxazepam has been shown to cause micronuclei and aneuploidy *in vitro* and to inhibit gap-junctional intercellular communication in human hepatoma cells *in vitro* (IARC, 1996). The discussion on the relevance of the latter findings is ongoing. Diazepam also induced bone marrow micronuclei which may be due, however, to low concurrent control values. Aneuploidy has been described also after administration of diazepam (Adler, 1993). Common phenomenon of compounds with aneugenic properties is alteration of the progression of cell division in both mitotic and meiotic cells. Differences in response between somatic and germinal cells were obvious for diazepam and several other compounds (Adler, 1993). In another study where high dosages of 32 benzodiazepines were applied in rats no evidence was found of gene mutation or other forms of genetic damage (Carlo *et al.*, 1989). It can be concluded that there is no evidence that oxazepam interacts directly with DNA.

The induction of hepatocarcinomas by oxazepam can be seen as a result of a promoter-like activity of this compound. The characterization of benzodiazepines as promoters was studied in various models, because of reports that diazepam increased the growth of intrarenally implanted neoplasm cells (Horrobin *et al.*, 1979); publication of an epidemiological study suggesting an association between benzodiazepine use and breast cancer preceded the latter study (Stoll, 1976). Mazue *et al.* (1982) could not detect a promotor effect of oxazepam in rats during a 12 weeks' administration period (*N*-2-fluorenylacetamide was used as initiator). The dosage of 200 mg kg⁻¹ used orally, however, was quite low in view of the fast metabolism of benzodiazepines in rats (van der Laan *et al.*, 1993). Other authors showed that oxazepam acts as a promotor of tumour growth in both rats and mice after initiation by diethylnitrosamine (Preat *et al.*, 1987; Diwan *et al.*, 1986). In mice receiving 0.15% oxazepam orally in the diet the incidence of neoplasms was increased. Diwan *et al.* (1986) have associated the promotion of hepatocellular carcinogenesis with induction of *N*-demethylase activity, which appears to be quite species- and strain-specific. As with the induction of hepatoblastoma in this respect again there is a great similarity between oxazepam and phenobarbital. Oxazepam (125 or

2500 p.p.m.) administered 3–21 days induced a variety of biochemical events such as increase of cell proliferation in liver and cytochrome P450 induction, increase in free radical formation, induction of glutathione (GSH) depletion and increased levels of circulating thyroid-stimulating hormone (TSH) (Griffin *et al.*, 1996). Phenobarbital is found to induce similar biochemical events (Ahobupa *et al.*, 1993; Griffin *et al.*, 1995). Phenobarbital and oxazepam can be seen as 'non-cytotoxic, non-genotoxic' carcinogens and the hypothesis has been proposed that those compounds stimulate clonal expansion of spontaneous preneoplastic cells. However, evidence is gathering showing that DNA hypomethylation may be the critical mechanism of carcinogenicity by phenobarbital and oxazepam (Ray *et al.*, 1994).

2.7.3.3 Similarity in biotransformation between animals and the human. The manner in which oxazepam is metabolized by the mice in the NTP studies is important for two reasons: first, the pattern of biotransformation in the mouse should be at least qualitatively similar to that of humans, to serve as a model for the human; second, the early appearance of liver tumours in the Swiss–Webster strain may suggest the existence of an activation pathway in this particular strain.

Taking the last point first: alongside the NTP carcinogenicity studies, data are gathered on the biotransformation of oxazepam in mice (Griffin and Burka, 1993). In male B6C3F₁ mice oxazepam is excreted unchanged for about 40% and as glucuronide for about 15% (increasing with the dose) (Griffin *et al.* 1995). After repeated administration the proportion glucuronidated is increasing. A metabolite called CPQ (diazepine ring narrowing and carbon dioxide release) counts for 5–15%. In addition 3'- and 4'-hydroxylated derivatives are found, indicating the potential formation of intermediate epoxide compounds. The differences between Swiss–Webster and B6C3F₁ mice are only minor, the latter excreting more unchanged oxazepam than glucuronide and slightly less hydroxylated than other metabolites. The slight difference in hydroxylation especially argues against a role of reactive intermediates in the induction of early liver tumours in Swiss–Webster mice.

With respect to the first point, oxazepam is biotransformed in the human mainly by glucuronidation (>95%), and excreted in this form by the kidney. Small amounts of other metabolites are formed by diazepine ring opening. These products, identified in urine by Sisenwine *et al.* (1972), are similar to the metabolites found in mice. Although the hydroxylated metabolites thus apparently play a minor role in the human, the qualitative similarity in the metabolite pattern is sufficient to declare the mouse studies to be of value and apply them to the human.

2.7.3.4 Epidemiology. As mentioned above, an epidemiological study suggested an association between benzodiazepine use and breast cancer

(Stoll, 1976). A case-control study in which 1075 cases and 1146 controls were interviewed did not support the contention that diazepam promotes or accelerates breast cancer growth. Very recently another case-controlled study has been published with respect to the relation of benzodiazepine use with the risk of 11 selected cancers: breast (6056 patients), large bowel (2203), malignant melanoma (1457), lung (1365), endometrium (812), ovary (767), non-Hodgkin's lymphoma (382), testis (314), Hodgkin's disease (299), thyroid (111) and liver (37). For sustained benzodiazepine use relative to no use, relative risk estimates for all 11 cancers were compatible with 1.0 at the 0.05 level of significance. Relative risk estimates both for sustained use that continued into the 2-year period before admission and for sustained use that ended up to more than 10 years previously were compatible with 1.0, suggesting a lack of tumour promotion and no increase in the risk after a latent interval. Results were also null for diazepam, chlordiazepoxide and other benzodiazepines considered separately. The data suggest that benzodiazepines do not influence the risk of cancer as a whole (Rosenberg *et al.*, 1995).

The similarity between oxazepam and phenobarbital is also important with respect to the human epidemiology figures in the use of both compounds. Phenobarbital use is still high in various countries, e.g. in the US in 1989 39% of the sedatives market (Woods *et al.*, 1992). Oxazepam is widely used as a sedative/hypnotic with a market share in western societies of 7–40% in 1989 (France 7%; UK 8%; The Netherlands 37%; Germany 40%), although some countries ranked lower (Italy 2%; US 2%) and another ranked higher (Sweden 58%). The carcinogenicity of anticonvulsant drugs, including phenobarbital, in man was studied in a retrospective set-up conducted on 9136 epileptic patients in a hospital in Denmark. In those treated for up to 10 years, the incidence of cancer at all sites except the liver was the same as or lower than that expected when compared with the incidence in the general population. In the same group three cases of liver cancer were observed in males whereas 1.1 were expected, and one liver cancer was observed in a female where 0.7 was expected. However, three out of four liver cancers in male patients were associated with treatment with thorotrast, which is known to induce liver tumours in man (Clemmesen *et al.*, 1974; Clemmesen and Hjalgrim-Hansen, 1978). Also, data from Olsen *et al.* (1989) provided no evidence of a link between liver neoplasms in humans with phenobarbital exposure. These findings were confirmed recently by Olsen *et al.* (1995) in a case-control study specifically related to the occurrence of hepatobiliary cancer. In a cohort of 8004 epileptic patients in Denmark, no association was seen between treatment with phenobarbital and cancer of the liver.

2.7.4 *Comment and Conclusion*

The decision of the IARC to label oxazepam as a 'possible human carcinogen'

can be explained taking into consideration the formal rules of the IARC. However, when all data are taken together, such as the similarity between phenobarbital and oxazepam, the epidemiological data on both phenobarbital and the benzodiazepines, as well as the mechanistic data with respect to the promotor action of oxazepam, it is unlikely that the carcinogenicity observed in mice has any relevance to man.

The IARC has received advice from a working group to modify the criteria for placing agents in the different categories of the IARC (Vainio *et al.*, 1992). It has been recommended to place substances, carcinogenic in experimental animals, with strong evidence that the mechanism in animals does not operate in humans, into category 3 (no or inadequate evidence in humans and less than sufficient evidence in animals). This will be a step in the right direction. The stringent use of the present rules tends to lead to non-sense decisions.

3 Reflection and Discussion

3.1 INTRODUCTION

The cases discussed above show how toxicological problems are solved, sometimes by a 'sense' approach, sometimes, regrettably, by a 'non-sense' approach. The latter, like traffic offences, fortunately do not necessarily cause accidents. So, many a 'non-sense' approach is tacitly and mercifully buried in the archives and only incidentally exhumed and exposed. However they are often the basis of a policy decision, which then may be far off the mark. So, such 'non-sense' results may do some other harm instead of preventing the harm expected.

After the discussion at the end of the case studies in the previous paragraph, and their summary in Table 3, we now have to look how 'non-sense' approaches can be prevented. We should have the 'right' data at our disposition and – very important – we should show the 'right' attitude towards them.

What does mean 'right' in this context? It means data which are accurate and complete, within our present frame of knowledge and technical capacity. It means also that results of different tests are put into relation with each other. Our most important tool is the coherent and integrated use of our present knowledge.

Science in general and toxicology especially are not infallible, whatever the general public may expect. We cannot anticipate on future insights (cf. pronethanol). We can however try and avoid committing sins. One of the cardinal sins for instance is the use of isolated results for important decisions (cf. noscapine). Another sin is neglecting knowledge we already have at our disposal (oxazepam). This may be demonstrated in the 'chain of tacit assumptions'. This chain often limits the correct application of science to the

TABLE 3
Summary of evaluations from cases

1. Pronethanol	1963–65: withdrawal of pronethalol; sensible decision based upon the, then limited, knowledge of the carcinogenesis process.
2. Zimeldine, nomifensine, indalpine	1982–87: withdrawal of zimeldine, nomifensine and indalpine; sensible conclusion based upon limited post-marketing experience, reliable tests for immunostimulation lacking at that time.
3. Tamoxifen	1985–96: benefit/risk balance of tamoxifen favourable for treatment, but not for prevention of breast cancer; sensible conclusion based upon complementary animal and post-marketing data
4. Noscapine	1989–90: noscapine genotoxic to human; conclusion based on <i>in vitro</i> genotoxicity studies only; after new <i>in vivo</i> studies conclusion corrected (1992).
5. Cyproterone acetate	1990–94: premature conclusion that CPA carcinogenic, later corrected by warning, awaiting new experimental data (end 1994).
6. Acitretin	1991–94: possibly too cautious conclusion on pregnancy postponement, owing to lack of data on: <ol style="list-style-type: none"> 1. Synthetic/natural retinoid teratogenicity comparison; 2. integration teratogenicity/toxicokinetic data (including human data) 3. relationship etretinate concentration in lipid depot and in plasma in human (sequestration efficiency).
7. Oxazepam	1996: decision that oxazepam 'possible human carcinogen' not sensible, based on too rigid interpretation of formal IARC rules.

practical problems of society. For toxicology this chain consists of many links, e.g., the assumptions that:

- excretion of high doses is a linear process;
- detoxification pathways cannot be overloaded;
- dose–response relationship is linear;
- dose extrapolation can be solely based upon body weight;
- a change in physiological/biochemical characteristics is a toxicological end-point, etc.

Such assumptions seem convenient in use, although we should know better. They are simplifications which often are unnecessary and harmful. They lead to an accumulation of pessimistic or conservative estimations, resulting in an, often unrealistic, worst-case scenario (Goodman, 1994). It leads us towards a ‘safe and sorry’ scenario: ‘safe’ because of pessimistic evaluation, ‘sorry’ because of the rejection of potentially useful active substances.

3.2 ‘UNITY OF LIFE’ PARADIGM

Comparative physiology and comparative biochemistry lie at the basis of the ‘unity of life’ paradigm in pharmacology and toxicology. The main routes of metabolism, such as the tricarboxylic acid cycle and β -oxidation of fatty acids, are similar in almost all organisms, animal as well as vegetable. The central physiological functions – circulation, respiration, autonomic regulation and digestion – are common in mammals. This, to begin with, urges us to use higher animals, especially mammals, if we need a model for the human. It is, however, in the details of enzyme apparatus and regulation of biological processes that there are subtle but essential differences. So, hydrocyanic acid is universally toxic for all animal organisms depending on the cytochrome-*a* group and on cytochrome oxidase for their respiratory chain function, but only a few species of protozoa and helminths are insensitive to otherwise toxic doses of hydrocyanic acid since they do not use this enzyme group (Albert, 1973).

This example shows that to use fruitfully the ‘unity of life’ paradigm, its limitations have to be tested, understood and account has to be taken of the subtle differences alluded to above. Conversely, one can use such differences to one’s advantage, e.g. to study the kinetics of biliary excretion in the rat, which lacks the gall bladder other species have, or the effects of pathologically low glucuronidation capacity by using the Gunn rat, which lacks glucuronic acid transferase.

The colourful picture of species similarity and difference has been the subject of many, sometimes speculative, reviews from, amongst others, Brodie (1964), Caldwell (1981) and on to Lin (1995). Much insight has been gained by studies on cytochrome P450 isoenzymes. Species differences in the

expression of the iso-enzyme pattern account largely for species (Nebert *et al.*, 1991) and sex (Kato and Yamazoe, 1992) differences in biotransformation. Body size differences can be accounted for by the largely empirical allometric approach (Mordenti, 1986). In toxicity comparisons this should be used systematically (Peters-Volleberg *et al.*, 1994), but in most cases it is not. Strangely enough, it seems that more attention has been given to species differences in the pharmacokinetics and biotransformation of substances than to those in their pharmaco- and toxico-dynamics.

How to manage these partly still unknown similarities and differences? Many authors recommend the study of pharmacotoxicity in animals in which the fate and the effect pattern of the pharmacological agent is similar to that in the human. However, it is improbable that fate as well as effect pattern will be simultaneously similar to those in the human. Moreover, what does one do if it occurs in, of all species, the cat: buy 300 inbred cats?

There seems to be only one practical approach. Carry out the orienting effect and also fate studies in several species and strains. This is already usual, but this practice might need to be extended. Then carry out the large studies (long-term toxicity and pharmacokinetics, carcinogenicity) in two, or maybe even only one, inbred species. In the design of those studies the similarities and differences found in the preceding orienting studies should be taken into account.

As for the issue rodents versus non-rodents, there is no uniformity in toxicological responsiveness among rodents as a group, nor among non-rodents as a distinctly different group. Thus, while there might be good reasons to conduct toxicological studies in more than one animal species, the artificial division into rodents and non-rodents cannot be supported by rational arguments (Zbinden, 1993).

The species specificity problem is further complicated by the use of inbred strains as a model for the highly random-bred human population. There are two opposite aims: to have a useful model for the random-bred human population, and to find secure, reproducible results. These aims are incompatible. Priority is given to reproducibility by using inbred strains (Kacew and Festing, 1996). One should be resigned to the fact that there is no exact model for the human. By using more species and strains in the orienting studies the basis should be laid for the interpretation and extrapolation of the study results to the human, as alluded above. Specific factorial designs, using several strains, may prevent obtaining misleading results by the use of a single strain, yet avoid the use of extremely large numbers of animals (Festing, 1995).

3.3 PROTOCOL TOXICOLOGY

Scientists working in free toxicological research sometimes look down upon protocol toxicology, the toxicological studies according to a rigid general

design. It is clear that such studies have a limited scope, but such are the requirements of practice since toxicology was awarded a social role. (Nevertheless any experiment – according to protocol or not – can reward a keen observer with a new and unexplained fact.) The enormous workload for toxicology in the second half of this century required the emergence of protocol toxicology to assure efficiency, comparability, consistency and equal justice in relation to manufacturer and consumer.

Protocol toxicology alone, in many cases, cannot give ultimate answers, and slight variations or supportive studies may be necessary to allow a well-founded conclusion. However, good protocol toxicology is better than cook-book toxicology. At present the large array of toxicological problems to be solved requires selection of approaches, choosing certain kinds of studies and deleting others. So one may tend more to the decision-tree approach. Under the influence of the ICH process (the process of global harmonization on toxicity study requirements by the International Conference on Harmonization) there is a tendency to less rigid ‘grand designs’ of toxicity investigations but with more standardization of the separate studies. This allows a more scientific approach with a flexible choice of relevant studies.

3.4 *IN VITRO* VERSUS *IN VIVO* TOXICOLOGY

In vitro methods in toxicology have been largely derived from those used in microbiology and biochemistry. They comprise a broad spectrum of methods, from subcellular (e.g., biotransformation by liver microsomes) over cellular (e.g., genotoxicity tests in lymphocyte cultures) and multicellular (e.g., embryo cultures) to organ levels (e.g., isolated perfused kidney). They have been extolled by the animal protection lobbies as being the ultimate recipe for eliminating the need for experiments with intact animals. Unfortunately, life is not that simple. However, for other reasons the *in vitro* methods are important. They allow the extension of the ‘unity of life’ paradigm by isolating the cells or tissues studied from the species-specific influences of the intact organism, thereby providing excellent tools to study mechanisms at a fundamental level. We are familiar with the fact that organisms in many cases use the same transmitters, enzymes or receptors to execute different physiological functions in divergent organs and tissues, so more accessible systems may provide information *in vitro* on responses in homologous systems which are difficult to study *in situ*. This shows how far-sighted Florkin was, when as early as 1944 he wrote: ‘L’évolution a souvent utilisé pour une nouvelle fonction une substance déjà existante en suscitant l’apparition d’un nouveau système biochimique récepteur de son action’ (Florkin, 1944). (The evolution has often used an already existing substance for a new function by engendering a new biochemical receptor system for its action.)

In vitro methods are therefore complementary to *in vivo* methods and are an example of the strongly advocated integration in toxicology. This complementarity is nicely illustrated in a recent paper by Kluwe (1996) on genotoxicity assessment, a subject which provokes considerable confusion among regulatory and industrial toxicologists. Kluwe rightly indicates that *in vitro* tests avoid the confounding by pharmacokinetics and competing adaptive processes, therefore, they are able to detect interference with genetic fidelity. *In vivo* tests are better suited to detect the probability of genetic alterations in the intact organism at realistic doses and systemic concentrations. Because current *in vivo* genotoxicity tests can be performed only in a limited number of cell types (bone marrow, liver, oocytes), it is important to have a measure of local exposure of target cells *in vivo* in addition to the tests *in vitro* (cf. noscapine; Ashby, 1994). Therefore, both approaches are needed to allow valid conclusions. The relationship between *in vivo* and *in vitro* tests for toxicology in general is illustrated by the 'toxico-hairpin' (Figure 2) (A. G. Rauws, unpublished, 1971).

3.5 INTEGRATIVE TOXICOLOGY

What is meant by integrative toxicology? It is not intended to be another slogan. From the 1950s onwards toxicity investigations mostly have at first consisted of a linear series of subsequent toxicity substudies (acute, subacute, semichronic, chronic, carcinogenicity studies). Later, the additional studies (teratogenicity, genotoxicity, etc.) caused this linear structure to grow into a branched one. The results of the different studies mostly were evaluated separately and the final evaluation often was nothing more than a bare catalogue of all results.

Integrative toxicology is the stepwise building up of a design, in which every new result is tested for its relevance for earlier results and vice versa, so a more dimensional network of studies grows instead of a linear structure. The old chain from acute to chronic studies will mostly be maintained, but may be enriched by insertion of toxicokinetic and mechanistic studies. So, for every substance its own, specific design will grow, in an ideal case able to answer all relevant questions on its toxicity.

As an example one may consider an integrated study of cholinesterase-inhibitor toxicity. Chronic toxicity occurs if the synthesis of acetyl-cholinesterases and cholinesterases and their possible reactivation lags behind the inhibition by chronic exposure to an inhibitor (Rauws and van Logten, 1973). So enzyme inhibition *per se* should not be considered to be a valid end-point of toxicity, although often (and inevitably) used as such. The inhibition of the different (acetyl)-cholinesterases can be studied *in vivo* in animals and *in vitro* in both animals and the human. Enzyme turn-over can be measured in animal and human by low-dose labelling with specific, analytically

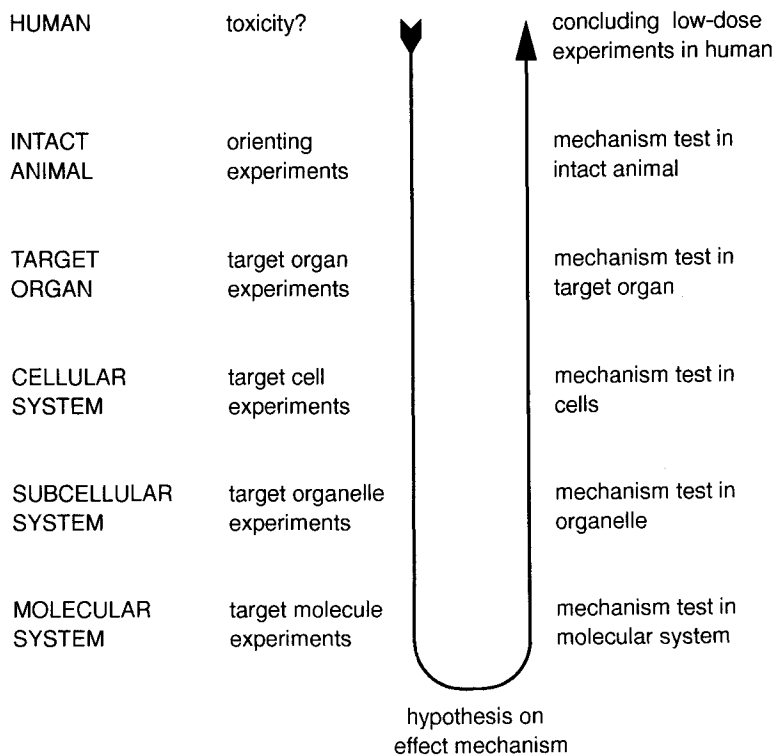

FIG. 2. The toxico-hairpin. Schematic representation of the tracing of an effect mechanism by descending into lower levels in the biological system (analytical phase) and of its validation by ascending to higher levels of biological organization.

accessible, irreversible inhibitors. Reactivation can be measured *in vitro*. The results of these studies and others measuring total (acetyl)-cholinesterase activity in organs and in the total organism would allow drawing up a balance sheet of the (acetyl)-cholinesterases in experimental animals and in the human. With this knowledge titration of animals until toxic levels and of humans to non-toxic inhibition levels would allow a well-founded extrapolation and determination of acceptable intakes. In the 1970s a proposal to that extent was considered too theoretical: today, it might have had a better chance.

As another example, which has been realized, the study of bromide (in its quality of an unintentional food additive) in our Institute (International Symposium on Residues and Toxicity of Bromide, 1983) may be mentioned. Residue studies served to state the problem. The chain from acute to chronic rat studies was combined with toxicokinetic studies with single and repeated administration, and with an interference study with chloride. All toxicity

studies were toxicokinetically monitored. After rat reproduction studies, human endocrinological and neurological studies were conducted. The doses, based upon animal data, were chosen to study the lower range of effects and plasma concentrations in the human. This all resulted in a well-founded recommendation for an acceptable daily intake. A general scheme of the integration of at least plain toxicity and toxicokinetic studies is shown in Figure 3 (Rauws and Groen, 1994).

'Ars longa, vita brevis' (Art takes time, life is but short): does this ideal not take too much time of the short active life of a new pharmacoon? This problem is not peculiar to the integrative approach. Every ideal study takes too long and it is also the art of the manufacturer and his staff to find the responsible and practicable middle course in 'keeping up with the Joneses', with his competitors, in his time-table. Presenting a well-designed, well-conducted and well-reported all-over toxicity dossier will certainly be appreciated by up-to-date authorities (which will hopefully represent the more important markets). As already hinted at above, integrative toxicity studies do not so much require more studies, but rather optimally designed studies at the right moment in the development and, above all, high-quality integration of scientific input and output before, during and after the study. The time schedule problems in development do exist anyhow, whether one does routine studies or integrated ones.

3.6 CONCLUSION

Looking back to the cases discussed and the more general considerations above we can discern weakness and strength of toxicology and its social function: the assessment of potential toxicity of pharmaca and other biologically active substances.

3.6.1 Weakness

- *Cook-book toxicology*: The thoughtless use of fixed protocols, without checking them for relevance. For example, concluding safety in chronic toxicity studies, without checking absorption of the substance from the form in which it is administered to the animals, by a toxicokinetic study – a failure still seen in recent dossiers – or extrapolation without taking the non-linear relationship between body size and clearance into account.
- *Short-cuts*: Rushing to conclusions on the basis of isolated results. For instance, using *in vitro* results without comparing effect concentrations with realistic concentrations *in vivo*. This is demonstrated and discussed in the paragraph on noscapine.

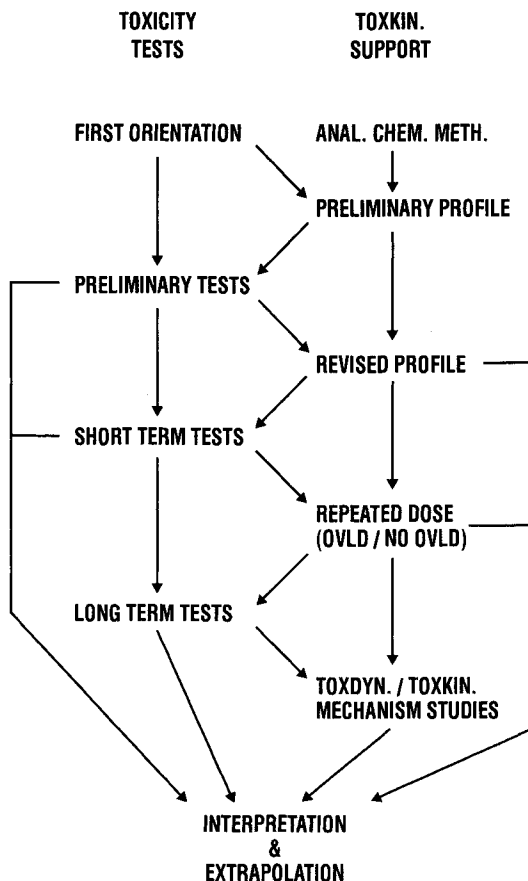

FIG. 3. The toxico-staircase. Recommended interplay of toxicity tests and toxicokinetic support in the development of a toxicity investigation from orienting studies until final assessment. OVL D/NO OVL D: overloading, and no overloading, respectively, with the substance studied. (Courtesy of *Nederlands Tijdschrift voor Geneeskunde* 1989; 133: 1260–1264, and *Drug Information Journal* 1994; 28: 295–300).

- *Effect misuse*: Using any effect as a toxicity end-point. For example, taking, now, cholinesterase inhibition as an end-point for toxicity, without taking the enzyme synthesis, catabolism and reactivation rates into account.

3.6.2 Strength

- *Fundamental science*: What helps toxicology is not counting dead bodies, but looking for mechanisms. Receptor theory (Ariëns *et al.*, 1956; Ariëns

and Beld, 1977; Levine, 1983) and interspecies toxicokinetics (Boxenbaum, 1984; Mordenti, 1986) have produced more insight in dose versus concentration versus effect relationships. Study of the P450 iso-enzymes has provided insight in the evolution of species differences (Nebert and Gonzalez, 1987). Fundamental study of DNA metabolism and replication and of oncogenes has allowed a more subtle evaluation of carcinogenicity studies (Murray, 1993).

- *Integrating results*: Combining and integrating results of studies – protocol-based, toxicokinetic and mechanistic – produces more dependable conclusions and guides further relevant research, and helps to avoid irrelevant studies (Monro, 1994).
- *Human studies*: The proof of the pudding is in the eating, by the human, not by the rat. As shown in the bromide example (International Symposium, 1983), studies with volunteers using well-founded low doses around the ‘no-effect’ level provide the keystone and the touchstone of the toxicity assessment.

With existing knowledge and with more thoughtful organization of studies the level of predictability and the reliability of toxicity studies can be raised appreciably. Hopefully, this way will be chosen more systematically in the future.

Authors' note

The views expressed in this text represent the personal opinions of the authors and do not necessarily correspond to those held by the National Institute of Public Health and the Environment or the Medicines Evaluation Board in The Netherlands.

References

- Ackerknecht, E. H. (1977). ‘Geschichte der Medizin’. Enke, Stuttgart.
- Adler, I.-D. (1993). Synopsis of the *in vivo* results obtained with the 10 known or suspected aneugens tested in the CEC collaborative study. *Mutat. Res.* **287**, 131–137.
- Ahobupa, M., Bereziat, J. C., Mantyla, E. and Bartsch, H. (1993). Dietary fat- and phenobarbital-induced alterations in hepatic antioxidant functions in mice. *Carcinogenesis* **14**, 1225–1228.
- Albert, A. (1973). ‘Selective toxicity’, p. 97. Chapman & Hall, London.
- Alcock, S. J. and Bond, P. A. (1964). Observations on the toxicity of Alderlin^R (pronethalol) in laboratory animals. *Proc. Eur. Soc. Stud. Drug Tox.* **4**, 30–39.
- Anonymous (1983). Sale of zimeldine discontinued. *Lancet* **ii**, 752.
- Anonymous (1985a). Consensus conference: adjuvant therapy for breast cancer. *J. Am. Med. Ass.* **254**, 3461–3463.
- Anonymous (1985b). Adverse reactions to antidepressants. *Br. Med. J.* **291**, 1638.

- Anonymous (1986). Withdrawal of nomifensine. *Lancet* **i**, 281.
- Antopol, W. and Taylor, I. M. (1942). Experimental study of the effects produced by large doses of vitamin B₆. *J. Neuropathol. Exp. Neurol.* **1**, 330–336.
- Ariëns, E. J. and Beld, A. J. (1977). The receptor concept in evolution. *Biochem. Pharmacol.* **26**, 913–918.
- Ariëns, E. J., van Rossum, J. M. and Simonis, A. M. (1956). A theoretical basis of molecular pharmacology. *Arzneim.-Forsch.* **6**, 282–293, 611–621, 737–746.
- Ashby, J. (1994). Regulatory requirements for three doses and proof of tissue localisation in rodent genetic toxicity assays. A call for supporting data. *Mutat. Res.* **208**, 243–244.
- Ashby, J. (1996). Alternatives to the 2-species bioassay for the identification of potential human carcinogens. *Human Exp. Toxicol.* **15**, 183–202.
- Balbi, A., Muscettola, G., Staiano, N., Martire, G. and De Lorenzo, F. (1980). Psychotropic drugs: Evaluation of mutagenic effects. *Pharmacol. Res. Commun.* **12**, 423–431.
- Barbacid, M. (1987). *Ras genes. Annu. Rev. Biochem.* **56**, 779–829.
- Bell, G. H., Davidson, J. N. and Scarborough, H. (1959). 'Textbook of Physiology and Biochemistry.' Churchill Livingstone, Edinburgh.
- Bem, J. L. and Peck, R. (1992). Dextromethorphan. An overview of safety issues. *Drug Safety* **7**, 190–199.
- Berbis, P., Bun, H., Al Mallah, N. R., Durand, A., Rognin, C., Geiger, J.-M. and Privat, Y. (1988). Residual plasma concentrations of acitretin (Ro 10-1670) and its metabolite (Ro 13-7652) after chronic administration. *Dermatologica* **177**, 244–246.
- Bernard, C. (1946). 'Introduction à l'Étude de la Médecine Expérimentale.' Gibert, Paris.
- Bernard, C. (1957). 'An Introduction to the Study of Experimental Medicine.' Dover, New York.
- Bloksma, N., Kubicka-Muranyi, M., Schuppe, H.-C., Gleichmann, E. and Gleichmann, H. (1995). Predictive immunotoxicological test systems: suitability of the popliteal lymph node assay in mice and rats. *Crit. Rev. Toxicol.* **25**, 369–396.
- Boxenbaum, H. (1984). Interspecies pharmacokinetic scaling and the evolutionary comparative paradigm. *Drug Metab. Rev.* **15**, 1071–1121.
- Brodie, B. B. (1964). Of mice, microsomes and men. *Pharmacologist* **6**, 12–26.
- Buchheim, R. (1853–1856). 'Lehrbuch der Arzneimittellehre'. Voss, Leipzig.
- Calabrese, E. J. (1984). Suitability of animal models for predictive toxicology: theoretical and practical considerations. *Drug Metab. Rev.* **15**, 505–523.
- Caldwell, J. (1981). The current status of attempts to predict species differences in drug metabolism. *Drug Metab. Rev.* **12**, 221–237.
- Cannon, W. B. (1963). 'The Wisdom of the Body.' Norton, New York.
- Carlo, P., Finollo, R., Ledda, A. and Brambilla, G. (1989). Absence of liver DNA fragmentation in rats treated with high oral doses of 32 benzodiazepine drugs. *Fund. Appl. Toxicol.* **12**, 34–41.
- Carlton, J. B., Robinson, A., Chan, M. and Mitchell, I. DeG. (1990). Noscapiene and polyploidy induction *in vitro*. Abstracts EEMS Meeting, York, 22–27 July, p. 153.
- Carmichael, P. L., Ugwumadu, A. H. N., Neven, P., Hewer, A. J., Poon, G. K. and Phillips, D. H. (1996). Lack of genotoxicity of tamoxifen in human endometrium. *Cancer Res.* **56**, 1475–1479.
- Catherino, W. H. and Jordan, V. C. (1993). A risk-benefit assessment of tamoxifen therapy. *Drug Safety* **8**, 381–397.
- Chou, R. C., Wyss, R., Huselton, C. A. and Wiegand, U. W. (1991). A newly discovered xenobiotic metabolic pathway: ethyl ester formation. *Life Sci.* **49**, PL169–PL172.
- Chou, R. C., Wyss, R., Huselton, C. A. and Wiegand, U. W. (1992). A potentially new metabolic pathway: ethyl esterification of acitretin. *Xenobiotica* **22**, 993–1002.
- Cintokai, K. I., Jones, C. C., Topham, J. C. and Watkins, P. A. (1978). Experience with mutagenic tests as indicators of carcinogenic activity. *Mutat. Res.* **53**, 167–168.

- Clemmesen, J. and Hjalgrim-Hensen, S. (1978). Is phenobarbital carcinogenic? A follow-up of 8078 epileptics. *Ecotoxicol. Environ. Safety* **1**, 457-470.
- Clemmesen, J., Fuglsang-Frederiksen, V. and Plum, C. M. (1974). Are anticonvulsants oncogenic? *Lancet* **i**, 705-707.
- Cohen, M. and Bendich, A. (1986). Safety of pyridoxine – a review of human and animal studies. *Toxicol. Lett.* **34**, 129-139.
- Commission of the European Communities (1994). 'Committee for Proprietary Medicinal Products, Pharmacovigilance Opinion no. 19 – Cyproterone Acetate.' Brussels, 14 December 1994.
- Cooper, D. R., Styles, J., Bradbrook, C., Charlesworth, J. D., Chu, Y.-H., O'Connor, P. J. and Margison, G. P. (1985). Methylated purines formed in DNA by dimethylnitrosamine in rats previously exposed to hepatotoxic and hepatocarcinogenic regimes: effects on the repair of O6-methylguanine. *Chem. Biol. Interact.* **53**, 283-301.
- Counts, J. L., Goodman, J. I. (1994). Hypomethylation of DNA: An epigenetic mechanism involved in tumor promotion. *Mol. Carcinogen.* **11**, 185-188.
- Dahlström, B., Mellstrand, T., Löfdahl, C.-G. and Johansson, M. (1982). Pharmacokinetic properties of nescapine. *Eur. J. Clin. Pharmacol.* **22**, 535-539.
- Daniel, Y., Inbar, M., Bar-Am, A., Peyser, M. R. and Lessing, J. B. (1996). The effects of tamoxifen treatment on the endometrium. *Fertil. Steril.* **65**, 1083-1089.
- Davidson, I. W. F., Parker, J. C. and Beliles, R. P. (1986). Biological basis for extrapolation across mammalian species. *Regul. Toxicol. Pharmacol.* **6**, 211-237.
- De la Iglesia, F. A., Barsoum, N., Cough, A., Mitchell, L., Martin, R. A., Difonso, C. and McGuire, E. M. (1981). Carcinogenesis bioassay of prazepam (Verstran) in rats and mice. *Toxicol. Appl. Pharmacol.* **57**, 39-54.
- Degraeve, N., Chollet, C., Moutschen, J., Moutschen-Dahmen, M. and Gilet-Delhalle, J. (1985). Investigation of the potential mutagenic activity of benzodiazepines in mice. *Mutat. Res.* **147**, 290.
- Deichmann, W. B., Henschler, D., Holmstedt, B. and Keil, G. (1986). What is there that is not a poison? A study of the *Third Defense* by Paracelsus. *Arch. Toxicol.* **58**, 207-213.
- Deml, E., Schwartz, L. R. and Oesterle, D. (1993). Initiation of enzyme-altered foci by the synthetic steroid cyproterone acetate in rat liver foci bioassay. *Carcinogenesis* **14**, 1229-1231.
- Die-Smulders, C. E. M. de, Sturkenboom, M. C. J. M., Veraart, J., Katwijk, C. van, Sastrowijoto, P. and Linden, E. van der (1995). Severe limb defects and craniofacial anomalies in a fetus conceived during acitretin therapy. *Teratology* **52**, 215-219.
- Diwan, B. A., Rice, J. M. and Ward, J. M. (1986). Tumor-promoting activity of benzodiazepine tranquilizers, diazepam and oxazepam, in mouse liver. *Carcinogenesis* **7**, 789-794.
- Diwan, B. A., Ward, J. M. and Rice, J. M. (1989). Promotion of malignant 'embryonal' liver tumors by phenobarbital: increased incidence and shortened latency of hepatoblastoma in (DBA/2 × C57BL/6)F1 mice initiated with *N*-nitrosodiethylamine. *Carcinogenesis* **10**, 1345-1348.
- Diwan, B. A., Ward, J. M., Kurata, Y. and Rice, J. M. (1994). Dissimilar frequency of hepatoblastomas and hepatic cystadenomas and adenocarcinomas arising in hepatocellular neoplasms of D2B6F1 mice initiated with *N*-nitrosodiethylamine and subsequently given Arochlor-1254, dichlorodiphenyltrichloroethane, or phenobarbital. *Toxicol. Pathol.* **22**, 430-439.
- Drinkwater, N. R. and Ginsler, J. J. (1986). Genetic control of hepatocarcinogenesis in C57/B1/6J and C3H/HeJ inbred mice. *Carcinogenesis* **7**, 1701-1707.
- Faccini, J. M., Irisarri E. and Monro, A. M. (1981). A carcinogenicity study in mice of a β -adrenergic antagonist, primidolol; increased total tumour incidence without tissue specificity. *Toxicology* **21**, 279-290.
- Fagus, J., Osterman, P. O., Siden, A. and Wiholm, B. E. (1985). Guillain-Barré syndrome

- following zimeldine treatment. *J. Neurol. Neurosurg. Psychiatry* **48**, 65–69.
- Festing, M. F. W. (1995). Use of a multi-strain assay could improve the NTP carcinogenesis bioassay program. *Environ. Health Perspect.* **103**, 44–52.
- Florkin, M. (1944). 'L'Évolution Biochimique.' Masson, Paris.
- Fox, K. A. and Lahcen, R. B. (1974). Liver-cell adenomas and peliosis hepatitis in mice associated with oxazepam. *Res. Commun. Chem. Path. Pharmacol.* **8**, 481–488.
- Fox, T. R., Schumann, A. M., Watanabe, P. G., Yano, B. L., Maher, V. M. and McCormick, J. J. (1990). Mutational analysis of the H-ras oncogene in spontaneous C57BL/6XC3H/He mouse liver tumors and tumors induced with genotoxic and non-genotoxic hepatocarcinogens. *Cancer Res.* **50**, 4014–4019.
- Frith, C. H., Ward, J. M. and Turusov, V. S. (1994). Tumors of the liver. In 'Pathology of Tumours in Laboratory Animals, Volume 2 – Tumours of the mouse' (Turusov, V. and Mohr, U., eds), no. 111, pp. 223–248. IARC Scientific Publications, Lyon.
- Furukawa, A., Ohuchida, A. and Wierzbica, K. (1989). *In vitro* mutagenicity tests on polyploidy inducers. *Environ. Mutagen.* **14**(Suppl. 15), 63–64.
- Gallo, M. A. and Doull, J. (1991). History and scope of toxicology. In 'Casarett and Doull's Toxicology' (Amdeer, M. O., Doull, J. and Klaassen, C. D., eds), pp. 3–11. Pergamon, Oxford.
- Gatehouse, D. G., Stemp, G., Pascoe, S., Wilcox, P., Oliver, J. and Tweats, D. J. (1990). Investigations into the induction of aneuploidy and polyploidy in cultured mammalian cells by the anti-tussive agent, noscapine. Abstr. EEMS Meeting, York, UK, 22–27 July, p. 140.
- Gatehouse, D. G., Stemp, G., Pascoe, S., Wilcox, P., Hawker, J. and Tweats, D. J. (1991). Investigations into the induction of aneuploidy and polyploidy in cultured mammalian cells by the anti-tussive agent noscapine hydrochloride. *Mutagenesis* **6**, 279–283.
- Geiger, J.-M. and Brindley, C. J. (1988). *Cis-trans* interconversion of acitretin in man. *Skin Pharmacol.* **1**, 230–236.
- Geiger, J.-M., Baudin, M. and Saurat, J.-H. (1994). Teratogenic risk with etretinate and acitretin treatment. *Dermatology* **189**, 109–116.
- Goodman, J. I. (1994). A rational approach to risk assessment requires the use of biological information: An analysis of the National Toxicology Program (NTP), final report of the Advisory Review by the NTP Board of Scientific Counselors. *Regul. Toxicol. Pharmacol.* **19**, 51–59.
- Goodman, J. I., Ward, J. M., Popp, J. A., Klaunig, J. E. and Fox, T. R. (1991). Mouse liver carcinogenesis: mechanisms and relevance. *Fund. Appl. Toxicol.* **17**, 651–665.
- Greaves, P. (1996). The evaluation of potential human carcinogens: a histopathologist's point of view. *Exp. Toxic. Pathol.* **48**, 169–174.
- Greaves, P., Goonetilleke, R., Nunn, G., Topham, J. and Orton, T. (1993). Two-year carcinogenicity study of tamoxifen in Alderley Park Wistar-derived rats. *Cancer Res.* **53**, 3919–3924.
- Griffin, R. J. and Burka, L. T. (1993). The metabolism and elimination of oxazepam in mice. *Drug Metab. Dispos.* **21**, 918–926.
- Griffin, R. J., Burka, L. T. and Cunningham, M. L. (1995). Activity of hepatic drug metabolizing enzymes following oxazepam-dosed feed treatment in B6CC3F1 mice. *Toxicol. Lett.* **76**, 251–256.
- Griffin, R. J., Dudley, C. N. and Cunningham, M. L. (1996). Biochemical effects of the mouse hepatocarcinogen oxazepam: similarities to phenobarbital. *Fund. Appl. Toxicol.* **29**, 147–154.
- Grønhøj Larsen, F., Jacobsen, P., Grønhøj Larsen, C., Nørgaard, A., Kragballe, K. and Nielsen-Kudsk, F. (1987). Single dose pharmacokinetics of etretin and etretinate in psoriatic patients. *Pharmacol. Toxicol.* **61**, 85–88.
- Grønhøj Larsen, F., Jacobsen, P., Grønhøj Larsen, C., Kragballe, K. and Nielsen-Kudsk, F.

- (1988). Pharmacokinetics of etretin and etretinate during long-term treatment of psoriasis patients. *Pharmacol. Toxicol.* **62**, 159–165.
- Grønhøj Larsen, F., Jacobsen, P., Knudsen, J., Wiesmann, K., Kragballe, K. and Nielsen-Kudsk, F. (1993). Conversion of acitretin to etretinate in psoriatic patients is influenced by ethanol. *J. Invest. Dermatol.* **100**, 623–627.
- Han, X. and Liehr, J. G. (1992). Induction of covalent DNA adducts in rodents by tamoxifen. *Cancer Res.* **52**, 1360–1363.
- Happle, R., Traupe, H., Bounameaux, Y. and Fisch, T. (1984). Teratogene Wirkung van Etretinat beim Menschen. *Deut. Med. Wschr.* **109**, 1476–1480.
- Hastings, P. (1974). 'Medicine. An International History.' Benn, London.
- Hathway, D. E. (1970). Biotransformations. In 'Foreign Compound metabolism in mammals', (D. E. Hathway, gen. rep.), Vol. 1, pp. 130–313. The Chemical Society, London.
- Henry, J. A. and Martin, A. J. (1987). The risk-benefit assessment of antidepressant drugs. *Med. Toxicol.* **2**, 445–462.
- Herrmann, L. (1874). 'Lehrbuch der experimentellen Toxicologie.' Hirschwald, Berlin.
- Hinsbergen, A., Sharma, V. and Mazmanian, D. (1992). Cognitive deterioration from long-term abuse of dextromethorphan: A case report. *J. Psychiatry Neurosci.* **19**, 375–377.
- Hirsimäki, P., Hirsimäki, Y., Nieminen, L. and Payne, B. J. (1993). Tamoxifen induces hepatocellular carcinoma in rat liver: a 1-year study with two antiestrogens. *Arch. Toxicol.* **67**, 49–54.
- Hollstein, M., Sidransky, D., Vogelstein, B. and Harris, C. C. (1991). *p53* Mutations in human cancers. *Science* **253**, 49–53.
- Holmstedt, B. and Liljestrand, G. (1963). 'Readings in Pharmacology.' Pergamon, Oxford, London, New York and Paris.
- Horrobin, D. F., Ghayur, T. and Karmali, R. A. (1979). Mind and cancer. *Lancet* **i**, 978.
- Howe, R. (1965). Carcinogenicity of 'Alderlin' (Pronethalol) in mice. *Nature* **207**, 594–595.
- Hummler, H. and Schüpbach, M. E. (1981). Studies in reproductive toxicology and mutagenicity with Ro 10-9359. In 'Retinoids. Advances in Basic Research and Therapy' (Orfanos, C. E. *et al.*, eds), pp. 49–59. Springer, Berlin.
- Idänpään-Heikkilä, J. E. (1967). An autoradiographic study of the distribution of ³H-noscapine in mice. *Eur. J. Pharmacol.* **2**, 26–34.
- Idänpään-Heikkilä, J. E. (1968). Studies on the fate of ³H-noscapine in mice and rats. *Ann. Med. Exp. Fenn.* **46**, 201–216.
- International Agency for Research on Cancer (IARC) (1977). 'IARC Monographs on the Evaluation of Carcinogenic Risks of Chemicals to Man, Vol. 13, Some Miscellaneous Pharmaceutical Substances,' pp. 57–73. IARC, Lyon.
- International Agency for Research on Cancer (IARC) (1987). 'IARC Monographs on the Evaluation of Carcinogenic Risks of Chemicals to Human. Overall Evaluations of Carcinogenicity: An Updating of IARC Monographs' Vols 1–42, Vol. 7 (Suppl.), pp. 1–440. IARC, Lyon.
- International Agency for Research on Cancer (IARC) (1990). 'IARC Monographs on the Evaluation of Carcinogenic Risks to Humans, Vol. 50. Pharmaceutical drugs.' IARC, Lyon.
- International Agency for Research on Cancer (IARC) (1996). 'IARC Monographs on the Evaluation of Carcinogenic Risks to Humans, Vol. 66, Final Draft Decision on Pharmaceutical Drugs.' IARC. Lyon.
- International Symposium on Residues and Toxicity of Bromide (1983). *Food Chem. Toxicol.* **21**, 355–422.
- Ioannides, C., Okine, L. and Parke, D. V. (1979). Effects of β -adrenoceptor antagonists on the hepatic mixed-function oxygenases in the rat. *Br. J. Pharmacol.* **10**, 451P–452P.
- Ishidate, M. (1988). Data Book of Chromosomal Aberration Tests. *In vitro*, p. 307. Elsevier, Amsterdam.

- Jackson, C. D. and Fishbein, L. (1986). A toxicological review of β -adrenergic blockers. *Fund. Appl. Toxicol.* **6**, 395-422.
- Jensen, B. K., Chaws, C. L. and Huselton, C. A. (1992). Clinical evidence that acitretin is esterified to etretinate when administered with ethanol. *Fed. Am. Soc. Exp. Biol. J.* **6**, A1570 (abstr. 3669).
- Jordan, V. G. (1995). Tamoxifen for breast cancer prevention. *Proc. Soc. Exp. Biol. Med.* **208**, 144-149.
- Kacew, S. and Festing, M. F. W. (1996). Role of rat strain in the differential sensitivity to pharmaceutical agents and naturally occurring substances. *J. Toxicol. Environ. Health* **47**, 1-30.
- Karlsson, M. O. and Dahlström, B. (1990). Serum protein binding of noscapiene: influence of a reversible hydrolysis. *J. Pharm. Pharmacol.* **42**, 140-143.
- Karlsson, M. O., Dahlström, B. and Neil, A. (1988). Characterization of high-affinity binding sites for the antitussive [3 H]noscapiene in guinea pig brain tissue. *Eur. J. Pharmacol.* **145**, 195-203.
- Karlsson, M. O., Dahlström, B., Eckernäs, S.-Å., Johansson, M. and Tufvesson Alm, A. (1990). Pharmacokinetics of oral noscapiene. *Eur. J. Clin. Pharmacol.* **39**, 275-279.
- Karmali, R. A., Volkman, A. and Muse, P. (1979). The influence of diazepam administration in rats bearing the R3230AC mammary carcinoma. *Prostaglandins Med.* **3**, 193-198.
- Kasper, P., Tegethoff, K. and Mueller, L. (1995). *In vitro* mutagenicity studies on cyproterone acetate using female rat hepatocytes for metabolic activation and as indicator cells. *Carcinogenesis* **16**, 2309-2314.
- Kato, R. and Yamazoe, Y. (1992). Sex specific cytochrome P450 as a cause of sex and species related differences in drug toxicity. *Toxicol. Lett.* **64/65**, 661-667.
- Kendal, M. E. and Rose, D. P. (1992). The effects of diethylstilbestrol, tamoxifen, and toremifene on estrogen-inducible hepatic proteins and estrogen receptor proteins in female rats. *Toxicol. Appl. Pharmacol.* **114**, 127-131.
- King, C. M. (1995). Tamoxifen and the induction of cancer. *Carcinogenesis* **16**, 1449-1454.
- Kistler, A. (1987). Limb bud cell cultures for estimating the teratogenic potential of compounds. Validation of the test system with retinoids. *Arch. Toxicol.* **60**, 403-414.
- Kistler, A. and Hummler, M. E. (1985). Teratogenesis and reproductive safety evaluation of the retinoid etretin (Ro 10-1670). *Arch. Toxicol.* **58**, 50-56.
- Kleinerman, R. A., Brinton, L. A., Hoover, R. and Fraumeni, J. F., Jr. (1984). Diazepam use and progression of breast cancer. *Cancer Res.* **44**, 1223-1225.
- Kluwe, W. M. (1996). The complementary role of 'in vitro' and 'in vivo' tests in genetic toxicology assessment. *Regul. Toxicol. Pharmacol.* **22**, 268-272.
- Kochhar, D. M., Penner, J. D. and Minutella, L. M. (1989). Biotransformation of etretinate and developmental toxicity of etretin and other aromatic retinoids in teratogenesis bioassays. *Drug Metab. Dispos.* **17**, 618-624.
- Kristofferson, A. and Nilsson, B. S. (1989). Zimeldine: febrile reactions and peripheral neuropathy. In 'Autoimmunity and Toxicology. Immune Disregulation Induced by Drugs and Chemicals' (Kammüller, M. E., Bloksma, N. and Seinen, W., eds), pp. 183-214. Elsevier Science Publishers, Amsterdam.
- Lambert, W. E., Meyer, E., De Leenheer, A. P., De Bersaques, J. and Kint, A. H. (1992). Pharmacokinetics and drug interactions of etretinate and acitretin. *J. Am. Acad. Dermatol.* **27**, S19-S22.
- Lang, R. and Redmann, U. (1979). Non-mutagenicity of some sex hormones in the Ames *Salmonella*/microsome mutagenicity test. *Mutat. Res.* **67**, 361-365.
- Lang, R. and Reimann, R. (1993). Studies for a genotoxic potential of some endogenous sex steroids. I. Communication: examination for the induction of gene mutations using the Ames *Salmonella*/microsome test and the HGPRT test in V79 cells. *Environ. Mol. Mutagen.* **21**, 272-304.

- Laugier, J. P., de Sousa, G., Bun, H., Geiger, J.-M., Surber, C. and Rahmani, R. (1994). Acitretin biotransformation into etretinate: role of ethanol on *in vitro* hepatic metabolism. *Dermatology* **188**, 122–125.
- Leake, C. D. (1975). 'An Historical Account of Pharmacology to the 20th Century.' Thomas, Springfield.
- Levine, R. R. (1983). Chapter 9: 'General Principles of the Quantitative Aspects of Drug Action. I. Dose–Response Relationships', pp. 175–209. In 'Pharmacology: Drug Actions and Reactions'. Little, Brown & Co, Boston and Toronto.
- Lewin, L. (1899). 'Die Nebenwirkungen der Arzneimittel.' Hirschwald, Berlin.
- Lin, J. H. (1995). Species similarities and differences in pharmacokinetics. *Drug Metab. Dispos.* **23**, 1008–1021.
- Löfberg, B., Chahoud, I., Bochert, G. and Nau, H. (1990). Teratogenicity of the 13-*cis* and all-*trans*-isomers of the aromatic retinoid etretin: Correlation to transplacental pharmacokinetics in mice during organogenesis after a single oral dose. *Teratology* **41**, 707–716.
- Löfberg, B., Reiners, J., Spielmann, H. and Nau, H. (1990). Teratogenicity of steady-state concentrations of etretinate and metabolite acitretin maintained in maternal plasma and embryo by intragastric infusion during organogenesis in the mouse: a possible model for the extended elimination phase in human therapy. *Dev. Pharmacol. Ther.* **15**, 45–51.
- Marselos, M. and Vainio, H. (1991). Carcinogenic properties of pharmaceutical agents evaluated in the IARC Monographs programme. *Carcinogenesis* **12**, 1751–1766.
- Martelli, A., Mattioli, F., Fazio, S., Andrae, U. and Brambilla, G. (1995). DNA repair synthesis and DNA fragmentation in primary cultures of human and rat hepatocytes exposed to cyproterone acetate. *Carcinogenesis* **16**, 1265–1269.
- Martelli, A., Brambilla-Campart, G., Ghia, M., Allavena, A., Mereto, E. and Brambilla, G. (1996a). Induction of micronuclei and initiation of enzyme-altered foci in the liver of female rats treated with cyproterone acetate, chlormadinone acetate or megestrol acetate. *Carcinogenesis* **17**, 5551–5554.
- Martelli, A., Mattioli, F., Ggia, M., Mereto, E. and Brambilla, G. (1996b). Comparative study of DNA repair induced by cyproterone acetate, chlormadinone acetate and megestrol acetate in primary cultures of human and rat hepatocytes. *Carcinogenesis* **17**, 1153–1156.
- Martelli, A. M., Ghia, M., Mattioli, F., Mereto, E. and Andrae, U. (1994). Experimental evidence for a carcinogenic risk of cyproterone acetate to humans. 27th Congresso Nazionale di Farmacologia, Turin (abstract).
- Martin, E. A., Rich, K. J., Heydon, R., White, I. N. H., Woods, K. L., Powles, T. J. and Smith, L. L. (1994). A comparison of ³²P-postlabelled tamoxifen liver DNA adducts in rats, mice and breast cancer patients. *Toxicologist* **14**, 405 (abstr. 1602). Abstr. 33rd Annu. Meeting Soc. Toxicol., Dallas, 13–17 March, 1994.
- Masarella, J., Vane, F., Buggé, C., Rodriguez, L., Cunningham, W. J., Franz, T. and Colburn, W. (1985). Etretinate kinetics during chronic dosing in severe psoriasis. *Clin. Pharmacol. Ther.* **37**, 439–446.
- Mazue, G., Remandet, B., Gouy, D., Berthe, J., Roncucci, R. and Williams, G. M. (1982). Limited *in vivo* bioassays on some benzodiazepines: lack of experimental initiating or promoting effect of the benzodiazepine tranquilizers Diazepam, Clorazepate, Oxazepam, and Lorazepam. *Arch. Int. Pharmacodyn.* **257**, 59–65.
- McClain, R. M. (1989). The significance of hepatic microsomal enzyme induction and altered thyroid function in rats: implications for thyroid gland neoplasia. *Toxicol. Pathol.* **17**, 294–306.
- McClain, R. M. (1995). Mechanistic considerations for the relevance of animal data on thyroid neoplasia to human risk assessment. *Mutation Research* **333**, 131–142.
- McNamara, P. J. and Blouin, R. A. (1990). Pharmacokinetic profile of two aromatic retinoids (etretinate and acitretin) in the obese Zucker rat. *J. Pharm. Sci.* **79**, 301–304.

- Meyer, H. H. and Gottlieb, R. (1911). 'Die Experimentelle Pharmakologie als Grundlage der Arzneibehandlung.' Urban & Schwarzenberg, Berlin.
- Miller, D. A. and DeLuca, H. F. (1985). Activation of retinoic acid by coenzyme A for the formation of ethyl retinoate. *Proc. Natl Acad. Sci. USA* **82**, 6419-6422.
- Milles, D. (1994). Geschichte der Toxikologie. Eine Einführung. In 'Lehrbuch der Toxikologie' (Marquardt, H. and Schäfer, S. G., eds) p. 5-14. Wissenschaftsverlag, München.
- Mitchell, I. DeG., Carlton, J. B., Chan, M. Y. W., Robinson, A. and Sunderland, J. (1991). Noscapine-induced polyploidy *in vitro*. *Mutagenesis* **6**, 479-486.
- Monro, A. (1994). Drug toxicokinetics: scope and limitations that arise from species differences in pharmacodynamic and carcinogenic responses. *J. Pharmacokinet. Biopharm.* **22**, 41-57.
- Mordenti, J. (1986). Man versus beast: Pharmacokinetic scaling in animals. *J. Pharm. Sci.* **75**, 1028-1040.
- Muller, F. (1933). 'Grieks Woordenboek'. Wolters, Groningen.
- Murray, R. K. (1993). Cancer, oncogenes and growth factors. In 'Harper's Biochemistry' (Murray, R. K., Granner, D. K., Mayes, P. A. and Rodwell, V. W., eds), pp. 710-728. Prentice-Hall, New York.
- Naranjo, C. A., Lane, D., Ho-Asjoe, M. and Lancot, K. L. (1990). A Bayesian assessment of idiosyncratic adverse reactions to new drugs: Guillain-Barré syndrome and zimeldine. *J. Clin. Pharmacol.* **30**, 174-180.
- National Toxicology Program (1993). Toxicology and carcinogenesis studies of oxazepam in Swiss-Webster and B6C3F₁ mice (feed studies). Technical Rep. Ser. No. 443.
- Nayak, K. P., Brochmann-Hanssen, E. and Leong Way, E. (1965). Biological disposition of noscapine. *J. Pharm. Sci.* **54**, 191-194.
- Nebert, D. W. and Gonzalez, F. J. (1987). P450 genes: structure, evolution and regulation. *Annu. Rev. Biochem.* **56**, 945-993.
- Nebert, D. W., Nelson, D. R., Coon, M. J. *et al.* (1991). The P450 superfamily: update on new sequences, gene mapping, and recommended nomenclature. *DNA and Cell Biol.* **10**, 1-14.
- Neumann, I., Thierau, D., Andrae, U., Greim, H. and Schwartz, L. R. (1992). Cyproterone acetate induces DNA damage in cultured rat hepatocytes and preferentially stimulates DNA synthesis in γ -glutamyltranspeptidase-positive cells. *Carcinogenesis* **13**, 373-378.
- Newberne, J. W., Newberne P. M., Gibson J. P., Huffman, K. W. and Palopoli, F. P. (1977). Lack of carcinogenicity of oxprenolol, a β -adrenergic blocking agent. *Tox. Appl. Pharmacol.* **41**, 535-546.
- Nilsson, B. S. (1983). Adverse reactions in connection with zimeldine treatment: a review. *Acta Psych. Scand.* **308**, 115-119.
- Ohri, S. K., Gaer, J. A. R. and Keane, P. F. (1991). Hepatocellular carcinoma and treatment with cyproterone acetate. *Br. J. Urol.* **67**, 213.
- Okine, L. K. N., Ioannides, C. and Parke, D. V. (1983). Studies on the possible mutagenicity of beta-adrenergic blocker drugs. *Toxicol. Lett.* **18**, 167-174.
- Olsen, J. H., Boice, J. D., Jensen, J. P. A. and Fraumeni, J. F., Jr (1989). Cancer among epileptic patients exposed to anticonvulsant drugs. *J. Natl Cancer. Inst.* **81**, 803-808.
- Olsen, J. H., Schulgen, G., Boice, Jr, Wilsner, J., Travis, L. B., Williams, G. M., Johnson, F. B. and McGee, J. O'D. (1995). Antiepileptic treatment and risk for hepatobiliary cancer and malignant lymphoma. *Cancer Res.* **55**, 294-297.
- Olsson, B., Bolme, P., Dahlström, B. and Marcus, C. (1986). Excretion of noscapine in human breast milk. *Eur. J. Clin. Pharmacol.* **30**, 213-215.
- Ozturk, M. (1991). p53 Mutation in hepatocellular carcinoma after aflatoxin exposure. *Lancet* **338**, 1356-1359.
- Paget, G. E. (1963). Carcinogenic action of pronethalol. *Brit. Med. J.* **2**, 1266-1267.
- Paravicini, U. (1981). Pharmacokinetics and metabolism of oral aromatic retinoids. In

- 'Retinoids: Advances in Basic Research and Therapy' (Orfanos, C. E. *et al.*, eds), pp. 13–20. Springer, Berlin.
- Peters-Volleberg, G. W. M., De Waal, E. J. and Van Der Laan, J. W. (1994). Interspecies extrapolation in safety evaluation of human medicines in the Netherlands (1990–1992): Practical considerations.
- Phillips, D. H., Carmichael, P. L., Hewer, A., Cole, K. J., Hardcastle, I. R., Poon, G. K., Keogh, A. and Strain, A. J. (1996a). Activation of tamoxifen and its metabolite α -hydroxytamoxifen to DNA-binding products: comparisons between human, rat and mouse hepatocytes. *Carcinogenesis* **17**, 89–94.
- Phillips, D. H., Hewer, A., Grover, P. L., Poon, G. K. and Carmichael, P. L. (1996b). Tamoxifen does not form detectable DNA adducts in white blood cells of breast cancer patients. *Carcinogenesis* **17**, 1149–1152.
- Pitot, H. C. (1995). The tamoxifen controversy – Clinical chemoprotective agent and experimental carcinogen. *Proc. Soc. Exp. Biol. Med.* **208**, 139–140.
- Porter, R., Parry, E. M. and Parry, J. M. (1992). Morphological transformation of an established Syrian hamster dermal cell with the anti-tussive agent noscapine. *Mutagenesis* **7**, 205–209.
- Preat, V., De Gerlache, J., Lans, M. and Roberfroid, M. (1987). Promoting effect of oxazepam in rat hepatocarcinogenesis. *Carcinogenesis* **8**, 97–100.
- Rabe, T., Feldmann, K., Heinemann, L. and Runnebaum, B. (1996). Cyproterone acetate: is it hepato- or genotoxic? *Drug Safety* **14**, 25–38.
- Rauws, A. G. and Groen, K. (1994). Future perspectives on toxicokinetics: A regulator's view. *Drug Information* **28**, 295–300.
- Rauws, A. G. and van Logten, M. J. (1973). The influence of dichlorvos from strips or sprays on cholinesterase activity in chicken. *Toxicology* **1**, 29–41.
- Ray, J. S., Harbison, M. L., McClain, R. M. and Goodman, Y. I. (1994). Alterations in the methylation status and expression of the *raf* oncogen in phenobarbital-induced and spontaneous B6C3F₁ mouse liver tumors. *Mol. Carcinogen.* **9**, 155–166.
- Reiners, J., Löfberg, B., Creech Kraft, J., Kochhar, D. M. and Nau, H. (1988). Transplacental pharmacokinetics of teratogenic doses of etretinate and other aromatic retinoids in mice. *Reprod. Toxicol.* **2**, 19–29.
- Robinson, R. L., van Ryzin, R. J., Stoll, R. E., Jensen, R. D. and Bagdon, R. E. (1984). Chronic toxicity/carcinogenesis study of temazepam in mice and rat. *Fund. Appl. Toxicol.* **4**, 394–405.
- Robinson, S. P., Langan-Fahey, L., Johnson, D. A. and Jordan, V. (1991). Metabolites, pharmacodynamics and pharmacokinetics of tamoxifen in rats and mice compared to the breast cancer patient. *Drug Metab. Disp.* **19**, 36–43.
- Rosenberg, L., Palmer, J. R., Zauber, A. G., Warshauer, M. E., Strom, B. L., Harlap, S. and Shapiro, S. (1995). Relation of benzodiazepine use to the risk of selected cancers: breast, large bowel, malignant melanoma, lung, endometrium, ovary, non-Hodgkin's lymphoma, testis, Hodgkin's disease, thyroid and liver. *Am. J. Epidem.* **141**, 1153–1160.
- Rubio, F., Jensen, B. K., Henderson, L., Garland, W. A., Szuna, A. and Town, C. (1994). Disposition of [¹⁴C]acitretin in humans following oral administration. *Drug Metab. Dispos.* **22**, 211–215.
- Rüdiger, T., Beckmann, J. and Queisser, W. (1995). Hepatocellular carcinoma after treatment with cyproterone acetate combined with ethinyloestradiol. *Lancet* **345**, 452–453.
- Sargent, L. M., Dragan, Y. P., Bahnub, N., Wiley, J. E., Sattler, C. A., Schroeder, P., Sattler, G. L., Jordan, V. C. and Pitot, H. C. (1994). Tamoxifen induces hepatic aneuploidy and mitotic spindle disruption after a single *in vivo* administration to female Sprague–Dawley rats. *Cancer Res.* **54**, 3357–3360.
- Sargent, L. M., Dragan, Y. P., Sattler, C., Bahnub, N., Sattler, G., Martin, P., Cisneros, A., Mann, J., Thorgeirsson, S., Jordan, V. C. and Pitot, H. C. (1996). Induction of hepatic

- aneuploidy *in vivo* by tamoxifen, toremifene and idoxifene in female Sprague-Dawley rats. *Carcinogenesis* **17**, 1051-1056.
- Schaumburg, H., Kaplan, J., Windebank, A., Vick, N., Rasmus, S., Pleasure, D. and Brown, M. J. (1983). Sensory neuropathy from pyridoxine abuse. *New Engl. J. Med.* **309**, 445-448.
- Schulte-Hermann, R. and Parzefall, W. (1980). Adaptive responses of rat liver to the gestagen and anti-androgen cyproterone acetate and other inducers. I. Induction of drug metabolizing enzymes. *Chem. Biol. Interact.* **31**, 279-286.
- Schulte-Hermann, R., Hoffmann, V., Parzefall, W., Kallebach, M., Gerhardt, A. and Schuppler, J. (1980). Adaptive response of rat liver to the gestagen and anti-androgen cyproterone acetate and other inducers. II. Induction of liver growth. *Chem. Biol. Interact.* **31**, 287-300.
- Schulte-Hermann, R., Ochs, H., Bursch, W. and Parzefall, W. (1988). Quantitative structure-activity studies on effects of sixteen different steroids on growth and monooxygenases of rat liver. *Cancer Res.* **48**, 2462-2468.
- Schuppler, J. and Günzel, P. (1979). Liver tumors and steroid hormones in rats and mice. *Arch. Toxicol. Suppl.* **2**, 181-195.
- Schuppler, J., Damm, J. and Schulte-Hermann, R. (1983). Assay of some endogenous and synthetic sex steroids for tumor-initiating activity in rat liver using the Solt-Faber system. *Carcinogenesis* **4**, 239-241.
- Sisenwine, S. F., Tio, C. O., Schrader, S. R. and Ruelius, H. W. (1972). The biotransformation of oxazepam (7-chloro-1,3-dihydro-3-hydroxy-5-phenyl-2H-1,4-benzodiazepine-2-on) in man, miniature swine and rat. *Arzneim.-Forsch.* **22**, 682-687.
- Smith, L. L. and White, I. N. H. (1995). Chemoprevention of breast cancer by tamoxifen: risks and opportunities. *Toxicol. Lett.* **82/83**, 181-186.
- Stoll, B. A. (1976). Psychosomatic factors and tumour growth. In 'Risk Factors in Breast Cancer', (Stoll, B. A., ed.), pp. 193-203. William Heineman Medical Books, London.
- Sturkenboom, M. C. J. M. (1995). 'A field-oriented postmarketing surveillance study on the teratogen acitretin.' Thesis Groningen, The Netherlands, pp. 133-144.
- Sturkenboom, M. C. J. M., de Jong-van den Berg, L. T. J., van Voorst-Vader, P. C., Cornel, M. C., Stricker, B. H. C. H. and Wesseling, H. (1994). Inability to detect plasma etretinate and acitretin is a poor predictor of the absence of these teratogens in tissue after stopping acitretin treatment. *Br. J. Clin. Pharmacol.* **38**, 229-235.
- Styles, J. A., Davies, A., Lim, C. K., De Matteis, F., Stanley, L. A., White, I. N. H., Yuan, Z.-X. and Smith, L. L. (1994). Genotoxicity of tamoxifen, tamoxifen epoxide and toremifene in human lymphoblastoid cells containing human cytochrome P450s. *Carcinogenesis* **15**, 5-9.
- Swierenga, S. H. H., Butler, S. G. and Hasnain, S. H. (1983). Activity of diazepam and oxazepam in various mammalian cell *in vitro* toxicity tests. *Environ. Mutagen.* **5**, 417.
- Thomas, C. (1989). Immunomodulation in mice induced by the antidepressant drug zimeldine. PhD thesis, Utrecht University, The Netherlands.
- Thomas, C., Groten, J., Kammüller, M. E., De Bakker, J. M., Seinen, W. and Bloksma, N. (1989). Popliteal lymph node reactions in mice induced by the drug zimeldine. *Int. J. Immunopharmacol.* **11**, 693-702.
- Thomas, C., Punt, P., Warringa, R., Högberg, T., Seinen, W. and Bloksma, N. (1990). Popliteal lymph node enlargement and antibody production in the mouse induced by zimeldine and related compounds with varying side chains. *Int. J. Immunopharmacol.* **12**, 561-568.
- Tiveron, C., Hartley-Asp, B., Johansson, C. J. and Pacchierotti, F. (1993). Noscipine does not show aneuploid activity in mouse oocytes. *Mutagenesis* **8**, 311-315.
- Topinka, J., Andrae, U., Schwartz, L. R. and Wolff, T. (1993). Cyproterone acetate generates DNA adducts in rat liver and in primary rat hepatocyte cultures. *Carcinogenesis* **14**, 423-427.

- Topinka, J., Binkova, B., Zhu, H. K., Andrae, U., Neumann, I., Schwartz, L. R., Werner, S. and Wolff, T. (1995). DNA-damaging activity of the cyproterone acetate analogues chlormadinone acetate and megestrol acetate in rat liver. *Carcinogenesis* **16**, 1483–1487.
- Topinka, J., Binkova, B., Schwartz, L. R. and Wolff, T. (1996). Cyproterone acetate is an integral part of hepatic DNA adducts induced by this steroidal drug. *Carcinogenesis* **17**, 167–169.
- Tsunoda, N. and Yoshimura, H. (1979). Metabolic fate of noscapine. II. Isolation and identification of novel metabolites produced by C–C bond cleavage. *Xenobiotica* **9**, 181–187.
- Tsunoda, N. and Yoshimura, H. (1981). Metabolic fate of noscapine. III. Further studies on identification and determination of the metabolites. *Xenobiotica* **11**, 23–32.
- Tucker, M. J. (1968). Observations relating to the carcinogenic action of pronethalol ('Alderlin'). *Proc. Eur. Soc. Study Drug Tox.* **10**, 175–182.
- Tucker, M. J., Adam, H. K. and Patterson, J. S. (1984). Tamoxifen. In "Safety Testing of New Drugs" (Laurence, D. R., McLean, A. E. M. and Weatherall, M., eds), pp. 125–161. Academic Press, New York.
- Tucker, M. J., Kalinowski, A. E. and Orton, T. C. (1996). Carcinogenicity of cyproterone acetate in the mouse. *Carcinogenesis* **17**, 1473–1476.
- Vainio, H. V., Heseltine, E., McGregor, D., Tomatis, L. and Wilbourn, J. (1992). Working Group on mechanisms of carcinogenesis and the evaluation of carcinogenic risks. *Cancer Res.* **52**, 2357–2361.
- Van Der Laan, J. W., De Groot, G., Wortelboer, H. and Noordhoek, J. (1993). Pharmacokinetic differences of desmethyldiazepam in three outbred Wistar strains related to differences in liver enzyme activities. *Pharmacol. Toxicol.* **73**, 229–232.
- Vancutsem, P. M., Lazarus, P. and Williams, G. M. (1994). Frequent and specific mutations of the rat *p53* gene in hepatocarcinomas induced by tamoxifen. *Cancer Res.* **54**, 3864–3867.
- Watanabe, S., Yamasaki, S., Tanae, A., Hibi, I. and Honna, T. (1994). Three cases of hepatocellular carcinoma among cyproterone users. *Lancet* **344**, 1567–1568.
- White, I. N. H., De Matteis, F., Davies, A., Smith, L. L., Crofton-Sleigh, C., Venitt, S., Hewer, A. and Phillips, D. H. (1992). Genotoxic potential of tamoxifen and analogues in female Fischer F344/N rats, DBA/2 and C57BL/6 mice and in human MLC-5 cells. *Carcinogenesis* **13**, 2197–2203.
- Wiegand, U. W. and Jensen, B. K. (1991). Pharmacokinetics of acitretin in humans. In 'Retinoids, 10 Years On' (Saurat, J.-H., ed.), pp. 192–203. Karger, Basel.
- Williams, G. M., Iatropoulos, M. J., Djordjevic, M. C. and Kaltnerberg, O. P. (1993). The triphenylethylene drug tamoxifen is a strong liver carcinogen in the rat. *Carcinogenesis* **14**, 315–317.
- Wolfe, T. R. and Caravati, E. M. (1995). Massive dextromethorphan ingestion and abuse. *Am. J. Emergency Med.* **13**, 174–176.
- Woods, J. H., Katz, J. L. and Winger, G. (1992). Benzodiazepines: Use, abuse, and consequences. *Pharmacol. Rev.* **44**, 151–347.
- Zbinden, G. (1985). 'Menschen, Tiere und Chemie'. M.T.C. Verlag, Zollikon, Switzerland.
- Zbinden, G. (1993). The concept of multi-species testing in industrial toxicology. *Regul. Toxicol. Pharmacol.* **17**, 85–94.

The Concept of Chiral Conformers and its Significance in Molecular Pharmacology

MIKLÓS SIMONYI

*Central Research Institute for Chemistry, Hungarian Academy of Sciences,
H-1525 Budapest, POB 17, Hungary*

1	Introduction	73
2	Ring Conformers	76
2.1	1,4-Dihydropyridines	76
2.2	Sugar Rings in DNA	79
2.3	Butterfly-like Conformations	82
2.4	1,4-Benzodiazepines	84
3	Conformers of Flexible Molecules	86
3.1	Human Serum Albumin	86
3.2	Tasting Peptides	89
3.3	Conformation and Ion Channel Function	91
3.3.1	Agonists Versus Antagonists	93
3.3.2	Subclass-selective Conformers of GABA	94
3.4	Molecular Parasites	97
3.4.1	CC-1065	98
3.4.2	Enediyne Antibiotics	100
3.4.3	A hybrid	104
4	Conclusion	105
	References	106

1 Introduction

The most predictive power of chemistry practised by thousands day by day is the ability to design on paper a compound that has never existed in nature. It results from the inevitably experience-based rules of drawing chemical formulae faithfully reflecting possible connectivities of atoms to form a molecule of given configuration. Chemical formalism is a reliable guide even in stereochemistry, considering the spatial features of molecules and their chemical consequences. Compared with this high level of scientific achievement, our ability to envisage conformational properties, i.e., the actual shape of molecules, is rather limited. This has particularly embarrassing consequences when we try to understand molecular recognition, the basic step in any type of biological effect; a poor fit could result from both wrong

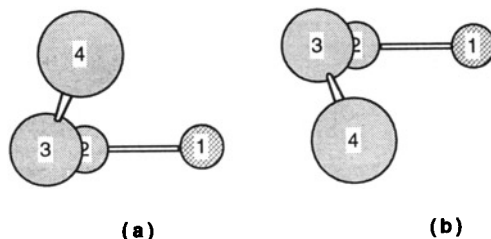

FIG. 1. Backbones of two enantiomeric conformers of butane: (a) $\tau = +60^\circ$; (b) $\tau = -60^\circ$.

configuration and unsuitable conformation, in the same way that a right glove will not fit on either the left hand or the right fist.

Chirality of an object implies a definite shape not identical with its mirror image. The simplest organic molecule that can accommodate chiral conformers is butane. Any position of a terminal carbon (e.g. C^4) out of the plane defined by the other three adjacent ones ($C^1-C^2-C^3$) makes the molecule chiral. Description of the actual geometry can be conveniently given by the dihedral (torsion) angle¹ $\tau(C^1-C^2-C^3-C^4)$; values different from 0° and 180° represent nonplanar conformations and identical angles of opposite signs (e.g. $\tau = +60^\circ$ and $\tau = -60^\circ$ in Figure 1) refer to conformations in a mirror image relation to each other.

The first problem encountered in defining chiral conformers is whether they are stable enough to justify discussion of their geometrical properties.² The above gauche conformations of butane in the gas phase correspond to local minima of about 2 and 4 kcal mol⁻¹ deep below the neighbouring rotational barriers of $\tau = \pm 120^\circ$ and $\tau = 0^\circ$ eclipsed conformers, respectively (Wiberg and Murcko, 1988; Allinger *et al.*, 1990). Note, however, the very low stability at room temperature of these staggered conformers. The *general chemical experience* (based on reactivity in homogeneous phases) also distinguishes conformers from stereoisomers. The former are taken as elements of a distribution in which the average thermal energy at ambient

¹In order to establish the sign of the torsion angle, view the molecule from the side of C^3 when C^3 and C^2 are eclipsed, and the C^1-C^2 bond coincides with the x axis. Appearance of the C^3-C^4 bond in the positive $X-Y$ hemiplane corresponds to positive sign (anticlockwise rotation of the front bond around C^2-C^3 , starting from $\tau = 0^\circ$), while rotation to the negative hemiplane (clockwise rotation of the front bond!) defines a negative dihedral angle, in complete agreement with the description given by Klyne and Prelog (1960). In general, we may remember that clockwise rotation of the front bond increases the negative and decreases the positive torsion angle.

²In the general usage, only conformations of minimal potential energy are regarded as 'conformers', 'or conformational isomers' (Eliel *et al.*, 1994).

temperature is more than enough to enable different conformers to surmount the rotational energy barriers that separate them from each other. Consequently, the species in Figure 1 are short-lived conformers in the usual sense so is it justified to talk about them at all?

In the general sense, conformers form a continuum from transients (that do not correspond to energy minima) to stereoisomers (stabilized by steep barriers of restricted rotation). Since several structural features can contribute to hindered rotation, it is not quite straightforward to recognize that from the chemical formula. The height of the energy barrier should be compared with the thermal energy, since rotamers become atropisomers at low temperatures (Oki, 1983), so the borderline between these categories is neither absolute, nor sharp. Furthermore, the *general chemical experience* fails as soon as flexible molecules adsorb to a surface. The adsorptive forces, in cooperation with the steric resistance of the surface could then overcome the effect of both rotational barriers and thermal energy and stabilize the molecule in a given conformation provided that it is adsorbed. Hence we extend the term conformer to any conformation stabilized by adsorption to a surface.

In molecular pharmacology protein molecules provide the surface and the process of adsorption is called binding. The binding of a molecule to a receptor, enzyme, or transport protein is the first of a sequence of molecular events leading to an effect of biological significance. Binding to a protein surface implies chiral discrimination; it either prefers one of the two enantiomers of chiral molecules, or selects one conformation out of the many possible ones a flexible molecule could have. Elucidation of the 'active conformation', i.e. the shape of the conformer bound, leads to a better understanding and prompts the synthesis of biologically active cyclic compounds in which the given conformation is preformed. Conversely, conformationally restricted analogues often help to reveal the active conformation.

The concept of chiral conformers is applied to molecules that possess a helical element of chirality, regardless of whether or not they are chiral in other conformations. Hence, molecules of central chirality may, in addition, assume conformations that are helically chiral, such as DNA.

One aim of this chapter is to demonstrate the importance of chirality in molecules that are generally considered nonchiral. Furthermore, it also attempts to show that the conformation – representing a conceptual level higher than the configuration in the description of molecular structure (Testa and Kier, 1991) – is a decisive attribute of the molecule as far as biological effects are concerned. In this regard, it seems relevant to quote here Oki (1984) who claimed even for purely chemical systems: 'Organic compounds are thought to be pure even though they may be a mixture of conformational isomers. This is because the isomers convert rapidly with each other at room temperature and their individual reactivities are little known'. This notion is especially true for the biological properties of organic compounds.

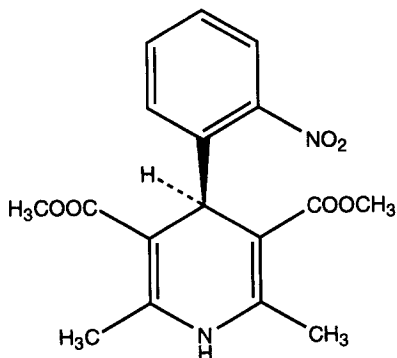

FIG. 2. Nifedipine.

2 Ring Conformers

2.1 1,4-DIHYDROPYRIDINES

The successful cardiovascular drug and calcium channel antagonist nifedipine (Figure 2) is not a chiral compound, since the DHP ring is symmetrically substituted and the 4-aromatic group can assume orthogonal arrangement. If other positions of the aromatic ring were frozen by binding to the Ca-channel, the conformation of the two rings would give rise to chirality. Goldmann and Stoltefuss (1991) reviewed conformational aspects of biological activity.

- (1) The 4-aryl substituted DHP ring assumes the form of a flat boat (Fossheim *et al.*, 1982) and the aryl group should be in a pseudoaxial position (Goldmann *et al.*, 1990), otherwise the compound is inactive. This gave rise to a 'sailing ship nomenclature' (Beard and McKie, 1981) adopted in order to distinguish the two edges of the DHP ring (Triggle *et al.*, 1989); its advantage is that *ortho*-substituents in the aromatic group will not change the assignment of the two enantiotopic faces, as would happen for the *re/si* nomenclature owing to alterations in the priority rule. Hence, the NH group is the *stern*, the C(4) atom is the *bow* of the boat, the aryl substituent is regarded as the *bowsprit*, the left edge is the *port* side, the right edge is the *starboard* side.
- (2) The orthogonal arrangement of the two rings is essential for biological activity (Goldmann and Stoltefuss, 1991), as proved by rigid analogues (Figures 3 and 4). Hence, the position of the *o*-nitrophenyl group does not lead to chiral conformation during the action of nifedipine.
- (3) For *ortho*- and *meta*-substituted derivatives, the aryl ring has two orthogonal conformations (Figure 5); the substituent can be positioned

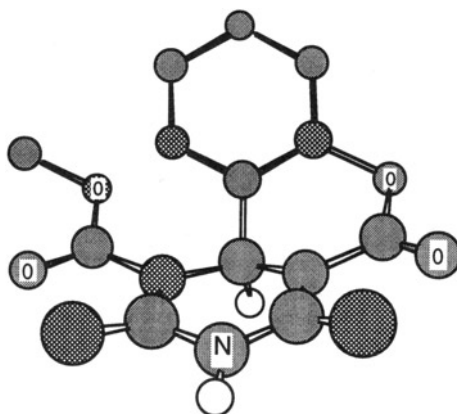

FIG. 3. Non-orthogonal aromatic ring: inactive.

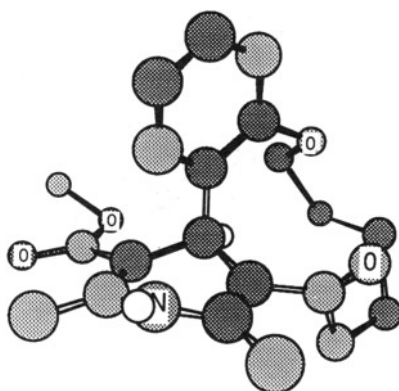

FIG. 4. Orthogonal aromatic ring: active.

either away from the C(4)-H bond (antiperiplanar, *ap*), or towards it (synperiplanar, *sp*). Rigid compounds show that only the latter is active (Baldwin *et al.*, 1987).

- (4) The last two analogues were tetrahydropyridines, which also proved that the ester groups should occupy equatorial positions (Baldwin *et al.*, 1987); the *sp* compound is 50 times less active if the ester group is axial (Figure 6).
- (5) The role of the ester groups was discerned by showing that the function of the ester at the *port* side was to ensure embedding into a lipophilic domain of the Ca-channel, while a hydrogen bond is formed with the binding site at the *starboard* side (Goldmann and Stoltefuss, 1991). This

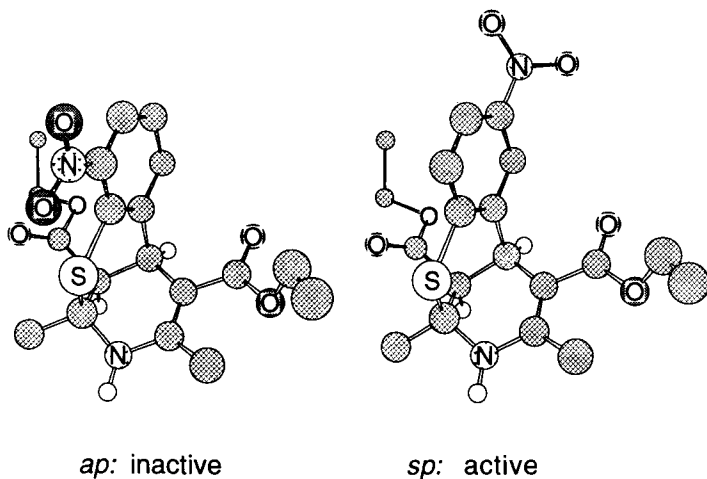

FIG. 5. Relative positions of the aromatic ring.

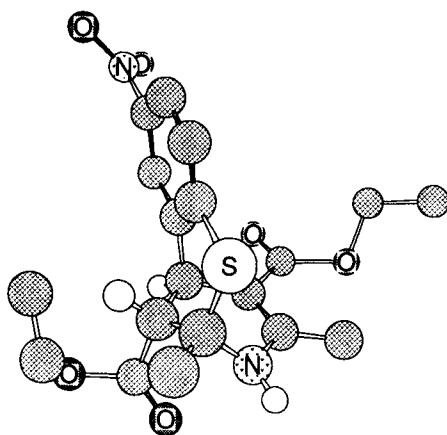

FIG. 6. Axial ester: decreased activity.

difference pinpoints how the symmetrical boat becomes harboured chirally by the biological environment.

- (6) The position of the *port*-side ester carbonyl with respect to the double bond in the DHP ring has been found decisive for the efficacy of certain derivatives of 1,4-dihydropyridines; Ca-antagonists should align *cis* orientation with their ester carbonyl, while Ca-agonists are required to assume *trans* conformation (Goldmann and Stoltefuss, 1991). Hence, we may depict the biologically active conformation of nifedipine, as shown in Figure 7. It may be emphasized that chirality is not an intrinsic

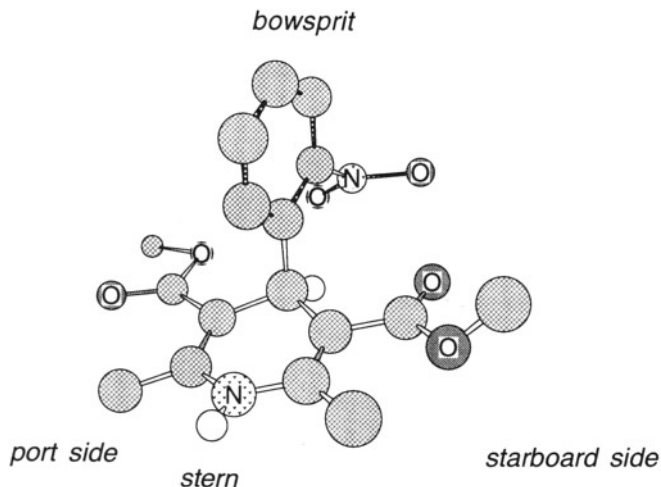

FIG. 7. The active conformation of nifedipine.

property of the molecule indicated by X-ray or NMR studies; it arises rather from the interaction leading to pharmacological activity.

It should be kept in mind, however, that the efficacy and even stereoselectivity of channel-active drugs may depend on the state (membrane potential) of the ion channel (Triggle, 1994).

2.2 SUGAR RINGS IN DNA

In cyclopentane, torsional forces (arising from the unstable conformation of 10 eclipsed hydrogens) work against the trend to maintain tetrahedral valence angles. As a consequence, the molecule is not flat but becomes puckered by moving the carbon atoms perpendicular to the quasi-plane of the ring. Since this torsion, unlike in cyclohexane, is not confined to certain atoms; the puckering rotates around the ring. This motion is called pseudorotation, because actual motion does not fall into the direction of rotation (Kilpatrick *et al.*, 1947). For substituted cyclopentanes, however, the conformation becomes more definite.

The principle became applied for furanose rings of nucleosides and nucleotides (Altona and Sundaralingam, 1972). Two parameters, the phase angle (P) and the puckering amplitude (θ) characterizing the furanose conformation were introduced. For the phase angle (varying from 0° to 360°), the $P = 0^\circ$ standard value was chosen at the maximum of the $\tau(1'-2'-3'-4')$ torsion angle (which is equivalent to $P = 180^\circ$ at the most negative τ).

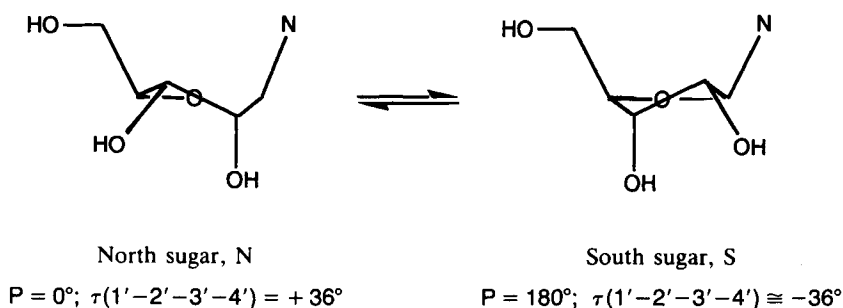

FIG. 8. Pseudorotational equilibrium of the ribofuranose ring.

Following from this definition, the range of $P = 0 \pm 90^\circ$ is associated with $\tau \geq 0$ (north sugar, N), while $P = 180 \pm 90^\circ$ refers to $\tau \leq 0$ (south sugar, S). The structure of β -purine and β -pyrimidine nucleosides and nucleotides were found to represent only two pseudorotational intervals (with widths in P values of about 40°) that are separated from each other by two surmountable potential energy barriers, allowing an equilibrium to be achieved (Altona and Sundaralingam, 1973), as shown in Figure 8.

More recently, efforts have been devoted to the elucidation of structural reasons affecting the equilibrium. While the gauche effect of the fragment O4'-4'-3'-O3' pushes the equilibrium to the South, another gauche effect of the O4'-1'-2'-O2' fragment (absent in the 2'-deoxy series) drives it towards North. The same influence is observed by the anomeric effect of the heterocyclic base, with cytosine exerting stronger effect than either adenine or guanine. The relatively weaker anomeric effect (Thibaudeau *et al.*, 1994) is further reduced by the presence of the 2'-OH group (Plavec *et al.*, 1993). This accommodates the finding that B-DNA prefers type S, while equilibrium is shifted towards the N class by different RNA models (Altona and Sundaralingam, 1972). The Chattopadhyaya group showed that conformational changes of the sugar moiety due to nucleobase interactions do not influence torsions of the phosphate backbone (Plavec *et al.*, 1994), which is primarily dictated by the pentose sugar conformation (Plavec *et al.*, 1995).

The visionary suggestion of the double helical structure of DNA (Crick and Watson, 1954) still keeps chemists busy understanding the structural reasons for this conformation. A monumental undertaking by the Eschenmoser group has aimed at understanding why Nature has chosen pentoses instead of hexoses for the composition of nucleic acids (Eschenmoser and Dobler, 1992). The group succeeded in synthesizing 'homo-DNA' in which they replaced the usual 2'-deoxyribofuranose rings by 2',3'-dideoxyglucopyranose moieties (Böhringer *et al.*, 1992), and proved that the artificial homo-DNA also displayed base-pairing properties (Hunziker *et al.*,

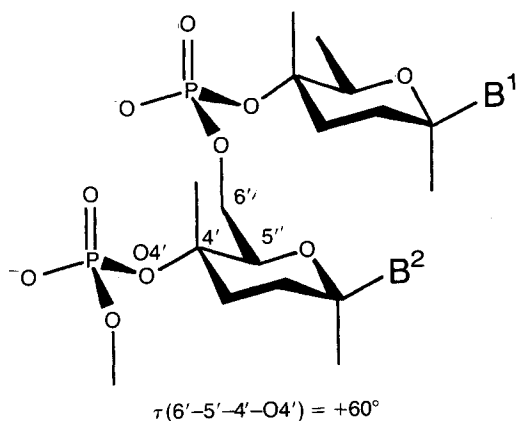

FIG. 9. The characteristic endocyclic torsion angle in homo-DNA.

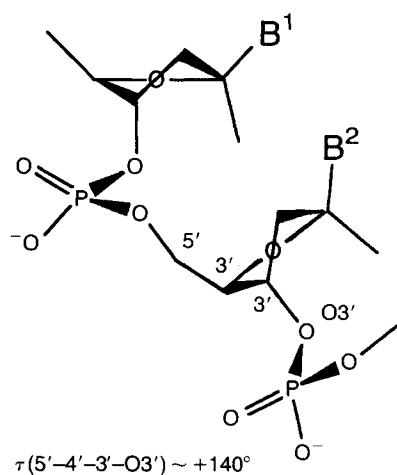

FIG. 10. The characteristic endocyclic torsion angle in B-DNA.

1993). Contrary to DNA, however, homo-DNA double strands showed increased stability owing to their linear arrangement as opposed to the right-handed double helix of native B-DNA. The enhanced stability of homo-DNA duplexes were partly attributed to the entropy benefit of the higher disorder due to increased base-pair distances (4.3 Å in homo-DNA versus 3.4 Å in DNA; Otting *et al.*, 1993). Notably, the difference in overall conformation could mainly be traced back to different endocyclic torsion angles, $\tau(6'-5'-4'-O4') = +60^\circ$ (Figure 9) in homo-DNA, and $\tau(5'-4'-3'-O3') = \sim 140^\circ$ (Figure 10) in DNA (Eschenmoser and Loewenthal, 1992).

While homo-DNA served as an analogue for DNA, evolutionary potential

hexose alternatives of RNA, the allo-, altro- and glucopyranosyl nucleic acids were found to be very weak pairing systems (Eschenmoser, 1996). It was also shown experimentally that the different stabilities of double strands are the direct consequence of the switch from the flexible five- to the more rigid six-membered rings; instead of natural ribofuranoses, the ribopyranose units in synthetic pyranosyl-RNA led again to stronger pairing of the double strand (Pitsch *et al.*, 1993).

As far as Nature's choice is concerned, hexoses and pyranoses instead of pentoses and furanoses would have resulted in double helices paired either too weakly, or too strongly to function as genetic material performing the information transfer required by living organisms.

As if life breathed from a five-membered ring.

2.3 BUTTERFLY-LIKE CONFORMATIONS

This, perhaps slightly unusual idea surfaced in a recent review on non-nucleoside reverse transcriptase (RT) inhibitors (De Clercq, 1996), as a common denominator for dozens of heterocyclic compounds belonging to widely diverging classes. It was characterized by a hydrophilic centre ('body') and two hydrophobic moieties ('wings'). It could be shown that the various structures roughly overlay each other in the HIV-1 RT-binding site (resolved to 2.2 Å by Ren *et al.*, 1995) and maintain their butterfly shape (De Clercq, 1996). A substituted thiazolobenzimidazole, NSC 625487, is shown as an example in Figure 11.

The above argument is complemented by the natural atropisomeric pair of alkaloids, michellamine A and B isolated from the tropical liana *Ancistrocladus abbreviatus*. Both of the stereoisomers have anti-HIV cytopathic activity (Manfredi *et al.*, 1991), with michellamine B being slightly more potent (Figure 12).

The butterfly shape *per se* is not enough, neither is it confined to anti-HIV activity. The muscarinic activity of pirenzepine (Hammer *et al.*, 1980) called

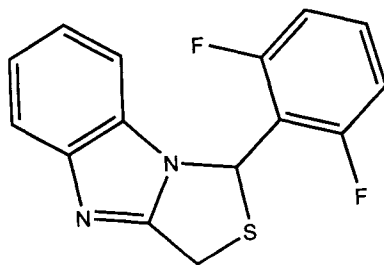

FIG. 11. The structure of NSC 625487.

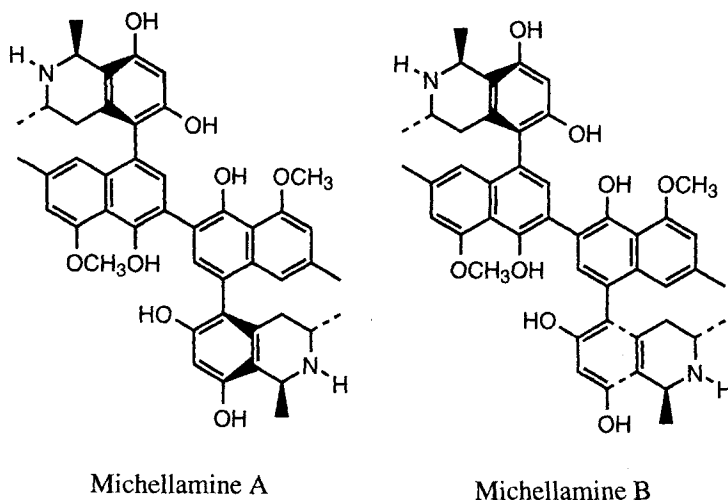

FIG. 12. Atropisomeric pair of alkaloids with anti-HIV cytopathic activity.

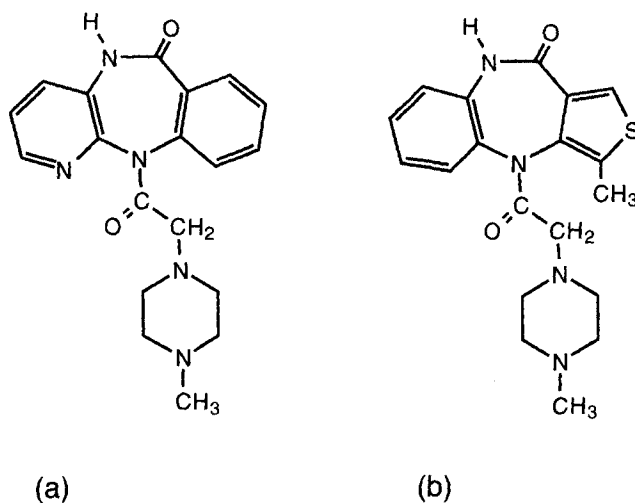

FIG. 13. Structures of pirenzepine (a), and telenzepine (b).

attention to the enzepine family (Figure 13) in which the inversion of the seven-membered ring leads to the existence of two possible conformations. The activation enthalpy of inversion is 18–20 kcal mol⁻¹ for pirenzepine (Trummlitz *et al.*, 1984) but 35.5 kcal mol⁻¹ for telenzepine (Eltze *et al.*, 1985).

The higher energy barrier leads to stable enantiomers of telenzepine of

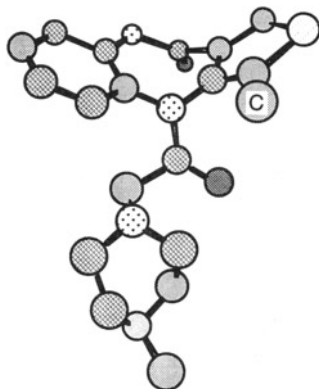

FIG. 14. The methyl group (C) in telenzepine gives rise to an increase in the inversion barrier.

which the (+)-isomer is 100 times more potent (Eveleigh *et al.*, 1989). The enantiomers were found to exhibit opposite kinetic patterns in muscarinic receptor binding (Eltze, 1990). The difference between the flexibility of pirenzepine and telenzepine is mainly the consequence of the methyl group that hinders the flipping of either the carbonyl oxygen, or the methylene group, as shown in Figure 14.

2.4 1,4-BENZODIAZEPINES

The substitution pattern of the seven-membered ring allows the existence of six different classes of benzodiazepines. Of these, the 1,4-class gained such a dominance owing to the success of its representatives as anxiolytics in the 1970s that sometimes it is overlooked that other kinds also exist. The 1,5-class is becoming important in providing CCK-B antagonists (Curotto *et al.*, 1995). Whereas the 1,5-class becomes asymmetric only by its substitution, 1,4-benzodiazepines are always chiral by virtue of their nonplanarity and the positions of the nitrogens (see Figure 15). Although obvious, even good organic chemists talk about *chiral* 1,4-benzodiazepines when reference to central chirality is made (Sunjić *et al.*, 1973).

The barrier to inversion for the diazepine ring is less than 20 kcal mol^{-1} (Linscheid and Lehn, 1967), unless a *t*-butyl substituent appears at N(1) that leads to stable atropisomers. This bulky group prevents high-affinity receptor binding and both isomers are inactive as anticonvulsants (Gilman *et al.*, 1990). It was a puzzle for some time to determine which conformer is active at the receptor. A conformationally restricted derivative suggested that conformation M of diazepam is the active species (Blount *et al.*, 1983), but

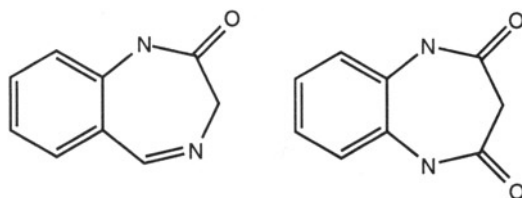

FIG. 15. 1,4-Benzodiazepines are always chiral.

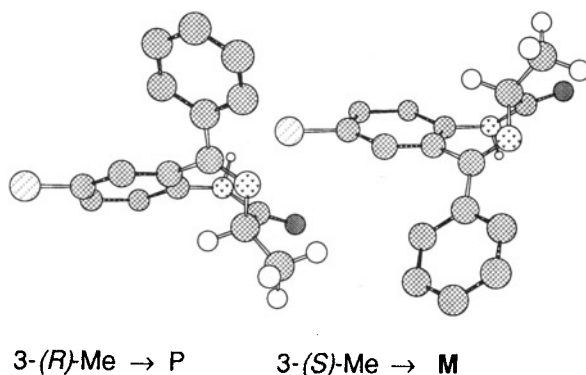

FIG. 16. The 3-methyl substituent chooses the equatorial position forcing the molecule into a single conformation.

the influence of the extra group of atoms was not taken into account. Studies on the 3-methyl-substituted diazepam analogues shed light on steric effects of the substituents. The two enantiomers of the 3-methyl diazepam derivative exist practically as single conformers in mirror image relation to each other (cf. Figure 16).

It was indeed the 3-(*S*)-methyl isomer that was potent and the 3-(*R*)-methyl enantiomer that was inactive. The 3,3-dimethyl derivative, however, without preferring either of the conformers, proved to be without activity. Finally, it could be established that the binding of the M conformer is exclusive, and the axial methyl group is not tolerated by the receptor-binding site (Simonyi *et al.*, 1990).

Further studies revealed that a 3-carboxyloxy substituent in the diazepam ring is favoured by the binding site even in axial position because of additional hydrogen bonding interaction (Maksay *et al.*, 1991). A recent report on a new, potent pharmacophore where activity is critically dependent on the presence of a single nitrogen atom is in accord with this conclusion (Macor *et al.*, 1995).

3 Conformers of Flexible Molecules

3.1 HUMAN SERUM ALBUMIN

Before these few sketches of the most abundant blood protein, a salute is in order to the recent monograph by Peters (1996) who dedicated a lifetime to the study of the subject.

Albumin is primarily responsible for drug-protein binding leading to the partitioning of drugs into free and bound phases. Its pharmacological importance stems from the 'physiological ultrafiltration' provided by vascular walls, and from the fact that both therapeutic and toxic effects are associated with the free rather than the total concentration of substances.

Further to the establishment of the complete genetic base sequence for human serum albumin (Minghetti *et al.*, 1986), its three-dimensional structure has been determined by X-ray crystallography (He and Carter, 1992). There are a number of aspects showing the conformation to be at least as important an attribute of the structure of albumin as its configuration. Let us begin with its name. Human albumin is composed of 585 amino acids of a single chain organized by disulfide bridges into eight and a half double loops forming three domains. This structure is brought about by 35 cystein units, of which 32 are located pairwise for the double loops, two form a single disulfide bond and one, Cys-34, is uncoupled. This pattern is common for albumins of most species (human, macaque, dog, sheep, pig, rabbit, guinea pig, mouse, chicken, alligator, turtle, frog and lamprey; exceptions are the cobra, *Xenopus laevis* and salmon), although pairwise sequence identity can be as low as 20% (Peters, 1996). About 30% of the Cys-34 residue functions as a carrier of glutathione, or cysteine in the form of mixed disulfide (Fahey *et al.*, 1977), with the rest remaining free despite oxidizing conditions. It is apparently protected by the protein conformation from being oxidized (Peters and Reed, 1978).

The many different compounds bound by albumin were classified as site I and site II types (Sudlow *et al.*, 1976) and represented by the binding of *rac*-warfarin and diazepam, respectively (Sjöholm *et al.*, 1979). These sites accommodate the binding of endogenous bilirubin-IX α (Figure 17a), the yellow pigment of jaundice produced by haem catabolism (site I, Brodersen, 1980) and the amino acid tryptophan (site II; Sjöholm *et al.*, 1979).

Experiments from independent laboratories have revealed that site I and II are distinct, but not independent from each other. Allosteric effects were observed by microcalorimetry between *rac*-warfarin and diazepam (Dröge *et al.*, 1985); cobinding of 5-F-L-tryptophan and *rac*-warfarin was found by ¹⁹F-nuclear magnetic resonance (NMR) to be allosterically related (Jenkins and Lauffer, 1990). A spectacular finding was made by Fitos *et al.* (1986b) on the mutual strengthening of binding for (*S*)-warfarin and (*S*)-lorazepam acetate (Figure 18) with the latter being practically stuck to and resistant to

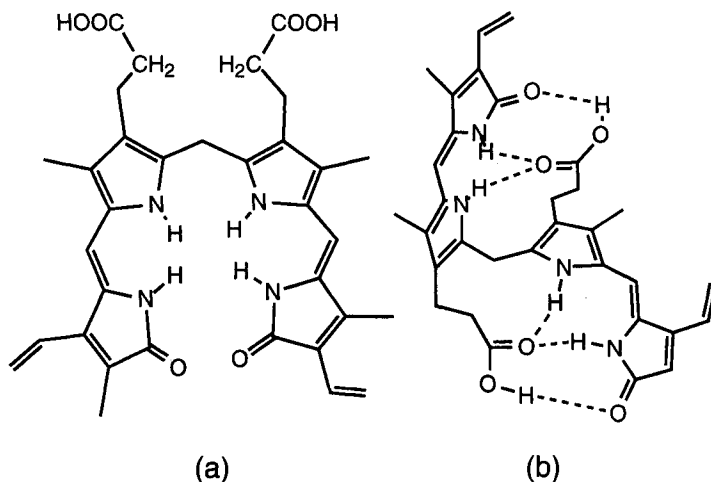

FIG. 17. The structure of bilirubin-IX α (a) and its binding conformation (b) at physiological pH.

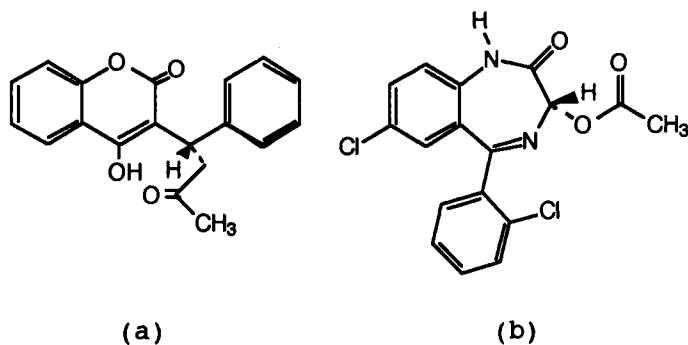

FIG. 18. (*S*)-warfarin (a), and (*S*)-lorazepam acetate (b), strengthening their binding to human albumin.

elution from a column of immobilized human serum albumin. Unsubstituted N(1), *o*-chloro substituent, and (*S*) configuration of the benzodiazepine were found to be structural features favouring the allosteric interaction (Fitos *et al.*, 1986b).

The reason for the allosteric effect is the changing conformation of albumin when binding occurs. Stopped-flow kinetic experiments demonstrated the binding of *rac*-warfarin to occur in three steps: after the first, diffusion controlled encounter, the molecule moves inside the protein in a rate-limiting step followed by the adjustment of the binding site (Bos *et al.*, 1989).

Conformational change of albumin was found by proton NMR to occur only upon specific binding (Oida, 1986). Phenothiazines were found to bind to two sites with different affinities; only the high-affinity component was found by calorimetry to be entropy-driven, which is indicative of hydrophobic binding and change in albumin conformation (Aki and Yamamoto, 1989). The simultaneous increase of the binding strengths of diazepam and tenoxicam is also accompanied by a conformational change (Brée *et al.*, 1993).

Binding-induced conformational change is, however, not confined to the protein. Bilirubin was found to produce pH-dependent circular dichroism spectra upon binding to human albumin (Blauer *et al.*, 1972). It was interpreted at physiological pH as the result of an H-bonded nonplanar binding conformation (Figure 17b, Lightner *et al.*, 1986). Despite the structural difference from warfarin, bilirubin also increased the binding strength of (*S*)-lorazepam acetate (Fitos *et al.*, 1990). It not only shows that an endogenous substance may influence protein binding, but also indicates that the allosteric interaction is not exceptional. The conformational change of the binding sites and the associated torsion suffered by the ligands is probably more general than believed.

For the 1,4-benzodiazepine, diazepam, conformer M was shown to bind exclusively (Alebić-Kolbah *et al.*, 1979), just as the 3,3-dimethyl derivative (Fitos *et al.*, 1986a). A more complex case is the binding of the 2,3-benzodiazepine, tofisopam (Figure 19). This molecule contains both helical and central elements of asymmetry; inversion in solution of the heterocyclic ring leaves the configurational asymmetry unaffected, so the two possible ring-conformers are in diastereomeric relation to each other (Figure 19a,b).

In solution, the inversion is slow owing to the 4-methyl group which slightly hinders the 5-ethyl substituent changing its position from equatorial (major conformer) to axial (minor conformer). Hence, four molecular species take part in the binding of *rac*-tofisopam to albumin. The binding is selective with respect to both configuration and conformation (Simonyi and Fitos, 1983). Interestingly, conformer-selectivity overcomes enantio-selectivity for (*S*)-tofisopam, but not for its enantiomer. Conformer P and the *quasi*-equatorial orientation of the 5-ethyl group were found to be preferred structural characteristics in the binding process (Visy and Simonyi, 1989).

Let us conclude with a few lively words by Peters (1996): 'In the 27 days between its birth and death, a typical albumin molecule makes about 15 000 passes through the circulation, shuttling cargo of various kinds between ports of call in its role as the tramp steamer of the body. And, like any ocean-going vessel, the albumin molecule incurs some damage on its travels, accumulating barnacles in the form of ligands that resist offloading.' This resistance results from the mutual conformational changes of protein and ligand, tightening each other like springs.

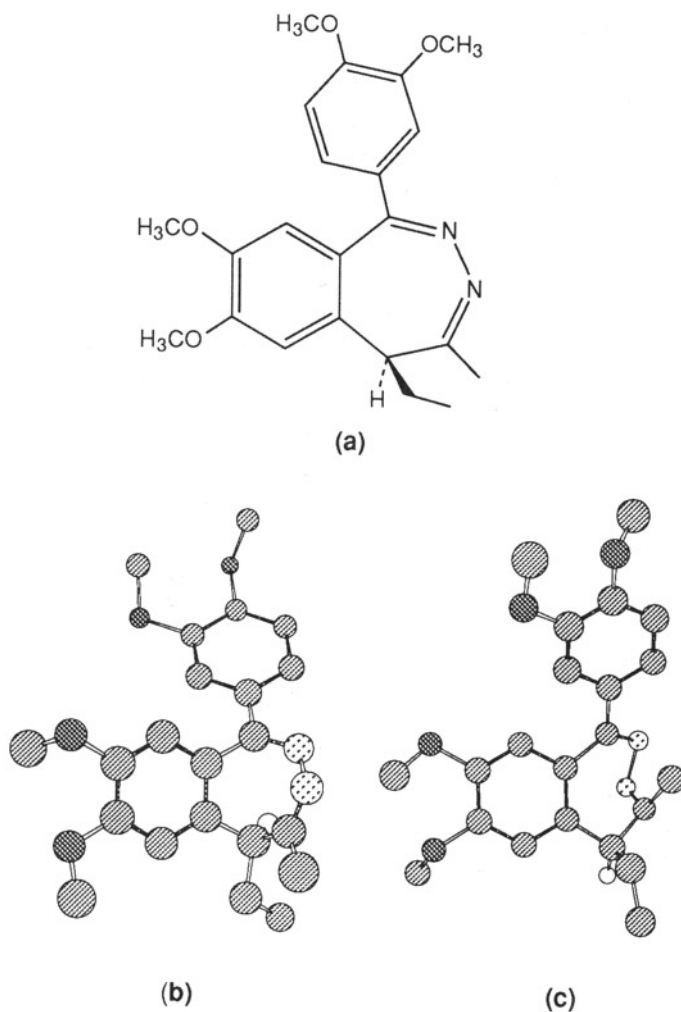

FIG. 19. (S)-Tofisopam (a), and its conformers, (S)-(-)-P (b), and (S)-(+)-M (c).

3.2 TASTING PEPTIDES

Although the scope of pharmacology does not include sweeteners, they serve as good examples for the influence of conformation on biological effects. Without such considerations, attempts to correlate chemical structure with sweet or bitter taste clearly have been hopeless. As the paper reporting the accidental discovery of aspartame critically remarks 'Structure-taste relationships consist merely of tasting compounds and looking at their structures'

(Mazur *et al.*, 1969). Over a quarter of a century later the task appears less frustrating.

The puzzle started by the observation that of the possible stereoisomers of aspartylphenylalanine methyl ester only the L-L combination was sweet, all others, i.e. L-D, D-L and D-D were bitter. Mazur *et al.* (1969) also noted that some changes are tolerable at the C-terminal unit of the peptide. Further complicating observations were related to homologues of the aspartic residue; while H-L-Glu-L-Phe-OMe was bitter (Mazur *et al.*, 1969; Ando *et al.*, 1993), replacement by the shorter aminomalonic acid (Ama) produced a sweet mixture of diastereomers, H-*rac*-Ama-L/(S)-Phe-OMe, of which the H-(S)-Ama-(S)-Phe-OMe isomer was thought to be sweet by analogy to aspartame (Fujino *et al.*, 1973). Efforts to set up a taste model resulted in conclusions to the contrary (Ariyoshi, 1976; Kawai *et al.*, 1982), which were proved correct by the determination of absolute configuration for the sweet and tasteless diastereomers, H-(R)-Ama-(S)-Phe-OMe and H-(S)-Ama-(S)-Phe-OMe, respectively (Ando *et al.*, 1993). Some of the results are collected in Table 1.

Construction of the taste model based upon both early conjectures (Schallenberger and Acree, 1967; Kier, 1972) and a large number of synthetic peptides (and derivatives) has been carried out by the Goodman group (Goodman *et al.*, 1987; Yamazaki *et al.*, 1991, 1994; Ando *et al.*, 1993). They realized that X-ray structures determined mainly by packing forces cannot predict taste properties (Ando *et al.*, 1993) and considered conformations allowed by NMR investigations and modelling studies. Because most compounds investigated have ample degrees of flexibility in solution (see Table 1) they exist in several conformational arrays. Of these (accessible for the free molecule) the most populated type was selected. The developed 'L' shape model explaining sweet taste visualizes the relative positions of three functional groups – a hydrogen bond donor (A-H), a hydrogen bond acceptor (B) and a large hydrophobic moiety (X), as shown for aspartame in Figure 20.

While the A-H and B groups are envisaged to form an intramolecular hydrogen bond, thereby creating a 6-membered ring-like structure at the N terminal (clearly impossible for L-Glu in place of L-Asp in aspartame), the position of the X, hydrophobic group depends mainly on a θ [C(O)-N-C ^{α} -C^X] torsion angle found critical for taste properties. For compounds preferring conformations of $40^\circ \leq \theta \leq 120^\circ$, the taste is sweet, for those of $-120^\circ \leq \theta \leq -40^\circ$ the taste is bitter, while structures preferring other θ values are tasteless (Yamazaki *et al.*, 1994). It is therefore clear that the 'L' model is a three-dimensional one unlike the two-dimensional shape of the letter L. The three-dimensional structure of sweet aspartame is given in Figure 21, and the generalized rule of taste is represented in Figure 22.

The taste model is in agreement with all structures reported to date. Until the taste receptor is discovered, this model remains the sophisticated explanation of taste.

TABLE 1
Selected peptides and their taste properties

Peptide	Taste	Reference
H-L-Asp-L-Phe-OMe	Sweet	1
H-D-Asp-L-Phe-OMe	Bitter	1
H-L-Asp-D-Phe-OMe	Bitter	1
H-D-Asp-D-Phe-OMe	Bitter	1
H-L-Asp-L-Met-OMe	Sweet	1
H-L-Asp-L-Tyr-OMe	Sweet	1
H-L-Ala-L-Phe-OMe	Bitter	1
H-L-Tyr-L-Phe-OMe	Bitter	1
Me ₂ -L-Asp-L-Phe-OMe	Not sweet	1
H-L-Asp-(OMe)-L-Phe	Not sweet	1
H-L-Asp-L-Phe-OEt	Sweet	1
H-L-Asp-L-Tyr-OEt	Sweet	1
H-L-Glu-L-Phe-OMe	Bitter	1,2
H- <i>rac</i> -Ama-L-Phe-OMe	Sweet	3
H-(<i>S</i>)-Ama-(<i>S</i>)-Phe-OMe	Tasteless	2
H-(<i>R</i>)-Ama-(<i>S</i>)-Phe-OMe	Sweet	2
H-(<i>S</i>)-Ama-(<i>S</i>)-Phe-OEt	Tasteless	2
H-(<i>R</i>)-Ama-(<i>S</i>)-Phe-OEt	Sweet	2
H-L-Asp-L-(α -Me)-Phe-OMe	Sweet	4
H-L-Asp-D-(α -Me)-Phe-OMe	Bitter	4
H-L-Asp-(<i>S</i>)-(c.Hex)-Gly-OMe	Sweet	4
H-L-Asp-(<i>R</i>)-(c.Hex)-Gly-OMe	Bitter	4
H-L-Asp-L-Ala-cPA ^a	Bitter	5
H-L-Asp-D-Ala-cPA ^a	Sweet	5
L-(<i>S</i>)-retro-inverso ^b	Sweet	5
L-(<i>R</i>)-retro-inverso ^b	Sweet	5
H-L-Asp- <i>t</i> -(1 <i>R</i> ,2 <i>R</i>)-AcP-OMe ^c	Sweet	6
H-L-Asp- <i>t</i> -(1 <i>S</i> ,2 <i>R</i>)-AcP-OMe ^c	Sweet	6
H-L-Asp- <i>t</i> -(1 <i>R</i> ,2 <i>S</i>)-AcP-OMe ^c	Tasteless	6
H-L-Asp- <i>t</i> -(1 <i>S</i> ,2 <i>S</i>)-AcP-OMe ^c	Bitter	6

(1) Mazur *et al.* (1969); (2) Ando *et al.* (1993); (3) Fujino *et al.* (1973); (4) Yamazaki *et al.* (1994); (5) Goodman *et al.* (1987); (6) Yamazaki *et al.* (1991).

^acPA = 2,2,5,5-Me₄-cyclopentanylamide; ^bRetro-inverso analogues are *N*-(H-L-Asp)-*N'*-(2,2,5,5-Me₄-cyclopentanyl)-carbonyl-(*S*)- and (*R*)-1,1-diaminoethane; ^cAcP = aminocyclopentanecarboxylic acid.

3.3 CONFORMATION AND ION CHANNEL FUNCTION

Transmitter-gated ion channels can be classified according to similarities in their protein structure. Members of the so-called Cys-loop superfamily are the nicotinic acetylcholine- and serotonin 5-HT₃ receptor-regulated cation

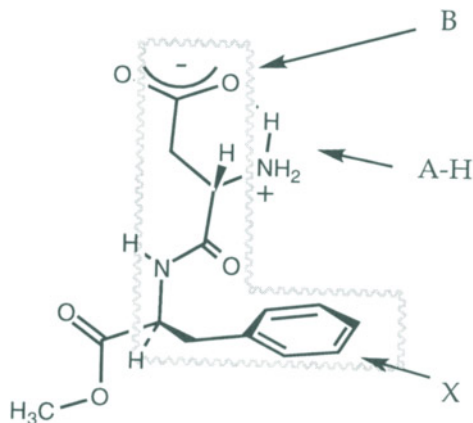

FIG. 20. The 'L' shape model for taste according to Ando *et al.* (1993).

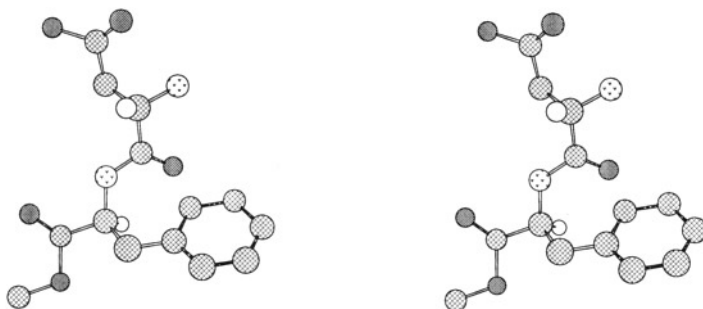

FIG. 21. Stereo view of a 'sweet' conformation of aspartame according to Yamazaki *et al.* (1994); torsion angles are:

$$\begin{aligned} \tau\{C(O_2)-C^{\beta 1}-C^{\alpha 1}-N\} &= -66^\circ; \tau\{C(O_2)-C^{\beta 1}-C^{\alpha 1}-C(O)\} = 172^\circ; \\ \tau\{C^{\beta 1}-C^{\alpha 1}-C(O)-N\} &= -66^\circ; \tau\{C(O)-N-C^{\alpha 2}-C^{\beta 2}\} = 79^\circ; \tau\{N-C^{\alpha 2}-C^{\beta 2}-C^\phi\} = -72^\circ. \end{aligned}$$

channels, and also the A-subclass of γ -aminobutyric acid- ($GABA_A$), glycine- and glutamate-gated anion channels (Barnard, 1996). These are composed of five subunits, each containing four membrane-spanning α -helices. Their organization is such that the second transmembrane segment lines the wall of the ion channel (Stephenson, 1995).

A significant step towards understanding the mechanism of channel opening was made by recording electron images of the open and closed acetylcholine

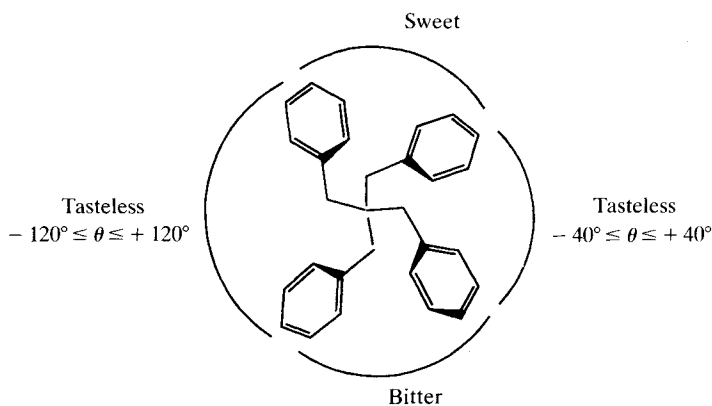

FIG. 22. Illustration of Goodman's three-dimensional model of taste: the 'L' is viewed from the bottom with the bond $C^{\alpha 2}-N$ eclipsed at the central point, and the stem of the 'L' being projected behind the plane of the paper; the phenyl groups representing the base of the 'L' for different structures are directed by critical values of the $\theta\{C(O)-N-C^{\alpha 2}-C^X\}$ torsion angle where taste changes.

receptor-ionophores (Unwin, 1995). Acetylcholine was found to initiate small rotations of the subunits causing a right-handed twist of the α -helices which line the membrane spanning pore. Without the twist, the ion channel remains closed. As the receptor-binding sites for neurotransmitters (and drugs) are supposed to be located at the interface of neighbouring subunits (Stephenson, 1995), it is conceivable that channel opening brings about torsions in the conformation of the ligand (neurotransmitter, or drug), too.

3.3.1 Agonists versus Antagonists

The most straightforward relation between conformation of the ligand and agonist/antagonist character of its efficacy was recently shown for the glycine receptor. Some β -amino acids, such as (*S*)- β -aminobutyric acid and taurine are partial agonists of this system; at low concentrations they inhibit glycine-evoked chloride ion currents, while at higher concentrations they produce significant membrane currents themselves. It was assumed that antiperiplanar conformations of β -amino acids mediated antagonistic receptor binding, whereas synperiplanar conformations brought about agonist responses (Schmieden and Betz, 1995), as shown in Figure 23.

A more general characterization of ligand efficacy has come to light from studies on the kinetics and thermodynamics of $GABA_A$ receptor binding by Maksay. Picrotoxin-like convulsants bind to the $GABA_A$ receptor and block its chloride ionophore. The effects of $GABA$ versus its antagonist, bicuculline

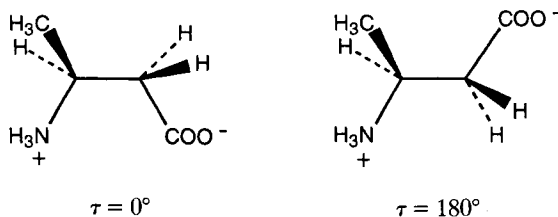

FIG. 23. Synperiplanar (agonist) and antiperiplanar (antagonist) conformation of (S)-β-aminobutyric acid according to Schmieden and Betz (1995).

on the kinetics of dissociation of a convulsant radioligand distinguished interconvertible open and closed forms of the ion channel (Maksay and Simonyi, 1986; Maksay and van Rijn, 1993). GABA_A agonists, benzodiazepine anticonvulsants and various central depressants open the ionophore and accelerate the dissociation of the channel blocker, while GABA_A antagonists and inverse agonists (convulsants) have opposite effects (Maksay and Simonyi, 1985; Maksay *et al.*, 1996).

Observations were made on enthalpy–entropy relationships in GABA_A-receptor binding (Maksay, 1994) and in glycine-receptor binding (Ruiz-Gomez *et al.*, 1989), in which data of agonists and antagonists appeared in separate clusters. These suggested the possible existence of a common correlation between thermodynamic driving forces of binding and ligand efficacies, which was, in fact, found (Maksay, 1996a). Accordingly, while agonist binding is an entropy-driven endothermic process, antagonist binding is exothermic, driven both by enthalpic and entropic terms; the binding of partial agonists is almost independent of temperature.

This phenomenon, far from being general (Testa *et al.*, 1987), is in accord with conformational changes of the receptor accompanying the transition between ionophore states. The entropy gain of agonist binding may be associated with a kind of relaxation to a less constrained conformation of the transmembrane helices lining the ionophore (Maksay, 1994).

The significance of such a correlation is further strengthened by recent results which extend it to serotonin 5-HT₃ receptor binding (Borea *et al.*, 1996; Maksay, 1996b). It may be taken as a strong evidence for conformational changes upon the binding of agonists to receptors gating ion channels.

3.3.2 Subclass-selective Conformers of GABA

The phenomenon described in the title of this section is not confined to GABA, and probably not even to ionophore receptors; several

neurotransmitters (such as acetylcholine, dopamine, serotonin and histamine) are achiral in terms of configuration. Their nonselective effects on a number of receptor subclasses which are distinguished by chiral drugs of restricted conformation (Simonyi, 1984) are associated with the flexibility of transmitter molecules. An obvious conclusion is that different subclasses of the same receptor prefer to recognize different chiral conformations of the natural transmitter.

A comprehensive review in this series by Krogsgaard-Larsen *et al.* (1988) dealt with the conformational aspects of GABAergic activities. Further to this excellent treatise, a hypothesis has recently been put forward on the discerning role of the two internal dihedral angles of the GABA molecule (Simonyi, 1996). A few relevant data are given in Table 2.

Conformations of GABA can be described in terms of three parameters – the distance between the ammonium and carboxylate terminals (δ_{N-C}) and two torsion angles (τ_N and τ_C), as shown in Figure 24. Subclass-selective agents of restricted conformation (Allan and Johnston, 1983; Krogsgaard-Larsen *et al.*, 1988) were subjected to molecular modelling in order to determine the above three parameters. Results of this analysis are summarized in Table 3.

According to the data obtained, binding sites of the GABA_A receptor-ionophore prefer GABA conformations with negative sign torsion angles. In contrast, the GABA uptake process requires both torsion angles to be positive. Consequently, both GABA_A and GABA transporter sites recognize 'helical' conformations which are of opposite sense. This is in line with experimental findings on enantiomerically related selectivities of several structurally related agents towards GABA_A and uptake activities.

The G-protein coupled (Hibert, 1996) metabotropic GABA_B receptor (Hill and Bowery, 1981) recognizes butterfly GABA conformations with torsion angles of opposite signs. The preference of the ionotropic GABA_C receptor (Feigenspan *et al.*, 1993; Qian and Dowling, 1993) is poorly understood: to date no chiral compound is known to show selectivity towards this subclass.

Another conclusion of this approach is that there might be no way to define precisely subclass-selective GABA conformations (compare the large intervals given in Table 3). The functioning receptor is supposed to distort the GABA conformer originally bound. This is in line with the dynamic character of both ionotropic (Unwin, 1995) and metabotropic (Hibert, 1996) receptor function. Moreover, the assumed distortions suffered by the GABA molecule are oppositely related for the GABA_A receptor and the GABA transporter. This hypothesis is a new, dynamic principle for the biological role of chiral GABA conformations.

An application of these ideas is given here to interpret the lack of GABAergic activity of the antiepileptic drug, gabapentin (Foot and Wallace, 1991; Taylor, 1994) containing a flexible GABA backbone. This compound

TABLE 2
Relative potencies of GABAergic agents (GABA = 1)

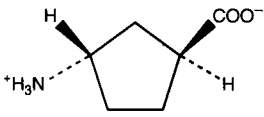
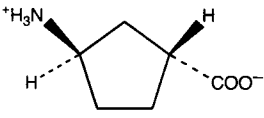
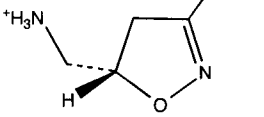
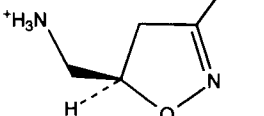
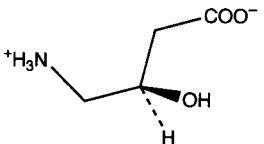
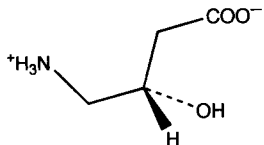
Compound	Potency for		
	GABA _A	GABA _B	GABA uptake
 1 <i>S</i> ,3 <i>S</i> - <i>trans</i> -ACP	5.0 ^a	Nt	Inactive ^b
 1 <i>R</i> ,3 <i>R</i> - <i>trans</i> -ACP	0.025 ^b	Nt	2.0 ^a
 <i>S</i> -Dihydromuscimol	8.0 ^c	0.0025 ^d	Inactive ^c
 <i>R</i> -Dihydromuscimol	0.106 ^d	0.0075 ^d	0.04 ^d
 <i>R</i> -GABOB	0.033 ^e	0.083 ^e	0.045 ^e
 <i>S</i> -GABOB	0.083 ^e	0.007 ^e	0.09 ^e

Nt = not tested

^aAllan and Johnston, 1983; ^bAllan *et al.* (1986); ^cKrogsgaard-Larsen *et al.* (1985); ^dKrogsgaard-Larsen *et al.* (1988); ^eFalch *et al.* (1986).

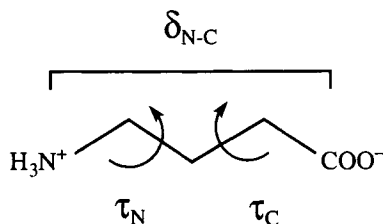

FIG. 24. Parameters describing GABA conformations.

TABLE 3
Subclass-selective parameters of GABA

Receptor subclass	δ_{N-C} (Å)	τ_N (°)	τ_C (°)
GABA _A	4.5–5.0	–90––170	–140––180
GABA _B	3.6–4.4	–90––120	+90–+160
GABA _C	3.1–4.6	±80–±180	0
GABA uptake	3.5–5.0	+90–+180	+90–+180

can be compared to the GABA_A-selective (*S*)-dihydromuscimol (*S*-DHM) and to the relatively potent GABA_B ligand, (*R*)-GABOB, as shown in Figure 25.

Choose now for gabapentin the helical torsion angles preferred by GABA_A receptors, and butterfly torsion angles recognized by GABA_B sites, then overlay gabapentin with the respective subclass-selective conformers; the result is seen in Figure 26. While at GABA_A the C(6) atom of gabapentin occupies the position of the oxygen atom in the isoxazole ring, the gabapentin C(7) atom will coincide with the β -OH group for GABA_B. Hence, the inactivity of gabapentin in the GABAergic system can be related to its rigid shape, providing hydrophobic CH₂ groups in critical directions where the hydrophilic/H-bond-forming environment might not accommodate it.

3.4 MOLECULAR PARASITES

Developments since the second half of the 1980s established the mechanism by which extremely potent antitumour agents (effective at subnanomolar to picomolar concentrations) exert their action on double-stranded DNA. These molecules have two functional parts: a flexible fraction possessing selective binding affinities to certain sequences of the double strand, and a reactive

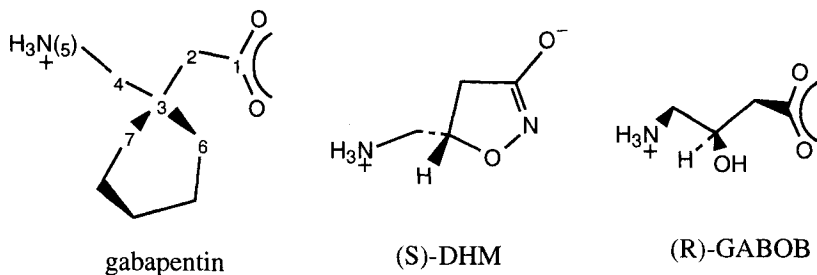

FIG. 25. Structures of gabapentin; the most potent GABA_A ligand, (*S*)-dihydro-muscimol; and the GABA_B ligand, (*R*)- γ -amino- β -hydroxy-butyric acid.

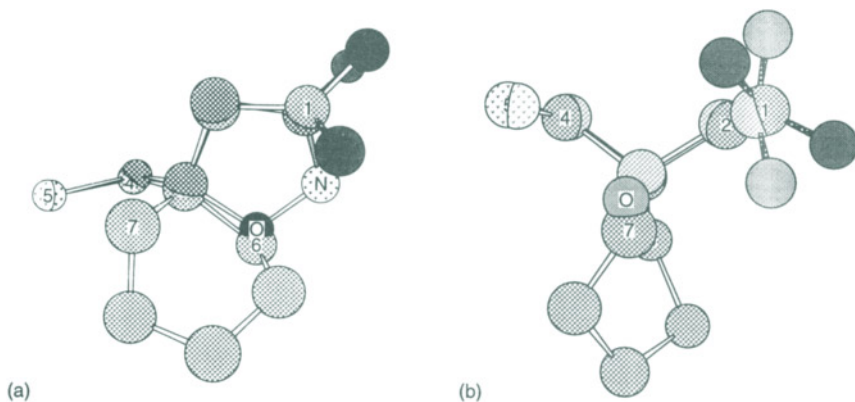

Fig. 26. Overlaying (a) helical gabapentin rotamer to (*S*)-DHM, preferred by GABA_A and, (b) butterfly rotamer to (*R*)-GABOB, preferred by GABA_B, shows coinciding C and O atoms.

moiety that attacks the DNA chain. The molecule first binds into the minor groove and positions the reactive group in the vicinity of the alkylation site; this is followed by covalent steps making the DNA chain incapable of replication. This mechanism of action was discovered in connection with two families of compounds, CC-1065 and its analogues on one hand, and the enediyne antibiotics on the other.

3.4.1 CC-1065

The antibiotic isolated from *Streptomyces zelensis* (Martin *et al.*, 1981) showed potent *in vivo* antitumour activity (Chidester *et al.*, 1981). The compound, known as (+)-CC-1065 (Figure 27), has been shown to bind with high affinity into a selected minor groove of double-stranded B-DNA and

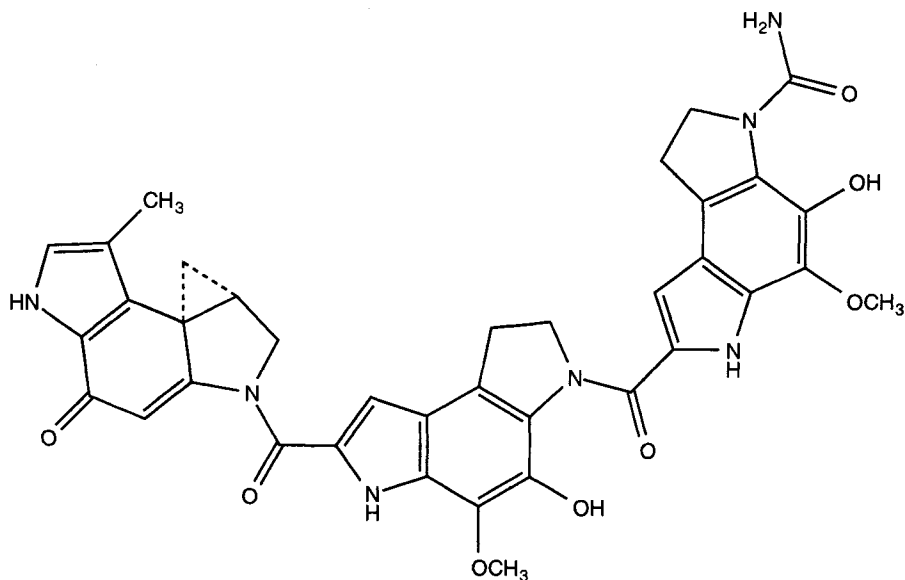

FIG. 27. Structure of (+)-CC-1065.

to alkylate it subsequently at an adenine N-3 site (Hurley and Needham-Van Devanter, 1986).

The crescent-like structure of CC-1065 proved to be ideally suited for binding at A-T-rich 5 bp consensus sequences (Hurley *et al.*, 1987) extending about a half of helix turn. Alkylation is brought about by the electrophilic cyclopropane condensed to the left-hand subunit. This grouping is the only one lending configurational chirality to the agent. Its enantiomer, *ent*(-)-CC-1065, also possesses cytotoxic potency which, surprisingly, is indistinguishable from that of the natural isomer (Boger, 1991).

A direct relationship between chemical reactivity and cytotoxic potency has been proposed by Hurley and Needham-Van Devanter (1986), who intuitively suggested that increased electrophilic reactivity might be associated with enhanced biological potency. If true, the central and right-hand subunits would not have any functional role contributing to the biological activity. The synthesis of a wide range of shortened and extended analogues, together with detailed tests on their DNA binding properties and cytotoxicity by the Boger group, revealed unexpected conclusions about the mechanism of DNA alkylation which, in fact, proved just the opposite of the intuitive suggestion.

Covalent alkylation of double-stranded DNA by a truncated CC-1065 containing the left-hand subunit only, was unobservable; the central subunit of the natural enantiomer was shown to stabilize the DNA-CC-1065 covalent complex formation. In contrast, the unnatural *ent*(-)-CC-1065 required the

full trimer molecule to bring about effective DNA alkylation. The central and right-hand subunits also functioned in restricting the accessible adenine alkylation sites by selecting the A–T-rich minor groove as the binding site (Boger *et al.*, 1990).

For binding selectivity, an amino group protrudes into the minor groove of G–C base pairs making it unsuitable for hydrophobic binding. Hence, the A–T base pairs permit a deeper penetration for CC-1065 and its analogues. In addition, A–T-rich minor grooves were shown to be constricted offering a narrower width, thus ensuring tighter binding of the nearly planar subunits of CC-1065 (Boger *et al.*, 1991).

By comparing solvolytic, i.e. chemical reactivity with biological activity of subunits derived from CC-1065 and duocarmycin analogues, a close correlation has been established between solvolytic *stability* and cytotoxic potency (Boger *et al.*, 1994). Such a relationship was prognosticated earlier by the finding that synthetic functional analogues of decreased chemical reactivity possessed enhanced cytotoxic and antitumour potency (Boger *et al.*, 1989; Boger and Ishizaki, 1990). This relationship was found to be quite general for agents such as CC-1065 acting by a binding-driven bonding mechanism: higher chemical reactivity leads to decreased selectivity towards the available alkylation sites, hence to lower efficiency in DNA alkylation and diminished cytotoxicity (Boger and Mésini, 1995).

Finally, the binding modes of enantiomers were discerned by showing that their alignment is opposite in the minor groove: to a duplex of 5'-(CTAATT)-3' sequence, the natural (+)-enantiomer extends from the adenine N3 alkylation site in the 3'→5' direction, while the (–)-enantiomer binds in a reverse, 5'→3' fashion. Having gained such a deep insight, a bifunctional agent was designed in order to cross-link the double strand (Boger, 1995).

The tight binding of (+)-CC-1065 brings about a binding-induced conformational change both in the DNA structure (Hurley *et al.*, 1987) and in CC-1065 as proved by intense induced CD spectra (Boger, 1991). Rotations have to occur around single bonds connecting the three subunits. The torsion forced by the geometry of the minor groove and compensated by the enthalpy of binding ceases to maintain coplanarity for the planes of the dihydropyrroloindol moieties in (+)-CC-1065 (a preferred conformation in solution). Hence, the molecular shape is adjusted into a chiral conformer (Figure 28) fitting the selected binding site.

3.4.2 *Enediyne Antibiotics*

The name refers to highly potent antibiotics, esperamicin A₁ isolated from *Actinomadura verucosopora* (Golik *et al.*, 1987) and calicheamicin γ_1^I from *Micromonospora echinospora* ssp. *calichensis* (Lee *et al.*, 1987b), causing

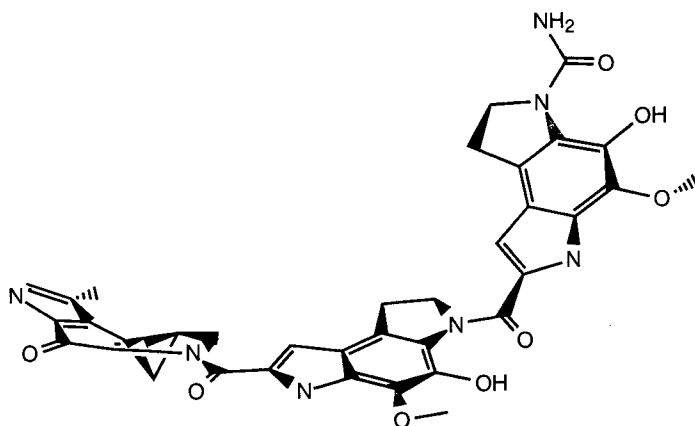

Fig. 28. The binding conformation of natural (+)-CC-1065.

DNA cleavage by a bicyclic structure in which a 10-membered ring – a kind of ‘silent explosive’ – contains a double and two triple bonds (*ene + diyne*; see Figure 29) in conjugation.

The highly reactive ring is made ‘silent’ by a dienone ‘safety lock’ provided by the second ring. The strained enediyne ring system ‘goes off’ by a cascade of events. First, a nucleophile reacts with the side-chain trisulfide, generating a thiolate group; then it attacks the endocyclic double bond in the six-membered ring and releases the safety lock. The additional strain created by transforming the sp^2 geometry of the bridgehead carbon atom into a tetragonal one triggers the enediyne ring to form a 1,4-benzenediyl biradical (Lockhart and Bergman, 1981) that immediately reacts further with the environment. In addition to the reactive bicyclic structure, the full antibiotic molecule of calicheamicin γ_1^I comprises four glycosidic moieties together with an inserted fully substituted iodothiobenzoate ring (R in Figure 29; Lee *et al.*, 1987a). The complete structure is given in Figure 30.

The oligosaccharide chain was shown to adopt an extended form regarded as ‘preorganized’ for binding to DNA minor groove. A strong contribution to this form comes from the N–O bond, which is rather unique in oligosaccharides. All four sugar moieties are of the 6-deoxy type, reinforcing hydrophobic character significant for DNA binding (Walker *et al.*, 1990). Calicheamicin γ_1^I was shown to cut DNA double strands selectively at TCCT·AGGA sequences with sensitivity towards both strands. (The agent anchors itself from the 5′ side of the TCCT, i.e. from the 3′ side of the complementary AGGA sequence.) It was emphasized that esperamicin A_1 , having a different arrangement of its carbohydrate chain and the aromatic moiety (Figure 31) does not exhibit strong sequence specificity (Zein *et al.*, 1989). Support for the hypothesis that the oligosaccharide chain serves as

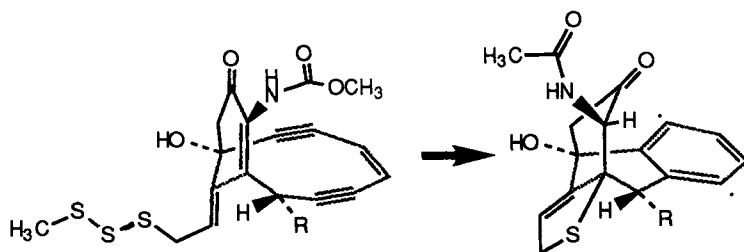
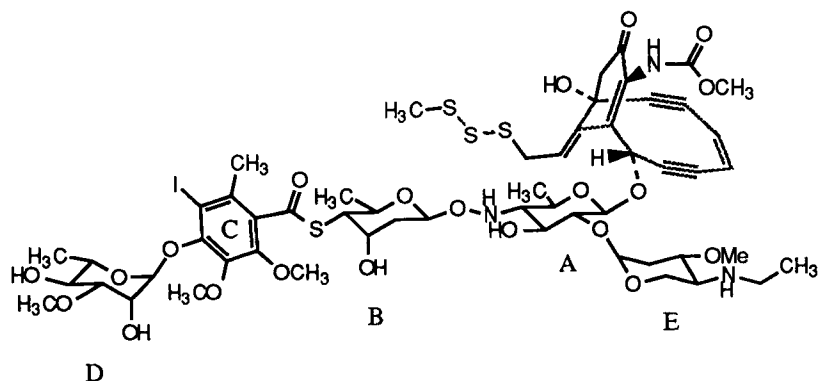

FIG. 29. The reactive group of enediyne.

FIG. 30. Structure of calicheamicin γ_1^I .

a vehicle to deliver the destroying group to the specific sequence also came from modelling studies. An interesting role of the aromatic ring was put forward through iodine-nitrogen attraction involving the amino substituents of the guanine residues (Hawley *et al.*, 1989).

An interesting stereochemical feature of the fully substituted aromatic unit came to light along with efforts towards total synthesis of calicheamicin γ_1^I : rotamers of the methoxyl and ester substituents gave rise to spontaneous resolution in the crystalline phase. The enantiomer structure shown in Figure 32 was proved by X-ray crystallography (Nicolaou *et al.*, 1988). Methanolic solution of optically pure crystals indicated racemization upon dissolution, hence the resolution occurred due to homochiral packing of the molecules – a rare phenomenon (Collet, 1990). The packing forces in the crystal overcome the thermal energy effective to surmount rotational barriers in solution. Nevertheless, the conformational chirality of the apparently achiral aromatic moiety is evident; it adds to the 19 configurational stereocentres contained by calicheamicin γ_1^I .

Further experiments demonstrated the role of the carbohydrate domain and the iodine atom in the sequence selectivity of calicheamicin γ_1^I (Nicolaou

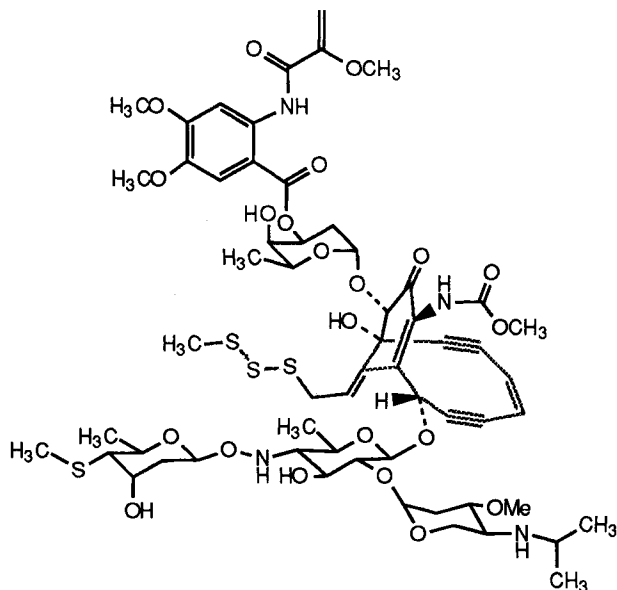
FIG. 31. The structure of esperamicin A₁.

et al., 1992), although additional specificity owing to the enediyne moiety was noted. From the strong competition for total synthesis of calicheamicin γ_1^I the Nicolaou group emerged triumphant (Nicolaou, 1993; Nicolaou *et al.*, 1993). The deep insight into the chemistry and biology of enediynes enabled them to design, synthesize and characterize an analogue, calicheamicin θ_1^I (with a thioacetate in place of the trisulfide in the side chain), which was found superior to calicheamicin γ_1^I in certain respects (Nicolaou *et al.*, 1994).

There is perhaps a minor aspect to be highlighted. So far we are uncertain how the nucleophile acts initiating the enediyne decomposition cascade. Since the agent needs to be bound into the selected minor groove, it should remain intact until its positioning is optimal, so a certain amount of time should pass before the triggering could start. A conformational change of the complex, however slight, probably brings the trisulfide side chain into contact with the nucleophilic group. The slight change may come from the DNA chain, or else, from the molecule. Of the sugar rings A, B and D were shown to be quite rigid; only ring E exhibited temperature-dependent NMR line-broadening and solvent-dependent proton-proton coupling, both being indicative of certain degree of conformational flexibility (Walker *et al.*, 1990). Alternatively, the change of conformation may start from the aromatic moiety having an important role, both in the binding affinity (Nicolaou *et al.*, 1992) and sequence selectivity (Hawley *et al.*, 1989). The methoxy groups of the

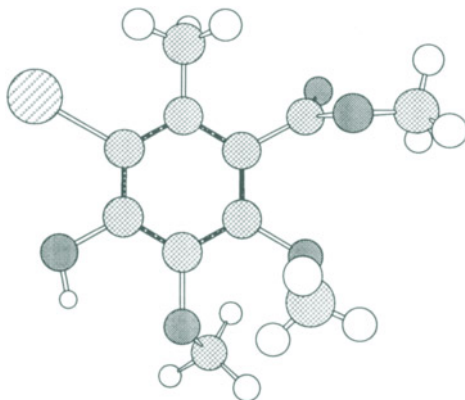

FIG. 32. The spontaneously resolving rotamer of the aromatic unit according to Nicolaou *et al.* (1988).

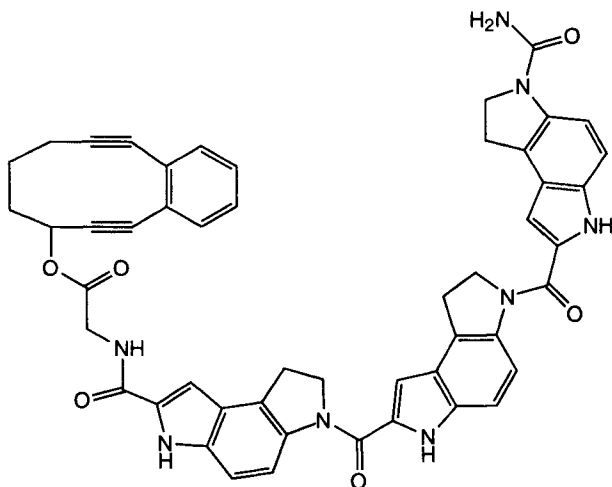

FIG. 33. A combination of CC-1065 with an enediyne.

aromatic ring under the influence of close contacts in the minor groove could flip around (Figure 32) and that might trigger a reaction by changing the position of the reactive site.

3.4.3 A Hybrid

The phenomenal potency of the agents reviewed in the preceding paragraphs prompted the idea to test a combination of the two classes. An attempt was

made to combine the properties of CC-1065 and the enediynes by Boger and Zhou (1993). The synthetic compound is shown in Figure 33.

The hybrid compound was found to exhibit detectable DNA cleavage at nanomolar concentration. Unlike calicheamicin γ_1^I , however, it did not exhibit double-strand DNA cuts. Among the factors blamed for the inferior efficiency were the slow cyclization rate of the enediyne (the trisulfide side-chain is missing), tight agent binding (instead of TCCT·AGGA sequences the enediyne is delivered to an A–T rich minor groove) and nonoptimal binding orientation of the enediyne subunit. Nevertheless, the inefficient cleavage of DNA by the hybrid agent is not a fiasco, but rather a success of the knowledge accumulated by careful studies of the two classes of agents. It also serves to maintain our fascination of the subtle ways that natural products work.

4 Conclusion

Traditional chemistry is the science of configuration. Conformations present special problems owing to their flexibility and multiplicity; it is in the biological effect of molecules that their role becomes highly important. Our knowledge is still insufficient in this respect. This is mainly because the biological environment does not accept flexible molecules as rigid structures. On the contrary, the binding site distorts the molecule, much like a hungry mouth chews on a bite of food. Chirality of conformers, therefore, represents the problem, how they can be modified. Hence, it is not only a static shape that can be chiral, but the distortion of the conformer may be brought about in mirror image alternatives.

Molecular modelling has matured over the years (Doucet and Weber, 1996) and undoubtedly will largely contribute to our understanding of conformations. Databases and other relevant information are readily available through communication networks and should also help. However, care should be exercised; most of the information available through the Internet has not been refereed may often be scientifically misleading (Simonyi, 1995).

Drug research appears now to have an interest in highly skilled techniques, such as combinatorial chemistry and high throughput screening instead of trying to find conceptual advances. The work of robots may prove reliable like that of a lawnmower without overlooking a piece of straw. However, it is like writing a prize-winning novel by permutating the letters of the alphabet: it will eventually yield all masterpieces of the future with translations in most languages, but there will be volumes full of single letters and many more unintelligible mixtures. Theories may often be misleading, equivocal, or vague, but many times they help in an indirect way. We end here with a story told by Cheng and Zee-Cheng (1981) about the role of hypotheses in drug research: ‘. . . during a war period, a group of Indian

soldiers were lost in the Burma jungle. After several weeks' search in vain by their comrades, the hope of their return gradually vanished. Yet a couple of months later, these Indian soldiers returned to their headquarters tired, but otherwise unharmed. They were asked by their commander-in-chief how they found their way back. A battered map was proudly presented to him. On close examination, the map was one of a suburb of Zurich, Switzerland! Somehow from that map and with faith, these soldiers reached their goal.'

Acknowledgements

The author thanks the following scientists for their valuable comments: Professors J. Chattopadhyaya (Uppsala), A. Eschenmoser (Zurich), M. Goodman (La Jolla), T. Peters Jr. (Cooperstown), Doctors I. Fitos (Budapest), G. Maksay (Budapest) and A. L. Tárnoky (Reading). Financial support from the National Science Fund through projects OTKA 15833 and OTKA 19304 is acknowledged.

References

- Aki, H. and Yamamoto, M. (1989). *J. Pharm. Pharmacol.* **41**, 674–679.
- Alebić-Kolbah, T., Kajfež, F., Rendić, S., Sunjić, V., Konowal, A. and Snatzke, G. (1979). *Biochem. Pharmacol.* **28**, 2457–2465.
- Allan, R. D. and Johnston, G. A. R. (1983). *Med. Res. Rev.* **3**, 91–118.
- Allan, R. D., Dickenson, H. W. and Fong, J. (1986). *Eur. J. Pharmacol.* **122**, 339–348.
- Allinger, N. L., Grev, R. S., Yates, B. F. and Schaefer III, H. F. (1990). *J. Am. Chem. Soc.* **112**, 114–118.
- Altona, C. and Sundaralingam, M. (1972). *J. Am. Chem. Soc.* **94**, 8205–8212.
- Altona, C. and Sundaralingam, M. (1973). *J. Am. Chem. Soc.* **95**, 2333–2344.
- Ando, T., Ota, M., Kashiwagi, T., Nagashima, N., Ariyoshi, Y., Chadha, R. K., Yamazaki, T. and Goodman, M. (1993). *J. Am. Chem. Soc.* **115**, 397–402.
- Ariyoshi, Y. (1976). *Agr. Biol. Chem.* **40**, 983–992.
- Baldwin, J. J., Claremon, D. A., Lumma, P. K., McClure, D. E., Rosenthal, S. A., Winquist, R. J., Faison, E. P., Kaczorowski, G. J., Trumble, M. J. and Smith, G. M. (1987). *J. Med. Chem.* **30**, 690–695.
- Barnard, E. (1996). *Trends Pharmacol. Sci.* **17**, 305–309.
- Beard, H. and McKie, R. (1981). 'Sailing: A Sailors Dictionary'. Workman, New York.
- Blauer, G., Harmatz, D. and Snir, J. (1972). *Biochim. Biophys. Acta* **278**, 68–88.
- Blount, J. F., Fryer, R. J., Gilman, N. W. and Todaro, L. J. (1983). *Mol. Pharmacol.* **24**, 425–428.
- Boger, D. L. (1991). In 'Heterocycles in Bio-organic Chemistry' (Bergman, J., van der Plas, H. C. and Simonyi, M., eds), pp. 103–129. The Royal Society of Chemistry, Cambridge.
- Boger, D. L. (1995). *Acc. Chem. Res.* **28**, 20–29.
- Boger, D. L. and Ishizaki, T. (1990). *Tetrahedron Lett.* **31**, 793–796.
- Boger, D. L. and Mésini, P. (1995). *J. Am. Chem. Soc.* **117**, 11647–11655.
- Boger, D. L. and Zhou, J. (1993). *J. Org. Chem.* **58**, 3018–3024.

- Boger, D. L., Ishizaki, T., Wysocki, Jr, R. J., Munk, S. A., Kitos, P. A. and Suntornwat, O. (1989). *J. Am. Chem. Soc.* **111**, 6461–6463.
- Boger, D. L., Coleman, R. S., Invergo, B. J., Sakya, S. M., Ishizaki, T., Munk, S. A., Zarrinmayeh, H., Kitos, P. A. and Collins Thompson, S. (1990). *J. Am. Chem. Soc.* **113**, 4623–4632.
- Boger, D. L., Zarrinmayeh, H., Munk, S. A., Kitos, P. A. and Suntornwat, O. (1991). *Proc. Natl Acad. Sci. USA* **88**, 1431–1435.
- Boger, D. L., Nishi, T. and Teegarden, B. R. (1994). *J. Org. Chem.* **59**, 4943–4949.
- Böhringer, M., Roth, H. J., Hunziker, J., Göbel, M., Krishnan, R., Giger, A., Schweizer, B., Schreiber, J., Leumann, C. and Eschenmoser, A. (1992). *Helv. Chim. Acta* **75**, 1416–1477.
- Borea, P. A., Dalpiaz, A., Gessi, S. and Gilli, G. (1996). *Eur. J. Pharmacol.* **298**, 329–334.
- Bos, O. J. M., Fischer, M. J. E., Wilting, J. and Janssen, L. H. M. (1989). *Biochem. Pharmacol.* **38**, 1979–1984.
- Brée, F., Urien, S., Nguyen, P., Tillement, J. P., Steiner, A., Vallat-Molliet, C., Testa, B., Visy, J. and Simonyi, M. (1993). *J. Pharm. Pharmacol.* **45**, 1050–1053.
- Brodersen, R. (1980). *Crit. Rev. Clin. Lab. Sci.* **11**, 305–399.
- Cheng, C. C. and Zee-Cheng, R. K. Y. (1981). *Heterocycles* **15**, 1275–1283.
- Chidester, C. G., Krueger, W. C., Mizensak, S. A., Duchamp, D. J. and Martin, D. G. (1981). *J. Am. Chem. Soc.* **103**, 7629–7635.
- Collet, A. (1990). In 'Problems and Wonders of Chiral Molecules' (Simonyi, M., ed.), pp. 91–109, Akadémiai Kiadó, Budapest.
- Crick, F. H. C. and Watson, J. D. (1954). *Proc. Roy. Soc. A* **223**, 80–96.
- Curotto, G., Donati, D., Pentasuglia, G. and Ursini, A. (1995). *Bioorg. Med. Chem. Lett.* **5**, 3011–3016.
- De Clercq, E. (1996). *Medical Virology* **6**, 97–117.
- Dröge, J. H., Janssen, L. H. and Wilting, J. (1985). *Biochim. Biophys. Acta* **827**, 396–402.
- Doucet, J.-P. and Weber, J. (1996). 'Computer-Aided Molecular Design: Theory and Applications.' Academic Press, London.
- Eliel, E. L., Wilen, S. H. and Mander, L. N. (1994). 'Stereochemistry of Organic Compounds'. Wiley, New York.
- Eltze, M. (1990). *Eur. J. Pharmacol.* **180**, 161–168.
- Eltze, M., Gonne, S., Riedel, R., Schlotke, B., Schudt, C. and Simon, W. A. (1985). *Eur. J. Pharmacol.* **112**, 211–224.
- Eschenmoser, A. (1996). In 'Chemical Synthesis' (Chatgililoglu, C. and Snieckus, U., eds), pp. 293–340. Kluwer Academic Publishers, Dordrecht.
- Eschenmoser, A. and Dobler, M. (1992). *Helv. Chim. Acta* **75**, 218–259.
- Eschenmoser, A. and Loewenthal, E. (1992). *Chem. Soc. Rev.* 1–16.
- Eveleigh, P., Hulme, E. C., Schudt, C. and Birdsall, N. J. M. (1989). *Mol. Pharmacol.* **35**, 477–483.
- Fahey, R. C., Hunt, J. S. and Windham, G. C. (1977). *J. Mol. Evol.* **10**, 155–160.
- Falch, E., Hedegaard, A., Nielsen, L., Jensen, B. R., Hjeds, H. and Krosgaard-Larsen, P. (1986). *J. Neurochem.* **47**, 898–903.
- Feigenspan, A., Wasse, H. and Bormann, J. (1993). *Nature* **361**, 159–161.
- Fitos, I., Simonyi, M., Tegye, Zs., Kajtár, M. and Ötvös, L. (1986a). *Arch. Pharm.* **319**, 744–749.
- Fitos, I., Tegye, Zs., Simonyi, M., Sjöholm, I., Larsson, T. and Lagercrantz, C. (1986b). *Biochem. Pharmacol.* **35**, 263–269.
- Fitos, I., Visy, J., Magyar, A., Kajtár, J. and Simonyi, M. (1990). *Chirality* **2**, 161–166.
- Foot, M. and Wallace, J. (1991). *Epilepsy Res. Suppl.* **3**, 109–114.
- Fosshem, R., Svarteng, K., Mostad, A., Römming, C., Shefter, E. and Triggle, D. J. (1982). *J. Med. Chem.* **25**, 126–131.

- Fujino, M., Wakimasu, M., Tanaka, K., Aoki, H. and Nakaima, N. (1973). *Naturwissenschaften* **60**, 351.
- Gilman, N. W., Rosen, P., Earley, J. V., Cook, Ch. and Todaro, L. J. (1990). *J. Am. Chem. Soc.* **112**, 3969–3978.
- Goldmann, S. and Stoltefuss, J. (1991). *Angew. Chem. Int. Ed. Engl.* **30**, 1559–1578.
- Goldmann, S., Born, L., Kazda, S., Pittel, B. and Schramm, M. (1990). *J. Med. Chem.* **33**, 1413–1418.
- Golik, J., Clardy, J., Dubay, G., Groenewold, G., Kawaguchi, H., Konishi, M., Krishnan, B., Ohkuma, H., Sithoh, K. and Doyle, T. W. (1987). *J. Am. Chem. Soc.* **109**, 3461–3462; 3462–3464.
- Goodman, M., Coddington, J. and Mierke, D. F. (1987). *J. Am. Chem. Soc.* **109**, 4712–4714.
- Hammer, R., Berrie, C. P., Birdsall, N. J. M., Burgen, A. S. V. and Hulme, E. C. (1980). *Nature* **283**, 90–92.
- Hawley, R. C., Kiessling, L. L. and Schreiber, S. L. (1989). *Proc. Natl Acad. Sci. USA* **86**, 1105–1109.
- He, X. M. and Carter, D. C. (1992). *Nature* **358**, 209–215.
- Hibert, M. F. (1996). In 'The Practice of Medicinal Chemistry' (Wermuth, C. G., ed.), pp. 523–546. Academic Press, London.
- Hill, D. R. and Bowery, N. G. (1981). *Nature* **290**, 149–152.
- Hunziker, J., Roth, H. J., Böhringer, M., Giger, A., Diederichsen, U., Göbel, M., Krishnan, R., Jaun, B. J., Leumann, C. and Eschenmoser, A. (1993). *Helv. Chim. Acta* **76**, 259–352.
- Hurley, L. H. and Needham-Van Devanter, D. R. (1986). *Acc. Chem. Res.* **19**, 230–237.
- Hurley, L. H., Needham-Van Devanter, D. R. and Lee, C. S. (1987). *Proc. Natl Acad. Sci. USA* **84**, 6412–6416.
- Jenkins, B. G. and Lauffer, R. B. (1990). *Mol. Pharmacol.* **37**, 111–118.
- Kawai, M., Nyfeler, R., Bermann, J. M. and Goodman, M. (1982). *J. Med. Chem.* **25**, 397–402.
- Kier, L. B. (1972). *J. Pharm. Sci.* **61**, 1394–1397.
- Kilpatrick, J. E., Pitzer, K. S. and Spitzer, R. (1947). *J. Am. Chem. Soc.* **69**, 2483–2488.
- Klyne, W. and Prelog, V. (1960). *Experientia* **16**, 521–523.
- Krogsgaard-Larsen, P., Nielsen, L., Falch, E. and Curtis, D. R. (1985). *J. Med. Chem.* **28**, 1612–1617.
- Krogsgaard-Larsen, P., Hjedts, H., Falch, E., Jørgensen, F. S. and Nielsen, L. (1988). In 'Advances in Drug Research' (Testa, B., ed.), vol. 17, 381–456, Academic Press, London.
- Lee, M. D., Dunne, T. S., Siegel, M. M., Chang, C. C., Morton, G. O. and Borders, D. B. (1987a). *J. Am. Chem. Soc.* **109**, 3464–3466.
- Lee, M. D., Dunne, T. S., Chang, C. C., Ellestad, G. A., Siegel, M. M., Morton, G. O., McGahren, W. J. and Borders, D. B. (1987b). *J. Am. Chem. Soc.* **109**, 3466–3468.
- Lightner, D. A., Reisinger, M. and Landen, G. L. (1986). *J. Biol. Chem.* **261**, 6034–6038.
- Linscheid, F. and Lehn, J.-M. (1967). *Bull. Soc. Chim. France* 992–997.
- Lockhart, T. P. and Bergman, R. G. (1981). *J. Am. Chem. Soc.* **103**, 4091–4096.
- Macor, J. E., Blake, J. F., Desai, K., Post, R. J. and Schmidt, A. W. (1995). *Bioorg. Med. Chem. Lett.* **5**, 2397–2402.
- Maksay, G. (1994). *Mol. Pharmacol.* **46**, 386–390.
- Maksay, G. (1996a). *Neurochem. Int.* **29**, 361–370.
- Maksay, G. (1996b). *J. Neurochem.* **67**, 407–411.
- Maksay, G. and Simonyi, M. (1985). *Eur. J. Pharmacol.* **117**, 275–278.
- Maksay, G. and Simonyi, M. (1986). *Mol. Pharmacol.* **30**, 321–328.
- Maksay, G. and van Rijn, C. M. (1993). *J. Neurochem.* **61**, 2081–2088.

- Maksay, G., Tegye, Zs. and Simonyi, M. (1991). *Mol. Pharmacol.* **39**, 725–732.
- Maksay, G., Molnár, P. and Simonyi, M. (1996). *Naunyn-Schmiedeberg's Arch. Pharmacol.* **353**, 306–313.
- Manfredi, K. P., Blunt, J. W., Cardellina, J. H., McMahon, J. B., Pannell, L. L., Cragg, G. M. and Boyd, M. R. (1991). *J. Med. Chem.* **34**, 3402–3405.
- Martin, D. G., Biles, C., Gerpheide, S. A., Hanka, L. J., Krueger, W. C., McGovren, J. P., Mizsak, S. A., Neil, G. L., Stewart, J. C. and Visser, J. (1981). *J. Antibiot.* **34**, 1119–1125.
- Mazur, R. H., Schlatter, J. M. and Goldcamp, A. H. (1969). *J. Am. Chem. Soc.* **91**, 2684–2691.
- Minghetti, P. P., Ruffner, D. E., Kuang, W. J., Dennison, O. E., Hawkins, J. W., Beattie, W. G. and Dugaiczky, A. (1986). *J. Biol. Chem.* **261**, 6747–6757.
- Nicolaou, K. C. (1993). *Angew. Chem. Int. Ed. Engl.* **32**, 1377–1385.
- Nicolaou, K. C., Ebata, T., Stylianides, N. A., Groneberg, R. D. and Carrol, P. J. (1988). *Angew. Chem. Int. Ed. Engl.* **27**, 1097–1099.
- Nicolaou, K. C., Tsay, S. C., Suzuki, T. and Joyce, G. F. (1992). *J. Am. Chem. Soc.* **114**, 7555–7557.
- Nicolaou, K. C., Smith, A. L. and Yue, E. W. (1993). *Proc. Natl Acad. Sci. USA* **90**, 5881–5888.
- Nicolaou, K. C., Li, T., Nakada, M., Hummel, C. W., Hiatt, A. and Wrasidlo, W. (1994). *Angew. Chem. Int. Ed. Engl.* **33**, 183–186.
- Oida, T. (1986). *J. Biochem. (Tokyo)* **100**, 99–113.
- Oki, M. (1983). *Top. Stereochem.* **14**, 1–81.
- Oki, M. (1984). *Acc. Chem. Res.* **17**, 154–159.
- Otting, G., Billeter, M., Wüthrich, K., Roth, H. J. J., Leumann, C. and Eschenmoser, A. (1993). *Helv. Chim. Acta* **76**, 2701–2756.
- Peters, T. Jr (1996). 'All about Albumin'. Academic Press, San Diego.
- Peters, T., Jr and Reed, R. G. (1978). In 'Transport by Proteins' (Blauer, G. and Sund, H., eds), pp. 57–73. de Gruyter, Berlin.
- Pitsch, S., Wendeborn, S., Jaun, B. and Eschenmoser, A. (1993). *Helv. Chim. Acta* **76**, 2161–2183.
- Plavec, J., Tong, W. and Chattopadhyaya, J. (1993). *J. Am. Chem. Soc.* **115**, 9734–9746.
- Plavec, J., Thibaudeau, C., Viswanadham, G., Sund, C. and Chattopadhyaya, J. (1994). *J. Chem. Soc. Chem. Commun.* 781–783.
- Plavec, J., Thibaudeau, C., Viswanadham, G., Sund, C., Sandström, A. and Chattopadhyaya, J. (1995). *Tetrahedron* **51**, 11775–11792.
- Qian, H. and Dowling J. E. (1993). *Nature* **361**, 162–164.
- Ren, J., Esnouf, R., Garman, E., Stammers, D., Kirby, I., Keeling, J., Jones, Y., Darby, G. and Somers, D. (1995). *Nature Structural Biol.* **2**, 293–302.
- Ruiz-Gomez, A., Garcia-Calvo, M., Vázquez, J., Marvizon, J. C. G., Valdivieso, F. and Mayor, F. (1989). *J. Neurochem.* **52**, 1775–1780.
- Schallenger, R. S. and Acree, T. E. (1967). *Nature* **216**, 480–482.
- Schmieden, V. and Betz, H. (1995). *Mol. Pharmacol.* **48**, 919–927.
- Simonyi, M. (1984). *Med. Res. Rev.* **4**, 359–413.
- Simonyi, M. (1995). *Chem. Brit.* **31**, 942.
- Simonyi, M. (1996). *Enantiomer* **1**, 403–414.
- Simonyi, M. and Fitos, I. (1983). *Biochem. Pharmacol.* **32**, 1917–1920.
- Simonyi, M., Maksay, G., Kovács, I., Tegye, Zs., Párkányi, L., Kálmán, A. and Ötvös, L. (1990). *Bioorg. Chem.* **12**, 1–12.
- Sjöholm, I., Ekman, B., Kober, A., Ljungstedt-Påhlman, I., Seiving, B. and Sjödin, T. (1979). *Mol. Pharmacol.* **16**, 767–777.
- Stephenson, F. A. (1995). *Biochem. J.* **310**, 1–9.

- Sudlow, G., Birkett, D. J. and Wade, D. N. (1976). *Mol. Pharmacol.* **12**, 1052–1061.
- Sunjić, V., Kajfež, F., Stromar, I., Blazevic, N. and Kolbah, D. (1973). *J. Heterocycl. Chem.* **10**, 591–599.
- Taylor, C. P. (1994). *Neurology* **44**(Suppl. 5), 10–15.
- Testa, B. and Kier, L. B. (1991). *Med. Res. Rev.* **11**, 35–48.
- Testa, B., Jenner, P., Kilpatrick, G. J., El Tayar, N., Van De Waterbeemd, H. and Marsden, C. D. (1987). *Biochem. Pharmacol.* **36**, 4041–4046.
- Thibaudeau, C., Plavec, J. and Chattopadhyaya, J. (1994). *J. Am. Chem. Soc.* **116**, 8033–8037.
- Triggle, D. J. (1994). *Chirality* **6**, 58–62.
- Triggle, D. J., Langs, D. A. and Janis, R. A. (1989). *Med. Res. Rev.* **9**, 123–180.
- Trummlitz, G., Schmidt, G., Wagner, H. W. and Luger, P. (1984). *Arzneim. Forsch/Drug Res.* **34**, 849–859.
- Unwin, N. (1995). *Nature* **373**, 37–43.
- Visy, J. and Simonyi, M. (1989). *Chirality* **1**, 271–275.
- Walker, S., Valentine, K. G. and Kahne, D. (1990). *J. Am. Chem. Soc.* **112**, 6428–6429.
- Wiberg, K. B. and Murcko, M. A. (1988). *J. Am. Chem. Soc.* **110**, 8029–8038.
- Yamazaki, T., Zhu, Y. F., Probstl, A., Chadha, R. K. and Goodman, M. (1991). *J. Org. Chem.* **56**, 6644–6655.
- Yamazaki, T., Benedetti, E., Kent, D. and Goodman, M. (1994). *Angew. Chem. Int. Ed. Engl.* **33**, 1437–1451.
- Zein, N., Poncin, M., Nilakantan, R. and Ellestad, G. A. (1989). *Science* **244**, 697–699.

Combinatorial Compound Libraries for Enhanced Drug Discovery Approaches*

EDUARD R. FELDER¹ and DIETER POPPINGER²

¹*Core Drug Discovery Technologies and*
²*Computer-Assisted Research, Ciba-Geigy, CH-4002 Basel, Switzerland***

1	Introduction	112
2	Historical Background	113
3	Basic Principles of Combinatorial Technologies	114
3.1	Arrays	114
3.2	Combinatorial Chemistry with Split Synthesis	120
3.3	Expression Libraries	125
3.4	Highly Diverse Libraries, Thematic Libraries, Analogue Series	126
3.5	Library Formats	127
3.6	Deconvolution Principles, Active Ingredients Determination	128
3.6.1	Without Microanalytical Contribution	128
3.6.2	With Microanalytical Contribution	135
3.7	Library Design and Information Management	138
4	Current Topics	139
4.1	Planning, Design, and Theoretical Interpretation	140
4.1.1	Managing Screening and Synthesis Data	140
4.1.2	Handling Combinatorial Structure Information	141
4.1.3	Searching Through Combinatorial Data	143
4.1.4	Statistical Aspects of Mixture Libraries	144
4.1.5	Assessing Diversity	145
4.1.6	Comparing Combinatorial Libraries	147
4.1.7	Designing Libraries	150
4.1.8	Evolutionary Synthesis	159
4.2	Chemical Libraries	160
4.2.1	Oligomer Libraries	161
4.2.2	Small-molecule Libraries	163
4.2.3	Tagging, Encoded Libraries	173
4.3	Quality Assessment of Libraries	174
4.4	Technical Support, Automation	175
4.4.1	Synthesis Equipment	176
4.4.2	Screening Operations	177
4.5	Target Applications	179
5	Discussion	180
	References	183
	Appendix	196

*Dedicated to Professor Ernst Felder on the occasion of his 77th birthday.

**Current address: ¹Core Technology Area, Novartis Pharma and ²Research Computing, Novartis Crop Protection, CH-4002, Basel, Switzerland.

1 Introduction

Drug discovery processes in the research-oriented pharmaceutical industry are the subject of steady verification with regards to their innovative drive towards compounds with unprecedented mechanisms of action or activity profiles. Single projects are challenged within the normal course of progress monitoring, but beyond that, in the broader sense of the overall research effort, the interplay of various technological disciplines may undergo more substantial rearrangements. This comprises a shift of emphasis in role and resources of particular technologies and the adjustment to a new equilibrium that takes into account the value that novel approaches can contribute. These rare events are invoked whenever a technological progress bears enough relevance to a potentially more efficient drug discovery process, so that its implementation justifies vast changes in the way resources are organized. In the past, some of the well-established components of today's research operations have induced major changes in the industry. Today, the recollections of the sudden impact that recombinant DNA technology or molecular modelling had in the past (just to mention two prominent cases) are still vivid, and the research community perceives that yet another technology wave must find the appropriate placement in modern drug discovery.

The issue of current debates is a growing multidisciplinary field that is often referred to with the simple term 'combinatorial technologies'. On one hand, there is a steady progress in the ability to build-up and validate high throughput assays with minimal consumption of material and with good predictive value of the therapeutic potential of new compounds. On the other hand, the simple principle of reshuffling structural subunits in a combinatorial fashion has been translated into a powerful experimental approach, which is based on an ingenious *portioning and mixing* procedure. This creates large numbers of new chemical entities, so-called *combinatorial libraries*, and may well be considered a methodological breakthrough.

Taken altogether, these developments, with the supporting technologies around them, have profound implications for the lead-finding process in drug discovery. This essay will discuss some aspects of the expected impact, with the bias of the authors' opinions, and illustrate fundamental principles and current topics of combinatorial technologies, with a selection of examples that are not a complete coverage of the published literature. The emphasis is placed on technologies with more direct links to the output of valuable lead compounds for the pharmaceutical industry, rather than on the development of tools that contribute to the improvement of drug discovery methods indirectly. Therefore the areas of artificial receptor (Boyce *et al.*, 1994; Borchardt and Still, 1994; Burger and Still, 1995; Goodman *et al.*, 1995) or catalyst development (Menger *et al.*, 1995) are neglected, and expression libraries will be described only in part.

In the last two years, various broad overviews on combinatorial tech-

nologies have been published (Felder, 1994; Gallop *et al.*, 1994; Gordon *et al.*, 1994; Krchnak and Lebl, 1995; Terrett *et al.*, 1995b; Thompson and Ellman, 1996; Valentine and Foote, 1996). More specialized reviews are mentioned when the corresponding topic is discussed. Meanwhile, a first handbook on combinatorial peptide and nonpeptide libraries has become available (Jung, 1996).

Without embarking in broader considerations of the debatable meaning of particular terms and expressions, we would like to define here a 'lead' as a compound with such physicochemical, structural and activity profiles, that motivate a project team to allocate resources of critical mass to explore the potential of its structure with a series of analogues in secondary assays with lower throughput. A 'hit' is simply a compound that showed activity in a screening run. Other frequently used expressions are summarized with short comments in the Appendix.

With all the due enthusiasm for the rise of a new powerful lead-finding approach, it is safe to assume that some overly optimistic assertions of the role of combinatorial technologies to bring about revolutionary improvements in drug discovery will be put into a more realistic perspective in the coming years.

2 Historical Background

The field of combinatorial libraries has its origins in the area of nucleic acids and peptide bio-oligomer engineering. In nature, the recombination of molecular subunits is the basis of immune systems and evolutionary mechanisms. Since it has become possible to incorporate complex mixtures of synthetic oligonucleotides (*random cassettes*) into microbial expression systems, similar processes may be imitated *in vitro*. The chemical synthesis of oligodeoxynucleotides had previously been brought to such a degree of perfection, that artificial gene fragments were no longer a bottleneck in the engineering of genetic mutations (Itakura *et al.*, 1984). Soon, the principle was exploited to generate huge numbers of randomly mutated peptide sequences (Cwirla *et al.*, 1990; Scott and Smith, 1990) within surface proteins of expression vectors. Pools of random nucleotide sequences were translated by the biological host system into short variable sequence stretches embedded in constant flanking regions of coat proteins. The unique aspects of expression library approaches will be discussed later (see section 3.3).

Highly reliable methods for the synthesis of peptides had been developed even before oligonucleotides were accessible with the same efficiency. It was therefore an obvious step to tackle the preparation of peptide libraries also directly, by straight synthesis of the target sequences, without flanking appendages. The principle of split synthesis (*split-and-mix*, *portioning/mixing*), on the other hand, which was first applied to synthetic

peptide libraries, is not obvious and should be considered a conceptual breakthrough. The method was first formulated (Furka, 1982) and presented by the Hungarian scientist Arpad Furka (Furka *et al.*, 1988a,b), who realized that with intriguingly simple means, a strategy for a controlled combinatorial synthesis could be devised. Back-to-back publications in the same issue of *Nature* (Houghten *et al.*, 1991; Lam *et al.*, 1991) presented refined combinatorial methodologies and drew the attention to the new concept by demonstrating the successful rapid identification of active compounds from synthetic peptide libraries.

It became evident, at that point, that combinatorial chemistry was bound to expand into other areas of organic chemistry. A priori, there is no reason to limit oneself to oligomeric structures built from standard amino acids or nucleotides. Any sequence of structure modifications (couplings, derivatizations, etc.) lends itself, in principle, to combinatorial approaches, provided that the chemistry involves broadly applicable, mutually compatible 'reaction modules'. These conditions, and the necessity to achieve highest yield standards in order to bypass lengthy purification procedures, are good reasons why the realization of diverse non-peptidic *small-molecule* libraries are a challenge that should not be underestimated. A first milestone in this field was set in Ellman's laboratory with the synthesis of a benzodiazepine library on solid phase (Bunin and Ellman, 1992).

3 Basic Principles of Combinatorial Technologies

Combinatorial compound libraries (CCL) are *ensembles* of molecules generated simultaneously (or in a rapid sequence of steps) by combining structural elements from a set of building blocks or reactants, with maximal use of parallel processes on the entirety of the components.

This section is an outline of general principles linked to the preparation and utilization of combinatorial libraries. It is meant to introduce the basic concepts of more lasting weight. In section 4 a choice of current efforts and topics that (these days) call the attention of research scientists are discussed.

3.1 ARRAYS

The definition of combinatorial compound libraries given above is broad enough to include 'multiple parallel syntheses', which in principle are nothing new. In our opinion, it is good practice to use a distinct term for discrete products, which are the result of mere throughput increase of traditional processes. Compounds synthesized individually, in physically separate reaction vessels, without interchange of intermediates during the assembly

process, are usually called *arrays* if a multitude of products are prepared in one batch. A common ground of arrays and other synthetic libraries is the underlying (combinatorial) chemistry, that has the potential to generate diversity in a modular fashion, with reactions that are broadly applicable with high yields. Already in this simplest form of library production, running multiple parallel syntheses efficiently, the access to partial or full automation is important for preventing human manipulation errors in typically tedious and repetitive protocols. Even more crucial is the validation of synthetic protocols with high yields over multiple steps, so as to dispense with intermediate purifications altogether, or to reduce them to automatable operations.

The thorough experiences with peptide and oligonucleotide syntheses had shown, that it is 'chemistry on solid phase', primarily, that seems predestined to fulfil those prerequisites of 'automation friendliness' by broad standardization of operation steps. Chemistry on solid supports is often carried out on 'resin' composed of many thousands of microparticles (*beads*, typically polystyrene derivatives), approximately 80–120 μm in size and with a loading capacity in the order of magnitude of 100 pmol (see also footnote to Figure 1).

An exciting challenge for modern organic chemistry is to demonstrate that many more synthetic schemes are adaptable to the solid phase format and moreover may be carried through three, four, and possibly more steps with near-quantitative yields. A factor to be exploited in solid phase chemistry is the opportunity to work with much larger excesses of reagents, if needed, without complicating the following work-up procedure. The intermediates being grafted to the solid carrier, reagents (and occasionally also some by-products) can be washed away by simple, repeated filtrations. On the other hand, the reaction conditions for solid phase chemistry need to be worked out in more or less laborious validation processes even if the solution chemistry is well established. For that reason the development of automated array synthesizers, which accommodate solution phase chemistry, remains attractive; the main difficulties to overcome are the realization of reliable liquid phase extractions and the interface to work-up stations for final purifications. Since arrays are composed of individually synthesized compounds, the identity of each member is known by its physical location and the record of operations carried out at that particular site. For a verification, routine analytical procedures (e.g., nuclear magnetic resonance, NMR) are suitable and also purity can easily be assessed. Usually multi-milligram quantities are prepared and therefore the array components undergo standard bioassay evaluation, much the same way as do compounds from corporate collections.

Testing the compounds while grafted on solid phase is not necessary in these cases, because enough material can be cleaved into solution and made available for types of assays, which are more informative than binding assays

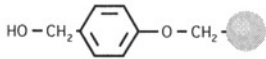
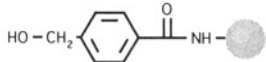
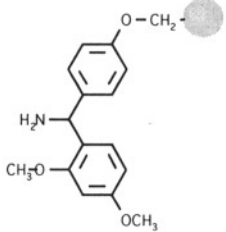
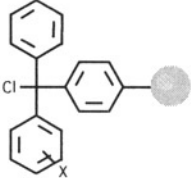
Cleavage			
Linker Structure	Reagent	Product	References
	Trifluoroacetic acid (TFA)	R-COOH R-OH	Wang, 1973 Sarshar <i>et al.</i> , 1996
	Ammonia OH ⁻	R-CONH ₂	Atherton <i>et al.</i> , 1981 Bray <i>et al.</i> , 1994
	TFA	R-CONH ₂	Rink, 1987
	Various acid conditions depending upon X	R-COOH R-NH ₂ R-OH	Barlos <i>et al.</i> , 1989



	<p>TFA HF E (electrophile)</p>		<p>Chenera <i>et al.</i>, 1995 Plunkett and Ellman, 1995b Han <i>et al.</i>, 1996</p>
	<p>TFA</p>	<p>R-NH₂</p>	<p>Hauske and Dorff, 1995</p>
	<p>Safety catch: 1. reduce to thioether 2. TFA</p>	<p>R-CONH₂</p>	<p>Patek and Lebl, 1991</p>
	<p>Safety catch: 1. oxidize to sulfone 2. mild base (baryta)</p>	<p>R-COOH</p>	<p>Schwyzler <i>et al.</i>, 1984</p>
	<p>Pyridine <i>p</i>-toluene-sulfonate (PPTS)</p>	<p>R-OH</p>	<p>Thompson and Ellman, 1994</p>

FIG. 1. A selection of solid-phase linkers with a useful stability profile for combinational chemistry.

Cleavage			
Linker Structure	Reagent	Product	References
	Photocleavage	R-CONH ₂	Brown <i>et al.</i> , 1995
	Photocleavage	R-COOH R-CONH ₂ R-OH	Baldwin <i>et al.</i> , 1995 Rich and Gurwara, 1975 Burbaum <i>et al.</i> , 1995
	Photocleavage	R-CONH ₂	Holmes and Jones, 1995
	Photocleavage	R-CONH ₂	Ajayaghosh and Pillal, 1995

	Hofmann elimination with mild base	tertiary amines (R) ₃ N	Morphy <i>et al.</i> 1996
	Safety catch 1. iodoacetonitrile 2. R ₁ R ₂ NH	R-CONR ₁ R ₂	Ellman, 1996
	0.5 % TFA	R-COOH	Sheppard and Williams, 1982
	NaOCH ₃ / MeOH	R-OH	Farall and Frechet, 1976; Meyers <i>et al.</i> , 1995

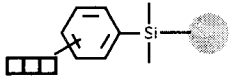
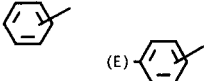
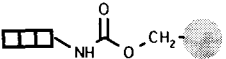
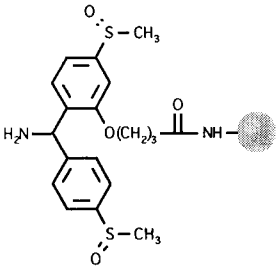
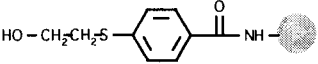
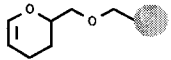
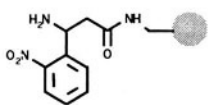
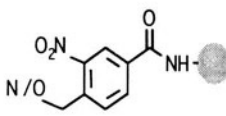
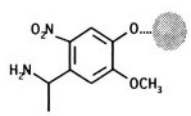
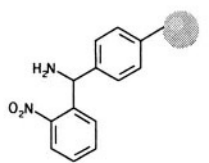
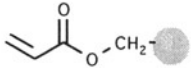
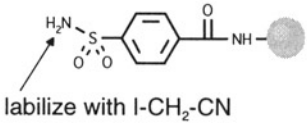
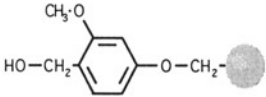
The most frequently used solid phase matrices are (1 or 2% divinylbenzene crosslinked) polystyrene (hydrophobic) and polystyrene grafted with polyethylene glycol (hydrophobic core and hydrophilic shell). The latter swells in a broad variety of solvents and also in water. Among others, also polyacrylamide, polyacrylamide/kieselguhr, polyacrylamide supported on macroporous polystyrene, polypropylene, polyacrylate and glass are used.

FIG. 1. Continued.

in heterogeneous phase. Owing to the modest throughput of individually addressed parallel syntheses, the screening capacity of conventional test systems is usually capable of handling the additional load produced in arrays. If samples are to be tested in solution, the syntheses on solid phase need to make use of cleavable linker moieties that anchor the reaction products to the carrier in the course of their assembly in a reversible manner. Moreover, taking into account the urge to avoid or simplify post-synthetic purification steps, linkers should be cleavable without leaving traces of reagents in the test samples. Some commonly used solid phase linkers and their cleavage conditions are listed in Figure 1.

To date, no standard set-up or equipment norm has arisen specifically for the purpose of array synthesis. More considerations to this regard follow in section 4.4.1. Useful arrangements may be as simple as multi-well reaction blocks with solvent-resistant frits at the bottom, if air and moisture exclusion are not critical. More complex instrumentations, with individually plumbed, closed reaction vessels, are already on the market. Operation control is mediated by robotic arm deliveries or multi-valve systems, or combinations of both.

A simple and powerful solution to serve the same purpose, the (*multi*)*pin method*, was first described by Geysen *et al.* (1984): The products are synthesized on functionalized polypropylene *pins*, which are dipped into wells containing the appropriate reagents for further derivatizations. For simultaneous processing, the pins are arranged to match the geometric layout of the wells, typically the standard 96-well microtitreplate format. In a further extension of this principle, researchers at Parke-Davis (Ann Arbor, MI, USA) have designed an apparatus with rods, each containing a resin portion (i.e. solid-phase beads) within a fritted chamber at the lower end (Hobbs De Witt *et al.*, 1993). Like pins, these rods may be exposed to various reagents by lowering them into reaction wells.

A more sophisticated miniaturized method combines solid phase peptide synthesis and photolithography (Fodor *et al.*, 1991). The photolabile nitroveratryloxycarbonyl protecting group is selectively cleavable from specific areas of a matrix, determined by light irradiation and the use of stencils. This liberates reactive amino groups for subsequent derivatizations exclusively in the areas previously exposed to light. The method provides total control over the spatial distribution of reactivity over time but suffers from noticeable restrictions on the chemistry compatible with photodeprotections. However it bears exciting potential for biosensor technology and microdiagnostic applications.

3.2 COMBINATORIAL CHEMISTRY WITH SPLIT SYNTHESIS

In its simplest expression, combinatorial chemistry may be the plain utilization of a set of validated reactions and compatible building blocks for

generating an array of discrete compounds in a single experimental run that systematically covers all the desired combinations of available reactants. In order to tap the extraordinary potential of combinatorial technologies, strategies that comprise actual recombination of intermediate products (from reactions run separately, in parallel) must be envisaged.

In most cases, products are built-up in a sequence of steps, leading to the assembly of either linear chains (e.g. peptides from amino acid building blocks) or otherwise shaped molecules, if reactions include simple functional conversions, e.g. for branched and cyclic structures or for derivatized scaffolds (Kocis *et al.*, 1995). In other cases multicomponent one-pot reactions are utilized. For the more common former case, with sequential pathways, the combinatorial principle of *split synthesis* was first conceived by A. Furka (1982) and illustrated for the synthesis of peptide libraries on solid phase (Furka *et al.*, 1988a). Typically, the amount of carrier beads available for the synthesis is divided into as many equal portions as building blocks (reactants) chosen for the first position (or first step). Each portion is exposed in a separate vessel to one of the first reactants out of the complete set. Here, slow-reacting chemicals are also given the opportunity to react to completion by virtue of their physical separation from reagents with higher reactivity. Once each and every reaction run in parallel is complete, the resin portions are thoroughly washed before they are all recombined to a common resin pool and mixed. This ensures that, apart from statistical deviations in the way beads are distributed to the portions, an equal representation of all intermediate products is obtained. For a second derivatization, the portioning to as many aliquots as reactants foreseen for that step is carried out and the reactions are again driven to quantitative yields in separate vessels. Washing, mixing and portioning can be continued for the number of cycles necessary to complete the synthesis.

The principle is illustrated in Figures 2 and 3. It can easily be recognized, that each individual bead carries only one compound species (*one-bead-one-compound*) since all the beads are exposed to only one reactant at a time, in every stage of the synthesis. As long as the compounds are kept physically separate (e.g. still grafted on the beads) the resulting library is a large collection of individual compounds. For practical reasons dictated by the limitations of functional assay formats, it is often required to cleave the compounds into solution, and test mixtures in a systematic fashion (see section 3.6).

An important factor to consider in the planning of combinatorial *split-and-mix* syntheses, which has implications on the statistical representation of compounds in the library, is the ratio of available beads versus the number of possible combinations. Excess beads results in redundancies of molecular species in the *one-bead-one-compound* approach. It has been calculated, that with a five-fold number of beads, 99% of all compounds are expected to be present in a given combinatorial library. For comments on the statistics of

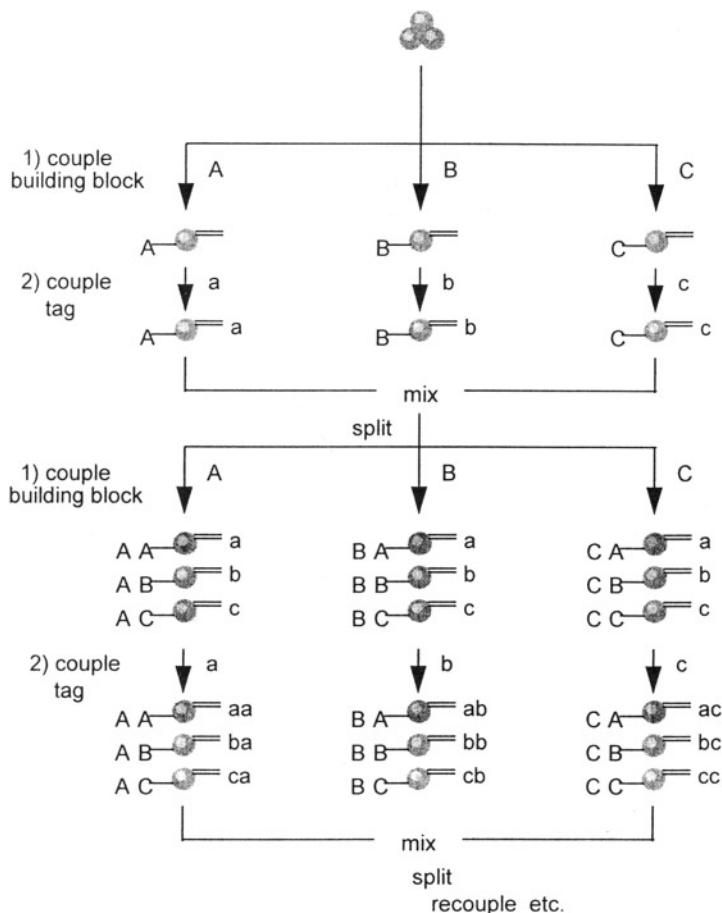

FIG. 2. Split synthesis: schematic of an encoded synthetic library assembly. Capital letters stand for building blocks, that are difficult to analyse. Lower case letters stand for tag components, that code for their identity. The randomization occurs by mixing beads rather than reagents.

split-and-mix see section 4.1.4. In any case, excess bead material is important to keep deviation from equimolar representation of each compound within acceptable limits.

The current analytical methods are not generally able, for any class of structures, to determine the identity of the synthesized compounds in the amounts present on a single bead (approximately 100 pmol) in a fast and reliable manner (unlike, e.g., the highly developed methods of rapid DNA and peptide sequencing). In the case of structures for which analytics is insufficiently developed, small amounts of side-components, which do have

Combinatorial libraries of trimers

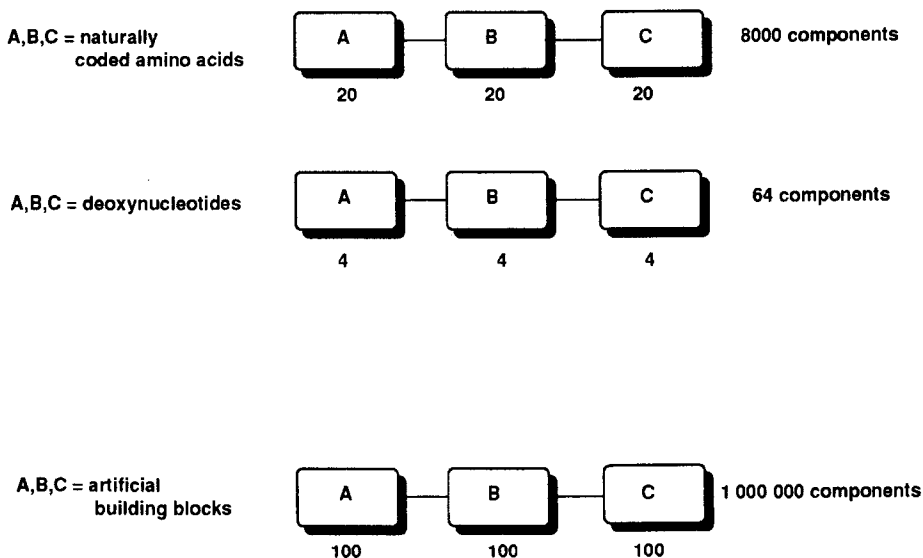

FIG. 3. The impact of the number of building blocks on the number of library components.

the necessary properties of easy detectability, are synthesized in parallel with the main component on the same bead. Such molecular tags code for the identity of the compounds to be tested and are analysed instead (Figures 2 and 4). They may be assembled sequentially, in alternating cycles with the derivatization cycles of the main component (*sequential tagging*) or by repeated applications of reagent cocktails. The latter represent a binary code, where presence or absence (bit 1 or 0) of certain tag components form binary words coding for the identity, as well as the position, of building blocks within the sequence of a library component (*binary tagging*).

While combinatorial chemistry is prevalently intertwined with solid phase chemistry for the reasons mentioned in section 3.1 (simplification of work-up procedures) and the opportunity to prepare physically separate individual compounds with the simple, yet powerful, *split synthesis* strategy (*one-bead-one-compound*), combinatorial syntheses in solution are valid alternatives in certain circumstances, namely if reactions that are incompatible with the solid format are involved. Liquid phase combinatorial synthesis on a soluble polymer support (polyethyleneglycol monomethyl ether), instead of on solid beads, was described by Han *et al.* (1995) in an effort to combine advantages of liquid and solid medium in one approach. Reactions are carried out in

Sequential code

with oligonucleotides: e.g. 4 nucleotides as tag monomer units
 or with peptides: e.g. 20 amino acids as tag monomer units



4 steps to be coded
 (with a choice of building blocks for each step)



⇒ decoding involves sequence determination of the tag

Binary code

e.g. with haloaromatic derivatives: e.g. 20 tag units, analytically resolved
 by gas chromatography

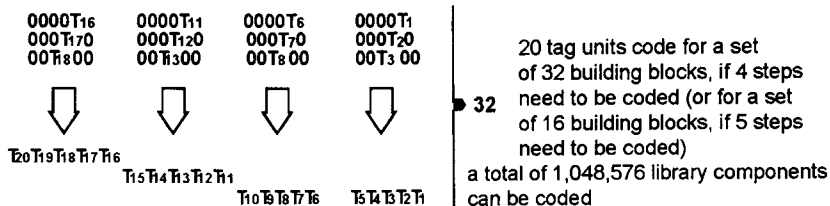

⇒ decoding involves just the determination of either the presence or the
 absence of each tag unit

FIG. 4. Tagging with sequential and binary codes. In sequential tagging, a particular sequence of tag units codes for a synthetic step. In binary tagging, defined mixtures of tag units from the first subset of tags (T₁–T₅) are added to the corresponding coupling reactions of the building blocks in the first position (A₁; a total of 32 variations). The building blocks in the second, third, etc., position are coded with mixtures of tag units from the second, third, etc., subset. Tags are added in minimal amounts (less than 1% of total loading) and linked covalently at random, causing traces of premature chain termination. The tag components are not covalently linked to each other.

solution (e.g. in methylene chloride and dimethylformamide) but at each stage of the combinatorial process the polymer may be precipitated by the addition of diethyl ether and washed. This principle of alternating solubilization and precipitation of polyethyleneglycol carriers had been previously applied in peptide, oligonucleotide and oligosaccharide synthesis (Green and Garson, 1969; Bonora *et al.*, 1990; Douglas *et al.*, 1991). Although theoretically attractive, this principle is highly demanding in practical terms, which is reflected in the fact that it has never been taken up for routine peptide or nucleotide chemistry.

3.3 EXPRESSION LIBRARIES

Biological expression systems are exceptionally powerful means to generate impressive numbers of bio-oligomeric structures in a virtually unlimited reservoir of molecular shapes that are selectable to meet the most demanding criteria of target recognition and binding. The diversity originates from combinatorial chemical synthesis of oligonucleotide mixtures to be incorporated into the genome of microorganisms and translated into peptides on the surface of cells or within bacteriophage envelopes. The strong assets of these approaches are steps of variation (randomization of nucleotide sequence), selection (affinity enrichment) and amplification, i.e. cycles of target recognition progression that include active reproduction of material with the desired properties. In essence, it is the ease of producing multiple copies of DNA, which is exploited with maximal efficiency, e.g. by simply growing cultures of selected phages in a natural reproduction process (infection of *Escherichia coli*).

Such straightforward amplification steps obviously do not have an equivalent counterpart in fully synthetic chemical libraries. Phage display libraries are probably the most widely applied format for the selection of peptides with particular binding properties. The display principle was illustrated in 1985 by Smith and later extended to construct libraries of exceptional size, e.g. for the selection of specific ligands for streptavidin (Devlin *et al.*, 1990). Other peptide expression methods include display on bacterial cells (Brown, 1992), peptides on plasmids (Cull *et al.*, 1992) and peptide display on polysomes (Mattheakis *et al.*, 1994), an *in vitro* system for very large libraries. Expression libraries are excellent examples of encoded libraries, due to the physical association of the coding DNA and the displayed peptide in one and the same microorganism or construct. Indeed it is DNA sequencing rather than protein analysis, which is used to deduce the identity of selected peptides.

Enough examples in the literature have convincingly demonstrated the utility of expression libraries for the determination of peptides with high target affinities (Barbas *et al.*, 1993; Folgori *et al.*, 1994; Meola *et al.*, 1995).

In the context of drug discovery activities, these methods may function as versatile tools but are inherently limited in their utility to produce drug leads. With the progress of general organic chemistry on solid phase to prepare *small-molecule* libraries and the increasingly efficient random screen operations with corporate collections, peptide leads are becoming less and less attractive. Peptides are unstable in biological fluids, have poor bioavailability and are difficult to formulate or to mimic with more 'drug-like' low molecular weight surrogates (Moore, 1994). Therefore, time savings in the lead identification phase are likely to translate into actual time delays in the lead optimization phase.

3.4 HIGHLY DIVERSE LIBRARIES, THEMATIC LIBRARIES, ANALOGUE SERIES

Combinatorial libraries are prepared with a goal in mind, either in the context of drug discovery programmes, or simply within research programmes demanding new chemical entities with a particular activity spectrum or binding properties. Depending on the time and stage of a project, the goal could be as ambitious as the identification of entirely new structures with unprecedented activity profile on a recently discovered new target. There may be a general lack of compounds that meet the criteria set in advance for considering a new structure as a lead. In such cases libraries are sought, which possess a high degree of diversity, i.e. cover a wide range of structural properties. Large libraries with large numbers of components could then seem a logical option to start with. Expression libraries can certainly provide the figures and, if 'tool development' is the goal, there is hardly a better alternative. However intelligible caveats remain if the effort tends towards drug development.

As we discuss in sections 3.7 and 4.1 there is more to diversity than large numbers of molecules, if one considers that a multitude of physicochemical parameters are relevant to the pharmacokinetic and pharmacodynamic properties of a drug candidate. Without an even rudimentary structure-activity relationship established, the preparation and testing of a whole panel of fundamentally different structures is first priority. A smaller but diverse library, with components lacking a prominent common denominator, may be more valuable for lead identification than, e.g., a gigantic peptide library with components that all share the flaw of poor bioavailability.

Once one or more interesting structures have been determined from a combinatorial library, second generation libraries with a structural bias (*thematic libraries, biased libraries, intelligent libraries*) can be generated to initiate the lead optimization process. This task is relatively straightforward provided that the initial structure originates from combinatorial chemistry. In that case, the modular, validated chemistry (worked out to produce the first library) can be applied to make new combinations that incorporate other

building blocks, with a bias around the known hit structure. The appropriate solid-phase chemistry may be much more difficult to develop around hits from natural compound sources or the random screen of corporate collections. The same applies for the preparation of more classical analogue series. The role of the latter may in part be taken over by thematic libraries, since a general trend initiated by combinatorial chemistry is the promotion of parallel processes. From a technical perspective, split syntheses lend themselves to the preparation of large libraries, whereas multiple parallel syntheses are useful in the domain of smaller thematic libraries.

3.5 LIBRARY FORMATS

When evaluated with regard to their performance in a bioassay, test samples from combinatorial libraries are often presented in new or unusual formats. Consequently, new assay systems need to be conceived or current ones must be adapted to suit the peculiarities of screening strategies. Such procedures are the subject of section 3.6. After the preparation process, libraries are made available either in a soluble format or with the components grafted on solid surfaces, typically polymer microparticles (*beads*).

Chemically synthesized combinatorial libraries are often obtained either as a collection of physically separate individual compounds grafted on solid surfaces (*one-bead-one-compound* or 'one compound per glass surface matrix area' – see Lam *et al.*, 1991 and Fodor *et al.*, 1991, respectively) or as a set of more or less complex mixtures (sublibraries or microeluates from bead pools) to be handled in solution, after cleavage from the solid carrier. As discussed below (see section 3.6) this is a consequence of the preparation and test strategies chosen for a particular project. In general terms, the solid format (with compounds grafted on a carrier) allows testing of a very large number of individual chemicals but imposes severe restrictions on the type of assay that is used. In practice, it is rarely possible to go beyond binding assays with a labelled *acceptor* molecule (receptor or enzyme). The format in solution, on the other hand, may be compatible with established functional assays, although for the evaluation of large libraries the present technical limitations force us to test mixtures rather than single compounds. The sequential unrandomization strategies described in section 3.6 are rational approaches to dealing with a number of fundamental problems that may arise in mixture testing. These strategies are only possible if the mixtures are assembled and grouped in a systematic fashion (sublibraries).

Recently a combined approach for testing combinatorial libraries in both the solid and soluble format was described (Felder *et al.*, 1995). A binding assay first discriminates 'beads carrying ligands' from the bulk of beads lacking binding properties. This smaller (selected) bead population is then subjected to cleavage and microelution in a microplate format (one bead per

well). Functional assays in the microeluates are used to discern non-specific binders from functionally active species. Combining the high-throughput capacity of binding assays (in a pre-screen) with more informative characterizations in solution on the selected subpopulation of potential candidates needs extensive logistical support and automation.

In very large combinatorial libraries each component is usually present in small amounts due to the difficulty of economically handling the enormous quantities of reagents involved, if scale-up to the milligram level per compound would be sought. For a library of 100 000 components, chemical synthesis on solid phase would then require more than 1 kg carrier and even the solvent consumption for washes would rapidly exceed the capacity of laboratory scales. This is just one of the reasons why there is a strong demand to miniaturize assay technologies (another is the consumption of recombinant target proteins). A breakthrough in this sense should ultimately allow to take full advantage of the *split-and-mix* approach that produces massive numbers of beads with one compound each. More sophisticated functional assays (rather than binding) would then characterize the test compounds from *split synthesis*.

3.6 DECONVOLUTION PRINCIPLES, ACTIVE INGREDIENTS DETERMINATION

To deconvolute literally means to 'unroll', and signifies the process of unravelling information about the composition of active ingredients, which becomes intricately concealed in the course of the combinatorial synthesis, but which is in principle accessible by reversing the order of complexity generation in a systematic fashion, guided by experimental tests.

In the simplest cases of array syntheses, the products are tested while keeping track of their physical position, which is known and protocolled in the preparation phase. The term deconvolution is not applicable here; the allocation of compound structures to activities is a matter of straightforward logistics, classical analytics and confirmation by individual re-synthesis of hits. The latter is an obvious step common to all approaches.

3.6.1 Without Microanalytical Contribution

There is no question that microanalytical technology is an integral part in the multidisciplinary field of molecular diversity generation. In this section we touch some deconvolution methods, which dispense with microanalysis as a structure determination tool. However, the role of analytics in the chemistry validation phase and in quality control remains as prominent here as in any other library approach. A common denominator of the following methods is the close interplay of chemical synthesis and bioassay evaluation,

which for complex libraries intertwine in a combined approach with mutual feed-back.

3.6.1.1 By physical position. The simplicity of allocating structures to activity by virtue of the logistic control of where compounds are synthesized and positioned for the assay was mentioned above. It is the logical standard method to use for arrays. The attractiveness of this approach was exploited to the extreme in devising the light-directed, spatially addressable parallel synthesis (Fodor *et al.*, 1991), which produces tens of thousands of compounds in 50 μm checkerboard patterns within 1 cm^2 . In a more generally accessible technology, the synthesis on pins (Geysen *et al.*, 1984; Bray *et al.*, 1990), the arrays are conveniently handled in the 96-well microtitre plate standard format at all stages of the preparation and assay operations.

3.6.1.2 By systematic comparison of sublibraries. In the near and foreseeable future, for reasons mentioned in section 3.5, the testing of more or less complex compound mixtures will remain attractive for the rapid evaluation of large combinatorial libraries. Some theoretical considerations on testing and comparing the performance of large mixtures of compounds (Konings *et al.*, 1996) were corroborated in an experimental model of phospholipase A2 inhibition (Wilson-Lingardo *et al.*, 1996). Substantial progress on the assay technology side, including a leap in the level of miniaturization, has yet to be achieved before testing individual compounds from combinatorial libraries will be possible without major concessions on either throughput or library size.

The powerful potential of the *sequential unrandomization* to discover active compounds in large libraries was demonstrated in 1991 by Houghten *et al.* (1991) and later confirmed in several published (e.g., Dooley *et al.*, 1993, 1994; Zuckermann *et al.*, 1994; Freier *et al.*, 1995; Blondelle *et al.*, 1996a,b) and probably many more unpublished examples. The method makes use of the split synthesis protocol in order to achieve equimolar representation of each component in a library to be tested in solution. It is an iterative process of alternating rounds of 'evaluation of sublibraries' and 'synthesis of mixtures with decreasing complexity' that ultimately converges to the test of a single component. The contribution of defined structural elements that are uniquely different in the various sublibraries, but common to all components in each of them, is measured with regard to the overall performance in a bioassay of mixtures. All the compounds bear a moiety composed of randomly combined building blocks and a defined part, which classifies the mixture (Figure 5). The known structural element of the best-performing sublibrary is in principle the sole determinant of the superiority of one sublibrary over the others, since all the molecules (in the same, as well as in all the other sublibraries) represent, as an ensemble, the same randomized region that comprises all possible combinations of building blocks used in the *split-and-*

Combinatorial Library of Pentapeptides

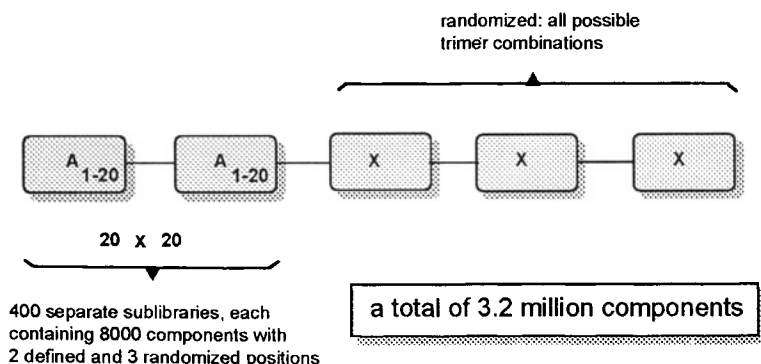

FIG. 5. A set of second-order sublibraries for testing mixtures in a sequential unrandomization in solution.

mix process. Once the most favourable building block in a certain position (for a particular assay) is determined, this same structural element can be shared by all the library components synthesized in a new round of synthesis, again divided systematically into sublibraries which are now less complex (since fewer combinations remain to be sorted out) and uniquely defined in another part of the general structure.

Among the benefits of the approach is the format compatibility with virtually any type of test system (including functional and cellular assays). A source of potential problems lies in the fact that complex mixtures may lead to unpredictable interferences between some components (e.g. physicochemical associations) although many of the phenomena are common to all sublibraries by virtue of the shared background of randomized combinations, and are therefore without influence on the selection process. Fortunately, the most critical phase of a sequential unrandomization is in the beginning, because at that point the mixtures are the most complex, with the lowest relative concentrations of individual components. If an unrandomization is unsuccessful this can usually be recognized no later than at the second round of deconvolution, when the most active sublibrary is further divided into mixtures with fewer components and the expected boost of activity does not occur in any of them. Therefore, the problems associated with a deconvolution are recognized early in the process, before time is wasted in lengthy procedures. The possibility that in early phases of an unrandomization the combined effects of whole families of homologous structures are measured, may occasionally prove to be an advantage, since

it allows to detect activities in mixtures, where each component is represented in minute quantities, at a concentration below the level of detection of the individual components.

As a consequence of the applied selection principle, only one structure results from one deconvolution. If further identifications of active components are envisaged, alternative pathways in the early stages of selection can be pursued by branching out towards other end points. This is illustrated in Figure 6 at the second round of the unrandomization: D-Ile (i) and D-Trp (w) are top-performers and the figure shows the choice to pursue with 'i' rather than with the slightly better 'w'.

Sequential unrandomization is probably the most widely used deconvolution method by systematic comparison of sublibraries. Various other strategies on how to deduce information about active species by comparison have been described by Furka (1994). These methods are less common and have their strength in the more limited area of peptide libraries and whenever compounds with many variable positions (e.g. five or more) are studied.

In the so called *domino strategy* (Furka and Sebestyen, 1995) active sequences of biooligomers are identified in three stages with stepwise reduction of complexity of partial libraries. In the first stage 'amino acid tester kits' are used: in all of their components a certain amino acid is present in one or more positions. If the *tester kits* of all utilized amino acids (e.g. 20) are evaluated, the experiment can indicate which amino acids are not present in the active sequences (by lack of activity of the corresponding kits). Consequently, an occurrence list of amino acids allows one to focus on building blocks that are indeed present in the active components. Assigning amino acids to positions can be done by *positional scanning* (Pinilla *et al.*, 1992) with so called 'first-order sublibraries' (*1st order SL*), i.e. with compounds bearing one defined position (with, e.g., the remaining four undefined). At this point the activity distribution over the various sublibraries, marked with the defined amino acids, provides sequence information (PO = positional occurrence) that can be completed and verified with tests on yet another kit of sublibraries (SL). Second-order sublibraries with two defined positions per sequence are synthesized with the knowledge of the previously determined positional occurrence. The non-overlapping sequences can be determined by using vicinal second-order sublibraries like dominoes (Figure 7).

Points to consider when planning experiments with partial libraries are the technical implications for the synthetic procedures. It is relatively straightforward to incorporate randomized positions in the first part of a synthesis (with *split-and-mix*) and conclude with one or two defined positions by keeping the contents of the reaction vessels separate, in a parallel mode ('split without mix'). The incorporation of a defined position at an earlier stage of the synthesis means carrying out all the following reactions in separate vessels and complicates the randomizations downstream dramatically. Either mixtures of

Iterations for Ac-rfxxxx-NH₂ (Inhibition of ³H-DAMGO Binding)

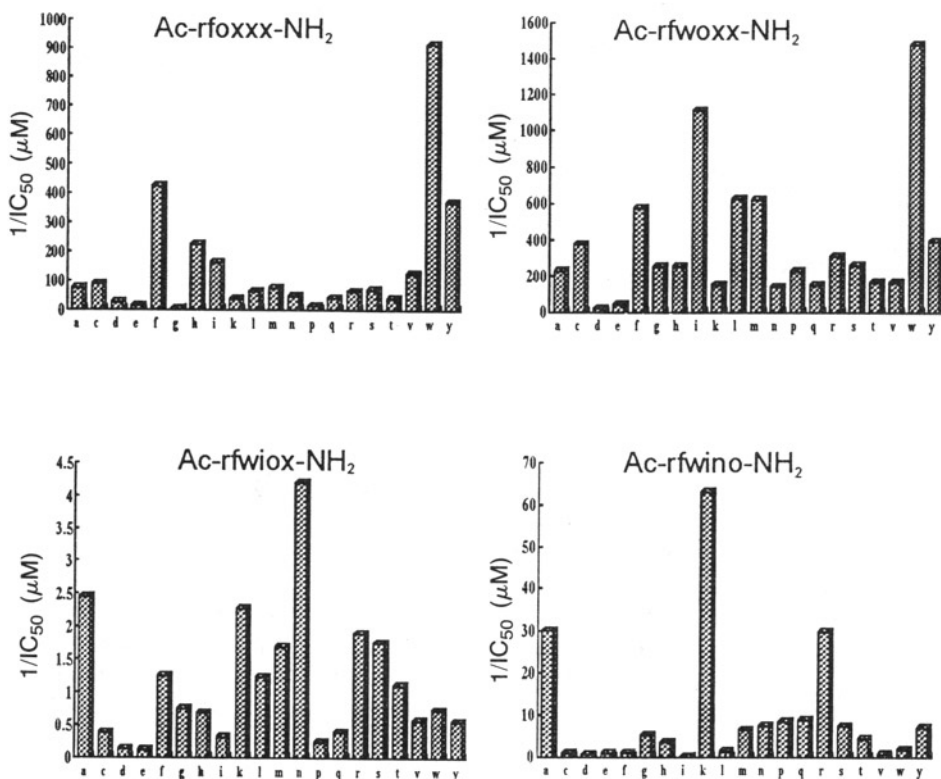

FIG. 6. Example of sequential unrandomization, as reported by Dooley *et al.* (1994). a – y = D-amino acids (one-letter code); o = defined point (on the abscissa); x = randomized position; DAMGO = (D-Ala², D-Leu⁵, Gly-ol⁵) enkephalin. The deconvoluted structure is Ac-r-f-w-i-n-k-NH₂.

building blocks are used (and equimolar representation of products becomes questionable owing to the kinetic disparity of the reagents) or further splitting of each vessel content is necessary (with demanding logistics).

A sophisticated and economic approach related to *positional scanning* was described in various contexts and named *orthogonal libraries* (Déprez *et al.*, 1995) or *indexed libraries* (Pirrung and Chen, 1995). With a given number of building blocks to be incorporated at various positions, two (orthogonal) libraries (A and B) are prepared by subdividing the building blocks into

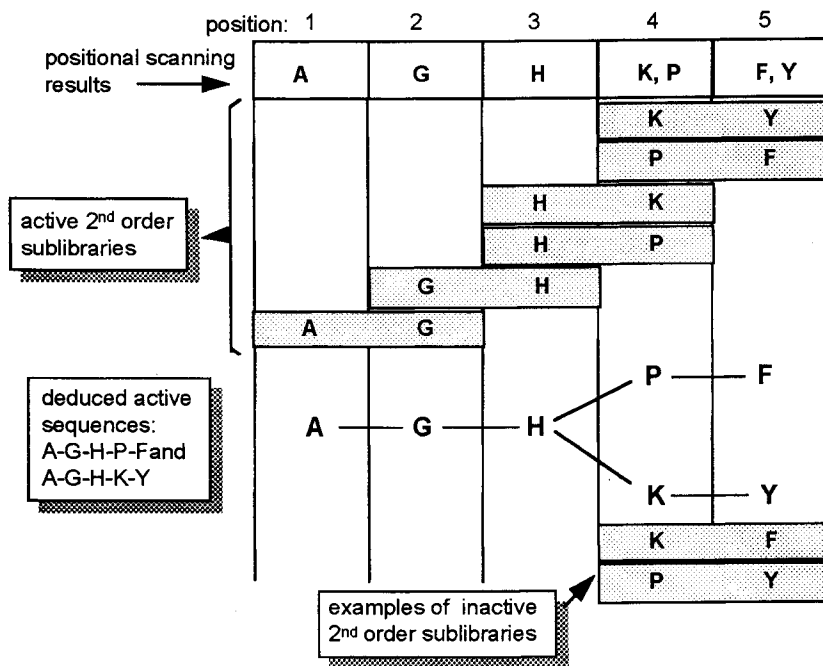

FIG. 7. The domino strategy: positional occurrence and positional scanning provide the identity of 1 or more building blocks that perform well in a certain position. Domino alignment of active second-order sublibraries (with two defined positions) provides sequence of active compounds.

smaller subgroups of maximally different reagents, which are all ultimately incorporated to form the same library components as a whole (Figure 8). The partitioning of the reagents for A and B are different, although one building block per group is always shared by one other group and the same complete set is used for A and B overall. This grouping system ensures that any sublibrary of A has only one component in common with a sublibrary of B. Ideally, in a given screen, an active compound will confer activity to one sublibrary of A and one sublibrary of B. The compound of interest is then defined as the unique component shared by the two sublibraries.

3.6.1.3 By Genetic Algorithm-guided Syntheses. The application of genetic algorithms to help evolve technical processes, by analogy to biological systems adapting to the demands of the environment, seems a conceptually elegant approach for combinatorial technologies also. In this instance, the genetic algorithm is a formalism that associates single steps of a synthesis

(a)

	A1	A2	A3	A4	A5
B1	bb1	bb6	bb11	bb16	bb21
B2	bb2	bb7	bb12	bb17	bb22
B3	bb3	bb8	bb13	bb18	bb23
B4	bb4	bb9	bb14	bb19	bb24
B5	bb5	bb10	bb15	bb20	bb25

(b)

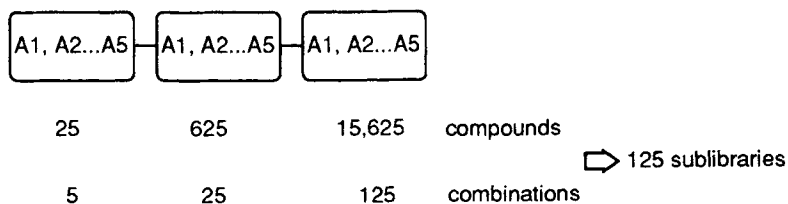

FIG. 8. Assembly of orthogonal libraries A and B: The set of available building blocks is divided into subgroups, e.g., A1, A2, A3, A4, A5 for library A and B1, B2, B3, B4, B5 for library B. Each subgroup comprises maximally diverse building blocks. Across the A and B series, subgroups share only one common synthon at a time. Within the A or B series, subgroups do not share common components. Orthogonal libraries A and B are prepared by combinatorial synthesis with subgroups (mixtures) rather than with individual building blocks, and without mixing portions. This effectively produces all possible combinations in a way that any sublibrary from A shares only 1 compound with any sublibrary from B. Maximal diversity within a subgroup of building blocks is supposed to avoid the preparation of homologues within a sublibrary.

with a 'genetic codon' and consequently procedures to 'whole genes' which undergo recombinations and mutations, and selection for better products. The assets of genetically evolving systems, be it in association with inheritable changes in living organisms, or in the formal analogy for the description of technical progress, consist of the capability to recognize a successful change, preserve it and convey it to the next generation. Improvements are obtained and built on the grounds of previous achievements as opposed to what results from simple trial and error strategies. Also, rare mutational events leave the door open for improvements that step out of local 'best solutions' and take the risk of going beyond, despite the likelihood of causing deterioration instead. A more detailed discussion of this principle follows in section 4.1.

3.6.2 With Microanalytical Contribution

Microanalytical compound identification techniques can be integrated into library evaluation strategies, which, by virtue of this added contribution, may dispense with the systematic classification into sublibraries and, in some cases with the necessity to test mixtures. The challenge is to reach the ability to identify minute quantities of oligomeric or small-molecule entities with diverse structures that may belong to any class of compounds accessible by combinatorial chemistry. The sensitivity should cope with fractions of the loading capacity of a single bead, if both bioassays and analytics are to be carried out on beads selected from a *one-bead-one-compound (split-and-mix)* library. In practice, quantities of 100 pmol or less are available for reliable characterization and, therefore, the method must aim at picomolar detection limits. The latest analytical developments (see section 4.6) indicate that direct analyses of library components will be more and more straightforward over a broad range of chemical structures.

An additional requirement for practical operation, is a throughput that matches the needs of efficient library evaluations in a variety of test systems. This throughput of structure determinations lags behind the overall bioassay throughput capacity. Only for certain classes of molecules is analytics fast and sensitive enough: peptides and oligonucleotides can be analysed rapidly in minimal quantities. Concepts and methods for the analysis of peptide libraries were described by Boutin *et al.* (1996). For compounds which are not analysable with a similar efficiency, the concept of *encoded combinatorial libraries* was developed on the basis of *sequential* or *binary tagging* (see section 3.2). Molecular tags are assembled stepwise in parallel with the synthetic steps they code for, and therefore they represent records that protocol the course of the synthesis. Tags must fulfil the requirements for ease of identification and chemical inertness under conditions of ligand synthesis.

3.6.2.1 By Binding of Labelled Acceptors (Targets). This method involves creating large libraries on beads (*one-bead-one-compound*) that consist of physically separate individual components. In a rapid approach the library can be screened without cleaving from the solid phase by exposing the beads to the solution of a labelled acceptor (solubilized receptors, enzymes or antibodies) which is linked to a reporter enzyme (e.g. alkaline phosphatase) or to a fluorescent dye. Ideally, a few beads with a strong binder retain the label even after stringent washes, while the background bead population destains quickly. It is then a matter of analysing either the ligands directly or the tags coding for them, which renders possible a separate resynthesis of the individual compounds in larger quantities. The few candidate hits may then be characterized in functional assays in order to sort out non-specific binders and artefacts. A seminal paper describing this approach appeared in 1991 (Lam *et al.*, 1991) with a study on a monoclonal antibody against β -endorphin and on streptavidin binders. As mentioned in sections 3.5 and 3.6.2.4 this method can be used as a prescreening selection step to eliminate the bulk of non-binding beads and screen a focused group of candidates.

3.6.2.2 By Controlled Release and Diffusion Assays from Spread-out Beads. Another principle exploiting the fact that individual beads from a *split-and-mix* library carry individual compounds was described by Quillan *et al.* (1995). Beads are spread out on either cell lawns or gels appropriately prepared to monitor the release of active components from the beads into the media with a reporter system. The important prerequisite for this approach is the utilization of a linker that releases compounds without the need of liquid elution (Jayawickreme *et al.*, 1994), i.e. in a dry or semi-dry state. The options for release are photocleavage or chemicals in the gas phase (e.g. ammonia or trifluoroacetic acid). The effect of compound release into the wet gel-like medium can be visually inspected.

3.6.2.3 By Bead Pooling and Redistribution. Bead pooling strategies aim to efficiently test '*one-bead-one-compound*' libraries with functional assays in solution. Controlled, portionwise cleavage of compounds from the solid phase must be possible and previously validated for a broad range of molecular structures expected to be present in the library. In a first step, bead pooling enhances the assay throughput by grouping beads randomly into pools of approximately 100 and testing the mixtures resulting from partial release of the compounds into microeluates collected in multi-well plates. Any interesting activity is correlated to the corresponding pool of beads, from which the mixture was cleaved and eluted. These beads are then redistributed in a *one-bead-per-well* format. A second portion of the compounds is released into solution and the activities of individual compounds are measured (see Figure 9). The use of branched or multiple linkers with different

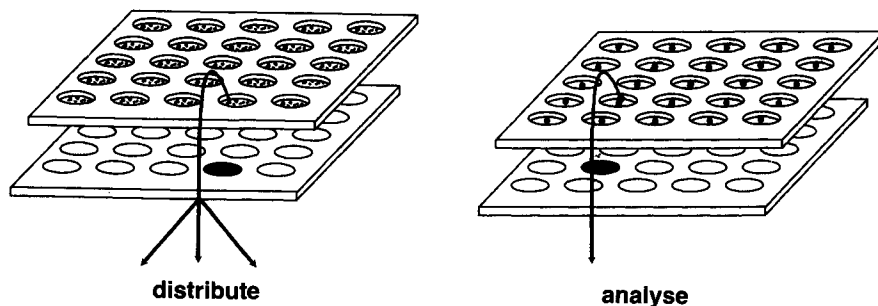

FIG. 9. Bead pooling and redistribution in the multiwell microplate format of *one-bead-one-compound* libraries. From a bead pool, aliquots of the loading capacity are cleaved, eluted and tested in solution. Bead pools that correspond to active microeluates are redistributed in a one bead per well format and again subjected to cleavage. The activities of single compounds in solution can be measured and the individual beads that release active compounds can be analysed, to determine the identity of the compounds.

cleavage specificity is best suited to ensure equimolar representations in the microeluates (Salmon *et al.*, 1993). The automation of accurate bead counting and distributing into multi-well plates is crucial for this approach and difficult to implement due to a lack of commercial instruments. With this method, any active compound is likely to be present in more than one pool, and therefore likely to be 'rediscovered' several times independently. The ratio of bead number versus number of possible combinations determines the redundancy of a particular compound in the library.

3.6.2.4 By Affinity Selection. The affinity of library components to a macromolecular acceptor (target) can be exploited to introduce a selection step in the screening procedure that rapidly puts the focus on a limited subpopulation of components, which may undergo further characterizations in a follow-up identification analysis or functional assay. In affinity selection mass spectrometry (Kaur *et al.*, 1995) a macromolecular soluble acceptor is incubated with mixtures generated by combinatorial chemistry. Binding components associate with the target and co-elute with the large molecular weight fraction in a simple size-exclusion chromatography. The mass of one or several ligands is measured directly in the presence of the macromolecular target. Since the exact mass distribution profile of the entire mixture is given by the synthetic protocol, only a handful of structures with the determined mass need to be resynthesized and further profiled, e.g. tested in order to discriminate actives from inactives, agonists from antagonists etc.

A similar approach called bioaffinity characterization mass spectrometry exploits new Fourier-transform ion cyclotron resonance (FTICR) mass spectrometry technologies, which when coupled to electrospray ionization (ESI) allow the investigation of specific, non-covalent complexes formed in solution (Bruce *et al.*, 1995). They will be useful for the investigation of very low relative concentration non-covalent associations directly from solution. Other variations of the concept introduce an affinity separation step that more closely resembles classical affinity chromatography. In affinity capillary electrophoresis/mass spectrometry (ACE/MS) the acceptor is present in the buffer as a plug, either partially or completely filling the capillary, and the library is introduced as a sample. The interacting ligands are subsequently detected by on-line mass spectrometry (Chu *et al.*, 1995). The combination of an affinity detection on beads by means of labelled acceptors and a functional assay on microeluates from the selected beads retaining the label was mentioned in section 3.5 (Felder *et al.*, 1995).

The affinity enrichment process commonly known as *biopanning* relies on subjecting a library of peptides expressed on filamentous phages to a selection for binding to the target immobilized on solid support or in solution. The selection of strong binders is followed by amplification and optionally with more rounds of selection and amplification. The sequence analysis of the DNA coding for the peptide insert enables the determination of the primary structure of interest (see also section 3.3).

3.7 LIBRARY DESIGN AND INFORMATION MANAGEMENT

Although molecular modelling has not fulfilled the initial hopes for an engineering approach to drug discovery, it is now generally accepted as a tool for medicinal chemistry. It is tempting to apply these methods to the problem of designing 'optimal' libraries. For example, computational methods could be used to construct libraries such that they consist of structurally or physicochemically diverse compounds, contain the maximum information for lead optimization, or are biased towards interesting pharmacophoric motifs or known lead structures. Moreover, it would be useful to have theories which help to relate structural characteristics of a library to its performance in a biological assay.

A somewhat less spectacular, but arguably more fundamental and far-reaching contribution of computer technology to the drug discovery process has been in the area of information systems. It is unthinkable to run large screening programmes without making use of database systems. Most research chemists use specialized scientific information systems to keep abreast of new developments, and many organizations develop wide-area network applications for global sharing of research results. With the advent

of combinatorial chemistry, information management has become even more important because of the large amount of data the combinatorial approach can generate. As in 'classical' lead discovery, the most important application of information systems is for the logistics of reagents for synthesis and samples for screening, and for keeping track of assay results. Other, related tasks are data management for high-throughput analytics, and producing instructions for automatic synthesizers. More in the theoretical direction of scientific data analysis are attempts to understand diversity, and to measure the similarity between different libraries, in order to avoid producing libraries that repeat structural motifs which have already been explored.

A number of computational approaches to addressing the library design and assessment problem has recently appeared in the literature. These are reviewed in section 4.1. The approaches that are being used in this evolving area are based on established methods from the chemical information and modelling fields, but take a new twist because of the size and the particular logical structure of the problem. First and foremost, the potentially huge number of compounds a library can contain implies the use of simple theoretical methods, and great care has to be taken that these methods produce meaningful results. Second, it is evident that computational chemistry will have to integrate with information systems and database technology.

Most established chemical database and modelling software vendors have now come onto the market with systems that support some aspects of combinatorial chemistry, or have announced future systems. These include Daylight Chemical Information Systems (1995) with the combinatorial library extensions to their Thor/Merlin system, Molecular Design Ltd (1995) with their Project Library software, Chemical Design with their extensions to the ChemX system (Davies and White, 1995), Tripos (1995) with their Legion and Selector products, and Molecular Simulations Inc. (1996) with extensions to the modelling programme CERIUS.

In the later sections of this review, we do not attempt to compare these commercial offerings. Any reference we make to commercial products is in order to explain the underlying technical and scientific issues; it should not in any way be taken as a judgment on the products. Specifically, we will address new aspects of chemical information handling, and discuss attempts at applying QSAR- and modelling-type approaches to the design of combinatorial libraries.

4 Current Topics

In this section recent research contributions with significance for the current strategies that involve combinatorial libraries for drug discovery are

illustrated. Rather than a complete enumeration of the published methods and results, this part is a review of original activities that contribute to the multidisciplinary character of the field and indicate the potential to exploit synergies from combinatorial technologies.

We chose to emphasize in more detail the planning and design side, including the assessment of molecular diversity. This is to stress our opinion that the technical achievements that provide greatly enhanced capacity in synthesizing large numbers of compounds should not distract us from using our tools with maximal efficiency. There is an increasing consensus that combinatorial technologies are not just a game of big numbers. The considerate application of library design strategies has a central role to fulfil, if this is to be confirmed. However, it is clear that if the same design criteria are applied for various libraries, e.g., maximal diversity within a population of library components, the largest library will always bear the most potential.

4.1 PLANNING, DESIGN, AND THEORETICAL INTERPRETATION

Information management for combinatorial chemistry has two main aspects: supporting the process of high-throughput synthesis (planning, execution, interpretation), and supporting the biological screening effort. These two areas have few data in common, and are usually supported by systems which are only loosely connected. Indeed, if combinatorial chemistry is viewed as nothing more than a new source of samples for high-throughput screening, then the only data common to both areas are compound registration numbers and consolidated assay data.

4.1.1 *Managing Screening and Synthesis Data*

The main components in the synthesis and screening process are: sample and plate logistics, run control, data storage and analysis, and follow-up. Many pharmaceutical companies have long-established information systems that deal with these tasks in the context of traditional screening programmes. Most often, these systems are based on the relational database management systems (Zaborowski and Hobbs De Witt, 1995). High-throughput screening (HTS) places additional strain on data management, but the consensus in the industry seems to be that the present systems can be extended to cope with the additional load. Nevertheless, a number of specialized screening data management systems are available which are aimed at the HTS market. These are client-server systems, which have PC-based user interfaces, and access relational databases which run on servers in the background. Examples include Activity Base (ID Business Solutions Ltd, Guildford, UK) and SCREEN (Molecular Design Ltd, San Leandro, CA).

Reaction databases are well-established tools for the synthetic chemist. More recent are collections which cover specifically synthesis aspects of combinatorial chemistry. For example, the SPS database from Synopsys (1996a) contains about 2000 reactions. Molecular Design Ltd has announced a database SPORE, which will initially contain several thousand reactions on solid supports.

To support information management at the level of the individual combinatorial laboratory, spreadsheet programs can be used to store reagent information, molecular weight, stoichiometric data, concentrations, volumes, and other parameters. If these spreadsheets are kept on a central file server, and some reasonable naming convention is used, then information can be effectively shared between laboratories. Using additional software (Synopsys, 1996b), standard spreadsheets can be extended such that chemical structures and reactions may be stored as diagrams, and then searched by structure and substructure; at least for data management at the laboratory level, this is a powerful and cost-effective solution.

To streamline stepwise deconvolution and multiple parallel synthesis, automatic synthesizers should be embedded in a general information system which supports high-throughput synthesis, analytics and screening. Commercially available synthesizers have their own software which controls temperature profiles, robotic arm movements, valve operations, and also handles interruptions of the normal operation. The higher-level information that must be defined includes the synthetic protocol (which steps are done in which order), some representation of synthesis batches and how they are mapped to the reaction vessels available, and lists of reagents and their association with reactant vessels. The format of this data, and whether it is entered directly using the synthesis robot software, or generated externally by other software and then imported, depends on the system. For example, the Advanced ChemTech (ACT) 496 Multiple Organic Synthesizer can import files with reagent data and references to robotic instructions, which are generated and stored in a chemical library database system (Davies and White, 1995). This area is very much in a state of flux.

4.1.2 Handling Combinatorial Structure Information

Handling combinatorial structure information presents special problems, because a large number of compounds can be made and must be registered, and because the compounds in one library are interrelated by virtue of the parallel or *split-and-mix* synthesis protocol. Although modern chemical information systems can cope with several million structures, this is not sufficient. Fortunately, it is not necessary to register and store all components of large mixture libraries explicitly, unless the components have been confirmed individually by analytics and have associated assay data. It is

sufficient to store high-level information per experiment, i.e. a description of compounds which a sample should theoretically contain. Generic structure representations similar to those used in the patent field can be used for this purpose.

Oligomer-based notations such as 'AlaLeuTyr' are the preferred way to record peptide information. To represent more general types of compounds, this string notation can be extended by using, instead of amino acid codes, a standardized brief name for more general types of molecular building blocks. An oligomer-based language for combinatorial libraries has been described by Siani *et al.* (1995), and is implemented in the Daylight Chemical Information System (James and Weininger, 1995). This language is capable of representing arbitrarily large combinatorial sets of structures in a very compact way. For example, the pentapeptide library in Figure 5 contains 3.2 million components, but can be represented compactly by recording abbreviations for the 20 alternatives at each position (5×20 building block symbols), and additional information about the chemical structure of the building blocks and the way they are connected. A similar representation is used in the Legion system of Tripos (Ash, 1996). An alternative approach to recording library information is scaffold-based. For example, to represent a set of 160 benzodiazepines (Figure 10), one would record the structure of the phenyl-substituted benzodiazepine (PBz) scaffold in a database, and also store four lists of substituents. This method is used in the chemical library information systems of Molecular Design Ltd (1995) and Chemical Design (Davies and White, 1995).

All of the above approaches represent a structure by linking structural fragments. How to do this is obvious in the case of peptides and nucleotides, and the reason why data management for biopolymers is basically straightforward. However, in the general case, the definition of fragments is arbitrary because chemical structures can be partitioned in an arbitrary way. In addition, it is surprisingly difficult to represent correctly more complex libraries, such as those of oligomers of varying chain lengths, mixtures of regioisomers, and intentionally created mixtures of mixtures. Unless database

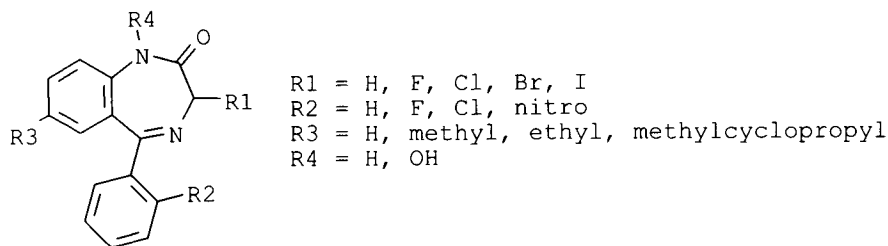

FIG. 10. A benzodiazepine library with 160 compounds.

systems can be made to deal with these complications (or these complex libraries are consciously avoided) attempts at automating the entire combinatorial chemistry workflow (Agrafiotis *et al.*, 1995) will fail. Some of these defects can be repaired by more elaborate library representations (C. A. James, personal communication 1996). More fundamentally, one should store in a database *what is known* about combinatorial synthesis (namely reagents and reaction schemes), in addition to *what is assumed* to be the outcome of synthesis (the combinatorial set of products). One of the chemical database vendors has announced a system which works along these lines (K. Davies and C. Briant, personal communication 1996).

4.1.3 Searching Through Combinatorial Data

Substructure searching is one of the main tasks demanded of chemical information systems, and should be possible in the case of combinatorial libraries as well. Looking up building block abbreviations like in sequence database searching (e.g., PBz in Figure 10) is rapid (Siani *et al.*, 1994) but of limited utility because there is no universal building block nomenclature. Moreover, substructures which do not correspond exactly to building blocks cannot be found in this way. For example, in the case of the benzodiazepine above, a search for the substructure 'Ph-Cl' would fail, even though the set contains 40 molecules which should match this query. Some degree of explicit structure enumeration by connectivities is unavoidable to solve this problem. The available commercial programs differ in how this is implemented. For example, the Project Library software by Molecular Design Ltd (1995) connects building blocks at search time. Siani *et al.* (1995) have described an enumerative approach based on the Daylight software. Preliminary work on how to avoid full enumeration when searching across building block boundaries has been reported (Smith, 1996).

Similarity searching is a different way to look through databases. Unlike substructure searching, which returns only those molecules which happen to contain precisely all atoms of the query structure, similarity searching has some degree of fuzziness, which is more in line with the way chemists tend to think about chemical structures. If exact answers are required, for example in the context of patents, then this fuzziness is undesirable, and exact searching techniques must be used. Although molecular similarity is such a pervasive concept in chemistry, it is difficult to quantify. There is a large number of molecular similarity measures; examples include those based on molecular connectivity, pharmacophore properties, and various interaction fields. For a review, see Maggiora and Johnson (1990). In the chemical information field, a commonly used similarity measurement is based on *molecular fingerprints*. A fingerprint is a compact record of computed molecular data, which can be used to characterize a molecule, much like the

fragmentation pattern in mass spectrometry can be used to characterize a compound. Structural fingerprints are usually derived by systematically checking which substructures occur in the molecule and are stored in a computer as a string of 0 and 1 bits. The structural similarity of two molecules can be defined by counting the common occurrence of features, and normalizing this measure such that it is between 0 (no common features) and 1 (identical molecules). One measure of this kind is the Tanimoto similarity index, which is often used in chemical information systems. Other similarity indices have been described (Carhart *et al.*, 1985; Holliday *et al.*, 1995).

Substructure and similarity searching can be extended beyond topology, by recording the occurrence of three-dimensional atom patterns (Willett, 1991). The use of such *3D pharmacophores* has a long history in drug design and, more recently, in database searching (Bures *et al.*, 1994; van Drie, 1995). Davies and Briant (1995) have constructed *pharmacophore fingerprints* by recording all three-point pharmacophores which can be formed from five generalized atom types (hydrogen bond donors, hydrogen bond acceptors, positive centres, aromatic centres, hydrophobic centres) at fixed triangle geometries. The computation involves conformational analysis, which can be very time-consuming for large databases (several weeks per 100 000 structures). Because of their size, these pharmacophore fingerprints are not stored routinely in a database for searching purposes, but they can be used for diversity assessment.

4.1.4 Statistical Aspects of Mixture Libraries

In the *split-and-mix* protocol of combinatorial synthesis, a statistical sampling of compounds is introduced, because the splitting process is random and cannot guarantee that each intermediate is present in each pool. This has the effect that not all expected compounds will be formed or that compounds are formed in uneven amounts, which can mislead subsequent deconvolution. The question of how many beads per expected compound are required in order to avoid this complication, has been studied by several authors (Burgess *et al.*, 1994; Zhao *et al.*, 1995, 1996; Boutin and Fauchère, 1996). Using Monte Carlo simulations, Zhao *et al.* (1995) found that about 20–30 beads per compound are required in mixtures of 10^3 – 10^5 compounds, if each compound is to be present on at least four beads in 99% of the cases. The required number of beads per compound increases with the number of components in the library.

A related question that arises in mixture library synthesis is whether iterative deconvolution can be expected to identify the most active compounds present in the library, given the statistical fluctuations of compound concentrations, the distribution of activities, and random experimental errors. Simulations on model systems show that, in general, iterative

deconvolution is more successful than positional scanning at identifying the most active compound (in particular, if the library has many compounds of similar activity). Also, deviations from equimolarity decrease the success rate of deconvolution and it appears to be beneficial to have many sublibraries in few deconvolution rounds (Freier *et al.*, 1995; Konings *et al.*, 1996). Experimental evidence is in support of the simulations, except that positional scanning was found to be more successful than suggested by the simulations (Wilson-Lingardo *et al.*, 1996).

4.1.5 Assessing Diversity

The diversity of a library is in some way related to the degree of similarity between the individual compounds in the library. Diversity is therefore dependent on the properties one chooses to define similarity. Several approaches have been described in the literature.

4.1.5.1 Measuring Diversity by Fingerprint Density. Because a structure fingerprint records the occurrence of distinct substructures, the number of 'on' bits it contains (the *fingerprint density*) can be taken as a measure of structural diversity. To apply this concept to libraries, one defines a *library fingerprint*, which is the logical OR of the structure fingerprints of all library components. The library fingerprint density then measures the number of different structural fragments which occur in *any* of the library structures, and can be used as diversity measure (Martin *et al.*, 1995). Full enumeration of libraries for fingerprint generation can be slow; Downs and Barnard (1996) have reported a computationally efficient algorithm. *Library pharmacophore fingerprints* can be defined as the logical OR of the pharmacophore fingerprints of all constituent molecules (Davies and Briant, 1995). These record the presence of pharmacophores in *any* conformation of *any* structure in the library. The pharmacophore diversity of a library can then be measured as the density of the pharmacophore fingerprint (K. Davies and C. Briant, personal communication 1996). Related work has been described by Mason *et al.* (1995) and Bures *et al.* (1995). It should be clear that, in principle, any spectrum of any measured or computed molecular property can be used to derive fingerprint-based library diversity measures. All that is required is a systematic scheme to discretize continuous property values, and faith in the significance of these properties or, preferably, scientific evidence which comes from validation studies (compare section 4.1.7.3).

The structure fingerprint diversity method was used by the Chiron group (Martin *et al.*, 1995) to compare some proprietary *N*-substituted glycine (NSG) libraries with biopolymer libraries and collections of commercial drug molecules. The NSG libraries were more diverse than the natural

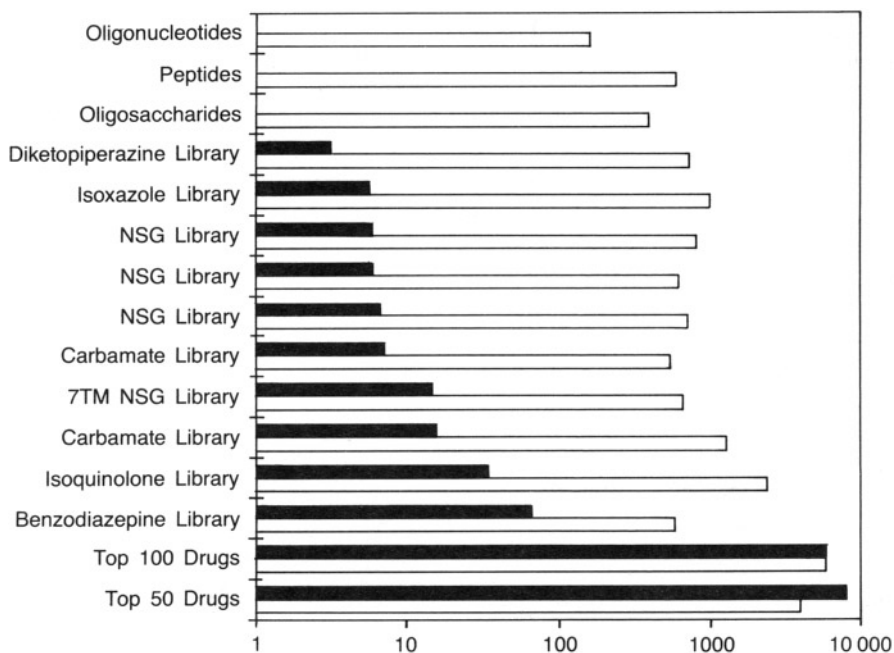

FIG. 11. Structural diversity of libraries and compound collections. Estimated total number of fragments per library (white) and estimated number per 100 library constituents (black). Most combinatorial libraries are more diverse than the natural biopolymers, and both less diverse (black) and less 'diversity-efficient' (white) than the 50 or 100 top-selling drugs. Data after Spellmeyer *et al.* (1997) and courtesy of Chiron Corp.

biopolymers, but less so than the set of commercial drug molecules (see Figure 11).

The Abbott group (Martin *et al.*, 1997) has used the number of different three-point pharmacophores represented in a library, as a diversity measure. They find that large compound collections typically cover 85–93% of 'pharmacophore space', whereas some small libraries and screening sets cover between 20% and 55%. If the pharmacophore diversity per compound is taken as the relevant measure, then the small libraries are actually more 'diversity-efficient' than the large compound collections. It would be interesting to determine whether this is reflected in a larger number of structurally different hits in random screening programmes.

4.1.5.2 Similarity and Property Profiles. Library fingerprints do not distinguish between substructures or pharmacophores occurring in one molecule or in different molecules. In general, they will therefore have a

tendency to average out library diversity measures. Recording all pairwise molecular similarities is, in principle, a better approach. The resulting distribution of similarities can be visualized as a histogram, but is not easy to condense into a single 'diversity index'. Similarity profiles have been used to visualize the diversity of screening compound collections (M. Pöhlchen, Tripos Inc., personal communication 1995), and the structural and physicochemical diversity of combinatorial libraries (Gobbi *et al.*, 1996). An example is shown in Figure 12.

Similarity profiles have also been proposed as a method to select structurally disparate sets of screening compounds from chemical databases (Turner *et al.*, 1996).

4.1.5.3 Autocorrelation Functions. Autocorrelation functions are statistical devices to measure the dependence of properties at one point on properties at other points. They have, for example, been used to study characteristics of non-periodic signals or two-dimensional image data. For characterizing molecules, an autocorrelation vector can be defined which records structural characteristics in a way similar to the molecular fingerprint, but is based on physicochemical properties such as electronegativities, charges, atomic volumes, or hydrogen bond donor/acceptor capabilities (Moreau and Broto, 1980). Each molecule now corresponds to a point in the multidimensional space of autocorrelation vectors; a library or structure collection can be represented as a multidimensional cloud of points. The similarity of two molecules can be defined as their Cartesian distance in this cloud, and library diversity is related to the cloud density. Moreau (1995) used this technique to compare the 'property diversity' of the Roussel-Uclaf structure collection with that of the Available Chemicals Directory (Molecular Design Ltd, San Leandro, CA) collection of commercially available compounds, a database of chemicals from over 750 suppliers comprising more than 170 000 molecules.

4.1.6 Comparing Combinatorial Libraries

As interesting as *post festum* diversity assessment may be, as such it contributes little to discovering more or better leads. The real issue is how to construct libraries such that they have little overlap with previous libraries or existing screening collections, and such that they make use of any previously accumulated structure-activity knowledge. This requires methods to *compare* combinatorial libraries and compound collections, and also methods which can be used to *design* diverse or focused libraries.

In this context, one question that could be asked about a new library is which existing library is most closely related, either in the sense of containing most of the 'new' molecules, or being most similar to them. This is the

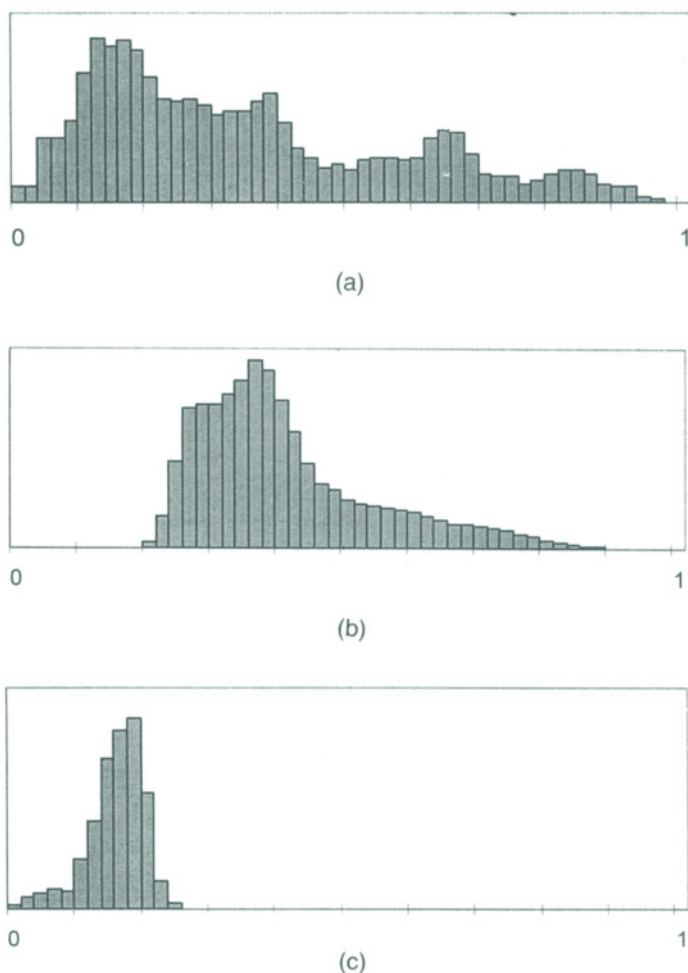

FIG. 12. Similarly profile of libraries. A set of 1383 screening compounds from one of Ciba's laboratories (a), a combinatorial library of 11 480 pyrazoles (Marzinzik and Felder, 1996) (b), and the similarity profile between the screening set and the library (c). The horizontal axis is Tanimoto similarities from 0 (dissimilar) to 1 (identical). The vertical axis is in arbitrary units. The screening set is quite diverse, although there appear to be some clusters of similar structures. The pyrazole library is, in comparison, less diverse. The structural overlap between the two is small.

extension of substructure and similarity searching from single compounds to libraries. The simplistic approach, comparing everything with everything at search time, is computationally too time consuming for practical purposes except for very small libraries. Gobbi *et al.* (1996) have used library

fingerprints for similarity searching. These are computed by enumerating libraries (or sampling them if they are very large) and then stored in a database. The Tanimoto criterion can now be applied to find libraries which are most similar to a given structure or library. These searches are essentially instantaneous and can be applied to very large library databases. Sadowski *et al.* (1995) have described the use of spatial autocorrelation functions as a means to compare libraries, using the electrostatic potential on the molecular surface as a characteristic property. The drawback of this approach is the computer time involved, which can be substantial. For example, it takes 2 days on a modern workstation to compute the spatial autocorrelation function for a library of 65 341 structures, even if rigid model structures are used (which defeats the purpose of spatial analysis, because most real-life libraries contain conformationally flexible compounds).

Another question one can ask about libraries is: 'Which building block, or which pattern of building blocks, is likely to be connected with which activity?'. In peptide chemistry, this is looking for consensus sequences. In the general case of chemical libraries, this question is difficult to answer, because (unlike in molecular biology) there is no fixed alphabet of building blocks from which the entire universe of interesting molecules can be built up. In particular, there is no reason why the occurrence of a building block, which was defined only for synthetic or structure registration convenience, should be related to a specific biological effect across a structurally diverse set of libraries. A pharmacophore-based consensus method has been proposed by Davies and Briant (1995). They compute the logical AND of two library pharmacophore fingerprints, which identifies those pharmacophores which occur in any molecule of library 1 *and* in any molecule in library 2. By comparing active pools in this way, and by judicious use of information about inactive pools, one can try to identify those pharmacophores which can be held responsible for biological activity. This type of analysis could be done with any fingerprint that encodes useful information.

A more fundamental problem is the 'radius of validity' of structure-activity models. It is known that QSAR (quantitative structure activity relationships) models tend to break down if one moves outside rather narrow classes of similar molecules. A combinatorial library which was constructed for lead-finding purposes will usually be structurally diverse, and almost by definition not be amenable to QSAR-type analysis. Studying qualitative trends within biased libraries therefore appears to be more promising. For example, Burbaum *et al.* (1995) have used a library of 217 sulfamoylbenz-amides to identify some structural factors which seem to affect carbonic anhydrase isoenzyme selectivity. Combs *et al.* (1996) have identified building block consensus patterns in a large amide library directed towards SH3 (Src homology 3) protein tyrosine kinase domains.

4.1.7 *Designing Libraries*

Rational library design is the attempt to produce 'better' libraries by applying theoretical models similar to the ones used in the rational design and selection of single compounds. Rational library design operates in search space which is defined by the availability of building blocks, the expected feasibility of reactions and the constraints of the synthesis protocol. Rational library design is concerned with controlling 'diversity' and 'focus'.

There are several reasons for trying to control the diversity of libraries. First, diverse libraries are expected to cover more of the accessible structure space, and should decrease the probability of getting trapped in the 'local minimum' of pre-existing knowledge and thus overlooking interesting leads. This is particularly the case if the number of tests that can be run is limited, for example by the amount of target enzyme available. Moreover, because it is difficult to work out robust synthesis conditions, chemists will be biased towards using structurally narrow building block sets. Second, structurally diverse actives may carry more information about structure-activity relationships than more homogeneous sets. Third, it is, in general, preferable to have several significantly different leads for subsequent optimization. Fourth, analytical identification of a single compound in a mixture will be easier if the compounds have been designed to have different properties (e.g. mass). Fifth, deconvolution of a mixture of similar compounds with similar activities can present problems. In some applications, it therefore makes sense to talk about a library being diverse in two dimensions, one concerning structural classes (for reasons of lead identification and subsequent lead optimization), and the other one concerning mass (for analytical reasons).

Whether it is worth using computational methods to enforce structural diversity, rather than just picking reagents at random, clearly depends on the size of the intended library relative to the size of the accessible structure space (and, of course, also on the computational effort involved). If the intended library is very small and the accessible structure space is very large, then randomly selected building blocks are unlikely to be similar and a synthesis from these will always produce a structurally diverse library. If the intended library covers a significant part of the accessible structure space, then this is no longer true, and a computational (rational) diversity design may be justified. It is not clear where the break point is. Young *et al.* (1996) have put forward statistical arguments, and used simple examples, which suggest that random designs may be adequate in many cases.

Designing focused libraries is, in principle, no different from designing individual compounds, with or without molecular modelling. Structural similarity to known leads, hypotheses about the pharmacophore, target receptor or enzyme structure information, and knowledge about drug metabolism, can all be used in the design. Whether one wants to design diverse or focused libraries, the size of the search space (i.e. the number of

molecules that could theoretically be made, by using all available reagents) imposes limits on what can realistically be achieved with computational methods. If the number of molecules that could be made is of the order of 10^{10} , then there is no hope that a significant proportion can be examined systematically and with theoretical rigour. In addition, there is little point in computationally comparing molecules if it is quicker to synthesize and screen them, and if the required assay capacity exists.

A complication that is frequently overlooked in the context of designing diverse libraries is the synthetic protocol. Consider a *split-and-mix* amide library that can be built up from two sets of 3000 amines and 3000 acid derivatives. The search space contains 9 million compounds, which can be visualized as the elements of a 3000×3000 matrix. The *split-and-mix* synthesis protocol will always produce libraries which correspond to *entire rows* and *columns* of this matrix. Running a suitable compound selection algorithm over the set of 9 million compounds will lead to a smaller number of optimally diverse amides, which can correspond to *any element* of the 3000×3000 matrix. Such a 'designed' library cannot be produced by *split-and-mix* synthesis. A satisfactory library design process should therefore take synthetic constraints into account, i.e. it should be able to simulate the synthesis protocol. Moreover, it should be possible to use historical information from other libraries (the problem of library series design).

The current practice of library design is to select sets of building blocks such that the desired number of different library components with different characteristics or sufficient predicted activity result. In doing this, a *design space* has to be defined, a set of *descriptors* has to be chosen to represent the library properties, the descriptors should be *validated*, and a suitable *selection algorithm* must exist.

4.1.7.1 Choosing the Design Space. The design space is the collection of molecules or building blocks from which the library will be picked or constructed. The size of the design space is the number of compounds that have to be computed and compared. For libraries which can be synthesized from simple, commercially available reagents, this size can be of the order of 10^{12} or more. Instead of solving the difficult problem of searching large combinatorial spaces, Martin *et al.* (1995) have proposed to design diverse libraries by making the sets of building blocks diverse. In a four-step synthesis with 1000 building blocks per step, this would factor the whole molecule design space of size 10^{12} into four building block subspaces of size 10^3 , which is computationally quite manageable. The underlying assumption is that a library which is built from diverse building blocks will also be diverse. This is a reasonable approximation if diversity can be measured by the number of different functional groups. If diversity has to be measured by more complex criteria, such as occurrence of 3D pharmacophores which can span adjacent building blocks, then this approximation cannot be expected to work, and

building block interactions have to be taken into account (at the extreme, by evaluating whole molecules). At present, there is no convincing evidence that this additional complexity is necessary in diversity design.

4.1.7.2 Choosing Parameters for Library Design. The ideal starting point for library design would be a theoretical method to estimate biological activity from the chemical structure, e.g. in the form of computed binding constants. If three-dimensional structure information on a target molecule is available, either from X-ray or as a good homology model, it should be possible to select building blocks such that they have a high affinity towards a particular receptor, *if the prediction method can be applied routinely to large sets of structures*. In principle, this is an attractive way to design libraries. In practice, computing reliable binding constants is exceedingly difficult, because there are too many contributions which are still poorly understood (Ajay and Murcko, 1995).

A more realistic approach to library design is to use the simpler parameters which have been used in the QSAR field (for a review, see, e.g., Loew *et al.*, 1993). A wide variety of parameters can be used; the question is generally which ones to choose. In the case of lead finding, one usually aims at making diverse libraries, which can be used in different assays. Thus, there is no structure–activity model that helps in selecting parameters. Descriptor validation, which is discussed below, aims at finding parameters which work for a variety of targets. In the absence of descriptor validation, the best that one can do is to use what appears plausible, in the light of molecular modelling and QSAR history.

In the QSAR area, there have been many attempts to derive *topological descriptors*, which are cheap to compute and easy to compare between different compounds. One popular set of descriptors was elaborated by Hall and Kier (1991). Other descriptors which have been suggested for diversity analysis are related to the eigenvalues of modified adjacency matrices (Burden, 1989; Pearlman, 1996; Rusinko *et al.*, 1996). The most commonly used topological descriptor is the structure fingerprint, which has been discussed above.

Martin *et al.* (1995) have pointed out that descriptors which are used to classify building blocks should exhibit some directionality because atom layers which come close to the biological receptor are more important for binding than layers close to the scaffold. They have therefore developed ‘atom layer tables’, which take the distance from the scaffold and also polarity effects into account. These tables can be compared between pairs of building blocks and thus used for library design purposes.

Geometrical descriptors (pharmacophores) can also be used to compute a distance measure between molecules (Davies and Briant, 1995). The method appears to be used in several companies to select structurally diverse compounds for screening, and it has also been used to construct a commercial

collection of samples for high-throughput screening. Finally, it can be argued that topological or geometric descriptors have no clear physical interpretation, and that one should use *physicochemical descriptors* such as the logarithm of the octanol–water partition coefficient (logP) as measure of lipophilicity, the molecular refraction as a measure of molecular size and polarizability, and the pK_a value. There is extensive literature on how to best compute these values, and we will not go into details here.

More recently, an empirical descriptor of direct biological relevance has been proposed by Kauvar *et al.* (1995). Measured binding affinities to a reference set of diverse proteins are used to derive an *affinity fingerprint* for a large set of compounds. This set could be a screening collection, a combinatorial array, or a set of building blocks attached to a model scaffold. The fingerprints of a small, diverse subset (the training set) can be correlated with the binding affinity of the remaining large set. The affinity of any compound in the large set to a new target can then be predicted from this relation, by assaying the *training set compounds* against the new target. Thus, affinity fingerprints could be used to assess the biological diversity of a set of compounds with respect to individual targets. This requires that all newly synthesized compounds are assayed against a reference panel of proteins. For a new target, the training set would be assayed, and some information would be obtained as to whether it is worth retesting the existing arrays, and about building block binding affinity. In this way, affinity fingerprints could be used to reduce the screening effort, and to provide some biologically inspired guidance to building block selection.

4.1.7.3 Validating Descriptors. Without proof that the chosen descriptors can be used to discriminate between active and inactive compounds, rational library design is of no value. For example, it is often stated that ligand–receptor interaction is strongly influenced by shape complementarity, and therefore one should obviously use three-dimensional descriptors for library design. No direct verification of this postulate has been reported in the literature, but there is some recent work on the related problem of using theoretical methods for selecting subsets of compound collections for screening purposes. One approach to evaluating these methods is to run ‘simulated screening’ experiments. In the case of similarity-based selection, the argument is as follows. If structural similarity is an indicator for similar biological activity, then picking, from a screening database, molecules which are similar to a lead structure should draw more actives than a random selection. The effectiveness of different parameters can be assessed by comparing their ‘enrichment factor’ over a random selection.

Such a ‘simulated screening’ experiment has been reported by Sheridan *et al.* (1996). Comparing topological and geometric pharmacophores, they find that both types of descriptors lead to a significant enrichment, but that geometric pharmacophores are in fact inferior. Martin *et al.* (1997)

have reached similar conclusions regarding the effectivity of two- versus three-dimensional descriptors for classifying compounds as actives and inactive. Moreau (1995) has compared two- and three-dimensional autocorrelation vectors and concluded that there is no justification for using three-dimensional structures. Cramer (1996) has reported that topological descriptors of the Kier–Hall type are ineffective, and whole molecule two-dimensional fingerprints and autocorrelation functions are only weakly effective. Side chain steric fields and two-dimensional fingerprints, and hydrogen bond spatial fingerprints, were found to be useful for discriminating active and inactive compounds. There is also evidence (Cramer, 1996; Kearsley *et al.*, 1996) that the computed logP value is a poor discriminator between actives and inactive.

It is clear that more work needs to be done along these lines. However, the balance of evidence that has been reported so far, suggests that two-dimensional fingerprints and related parameters are to be preferred. The three-dimension-based descriptors which have been used to date, do not seem to yield more useful information, in particular considering the large effort needed to generate them. Also, in view of the caveat of Young *et al.* (1996), one should in general be wary of using computationally expensive library design methods.

4.1.7.4 Algorithms for Library Design. Having selected and validated a set of molecular descriptors, the next problem is how to use them to select reagents for combinatorial synthesis. This problem also arises in the context of selecting compounds for screening, and some of the concepts developed in this area can be used directly for library design. The proviso is, of course, that using computational methods must be more successful than picking compounds at random or by intuition, and also cheaper than buying additional synthesis and screening capacity.

Common to all computational approaches to compound selection is that the descriptor space should be close to orthogonal, i.e. the various descriptors should not be systematically dependent on each other. This condition is rarely met. For example, many topological descriptors have a strong size component, because large molecules have, on average, more features than small ones. Mathematical techniques such as principle component analysis and multidimensional scaling (see, e.g., Martens and Naes, 1989) can be used to construct low-dimensional, orthogonal parameter spaces from descriptor values and structure similarity matrices.

Having constructed a suitable search space, different mathematical methods can be used to select representative or particularly significant compounds. A very simple approach is to draw a regular grid in parameter space, and pick structures such that they represent nodes of this grid. This is one class of experimental design methods, on which there is a vast literature

(see, e.g., Lorenzen and Anderson, 1993; Weihs *et al.*, 1995). For example, one could choose to differentiate building blocks by three characteristic properties, size, polarity, and hydrophobicity. A 2^3 factorial design (one particular experimental design recipe) would suggest to pick the eight building blocks at the corner of the property cube, one with size, polarity, hydrophobicity as $+++$, one with $++-$, one with $+--$, and so forth. Hellberg *et al.* (1991) have used this method to construct minimum analogue peptide sets, which cover the physicochemical space with a minimum number of compounds. The same approach has been used to construct small, diverse dipeptide libraries (Horwell *et al.*, 1992; Boden *et al.*, 1996).

For designing libraries, factorial designs of building blocks become unmanageable if the number of descriptors exceeds 6 or 7. One way around this problem is to use the so-called *D-optimal design* method, which selects experimental points such that the variance of a polynomial fit to the data is minimized (Mitchell, 1974; Baroni *et al.*, 1993). Other groups prefer to use 'dissimilarity design' methods, in which some function of the pairwise molecular similarities is optimized (Lajiness *et al.*, 1989; Taylor, 1995). An example of this approach is shown in Figure 13.

D-Optimal design methods have been used by Martin *et al.* (1995) as a statistical aid to selecting building blocks for library design. In practice, the theoretical selection is refined and modified by chemical criteria, such as synthetic feasibility or bias towards particular pharmacophoric motifs. While this is the proper way to use theoretical design, the contributions that theory and chemists' knowledge made to designing successful libraries become difficult to disentangle.

Another class of selection methods tries to sort similar objects into groups, and select one representative object from each group. These *clustering methods* (Barnard and Downs, 1992) require a measure of the distance between the objects. In chemical applications, fingerprint dissimilarity is a popular distance measure. The direct application of clustering methods to library design is computationally not feasible, because the search space is too large. Clustering sets of building blocks, which contain a few thousand structures at most, is a more reasonable proposition, and is implemented in the commercial Selector software (Tripos, 1995). An instructive application of clustering methods to compound selection has been described by Shemetulskis *et al.* (1995). Moreau (1995) has used a clustering method based on autocorrelation vectors to select diverse sets of building blocks for library synthesis.

Experimental design, dissimilarity, and clustering methods can be applied to any combination of structural or physicochemical data, and will select a subset of structures which are different according to these descriptors. This is illustrated in Figure 14. Whether the descriptors are meaningful should always be checked, as we have pointed out in section 4.1.7.3.

Even if it can be shown that the chosen descriptors are related to biology,

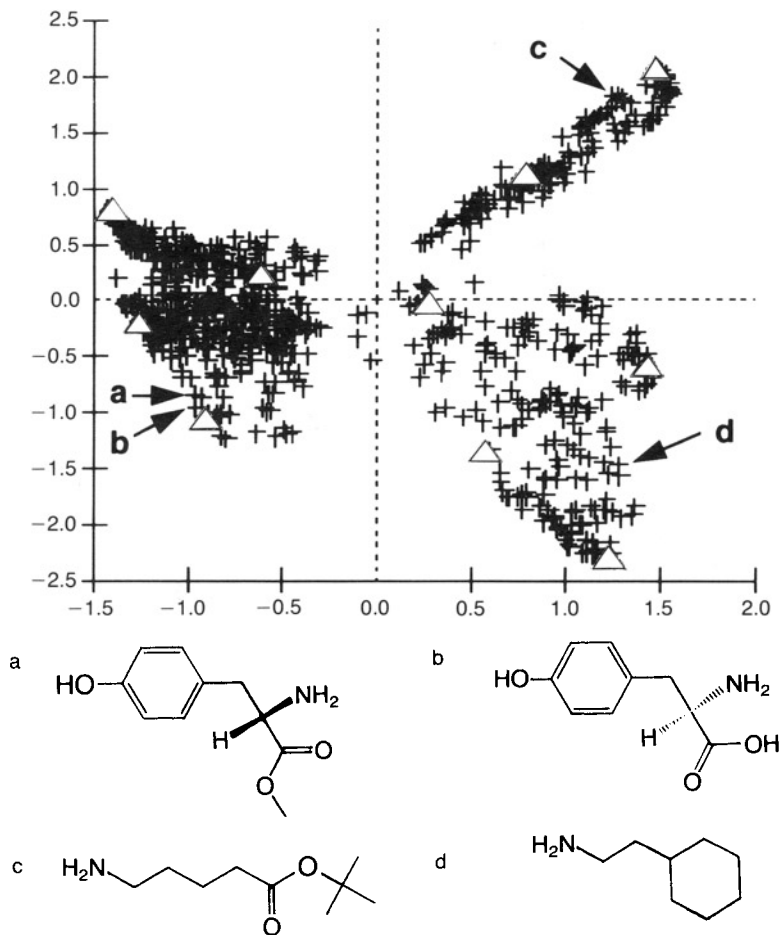

FIG. 13. Algorithmic selection of structurally dissimilar building blocks. The total building block set is derived from 1000 commercially available primary amines (crosses). The design space has two dimensions from multidimensional scaling of the two-dimensional fingerprint Tanimoto matrix. The distance of points in this space is related to the structural similarity of building blocks, compare for example the corresponding reagents (a) and (b) versus (c). The algorithm selected 10 building blocks (open triangles), which have maximum distance (dissimilarity).

it is not clear whether optimizing building block sets or libraries by dissimilarity design or clustering will increase or decrease the hit rate, compared with random selection. In compound selection simulation experiments, conflicting results were obtained (Lajiness, 1991; Taylor, 1995). For actual screening programmes, Carhart *et al.* (1985) and Moreau (1995) have

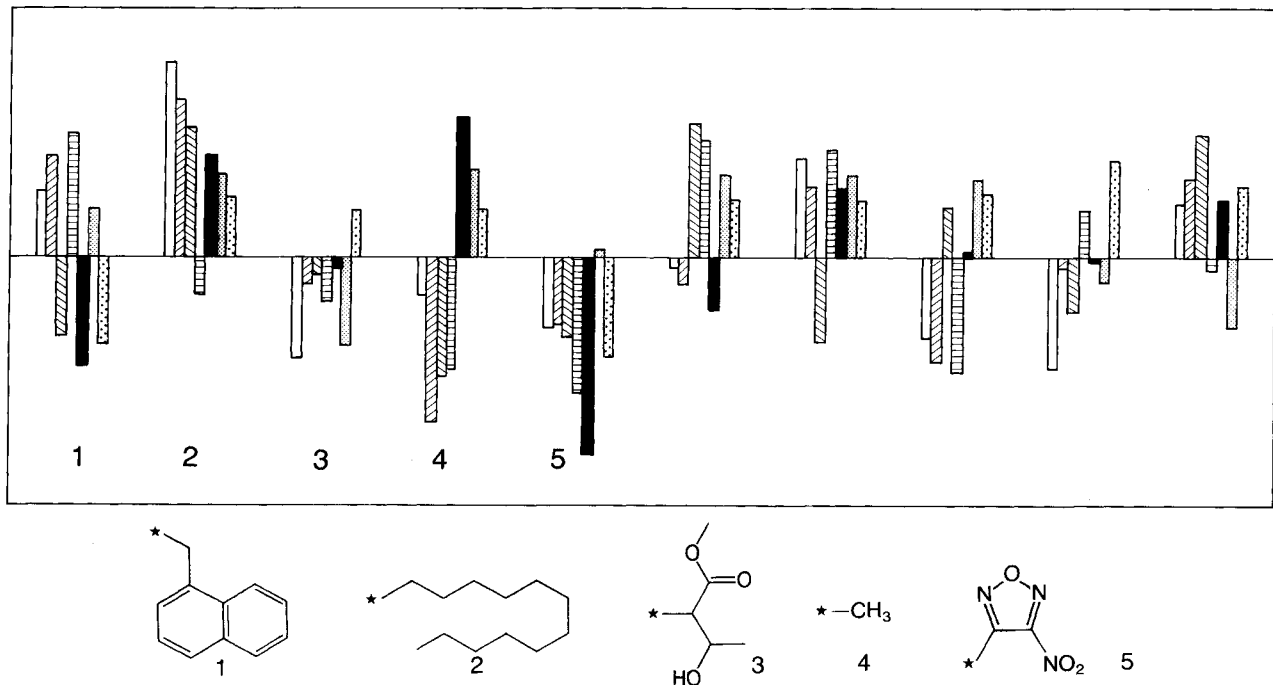

FIG. 14. Diverse building blocks and their properties, selected from a set of 600 commercially available primary amines of molecular weight <200. Dissimilarity design was applied in a 5-dimensional PCA space measuring physical descriptors (lipophilicity, size, flexibility, electron donor property, electron acceptor property), plus two substructure similarity dimensions from multidimensional scaling of the 2D fingerprint Tanimoto matrix. The bar chart shows, from left, the five descriptor values in the above order (centered at zero and scaled to unit variance) and the coordinates in the 2-dimensional MDS space, for 10 algorithmically selected building blocks. The first five building blocks are displayed with the attachment point marked by*. Note that each selected building block has a distinct property pattern. For example, (2) stands out by its lipophilicity, (4) by its size, and (5) by its electron acceptor strength (LUMO).

reported an increased hit rate for compound sets which were computationally constructed to be diverse, compared with sets from random selection.

4.1.7.5 Using Genetic Algorithms to Design Libraries. Library design by optimizing sets of building blocks can be criticized, because it neglects relations between side-chains. It would be preferable to optimize combinatorial libraries directly. The major problem that arises here is that the library search space is large, discontinuous, and cannot be represented by a simple target function. Genetic algorithms (for a review, see e.g., Hibbert, 1993) are stochastic search methods based on the Darwinian model of natural selection and evolution, which are known to perform well on such difficult problems.

The basic genetic algorithm is very simple, and particularly easy to understand when applied to biopolymers. Unlike other optimization methods, genetic algorithms work with a population of solutions, rather than with a single solution. Thus, an initial population of molecules is chosen, e.g. a random set of 100 peptides. Molecules are changed by 'mutation' (by randomly exchanging one amino acid building block), or by 'cross-over' (cutting two sequences at a random position, and combining the left-right and right-left parts), or other systematic operations. A 'fitness' score is computed for the new molecules, and the fittest children are allowed to replace the weakest parents. There are different flavours of genetic algorithms, which differ in the way this Darwinian selection is performed. A wide variety of scoring functions can be used; for example, one could compare each individual with a reference sequence, or match it onto a target three-dimensional structure. Genetic algorithms are robust, can cope with noisy data, and produce a family of solutions. This is important in the context of chemical libraries because screening data is usually imprecise, and single peak solutions are often not desirable. Genetic algorithms should therefore be a good match for optimization problems arising in library design.

Sheridan and Kearsley (1995) have used a genetic algorithm to optimize combinatorial libraries. The problem they tried to solve is how to assemble molecules from a large set of building blocks, such that they are similar to a target molecule. A combinatorial set of simple tripeptoids was used as a test case. The search space contains about 10^{10} compounds. The 'fitness' was measured by structural (fingerprint) similarity to one or two reference structures, and (in a different experiment) by the match to a QSAR-type model for ACE activity. After about 20 iterations, and after examining only a few thousand candidate molecules, the algorithm produced structures which were very similar or identical to the target structures, or the reference structures from which the QSAR model was derived. It was also observed that both the nature and the quality of resulting structures are sensitive to

the random starting point, and also to the Darwinian selection protocol. This is a well-known and general drawback of genetic algorithms.

4.1.8 Evolutionary Synthesis

The design concepts outlined above all suffer from the fact that they assume a mathematical relation between some structural properties and the biological effect. The final design clearly will not be any better than this theoretical model. A more satisfactory approach would be to use measured activity data for a library directly to propose the next generation of synthesis, under the constraints of synthesis protocols and available starting materials. Ideally, these suggestions would be fed directly into an automatic synthesizer, which would then pass the synthesized samples onto a screening station.

Some initial steps towards this goal have been taken. Weber *et al.* (1995) described the use of genetic algorithms to iteratively refine a small array of thrombin inhibitors which are prepared by a four-component Ugi reaction. The four sets of reagents were selected from commercial sources to have diverse properties, and define a search space of 160 000 compounds. One reagent set was biased towards serine protease binding. Each reaction product was encoded by a 'genome' string which identifies the four reagents. Other parameters such as reaction conditions could be included if desired. It is important to note that the reagent identifiers do not contain any QSAR-type model information such as structural similarity, physicochemical properties, or expected receptor binding contribution. The measured inhibitor activity was used as a fitness function. In effect, the algorithm pushes a search window of 20 compounds through chemical space, guided by assay data at each window position. After 16 rounds of parallel syntheses of 20 compounds each, i.e. after probing only 0.2% of the search space, submicromolar leads were found. Similar work for hexapeptides as protease substrates has been described by Singh *et al.* (1995).

Genetic algorithms work for library optimization because they enrich the population with molecules which were made from 'successful' building blocks. The underlying assumption in the work of Weber and Singh is only that the nature of building blocks is *in some way* related to biological effects. This is a much safer and robust assumption than the theoretical models used traditionally in rational drug design. One can argue that evolutionary synthesis is scientifically unsatisfactory, and amounts to nothing more than automating the past empirical methods of medicinal chemistry. Nevertheless, if this approach can be made to work in the general case, it will relieve the chemist from much repetitive work. Evolutionary methods could find widespread application in the combinatorial library field, once the use of automatic synthesizers becomes routine, and the technical gaps between high-throughput organic synthesis and high-throughput screening have been closed.

4.2 CHEMICAL LIBRARIES

Lead finding in the pharmaceutical industry must take into account the downstream effort of lead identification and drug development. It should aim for new chemical entities within classes of molecules that are not *per se* afflicted with properties that are generally linked with obvious complications with respect to stability, bioavailability, toxicity, formulation, economy of manufacturing a.o. The experience gathered over decades of drug development has already provided a wealth of information on success factors that have to be met in addition to potent intrinsic activity, and which are, to a large extent, outside the reach of verification in a primary high throughput screen. Low molecular weight is clearly one of those factors. Although relatively large peptides or proteins can make-up very successful drugs (say insulin or erythropoietin), the likelihood of developing an economically viable product from molecules larger than 1000 Da decreases abruptly. For this reason the call for small-molecule libraries is a logic consequence that indicates the ambition of the industry to use combinatorial libraries for scopes beyond the development of powerful tools. For the latter, most of the restrictions that apply to drug candidates are irrelevant. As a matter of fact, expression libraries of large biooligomers are excellent means to identify potent and selective compounds that have utility as research or diagnostic tools.

The distinction between what should be classified as a tool and a lead for drug development is itself sometimes difficult to make. The boundaries between short oligomers (say trimers) and small-molecules is also quite blurred. By chemical synthesis of non-expressible oligomers, using artificial building blocks rather than e.g., naturally coded L-amino acids, it is possible to eliminate some serious drawbacks of the less attractive biooligomers. Resistance towards rapid metabolic inactivation can be enhanced likewise by introducing linkages other than peptide amide or nucleotide phosphodiester bonds. With a set of monomers that can be expanded to numbers of 100 or more different units, it is clear that highest levels of molecular diversity can be obtained with very short oligomers (see Figure 3). With the two linkages it takes to make-up trimeric structures it becomes difficult to argue about fundamental differences between 'oligomeric structures' and 'decorated scaffolds', since the backbone character that may have prominent influence on the overall behaviour of longer oligomers, loses much of its significance in this case. The fact that a combinatorial library of synthetic dimer and trimer *N*-(substituted) glycine peptoids has led to the identification of high-affinity ligands for 7-transmembrane G-protein-coupled receptors (Zuckermann *et al.*, 1994) exemplifies the good prospects of utilizing libraries from minimal linear extensions of building blocks.

4.2.1 Oligomer Libraries

As mentioned in the introduction, the origin of combinatorial chemistry resides in oligonucleotide and peptide chemistry and since then general organic chemistry has moved into the field with increasing consistency. Libraries of non-polymeric organic molecules have become more common (see section 4.2.2), but also non-natural polymers and oligomers have raised considerable interest.

The advances of molecular biology and immunology in the course of the last decade have led to a rise in demand for synthetic peptides and their use for epitope mapping. The experiments of Geysen *et al.* (1986) stressed the concept that short peptides (mimotopes), bearing critical binding residues, can mimic the folded antigenic determinants of proteins (continuous or discontinuous epitopes). The work also demonstrated that screening without removal of the peptides from the solid support was possible, and the *multi-pin method* was developed (see also Bray *et al.*, 1990).

Other approaches have since then increased the diversity of procedures to generate preorganized peptide sets for biological screening. The *teabag method* (Houghten, 1985) keeps solid phase resin portions confined in small bags, which are permeable to solvents and reagents only, therefore allowing exposure of various bead portions to the same reagent in a common vessel, but preventing cross-contamination of beads between portions. Teabags are, in principle, functional equivalents to very large beads, with the same aptitude to undergo *split synthesis*. The latter is a conceptual breakthrough for systematic multiple syntheses (Furka *et al.*, 1988a) (see Figure 2) and is based on a *portioning-mixing* strategy. In a follow-up paper, Sebestyen *et al.* (1995) outlined the specific implications of the approach on the efficiency of multiple peptide synthesis (for an early review of lasting significance see Jung and Beck-Sickinger, 1992).

The fact that biologically relevant receptor systems respond to the activity of a peptide in the presence of a large number of other (inactive) sequences has been exploited with the utilization of peptide libraries in systematic deconvolution procedures from mixtures, as in sequential unrandomization (Houghten *et al.*, 1991) and positional scanning (Pinilla *et al.*, 1992). Whilst peptides are themselves considered poor drug candidates, the attractiveness of peptide libraries results from the immense potential for biological activity and specific binding interactions that resides in this class of compounds.

Slight modifications of naturally encoded peptides (e.g., the incorporation of D-amino acids) may already have drastic effects on the activity and metabolic stability of peptides. With relatively simple chemical derivatizations or more sophisticated interventions, such as peptide bond mimics, cyclizations, conjugate formations etc., the influence on the physicochemical properties may be such that an acceptable starting point for a lead optimization is reached (Moore, 1994; Fauchère, 1995; Boden *et al.*, 1996).

In the *libraries-of-libraries* approach such steps are taken on the entirety of a library or on subpopulations, rather than on single compounds (Ostresh *et al.*, 1994). Various post-assembly modifications have been investigated, including permethylation and amide bond reduction.

It is therefore attractive to prepare libraries of compounds reminiscent of peptides with regard to the functional group display in space, using an enlarged toolbox of building blocks, linked with proteolytically stable bond types. In many instances the technical advantages in the preparation could be maintained by using repetitive processes of validated chemistry on solid phase, with a large choice of simple synthons.

Some artificial oligomers, which give straightforward access to a large diversity of structures, are outlined in Figure 15. Oligomers of *N*-substituted glycines (Simon *et al.*, 1992), also referred to as *peptoids*, have drawn the attention of the pharmaceutical research community, once examples of proven efficacy (Zuckermann *et al.*, 1994), enzymatic stability (Miller *et al.*, 1994, 1995) ease of preparation (Zuckermann *et al.*, 1992) and versatility of derivatization (Pei and Moos, 1994; Goff and Zuckermann, 1995) were reported. An outstanding improvement of the synthesis protocol enables the introduction of side-chain functionalities by straight use of commercially available amines in a nucleophilic reaction that displaces bromine from bromoacetic acid, which is used as a common submonomer unit for every chain elongation step.

Bio-oligomers other than peptides have made their appearance in the combinatorial chemistry arena.

The term 'aptamers' was created at the beginning of this decade, in the context of nucleic acid libraries that directly produce binding entities, by variation, selection and amplification, without the mediation of an expression host and the translation into peptide sequences.

In 1990, techniques which allow the simultaneous screening of more than 10^{15} individual nucleic acid molecules were developed (Ellington and Szostak, 1990; Tuerk and Gold, 1990).

L. Yan *et al.* (1994) established a sulfoxide glycosylation reaction that can be used to form both α - and β -glycosidic linkages stereospecifically to secondary alcohols on a solid support. More recently, Rademann and Schmidt (1996) have demonstrated a method for oligosaccharide synthesis with potential for combinatorial chemistry.

Synthetic schemes for the solid phase synthesis of other artificial, chain-like oligomers have been worked out so as to include the synthesis of combinatorial libraries in the scope of the method. *Peptide nucleic acids* (PNA) are oligonucleotide analogues with an achiral oligo-(*N*-(2-aminoethylglycine) backbone (for a review see Hyrup and Nielsen, 1996). Richter and Zuckermann (1995) have developed an improved submonomer approach from inexpensive precursors on solid phase, which opens interesting prospects for libraries aimed at DNA or RNA targets. At ISIS

Pharmaceuticals (Carlsbad, CA), techniques were devised for rapid introduction of functionalities into phosphodiester backbones. The monomers are *N*-substituted DMT-hydroxymethyl-pyrrolidinol phosphoramidites, which are compatible with automated oligonucleotide synthesis (Hébert *et al.*, 1994). A class of biopolymer mimetics consisting of α -aza-amino acids linked in a repetitive manner was termed 'azatides' by Han and Janda (1996), with a claim that combinatorial library construction of such polymers may provide global peptidomimetic libraries.

4.2.2 *Small-molecule Libraries*

Recent efforts in combinatorial chemistry are directed towards the design of synthetic schemes that provide sufficient diversity with libraries of 'small molecules' that more closely resemble attractive lead compounds in terms of molecular weight, the tendency to assume preferred conformations and the suitability to derive analogue series from their structure with due efficiency. In many instances one aims for multistep protocols that allow the integration of large collections of building blocks (commercially available reagents), thus bearing the potential to produce a large number of molecules with disparate physicochemical properties.

Such systems are especially valuable because they are appropriate for first-generation hit searches with, say, *split-and-mix* syntheses, as well as for follow-up thematic libraries once a hit needs to be elaborated upon. Chemical pathways of such broad scope are most often worked out and validated on solid phase. The adaptation of known solution chemistry to this medium is not a trivial task. It is, on the contrary, a challenge that requires commensurate resources. High yields and reproducibility are crucially important if the purification of intermediates is to be reduced to simple washing steps. The revenue from the invested time for thorough assessments of scope and limitations of a reaction scheme on solid phase is the invaluable gain in quality consistency in the production phase of libraries, when the progress of reactions in every single vessel, for every single component, cannot be monitored in full detail.

Lately, the chemistry of small-molecule generation for combinatorial libraries has been reviewed comprehensively in a special issue of the *Accounts of Chemical Research* (Valentine and Foote, 1996) and by Thompson and Ellman (1996). In other valuable reports, reactions on solid phase, that may or may not be part of a combinatorial scheme, have been compiled (Früchtel and Jung, 1996; Hermkens *et al.*, 1996).

Here, we provide a schematic overview (Figure 16) which is a summary of principal diversity generation systems on solid phase, meeting the criteria for broad scope of applicability. Solid phase organic chemistry (SPOC) has come of age, now that several years were spent to extend the horizon beyond

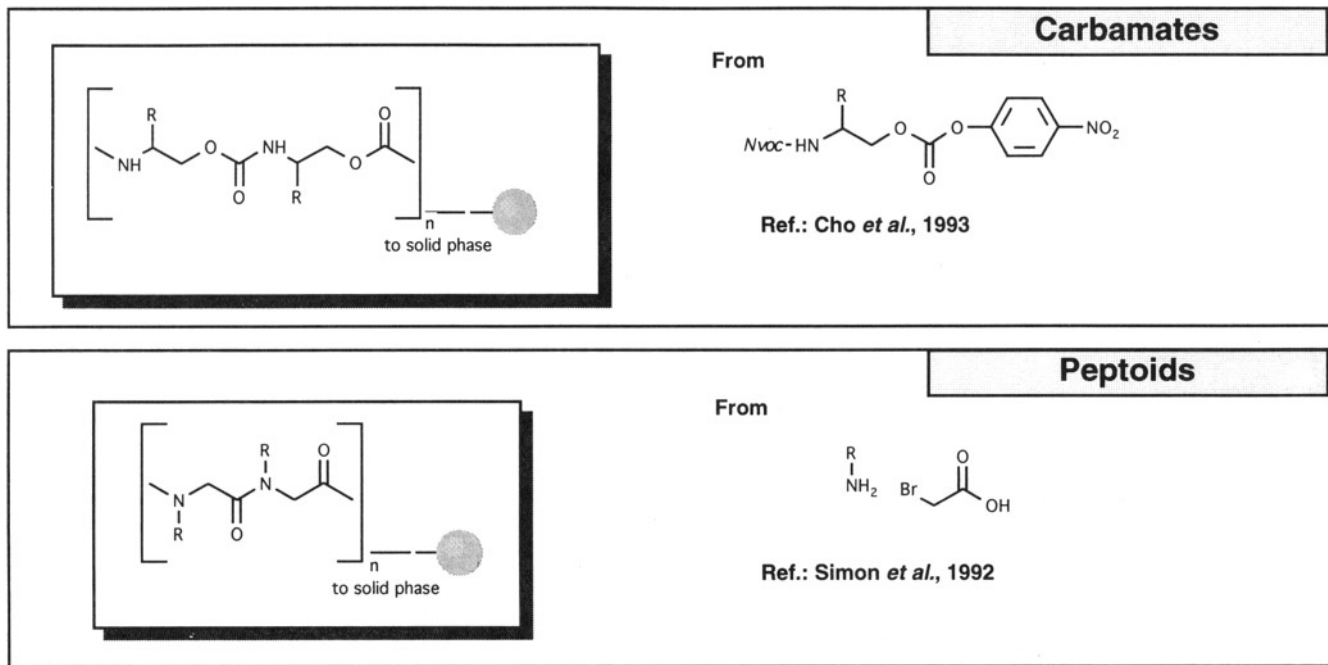
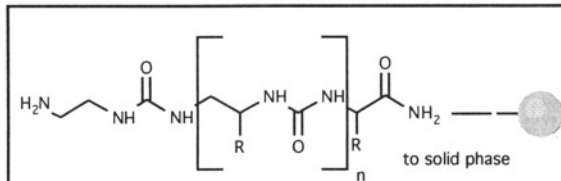
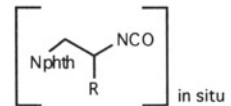

FIG. 15. Examples of non-bio-oligomeric compound classes, suitable for chain-like assembly.

Ureas



From



Ref.: Burgess *et al.*, 1995

see also Hutchins and Chapman, 1995

Azatides

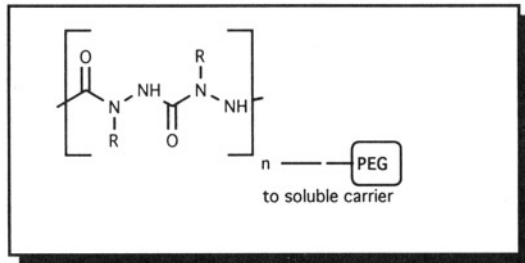

From

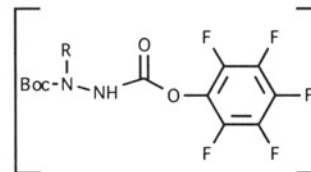

Ref.: Han and Janda, 1996

FIG. 15. Continued.

peptide and oligonucleotide chemistry. The difficulty of designing a sequence of compatible reactions, to refine the experimental conditions and reach near-quantitative yields over multistep procedures, is reflected by the proportionally modest number of mature chemical diversity systems, compared with the abundant number of organic reactions described on solid phase.

The basic repertoire of such reactions is quite remarkable and comprises the following, just to mention some less obvious examples:

- Aldol reactions (Kurth *et al.*, 1994)
- Claisen condensations (Marzinzik and Felder, 1996)
- Reductive alkylations (Gordon and Steele 1995)
- Cycloadditions (Beebe *et al.*, 1992; Pei and Moos, 1994; Murphy *et al.*, 1995; Ruhland *et al.*, 1996)
- Michael additions (Chen *et al.*, 1994; Ley *et al.*, 1995)
- Mitsunobu reactions (Richter and Gadek, 1994; Krchnak *et al.*, 1995; Rano and Chapman, 1995)
- Stille couplings (Forman and Sucholeiki, 1995; Plunkett and Ellman, 1995a) and Sucholeiki
- Suzuki couplings (Frenette and Friesen, 1994)
- Heck reactions (Yu *et al.*, 1994)
- Oxidations (Chen *et al.*, 1994)
- Reductions (Kurth *et al.*, 1994)
- Wittig reactions (Chen *et al.*, 1994; Johnson, 1995)

Experience has shown that organic chemistry on solid phase has its distinct peculiarities, which are 'unexplored territory' for the majority of chemists. The solid support, as such, turns out to be a factor that needs to be considered in the parameters that are adjusted in the course of the elaboration of optimal reaction conditions. Working out the best experimental procedures is in some ways not as straightforward as it may occur in solution syntheses, if we consider the complications for the analytical monitoring, or the restrictions in controlling the exact stoichiometry of the reaction components. On the other hand, multiple parallel synthesis is greatly facilitated on solid phase, which helps to rapidly test a high number of different conditions (Bray *et al.*, 1995). Ample data on the effect of systematic changes can be collected and processed to help identify the optimal protocols. In some instances a large excess of one reagent drives an otherwise sluggish reaction to completion and improves yield and purity of the reaction product. Solid phase synthesis offers the benefit that large excesses can be dealt with much more easily in the work-up by removing the unreacted species with simple filtrations. For certain reaction types (e.g., cycloadditions) some expected side products are also conveniently washed away. Ruhland *et al.* (1996) have taken advantage of this circumstance for the synthesis of diverse β -lactams on solid support.

FIG.

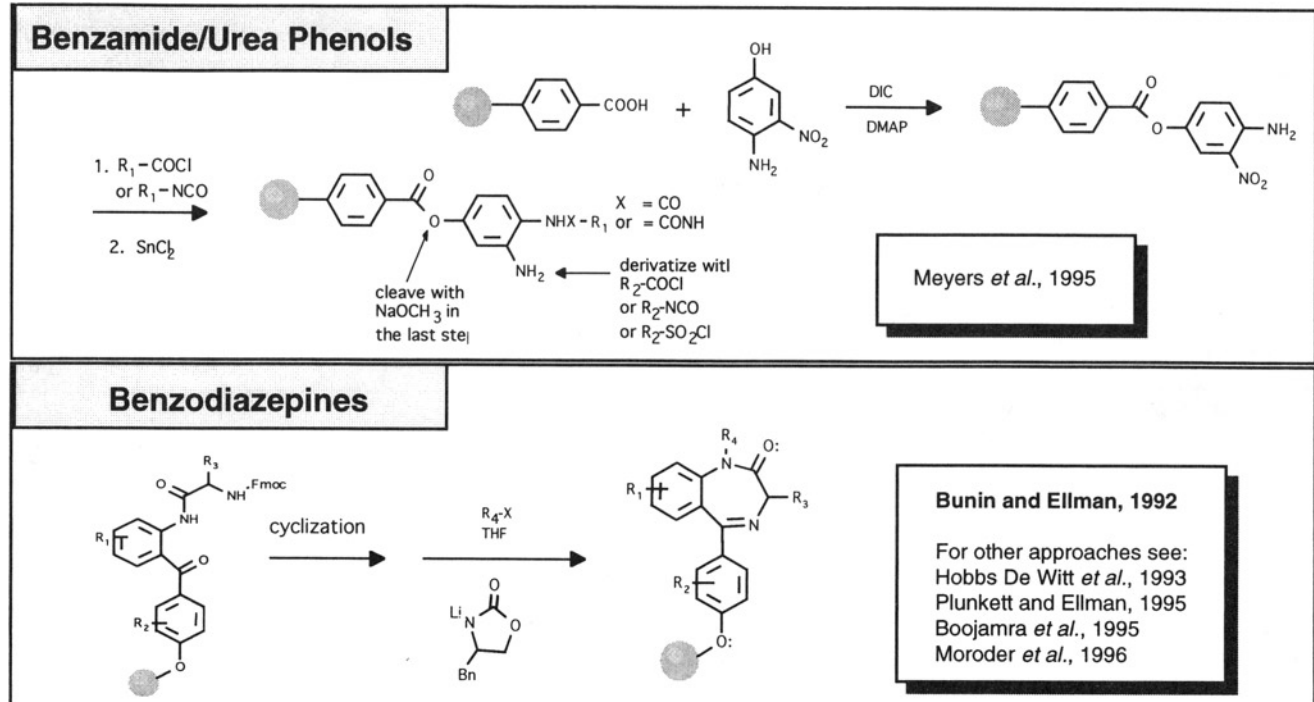

base.

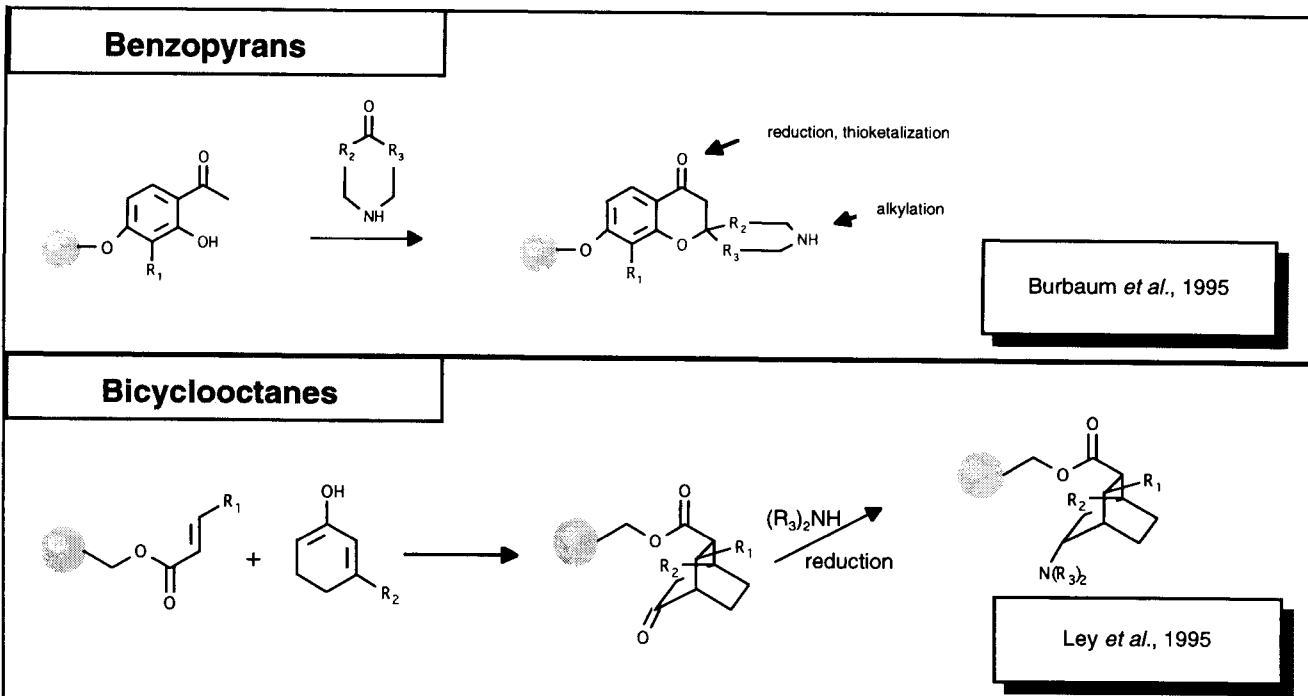
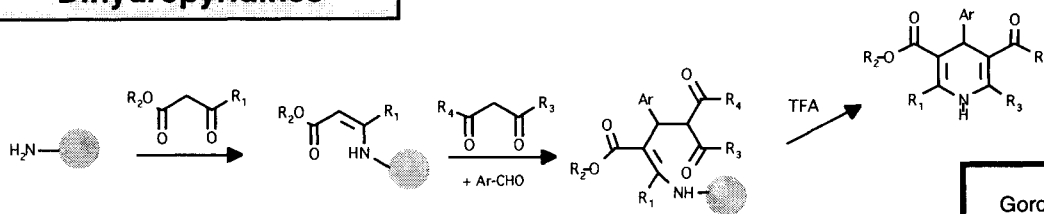

FIG. 16. Continued.

Dihydropyridines



Gordeev *et al.*, 1996

Hydantoins

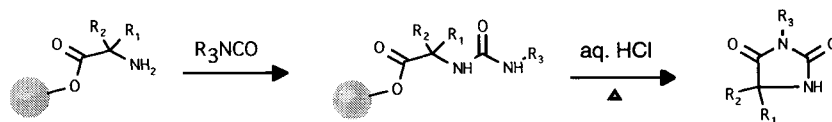

Hobbs De Witt *et al.*, 1993

For other approaches see:
Dressman *et al.*, 1996

β-Lactams

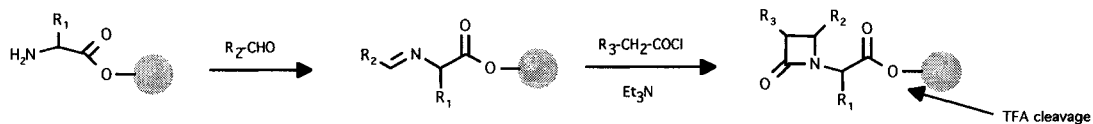

Ruhland *et al.*, 1996

FIG. 16. Continued.

Piperazinediones

Gordon and Steele, 1995

For other approaches see:
Safar *et al.*, 1995

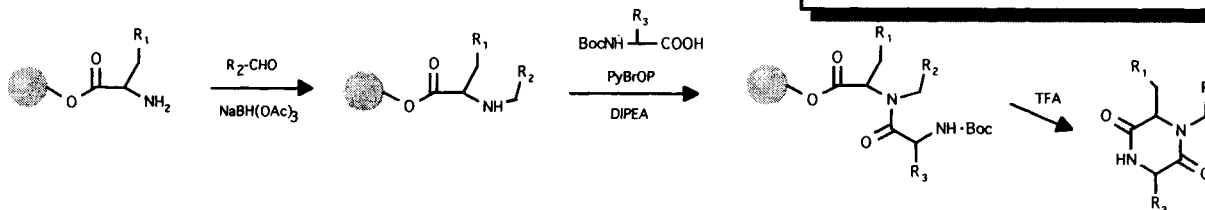

Pyrazoles and Isoxazoles

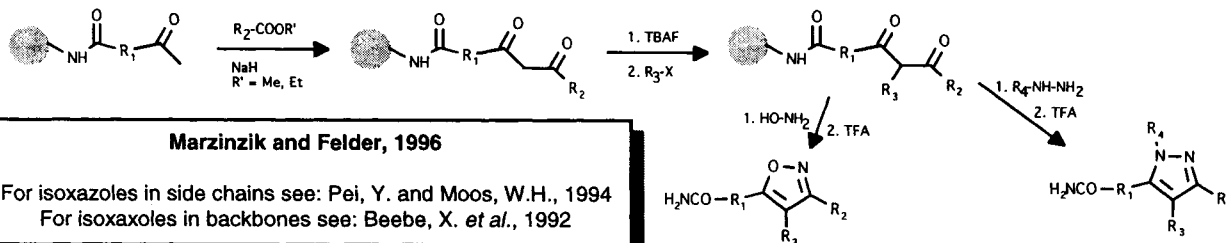

Marzinzik and Felder, 1996

For isoxazoles in side chains see: Pei, Y. and Moos, W.H., 1994
For isoxazoles in backbones see: Beebe, X. *et al.*, 1992

FIG. 16. Continued.

Pyrrolidines

Murphy *et al.*, 1995

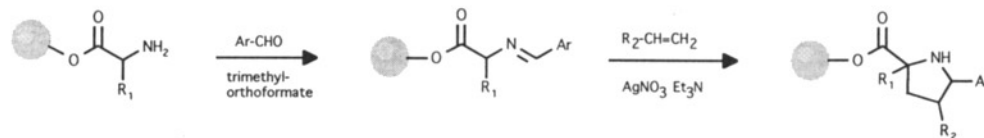

Thiazolidines

Patek *et al.*, 1995

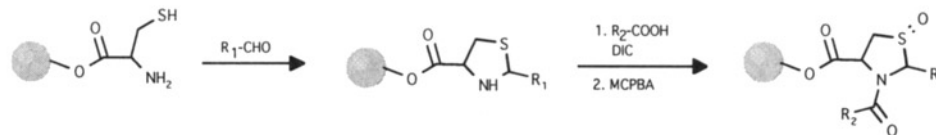

FIG. 16. Continued.

An alternative to the solid phase methods is combinatorial chemistry in solution which, although pursued by a minority of research groups, has some distinct advantages that are appealing in certain cases, despite the well-known complications during reaction work-up. Above all, there is a greater flexibility to use the full spectrum of reagents and reaction protocols described in the literature. The intricacy of choosing the suitably compatible linker for stable attachment in the course of the synthesis and clean detachment of the compounds from the carrier is avoided completely. The same applies to the specialized reaction-monitoring techniques. Boger *et al.* (1996) have pointed out that if the ease of sample isolation attributed to solid phase synthesis could be approximated in a solution strategy, combinatorial solution chemistry would become a very attractive option. The principle they proposed is based on known liquid/liquid extraction schemes that separate reagents from intermediates and products by virtue of charge differences that direct the compounds in either the organic or aqueous phase. The modest size of the example library with 27 members gives little indication on the general validity of the approach.

Another combinatorial mode of solution chemistry worthwhile pursuing involves multicomponent condensations (MCC), where three or more reactants combine in one step, and fragments of each are incorporated into the product molecule (with no need for bifunctional building blocks). These types of reactions have been reviewed by Ugi *et al.* (1994) and Armstrong *et al.* (1996); both groups have initiated the application of such chemistry in combinatorial synthesis, and both have also demonstrated the suitability of solution synthesis formats (Goebel and Ugi, 1995; Keating and Armstrong, 1996). Armstrong's work includes an interesting concept of trapping the products, arising in one step from Ugi four-component condensations, onto a solid resin, thereby facilitating the post-synthesis work-up. Some advantages of both formats, solid and liquid phase synthesis, are therefore united in one approach.

One fundamental drawback of multicomponent reactions remains the impossibility to follow the *split synthesis* concept and obtain large *one-bead-one-compound* libraries. So far, combinatorial chemistry with MCC has centred on the Ugi (Keating and Armstrong, 1996; Mjalli *et al.*, 1996; Strocker *et al.*, 1996; Tempest *et al.*, 1996; Zhang *et al.*, 1996), Passerini (Armstrong *et al.*, 1996), Biginelli (Wipf and Cunningham, 1995) and Pauson Khand (Bolton, 1996) reactions. The majority of syntheses were carried out on solid phase. Recently, a three-component 1,3-dipolar cycloaddition was used for the preparation of highly substituted pyrrolidines from hydroxybenzaldehydes attached to Wang's resin (via Mitsunobu coupling) followed by a one-pot reaction with an α -aminoester and a maleimide (Hamper *et al.*, 1996). In an interesting study, Holmes *et al.* (1995) investigated the stepwise and one-pot three-component condensations of amino acids, aldehydes and mercapto carboxylic acids to assemble 4-thiazolidinones and

4-metathiazanones, both in solution and on solid support. Incidentally, they found evidence that their intermediate aromatic imines are stable enough to survive washings and resin portioning, if a *split synthesis* is envisaged.

All in all, the preference for combinatorial chemistry on the solid phase is very pronounced. The restrictions that come with this format are subjected to intense amelioration studies. The choice of linkers, and of functionalities they leave behind on the library components upon cleavage, should be widened. In rare instances it is already possible to turn to 'traceless linkers', which do not leave footmarks (in the form of extra moieties) on the molecules to be tested (Plunkett and Ellman, 1995a; see Figure 1). The analytical procedures to monitor reactions are also improving steadily, as discussed in section 4.3. The *split synthesis* approach on solid phase provides large numbers of physically separate compounds, provided that they remain grafted on the beads or are distributed in separate compartments before cleavage. The vision that the amount of test material carried by a single bead suffices for identification and profiling in a primary assay may soon become reality. This is already the case for certain compound classes (e.g., oligonucleotides, peptides).

4.2.3 Tagging, Encoded Libraries

Encoding the synthesis steps with molecular tags (see section 3.2, Figure 4) is currently a valid concept that is mainly utilized for the indirect identification of small molecules, for which sensitive analytics is not generally available. The tags first employed were oligonucleotides (Needels *et al.*, 1993; Nielsen *et al.*, 1993) and peptides (Kerr *et al.*, 1993; Nikolaiev *et al.*, 1993). Oligonucleotides are unable to withstand the harsh reaction conditions that may be necessary for the synthesis of a large spectrum of compound classes. Peptide tags, instead, are more broadly applicable, but because of the larger quantities needed for their detection, methods that keep ligands separate from the tags during the screening process were devised in order to exclude artefacts (Lebl *et al.*, 1993; Felder *et al.*, 1995).

Still and colleagues have worked out a useful approach in which sets of distinct halocarbon derivatives are appended to the solid phase resin via acylcarbene insertion according to a binary coding strategy (Nestler *et al.*, 1994; Ohlmeyer *et al.*, 1993). These tags are liberated oxidatively by ceric ammonium nitrate, and silylated for the analysis by electron-capture gas chromatography.

Another binary tagging method incorporates cocktails of secondary amine tags on a differentially functionalized polymer support (Ni *et al.*, 1996). They are released from selected beads upon exposure to acid hydrolysis. By straight conversion to fluorescent dansyl sulfonamides, sensitive high-performance liquid chromatography (HPLC) analysis is used for decoding.

In a newly developed version, a semiconductor memory unit is safely embedded in porous microreactors containing solid phase beads (Nicolaou *et al.*, 1995). Radiofrequency tags can be applied and later decoded by sending and receiving pulsed radiosignals (100–400 kHz) that bear coded information for each synthesis step. For its implementation this method requires access to sophisticated technology. All issues of chemical compatibility between tags and library components, or the interference of tags with certain assays, are therefore circumvented. A similar method was developed by Moran *et al.* (1995), proposing a simplified alternative, which makes use of glass-encased microchips, each with a unique binary code ID, which can be scanned and recorded using radiofrequency. By tracking the fate of each unit, downloading of digital information onto the chips with a WRITE function becomes unnecessary during synthesis.

Ultimately, once microanalytical technologies develop greater sensitivity and throughput, it may well be that encoding strategies will lose significance very rapidly.

4.3 QUALITY ASSESSMENT OF LIBRARIES

The burgeoning synthetic activities in combinatorial chemistry pose the question on how best to characterize the quality of library material and the validity of a preparation process. Although full characterization of each component of a library by the ordinary routines of single compound analytics is feasible only for small arrays, for every library type a quality assessment method should be available. As already mentioned, the present-day technological limitations force us to accept compromises in the way we deal with the large number of new chemical entities that arise, unless we renounce the attainment, to the full potential, of combinatorial technologies. Before miniaturization of methods is improved, and before throughput of handling materials and of processing data enable us to analyse and screen massive numbers of microeluates from single beads, the necessity sometimes to characterize complex mixtures of several dozens or up to thousands of components remains, as long as mixtures are part of the screening strategy (e.g. out of the *split-and-mix* process, when cleaving material from a bead pool or sublibrary). Even with a lower throughput capacity, highly sensitive analytics are valuable, if sampling representative specimens from a bead population is taken as a measure to monitor the quality of a *split synthesis* (*one-bead-one-compound*).

The more a reaction sequence used to generate the library has been thoroughly validated previous to the actual 'production phase', the more a sampling approach is acceptable for deducing information on the overall library quality. In any case, if the quality control of individual compounds must be neglected, the overall assessment of a library's quality as an

ensemble of components should meet rigorous standards in the interest of reproducibility of results. Analytical measurements on an entire mixture may (at the very least) provide fingerprints for comparison upon resynthesis. Also, in the library assembly phase there are opportunities for analytical supervision, e.g. by monitoring the disappearance of functional groups, to indicate complete conversion of starting materials (Chu and Reich, 1995).

Noticeable progress of microanalytical technologies suitable for combinatorial chemistry has been made. Electrospray mass spectrometry was recognized early on as one of the most valuable techniques to assess mass distribution in large mixtures (Metzger *et al.*, 1994), and to determine precise masses of discretely or components from small pools. This method, as well as other MS techniques, are sensitive enough to measure material from a single bead (Brummel *et al.*, 1996). In conjunction with other analytical tools, especially separation methods (liquid chromatography (LC)–MS) or fragmentation analyses (MS–MS), mass spectrometry is best suited to characterize compound pools. MS data processing and interpretation is more straightforward than for NMR and IR. With a choice of LC, LC–MS and flow injection MS, the basic needs for high throughput analysis can be coped with in most cases (see also Gordon and Steele, 1995; Stevenson *et al.*, 1995).

To monitor the progress of reactions on solid phase in a non-destructive way, without cumbersome cleavage of material from the support, analyses by NMR and IR have been adapted to the specifications of combinatorial chemistry. Because of the modest throughput, which is also limited by the time it takes to interpret the results, these methods are best used in the validation phase of a synthetic scheme or in a statistical sampling mode. Narrow line width ^1H -NMR spectra can be obtained on resin-bound samples by combining magic-angle spinning and high-resolution probe technology (Fitch *et al.*, 1994). To enable a sufficiently high tumbling rate on the solid phase, the use of polyethylene glycol (PEG) grafted polystyrene providing long spacer chains between the matrix and the analyte, seems necessary. With ^{13}C -labelled moieties the sensitivity reaches the level of single bead detection (Sarkar *et al.*, 1996).

FT-IR microspectroscopy equally allows data collection from a single resin bead (Yang *et al.*, 1995). Also, IR spectroscopy directly on polypropylene pins, as used in the *multi-pin* method of parallel synthesis, was described by Gremlich and Berets (1996). With the prospects for further progress in mind encoded synthetic libraries may become obsolete in the future if a competitive microanalytical throughput can be reached.

4.4 TECHNICAL SUPPORT, AUTOMATION

It is obviously useless to produce millions of compounds without the capacity to deal with the logistics and perform their evaluation within a similar time

frame. The success of combinatorial libraries operations depends upon their embedding in an environment that promotes the multidisciplinary character of the field and discerns the synergies that can be drawn from combinatorial technologies. We have emphasized the role of planning logistics and overall data processing in section 4.1. The importance of high performance analytical capacity was mentioned in the discussion on quality assessment (section 4.3) but it applies also to the development and implementation of innovative assay technologies. The development of new primary screens is a task of general significance in drug discovery but it needs to give more consideration to the strategic peculiarities that combinatorial libraries bring about, e.g., testing of complex mixtures, testing of minute quantities, rapid feed-back of results and coordination with synthesis units in the course of a stepwise deconvolution, testing on (or from) individual beads, etc. The benefits of such efforts are also evident when using compound sources other than combinatorial libraries.

4.4.1 *Synthesis Equipment*

The advent of the *split-and-mix* concept and the increasing demand for small-molecule libraries have both contributed to create a considerable challenge for the manufacturers of automated synthesizers. The commercial availability of instruments with the capacity to interface with the logistics software, process large numbers of reactions in parallel, accommodate to inert gas atmosphere and elevated temperature conditions, and perform the *split-and-mix* operation, is lagging years behind the users' needs. The situation is complicated by the difficulty of estimating the size of the market for a very complex instrument that offers all the basic operations that arise in combinatorial chemistry. The latter is meant to gain a foothold in the majority of medicinal chemistry labs, but complexity, size and costs are factors that easily get out of hand with equipment that covers the full spectrum of operations. Initially, the commercial providers have developed smaller units that are in some way more or less restricted to perform frequently used tasks, but cannot cope with the scenarios of full-blown combinatorial chemistry. Typical examples are stand-alone array synthesizers for parallel syntheses or robotic dispensers for portioning and mixing in open vessel arrangements. Severe restrictions on cooling, heating and inert atmosphere conditions are not uncommon.

An attractive 'high end' system should be compatible with 'lower end', bench-top modules, which could be spread-out to the chemists' laboratories, e.g., small parallel synthesizers useful to work out reaction sequences and their scope and limitations. The procedures could then be transferred to a larger library production instrument situated in a core facility. Common interfaces to an overall data management system should be established.

A general consensus on the technical specifications of a successful instrument is yet to be established. The difficulties reside in the slightly different requirements put forward by the various users, and in the general request for pronounced flexibility of the system in terms of reprogramming the machine for other tasks, under new conditions.

4.4.2 Screening Operations

The importance of setting up a good balance between combinatorial chemistry and complementary resources has been mentioned. On the screening side, at least one high throughput system per project is needed, together with an appropriate system for deeper characterization of hits.

Assays with read-outs that are not directly traceable to known molecular mechanisms are problematic and should then be backed-up with a test system that discriminates between modes of action. The quest for extreme miniaturization is understandable, not only because difficult target proteins may be available in minute quantities early on in a new project, but also in view of the opportunities to test material from single beads of *one-bead-one-compound* libraries with functional assays or binding assays in solution, in the absence of the solid synthesis carrier.

The call for enhanced screening efficiency leads to simplified assay protocols with regard to the operational execution, but which are more demanding on the development and validation side.

Radioisotope assays are still very common, but colorimetric, luminescent and fluorescent labels are catching up. Numerous fluorescent assay technologies are being developed to enable rapid screen design for most cellular events. The luciferase reporter gene is gaining significance in HTS laboratories. Signal emission half-life in the luciferase assay has increased from a flash to a glow lasting for hours.

Moreover, a range of homogeneous assay technologies have emerged from more laborious traditional techniques. Scintillation proximity assays have progressed from conventional ligand-receptor binding assays. Fluorescence polarization is a method capable of measuring ligand-receptor interactions in a homogeneous solution without separation steps, due to the distinctly higher polarization mediated by the acceptor-ligand complex, compared with the free ligand. In fluorescence correlation spectroscopy, with confocal optics and detection the principle can be miniaturized to accommodate sub-microlitre sample volumes (Eigen and Rigler, 1994; Rigler, 1995).

The circumstances for exploiting the full capacity of the new prolific compound sources are favourable owing to the increasing number of targets with therapeutic potential, identified through our understanding of the molecular mechanisms of diseases and the data gathered from genomics (Murray *et al.*, 1994; Rubin and Barsh, 1996; Guidi and Fox, 1996).

TABLE 1
Examples of target applications

Target or target activity	Compound class of hit	Reference
α_1 -Adrenergic receptor	Tripeptoids	Zuckermann <i>et al.</i> (1994)
α -MSH antagonists	Hexapeptides	Jayawickreme <i>et al.</i> (1994)
μ -Opioid and kappa 3 receptor	Acetylated hexapeptides (<i>acetalins</i>)	Dooley <i>et al.</i> (1993)
μ -Opioid receptor	Tripeptoids	Zuckermann <i>et al.</i> (1994)
^{99}Tc binding peptides	Hexapeptides	Malin <i>et al.</i> (1995)
Antimicrobial activity	Conformationally defined peptides	Blondelle <i>et al.</i> (1996a)
Carbonic anhydrase	Benzopyrans and sulfamoylbenzamides	Burbaum <i>et al.</i> (1995)
Central analgesic activity	All D-amino acid peptide	Dooley <i>et al.</i> (1994)
Chymotrypsin inhibitors	Cyclic peptide derivatives	Eichler <i>et al.</i> (1994)
Cyclin-dependent kinase 2	Peptides expressed on <i>Escherichia coli</i>	Colas <i>et al.</i> (1996)
Cyclo-oxygenase-1 inhibitors	4-Thiazolidinones	Look <i>et al.</i> (1996)
Elastase inhibitors	Aminimides	Peisach <i>et al.</i> (1995)
Endothelin antagonists	Hexapeptides with non-natural amino acids	Neustadt <i>et al.</i> (1995)
Endothelin antagonists	Tetrapeptides including non-natural amino acids	Terrett <i>et al.</i> (1995a)
Factor Xa inhibitors	Small molecules (not disclosed)	Al-Obeidi <i>et al.</i> (1995)
Heart chymase inhibitors	Peptide derivatives	Bastos <i>et al.</i> (1995)
HIV envelope-mediated cell fusion inhibitors	Oligonucleotides	Wyatt <i>et al.</i> (1994)
HIV integrase	Hexapeptides	Puras-Lutzke <i>et al.</i> (1995)
HIV protease inhibitors	Small molecules	Wang <i>et al.</i> (1995)
HIV RNA binders	Peptides	Harada <i>et al.</i> (1996)
HIV Tat/TAR inhibitors	Peptoids	Hamy <i>et al.</i> (1997)
L-Selectin antagonists	Oligonucleotides	O'Connell <i>et al.</i> (1996)
Melittin inhibitors	Hexapeptides	Blondelle <i>et al.</i> (1996)
Organ targeting <i>in vivo</i>	Phage display	Pasqualini and Ruoslahti (1996)
Phosphatidylinositol 3-kinase SH3 domain	Nonapeptides	Chen <i>et al.</i> (1993)
Phospholipase A ₂ and leukotriene B ₄ inhibitors	Pentameric non-natural phosphodiester	Davis <i>et al.</i> (1995)
Src SH3 domain	Pentapeptides with non-natural chain elongation	Combs <i>et al.</i> (1996)

TABLE 1 Continued

Target or target activity	Compound class of hit	Reference
Src SH3 domain	Phage display	Sparks <i>et al.</i> (1994)
Tachykinin NK3 receptor selective antagonists	Dipeptide derivatives	Boden <i>et al.</i> (1996)
Thrombin inhibitors	Oligonucleotides	Bock <i>et al.</i> (1992)
Trypsin inhibitors	Hexapeptides	Eichler and Houghten (1993)
Tyrosine phosphatase PTB1B inhibitors	Tripeptide substituted cinnamic acid derivatives	Moran <i>et al.</i> (1995)
Urokinase receptor antagonists	Phage display	Goodson <i>et al.</i> (1994)

4.5 TARGET APPLICATIONS

Obviously, the best way to substantiate the potential of a new technology would be the compilation and interpretation of success stories and, sure enough, failures in the course of 'real life' applications. Understandably, failures are rarely documented in detail in the published literature. In the case of combinatorial technologies it is quite clear that information on positive achievements, on the application side, are held back at least until a patent publication is released. At this point in time, it is safe to assume that the most meaningful successes in the lead-finding area occur in the private pharmaceutical industry and that the structure information of the most interesting compounds is not publicly available. Al-Obeidi *et al.* (1995) have communicated the discovery and optimization of active site inhibitors of Factor Xa, but have chosen to delay the disclosure of the relevant formulae until the patent has been published.

As we approach the conclusion of our overview, it would be a matter of course to list the clinically relevant targets and original structures of hits, or better leads, retrieved from combinatorial libraries. This is, in our opinion, premature for the reasons mentioned above, and even a rigorous search of the documented examples would, inappropriately, give a wrong picture of the current situation. Nevertheless, we have compiled a fragmentary table from literature data (Table 1) to give an impression of the reported case studies and the compound classes involved. Because to the bias of released information towards model studies of little weight in the strategic focus of

the organizations behind them, it would be wrong to draw general conclusions on the performance potential of combinatorial technologies.

5 Discussion

With the significant progress in different technology disciplines and various conceptual innovations, a new era in the way drug discovery is approached has begun. While the development phase of drugs is highly regulated, and its time-frame cannot accommodate short cuts for reasons of safety, the lead-finding operation is a more open field, likely to accept any goal-oriented method that delivers valid candidate compounds with efficiency. In addition to tangible time savings, better lead finding can provide broader coverage of unexplored territory since it operates in the discovery stage, before the focus is set on a particular compound or family of analogues.

Combinatorial technologies seem to approach this struggle for exhaustive search of structural space in a more satisfying way. The most immediate benefit is the output of myriads of compounds that can be tested in primary screens but, more importantly, the composition of libraries and their preparation can be designed and organized in a systematic way, as opposed to the situation with other compound sources such as corporate collections (with a bias towards previously run drug-discovery programmes) and natural extracts. In this sense, the added value of combinatorial libraries is understandable also from the perspective of large organizations, which already have access to large numbers of test samples. Furthermore, the preorganized assembly of libraries and sublibraries, with previously validated synthetic pathways, paves the way for a more rapid and more comprehensive lead optimization. This will become more apparent in the future, when the majority of hits will originate from combinatorial library screening. Meanwhile, combinatorial chemistry on hits from other sources (e.g., natural products) is a difficult task and hardly competitive if the synthesis on solid phase is not already developed. With an enlarged repertoire of solid phase reactions, worked out over the coming years, this type of application will also become more attractive.

By emphasizing the aspects of library design and the deconvolution strategies, we reason that combinatorial technologies differ distinctly from random screening and embrace a rational component of considerable weight. A new touch for this rational side may be the attitude to support rather than look down on massive experimentation. The rationale of reducing the numbers of compounds to be synthesized serves the purpose of taking into account the technical and practical limitations of an organization's resources and is much less an ambition to predict the structure of most active compounds. The question being asked is '*How many combinations can you synthesize and test in a given time frame?*'. It is then a matter of exploiting

that limited number with an optimal choice of candidates. This acknowledges the experiences of recent years, that the prediction of lead structures by modelling is extremely elusive, even in cases of well-characterized target sites. The strengths of molecular modelling are brought out, when a wealth of information minimizes the uncertainty of assumptions, e.g., in an advanced optimization phase. In the future, with a stronger knowledge base of the mechanisms that govern the interactions of drugs at the receptor site, a shift towards, again, more prediction-oriented drug discovery approaches will be possible. Currently, for the needs of the pharmaceutical industry, *de novo* ligand design is not competitive with large screening operations. Once the ability is built-up to cope with the millions of test samples that combinatorial technologies make available, a preference to exhaust all the possibilities will remain, if nothing else, to allow for the unpredictable to surprise us. To pick an arbitrary case, α -ethylisoprenaline is reported to be a potent β -adrenergic stimulant, while the α -methyl and α -propyl derivatives are not (Main, 1990). Examples of dramatic consequences of minor structural changes on a molecule's activity are a reality that should caution against a priori limitations in the number of test compounds, unless they are dictated by the shortage of resources.

A point of persistent controversy in medicinal chemists circles is the question, to what extent testing mixtures is (if at all) advisable. The success potential of mixtures is most evident on the grounds of the prolific flow of active structures isolated from natural extracts. Synthetic libraries offer the advantage that relative concentrations and systematic classification into organized groups are controllable, which opens new opportunities on how to deal with complexity. To the sceptics, we recommend the study of successful deconvolutions reported in the literature (see section 3.6.1.2) and the reading of the thorough model studies of Konings *et al.* (1996) and Wilson-Lingardo *et al.* (1996).

The long-term perspective, on the other hand, an ultimate goal for combinatorial technologies, is to provide the capability to test large numbers of individual compounds, as they arise in the *split synthesis* process from individual beads. If the automation of synthesis and screening does indeed progress as fast as some expect, information technology will become an indispensable part of drug discovery. This will be mainly in the area of screening data management and sample logistics. Large-scale data analysis is another application of information technology that is certain to become increasingly important, as the production of libraries comes up to speed.

Whether computational chemistry and rational library design will have a large impact on combinatorial chemistry is less clear. Much more work on validating the assumptions in rational library design is needed, and more examples of rationally designed libraries are required, before this question can be answered.

It has been stated that chemistry research laboratories in the future may

in part resemble the present-day assay laboratories (Früchtel and Jung, 1996). Equally, computational chemistry may, in the future, lose its appeal as a rational drug design tool, and evolve into a computational and information systems attachment to laboratory automation. As organic synthesis, analytics, and screening are evolving towards high-throughput technologies, scientific information handling and scientific computing will have to develop from a small to a massive scale. In that case, the role of computational chemists in drug discovery would change, from solving detailed molecular design problems to developing and validating robust methods for large-scale compound selection and data interpretation.

The scenario of such operational environments are probably exaggerated visions of possible destinations brought about by the current trends. As is well known, the extreme intentions of technological developments are usually scaled down before they are carried to completion.

Because the number of compounds that are developed to reach the market cannot increase by orders of magnitude for obvious reasons, an unavoidable focusing process has to take into account strengths and weaknesses of each lead source and estimate the probability of success for each compound in the context of the particular project situations (resources, competition, acceptable formulations, etc.). The sheer number of leads output is less critical than the capability to generate increasingly attractive leads. The most significant new aspect coming into play is the opportunity to choose from a wide and diverse selection of candidates, with an increased likelihood that only excellent leads are carried further. To support this prospect, high-throughput assays with predictive value for toxicological and bioavailability properties are needed. A large back-up of alternative candidates, with entirely different physicochemical properties, is an invaluable asset where a development compound fails to confirm its potential.

Having highlighted the distinct value of combinatorial technologies for the drug discovery process, it is important to state that the success in the applications, within an organization, will depend on establishing a good balance with complementary resources of the more traditional medicinal chemistry efforts. The latter support individual lead optimization going beyond modular chemistry and also the design and preparation of tailored building blocks for thematic libraries.

Acknowledgements

We are indebted to Ernst Felder, Andreas Marzinzik, Hans Rink and Bernhard Rohde for reading and discussing the manuscript with us and providing valuable feedback. We thank David Spellmeyer (Chiron) and Yvonne Martin (Abbott) for sending us preprints of their work.

References

- Agrafiotis, D. A., Bone, R. F., Salemme, F. R. and Soll, R. M. (1995). System and method of automatically generating chemical compounds with desired properties. United States Patent 5,463,564 (Oct. 31, 1995).
- Ajay and Murcko, M. A. (1995). Computational methods to predict binding free energy in ligand receptor complexes. *J. Med. Chem.* **38**, 4953–4967.
- Ajayaghosh, A. and Pillal, V. N. R. (1995). Solid-phase synthesis and C-terminal amidation of peptides using a photolabile *o*-nitrobenzhydrylaminopolystyrene support. *Tetrahedron Lett.* **36**, 777–780.
- Al-Obeidi, F. A. D., Wildgoose, P., Stringer, S. K., Safar, P., Safarova, A., Abdul-Latif, F. A., Thorpe, D. S., Seligmann, B. E., Sepetov, K. F., Strop, P. and Ostrem, J. A. (1995). Discovery and optimization of a specific, orally available, active site inhibitor of Factor Xa discovered using synthetic combinatorial chemistry. *J. Invest. Med.* **43**(Suppl. 2), 232A.
- Armstrong, R. W., Combs, A. P., Tempest, P. A., Brown, S. D. and Keating, T. A. (1996). Multiple-component condensation strategies for combinatorial library synthesis. *Acc. Chem. Res.* **29**, 123–131.
- Ash, J. (1996). SYBYL line notation: Full Markush, combinatorial and query specification in a single language. Fourth Int. Conf. Chemical Structures, Abstr. No. 49, Noordwijkerhout, June 2–5, 1996.
- Atherton, E., Logan, C. J. and Sheppard, R. C. (1981). Peptide synthesis. Part 2. Procedure for solid-phase synthesis using *N*-fluorenylmethoxycarbonylamino-acids on polyamide supports. Synthesis of substance P and of acyl carrier protein 65-74 decapeptide. *J. Chem Soc. Perkin Trans. I*, 538–546.
- Baldwin, J. J., Burbaum, J. J., Henderson, I. and Ohlmeyer, M. H. J. (1995). Synthesis of a small molecule combinatorial library encoded with molecular tags. *J. Am. Chem. Soc.* **117**, 5588–5589.
- Barbas III, C. F., Rosenblum, J. S. and Lerner, R. A. (1993). Direct selection of antibodies that coordinate metals from semisynthetic combinatorial libraries. *Proc. Natl Acad. Sci. USA* **90**, 6385–6389.
- Barlos, K., Gatos, D., Kallitsis, J., Papaphotiu, G., Sotiriu, P., Wenqing, Y. and Schäfer, W. (1989). Darstellung geschützter Peptid-Fragmente unter Einsatz substituierter Triphenylmethyl-Harze. *Tetrahedron Lett.* **30**, 3943–3946.
- Barnard, J. M. and Downs, G. M. (1992). Clustering of chemical structures on the basis of two-dimensional similarity measures. *J. Chem. Inf. Comput. Sci.* **32**, 644–649.
- Baroni, M., Clementi, S., Cruchiani, G., Wold, N. and Wold, S. (1993). D-Optimal designs in QSAR. *Quant. Struct. -Act. Relat.* **12**, 225–231.
- Bastos, M., Maeji, N. J. and Abeles, R. H. (1995). Inhibitors of human heart chymase based on a peptide library. *Proc. Natl Acad. Sci. USA* **92**, 6738–6742.
- Beebe, X., Schore, N. E. and Kurth, M. J. (1992). Polymer-supported synthesis of 2,5-disubstituted tetrahydrofurans. *J. Am. Chem. Soc.* **114**, 10061–10062.
- Blondelle, S. E., Takahashi, E., Weber, P. A. and Houghten, R. A. (1994). Identification of antimicrobial peptides by using combinatorial libraries made up of unnatural amino acids. *Antimicrob. Agents Chemother.* **38**, 2280–2286.
- Blondelle, S. E., Takahashi, E., Houghten, R. A. and Perez-Paya, E. (1996a). Rapid identification of compounds with enhanced antimicrobial activity by using conformationally defined combinatorial libraries. *Biochem. J.* **313**, 141–147.
- Blondelle, S., Houghten, R. A. and Perez-Paya, E. (1996b). Identification of inhibitors of melittin using nonsupport-bound combinatorial libraries. *J. Biol. Chem.* **271**, 4093–4099.
- Bock, L. C., Griffin, L. C., Latham, J. A., Vermaas, E. H. and Toole, J. J. (1992). Selection of single-stranded DNA molecules that bind and inhibit human thrombin. *Nature* **355**, 564–566.

- Boden, P., Eden, J. M., Hodgson, J., Horwell, D. C., Hughes, J., McKnight, A. T., Lewthwaite, R. A., Pritchard, M. C., Raphy, J., Meecham, K., Ratcliffe, G. S., Suman-Chauhan, N. and Woodruff, G. N. (1996). Use of a dipeptide chemical library in the development of non-peptide tachykinin NK3 receptor selective antagonists. *J. Med. Chem.* **39**, 1664–1675.
- Boger, D. L., Tarby, C. M., Myers, P. L. and Caporale, L. H. (1996). Generalized dipeptidomimetic template: solution phase parallel synthesis of combinatorial libraries. *J. Am. Chem. Soc.* **118**, 2109–2110.
- Bolton, G. L. (1996). Solid phase synthesis of azabicyclo[4.3.0]nonen-8-one amino acid derivatives via intramolecular Pauson–Khand cyclization. *Tetrahedron Lett.* **37**, 3433–3436.
- Bonora, G. M., Scremin, C. L., Colonna, F. P. and Garbesi, A. (1990). High efficiency liquid phase. Synthesis of oligonucleotides on a soluble polymer. *Nucl. Acids Res.* **18**, 3155–3159.
- Borhardt, A. and Still, W. C. (1994). Synthetic receptor for internal residues of a peptide chain. Highly selective binding of (L)X-(L)Pro-(L)X tripeptides. *J. Am. Chem. Soc.* **116**, 7467–7468.
- Boutin, J. A., and Fauchère, A. L. (1996). Combinatorial peptide synthesis: Statistical evaluation of peptide distribution. *TIPS* **17**, 8–12.
- Boutin, J. A., Hennig, P., Lambert, P. H., Bertin, S., Petit, L., Mahieu, J. P., Serkiz, P., Volland, J. P., Fauchère, J.-L. (1996). Combinatorial peptide libraries: Robotic synthesis and analysis by nuclear magnetic resonance, mass spectrometry, tandem mass spectrometry, and high-performance capillary electrophoresis techniques. *Anal. Biochem.* **234**, 126–141.
- Boyce, R., Li, G., Nestler, P., Suenaga, T. and Still, W. C. (1994). Peptidosteroidal receptors for opioid peptides. Sequence-selective binding using a synthetic receptor library. *J. Am. Chem. Soc.* **116**, 7955–7956.
- Bray, A. M., Maeji, N. J. and Geysen, H. M. (1990). The simultaneous multiple production of solution phase peptides: assessment of the Geysen method of simultaneous peptide synthesis. *Tetrahedron Lett.* **31**, 5811–5814.
- Bray, A. M., Jhingran, A. G., Valerio, R. M. and Maeji, N. J. (1994). Simultaneous multiple synthesis of peptide amides by the multipin method. Application of vapor-phase ammonolysis. *J. Org. Chem.* **59**, 2197–2203.
- Bray, A. M., Chiefari, D. S., Valerio, R. M. and Maeji, N. J. (1995). Rapid optimization of organic reactions on solid phase using the multipin approach: synthesis of 4-aminoproline analogues by reductive amination. *Tetrahedron Lett.* **36**, 5081–5084.
- Brown, B. B., Wagner, D. S. and Geysen, H. M. (1995). A single-bead decode strategy using electrospray ionization mass spectrometry and a new photolabile linker: 3-Amino-3-(2-nitrophenyl)propionic acid. *Molec. Diversity* **1**, 4–12.
- Brown, S. (1992). Engineered iron oxide adhesion mutants of the *Escherichia coli* phage lambda receptor. *Proc. Natl Acad. Sci. USA* **89**, 8651–8655.
- Bruce, J. E., Anderson, G. A., Chen, R., Cheng, X., Gale, D. C., Hofstadler, S. A., Schwartz, B. L. and Smith, R. D. (1995). Bio-affinity characterization mass spectrometry. *Rapid Comm. Mass Spectrom.* **9**, 644–650.
- Brummel, C. L., Vickerman, J. C., Carr, S. A., Hemling, M. E., Roberts, G. D., Johnson, W., Weinstock, J., Gaitanopoulos, D., Benkovic, S. J. and Winograd, N. (1996). Evaluation of mass spectrometric methods applicable to the direct analysis of non-peptide bead-bound combinatorial libraries. *Anal. Chem.* **68**, 237–242.
- Bunin, B. A. and Ellman, J. A. (1992). A general and expedient method for the synthesis of 1,4-benzodiazepine derivatives. *J. Am. Chem. Soc.* **114**, 10997–10998.
- Burbaum, J. J., Ohlmeyer, M. H. J., Reader, J. C., Henderson, I., Dillard, L. W., Li, G., Randle, T. L., Sigal, N. H., Chelsky, D. and Baldwin, J. J. (1995). A paradigm for drug discovery employing encoded combinatorial libraries. *Proc. Natl. Acad. Sci. USA* **92**, 6027–6031.

- Burden, F. R. (1989). Molecular identification numbers for substructure searches. *J. Chem. Inf. Comp. Sci.* **29**, 225–227.
- Bures, M. G., Brown, R. and Martin, Y. C. (1995). Abstracts of papers of the American Chemical Society, 210, 60–CINF.
- Bures, M. G., Martin, Y. C. and Willett, P. (1994). Searching techniques for databases of three-dimensional structures. *Topics Stereochem.* **21**, 467–511.
- Burger, M. T. and Still, W. C. (1995). Synthetic ionophores. Encoded combinatorial libraries of cyclen-based receptors for Cu^{2+} and Co^{2+} . *J. Org. Chem.* **60**, 7382–7383.
- Burgess, K., Liaw, A. I. and Wang, N. (1994). Combinatorial technologies involving reiterative division/coupling/recombination: Statistical considerations. *J. Med. Chem.* **37**, 2985–2987.
- Burgess, K., Linthicum, D. S. and Shin, H. W. (1995). Solid-phase synthesis of non-natural biopolymers with repetitive urea subunits. *Angew. Chem., Int. Ed. Engl.* **34**, 907–909.
- Carhart, R. E., Smith, D. H. and Ventkatataraghavan, R. (1985). Atom pairs as molecular features in structure–activity studies: Definitions and applications. *J. Chem. Inf. Comput. Sci.* **25**, 64–73.
- Chen, C., Ahlberg Randall, L. A., Miller, R. B., Jones, A. D. and Kurth, M. J. (1994). Analogous organic synthesis of small-compound libraries: validation of combinatorial chemistry in small-molecule synthesis. *J. Am. Chem. Soc.* **116**, 2661–2662.
- Chen, J. K., Lane, W. S., Brauer, A. W., Tanaka, A. and Schreiber, S. L. (1993). Biased combinatorial libraries: novel ligands for the SH3 domain of phosphatidylinositol 3-kinase. *J. Am. Chem. Soc.* **115**, 12591–12592.
- Chenera, B., Finkelstein, J. A. and Veber, D. F. (1995). Protodetachable arylsilane polymer linkages for use in solid phase organic synthesis. *J. Am. Chem. Soc.* **117**, 11999–12000.
- Cho, C. Y., Moran, E. J., Cherry, S. Z., Stephens, J. C., Fodor, S., Adams, A., Sundaram, A., Jacobs, J. W. and Schultz, P. G. (1993). An unnatural biopolymer. *Science* **261**, 1303–1305.
- Chu, S. S. and Reich, S. H. (1995). NPIT: A new reagent for quantitatively monitoring reactions of amines in combinatorial synthesis. *Bioorg. Med. Chem. Lett.* **5**, 1053–1058.
- Chu, Y. H., Kirby, D. P. and Karger, B. L. (1995). Free solution identification of candidate peptides from combinatorial libraries by affinity capillary electrophoresis/mass spectrometry. *J. Am. Chem. Soc.* **117**, 5419–5420.
- Colas, P., Cohen, B., Jessen, T., Grishina, I., McCoy, J. and Brent, R. (1996). Genetic selection of peptide aptamers that recognize and inhibit cyclin-dependent kinase 2. *Nature* **380**, 548–550.
- Combs, A. P., Kapoor, T. M., Feng, S. K., Chen, J., Daudé-Snow, L. F. and Schreiber, S. L. (1996). Protein structure-based combinatorial chemistry: Discovery of non-peptide binding elements to SrcSH3 domain. *J. Am. Chem. Soc.* **118**, 287–288.
- Cramer, R. D. (1996). Validated molecular diversity in library design. Fourth Int. Conf. on Chemical Structures, Abst. No. 50, Noordwijkerhout, June 2–5, 1996.
- Cull, M. G., Miller, J. F. and Schatz, P. J. (1992). Screening for receptor ligands using large libraries of peptides linked to the C terminus of the lac repressor. *Proc. Natl Acad. Sci. USA* **89**, 1865–1869.
- Cwirla, S., Peters, E. A., Barrett, R. W. and Dower, W. J. (1990). Peptides on phage: a vast library of peptides for identifying ligands. *Proc. Natl Acad. Sci. USA* **87**, 6378–6382.
- Davies, K. and Briant, C. (1995). Combinatorial chemistry library design using pharmacophore diversity. Network Science (<http://www.awod.com>), July 1995.
- Davies, K. and White, C. (1995). An information management architecture for combinatorial chemistry. Network Science (<http://www.awod.com>), July 1995.
- Davis, P. W., Vickers, T. A., Wilson-Lingardo, L., Wyatt, J. R., Guinosso, C. J., Sanghvi, Y. S., DeBaets, E. A., Acevedo, O. L., Cook, P. D. and Ecker, D. J. (1995). Drug leads from combinatorial phosphodiester libraries. *J. Med. Chem.* **38**, 4363–4366.

- Daylight Chemical Information Systems Inc. (1995). Daylight User Manual, v4. 41. DCIS Inc., Santa Fe, NM.
- Déprez, B., Williard, X., Bourel, L., Coste, H., Hyafil, F. and Tartar, A. (1995). Orthogonal combinatorial chemical libraries. *J. Am. Chem. Soc.* **117**, 5405–5406.
- Devlin, J. J., Panganiban, L. C. and Devlin, P. E. (1990). Random peptide libraries: a source of specific protein binding molecules. *Science* **249**, 404–406.
- Dooley, C. T., Chung, N. N., Schiller, P. W. and Houghten, R. A. (1993). Acetalins: opioid receptor antagonists determined through the use of synthetic peptide combinatorial libraries. *Proc. Natl Acad. Sci. USA* **90**, 10811–10815.
- Dooley, C. T., Chung, N. N., Wilkes, B. C., Schiller, P. W., Bidlack, J. M., Pasternak, G. W. and Houghten, R. A. (1994). An all D-amino acid opioid peptide with central analgesic activity from a combinatorial library. *Science* **266**, 2019–2022.
- Dooley, C. T., Kaplan, R. A., Chung, N. N., Schiller, P. W., Bidlack, J. M. and Houghten, R. A. (1995). Six highly active mu-selective opioid peptides identified from two synthetic combinatorial libraries. *Peptide Res.* **8**, 124–137.
- Douglas, S. P., Whitfield, D. M. and Krepinsky, J. J. (1991). Polymer-supported solution synthesis of oligosaccharide. *J. Am. Chem. Soc.* **113**, 5095–5097.
- Downs, G. M. and Barnard, J. M. (1996). Techniques for generating descriptive fingerprints in combinatorial libraries. Fourth Int. Conf. on Chemical Structures, Abstract No. 13, Noordwijkerhout, June 2–5, 1996.
- Dressman, B. A., Spangle, L. A. and Kaldor, S. W. (1996). Solid phase synthesis of hydantoins using a carbamate linker and a novel cyclization/cleavage step. *Tetrahedron Lett.* **37**, 937–940.
- Eichler, J. and Houghten, R. A. (1993). Identification of substrate-analog trypsin inhibitors through the screening of synthetic peptide combinatorial libraries. *Biochemistry* **32**, 11035–11041.
- Eichler, J., Lucka, A. W. and Houghten, R. A. (1994). Cyclic peptide template combinatorial libraries: Synthesis and identification of chymotrypsin inhibitors. *Peptide Res.* **7**, 300–307.
- Eigen, M. and Rigler, R. (1994). Sorting single molecules: application to diagnostics and evolutionary biotechnology. *Proc. Natl Acad. Sci. USA* **91**, 5740–5747.
- Ellington, A. D. and Szostak, J. W. (1990). *In vitro* selection of RNA molecules that bind specific ligands. *Nature* **346**, 818–822.
- Ellman, J. A. (1996). Design, synthesis, and evaluation of small-molecule libraries. *Acc. Chem. Res.* **29**, 132–143.
- Farall, M. J. and Frechet, J. M. J. (1976). Bromination and lithiation: two important steps in the functionalization of polystyrene resins. *J. Org. Chem.* **41**, 3877–3882.
- Fauchère, J.-L. (1995). Discovery and optimization of pseudopeptide leads towards peptidomimetic drugs. *Lett. Pept. Sci.* **2**, 115–120.
- Felder, E. R. (1994). The challenge of preparing and testing combinatorial compound libraries in the fast lane, at the front end of drug development. *Chimia* **48**, 531–541.
- Felder, E. R., Heizmann, G., Matthews, I. T., Rink, H. and Spieser, E. (1995). A new combination of protecting groups and links for encoded synthetic libraries suited for consecutive tests on the solid phase and in solution. *Molec. Diversity* **1**, 109–112.
- Fitch, W. L., Detre, G. and Holmes, C.P. (1994). High-Resolution ¹H NMR in Solid-Phase Organic Synthesis. *J. Org. Chem.* **59**, 7955–7956.
- Fodor, S. P. A., Read, J. L., Pirrung, M. C., Stryer, L., Lu, A. T. and Solas, D. (1991). Light-directed, spatially addressable parallel chemical synthesis. *Science* **251**, 767–773.
- Folgori, A., Tafi, R., Meola, A., Felici, F., Galfre, G., Cortese, R., Monaci, P. and Nicosia, A. (1994). A general strategy to identify mimotopes of pathological antigens using only random peptide libraries and human sera. *EMBO J.* **13**, 2236–2243.
- Forman, F. W. and Sucholeiki, I. (1995). Solid-phase synthesis of biaryls via the Stille reaction. *J. Org. Chem.* **60**, 523–528.

- Freier, S. M., Konings, D. A. M., Wyatt, J. R. and Ecker, D. J. (1995). Deconvolution of combinatorial libraries for drug discovery: A model system. *J. Med. Chem.* **38**, 344–352.
- Frenette, R. and Friesen, R. W. (1994). Biaryl synthesis via Suzuki coupling on a solid support. *Tetrahedron Lett.* **35**, 9177–9180.
- Früchtel, J. S. and Jung, G. (1996). Organic chemistry on solid supports. *Angew. Chem., Int. Ed. Engl.* **35**, 17–42.
- Furka, A. (1982). Study on possibilities of systematic searching for pharmaceutically useful peptides. Written and notarized document, Dr Judik Bókai, State Notary Public, Budapest, Hungary, pp. 1–11.
- Furka, A. (1994). Sub-library composition of peptide libraries: potential application in screening. *Drug Dev. Res.* **33**, 90–97.
- Furka, A. and Sebestyen, F. (1995). Composition of biooligomer libraries: Potential application in screening. In 'Peptides 1994 – Proc. 23rd Eur. Pept. Symp.' (Maia, H. L. S. ed.), pp. 498–499. Escom, Leiden.
- Furka, A., Sebestyen, F., Asgedom, M. and Dibo, G. (1988a). Cornucopia of peptides by synthesis. Abstr. 14th Int. Congr. Biochem. Prague **5**(Abstr FR:013), 47.
- Furka, A., Sebestyen, F., Asgedom, M. and Dibo, G. (1988b). More peptides by less labor. Abstr. 10th Int. Symp. Med. Chem. Budapest Abstr. P-168, 288.
- Gallop, M. A., Barrett, R. W., Dower, W. J., Fodor, S. P. A. and Gordon, E. M. (1994). Applications of combinatorial technologies to drug discovery. 1. Background and peptide combinatorial libraries. *J. Med. Chem.* **37**, 1233–1251.
- Geysen, H. M., Meloen, R. H. and Barteling, S. J. (1984). Use of peptide synthesis probe viral antigens for epitopes to a resolution of a single amino acid. *Proc. Natl Acad. Sci, USA* **81**, 3998–4002.
- Geysen, H. M., Rodda, S. J. and Mason, T. J. (1986). A priori delineation of a peptide which mimics a discontinuous antigenic determinant. *Mol. Immunol.* **23**, 709–715.
- Gobbi, A., Poppinger, D. and Rohde, B. (1996). CICLOPS – the Ciba chemical library optimization system. Fourth Int. Conf. on Chemical Structures, Abstract No. 10, Noordwijkerhout, June 2–5, 1996.
- Goebel, M. and Ugi, I. (1995). Beyond peptide and nucleic acid combinatorial libraries – Applying unions of multicomponent reactions towards the generation of carbohydrate combinatorial libraries. *Tetrahedron Lett.* **36**, 6043–6046.
- Goff, D. A. and Zuckermann, R. N. (1995). Solid-phase synthesis of highly substituted peptoid 1(2H)-isoquinolinones. *J. Org. Chem.* **60**, 5748–5749.
- Goodman, M. S., Jubian, V. and Hamilton, A. D. (1995). A combinatorial approach to artificial receptor design. *J. Am. Chem. Soc.* **117**, 11610–11611.
- Goodson, R. J., Doyle, M. V., Kaufman, S. E. and Rosenberg, S. (1994). High-affinity urokinase receptor antagonists identified with bacteriophage peptide display. *Proc. Natl Acad. Sci. USA* **91**, 7129–7133.
- Gordeev, M. F., Patel, D. V. and Gordon, E. M. (1996). Approaches to combinatorial synthesis of heterocycles: A solid-phase synthesis of 1,4-dihydropyridines. *J. Org. Chem.* **61**, 924–928.
- Gordon, D. W. and Steele, J. (1995). Reductive alkylation on a solid phase: Synthesis of a piperazinedione combinatorial library. *Bioorg. Med. Chem. Lett.* **5**, 47–50.
- Gordon, E. M., Barrett, R. W., Dower, W. J., Fodor, S. P. A., Gallop, M. A. (1994). Applications of combinatorial technologies to drug discovery. 2. Combinatorial organic synthesis, library screening strategies, and future directions. *J. Med. Chem.* **37**, 1385–1401.
- Green, B. and Garson, L. R. (1969). Peptide synthesis by the soluble-polymer technique. *J. Chem. Soc. (C)*, 401–405.
- Gremlich, H.-U. and Berets, S. L. (1996). Use of FT-IR internal reflection spectroscopy in combinatorial chemistry. *Appl. Spectroscopy* **50**(4), 532–536.

- Guidi, J. N. and Fox, E. A. (1996). Information retrieval and genomics – An introduction. *Computers Biol. Med.* **26**, 179–182.
- Hall, L. H. and Kier, L. B. (1991). The molecular connectivity chi indexes and kappa shape indexes in structure-property modeling. In 'Reviews in Computational Chemistry' (Lipkowitz, K. B. and Boyd, D. B., eds.), pp. 367–422. VCH Publishers Inc., New York.
- Hamper, B. C., Dukeshere, D. R. and South, M. S. (1996). Solid phase synthesis of proline analogs via a three component 1,3-dipolar cycloaddition. *Tetrahedron Lett.* **37**, 3671–3674.
- Hamy, F., Felder, E. R., Heizmann, G., Lazdins, J., Aboul-Ela, F., Varani, G., Karn, J. and Klimkait, T. (1997). An inhibitor of the Tat/TAR RNA interaction that effectively suppresses HIV-1 replication. *Proc. Natl Acad. Sci. USA*, in press.
- Han, H. and Janda, K. D. (1996). Azatides: solution and liquid phase syntheses of a new peptidomimetic. *J. Am. Chem. Soc.* **118**, 2539–2544.
- Han, H., Wolfe, M. M., Brenner, S. and Janda, K. D. (1995). Liquid-phase combinatorial synthesis. *Proc. Natl Acad. Sci. USA* **92**, 6419–6423.
- Han, Y., Walker, S. D. and Young, R. N. (1996). Silicon directed ipso-substitution of polymer bound arylsilanes: preparation of biaryls via the Suzuki cross-coupling reaction. *Tetrahedron Lett.* **37**, 2703–2706.
- Harada, K., Martin, S. S. and Frankel, A. D. (1996). Selection of RNA-binding peptides *in vivo*. *Nature* **380**, 175–179.
- Hauske, J. R. and Dorff, P. (1995). A solid phase Cbz chloride equivalent – a new matrix specific linker. *Tetrahedron Lett.* **36**(10), 1589–1592.
- Hébert, N., Davis, P. W., De Baets, E. L. and Acevedo, O. L. (1994). Synthesis of *N*-substituted hydroxyprolinol phosphoramidites for the preparation of combinatorial libraries. *Tetrahedron Lett.* **35**(51), 9509–9512.
- Hellberg, S., Erikson, L., Jonsson, J., Lindgren, F., Sjöström, M., Skegerberg, B., Wold, S. and Andrews, P. (1991). Minimum analogue peptide sets (MAPS) for quantitative structure–activity relationships. *Int. J. Pept. Protein Res.* **37**, 414–424.
- Hermkens, P. H. H., Ottenheijm, H. C. J. and Rees, D. (1996). Solid-phase organic reactions: a review of the recent literature. *Tetrahedron* **52**, 4527–4554.
- Hibbert, D. B. (1993). Genetic algorithms in chemistry. *Chemometrics and Intelligent Laboratory Systems* **19**, 277–293.
- Hobbs De Witt, S., Kiely, J. S., Stankovic, C. J., Schroeder, M. C., Reynolds Cody, D. M. and Pavia, M. R. (1993). Diversomers: An approach to nonpeptide, nonoligomeric chemical diversity. *Proc. Natl Acad. Sci. USA* **90**, 6909–6913.
- Holliday, J. D., Ranade, S. S. and Willett, P. (1995). A fast algorithm for selecting sets of dissimilar molecules from large chemical databases. *Quant. Struct.-Act. Relat.* **14**, 501–506.
- Holmes, C. P. and Jones, D. J. (1995). Reagents for combinatorial organic synthesis: Development of a new *o*-nitrobenzyl photolabile linker for solid phase synthesis. *J. Org. Chem.* **60**, 2318–2319.
- Holmes, C. P., Chinn, J. P., Look, G. C., Gordon, E. M. and Gallop, M. A. (1995). Strategies for combinatorial organic synthesis: solution and polymer-supported synthesis of 4-thiazolidinones and 4-metathiazanones from amino acids. *J. Org. Chem.* **60**, 7328–7333.
- Horwell, D. C., Howson, W., Ratcliffe, G. S. and Rees, D. C. (1992). The design of a dipeptide library for screening at peptide receptor sites. *Bioorg. Med. Chem Lett.* **3**, 799–802.
- Houghten, R. A. (1985). General method for the rapid solid-phase synthesis of large numbers of peptides: specificity of antigen–antibody interaction at the level of individual amino acids. *Proc. Natl Acad. Sci. USA* **82**, 5131–5135.
- Houghten, R. A. (1993). The broad utility of soluble peptide libraries for drug discovery. *Gene* **137**, 7–11.
- Houghten, R. A., Pinilla, C., Blondelle, S. E., Appel, J. R., Dooley, T. and Cuervo, J. H.

- (1991). Generation and use of synthetic peptide combinatorial libraries for basic research and drug discovery. *Nature* **354**, 84–86.
- Hutchins, S. M. and Chapman, K. T. (1995). A strategy for urea linked diamine libraries. *Tetrahedron Lett.* **36**, 2583–2586.
- Hyrup, B. and Nielsen, P. E. (1996). Peptide Nucleic Acids (PNA): synthesis, properties and potential applications. *Bioorg. Med. Chemistry* **4**, 5–23.
- Itakura, K., Rossi, J. J. and Wallace, R. B. (1984). Synthesis and use of synthetic oligonucleotides. *Annu. Rev. Biochem.* **53**, 323–356.
- James, C. A. and Weininger, D. (1995). A database system for combinatorial synthesis experiments. Network Science (<http://www.awod.com>), July 1995.
- Jayawickreme, C. K., Graminski, G. F., Quillan, J. M. and Lerner, M. R. (1994). Creation and functional screening of a multi-use peptide library. *Proc. Natl. Acad. Sci. USA* **91**, 1614–1618.
- Johnson, C. R. and Zhang, B. (1995). Solid phase synthesis of alkenes using the Horner–Wadsworth–Emmons reaction and monitoring by gel phase ^{31}P NMR. *Tetrahedron Lett.* **36**, 9253–9256.
- Jung, G. (1996). Combinatorial peptide and nonpeptide libraries: a handbook. VCH Verlagsgesellschaft, Weinheim.
- Jung, G. and Beck-Sickinger, A. G. (1992). Multiple peptide synthesis methods and their applications. *Angew. Chem., Int. Ed. Engl.* **31**, 367–486.
- Kaur, S., Huebner, V., Tang, D., McGuire, L., Drummond, R. and Csetjey, J. (1995). Identification of specific receptor peptoid ligands in combinatorial mixtures by affinity selection and mass spectrometry. Abstracts of 43rd ASMS Conference on Mass Spectrometry and Allied Topics, p. 300.
- Kauvar, L. M., Higgins, D. L., Villar, H. O., Sportsman, J. R., Engqvist-Goldstein, A., Bukar, R., Bauer, K. E., Dille, H. and Rocke, D. M. (1995). Predicting ligand binding to proteins by affinity fingerprinting. *Chem. Biol.* **2**, 107–118.
- Kearsley, S. K., Sallamak, S., Fluder, E. M. Andose, J. D., Mosley, R. T. and Sheridan, R. P. (1996). Chemical similarity using physicochemical property descriptors. *J. Chem. Inf. Comput. Sci.* **36**, 118–127.
- Keating, T. A. and Armstrong, R. W. (1996). Postcondensation modifications of Ugi four-component condensation products – 1-Isocyanocyclohexene as a convertible isocyanide – Mechanisms of conversion, synthesis of diverse structures, and demonstration of resin capture. *J. Am. Chem. Soc.* **118**, 2574–2583.
- Kerr, J. M., Banville, S. C. and Zuckerman, R. N. (1993). Encoded combinatorial peptide libraries containing non-natural amino acids. *J. Am. Chem. Soc.* **115**, 2529–2531.
- Kocis, P., Issakova, O., Sepetov, N. F. and Lebl, M. (1995). Kemp's triacid scaffolding for synthesis of combinatorial nonpeptide uncoded libraries. *Tetrahedron Lett.* **36**, 6623–6626.
- Konings, D. A. M., Wyatt, J. R., Ecker, D. J. and Freier, S. M. (1996). Deconvolution of combinatorial libraries for drug discovery: theoretical comparison of pooling strategies. *J. Med. Chem.* **39**, 2710–2719.
- Krchnak, V. and Lebl, M. (1995). Synthetic library techniques: Subjective (biased and generic) thoughts and views. *Molec. Diversity* **1**, 193–216.
- Krchnak, V., Flegelova, Z., Weichsel, A. S. and Lebl, M. (1995). Polymer-supported Mitsunobu ether formation and its use in combinatorial chemistry. *Tetrahedron Lett.* **36**, 6193–6196.
- Kurth, M. J., Ahlberg Randall, L. A., Chen, C., Melander, C. and Miller, R. (1994). Library-based lead compound discovery: antioxidants by an analogous synthesis deconvolutive assay strategy. *J. Org. Chem.* **59**, 5862–5864.
- Lajiness, M. (1991). An evaluation of the performance of dissimilarity selection. In 'QSAR: Rational approaches to the design of bioactive compounds' (Silipo, C. and Vittoria, A., eds), pp. 173–198. Elsevier, Amsterdam.
- Lajiness, M., Johnson, M. A. and Maggiora, G. M. (1989). Implementing drug screening

- programs using molecular similarity methods. In 'QSAR: Quantitative Structure-Activity Relationships in Drug Design' (Fauchère, J. L., ed.), pp. 173-176. Alan Liss Inc., New York.
- Lam, K. S., Salmon, S. E., Hersh, E. M., Hruby, V. J., Kazmierski, W. M. and Knapp, R. J. (1991). A new type of synthetic peptide library for identifying ligand-binding activity. *Nature* **354**, 82-84.
- Lebl, M., Patek, M., Kocis, P., Krchnak, V., Hruby, V. J., Salmon, S. E. and Lam, K. S. (1993). Multiple release of equimolar amounts of peptides from a polymeric carrier using orthogonal linkage-cleavage chemistry. *Int. J. Peptide Protein Res.* **41**, 201-203.
- Ley, S. V., Mynett, D. M. and Koot, W.-J. (1995). Solid phase synthesis of bicyclo[2.2.2]octane derivatives via tandem Michael addition reactions and subsequent reductive amination. *Synlett* 1017-1020.
- Loew, G.H., Villar, H.O. and Alkorta, I. (1993). Strategies for indirect computer-aided drug design. *Pharmaceut. Res.* **10**, 475-486.
- Look, G. C., Schullek, J. R., Holmes, C. P., Chinn, J. P., Gordon, E. M. and Gallop, M. A. (1996). The identification of cyclooxygenase-1 inhibitors from 4-thiazolidinone combinatorial libraries. *Bioorg. Med. Chem. Lett.* **6**, 707-712.
- Lorenzen, T. J. and Anderson, V. L. (1993). Design of Experiments: A No-name Approach'. Marcel Dekker, New York.
- Maggiora, G. M. and Johnson, M. A. (1990). 'Concepts and Applications of Molecular Similarity'. Wiley, New York.
- Main, B. G. (1990). β -Adrenergic receptors. In 'Comprehensive Medicinal Chemistry' (Hansch, C., Sammes, P. G., Taylor, J. B. and Emmet, J. C., eds.), Vol. 3, Chapt. 12.2, p. 195, Pergamon Press, Oxford.
- Malin, R., Steinbrecher, R., Jannsen, J., Semmler, W., Noll, B., Johannsen, B., Frömmel, C., Höhne, W. and Schneider-Mergener, J. (1995). Identification of Technetium-99m binding peptides using combinatorial cellulose-bound peptide libraries. *J. Am. Chem. Soc.* **117**, 11821-11822.
- Martens, H. and Naes, T. (1989). 'Multivariate Calibration'. Wiley, New York.
- Martin, E. J., Blaney, J. M., Siani, M. A., Spellmeyer, D. C., Wong, A. K. and Moos, W. H. (1995). Measuring diversity: Experimental design of combinatorial libraries for drug discovery. *J. Med. Chem.* **38**, 1431-1436.
- Martin, Y. C., Brown, R. D. and Bures, M. G. (1997). Quantifying diversity. In 'Combinatorial Chemistry and Molecular Diversity in Drug Discovery' (Gordon, E. M. and Kerwin, Jr, J. F., eds). Wiley, New York.
- Marzinzik, A. L. and Felder, E. R. (1996). Solid support synthesis of highly functionalized pyrazoles and isoxazoles; scaffolds for molecular diversity. *Tetrahedron Lett.* **37**, 1003-1006.
- Mason, J. S., Picket, S. D., McLay, I. M. and Lewis, R. A. (1995). *Abstr. Papers Am. Chem. Soc.* **210**, 26-CINF.
- Mattheakis, L. C., Bhatt, R. R. and Dower, W. J. (1994). An *in vitro* polysome display system for identifying ligands from very large peptide libraries. *Proc. Natl Acad. Sci. USA* **91**, 9022-9026.
- Menger, F. M., Eliseev, A. V. and Migulin, V. A. (1995). Phosphatase catalysis developed via combinatorial organic chemistry. *J. Org. Chem.* **60**, 6666-6667.
- Meola, A., Delmastro, P., Monaci, P., Luzzago, A., Nicosia, A., Felici, F., Cortese, R. and Galfre, G. (1995). Derivation of vaccines from mimotopes: Immunologic properties of human hepatitis B virus surface antigen mimotopes displayed on filamentous phage. *J. Immunol.* **154**, 3162-3172.
- Metzger, J. W., Kempter, C., Wiesmüller, K. H. and Jung, G. (1994). Electrospray mass spectrometry and tandem mass spectrometry of synthetic multicomponent peptide mixtures: Determination of composition and purity. *Anal. Biochem.* **219**, 261-277.

- Meyers, H. V., Dilley, G. J., Durgin, T. L., Powers, T. S., Winssinger, N. A., Zhu, H. and Pavia, M. R. (1995). Multiple simultaneous synthesis of phenolic libraries. *Molec. Diversity* **1**, 13–20.
- Miller, S. M., Simon, R. J., Ng, S., Zuckermann, R. N., Kerr, J. M. and Moos, W. H. (1994). Proteolytic studies of homologous peptides and *N*-substituted glycine peptoid oligomers. *Bioorg. Med. Chem. Lett.* **4**, 2657–2662.
- Miller, S. M., Simon, R. J., Ng, S., Zuckermann, R. N., Kerr, J. M. and Moos, W. H. (1995). Comparison of proteolytic susceptibilities of homologous L-aminoacid, D-aminoacid, and *N*-substituted glycine peptide and peptoid oligomers. *Drug Dev. Res.* **35**, 20–32.
- Mitchell, T. J. (1976). *Technometrics* **16**, 203–210.
- Mjalli, A. M. M., Sarshar, S. and Baiga, T. J. (1996). Solid phase synthesis of pyrroles derived from a four component condensation. *Tetrahedron Lett.* **37**, 2943–2946.
- Molecular Design Ltd (1995). 'Project Library User's Guide'. San Leandro, CA 94577, USA. See also: 'Combinatorial Chemistry: A Strategy for the Future'. Network Science (<http://www.awod.com>), July 1995.
- Molecular Simulations Inc. (1996). CERIU2 Simulation Tools. MS Inc., San Diego, CA.
- Moore, G. J. (1994). Designing peptide mimetics. *TIPS* **15**, 124.
- Moran, E. J., Sarshar, S., Cargill, J. F., Shahbaz, M. M., Lio, A., Mjalli, A. M. M. and Armstrong, R. W. (1995). Radio frequency tag encoded combinatorial library method for the discovery of tripeptide-substituted cinnamic acid inhibitors of the protein tyrosine phosphatase PTB1B. *J. Am. Chem. Soc.* **117**, 10787–10788.
- Moreau, G. (1995). Use of similarity analysis to reduce large molecular libraries (in-house, combinatorial or commercial) to smaller sets of representative molecules. Conf. Proc. Synthetic Chemical Libraries in Drug Discovery. London, October 30–31, 1995.
- Moreau, G. and Broto, P. (1980). The autocorrelation of a topological structure: A new molecular descriptor. *Nouv. J. Chim.* **4**, 359–360.
- Morphy, J. R., Rankovic, Z. and Rees, D. C. (1996). A novel linker strategy for solid-phase synthesis. *Tetrahedron Lett.* **37**, 3209–3212.
- Murphy, M. M., Schullek, J. R., Gordon, E. M. and Gallop, M. A. (1995). Combinatorial organic synthesis of highly functionalized pyrrolidines: Identification of a potent angiotensin converting enzyme inhibitor from a mercaptoacyl proline library. *J. Am. Chem. Soc.* **117**, 7029–7030.
- Murray, J. C., Buetow, K. H., Weber, J. L., Ludwigsen, S., Scherpbier-Heddema, T., Manion, F., Quillen, J., Sheffield, V. C., Sunden, S., Duyk, G. M., Weissenbach, J., Gyapay, G., Dib, C., Morrissette, J., Lathrop, G., M., Vignal, A., White, R., Matsunami, N., Gerken, S., Melis, R., Albertsen, H., Plaetke, R., Odelberg, S., Ward, D., Dausset, J., Cohen, D. and Cann, H. (1994). A comprehensive human linkage map with centimorgan density. *Science* **265**, 2049–2054.
- Needels, M. C., Jones, D. G., Tate, E. H., Heinkel, G. L., Kochersperger, L. M., Dower, W. J., Barrett, R. W. and Gallop, M. A. (1993). Generation and screening of an oligonucleotide-encoded synthetic peptide library. *Proc. Natl Acad. Sci. USA* **90**, 10700–10704.
- Nestler, H. P., Bartlett, P. A. and Still, W. C. (1994). A general method for molecular tagging of encoded combinatorial chemistry libraries. *J. Org. Chem.* **59**, 4723–4724.
- Neustadt, B., Wu, A., Smith, E. M., Nechuta, T., Fawzi, A., Zhang, H. and Ganguly, A. K. (1995). A case study of combinatorial libraries: endothelin receptor antagonists hexapeptides. *Bioorg. & Med. Chem. Lett.* **17**, 2041–2044.
- Ni, Z. J., Maclean, D., Holmes, C. P., Murphy, M. M., Ruhland, B., Jacobs, J. W., Gordon, E. M. and Gallop, M. A. (1996). Versatile approach to encoding combinatorial organic syntheses using chemically robust secondary amine tags. *J. Med. Chem.* **39**, 1601–1608.
- Nicolaou, K. C., Xiao, X.-Y., Parandoosh, Z., Senyei, A. and Nova, M. P. (1995). Radiofrequency encoded combinatorial chemistry. *Angew. Chem., Int. Ed. Engl.* **34**, 2289–2291.

- Nielsen, J., Brenner, S. and Janda, K. D. (1993). Synthetic methods for the implementation of encoded combinatorial chemistry. *J. Am. Chem. Soc.* **115**, 9812–9813.
- Nikolaiev, V., Stierandova, A., Krchnak, V., Seligmann, B., Lam, K. S., Salmon, S. E. and Lebl, M. (1993). Peptide-encoding for structure determination of non-sequenceable polymers within libraries synthesized and tested on solid-phase supports. *Peptide Res.* **6**, 161–170.
- O'Connell, D., Koenig, A., Jennings, S., Hicke, B., Han, H. L., Fritzwater, T., Chang, Y. F., Varki, N., Parma, D. and Varki, A. (1996). Calcium-dependent oligonucleotide antagonists specific for L-selectin. *Proc. Natl Acad. Sci. USA* **93**, 5883–5887.
- Ohlmeyer, M. H., Swanson, R. N., Dillard, L. W., Reader, J. C., Asouline, G., Kobayashi, R., Wigler, M. and Still, W. C. (1993). Complex synthetic chemical libraries indexed with molecular tags. *Proc. Natl Acad. Sci. USA* **90**, 10922–10926.
- Ostresh, J. M., Husar, G. M., Blondelle, S. E., Dörner, B., Weber, P. A. and Houghten, R. A. (1994). Libraries from libraries: Chemical transformation of combinatorial libraries to extend the range and repertoire of chemical diversity. *Proc. Natl Acad. Sci. USA* **91**, 11138–11142.
- Pasqualini, R. and Ruoslahti, E. (1996). Organ targeting *in vivo* using phage display peptide libraries. *Nature* **380**, 364–366.
- Patek, M. and Lebl, M. (1991). Safety-catch anchoring linkage for synthesis of peptide amides by Boc/Fmoc strategy. *Tetrahedron Lett.* **32**, 3891–3894.
- Patek, M., Drake, B. and Lebl, M. (1995). Solid phase synthesis of 'small' organic molecules based on a thiazolidine scaffold. *Tetrahedron Lett.* **36**, 2227–2230.
- Pearlman, R. S. (1996). Novel software tools for addressing chemical diversity. Network Science (<http://www.awod.com>), June 1996.
- Pei, Y. and Moos, W. H. (1994). Post-modification of peptoid side chains: (3 + 2) cycloaddition of nitrile oxides with alkenes and alkynes on the solid-phase. *Tetrahedron Lett.* **35**, 5825–5828.
- Peisach, E., Casebier, D., Gallion, S. L., Furth, P., Petsko, G. A., Hogan Jr., J. C. and Ringe, D. (1995). Interaction of a peptidomimetic aminimide inhibitor with elastase. *Science* **269**, 66–69.
- Pinilla, C., Appel, J. R., Blanc, P. and Houghten, R. A. (1992). Rapid identification of high affinity peptide ligands using positional scanning synthetic peptide combinatorial libraries. *BioTechniques* **13**, 901–905.
- Pirrung, M. C. and Chen, J. (1995). Preparation and screening against acetylcholinesterase of a non-peptide indexed combinatorial library. *J. Am. Chem. Soc.* **117**, 1240–1245.
- Plunkett, M. J. and Ellman, J. A. (1995a). A silicon-based linker for traceless solid-phase synthesis. *J. Org. Chem.* **60**, 6006–6007.
- Plunkett, M. J. and Ellman, J. A. (1995b). Solid-phase synthesis of structurally diverse 1,4-benzodiazepine derivatives using the Stille coupling reaction. *J. Am. Chem. Soc.* **117**, 3306–3307.
- Puras-Lutzke, R. A., Eppens, N. A., Weber, P. A., Houghten, R. A. and Plasterk, R. H. A. (1995). Identification of a hexapeptide inhibitor of the human immunodeficiency virus integrase protein by using a combinatorial chemistry library. *Proc. Natl Acad. Sci. USA* **92**, 11456–11460.
- Quillan, J. M., Jayawickreme, C. K. and Lerner, M. R. (1995). Combinatorial diffusion assay used to identify topically active melanocyte-stimulating hormone receptor antagonists. *Proc. Natl Acad. Sci. USA* **92**, 2894–2898.
- Rademann, J. and Schmidt, R. R. (1996). A new method for the solid phase synthesis of oligosaccharides. *Tetrahedron Lett.* **37**, 3989–3990.
- Rano, T. A. and Chapman, K. T. (1995). *Tetrahedron Lett.* **36**, 3789–3792.
- Rich, D. H. and Gurwara, S. K. (1975). Preparation of a new *o*-nitrobenzyl resin for solid-phase synthesis of tert.-butyloxycarbonyl protected peptide acids. *J. Am. Chem. Soc.* **97**, 1575–1578.

- Richter, L. S. and Gadek, T. R. (1994). A surprising observation about Mitsunobu reactions in solid phase synthesis. *Tetrahedron Lett.* **35**, 4705–4706.
- Richter, L. S. and Zuckermann, R. N. (1995). Synthesis of peptide nucleic acids (PNA) by submonomer solid-phase synthesis. *Bioorg. Med. Chem. Lett.* **5**, 1159–1162.
- Rigler, R. (1995). Fluorescence correlation, single molecule detection and large number screening. Applications in biotechnology. *J. Biotechnol.* **41**, 177–186.
- Rink, H. (1987). Solid-phase synthesis of protected peptide fragments using a trialkoxy-diphenyl-methylester resin. *Tetrahedron Lett.* **28**, 3787–3790.
- Rubin, E. M. and Barsh, G. S. (1996). Biological insights through genomics – Mouse to man. *J. Clin. Invest.* **97**, 275–280.
- Ruhland, B., Bhandari, A., Gordon, E. M. and Gallop, M. A. (1996). Solid-supported combinatorial synthesis of structurally diverse β -lactams. *J. Am. Chem. Soc.* **118**, 253–254.
- Rusinko, A., Webster Andrews, E., Brown, F. K., Cummins, D. J., Farnen, M. W., Manius, J. A. and Young, S. S. (1996). Novel uses of graph eigenvalues: applications to database mining and combinatorial chemistry. Fourth Int. Conf. Chemical Structures, Abstr. No. 6, Noordwijkerhout, June 2–5, 1996.
- Sadowski, S. K., Wagener, M. and Gasteiger, J. (1995). Assessing similarity and diversity of combinatorial libraries by spatial autocorrelation functions and neural networks. *Angew. Chem., Int. Ed.* **34**, 2674–2677.
- Safar, P., Stierandova, A. and Lebl, M. (1995). Amino acid-like subunits based on iminodiacetic acid and their application in linear and DkP libraries. In *Peptides* **94**, Proc. 23 EPS (H. L. S. Maia, ed.), pp. 471–472. ESCOM, Leiden.
- Salmon, S. E., Lam, K. S., Lebl, M., Kandola, A., Khattri, P. S., Wade, S., Patek, M., Kocis, P., Krchnak, V., Thorpe, D. and Felder, S. (1993). Discovery of biologically active peptides in random libraries. Solution phase testing after staged orthogonal release from resin beads. *Proc. Natl Acad. Sci. USA* **90**, 11708–11712.
- Sarkar, S. K., Garigipati, R. S., Adams, J. L. and Keifer, P. A. (1996). An NMR method to identify nondestructively chemical compounds bound to a single solid-phase-synthesis bead for combinatorial chemistry applications. *J. Am. Chem. Soc.* **118**, 2305–2306.
- Sarshar, S., Siev, D. and Mjalli, A. M. M. (1996). Imidazole libraries on solid support. *Tetrahedron Lett.* **37**, 835–838.
- Schwyzler, R., Felder, E. R. and Failli, P. (1984). The CAMET and CASET links for the synthesis of protected oligopeptides and oligonucleotides on solid and soluble supports. *Helv. Chim. Acta* **67**, 1316–1327.
- Scott, J. K. and Smith, G. P. (1990). Searching for peptide ligands with an epitope library. *Science* **249**, 386–390.
- Sebestyen, F., Szalatnyai, T., Durgo, J. A. and Furka, A. (1995). Binary synthesis of multicomponent peptide mixtures by the portioning-mixing technique. *J. Pept. Sci.* **1**, 26–30.
- Shemetulski, N. E., Dunbar, J. B., Dunbar, B. W., Moreland, D. W. and Humblet, C. (1995). Enhancing the diversity of a corporate database using chemical database clustering and analysis. *J. Comp. Aided Mol. Design* **9**, 315–416.
- Sheppard, R. C. and Williams, B. J. (1982). A new protecting group combination for solid phase synthesis of protected peptides. *J. Chem. Soc. Chem. Commun.* 587–589.
- Sheridan, R. P. and Kearsley, S. K. (1995). Using a genetic algorithm to suggest combinatorial libraries. *J. Chem. Inf. Comput. Sci.* **35**, 310–320.
- Sheridan, R. P., Miller, M. D., Underwood, D. J. and Kearsley, S. K. (1996). Chemical similarity using geometric atom pair descriptors. *J. Chem. Inf. Comput. Sci.* **36**, 128–136.
- Siani, M. A., Weininger, D., James, and Blaney, J. M. (1994). CHUCKLES: A method for representing and searching peptide and peptoid sequences on both monomer and atomic levels. *J. Chem. Inf. Comput. Sci.* **34**, 599–593.

- Siani, M. A., Weininger, D., James, C. A. and Blaney, J. M. (1995). CHORTLES: A method for representing oligomeric and template-based mixtures. *J. Chem. Inf. Comput. Sci.* **35**, 1026–1033.
- Simon, R. J., Kania, R. S., Zuckermann, R. N., Huebner, V. D., Jewell, D. A., Banville, S., Ng, S., Wang, L., Rosenberg, S., Marlowe, C. K., Spellmeyer, D. C., Tan, R., Frankel, A. D., Santi, D. V., Cohen, F. E. and Bartlett, P. A. (1992). Peptoids: a modular approach to drug discovery. *Proc. Natl Acad. Sci. USA* **89**, 9367–9371.
- Singh, J., Ator, M. A., Jaeger, E. P., Allen, M. P., Whipple, D. A., Solowej, J. E., Chowdhary, S. and Treasurywala, A. M. (1995). Application of genetic algorithms to combinatorial synthesis: A computational approach to lead identification and lead optimization. *J. Am. Chem. Soc.* **118**, 1669–1676.
- Smith, D. H. (1996). Managing the combinatorial explosion. Fourth Int. Conf. Chemical Structures, Abstr. No. 11, Noordwijkerhout, June 2–5, 1996.
- Smith, G. P. (1985). Filamentous fusion phage: novel expression vectors that display cloned antigens on the virion surface. *Science* **228**, 1315–1317.
- Sparks, A. B., Quilliam, L. A., Thorn, J. M., Der, C. J. and Kay, B. K. (1994). Identification and characterization of Src SH3 ligands from phage-displayed random peptide libraries. *J. Biol. Chem.* **269**, 23853–23856.
- Spellmeyer, D. C., Blaney, J. M. and Martin, E. (1997). Computational approaches to chemical libraries. In 'Computer-assisted Molecular Modeling in Molecular Pharmacology'. (Charifson, P., ed.), Marcel Dekker, New York.
- Stevenson, C. L., Augustijns, P. F. and Hendren, R. W. (1995). Permeability screen for synthetic peptide combinatorial libraries using caco-2 cell monolayers and LC-MS-MS. *Pharm. Res.* **12**, 94.
- Strocker, A. M., Keating, T. A., Tempest, P. A. and Armstrong, R. W. (1996). Use of a convertible isocyanide for generation of Ugi reaction derivatives on solid support: synthesis of α -acylaminoesters and pyrroles. *Tetrahedron Lett.* **37**, 1149–1152.
- Synopsys Scientific Systems Ltd. (1996a). Solid Phase Synthesis Database. <http://www.synopsys.co.uk/>
- Synopsys Scientific Systems Ltd. (1996b). Accord for Excel. <http://www.synopsys.co.uk/>
- Taylor, R. (1995). Simulation analysis of experimental design strategies for screening random compounds as potential new drugs and agrochemicals. *J. Chem. Inf. Comp. Sci.* **35**, 59–67.
- Tempest, P. A., Brown, S. D. and Armstrong, R. W. (1996). Solid-phase, parallel syntheses by Ugi multicomponent condensation. *Angew. Chem., Int. Ed. Engl.* **35**, 640–642.
- Terrett, N. K., Bojanic, D., Brown, D., Bungay, P. J., Gardner, M., Gordon, D. W., Mayers, C. J. and Steele, J. (1995a). The combinatorial synthesis of a 30,752-compound library: discovery of SAR around the endothelin antagonist, FR-139,317. *Bioorg. Med. Chem. Lett.* **5**, 917–922.
- Terrett, N. K., Gardner, M., Gordon, D. W., Kobylecki, R. J. and Steele, J. (1995b). Combinatorial synthesis – The design of compound libraries and their application to drug discovery. *Tetrahedron* **51**, 8135–8173.
- Thompson, L. A. and Ellman, J. A. (1994). Straightforward and general method for coupling alcohols to solid supports. *Tetrahedron Lett.* **35**, 9333–9336.
- Thompson, L. A. and Ellman, J. A. (1996). Synthesis and applications of small molecule libraries. *Chem. Rev.* **96**, 555–600.
- Tripos Inc. (1995). 'Legion and Selector Software'. Tripos Inc, St Louis, MO.
- Tuerk, C. and Gold, L. (1990). Systematic evolution of ligands by exponential enrichment: RNA ligands to Bacteriophage T4 DNA Polymerase. *Science* **249**, 505–510.
- Turner, D. B., Tyrrell, S. M. and Willett, P. (1996). Comparison of compound-selection techniques. Fourth Int. Conf. Chemical Structures, Abstr. No. 28, Noordwijkerhout, June 2–5, 1996.

- Ugi, I., Dömling, A. and Hörl, W. (1994). Multicomponent reactions in organic chemistry. *Endeavour* **18**, 115–122.
- Valentine, J. S. and Foote, C. S. (1996). *Acc. Chem. Res.* **29**, 112–170.
- van Drie, J. H. (1995). 3D Database searching in drug discovery. Network Science (<http://www.awod.com>), September 1995.
- Wang, G. T., Li, S., Wideburg, N., Krafft, G. A. and Kempf, D. J. (1995). Synthetic chemical diversity: solid phase synthesis of libraries of c2 symmetric inhibitors of HIV protease containing diamino diol and diamino alcohol cores. *J. Med. Chem.* **38**, 2995–3002.
- Wang, S. S. (1973). *p*-Alkoxybenzyl alcohol resin and *p*-alkoxybenzyloxycarbonylhydrazide for solid phase synthesis of protected peptide fragments. *J. Am. Chem. Soc.* **95**, 1328–1333.
- Weber, L., Wallbaum, S., Broger, C. and Gubernator, K. (1995). Optimization of the biological activity of combinatorial compound libraries by a genetic algorithm. *Angew. Chem. Int. Ed.* **34**, 2280–2282.
- Wehs, C., Berres, M. and Grize, Y. L. (1995). Statistical design of experiments in industrial practice. *Surv. Math. Ind.* **5**, 49–73.
- Willett, P. (1991). 3D Chemical Structure Handling. Wiley Int., New York.
- Wilson-Lingardo, L., Davis, P. W., Ecker, D. J., Hebert, N., Acevedo, O., Sprankle, K., Brennan, T., Schwarcz, L., Freier, S. M. and Wyatt, J. R. (1996). Deconvolution of combinatorial libraries for drug discovery: Experimental comparison of pooling strategies. *J. Med. Chem.* **39**, 2720–2726.
- Winter, J. (1994). Bacteriophage display: Peptide libraries and drug discovery. *Drug Dev. Res.* **33**, 71–89.
- Wipf, P. and Cunningham, A. (1995). A solid phase protocol of the Biginelli dihydropyrimidine synthesis suitable for combinatorial chemistry. *Tetrahedron Lett.* **36**, 7819–7822.
- Wyatt, J. R., Vickers, T. A., Roberson, J. L., Buckheit, R. W., Klimkait, T., Debaets, E., Davis, P. W., Rayner, B., Imbach, J. L. and Ecker, D. J. (1994). Combinatorially selected guanosine-quartet structure is a potent inhibitor of Human Immunodeficiency Virus envelope-mediated cell fusion. *Proc. Natl Acad. Sci. USA* **91**, 1356–1360.
- Yan, B., Kumaravel, G., Anjaria, H., Wu, A., Petter, R. C., Jewell, C. F. and Wareing, J. R. (1995). Infrared spectrum of a single resin bead for real-time monitoring of solid-phase reactions. *J. Org. Chem.* **60**, 5736–5738.
- Yan, L., Taylor, C. M., Goodnow, R. and Kahne, D. (1994). Glycosylation on the Merrifield resin using anomeric sulfoxides. *J. Am. Chem. Soc.* **116**, 6953–6954.
- Yang, M., Wu, Z. and Fields, S. (1995). Protein–peptide interactions analyzed with the yeast two-hybrid system. *Nucl. Acids Res.* **23**, 1152–1156.
- Young, S. S., Farmen, M. and Rusinko, A. (1996). Random versus rational. Which is better for general compound screening?. Network Science (<http://www.awod.com>), August 1996.
- Yu, K.-L., Deshpande, M. S. and Vyas, D. M. (1994). Heck reactions in solid phase synthesis. *Tetrahedron Lett.* **35**, 8919–8922.
- Zaborowski, M. and Hobbs DeWitt, S. (1995). Data management for combinatorial chemistry. Network Science (<http://www.awod.com>), November 1995.
- Zhang, C, Moran, E. J., Woiwode, T. F., Short, K. M. and Mjalli, A. M. M. (1996). Synthesis of tetrasubstituted imidazoles via α -(*N*-acyl-*N*-alkylamino)- β -ketoamides on Wang resin. *Tetrahedron Lett.* **37**, 751–754.
- Zhao, P. L., Nachbar, J. A., Bolognese, J. A. and Chapman, K. (1996). Two new criteria for choosing sample sizes in combinatorial chemistry. *J. Med. Chem.* **39**, 350–352.
- Zhao, P. L., Zambias, R., Bolognese, J. A., Boulton, D. and Chapman, K. (1995). Sample size determination in combinatorial chemistry. *Proc. Natl. Acad. Sci USA* **92**, 10212–10216.
- Zuckermann, R. N., Kerr, J. M., Kent, S. B. H. and Moos, W. H. (1992). Efficient method for the preparation of peptoids (Oligo(*N*-substituted glycines)) by submonomer solid-phase synthesis. *J. Am. Chem. Soc.* **114**, 10646–10647.

Zuckermann, R. N., Martin, E. J., Spellmeyer, D. C., Stauber, G. B., Shoemaker, K. R., Kerr, J. M., Figliozzi, G. M., Goff, D. A., Siani, M. A., Simon, R. J., Banville, S. C., Brown, E. G., Wang, L., Richter, L. S. and Moos, W. H. (1994). Discovery of nanomolar ligands for 7-transmembrane G-protein-coupled receptors from a diverse *N*-(substituted) glycine peptoid library. *J. Med. Chem.* **37**, 2678–2685.

Appendix

SOME TERMS AND EXPRESSIONS

Bead A solid, insoluble, spherical microparticle, typically used for solid phase chemical synthesis. Diameters range from *c.* 10 to *c.* 300 μm . Materials are, e.g., crosslinked polystyrene matrix, polyamide, Sepharose, glass, polystyrene grafted with polyoxyethylene. The term is also used for non-spherical particles. There are approximately 2.5 million '90 μm -beads' per gram of resin. Beads may be used as a carrier to synthesize library components (solid phase synthesis) and also to keep such compounds physically separate from each other (after *split synthesis*), for binding assays, e.g., with a labelled target protein (acceptor) or for **bead pooling**.

Bead pooling Bead pooling strategies aim to efficiently test 'one-bead-one-compound' libraries beyond simple binding assays with labelled acceptors, i.e. with functional assays in solution. Ligands are therefore cleaved from the beads (partial cleavage of a first portion). In order to achieve an acceptable throughput it is necessary to test mixtures resulting from bead pools (e.g. 100 or 1000 beads) in a multiwell format. Interesting activities are then correlated to a particular pool of 'mother beads' carrying a molecular tag. These beads are redistributed on a singular basis into new multiwell plates, where a second portion of the ligands is released into solution and the activities of single compounds are measured. Bead pooling on a large scale requires advanced automation.

Encoded libraries (= ESL = encoded synthetic libraries = encoded 'one-bead-one-compound' libraries) If the ligands assembled on a *one-bead-one-compound* library are not directly sequenceable molecules, the identity of positive hits is determined by sequencing or determining the composition of a 'tag' molecule residing on the same bead. The tag has to be built up in parallel with the potential ligand. Two classes of molecular tags have been described and applied: *sequential tags* and *bitmap (non-sequential) tags*. The former are typically oligonucleotides or peptides, synthesized by alternating cycles of ligand and tag chain elongation with the help of orthogonal protection groups. For instance, an amino acid or a dipeptide unit may code

for the identity of an 'artificial' building block which is neither an amino acid nor a nucleotide. Bitmap tags on the other hand are 'read' in a binary mode: the mere presence or absence of a series of tag building blocks (which don't need to be linked together) translates into *words* of information coding for both the presence *and the position* of a non-sequenceable ligand building block. The potential ligand is always present in vast excess over the tag sequence.

High diversity libraries Libraries with maximal element variability. The latter is preferentially achieved by including a large number of building blocks in relatively short sequences rather than by sequence elongation.

Iterative deconvolution The libraries consist of a set of separate sublibraries (compound mixtures) in solution. The evaluating assay may therefore be any test system applicable to compound solutions, including functional assays in cellular systems. The sublibraries are mixtures of compounds (typically oligomeric sequences) with a (known) constant, a randomized and a (known, defined) variable region. In analogy to the *one-bead-one-compound* approach the sublibraries are prepared with the portioning-mixing procedure in order to ensure equal representations of all (slow- and fast-reacting) building blocks. They are tested as if they were single compounds. In an iterative process, the mixtures are compared with each other, the 'winning' variable regions are determined and incorporated as constant positions in a following round of synthesis which produces less complex mixtures. Repetitive cycles of this procedure lead ultimately to one defined molecule with the best performance in the test system used. This strategy circumvents the necessity for analytical identification. Building blocks other than natural amino acids or nucleotides can be incorporated. The first set of sublibraries comprises as many mixtures as the number of building blocks, if only one position is defined in the beginning, e.g. 20 sublibraries for 20 amino acids. If two positions are defined, the number is $(20 \times 20 =)$ 400. For each subsequent round of tests, 20 new sublibraries are prepared. If positions are defined contemporaneously, the number of sublibraries to be tested increases multiplicatively rather than additively.

Mimotopes Small linear mimics of discontinuous epitopes.

One-bead-one-compound approach A library of potential ligands (e.g. oligomeric sequences) is synthesized on solid microparticles (e.g. resin beads), using a portioning/mixing procedure (split synthesis). Each particle is loaded with only one type of ligand (approximately 100 to 1000 pmol). The potential ligands are completely deprotected but remain grafted on the beads. They are screened by incubating the beads with a solution of labelled *acceptor* molecules (e.g. a fluorescent enzyme or receptor) which may be recycled and

used in a separate experiment. After a number of wash operations with increasing stringency, the bead population is either visually inspected (e.g. while irradiating at excitation wavelength) or sorted with an adapted *fluorescence activated cell sorter* (FACCS). The ligands of beads carrying the label are determined either by sequencing directly the ligand or by analysing an 'identification tag' residing on the same bead (see **Encoded libraries**). The library elements are on physically separate entities (beads). The observed bindings originate from interactions with single compounds in heterogeneous phase. The approach may lead to a variety of lead structures.

Peptoids Oligomeric sequences of *N-substituted glycines*. Peptide surrogates preferentially used for combinatorial libraries in order to display functionalities of peptides or potentially many other 'side chains' in a novel backbone. Resistant to peptidases.

Phage libraries Consist of up to 10^{15} filamentous phage clones, each displaying an extraneous peptide sequence on the phage surface protein. The peptide is coded by a DNA sequence in the phage genome. An acceptor of interest (e.g. an antibody, receptor, enzyme, etc.) is used to affinity purify phages that display binding peptides.

Pin technology Compounds are synthesized simultaneously at the tip of plastic pins in the 96-multiwell plate format.

RPD Recombinant peptide diversity: peptides expressed on the surface of cells or phages, randomized by means of genetic engineering of the DNA coding for them.

Sequential unrandomization An operation that is part of some iterative deconvolution strategies. Each time sublibraries are tested and compared with each other a 'winning' sublibrary is determined. Its superiority originates from the contribution of a unique variable that is defined for each sublibrary. The 'winning' variable will be constantly included in the next rounds of synthesis, resulting in sublibraries with fewer and more defined components where the number of randomized positions is diminished by one and the number of constant positions increased by one. Each 'unrandomization' step may be carried out at a single or at multiple positions simultaneously. For single positions, the number of sublibraries to be tested for a round of assays is equal to the number of building blocks N . An unrandomization step at two positions (simultaneously) requires $N \times N$ tests (second-order sublibraries). A typical example is the simultaneous unrandomization of the two N -terminal positions in a peptide library by testing ($20 \times 20 =$) 400 sublibraries. Subsequently, the positions are unrandomized sequentially at single

positions. This requires 20 additional tests per position; the total number of tests increases additively.

‘Small molecule’ libraries Libraries of non-oligomeric, non-peptidic, bio-stable compounds with molecular mass below approximately 600 Da.

Split Synthesis (= split-and-mix, = Portioning-Mixing, = Divide, Couple and Recombine) An ingenious procedure used for randomizing one or more positions within an oligomer and making sure that only one sequence (i.e. a number of identical oligomers with the same sequence) is represented on any particular bead. The method involves distributing a pool of resin beads into separate reaction vessels (*portioning*), each reacting with (for instance) a different (unique) amino acid allowing the coupling reactions to go to completion (*couple*). This avoids competition between slow- and fast-reacting amino acids and makes sure that each bead ‘sees’ only one reactant. The portions are then recombined (*mixing*), leading to a randomization of the sequence position.

Tea bags Solid phase resin beads are divided in portions and packed into foraminated or porous bags which are permeable to solvents and reagent solutions. An experimental set-up which is sometimes applied in the sequential unrandomizations for introducing defined variable sequence positions.

Thematic libraries (= intelligent libraries = biased libraries) Sizeable compound libraries for structural motif refinement comprising a comprehensive combinatorial reshuffle of a set of selected building blocks, whereby the selection relies on pre-existing information or hypotheses on what type of functionalities are important.

This Page Intentionally Left Blank

Reversal of Chloroquine Resistance in Malaria: A New Concept of Chemotherapy*

SANJAY BATRA and AMIYA P. BHADURI

Medicinal Chemistry Division, Central Drug Research Institute, Lucknow 226 001, India

1	Introduction	202
2	The Mechanism of Action of Chloroquine	203
2.1	DNA Interaction Theory	203
2.2	Inhibition of Protein Synthesis	204
2.3	Haem-CQ Complex Theory	204
2.4	Interference with Haemoglobin Degradation	205
2.4.1	Inhibition of Vacuolar Proteases	205
2.4.2	Increase in Vacuolar pH	206
2.4.3	Inhibition of Vacuolar Phospholipases	206
2.4.4	Inhibition of Iron Release	207
2.4.5	Inhibition of Haem Polymerase and Haem Oxygenase	207
3	Current Status of Chloroquine Resistance	208
4	The Mechanism of Chloroquine Resistance in <i>Plasmodia</i>	210
4.1	Increased Proteolytic Activity	210
4.2	Increased Permease Activity	211
4.3	Increased Drug Metabolism	211
4.4	Gene Amplification Theory	212
4.5	Decreased Haem Polymerase, Haem and Haemozoin	213
5	Strategies for the Development of Chloroquine Resistance Reversal Agents	214
5.1	Interference with the Efflux of Chloroquine in Resistant Parasites	214
5.1.1	Calcium Channel Blockers	214
5.1.2	Antidepressants and Neuronal Monoamine Re-uptake Inhibitors	215
5.1.3	Antihistamines	220
5.1.4	Verapamil and Chlorpromazine Analogues	220
5.1.5	Prostaglandin Oligomers	221
5.2	Reversal of Resistance in <i>mdr</i> Cancer Cells and in CQR Parasites: Are They Linked?	222
5.3	Interference with the Haem Degradation Pathway in CQR Parasites	223
6	Conclusion	226
	References	227

*This article is dedicated to (the late) Drs Satyavan Sharma and Manju Seth.

LIST OF ABBREVIATIONS

AEI	Activity enhancement index
A-T	Adenine – thymine
CQ	Chloroquine
CQR	Chloroquine resistant
CQS	Chloroquine sensitive
DNA	Deoxyribose nucleic acid
G-C	Guanine – cytosine
mdr	Multidrug resistant
Pgh-1	P-glycoprotein homologue-1
RMI	Response modification index
RNA	Ribose nucleic acid
RRA	Resistance reversal agent

1 Introduction

The long-drawn battles between malarial parasites and human subjects continue to expose our inadequacy to assess the capabilities of *Plasmodium falciparum* to survive and grow in the human body. The evidence for this observation is more than 2 million deaths per year in the world attributed to malaria.

The control of transmission of malaria parasites by insecticides and development of drugs representing diversity in molecular structures have not been able to limit the spread of the disease. The main reasons ascribed to this failure are the ability of the vector to survive in the presence of insecticides and the emergence of drug-resistant parasites (Vander Kaay, 1991). Drug resistance is defined as ‘the ability of the parasite to survive and multiply in the presence of concentrations of drug(s) which normally would destroy it’. The ability of the parasite to stand the pressure of the drug was first observed in 1910 in Brazil when some subjects infected with *P. falciparum* failed to respond to a regimen therapy with quinine which normally would have eradicated the parasite (Nocht and Werner, 1910). Since then resistance of malarial parasite for a single or a combination of drugs has been reported from various endemic areas. Chloroquine (CQ), a 4-aminoquinoline derivative, developed in 1940s as a blood schizontocide, exhibits rapid action, low toxicity, has low cost, can be used in pregnancy and is possibly the best studied antimalarial agent to date. Resistance to this useful drug is, therefore, a matter of serious concern and it calls for a new strategy of chemotherapy for combating the parasite. The simplest useful strategy would be to undo what *Plasmodia* have done. For example, if *Plasmodia* have developed resistance for CQ, an agent may be discovered which in combination with CQ may make CQ-resistant (CQR) *Plasmodia*

susceptible to CQ. Discovery of such an agent, hereafter called resistance reversal agent (RRA), is possible only after a careful and critical analysis of all the reported mechanisms of CQ action.

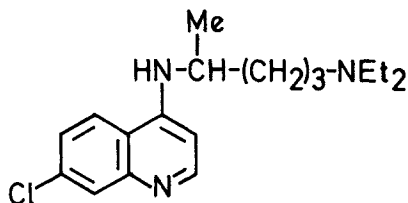

Chloroquine

2 The Mechanism of Action of Chloroquine

The mechanism of antimalarial action of CQ is incompletely understood. The relevant theories have been discussed in detail by Slater (1993), who analysed the proposed mechanisms with a focus on their capability to explain the various morphological and physiological changes exerted by CQ. In this section a summary of the important mechanism of action of CQ is presented to stimulate thinking on the possible cause(s) for the development of plasmodial resistance towards CQ. This drug is blood schizontocidal and affects only the intraerythrocytic stages of the life cycle of the malaria parasite. It does not affect the sporogonic, exoerythrocytic and mature stages at therapeutic concentrations. *In vitro* studies have shown that CQ does not prevent (i) the transformation of trophozoites to schizonts, (ii) the invasion of red blood cells by merozoites, or (iii) the transformation of merozoites to the ring stage (Zhang *et al.*, 1986). It was observed that the malarial parasite is susceptible to this drug in the late ring stage of the intraerythrocytic cycle (Yayon *et al.*, 1983). Reports on the possible mechanism of CQ action first appeared in the mid-1960s and this continues to this date. This indicates that the mechanism is far from being clear. The proposed mechanisms of CQ action in biophase are as follows.

2.1 DNA INTERACTION THEORY

The possible ability of CQ to intercalate with DNA and inhibit the vital cellular functions such as DNA replication and RNA synthesis leading to the death of the parasite was proposed by Parker and Irvin (1952) on the basis of their *in vitro* observation that quinoline and acridine containing anti-malarials interact with DNA. Subsequently, two types of interactions between DNA and CQ were suggested (Allison *et al.*, 1965a; Cohen and

Yielding, 1965). The first one relates to the secondary DNA structure while the second one postulates electrostatic interactions between the positively charged diaminopentane side-chain of CQ and the negatively charged phosphate residues of the nucleic acids. The latter was found to be the larger contributor towards the total binding energy of DNA-CQ complex (Marquez *et al.*, 1974). A substructural analysis was made indicating that the 7-chloroquinoline ring interacts with the guanine base, and that the diaminopentane side-chain interacts with phosphate residue (Hahn *et al.*, 1966). This concept received support from the model studies on the affinity of CQ for G/C-rich DNA or synthetic GC polymers (Allison *et al.*, 1965b; Cohen and Yielding, 1965). However, this hypothesis was rejected because (i) the malaria genome consists of 75% AT residues (Weber, 1988), (ii) binding of CQ to DNA, being dependent on salt concentrations, is likely to be far less at physiological levels of electrolytes (Kwaky-Berko and Meshnick, 1989), and (iii) it cannot explain the stage specificity of CQ action and strain's specificity of CQ resistance.

2.2 INHIBITION OF PROTEIN SYNTHESIS

The second hypothesis for explaining CQ action relates to the impediment of protein synthesis in *Plasmodia* and is based on two observations. It was reported that high CQ concentrations *in vitro* were able to reduce the protein synthesis in *P. falciparum* (Surolia and Padmanaban, 1991). The second observation was concerned with the stimulation of the cell-free protein synthesis of trophozoite extracts by haem. It was suggested that the high affinity of CQ for haem could ultimately have resulted in the reduction of protein synthesis. Like earlier hypotheses, the concept of possible reduction in protein synthesis by CQ cannot explain the stage-specific effect of this drug. It also overlooks the fact that the concentration of haem required to stimulate protein synthesis is fatal to *P. falciparum* (Fitch *et al.*, 1982, 1983). The concept of reduced protein synthesis was almost pushed to the point of non-consideration because of the reports of non-inhibition of protein synthesis by CQ in *P. berghei*, *P. lophurae* and *P. falciparum* (Homewood *et al.*, 1971; Sherman, 1976; Kirby *et al.*, 1989).

2.3 HAEM-CQ COMPLEX THEORY

Haem is released because of proteolysis of haemoglobin by the intra-erythrocytic malarial trophozoites. Despite the fact that relevance of haem for the stimulation of protein synthesis was ruled out, the attraction to understand the biochemical importance of haem continued because it inhibits various enzyme activities (Vander Jagt *et al.*, 1986) responsible for disrupting

the phospholipid structure of the membrane (Ginsburg and Damel, 1983; Schmitt *et al.*, 1993) and it increases lipid peroxidation (Tappel, 1953). Because of these effects, the parasite possibly prevents the accumulation of lethal levels of free haem by metabolizing it to haemozoin and finally to bilirubin. Chou *et al.* (1980) reported that CQ binds with haem with high affinity to form a CQ-haem complex. The formation of this complex was also evident with the non-invasive spectroscopic technique reported by Balasubramanian *et al.* (1984). Fitch (1983, 1986) suggested that CQ interferes with the metabolic processing of free haem by blocking the formation of haemozoin. This hypothesis received indirect support from the observation made by Warhurst (1981) that ferric haem was capable of binding to all quinoline-antimalarial drugs but not to their inactive isomers. It was soon realized that all quinoline-containing compounds do bind to haem in aqueous solution (Blauer, 1986a,b, 1988). Orjih and coworkers (1981) proposed that the selective antimalarial action of CQ results from the accumulation of this toxic CQ-haem complex. It was reported that CQ-susceptible *P. berghei* accumulated $20 \mu\text{M}$ of haem kg^{-1} or more as CQ-haem complex, which is sufficient to lyse the parasite. The importance of the toxic complex was also realized from the report of Sugioka *et al.* (1987) who observed the peroxidative cleavage of lipid membranes by this toxic complex. In addition to this observation, it was reported that the free haem or the CQ-haem complex was a good inhibitor of vacuolar protease (Vander Jagt *et al.*, 1986, 1987; Gluzman *et al.*, 1994). This led to the suggestion that the inhibition of this enzyme activity may lead to impairment of further haemoglobin degradation. The shortcomings of this hypothesis have been discussed in detail by Slater (1993). At present, the main debate centres around the questions raised by the formation of the CQ-haem complex. It is being argued that CQ accumulation as a result of CQ-haem interaction must involve specific receptors. This concept did not receive wide acceptance because of the overall agreement among most investigators that CQ accumulates by a weak base mechanism and not by binding to haem.

2.4 INTERFERENCE WITH HAEMOGLOBIN DEGRADATION

2.4.1 Inhibition of Vacuolar Proteases

The haemoglobin degradation pathway as a biochemical site for CQ action has also been proposed. It has been reported (Zarchin *et al.*, 1986) that CQ inhibits the production of amino acids in infected erythrocytes at concentrations which arrest parasite growth and this led to the identification of the haemoglobin degradation pathway as the site of CQ action. There are three proteolytic enzymes involved in haemoglobin degradation in the digestive vacuole (Gluzman *et al.*, 1994). These are aspartic proteases, aspartic

haemoglobinase I and II, and cysteine protease. It has been suggested that CQ blocks the process of haemoglobin degradation by inhibiting vacuolar proteases. Gyang *et al.* (1982) reported 60% inhibition of partially purified aspartic protease by 33 mM of CQ. This observation raised some justified objections for accepting protease hypothesis because the CQ concentration in the food vacuole never exceeds 1–5 mM.

2.4.2 Increase in Vacuolar pH

Yet another hypothesis for impaired haemoglobin degradation relates to an increase in vacuolar pH. The pH of the food vacuole of the parasite has been found to be acidic and ranges between 0.5 and 5.0 (Yayon *et al.*, 1984a; Krogstad *et al.*, 1985). The various proteases present in the food vacuole function well in this acidic pH and in the event of a rise in pH, haemoglobin breakdown is drastically reduced (Goldberg *et al.*, 1990; Goldberg, 1993). It is suggested that CQ, being a weak base, exists in a doubly protonated form in the lysosome and this helps to raise the pH of the food vacuole, leading to the impairment of haemoglobin degradation and supply of amino acids essential to the parasite (Homewood *et al.*, 1972). Krogstad *et al.* (1992) proposed that the malarial parasite had a greater capacity to concentrate CQ than the mammalian lysosome because he found that the trophozoite food vacuole could concentrate CQ 600 times more than mammalian lysosomes. However these claims were refuted by Ginsburg and coworkers (Ginsburg and Geary, 1987; Ginsburg, 1990; Ginsburg and Krugliak, 1992) who questioned the correctness of the procedure employed to measure vacuolar pH. They also reported the concentration of CQ required to raise vacuolar pH was extraordinarily high compared with pharmacological concentrations. These two contradictory reports have brought no consensus over the concept that vacuolar pH change could be the biochemical site of the CQ action.

2.4.3 Inhibition of Vacuolar Phospholipases

Vacuolar phospholipase in *Plasmodia* was also identified as a biochemical target site for the CQ action. Yayon *et al.* (1984b) suggested that the breakdown of the endocytic vesicle in the food vacuole was inhibited by CQ and that this process involved inhibition of phospholipases. Inhibition of the lysosomal phospholipases by CQ was also reported by other workers (Waite *et al.*, 1976; Vanden Bosch, 1980; Matsuzawa and Hostetler, 1980a,b; Mallorga *et al.*, 1980; Naor and Catt, 1981; Yayon and Ginsburg, 1983). Ginsburg and Krugliak (1992) reported the inhibition of malaria phospholipase A by two quinoline-containing antimalarials, namely quinine and mefloquine. However, these observations did not evoke widespread interest

because the subsequent characterization of phospholipase was not carried out unambiguously.

2.4.4 *Inhibition of Iron Release*

The involvement of haemoglobin degradation to explain the mechanism of action of CQ has been extended to correlate inhibition of iron release with CQ action. It was demonstrated by Gabay and Ginsburg (1993) that the acidification of the red blood lysate to pH 4.0–5.5 led to haem denaturation and release of iron, a necessary component for the parasite anabolism (Peto and Thomson, 1986; Hershko and Peto, 1988). The mechanism of iron release proposed by Gabay and Ginsburg (1993) involves the formation of ferryl radicals which subsequently attack adjacent haem molecules and cause the release of iron. These radicals were found to be insensitive to scavengers of reactive oxygen intermediates (Harel and Kanner, 1988; Puppo and Halliwell, 1988; Petersen *et al.*, 1989; Rice-Evans *et al.*, 1989). It was suggested (Blauer and Ginsburg, 1982; Blauer, 1986a, 1988) that the quinoline ring might interact with the porphyrin ring of haem and prevent the formation of ferryl or porphyrin radicals. According to these authors, such a mechanism inhibited the parasite propagation by depriving the necessary supply of the iron (Wyler, 1992). This hypothesis indicates the action of quinoline-containing antimalarials as cytostatic (Gabay *et al.*, 1994), but fails to explain the cytotoxic effects of these compounds on *Plasmodia* (Krugliak and Ginsburg, 1991). It is also difficult to envisage the structural complementarity of CQ with haem and haemozoin as the cause for arresting the propagation of the radical reaction.

2.4.5 *Inhibition of Haem Polymerase and Haem Oxygenase*

Despite various arguments and counter-arguments extended by workers busy elucidating the mechanism of action of CQ, the fact remains that haemoglobin degradation as the site of CQ action continues to appeal to many workers. Slater *et al.* (1991) reported that haemozoin consists of a haem polymer linked between the central ferric ion of one haem and the oxygen of the carboxylate group of another. The formation of this specific linkage between haem units is mediated by an enzyme named haem polymerase (Chou and Fitch, 1992; Slater and Cerami, 1992). It was proposed that inhibition of this enzyme would prevent the interlinking of haem units to yield haemozoin and would result in the higher titre of haem, which could be lethal to the parasite. This hypothesis raised a number of questions. For example, the presence of another haem-degrading enzyme, namely haem oxygenase, was reported in *Plasmodia* (Srivastava *et al.*, 1992a, 1992b). It has also been

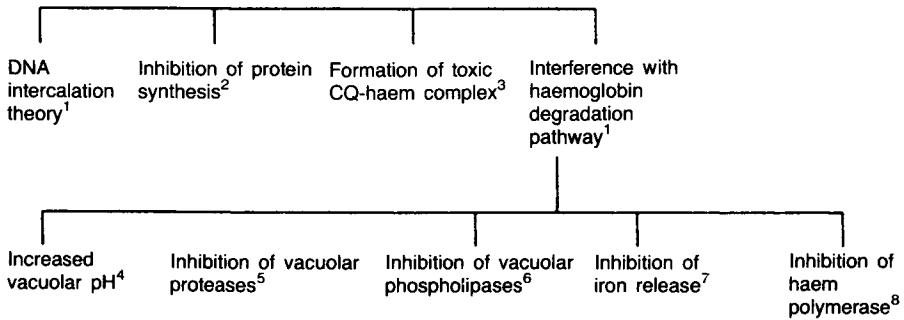

FIG. 1. Summary of the proposed mechanisms of action of chloroquine. Data from the following sources: ¹Parker and Irvine (1952); ²Surolia and Padmanaban (1991); ³Chou *et al.* (1980); ⁴Homewood *et al.* (1972); ⁵Gyang *et al.* (1982); ⁶Ginsberg and Geary (1987); ⁷Gabay and Ginsberg (1993); ⁸Slater and Cerami (1992).

reported that haem has the capability to polymerize to haemozoin in the absence of haem polymerase (Dorn *et al.*, 1995). It is also not well understood whether CQ has the capability to depolymerize haemozoin to haem; even the very formation of haemozoin as an experimental artefact has been proposed by Warhurst (1995). A survey of all these hypotheses indicates that the haemoglobin degradation pathway continues to be preferred by workers for elucidating the mechanism of antimalarial action of CQ (Figure 1).

3 Current Status of Chloroquine Resistance

Plasmodium falciparum is probably the most evasive of all *Plasmodia* and has acquired resistance not only towards CQ but also for other 4-aminoquinolines and antifolate antimalarials (Bjorkman and Howard, 1990a; Mockenhaupt, 1995). Acquisition of *in vitro* resistance even to the most current drug, namely artemisinin, has also been reported (Kamcohonwongpaisan *et al.*, 1994). The distribution of CQ-resistant populations of *P. falciparum* has become almost identical to that of the non-resistant species. Malaria is prevalent in South-East Asia, Oceania, East, Central and West Africa and South America. The frequency and degree of CQ resistance are high in the areas which have been affected for a very long period. Areas which are recently affected show considerable heterogeneity (Wernsdorfer, 1991).

The reports of CQ resistance in *P. falciparum* from South America (Moore and Lanier, 1961; Young and Moore, 1961) and South-East Asia (Harinasuta

et al., 1962) started appearing in the early 1960s. Since then, in about three-quarters of all countries (around 100) afflicted with falciparum malaria, CQ resistance has been reported (Wernsdorfer, 1991). The historical background of the spread of CQ resistance has been discussed in detail by Peters (1987). A WHO report (1984) provided the chronology of the spread of drug-resistant malaria. The status and epidemiology of drug resistance have been discussed by various workers (Doberstyn, 1984; WHO, 1987; Najera, 1989; Bjorkman and Howard, 1990a; Wernsdorfer, 1991, 1994).

After the first documental evidence of CQ resistance in *P. falciparum*, the march of CQ resistance has been relentless. In Asia, the point of origin was Thailand from where the parasite invaded the Malay peninsula within a span of a few years. By the mid-1960s it was present in the Oceania region and in the 1970s it encompassed the regions of Burma, India, Pakistan and eventually appeared in East Africa (Payne, 1988). In India, the problem of resistance in *P. falciparum* is always increasing (Anonymous, 1994). The most affected parts are the remote eastern regions adjoining Thailand and Burma, the States of Bihar, Orissa, Gujarat, Rajasthan, Karnataka and Haryana. Other less affected areas include the States of Uttar Pradesh, Madhya Pradesh and Delhi (Pattanayak *et al.*, 1994).

In Africa, the spread of CQR *P. falciparum* has also been rapid. The earlier reports (Fogh *et al.*, 1979; Kean, 1979) of resistance were from the non-immune population in East Africa but only after 3 years CQ resistance appeared in semi-immunes also (Kihamia and Gill, 1982). Thereafter, a number of reports have indicated the rate of drug failure from 10% (Watkins *et al.*, 1987) to 90% (Brasseur *et al.*, 1988; Hellgren *et al.*, 1989; Mulder *et al.*, 1992), with various parasite susceptibilities within the affected countries (Kilimali and Mkufya, 1985). The march of CQR *Plasmodia* in Central and West Africa was evident from the report made in the early 1990s (Basco *et al.*, 1993). The areas affected were Madagascar (Lepers *et al.*, 1989), Somalia (Warsame *et al.*, 1988), Rwanda (Garcia-Vidal *et al.*, 1989) and Zambia (Lemnge and Inambao, 1988). In contrast to the rapid increase of resistant strains in East and Central Africa, West Africa remained sensitive to CQ for a longer duration, as the first report of CQ resistance in this area appeared in 1986 (Neequaye, 1986). However, this region now has intensive malaria transmission and high endemicity (Landgraf *et al.*, 1994). The region includes countries such as Benin (Le Bras *et al.*, 1986; Chippaux *et al.*, 1987), Ghana (Neequaye, 1986), Nigeria (Lege-Oguntoye *et al.*, 1989; Daniel and Molta, 1989) and Cameroon (Sansone *et al.*, 1985; Oduola *et al.*, 1989; Mulder *et al.*, 1992).

While the first report of resistance to quinine was reported from Brazil, the first report of CQR *P. falciparum* in the northern region of South America appeared in the early 1960s (Moore and Lanier, 1961; Young and Moore, 1961). In most areas of South America where transmission of CQR *P. falciparum* continues, the severity and distribution are limited compared

with Asia and Africa. The noteworthy regions which are afflicted by CQR *P. falciparum* include Brazil, Columbia, French Guiana, Guyana, Surinam, Bolivia, Ecuador, Venezuela and Panama (Kremsner *et al.*, 1989).

This overview of the spread of CQR *Plasmodia* and the report of an end of an effective alternative in some of the affected areas (Wernsdorfer, 1991) clearly indicate the need for discovering another strategy for combating malaria. In this scenario the advent of RRAs would be a most welcome sign. As indicated in the later text, the consciousness of RRA and possibly a candidate RRA for preclinical studies may become a reality by the end of this century. However, the strategy for the development of RRAs, in principle, has to be based on the mechanism of CQ action and on the pathway by which *Plasmodia* develop resistance for CQ.

4 The Mechanism of Chloroquine Resistance in *Plasmodia*

CQ resistance of *P. falciparum* has been attributed to drug pressure, extensive use of subcurative doses and increased virulence of resistant parasites (Bjorkman and Howard, 1990b).

4.1 INCREASED PROTEOLYTIC ACTIVITY

Eckmann *et al.* (1977) reported that mice infected with CQ-sensitive (CQS) *P. berghei* generated only 20% carbon monoxide (CO), a breakdown product of the α -methine bridge of haem. Conversely, CQR-infected mice produced almost 100% of the CO. On the basis of this observation it was suggested that in the CQS parasite the haem of haemoglobin was converted to haemozoin and did not undergo further catabolism. In the CQR parasite increased proteolytic activity was investigated later by Mahoney and Eaton (1981) who reported 700–800% enhanced protease activity in CQR parasites compared with CQS parasites. They also found that interaction of CQ with haemoglobin was most efficient during proteolysis. These observations led to the hypothesis that in CQS parasites, less effective and incomplete proteolysis allowed haemozoin formation while in the CQR parasite an extremely efficient proteolysis did not offer an opportunity to produce haemozoin. The pure proteases from CQS and CQR parasites have been isolated and characterized (Vander Jagt *et al.*, 1986, 1992; Rosenthal *et al.*, 1988; Goldberg *et al.*, 1991; Rosenthal and Nelson, 1992; Gluzman *et al.*, 1994; Rosenthal, 1995). This helped in comparing proteases from CQS and CQR *P. falciparum* and it was reported (Vander Jagt *et al.*, 1987) that there was considerable similarity between the two. Wood and Eaton (1993) observed that the apparent rates of *in vivo* proteolytic activity in intact CQS and CQR *P. berghei*-infected erythrocytes were almost identical. These

reports raised doubts about proteases as the causative factor of CQ resistance.

4.2 INCREASED PERMEASE ACTIVITY

Warhurst (1986) proposed a permease model to explain the entry of CQ into the malarial parasite. This resistance towards CQ may be due to altered entry of CQ into the malarial parasite (Warhurst, 1988). The various possibilities, namely the change of permeability of membrane, reduction in the quantity of permease and reduced affinity of permease for CQ, could explain the mechanism of resistance. Warhurst also conceived that permease could be present in lysosomal membranes, which possibly helps to export CQ from lysosome back into the parasite cytoplasm. However, the hypothetical CQ carrier was not isolated and characterized. Krogstad *et al.* (1987) found that the rates of uptake of CQ in CQR and CQS *P. falciparum* were similar. This indicated that CQ affinity for permease, if any, was not the outcome of resistance. Despite the fact that permease presence could not be demonstrated, the hypothesis did stimulate thinking in the direction of CQ influx and CQ efflux. Krogstad *et al.* (1987) suggested enhanced drug efflux in erythrocytes infected with CQR parasites compared with CQS *Plasmodia*. The efflux was conceived to occur through a drug exporter mechanism which was either absent or deficient in erythrocytes infected with CQS *Plasmodia*. Ferrari and Cutler (1991) could not explain the kinetics of release of CQ by erythrocytes infected with CQR parasites by basal diffusion of CQ across the membrane, and therefore the need to postulate the involvement of a drug exporter did not arise.

4.3 INCREASED DRUG METABOLISM

Increased drug metabolism in CQR parasites as a possible cause of resistance has been investigated. Elevated metabolic rate with the involvement of cytochrome P450 was suggested (Golovenko, 1981). The malarial parasite possesses aryl hydrocarbon hydroxylase and aminopyrine *N*-demethylase activities, the two monooxygenases which can metabolize CQ to an inactive metabolite (McChesney *et al.*, 1967). Consideration of increased drug metabolism gained support from the report of Salganik *et al.* (1987) who found that these monooxygenase activities are higher in CQR *P. berghei* than in the sensitive strain. In an extended study, Rabinowich *et al.* (1987) reported that an inhibitor of these enzymes such as the copper-lysine complex was able to decrease the metabolic degradation and excretion of CQ. In a similar study Ndifor *et al.* (1990) reported increased *N*-demethylase and *O*-deethylase activities in resistant strains of *P. berghei* and *P. falciparum*.

It was suggested by Surolia and Padmanaban (1991, 1992) that synthesis of cytochrome P450 would require haem and any inhibition of its synthesis would lead to the inhibition of P450 synthesis (Surolia and Padmanaban, 1991). These workers proposed that increased P450-dependent activity in the CQR *P. falciparum* was due to the overexpression of the P450 gene and not to the differential efflux between the sensitive and the resistant strains (Surolia *et al.*, 1993).

4.4 GENE AMPLIFICATION THEORY

The concept of a higher efflux rate of CQ in CQR plasmodia has similarity to situations experienced in multidrug-resistant (mdr) mammalian tumour cells (Miyama *et al.*, 1985). In these tumour cells the mechanism of resistance was attributed to increased drug efflux mediated by a 170 kDa glycoprotein (P-glycoprotein). It was assumed that CQR *Plasmodia* may also possess such a drug-resistant gene (Cornwell *et al.*, 1986). In fact, two mdr genes of CQR *P. falciparum* were isolated (Wilson *et al.*, 1989; Foote *et al.*, 1989). These were termed *Pfmdr-1* and *Pfmdr-2*. Comparative studies with *Pfmdr-1* and human mdr 1 revealed 54% homology and it was realized that *Pfmdr-2* was not involved in CQ resistance (Wilson *et al.*, 1989). Foote *et al.* (1989) reported that the *Pfmdr-1* gene was present on chromosome 5 and amplification of this gene was related to extensive polymorphism in CQR isolates. Foote *et al.* (1990) suggested two different alleles, K-1 and 7G8. The five key positions which differed in *Pfmdr-1* sequence of resistant isolates from that of the sensitive isolates were asparagine-86 to tyrosine-86 in the K-1 type. In the 7G8 allele the differences identified were serine-1034 to cysteine-1034, asparagine-1042 to aspartic acid-1042 and aspartic acid-1246 to tyrosine-1246. These findings suggested that CQR was a multigenic event. Multigenic basis has also been demonstrated *in vitro* for CQR rodent malaria (Rosario, 1976; Padua, 1981). Contrary to these reports, observations made by Wellems *et al.* (1990) added a new dimension in this direction. These authors observed that a genetic cross between CQR and CQS cloned isolates of *P. falciparum* show no linkage of the *Pfmdr-1* with the drug-resistant phenotype. The CQR parent used in the genetic cross possessed amplified levels of *Pfmdr-1* gene but this amplification segregated independently of the CQR phenotype. All CQR progeny exhibited higher drug efflux, which suggested that either one gene or a small group of genes controlled the process. Cowman (1991) analysed the protein product of the *Pfmdr-1* and its involvement in the CQ efflux. He observed that the protein product of *Pfmdr-1*, namely P-glycoprotein homologue 1 (*Pgh-1*), did not increase in most of the CQR isolates of *P. falciparum*. It was therefore concluded that it was not directly involved in the CQR phenotype. The recent report by Haruki *et al.* (1994) helped to conclude that the CQ resistance of *P.*

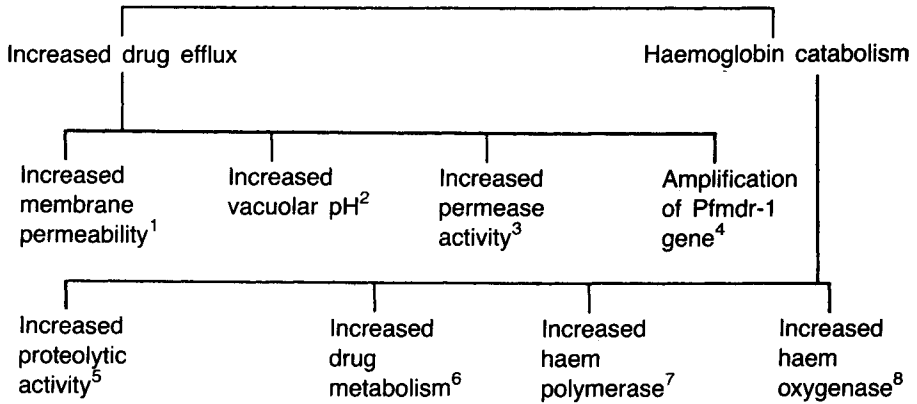

FIG. 2. Summary of the proposed mechanisms of chloroquine resistance in *Plasmodia*. Data from the following sources: ¹Krogstad *et al.* (1987); ²Ginsberg (1990); ³Warhurst (1988); ⁴Wilson *et al.* (1989); ⁵Mahoney and Eaton (1981); ⁶Suroliya and Padmanaban (1991); ⁷Slater (1993); ⁸Srivastava *et al.* (1992a).

falciparum was not regulated by the mutation of *Pfmdr-1*. The latest report by Cremer *et al.* (1995) also ruled out the correlation between the CQ resistance and the *Pfmdr-1* product.

4.5 DECREASED HAEM POLYMERASE, HAEM AND HAEMOZOIN

Studies on the degradation pathways of haemoglobin for understanding the cause of resistance have received considerable attention (Figure 2). Orjih and Fitch (1993) reported that the amount of haemozoin in the CQS *P. falciparum* was greater than that in the CQR parasites. Wood and Eaton (1993) observed decreased haemozoin in the CQR *P. berghei*. It was suggested that decrease in parasite haem was associated with decrease in CQ uptake thereby causing resistance to CQ. The presence of haem oxygenase and biliverdin reductase for haem degradation has also been reported (Srivastava *et al.*, 1992a, 1992b). These authors observed a seven- to ten-fold increase in haem oxygenase and biliverdin reductase activities in the cell free CQR *P. berghei* (Srivastava and Pandey, 1995). They too observed a decrease in haem polymerase activity, and that haemozoin was the substrate for haem oxygenase (*P. Srivastava and V. C. Pandey, unpublished work*). The increased levels of haem oxygenase and biliverdin reductase could, therefore, be attributed to plasmodial resistance towards CQ. The titre of haem oxygenase and biliverdin reductase

activities in resistant strains of *Plasmodia* infecting experimental animals and humans can become the enzyme markers for the correct identification and classification of resistant strains. Special attention must be given to estimate these enzyme titres in field isolates of *P. falciparum* and to understand the status of these two enzyme activities in mdr strains of parasite.

5 Strategies for the Development of Chloroquine Resistance Reversal Agents

The key point for developing a strategy to obtain RRA is the identification of the biochemical events which may be correlated with the development of resistance. From the preceding text it is obvious that the biochemical events which can be correlated with CQ resistance are (i) rapid rate of efflux in the CQR isolates and (ii) increased capability of CQR parasite to degrade haem or haemozoin. On the basis of these concepts two distinct schools have emerged. The first is concerned with the reversing of the higher efflux capability of CQR parasites leading to the higher residence time of CQ in the parasite. The second school presumes that the inhibition of the enhanced degradation of haem and haemozoin may help in the development of RRA. Exploitation of the results obtained from resistance reversal studies in human multidrug-resistant neoplastic cells led to the development of the first strategy for obtaining RRAs. The design of this strategy was based on the observation that some homology exists between the *Pfmdr-1* gene and genes encoding for the P-glycoprotein associated with drug resistance in the cancer cells (Wilson *et al.*, 1989; Foote *et al.*, 1989). It was assumed that inhibition of the P-glycoprotein-mediated pump responsible for the rapid efflux of the drug could increase the CQ residence time and result in making the CQR parasite susceptible to CQ. Since the development of RRA involves chemotherapy, a detailed analysis of the available results is essential. It is necessary that the available data of *in vitro* and *in vivo* studies are discussed since these would help to ascertain the success of the strategy employed for developing RRA.

5.1 INTERFERENCE WITH THE EFFLUX OF CHLOROQUINE IN RESISTANT PARASITES

5.1.1 Calcium Channel Blockers

The first report of the reversal of CQ resistance in *P. falciparum* was made by Martin *et al.* (1987). In an *in vitro* study, they observed that verapamil, a Ca^{2+} channel blocker, when administered along with CQ, was able to reverse CQ resistance in CQR W-2 (Indochina) and the IEC-306 (Brazil) strains of *P. falciparum*. Their experiments were based on reports that

verapamil was capable of reversing the resistance in the *mdr* neoplastic cells by inhibiting the drug efflux from resistant cells (Slater *et al.*, 1982; Rogan *et al.*, 1984; Fojo *et al.*, 1985). It was observed that 1–2 μM of verapamil were able to reduce the IC_{50} of the CQR W-2 clone to that of the CQS D-6 isolate, but the IC_{50} of the CQS D-6 isolate for this combination of drugs remained unchanged. Simultaneously, Milhous *et al.* (1987) reported that other Ca^{2+} antagonists also reversed CQ resistance *in vivo*. Further, *in vivo* studies carried out with the Ca^{2+} antagonists as RRA are limited. Tanabe *et al.* (1990) reported the *in vivo* effects of Ca^{2+} antagonists in rodents infected with CQS and CQR lines of *P. chabaudi*. It was found that when Ca^{2+} antagonists (verapamil, nifedipine or diltiazem) were given in combination with CQ, the CQS-infected mice became more susceptible to CQ. In the CQR-infected mice they reported considerable decrease in the parasitaemia when 3 mg kg^{-1} CQ (i.p.) in combination with 50 mg kg^{-1} verapamil (subcutaneous injection) was administered. In another *in vivo* study (Valecha *et al.*, 1992) on the evaluation of verapamil as RRA in rodent model against the CQR *P. berghei*, it was found that although the combination of verapamil and CQ was able to suppress the parasitaemia, there was only an incomplete reversal of resistance even at 50 mg kg^{-1} of verapamil administered subcutaneously.

5.1.2 Antidepressants and Neuronal Monoamine Re-uptake Inhibitors

Bitonti *et al.* (1988) reported that desipramine, a tricyclic antidepressant, was also capable of reversing CQ resistance *in vitro*. Their study was inspired by a few earlier reports that tricyclic antidepressants were associated with weak antimalarial and Ca^{2+} antagonistic activities (Reynolds and Claxton, 1982; Kristiansen and Jepsen, 1985; Dutta *et al.*, 1986, 1990). They analysed the resistance reversal properties of desipramine, protriptyline, imipramine, nortriptyline, doxepin, amoxepin, maprotiline, mianserin and trazodone (Figure 3). The study included the effect of these drugs on CQS D-6 isolate and CQR W-2 and FCR-3 (West Africa) clones of *P. falciparum*. On the basis of the results obtained from the *in vitro* studies they concluded that of all antidepressants, desipramine was the most efficient RRA. The *in vitro* concentrations of 150 ng ml^{-1} and 120 ng ml^{-1} brought down the CQ IC_{50} by about 80% in CQR FCR-3 and W-2 strains, respectively. It was also observed that desipramine increased the accumulation of [^3H]CQ by 10 times in the W-2 clone and three times in the FCR-3 clone but did not influence the CQ accumulation by the CQS D-6 isolate. On the basis of these increased accumulations they rationalized the mechanism of reversal with the inhibition of drug efflux linked to P-glycoprotein. They also reported the synergistic effect of a combination of CQ and desipramine against *P. falciparum*. They extended their study to evaluate the *in vivo* effect of desipramine with CQ

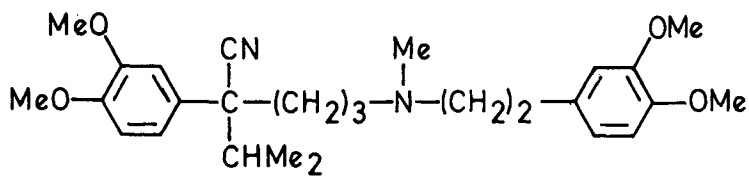

Verapamil

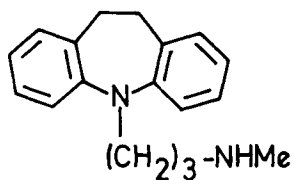

Desipramine

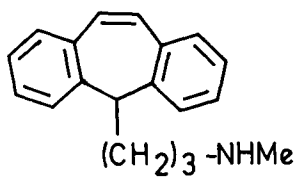

Protryptiline

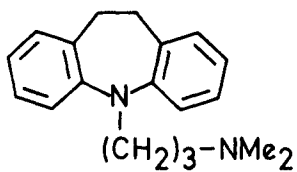

Imipramine

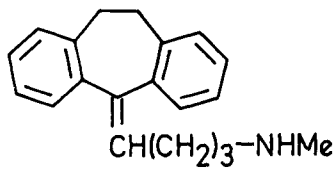

Nortryptiline

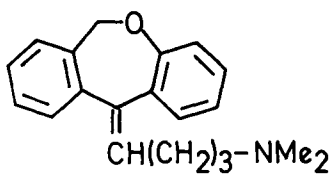

Doxepin

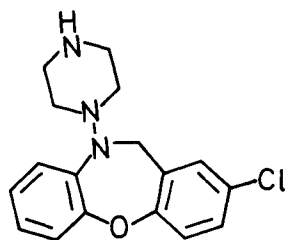

Amoxepin

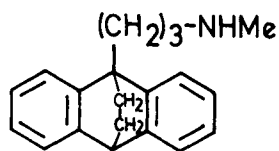

Maprotiline

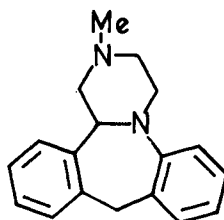

Mianserin

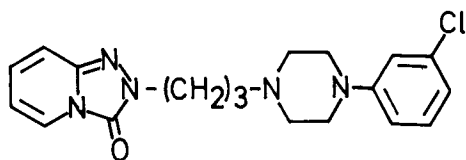

Trazodone

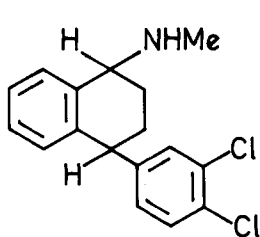

Sertraline

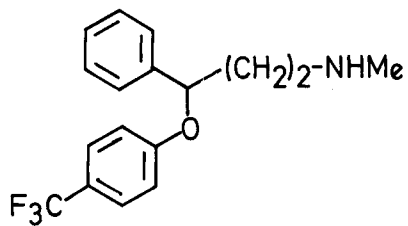

Fluoxetine

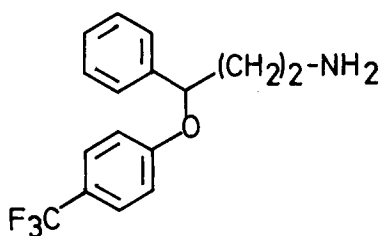

Norfluoxetine

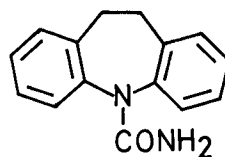

Carbamezepine

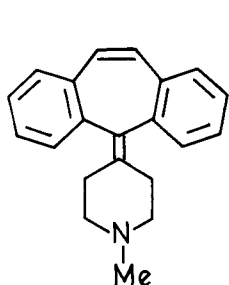

Cyproheptadine

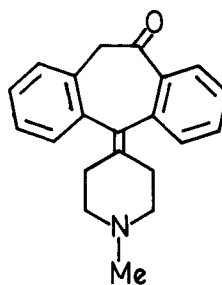

Ketotifen

FIG. 3. Chemical structure of components evaluated as RRA.

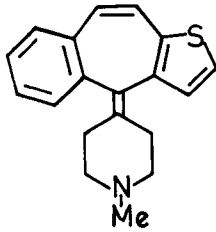

Pizotyline

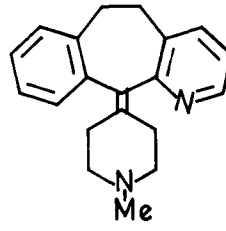

Azatadine

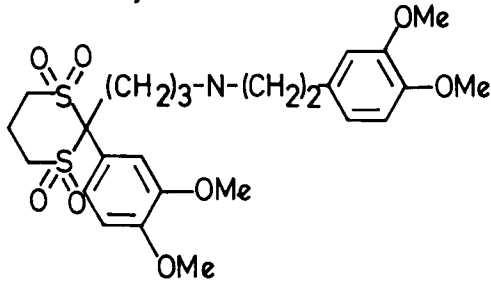

Tiapamil

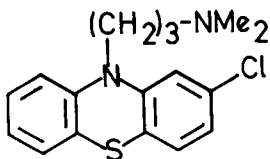

Chlorpromazine

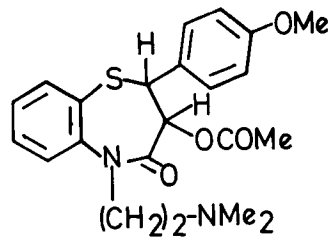

Diltiazem

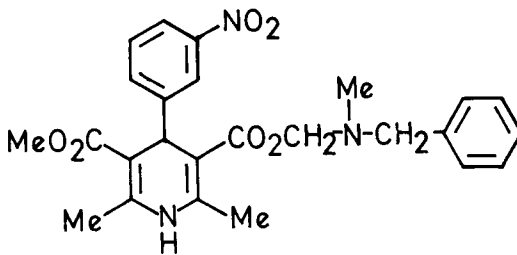

Nicardipine

FIG. 3. Continued.

in owl monkeys (*Aotus lemurinus lemurinus*). These monkeys were infected with CQR Vietnam Smith strain of *P. falciparum*. The treatment was given after 5 days when parasitaemia was established. The monkeys treated with CQ (20 mg kg⁻¹ once per day for 3 days) and desipramine (25 mg kg⁻¹ three times a day for 3 days) showed a marked decrease in parasitaemia in contrast to the one treated with CQ (20 mg kg⁻¹ once per day for 3 days) alone. It was also found that there was a striking reduction in parasitaemia in the CQR-infected owl monkey after 3 days of treatment with this combination, although 7 days are usually necessary to cure the owl monkeys infected with the CQS *P. falciparum* (Schmidt, 1973). Bitonti *et al.* (1988) concluded that although doses of desipramine used appeared to be higher than the comparable doses of desipramine in humans, the peak plasma concentrations were of the same range as those observed in humans receiving conventional doses of desipramine. However, they suggested that the dose needed in humans to obtain clearance of parasites may be less than that administered to monkey, making the clinical use of desipramine as RRA a realistic possibility.

This led to *in vitro* studies on 20 freshly isolated strains of *P. falciparum* out of which 14 were CQR and six were CQS. Basco and Le Bras (1990) argued that since all studies carried out earlier were restricted to strains which were well adapted to the *in vitro* condition, it was essential to examine the resistance reversal property of desipramine in the wild strains. It was observed that a combination of 2.5 to 5.8 times less CQ than its IC₅₀ value in each strain and 625 nM of desipramine was able to cause resistance reversal in all 14 CQR isolates while the CQS isolates were unaffected. They concluded that the reversal of CQ resistance was possible in all phenotypes.

In a recent *in vitro* study (Coutaux *et al.*, 1994) it was observed that antidepressants which act as neuronal monoamine reuptake inhibitors also modify the antimalarial activity of CQ against the CQR *P. falciparum*. The drugs evaluated in this report were desipramine, sertraline, fluoxetine, norfluoxetine and carbamazepine (Figure 3). It was found that in addition to desipramine, fluoxetine and norfluoxetine at 10 µg ml⁻¹, were also able to reverse CQ resistance. However, sertraline has reversal action of a lower order (RMI^a decreased by 75% only at 10 µg ml⁻¹) while carbamazepine (10 µg ml⁻¹) was found to be inactive. Gerena *et al.* (1992) have also reported the resistance reversal action of fluoxetine hydrochloride in CQR *P. falciparum*, *in vitro*.

$$^a\text{Response Modification Index (RMI)} = \frac{\text{IC}_{50}(\text{A,B})}{\text{IC}_{50}(\text{A})}$$

Where IC₅₀(A) is the CQ IC₅₀ and IC₅₀(A,B) represents the new CQ IC₅₀ obtained in the presence of RRA B at a given concentration.

5.1.3 Antihistamines

Peters *et al.* (1990) evaluated the properties of cyproheptadine, ketotifen, pizotyline, azatadine and loratadine (Figure 3) as RRA, both *in vitro* and *in vivo*. The *in vitro* effects were evaluated in the CQR K-1 strain of *P. falciparum* while the *in vivo* examinations were carried out in rodents infected with CQR *P. yoelii*. It has been reported that cyproheptadine at a concentration of $0.6 \mu\text{M}$ with CQ resulted in restoration of CQ activity with the Activity Enhancement Index (AEI^b) of 4.4 which was close to that of the positive controls, verapamil (AEI of 11.6 at $2 \mu\text{M}$) and desipramine (AEI of 7.87 at $9.3 \mu\text{M}$). The other active compounds were pizotyline, ketotifen and azatadine with AEIs of 4.38, 3.63 and 4.4, respectively, given in combination with CQ at concentrations equivalent to their EC₂₀s ($1.27 \mu\text{M}$, $0.37 \mu\text{M}$ and $0.99 \mu\text{M}$ respectively). Loratadine was, however, reported to be inactive with an AEI of less than 1.0 at $2.5 \mu\text{M}$.

In the *in vivo* examination Peters *et al.* (1990) observed that cyproheptadine, ketotifen, pizotyline and azatadine were also associated with some inherent antimalarial activity against the CQR *P. yoelii* strains with ED₉₀ of 10.0, 18.0, 21.0 and $140 \text{ mg kg}^{-1} \times 4$ given subcutaneously. These antihistaminics restored the activity of CQ in CQR *P. yoelii* *in vivo* at a dose of 3.0 mg kg^{-1} with AEI being 8.33, 7.07, 4.42 and 2.63 for cyproheptadine, ketotifen, pizotyline and azatadine respectively. These workers reported greater efficacy of these compounds compared with verapamil (AEI of 1.10 at 3.0 mg kg^{-1}) and desipramine (AEI of 1.20 at 3.0 mg kg^{-1}). Since all these antihistaminics were associated with some inherent antimalarial activity, also reported earlier by Pan *et al.* (1986), Huang *et al.* (1988), Zhou *et al.* (1988), a synergistic type of action was proposed by Peters *et al.* (1990) and they concluded that although cyproheptadine exhibited good resistance reversal *in vivo*, the effective concentration was much higher than the dose usually attained in humans.

5.1.4 Verapamil and Chlorpromazine Analogues

Kyle *et al.* (1990) evaluated a few other Ca²⁺ antagonists as possible RRAs. The various drugs explored for their resistance reversal properties included D-600 (methoxy-verapamil), Ro 11-2933/001 (a tiapamil analogue), chlorpromazine, SKF-2133-A (a chlorpromazine analogue), verapamil and

$${}^b\text{AEI} = \frac{\text{ED}_{90} \text{ of CQ alone}}{\text{ED}_{90} \text{ of CQ + partner}}$$

AEI of less than 2.0 for an RRA indicates the compound to be inactive.

diltiazem. This study also was conducted with the CQS D-6 isolate and the CQR W-2 clone of *P. falciparum*. It was observed that all Ca^{2+} antagonists were capable of potentiating the efficacy of quinoline-containing anti-malarials *in vitro*. Enhancement of the antimalarial activities by verapamil and chlorpromazine were similar to their structural analogues Ro-11-2933/001 and SKF-2133A. However, none of the combinations was able to enhance the activity of any quinoline-containing antimalarial drug in the CQS D-6 isolate. The study was extended to examine the ability of Ro 11-2933/001 and chlorpromazine to reverse the resistance using clinically achievable concentrations. It was found that in the presence of $6.25 \times 10^{-6} \text{ M}$ of chlorpromazine the IC_{50} of CQ for the CQR strain decreased to that observed in the CQS strain. It was also observed that at equimolar concentrations, chlorpromazine was 45% more effective than Ro 11-2933/001 in potentiating the antimalarial activity of CQ in the CQR W-2 clone. However, in *in vivo* studies carried out by Williams *et al.* (1992), the verapamil analogue Ro 11-2933/001 was unable to clear the parasitaemia when administered along with CQ. This study was initiated in eight monkeys (*Aotus trivirgatus*) infected with the CQR Vietnam Smith strain of *P. falciparum* and doses used were 25 mg kg^{-1} CQ (intramuscularly) and 10 mg kg^{-1} Ro-11-2933/001 (intramuscularly) or 200 mg kg^{-1} (oral). These workers also pointed out shortcomings in the earlier report by Bitonti *et al.* (1988) which included the *in vivo* data on only two monkeys without considering the phenomenon of self cure.

5.1.5 Prostaglandin Oligomers

Recently Chandra *et al.* (1993) have shown reversal of CQ resistance by prostaglandin derivatives *in vivo*. They anticipated that since membrane transport phenomena may have an important role in drug resistance, membrane-active substances would be able to induce a change in the drug resistance of the parasite. Since prostaglandin oligomers were reported to be associated with membrane activity *in vitro* (Ohnishi and Devlin, 1979; Uribe *et al.*, 1987; Kometani *et al.*, 1989), these workers examined the resistance reversal properties of such oligomers in rodents using the CQR *P. berghei*. During this study the effects of an oligomeric ester of prostaglandin (PG) B_2 (OC-5186), a monomeric ester of PGB_2 (OC-5181), an oligomeric ester of PGE_2 (MR 356), an unesterified monomer of PGA_2 and PGB_2 were evaluated. MR-356 which was reported to suppress the growth of *P. chabaudi* and *P. vinkei* *in vivo* (Ohnishi *et al.*, 1989a) and *P. falciparum* *in vitro* (Ohnishi *et al.*, 1989b) was unable to reverse the resistance when given at a dose of $3\text{--}6 \text{ mg kg}^{-1}$ in combination with 15 mg kg^{-1} CQ by i.p. route for 4 days. The PGB_2 derivative OC-5186 was able to reverse CQ resistance at a dose of $3\text{--}12 \text{ mg kg}^{-1} \text{ day}^{-1}$ along with 15 mg kg^{-1} CQ given

for 4 days. Possibly, a wider therapeutic window ($1.5\text{--}20\text{ mg kg}^{-1}$) would be of interest for the clinical application of OC-5186. Although OC-5181 exhibits some resistance reversal properties (at $6\text{ mg kg}^{-1}\text{ day}^{-1}$ along with CQ $15\text{ mg kg}^{-1}\text{ day}^{-1}$), the other monomer derivatives of PGA₂ and PGB₂ were inactive. Since OC-5186 and OC-5181 were capable of increasing the drug influx in *mdr* human leukaemia cells, they may behave in a similar fashion for the CQR parasite thereby increasing the drug accumulation.

5.2 REVERSAL OF RESISTANCE IN *mdr* CANCER CELLS AND IN CQR PARASITES: ARE THEY LINKED?

The various reports on resistance reversal in CQR parasites which appeared between 1987 to 1990 led Ginsburg (1991) to examine critically the strategy of linking the reversal of resistance in the CQR parasites to that of the *mdr* neoplastic cells. His view was that the extrapolation of the results of reversal of resistance in the *mdr* cancer cells to that of the CQR parasites was not logical since the phenomenology of resistance was different in both cells. The major differences pointed out are:

- (1) Possible absence of an efflux pump in malarial parasite as compared to the *mdr* cancer cells.
- (2) Although both cells accumulate less drug, metabolically deprived *mdr* cancer cells can reach drug concentrations equal to the susceptible cells while the metabolically deprived malarial parasite inhibits drug uptake.
- (3) In the cancer cells RRAs restore the drug levels equal to the sensitive cells but they are unable to do so in the CQR parasite.
- (4) *Mdr* cancer cells exhibit a cross-resistance which is absent in the CQR parasite because they are usually susceptible to other quinolines.
- (5) Few calmodulin antagonists can reverse resistance in *mdr* cancer cells, but fail to do so in the CQR parasites.

Ginsburg (1988) also hypothesized a mechanism for the Ca²⁺ antagonist to act as RRAs. He suggested that since the pH of the food vacuole was established by the ATP-driven proton pump and proton leak, a high pumping activity or a low efflux of proton would result in highly acidic pH leading to increased CQ solubility. The CQR parasites were presumed to possess either a low pump activity or an increased proton leak, or both. Because these RRA are capable of restoring the susceptibility to CQ, they may affect the pH of the parasite's acidic compartment owing to increased proton leak from the Ca²⁺ channels present on the membrane of the food vacuole. However, this hypothesis is debatable since Ca²⁺ channels are absent in malaria parasites (Ye and Van Dyke, 1988) and the role of Ca²⁺ metabolism in the CQR parasites is not defined. In addition to these shortcomings, as

discussed above, there are now reports of a lack of correlation between the CQ resistance in malaria parasite and the *Pfmdr-1* gene. On the basis of *in vitro* and *in vivo* results of RRA-like Ca^{2+} antagonists, antihistaminics and prostaglandins, workers have advocated the need for evaluation of detailed pharmacokinetic and toxicology profiles of any combination before taking it to clinics. The need for such an exercise arose because Watt *et al.* (1990) reported the iatrogenic toxicity of a combination of CQ and verapamil. They found that this combination produced deleterious effects on the Hep G-2 liver cells *in vitro*, although both drugs were not toxic individually even at suprathreshold concentrations. Some of the other observations made in this direction are also relevant at this stage. The dose of verapamil which causes resistance reversal is about ten-fold that required to evoke K^{+} -dependent contraction of vessels (Millard *et al.*, 1983). Such a high dose of verapamil may induce cardiovascular effects (Bitonti *et al.*, 1988). Suggestions to circumvent this problem with the help of isomerically pure drugs were also made (Krishna and Squire-Pollard, 1990; Solomone and Godfraind, 1990; Deloron *et al.*, 1991). Both the *R*(+) and *S*(-) enantiomers of verapamil act as RRAs (Ye and Van Dyke, 1988) but the cardiovascular effect is limited to the *S*(-) enantiomer.

5.3 INTERFERENCE WITH THE HAEM DEGRADATION PATHWAY IN CQR PARASITES

The results of evaluation of Ca^{2+} channel blockers, antidepressants and antihistaminics suggest extremely low utility of these drugs as RRA for the treatment of CQ-resistant malaria in humans. In the light of this observation the second strategy for the development of RRA acquires an added attraction. This approach involves compounds that can interfere with the haem degradation pathway of the CQR parasite (Figure 4).

The recent report made by Warhurst (Warhurst, 1995) justifies the exploratory research activities for discovering selective inhibitors of haem polymerization reactions (and not selective inhibitors of haem polymerase). Similarly, the discovery of selective inhibitors of haem oxygenase can also be envisaged. Knowledge of different molecular entities as specific inhibitors of haem polymerization reactions and haem oxygenase would offer an added advantage for designing RRAs. It is also possible that a single molecule may exhibit both of these activities and in the event of such a situation it would be interesting to analyse the substructural components (pharmacophores) responsible for these activities. It was argued that any chemical entity which could block these transformations might be the desired RRA. This led to the detailed evaluations of the CDRI compound 87/209, a pyrrolidinoalkane amine. This compound did reverse CQ resistance both *in vitro* and *in vivo*. The *in vitro* studies (De *et al.*, 1993) were conducted with the CQS D-6 isolate and the CQR GA-3 W-2, VS-1 clones, Kenya-91, Smith and S-40/88 isolates.

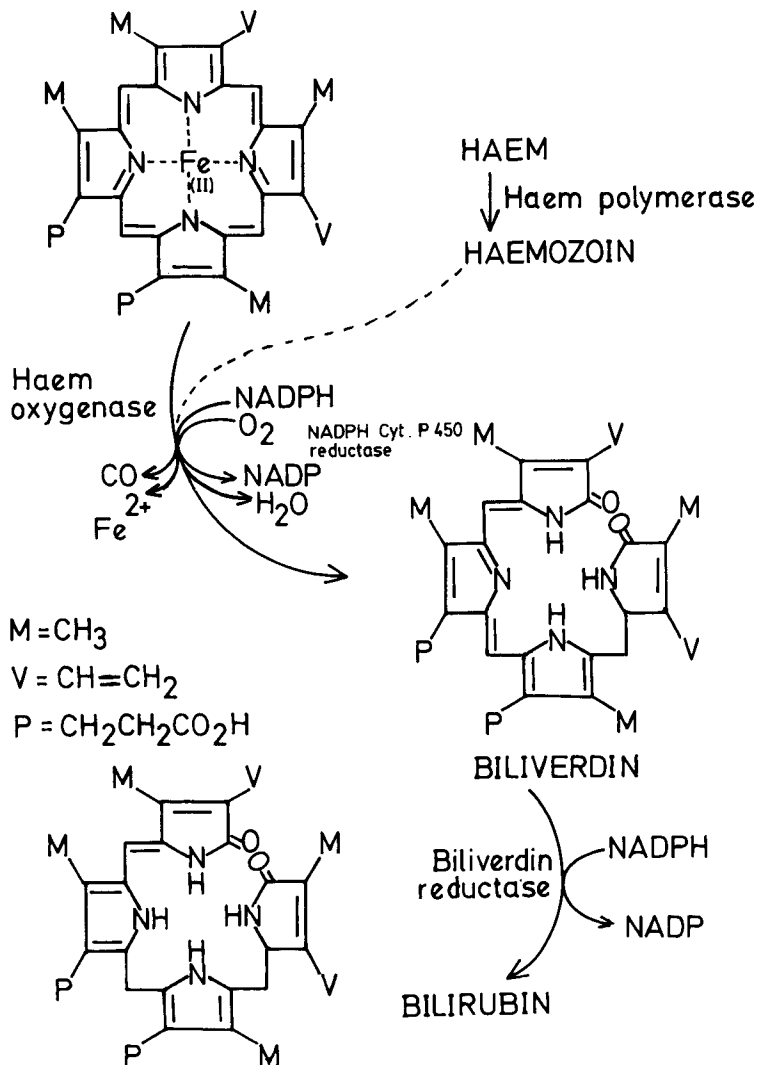
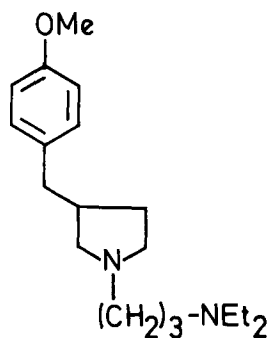

FIG. 4. The haem degradation pathway.

The capability of CDRI 87/209 (WR 268954) to potentiate CQ susceptibility in all the CQR strains was reported and it was found to be better than verapamil. The concentrations used to obtain effective restoration of CQ activity were 5 μM for S-40/88 and Smith isolates and 10 μM for all other strains. Walter *et al.* (1993) also carried out a detailed *in vitro* study to understand the mechanism of action of CDRI 87/209. The studies were conducted with CQS FCH-5 and CQR-K-1 strains of *P. falciparum*. It was



CDRI-87/209

observed that the IC_{50} value for CQ in the CQR K-1 strain (75 ng ml^{-1}) in combination with 100 ng ml^{-1} CDRI 87/209 decreased to 25 ng ml^{-1} but the IC_{50} value for the CQS FCH-5 strain remained unaffected. It was also reported that, unlike verapamil, CDRI 87/209 did not affect the concentrations of [^3H]CQ in erythrocytes infected with the K-1 strain of parasite. The mechanism involved for resistance reversal of this compound was, therefore, different from that of verapamil. The latest report (Srivastava *et al.*, 1995) on the mechanism of action of CDRI 87/209 indicated interference with the activity of haem polymerase and haem oxygenase in CQR parasites. This compound exhibited 100% inhibition of haem polymerase and haem oxygenase activities in CQR *P. yoelii* at $10 \mu\text{M}$ and $80 \mu\text{M}$ respectively, *in vitro*. This study was extended to *in vivo* evaluation of CDRI 87/209 against CQR *P. berghei* and *P. yoelii nigeriensis*-infected *Mastomys coucha* and Swiss albino mice, respectively. The major characteristic of this evaluation was the oral administration of drugs. In the *in vivo* examination of CDRI 87/209 as RRA against *P. berghei* in *M. coucha* these workers observed that 10 mg kg^{-1} of CQ and 15 mg kg^{-1} of CDRI 87/209, given in a 10-day schedule, were able to eradicate parasitaemia although individually both the drugs were inactive. The remarkable achievement of this experiment was the increase in mean survival time to more than 3 months. *In vivo* evaluation of this RRA was also reported in *P. yoelii nigeriensis*-infected Swiss albino mice. An identical dose of 10 mg kg^{-1} of CQ and 15 mg kg^{-1} of CDRI 87/209 in 10-day schedule was also able to reverse CQ resistance in this experiment. The mean survival time increased to more than 1 month, providing additional evidence for the excellent performance of CDRI 87/209 as a RRA. These workers isolated malarial parasites from the CQR-infected animals and animals treated with CDRI 87/209. It was observed that CQR *P. berghei* was associated with ten-fold-higher activity of haem oxygenase and two times less activity of haem polymerase compared with CQS *P. berghei*. However, in the malarial parasites (both *P. yoelii* and *P. berghei*) isolated from animals

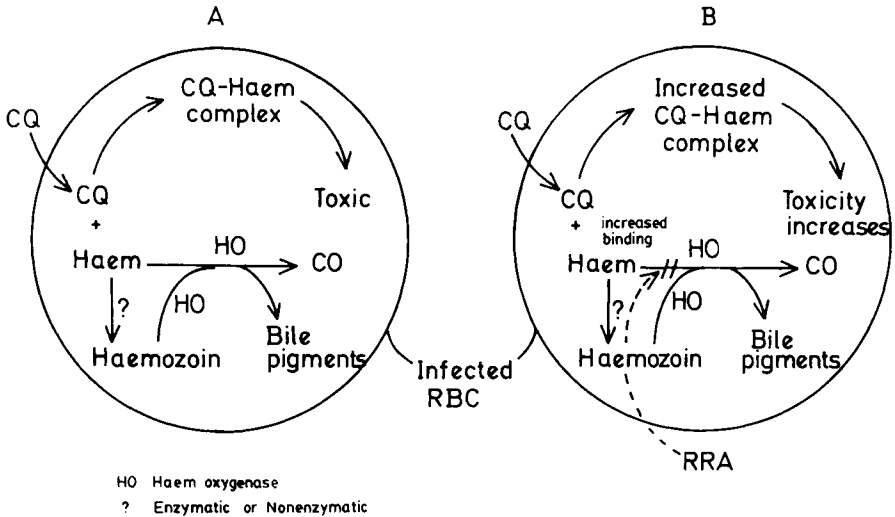

FIG. 5. Possible mode of action of CQ resistance reversal agent.

treated with CDRI 87/209 there was complete inhibition of haem oxygenase and haem polymerase activities resulting in increased and decreased levels of haem and haemozoin, respectively. These authors further reported a significant inhibition of haem oxygenase of CQR and CQS strains of *P. falciparum* by CDRI 87/209. This mechanism of reversal of resistance seems logical since it links to the mechanism of CQ action and CQ resistance in the biophase. On the basis of this recent report it was suggested that this RRA primarily decreases the haem oxygenase and haem polymerase activities which in turn increase the level of haem and decrease the amount of haemozoin. This provides an opportunity to the CQ to bind to enhanced haem in CQR parasite thereby increasing its toxicity and causing the death of malarial parasite. This postulated mode of action is diagrammatically presented in Figure 5.

6 Conclusion

Despite the fact that the finer details of the mechanism of CQ action and the cause of resistance in *Plasmodia* are still being researched, the development of a RRA has become a distinct possibility. The major impediment for the *in vivo* evaluation against the CQR *P. falciparum* is the non-availability of *Aotus* monkey. Several reports on CQ resistance reversal by a number of drugs in combination with CQ suggest that the therapeutic use of any combination may be recommended only after pharmacokinetic

and toxicological studies. This becomes mandatory because the drug–drug interactions which are bound to take place may change the pharmacokinetic and toxicological profile of the individual components.

Despite the fact that oral efficacy of RRAs are reported in experimental rodent models, the dose schedule must be shortened to make it a clinically viable proposition. The correlation of the pharmacokinetic property of a drug with the development of resistant plasmodia is being currently debated. In view of the lessons learned from the bioclearance studies of artemisinin it is tempting to propose that an RRA which can evoke a quicker bioclearance of CQ if given in combination with the RRA, but is capable of retaining the lethal blood concentration in host, would provide additional clinical advantage. In the recommended dose schedule of RRA–CQ combination various safeguards must be built in to ensure that resistance to this combination does not appear within a short time, and special care must be taken to ensure the patient's compliance.

References

- Allison, J. L., O'Brien, R. L. and Hahn, F. E. (1965a). *Science* **149**, 1111–1112.
- Allison, J. L., O'Brien, R. L. and Hahn, F. E. (1965b). *Antimicrob. Agents Chemother.* **310**–314.
- Anon. (1994). Drug resistance status of *P. falciparum* in India – Situational analysis. Directorate of National Malaria Eradication Programme, Delhi.
- Balasubramanian, D., Rao, C. M. and Panjipan, B. (1984). *Science* **223**, 828–830.
- Basco, L. K., Ringwald, P., Simon, F., Doury, J. C. and Le Bras, J. (1993). *Trop. Med. Parasitol.* **44**, 111–112.
- Basco, L. K. and Le Bras, J. (1990). *Trans. R. Soc. Trop. Med. Hyg.* **84**, 479–481.
- Bitonti, A. J., Sjoerdsma, A., McCann, P. P., Kyle, D. E., Oduola, A. M. J., Rossan, R. N., Milhous, W. K. and Davidson, D. E. (1988). *Science* **242**, 1301–1303.
- Bjorkman, A. and Phillips-Howard, P. A. (1990a). *Trans. R. Soc. Trop. Med. Hyg.* **84**, 177–180.
- Bjorkman, A. and Phillips-Howard, P. A. (1990b). *Trans. R. Soc. Trop. Med. Hyg.* **84**, 323–324.
- Blauer, G. (1986a). *Archs. Biochem. Biophys.* **251**, 306–314.
- Blauer, G. (1986b). *Archs. Biochem. Biophys.* **251**, 315–322.
- Blauer, G. (1988). *Biochem. Int.* **17**, 729–734.
- Blauer, G. and Ginsburg, H. (1982). *Biochem. Int.* **5**, 519–523.
- Brasseur, P., Kouamou, J., Brondicourt, O., Moyou-Somo, R. and Druilhe, P. (1988). *Am. J. Trop. Med. Hyg.* **39**, 166–172.
- Chandra, S., Ohnishi, S. T. and Dhawan, B. N. (1993). *Am. J. Trop. Med. Hyg.* **48**, 645–651.
- Chippaux, J. P., Massougbedji, A., Olliaro, P., Gay, F., Caligaris, S. and Danis, M. (1987). *Trans. R. Soc. Trop. Med. Hyg.* **83**, 584–585.
- Chou, A. C. and Fitch, C. D. (1992). *Life Sci.* **51**, 2073–2078.
- Chou, A. C., Chevli, R. and Fitch, C. D. (1980). *Biochemistry* **19**, 1543–1549.
- Cohen, S. N. and Yielding, K. L. (1965). *J. Biol. Chem.* **240**, 3123–3131.
- Cornwell, M. M., Safa, A. R., Felsted, R. L., Gottesman, M. M. and Pastan, I. (1986). *Proc. Natl Acad. Sci. USA* **83**, 3847–3850.

- Coutaux, A. F., Mooney, J. J. and Wirth, D. F. (1994). *Antimicrob. Agents Chemother.* **38**, 1419-1421.
- Cowman, A. F. (1991). *Parasitol. Today* **7**, 70-76.
- Cremer, G., Basco, L. K., Le Bras, J., Camus, D. and Slomianny, C. (1995). *Exp. Parasitol.* **81**, 1-8.
- Daniel, H. I. and Molta, N. B. (1989). *Ann. Trop. Med. Parasitol.* **83**, 331-338.
- De, D., Bhaduri, A. P. and Milhous, W. K. (1993). *Am. J. Trop. Med. Hyg.* **49**, 113-120.
- Deloron, P., Basco, L. K., Dubois, B., Gaudin, C., Clavier, F., Le Bras, J. and Verdier, F. (1991). *Antimicrob. Agents Chemother.* **35**, 1338-1342.
- Doberstyn, E. B. (1984). *Experientia* 1311-1317.
- Dorn, A., Stoffel, R., Matlle, H., Bubendorf, A. and Ridley, R. G. (1995). *Nature* **374**, 269-271.
- Dutta, P., Siegal, L., Pinto, J. and Meshnick, S. (1986). *Fed. Proc.* **45**, 202.
- Dutta, P., Pinto, J. and Rivlin, R. (1990). *J. Protozool.* **37**, 54-58.
- Eckmann, J. R., Modler, S., Eaton, J. W., Berger, E. and Engel, R. R. (1977). *J. Lab. Clin. Med.* **90**, 767-770.
- Ferrari, V. and Cutler, D. J. (1991). *Biochem. Pharmac.* **42**, S167-S179.
- Fitch, C. D. (1983). In 'Malaria and the Red Cell', Ciba Foundation Symposium 94, pp. 222-232. Pitman Press, London.
- Fitch, C. D. (1986). *Parasitol. Today* **2**, 330-331.
- Fitch, C. D., Chevli, R., Banyal, H. S., Phillips, G., Pfaller, M. A. and Krogstad, D. J. (1982). *Antimicrob. Agents Chemother.* **21**, 819-822.
- Fitch, C. D., Chevli, R., Kanjanangulpan, P., Dutta, P., Chevli, K. and Chou, A. C. (1983). *Blood* **62**, 1165-1168.
- Fogh, S., Jepsen, S. and Effersoe, P. (1979). *Trans. R. Soc. Trop. Med. Hyg.* **72**, 228-229.
- Fojo, A. T., Akiyama, S., Gottesman, M. M., Pastan, I. H. (1985). *Cancer Res.* **45**, 3002-3007.
- Foote, S. J., Kyle, D. E., Martin, R. K., Oduola, A. M. J., Kemp, D. J. and Cowman, A. F. (1990). *Nature* **345**, 255-258.
- Foote, S. J., Thompson, J. K., Cowman, A. F. and Kemp, D. J. (1989). *Cell* **57**, 921-930.
- Gabay, T. and Ginsburg, H. (1993). *Exp. Parasitol.* **77**, 261-272.
- Gabay, T., Krugliak, M., Shalmiev, G. and Ginsburg, H. (1994). *Parasitology* **108**, 371-381.
- Garcia-Vidal, J., Ngirabega, J. D., Soldevila, M., Navarro, R. and Bada, J. L. (1989). *Trans. R. Soc. Trop. Med. Hyg.* **83**, 490.
- Gerena, L., Bass, G. T. Sr, Kyle, D. E., Oduola, A. M. J., Milhous, W. K. and Martin, S. K. (1992). *Antimicrob. Agents Chemother.* **36**, 2761-2765.
- Ginsburg, H. (1988). *Parasitol. Today* **4**, 209-211.
- Ginsburg, H. (1990). *Parasitol. Today* **8**, 334-337.
- Ginsburg, H. (1991). *Exp. Parasitol.* **73**, 227-232.
- Ginsburg, H. and Damel, R. A. (1983). *Biochem. Biophys. Acta* **732**, 316-319.
- Ginsburg, H. and Geary, T. G. (1987). *Biochem. Pharmac.* **36**, 1567-1576.
- Ginsburg, H. and Krugliak, M. (1992). *Biochem. Pharmac.* **43**, 63-70.
- Gluzman, I. Y., Francis, S. E., Oksman, A., Smith, C. E., Duffin, K. L. and Goldberg, D. E. (1994). *J. Clin. Invest.* **93**, 1602-1608.
- Goldberg, D. E. (1993). *Semin. Cell. Biol.* **4**, 355-361.
- Goldberg, D. E., Slater, A. F. G., Cerami, A. and Henderson, G. B. (1990). *Proc. Natl Acad. USA* **87**, 2931-2935.
- Goldberg, D. E., Slater, A. F. G., Beavis, R., Chait, B., Cerami, A. and Henderson, G. B. (1991). *J. Exp. Med.* **173**, 961-969.
- Golovenko, N. Y. (1981). In 'Mechanisms of Reactions of Xenobiotic Metabolism in Biological Membranes', Naukova Dumka, Kiev, USSR.
- Gyang, F. N., Poole, B. and Trager, W. (1982). *Molec. Biochem. Parasitol.* **5**, 263-273.

- Hahn, F. E., O'Brien, R. L., Ciak, J., Allison, J. L. and Olenick, J. G. (1966). *Mil. Med.* **131**, 1071-1089.
- Harel, S. and Kanner, J. (1988). *Free Radical Res. Comm.* **5**, 21-33.
- Harinasuta, T., Migasen, S. and Bokonnag, D. (1962). UNESCO 1st Regional Symposium on Scientific Knowledge of Tropical Parasite, Singapore, pp. 148-153.
- Haruki, K., Bray, P. G., Ward, S. A., Hommel, M. and Ritchie, G. Y. (1994). *Trans. R. Soc. Trop. Med. Hyg.* **88**, 694.
- Hellgren, U., Kihamia, M. C. M., Mahikwano, L. F., Bjorkman, A., Eriksson, O. and Rombo, L. (1989). *Bull. W.H.O.* **67**, 197-202.
- Hershko, C. and Peto, T. E. A. (1988). *J. Exp. Med.* **168**, 375-387.
- Homewood, C. A., Warhurst, D. C. and Baggaley, V. C. (1971). *Trans. Soc. Trop. Med. Hyg.* **65**, 10.
- Homewood, C. A., Warhurst, D. C., Peters, W. and Baggaley, V. C. (1972). *Nature* **235**, 50-52.
- Huang, W.-Z., Luo, M.-Z., Zhou, M.-X. and Pan, X.-Q. (1988). *New Drugs Clin. Rem.* **7**, 237-238.
- Kamchoh Wongpaisan, S., Chandrangam, G., Avery, M. A. and Yuthavong, Y. (1994). *J. Clin. Invest.* **93**, 467-473.
- Kean, B. H. (1979). *JAMA* **241**, 395.
- Kihamia, C. F. and Gill, H. S. (1982). *Lancet* **ii**, 43.
- Kilimali, V. A. E. B. and Mkufya, A. R. (1985). *Trans. R. Soc. Trop. Med. Hyg.* **79**, 478-481.
- Kirby, G. C., O'Neill, M. J., Phillipson, D. and Warhurst, D. C. (1989). *Biochem. Pharmac.* **38**, 4367-4374.
- Kometani, T., Devlin, T. M. and Ohnishi, S. T. (1989). *Prostaglandins Leukot Essent. Fatty Acids* **37**, 37-43.
- Kremsner, P. G., Zotter, G. M., Feldmeier, H., Graninger, W., Kollaritsch, M., Wiedermann, G., Rocha, R. M. and Wernsdorfer, W. H. (1989). *Bull. W.H.O.* **67**, 289-293.
- Krishna, S. and Squire-Pollard, L. (1990). *Parasitol. Today* **6**, 196-198.
- Kristiansen, J. E. and Jepsen, S. (1985). *Acta Pathol. Microbiol. Immunol. Scand. Sect. B.* **93B**, 249-251.
- Krogstad, D. J., Schlesinger, P. H. and Gluzman, I. Y. (1985). *J. Cell Biol.* **101**, 2302-2309.
- Krogstad, D. J., Gluzman, I. Y., Kyle, D. E., Oduola, A. M. J., Martin, S. K., Milhous, W. K. and Schlesinger, P. H. (1987). *Science* **238**, 1283-1285.
- Krogstad, D. J., Gluzman, I. Y., Herwaldt, B. L., Schlesinger, P. H. and Wellems, T. E. (1992). *Biochem. Pharmac.* **43**, 57-62.
- Krugliak, M. and Ginsburg, H. (1991). *Life Sci.* **40**, 1213-1219.
- Kwakye-Berko, F. and Meshnick, S. R. (1989). *Molec. Biochem. Parasitol.* **35**, 51-56.
- Kyle, D. E., Oduola, A. M. J., Martin, S. K. and Milhous, W. K. (1990). *Trans. R. Soc. Trop. Med. Hyg.* **84**, 474-478.
- Landgraf, B., Kollaritsch, H., Wiedermann, G. and Wernsdorfer, W. H. (1994). *Trans. R. Soc. Trop. Med. Hyg.* **88**, 440-442.
- Le Bras, J., Hatfin, I., Bouree, P., Coco-Ciacci, O., Gasin, J. P., Rey, M., Charmont, G. and Rove, R. (1986). *Lancet* **ii**, 1043-1044.
- Lege-Ogutoye, L., Abua, J. U., Werblinska, B., Ogala, W. N., Slotboom, A. B. and Olurinola, P. F. (1989). *Trans. R. Soc. Trop. Med. Hyg.* **83**, 599-601.
- Lemnge, M. M. and Inambao, A. W. (1988). *Trans. R. Soc. Trop. Med. Hyg.* **82**, 194-196.
- Lepers, J. P., Deloron, P., Mouden, J. C., Le Bras, J. and Coulanges, P. (1989). *Trans. R. Soc. Trop. Med. Hyg.* **83**, 491-492.
- Mahoney, J. R. and Eaton, J. W. (1981). *Biochem. Biophys. Res. Commun.* **100**, 1266-1271.

- Mallorga, P., Tallman, J. F., Henneberry, R. C., Hirata, F., Srittmatter, W. T. and Axelrod, J. (1980). *Proc. Natl Acad. Sci. USA* **77**, 1341-1345.
- Marquez, V. E., Cranston, J. W., Ruddon, R. W. and Burckhalter, J. H. (1974). *J. Med. Chem.* **17**, 856-862.
- Martin, S. K., Oduola, A. M. J. and Milhous, W. K. (1987). *Science* **235**, 899-901.
- Matsuzawa, Y. and Hostetler, K. Y. (1980a). *J. Lipid Res.* **21**, 202-214.
- Matsuzawa, Y. and Hostetler, K. Y. (1980b). *J. Biol. Chem.* **255**, 5190-5194.
- McChesney, E. W., Fasco, M. J. and Banks, W. F. Jr (1967). *J. Pharmac. Exp. Therap.* **158**, 323-331.
- Milhous, W. K. *et al.* (1987). IIIrd International Conference on Malaria and Babesiosis, Annecy, France.
- Millard, R. W., Grupp, G., Grupp, I. L., DiSalvo, J., DePover, A. and Schwartz, A. (1983). *Circ. Res.* **52**(Suppl. 1), 29-39.
- Miyama, S. I., Fojo, A. T., Hanover, J. A., Pastan, I. and Gottesman, M. M. (1985). *Somat. Cell. Mol. Genet.* **11**, 117.
- Mockenhaupt, F. P. (1995). *Parasitol. Today* **11**, 248-253.
- Moore, D. V. and Lanier, J. E. (1961). *Am. J. Trop. Med. Hyg.* **10**, 5-9.
- Mulder, B., Gazin, P., Eggelte, T. A. and Cot, M. (1992). *Trans. R. Soc. Trop. Med. Hyg.* **86**, 376.
- Najera, J. A. (1989). *Bull. W.H.O.* **67**, 229-243.
- Naor, Z. and Catt, K. J. (1981). *J. Biol. Chem.* **256**, 2226-2229.
- Ndifor, A. M., Ward, S. A. and Howells, R. E. (1990). *Mol. Biochem. Parasitol.* **41**, 251-258.
- Neequaye, J. (1986). *Lancet* **i**, 153.
- Nocht, B. and Werner, H. (1910). *Dtsch. Med. Wochenschr.* **36**, 1557-1560.
- Oduola, A. M. J., Moyou-Somo, R. S., Kyle, D. E., Martin, S. K., Gerena, L. and Milhous, W. K. (1989). *Trans. R. Soc. Trop. Med. Hyg.* **83**, 308-310.
- Ohnishi, S. T. and Devlin, T. M. (1979). *Biochem. Biophys. Res. Comm.* **89**, 240-245.
- Ohnishi, S. T., Ohnishi, N., Oda, Y. and Katsuaka, M. (1989a). *Cell Biochem. Funct.* **7**, 105-109.
- Ohnishi, S. T., Sdanaga, K. K., Katsuaka, M. and Weidanz, W. P. (1989b). *Mol. Cell Biochem.* **91**, 159-165.
- Orjih, A. U. and Fitch, C. D. (1993). *Biochem. Biophys. Acta* **1157**, 270-274.
- Orjih, A. U., Banyal, H. S., Chevli, R. and Fitch, C. D. (1981). *Science* **214**, 667-669.
- Padua, R. A. (1981). *Exp. Parasitol.* **52**, 419-426.
- Pan, X.-Q., Zhou, M.-Y., Yan, Z.-Z., Gau, Q. and Ren, D.-X. (1986). *Pharm. Ind.* **19**, 22-24.
- Parker, F. S. and Irvin, J. L. (1952). *J. Biol. Chem.* **199**, 897-909.
- Pattanayak, S., Sharma, V. P., Kalra, N. L., Orlov, V. S. and Sharma, R. S. (1994). *Ind. J. Malar.* **31**, 141-199.
- Payne, D. (1988). *Parasitol. Today* **4**, 112-115.
- Peters, W. (1987). In 'Chemotherapy and Drug Resistance in Malaria' Vols I and II. Academic Press, London.
- Peters, W., Ekong, R., Robinson, B. L., Warhurst, D. C. and Pan, X.-Q. (1990). *Ann. Trop. Med. Parasitol.* **84**, 541-551.
- Petersen, R. I., Symons, M. C. R. and Taiwo, F. A. (1989). *J. Chem. Soc. Faraday Trans.* **85**, 2435-2443.
- Peterson, D., Natiker, D. and Wellems, T. (1988). *Proc. Natl Acad. Sci. USA* **85**, 9114-9118.
- Peto, T. E. A. and Thompson, J. L. (1986). *Br. J. Haematol.* **63**, 273-280.
- Puppo, A. and Halliwell, B. (1988). *Biochem. J.* **249**, 185-190.
- Rabinovich, S. A., Mulkovskaya, I. M., Makasakovskaya, E. V., Chekhonadskikh, T. V., Pankova, T. G. and Salganik, R. I. (1987). *Bull. W.H.O.* **65**, 387-389.

- Reynolds, C. H. and Claxton, P. T. J. (1982). *Biochem. Pharmacol.* **31**, 419–421.
- Rice-Evans, C., Okunade, G. and Khan, R. (1989). *Free Radical Res. Commun.* **7**, 45–54.
- Rogan, A. M., Hamilton, T. C., Young, R. C., Klecker, R. W. Jr and Ozols, R. F. (1984). *Science* **224**, 994–996.
- Rosário, V. E. (1976). *Nature* **261**, 585–586.
- Rosenthal, P. J. (1995). *Exp. Parasitol.* **80**, 272–281.
- Rosenthal, P. J., Mckerrow, J. H., Aikawa, M., Nagasawa, H. and Leech, J. H. (1988). *J. Clin. Invest.* **82**, 1560–1566.
- Rosenthal, P. J. and Nelson, R. G. (1992). *Mol. Biochem. Parasitol.* **51**, 143–152.
- Salganik, R. I., Pankova, T. G., Chekhonadskikh and Igonina, T. M. (1987). *Bull. W.H.O.* **65**, 381–386.
- Sansonetti, P. J., Le Bras, J., Verdier, F., Charmot, G. and Lapresle, C. (1985). *Lancet* **i**, 1154–1155.
- Schmidt, L. H. (1973). *Trans. R. Soc. Trop. Med. Hyg.* **67**, 446–474.
- Schmitt, T. H., Frezzatti, W. A. Jr and Schreier, S. (1993). *Arch. Biochem. Biophys.* **307**, 96–103.
- Sherman, I. W. (1976). *Comp. Biochem. Physiol.* **53B**, 447–450.
- Slater, A. F. G. (1992). *Exp. Parasitol.* **74**, 362–365.
- Slater, A. F. G. (1993). *Pharmac. Ther.* **57**, 203–235.
- Slater, A. F. G. and Cerami, A. (1992). *Nature* **355**, 167–169.
- Slater, A. F. G., Swiggard, W. J., Orton, B. R., Flitter, W. D., Goldberg, D. E., Cerami, A. and Henderson, G. B. (1991). *Proc. Natl Acad. Sci. USA* **88**, 325–329.
- Slater, L. M., Murray, S. L., Wetzel, M. W., Wisdom, R. M. and DuVall, E. M. (1982). *J. Clin. Invest.* **70**, 1131–1134.
- Solomone, S. and Godfraind, T. (1990). *TIPS* **11**, 475–476.
- Srivastava, P. and Pandey, V. C. (1995). *Int. J. Parasitol.* **25**, 1061–1064.
- Srivastava, P., Pandey, V. C. and Bhaduri, A. P. (1995). *Trop. Med. Parasitol.* **46**, 83–87.
- Srivastava, P., Puri, S. K., Dutta, G. P. and Pandey, V. C. (1992a). *Med. Sci. Res.* **20**, 321–322.
- Srivastava, P., Puri, S. K., Mohan, A. and Pandey, V. C. (1992b). VIII Int. Congress for Trop. Med. and Malaria, Pattaya, Thailand.
- Sugioka, Y., Suzuki, M., Sugioka, K. and Nakano, M. (1987). *FEBS Lett.* **223**, 251–254.
- Surolia, N. and Padmanaban, G. (1991). *Biochemistry* **88**, 4786–4790.
- Surolia, N. and Padmanaban, G. (1992). *Biochem. Biophys. Res. Commun.* **187**, 744–750.
- Surolia, N., Karthikeyan, G. and Padmanaban, G. (1993). *Biochem. Biophys. Res. Commun.* **197**, 562–569.
- Tanabe, K., Kato, M., Izumo, A., Hagiwara, A. and Doi, S. (1990). *Exp. Parasitol.* **70**, 419–426.
- Tappel, A. L. (1953). *Archs. Biochem. Biophys.* **44**, 378–395.
- Uribe, S., Ohnishi, S., Israelite, C. and Devlin, T. M. (1987). *Biochem. Biophys. Acta* **924**, 87–98.
- Valecha, N., Biswas, S., Dewan, S. and Bhabhani (1992). *Ind. J. Malar.* **29**, 47–53.
- Vanden Bosch, H. (1980). *Biochem. Biophys. Acta* **604**, 191.
- Vander Jagt, D. L., Hunsaker, L. A. and Campos, N. M. (1986). *Molec. Biochem. Parasitol.* **18**, 389–400.
- Vander Jagt, D. L., Hunsaker, L. A. and Campos, N. M. (1987). *Biochem. Pharmac.* **36**, 3285–3291.
- Vander Jagt, D. L., Hunsaker, L. A., Campos, N. M. and Scaletti, J. V. (1992). *Biochem. Biophys. Acta* **1122**, 256–254.
- Vander Kaay, H. J. (1991). *Acta Leiden* **60**, 191–206.
- Waite, M., Griffin, H. D. and Fanson, R. (1976). In 'Lysosomes in Biology and Pathology' (J. T. Dingle and R. T. Dean, eds), Vol. 5, pp. 257–305. North Holland, Amsterdam.

- Walter, R. D., Seth, M. and Bhaduri, A. P. (1993). *Trop. Med. Parasitol.* **44**, 5–8.
- Warhurst, D. C. (1981). *Biochem. Pharmac.* **30**, 3323–3327.
- Warhurst, D. C. (1986). *Parasitol. Today* **2**, 331–334.
- Warhurst, D. C. (1988). *Parasitol. Today* **4**, 211–213.
- Warhurst, D. C. (1995). *Parasitol. Today* **11**, 204–205.
- Warsame, M., Lebbad, S. A., Wernsdorfer, W. and Bjorkman, A. (1988). *Trans. R. Soc. Trop. Med. Hyg.* **82**, 202–204.
- Watkins, W. M., Percy, M., Crampton, J. M., Ward, S., Koech, D. and Howells, R. E. (1987). *Trans. R. Soc. Trop. Med. Hyg.* **82**, 21–26.
- Watt, G., Long, G. W., Gorgi, M. and Martin, S. K. (1990). *Trans. R. Soc. Trop. Med. Hyg.* **84**, 187–190.
- Weber, J. L. (1988). *Exp. Parasitol.* **66**, 143–170.
- Wellems, T. E., Panton, L. J., Gluzman, I. Y., Rosario, V. E., Gwadz, R. W., Walker-Jonah, A. and Krogstad, D. J. (1990). *Nature* **345**, 253–255.
- Wernsdorfer, W. H. (1991). *Parasitol. Today* **11**, 297–303.
- Wernsdorfer, W. H. (1994). *Acta Tropica* **56**, 143–156.
- Williams, H. L., Johnson, D. J., Okoye, V. C. N. and Martin, S. K. (1992). *Ann. Trop. Med. Parasitol.* **86**, 467–473.
- Wilson, C. M., Serrano, A. E., Wasley, A., Bogenschutz, M. P., Shankar, A. H. and Wirth, D. F. (1989). *Science* **244**, 1184–1186.
- Wood, P. A. and Eaton, J. W. (1993). *Am. J. Trop. Med. Hyg.* **48**, 465–472.
- World Health Organization (1984). *Tech. Rep. Ser.* No. 711.
- World Health Organization (1987). *Bull. W.H.O.* **65**, 797–816.
- Wyler, D. J. (1992). *New Eng. J. Med.* **327**, 1591–21.
- Yayon, A. and Ginsburg, H. (1983). *Cell Biol. Int. Rep.* **7**, 895.
- Yayon, A., Waa, J. A. V., Yayon, M., Geary, T. G. and Jensen, J. B. (1983). *J. Protozool.* **30**, 642–647.
- Yayon, A., Cabantchik, Z. I. and Ginsburg, H. (1984a). *EMBO J.* **3**, 2695–2700.
- Yayon, A., Timberg, R., Friedman, S. and Ginsburg, H. (1984b). *J. Protozool.* **31**, 367–372.
- Ye, Z. and Van Dyke, K. (1988). *Biochem. Biophys. Res. Commun.* **155**, 476–481.
- Young, M. D. and Moore, D. V. (1961). *Am. J. Trop. Med. Hyg.* **10**, 317–320.
- Zarchin, S., Krugliak, M. and Ginsburg, H. (1986). *Biochem. Pharmacol.* **35**, 2435–2442.
- Zhang, Y., Asante, K. S. O. and Jung, A. (1986). *J. Parasitol.* **72**, 830–836.
- Zhou, M.-X., Pan, X.-Q. and Tong, X.-M. (1988). *Ch. J. Parasitol. Parasit. Dis.* **6**, 130–133.

SUBJECT INDEX

A

Acitretin
 compartment models, 43
 effect of ethanol on, 41
 epidemiology, 44–5
 formation of etretinate from, 41–4
 history, 39–41
 teratogenic effects of, 39–45
13-*cis*-Acitretin, 42
Acridine, 203
Actinomadura verucospora, 100
Active conformation, 75
Activity base, 140
Adenoma
 hepatocellular, 26, 48, 49
 thyroid follicular cell, 48
Affinity capillary electrophoresis/mass spectrometry (ACE/MS), 138
Affinity fingerprint, 153
Affinity selection, 137–8
Albumin, human serum, 86–8
 binding of (*S*)-tofisopam to, 88
 compounds bound by, 86
 three-dimensional structure, 86
Alcohol, effect on acitretin, 41
Aldol reactions, 166
Alkaline phosphatase, 136
 α -ethylisoprenaline, 181
Ames test, 22, 35
 Ames bacterial gene mutation assay, 26
 of cyproterone acetate, 35
Amino acid tester kits, 131
(*R*)- γ -Amino- β -hydroxy-butyric acid, 98
(*S*)- β -Aminobutyric acid conformation, 93, 94
Amoxepin, 215, 216
Anaemia, immune haemolytic, 24
Animals as experimental models, 17
Antidepressants
 in reversal of chloroquine resistance, 215–19
 toxicity, 23–5
Antihistamines, 220
Aptamers, 162
Arochlor-1254, hepatoblastoma formation and, 49

Artemisinin, 208
Artificial receptor, 112
L-Ascorbic acid, megadosing, 18
Aspartame, sweet, 90, 92
Aspartylphenylalanine methyl ester stereoisomers, 90
Atom layer tables, 152
Atropisomers, 75
Automatic synthesizers, 141
Automation friendliness, 115
Available Chemicals Directory, 147
Azatadine, 218, 219, 220
Azatides, 163

B

Bacterial cells, display on, 125
B-DNA, 81
Bead, definition, 196
Bead pooling, 136–7, 196
Benzodiazepine library, 114, 142
1,4-Benzodiazepines, 84–5
1,5-Benzodiazepines, 85
 β -Blockers, carcinogenic effects, 20–1
 β -Oxidation of fatty acids, 55
Biased libraries, 126, 199
Bicuculline, 93
Biginelli reactions, 172
Bilirubin, binding conformation, 88
Bilirubin-IX alpha, binding conformation, 86, 87
Binary tagging, 123, 124, 135, 173
Bioaffinity characterization mass spectrometry, 138
Biomacromolecules, 7, 8
Biopanning, 138
Biotransformation studies
 on nescapine, 32
 on oxazepam, 51
Bitmap (non-sequential) tagging, 196
Breast cancer
 association with benzodiazepine, 50, 51–2
 association with tamoxifen, 25, 26, 27
Bromide, toxicokinetic studies, 59, 62
Butane, chiral conformers, 74
Butterfly-like conformations, 82–4, 95

C

- Calcium channel blockers, 214–15
- Calicheamicin gamma¹, 100–2
- Calicheamicin theta¹, 103
- Carbamazepine, 217, 219
- Carbonic anhydrase isoenzyme selectivity, 150
- Carcinoma
 association with oxazepam, 48
 tamoxifen-induced, 26, 27
- Catalyst development, 112
- CC-1065, 98–100
 binding conformation, 101
 (+)-CC-1065, 100, 101
 combination with an enediyne, 103–4
 DNA-CC-1065, 99
ent(-)-CC-1065, 99
- CCK-B antagonists, 84
- CDRI 87/209, 223–6
- Cells, dissolvement and, 8–9
- CERIUS program, 139
- Chain of tacit assumptions, 53–4
- Chemical design, 142
- Chemical libraries, 160–74
 information systems, 142
 oligomer libraries, 161–3, 164–5
 small-molecule libraries, 163–73, 176
 tagging, encoded libraries, 173–4
- ChemX system, 139
- Chiral discrimination, 75
- Chirality, definition, 74
- Chlordiazepoxide, breast cancer risk, 52
- Chloride, toxicokinetic studies, 59
- Chlormadinone acetate, 38
- β -chloroethylamine derivative, as
 carcinogen, 21, 22
- Chloroquine (CQ)
 mechanism of action, 203–8
 DNA interaction theory, 203–4
 haem-CQ complex theory, 204–5
 increase in vacuolar pH, 206
 inhibition of haem polymerase and
 haem oxygenase, 207–8
 inhibition of iron release, 207
 inhibition of protein synthesis, 204
 inhibition of vacuolar phospholipases,
 206–7
 inhibition of vacuolar proteases, 205–6
 interference with haemoglobin
 degradation, 205–8
 resistance reversal agent (RRA), 203
 antidepressants and neuronal
 monoamine re-uptake inhibitors,
 215–19
 antihistamines, 219–20
 calcium channel blockers, 214–15
 development of, 213–26
 interference with haem degradation
 pathway in CQR parasites, 223–6
 prostaglandin oligomers, 221–2
 resistance reversal, 222–3
 verapamil and chlorpromazine
 analogues, 220–1
 resistance to, 202, 208–10
 decreased haem polymerase, haem and
 haemozoin, 213
 gene amplification theory, 212–13
 increased drug metabolism, 211–12
 increased permease activity, 211
 increased proteolytic activity, 210–11
 mechanism, 210–13
 structure, 203
- Chlorpromazine, 218, 220, 221
- Circulatory normalcy, 10
- Claisen condensations, 166
- Clustering methods, 155
- Combinatorial compound libraries (CCL),
 112
 algorithms for library design, 154–8
 chemical libraries, 160–74
 oligomer libraries, 161–3, 164–5
 small-molecule libraries, 163–73
 tagging, encoded libraries, 173–4
 definition, 114
 design space, 151–2
 encoded, 196
 evolutionary synthesis, 159
 geometrical descriptors (pharmacophores)
 152–3
 history, 113–14
 libraries-of-libraries approach, 162
 parameters for library design, 152–3
 peptide and nonpeptide libraries, 113
 physicochemical descriptors, 153
 quality assessment of libraries 174–5
 selection algorithm, 151
 simulated screen experiments, 153
 target applications, 178–9, 179–80
 technical support, automation, 175–7
 screening operations, 177
 synthesis equipment, 176–7
 topological descriptors, 152
 two-dimensional fingerprints, 154

- using genetic algorithms to design libraries, 158–9
- validating descriptors, 151, 153–4
- Combinatorial mode of solution chemistry, 166–73
- Combinatorial technologies, 112
 - arrays, 114–20
 - array synthesis, instrumentation for, 120
 - basic principles, 114–39
 - benefits, 180
 - chemical libraries, 160–74
 - oligomer libraries, 161–3, 164–5
 - small-molecule libraries, 163–73, 176
 - tagging, encoded libraries, 173–4
 - combinatorial chemistry with split synthesis, 120–5
 - deconvolution, 128–38, 196
 - by affinity selection, 137–8
 - by bead pooling and redistribution, 136–7
 - by binding of labelled acceptors (targets), 127, 136, 138
 - by controlled and diffusion assays from spread-out beads, 136
 - by genetic algorithm-guided syntheses, 133–5
 - by physical position, 129
 - by systematic comparison of sublibraries, 129–33
 - with microanalytical contribution, 135–8
 - without microanalytical contribution, 128–35
 - expression libraries, 125–6
 - first-order sublibraries, 131
 - highly diverse libraries, thematic libraries, analogue series, 126–7
 - historical background, 113–14
 - in vitro* system, 125
 - library design and information management, 138–9
 - library formats, 127–8
 - planning, design and theoretical interpretation, 140–59
 - assessing diversity, 145–7
 - autocorrelation functions, 147
 - automatic synthesizers, 141
 - comparing combinatorial libraries, 147–9
 - designing libraries, 150–9
 - fingerprint density measurement, 145–6
 - handling combinatorial structure information, 141–3
 - high-throughput screening (HTS), 140
 - managing screening and synthesis data, 140–1
 - oligomer-based notation, 142
 - reaction databases, 141
 - scaffold-based recording, 142
 - searching through combinatorial data, 143–4
 - similarity and property profiles, 146–7, 148
 - similarity searching, 143–4
 - statistical aspects of mixture libraries, 144–5
 - substructure searching, 143
 - quality assessment of libraries, 174–5
 - second-order sublibraries, 131
 - technical support, automation, 175–7
 - screening operations, 177
 - synthesis equipment, 176–7
- Conformers, chiral
 - defining, 74
 - distinguishing from stereoisomers, 74–5
 - of flexible molecules, 86–105
 - agonists versus antagonists, 93–4
 - CC-1065, 98–100
 - enediynes antibiotics, 100–4
 - enediynes/CC-1065 hybrid, 103–4
 - GABA conformers, 94–7
 - human serum albumin, 86–8
 - ion channel functions and, 91–7
 - molecular parasites, 97–8
 - tasking peptides, 89–90, 91
 - ring, 76–85
 - butterfly-like, 82–4, 95
 - 1,4-benzodiazepines, 84–5
 - 1,4-dihydropyridines, 76–9
 - sugar-rings in DNA 79–82
- CPQ 51
- Cycloadditions, 166
- Cyclohexane, 79
- Cyclopentane, conformation, 79
- Cycloproheptadine, 217, 219
- Cyproterone acetate (CPA) as liver carcinogen, 34–9
 - alternatives to, 37–8
 - epidemiology, 38
 - genotoxicity, 35–6
 - history, 34–5
- Cys-loop super family, 91–2
- Cytochrome P450 isoenzymes, 55

D

- D-600 (methoxy-verapamil), 220
D-optimal design, 156
Dansylsulfonamides, 173
Daylight Chemical Information System, 142
Daylight software, 143
DDT, hepatoblastoma formation and, 49
Deconvolution, 128–38, 196
 by affinity selection, 137–8
 by bead pooling and redistribution, 136–7
 by binding of labelled acceptors (targets), 127, 136, 138
 by controlled and diffusion assays from spread-out beads, 136
 by genetic algorithm-guided syntheses, 133–5
 by physical position, 129
 by systematic comparison of sublibraries, 129–33
 without microanalytical contribution, 128–35
Desipramine, 215, 216, 219, 220
Dextromorphan, 34
Diazepam
 aneugenicity, 50
 binding of, 86, 88
 3-carboxyloxy, 85
 carcinogenicity, 46–7
 3,3-dimethyl derivative, 85, 88
 3-methyl derivatives, 85
Diethylnitrosamine, 50
Diethylstilboestrol (DES), 25
(*S*)-Dihydromuscicol (*S*-DHM), 97, 98
1,4-Dihydropyridines, 76–9
Diltiazem, 215, 218, 221
3,3-Dimethyl diazepam derivative, 85, 88
Dissimilarity design, 155
Dissolvement
 at biological levels, 7–9
 molecular machines and membranes, 8
 organelles and cells, 8–9
 tissues, organs and organisms, 9
concept of, 4–5
at molecular levels, 5–6
 macromolecules, 6–7
 molecular aggregates, 7
 molecules, 5–6
at pharmacological levels, 9–13
 drug-drug interactions, 12–13
 drug-organism transactions, 11–12
 molecular aggregations, 10–11

- targets, 9–10
Diversity index, 147
Divide, couple and combine, 198
DNA interaction theory, 203–4
DNA sequencing, 125, 138
DNA, sugar rings in, 79–82
 phase angle, 79
 pseudorotational equilibrium of
 ribofuranose ring, 80, 81
 puckering amplitude, 79
Domino strategy, 131, 133
Dose-response relationship, 18
Doxepin, 215, 216
Drug-drug interactions, dissolvement and, 12–13
Drug-organism transactions, dissolvement and, 11–12
Drug-target complex, properties of, 9

E

- Electron-capture gas chromatography, 173
Electrospray ionization, 138
Electrospray mass spectrometry, 175
Encoded combinatorial libraries, 135
Endometrial carcinoma, association with tamoxifen, 26
Endometrial hyperplasia, association with tamoxifen, 26
Endometrial polyps, association with tamoxifen, 26
Enediyne antibiotics, 98, 100–4
 combination with CC-1065, 103–4
 conformation in, 84
 reactive group, 102
Escherichia coli, infection by, 125
Esperamicin A1, 100, 101, 103
Ethoxyresorufin de-ethylase, 22
Ethyleneimine formation, 21
Etretinate
 compartment models, 43
 formation from acitretin, 41–4
Expression libraries, 112

F

- Factor Xa inhibitors, 179
Fingerprint density measurement, 145–6
Fingerprint dissimilarity, 155
Fingerprints
 affinity, 153
 library, 145

library pharmacophore, 145
 molecular, 143–4
 pharmacophore, 144
 structure, 152
 two-dimensional, 154
 Flow-injection mass spectrometry, 175
N-2-Fluorenylacetamide, 50
 Fluorescence activated cell sorter (FACS),
 197
 Fluoxetine, 217, 219
 Fourier-transform ion cyclotron resonance
 (FTICR), 138
 Fragmentation analysis, 175
 FT-IR microspectroscopy, 175

G**GABA**

subclass-selective conformers of, 94–7
 subclass-selective parameters, 97
 GABA-A receptor binding, 93, 94
 GABAergic agents, 94–7
 Gabapentin
 GABAergic activity, 95, 97
 structure, 98
 (*R*)-GABOB, 97, 99
 Gene amplification theory, 212–13
 General chemical experience, 75
 Glucuronide excretion, 51
 Glycine-receptor binding, 93, 94
 Guillain-Barré syndrome, 24

H

Haem, 213
 Haem degradation pathway in CQR
 parasites, 223–6
 Haem oxygenase, inhibition of, 207–8
 Haem polymerase, inhibition of, 207–8, 213
 Haem-CQ complex theory, 204–5
 Haemoglobin degradation, 205–8
 Haemozoin, 213
 Heck reactions, 166
 Hepatoblastoma
 association with Arochlor-1254, 49
 association with DDT, 49
 association with oxazepam, 49, 50
 association with phenobarbital, 49
 Hepatocellular adenomas
 association with oxazepam, 48, 49
 tamoxifen-induced, 26
 Hepatocellular carcinoma

p53 tumour suppressor gene mutations,
 tamoxifen-induced, 27
 association with oxazepam, 48
 Hepatomas, association with cyproterone
 acetate, 34
 High-performance liquid chromatography
 (HPLC), 173
 High-throughput screening (HTS), 140
 Highly diverse libraries, 126–7
 Hit compound, 113
 Homeostasis, 17
 Homo-DNA, 80–1
 Human lymphocyte chromosome aberration
 assay 26
 Human serum albumin, 86–8
 binding of (*S*)-tofisopam to, 88
 compounds bound by, 86
 three-dimensional structure, 86
 Hydrocyanic acid, 55
o-Hydroxytamoxifen, 28
 Hypoxanthine-guanine phosphoribosyl
 transferase (HGPRT) test, 35
 of cyproterone acetate, 35

I

Imipramine, 215, 216
In vitro chromosome aberration test, 31
 of cyproterone acetate, 35
In vivo bone marrow metaphase test in rats,
 31
 Indalpine, 23–5
 Indexed libraries, 132
 Intelligent libraries, 126, 199
 Interspecies toxicokinetics, 62
 Intravascular haemolysis, 24

K

Ketotifen, 217, 219, 220

L

Labetolol, 21
 Lactam synthesis, 166
 Lead compound, 113
 Legion products, 139
 Legion system of Tripos, 142
 Library fingerprint, 145
 Library pharmacophore fingerprints, 145
 Ligand-effector-water complex system, 10,
 11

Liquid chromatography (LC), 175
 Liquid chromatography mass spectrometry (LC-MS), 175
 Loratadine, 219, 220
 (S)-Lorazepam, binding, 86, 88

M

Macro-autoradiography of noscapine, 32
 Macromolecules, dissolution and, 6–7
 Mammalian cell gene mutation assay, 26
 Maprotiline, 215, 216
 Materia pedica, 17
 Mefloquine, 206
 Megestrol acetate, 38
 Membranes, dissolution and, 8
 4-Metathiazanones, 172
 3-Methyl diazepam derivatives, 85
 Mianserin, 215, 216
 Micelles, 7
 Michael additions, 166
 Michellamine A, 82
 Michellamine B, 82
Micromonospora echinospora spp.
 calichensis, 100
 Milieu intérieur, 17
 Mimotapes, definition, 197
 Mitochondria, dissolution and, 8–9
 Mitsunobu reactions, 166, 172
 Modelling-type approach, 139
 Moderate coupling among sub-systems, 4
 Molecular aggregations, dissolution and, 7, 10–11
 Molecular fingerprints, 143–4
 Molecular machines, dissolution and, 8
 Molecular tags, 123, 173
 Molecules, dissolution and, 5–6
 Monoamine re-uptake inhibitors, 215–19
 Monomer-to-residue transformation, 7
 Monomers, 6, 7
 Multicomponent condensations, 172
 Multidimensional scaling, 155
 Multi-pin method, 116, 161, 175
 496 Multiple Organic Synthesizer, 141
 Multiple parallel syntheses, 114
 Mutagenicity tests, 21

N

N-substituted
 DMT-hydroxylmethyl-pyrrolidinol
 phosphoramidites, 163

N-substituted glycine (NSG) libraries, 145–6
 Narcotine *see* noscapine
 Nicardipine, 215, 218
 Nifedipine
 active conformation, 78–9
 antiperiplanar, *ap*, 77
 axial ester, 77, 78
 conformation, 76–9
 ortho- and *meta*-substituted derivatives, 76–7, 78
 orthogonal arrangement of rings, 76, 77
 role of ester groups, 77–8
 sailing ship nomenclature, 76–8
 synperiplanar, *sp*, 77
 Nomifensine, 23–5
 Non-nucleoside reverse transcriptase (RT)
 inhibitors, 82
 Nonpeptide libraries, 113
 Norfluoxetine, 217, 219
 Nortriptyline, 215, 216
 Noscapine acid, 31
 Noscapine, genotoxicity, 30–4, 53
 AUC values
 history, 31
 in vitro studies, 32–3
 in vivo mouse oocyte study, 33
 pharmacokinetics, 30–1
 NSC 625487, 82

O

OC-5181, 221–2
 OC-5186, 221–2
 Oligomer-based notation, 142
 Oligonucleotide synthesis, 125
 Oligonucleotide tagging, 173
 Oligosaccharide synthesis, 125
 One-bead-one-compound, 121, 123, 127, 136, 137, 196–7
 libraries, 135, 172, 174
 One-bead-per-well format, 136
 Organelles, dissolution and, 8–9
 Organisms, dissolution and, 9
 Organs, dissolution and, 9
 Orthogonal libraries, 132, 134
 Oxazepam, carcinogenicity of, 45–53
 biotransformation in animals and humans, 51
 classification of carcinogenic risk, 46
 epidemiology, 51–2
 glucuronidation of, 48
 history, 46–8

- incidences of neoplasms, 47
 mechanisms, 50–1
 metabolite excretion, 51
 similarity with phenobarbital, 48, 49,
 50–1, 52, 53
- P**
- P450 iso-enzymes, 62
P53 tumour suppressor gene
 role in human cancer, 49
 tamoxifen-induced mutations, 27
 Pain relief, 10
 Pancreatic islet cell hyperplasia,
 association with cyproterone acetate, 35
 Passerini reactions, 172
 Pauson Khand reactions, 172
 Peptide display on polysomes, 125
 Peptide libraries, 113
 Peptide nucleic acids (PNA), 162
 Peptide synthesis, 125
 Peptide tagging, 173
 Peptoids, 162, 198
 Phage display libraries, 125, 198
 Pharmacophore fingerprints, 144
 Pharmacophore space, 146
 Pharmacophores, 152–3, 223, 144
 Phenobarbital, similarity with oxazepam, 48,
 49, 50–1, 52, 53
 Phenothiazine, binding, 88
 Phenyl-substituted benzodiazepine (Pbz)
 scaffold, 142
 Phospholipase A2 inhibition, 129
 Phospholipases, vacuolar, inhibition of, 206–7
 Photolithography, 120
 Pin technology, 198
See also multi-pin method
 Pirenzepine, 83
 flexibility, 84
 muscarinic activity, 82
 Pizotyline, 218, 219, 220
Plasmodium berghei, 204, 205, 210, 211,
 215, 221, 225
Plasmodium chabaudi, 215, 221
Plasmodium falciparum, 202, 204, 208–10,
 215, 219–20, 221, 226
Plasmodium lophurae, 204
Plasmodium vinkei, 221
Plasmodium yoelii, 220, 225
 Poisons, 17
 Polyethyleneglycol carriers,
 solubilization and precipitation of, 125
 Polyethyleneglycol monomethyl ether, 123
 Polyps, adenomatous, of the pyloric antrum
 association with cyproterone acetate, 35
 Polysomes, peptide display on, 125
 Popliteal lymph node assay in mice, 24–5
 Portion-mixing strategy, 112, 113, 161
 Portioning-mixing, 198
 Positional scanning, 131, 132
 Prazepam, carcinogenicity, 46
 Principle component analysis, 154
 Project Library software, 139, 143
 Pronethanol, toxicity, 20–2, 53
 Prostaglandin oligomers, 221–2
 Proteases, vacuolar, inhibition of, 205–6
 Protriptyline, 215, 216
 Pseudorotation, 79
 Psoriasis
 acitretin in treatment of, 39
 etretinate in treatment of, 39
 Pyridoxine (vitamin B6) neurotoxicity, 18
- Q**
- QSAR (quantitative structure activity
 relationships), 149, 152, 158
 QSAR-type approach, 139
 Quinine, 206
 resistance to, 202, 209
 Quinoline, 203
- R**
- Rac*-warfarin, binding of, 86, 87
 Radiofrequency tag, 174
 Radius of validity of structure-activity
 models, 149
 Random cassettes, 113
Ras oncogene, role in human cancer, 49
 Receptor theory, 61
 Recombinant peptide diversity, 198
 Reductive alkylations, 166
 Residues, 6, 7
 Retinoic acid, 39
 esterification of, 41
 Reverse transcriptase (RT) inhibitors,
 non-nucleoside, 82
 RNA, hexose alternatives in, 82
 Ro 11-22933/001, 220, 221
 Rotamers, 75
 Roussel-Uclaf structure collection, 147

S

- Safe threshold concept, 36
 Sailing ship nomenclature, 76
 SCREEN, 140
 Selector products, 139
 Sequential tagging, 123, 124, 135, 196
 Sequential unrandomization, 127, 129–32, 198
 Serotonin 5-HT₃ receptor binding, 94
 Sertraline, 217, 219
 SKF-2133-A, 220, 221
 Small-molecule libraries, 114, 126, 199
 Solid phase chemistry, 115
 Solid phase linkers, 120, 116–19
 Solid phase organic chemistry, 163–6, 173
 Solid phase peptide synthesis, 120
 Sotalol, 21
 Split synthesis, 113, 121–5, 129, 161, 172, 173, 198
 Split without mix, 131
 Split-and-mix, 113, 121, 122, 128, 129–30, 131, 135, 141, 151, 163, 174
 statistics of, 144–5
 Split-and-mix amide library, 151
 Split-and-mix library, 135, 136
 Split synthesis, 128, 173
 SPORE database, 141
 SPS database, 141
 Stereoisomers, distinguishing from
 conformers, 74–5
 Stille couplings, 166
Streptomyces zeilensis, 98
 Strong coupling among sub-systems, 5, 13
 Structure fingerprint, 152
 Sulfamoylbenzamide library, 149
 Suzuki couplings, 166
 Sweet aspartame, 90, 92
 Symptom palliation, 10
 Synergetics of complex systems, 2–3
 moderate coupling among sub-systems, 4
 strong coupling among sub-systems, 5, 13
 weak coupling among sub-systems, 3, 13

T

- Tagging
 binary 123, 124, 135, 173
 bitmap (non-sequential), 196
 molecular, 123, 173
 oligonucleotide, 173
 peptide, 173
 radiofrequency, 174
 sequential, 123, 124, 135, 196
 Tamoxifen, 25–30
 genotoxicity, 26–8
 history, 26
 risk assessment, 29–30
 Targets
 applications, 178–9, 179–80
 binding of, 127, 136, 138
 dissolvement and, 9–10
 Taste model, 90, 92, 93
 Tasting peptides, conformation in, 89–90, 91
 Taurine, 93
 Teabag method, 161, 199
 Telenzepine, 83–4
 Tenoxican, binding strength of, 88
 Tetrahydropyridines, 77
 Thematic libraries, 126–7, 199
 4-Thiazolidinones, 172
 Thor/Merlin system, 139
 Thorotrast, 52
 Thyroid follicular cell adenoma, association
 with oxazepam, 48
 Tiapamil, 218
 Tissues, dissolvement and, 9
 Tofisopam, binding of, 88, 89
 conformers, 89
 Toremifene, 29
 Toxic-hairpin, 58, 59
 Toxic-staircase, 61
 Toxicology
 cookbook, 19, 57, 60
 definition, 16
 effect misuse, 61
 fundamental science, 61–2
 history, 16–18
 human studies, 62
 in vitro versus *in vivo*, 57–8
 integrating results, 62
 integrative, 58–60
 modern, 18–19
 protocol, 56–7
 regulatory, 19
 short-cuts, 60
 social role, 19
 strength, 61–2
 weakness, 60–1
 Traceless linkers, 173
 Training set compounds, 154
 Transaction, definition, 11
 Trazodone, 215, 217

Tricarboxylic acid cycle, 55
Tryptophan, binding of, 86

U

Ugi reactions, 159, 172
Unity of life paradigm, 18, 55–6, 58
Unscheduled DNA synthesis (UDS) assay,
26

V

Valency electrons, 6

Verapamil, 214–15, 216, 220–1
and chlorpromazine analogues, 220–1

W

(*S*)-Warfarin, 86
Weak coupling among sub-systems, 3, 13
Wittig reactions, 166

Z

Zimeldine, 23–5

This Page Intentionally Left Blank

CUMULATIVE INDEX OF AUTHORS

- Adam, F., 17, 61
 Albengres, E., 13, 59
 Amer, M. S., 12, 1
 Ammon, H. P. T., 27, 1
 Andersson, C.-M., 28, 65
 Andrews, J., 19, 311
 Ariëns, E. J., 3, 235
 Audus, K. L., 23, 1
 Baker, G. B., 15, 169
 Balant, J. P., 19, 1
 Bandoli, G., 25, 203
 Barré, J., 13, 59
 Bass, P., 8, 205
 Batra, S., 30, 201
 Beach, A. S., 5, 115
 Beach, J. E., 5, 115
 Bebbington, A., 2, 143
 Beijersbergen van Henegouwen, G. M. J.,
 29, 79
 Bélanger, P. M., 24, 1
 Belleau, B., 2, 89
 Bennett, A., 8, 83
 Berger, M. R., 19, 243
 Bertilsson, L., 25, 1
 Bhaduri, A. P., 30, 201
 Bickel, M. H., 25, 55
 Blair, A. M. J. N., 5, 115
 Bloom, B. M., 3, 121; 8, 1
 Blum, M., 19, 197
 Bodor, N., 13, 255
 Borchardt, R. T., 23, 1
 Bosin, T. R., 5, 1; 11, 191
 Boxenbaum, H., 19, 139
 Breit, S. N., 24, 121
 Bresloff, P., 11, 1
 Brimblecombe, R. W., 2, 143; 7, 165
 Brittain, R. T., 5, 197
 Brocklehurst, W. E., 5, 109
 Buckett, W. R., 10, 53
 Bürki, K., 26, 143
 Campagne, E., 5, 1; 11, 191
 Casy, A. F., 18, 178
 Chappell, W. R., 20, 1
 Chignell, C. F., 5, 55
 Chikhale, P. J., 23, 1
 Chu, D. T. W., 21, 39
 Clarke, A. J., 5, 115
 Cohen, N. C., 14, 41
 Collier, H. O. J., 3, 171; 5, 95
 Copp, F. C., 1, 161
 Cos, J. S. G., 5, 115
 Coutts, R. T., 15, 169
 Crespi, C. L., 26, 179
 Creveling, C. R., 2, 47
 Crossland, N. O., 12, 53
 d'Athis, P., 13, 59
 Davis, B., 10, 1
 Davis-Bruno, K. L., 25, 173
 Day, R. O., 24, 121
 De Benedetti, P. G., 16, 227
 De Clercq, E., 17, 1
 De Luca, H. F., 28, 269
 De Waal, E. J., 30, 15
 Dolmella, A., 25, 203
 Dostert, P., 23, 65
 Doyle, F. P., 1, 1, 107
 D'Souza, R. W., 19, 139
 Duax, W. L., 18, 116
 Durckheimer, W., 17, 61
 Dutta, A. S., 21, 145
 Dwivedy, I., 29, 171
 Eichelbaum, M., 28, 1
 Epstein, C., 5, 115
 Ettinger, R. A., 28, 269
 Falch, E., 17, 381
 Fauchère, J.-L., 15, 29; 23, 127
 Fearnly, G. R., 7, 107
 Felder, E. R., 30, 111
 Fernandes, P. B., 21, 39
 Ferris, R. M., 6, 121
 Fessenden, J. S., 4, 95
 Fessenden, R. J., 4, 95
 Fichtl, B., 20, 117
 Fischer, G., 17, 61
 Foster, A. B., 14, 1
 Fuller, R. W., 17, 349
 Furchgott, R. F., 3, 21
 Furst, C. I., 4, 133
 Ganellin, C. R., 4, 161
 Gerecke, M., 14, 165
 Giannis, A., 29, 1
 Goldman, I. M., 3, 121

- Grana, E., 2, 127
 Grant, D., 19, 197
 Gray, P., 19, 311
 Gross, A. S., 28, 1
 Griffin, J. F., 18, 116
 Gundert-Remy, U. M., 19, 1
 Haefely, W., 14, 165
 Hall, L. H., 22, 1
 Hallberg, A., 28, 65
 Halushka, P. V., 25, 173
 Hamburger, M., 20, 167
 Häring, H. U., 27, 1
 Heim, M. E., 19, 243
 Herz, A., 6, 79
 Hjeds, H., 17, 381
 Högberg, T., 28, 65
 Hostettmann, K., 20, 167
 Houin, G., 13, 59
 Howe, R., 9, 7
 Howes, J. F., 11, 97
 Iversen, L. L., 2, 1
 Jack, D., 5, 197
 Janis, R. A., 16, 309
 Jefford, C. W., 29, 271
 Jenner, P., 13, 95
 Jepson, E. M., 9, 1
 Jørgensen, F. S., 17, 381
 Kagechika, H., 24, 81
 Kalow, W., 25, 1
 Kane, S. E., 28, 181
 Kellerer, M., 27, 1
 Kenakin, T. P., 15, 71
 Keppler, B. K., 19, 243
 Kier, L. B., 22, 1; 26, 1; 30, 1
 King, J., 5, 115
 Kirrstetter, R., 17, 61
 Kirshner, N., 6, 121
 Klenner, T., 19, 243
 Knapp, D. R., 5, 1
 Kolb, V. M., 16, 281
 Kritchevsky, D., 9, 41
 Krogsgaard-Larsen, P., 17, 381
 Kyburz, E., 14, 165
 Laduron, P. M., 22, 107
 Lands, W. E. M., 14, 147
 Laube, H., 27
 Lawton, G., 23, 16
 Lecomte, M., 13, 59
 Ledermann, B., 26, 143
 Lee, T. B., 5, 115
 Leurs, R., 20, 217
 Loveday, D. E. E., 5, 115
 Mackay, D., 3, 1
 Marston, A., 20, 167
 McMartin, C., 22, 39
 Mehta, M. D., 1, 107
 Mesnil, M., 13, 95
 Metz, D. H., 10, 101
 Meyer, U. A., 19, 197; 25, xi; 26, ix; 27, xi; 28, xiii
 Millard, B. J., 6, 157
 Miller, D. W., 23, 1
 Möhler, H., 14, 165
 Mordenti, J., 20, 1
 Moss, G. F., 5, 115
 Mosthaf, L., 27, 1
 Muranishi, S., 21, 1
 Nayler, J. H. C., 1, 1; 17, 1
 Nayler, W. G., 12, 39
 Neiss, E. S., 5, 1
 Neumann, H.-G., 15, 1
 Nicholls, A. J., 17, 235
 Nicolini, M., 25, 203
 Niecieki, A. v., 20, 117
 Nielsen, L., 17, 381
 Orr, T. S. C., 5, 115
 Paciorek, P. M., 23, 161
 Parkes, D., 8, 11; 12, 247
 Parrett, J. R., 9, 103
 Pars, H. G., 11, 97
 Pasutto, F. M., 15, 169
 Paton, W. D. M., 3, 57
 Poppinger, D., 30, 111
 Porter, C. C., 4, 71
 Pratesi, P., 2, 127
 Pullman, B., 18, 1
 Rang, H. P., 3, 57
 Rauws, A. G., 30, 15
 Ray, S., 29, 171
 Razdan, R. K., 11, 97
 Remacle, J., 16, 1
 Ritchie, A. C., 5, 197
 Ritchie, J. T., 5, 115
 Roberfroid, M. B., 16, 1
 Robinson, B. F., 10, 93
 Roseboom, H., 19, 1
 Rossum, van J. M., 3, 189
 Rübsam, F., 29, 1
 Ruffolo, R. R., 17, 235
 Salmon, J. A., 15, 111
 Sarges, R., 18, 139
 Schanberg, S. M., 6, 121
 Schanker, L. S., 1, 72
 Schröder, H., 28, 253

- Sebille, B., **13**, 59
Sharma, S., **24**, 199; **25**, 103
Shaw, K. M., **11**, 75
Sheard, P., **5**, 115
Shen, T. Y., **12**, 89
Shudo, K., **24**, 81
Silver, P. J., **16**, 309
Simonyi, M., **30**, 73
Sokolovsky, M., **18**, 432
Stone, C. A., **4**, 71
Stone, T. W., **18**, 292
Strange, P. G., **28**, 313
Strolin Benedetti, M., **23**, 65
Teschemacher, H. J., **6**, 79
Testa, B., **13**, viii, 1, 95; **14**, viii; **15**, viii;
16, viii, 85; **17**, xi; **18**, ix; **19**, xi;
20, ix; **21**, ix; **22**, viii; **23**, viii;
24, viii; **25**, xi; **26**, ix, 1; **27**, xi; **28**, xiii;
30, 1
Thody, A. J., **11**, 23
Thomas, R., **19**, 311
Thompson, S. E., **23**, 1
Thurieu, C., **23**, 127
Tillement, J.-P., **13**, 59
Timmerman, H., **20**, 217
Timmermans, P. B. M. W. M., **13**, 209
Triggle, D. J., **2**, 173; **16**, 309
Tute, M. S., **6**, 1; **26**, 45
Urien, S., **13**, 59
Urquhart, J., **26**, 237
van der Goot, H., **20**, 217
van der Laan, J. W., **30**, 15
van der Schoot, J. B., **2**, 47
van de Waterbeemd, H., **16**, 85
van Heyningen, E. M., **4**, 1
van Zwieten, P. A., **13**, 209
Vaughan Williams, E. M., **9**, 69
Verspohl, L., **27**, 1
Viehe, M. G., **16**, 1
Wahl, M. A., **27**, 1
Walter, K., **20**, 117
Walton, K. W., **9**, 55
Waser, P. G., **3**, 81
Waterfall, J. F., **23**, 161
Williams, K. M., **24**, 121
Wilson, C. A., **8**, 119
Winter, C. A., **12**, 89
Zanger, U. M., **19**, 197
Zeelen, F. J., **22**, 149; **25**, 87
Zini, R., **13**, 59

This Page Intentionally Left Blank

CUMULATIVE INDEX OF TITLES

- Activities and sites of antinociceptive action of morphine-like analgesics, **6**, 79
- Adrenergic neurone blocking agents, **1**, 161
- Advances in penicillin research, **7**, 1
- Advances in the development of pharmaceutical antioxidants, **28**, 65
- Aldose reductase inhibitors as new antidiabetic drugs, **27**, 171
- Aldose reductase inhibitors: Structure–activity relationships and therapeutic potential, **18**, 139
- Alzheimer's Disease: A pharmacological challenge, **25**, 203
- Amantadine, **8**, 11
- Antitussives, **1**, 107
- Atom description in QSAR models: development and use of an atom level index, **22**, 1
- Autoradiographic investigations of cholinergic and other receptors in the motor endplate, **3**, 81
- The Binding of drugs to blood plasma macromolecules: Recent advances and therapeutic significance, **13**, 59
- Bioactivation of organic nitrates and other nitrovasodilators, **28**, 253
- Biochemical actions and clinical pharmacology of anti-inflammatory drugs, **24**, 121
- The Biochemistry of guanethidine, **4**, 133
- Biochemistry and pharmacology of methyldopa and some related structures, **4**, 71
- Biologically active benzo[b]thiophene derivatives, **5**, 1
- Biologically active benzo[b]thiophene derivatives II, **11**, 191
- Biological properties of silicon compounds, **4**, 95
- Brain uptake of drugs: The influence of chemical and biological factors, **23**, 1
- Bromocriptine, **12**, 247
- Central and peripheral α -adrenoceptors. Pharmacological aspects and clinical potential, **13**, 209
- Cephalosporins, **4**, 1
- The Changing world of steroids, **25**, 87
- Chemical and biological studies on indomethacin, sulindac and their analogs, **12**, 89
- Chronopharmacology in drug research and therapy, **24**, 1
- Clinical aspects of diabetes mellitus, **27**, 17
- Combinatorial compound libraries for enhanced drug discovery approaches, **30**, 111
- Complexity and emergence in drug design, **26**, 1
- Compounds acting on glucose absorption, **27**, 151
- Compounds acting on glucose uptake: biguanides, **27**, 137
- Compounds acting on insulin secretion: sulphonylureas, **27**, 108
- The Concept of chiral conformers and its significance in molecular pharmacology, **30**, 73
- The Concept of emergence–dissolution in drug research, **30**, 1
- Conformational perturbation in regulation of enzyme and receptor behaviour, **2**, 89
- Correlates of variable patient compliance in drug trials: relevance in the new health care environment, **26**, 237
- Cyclic nucleotides and the heart, **12**, 39
- Cyclic nucleotides as targets for drug design, **12**, 1
- The Design and biological profile of angiotensin-converting enzyme inhibitors, **23**, 161
- Design of new drugs for helminth diseases: Lead optimization in benzimidazoles, **25**, 103
- Design and therapeutic potential of peptides, **21**, 145
- Development of estrogen antagonists as pharmaceutical agents, **29**, 171
- Deuterium isotope effects in the metabolism of drugs and xenobiotics: Implications for drug design, **14**, 1

- Digitalis: Its mode of action, receptor, and structure–activity relationships, **19**, 311
- Disodium cromoglycate [Intal®], **5**, 115
- Dopamine receptors: Studies on structure and function, **28**, 313
- Drug action and cellular calcium regulation, **16**, 309
- Drug design in three dimensions, **14**, 41
- Drug design: the present and the future, **26**, 45
- Drugs? Drug research? Advances in drug research? Musings of a medicinal chemist, **13**, 1
- Drugs for filariasis, **24**, 199
- Drug targeting towards the lymphatics, **21**, 1
- Electrophysiological basis for a rational approach to antidysrhythmic therapy, **9**, 69
- Elements for the rational design of peptide drugs, **15**, 29
- Endogenous broncho-active substances and their antagonism, **5**, 95
- Evaluation of the stability of peptides and pseudopeptides as a tool in peptide drug design, **23**, 127
- Extrapolation of toxicological and pharmacological data from animals to humans, **20**, 1
- Factors affecting the storage of drugs and other xenobiotics in adipose tissue, **25**, 55
- Fibrinolysis, **7**, 107
- Foodstuffs as sources of psychoactive amines and their precursors; content, significance and identification, **15**, 169
- Free radicals in drug research, **16**, 1
- Gastric antisecretory and antiulcer agents, **8**, 205
- Genetic polymorphisms of drug metabolism, **19**, 197
- Towards Genomic pharmacology: from membranal to nuclear receptors, **22**, 107
- 2-Halogenoethylamines and receptors analysis, **2**, 173
- Histaminergic agonists and antagonists recent developments, **20**, 217
- Hyperlipidaemia and the pathogenesis of atherosclerosis, **9**, 55
- Hypolipidaemic agents, **9**, 7
- Hypothalamic amines and the release of gonadotrophins and other pituitary hormones, **8**, 119
- Indane and indene derivatives of biological interest, **4**, 163
- The Inhibition of nonadrenaline uptake by drugs, **2**, 1
- Inhibition of prostaglandin, thromboxane and leukotriene biosynthesis, **15**, 111
- Integrated control of trematode diseases, **12**, 53
- Interethnic factors affecting drug response, **25**, 1
- Interferon and interferon inducers, **10**, 101
- Interspecies pharmacokinetic scaling, biological design and neoteny, **19**, 139
- A Kinetic approach to the mechanism of drug action, **3**, 57
- Laboratory models of atherosclerosis, **9**, 41
- Limitations of molecular pharmacology. Some implications of the basic assumptions underlying calculations on drug-receptor interactions and the significance of biological drug parameters, **3**, 189
- Mass spectrometry in drug research, **6**, 157
- Mechanisms in angina pectoris in relation to drug therapy, **10**, 93
- Mechanisms of action of antiinflammatory drugs, **14**, 147
- Mechanisms of insulin action, **27**, 25
- Medicinal chemistry of steroids: Recent developments, **22**, 149
- Medicinal photochemistry: Phototoxic and phototherapeutic aspects of drugs, **29**, 79
- Metal complexes as antitumour agents, **19**, 243
- Miscellaneous antirheumatic drugs and their possible modes of action, **11**, 1
- Molecular aspects of the storage and uptake of catecholamines, **6**, 121
- Molecular mechanisms of specificity in DNA-antitumour drug interactions, **18**, 1
- Molecular pharmacology and therapeutic potential of thromboxane A₂ receptor antagonists, **25**, 173

- Monoamine oxidase: From physiology and pathophysiology to the design and clinical application of reversible inhibitors, **23**, 65
- Multidrug resistance of cancer cells, **28**, 181
- Muscarinic cholinergic receptors and their interactions with drugs, **18**, 432
- Muscarinic receptors in peripheral and central nervous systems, **2**, 143
- The Nature of catecholamine-adenine mononucleotide interactions in adrenergic mechanisms, **3**, 121
- A New method for the analysis of drug-receptor interactions, **3**, 1
- Noninhalation anaesthetics, **10**, 1
- Novel approaches to the design of safer drugs: Soft drugs and site-specific chemical delivery systems, **13**, 255
- Opioid receptors and their ligands: Recent developments, **18**, 177
- The Parameterization of lipophilicity and other structural properties in drug design, **16**, 85
- Penicillins and related structures, **1**, 1
- Peptidomimetics in drug design, **29**, 1
- Peroxidic antimalarials, **29**, 271
- Pharmacokinetic criteria for drug research and development, **19**, 1
- Pharmacokinetics of peptides and proteins: Opportunities and challenges, **22**, 39
- Pharmacological approaches to the therapy of angina, **9**, 103
- The Pharmacology and therapeutic potential of serotonin receptor agonists and antagonists, **17**, 349
- Physiological transport of drugs, **1**, 72
- The Pineal gland: A review of the biochemistry, physiology and pharmacological potential of melatonin and other pineal substances, **11**, 75
- Potential therapeutic agents derived from the cannabinoid nucleus, **11**, 97
- The Prevention of ischaemic heart disease—clinical management, **9**, 1
- Principles and practice of Hansch Analysis: A guide to structure–activity correlation for the medicinal chemist, **6**, 83
- Psychotomimetic drugs; biochemistry and pharmacology, **7**, 165
- Purine receptors and their pharmacological roles, **18**, 292
- The Rate of contemporary drug discovery, **8**, 1
- Recent β -adrenoreceptor stimulants, **5**, 197
- Recent advances in GABA agonists, antagonists and uptake inhibitors; structure–activity relationships and therapeutic potential, **17**, 381
- Recent advances in the molecular pharmacology of benzodiazepine receptors and in the structure–activity relationships of their agonists, **14**, 165
- Recent advances in the search for selective antiviral agents, **17**, 1
- Recent developments in the field of cephem antibiotics, **17**, 61
- Recent developments in the field of quinoline antibacterial agents, **21**, 39
- Recent experimental and conceptual advances in drug receptor research in the cardiovascular system, **17**, 235
- Receptor theory and structure–action relationships, **3**, 235
- Regulation of glucose homeostasis, **27**, 3
- Reversal of chloroquine resistance in malaria. A new concept of chemotherapy, **30**, 201
- The Role of slow-reacting substances in asthma, **5**, 109
- Search for new drugs of plant origin, **20**, 167
- The Secretory machinery of insulin release, **27**, 77
- Sense and non-sense in toxicity assessment of medicinal products, **30**, 15
- The Significance of melanocyte-stimulating hormone [MSH] and the control of its secretion in the mammal, **11**, 23
- Spectroscopic techniques for the study of drug interactions with biological systems, **5**, 55
- Stereochemical aspects of drug action and disposition, **28**, 1

- The Stereoelectronic effects at opiate receptor: their influence on affinity and intrinsic activity, **16**, 281
- Steroidal neuromuscular blocking agents, **10**, 53
- Structural evolution of retinoids, **24**, 81
- Structure and activity at adrenergic receptors of catecholamines and related compounds, **2**, 127
- Structure-activity relationships and mechanism of action of antibacterial sulphanilamides and sulphones, **16**, 227
- The Structure and receptor binding of steroid hormones, **18**, 115
- Substrates and inhibitors of dopamine β -hydroxylase [DBH], **2**, 47
- Therapeutic use of insulin, **27**, 50
- Tissue binding versus plasma binding of drugs: General principles and pharmacokinetic consequences, **20**, 117
- Tissue and receptor selectivity: similarities and differences, **15**, 71
- Tolerance, physical dependence and receptors. A theory of the genesis of tolerance and physical dependence through drug-induced changes in the number of receptors, **3**, 171
- Toxication mechanisms in drug metabolism, **15**, 1
- Transgenic animals as pharmacological tools, **26**, 143
- The Use of β -haloalkylamines in the differentiation of receptors and in the determination of dissociation constants of receptor-agonists complexes, **3**, 21
- The Vitamin D endocrine system and its therapeutic potential, **28**, 269
- Xenobiotic metabolism by brain monooxygenases and other cerebral enzymes, **13**, 95
- Xenobiotic-metabolizing human cells as tools for pharmacological research, **26**, 179