

Elementary Analytic Functions

Complex Functions Theory a-1

Leif Mejlbro



Leif Mejlbro

Elementary Analytic Functions

Complex Functions Theory a-1

Elementary Analytic Functions – Complex Functions Theory a-1
© 2010 Leif Mejlbro & Ventus Publishing ApS
ISBN 978-87-7681-690-2

Contents

	Introduction	7
1	The Complex Numbers	9
1.1	Rectangular form of complex numbers	10
1.2	Polar form of complex numbers	13
1.3	The binomial equation	20
1.4	The general equation $Az^2 + Bz + C = 0$ of second degree	26
1.5	The equations of third and fourth degree	27
	The equation of third degree	28
	The equation of fourth degree	31
1.6	Rational roots and multiple roots of a polynomial	32
	Procedure of finding rational roots	33
	Procedure of finding multiple roots	35
1.7	Symbolic currents and voltages. Time vectors	37
2	Basic Topology and Complex Functions	40
2.1	Basic Topology	40
	Topology of open sets	42
	Compact sets	44
	Relative topology	48

Free eBook on Learning & Development

By the Chief Learning Officer of McKinsey

[Download Now](#)

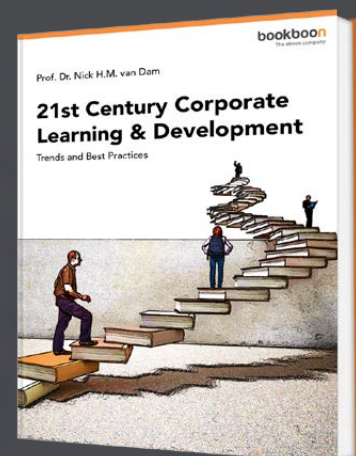

	Connected sets	50
	Uniform continuity	55
	The Fix Point Theorem and some of its consequences	56
2.2	Complex functions	67
2.3	Complex limits and complex sequences	68
	Complex limits	69
	Complex sequences	71
2.4	The complex innity versus the real innities	72
2.5	Complex line integrals	74
	Complex curves	74
	Complex line integrals	75
	Practical computation of complex line integrals	77
3	Analytic Functions	84
3.1	Complex differentiable functions and analytic functions	84
3.2	Cauchy-Riemann's equations in polar coordinates	94
3.3	Cauchy's integral theorem	98
3.4	Cauchy's integral formula	109
3.5	Simple applications in Hydrodynamics	119
4	Some elementary analytic functions	123
4.1	Polynomials	123
4.2	Rational functions	126

www.sylvania.com

**We do not reinvent
the wheel we reinvent
light.**

Fascinating lighting offers an infinite spectrum of possibilities: Innovative technologies and new markets provide both opportunities and challenges. An environment in which your expertise is in high demand. Enjoy the supportive working atmosphere within our global group and benefit from international career paths. Implement sustainable ideas in close cooperation with other specialists and contribute to influencing our future. Come and join us in reinventing light every day.

Light is OSRAM

**OSRAM
SYLVANIA**



	General linear fractional transformations	126
	Decomposition of rational functions	126
	Decomposition formula for multiple roots in the denominator	131
4.3	The exponential	135
4.4	The trigonometric and hyperbolic functions	137
	Definition of the complex trigonometric and hyperbolic functions	137
	Addition formulæ	139
	Zeros of the trigonometric and hyperbolic functions	141
	Table of some elementary analytic functions and their real and imaginary parts	142
	Index	143



Discover the truth at www.deloitte.ca/careers

Deloitte.

© Deloitte & Touche LLP and affiliated entities.



Introduction

Complex Functions Theory (or the *Theory of Analytic Functions*) is a classical and central topic of Mathematics. Its applications in Physics and the technical sciences are well-known and important. Examples of such applications are the *harmonic functions* in the theory of *plane electrostatic fields* or plane flows in *Hydrodynamics* and *Aerodynamics*. Furthermore, the *biharmonic equation* is used in the solution of *two-dimensional elasticity problems*.

From a mathematical point of view the results of *Complex Functions Theory* imply that the investigation of many functions – including the most commonly used ones like the *exponentials*, the logarithms, the *trigonometric* and the *hyperbolic functions* can be reduced to an investigation of their *power series*, which locally can be approximated by *polynomials*.

A natural extension of the power series is given by the so-called *Laurent series*, in which we also allow negative exponents. These are applied in sampling processes in *Cybernetics*, when we use the so-called *z-transform*. The *z-transform* of a sequence just provides us with a very special Laurent series.

From a mathematical point of view the Laurent series give an unexpected bonus by leading to the *residue calculus*. Using a standard technique, which will be given in the books, followed by an application of the *residue theorem* it is possible to compute the exact value of many integrals and series, a task which cannot be solved within the realm of the *Real Calculus* alone as given in the *Ventus: Calculus* series. In order to ease matters in the computations, simple rules for calculating the residues are given.

In this connection one should also mention the *Laplace transform*, because if the Laplace transformed of a function exists in an open domain, then it is even analytic in this domain, and all the theorems of these present books can be applied. It should be well-known that the Laplace transform is a must in the technical sciences with lots of applications, like e.g. the *transfer functions* in *Cybernetics* and in *Circuit Theory*. The reason for using the Laplace transform stems from the fact that “complicated” operations like integration and differentiation are reduced to simpler algebraic operations. In this connection it should be mentioned that the *z-transform* above may be considered as a *discrete Laplace transform*, so it is no wonder why the *z-transform* and the Laplace transform have similar rules of computation.

Complex Functions Theory is very often latently involved in the derivation of classical results. One such example is *Shannon’s theorem*, or the *sampling theorem*, (originally proved in 1916 by Whittaker, an English mathematician, much earlier than Shannon’s proof). We shall, however, not prove this famous theorem, because a proof also requires some knowledge of *Functional Analysis* and of the *Fourier transform*.

The examples of applications mentioned above are far from exhausting all possibilities, which are in fact numerous. However, although *Complex Functions Theory* in many situation is a very powerful means of solving specific problems, one must not believe that it can be used in all thinkable cases of physical or technical setups. One obstacle is that it is a two-dimensional theory, while the real world is three-dimensional. Another one is that analytic functions are not designed to give a direct description of *causality*. In such cases one must always paraphrase the given problem in a more or less obvious way. A third problem is exemplified by *low temperature Physics*, where the existence of the absolute zero at 0° K implicitly has the impact that one cannot describe any non-constant process by analytic functions in a small neighbourhood of this absolute zero. One should therefore be very content with that there are indeed so many successful applications of *Complex Functions Theory*.

Complex Functions Theory is here described in an **a** series and a **c** series. The **c** series gives a lot of supplementary and more elaborated examples to the theory given in the **a** series, although there are also some simpler examples in the **a** series. When reading a book in the **a** series the reader is therefore recommended also to read the corresponding book in the **c** series. The present **a** series is divided into three successive books, which will briefly be described below.

a-1 The book *Elementary Analytic Functions* is defining the battlefield. It introduces the analytic functions using the *Cauchy-Riemann equations*. Furthermore, the powerful results of the *Cauchy Integral Theorem* and the *Cauchy Integral Formula* are proved, and the most elementary analytic functions are defined and discussed as our building stones. The important applications of Cauchy's two results mentioned above are postponed to **a-2**.

a-2 The book *Power Series* is dealing with the correspondence between an analytic function and its complex power series. We make a digression into the theory of *Harmonic Functions*, before we continue with the *Laurent series* and the *Residue Calculus*. A handful of simple rules for computing the residues is given before we turn to the powerful applications of the residue calculus in computing certain types of *trigonometric integrals*, *improper integrals* and the sum of some not so simple series.

a-3 The book *Transforms, Stability, Riemann surfaces, and Conformal maps* starts with some transforms, like the *Laplace transform*, the *Mellin transform* and the *z-transform*. Then we continue with pointing out the connection between analytic functions and *Geometry*. We prove some classical criteria for stability in *Cybernetics*. Then we discuss the inverse of an analytic function and the consequence of extending this to the so-called *multi-valued functions*. Finally, we give a short review of the *conformal maps* and their importance for solving a *Dirichlet problem*.

The author is well aware of that the topics above only cover the most elementary parts of *Complex Functions Theory*. The aim with this series has been hopefully to give the reader some knowledge of the mathematical technique used in the most common technical applications.

Leif Mejlbro
30th July 2010

1 The Complex Numbers

We shall in this chapter shortly review the complex numbers and related matters more or less known from the elementary calculus. We shall use the following well-known notation:

- The set of natural numbers:

$$\mathbb{N} = \{1, 2, 3, \dots\} \quad \text{and} \quad \mathbb{N}_0 = \mathbb{N} \cup \{0\} = \{0, 1, 2, 3, \dots\}.$$

- The set of integers (i.e. Zahl in German),

$$\mathbb{Z} = \{\dots, -2, -1, 0, 1, 2, \dots\}.$$

- The set of rational numbers (i.e. quotients),

$$\mathbb{Q} = \left\{ \frac{p}{q} \mid p \in \mathbb{Z}, q \in \mathbb{N} \right\}.$$

- The set of real numbers, \mathbb{R} .

- The set of complex numbers,

$$\mathbb{C} = \{z = x + iy \mid x, y \in \mathbb{R}\}.$$

1.1 Rectangular form of complex numbers

A complex number $z \in \mathbb{C}$ is formally defined as the sum

$$z = x + iy, \quad x, y \in \mathbb{R},$$

where the symbol “ i ” is assumed to be a specific solution of the equation $z^2 = -1$, so we adjoin one root “ i ” of this equation to the field \mathbb{R} of real numbers to get the extended complex field \mathbb{C} . Thus $i^2 := -1$, which does not make sense in \mathbb{R} .

Since $\mathbb{C} \sim \mathbb{R} \times \mathbb{R}$ is two-dimensional, it is natural to identify \mathbb{C} with the usual Euclidean plane, so we let $z = x + iy \in \mathbb{C}$, $x, y \in \mathbb{R}$, geometrically be described by the point $(x, y) \in \mathbb{R} \times \mathbb{R}$ with some “strange” rule of multiplication given by the above $i^2 = -1$. Due to this geometric interpretation we also call $\mathbb{C} \sim \mathbb{R}^2 = \mathbb{R} \times \mathbb{R}$ the *complex plane*.

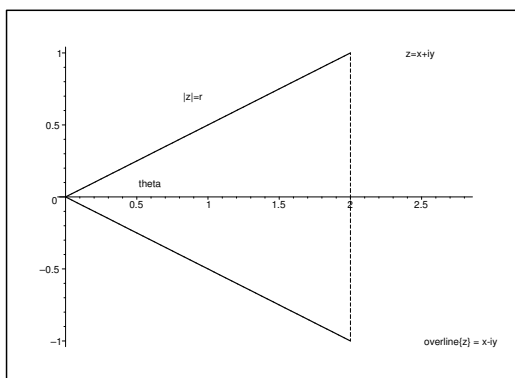

Figure 1: The complex plane.

In the complex plane the *real axis* is identified with the X -axis, and the *imaginary axis* is identified with the Y -axis. Points on the X -axis are identified with the usual real numbers, while points on the Y -axis are called *imaginary numbers*. This unfortunate terminology stems from a time, when the complex numbers were not clearly understood. It has ever since been customary to use word even for the y -coordinate itself.

Given a complex number $z = x + iy$, $x, y \in \mathbb{R}$, it follows by the geometrical interpretation that the *real* coordinates (x, y) are uniquely determined. We introduce the following fundamental notations, cf. also Figure 1.

- $x := \Re z =$ *real part* of z .
- $y := \Im z =$ *imaginary part* of z .
- $r := |z| = \sqrt{x^2 + y^2} =$ *absolute value* (or *module*) of z .
- $\Theta = \arg z =$ *argument* of $z \neq 0$, i.e. the angle from the X -axis to the vector $(x, y) \in \mathbb{R}^2$, modulo 2π .
- $\bar{z} := x - iy =$ *complex conjugated* of z , i.e. the reflection of z with respect to the real axis.

Here the *argument* needs a comment, because the angle Θ is only determined modulo 2π . This means that $\arg z$ is not a number, but a set (of numbers),

$$\arg z = \{ \Theta_0 + 2p\pi \mid p \in \mathbb{Z} \}, \quad z \neq 0,$$

where Θ_0 is any fixed chosen angle between the X -axis and the vector of coordinates (x, y) .

If $z = 0$, we *define* $\arg 0 := \mathbb{R}$.

Even if $\arg z$ is a *set* of numbers, it is the common practice sloppily to think of $\arg z$ as just one of its many values. If one wants to be more precise, one may introduce the *principal argument* by

$$\text{Arg } z := \Theta_0 \in] - \pi, \pi] \cap \arg z, \quad z \neq 0,$$

i.e. $\text{Arg } z$ is the *uniquely determined* angle in the fixed interval $] - \pi, \pi]$ of length 2π of the vector (x, y) from the X -axis.

Another useful definition is

$$\text{Arg}_0 z := \Theta_0 \in]0, 2\pi] \cap \arg z, \quad z \neq 0,$$

which is also uniquely determined, whenever $z \neq 0$. This single-valued function $\text{Arg}_0 z$ will be convenient later on. For some strange reason it is not given a specific name.

Notice that the principal argument $\text{Arg} : \mathbb{C} \setminus \{0\} \mapsto] - \pi, \pi]$ is *not* defined for $z = 0$.

We shall later see the importance of the multi-valued functions, of which $\arg z$ is our first example. The general principle is here that *sets* (or multi-valued functions) are written in lower-case letters, like in $\arg z$, while a derived single-valued function specified by some additional rule, in the chosen case e.g. $\text{Arg } z$, starts with an upper-case letter. When this specification of the singular-valued function uses the principal argument in a more or less obvious way, we also call the result the *principal value* of the underlying multi-valued function.

Remark 1.1.1 The reader should be aware of that some authors instead use the lower-case name for the single-valued function and the upper-case name for the multi-valued function. We shall later on meet other examples of different notation in *Complex Function Theory*. \diamond

The *conjugation* of a complex number, is geometrically interpreted as a reflection in the X -axis, cf. Figure 1. If we define *complex addition* in \mathbb{C} as the corresponding addition of vectors in $\mathbb{R}^2 \sim \mathbb{C}$, then it is easily seen that we have in the adopted notation,

$$z + \bar{z} = 2x = 2\Re z, \quad z - \bar{z} = 2iy = 2i\Im z, \quad \overline{z_1 + z_2} = \bar{z}_1 + \bar{z}_2.$$

We define the *complex multiplication* by adding the multiplication rules $i \cdot i = i^2 = -1$, already mentioned earlier, and $x \cdot i = i \cdot x = ix = xi$ for any $x \in \mathbb{R}$ to the usual real multiplication. We usually omit the dot \cdot as the notation of multiplication and only use it occasionally for clarity. Here, $it = ti$, $t \in \mathbb{R}$, is of course interpreted in the complex plane as the point on the imaginary axis with the coordinates $(0, t) \in \mathbb{R}^2$.

We note the important computation

$$(1) \quad z \cdot \bar{z} = (x + iy)(x - iy) = x^2 + y^2 = |z|^2 = r^2 \geq 0, \quad \text{for all } z \in \mathbb{C}.$$

Example 1.1.1 A simple application of (1) is given by the computation of a quotient of two complex numbers in order to find the real and imaginary parts of the quotient. Consider the denominator $a + ib \neq 0$, $a, b \in \mathbb{R}$, and the numerator $c + id$, $c, d \in \mathbb{R}$. The trick is to multiply both the denominator and the numerator by the conjugated of the denominator, which is $\neq 0$. Thus

$$\frac{c + id}{a + ib} = \frac{c + id}{a + ib} \cdot \frac{a - ib}{a - ib} = \frac{ac + bd}{a^2 + b^2} + i \frac{ad - bc}{a^2 + b^2},$$

from which

$$\Re\left(\frac{c + id}{a + ib}\right) = \frac{ac + bd}{a^2 + b^2} = \frac{1}{a^2 + b^2} \begin{vmatrix} b & -a \\ c & d \end{vmatrix}, \quad a^2 + b^2 > 0,$$

and

$$\Im\left(\frac{c + id}{a + ib}\right) = \frac{ad - bc}{a^2 + b^2} = \frac{1}{a^2 + b^2} \begin{vmatrix} a & b \\ c & d \end{vmatrix}, \quad a^2 + b^2 > 0.$$

In particular,

$$(2) \quad \frac{1}{z} = \frac{1}{x + iy} = \frac{x}{x^2 + y^2} - i \frac{y}{x^2 + y^2} \quad \text{for } z \neq 0,$$

which can also be seen by the following simpler computation,

$$\frac{1}{z} = \frac{1}{z} \cdot \frac{\bar{z}}{\bar{z}} = \frac{\bar{z}}{|z|^2} \quad \text{for } z \neq 0. \quad \diamond$$

Remark 1.1.2 Here we should give a warning. A common error in computing

$$\frac{1}{z} = \frac{1}{x + iy}$$

is to believe that one can split by the + in the denominator, which will give us the wrong result,

$$\frac{1}{x} + \frac{1}{iy} = \frac{1}{x} - i \frac{1}{y}, \quad \text{using that } \frac{1}{i} = \frac{i}{i^2} = -i.$$

The frequency of students making this error is approximately once or twice per course, so it happens more often than one would believe. That this result is indeed wrong is seen by comparing with the right result (2). In fact, by identifying the real parts and the imaginary parts we get

$$\frac{x}{x^2 + y^2} = \frac{1}{x} \quad \text{and} \quad \frac{y}{x^2 + y^2} = \frac{1}{y}, \quad (x, y) \neq (0, 0),$$

from which

$$x^2 = x^2 + y^2 = y^2.$$

The only solution is $x = y = 0$, which is not possible, because we have assumed that $(x, y) \neq (0, 0)$. \diamond

It follows immediately from the definition of the *absolute value* of z that $|z| := \sqrt{x^2 + y^2}$ in the complex plane can be interpreted as the Euclidean distance from $0 \sim (0, 0)$ to $z \sim (x, y)$ (in the Euclidean space). This implies that $|z_1 - z_2|$ indicates the usual Euclidean distance between $z_1 \sim (x_1, y_1)$ and $z_2 \sim (x_2, y_2)$ in the complex plane,

$$|z_2 - z_1| = \sqrt{(x_2 - x_1)^2 + (y_2 - y_1)^2}.$$

Then it follows by elementary geometry (cf. Figure 2) that the *triangle inequality* holds, i.e.

$$|z_3 - z_1| \leq |z_3 - z_2| + |z_2 - z_1|,$$

and that also

$$||z_2| - |z_1|| \leq |z_2 \pm z_1| \leq |z_2| + |z_1|.$$

SIMPLY CLEVER

ŠKODA



We will turn your CV into
an opportunity of a lifetime



Do you like cars? Would you like to be a part of a successful brand?
We will appreciate and reward both your enthusiasm and talent.
Send us your CV. You will be surprised where it can take you.

Send us your CV on
www.employerforlife.com



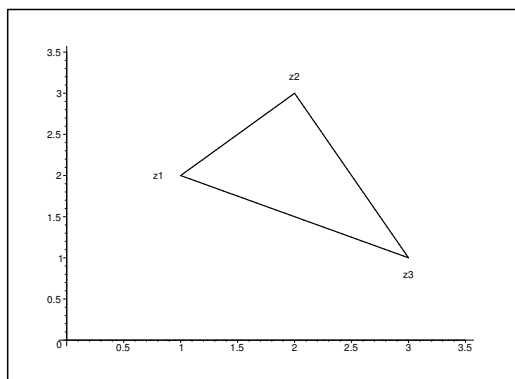

Figure 2: The triangle inequality in the complex plane.

Remark 1.1.3 One should always use the notation $z = x + iy$ introduced here, and avoid the “alternative” $z = x + y\sqrt{-1}$. The reason is that the square root, $\sqrt{\cdot}$, is a multi-valued function, so $\sqrt{-1}$ is not uniquely determined. All this will be explained later. That something is wrong, if we assume that $\sqrt{-1}$ is single-valued, can be seen by noting that this would imply the following strange computation,

$$“1 = \sqrt{1} = \sqrt{(-1) \cdot (-1)} = \sqrt{-1} \cdot \sqrt{-1} = (\sqrt{-1})^2 = -1”,$$

which obviously is wrong. \diamond

Remark 1.1.4 The notation “i” for the imaginary unit is due to Euler. Unfortunately, “i” also denotes the *electric current* in *Circuit Theory*, so one writes instead “j” for the imaginary unit. This may cause some confusion. The situation is, however, even worse because one in some applied sciences uses “j” for “-i”. One case is known of a university, where the scientists on the ground floor in one particular building used the definition $j := i$, while the scientists (from another institute) on the first floor used $j = -i$ instead! Therefore, in the applications the reader should always check which definition of “j” has been used. \diamond

1.2 Polar form of complex numbers

A complex number $z = x + iy$ is uniquely determined by its *absolute value* $r = |z|$ and anyone of its *arguments* $\Theta \in \arg z$. It follows by the Geometry that

$$x = \Re z = r \cdot \cos \Theta \quad \text{and} \quad y = \Im z = r \cdot \sin \Theta,$$

hence

$$(3) \quad z = x + iy = r\{\cos \Theta + i \cdot \sin \Theta\}.$$

This shows that the pair (r, Θ) is just the usual *polar coordinates* of the corresponding point in the complex plane.

Consider two complex numbers $z_1, z_2 \in \mathbb{C}$, given by polar coordinates, i.e. according to (3),

$$z_1 = r_1 \{\cos \Theta_1 + i \sin \Theta_1\} \quad \text{and} \quad z_2 = r_2 \{\cos \Theta_2 + i \sin \Theta_2\}.$$

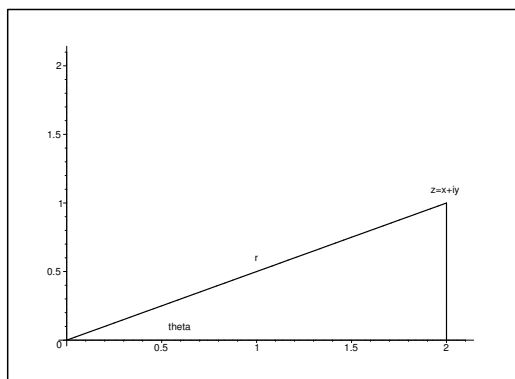

Figure 3: Polar coordinates of a complex number.

Thus, $r_1 = |z_1|$ and $\Theta_1 \in \arg z_1$, and similarly for z_2 . Then we get by the addition formulæ for cosine and sine that

$$\begin{aligned} z_1 \cdot z_2 &= r_1 \{\cos \Theta_1 + i \sin \Theta_1\} \cdot r_2 \{\cos \Theta_2 + i \sin \Theta_2\} \\ &= r_1 r_2 \{(\cos \Theta_1 \cos \Theta_2 - \sin \Theta_1 \sin \Theta_2) + i(\cos \Theta_1 \sin \Theta_2 + \sin \Theta_1 \cos \Theta_2)\} \\ &= r_1 r_2 \{\cos(\Theta_1 + \Theta_2) + i \sin(\Theta_1 + \Theta_2)\}, \end{aligned}$$

from which follows that

$$(4) \quad |z_1 z_2| = r_1 r_2 = |z_1| \cdot |z_2| \quad \text{and} \quad \Theta_1 + \Theta_2 \in \arg(z_1 z_2).$$

Let in general A and B be two non-empty subsets of \mathbb{R} or \mathbb{C} . We define their *sum* by

$$A + B = \{a + b \mid a \in A, b \in B\}.$$

Since $\Theta_1 \in \arg z_1$ and $\Theta_2 \in \arg z_2$, it immediately follows from (4) by using the definition above that

$$\arg z_1 + \arg z_2 \subseteq \arg(z_1 z_2).$$

On the other hand, every argument in $\arg(z_1 z_2)$ can in fact be found in this way. We therefore conclude that

$$(5) \quad |z_1 z_2| = |z_1| \cdot |z_2| \quad \text{and} \quad \arg(z_1 z_2) = \arg z_1 + \arg z_2,$$

where the latter equation is a relation between sets.

Example 1.2.1 Formula (5) could lead to the wrong conclusion that e.g. $\arg(z^2)$ is equal to $2 \cdot \arg z$. This is *not* true if $z \neq 0$. Let $\Theta \in \arg z$ be any argument of the complex number $z \neq 0$. Then

$$\arg(z^2) = \{2\Theta + 2p\pi \mid p \in \mathbb{Z}\},$$

because the argument is always given modulo 2π .

On the other hand,

$$2 \cdot \arg z = 2\{\Theta + 2p\pi \mid p \in \mathbb{Z}\} = \{2\Theta + 4p\pi \mid p \in \mathbb{Z}\},$$

so the factor 2 implies that the elements of $2 \cdot \arg z$ are given modulo 4π . Hence,

$$2 \cdot z \subset \arg(z^2) \quad \text{and} \quad 2 \cdot \arg z \neq \arg(z^2). \quad \diamond$$

Example 1.2.2 Notice that formula (5) holds for the *argument*, but not necessarily for the *principal argument*. For the latter we must also require that

$$\text{Arg } z_1 + \text{Arg } z_2 \in]-\pi, \pi],$$

which is not always the case.

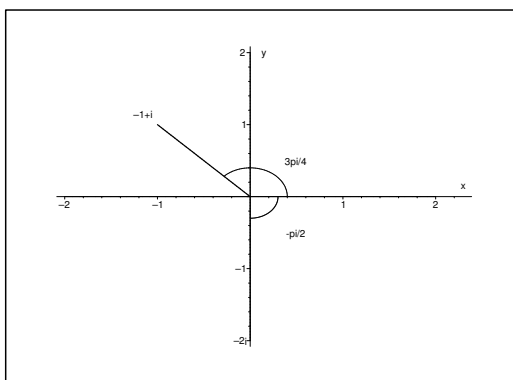

Figure 4: Formula (5) does not hold for the principal argument.

An example in which (5) does not hold for the principal argument is given by $z_1 = z_2 = -1 + i$. Then

$$\text{Arg } z_1 = \text{Arg } z_2 = \frac{3\pi}{4}, \quad \text{so } \text{Arg } z_1 + \text{Arg } z_2 = \frac{3\pi}{2} \notin]-\pi, \pi],$$

and the sum is not a principal argument. We note that

$$(-1 + i)^2 = -2i, \quad \text{where } \text{Arg}(-2i) = -\frac{\pi}{2} = \frac{3\pi}{2} - 2\pi. \quad \diamond$$

Formula (4) inspired mathematicians to introduce the following extremely useful definition.

Definition 1.2.1 The complex exponential $\exp : \mathbb{C} \rightarrow \mathbb{C}$ is defined as the function

$$(6) \quad \exp z := e^x \{ \cos y + i \sin y \} \quad \text{for } z = x + iy, \quad x, y \in \mathbb{R}.$$

We see that if $y = 0$, this is just the usual real exponential, so Definition 1.2.1 is an extension of the real exponential. We shall see that the complex exponential inherits the same properties as the familiar real exponential has.

Remark 1.2.1 Instead of $\exp z$ one often writes e^z , although the latter in principal is not correct, and it can formally lead to misunderstandings. The danger is, however, small, because one has become used to consider e^z as an *exponential function* (namely $\exp z$) and not as a *power function*, i.e. the number e raised to the power z , which later on is proved to give quite a different result. \diamond

If we put $x = 0$ and $y = \Theta \in \mathbb{R}$ into (6), then we get another important formula, namely

$$(7) \quad e^{i\Theta} = \cos \Theta + i \sin \Theta, \quad \Theta \in \mathbb{R}.$$

This implies that a complex number z of the polar form (3) then can be written in the shorter form

$$(8) \quad z = r \cdot \{\cos \Theta + i \sin \Theta\} = r \cdot e^{i\Theta}.$$

In particular, $|z| = r = r |e^{i\Theta}|$, from which follows that $|e^{i\Theta}| = 1$ for every $\Theta \in \mathbb{R}$.

The difficult computation of (4) now immediately gives the following result,

$$(9) \quad z_1 \cdot z_2 = \{r_1 e^{i\Theta_1}\} \cdot \{r_2 e^{i\Theta_2}\} = r_1 r_2 \cdot e^{i(\Theta_1 + \Theta_2)},$$

and in particular,

$$e^{i\Theta_1} \cdot e^{i\Theta_2} = e^{i(\Theta_1 + \Theta_2)}, \quad \Theta_1, \Theta_2 \in \mathbb{R}.$$



Cynthia | AXA Graduate

AXA Global Graduate Program

Find out more and apply

redefining / standards 

Combining this result with formula (6) we derive that the complex exponential satisfies precisely the same functional equation

$$(10) \quad \exp(z_1 + z_2) = \exp z_1 \cdot \exp z_2, \quad z_1, z_2 \in \mathbb{C},$$

as the real exponential, so Definition 1.2.1 is an extremely fortunate extension of the real exponential.

Concerning the complex conjugation of $\exp z$ it follows from (6) that

$$\overline{\exp z} = \overline{e^x \{\cos y + i \sin y\}} = e^x \cdot \{\cos y - i \sin y\} = e^{x-iy} = \exp \bar{z},$$

so

$$\overline{\exp \bar{z}} = \exp z.$$

The polar coordinates are extremely useful, when we consider *products*, where rectangular coordinates are more troublesome. In fact, if

$$z_1 = x_1 + iy_1 = r_1 e^{i\Theta_1} \quad \text{and} \quad z_2 = x_2 + iy_2 = r_2 e^{i\Theta_2},$$

then we get in *polar coordinates* that

$$z_1 \cdot z_2 = \{r_1 e^{i\Theta_1}\} \cdot \{r_2 e^{i\Theta_2}\} = r_1 r_2 e^{i(\Theta_1 + \Theta_2)},$$

and for comparison in *rectangular coordinates*,

$$(11) \quad z_1 \cdot z_2 = \{x_1 + iy_1\} \{x_2 + iy_2\} = \{x_1 x_2 - y_1 y_2\} + i \{x_1 y_2 + x_2 y_1\}.$$

However, although (11) is more complicated than the formula of the product in polar coordinates, we shall also need (11) in the following.

It should also be mentioned that *rectangular coordinates* are well suited for *addition* of complex numbers, while the polar coordinates are almost hopeless in the case of addition. The real hard problems involve both rectangular coordinates and polar coordinates, because some operations are more easy to apply in one type of coordinates than in the other and *vice versa*.

Let $z = r e^{i\Theta}$ and $n \in \mathbb{N}$. It follows from the above that

$$z^n = r^n e^{in\Theta}.$$

If $r = 1$ we get *Moivre's formula*,

$$(12) \quad \{e^{i\Theta}\}^n = e^{in\Theta}, \quad n \in \mathbb{N},$$

hence by applying (7),

$$(13) \quad \cos n\Theta + i \sin n\Theta = \{\cos \Theta + i \sin \Theta\}^n, \quad n \in \mathbb{N}.$$

Example 1.2.3 Formula (13) gives an easy way to express $\cos n\Theta$ and $\sin n\Theta$ by means of $\cos \Theta$ and $\sin \Theta$. We shall demonstrate this technique by putting $n = 3$ into (13). We get by the *binomial formula*,

$$\begin{aligned}\cos 3\Theta + i \sin 3\Theta &= \{\cos \Theta + i \sin \Theta\}^3 \\ &= \cos^3 \Theta - 3 \cos \Theta \sin^2 \Theta + i \{3 \cos^2 \Theta \sin \Theta - \sin^3 \Theta\}.\end{aligned}$$

Then split this identity into its real and imaginary parts to get

$$\begin{aligned}\cos 3\Theta &= \cos^3 \Theta - 3 \cos \Theta \sin^2 \Theta = 4 \cos^3 \Theta - 3 \cos \Theta, \\ \sin 3\Theta &= 3 \cos^2 \Theta \sin \Theta - \sin^3 \Theta = 3 \sin \Theta - 4 \sin^3 \Theta,\end{aligned}$$

where we have used that $\sin^2 \Theta = 1 - \cos^2 \Theta$ and $\cos^2 \Theta = 1 - \sin^2 \Theta$ in order to obtain the final expressions. \diamond

Example 1.2.4 We have above developed several ways to compute a power of a complex number. We shall now demonstrate that some of them give smaller computations than others. We shall compute the complex number $(1 + i)^{10}$ in various ways.

First method. Due to the very special structure of $1 + i$ the easiest way is here to apply a known rule of computation,

$$(1 + i)^{10} = \{(1 + i)^2\}^5 = (2i)^5 = 32i.$$

Second method. We shall here use *polar coordinates*. Since

$$1 + i = \sqrt{2} \cdot \exp\left(i \frac{\pi}{4}\right) \quad \left[= \sqrt{2} \left\{ \cos \frac{\pi}{4} + i \sin \frac{\pi}{4} \right\}\right],$$

we get

$$(1 + i)^{10} = \left(\sqrt{2}\right)^{10} \cdot \left\{ \exp\left(i \frac{\pi}{4}\right) \right\}^{10} = 2^5 \cdot \exp\left(i \frac{5\pi}{2}\right) = 32 \exp\left(i \frac{\pi}{2}\right) = 32i.$$

Third method. Here we try the *binomial formula*, which gives the following tedious computation,

$$(1 + i)^{10} = \sum_{n=0}^{10} \binom{10}{n} i^n = 1 + 10i - 45 - 120i + 210 + 252i - 210 - 120i + 45 + 10i - 1 = 32i.$$

Fourth method. The troublesome one. Use the formula $(1 + i)^n = (1 + i) \cdot (1 + i)^{n-1}$ successively to compute

$$1 + i, (1 + i)^2, (1 + i)^3, \dots, (1 + i)^{10} = 32i.$$

This is of course a very clumsy way of computation, although the result is again the right one, namely $32i$.

Fifth method. Apply a pocket calculator. In this simple example we shall of course again get the right result, $32i$. However, the aim of the present books on *Complex Functions Theory* is as long as possible to avoid approximate results, which pocket calculators and computers in general will produce. The viewpoint is that since these devices exist, they should also be used, but *only when all other methods fail!* In general one loses some information by using pocket calculators or computers, which in some cases may be fatal. Therefore, this method should never be the first one to apply.

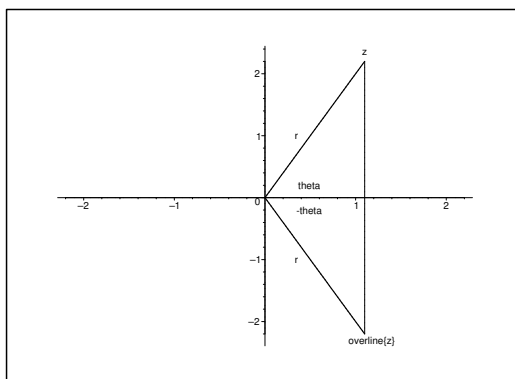

Figure 5: Complex conjugation replaces the argument Θ by $-\Theta$.

It is seen that the first two methods are the most elegant ones in this very special example. \diamond

It follows from Figure 5 that

$$\arg \bar{z} = -\arg z.$$

Since

$$\frac{1}{z} = \frac{\bar{z}}{z \cdot \bar{z}} = \frac{r}{r^2} \cdot e^{i(-\Theta)} = \frac{1}{r} \cdot e^{-i\Theta},$$

we can extend *Moirve's formula* to negative exponents. If $z_1 = r_1 \exp(i\Theta_1)$ and $z_2 = r_2 \exp(i\Theta_2) \neq 0$, then

$$\frac{z_1}{z_2} = \frac{r_1 \exp(i\Theta_1)}{r_2 \exp(i\Theta_2)} = \frac{r_1}{r_2} \cdot \exp(i\{\Theta_1 - \Theta_2\}) = \frac{r_1}{r_2} e^{i(\Theta_1 - \Theta_2)},$$

thus for $z_2 \neq 0$ [cf. (5)],

$$(14) \quad \left| \frac{z_1}{z_2} \right| = \frac{r_1}{r_2} = \frac{|z_1|}{|z_2|} \quad \text{and} \quad \arg \left(\frac{z_1}{z_2} \right) = \arg z_1 - \arg z_2.$$

We note that (14) is *not* true for the *principal argument*.

1.3 The binomial equation

We have seen above that we can use both rectangular and polar coordinates when we compute a *product* or a *quotient* of complex numbers, and that polar coordinates in these cases are the most convenient to use.

Concerning *addition* and *subtraction* one should, however, always use rectangular coordinates instead, because polar coordinates in here usually give some very messy considerations. They will only be applicable in very special cases.

We shall now turn to the problem of taking the n^{th} root of a complex number. It will be demonstrated in the following that in this case one should apply polar coordinates and only in extremely rare cases use rectangular coordinates.

In order to get started we mention without proof the following theorem:

Theorem 1.3.1 The fundamental theorem of algebra. *If $P(z)$ is a polynomial of degree ≥ 1 , then $P(z)$ has at least one root.*

We shall later give a couple of proofs of this theorem, but here we only take it for granted.

Using *the fundamental theorem of algebra* it is easy to prove the following

Corollary 1.3.1 *Every polynomial $P(z)$ of degree n has precisely n complex roots, when these are counted by their multiplicity.*

PROOF. First note that the polynomial $z - \alpha$ of degree 1 has precisely one root, namely $z = \alpha$ (because $z - \alpha \neq 0$ for $z \neq \alpha$). Furthermore, the polynomial $z - \alpha$ is a divisor in $z^m - \alpha^m$ for every $m \in \mathbb{N}$ and every $\alpha \in \mathbb{R}$. In fact, it is easy to check by computing the right hand side, that

$$(15) \quad z^m - \alpha^m = (z - \alpha) \{z^{m-1} + \alpha z^{m-2} + \alpha^2 z^{m-3} + \dots + \alpha^{m-2} z + \alpha^{m-1}\},$$

and the claim follows.

Clearly, $P(z)$ above is a linear combination of terms z^m , $m = 0, 1, \dots, n$, so (15) implies that $z - \alpha$ is a divisor in $P(z) - P(\alpha)$.

I joined MITAS because
I wanted **real responsibility**

The Graduate Programme
for Engineers and Geoscientists
www.discovermitas.com



Real work
International opportunities
Three work placements



Month 16
I was a construction
supervisor in
the North Sea
advising and
helping foremen
solve problems



To ease notation we write $P(z) = P_n(z)$ to indicate that $P_n(z)$ is of degree n . When $n \geq 1$, then the *fundamental theorem of algebra* tells us that $P_n(z)$ has (at least) one root α_1 , so $P_n(\alpha_1) = 0$. This implies also that $z - \alpha_1$ is a divisor in

$$P_n(z) - P_n(\alpha_1) = P_n(z), \quad (\text{because } P_n(\alpha_1) = 0)$$

Hence there is a polynomial $P_{n-1}(z)$ of degree $n - 1$, such that

$$P_n(z) = (z - \alpha_1) P_{n-1}(z).$$

If $n = 1$, then $P_{n-1}(z) \neq 0$ is a constant, and α_1 is the only root.

If $n > 1$, we repeat the process above on $P_{n-1}(z)$, which has a root α_2 , so

$$P_n(z) = (z - \alpha_1) P_{n-1}(z) = (z - \alpha_1)(z - \alpha_2) P_{n-2}(z).$$

This process can be repeated n times, giving

$$P_n(z) = (z - \alpha_1)(z - \alpha_2) \cdots (z - \alpha_n) \cdot P_0(z),$$

where $P_0(z) \neq 0$ is a constant (a nontrivial polynomial of degree zero). Some of the α_j may be identical, but this does not change the fact that the roots of $P_n(z)$ are precisely the n numbers $\alpha_1, \dots, \alpha_n$. \square

Using Corollary 1.3.1 it is easy to prove the following theorem on the *binomial equation*.

Theorem 1.3.2 *Given $a = r e^{i\Theta} \neq 0$ in polar coordinates. The binomial equation (i.e. there are only two terms in this equation)*

$$z^n = a = r e^{i\Theta},$$

has its n (different) roots given by

$$(16) \quad z = \sqrt[n]{r} \cdot \left\{ \cos \left(\frac{\Theta}{n} + p \cdot \frac{2\pi}{n} \right) + i \sin \left(\frac{\Theta}{n} + p \cdot \frac{2\pi}{n} \right) \right\} = \sqrt[n]{r} \cdot \exp \left(i \left\{ \frac{\Theta}{n} + p \cdot \frac{2\pi}{n} \right\} \right)$$

for $p = 0, 1, \dots, n - 1$.

PROOF. It follows by insertion that anyone of the n complex numbers, given by (16) is a solution. The polynomial $z^n - a$ has degree n , so it suffices to prove that the n numbers of (16) are mutually different from each other. Using the module and the principal argument we get

$$|z| = \sqrt[n]{|a|} > 0 \quad \text{and} \quad \text{Arg } z \in \frac{1}{n} \cdot \arg z = \left\{ \frac{\Theta}{n} + \frac{2p\pi}{n} \mid p \in \mathbb{Z} \right\}.$$

There are precisely n numbers in the set $\frac{1}{n} \cdot \arg a \cap] - \pi, \pi]$, so the principal argument $\text{Arg } z$ has precisely n mutually different values. This means that the n roots in (16) are also mutually different, and the theorem is proved. \square

The geometrical interpretation of (16) is that the n solutions of a binomial equation $z^n = a \neq 0$ all lie on a circle of radius $\sqrt[n]{|a|}$ and centre 0 and that they form a regular polygon of n vertices (the roots in the complex plane). This implies that if we have found just one root, then it is easy, using Geometry, to find the other roots.

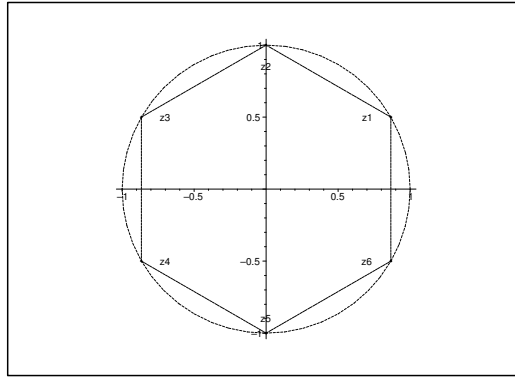

Figure 6: The roots of a binomial equation $z^6 = a$ form a regular polygon of 6 vertices.

The easiest way to remember formula (16) is to use the complex exponential. In fact, since

$$e^{2i\pi} = \cos 2\pi + i \cdot \sin 2\pi = 1,$$

we have

$$(17) \quad z^n = r e^{i\Theta} = r \cdot e^{i(\Theta+2p\pi)}, \quad p \in \mathbb{Z},$$

from which we get by the “usual procedure” known in Real Analysis,

$$(18) \quad z = \sqrt[n]{r} \cdot \exp\left(i \left\{ \frac{\Theta}{n} + p \cdot \frac{2\pi}{n} \right\}\right), \quad p \in \mathbb{Z}.$$

The solutions (18) are repeated cyclically of period n for $p \in \mathbb{Z}$.

We note the trick of multiplying by $e^{2ip\pi} = 1$ for all $p \in \mathbb{Z}$.

Finally, if $a = 0$, then $z = 0$ is of course a root of multiplicity n in the equation $z^n = 0$, which can also be written

$$z^n = (z - 0)(z - 0) \cdots (z - 0) = (z - 0)^n = 0.$$

Example 1.3.1 We shall solve the binomial equation

$$z^3 = -2 - 2i.$$

Since $r = |-2 - 2i| = 2\sqrt{2} = (\sqrt{2})^3$, and $n = 3$, all roots lie on a circle of radius

$$\sqrt[3]{|-2 - 2i|} = \sqrt[3]{(\sqrt{2})^3} = \sqrt{2}.$$

An argument of $-2-2i$ is $-\frac{3\pi}{4} \in \arg(-2-2i)$. Hence, one of the three roots must have the argument

$\Theta = \frac{1}{3} \left\{ -\frac{3\pi}{4} \right\} = -\frac{\pi}{4}$. This means that one of the roots is given by

$$z_1 = \sqrt{2} \cdot \exp\left(-i\frac{\pi}{4}\right) = \sqrt{2} \cdot \left\{ \cos\left(-\frac{\pi}{4}\right) + i \sin\left(-\frac{\pi}{4}\right) \right\} = 1 - i.$$

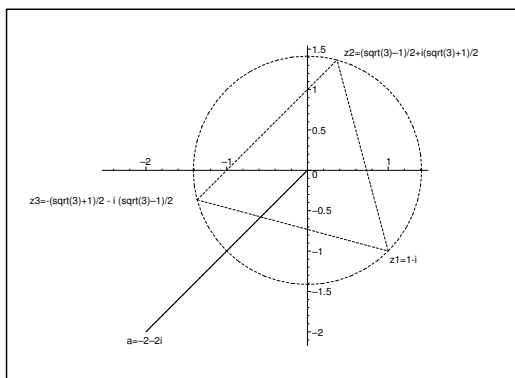

Figure 7: The geometrical solution of the equation $z^3 = -2 - 2i$.

The other two roots z_1 and z_2 lie also on the circle $|z| = \sqrt{2}$, and z_1 , z_2 and z_3 form an equilateral triangle, so

$$z_2 = z_1 \cdot \exp\left(\frac{2\pi i}{3}\right) = (1-i) \cdot \left\{ -\frac{1}{2} + i\frac{\sqrt{3}}{2} \right\} = \frac{\sqrt{3}}{2} - \frac{1}{2} + i\left\{ \frac{\sqrt{3}}{2} + \frac{1}{2} \right\},$$

$$z_3 = z_1 \cdot \exp\left(\frac{4\pi i}{3}\right) = (1-i) \cdot \left\{ -\frac{1}{2} - i\frac{\sqrt{3}}{2} \right\} = -\frac{\sqrt{3}}{2} - \frac{1}{2} - i\left\{ \frac{\sqrt{3}}{2} - \frac{1}{2} \right\}. \quad \diamond$$

We see that it is convenient to know the exact values of $\cos \frac{\pi}{n}$ and $\sin \frac{\pi}{n}$ for $n \in \mathbb{N}$. We mention that

$$\cos \frac{\pi}{1} = -1, \quad \cos \frac{\pi}{2} = 0, \quad \cos \frac{\pi}{3} = \frac{1}{2}, \quad \cos \frac{\pi}{4} = \frac{\sqrt{2}}{2}, \quad \cos \frac{\pi}{5} = \frac{1 + \sqrt{5}}{4}, \quad \cos \frac{\pi}{6} = \frac{\sqrt{3}}{2},$$

$$\sin \frac{\pi}{1} = 0, \quad \sin \frac{\pi}{2} = 1, \quad \sin \frac{\pi}{3} = \frac{\sqrt{3}}{2}, \quad \sin \frac{\pi}{4} = \frac{\sqrt{2}}{2}, \quad \sin \frac{\pi}{5} = \frac{\sqrt{10 - 2\sqrt{5}}}{4}, \quad \cos \frac{\pi}{6} = \frac{1}{2}.$$

The reader should know by heart most of these values. Only

$$\cos \frac{\pi}{5} = \frac{1 + \sqrt{5}}{4} \quad \text{and} \quad \sin \frac{\pi}{5} = \frac{\sqrt{10 - 2\sqrt{5}}}{4}$$

may not be well-known.

Remark 1.3.1 From the values above one could easily jump to the wrong conclusion that $\cos \frac{\pi}{n}$ and $\sin \frac{\pi}{n}$ can always be expressed by square roots. *This is not the case!* It can be proved for $n \leq 20$ that this is only possible for

$$n = 1, 2, 3, 4, 5, 6, 8, 10, 12, 15, 16, 17, 20, \quad (n \leq 20),$$

and it is *not* possible for

$$n = 7, 9, 11, 13, 14, 18, 19, \quad (n \leq 20).$$

This question is connected with the classical problem of when a regular polygon of n vertices can be constructed by means of ruler and compass. Without proof we mention that this can only be done, if n has the following structure,

$$n = 2^q \cdot p_1 \cdots p_k,$$

where $q \in \mathbb{N}_0$, and where p_1, \dots, p_k are *pairwise mutually different primes* of the very special structure $2^{2^m} + 1$. Only very few *primes* of this structure are known,

$$3, \quad 5, \quad 17, \quad 257, \quad 65,537.$$

One does not know if there are any other than the five mentioned primes above.

ie business school

93%
OF MIM STUDENTS ARE
WORKING IN THEIR SECTOR 3 MONTHS
FOLLOWING GRADUATION

MASTER IN MANAGEMENT

- STUDY IN THE CENTER OF MADRID AND TAKE ADVANTAGE OF THE UNIQUE OPPORTUNITIES THAT THE CAPITAL OF SPAIN OFFERS
- PROPEL YOUR EDUCATION BY EARNING A DOUBLE DEGREE THAT BEST SUITS YOUR PROFESSIONAL GOALS
- STUDY A SEMESTER ABROAD AND BECOME A GLOBAL CITIZEN WITH THE BEYOND BORDERS EXPERIENCE

Length: 10 MONTHS
Av. Experience: 1 YEAR
Language: ENGLISH / SPANISH
Format: FULL-TIME
Intakes: SEPT / FEB

5 SPECIALIZATIONS
PERSONALIZE YOUR PROGRAM

#10 WORLDWIDE
MASTER IN MANAGEMENT
FINANCIAL TIMES

55 NATIONALITIES
IN CLASS

www.ie.edu/master-management | mim.admissions@ie.edu | [f](#) [t](#) [i](#) Follow us on IE MIM Experience



According to folklore there exists in the archives of the University of Göttingen a paper, in which an amateur mathematician once constructed a regular polygon of 257 vertices with ruler and compass, so it can be done. The author has only experienced the construction of regular polygons of 3 (easy), 5 (at high school) and 17 vertices (at university). The more elaborated constructions, i.e. for at least $n = 5$, are of course curia and not of practical use. \diamond

1.4 The general equation $Az^2 + Bz + C = 0$ of second degree

We shall find the formula of the roots of a general complex polynomial $Az^2 + Bz + C$ of degree 2, where $A \in \mathbb{C} \setminus \{0\}$ and $B, C \in \mathbb{C}$, and we shall show that it is *formally* identical with the well-known solution formula when the coefficients are real.

The difference from the real case is the the *real square root*

$$\sqrt{\cdot} : \mathbb{R}_+ \cup \{0\} \rightarrow \mathbb{R}_+ \cup \{0\}$$

is uniquely determined by the requirement that both the domain and the range are $\mathbb{R}_+ \cup \{0\}$.

On the other hand, the *complex square root* $\sqrt{\cdot} : \mathbb{C} \rightarrow \mathbb{C}$ is defined as a so-called *2-valued function*, where \sqrt{a} is a shorthand for the set of both solutions of the binomial equation $z^2 = a$ of degree 2.

Theorem 1.4.1 *Let $A \in \mathbb{C} \setminus \{0\}$, and $B, C \in \mathbb{C}$ be complex constants. The solutions of the equation of second degree*

$$(19) \quad Az^2 + Bz + C = 0$$

is given by

$$(20) \quad z = \frac{-B \pm \sqrt{B^2 - 4AC}}{2A},$$

where we choose any one of the the two possible values of $\sqrt{B^2 - 4AC}$ in (20).

PROOF. The simple, though tedious proof is to insert (20) into (19), thus checking that we have obtained the solutions. Notice that when $\sqrt{B^2 - 4AC} = 0$, then (20) gives a root of multiple 2.

A more elegant way is the well-known derivation of (20) from (19).

Multiply (19) by $4A \neq 0$, and then add $B^2 - 4AC$. This gives the equivalent equation of the same roots,

$$\begin{aligned} B^2 - 4AC &= \{4A^2z^2 + 4ABz + 4AC\} + B^2 - 4AC \\ &= \{2Az\}^2 + 2 \cdot 2Az \cdot B + B^2 = \{2Az + B\}^2. \end{aligned}$$

Therefore, if we put $w = 2Az + B$, then solving (19) is equivalent to solving the binomial equation

$$w^2 = \{2Az + B\}^2 = B^2 - 4AC.$$

If we choose $\sqrt{B^2 - 4AC}$ as any of its two possible values, then

$$w = 2Az + B = \pm \sqrt{B^2 - 4AC},$$

from which (20) easily follows. \square

Remark 1.4.1 At this early stage of the description we have been forced to make some strange manoeuvres in order to tackle the complex square root. We shall later return to this problem and ease the matters. \diamond

1.5 The equations of third and fourth degree

It is possible also to find exact solution formulæ of the general equations

$$Az^3 + Bz^2 + Cz + D = 0 \quad \text{of third degree,}$$

$$Az^4 + Bz^3 + Cz^2 + Dz + E = 0 \quad \text{of fourth degree,}$$

but they are not so useful in practice as the solution formula (20) of the equation of second degree (19), so they are very rarely included in the syllabus.

For completeness and for historical reasons we include these solution procedures in this section. The reader is, however, warned *not* to use them, unless it is explicitly required.

We shall start with a small historical excursion.

The first time such solution formulæ are mentioned is in *Ars Magna*, Nuremberg 1549. Here *Girolamo Cardano* (1501–1576) writes in a paper that *Scipio del Ferro* discovered about 1515 a method to solve an equation of the type

$$x^3 + px = q.$$

This was later on not denied by *Nicolo Tartaglia*, though he claims that he independently of *del Ferro* had found another method of solving a similar equation,

$$x^3 + px^2 = q.$$

Although *Cardano* did not find the solution himself and never claimed that he had done it, his description became the most popular, so the formula has ever since been known as *Cardano's formula*.

It was obviously difficult in those days to write mathematical equations, because the present formalism had not yet been invented. In the chapter “*De cubo & rebus æqualibus numerus*” of *Ars Magna*, *Cardano* is solving the equation

$$\text{cub}^s p; 6 \text{ reb}^s \text{ æq̄lis } 20,$$

which translated into the modern terminology is the same as

$$x^3 + 6x = 20.$$

The solution of the equation of fourth degree is due to *Ferrari*, and it was also published by *Cardano* in *Ars Magna*.

For a long time it was an unsolved problem if one could find general solution formulæ for equations of higher degree. That problem was finally solved by *Evariste Galois* (1811–1832). Born in Paris, *Galois* was a devoted republican, and he was twice in prison for political reasons. He tried twice to enter *École Polytechnique*, but failed. Finally, he succeeded in getting into *École Normale*. Nevertheless he founded (in letters to his friends) that branch of *Algebra*, which today is called *Galois Theory*, named after him.

Unfortunately he died too young in a duel over a loose woman. Some people have believed that he was lured by his political enemies into this duel, but recent historical investigations seem instead to believe that the duel was purely emotional. Quite dramatically in this context he wrote the night

before the duel a letter to his friend *Auguste Chevalier*, in which he sketched his discovery of the connection between *Group Theory* and the solution of equations of degree n by means of roots, and he concluded that no *general* solution formula existed for $n \geq 5$. Of course, this does not mean that no equation of degree ≥ 5 can be solved. Some of them can, but not all of them.

The equation of third degree. We consider the equation

$$x^3 + a_1x^2 + a_2x + a_3 = 0.$$

Using the substitution $x = y - \frac{1}{3}a_1$, this equation is transferred into the equivalent equation

$$y^3 + py + q = 0,$$

where

$$p = -\frac{1}{3}a_1^2 + a_2 \quad \text{and} \quad q = \frac{2}{27}a_1^3 - \frac{1}{3}a_1a_2 + a_3.$$

If we put $y = u + v$, then

$$(21) \quad u^3 + v^3 + (3uv + p)(u + v) + q = 0.$$

For each given y we choose the variables u and v , such that

$$y = u + v \quad \text{and} \quad -\frac{p}{3} = uv.$$

This means that u and v are the roots of the equation of second degree,

$$z^2 - yz - \frac{p}{3} = 0.$$

Finally, note that if $uv = -\frac{p}{3}$, then (21) reduces to $u^3 + v^3 = -q$. Hence, we have proved

Theorem 1.5.1 *A complex number $y \in \mathbb{C}$ is a root of the special equation of third degree*

$$y^3 + py + q = 0,$$

if and only if it can be written in the form $y = u + v$, where u and v satisfy the equations

$$(22) \quad u^3 + v^3 = -q \quad \text{and} \quad uv = -\frac{p}{3}.$$

The two equations of (22) *imply* (though they are *not* equivalent to)

$$u^3 + v^3 = -q \quad \text{and} \quad u^3v^3 = -\frac{1}{27}p^3.$$

From the general

$$(z - \alpha)(z - \beta) = z^2 - \{\alpha + \beta\}z + \alpha\beta = z^2 + a_1z + a_2 = 0$$

follows that the sum of the roots is equal to $-a_1$ and the product of the roots is a_2 . Therefore, we have in the present case that u^3 and v^3 are the roots of the following equation of second degree

$$z^2 + qz - \frac{1}{27}p^3 = 0.$$

Using the solution formula of Theorem 1.4.1 it follows that

$$\left. \begin{array}{l} u^3 \\ v^3 \end{array} \right\} = -\frac{q}{2} \pm \sqrt{\frac{q^2}{4} + \frac{p^3}{27}} = -\frac{q}{2} \pm \sqrt{\left(\frac{q}{2}\right)^2 + \left(\frac{p}{3}\right)^3},$$

hence

$$u = \sqrt[3]{-\frac{q}{2} + \sqrt{\left(\frac{q}{2}\right)^2 + \left(\frac{p}{3}\right)^3}} \quad \text{and} \quad v = \sqrt[3]{-\frac{q}{2} - \sqrt{\left(\frac{q}{2}\right)^2 + \left(\frac{p}{3}\right)^3}},$$

where $\sqrt{\left(\frac{q}{2}\right)^2 + \left(\frac{p}{3}\right)^3}$ is chosen as one (fixed) of the two possible values, while $\sqrt[3]{}$ here denotes all three possible values. This means that we shall formally check $3 \cdot 3 = 9$ possible solutions, of which only three are indeed solutions. Fortunately, the requirement $u \cdot v = -\frac{p}{3}$ reduces this number to precisely three possibilities, so we have proved



“I studied English for 16 years but...
...I finally learned to speak it in just six lessons”
Jane, Chinese architect

ENGLISH OUT THERE

Click to hear me talking before and after my unique course download



Theorem 1.5.2 *The complete solution of the equation*

$$y^3 + py + q = 0$$

of degree three is given by

$$y = u + v = \sqrt[3]{-\frac{q}{2} + \sqrt{\left(\frac{q}{2}\right)^2 + \left(\frac{p}{3}\right)^3}} + \sqrt[3]{-\frac{q}{2} - \sqrt{\left(\frac{q}{2}\right)^2 + \left(\frac{p}{3}\right)^3}},$$

where the three solutions are specified by the additional requirement that $u \cdot v = -\frac{p}{3}$.

Assuming that p and q are real, Viète found in 1591 a trigonometric solution by applying the formula

$$\cos 3v = 4 \cos^3 v - 3 \cos v,$$

cf. Example 1.2.3.

We shall prove that if

$$\frac{q^2}{4} + \frac{p^3}{27} = \left(\frac{q}{2}\right)^2 + \left(\frac{p}{3}\right)^3 < 0, \quad \text{in particular } \left(\frac{p}{3}\right)^3 < 0,$$

then there are three different *real* solutions of the equation.

First notice that in this case u^3 and v^3 are clearly complex conjugated. Then introduce the angle φ by

$$-\frac{q}{2} \pm \sqrt{\frac{q^2}{4} + \frac{p^3}{27}} = -\frac{q}{2} \pm i \sqrt{-\frac{q^2}{4} - \frac{p^3}{27}} = \sqrt{-\frac{p^3}{27}} \cdot \{\cos \varphi \pm i \cdot \sin \varphi\} = \sqrt{\left(-\frac{p}{3}\right)^3} \cdot e^{i\varphi}.$$

When the real parts are identified, we get

$$\cos \varphi = \frac{-\frac{q}{2}}{\sqrt{-\frac{p^3}{27}}}.$$

Then we get by taking the cubic root,

$$\left. \begin{array}{l} u_0 \\ v_0 \end{array} \right\} = \sqrt{-\frac{p}{3}} \cdot \exp\left(\pm i \frac{\varphi}{3}\right) = \sqrt{-\frac{p}{3}} \cdot \left\{ \cos \frac{\varphi}{3} \pm i \sin \frac{\varphi}{3} \right\},$$

and we have proved

Corollary 1.5.1 *Given real constants $p, q \in \mathbb{R}$, such that*

$$\frac{q^2}{4} + \frac{p^3}{27} = \left(\frac{q}{2}\right)^2 + \left(\frac{p}{3}\right)^3 < 0.$$

The equation

$$y^3 + py + q = 0$$

of third degree has the following three different real solutions,

$$\beta_1 = 2\sqrt{-\frac{p}{3}} \cdot \cos \frac{\varphi}{3}, \quad \beta_2 = 2\sqrt{-\frac{p}{3}} \cdot \cos \left(\frac{\varphi + 2\pi}{3}\right), \quad \beta_3 = 2\sqrt{-\frac{p}{3}} \cdot \cos \left(\frac{\varphi + 4\pi}{3}\right).$$

The equation of fourth degree. We consider the equation

$$x^4 + a_1x^3 + a_2x^2 + a_3x + a_4 = 0$$

of fourth degree. Using the substitution $x = y - a_1/4$ it is transformed into

$$(23) \quad y^4 + py^2 + qy + r = 0,$$

where one with some effort can find p , q and r expressed by the coefficients a_1 , a_2 , a_3 and a_4 .

The simplest case is when $q = 0$, because then

$$y^4 + py^2 + r = \{y^2\}^2 + p \cdot y^2 + r = 0$$

can be considered as an equation of second degree in y^2 , and the four solutions are easily found.

Then assume that $q \neq 0$, and let $z \in \mathbb{C}$ be any complex number. Then we can transform (23) into

$$(24) \quad (y^2 + z)^2 - \{(2z - p)y^2 - qy + z^2 - r\} = 0.$$

The nasty trick is to choose z as a solution of the equation

$$(25) \quad 4(2z - p)(z^2 - r) - q^2 = 0$$

of third degree, using the method described previously!

It follows from $q \neq 0$ that also $2z - p \neq 0$, hence

$$(26) \quad (2z - p)y^2 - qy + z^2 - r = (ay + b)^2,$$

where

$$(27) \quad a = \sqrt{2z - p} \quad \text{and} \quad b = -\frac{q}{2a}.$$

By insertion of (26) into (24) we get of course

$$(y^2 + z)^2 = (ay + b)^2,$$

or

$$(y^2 + z)^2 - (ay + b)^2 = \{y^2 + z + ay + b\} \{y^2 + z - ay - b\} = 0.$$

Thus, we have proved [cf. also (25)–(27) above],

Theorem 1.5.3 *The four solutions of the equation*

$$y^4 + py^2 + qy + r = 0, \quad q \neq 0,$$

are the same as the four solutions of the two equations of second degree

$$y^2 + ay + z + b = 0 \quad \text{and} \quad y^2 - ay + z - b = 0,$$

where z is any fixed solution of the equation

$$4(2z - p)(z^2 - r) - q^2 = 0,$$

and where

$$a = \sqrt{2z - p} \quad \text{and} \quad b = -\frac{q}{2a}.$$

Clearly, Theorem 1.5.3 demonstrates that even if it is possible to find the exact solutions of an equation of fourth degree, the solution procedure and the results are so complicated that no sane person would use it as a standard procedure.

1.6 Rational roots and multiple roots of a polynomial

In the applications the polynomials are very important functions. Therefore, it must also be important to find the roots of a given polynomial. For the time being we have only the result of the *Fundamental Theorem of Algebra* which tells us that a polynomial of degree n has precisely n roots, counted by multiplicity. However, finding these roots may be far more difficult than one would expect. This is an important issue, but at this stage we can only produce the simplest procedures, which may or may not give us some of the roots.

We shall start with the well-known method of finding rational roots in a polynomial of integer coefficients. First we introduce the following notation.

Let $p \in \mathbb{N}$ and $a \in \mathbb{Z}$ be integers. If $p \neq 0$ is divisor in a , i.e. there is a $b \in \mathbb{Z}$, such that $a = p \cdot b$, then we write $p|a$.

Theorem 1.6.1 *Let*

$$(28) \quad a_0 z^n + a_1 z^{n-1} + \cdots + a_{n-1} z + a_n = 0$$

be a polynomial of integer coefficients, $a_0, a_1, \dots, a_n \in \mathbb{Z}$. If (28) has a rational root $\frac{p}{q} \in \mathbb{Q}$, where q is not divisor in p , then

$$p|a_n \quad \text{and} \quad q|a_0.$$

PROOF. Put $z = \frac{p}{q} \in \mathbb{Q}$ into (28) and multiply by q^n ,

$$\begin{aligned} a_0 p^n + a_1 p^{n-1} q + a_2 p^{n-2} q^2 + \cdots + a_{n-1} p q^{n-1} + a_n q^n \\ = a_0 p^n + q \{a_1 p^{n-1} + \cdots + a_n q^{n-1}\} \\ = p \{a_0 p^{n-1} + \cdots + a_{n-1} q^{n-1}\} + a_n q^n. \end{aligned}$$

All numbers are integers, so if $\frac{p}{q}$ is a root, this expression is 0, which is only possible, if

$$q|a_0 p^n \quad \text{i.e.} \quad q|a_0 \quad \text{and} \quad p|a_n q^n \quad \text{i.e.} \quad p|a_n. \quad \square$$

Notice that Theorem 1.6.1 does not assure that a given polynomial of integer coefficients indeed has a rational root. The polynomial $P(z) = z^2 + z + 1$ has integer coefficients, so $p = \pm 1$ and $q = 1$, and $z = \pm 1$ are the only possible *rational* roots. A simple check shows that

$$P(1) = 3 \neq 0 \quad \text{and} \quad P(-1) = 1 \neq 0,$$

so $P(z)$ does not have rational roots. Using the solution formula for equations of second degree we find that the roots are the complex conjugated

$$z = -\frac{1}{2} \pm i \frac{\sqrt{3}}{2}.$$

Procedure of finding rational roots.

- 1) Check that the polynomial (28) has (real) integer coefficients $a_0, a_1, \dots, a_n \in \mathbb{Z}, a_0 \neq 0$.
- 2) Find all possible *positive* divisors of a_0 (the set \mathcal{Q}).
- 3) Find all possible positive and negative divisors of a_n (the set \mathcal{P}).
- 4) Check all possible rational roots, i.e. the elements of

$$\mathcal{R} = \left\{ \pm \frac{p}{q} \mid p \in \mathcal{P}, q \in \mathcal{Q} \right\}$$

in the polynomial (28).

Example 1.6.1 We shall find the four roots of the polynomial

$$P_4(z) = 6z^4 - 5z^3 + 3z^2 + 3z - 2$$

of degree four and of integer coefficients, by first finding all the possible rational roots.

It follows from $a_0 = 6$ and $a_4 = -2$ that if $\frac{p}{q} \in \mathbb{Q}$ is a rational root, then

$$p \in \{\pm 1, \pm 2\} \quad \text{and} \quad q \in \{1, 2, 3, 6\}.$$

Excellent Economics and Business programmes at:



**university of
 groningen**



**“The perfect start
 of a successful,
 international career.”**

CLICK HERE
 to discover why both socially
 and academically the University
 of Groningen is one of the best
 places for a student to be

www.rug.nl/feb/education



This gives us the following mutually different possibilities of rational roots,

$$\frac{p}{q} \in \left\{ \pm 1, \pm 2, \pm \frac{1}{2}, \pm \frac{1}{3}, \pm \frac{2}{3}, \pm \frac{1}{6} \right\}.$$

Then by insertion,

$$P_4(\pm 1) = 6 \mp 5 + 3 \pm 3 - 2 = 7 \mp 2 \neq 0,$$

$$P_4(\pm 2) = 6 \cdot 16 \mp 5 \cdot 8 + 3 \cdot 4 \pm 3 \cdot 2 - 2 = 106 \mp 34 \neq 0,$$

$$P_4\left(\pm \frac{1}{2}\right) = 6 \cdot \frac{1}{6} \mp 5 \cdot \frac{1}{8} + 3 \cdot \frac{1}{4} \pm 3 \cdot \frac{1}{2} - 2 = -\frac{7}{8} \pm \frac{7}{8}.$$

It follows that $P_4\left(\frac{1}{2}\right) = 0$, so $z = \frac{1}{2}$ is a root.

We may of course proceed by computing the remainder possible values, $P_4\left(\pm \frac{1}{3}\right)$, $P_4\left(\pm \frac{2}{3}\right)$ and $P_4\left(\pm \frac{1}{6}\right)$. We shall, however, here give an alternative method, which reduces the degree by 1. In fact, since $z = \frac{1}{2}$ is a root, $2 \cdot \left(z - \frac{1}{2}\right) = 2z - 1$ must be a divisor of $P_4(z)$, so

$$P_4(z) = (2z - 1)P_3(z).$$

It follows from the polynomial division

$$\begin{aligned} P_4(z) &= 6z^4 - 5z^3 + 3z^2 + 3z - 2 \\ &= 3z^3(2z - 1) - z^2(2z - 1) + z(2z - 1) + 2(2z - 1) \\ &= (2z - 1) \{3z^3 - z^2 + z + 2\}, \end{aligned}$$

that

$$P_3(z) = 3z^3 - z^2 + z + 2.$$

The possible rational roots of $P_3(z)$ [which are also possible rational roots of $P_4(z)$] are

$$\pm 1, \quad \pm 2, \quad \pm \frac{1}{3}, \quad \pm \frac{2}{3},$$

of which we have already checked ± 1 and ± 2 above. We find

$$P_3\left(\pm \frac{1}{3}\right) = \pm 3 \cdot \frac{1}{27} - \frac{1}{9} \pm \frac{1}{3} + 2 = \frac{17}{9} \pm \frac{4}{9} \neq 0,$$

$$P_3\left(\pm \frac{2}{3}\right) = \pm 3 \cdot \frac{8}{27} - \frac{4}{9} \pm \frac{2}{3} + 2 = \frac{14}{9} \pm \frac{14}{9},$$

from which follows that $P_3\left(-\frac{2}{3}\right) = 0$, so $z = -\frac{2}{3}$ is a rational root, and $3 \left\{ z - \left(-\frac{2}{3}\right) \right\} = 3z + 2$ must be a divisor of $P_3(z)$, i.e.

$$P_3(z) = (3z + 2)P_2(z).$$

It follows from

$$P_3(z) = 3z^3 - z^2 + z + 2 = z^2(3z + 2) - z(3z + 2) + (3z + 2) = (3z + 2) \{z^2 - z + 1\}$$

that

$$P_4(z) = 6z^4 - 5z^3 + 3z^2 + 3z - 2 = (2z - 1)(3z + 2) \{z^2 - z + 1\},$$

from which follows that $P_4(z)$ has two rational roots and two complex conjugated roots

$$\frac{1}{2}, \quad -\frac{2}{3}, \quad \frac{1}{2} \pm i \frac{\sqrt{3}}{2},$$

where we have used the usual solution formula for the equation $z^2 - z + 1 = 0$ of degree 2. \diamond

We now turn to the problem of finding possible multiple roots. Here we shall use the following simple theorem.

Theorem 1.6.2 *Given a general polynomial $P(z)$ of complex coefficients. If $a \in \mathbb{C}$ is a root of multiplicity $k \geq 2$ in $P(z)$, then $a \in \mathbb{C}$ is a root of multiplicity $k - 1 \geq 1$ in $P'(z)$.*

PROOF. We have not yet formally defined complex differentiation, so we shall here take for granted that e.g.

$$\frac{dz^k}{dz} = k z^{k-1},$$

so $P'(z)$ is derived from $P(z)$ as if $P(z)$ was a real polynomial. We shall of course later prove this claim.

Let $a \in \mathbb{C}$ be a root of multiplicity $k \geq 2$ in $P(z)$. Then

$$P(z) = (z - a)^k Q(z),$$

where $Q(z)$ is also a polynomial, so

$$P'(z) = k(z - a)^{k-1} Q(z) + (z - a)^k Q'(z) = (z - a)^{k-1} \tilde{Q}(z),$$

where $\tilde{Q}(z) = k \cdot Q(z) + (z - a)Q'(z)$ again is a polynomial. Clearly, $(z - a)^{k-1}$ is a divisor in both $P(z)$ and in $P'(z)$. \square

Procedure of finding multiple roots. We assume that $P(z)$ has a root $a \in \mathbb{C}$ of multiplicity $k \geq 2$. It follows from Theorem 1.6.2 that $(z - a)^{k-1}$ is a divisor in both $P(z)$ and $P'(z)$. Then by a division,

$$P(z) = Q_0(z) \cdot P'(z) + R_1(z),$$

where $Q_0(z)$ is a polynomial of degree 1, and the remainder term $R_1(z)$ is a polynomial of degree $\leq k - 2$. We get by a rearrangement,

$$R_1(z) = P(z) - Q_0(z) \cdot P'(z).$$

Since $(z - a)^{k-1}$ is a divisor on the right hand side, we also have that it is a divisor in $R_1(z)$.

In the next step we find polynomials $Q_1(z)$ and $R_2(z)$, such that

$$P'(z) = Q_1(z) \cdot R_1(z) + R_2(z),$$

where the degree of $R_2(z)$ is smaller than the degree of $R_1(z)$.

In the next step we compute

$$R_1(z) = Q_2(z)R_2(z) + R_3(z),$$

etc.. Since the degrees of the remainder terms $R_k(z)$ are decreasing, we must have $R_{j+1}(z) = 0$ after a final number of steps. Then the roots of $R_j(z)$ are all the multiple roots of $P(z)$. We have more precisely:

If

$$(29) \quad P(z) = A \cdot (z - a_1)^{k_1} \cdots (z - a_n)^{k_n},$$

then

$$(30) \quad R_j(z) = B \cdot (z - a_1)^{k_1-1} \cdots (z - a_n)^{k_n-1}.$$

Notice that if some $k_\ell = 1$, then the factor $(z - a_\ell)^{k_\ell-1} = 1$ in (34).

Usually the process stops here, but in some cases one may get more information in the following way:

1) Clearly, when we divide (29) by (30), then we get

$$\frac{P(z)}{R_j(z)} = \frac{A}{B} (z - a_1) \cdots (z - a_n),$$

i.e. a polynomial having all the same roots as $P(z)$, only as simple roots.

2) Another possibility is to repeat the method on $R_j(z)$ we can also isolate the roots of multiplicity ≥ 3 , etc..

Example 1.6.2 Given the existence of some multiple root, find all the roots of the polynomial of complex coefficients,

$$P(z) = z^3 - (1 + 2i)z^2 - (1 - 2i)z + 1.$$

A formal differentiation gives

$$P'(z) = 3z^2 - (2 + 4i)z - (1 - 2i),$$

and it is not hard by division to find that

$$P(z) = \left\{ \frac{1}{3}z - \frac{1+2i}{9} \right\} P'(z) + \frac{4}{9}iz + \frac{4}{9} = \left\{ \frac{1}{3}z - \frac{1+2i}{9} \right\} P'(z) + \frac{4}{9}i(z-i).$$

The only *possible* multiple root (in fact of multiplicity 2) is $z = i$. Instead of continuing the procedure as described above we simply check it by dividing $P(z)$ by $(z - i)^2 = z - 2iz - 1$. This gives

$$P(z) = z^3 - (1 + 2i)z^2 - (1 - 2i)z + 1 = (z - 1)(z - i)^2,$$

and $z = i$ is indeed a root of multiplicity 2. The remainder single root is $z = 1$. \diamond

1.7 Symbolic currents and voltages. Time vectors.

In this section we show that we already at this early stage of the theory have some useful applications of complex functions and numbers in some technical sciences.

In the theory of oscillations in *electric circuits* one considers periodic functions of some period T , i.e.

$$f(t) = f(t + nT) \quad \text{for all } n \in \mathbb{Z}.$$

such functions are usually described by a *Fourier series*, i.e.

$$(31) \quad f(t) \sim \frac{1}{2} a_0 + \sum_{n=1}^{+\infty} \left\{ a_n \cos\left(\frac{2n\pi t}{T}\right) + b_n \sin\left(\frac{2n\pi t}{T}\right) \right\},$$

where the symbol \sim means that the trigonometric series on the right hand side may not be pointwise equal to $f(t)$, but it nevertheless in some sense describes most of the properties of $f(t)$.

Clearly, the basic oscillations of (31) are either $\cos\left(\frac{2n\pi t}{T}\right)$ or $\sin\left(\frac{2n\pi t}{T}\right)$. Then notice that $\sin \Theta = \cos\left(\Theta - \frac{\pi}{2}\right)$, meaning that it suffices to use only the cosine function. With abuse of the language we define e.g. a *sine shaped oscillating voltage*, or just a *sine shaped voltage*, by

$$(32) \quad v(t) = v_a \cos(\omega t + \varphi),$$

where the constant $v_a > 0$ is called the *amplitude*, and the constant $\omega > 0$ the *angular speed*, while the constant $\varphi \in \mathbb{R}$ is called the *phase angle*. Finally, the increasing function $\omega t + \varphi$ of t is called the *phase function*.

American online

LIGS University

is currently enrolling in the
Interactive Online **BBA, MBA, MSc,**
DBA and PhD programs:

- ▶ enroll **by September 30th, 2014** and
- ▶ **save up to 16%** on the tuition!
- ▶ pay in 10 installments / 2 years
- ▶ Interactive **Online education**
- ▶ visit www.ligsuniversity.com to find out more!

Note: LIGS University is not accredited by any nationally recognized accrediting agency listed by the US Secretary of Education. More info [here](#).





Analogously we define a *sine shaped current* by

$$(33) \quad I(t) = i_a \cos(\omega t + \varphi),$$

which is completely characterized by the constants $i_a > 0$, the *amplitude*, $\omega > 0$, i.e. its *angular speed*, and $\varphi \in \mathbb{R}$, its *phase angle*.

Then note that (33) can also be written

$$(34) \quad I(t) = i_a \Re \left\{ e^{i(\omega t + \varphi)} \right\} = i_a \Re \left\{ e^{i\varphi} \cdot e^{i\omega t} \right\}.$$

Given $\omega > 0$, we see that we can represent $I(t)$ by the complex *number* (and not a function)

$$(35) \quad I = i_a e^{i\varphi}.$$

In *Circuit Theory*, this constant I is called the *symbolic current*.

Analogously we use (32) to define the *symbolic voltage* $V \in \mathbb{C}$ as the complex number

$$(36) \quad V = v_a e^{i\varphi}.$$

On the other hand, given e.g. the symbolic current $I \in \mathbb{C}$, then the corresponding sine shaped current is easily reconstructed by the formula

$$(37) \quad I(t) = \Re \left\{ I \cdot e^{i\omega t} \right\},$$

and analogously for the symbolic voltage.

The advantage of this notation is demonstrated by the following. Consider two sine shaped currents of the *same* angular speed. Let their corresponding symbolic currents be $I_1, I_2 \in \mathbb{C}$. Using (37) we get concerning their sum,

$$I(t) = I_1(t) + I_2(t) = \Re \left\{ I_1 e^{i\omega t} \right\} + \Re \left\{ I_2 e^{i\omega t} \right\} = \Re \left\{ (I_1 + I_2) e^{i\omega t} \right\},$$

from which follows that the symbolic current I of $I(t)$ is

$$(38) \quad I = I_1 + I_2.$$

Therefore, keeping the angular speed fixed, we can add sine shaped currents just by adding their corresponding symbolic currents.

Sometimes symbolic currents and symbolic voltages are called *time vectors* (representing vectors in the complex plane).

We can get more out of this idea, always assuming that the angular speed $\omega > 0$ is kept fixed. Let $I(t)$ be given by (33), i.e.

$$I(t) = i_a \cos(\omega t + \varphi) \quad \text{and} \quad I = i_a e^{i\varphi}.$$

Let a dot above a letter denote a differentiation with respect to the real time variable t . Then

$$\dot{I}(t) = \frac{dI}{dt} = -i_a \omega \sin(\omega t + \varphi) = \Re \left\{ i\omega \cdot i_a e^{i\varphi} \cdot e^{i\omega t} \right\},$$

so the symbolic current of $\dot{I}(t)$ is given by

$$(39) \quad \dot{I} = i\omega \cdot i_a e^{i\varphi} = i\omega I.$$

Similarly, we have $\dot{V} = i\omega V$ for the symbolic voltages.

Let the stationary current $I(t)$, given by (33), run through a circuit consisting of a *resistance* R , an *inductance* L , and a *capacitance* C . Then we get from the well-known left column below the corresponding symbolic voltages in the right column,

$$\begin{array}{ll} V_R(t) = RI(t), & V_R = RI, \\ V_L(t) = L\dot{I}(t), & V_L = i\omega LI, \\ V_C(t) = \frac{1}{C} \int I(t) dt, & V_C = \frac{1}{i\omega C} I. \end{array}$$

The equations in the right column are called the *symbolic elementary relations*. They are all algebraic equations between complex numbers as *Ohm's law*, $V = Z \cdot I$, where we call

$$Z_R = R, \quad Z_L = i\omega L, \quad Z_C = \frac{1}{i\omega C},$$

the *elementary impedances*. The reciprocal numbers,

$$Y_R = \frac{1}{R}, \quad Y_L = \frac{1}{i\omega L}, \quad Y_C = i\omega C,$$

are called the *elementary admittances*.

This small review of *Elementary Circuit Theory* shows that even at this early stage of the *Complex Functions Theory* one may save a lot of time in the computations and obtain more clarity by using

DON'T EAT YELLOW SNOW

What will your advice be?

Some advice just states the obvious. But to give the kind of advice that's going to make a real difference to your clients you've got to listen critically, dig beneath the surface, challenge assumptions and be credible and confident enough to make suggestions right from day one. At Grant Thornton you've got to be ready to kick start a career right at the heart of business.

Sound like you? Here's our advice: visit GrantThornton.ca/careers/students

Scan here to learn more about a career with Grant Thornton.

 **Grant Thornton**
An instinct for growth™

© Grant Thornton LLP. A Canadian Member of Grant Thornton International Ltd

2 Basic Topology and Complex Functions

2.1 Basic Topology

In this section we collect all the necessary results from topology. Readers already familiar with these ideas may skip this section and proceed directly to the next section, in which the complex functions are introduced. Nevertheless, it is felt to be quite convenient to have all these abstract concepts collected somewhere in this series, as they form the theoretical basis of *Calculus* and *Mathematical Analysis*.

The motivation is the idea of a *continuous function*. Let us for the time being consider a real function $f : \mathbb{R} \rightarrow \mathbb{R}$. It is well-known that f is *continuous at a point* $x_0 \in \mathbb{R}$, if one to every $\varepsilon > 0$ can find a $\delta = \delta(\varepsilon) > 0$, depending on ε , such that

$$(40) \text{ if } |x - x_0| < \delta, \quad \text{then } |f(x) - f(x_0)| < \varepsilon.$$

In other words (and roughly speaking): “If x lies close to x_0 , then the image $f(x)$ lies close to $f(x_0)$ ”, where the later closeness in some way is governed by the former one.

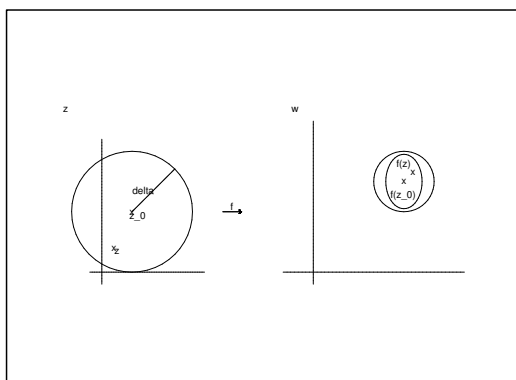

Figure 8: Geometrical description of a continuous complex function $f : \mathbb{C} \rightarrow \mathbb{C}$ from the complex z plane into the complex w plane.

The definition above is immediately extended to functions $f : \Omega \rightarrow \mathbb{C}$, where $\Omega \subseteq \mathbb{C}$. Here we may consider \mathbb{C} as equivalent to \mathbb{R}^2 with $z = x + iy \in \mathbb{C}$ corresponding to $(x, y) \in \mathbb{R}^2$. There is nothing mysterious in this, because the complex plane \mathbb{C} has been given the same geometry as the Euclidean space $E_2 = \mathbb{R}^2$. We see that the definition (40) in this extended case in words should be written in the following way:

Given a nonempty set $\Omega \subseteq \mathbb{C}$. A function $f : \Omega \rightarrow \mathbb{C}$ is continuous at a point $z_0 \in \Omega$, if one to every $\varepsilon > 0$ can find a $\delta = \delta(\varepsilon) > 0$, such that

- if $z \in \Omega$, and the distance from z_0 to z is smaller than δ , i.e. $|z - z_0| < \delta$, then the distance between the images by f is smaller than ε , i.e. $|f(z) - f(z_0)| < \varepsilon$.

The geometry of Figure 7 shows that it is natural to describe continuity by means of discs.

By the *open disc* of centre $z_0 \in \mathbb{C}$ and radius $r > 0$ we shall understand the set

$$(41) B(z_0, r) = \{z \in \mathbb{C} \mid |z - z_0| < r\}.$$

This set is indeed described by a disc in Figure 7.

It follows that $f : \Omega \rightarrow \mathbb{C}$ is continuous at a point $z_0 \in \Omega$ if to any $\varepsilon > 0$ there exists a $\delta = \delta(\varepsilon) > 0$, such that we for all $z \in B(z_0, \delta) \cap \Omega$ have that $f(z) \in B(f(z_0), \varepsilon)$.

For clearness and in order to save space, statements like this were fifty years ago *only* described by using quantifiers in the following way,

$$(42) \quad \forall \varepsilon > 0 \exists \delta > 0 \forall z \in B(z_0, \delta) \cap \Omega : f(z) \in B(f(z_0), \varepsilon),$$

leaving the geometrical interpretation to the reader. However, most people felt that (42) was difficult to read, so there has ever since been a tendency also to give the description in words and on a figure. We shall here let the use of quantifiers \forall (= for all) and \exists (= there exists) signal that we are dealing with some results, which are fundamental for the theoretical stuff, but not so important for the applications, if we believe in the theorems and formulæ.

We shall later as also need *closed discs* of centre $z_0 \in \mathbb{C}$ and radius $r > 0$. These are defined by

$$B[z_0, r] = \{z \in \mathbb{C} \mid |z - z_0| \leq r\},$$

so ordinary brackets are used for open discs, while square brackets are used for closed discs.

.....Alcatel-Lucent 

www.alcatel-lucent.com/careers

What if you could build your future and create the future?

One generation's transformation is the next's status quo. In the near future, people may soon think it's strange that devices ever had to be "plugged in." To obtain that status, there needs to be "The Shift".



It was early in the twentieth century realized that the system of open discs was too rigid for the mathematical applications. Instead one introduced

Definition 2.1.1 A set $\Omega \subseteq \mathbb{C}$ is said to be open, if there to every $z_0 \in \Omega$ exists an $r > 0$, such that $B(z_0, r) \subseteq \Omega$, i.e. if $B(z_0, r)$ is a subset of Ω .

We say that a set $A \subseteq \mathbb{C}$ is closed, if its complementary set $\mathbb{C} \setminus A$ is open.

Topology of open sets.

We say that a system \mathcal{O} of subsets of \mathbb{C} is a *topology*, and its elements are called *open sets*, if \mathcal{O} satisfies the following three conditions:

- 1) $\mathbb{C} \in \mathcal{O}$ and $\emptyset \in \mathcal{O}$.
- 2) If $\{\Omega_j \mid j \in I\}$ is any system of open sets, then

$$\bigcup_{j \in I} \Omega_j \in \mathcal{O}.$$

- 3) If $\{\Omega_j \mid j = 1, \dots, n\}$ is a *finite* system of open sets, then

$$\bigcap_{j=1}^n \Omega_j \in \mathcal{O}.$$

Remark 2.1.1 It is easy to check that the system \mathcal{O} of all sets in Definition 2.1.1 indeed satisfies the three conditions above, so the two definitions are consistent.

One should note that the empty set, \emptyset , is open of formal reasons, because the condition reads: *For every $z_0 \in \emptyset$, etc.* and there is no point $z_0 \in \emptyset$.

Note also that an infinite intersection of open sets may not be open. A simple example in \mathbb{R} is the closed interval

$$[0, 1] = \bigcap_{n=1}^{+\infty} \left] -\frac{1}{n}, 1 + \frac{1}{n} \right[,$$

and a similar example in \mathbb{C} is given by the closed unit disc,

$$B[0, 1] = \bigcap_{n=1}^{+\infty} B\left(0, 1 + \frac{1}{n}\right). \quad \diamond$$

Remark 2.1.2 The three condition above defining a topology cannot be reduced further, if one wants to define concepts like continuity. They are *not* dependent on a given metric which does not have always to exist in a topological space. However, in the present cases of \mathbb{R} and \mathbb{C} it would of course be stupid not to use the natural distance as defining the topology as above.

The word *topology* comes from Greek: $\tau\acute{o}\pi\omicron\varsigma$ = place, and $\lambda\acute{o}\gamma\omicron\varsigma$ = word, thought. \diamond

The system $\mathcal{F} = \{A \setminus \Omega \mid \Omega \in \mathcal{O}_A\}$ is called the system of *closed sets* in the given topology \mathcal{O}_A .

Although it may at the first glance seem to be very abstract to use open sets instead of distances, it is in many cases more convenient to do so.

We first define the *inverse map*, or just the *inverse*, of a function $f : \Omega \rightarrow \mathbb{C}$. Let $\mathcal{D}(A)$ denote the family of all possible subsets of the set A . Then the *inverse* $f^{\circ-1} : \mathcal{D}(\mathbb{C}) \rightarrow \mathcal{D}(\Omega)$ is given by

$$f^{\circ-1}(A) := \{z \in \Omega \mid f(z) \in A\} \subseteq \Omega, \quad A \in \mathcal{D}(\mathbb{C}).$$

In particular, if $A \cap f(\Omega) = \emptyset$, then of course $f^{\circ-1}(A) = \emptyset$.

Now we can give a more elegant definition of continuity.

Definition 2.1.2 *Let Ω be an open and non-empty subset of \mathbb{C} , and let $f : \Omega \rightarrow \mathbb{C}$ be a function. Then f is continuous in Ω (i.e. continuous at every point of Ω) if*

$$f^{\circ-1}(\omega) \in \mathcal{O}_\Omega \quad \text{for every } \omega \in \mathcal{O}_\mathbb{C},$$

i.e. the inverse by f of every open set is again open.

We must of course check that Definition 2.1.2 is consistent with the previous one given by (40).

PROOF. Let Ω be open, and let $f : \Omega \rightarrow \mathbb{C}$ be continuous in the sense of Definition 2.1.2. We shall prove that it is continuous at every point $z_0 \in \Omega$ in the sense of (40), or – written by quantifiers – we shall prove that

$$(43) \quad \forall z_0 \in \Omega \forall \varepsilon > 0 \exists \delta > 0 \forall z \in \Omega : |z - z_0| < \delta \Rightarrow |f(z) - f(z_0)| < \varepsilon.$$

Assume that $z_0 \in \Omega$ and $\varepsilon > 0$ have been chosen arbitrarily. According to (43) we shall consider the open set

$$\omega = B(f(z_0), \varepsilon).$$

This set is open, so $f^{\circ-1}(\omega)$ is open by Definition 2.1.2. Furthermore, $z_0 \in f^{\circ-1}(\omega)$, so by Definition 2.1.1 there is a $\delta > 0$, such that

$$B(z_0, \delta) \subseteq f^{\circ-1}(\omega).$$

This implies that if $z \in B(z_0, \delta)$, i.e. $|z - z_0| < \delta$, then $f(z) \in \omega = B(f(z_0), \varepsilon)$, i.e. $|f(z) - f(z_0)| < \varepsilon$.

This is true for every $z_0 \in \Omega$ and every $\varepsilon > 0$, so the claim is proved. \square .

Remark 2.1.3 Conversely, it is possible to prove that (43) also implies Definition 2.1.2, so the two definitions are equivalent. Condition (43) is most useful in explicit computations, while Definition 2.1.2 is far the best one to use in theoretical consideration, so the two definitions are supplementary to each other. \diamond

Theorem 2.1.1 *Let Ω and ω be two open and nonempty subsets of \mathbb{C} , and let $f : \Omega \rightarrow \omega$ and $g : \omega \rightarrow \mathbb{C}$ be two continuous maps. Then the composition $g \circ f : \Omega \rightarrow \mathbb{C}$ is also continuous.*

PROOF. This proof really demonstrates the power of Definition 2.1.2, where an application of the equivalent (43) would become very messy in comparison.

We shall prove that if $A \in \mathcal{O}$ is any open subset of \mathbb{C} , then $(f \circ g)^{\circ-1}(A) \in \mathcal{O}$ is also open.

However, $g : \omega \rightarrow \mathbb{C}$ is continuous, hence $g^{\circ-1}(A) \subseteq \omega$ is open in ω , and $f : \Omega \rightarrow \omega$ is continuous, so

$$f^{\circ-1}(g^{\circ-1}(A)) = (g \circ f)^{\circ-1}(A) \in \mathcal{O}_{\Omega}$$

is open, and the theorem is proved. \square

Compact sets.

The following definitions may also at a first glance seem rather abstract with no connection with the topic of this book, but a closer look will show that its consequences are indeed fundamental.

Definition 2.1.3 *Given any $A \subseteq \mathbb{C}$. By an open covering of A we understand a system*

$$\mathcal{C} = \{\Omega_j \mid j \in I\}$$

of open sets, such that

$$A \subseteq \bigcup_{j \in I} \Omega_j.$$

An open covering \mathcal{C} is called finite, if the index set $I = \{1, \dots, n\}$ is finite.

Definition 2.1.4 *A set $A \subseteq \mathbb{C}$ is called compact, if every open covering of A contains a finite covering.*

First we prove the following important consequence, which also gives a better understanding of compactness.

Theorem 2.1.2 *A set $A \subseteq \mathbb{C}$ is compact, if and only if it is closed and bounded.*

Remark 2.1.4 Theorem 2.1.2 says that concerning compactness in \mathbb{C} we might as well just check if the given set is closed and bounded. However, in the mathematical proofs it is usually much easier to use Definition 2.1.4 instead of Theorem 2.1.2. Here it should also be mentioned that there exist more general topological spaces in which being closed and bounded is *not* the same as being compact. \diamond

PROOF. First assume that A is compact in the sense of Definition 2.1.4. Clearly, $\{B(z, 1) \mid z \in A\}$ is an open covering of A , so it contains a finite covering

$$A \subseteq \bigcup_{j=1}^n B(z_j, 1) \subseteq B(0, \max |z_j| + 1),$$

proving that A is contained in one single disc of finite radius, hence, it is bounded.

Then assume that A is not closed. We shall prove that A is not compact.

Let \bar{A} denote the closure of A , i.e. $\bar{A} \supseteq A$ is the smallest closed set containing A . By assumption, there is a point $z_0 \in \bar{A} \setminus A$, so we can find a sequence $(z_n) \subseteq A$, such that

$$|z_0 - z_n| < \frac{1}{n} \quad \text{for all } n \in \mathbb{N}.$$

Note that all $z_n \in A$, while $z_0 \notin A$. Then clearly,

$$\left\{ \left\{ z \in \mathbb{C} \mid |z - z_0| > \frac{1}{n} \right\} \mid n \in \mathbb{N} \right\}$$

is an open covering of A , which does not contain a finite covering, so A is not compact. We get by contraposition that if A is compact, then A is also closed.

We have now proved the easy part, namely that if A is compact, then A is closed and bounded.

Let us turn to the rather complicated proof of the claim that in the special case of $\mathbb{C} \sim \mathbb{R}^2$ a bounded and closed set is also compact.

Assume that A is bounded and closed. Let $\mathcal{C} = \{\Omega_j \mid j \in J\}$ be any open covering of A . Each Ω_j is open, so to every $z \in \Omega_j$ there is an $r_{z,j} > 0$, such that

$$B(z, r_{z,j}) \subseteq \Omega_j.$$

Clearly,

$$\mathcal{B} = \{B(z, r_{z,j}) \mid z \in \Omega_j, j \in J\}$$

is also an open covering of A , because each $z \in A$ already belongs to some Ω_j . The claim is proved if \mathcal{B} contains a finite covering, because then (where we change the indices conveniently)

$$A \subseteq \bigcup_{j=1}^n B(z, r_{z,j}) \subseteq \bigcup_{n=1}^n \Omega_j.$$

Thus, it suffices to prove that every covering of A by open discs of the type $\mathcal{A} = \{B(z, r_z) \mid z \in A\}$ contains a finite covering, so we assume that we are given such a system \mathcal{A} in the following.

First choose $z_1 \in A$, such that

$$r_1 := r_{z_1} \geq \frac{1}{2} \sup \{r_z \mid z \in A\}.$$

If $A \subseteq B(z_1, r_1)$, then the claim follows. Hence, we assume that $A \setminus B(z_1, r_1) \neq \emptyset$.

Then choose $z_2 \in A \setminus B(z_1, r_1)$, such that

$$r_2 := r_{z_2} \geq \frac{1}{2} \sup \{r_z \mid z \in A \setminus B(z_1, r_1)\}.$$

Proceed in this way, so in the n^{th} step we choose a point

$$z_n \in A \setminus \bigcup_{j=1}^{n-1} B(z_j, r_j),$$

such that

$$(44) \quad r_n := r_{z_n} \geq \frac{1}{2} \sup \left\{ r_z \mid z \in A \setminus \bigcup_{j=1}^{n-1} B(z_j, r_j) \right\}.$$

If this process stops after a finite number of steps, then we must have

$$A \setminus \bigcup_{j=1}^{n-1} B(z_j, r_j) = \emptyset, \quad \text{i.e.} \quad A \subseteq \bigcup_{j=1}^{n-1} B(z_j, r_j),$$

and we have found a finite covering.

Assuming that A is closed and bounded (in \mathbb{C}) we shall prove that this process always stops after a finite number of steps. This is done *contrariwise*, so we assume that the process never stops. This implies that we by this process have selected an infinite sequence (z_n) by using (44). We shall prove that this assumption nevertheless will contradict (44), which means that the process will always stop after a finite number of steps, and the theorem will be proved.

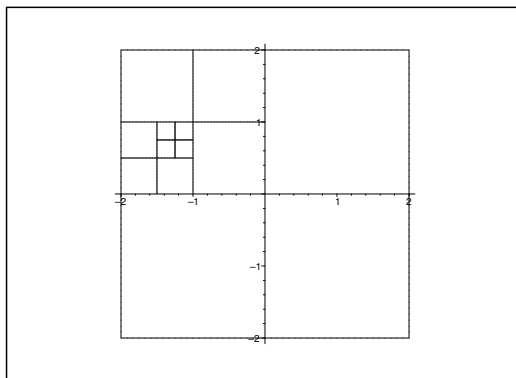

Figure 9: Construction of an accumulation point by a decreasing sequence of closed squares in $\mathbb{C} \sim \mathbb{R}^2$.

The set A was assumed bounded, so A is contained in a bounded square as in Figure 9, and all the infinite numbers z_n are lying in this square. We divide the square into four squares of half the edge length. At least one of these must also contain infinite many of the numbers z_n . Choose anyone of the smaller square having this property.

Then divide the chosen square into four smaller squares and choose one of these, which again contain infinitely many of the points z_n .

Proceed in this way, in each step halving the edge length and choosing a square, which contains infinitely many of the z_n .

We conclude from the geometry of this construction that *every countable sequence (z_n) on a bounded set has at least one accumulation point* (also called a *cluster point* by some authors).

Let z^* be an accumulation point of the sequence (z_n) . This means that no matter how small $\varepsilon > 0$ is chosen, the open disc $B(z^*, \varepsilon)$ will always contain infinitely many of the elements z_n . We shall prove that $z^* \in A$.

Contrariwise. Assume that $z^* \notin A$, i.e. $z^* \in \mathbb{C}A$, which is open, because A is closed. Then there is an $\varepsilon > 0$, such that

$$B(z^*, \varepsilon) \subseteq \mathbb{C}A, \quad \text{i.e.} \quad B(z^*, \varepsilon) \cap A = \emptyset,$$

which is not possible. Hence, $z^* \in A$.

Then we shall prove that $z^* \neq z_n$ for all $n \in \mathbb{N}$.

Contrariwise. If $z^* = z_m$ for some $m \in \mathbb{N}$, then $z_n \notin B(z_m, r_m)$ for all $n > m$, from which follows that z_m is not an accumulation point. Hence, $z^* \neq z_n$ for all $n \in \mathbb{N}$.

Then we prove that $z^* \notin B(z_n, r_n)$ for all $n \in \mathbb{N}$.

Contrariwise. Assume that $z^* \in B(z_m, r_m)$ for some $m \in \mathbb{N}$. Then

$$z_n \notin B(z_m, r_m) \quad \text{whenever } n > m.$$

Since

$$B(z^*, r_m - |z^* - z_m|) \subseteq B(z_m, r_m),$$

we again conclude that z^* cannot be an accumulation point. Hence, $z^* \notin B(z_n, r_n)$ for all $n \in \mathbb{N}$.

Then note that since $z^* \in A$, there is an $r^* > 0$, such that $B(z^*, r^*) \in \mathcal{A}$ belongs to our system, and since z^* is an accumulation point, there are infinitely many of the points z_n lying in the smaller disc $B\left(z^*, \frac{1}{2}r^*\right)$. Let z_n be anyone of these. It was proved above that $z^* \notin B(z_n, r_n)$, hence $r_n \leq \frac{1}{2}r^*$ for all such points $z_n \in B\left(z^*, \frac{1}{2}r^*\right)$.

Finally, also

$$z^* \in A \subseteq \bigcup_{j=1}^{n-1} B(z_j, r_j),$$

so by (44),

$$\frac{1}{2}r^* > r_n \geq \frac{1}{2} \sum \left\{ r_z \mid z \in A \setminus \bigcup_{j=1}^{n-1} B(z_j, r_j) \right\} \geq \frac{1}{2}r^*,$$

which clearly is a *contradiction*.

We conclude that the process indeed stops after a finite number of steps, and we have selected a finite covering from any given open covering of the bounded and closed set A , so we have finally proved that A is compact. \square

Remark 2.1.5 A closer look on the present proof of a bounded and closed set being compact shows that it relies heavily on the geometry described in Figure 9, but not at all on the special algebraic structure of \mathbb{C} . A simple consequence is that whenever one can talk of halving intervals, squares, cubes etc. as in Figure 9, or similarly, then every bounded and closed set is also compact, so the halving property is sufficient, though not necessary for this result. We shall not here give the precise condition, which does not assume the halving property. \diamond

The trouble of the proof of Theorem 2.1.2 is now really rewarded, because a simple consequence is

Theorem 2.1.3 First main theorem for continuous functions. *Assume that $f : \Omega \rightarrow \mathbb{C}$ is continuous. Then the image $f(A)$ of every compact set $A \subset \Omega$ is also compact.*

PROOF. Let $\{\omega_j \mid j \in J\}$ be any open covering of $f(A)$. It follows from $A \subset \Omega$ and f being continuous that $\{f^{-1}(\omega_j) \mid j \in J\}$ is an open covering of the compact set A . Hence, it contains a finite covering $\{f^{-1}(\omega_j) \mid j = 1, \dots, n\}$. Finally, applying the map f we obtain that $\{\omega_j \mid j = 1, \dots, n\}$ is a finite covering of $f(A)$, so $f(A)$ is also compact. \square

Remark 2.1.6 The proof of Theorem 2.1.3 is general and it is not linked to the complex numbers. If e.g. instead $f : \mathbb{R} \rightarrow \mathbb{R}$ is a continuous and real function, and $A \subset \mathbb{R}$ is some bounded and closed, i.e. compact set, then the image $f(A)$ is again bounded and closed. In particular, $f(A)$ contains a maximum and a minimum. \diamond

Relative topology.

So far the topological space (or universe) has been open. We shall now consider any subset of this universe and define the *relative topology* inherited from the topology of the larger space. This construction will be general, even if we apparently only consider \mathbb{C} or \mathbb{R} .

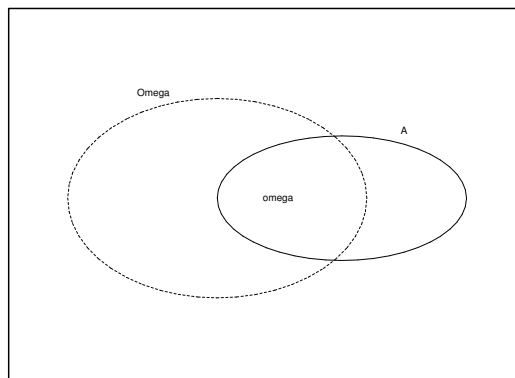

Figure 10: Definition of the relative topology on a subset A .

Let $A \subset \mathbb{C}$ (or $\subset \mathbb{R}$) be any nonempty subset. A set $\omega \subseteq A$ is called *relatively open* in A , if there is an open set $\Omega \subseteq \mathbb{C}$ (or $\subseteq \mathbb{R}$), such that

$$\omega = A \cap \Omega.$$

Let \mathcal{O} denote the system of open sets in \mathbb{C} (or \mathbb{R}), cf. Definition 2.1.1, and let \mathcal{O}_A denote the set of *relatively open sets* in A . Then clearly,

$$\mathcal{O}_A = \{A \cap \Omega \mid \Omega \in \mathcal{O}\},$$

from which follows that \mathcal{O}_A also satisfies the three conditions of a topology, mentioned earlier. We call \mathcal{O}_A the *relative topology* on A .

Example 2.1.1 Open sets in the relative topology of a set A may not be open in the larger space. A simple example is given by the relative open sets in the closed interval $[0, 1]$. These are

- 1) the ordinary open sets in $]0, 1[$,
- 2) the open sets in $]0, 1[$, supplied with one or both of the endpoints $\{0\}$ and $\{1\}$.

We have e.g. for the half open interval $[0, a[$, $0 < a \leq 1$ which is not open in the larger space \mathbb{R} , that

$$[0, a[=] - a, a[\cap [0, 1] =] - a, a[\cap A \quad \text{for } 0 < a \leq 1.$$

Since $] - a, a[$ is open in \mathbb{R} , it follows that $[0, a[$ is open relative to $A = [0, 1]$, but not in the larger space \mathbb{R} . \diamond

Since the relative topology \mathcal{O}_A on A satisfies the general conditions of a topology, we immediately get

Definition 2.1.5 A function $f : A \rightarrow \mathbb{C}$ is continuous, if

$$f^{-1}(\Omega) \in \mathcal{O}_A \quad \text{for all } \Omega \in \mathcal{O}.$$



Maastricht University

*Leading
in Learning!*

Join the best at
the Maastricht University
School of Business and
Economics!

Top master's programmes

- 33rd place Financial Times worldwide ranking: MSc International Business
- 1st place: MSc International Business
- 1st place: MSc Financial Economics
- 2nd place: MSc Management of Learning
- 2nd place: MSc Economics
- 2nd place: MSc Econometrics and Operations Research
- 2nd place: MSc Global Supply Chain Management and Change

Sources: Keuzegids Master ranking 2013; Elsevier 'Beste Studies' ranking 2012; Financial Times Global Masters in Management ranking 2012

**Maastricht
University is
the best specialist
university in the
Netherlands
(Elsevier)**

Visit us and find out why we are the best!
Master's Open Day: 22 February 2014

www.mastersopenday.nl



There is no need to assume that f is mapping into \mathbb{C} , so we get immediately the extension of this definition to

Definition 2.1.6 Given two nonempty topological spaces A and B , and let \mathcal{O}_A and \mathcal{O}_B denote the systems of (relatively) open sets in A , resp. B . a map $f : A \rightarrow B$ is continuous, if

$$f^{\circ-1}(\Omega) \in \mathcal{O}_A \quad \text{for all } \Omega \in \mathcal{O}_B.$$

Connected sets.

Definition 2.1.6 is the most general definition of a continuous map. We notice the following special case which will be applied below. Let A be any topological space, and choose $B = \mathbb{Z}$, i.e. the set of all integers with the relative topology from \mathbb{R} . It follows for any $n \in \mathbb{Z}$ that

$$\{n\} = \mathbb{Z} \cap B\left(n, \frac{1}{3}\right) \quad \text{and} \quad \{n\} = \mathbb{Z} \setminus \left\{ \bigcup_{m \neq n} B\left(m, \frac{1}{3}\right) \right\}.$$

It follows from the former equation that every $n \in \mathbb{Z}$ is a relatively open set, and from the latter equation that it is also the relative complement of an open set, hence relatively closed. We conclude that every point $n \in \mathbb{Z}$ is both open and closed in the relative topology $\mathcal{O}_{\mathbb{Z}}$ of \mathbb{Z} .

Definition 2.1.7 A subset $A \subseteq \mathbb{C}$ is said to be connected, if the only possible continuous maps $f : A \rightarrow \mathbb{Z}$ with the relative topology $\mathcal{O}_{\mathbb{Z}}$ are the constant functions.

A less abstract description of a connected set is given by the following theorem.

Theorem 2.1.4 A subset A of \mathbb{C} is not connected, if and only if we can find two nonempty disjoint relatively open subsets $A_1, A_2 \in \mathcal{O}_A$, such that

$$A = A_1 \cup A_2, \quad A_1 \cap A_2 = \emptyset, \quad A_1, A_2 \in \mathcal{O}_A.$$

PROOF. If there exists a disjoint splitting of A into two relatively open sets as above, we define a map $f : A \rightarrow \mathbb{Z}$ by

$$f(z) = \begin{cases} 1 & \text{for } z \in A_1, \\ 2 & \text{for } z \in A_2, \end{cases} \quad A = A_1 \cup A_2, \quad A_1 \cap A_2 = \emptyset.$$

Then $f^{\circ-1}(\{1\}) = A_1 \in \mathcal{O}_A$ and $f^{\circ-1}(\{2\}) = A_2 \in \mathcal{O}_A$, so f is continuous. Clearly, f is not a constant function (it has two different values), so A cannot be connected.

Conversely, assume that A is not connected. There exists a continuous and non-constant function $f : A \rightarrow \mathbb{Z}$. Without loss of generality we may assume that $f(A) = \{1, 2\}$.

It follows from the assumption of continuity that

$$A_1 = f^{\circ-1}(\{1\}) \in \mathcal{O}_A \quad \text{and} \quad A_2 = f^{\circ-1}(\{2\}) \in \mathcal{O}_A,$$

and it is obvious that

$$A_1 \neq \emptyset, \quad A_2 \neq \emptyset, \quad A = A_1 \cup A_2, \quad \text{and} \quad A_1 \cap A_2 = \emptyset. \quad \square$$

Corollary 2.1.1 *An open and nonempty set Ω is connected, if and only if for every possible disjoint splitting $\Omega = \Omega_1 \cup \Omega_2$ of Ω into two open sets, the set Ω_1 is either \emptyset or Ω , corresponding to Ω_2 is either Ω or \emptyset .*

PROOF. Using contraposition we shall prove that the open set Ω is *not* connected, if and only if there is a nontrivial disjoint open splitting $\Omega = \Omega_1 \cup \Omega_2$, i.e. $\Omega_1 \neq \emptyset$ and $\neq \Omega$, and both Ω_1 and Ω_2 are open sets. This has already been proved in Theorem 2.1.4.

The following theorem now follows immediately from Corollary 2.1.1.

Theorem 2.1.5 *Second main theorem for continuous functions. Every connected set is mapped by any continuous function into another connected set.*

PROOF. Let $f : A \rightarrow f(A)$ be continuous, and assume A is connected. Let $g : f(A) \rightarrow \mathbb{Z}$ be any continuous function. We shall prove that g is a constant function.

We know that the composite map $g \circ f : A \rightarrow \mathbb{Z}$ is continuous, so $g \circ f$ is constant, because A is connected. This means that $g : f(A) \rightarrow \mathbb{Z}$ is constant. Since g was any continuous function, we conclude that $f(A)$ is connected. \square

We proceed by including some more definitions from *Point Set Theory*. Traditionally they should have been in the same section as the definition of topology, but we have judged that it would be better, if they were put closer to the place, where they are applied.

Definition 2.1.8 *A boundary point of a set A is a point z_0 , such that*

$$A \cap B(z_0, r) \neq \emptyset \quad \text{and} \quad \mathbb{C}A \cap B(z_0, r) \neq \emptyset \quad \text{for all } r > 0.$$

A boundary point of A may, or may not, be an element of A .

The set of all boundary points is called the boundary, and it is denoted by ∂A .

An isolated point of A is a point $z_0 \in A$, for which there exists an $r > 0$, such that

$$A \cap B(z_0, r) = \{z_0\}.$$

The interior A° of A is the largest open set contained in A . The closure \bar{A} of A is the complement of the interior of the complement of A , i.e. $\bar{A} = \mathbb{C}(\{\mathbb{C}A\}^\circ)$.

It is easy to prove that $\bar{A} = A^\circ \cup \partial A$, that A° , ∂A and $\{\mathbb{C}A\}^\circ$ form a disjoint splitting of $\mathbb{C} = A^\circ \cup \partial A \cup \{\mathbb{C}A\}^\circ$ for every subset A , and that an isolated point is always a boundary point.

In *Complex Functions Theory* we shall mostly deal with (nonempty) open connected sets. Such sets are also called *open domains*. A *domain* is a set, such that its interior is an open domain. If a domain also is closed, we call it a *closed domain*.

An important theorem is

Theorem 2.1.6 *In an open domain A , any two points z_0 and $z \in A$ can always be joined by a continuous curve, which lies entirely in A .*

PROOF. Choose any $z_0 \in A$, and let A_1 denote the set of all $z \in A$, which can be joined with z_0 by a continuous curve $\Gamma_z \subset A$, lying entirely in A .

Let $z \in A_1 \subseteq A$. Since A is open, there is an $r > 0$, such that $B(z, r) \subseteq A$. Then note that every point $w \in B(z, r)$ can be joined with z_0 by a continuous curve by using Γ_z to get from z_0 to z and then continue from z to w by following the corresponding radius lying also in A . Hence, $B(z, r) \subseteq A_1$, and it follows that the set A_1 is open. Clearly, $z_0 \in A_1$, so $A_1 \neq \emptyset$.

Put $A_2 = A \setminus A_1$. Then A_2 is the set of all points $z \in A$, which *cannot* be joined with z_0 by any continuous curve in A . Repeating the argument on A_1 above with obvious modifications we also conclude that A_2 is open.

Then we have a disjoint splitting of $A = A_1 \cup A_2$ into two open sets. Since A is connected, and $A_1 \neq \emptyset$, we must have $A_2 = \emptyset$, so $A_1 = A$, and the claim is proved. \square

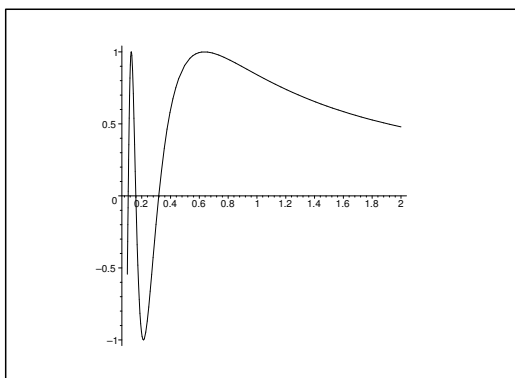

Figure 11: The set of the union of the graph of the function $\sin \frac{1}{x}$, $x > 0$, and the Y -axis is connected, and yet no point on the axis can be joined with any point on the graph by a continuous curve lying entirely in this set.

Example 2.1.2 If A is not an open domain, but just a connected set, we may not be able to join two points in A by a curve. The classical example is the union of the graph of $\sin \frac{1}{x}$, $x > 0$, and the Y -axis, cf. Figure 11. \diamond

The domains in *Complex Functions Theory* will usually be nice in the following sense that their boundaries will be composed of *isolated points* and/or continuous and piecewise differentiable curves, mostly just line segments, half lines, lines, circular arcs or circles.

Later on, the isolated points of the boundary will in particular be extremely important in the so-called *residue calculus*.

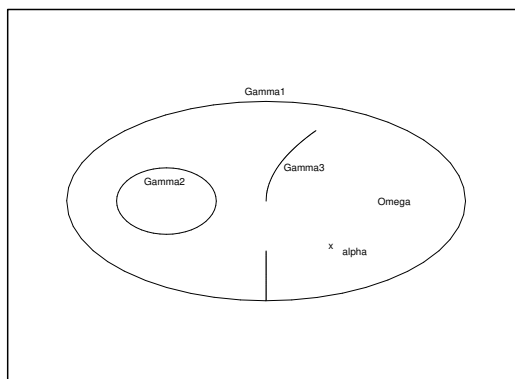

Figure 12: Example of a “typical” domain Ω .

We still need some more concepts from *Set Point Theory*.

Definition 2.1.9 A domain Ω in \mathbb{C} is called simply connected, if every simple closed curve which lies in Ω° only encloses points in Ω . If one can find a simple closed curve in Ω enclosing a point $z \notin \Omega$, then Ω is called multiply connected.

BI NORWEGIAN BUSINESS SCHOOL

EFMD EQUIS ACCREDITED

Empowering People. Improving Business.

BI Norwegian Business School is one of Europe’s largest business schools welcoming more than 20,000 students. Our programmes provide a stimulating and multi-cultural learning environment with an international outlook ultimately providing students with professional skills to meet the increasing needs of businesses.

BI offers four different two-year, full-time Master of Science (MSc) programmes that are taught entirely in English and have been designed to provide professional skills to meet the increasing need of businesses. The MSc programmes provide a stimulating and multi-cultural learning environment to give you the best platform to launch into your career.

- MSc in Business
- MSc in Financial Economics
- MSc in Strategic Marketing Management
- MSc in Leadership and Organisational Psychology

www.bi.edu/master



Another description is that a simply connected set Ω is “without holes”. If we consider its complement $\mathbb{C} \setminus \Omega$ written as a disjoint union of maximal open sets (its *connected components*), then all its connected components are unbounded.

If $n - 1$ of the connected components of the complement $\mathbb{C} \setminus \Omega$ are bounded, we also say that Ω is *n-connected*.

A typical example is, when Ω is the open unit disc with the exception of $n - 1$ different points inside the unit circle. This set Ω is *n-connected*. Again we refer to *residue calculus* for important applications.

We have noted that simple closed curves have started to appear. Such curves will always be continuous, and piecewise differentiable and without double points (intersection points, etc.), and their two endpoints will always coincide. Such curves will always be given a sense of orientation, i.e. the way it is traversed according to its parametric description.

We shall adopt the following convention that if a *simply* or *multiply connected* domain Ω is bounded by closed curves as above, then Ω always *lies to the left* on any of these curves, seen in their sense of orientation.

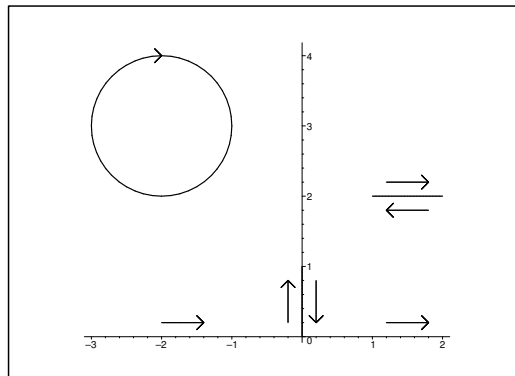

Figure 13: The domain Ω lies to the left of the boundary curves. Notice that the line segments are traversed in both direction, so a line segment is consisting of two identical curves, apart from their opposite orientations.

Uniform continuity.

Definition 2.1.10 A map $f : \Omega \rightarrow \mathbb{C}$ is uniformly continuous in the set Ω , if to every $\varepsilon > 0$ there is $\delta = \delta(\varepsilon) > 0$ only depending on ε , such that for all $x, y \in \Omega$,

$$|f(x) - f(y)| < \varepsilon, \quad \text{whenever } |x - y| < \delta.$$

The importance of uniform continuity is demonstrated by the following

Theorem 2.1.7 Third main theorem for continuous functions. *Every continuous function f on a compact set K is uniformly continuous.*

PROOF. Since f is continuous, we have, expressed by quantifiers,

$$\forall \varepsilon > 0 \forall x \in K \exists \delta_x > 0 \forall y \in \Omega : |x - y| < \delta_x \Rightarrow |f(x) - f(y)| \leq \frac{\varepsilon}{2},$$

where δ_x depends on both ε and x . The condition above can also be written by using sets instead,

$$\forall \varepsilon > 0 \forall x \in K \exists \delta_x > 0 : f(B(x, \delta_x) \cap K) \subseteq B\left(f(x), \frac{\varepsilon}{2}\right).$$

Now, $\left\{ B\left(x, \frac{1}{2}\delta_x\right) \mid x \in K \right\}$ is an open covering of the compact set K , so it contains a *finite covering*

$$\mathcal{B} := \left\{ B\left(x_j, \frac{1}{2}\delta_j\right) \mid j = 1, \dots, n \right\},$$

with obvious changes of notation.

Then put

$$\delta := \min \left\{ \frac{1}{2}\delta_j \mid j = 1, \dots, n \right\} > 0,$$

and let $x, y \in K$ satisfy $|x - y| < \delta$. Since \mathcal{B} is a covering of K , we have $x \in B\left(x_j, \frac{1}{2}\delta_j\right)$ for some j , so by the *triangle inequality*,

$$|y - x_j| \leq |y - x| + |x - x_j| \leq \delta + \frac{1}{2}\delta_j < \frac{1}{2}\delta_j + \frac{1}{2}\delta_j = \delta_j,$$

so $y \in B(x_j, \delta_j)$.

Also, $x \in B(x_j, \delta_j)$, so by using the *triangle inequality* once more we get

$$|f(y) - f(x)| \leq |f(y) - f(x_j)| + |f(x) - f(x_j)| < \frac{\varepsilon}{2} + \frac{\varepsilon}{2} = \varepsilon.$$

Here, δ is independent of the arbitrarily chosen points x and $y \in K$, so it follows that f is uniformly convergent. \square

The Fix Point Theorem and some of its consequences.

We shall later need the *Theorem of Implicit Given Functions* and the *Theorem of Inverse Mapping*. In the proofs of these important theorems we shall use the *Fix Point Theorem*. Since all these theorems are of interest in a more general setting, and the proofs are rarely seen in elementary textbooks, we shall prove these theorems in \mathbb{R}^n instead of just restrict ourselves to $\mathbb{C} \in \mathbb{R}^2$.

Thus we consider the Euclidean space \mathbb{R}^n with its *norm* given by

$$\|\mathbf{x}\| := \sqrt{x_1^2 + \cdots + x_n^2} \quad \text{for } \mathbf{x} = (x_1, \dots, x_n) \in \mathbb{R}^n.$$

Definition 2.1.11 Let $\mathbf{f} : \mathbb{R}^n \rightarrow \mathbb{R}^n$ be a map. A point $\mathbf{x}_0 \in \mathbb{R}^n$ is called a *fix point* of \mathbf{f} , if

$$(45) \quad \mathbf{f}(\mathbf{x}_0) = \mathbf{x}_0.$$

The map \mathbf{f} is called a *contraction*, if there is a constant $C \in [0, 1[$, such that

$$(46) \quad \|\mathbf{f}(\mathbf{x}) - \mathbf{f}(\mathbf{y})\| \leq C \|\mathbf{x} - \mathbf{y}\|.$$

We shall without proof use the well-known fact that $(\mathbb{R}^n, +, \cdot, \|\cdot\|)$ is a complete vector space, i.e. every *Cauchy sequence* is also convergent.

Theorem 2.1.8 The Fix Point Theorem. *If $\mathbf{f} : \mathbb{R}^n \rightarrow \mathbb{R}^n$ is a contraction indexcontraction, then \mathbf{f} has precisely one fix point $\mathbf{x}_0 \in \mathbb{R}^n$.*

PROOF. *Uniqueness*, i.e. there is at most one fix point. In fact, assume that both \mathbf{x}_1 and \mathbf{x}_2 are fix points, so $\mathbf{f}(\mathbf{x}_1) = \mathbf{x}_1$ and $\mathbf{f}(\mathbf{x}_2) = \mathbf{x}_2$. Then

$$\|\mathbf{x}_1 - \mathbf{x}_2\| = \|\mathbf{f}(\mathbf{x}_1) - \mathbf{f}(\mathbf{x}_2)\| \leq C \cdot \|\mathbf{x}_1 - \mathbf{x}_2\|.$$

Since \mathbf{f} is a contraction, $0 \leq C < 1$, so this inequality only holds for $\|\mathbf{x}_1 - \mathbf{x}_2\| = 0$, i.e. $\mathbf{x}_1 = \mathbf{x}_2$, and we have proved uniqueness.

Existence. Choose any $\mathbf{x} \in \mathbb{R}^n$, and consider the sequence

$$\mathbf{x}, \quad \mathbf{f}(\mathbf{x}), \quad \mathbf{f}(\mathbf{f}(\mathbf{x})), \quad \dots, \quad \mathbf{f}^{\circ p}(\mathbf{x}), \quad \dots,$$

where $\mathbf{f}^{\circ p} = \mathbf{f} \circ \cdots \circ \mathbf{f}$ (p “factors”) denotes p compositions of \mathbf{f} with itself. Since \mathbf{f} is a contraction, we get by using the *triangle inequality*,

$$\begin{aligned} \left\| \mathbf{f}^{\circ(p+m)}(\mathbf{x}) - \mathbf{f}^{\circ p}(\mathbf{x}) \right\| &\leq \sum_{j=0}^{m-1} \left\| \mathbf{f}^{\circ(p+j+1)}(\mathbf{x}) - \mathbf{f}^{\circ(p+j)}(\mathbf{x}) \right\| \\ &\leq \sum_{j=0}^{m-1} C^{p+j} \|\mathbf{f}(\mathbf{x}) - \mathbf{x}\| \leq \frac{C^p}{1-C} \|\mathbf{f}(\mathbf{x}) - \mathbf{x}\|. \end{aligned}$$

For any given $\varepsilon > 0$, choose $N \in \mathbb{N}$, such that

$$\frac{C^N}{1-C} \|\mathbf{f}(\mathbf{x}) - \mathbf{x}\| \leq \varepsilon,$$

which is possible, because $\mathbf{x} \in \mathbb{R}^n$ is fixed, and $C^p \rightarrow 0$ decreasingly for $p \rightarrow +\infty$. Then it follows from the estimate above that

$$\left\| \mathbf{f}^{\circ(p+m)}(\mathbf{x}) - \mathbf{f}^{\circ p}(\mathbf{x}) \right\| < \varepsilon \quad \text{for all } p \geq N \text{ and all } m \in \mathbb{N}.$$

This is the condition that $(\mathbf{f}^{\circ p}(\mathbf{x}))_{p \in \mathbb{N}}$ is a *Cauchy sequence* in \mathbb{R}^n for every given \mathbf{x} . Since \mathbb{R}^n is a complete space, this Cauchy sequence is convergent, so

$$\mathbf{f}^{\circ p}(\mathbf{x}) \rightarrow \mathbf{x}_0 \in \mathbb{R}^n \quad \text{for } p \rightarrow +\infty.$$

The trick is to notice that when we apply \mathbf{f} on this limit (and change indices from $p+1$ to p), then also

$$\mathbf{f}^{\circ p}(\mathbf{x}) \rightarrow \mathbf{f}(\mathbf{x}_0) \in \mathbb{R}^n,$$

and the two limit points are equal, hence $\mathbf{f}(\mathbf{x}_0) = \mathbf{x}_0$, and we have proved that \mathbf{x}_0 is a fix point. \square

It follows from the uniqueness above that we shall always get the same limit $\mathbf{x}_0 \in \mathbb{R}^n$, no matter which $\mathbf{x} \in \mathbb{R}^n$ we use as our initial value. This method is called the *iteration method*, or the *method of successive approximations*.

Need help with your dissertation?

Get in-depth feedback & advice from experts in your topic area. Find out what you can do to improve the quality of your dissertation!

Get Help Now



Go to www.helpmyassignment.co.uk for more info



We consider the spaces \mathbb{R}^k of points $\mathbf{x} = (x_1, \dots, x_k)$ and \mathbb{R}^p of points $\mathbf{y} = (y_1, \dots, y_p)$, and an open set $\Omega \subseteq \mathbb{R}^k \times \mathbb{R}^p = \mathbb{R}^{k+p}$. Let $\mathbf{f} : \Omega \rightarrow \mathbb{R}^p$, i.e. $\mathbf{f} = (f_1, \dots, f_p)$, where each f_j is a map $f_j : \Omega \rightarrow \mathbb{R}$. Assume that every f_j , $j = 1, \dots, p$, is continuous with continuous partial derivatives with respect to every variable $x_1, \dots, x_k, y_1, \dots, y_p$.

Consider the system of equations

$$(47) \quad \mathbf{f}(\mathbf{x}, \mathbf{y}) = \mathbf{0},$$

i.e. in coordinates,

$$(48) \quad \begin{cases} f_1(x_1, \dots, x_k, y_1, \dots, y_p) = 0, \\ \dots \\ f_p(x_1, \dots, x_k, y_1, \dots, y_p) = 0. \end{cases}$$

The set of solutions F is then a subset of Ω :

$$F = \{(\mathbf{x}, \mathbf{y}) \in \Omega \mid \mathbf{f}(\mathbf{x}, \mathbf{y}) = \mathbf{0}\}.$$

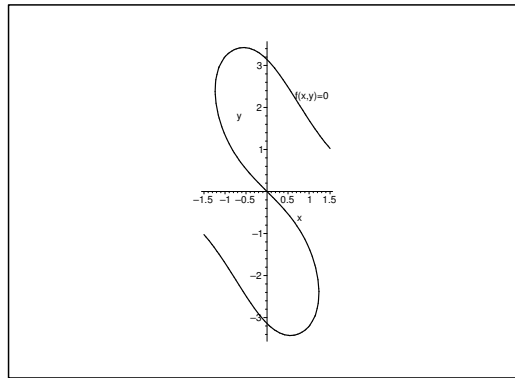

Figure 14: Implicit function in the case of $k = p = 1$. Equation (47) is reduced to $f(x, y) = 0$, and it describes a curve in $\mathbb{R} \times \mathbb{R} = \mathbb{R}^2$.

It is possible here that $F = \emptyset$. If $k = p = 1$, one example is $f(x, y) = x^2 + y^2 + 1$, where the equation $f(x, y) = 0$ does not have any solution in \mathbb{R}^2 . We shall in the following assume that this is not the case.

We define the *Jacobian* or the *functional matrix* of \mathbf{f} with respect to the variables y_1, \dots, y_p as the $(p \times p)$ matrix

$$(49) \quad \mathbf{f}'_{\mathbf{y}}(\mathbf{x}, \mathbf{y}) = \frac{\partial (f_1, \dots, f_p)}{\partial (y_1, \dots, y_p)} := \begin{pmatrix} \frac{\partial f_1}{\partial y_1} & \dots & \frac{\partial f_1}{\partial y_p} \\ \vdots & & \vdots \\ \frac{\partial f_p}{\partial y_1} & \dots & \frac{\partial f_p}{\partial y_p} \end{pmatrix},$$

where $\mathbf{f}'_{\mathbf{y}}(\mathbf{x}, \mathbf{y})$ is a conveniently short notation of this matrix, while $\frac{\partial(f_1, \dots, f_p)}{\partial(y_1, \dots, y_p)}$ gives a mnemonic way of writing this matrix.

Theorem 2.1.9 Theorem of Implicit Given Functions. *Given a nonempty open set $\Omega \subseteq \mathbb{R}^{k+p}$ and a map $\mathbf{f} : \Omega \rightarrow \mathbb{R}^p$ of continuous coordinate functions*

$$f_1, \dots, f_p : \Omega \rightarrow \mathbb{R},$$

which all have continuous partial derivatives with respect to the \mathbf{y} variables y_1, \dots, y_p . Let $(\mathbf{x}_0, \mathbf{y}_0) \in \Omega$ be a solution of the equation

$$\mathbf{f}(\mathbf{x}, \mathbf{y}) = \mathbf{0},$$

and assume that the Jacobian $\mathbf{f}'_{\mathbf{y}}(\mathbf{x}, \mathbf{y})$ with respect to y_1, \dots, y_p is regular at $(\mathbf{x}_0, \mathbf{y}_0)$, i.e. we assume that

$$\det \mathbf{f}'_{\mathbf{y}}(\mathbf{x}_0, \mathbf{y}_0) \neq 0.$$

Then there exist constants $a, b > 0$ and corresponding sets

$$A = \{\mathbf{x} \in \mathbb{R}^k \mid \|\mathbf{x} - \mathbf{x}_0\| \leq a\} \subseteq \mathbb{R}^k, \quad B = \{\mathbf{y} \in \mathbb{R}^p \mid \|\mathbf{y} - \mathbf{y}_0\| \leq b\} \subseteq \mathbb{R}^p,$$

and a continuous map $\mathbf{g} : A \rightarrow B$, such that

$$F \cap \{A \times B\} = \{(\mathbf{x}, \mathbf{g}(\mathbf{x})) \mid \mathbf{x} \in A\}$$

is the graph of \mathbf{g} in $A \times B$, i.e. such that

$$\mathbf{f}(\mathbf{x}, \mathbf{g}(\mathbf{x})) = \mathbf{0} \quad \text{for } \mathbf{x} \in A.$$

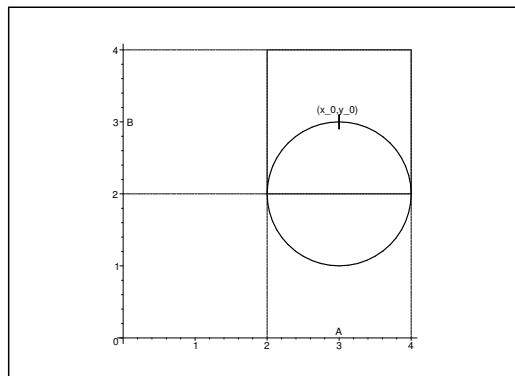

Figure 15: Illustration of the Theorem of Implicit Given Functions in the case of $k = p = 1$ and $f(x, y) = 0$ describing a circle in \mathbb{R}^2 .

This theorem shows that under the given assumptions, the equation $\mathbf{f}(\mathbf{x}, \mathbf{y}) = \mathbf{0}$ can *locally* be solved, such that $\mathbf{y} = \mathbf{g}(\mathbf{x})$ is a function \mathbf{x} .

PROOF. It follows from the assumptions that $\mathbf{f}'_{\mathbf{y}}(\mathbf{x}, \mathbf{y})$ is continuous, so there are constants $a', b' > 0$, such that

$$\det \mathbf{f}'_{\mathbf{y}}(\mathbf{x}, \mathbf{y}) \neq 0 \quad \text{for } \|\mathbf{x} - \mathbf{x}_0\| < a' \text{ and } \|\mathbf{y} - \mathbf{y}_0\| < b'.$$

Consider for any given $(\mathbf{x}, \mathbf{y}) \in \Omega$ the vector written as a $p \times 1$ matrix (a column)

$$(50) \quad \mathbf{T}(\mathbf{x}, \mathbf{y}) := \mathbf{y} - \{\mathbf{f}'_{\mathbf{y}}(\mathbf{x}_0, \mathbf{y}_0)\}^{-1} \mathbf{f}(\mathbf{x}, \mathbf{y}) \in \mathbb{R}^p.$$

Since $\mathbf{f}(\mathbf{x}_0, \mathbf{y}_0) = \mathbf{0}$, it follows that

$$\mathbf{T}(\mathbf{x}_0, \mathbf{y}_0) = \mathbf{y}_0.$$

Clearly, the map $\mathbf{T} : \Omega \rightarrow \mathbb{R}^p$ is continuous partial derivatives with respect to y_1, \dots, y_p . Since $\{\mathbf{f}'_{\mathbf{y}}(\mathbf{x}_0, \mathbf{y}_0)\}^{-1}$ is a constant matrix, we get

$$\mathbf{T}'_{\mathbf{y}}(\mathbf{x}, \mathbf{y}) = \mathbf{I} - \{\mathbf{f}'_{\mathbf{y}}(\mathbf{x}_0, \mathbf{y}_0)\}^{-1} \mathbf{f}'_{\mathbf{y}}(\mathbf{x}, \mathbf{y}),$$

where \mathbf{I} is the $p \times p$ unit matrix. In particular, $\mathbf{T}'_{\mathbf{y}}(\mathbf{x}_0, \mathbf{y}_0) = \mathbf{0}$, which implies that

$$\frac{\partial T_r}{\partial y_s}(\mathbf{x}_0, \mathbf{y}_0) = 0 \quad \text{for } r, s = 1, \dots, p.$$

The elements of $\mathbf{T}'_{\mathbf{y}}(\mathbf{x}, \mathbf{y})$ are all continuous. Hence, there exist positive constants $a'' < a'$ and $b < b'$, such that

$$(51) \quad \left| \frac{\partial T_r}{\partial y_s}(\mathbf{x}, \mathbf{y}) \right| \leq \frac{1}{2p^2} \quad \text{for } \|\mathbf{x} - \mathbf{x}_0\| \leq a' \text{ and } \|\mathbf{y} - \mathbf{y}_0\| \leq b.$$

If necessary, we may choose an even smaller $a \in]0, a'']$, such that also

$$(52) \quad \|\mathbf{T}(\mathbf{x}, \mathbf{y}_0) - \mathbf{y}_0\| \leq \frac{b}{2} \quad \text{for } \|\mathbf{x} - \mathbf{x}_0\| \leq a.$$

We conclude from (51) for all $\mathbf{x} \in \mathbb{R}^k$, for which $\|\mathbf{x} - \mathbf{x}_0\| \leq a$, and all $\mathbf{y}, \mathbf{y}^* \in \mathbb{R}^p$, for which $\|\mathbf{y} - \mathbf{y}_0\| \leq b$ and $\|\mathbf{y}^* - \mathbf{y}_0\| \leq b$, that

$$(53) \quad \|\mathbf{T}(\mathbf{x}, \mathbf{y}) - \mathbf{T}(\mathbf{x}, \mathbf{y}^*)\| \leq \frac{1}{2} \|\mathbf{y} - \mathbf{y}^*\|.$$

In fact, for every $j = 1, \dots, p$, we get by *Taylor's formula*

$$T_j(\mathbf{x}, \mathbf{y}) - T_j(\mathbf{x}, \mathbf{y}^*) = \frac{\partial T_j}{\partial y_1}(\eta_1) \cdot (y_1 - y_1^*) + \dots + \frac{\partial T_j}{\partial y_p}(\eta_p) \cdot (y_p - y_p^*),$$

where each η_k is some point on the line segment between y_k and y_k^* . Hence,

$$|T_j(\mathbf{x}, \mathbf{y}) - T_j(\mathbf{x}, \mathbf{y}^*)| \leq p \cdot \frac{1}{2p^2} \|\mathbf{y} - \mathbf{y}^*\| = \frac{1}{2p} \|\mathbf{y} - \mathbf{y}^*\|,$$

so

$$\|\mathbf{T}(\mathbf{x}, \mathbf{y}) - \mathbf{T}(\mathbf{x}, \mathbf{y}^*)\| \leq p \cdot \frac{1}{2p} \|\mathbf{y} - \mathbf{y}^*\| = \frac{1}{2} \|\mathbf{y} - \mathbf{y}^*\|,$$

and (53) is proved.

Choosing in particular $\mathbf{y}^* = \mathbf{y}_0$ in (53), we get

$$\|\mathbf{T}(\mathbf{x}, \mathbf{y}) - \mathbf{T}(\mathbf{x}, \mathbf{y}_0)\| \leq \frac{1}{2} \|\mathbf{y} - \mathbf{y}_0\| \leq \frac{b}{2} \quad \text{for } \|\mathbf{x} - \mathbf{x}_0\| \leq a \text{ and } \|\mathbf{y} - \mathbf{y}_0\| \leq b.$$

When we combine this estimate with (52) for $\|\mathbf{x} - \mathbf{x}_0\| \leq a$ and $\|\mathbf{y} - \mathbf{y}_0\| \leq b$, then we get by the triangle inequality,

$$(54) \quad \|\mathbf{T}(\mathbf{x}, \mathbf{y}) - \mathbf{y}_0\| \leq \|\mathbf{T}(\mathbf{x}, \mathbf{y}) - \mathbf{T}(\mathbf{x}, \mathbf{y}_0)\| + \|\mathbf{T}(\mathbf{x}, \mathbf{y}_0) - \mathbf{y}_0\| \leq \frac{b}{2} + \frac{b}{2} = b.$$

It follows from (53) and (54) that $\mathbf{T}(\mathbf{x}, \mathbf{y})$ defines for every fixed $\mathbf{x} \in A := \{\mathbf{x} \in \mathbb{R}^k \mid \|\mathbf{x} - \mathbf{x}_0\| \leq a\}$ a map of $B := \{\mathbf{y} \in \mathbb{R}^p \mid \|\mathbf{y} - \mathbf{y}_0\| \leq b\}$ into itself, i.e.

$$\mathbf{T}(\mathbf{x}, \cdot) : B \rightarrow B \quad \text{for every fixed } \mathbf{x} \in A,$$

and $\mathbf{T}(\mathbf{x}, \cdot)$ is clearly a *contraction* of constant $\frac{1}{2}$. In particular, the sequence given successively by

$$\mathbf{y}_n = \mathbf{T}(\mathbf{x}, \mathbf{y}_{n-1}), \quad n \in \mathbb{N},$$

is a *Cauchy sequence* in \mathbb{R}^p , hence convergent with a limit point $\mathbf{y} \in \mathbb{R}^p$.



Brain power

By 2020, wind could provide one-tenth of our planet's electricity needs. Already today, SKF's innovative know-how is crucial to running a large proportion of the world's wind turbines.

Up to 25 % of the generating costs relate to maintenance. These can be reduced dramatically thanks to our systems for on-line condition monitoring and automatic lubrication. We help make it more economical to create cleaner, cheaper energy out of thin air.

By sharing our experience, expertise, and creativity, industries can boost performance beyond expectations. Therefore we need the best employees who can meet this challenge!

The Power of Knowledge Engineering

Plug into The Power of Knowledge Engineering.
Visit us at www.skf.com/knowledge

SKF



The set B is closed, and all $\mathbf{y}_n \in B$, hence also $\mathbf{y}_n \rightarrow \mathbf{y} \in B$. According to Theorem 2.1.8, *The Fixed Point Theorem*, there is precisely one point $\mathbf{y} \in B$, such that

$$\mathbf{T}(\mathbf{x}, \mathbf{y}) = \mathbf{y}, \quad \text{i.e.} \quad \mathbf{f}(\mathbf{x}, \mathbf{y}) = \mathbf{0} \quad \text{by (50).}$$

Hence, $\mathbf{y} = \mathbf{g}(\mathbf{x})$ is a function of $\mathbf{x} \in A$, i.e. $\mathbf{g} : A \rightarrow B$, and we have

$$\mathbf{f}(\mathbf{x}, \mathbf{g}(\mathbf{x})) = \mathbf{0} \quad \text{for } \mathbf{x} \in A.$$

It follows for every $\mathbf{x} \in A$ that $\mathbf{y}_n(\mathbf{x}) \rightarrow \mathbf{g}(\mathbf{x})$, i.e. more precisely by the iteration process,

$$\|\mathbf{y}_n(\mathbf{x}) - \mathbf{g}(\mathbf{x})\| \leq \left\{\frac{1}{2}\right\}^n \|\mathbf{y}_0 - \mathbf{g}(\mathbf{x})\| \leq \left\{\frac{1}{2}\right\}^n b,$$

so the convergence is uniform in A .

The expression of $\mathbf{T}(\mathbf{x}, \mathbf{y})$ implies that all the functions $\mathbf{y}_n(\mathbf{x})$ are continuous in A , and since the limit function of a uniformly convergent sequencer of continuous functions is also continuous, it follows that $\mathbf{g}(\mathbf{x})$ is also continuous. \square

It is worth noticing that if $\mathbf{f}(\mathbf{x}, \mathbf{y})$ has some nice differentiability properties, and the equation $\mathbf{f}(\mathbf{x}, \mathbf{y}) = \mathbf{0}$ implicitly defines a function $\mathbf{g}(\mathbf{x})$, such that $\mathbf{f}(\mathbf{x}, \mathbf{g}(\mathbf{x})) = \mathbf{0}$, then $\mathbf{g}(\mathbf{x})$ inherits these differentiability properties, and the (partial) derivatives of $\mathbf{g}(\mathbf{x})$ can be found by a process called *implicit differentiation*. We have more precisely

Theorem 2.1.10 Theorem of Implicit Differentiation. *Let $\Omega \subseteq \mathbb{R}^{k+p}$ be an open set, and let $\mathbf{f} : \Omega \rightarrow \mathbb{R}^p$ be a map, such that the coordinate functions $f_1, \dots, f_p : \Omega \rightarrow \mathbb{R}$ are all continuous functions of continuous partial derivatives of order $\leq n$ with respect to all the variables x_1, \dots, x_k and y_1, \dots, y_p . Let $(\mathbf{x}_0, \mathbf{y}_0) \in \Omega$ be a solution of the equation*

$$\mathbf{f}(\mathbf{x}, \mathbf{y}) = \mathbf{0},$$

and assume that the Jacobian $\mathbf{f}'_{\mathbf{y}}(\mathbf{x}, \mathbf{y})$ with respect to the variables y_1, \dots, y_p is regular at the point $(\mathbf{x}_0, \mathbf{y}_0)$, i.e. $\det \mathbf{f}'_{\mathbf{y}}(\mathbf{x}_0, \mathbf{y}_0) \neq \mathbf{0}$. Then the coordinate functions g_1, \dots, g_p of the function $\mathbf{y} = \mathbf{g}(\mathbf{x})$ have continuous partial derivatives of order $\leq n$ with respect to x_1, \dots, x_k . These partial derivatives of g_1, \dots, g_p with respect to x_1, \dots, x_k are found by implicit differentiation, i.e. one differentiates the p equations

$$f_1(\mathbf{x}, \mathbf{g}(\mathbf{x})) = 0, \dots, f_p(\mathbf{x}, \mathbf{g}(\mathbf{x})) = 0$$

with respect to the k variables x_1, \dots, x_k , and then solves the system of equations with respect to each $\frac{\partial g_j}{\partial x_k}$, and similarly for higher order derivatives.

PROOF. We have already proved in Theorem 2.1.9 that $\mathbf{g}(\mathbf{x})$ exists and is continuous in a set

$$(55) \quad A = \{\mathbf{x} \in \mathbb{R}^k \mid \|\mathbf{x} - \mathbf{x}_0\| \leq a\} \quad \text{for some } a > 0.$$

It suffices to prove the theorem for $n = 1$, because then it will follow by induction for higher order derivatives.

We assume that the coordinate functions f_1, \dots, f_p all have continuous partial derivatives of first order with respect to all the variables x_1, \dots, x_k and y_1, \dots, y_p .

Let the set A in (55) be specified by the proof of Theorem 2.1.9, and consider two neighbouring points in A ,

$$\mathbf{x} = (x_1, \dots, x_k) \quad \text{and} \quad \mathbf{x} + \Delta\mathbf{x} = (x_1 + \Delta x_1, \dots, x_k + \Delta x_k) \in A.$$

Then both points $(\mathbf{x}, \mathbf{g}(\mathbf{x}))$ and $(\mathbf{x} + \Delta\mathbf{x}, \mathbf{g}(\mathbf{x} + \Delta\mathbf{x}))$ belong to the solution set F .

We introduce the shorthand

$$\Delta\mathbf{g} := \mathbf{g}(\mathbf{x} + \Delta\mathbf{x}) - \mathbf{g}(\mathbf{x}) = (\Delta g_1, \dots, \Delta g_p).$$

For every $j = 1, \dots, p$,

$$f_j(\mathbf{x}, \mathbf{g}(\mathbf{x})) = 0 \quad \text{and} \quad f_j(\mathbf{x} + \Delta\mathbf{x}, \mathbf{g}(\mathbf{x} + \Delta\mathbf{x})) = 0,$$

hence by *Taylor's formula*,

$$\begin{aligned} 0 &= f_j(\mathbf{x} + \Delta\mathbf{x}, \mathbf{g}(\mathbf{x} + \Delta\mathbf{x})) - f_j(\mathbf{x}, \mathbf{g}(\mathbf{x})) \\ &= \frac{\partial f_j}{\partial x_1} \Delta x_1 + \dots + \frac{\partial f_j}{\partial x_k} \Delta x_k + \frac{\partial f_j}{\partial y_1} \Delta g_1 + \dots + \frac{\partial f_j}{\partial y_p} \Delta g_p, \end{aligned}$$

where the partial derivatives are taken at a point $(\mathbf{x} + \theta_j \Delta\mathbf{x}, \mathbf{g}(\mathbf{x}) + \theta_j \Delta\mathbf{g})$ for some $0 \leq \theta_j \leq 1$, [not necessarily the same θ_j for all $j = 1, \dots, n$.] Thus we obtain the following system of equations

$$(56) \quad \begin{pmatrix} \frac{\partial f_1}{\partial x_1} & \dots & \frac{\partial f_1}{\partial x_k} \\ \vdots & & \vdots \\ \frac{\partial f_p}{\partial x_1} & \dots & \frac{\partial f_p}{\partial x_k} \end{pmatrix} \begin{pmatrix} \Delta x_1 \\ \vdots \\ \Delta x_k \end{pmatrix} + \begin{pmatrix} \frac{\partial f_1}{\partial y_1} & \dots & \frac{\partial f_1}{\partial y_p} \\ \vdots & & \vdots \\ \frac{\partial f_p}{\partial y_1} & \dots & \frac{\partial f_p}{\partial y_p} \end{pmatrix} \begin{pmatrix} \Delta g_1 \\ \vdots \\ \Delta g_p \end{pmatrix} = \begin{pmatrix} 0 \\ \vdots \\ 0 \end{pmatrix},$$

where each $\frac{\partial f_j}{\partial x_\ell}$ or $\frac{\partial f_j}{\partial y_m}$ from the j^{th} row is expanded at the point $(\mathbf{x} + \theta_j \Delta\mathbf{x}, \mathbf{g}(\mathbf{x}) + \theta_j \Delta\mathbf{g})$ for some $\theta \in [0, 1]$.

It follows from the assumptions of the theorem that when $\Delta\mathbf{x} \rightarrow \mathbf{0}$, then all the coefficients converge towards the corresponding partial derivative at $(\mathbf{x}, \mathbf{g}(\mathbf{x}))$. In particular, the coefficient matrix of the $\Delta\mathbf{g}$ column converges towards the regular Jacobian $\mathbf{f}'_{\mathbf{y}}, \mathbf{g}(\mathbf{x})$, so by the continuity, this coefficient matrix of the $\Delta\mathbf{g}$ column is also regular, when $\|\Delta\mathbf{x}\|$ is sufficiently small. In this case we find the $\Delta\mathbf{g}$ column by solving (56),

$$(57) \quad \begin{pmatrix} \Delta g_1 \\ \vdots \\ \Delta g_p \end{pmatrix} = - \begin{pmatrix} \frac{\partial f_1}{\partial y_1} & \dots & \frac{\partial f_1}{\partial y_p} \\ \vdots & & \vdots \\ \frac{\partial f_p}{\partial y_1} & \dots & \frac{\partial f_p}{\partial y_p} \end{pmatrix}^{-1} \begin{pmatrix} \frac{\partial f_1}{\partial x_1} & \dots & \frac{\partial f_1}{\partial x_k} \\ \vdots & & \vdots \\ \frac{\partial f_p}{\partial x_1} & \dots & \frac{\partial f_p}{\partial x_k} \end{pmatrix} \begin{pmatrix} \Delta x_1 \\ \vdots \\ \Delta x_k \end{pmatrix}.$$

Choosing $\Delta x_m = 0$ for $m \neq j$, and $\Delta x_j \neq 0$ in (57) we get by multiplying the latter two matrices,

$$\begin{pmatrix} \frac{\Delta g_1}{\Delta x_j} \\ \vdots \\ \frac{\Delta g_p}{\Delta x_j} \end{pmatrix} = - \begin{pmatrix} \frac{\partial f_1}{\partial y_1} & \dots & \frac{\partial f_1}{\partial y_p} \\ \vdots & & \vdots \\ \frac{\partial f_p}{\partial y_1} & \dots & \frac{\partial f_p}{\partial y_p} \end{pmatrix}^{-1} \begin{pmatrix} \frac{\partial f_1}{\partial x_j} \\ \vdots \\ \frac{\partial f_p}{\partial x_j} \end{pmatrix} \quad \text{for every } j = 1, \dots, k.$$

By taking the limit $\Delta x_j \rightarrow 0$ it follows that g_1, \dots, g_p at \mathbf{x} have partial derivatives with respect to x_j , and that the coefficient matrix of $\frac{\partial \mathbf{f}}{\partial x_j}$ by this limit process is $-\{\mathbf{f}'_{\mathbf{y}}(\mathbf{x}, \mathbf{g}(\mathbf{x}))\}^{-1}$ of continuous elements. Hence

$$(58) \quad \frac{\partial \mathbf{g}}{\partial x_j} = -\{\mathbf{f}'_{\mathbf{y}}(\mathbf{x}, \mathbf{g}(\mathbf{x}))\}^{-1} \frac{\partial \mathbf{f}}{\partial x_j},$$

where we consider $\frac{\partial \mathbf{g}}{\partial x_j}$ and $\frac{\partial \mathbf{f}}{\partial x_j}$ as columns. Equation (58) is of course equivalent to

$$(59) \quad \frac{\partial \mathbf{f}}{\partial x_j} + \mathbf{f}'_{\mathbf{y}}(\mathbf{x}, \mathbf{g}(\mathbf{x})) \frac{\partial \mathbf{g}}{\partial x_j} = \mathbf{0},$$

i.e. written in all details as a matrix equation,

$$\begin{pmatrix} \frac{\partial f_1}{\partial x_j} \\ \vdots \\ \frac{\partial f_p}{\partial x_j} \end{pmatrix} + \begin{pmatrix} \frac{\partial f_1}{\partial y_1} & \dots & \frac{\partial f_1}{\partial y_p} \\ \vdots & & \vdots \\ \frac{\partial f_p}{\partial y_1} & \dots & \frac{\partial f_p}{\partial y_p} \end{pmatrix} \begin{pmatrix} \frac{\partial g_1}{\partial x_j} \\ \vdots \\ \frac{\partial g_p}{\partial x_j} \end{pmatrix} = \begin{pmatrix} 0 \\ \vdots \\ 0 \end{pmatrix},$$

or explicitly

$$(60) \quad \begin{cases} \frac{\partial f_1}{\partial x_j} + \frac{\partial f_1}{\partial y_1} \frac{\partial g_1}{\partial x_j} + \dots + \frac{\partial f_1}{\partial y_p} \frac{\partial g_p}{\partial x_j} = 0, \\ \dots \\ \frac{\partial f_p}{\partial x_j} + \frac{\partial f_p}{\partial y_1} \frac{\partial g_1}{\partial x_j} + \dots + \frac{\partial f_p}{\partial y_p} \frac{\partial g_p}{\partial x_j} = 0, \end{cases}$$

where all the derivatives of f_j are taken at the point $(\mathbf{x}, \mathbf{g}(\mathbf{x}))$. We see that the system of equations (60) is obtained by implicit differentiation of each of the equations

$$f_1(\mathbf{x}, \mathbf{g}(\mathbf{x})) = 0, \quad \dots, \quad f_p(\mathbf{x}, \mathbf{g}(\mathbf{x})) = 0,$$

with respect to x_j .

Hence, the claim is proved for $n = 1$. If $n = 2$, we apply the same method on (59), and then in general by induction. \square

The most important case is when $k = p = 1$.

Corollary 2.1.2 *Let $\Omega \subseteq \mathbb{R}^2$ be an open and nonempty set, and let $f : \Omega \rightarrow \mathbb{R}$ be a continuous function with a continuous partial derivative with respect to y . Let the point $(x_0, y_0) \in \Omega$ satisfy the conditions*

$$f(x_0, y_0) = 0 \quad \text{and} \quad f'_y(x_0, y_0) \neq 0.$$

There exist a constant $a > 0$ and a continuous map $g : [x_0 - a, x_0 + a] \rightarrow \mathbb{R}$, such that the solution of the equation $f(x, y) = 0$ for $|x - x_0| \leq a$ is uniquely determined by $y = g(x)$.

If f has continuous partial derivatives $\leq n$ with respect to both x and y (including the mixed derivatives), then $g(x)$ is n times continuously differentiable.

An important application of the *Theorem of Implicit Given Functions* is

TURN TO THE EXPERTS FOR SUBSCRIPTION CONSULTANCY

Subscribe is one of the leading companies in Europe when it comes to innovation and business development within subscription businesses.

We innovate new subscription business models or improve existing ones. We do business reviews of existing subscription businesses and we develop acquisition and retention strategies.

Learn more at [linkedin.com/company/subscribe](https://www.linkedin.com/company/subscribe) or contact Managing Director Morten Suhr Hansen at mha@subscribe.dk

SUBSCRIBE - to the future



Theorem 2.1.11 Theorem of Inverse Map. *Let Ω be an open and nonempty subset of \mathbb{R}^p , and let $\mathbf{f} : \Omega \rightarrow \mathbb{R}^p$ be a map of class $C^1(\Omega)$, i.e. all its coordinate functions have continuous derivatives of first order with respect to all the variables. Let $\mathbf{y}_0 \in \Omega$ be a point, for which the matrix $\mathbf{f}'_{\mathbf{y}}(\mathbf{y}_0)$ is regular, and put $\mathbf{x}_0 = \mathbf{f}(\mathbf{y}_0)$.*

There exist constants $a, b > 0$, corresponding to the sets

$$A = \{\mathbf{x} \in \mathbb{R}^p \mid \|\mathbf{x} - \mathbf{x}_0\| \leq a\} \subseteq \mathbb{R}^p, \quad B = \{\mathbf{y} \in \Omega \mid \|\mathbf{y} - \mathbf{y}_0\| \leq b\} \subset \Omega,$$

and a map $\mathbf{g} : A \rightarrow B$ of class $C^1(A)$, such that

$$\{(\mathbf{f}(\mathbf{y}), \mathbf{y}) \in A \times B\} = \{(\mathbf{x}, \mathbf{g}(\mathbf{x})) \mid \mathbf{x} \in A\}.$$

PROOF. Let $\mathbf{f} : \Omega \rightarrow \mathbb{R}^p$ be as in the assumptions. Choose $k = p$ and put $\Omega_1 = \mathbb{R}^p \times \Omega$. Then define a map $\mathbf{F} : \Omega_1 \rightarrow \mathbb{R}^p$ by

$$\mathbf{F}(\mathbf{x}, \mathbf{y}) := \mathbf{f}(\mathbf{y}) - \mathbf{x}, \quad \text{for } \mathbf{x} \in \mathbb{R}^p \text{ and } \mathbf{y} \in \Omega.$$

The corresponding coordinate functions F_1, \dots, F_p are all of class $C^1(\Omega_1)$, and the solution set of the equation

$$(61) \quad \mathbf{F}(\mathbf{x}, \mathbf{y}) = \mathbf{f}(\mathbf{y}) - \mathbf{x} = \mathbf{0} \quad \text{in } \Omega_1,$$

is clearly the set

$$\{(\mathbf{f}(\mathbf{y}), \mathbf{y}) \mid \mathbf{y} \in \Omega\}.$$

On the other hand, we can also solve (61) by Theorem 2.1.9, whenever $(\mathbf{x}_0, \mathbf{y}_0) \in \Omega_1$ is a point, for which

$$\mathbf{f}(\mathbf{y}_0) = \mathbf{x}_0 \quad \text{and} \quad \det \mathbf{f}'_{\mathbf{y}}(\mathbf{y}_0) \neq 0,$$

from which we obtain the description $\mathbf{y} = \mathbf{g}(\mathbf{x})$ in a neighbourhood of \mathbf{x}_0 , and the theorem follows. \square

Theorem 2.1.11 on inverse mappings tells us that under the given assumptions, for every $\mathbf{x} \in A$ there is precisely one $\mathbf{y} \in B$, in fact $\mathbf{y} = \mathbf{g}(\mathbf{x})$, for which $\mathbf{x} = \mathbf{f}(\mathbf{y})$.

The partial derivatives of g_1, \dots, g_p are found from the matrix equation

$$\mathbf{g}'_{\mathbf{x}}(\mathbf{x}) = \{\mathbf{f}'_{\mathbf{y}}(\mathbf{g}(\mathbf{x}))\}^{-1}.$$

In particular, $\mathbf{g}'_{\mathbf{x}}(\mathbf{x})$ is regular for all $\mathbf{x} \in A$.

If the functions f_1, \dots, f_p all belong to $C^n(\Omega)$, then the functions g_1, \dots, g_p will all belong to $C^n(A)$.

2.2 Complex functions

A *complex function* $f : \Omega \rightarrow \mathbb{C}$ is a function $w = f(z)$, defined on a domain $\Omega \subseteq \mathbb{C}$, which is a subset of \mathbb{C} .

Conventionally we write $z = x + iy \in \Omega$ in the domain, and $w = u + iv \in \mathbb{C}$ for the values in the range. The letters have been chosen from German: “**Z**ahl = number” and “**W**ert = value”. We always let tacitly $x + iy$ and $u + iv$ denote their splitting into real and imaginary parts.

If we turn to the *geometrical* interpretation of the complex plane, then it follows that a complex function

$$w = f(z), \quad z \in \Omega \subseteq \mathbb{C}, \quad w \in \mathbb{C},$$

is *equivalently* described by a pair of real functions $u(x, y)$ and $v(x, y)$ in two real variables $(x, y) \in \Omega_1 \subseteq \mathbb{R}^2$, where $\mathbb{R}^2 \supseteq \Omega_1 \sim \Omega \subseteq \mathbb{C}$ by the usual correspondence. Hence,

$$w = f(z) = u + iv = u(x, y) + iv(x, y).$$

This pair of real functions $(u(x, y), v(x, y))$ in two real variables will be very important in the following, as well as its shorter description as a complex function $w = f(z)$.

Using the definitions of Section 2.1 we repeat the following simple result.

Theorem 2.2.1 *A complex function $f : \Omega \rightarrow \mathbb{C}$ is continuous [at a point $z_0 = x_0 + iy_0 \in \Omega$], if and only if the two corresponding real functions $u(x, y)$ and $v(x, y)$ in two real variables are both continuous [at the point $(x_0, y_0) \in \Omega_1$].*

This means that a continuous complex function inherits all the usual simple theorems of continuous real functions of two real variables. Here, we only mention the following obvious

Theorem 2.2.2 *Finite sums, differences, products and quotients (when the denominator is $\neq 0$) of continuous complex functions are all continuous complex functions. If the composition of two continuous complex functions is defined, then it is again continuous.*

The proof of the latter claim follows directly from Theorem 2.1.1.

Example 2.2.1 In order to become familiar with this new concept of a complex function we shall here investigate the simple complex function $w = f(z) = z^2$ defined on the closed disc $\Omega = \{z \in \mathbb{C} \mid |z - 1| \leq 1\}$ of centrum $1 \sim (1, 0) \in \mathbb{R}^2$ and radius 1.

It follows from the computation

$$w = u + iv = z^2 = (x + iy)^2 = x^2 - y^2 + i \cdot 2xy$$

by taking the real and imaginary parts that

$$u(x, y) = x^2 + y^2 \quad \text{and} \quad v(x, y) = 2xy.$$

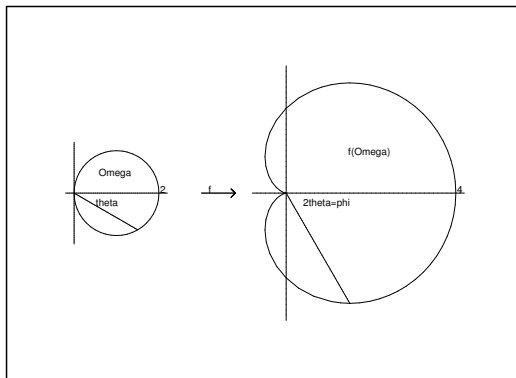

Figure 16: The image $f(\Omega)$ of the closed disc $\Omega = \{z \in \mathbb{C} \mid |z - 1| \leq 1\}$ by the map $w = f(z) = z^2$.

Both functions $u(x, y)$ and $v(x, y)$ are continuous in \mathbb{R}^2 , and

$$\Omega_1 = \{(x, y) \in \mathbb{R}^2 \mid (x - 1)^2 + y^2 \leq 1\} \sim \Omega = \{z \in \mathbb{C} \mid |z - 1| \leq 1\}$$

is compact. From Theorem 2.1.3 follows that $f(\Omega)$ is also compact.

Furthermore, Ω_1 is connected, hence by Theorem 2.1.5 the image $f(\Omega)$ is also connected.

In order to get an idea of where $f(\Omega)$ is lying in \mathbb{C} we find the image of the boundary curve of $\Omega_1 \sim \Omega$, described here most conveniently in *polar coordinates*. The boundary curve of Ω_1 is described by

$$r = r(\theta) = 2 \cdot \cos \theta, \quad -\frac{\pi}{2} \leq \theta \leq \frac{\pi}{2},$$

in polar coordinates, cf. also Figure 16. Hence, the image is given by

$$w = z^2 = \{r(\theta) \cdot e^{i\theta}\}^2 = 4 \cos^2 \theta \cdot e^{i2\theta} = 2(1 + \cos 2\theta) \cdot e^{i2\theta}.$$

Then change parameter to $\varphi = 2\theta \in [-\pi, \pi]$ to get the boundary curve of the image in polar coordinates (R, φ) in the w -plane,

$$R = R(\varphi) = 2 \cdot (1 + \cos \varphi), \quad \varphi \in [-\pi, \pi],$$

which is the equation of a *cardioid*, thus in particular a closed curve.

Since $f(\Omega)$ is compact, in particular bounded, this image is lying inside the cardioid.

Note that if the circle is traversed in the positive direction of the plane, then the same is true for the cardioid, and the interiors, Ω° and $f(\Omega)^\circ$, are lying to the left in the sense of orientation of the curve. This is a general principle for those complex maps we are going to study in these three books. \diamond

2.3 Complex limits and complex sequences

Formally the introduction of limits and complex sequences is the same as is the real case. Nevertheless, the reader should be very careful here, because there is a hidden difference in the geometry, which has a very strong impact on the rest of the theory. The difference lies in the fact that a limit in \mathbb{C} is far more restrictive than a limit in \mathbb{R} .

If $x \rightarrow x_0$ in \mathbb{R} , we shall only consider two directions of the limit. Either $x \rightarrow x_0^-$ from below, or $x \rightarrow x_0^+$ from above. However, in \mathbb{C} the limit $z \rightarrow z_0$ does not specify any direction of preference, only that the limit must be the same, no matter how $|z - z_0| \rightarrow 0$. This fundamental difference in the geometry causes a very strong difference in the concepts of *real differentiability* and *complex differentiability*. Therefore, the reader who is not familiar with complex functions should be very cautious in understanding the definitions below and their difference from the real case. They are *not* obvious at all!

Complex limits

Let $z_0 \in \Omega$ be a point of a set $\Omega \subseteq \mathbb{C}$. We start by recalling that z_0 is *not an isolated point* in Ω , if for every $r > 0$ there is a point $z \in \Omega \setminus \{z_0\}$ lying in an r -neighbourhood of z_0 , i.e. such that

$$0 < |z - z_0| < r, \quad z \in \Omega.$$

What do you want to do?

No matter what you want out of your future career, an employer with a broad range of operations in a load of countries will always be the ticket. Working within the Volvo Group means more than 100,000 friends and colleagues in more than 185 countries all over the world. We offer graduates great career opportunities – check out the Career section at our web site www.volvogroup.com. We look forward to getting to know you!

VOLVO
 AB Volvo (publ)
www.volvogroup.com

VOLVO TRUCKS | RENAULT TRUCKS | MACK TRUCKS | VOLVO BUSES | VOLVO CONSTRUCTION EQUIPMENT | VOLVO PENTA | VOLVO AERO | VOLVO IT
 VOLVO FINANCIAL SERVICES | VOLVO 3P | VOLVO POWERTRAIN | VOLVO PARTS | VOLVO TECHNOLOGY | VOLVO LOGISTICS | BUSINESS AREA ASIA



Definition 2.3.1 Assume that $z_0 \in \Omega$ is not an isolated point of Ω , and let $f : \Omega \setminus \{z_0\} \rightarrow \mathbb{C}$ be a complex function.

The function $f(z)$ has the complex limit $c \in \mathbb{C}$ for $z \rightarrow z_0$ in Ω , if one to every $\varepsilon > 0$ can find a $\delta > 0$, such that

$$|f(z) - c| < \varepsilon \quad \text{for all } z \in \Omega \text{ for which } 0 < |z - z_0| < \delta = \delta(\varepsilon).$$

When this is the case we write

$$\lim_{\substack{z \in \Omega \\ z \rightarrow z_0}} f(z) = \lim_{z \rightarrow z_0} f(z) = c, \quad \text{or} \quad f(z) \rightarrow c \text{ for } z \rightarrow z_0 \text{ in } \Omega,$$

where the notation $\lim_{z \rightarrow z_0} f(z)$ tacitly assumes that the limit takes place in the set Ω .

It follows from Definition 2.3.1 that if f is defined and *continuous* at z_0 , then

$$\lim_{z \rightarrow z_0} f(z) = c = f(z_0).$$

In many cases we also need to define the limit when $f(z)$ tends to infinity. To make this precise we introduce

Definition 2.3.2 Assume that $z_0 \in \Omega$ is not an isolated point of Ω , and let $f : \Omega \setminus \{z_0\} \rightarrow \mathbb{C}$ be a complex function. If to every $K > 0$ we can find a $\delta > 0$, such that

$$|f(z)| > K \quad \text{for all } z \in \Omega \text{ for which } 0 < |z - z_0| < \delta = \delta(K),$$

then we say that $f(z)$ tends towards (complex) infinity, ∞ , for $z \rightarrow z_0$ in Ω , and we either write

$$\lim_{\substack{z \in \Omega \\ z \rightarrow z_0}} f(z) = \lim_{z \rightarrow z_0} f(z) = \infty \quad \text{or} \quad f(z) \rightarrow \infty \text{ for } z \rightarrow z_0 \text{ in } \Omega.$$

Note that this is the first time that we see the *complex infinity* ∞ , which we write without any sign in front of it. We shall discuss this more thoroughly in Section 2.4, because there is a difference between real and complex infinities which may not be confused.

Using Definition 2.3.2 above it is now possible also to define what we mean by a limit of the function $f(z)$, when $z \rightarrow \infty$ in Ω .

Definition 2.3.3 Let $f : \Omega \rightarrow \mathbb{C}$ be a complex function defined on an unbounded region Ω .

Let $c \in \mathbb{C}$ be a constant. If to every given $\varepsilon > 0$ there exists a $K = K(\varepsilon) > 0$, such that

$$|f(z) - c| < \varepsilon \quad \text{for all } z \in \Omega, \text{ for which } |z| > K,$$

we say that $f(z)$ has the limit $c \in \mathbb{C}$ for $z \rightarrow \infty$, and we write

$$\lim_{\substack{z \in \Omega \\ z \rightarrow \infty}} f(z) = \lim_{z \rightarrow \infty} f(z) = c \quad \text{or} \quad f(z) \rightarrow c \text{ for } z \rightarrow \infty \text{ in } \Omega.$$

We say that $f(z)$ tends to ∞ for $z \rightarrow \infty$, if there to every $C > 0$ exists a constant $K = K(C) > 0$, such that

$$|f(z)| > C \quad \text{for all } z \in \Omega \text{ for which } |z| > K.$$

In this case we write

$$\lim_{\substack{z \in \Omega \\ z \rightarrow \infty}} f(z) = \lim_{z \rightarrow \infty} f(z) = \infty \quad \text{or} \quad f(z) \rightarrow \infty \text{ for } z \rightarrow \infty \text{ in } \Omega.$$

Example 2.3.1 The two possibilities of Definition 2.3.3 are far from exhausting. We mention that the limit of $f(z) = \exp(z) = e^z$, where the complex exponential was defined in Definition 1.2.1, does *not* exist for $z \rightarrow \infty$. In fact, in the real we have

$$\lim_{x \rightarrow +\infty} e^x = +\infty \quad \text{and} \quad \lim_{x \rightarrow -\infty} e^x = 0,$$

while on the imaginary axis e^{iy} oscillates for both $y \rightarrow +\infty$ and for $y \rightarrow -\infty$ without having any limit. \diamond

Complex sequences

Here we introduce the complex sequences (z_n) , i.e. $z_n \in \mathbb{C}$ for $n \in \mathbb{N}$.

Formally, a complex sequence is defined as a function $f : \mathbb{N} \rightarrow \mathbb{C}$ by $f(n) = z_n$. This definition has the advantage that the limit

$$\lim_{n \rightarrow +\infty} z_n = \lim_{n \rightarrow +\infty} f(n), \quad \Omega = \mathbb{N},$$

is already defined in Definition 2.3.3. It is therefore nothing new in the following definition. It has only been restated because many readers will feel a little uneasy by this “abstract” reference to Definition 2.3.3 applied on the function $f : \mathbb{N} \rightarrow \mathbb{C}$, given by $f(n) = z_n$.

Definition 2.3.4 Given a sequence (z_n) of complex numbers. Given a constant $c \in \mathbb{C}$. If to every $\varepsilon > 0$ there exists an $N = N(\varepsilon) \in \mathbb{N}$, such that

$$|z_n - c| < \varepsilon \quad \text{for every } n \geq N = N(\varepsilon),$$

i.e. the difference between z_n and c becomes numerically as small as we wish eventually, then we say that the complex sequence (z_n) converges towards the limit $c \in \mathbb{C}$, and we write

$$\lim_{n \rightarrow +\infty} z_n = \lim z_n = c \quad \text{or} \quad z_n \rightarrow c \text{ for } n \rightarrow +\infty.$$

If instead, to every $C > 0$ there exists an $N = N(C) \in \mathbb{N}$, such that

$$|z_n| > C \quad \text{for every } n \geq N = N(C),$$

i.e. if z_n numerically can be as large as we want eventually, then we say that the complex sequence (z_n) tends to (complex) infinity for $n \rightarrow +\infty$, and we write

$$\lim_{n \rightarrow +\infty} z_n = \lim z_n = \infty \quad \text{or} \quad z_n \rightarrow \infty \text{ for } n \rightarrow +\infty.$$

Clearly, a complex sequence (z_n) , where $z_n = x_n + iy_n$ (split into its real and imaginary parts), is convergent with the limit $c = a + ib$ (also split into its real and imaginary parts), if and only if the two real sequences (x_n) and (y_n) are both convergent with their limits $\lim x_n = a$ and $\lim y_n = b$, respectively. This observation implies that all the usual theorems on convergent sequences in \mathbb{R} also hold for convergent complex sequences in \mathbb{C} . We mention

Theorem 2.3.1 Given two convergent complex sequences (z_n) and (w_n) of limits z_0 and w_0 , respectively. Then

$$\lim_{n \rightarrow +\infty} (z_n \pm w_n) = z_0 \pm w_0 \quad \text{and} \quad \lim_{n \rightarrow +\infty} z_n w_n = z_0 w_0.$$

If furthermore, $w_0 \neq 0$, and $w_n \neq 0$ for all $n \in \mathbb{N}$ (or just eventually), then also

$$\lim_{n \rightarrow +\infty} \frac{z_n}{w_n} = \frac{z_0}{w_0}.$$

Remark 2.3.1 We shall later see that we may relax the latter assumptions. In some cases, when both z_0 and w_0 are 0, it may be possible to define the limit of the quotient sequence, even if we formally have “0/0”. For the time being we shall stick to Theorem 2.3.1 above. \diamond

2.4 The complex infinity versus the real infinities

In *Complex Functions Theory* there are two types of infinity, namely *oriented infinity* and *non-oriented infinity*. In the first case we are given an *orientation* or *direction*, by which we mean a complex number of unit length $e^{i\varphi}$, $\varphi \in [0, 2\pi[$, and we consider the corresponding half line $\{z = e^{i\varphi}t \mid t \in \mathbb{R}_+\}$ starting at 0. When we let $t \rightarrow +\infty$ along this half line, we say that $z = e^{i\varphi}t \rightarrow e^{i\varphi}\infty$, i.e. z tends towards infinity in the *direction* $e^{i\varphi}$.

The most common cases are when $e^{i\varphi} = +1$, in which case $z \rightarrow +\infty$ along the positive real axis, i.e. $z \in \mathbb{R}_+$ through this limit process, and when $e^{i\varphi} = -1$, in which case $z \rightarrow -\infty$ along the negative real axis, i.e. $z \in \mathbb{R}_-$ through this limit process. These are well-known from *Real Calculus*. However, we now have obvious generalizations to e.g. $z \rightarrow i\infty$, in which case z tends towards infinity along the positive imaginary axis, and also $z \rightarrow -i\infty$, when z tends towards infinity along the negative imaginary axis.

This definition may again be extended by translation. If $a \in \mathbb{R}$ is a given constant, then it is obvious that $z \rightarrow a + i\infty$ means that z tends to infinity along the half line $\{z = a + it \mid t \in \mathbb{R}_+\}$, and similarly for $z \rightarrow a - i\infty$. These two limits are e.g. used in connection with a formula of the *inverse Laplace transform*.

It should also be mentioned that the limit $z \rightarrow e^{i\varphi}\infty$ occurs in connection with other formulæ of some inverse transforms to be defined in *Ventus: Complex Functions Theory a-3*.

The structure of these *oriented infinities* is now obvious: Select a half line and then let the restriction of the given function to this half line tend towards infinity.

However, we also introduced a *complex infinity* (or more precisely, a *non-oriented infinity*) in Definition 2.3.2, Definition 2.3.3 and Definition 2.3.4. This infinity was just denoted ∞ without indicating any sign or direction in front of this symbol. If $z \rightarrow \infty$, this means that the *absolute value* $|z| \rightarrow +\infty$ without any specification of the direction of z , i.e. the argument of z is not at all specified by this limit.

We see in particular that if $z_n \rightarrow +\infty$, where all $z_n \in \mathbb{R}_+$, and $w_n \rightarrow -\infty$ where all $w_n \in \mathbb{R}_-$, then also $z_n \rightarrow \infty$ and $w_n \rightarrow \text{infity}$ in \mathbb{C} . Clearly, this example shows that one cannot conclude from $z_n \rightarrow \infty$ that either $z_n \rightarrow +\infty$ or $z_n \rightarrow -\infty$. If e.g. $z_n = (-1)^n n$, then clearly all $z_n \in \mathbb{R}$, and also

$z_n \rightarrow \infty$ in \mathbb{C} (non-oriented infinity) for $n \rightarrow +\infty$, but the limit of z_n does not exist in \mathbb{R} , because $z_{2n} = +2n \rightarrow +\infty$ and $z_{2n+1} = -(2n+1) \rightarrow -\infty$ for $n \rightarrow +\infty$, and we do not identify $+\infty$ and $-\infty$ as *oriented infinities*. Only when we do not consider the orientation we identify these two infinities, but leaving out the orientation means also that the signs \pm no longer make sense, so we cannot use other symbols in this non-oriented case than ∞ .

In order not to confuse ourselves we shall in the following consequently always write $\lim_{n \rightarrow +\infty}$ for a limit taken over the positive real line instead of the usual one $\lim_{n \rightarrow \infty}$, which is commonly used in *Real Calculus*.

 **gaiTeye**[®]
Challenge the way we run

**EXPERIENCE THE POWER OF
FULL ENGAGEMENT...**

.....

**RUN FASTER.
RUN LONGER..
RUN EASIER...**

**READ MORE & PRE-ORDER TODAY
WWW.GAITEYE.COM**

Remark 2.4.1 Another reason for writing ∞ for this unspecified infinity is that no ordering $<^*$ of \mathbb{C} will respect the elementary rules of calculus, a remark which we include here. It is well-known that the usual ordering $<$ of $\mathbb{R} \cup \{+\infty, -\infty\}$ respects the elementary rules of calculus, i.e. sums and products of positive real numbers (including $+\infty$) are again positive. Clearly, \mathbb{C} can be ordered, e.g. by the lexicographic ordering, but \mathbb{C} cannot be ordered by any (complete) ordering $<^*$, such that sums and products of “positive elements” again are “positive”. In fact, assume that this was the case. Because $i \neq 0$, then either $0 <^* i$ or $0 <^* -i$. Assume that $0 <^* i$. (The alternative $0 <^* -i$ would give similar computations, because $(-1)^2 = (-1)^4 = 1$; just modify the proof below.) By the assumption that sums and products of “positive numbers” are “positive” we get the following contradiction,

$$0 <^* i^2 + i^4 = -1 + 1 = 0, \quad \text{because } 0 = 0. \quad \diamond$$

2.5 Complex line integrals

The *complex line integrals* are defined similarly to the real line integrals with the important difference that we also in some obscure way involve complex multiplication. We shall, however, first start by describing the type of complex curves which we shall consider in these books on *Complex Functions Theory*.

Complex curves

All *complex curves* in the *Ventus: Complex Functions Theory* series will be of a restricted type given by the following parametric description:

$$C: \quad z = z(t) = x(t) + i \cdot y(t), \quad t \in [a, b],$$

where $[a, b]$ is a compact interval on the real axis. We shall later also consider the trivial modifications, when the interval is unbounded, but for the time being we just consider a compact parametric interval. Furthermore, the real functions $x(t)$ and $y(t)$ for $t \in [a, b]$ are always continuous and piecewise continuously differentiable.

Each curve C inherits an *orientation* or *sense of direction*, specified by the increase of the parameter $t \in [a, b]$, so the curve C starts at $z(a)$ and ends at $z(b)$. This orientation will always (mostly tacitly) be assumed in the following.

If a curve C of the type above does not contain double points, we call it a *simple curve*.

Although the curves considered here – in spite of the restrictions on them – are fairly general, we shall usually only consider simple curves for which each curve arc is either a straight line segment or a circular arc in the complex plane. In some cases we also consider curves which are not simple, but it will be extremely seldom – if ever – that we consider curves which are not composed by circular arcs and line segments.

Complex line integrals

Let $f(z)$ be a bounded piecewise continuous complex function defined on a curve C with a given orientation. We define the (complex) *line integral* of $f(z)$ along C by

$$(62) \quad \int_C f(z) dz := \lim_{n \rightarrow +\infty} \sum_{k=0}^{n-1} f(\zeta_k) \cdot \{z_{k+1} - z_k\}$$

where $z(a) = z_0, z_1, \dots, z_n = z(b)$ are points on C traversed in the given order, and which divide C into n curve segments of length ℓ_k , all tending towards zero, when n tends towards $+\infty$, and where ζ_k is any point on the curve segment between z_k and z_{k+1} .

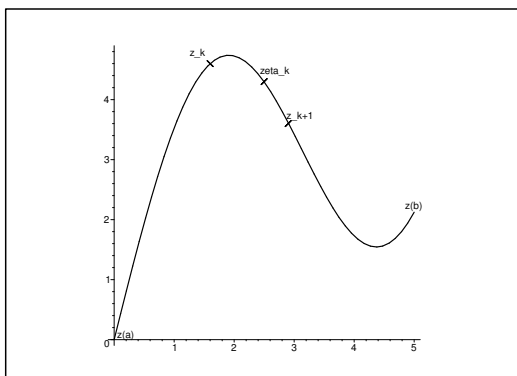

Figure 17: The complex line integral.

Under the given assumptions on C and f , the complex line integral $\int_C f(z) dz$ is well-defined. In fact, if we write

$$f(z) = u(x, y) + i v(x, y),$$

$$z_k = x_k + i y_k, \quad x_{k+1} - x_k = \Delta x_k, \quad y_{k+1} - y_k = \Delta y_k,$$

$$\zeta_k = \xi_k + i \eta_k, \quad u(\xi_k, \eta_k) = u_k, \quad v(\xi_k, \eta_k) = v_k,$$

then we get by splitting into real and imaginary parts,

$$(63) \quad \sum_{k=0}^{n-1} f(\zeta_k) \{z_{k+1} - z_k\} = \sum_{k=0}^{n-1} \{u_k \Delta x_k - v_k \Delta y_k\} + i \sum_{k=0}^{n-1} \{u_k \Delta y_k + v_k \Delta x_k\},$$

where the terms on the right hand side of (63) are approximations of some real line integrals. This shows that $\int_C f(z) dz$ exists.

It then follows from (62) and (63) that

$$(64) \quad \int_C f(z) dz = \int_{C^*} \{u dx - v dy\} + i \int_{C^*} \{u dy + v dx\},$$

where C and C^* are *geometrically* the same curve in the Euclidean plane, i.e. C is the complex curve in \mathbb{C} , while C^* represents the corresponding real curve in \mathbb{R}^2 . It will not cause any misunderstanding, if we in the following in both cases just write C .

An easy way to remember (64) is formally to use the computation

$$f(z) dz = (u + iv)(dx + i dy) = (u dx - v dy) + i(u dy + v dx),$$

and then continue with the familiar real line integrals along C on the right hand side of this equation.

It follows from (64) that all the usual rules of computations for real line integrals also hold for complex line integrals. We mention the *linearity*,

$$(65) \quad \int_C \{\lambda f(z) + \mu g(z)\} dz = \lambda \int_C f(z) dz + \mu \int_C g(z) dz, \quad \lambda, \mu \in \mathbb{C},$$

and the *rule of composition of curves*,

$$(66) \quad \int_C f(z) dz = \int_{C_1} f(z) dz + \int_{C_2} f(z) dz,$$

where $C = C_1 + C_2$, i.e. C_1 and C_2 are two curves, and where $C = C_1 + C_2$ denotes the curve, which is obtained by composition of the two curves C_1 and C_2 .

An obvious extension of the addition of curves is to let $-C$ denote the curve C of *reversed orientation*. Then clearly,

$$(67) \quad \int_{-C} f(z) dz = - \int_C f(z) dz.$$

We finally mention (without its simple proof) the following important result, which will be frequently used in the following.

Theorem 2.5.1 *Given a curve C . Let L denote its length, and let $M = \max_{z \in C} |f(z)|$. Then we have the estimate*

$$(68) \quad \left| \int_C f(z) dz \right| \leq M \cdot L.$$

Later on a typical application of Theorem 2.5.1 will be to choose a sequence of curves C_n of corresponding lengths L_n , and $M_n = \max_{z \in C_n} |f(z)|$. The trick is to select the C_n , such that

$$\left| \int_{C_n} f(z) dz \right| \leq M_n \cdot L_n \rightarrow 0 \quad \text{for } n \rightarrow +\infty,$$

where the C_n are also used to avoid e.g. a singularity of the integrand.

Practical computation of complex line integrals

Concerning the practical computation of a complex line integral we mention the following:

If $z(t) = x(t) + iy(t)$ is a C^1 curve, i.e. it is continuously differentiable everywhere in its parametric interval, then it follows from (64) that

$$\begin{aligned} \int_C f(z) dz &= \int_C (u dx - v dy) + i \int_C (u dy + v dx) \\ &= \int_a^b \left\{ u(x(t), y(t)) \frac{dx}{dt} - v(x(t), y(t)) \frac{dy}{dt} \right\} dt \\ &\quad + i \int_a^b \left\{ u(x(t), y(t)) \frac{dy}{dt} + v(x(t), y(t)) \frac{dx}{dt} \right\} dt \\ &= \int_a^b f(z(t)) z'(t) dt, \end{aligned}$$

This e-book
is made with
SetaPDF

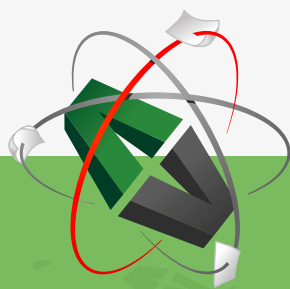

PDF components for **PHP** developers

www.setasign.com



i.e.

$$(69) \quad \int_C f(z) dz = \int_a^b f(z(t)) z'(t) dt,$$

where the left hand side of (69) denotes the *abstract complex line integral*, while the right hand side of (69) can be considered as a pair of *explicit real integrals known from calculus*, one for its real part, and the other one for its imaginary part.

Example 2.5.1 We shall later on show that there are many shot cuts to computing a complex line integral, so the following example shall only demonstrate the technique, when we are only allowed to use the definition.

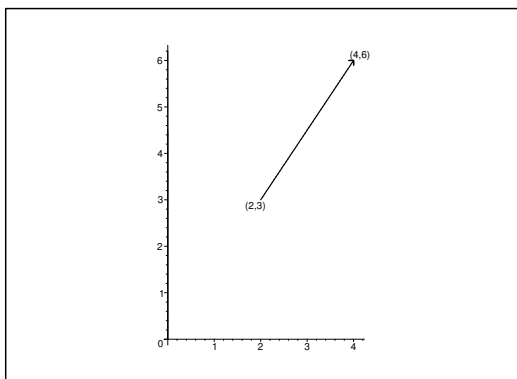

Figure 18: The integration curve of Example 2.5.1.

Let the curve C have the parametric description

$$x(t) = 2t \quad \text{and} \quad y(t) = 3t, \quad \text{for } t \in [1, 2],$$

thus

$$z(t) = 2t + 3it = (2 + 3i)t, \quad \text{for } t \in [1, 2].$$

Let $f(z) = z^2$. Then by (11.8),

$$\begin{aligned} \int_C z^2 dz &= \int_1^2 (2 + 3i)^2 t^2 (2 + 3i) dt = (2 + 3i)^3 \int_1^2 t^2 dt \\ &= (8 + 36i - 54 - 27i) \left[\frac{t^3}{3} \right]_1^2 = \frac{7}{3} (-46 + 9i). \end{aligned}$$

Another way of computation is the following, where we use (64) and well-known rules for real line

integrals,

$$\begin{aligned}
 \int_C z^2 dz &= \int_C (x^2 - y^2 + 2ixy) (dx + i dy) \\
 &= \int_C \{(x^2 - y^2) dx - 2xy dy\} + i \int_C \{2xy dx + (x^2 - y^2) dy\} \\
 &= \int_C \left\{ d\left(\frac{x^3}{3}\right) - d(xy^2) \right\} + i \int_C \left\{ d(x^2y) - d\left(\frac{y^3}{3}\right) \right\} \\
 &= \frac{1}{3} \int_C d(x^3 - 3xy^2) + \frac{i}{3} \int_C d(3x^2y - y^3) \\
 &= \frac{1}{3} [x^3 - 3xy^2]_{(x,y)=(2,3)}^{(4,6)} + \frac{i}{3} [3x^2y - y^3]_{(x,y)=(2,3)}^{(4,6)} \\
 &= \frac{1}{3} [x^3 + 3x^2 \cdot iy + 3x(iy)^2 + (iy)^3]_{(x,y)=(2,3)}^{(4,6)} = \left[\frac{z^3}{3} \right]_{z=2+3i}^{4+6i},
 \end{aligned}$$

which one would expect. This will indeed be proved later on, but at the same time we must warn the reader that one cannot always generalize “obvious” rules from the real to the complex case. We shall give an example by Theorem 2.5.2. \diamond

Remark 2.5.1 Let $\Omega \subseteq \mathbb{R}^2$ be an open domain, and let $u, v : \Omega \rightarrow \mathbb{R}$ be a pair of continuous real functions. They clearly define a continuous *vector field* $(u(x, y), v(x, y))$ on Ω which often can be given physical interpretations, like e.g. the *velocity field* of a *flow*, or a *field of forces*. Let a curve C be given by the parametric description $z = z(t)$, where we usually in applications consider the parameter t as the *time*. Then the real line integral

$$(70) \quad W = \int_C (u, v) \cdot (dx, dy) = \int_C u dx + v dy$$

is a measure of the work of a unit particle by the field of forces along the curve C .

When C is a closed curve, (70) is called the *circulation* of the vector field (u, v) along C . Let (u, v) in such a case describe a flow. If

$$\int_C u dx + v dy \neq 0,$$

then this means that the flow contains whirls inside C .

We note that if we are given the vector field (u, v) is also makes sense to consider the real line integral

$$(71) \quad \int_C \{-v(x, y) dx + u(x, y) dy\}.$$

Assume that C is a closed C^1 curve circling around a bounded domain Ω lying to the left of C , i.e. C is given a *positive orientation*, then (71) describes the circulation of the vector field $(-v, u)$ along the boundary $\partial\Omega = C$. Since $(-v, u)$ is obtained by a rotation of $+\frac{\pi}{2}$ of the original vector field (u, v) , it follows that (71) expresses the flow of the velocity field (u, v) through this boundary.

The reader may find more details on these real line integrals in \mathbb{R}^2 in the *Ventus: Calculus 2* series. Here we shall use them as a bridge to *Complex Functions Theory* via complex line integrals. \diamond

Remark 2.5.2 A very often used technique is to add a line integral and then subtract it again, so that we may obtain two simpler line integrals.

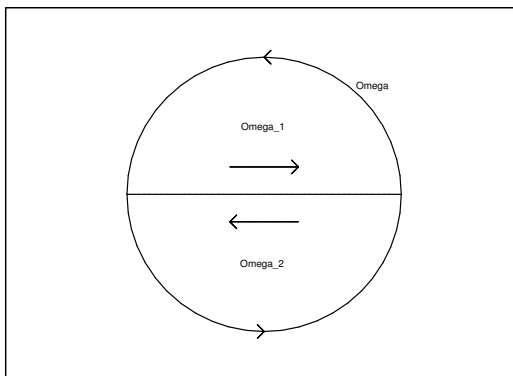

Figure 19: Splitting of a complex line integral along a closed curve into two simpler line integrals of the same type by adding and subtracting a complex line integral.

Let $\Gamma = C_1 - C_1$ denote a curve traversed in both directions. Then clearly,

$$\int_{\Gamma} f(z) dz = \int_{C_1} f(z) dz - \int_{C_1} f(z) dz = 0,$$

so we just add 0 to the line integral. This may seem trivial, but the idea is that one complicated line integral may be replaced by a sum of simple line integrals along closed curves, hence also complicated domains may be broken up into a sum of simple domains.

The domain of Figure 19 is, however, not so complicated. The figure only serves to show the principle. The boundary of the domain Ω is here a circle. By adding a diameter and then subtracting it again we just add 0 to the corresponding line integral, but the line integral along the closed circle (positive orientation) can now be written as the sum of two line integrals along the boundaries of the two half discs, both with a positive orientation. \diamond

In *Complex Functions Theory*, line integrals along closed simple curves are occurring frequently, therefore we introduce a special notation for such line integrals.

Let C be a *simple closed curve with positive orientation*, then we denote the line integral along C of a function $f(z)$ by

$$\oint_C f(z) dz.$$

If instead C is a simple closed curve with *negative orientation*, then we write

$$- \oint_C f(z) dz$$

for this line integral.

For such closed simple curves, any point may be chosen as its start (and end) point.

As already indicated in Remark 2.5.2 we shall see that complicated complex line integrals often can be reduced to a sum of complex line integrals along simple closed curves. In order to deal with such simple line integrals we here prove the following extremely important theorem, the profound impact of which will be made clear later on.

Free eBook on Learning & Development

By the Chief Learning Officer of McKinsey

[Download Now](#)

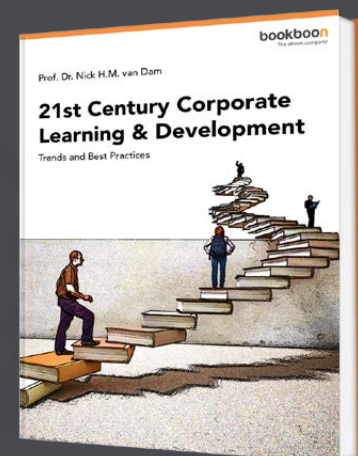

Theorem 2.5.2 For every radius $r > 0$ we have

$$(72) \quad \oint_{|z|=r} \frac{1}{z} dz = 2\pi i,$$

so the value is independent of the size of the radius $r > 0$.

PROOF. Choose the parametric description

$$z(t) = r e^{it} \quad \text{with } z'(t) = ir \cdot e^{it} \quad \text{for } t \in [0, 2\pi],$$

where it is left to the reader to prove the expression of $z'(t)$ above. Then by (69),

$$\oint_{|z|=r} \frac{1}{z} dz = \int_0^{2\pi} \frac{1}{r e^{it}} \cdot ir e^{it} dt = i \int_0^{2\pi} dt = 2\pi i. \quad \square$$

Remark 2.5.3 It is here worth to compare the proof above of Theorem 2.5.2 with the traditional proof when we are only using real calculus. First note that (cf. Example 1.1.1)

$$\frac{1}{z} = \frac{1}{x + iy} = \frac{x}{x^2 + y^2} - i \frac{y}{x^2 + y^2}.$$

Then apply (64) and split into real and imaginary parts,

$$\oint_{|z|=r} \frac{1}{z} dz = \oint_{|z|=r} \left\{ \frac{x}{x^2 + y^2} dx + \frac{y}{x^2 + y^2} dy \right\} + i \oint_{|z|=r} \left\{ \frac{x}{x^2 + y^2} dy - \frac{y}{x^2 + y^2} dx \right\}.$$

We get by computing the real part,

$$\oint_{|z|=r} \left\{ \frac{x}{x^2 + y^2} dx + \frac{y}{x^2 + y^2} dy \right\} = \oint_{|z|=r} d \left(\frac{\ln(x^2 + y^2)}{2} \right) = \oint_{|z|=r} d \ln r = 0,$$

because $x^2 + y^2 = r^2$ is constant on the integration path and the differential form is exact, and the end points are identical, so the result is 0 for many reasons.

This is not the case for the imaginary part, in which case we instead split the integral in the following way and use the parametric description $x = r \cos \varphi$ and $y = r \sin \varphi$, $\varphi \in [0, 2\pi]$, of the curve $|z| = r$,

$$\begin{aligned} & \oint_{|z|=r} \left\{ \frac{x}{x^2 + y^2} dy - \frac{y}{x^2 + y^2} dx \right\} \\ &= \oint_{\substack{|z|=r \\ y>0}} \left\{ \frac{x}{x^2 + y^2} dy - \frac{y}{x^2 + y^2} dx \right\} + \oint_{\substack{|z|=r \\ y<0}} \left\{ \frac{x}{x^2 + y^2} dy - \frac{y}{x^2 + y^2} dx \right\} \\ &= \int_0^\pi \left\{ \frac{r \cos \varphi}{r^2} \cdot r \cos \varphi - \frac{r \sin \varphi}{r^2} (-r \sin \varphi) \right\} d\varphi \\ &\quad + \int_\pi^{2\pi} \left\{ \frac{r \cos \varphi}{r^2} \cdot r \cos \varphi - \frac{r \sin \varphi}{r^2} (-r \sin \varphi) \right\} d\varphi \\ &= \int_0^\pi \{ \cos^2 \varphi + \sin^2 \varphi \} d\varphi + \int_\pi^{2\pi} \{ \cos^2 \varphi + \sin^2 \varphi \} d\varphi = \pi + \pi = 2\pi, \end{aligned}$$

and the result of (72) follows.

The reason for this messy computation (there are many variants of this) is that

$$\omega = \frac{x}{x^2 + y^2} dy - \frac{y}{x^2 + y^2} dx, \quad (x, y) \neq (0, 0),$$

is the classical example of a *closed differential form* which is not exact, because all the curves $|z| = r$ circle around a domain which is not *simply connected*. \diamond

In *Complex Functions Theory* the most interesting case is when the line integral is *independent* of the integration curve, as long as

- 1) the end points are kept fixed,
- 2) the integration curve is deformed through elementary curves without singularities of the integrand.

Assume that $f(z) = u(x, y) + iv(x, y)$, where both u and v are real C^1 functions in an open domain Ω , which contains the integration curve C . It follows from the real calculus that a *necessary* condition for these two conditions to hold is that the differential forms

$$(73) \quad u dx - v dy \quad \text{and} \quad u dy + v dx$$

on the right hand side of (64) are both *closed differential forms*. (Theorem 2.5.1 shows that this is *not* a sufficient condition).

We recall that the differential forms of (73) are *closed* in real calculus, if they fulfil

Cauchy-Riemann's equations:

$$(74) \quad \frac{\partial u}{\partial x} = \frac{\partial v}{\partial y} \quad \text{and} \quad \frac{\partial u}{\partial y} = -\frac{\partial v}{\partial x}.$$

Remark 2.5.4 In Russian literature Cauchy-Riemann's equations (74) are instead named after d'Alembert and Euler. \diamond

We shall see in Chapter 3 that *Cauchy-Riemann's equations* (74) play a central rôle in *Complex Functions Theory*. In engineering applications they are also fundamental in e.g. two-dimensional *Electrostatics* and *Hydrodynamics*.

Remark 2.5.5 According to folklore the symbol $\frac{\partial}{\partial x}$ etc. of partial differentiation should have been introduced by Euler in 1776. The author of this book have not been able to get this story confirmed, but it is plausible, because Euler at that time lived in St. Peterburg in Russia. When he needed a notation of his newly invented partial differentiation he may have chosen the italicized Russian "d". \diamond

3 Analytic Functions

The first two chapters of this book have more or less been a revision of known facts from real calculus and topology, and we have only occasionally mentioned complex functions.

In this chapter we shall introduce the main topic, namely the *analytic functions*. We shall, however, start by first introducing the *complex differentiable functions*.

3.1 Complex differentiable functions and analytic functions

The definition of complex differentiability of a complex function is formally identical with the definition of real differentiability, and yet there is a fundamental difference between the two definitions, which will give the complex continuously differentiable functions much better properties than the real continuously differentiable functions. Therefore, one should not be misled to believe that the following definition is “just the same as the definition of real differentiability”. This is not quite the case!

Definition 3.1.1 *Let Ω be an open and nonempty subset of \mathbb{C} , and let $f : \Omega \rightarrow \mathbb{C}$ be a complex function on Ω . The function f is complex differentiable at a point $z_0 \in \Omega$, if the limit*

$$(75) \quad \lim_{\substack{z \rightarrow z_0 \\ z \in \Omega}} \frac{f(z) - f(z_0)}{z - z_0}$$

exists. If this is the case, we denote this limit by

$$f'(z_0), \quad \text{or} \quad \frac{df}{dz}(z_0), \quad \text{or just} \quad \frac{df}{dz} \text{ or } f'.$$

If f is complex differentiable at z_0 , then it follows from (75) that $f(z) \rightarrow f(z_0)$ for $z \rightarrow z_0$ in Ω , thus f is continuous at z_0 .

That complex differentiability is a fairly strong property – stronger than real differentiability – follows from the fact that the limit in (75) does not follow a specified direction as in the real case, where (by changing the notation to real x) either $x \rightarrow x_0^-$ from below, or $x \rightarrow x_0^+$ from above, and no other possibility. In (75) we require that the limit is the same, *no matter how* $z \rightarrow z_0$, i.e. independently of the direction.

We may on the other hand benefit from the fact that the two definitions have *formally* identical structures. This implies that every proof of a theorem of real differentiability which only relies on the definition itself is straightforward carried over to complex differentiability. Hence we immediately get the following theorem:

Theorem 3.1.1 *Let f and g be two complex functions defined on an open and nonempty set $\Omega \subseteq \mathbb{C}$, and assume that both f and g are differentiable at the same point $z \in \Omega$. Then $f + g$, $f - g$, $f \cdot g$, and if also $g(z) \neq 0$, the quotient $\frac{f}{g}$ are all differentiable at the point $z \in \Omega$, and we have the following differentiation rules*

$$(f + g)'(z) = f'(z) + g'(z),$$

$$(f - g)'(z) = f'(z) - g'(z),$$

$$(f \cdot g)'(z) = f'(z)g(z) + f(z)g'(z),$$

$$\left\{ \frac{f}{g} \right\}'(z) = \frac{f'(z)g(z) - f(z)g'(z)}{\{g(z)\}^2} = \frac{f'(z)}{g(z)} - f(z) \cdot \frac{g'(z)}{\{g(z)\}^2}, \quad \text{if } g(z) \neq 0.$$



www.sylvania.com

We do not reinvent
the wheel we reinvent
light.

Fascinating lighting offers an infinite spectrum of possibilities: Innovative technologies and new markets provide both opportunities and challenges. An environment in which your expertise is in high demand. Enjoy the supportive working atmosphere within our global group and benefit from international career paths. Implement sustainable ideas in close cooperation with other specialists and contribute to influencing our future. Come and join us in reinventing light every day.

Light is OSRAM

OSRAM
SYLVANIA

Remark 3.1.1 In most elementary textbooks one is taught the formula

$$\left\{ \frac{f}{g} \right\}'(z) = \frac{f'(z)g(z) - f(z)g'(z)}{\{g(z)\}^2}, \quad \text{if } g(z) \neq 0,$$

for the derivative of a quotient. This may be helpful in one situation, when one has arrived to an expression like $f'(z)g(z) - f(z)g'(z)$. If we had had a $+$ between the two terms, then we could reduce it to $(f \cdot g)'(z)$. This is not the case here, but a multiplication with $\frac{\{g(z)\}^2}{\{g(z)\}^2} = 1$ does the trick,

$$f'(z)g(z) - f(z)g'(z) = \{g(z)\}^2 \cdot \frac{f'(z)g(z) - f(z)g'(z)}{\{g(z)\}^2} = \{g(z)\}^2 \cdot \left\{ \frac{f}{g} \right\}'(z).$$

This will also be used later on.

On the other hand, if we do not need the reformulation above, this formula often requires much larger computations than the equivalent formula

$$\left\{ \frac{f}{g} \right\}'(z) = \frac{f'(z)}{g(z)} - f(z) \cdot \frac{g'(z)}{\{g(z)\}^2} \quad \text{for } g(z) \neq 0,$$

which is easily derived from the classical formula above. The latter formula is remembered by noticing that

$$\left\{ \frac{f}{g} \right\}'(z) = \left\{ f \cdot \frac{1}{g} \right\}'(z) = f'(z) \cdot \frac{1}{g(z)} + f(z) \cdot \left\{ \frac{1}{g} \right\}'(z) = \frac{f'(z)}{g(z)} - f(z) \cdot \frac{g'(z)}{\{g(z)\}^2}. \quad \diamond$$

Although Definition 3.1.1 contains an improvement compared with real differentiability, it still does not quite have all the nice properties which we need. We therefore introduce a more restrictive class of complex functions by the following definition.

Definition 3.1.2 The complex function $f : \Omega \rightarrow \mathbb{C}$ is analytic (or holomorphic) in the open and nonempty set Ω , if

- 1) the function f is complex differentiable at every $z \in \Omega$,
- 2) the derivative f' is continuous everywhere in Ω .

One of the main topics of these books is that the class of analytic functions have extremely nice properties. However, a strange thing is that condition 2) above in Definition 3.1.2 is not at all necessary! It can be *proved* that it *follows* from condition 1). It is well-known that this unexpected result does not hold for real differentiability, so being (real) analytic is a far stronger condition than being just real differentiable. By a real analytic function we here understand an analytic function in Ω restricted to the set $\Omega \cap \mathbb{R}$.

For practical reasons we shall for the time being require both conditions of Definition 3.1.2 of analytic functions, without bothering too much with the fact that the latter of the two conditions is superfluous.

Obviously, Theorem 3.1.1 also holds for the class of analytic functions on Ω . In the same way we prove

Theorem 3.1.2 The chain rule. Assume that $f : \Omega \rightarrow \mathbb{C}$ and $g : \Omega_1 \rightarrow \mathbb{C}$ are analytic functions and that f maps Ω into Ω_1 , i.e. $f(\Omega) \subseteq \Omega_1$. Then the composite map $g \circ f : \Omega \rightarrow \mathbb{C}$ is also analytic, and

$$(g \circ f)'(z) = g'(f(z)) \cdot f'(z).$$

In fact, the proof of the chain rule in the real case only uses the formal definition of taking the limit of a difference quotient, so the proof in the real is immediately carried over.

Example 3.1.1 *Polynomials are analytic functions.* So far we have not proved that there exists any analytic function. It is, however, trivial that all constant functions are analytic. In fact, if $f(z) = c$, then

$$\lim_{z \rightarrow z_0} \frac{f(z) - f(z_0)}{z - z_0} = \lim_{z \rightarrow z_0} \frac{c - c}{z - z_0} = \lim_{z \rightarrow z_0} 0 = 0,$$

so $f'(z) = 0$ is continuous.

Furthermore, $f(z) = z$ is also analytic,

$$\lim_{z \rightarrow z_0} \frac{f(z) - f(z_0)}{z - z_0} = \lim_{z \rightarrow z_0} \frac{z - z_0}{z - z_0} = \lim_{z \rightarrow z_0} 1 = 1,$$

is also continuous, hence $f(z) = z$ is analytic with $f'(z) = 1$.

Then it follows from Theorem 3.1.1 that $f(z) = z^n = z \cdots z$ is analytic, and by induction we derive that $f'(z) = nz^{n-1}$. In fact, we have just proved this rule for $n = 1$. Assuming that it holds for some $n \in \mathbb{N}$ we get by Theorem 3.1.1 that

$$\frac{d}{dz} (z^{n+1}) = \frac{d}{dz} \{z \cdot z^n\} = 1 \cdot z^n + z \cdot nz^{n-1} = (n+1)z^n,$$

and the claim is proved.

Once we have proved the above, it immediately follows from Theorem 3.1.1 that every complex polynomial $P(z)$ is analytic with formally the same derivative $P'(z)$ as if it had been a real polynomial.

Finally, by differentiating a quotient of polynomials, every rational function $R(z) = \frac{P(z)}{Q(z)}$, for $Q(z) \neq 0$, is analytic in the set $\mathbb{C} \setminus \{z \in \mathbb{C} \mid Q(z) = 0\}$ with the expected derivative

$$R'(z) = \frac{d}{dz} \left\{ \frac{P(z)}{Q(z)} \right\} = P'(z) \cdot \frac{1}{Q(z)} - P(z) \cdot \frac{Q'(z)}{\{Q(z)\}^2} \quad \text{for } Q(z) \neq 0. \quad \diamond$$

Example 3.1.2 *There exist complex functions $f(z) = u(x, y) + iv(x, y)$, which are not analytic, and yet $u, v \in C^\infty(\mathbb{R}^2)$.* We have shown in Example 3.1.1 that all polynomials and rational functions are analytic functions. One may be misled by this to believe that if $f \in C^\infty(\mathbb{R})$ is a real C^∞ function, then $f(x)$ is made analytic by just writing $f(z)$. **This is not true!** And yet the author has found this claim in some textbooks! It is therefore of paramount importance immediately to give a counterexample.

Consider the function

$$w = f(z) = \bar{z} = x - iy = u(x, y) + iv(x, y),$$

from which

$$u(x, y) = x \quad \text{and} \quad v(x, y) = -y.$$

Clearly, both $u, v \in C^\infty(\mathbb{R}^2)$, and $f(z) = \bar{z}$ is continuous. However, it is *not* analytic. In fact, let $z = z_0 + \Delta z$, where $\Delta z = \Delta x + i\Delta y \neq 0$. When we check Definition 3.1.1, we get for the difference quotient

$$\frac{f(z) - f(z_0)}{z - z_0} = \frac{\overline{z_0 + \Delta z} - \bar{z}_0}{z_0 + \Delta z - z_0} = \frac{\overline{\Delta z}}{\Delta z} = \frac{\Delta x - i\Delta y}{\Delta x + i\Delta y} = \begin{cases} 1 & \text{for } \Delta y = 0 \text{ and } \Delta x \rightarrow 0, \\ -1 & \text{for } \Delta x = 0 \text{ and } \Delta y \rightarrow 0. \end{cases}$$

We get (at least) two different values of the “possible limit”, which means that the complex limit does not exist at any point $z_0 \in \mathbb{C}$, so $f(z) = \bar{z}$ is nowhere an analytic function. \diamond

As mentioned earlier, an analytic function $f(z) = u(x, y) + iv(x, y)$ may also be described by a pair of real C^1 functions $(u(x, y), v(x, y))$ in two real variables (x, y) . Concerning notation we shall let $\frac{d}{dz}$ denote complex differentiation as defined above, while differentiation with respect to either x or y is always denoted as a *partial differentiation*, $\frac{\partial}{\partial x}$ and $\frac{\partial}{\partial y}$, in spite of the fact, that if $f'(z)$ exists, then

$$f'(z) = \frac{df}{dz}(z) = \frac{\partial u}{\partial x}(x, y) + i\frac{\partial v}{\partial x}(x, y).$$

This is true, because partial differentiation with respect to x is just one way of finding the derivative. On the other hand, we do not differentiate with respect to the other real variable y , so it is quite reasonable to write the expression as a partial differentiation with respect to x .

We may of course use a similar construction, when we differentiate along the imaginary axis, i.e. with respect to the purely imaginary variable iy , $y \in \mathbb{R}$. Then also

$$f'(z) = \frac{1}{i} \cdot \frac{\partial u}{\partial y}(x, y) + \frac{i}{i} \cdot \frac{\partial v}{\partial y}(x, y) = \frac{\partial v}{\partial y}(x, y) - i\frac{\partial u}{\partial y}(x, y),$$

so by identifying the real and the imaginary parts we once more have derived the *Cauchy-Riemann equations*, cf. (74)

$$\frac{\partial u}{\partial x} = \frac{\partial v}{\partial y} \quad \text{and} \quad \frac{\partial u}{\partial y} = -\frac{\partial v}{\partial x}.$$

Hence, we have proved the easy part of

Theorem 3.1.3 *Let $f(z) = u(x, y) + iv(x, y)$ be a complex function on the open and nonempty set Ω , and assume that the real functions u and v are of class $C^1(\Omega)$ in the corresponding real variables x and y .*

Then the complex function $f(z)$ is analytic in Ω , if and only if $u(x, y)$ and $v(x, y)$ satisfy Cauchy-Riemann's equations in Ω ,

$$(76) \quad \frac{\partial u}{\partial x} = \frac{\partial v}{\partial y} \quad \text{and} \quad \frac{\partial u}{\partial y} = -\frac{\partial v}{\partial x}.$$

The conclusion of Theorem 3.1.3 is not true, if either u or v is not of class $C^1(\Omega)$.

CONTINUATION OF THE PROOF OF THEOREM 3.1.3. We assume that $f(z) = u(x, y) + iv(x, y)$, where $u, v \in C^1$ satisfy *Cauchy-Riemann's equations*. We shall prove that f is analytic at any fixed point $z_0 = x_0 + iy_0 \in \Omega$.

Let all the real partial derivatives in the following be developed in the corresponding point (x_0, y_0) in \mathbb{R}^2 . Then it follows from the definition of differentiability that

$$(77) \quad \begin{cases} u(x_0 + \Delta x, y_0 + \Delta y) - u(x_0, y_0) = \frac{\partial u}{\partial x} \cdot \Delta x + \frac{\partial u}{\partial y} \cdot \Delta y + \alpha \cdot \sqrt{(\Delta x)^2 + (\Delta y)^2}, \\ v(x_0 + \Delta x, y_0 + \Delta y) - v(x_0, y_0) = \frac{\partial v}{\partial x} \cdot \Delta x + \frac{\partial v}{\partial y} \cdot \Delta y + \beta \cdot \sqrt{(\Delta x)^2 + (\Delta y)^2}, \end{cases}$$

where $\alpha = \alpha(\Delta x, \Delta y) \rightarrow 0$ and $\beta = \beta(\Delta x, \Delta y) \rightarrow 0$ for $(\Delta x, \Delta y) \rightarrow (0, 0)$.

We write $\Delta z = \Delta x + i\Delta y$ and shall prove that the limit exists, when $\Delta z \rightarrow 0$. Notice that $\sqrt{(\Delta x)^2 + (\Delta y)^2} = |\Delta z|$, so if $\Delta z \rightarrow 0$, then also $\Delta x \rightarrow 0$ and $\Delta y \rightarrow 0$. Clearly,

$$f(z_0 + \Delta z) - f(z_0) = \left\{ \frac{\partial u}{\partial x} \cdot \Delta x + \frac{\partial u}{\partial y} \cdot \Delta y \right\} + i \left\{ \frac{\partial v}{\partial x} \cdot \Delta x + \frac{\partial v}{\partial y} \cdot \Delta y \right\} + \eta \cdot |\Delta z|,$$

where $\eta := \alpha + i\beta$.



Discover the truth at www.deloitte.ca/careers

Deloitte.

© Deloitte & Touche LLP and affiliated entities.



Now, apply *Cauchy-Riemann's equations* to get

$$\begin{aligned} f(z_0 + \Delta z) - f(z_0) &= \left\{ \frac{\partial u}{\partial x} \cdot \Delta x - \frac{\partial v}{\partial x} \cdot \Delta y \right\} + i \left\{ \frac{\partial v}{\partial x} \cdot \Delta x + \frac{\partial u}{\partial x} \cdot \Delta y \right\} + \eta \cdot |\Delta z| \\ &= \left\{ \frac{\partial u}{\partial x} + i \frac{\partial v}{\partial x} \right\} (\Delta x + i \Delta y) + \eta \cdot |\Delta z| \\ &= \left\{ \frac{\partial u}{\partial x} + i \frac{\partial v}{\partial x} \right\} \Delta z + \eta \cdot |\Delta z|. \end{aligned}$$

Since $\frac{\partial u}{\partial x} + i \frac{\partial v}{\partial x}$ by the initial assumption only depends on the point (x_0, y_0) and not on Δz , it may here be considered as a constant, and since $\eta \rightarrow 0$ for $\Delta z \rightarrow 0$, i.e.

$$\left| \frac{\eta \cdot |\Delta z|}{\Delta z} \right| \rightarrow 0 \quad \text{for } \Delta z \rightarrow 0,$$

it follows for every fixed $z_0 \in \Omega$ that

$$\frac{f(z_0 + \Delta z) - f(z_0)}{\Delta z} = \frac{\partial u}{\partial x} + i \frac{\partial v}{\partial x} + \eta \cdot \frac{|\Delta z|}{\Delta z} \rightarrow \frac{\partial u}{\partial x} + i \frac{\partial v}{\partial x} \quad \text{for } \Delta z \rightarrow 0,$$

hence $f(z)$ is indeed complex differentiable at every $z \in \Omega$ and its derivative is given by

$$(78) \quad f'(z) = \frac{\partial u}{\partial x} + i \frac{\partial v}{\partial x}.$$

Finally, since u and $v \in C^1$, it follows from (78) that the derivative $f'(z)$ is continuous in Ω , thus $f(z)$ is analytic. \square

It follows from *Cauchy-Riemann's equations* (76) and formula (78) that if $f = u + iv$ is analytic, then we can express the derivative $f'(z)$ by means of the partial derivatives of the functions $u(x, y)$ and $v(x, y)$ in the following ways,

$$(79) \quad f'(z) = \frac{\partial u}{\partial x} + i \frac{\partial v}{\partial x} = \frac{\partial v}{\partial y} - i \frac{\partial u}{\partial y} = \frac{\partial u}{\partial x} - i \frac{\partial u}{\partial y} = \frac{\partial v}{\partial y} + i \frac{\partial v}{\partial x}.$$

We note in particular that the *complex derivative* $f'(z)$ can be expressed by (real) partial derivatives of the real part u (resp. the imaginary part v) of f .

It was shown in Example 3.1.1 that every rational function $R(z) = \frac{P(z)}{Q(z)}$ is analytic outside the zeros of the denominator $Q(z)$. Rich as this class may seem, it is not big enough for all our purposes. We may now apply Theorem 3.1.3 to prove the existence of other types of analytic functions.

Theorem 3.1.4 *The complex exponential $\exp(z)$, or e^z , is analytic in \mathbb{C} with the derivative*

$$\frac{d}{dz} \exp(z) = \exp(z), \quad \left[\text{or } \frac{d}{dz} e^z = e^z \right].$$

PROOF. By Definition 1.2.1,

$$f(z) = \exp(z) = u + iv = e^x \{\cos y + i \sin y\}, \quad z = x + iy,$$

hence by splitting into real and imaginary parts,

$$u(x, y) = e^x \cos y \quad \text{and} \quad v(x, y) = e^x \sin y.$$

Clearly, u and $v \in C^\infty(\mathbb{R}^2)$, and

$$\begin{aligned} \frac{\partial u}{\partial x} &= e^x \cos y, & \frac{\partial v}{\partial y} &= e^x \cos y, \\ \frac{\partial u}{\partial y} &= -e^x \sin y, & \frac{\partial v}{\partial x} &= e^x \sin y. \end{aligned}$$

It follows immediately that *Cauchy-Riemann's equations* are fulfilled, hence $f(z) = \exp(z)$ is analytic, and if we use (79) we get the derivative

$$f'(z) = \frac{\partial u}{\partial x} + i \frac{\partial v}{\partial x} = e^x \cos y + i e^x \sin y = e^x \{\cos y + i \sin y\} = \exp(z). \quad \square$$

There are other ways to construct analytic functions outside the class of polynomials. We shall in Example 3.1.3 give an example, in which we shall need the following theorem, which also will occur later on in other connections.

Theorem 3.1.5 The theorem of inverse map. *Assume that $f : \Omega \rightarrow \mathbb{C}$ is analytic in Ω , and let $z_0 \in \Omega$ be a point in which $f'(z_0) \neq 0$.*

There exists an open and connected subset Ω_0 of Ω , such that

- 1) *The point z_0 lies in Ω_0 , and $f'(z) \neq 0$ for every $z \in \Omega_0$.*
- 2) *The set Ω_0 is by f mapped bijectively onto an open and connected set ω_0 .*
- 3) *The inverse map $g = f^{\circ-1} : \omega_0 \rightarrow \Omega_0$ is analytic in ω_0 , and its derivative is given by*

$$g' = \frac{1}{f' \circ g}, \quad \text{i.e.} \quad g'(w) = \frac{1}{f'(g(w))}, \quad \text{where } w = f(z).$$

PROOF. Write $z = x + iy$ and $w = u + iv$. Then the map $w = f(z)$ is determined by the pair of functions $(u(x, y), v(x, y))$, both of class C^1 . Putting $f'(z) = a(x, y) + ib(x, y)$, which exists by assumption, it follows from *Cauchy-Riemann's equations* that the *Jacobian* is given by

$$\frac{\partial(u, v)}{\partial(x, y)} = \begin{pmatrix} \frac{\partial u}{\partial x} & \frac{\partial u}{\partial y} \\ \frac{\partial v}{\partial x} & \frac{\partial v}{\partial y} \end{pmatrix} = \begin{pmatrix} a & -b \\ b & a \end{pmatrix}.$$

The corresponding determinant is then

$$a^2 + b^2 = |f'(z)|^2 \quad (\neq 0 \text{ for } z = z_0).$$

The function $f'(z)$ is continuous, hence it follows from Theorem 2.1.11 on page 63 that there is an open neighbourhood $\Omega_0 \subseteq \Omega$ of z_0 , which we without loss of generality of course may choose connected,

such that $f'(z) \neq 0$ in Ω_0 , and such that f maps Ω_0 *bijectively* onto the open set $\omega_0 = f(\Omega_0)$, which by Theorem 2.1.5 on page 48 must be connected.

Thus, the inverse map $z = g(w)$, $g : \omega_0 \rightarrow \Omega_0$, exists, and it is given by the pair of functions $x(u, v)$ and $y(u, v) \in C^1(\omega_0)$, which has the *Jacobian*

$$\begin{pmatrix} \frac{\partial x}{\partial u} & \frac{\partial x}{\partial v} \\ \frac{\partial y}{\partial u} & \frac{\partial y}{\partial v} \end{pmatrix} = \frac{\partial(x, y)}{\partial(u, v)} = \begin{pmatrix} a & -b \\ b & a \end{pmatrix}^{-1} = \frac{1}{a^2 + b^2} \begin{pmatrix} a & b \\ -b & a \end{pmatrix}.$$

Hence by identification,

$$\frac{\partial x}{\partial u} = \frac{a}{a^2 + b^2} = \frac{\partial y}{\partial v} \quad \text{and} \quad \frac{\partial x}{\partial v} = \frac{b}{a^2 + b^2} = -\frac{\partial y}{\partial u},$$

proving that the pair $(x(u, v), y(u, v))$ satisfies *Cauchy-Riemann's equations* in the variables (u, v) . Hence, $g(w)$ is analytic with the (continuous) derivative

$$g'(w) = \frac{\partial x}{\partial u} + i \frac{\partial y}{\partial u} = \frac{a - ib}{a^2 + b^2} = \frac{a - ib}{(a + ib)(a - ib)} = \frac{1}{a + ib} = \frac{1}{f'(z)},$$

and the theorem follows. \square

SIMPLY CLEVER

ŠKODA



We will turn your CV into
an opportunity of a lifetime



Do you like cars? Would you like to be a part of a successful brand?
We will appreciate and reward both your enthusiasm and talent.
Send us your CV. You will be surprised where it can take you.

Send us your CV on
www.employerforlife.com



Example 3.1.3 Note that Theorem 3.1.5 is only a *local* result. Even if $f'(z) \neq 0$ for every $z \in \Omega$, the function $f(z)$ is not necessarily injective, which is demonstrated by the following.

Consider the *complex exponential* $f(z) = \exp(z)$. Then for every $k \in \mathbb{Z}$,

$$f(z + 2ik\pi) = e^x \{\cos(y + 2k\pi) + i \sin(y + 2k\pi)\} = e^x \{\cos y + i \sin y\} = f(z),$$

proving that $f(z) = \exp(z)$ is *periodic* of period $2i\pi$. In particular, it cannot be injective on all of \mathbb{C} .

On the other hand,

$$|f'(z)| = |\exp(z)| = |e^x(\cos y + i \sin y)| = e^x > 0,$$

for every $z \in \mathbb{C}$. This means that an inverse $g(w)$ of $\exp(z)$ exists *locally* in a neighbourhood of every given $w : 0 \in \omega = f(\mathbb{C}) = \mathbb{C} \setminus \{0\}$.

We shall not here give an explicit expression of such an inverse, because we shall return to it in Example 3.2.1. Notice, however, that for everyone of these we can always, using Theorem 3.1.5, find its derivative. In fact, since $w = f(z) = \exp(z) = f'(z)$,

$$g'(w) = \frac{1}{f'(z)} = \frac{1}{\exp(z)} = \frac{1}{w} \quad \text{for all } w \in \omega_0,$$

where ω_0 is such a neighbourhood of w_0 as specified in Theorem 3.1.5.

Clearly, the function $g(w)$ must be connected with ideas which may be coined “the logarithm of w ”, cf. Example 3.2.1. \diamond

3.2 Cauchy-Riemann's equations in polar coordinates

In some cases it is more convenient to apply *Cauchy-Riemann's equations in polar coordinates*.

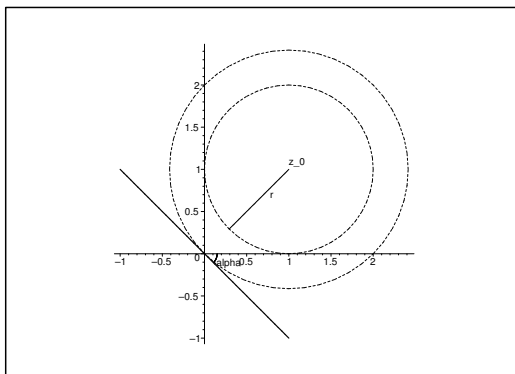

Figure 20: A neighbourhood (an open disc) of $z_0 \in \mathbb{C} \setminus \{0\}$ not containing origo 0.

Let $f(z) = u(x, y) + iv(x, y)$ be defined in an open domain Ω , which does not contain $z = 0$, and choose some $z_0 = x_0 + iy_0 \in \Omega$. It is a *local* property of a pair of real functions to satisfy *Cauchy-Riemann's equations*. Thus it suffices to consider a subset $\Omega_1 = B(z_0, r) \subseteq \Omega$, where $r \in]0, |z_0|[$. A glance on Figure 20 shows that the points $z \in \Omega_1$ are uniquely determined, not only by their rectangular coordinates (x, y) , but also by their *polar coordinates* in the following way.

It follows from Figure 20 that we can find an $\alpha \in \mathbb{R}$, such that

$$(r, \Theta) \in \Omega_1^* \subseteq \mathbb{R}_+ \times]\alpha, \alpha + \pi[,$$

where α is determined by the tangent through 0 to the circle $|z - z_0| = |z_0|$. Thus we have a bijective correspondence between the points of Ω_1 in rectangular coordinates and the parameter domain Ω_1^* of the polar coordinates, where this correspondence is given by

$$(80) \quad x = r \cdot \cos \Theta \quad \text{and} \quad y = r \cdot \sin \Theta.$$

Then we have

Theorem 3.2.1 *Assume that $f(z) = u(x, y) + iv(x, y)$ is defined in some open and nonempty set Ω , which does not contain 0, and assume that the real functions $u(x, y)$ and $v(x, y)$ are of class $C^1(\Omega)$. The complex function $f(z)$ is analytic in Ω , if and only if $u(x, y)$ and $v(x, y)$ satisfy Cauchy-Riemann's equations*

$$(81) \quad \frac{\partial u}{\partial r} = \frac{1}{r} \frac{\partial v}{\partial \Theta} \quad \text{and} \quad \frac{1}{r} \frac{\partial u}{\partial \Theta} = -\frac{\partial v}{\partial r}$$

in polar coordinates in Ω (i.e. strictly speaking in the parameter domain Ω^ of the polar coordinates). Whenever the equations of (81) are fulfilled, the derivative is given by*

$$(82) \quad f'(z) = e^{-\Theta} \left\{ \frac{\partial u}{\partial r} + i \frac{\partial v}{\partial r} \right\}.$$

PROOF. The fairly tedious proof goes as follows:

Under the given assumptions it suffices to prove that the rectangular Cauchy-Riemann equations are equivalent to the polar Cauchy-Riemann equations (81) above. It follows from (80) by the chain rule that

$$(83) \quad \begin{cases} \frac{\partial u}{\partial r} = \frac{\partial u}{\partial x} \frac{\partial x}{\partial r} + \frac{\partial u}{\partial y} \frac{\partial y}{\partial r} = \frac{\partial u}{\partial x} \cos \Theta + \frac{\partial u}{\partial y} \sin \Theta = \frac{1}{r} \left\{ x \frac{\partial u}{\partial x} + y \frac{\partial u}{\partial y} \right\}, \\ \frac{\partial u}{\partial \Theta} = \frac{\partial u}{\partial x} \frac{\partial x}{\partial \Theta} + \frac{\partial u}{\partial y} \frac{\partial y}{\partial \Theta} = -\frac{\partial u}{\partial x} r \sin \Theta + \frac{\partial u}{\partial y} r \cos \Theta = -y \frac{\partial u}{\partial x} + x \frac{\partial u}{\partial y}, \end{cases}$$

and similarly,

$$(84) \quad \frac{\partial v}{\partial r} = \frac{1}{r} \left\{ x \frac{\partial v}{\partial x} + y \frac{\partial v}{\partial y} \right\}, \quad \frac{\partial v}{\partial \Theta} = -y \frac{\partial v}{\partial x} + x \frac{\partial v}{\partial y}.$$

Assume that the *rectangular Cauchy-Riemann equations* hold. Then we get

$$r \frac{\partial u}{\partial r} = x \frac{\partial u}{\partial x} + y \frac{\partial u}{\partial y} = -y \frac{\partial v}{\partial x} + x \frac{\partial v}{\partial y} = \frac{\partial v}{\partial \Theta},$$

and

$$r \frac{\partial v}{\partial r} = x \frac{\partial v}{\partial x} + y \frac{\partial v}{\partial y} = y \frac{\partial u}{\partial x} - x \frac{\partial u}{\partial y} = -\frac{\partial u}{\partial \Theta},$$

and as $r > 0$ we get (81), so we have proved that the *polar Cauchy-Riemann equations* also hold.

Assume conversely the *polar Cauchy-Riemann equations* (81). Then it follows from (83) and (84) that

$$x \frac{\partial u}{\partial x} + y \frac{\partial u}{\partial y} = -y \frac{\partial v}{\partial x} + x \frac{\partial v}{\partial y}, \quad x \frac{\partial v}{\partial x} + y \frac{\partial v}{\partial y} = y \frac{\partial u}{\partial x} - x \frac{\partial u}{\partial y},$$

hence by a rearrangement,

$$(85) \quad \begin{cases} x \left\{ \frac{\partial u}{\partial x} - \frac{\partial v}{\partial y} \right\} + y \left\{ \frac{\partial u}{\partial y} + \frac{\partial v}{\partial x} \right\} = 0, \\ -y \left\{ \frac{\partial u}{\partial x} - \frac{\partial v}{\partial y} \right\} + x \left\{ \frac{\partial u}{\partial y} + \frac{\partial v}{\partial x} \right\} = 0. \end{cases}$$

Consider (85) as a linear system in the two variables

$$\frac{\partial u}{\partial x} - \frac{\partial v}{\partial y} \quad \text{and} \quad \frac{\partial u}{\partial y} + \frac{\partial v}{\partial x}.$$

The corresponding determinant is $x^2 + y^2 \neq 0$, because $0 \notin \Omega$. Hence, the solution of (85) is unique by *Cramer's formula*, namely the zero solution. This implies that

$$\frac{\partial u}{\partial x} = \frac{\partial v}{\partial y} \quad \text{and} \quad \frac{\partial u}{\partial y} = -\frac{\partial v}{\partial x},$$

and we have proved the *rectangular Cauchy-Riemann equations*. Thus the two variants of the Cauchy-Riemann equations are indeed equivalent.

It remains to prove (82). We get by using (83) and (84) and the *rectangular Cauchy-Riemann equations*,

$$\begin{aligned} e^{-i\Theta} \left\{ \frac{\partial u}{\partial r} + i \frac{\partial v}{\partial r} \right\} &= \frac{1}{r \cdot e^{i\Theta}} \left\{ r \frac{\partial u}{\partial r} + ir \frac{\partial v}{\partial r} \right\} = \frac{1}{z} \left\{ x \frac{\partial u}{\partial x} + y \frac{\partial u}{\partial y} + ix \frac{\partial v}{\partial x} + iy \frac{\partial v}{\partial y} \right\} \\ &= \frac{1}{z} \left\{ x \frac{\partial u}{\partial x} - y \frac{\partial v}{\partial x} + ix \frac{\partial v}{\partial x} + iy \frac{\partial u}{\partial x} \right\} = \frac{1}{z} \{x + iy\} \frac{\partial u}{\partial x} + \frac{1}{z} \cdot i \{x + iy\} \frac{\partial v}{\partial x} \\ &= \frac{\partial u}{\partial x} + i \frac{\partial v}{\partial x} = f'(z), \end{aligned}$$

and Theorem 3.2.1 is proved. \square

Cynthia | AXA Graduate



AXA Global Graduate Program

Find out more and apply

redefining / standards 



Example 3.2.1 *Logarithms.* It is customary in *Complex Functions Theory* to consider at least three different types of logarithms, so we give here a small introduction to these, leaving a more thorough discussion of this matter to *Ventus: Complex Functions Theory a-3*.

In order not to confuse ourselves we shall *always* let $\ln : \mathbb{R}_+ \rightarrow \mathbb{R}$ denote the usual *natural logarithm*, known from real calculus, and let Log , \log , etc. denote some “complex logarithm”, which must be specified. We introduce Log in this example, while the more difficult \log is postponed to *Ventus: Complex Functions Theory a-3*.

Notice that since \ln is not defined on any open subset of \mathbb{C} , it is not an analytic function in the sense of Definition 3.1.2.

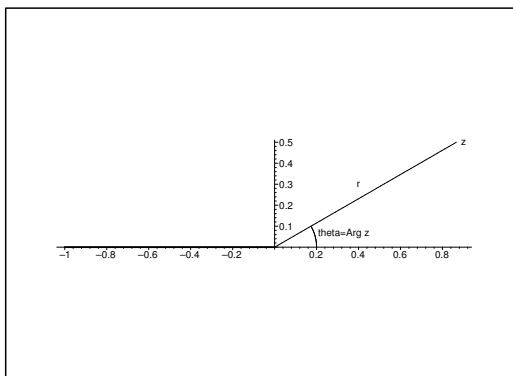

Figure 21: The domain Ω of the principal logarithm.

The *principal logarithm* $\text{Log} : \Omega \rightarrow \mathbb{C}$ is defined on the complex plane with a slit, i.e. on

$$\Omega = \mathbb{C} \setminus \{x \in \mathbb{R} \mid x \leq 0\} = \mathbb{C} \setminus \{\mathbb{R}_- \cup \{0\}\},$$

so the principal logarithm is defined everywhere outside the closed negative real axis, i.e. outside $\mathbb{R}_- \cup \{0\}$.

Recalling the definition of the *principal argument* $\text{Arg } z$ in Section 1.1 we see that Ω is the natural open domain of Arg , i.e.

$$\text{Arg } z \in] -\pi, \pi[\quad \text{for } z \in \Omega.$$

We now define the principal logarithm Log by

$$(86) \quad \text{Log } z := \ln |z| + i \cdot \text{Arg } z = \ln r + i\theta, \quad \text{for } z \in \Omega.$$

Clearly, both $\ln r$ and θ are C^∞ functions of (r, θ) , and we see that

$$\begin{aligned} \frac{\partial u}{\partial r} = \frac{1}{r}, \quad \frac{\partial v}{\partial \theta} = 1, \quad \text{i.e.} \quad \frac{\partial u}{\partial r} = \frac{1}{r} \frac{\partial v}{\partial \theta}, \\ \frac{\partial u}{\partial \theta} = 0, \quad \frac{\partial v}{\partial r} = 0, \quad \text{i.e.} \quad \frac{1}{r} \frac{\partial u}{\partial \theta} = -\frac{\partial v}{\partial r}, \end{aligned}$$

so Log fulfils the *polar Cauchy-Riemann equations*, hence $f(z) = \text{Log } z$ is analytic in the open set Ω , and its derivative is given by

$$f'(z) = e^{-i\Theta} \left\{ \frac{\partial u}{\partial r} + i \frac{\partial v}{\partial r} \right\} = \frac{1}{r} e^{-i\Theta} = \frac{1}{r e^{i\Theta}} = \frac{1}{z}.$$

Note that

$$\exp(\text{Log}(z)) = \exp(\ln r + i\Theta) = e^{\ln r} \cdot e^{i\Theta} = r e^{i\Theta} = z,$$

so the restriction of \exp to the strip

$$f(\Omega) = \{w = u + iv \mid u \in \mathbb{R}, v \in]-\pi, \pi[\}$$

is the inverse of $\text{Log } z$, cf. also Example 3.1.3.

Finally, we note that if $z \in \mathbb{R}_+ \subset \Omega$, then $\text{Log } z = \ln z$, so in this sense Log is one possible analytic extension of $\ln : \mathbb{R}_+ \rightarrow \mathbb{R}$. \diamond

In principle, analyticity of a function is closely related to some *open* set. However, it may sometimes also be convenient to use more imprecise phrases like e.g. “ $f(z)$ is analytic in a *closed* set A ”, or in an even more general set. By this terminology we shall understand that there exists an open subset ω of the domain of f , such that $A \subset \omega$, and such that f is analytic in the larger set ω . In particular, if f is analytic at a point z_0 , this means that there exists an $r > 0$, such that the open disc $B(z_0, r)$ is contained in the domain of f , and such that f is analytic in this disc $B(z_0, r)$.

3.3 Cauchy’s integral theorem

We shall now prove one of the main theorems in *Complex Functions Theory* and show some of its consequences.

Theorem 3.3.1 Cauchy’s integral theorem, (A. Cauchy, 1825). *Assume that the function $f(z)$ is analytic in a simply connected open domain Ω . Given two points z_0 and $z_1 \in \Omega$. The line integral $\int_C f(z) dz$, where C is any piecewise differentiable curve in Ω from z_0 to z_1 , is independent of how C goes from z_0 to z_1 in Ω .*

PROOF. This statement follows immediately from well-known results in real calculus. In fact, since

$$\int_C f(z) dz = \int_C \{u dx - v dy\} + i \int_C \{u dy + v dx\},$$

we see that $\int_C f(z) dz$ does not depend on the integration path C from z_0 to z_1 , if and only if the two differential forms $u dx - v dy$ and $u dy + v dx$ are exact.

Now, f is analytic in Ω , so $u(x, y)$ and $v(x, y)$ are of class $C^1(\Omega)$. Since Ω is *simply connected*, cf. Definition 2.1.9, these differential forms are exact, if and only if they are closed, i.e. if and only if

$$\frac{\partial u}{\partial y} = -\frac{\partial v}{\partial x} \quad \text{and} \quad \frac{\partial u}{\partial x} = \frac{\partial v}{\partial y},$$

which we recognize as Cauchy-Riemann's equations. These hold, because $f(z)$ by assumption is analytic in all of Ω . \square

A frequently used variant of Cauchy's integral theorem is the following.

Theorem 3.3.2 *Assume that $f(z)$ is analytic in a simply connected open domain Ω . Then*

$$\oint_C f(z) dz = 0$$

for every closed and piecewise differentiable curve C in Ω .

PROOF. Cut the curve C into two curve segments, $C = C_1 + C_2$, where C_1 starts at the point z_0 and ends at z_1 , while C_2 goes from z_1 to z_0 instead. This implies that $-C_2$ is again a curve from z_0 and z_1 , so we conclude from Cauchy's integral theorem that

$$\int_{C_1} f(z) dz = \int_{-C_2} f(z) dz = - \int_{C_2} f(z) dz,$$

so

$$\oint_C f(z) dz = \int_{C_1} f(z) dz + \int_{C_2} f(z) dz = \int_{C_1} f(z) dz - \int_{C_1} f(z) dz = 0. \quad \square$$

Example 3.3.1 Compute the line integral

$$\oint_C \frac{1}{z} dz,$$

where

$$C: x^2 + 2y^2 = 1$$

is an ellipse of positive orientation.

We first note that we have already proved in Theorem 2.5.1 that the similar integral

$$\oint_{|z|=1} \frac{1}{z} dz = 2\pi i.$$

Furthermore, Example 3.1.1 shows that $\frac{1}{z}$ is analytic for $z \neq 0$.

The trick is to add and subtract $\oint_{|z|=1} \frac{1}{z} dz$ and then rearrange the closed integration paths, where Γ_1 and Γ_2 denote the two closed crescent shaped curves of negative orientation. It follows from Theorem 3.3.2 that

$$- \oint_{\Gamma_1} \frac{1}{z} dz = - \oint_{\Gamma_2} \frac{1}{z} dz = 0,$$

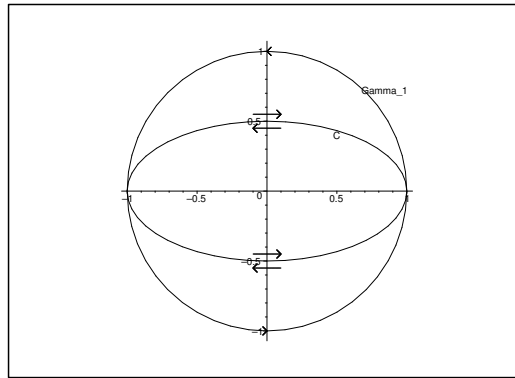

Figure 22: Application of Theorem 3.3.2 by adding and subtracting a known line integral.

hence (cf. Figure 22), where $\oint_{\gamma} \dots dz$ is always taken in the positive orientation of the curve γ ,

$$\begin{aligned} \oint_C \frac{1}{z} dz &= \oint_C \frac{1}{z} dz - \oint_{|z|=1} \frac{1}{z} dz + \oint_{|z|=1} \frac{1}{z} dz \\ &= -\oint_{\Gamma_1} \frac{1}{z} dz - \oint_{\Gamma_2} \frac{1}{z} dz + \oint_{|z|=1} \frac{1}{z} dz \\ &= -0 - 0 + 2\pi i = 2\pi i. \quad \diamond \end{aligned}$$

I joined MITAS because
I wanted **real responsibility**

The Graduate Programme
for Engineers and Geoscientists
www.discovermitas.com



Month 16

I was a construction
supervisor in
the North Sea
advising and
helping foremen
solve problems

Real work
International opportunities
Three work placements



 **MAERSK**



The method of Example 3.3.1 may of course be used on any other closed and piecewise differentiable curve C which circles around $z = 0$. For all such curves C for which this circulation is 1 we therefore have

$$\oint_C \frac{1}{z} dz = \oint_{|z|=1} \frac{1}{z} dz = 2\pi i.$$

We note that if C does not circle around 0, then it follows trivially from Theorem 3.3.2 that

$$\oint_C \frac{1}{z} dz = 0.$$

Roughly speaking, Cauchy's integral theorem shows that a line integral along a closed curve C of an analytic function on and inside C with the exception of one point z_0 inside C can be transformed into a circle Γ in Ω of centre z_0 , without changing the value of the line integral, i.e.

$$\oint_C f(z) dz = \oint_{\Gamma} f(z) dz.$$

We shall later exploit this observation, and finally derive a result, in which it is no longer necessary to add and subtract some line integral along a closed curve. However, for a time being it will be a good exercise for the reader to try this technique, even if it later becomes unnecessary due to some results in *Ventus: Complex Functions Theory a-2*.

Example 3.3.2 In this example we shall demonstrate one of the possible pitfalls by using an apparent simple change of variable. We know from Theorem 2.5.1 that

$$\oint_{|z|=1} \frac{1}{z} dz = 2\pi i.$$

On the other hand, we also have

$$\frac{1}{z} dz = \frac{1}{2} \cdot \frac{2z}{z^2} dz = \frac{1}{2} \frac{1}{w} dw, \quad w = z^2,$$

so we should apparently have

$$(87) \quad "2\pi i = \oint_{|z|=1} \frac{1}{z} dz = \frac{1}{2} \oint_{|w|=1} \frac{1}{w} dw = \frac{1}{2} \cdot 2\pi i = \pi i,"$$

which obviously is wrong! In the present case it is easy to find the error, because the curve

$$C: \quad |z| = 1, \quad \text{i.e.} \quad z = e^{i\Theta}, \quad \Theta \in [0, 2\pi],$$

is by the map $w = z^2$ mapped into

$$C_1: \quad |w| = 1, \quad \text{where } w = e^{2i\Theta} = e^{i\varphi}, \quad \varphi = 2\Theta \in [0, 4\pi].$$

Hence, strictly speaking $C_1 = C + C$ circles twice around 0, so instead of (87) we should have

$$2\pi i = \oint_{|z|=1} \frac{1}{z} dz = \frac{1}{2} \oint_{|w|=1} \frac{1}{w} dw + \frac{1}{2} \oint_{|w|=1} \frac{1}{w} dw = \frac{1}{2} \cdot 2 \cdot 2\pi i = 2\pi i,$$

which is a true statement.

Of course one can change variable as above and analyze the image of the integration path. However, for the untrained this is a dangerous procedure, so for the time being the reader is warned not to use this procedure. \diamond

Example 3.3.3 We shall compute the line integral

$$\oint_{|z|=2} \frac{2z}{z^2+1} dz,$$

where the integrand is analytic except at the points $\pm i$ inside the integration curve $C : |z| = 2$.

We have just learned from Example 3.3.2 that one at this stage should avoid changing variable to e.g. $w = z^2 + 1$, even if

$$\frac{2z}{z^2+1} dz = \frac{1}{w} dw,$$

and even it is possible to proceed this way by analyzing the image of the curve. Instead we recall the old technique of decomposition of a rational function. In the present case we get

$$\frac{2z}{z^2+1} = \frac{2z}{(z+i)(z-i)} = \frac{a}{z+i} + \frac{b}{z-i},$$

where

$$a = \lim_{z \rightarrow -i} \frac{2z}{z-i} = 1 \quad \text{and} \quad b = \lim_{z \rightarrow i} \frac{2z}{z+i} = 1.$$

Then use the safe *translations* of the variables, $w_1 = z + i$ and $w_2 = z - i$ to get

$$\begin{aligned} \oint_{|z|=2} \frac{2z}{z^2+1} dz &= \oint_{|z|=2} \frac{1}{z+i} dz + \oint_{|z|=2} \frac{1}{z-i} dz = \oint_{|w_1-i|=2} \frac{1}{w_1} dw_1 + \oint_{|w_2+i|=2} \frac{1}{w_2} dw_2 \\ &= \oint_{|w_1|=1} \frac{1}{w_1} dw_1 + \oint_{|w_2|=1} \frac{1}{w_2} dw_2 = 2\pi i + 2\pi i = 4\pi i, \end{aligned}$$

where we have used that $w_1 = 0$ lies inside $|w_1 - i| = 2$, and $w_2 = 0$ lies inside $|w_2 + i| = 2$, and that Example 3.3.1 allows us to deform the line integrals into line integrals along the unit circle.

We notice that if we instead use the definition itself of a complex line integral, i.e. apply that the integration path has the following parametric description

$$z(t) = 2e^{it}, \quad t \in [0, 2\pi],$$

then we get

$$\begin{aligned} \oint_{|z|=2} \frac{2z}{z^2+1} dz &= \int_0^{2\pi} \frac{2 \cdot 2e^{it}}{4e^{2it}+1} \cdot 2ie^{it} dt = \int_0^{2\pi} \frac{8ie^{2it}}{4e^{2it}+1} dt = \dots \\ &= -\int_0^{2\pi} \frac{8\sin 2t}{17+8\cos 2t} dt + 8i \int_0^{2\pi} \frac{4+\cos 2t}{17+8\cos 2t} dt. \end{aligned}$$

It is possible, though not so easy in the latter case, to compute these trigonometric integrals by methods from the real calculus. Cf. e.g. the *Ventus: Calculus 1* series. Here we have found the result $4\pi i$ by complex methods, so by splitting into real and imaginary parts, follows by a trivial reduction,

$$\int_0^{2\pi} \frac{\sin 2t}{17+8\cos 2t} dt = 0 \quad \text{and} \quad \int_0^{2\pi} \frac{4+\cos 2t}{17+8\cos 2t} dt = \frac{\pi}{2}.$$

We shall in *Ventus: Complex Functions Theory a-2* develop other and easier methods of computing such trigonometric integrals. \diamond

The next result is an inverse to Cauchy's integral theorem.

Theorem 3.3.3 Assume that $f(z) = u(x, y) + iv(x, y)$ is defined in an open domain Ω , where $u(x, y)$ and $v(x, y)$ are both of class C^2 in the corresponding real variables (x, y) .

If for every open simply connected subset Ω_0 of Ω and for every closed piecewise differentiable curve C in Ω_0 we have

$$(88) \quad \oint_C f(z) dz = 0,$$

then $f(z)$ is an analytic function in Ω .

Remark 3.3.1 First note that the claim is true, if (88) holds for every closed curve C in the larger set Ω itself, because this is a stronger requirement, which is not necessary. To see this, consider the analytic function $f(z) = \frac{1}{z}$ in $\Omega = \mathbb{C} \setminus \{0\}$, which is *not* simply connected. The assumptions of Theorem 3.3.3 are fulfilled for every simply connected subset $\Omega_0 \subset \Omega$, but not for the curve $|z| = 1$ in Ω , in which case we already know that

$$\oint_{|z|=1} \frac{1}{z} dz = 2\pi i \neq 0. \quad \diamond$$

PROOF. It suffices to prove Cauchy-Riemann's equations at every point $z_0 \in \Omega$. Choose an open simply connected subset $\Omega_0 \subseteq \Omega$, such that $z_0 \in \Omega$. Then by (88),

$$\oint_C f(z) dz = \oint_C (u dx - v dy) + i \oint_C (v dx + u dy) = 0$$

for every closed curve C in Ω_0 . According to the real calculus (cf. e.g. the *Ventus: Calculus 2* series) this implies that the two real differential forms $u dx - v dy$ and $v dx + u dy$ are both exact, so there exist C^1 functions (actually indefinite integrals) $\Phi(x, y)$ and $\Psi(x, y)$ on Ω_0 , such that

$$u dx - v dy = d\Phi = \frac{\partial \Phi}{\partial x} dx + \frac{\partial \Phi}{\partial y} dy, \quad \text{and} \quad v dx + u dy = d\Psi = \frac{\partial \Psi}{\partial x} dx + \frac{\partial \Psi}{\partial y} dy.$$

when we identify the coefficients of dx and dy we get

$$(89) \quad u = \frac{\partial \Phi}{\partial x}, \quad -v = \frac{\partial \Phi}{\partial y}, \quad v = \frac{\partial \Psi}{\partial x}, \quad u = \frac{\partial \Psi}{\partial y}.$$

By assumption, u and v are of class C^1 , hence Φ and Ψ are of class C^2 . In particular we can reverse the order of differentiation, so it follows from (89) that

$$\frac{\partial u}{\partial x} = \frac{\partial}{\partial x} \left\{ \frac{\partial \Psi}{\partial y} \right\} = \frac{\partial}{\partial y} \left\{ \frac{\partial \Psi}{\partial x} \right\} = \frac{\partial v}{\partial y} \quad \text{and} \quad \frac{\partial u}{\partial y} = \frac{\partial}{\partial y} \left\{ \frac{\partial \Phi}{\partial x} \right\} = \frac{\partial}{\partial x} \left\{ \frac{\partial \Phi}{\partial y} \right\} = -\frac{\partial v}{\partial x},$$

and we conclude that Cauchy-Riemann's equations are satisfied at every point $z_0 \in \Omega_0$, and the derivative is

$$f'(z_0) = \frac{\partial u}{\partial x} + i \frac{\partial v}{\partial x}, \quad z_0 \in \Omega.$$

The right hand side is continuous, hence $f'(z)$ is continuous, and we have proved that $f(z)$ is analytic at every point of Ω . \square

It is easy to extend Cauchy’s integral theorem to open domains which are not simply connected.

Theorem 3.3.4 Cauchy’s integral theorem for multiply connected domains. *Assume that $f(z)$ is analytic in an open domain Ω , and let C_1, \dots, C_n denote n simple, closed and piecewise differentiable curves, such that their sum $C = C_1 + \dots + C_n$ forms the boundary of a multiply connected domain $\omega \subset \Omega$. The orientations of the curves C_1, \dots, C_n are chosen, such that ω always lies to the left of the curves. Then*

$$\sum_{j=1}^n \int_{C_j} f(z) dz = \int_{C_1} f(z) dz + \dots + \int_{C_n} f(z) dz = 0.$$

ie business school

93%
OF MIM STUDENTS ARE
WORKING IN THEIR SECTOR 3 MONTHS
FOLLOWING GRADUATION

MASTER IN MANAGEMENT

- STUDY IN THE CENTER OF MADRID AND TAKE ADVANTAGE OF THE UNIQUE OPPORTUNITIES THAT THE CAPITAL OF SPAIN OFFERS
- PROPEL YOUR EDUCATION BY EARNING A DOUBLE DEGREE THAT BEST SUITS YOUR PROFESSIONAL GOALS
- STUDY A SEMESTER ABROAD AND BECOME A GLOBAL CITIZEN WITH THE BEYOND BORDERS EXPERIENCE

Length: 10 MONTHS
Av. Experience: 1 YEAR
Language: ENGLISH / SPANISH
Format: FULL-TIME
Intakes: SEPT / FEB

5 SPECIALIZATIONS
PERSONALIZE YOUR PROGRAM

#10 WORLDWIDE
MASTER IN MANAGEMENT
FINANCIAL TIMES

55 NATIONALITIES
IN CLASS

www.ie.edu/master-management | mim.admissions@ie.edu | Follow us on IE MIM Experience



PROOF. It suffices to prove Theorem 3.3.4 for $n = 2$, because then the general claim easily follows by recursion.

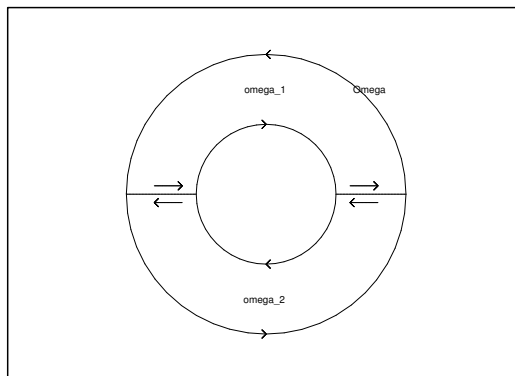

Figure 23: Adding and subtracting line integrals in the proof of Theorem 3.3.4.

The idea is just to add curve segments γ_1 and $-\gamma_1$, γ_2 and $-\gamma_2$ and the corresponding line integrals, which sum up to 0. By cutting the curves C_1 and C_2 in the right way and adding the curve segments above we obtain two closed curves, Γ_1 and Γ_2 , on which we can use Cauchy’s integral theorem for simply connected domains. We see that all curve segments are used just once, and that their orientations match with Γ_1 , resp. Γ_2 . Thus

$$\oint_{C_1} f(z) dz - \oint_{C_2} f(z) dz = \oint_{\Gamma_1} f(z) dz + \oint_{\Gamma_2} f(z) dz = 0 + 0 = 0,$$

where $-\oint_{C_2} f(z) dz$ indicates that the inner curve C_2 has negative orientation. \square

We used latently *indefinite integrals* in the proof of Theorem 3.3.3. In fact, we found C^2 functions Φ and Ψ which by (89) satisfied Cauchy-Riemann’s equations, i.e.

$$F(z) := \Phi(x, y) + i\Psi(x, y)$$

is analytic, and we find its derivative by (89),

$$F'(z) = \frac{\partial\Phi}{\partial x} + i \frac{\partial\Psi}{\partial x} = u + iv = f(z).$$

This leads to the following

Definition 3.3.1 Given an open connected subset Ω of \mathbb{C} . Assume that $f : \Omega \rightarrow \mathbb{C}$ is a continuous complex function. If we can find an analytic function $F : \Omega \rightarrow \mathbb{C}$, such that $F'(z) = f(z)$ for every $z \in \Omega$, then F is called an *indefinite integral* of f in Ω .

Note that we in Definition 3.3.1 only assume that f is continuous. We shall, however, later see that *if f has an indefinite integral, then f is also analytic!* In particular, $f'(z)$ exists, so in *Complex Functions Theory* it is a very strong property of a function to have an indefinite integral.

We shall in the following investigate more closely the properties of indefinite integrals. We start with the following simple lemma.

Lemma 3.3.1 *Assume that an analytic function $H : \Omega \rightarrow \mathbb{C}$ satisfies $H'(z) \equiv 0$ in Ω . Then H is constant in Ω .*

PROOF. Write $H(z) = U(x, y) + iV(x, y)$, where U and $V \in C^1(\Omega)$. It follows from H being analytic that

$$H'(z) = \frac{\partial U}{\partial x} + i \frac{\partial V}{\partial x} = \frac{\partial V}{\partial y} - i \frac{\partial U}{\partial y} = 0,$$

where we have used Cauchy-Riemann's equations. When we split into real and imaginary parts, we get

$$\frac{\partial U}{\partial x} = 0, \quad \frac{\partial U}{\partial y} = 0, \quad \text{and} \quad \frac{\partial V}{\partial x} = 0, \quad \frac{\partial V}{\partial y} = 0.$$

In particular, U and $V \in C^\infty$ and $dU = dV = 0$. Choosing any $z_0 = x_0 + iy_0 \in \Omega$ and any curve C in Ω , which starts at z_0 and ends at $z \in \Omega$, we get by the usual methods from real calculus (cf. e.g. the *Ventus: Calculus 2* series),

$$U(x, y) - U(x_0, y_0) = \int_C dU = \int_C \left\{ \frac{\partial U}{\partial x} dx + \frac{\partial U}{\partial y} dy \right\} = 0,$$

hence $U(x, y) = U(x_0, y_0) = k_1 \in \mathbb{R}$.

Similarly, $V(x, y) = V(x_0, y_0) = k_2 \in \mathbb{R}$ is a constant, and we conclude that

$$H(z) = U(x, y) + iV(x, y) = k_1 + ik_2 = k \in \mathbb{C}$$

is a constant. \square

The theorem below follows immediately from Lemma 3.3.1,

Theorem 3.3.5 *If $F(z)$ is an indefinite integral of the continuous and complex function f in Ω , then the set of all indefinite integrals is given by $F(z) + c$, where $c \in \mathbb{C}$ is a constant.*

PROOF. It follows from

$$\frac{d}{dz} \{F(z) + c\} = F'(z) + 0 = f(z),$$

that every $F(z) + c$ indeed is an indefinite integral.

Conversely, assume that F and G are two indefinite integrals of f . Then $H(z) := G(z) - F(z)$ is an analytic function, and

$$H'(z) = G'(z) - F'(z) = f(z) - f(z) = 0 \quad \text{in } \Omega.$$

According to Lemma 3.3.1 we have $H(z) = G(z) - F(z) = c \in \mathbb{C}$, from which follows that

$$G(z) = F(z) + c. \quad \square$$

We conclude from Theorem 3.3.5 that if a continuous function $f : \Omega \rightarrow \mathbb{C}$ has an indefinite integral, then to every $z_0 \in \Omega$ and every $c \in \mathbb{C}$ there is precisely one indefinite integral $F(z)$ of $f(z)$, such that $F(z_0) = c$.

Theorem 3.3.6 *Let f be a continuous function in an open and simply connected set $\Omega \subseteq \mathbb{C}$. Then f has an indefinite integral, if and only if the line integral along every closed and piecewise differentiable curve C in Ω of the differential form $f(z) dz$ is 0.*

When this condition is fulfilled, then an indefinite integral F of f is given by

$$F(z) = \int_C f(\zeta) d\zeta,$$

where C is any piecewise differentiable curve in Ω starting at a fixed point $z_0 \in \Omega$ and ending at the variable point $z \in \Omega$.

PROOF. Let us start by first writing down the condition that $F(z) = U(x, y) + iV(x, y)$ is an indefinite integral of $f(z) = u(x, y) + iv(x, y)$. This holds, if and only if U and $V \in C^1(\Omega)$ and – using that $F(z)$ is analytic –

$$F'(z) = \frac{\partial U}{\partial x} + i \frac{\partial V}{\partial x} = \frac{\partial V}{\partial y} - i \frac{\partial U}{\partial y} = u + iv,$$

thus

$$\frac{\partial U}{\partial x} = \frac{\partial V}{\partial y} = u, \quad \frac{\partial V}{\partial x} = -\frac{\partial U}{\partial y} = v.$$

This is again equivalent to U and $V \in C^1(\Omega)$ and

$$dU = u dx - v dy, \quad dV = v dx + u dy,$$

i.e. equivalent to the exactness of both differential forms $u dx - v dy$ and $v dx + u dy$. Cf. e.g. the *Ventus: Calculus 2* series. Now, Ω is assumed to be simply connected, so this is by real calculus true if and only if the real line integrals

$$\int_C \{u dx - v dy\} \quad \text{and} \quad \int_C \{v dx + u dy\}$$

only depend on the endpoints of C and not of the shape of C . Hence the line integral

$$\int_C f(z) dz = \int_C \{u dx - v dy\} + i \int_C \{v dx + u dy\}$$

does only depend on the endpoints of C , and we have proved the first part of the theorem.

If $f(z) = u + iv$ has an indefinite integral, then $u dx - v dy$ and $v dx + u dy$ must be exact differential forms. Fix $z_0 \in \Omega$ and define

$$U(x, y) = \int_C \{u dx - v dy\} \quad \text{and} \quad V(x, y) = \int_C \{v dx + u dy\},$$

where C is any piecewise differential curve starting at z_0 and ending at z . Then we obtain an indefinite integral $F(z) = U(x, y) + iV(x, y)$ of f by the definition

$$F(z) = \int_C \{u \, dx - v \, dy\} + i \int_C \{v \, dx + u \, dy\} = \int_C f(\zeta) \, d\zeta. \quad \square$$

Theorem 3.3.7 *Let a continuous function f have an indefinite integral on an open and simply connected domain $\Omega \subseteq \mathbb{C}$. Then, for every piecewise differentiable curve C in Ω , starting at z_1 and ending at z_2 ,*

$$\int_C f(z) \, dz = F(z_2) - F(z_1).$$



“I studied English for 16 years but...
...I finally learned to speak it in just six lessons”
Jane, Chinese architect

ENGLISH OUT THERE

Click to hear me talking before and after my unique course download



PROOF. Using Theorem 3.3.6, define the indefinite integral

$$G(z) := \int_C f(z) dz,$$

where C goes from z_1 to z , thus $G(z_1) = 0$. Since $F(z_1)$ is a constant, $F(z) - F(z_1)$ is an indefinite integral, which also has the value 0 at z_1 . Hence they are equal, so

$$G(z) = \int_C f(z) dz = F(z) - F(z_1).$$

Finally, choose z_2 as the endpoint of C , and the theorem follows. \square

Example 3.3.4 Let $n \in \mathbb{Z} \setminus \{-1\}$. Then $F(z) = \frac{1}{n+1} z^{n+1}$ is analytic in $\Omega = \mathbb{C}$ for $n \in \mathbb{N}_0$, and in $\Omega = \mathbb{C} \setminus \{0\}$ if $n \leq -2$.

Clearly, $f(z) = F'(z) = z^n$ for $z \in \Omega$, so it follows from Theorem 3.3.7 that

$$\int_C z^n dz = \frac{1}{n+1} z_2^{n+1} - \frac{1}{n+1} z_1^{n+1}, \quad n \in \mathbb{Z}, \text{quadn} \neq -1,$$

as expected, where C as usual is a piecewise differential curve from z_1 to z_2 lying in Ω . In particular,

$$\oint_C z^n dz = 0 \quad \text{for } n \in \mathbb{Z} \setminus \{-1\}$$

for any closed curve in the domain of the integrand. Therefore, the only exception is $n = -1$, for which we found in Theorem 2.5.1 the important result

$$\oint_{|z|=1} \frac{1}{z} dz = 2\pi i. \quad \diamond$$

Example 3.3.5 It follows from Example 3.2.1 that the function $f(z) = \frac{1}{z}$ in the open and simply connected domain $\Omega = \mathbb{C} \setminus \{\mathbb{R}_- \cup \{0\}\}$ has the *principal logarithm* $\text{Log } z$ as an indefinite integral. Now, $\text{Log } 1 = \ln 1 + i \cdot 0 = 0$, so we get from Theorem 3.3.7 that

$$\text{Log } z = \int_C \frac{1}{z} dz = \int_1^z \frac{1}{\zeta} d\zeta,$$

where C is any piecewise differential curve lying in Ω starting at 1 and ending at z . \diamond

3.4 Cauchy's integral formula

In Example 3.3.1 and Example 3.3.3 we used a rather clumsy method to compute line integrals of the form $\oint_C f(z) dz$, where $f(z)$ is not defined everywhere inside the curve C . It follows from Example 3.3.4 that

$$\oint_{|z|=1} z^n dz = \begin{cases} 0 & \text{for } n \in \mathbb{Z} \setminus \{-1\}, \\ 2\pi i & \text{for } n = -1. \end{cases}$$

It does look like we might exploit this result in order to get a more streamlined solution procedure. This is one of the ideas behind the following theorem, so one should not be surprised that this construction occurs in the proof.

Theorem 3.4.1 Cauchy's integral formula. *Given an analytic function $f(z)$ in an open domain Ω . Let C be composed of simple closed and piecewise differentiable curves in Ω with their orientations chosen such that every point inside C belongs to Ω . Let $z_0 \in \Omega$ be any point inside C . Then*

$$(90) \quad f(z_0) = \frac{1}{2\pi i} \int_C \frac{f(z)}{z - z_0} dz.$$

Remark 3.4.1 It is a strange phenomenon that the value of an analytic function $f(z)$ at a point z_0 inside C is expressed only by the values of $f(z)$ on C and then of course by the point z_0 itself. In other words, if we only know the values of an analytic function $f(z)$ on a closed curve C , then we can reconstruct $f(z)$ by (90) at every point inside C . This shows once more that the analyticity of a function is a very strong property.

We should also mention that if z_0 instead lies *outside* C , then $\frac{f(z)}{z - z_0}$ is analytic everywhere inside and on C , so it follows from Theorem 3.3.4, i.e. Cauchy's integral theorem for multiply connected domains, that

$$\frac{1}{2\pi i} \int_C \frac{f(z)}{z - z_0} dz = 0 \quad \text{for } z_0 \text{ outside } C.$$

Therefore, (90) cannot be used to reconstruct $f(z)$ outside the curve C . \diamond

PROOF. Let Ω denote the open set inside C , i.e. Ω is bounded and has C as its boundary, and the curve segments of C are oriented such that Ω lies to the left of C .

Let $z_0 \in \Omega$. Since Ω is open, there exists an $R > 0$, such that

$$B(z_0, R) = \{z \in \mathbb{C} \mid |z - z_0| < R\} \subseteq \Omega.$$

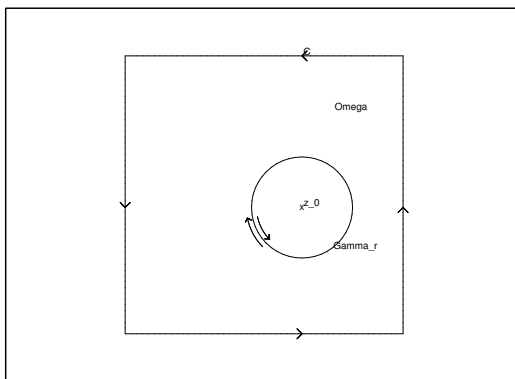

Figure 24: Integration paths in the proof of Cauchy's integral formula.

Let Γ_r denote the curve $|z - z_0| = r$ for $0 < r < R$ with positive orientation. Then $C - \Gamma_r$ is the boundary of a multiply connected domain, in which

$$0 = \int_{C - \Gamma_r} \frac{f(z)}{z - z_0} dz = \int_C \frac{f(z)}{z - z_0} dz - \oint_{\Gamma_r} \frac{f(z)}{z - z_0} dz,$$

hence

$$(91) \quad \int_C \frac{f(z)}{z - z_0} dz = \oint_{\Gamma_r} \frac{f(z)}{z - z_0} dz \quad \text{for all } r \in]0, R[.$$

The function $f(z)$ is analytic, thus the limit

$$f'(z_0) = \lim_{z \rightarrow z_0} \frac{f(z) - f(z_0)}{z - z_0}$$

exists and is finite. In particular, there is a constant $k > 0$, such that

$$(92) \quad \left| \frac{f(z) - f(z_0)}{z - z_0} \right| < k \quad \text{when } 0 < |z - z_0| < \frac{R}{2}.$$

For any $r \in \left]0, \frac{R}{2}\right[$ we get from (91) that

$$(93) \quad \int_C \frac{f(z)}{z - z_0} dz = \oint_{\Gamma_r} \frac{f(z)}{z - z_0} dz = f(z_0) \oint_{\Gamma_r} \frac{dz}{z - z_0} + \oint_{\Gamma_r} \frac{f(z) - f(z_0)}{z - z_0} dz.$$

Here

$$f(z_0) \oint_{\Gamma_r} \frac{dz}{z - z_0} = f(z_0) \oint_{|z - z_0| = r} \frac{dz}{z - z_0} = f(z_0) \oint_{|w| = 1} \frac{dw}{w} = 2\pi i \cdot f(z_0),$$

or, *alternatively* by using the parametric description $z - z_0 = r e^{i\Theta}$ with $dz = i r e^{i\Theta} d\Theta$, $\Theta \in [0, 2\pi]$,

$$f(z_0) \oint_{\Gamma_r} \frac{dz}{z - z_0} = f(z_0) \int_0^{2\pi} \frac{i r e^{i\Theta}}{r e^{i\Theta}} d\Theta = 2\pi i \cdot f(z_0).$$

Concerning the second integral of (93) we use the estimate (68) for $0 < r < \frac{R}{2}$, which by (92) gives

$$\left| \oint_{\Gamma_r} \frac{f(z) - f(z_0)}{z - z_0} dz \right| \leq k \cdot 2\pi r \rightarrow 0 \quad \text{for } r \rightarrow 0+.$$

Since the line integral of (90) does not depend on r , we get from (93) by letting $r \rightarrow 0+$,

$$\begin{aligned} \int_C \frac{f(z)}{z - z_0} dz &= 2\pi i \cdot f(z_0) + \oint_{\Gamma_r} \frac{f(z) - f(z_0)}{z - z_0} dz \\ &= 2\pi i \cdot f(z_0) + \lim_{r \rightarrow 0+} \oint_{\Gamma_r} \frac{f(z) - f(z_0)}{z - z_0} dz = 2\pi i \cdot f(z_0), \end{aligned}$$

and the theorem follows. \square

If we in particular choose $C = \Gamma_r$ in (90) with the parametric description $z = z_0 + r e^{i\Theta}$ for $\Theta \in [0, 2\pi]$, then we get

$$f(z_0) = \frac{1}{2\pi i} \oint_{\Gamma_r} \frac{f(z)}{z - z_0} dz = \frac{1}{2\pi i} \int_0^{2\pi} \frac{f(z_0 + r e^{i\Theta})}{r e^{i\Theta}} \cdot i r e^{i\Theta} d\Theta = \frac{1}{2\pi} \int_0^{2\pi} f(z_0 + r e^{i\Theta}) d\Theta,$$

so we have proved

Corollary 3.4.1 The mean value theorem. Let $f(z)$ be an analytic function defined in an open domain Ω . If $z_0 \in \Omega$, then

$$(94) \quad f(z_0) = \frac{1}{2\pi} \int_0^{2\pi} f(z_0 + re^{i\Theta}) d\Theta \quad \text{for all } r \in]0, r_0],$$

where $B[z_0, r_0] \subseteq \Omega$. In other words, the value $f(z_0)$ is the mean value of $f(z)$ along the circle $|z - z_0| = r \leq r_0$.

The following important consequence of Cauchy's integral formula is at this stage not at all obvious.

Theorem 3.4.2 Every analytic function f defined in an open domain Ω is complex differentiable of any order in Ω .

If C is a composite curve with a well-defined interior ω (i.e. lying to the left of C), such that $\omega \cup C \subset \Omega$, then for every $z \in \omega$,

$$(95) \quad f^{(n)}(z) = \frac{n!}{2\pi i} \int_C \frac{f(\zeta)}{(\zeta - z)^{n+1}} d\zeta, \quad n \in \mathbb{N}_0.$$

Excellent Economics and Business programmes at:



**university of
 groningen**



**“The perfect start
 of a successful,
 international career.”**

CLICK HERE
 to discover why both socially
 and academically the University
 of Groningen is one of the best
 places for a student to be

www.rug.nl/feb/education



Remark 3.4.2 Note that (95) is obtained from (90) by replacing z by ζ , and then z_0 by z , and finally differentiate the result under the integral sign with respect to z , which here is considered as a parameter, because we integrate with respect to ζ . \diamond

PROOF. The first step goes as in the proof of Cauchy's integral formula, i.e. for every given $z \in \omega$ there is an $R > 0$, such that (91) is fulfilled, i.e.

$$\int_C \frac{f(\zeta)}{\zeta - z} d\zeta = \oint_{\Gamma_r} \frac{f(\zeta)}{\zeta - z} d\zeta \quad \text{for all } r \in]0, R[.$$

We keep $z \in \omega$ and $R > 0$ fixed in the following, and choose any $r \in \left]0, \frac{R}{2}\right[$. If $h \in \mathbb{C}$ is chosen such that $0 < |h| < r$, then both z and $z + h$ lie inside Γ_r , so by (90),

$$f(z) = \frac{1}{2\pi i} \oint_{\Gamma_r} \frac{f(\zeta)}{\zeta - z} d\zeta \quad \text{and} \quad f(z+h) = \frac{1}{2\pi i} \oint_{\Gamma_r} \frac{f(\zeta)}{\zeta - (z+h)} d\zeta.$$

We shall check the complex differentiability, so we consider the usual differential quotient, noting that $(z+h) - z = h$,

$$\begin{aligned} \frac{f(z+h) - f(z)}{h} &= \frac{1}{2\pi i} \int_C f(\zeta) \cdot \frac{1}{h} \left\{ \frac{1}{\zeta - (z+h)} - \frac{1}{\zeta - z} \right\} d\zeta \\ (96) \qquad &= \frac{1}{2\pi i} \int_C \frac{f(\zeta)}{\{\zeta - (z+h)\}\{\zeta - z\}} d\zeta, \end{aligned}$$

where we for technical reasons later on have changed Γ_r back to C . We want to prove that (96) for $h \rightarrow 0$ in \mathbb{C} converges towards (95) for $n = 1$, i.e. we want to prove that

$$f'(z) = \frac{1}{2\pi i} \int_C \frac{f(\zeta)}{(\zeta - z)^2} d\zeta.$$

It suffices to prove that their difference converges towards 0 for $h \rightarrow 0$ in \mathbb{C} . We get

$$\begin{aligned} \frac{f(z+h) - f(z)}{h} - f'(z) &= \frac{1}{2\pi i} \int_C f(\zeta) \cdot \left\{ \frac{1}{\{\zeta - (z+h)\}\{\zeta - z\}} - \frac{1}{(\zeta - z)^2} \right\} d\zeta \\ (97) \qquad &= \frac{1}{2\pi i} \int_C f(\zeta) \cdot \frac{h}{\{\zeta - (z+h)\}(\zeta - z)^2} d\zeta. \end{aligned}$$

The trick of using C instead of Γ_r implies that since every $\zeta \in C$ lies outside Γ_R , we have the estimate

$$|\{\zeta - (z+h)\}(\zeta - z)^2| > R^2 \cdot \frac{R}{2} = \frac{1}{2} R^3 \quad \text{for } \zeta \in C,$$

for the denominator, so we get the following estimate of (97),

$$\left| \frac{f(z+h) - f(z)}{h} - f'(z) \right| \leq \frac{1}{2\pi} \sup_{\zeta \in C} |f(\zeta)| \cdot \frac{1}{R^3} \cdot |h| \cdot \ell(C) \rightarrow 0 \quad \text{for } h \rightarrow 0,$$

and we conclude that $f'(z)$ exists and is given by (95) for $n = 1$.

The general result is then proved by induction in the following way:

Assume that (95) holds for $n = 1$, i.e.

$$f^{(n-1)}(z) = \frac{(n-1)!}{2\pi i} \int_C \frac{f(\zeta)}{(\zeta-z)^n} d\zeta.$$

When we repeat the previous argument for $n = 1$, we find the difference quotient

$$\frac{f^{(n-1)}(z+h) - f^{(n-1)}(z)}{h} = \frac{(n-1)!}{2\pi i} \int_C f(\zeta) \cdot \frac{1}{h} \left\{ \frac{1}{\{\zeta - (z+h)\}^n} - \frac{1}{(\zeta-z)^n} \right\} d\zeta.$$

For every fixed ζ , the function $\frac{1}{(\zeta-z)^n}$ has the derivative $\frac{n}{(\zeta-z)^{n+1}}$ with respect to z . The idea is again to consider the difference

$$(98) \quad \frac{1}{h} \left\{ \frac{1}{\{\zeta - (z+h)\}^n} - \frac{1}{(\zeta-z)^n} \right\} - \frac{n}{(\zeta-z)^{n+1}},$$

and then estimate the corresponding line integral along C . A straightforward computation of (98) does not look promising, unless we introduce the simplifications

$$A = \zeta - z \quad \text{and} \quad B = \zeta - (z+h), \quad \text{thus } h = A - B.$$

Then (98) becomes

$$\begin{aligned} \frac{B^{-n} - A^{-n}}{A - B} - nA^{-n-1} &= \frac{1}{A^n B^n} \cdot \frac{A^n - B^n}{A - B} - nA^{-n-1} = \frac{1}{A^{n+1} B^n} \left\{ A \frac{A^n - B^n}{A - B} - nB^n \right\} \\ &= \frac{1}{A^{n+1} B^n} \{A^n + A^{n-1}B + \dots + AB^{n-1} - nB^n\} \\ &= \frac{1}{A^{n+1} B^n} \{(A^n - B^n) + (A^{n-1} - B^{n-1})B + \dots + (A - B)B^{n-1}\} \\ &= \frac{A - B}{A^{n+1} B^n} \{(A^{n-1} + A^{n-2}B + \dots + B^{n-1}) + (A^{n-2} + \dots + B^{n-2})B + \dots + B^{n-1}\} \\ &= \frac{h}{A^{n+1} B^n} \{A^{n-1} + 2A^{n-1}B + \dots + nB^{n-1}\}. \end{aligned}$$

The integration path C is bounded, so there is a constant $k \in \mathbb{R}_+$, such that

$$|\zeta - z| = |A| < k \quad \text{and} \quad |\zeta - (z+h)| = |B| < k \quad \text{for all } \zeta \in C.$$

We proved previously that also

$$|\zeta - z| > R \quad \text{and} \quad |\zeta - (z+h)| > \frac{1}{2}R \quad \text{for } \zeta \in C,$$

so if the numerator is estimated upwards and the denominator downwards, we increase the absolute value of the quotient,

$$\left| \frac{B^{-n} - A^{-n}}{A - B} - nA^{-n-1} \right| \leq |h| \cdot \frac{1}{R^{n+1}} \cdot \frac{2^n}{R^n} \cdot (1 + 2 + \dots + n)k^{n-1} = k_n \cdot |h|,$$

where k_n is a fixed constant, only depending on n , k and R . Then we get as previously,

$$\left| \frac{f^{(n-1)}(z+h) - f^{(n-1)}(z)}{h} - \frac{n!}{2\pi i} \int_C \frac{f(\zeta)}{(\zeta-z)^{n+1}} d\zeta \right| \leq \frac{(n-1)!}{2\pi} \sup_{\zeta \in C} |f(\zeta)| \cdot k_n \cdot |h| \cdot \ell(C) \rightarrow 0 \text{ for } h \rightarrow 0,$$

and it follows that

$$\frac{f^{(n-1)}(z+h) - f^{(n-1)}(z)}{h} \rightarrow \frac{n!}{2\pi i} \int_C \frac{f(\zeta)}{(\zeta-z)^{n+1}} d\zeta = f^{(n)}(z) \quad \text{for } h \rightarrow 0,$$

so f is n times complex differentiable at every z inside C .

Since $n \in \mathbb{N}$ is arbitrary, $f \in C^\infty$ inside C , and $f^{(n)}(z)$, $n \in \mathbb{N}$, is given by (95).

Note that if $n = 0$, then (95) is reduced to (90).

Since Ω is an open domain, we can to every $z \in \Omega$ find an $r = r_z > 0$, such that $B[z, r_z] \subset \Omega$. By finally choosing $C = \Gamma_r$, we conclude that $f \in C^\infty$ in Ω . \square

From Theorem 3.4.2 follows the following unexpected result, which again shows that being analytic is really a strong property of a function.

Corollary 3.4.2 *If a continuous function f has an indefinite integral on an open domain Ω , then f is analytic in Ω .*

PROOF. It follows from the assumption that there exists an analytic function $F(z)$, such that

$$F'(z) = f(z) \quad \text{in } \Omega.$$

It follows from Theorem 3.4.2 that $F(z)$ is differentiable of any order $n \in \mathbb{N}$, hence the same must be true for $f(z)$. In particular, $f'(z)$ is continuous, so $f(z)$ is analytic. \square

By Theorem 3.3.6 a continuous function f on an open and simply connected set Ω has an indefinite integral, if and only if the line integral along any closed and piecewise differentiable curve C in Ω is 0. We therefore obtain the following improvement of Theorem 3.3.3, where we no longer have to assume that u and v are of class C^1 .

Theorem 3.4.3 Morera's theorem. *Let $f : \omega \rightarrow \mathbb{C}$ be continuous on the open domain Ω . If for every open simply connected subset $\Omega_0 \subseteq \Omega$ and every closed and piecewise differentiable curve C in Ω_0 ,*

$$(99) \quad \oint_C f(z) dz = 0,$$

then f is analytic in Ω .

It is remarkable that even if we only assume that f is continuous, the assumption (99) for all such curves C nevertheless implies that f is (complex) differentiable of every order $n \in \mathbb{N}$.

Morera's theorem above then implies the next important result.

Theorem 3.4.4 (Karl Weierstraß, about 1860). *Let (f_n) be a sequence of analytic functions in an open domain Ω . Assume that (f_n) is uniformly convergent on every compact subset of Ω . Then the limit function f is analytic in Ω , and the sequence (f'_n) of its derivatives converges pointwise towards f' in Ω , and uniformly on every compact subset of Ω .*

Remark 3.4.3 By repeating Theorem 3.4.4 we conclude under the given assumptions that for every fixed $k \in \mathbb{N}$, the sequence $(f_n^{(k)})$ converges pointwise towards $f^{(k)}$ in Ω , and uniformly on every compact subset of Ω . \diamond

PROOF. The real sequences $\{\Re f_n\}$ and $\{\Im f_n\}$ are uniformly convergent on every compact subset of Ω , hence their limit functions, $\Re f$ and $\Im f$, are both continuous on Ω , because every point $(x, y) \in \Omega$ is a also compact set. Thus, the complex limit function f exists and is continuous in Ω .

American online

LIGS University

is currently enrolling in the
Interactive Online **BBA, MBA, MSc,**
DBA and PhD programs:

- ▶ enroll **by September 30th, 2014** and
- ▶ **save up to 16%** on the tuition!
- ▶ pay in 10 installments / 2 years
- ▶ Interactive **Online education**
- ▶ visit www.ligsuniversity.com to find out more!

Note: LIGS University is not accredited by any nationally recognized accrediting agency listed by the US Secretary of Education. More info [here](#).



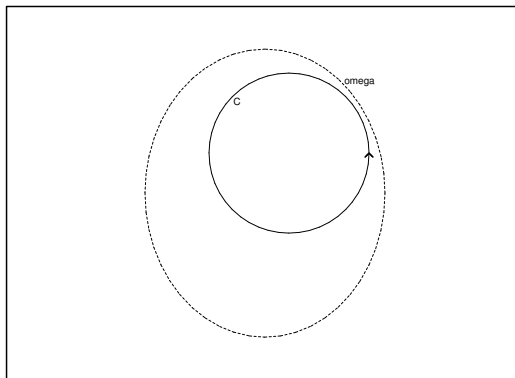

Figure 25: A closed integration path C in ω .

Let ω be an open disc in Ω , and let C be any closed and piecewise differentiable curve in ω . Clearly, ω is simply connected, so

$$\oint_C f_n(z) dz = 0 \quad \text{for all } n \in \mathbb{N}.$$

The bounded and closed curve C is also *compact* as a set (cf. Theorem 2.1.2), so we get the estimate

$$\left| \oint_C f(z) dz - \oint_C f_n(z) dz \right| = \left| \oint_C \{f(z) - f_n(z)\} dz \right| \leq \sup_{z \in C} |f(z) - f_n(z)| \cdot \ell(C),$$

where $\sup_{z \in C} |f(z) - f_n(z)| \rightarrow 0$ for $n \rightarrow +\infty$, because (f_n) converges uniformly towards f on C . Therefore, this difference tends towards 0 for $n \rightarrow +\infty$, and we have shown that

$$\oint_C f(z) dz = \lim_{n \rightarrow \infty} \oint_C f_n(z) dz = 0$$

for every such curve C in ω . By Morera's theorem, f is then analytic in ω , and hence also in Ω , because ω was chosen as any open disc in Ω .

Choose any $z_0 \in \Omega$, and then an $R > 0$, such that $B[z_0, R] \subseteq \Omega$. Let Γ_r in general denote the circle $|z - z_0| = r$ of positive orientation. Choose $C := \Gamma_R$ and any other Γ_r , where $0 < r < R$.

If $z \in B(z_0, R)$, then it follows from Theorem 3.4.2 that

$$f'(z) = \frac{1}{2\pi i} \oint_C \frac{f(\zeta)}{(\zeta - z)^2} d\zeta \quad \text{and} \quad f'_n(z) = \frac{1}{2\pi i} \oint_C \frac{f_n(\zeta)}{(\zeta - z)^2} d\zeta,$$

so

$$|f'(z) - f'_n(z)| = \left| \frac{1}{2\pi i} \oint_C \{f(\zeta) - f_n(\zeta)\} \cdot \frac{1}{(\zeta - z)^2} d\zeta \right|,$$

where we have obtained that the differentiation with respect to z does not occur on the right hand side of this equation.

In the estimation of this difference we make the denominator smaller, $|\zeta - z| \geq R - r$ for all $\zeta \in C$ and all $z \in \Gamma_r$. Thus,

$$\sup_{z \in \Gamma_r} |f'(z) - f'_n(z)| \leq \frac{1}{2\pi} \cdot \frac{2\pi R}{(R-r)^2} \cdot \sup_{\zeta \in C} |f(\zeta) - f_n(\zeta)| \rightarrow 0 \quad \text{for } n \rightarrow +\infty,$$

because $f_n(\zeta) \rightarrow f(\zeta)$ uniformly in $\zeta \in C$. It follows that $f'_n(z) \rightarrow f'(z)$ uniformly for $n \rightarrow +\infty$ on every Γ_r for every $r \in]0, R[$. We even conclude that $f'_n(z) \rightarrow f'(z)$ uniformly on every closed disc $B[z_0, r]$, $r \in]0, R[$, because $\frac{1}{2\pi} \cdot \frac{2\pi R}{(R-r)^2}$ increases, when $r (< R)$ increases.

Finally, let K be any compact subset of Ω . To every $z \in K$ there is an $R_z > 0$, such that $B[z, R_z] \subset \Omega$. Putting $r_z = \frac{1}{2}R_z$ we see that $\{B(z, r_z) \mid z \in K\}$ is an open covering of K . Then extract a *finite* covering from this covering, i.e. there are finitely many points $z_1, \dots, z \in K$ with (change of notation) $r_{z_j} = r_j$, such that

$$K \subset \bigcup_{j=1}^p B(z_j, r_j) \subset \bigcup_{j=1}^p B[z_j, r_j] \subset \Omega.$$

It follows from the above that $f'_n(z) \rightarrow f'(z)$ uniformly for $n \rightarrow +\infty$ on every $B[z_j, r_j]$, hence also on every *finite* union of such closed discs, and we have proved that the convergence is uniform on every compact subset K of Ω . \square

Theorem 3.4.4 is often applied on convergent series of analytic functions, where we must replace the term f_n by the n -th section $s_n := \sum_{j=1}^n f_j$ of the series. Then

Corollary 3.4.3 *Let $\{f_n\}$ be a sequence of analytic functions on an open domain Ω . Assume that the series*

$$f(z) = \sum_{n=1}^{+\infty} f_n(z)$$

is pointwise convergent in Ω , and uniformly convergent on every compact subset of Ω . Then $f(z)$ is analytic in Ω , and $f'(z)$ is given by termwise differentiation of the series

$$(100) \quad f'(z) = \sum_{n=1}^{+\infty} f'_n(z),$$

which is pointwise convergent in Ω , and uniformly convergent on every compact subset of Ω .

PROOF. A series is (uniformly) convergent, if and only if its sectional sequence (s_n) is (uniformly) convergent, where

$$s_n(z) = \sum_{j=1}^n f_j(z), \quad \text{and} \quad s'_n(z) = \sum_{j=1}^n f'_j(z),$$

because these sums are finite. Then the corollary follows immediately from Theorem 3.4.4. \square

Let $f : \Omega \rightarrow \mathbb{C}$ be analytic in an open domain Ω . If $z_0 \in \Omega$, then we can choose $r > 0$, such that $B[z_0, r] \subset \Omega$, and we get by Theorem 3.4.2,

$$f^{(n)}(z_0) = \frac{n!}{2\pi i} \oint_{|z-z_0|=r} \frac{f(z)}{(z-z_0)^{n+1}} dz,$$

from which we get the estimate

$$\left| f^{(n)}(z_0) \right| \leq \frac{n!}{2\pi} \cdot \frac{1}{r^{n+1}} \sup_{|z-z_0|=r} |f(z)| \cdot 2\pi r = \frac{n!}{r^n} \sup_{|z-z_0|=r} |f(z).$$

Thus we have proved

Theorem 3.4.5 Cauchy's inequalities. *Let $f(z)$ be analytic in a domain containing the closed disc $B[z_0, r]$. Let*

$$M_r = \sup_{|z-z_0|=r} |f(z)|$$

denote the maximum of $|f(z)|$ on the circle $|z - z_0| = r$. Then

$$(101) \quad \left| f^{(n)}(z_0) \right| \leq M_r \cdot \frac{n!}{r^n} \quad \text{for every } n \in \mathbb{N}_0,$$

which can be rewritten as

$$(102) \quad \frac{|f^{(n)}(z_0)|}{n!} \cdot r^n \leq M_r \quad \text{for every } n \in \mathbb{N}_0.$$

Remark 3.4.4 Roughly speaking, (101) and (102) mean that the sequence $(f^{(n)}(z_0))$ of the derivatives of an analytic function f at a point z_0 cannot increase too much. This is contrasting the real case, because there are functions $f \in C^\infty(\mathbb{R})$, which do not fulfill an analogue of (101), where we put

$$M_r = \max\{|f(x_0 - r)|, |f(x_0 + r)|\}, \quad r > 0.$$

Such real C^∞ functions cannot be extended to analytic functions, and we see once again that there is a big difference between a real function being infinitely often real differentiable, and a complex function being infinitely often complex differentiable. \diamond

3.5 Simple applications in Hydrodynamics

Consider a non-compressible fluid with a flow over an open domain Ω of the (x, y) plane. The fluid is then described by its *velocity field* $\vec{V}(x, y)$, where we conventionally write

$$(103) \quad \vec{V}(x, y) = (u, -v) = (u(x, y), -v(x, y)), \quad u, v \in C^1(\Omega).$$

We notice the change of sign on the second component of \vec{V} . This will be explained later on.

Assume that there are neither sources nor sinks for the flow in Ω . Then it follows by the classical *Gauß's theorem* for every subset $\omega \subset \Omega$ that

$$(104) \quad \iint_{\omega} \operatorname{div} \vec{V} \, dx \, dy = 0.$$

By letting the domain ω shrink to the point $(x, y) \in \Omega$ we get by this limit process that

$$(105) \quad \operatorname{div} \vec{V} = \frac{\partial u}{\partial x} - \frac{\partial v}{\partial y} = 0,$$

so the field \vec{V} is *divergence free*.

It follows for such divergence free velocity fields of the type (103) that the first one of Cauchy-Riemann's equations

$$\frac{\partial u}{\partial x} = \frac{\partial v}{\partial y}$$

is fulfilled. This is the reason for the choice of the sign in (103).

DON'T EAT YELLOW SNOW

What will your advice be?

Some advice just states the obvious. But to give the kind of advice that's going to make a real difference to your clients you've got to listen critically, dig beneath the surface, challenge assumptions and be credible and confident enough to make suggestions right from day one. At Grant Thornton you've got to be ready to kick start a career right at the heart of business.

Sound like you? Here's our advice: visit GrantThornton.ca/careers/students

Scan here to learn more about a career with Grant Thornton.



 **Grant Thornton**
An instinct for growth™

© Grant Thornton LLP. A Canadian Member of Grant Thornton International Ltd

If the field $\vec{V} = (u, -v)$ is also *rotation free*, i.e.

$$-\frac{\partial u}{\partial y} - \frac{\partial v}{\partial x} = 0,$$

then the second one of Cauchy-Riemann's equations is also satisfied in Ω .

Hence for a divergence free and rotation free velocity field $\vec{V} = (u, -v)$, the pair of functions (u, v) satisfies Cauchy-Riemann's equations, so the corresponding complex function

$$f(z) = u(x, y) + iv(x, y)$$

is an analytic function.

Such flows are called *potential flows*, and we have proved

Theorem 3.5.1 *Let $\vec{V} = (u(x, y), -v(x, y))$ be a C^1 velocity field, which is divergence free and rotation free in an open domain Ω in the real plane. Then $f(z) = u + iv$ is an analytic function in Ω . Conversely, if $f(z) = u + iv$ is analytic in Ω , then the field $\vec{V} := (u, -v)$ defines a divergence free and rotation free flow in Ω .*

The application of any mathematical theory in any of the technical sciences may only be considered as an *ideal model* of what really happens. The engineers must never forget the limitations of such models. For instance, it will be very difficult in practice to find any field which is rotation free. However, if the flow is very slow, one may still successfully make this assumption, which reduces the analysis to *Complex Functions Theory*. Examples of such slow flows are the flow of water in the soil near a network of drainpipes, or the diffusion of chloride ions into concrete pillars in salty waters.

However, even if the velocity field is not rotation free, one may still in some cases get reasonable results by assuming that this is the case. This was indeed the case in Joukowski's first investigation of the velocity field around a wing of an aeroplane, where no one would believe that the flow is rotation free. In spite of this fact, Joukowski obtained reasonable results.

If Ω is connected and the field $\vec{V}(x, y) = (u, -v)$ is *divergence free* and *rotation free* in Ω , then Theorem 3.5.1 provides us with an analytic function $f(z) = u + iv$ in Ω . 3mm

If Ω is also *simply connected*, then $f(z)$ has an indefinite integral $F(z)$ which – apart from an arbitrary complex constant – is uniquely determined,

$$(106) \quad F(z) = \varphi(x, y) + i\psi(x, y) + c, \quad c \in \mathbb{C} \text{ arbitrary.}$$

Then we get by Cauchy-Riemann's equations,

$$F'(z) = \frac{\partial \varphi}{\partial x} + i \frac{\partial \psi}{\partial x} = \frac{\partial \varphi}{\partial x} - i \frac{\partial \varphi}{\partial y} = f(z) = u + iv,$$

thus

$$\frac{\partial \varphi}{\partial x} = u \quad \text{and} \quad \frac{\partial \varphi}{\partial y} = -v,$$

and whence

$$(107) \quad \overrightarrow{\text{grad}} \varphi = (u, -v) = \vec{V}.$$

Due to the analysis above, the function $\varphi(x, y) = \Re F(z)$ is also called the *velocity potential* of the flow, and the underlying analytic function $F(z)$ [any indefinite integral of $f(z)$] is called the *complex potential*. It follows from

$$(108) \quad \overline{F'(z)} = \frac{\partial \varphi}{\partial x} + i \frac{\partial \varphi}{\partial y} = u - iv \sim \vec{V},$$

that *the complex conjugated of the derivative of a complex potential is equivalent to the velocity field*.

Finally, assuming that $\vec{V}(x, y) \neq \vec{0}$ it follows from Cauchy-Riemann's equations that

$$|F'(z)|^2 = |f(z)|^2 = \left\{ \frac{\partial \varphi}{\partial x} \right\}^2 + \left\{ \frac{\partial \varphi}{\partial y} \right\}^2 = \left\{ \frac{\partial \psi}{\partial x} \right\}^2 = u^2 + v^2 = |\vec{V}|^2 \neq 0,$$

so $\overrightarrow{\text{grad}} \varphi \neq \vec{0}$ and $\overrightarrow{\text{grad}} \psi \neq \vec{0}$.

Using Cauchy-Riemann's equations once more it follows that

$$\overrightarrow{\text{grad}} \varphi \cdot \overrightarrow{\text{grad}} \psi = \left(\frac{\partial \varphi}{\partial x}, \frac{\partial \varphi}{\partial y} \right) \cdot \left(\frac{\partial \psi}{\partial x}, \frac{\partial \psi}{\partial y} \right) = \left(\frac{\partial \varphi}{\partial x}, \frac{\partial \varphi}{\partial y} \right) \cdot \left(-\frac{\partial \varphi}{\partial y}, \frac{\partial \varphi}{\partial x} \right) = 0.$$

This proves that the vector fields $\overrightarrow{\text{grad}} \varphi$ and $\overrightarrow{\text{grad}} \psi$ are perpendicular to each other at every point (x, y) , in which $\vec{V}(x, y) \neq \vec{0}$.

The curves $\varphi(x, y) = \text{constant}$ are called the *equipotential curves* or the *potential lines* of the flow. They are perpendicular to the velocity field $\overrightarrow{\text{grad}} \varphi$ at every point, thus their tangent field is given by $\overrightarrow{\text{grad}} \psi$.

The curves $\psi(x, y) = \text{constant}$ are called the *streamlines*. They have the velocity field $\vec{V} = \overrightarrow{\text{grad}} \varphi$ as their tangent field.

4 Some elementary analytic functions

In this chapter we review the simplest elementary analytic functions, namely the *polynomials*, the *rational functions*, the *exponential*, and the *trigonometric* and *hyperbolic functions*. These are also the most important analytic functions, and they occur again and again in the applications.

4.1 Polynomials

A complex *polynomial* $P(z)$ is a function of the form

$$(109) \quad P(z) = a_n z^n + a_{n-1} z^{n-1} + \cdots + a_1 z + a_0, \quad z \in \mathbb{C},$$

where a_0, \dots, a_n are complex constants with the coefficient $a_n \neq 0$ of the term of largest $n \in \mathbb{N}$, where we call this $n \in \mathbb{N}$ the *degree* of the polynomial. Thus, the polynomials are finite linear combinations of the simple power functions z^k , $k \in \mathbb{N}$.

We add to the class of all polynomials the *zero polynomial* $P(z) \equiv 0$, in which case all the coefficients are zero, so the zero polynomial is formally not included in the definition above. It is customary to give the zero polynomial the degree $-\infty$. If we multiply two polynomials of degree m and n , respectively, then the product is a polynomial of degree $m+n$. This is obvious for $m > 0$ and $n > 0$, and we see that since $n - \infty = -\infty$ it also holds if one of the polynomials is the zero polynomial.

We have already shown in Example 3.1.1 that z^n is analytic with the derivative nz^{n-1} for $n \in \mathbb{N}$, and that a constant $c = c \cdot z^0$ has 0 as its derivative. By the linearity described in Theorem 3.1.1 follows that (109) is analytic with the obvious derivative

$$P'(z) = na_n z^{n-1} + (n-1)a_{n-1} z^{n-2} + \cdots + 2a_2 z + a_1.$$

The most important result on polynomials is the *Fundamental Theorem of Algebra*, which in one of its forms states that any polynomial $P(z)$ of degree $n \in \mathbb{N}$ has precisely n roots, when these are counted by their multiplicity. Hence, (109) can also be written as a factorization,

$$(110) \quad P(z) = a_n z^n + a_{n-1} z^{n-1} + \cdots + a_1 z + a_0 = a_n (z - \zeta_1)^{p_1} \cdots (z - \zeta_k)^{p_k},$$

where $\zeta_1, \dots, \zeta_k \in \mathbb{C}$ are the k different roots of $P(z)$, where the power $p_j \geq 1$ of $(z - \zeta_j)^{p_j}$ is the multiplicity of the root ζ_k , and where $p_1 + \cdots + p_k = n$ is the degree of the polynomial.

We shall now prove this result. It will follow from

Theorem 4.1.1 Liouville's Theorem. *Every bounded analytic function defined on all of \mathbb{C} is a constant.*

PROOF. Assume that f is analytic and bounded in \mathbb{C} , e.g. $|f(z)| \leq M$ for all $z \in \mathbb{C}$. Choose any $z_0 \in \mathbb{C}$ and any $r > 0$. Then it follows from *Cauchy's inequalities* that

$$|f'(z_0)| \leq M_r \cdot \frac{1}{r} \leq \frac{M}{r} \rightarrow 0 \quad \text{for } r \rightarrow +\infty.$$

The left hand side is independent of r , so we conclude that $f'(z) \equiv 0$ everywhere in \mathbb{C} , and it follows from Lemma 3.3.1 that $f(z) \equiv c$ is constant. \square

Theorem 4.1.2 The Fundamental Theorem of Algebra. *Every polynomial $P(z)$ of degree $n \geq 1$ has at least one root.*

Remark 4.1.1 Theorem 4.1.2 is not the same version as the one mentioned above. The latter will follow below in Corollary 4.1.1 as an easy consequence of Theorem 4.1.2. \diamond

PROOF. Assume that the polynomial $P(z)$ of degree $n \geq 1$ does not have a root. Then the reciprocal $f(z) := \frac{1}{P(z)}$ is analytic in all of \mathbb{C} . We shall derive a contradiction.

First note that for $z \neq 0$,

$$P(z) = a_n z^n + a_{n-1} z^{n-1} + \cdots + a_1 z + a_0 = a_n z^n \left\{ 1 + \frac{a_{n-1}}{a_n} \cdot \frac{1}{z} + \cdots + \frac{a_0}{a_n} \cdot \frac{1}{z^n} \right\},$$

.....Alcatel-Lucent 

www.alcatel-lucent.com/careers



What if you could build your future and create the future?

One generation's transformation is the next's status quo. In the near future, people may soon think it's strange that devices ever had to be "plugged in." To obtain that status, there needs to be "The Shift".



where clearly

$$1 + \frac{a_{n-1}}{a_n} \cdot \frac{1}{z} + \cdots + \frac{a_0}{a_n} \cdot \frac{1}{z^n} \rightarrow 1 \quad \text{for } z \rightarrow \infty,$$

so

$$|P(z)| \rightarrow +\infty \quad \text{for } z \rightarrow \infty,$$

and hence

$$f(z) = \frac{1}{P(z)} \rightarrow 0 \quad \text{for } z \rightarrow \infty.$$

It follows from the definition of convergence for $z \rightarrow \infty$ that there exists an R , such that $|f(z)| \leq 1$ for $|z| \geq R$. Furthermore, the closed disc $B[0, R]$ is compact, and $|f(z)|$ is continuous and real, hence $|f(z)|$ has a maximum M in $B[0, R]$. Since $\mathbb{C} = B[0, R] \cup \{\mathbb{C} \setminus B[0, R]\}$, it follows that $|f(z)| \leq \max\{M, 1\}$ in \mathbb{C} , so $f(z)$ is a bounded analytic function. Using Liouville's theorem above it follows that $f(z)$ is a constant, which even must be zero, because we have proved already that $f(z) \rightarrow 0$ for $z \rightarrow \infty$. Hence, $f(z) \equiv 0$ has degree $-\infty$, contradicting the assumption that the degree was $n \geq 1$. We therefore conclude that $P(z)$ has at least one root. \square

Corollary 4.1.1 *Every polynomial $P_n(z)$ of degree $n \geq 1$ has precisely n complex roots, counted by their multiplicity.*

PROOF. We shall prove that we can write $P_n(z)$ in the form (110). First it follows from the *Fundamental Theorem of Algebra* above that $P_n(z)$ has at least one root ζ_1 . This means that ζ_1 is a divisor in $P_n(z)$, so

$$P_n(z) = (z - \zeta_1) P_{n-1}(z),$$

where $P_{n-1}(z)$ is a polynomial of degree $n - 1$. Then repeat this process on $P_{n-1}(z)$, etc.. After n steps we have found precisely n roots and a (constant) polynomial $P_0(z) = a_n \neq 0$ of degree zero, and (110) follows. \square

Clearly, the polynomials form a very important class of analytic functions, and the *Fundamental Theorem of Algebra* also gives us the information of the number of roots. Furthermore, we have already in Section 1.5 given some methods of *finding* these roots, which are useful in the applications. However, in general it is unfortunately not an easy task to find even approximate values of the roots of a polynomial of high degree, a problem which often occurs in engineering applications. There do exist some long forgotten methods to find these roots in general, but it will be too much to include all these methods here.

The observation above is just one of the indications that polynomials may not be so easy to handle as one would think at a first glance. One could easily write a book on polynomials alone collecting relevant and perhaps not so commonly known results for the practical applications in the engineering sciences.

4.2 Rational functions

The *rational functions* are derived from the polynomials. Let $P(z)$ and $Q(z)$ be polynomials without roots in common. Assume that $P(z)$ is not the zero polynomial and that $Q(z)$ is a polynomial of degree ≥ 1 .

A *rational function* $f(z)$ is a quotient

$$(111) \quad f(z) = \frac{P(z)}{Q(z)} \quad \text{for } z \in \{z \in \mathbb{C} \mid Q(z) \neq 0\}$$

of two polynomials as described above, so $f(z)$ is defined in \mathbb{C} with the exception of the finite number of roots of the denominator.

It follows immediately from Example 3.1.1 and Theorem 3.1.1 that a rational function is analytic, and that its derivative is found as in the real case.

General linear fractional transformations

A special case of rational functions is given by the class of *general linear fractional transformations*, also called *Möbius transformations*. These have the structure

$$(112) \quad f(z) := \frac{az + b}{cz + d}, \quad \text{where } \begin{vmatrix} a & b \\ c & d \end{vmatrix} = ad - bc \neq 0,$$

defined in the set $\Omega = \{z \in \mathbb{C} \mid cz + d \neq 0\}$.

If $c = 0$, then $d \neq 0$, and (112) is reduced to a polynomial of degree 1, which we include in this class, and in which case $\Omega = \mathbb{C}$.

If instead $c \neq 0$, then $\Omega = \left\{ z \in \mathbb{C} \mid z \neq -\frac{d}{c} \right\}$.

For completeness we notice that if $\begin{vmatrix} a & b \\ c & d \end{vmatrix} = 0$, then (a, b) and (c, d) are linearly dependent, and since $(c, d) \neq (0, 0)$, there is a constant $\lambda \in \mathbb{C}$, such that $a = \lambda c$ and $b = \lambda d$, so $f(z) = \lambda$ is a constant. This shows that the condition of the determinant in (112) is very natural.

We shall return to the general linear fractional transformations in *Ventus: Complex Functions Theory a-3*.

Decomposition of rational functions

Every rational function $f(z) = \frac{P(z)}{Q(z)}$, where $P(z)$ and $Q(z)$ are polynomials satisfying the usual condition given above, can uniquely be decomposed into a sum of a polynomial and fractions of the type $c_{jk}(z - \zeta_k)^{-j}$, where $(z - \zeta_k)^j$ is a divisor of $Q(z)$. In the applications, such decompositions are usually easier to handle than $f(z)$ itself, so this shows again the importance of finding the roots of the denominator $Q(z)$.

Here we shall describe the procedure of *decomposition*, given that the denominator of degree $m \geq 1$ is *normed*, i.e. the constant $b_m \equiv 1$, and is *factorized*, i.e. it has the structure

$$(113) \quad Q(z) = (z - \zeta_1)^{p_1} \cdots (z - \zeta_k)^{p_k}, \quad \text{where } p_1, \dots, p_k \in \mathbb{N} \text{ and } p_1 + \cdots + p_k = m.$$

Let the *numerator* $P(z)$ be of degree n , where we do not necessarily have to factorize $P(z)$.

If $n \geq m$, then we first divide $P(z)$ by $Q(z)$, giving

$$P(z) = P_1(z)Q(z) + R(z),$$

where $P_1(z)$ is a polynomial of degree $n - m$, and the *remainder* $R(z)$ has degree $< m$. This procedure is well-known from high school, and it is also well-known that when we divide by $Q(z)$ we uniquely obtain

$$(114) \quad \frac{P(z)}{Q(z)} = P_1(z) + \frac{R(z)}{Q(z)}.$$

We must here emphasize the importance first separately to find the polynomial in (114), because otherwise we shall lose it by the following procedure, and the final result becomes wrong.

Once the polynomial $P_1(z)$ has been found, we choose in the remaining part of the procedure the simplest looking of the two polynomials $P(z)$ and $R(z)$ as they both will lead to the same result, which will follow from the proof below.

First it follows from (114) and (113) that

$$(115) \quad \frac{P(z)}{Q(z)} = \frac{P(z)}{(z - \zeta_1)^{p_1} \cdots (z - \zeta_k)^{p_k}} = P_1(z) + \frac{R(z)}{(z - \zeta_1)^{p_1} \cdots (z - \zeta_k)^{p_k}}.$$

We multiply (115) by one of the maximal factors in the denominator, e.g. $(z - \zeta_1)^{p_1}$. Then

$$(116) \quad (z - \zeta_1)^{p_1} \frac{P(z)}{Q(z)} = \frac{P(z)}{(z - \zeta_2)^{p_2} \cdots (z - \zeta_k)^{p_k}} = P_1(z) \cdot (z - \zeta_1)^{p_1} + \frac{R(z)}{(z - \zeta_2)^{p_2} \cdots (z - \zeta_k)^{p_k}}.$$

Clearly, the right hand side of (116) is analytic at $z = \zeta_1$, so we get by taking the limit $z \rightarrow \zeta_1$,

$$(117) \quad \lim_{z \rightarrow \zeta_1} (z - \zeta_1)^{p_1} \cdot \frac{P(z)}{Q(z)} = \frac{P(\zeta_1)}{(\zeta_1 - \zeta_2)^{p_2} \cdots (\zeta_1 - \zeta_k)^{p_k}} = \frac{R(\zeta_1)}{(\zeta_1 - \zeta_2)^{p_2} \cdots (\zeta_1 - \zeta_k)^{p_k}} := a_{1p_1}.$$

In particular, $P(\zeta_1) = R(\zeta_1)$, proving that we shall always get the right coefficient a_{1p_1} , no matter if we choose $P(z)$ or $R(z)$ from the beginning.

We have found a_{1p_1} above. We claim that it is the coefficient of $(z - \zeta_1)^{-p_1}$ in the decomposition. To see this we add and subtract the term $a_{1p_1} (z - \zeta_1)^{-p_1}$ to get

$$(118) \quad \begin{aligned} \frac{P(z)}{Q(z)} &= P_1(z) + \frac{a_{1p_1}}{(z - \zeta_1)^{p_1}} + \frac{R(z)}{(z - \zeta_1)^{p_1} \cdot (z - \zeta_k)^{p_k}} - \frac{a_{1p_1}}{(z - \zeta_1)^{p_1}} \\ &= P_1(z) + \frac{a_{1p_1}}{(z - \zeta_1)^{p_1}} + \frac{R(z) - a_{1p_1} (z - \zeta_1)^{p_2} \cdots (z - \zeta_k)^{p_k}}{(z - \zeta_1)^{p_1} \cdots (z - \zeta_k)^{p_k}}. \end{aligned}$$

We notice in the latter fraction that the numerator

$$R(z) - a_{1p_1} (z - \zeta_1)^{p_2} \cdots (z - \zeta_k)^{p_k}$$

by (117) is a polynomial which is zero for $z = \zeta_1$. Hence

$$R(z) - a_{1p_1} (z - \zeta_1)^{p_2} \cdots (z - \zeta_k)^{p_k} = R_1(z) \cdot (z - \zeta_1)$$

for a polynomial $R_1(z)$, and (118) is reduced to

$$(119) \frac{P(z)}{Q(z)} = P_1(z) + \frac{a_{1p_1}}{(z - \zeta_1)^{p_1}} + \frac{R_1(z)}{(z - \zeta_1)^{p_1-1} (z - \zeta_2)^{p_2} \dots (z - \zeta_k)^{p_k}}.$$

Then repeat the procedure of (116), (117) and (118) on (119) with a multiplication by successively $(z - \zeta_1)^{p_1-1}, \dots$, then $(z - \zeta_2)^{p_2}, \dots, (z - \zeta_k)^{p_k}, \dots$. After a finite number of steps we have obtained that

$$(120) \frac{P(z)}{Q(z)} = P_1(z) + \left\{ \frac{a_{1p_1}}{(z - \zeta_1)^{p_1}} + \dots + \frac{a_{11}}{z - \zeta_1} \right\} + \dots + \left\{ \frac{a_{kp_k}}{(z - \zeta_k)^{p_k}} + \dots + \frac{a_{k1}}{z - \zeta_k} \right\}.$$

All coefficients $a_{1p_1}, \dots, a_{11}, \dots, a_{kp_k}, \dots, a_{k1}$ are uniquely determined by this procedure, and (120) is called the *complex decomposition* of the rational function $\frac{P(z)}{Q(z)}$.

In practice one starts by first finding all the fractions of this type of highest degree, i.e. the block

$$\begin{aligned} \frac{a_{1p_1}}{(z - \zeta_1)^{p_1}} + \dots + \frac{a_{kp_k}}{(z - \zeta_k)^{p_k}} &= \frac{P(\zeta_1)}{(\zeta_1 - \zeta_2)^{p_2} \dots (\zeta_1 - \zeta_k)^{p_k}} \cdot \frac{1}{(z - \zeta_1)^{p_1}} + \dots \\ &+ \frac{P(\zeta_k)}{(\zeta_k - \zeta_1)^{p_1} \dots (\zeta_k - \zeta_{k-1})^{p_{k-1}}} \cdot \frac{1}{(z - \zeta_k)^{p_k}}, \end{aligned}$$



Maastricht University

Leading in Learning!

**Join the best at
the Maastricht University
School of Business and
Economics!**

Top master's programmes

- 33rd place Financial Times worldwide ranking: MSc International Business
- 1st place: MSc International Business
- 1st place: MSc Financial Economics
- 2nd place: MSc Management of Learning
- 2nd place: MSc Economics
- 2nd place: MSc Econometrics and Operations Research
- 2nd place: MSc Global Supply Chain Management and Change

Sources: Keuzegids Master ranking 2013; Elsevier 'Beste Studies' ranking 2012; Financial Times Global Masters in Management ranking 2012

Maastricht University is the best specialist university in the Netherlands (Elsevier)

**Visit us and find out why we are the best!
Master's Open Day: 22 February 2014**

www.mastersopenday.nl



and then subtract this block from the quotient $\frac{P(z)}{Q(z)}$, followed by a reduction. The result has the structure

$$\frac{\tilde{P}(z)}{(z - \zeta_1)^{p_1-1} (z - \zeta_2)^{p_2-1} \dots (z - \zeta_k)^{p_k-1}},$$

so the degree of the denominator has been decreased by k .

In one important special case, when all the roots of $Q(z)$ are simple, i.e. $p_1 = \dots = p_m = 1$, the decomposition becomes particular simple.

Theorem 4.2.1 *Assume that $Q(z) = (z - \zeta_1) \dots (z - \zeta_m)$ has only simple roots and that the degree of the polynomial $P(z)$ is $< m$. Then the decomposition of $\frac{P(z)}{Q(z)}$ is given by*

$$(121) \quad \frac{P(z)}{Q(z)} = \sum_{j=1}^m \frac{P(\zeta_j)}{Q'_j(\zeta_j)} \cdot \frac{1}{z - \zeta_j} \quad \text{for } z \in \mathbb{C} \setminus \{\zeta_1, \dots, \zeta_m\}.$$

PROOF. We know already that the decomposition has the structure

$$\frac{P(z)}{Q(z)} = \frac{a_1}{z - \zeta_1} + \dots + \frac{a_m}{z - \zeta_m}.$$

Now, $Q(\zeta_j) = 0$, so following (117) the coefficient a_j is given by

$$a_j = \lim_{z \rightarrow \zeta_j} (z - \zeta_j) \cdot \frac{P(z)}{Q(z)} = \lim_{z \rightarrow \zeta_j} P(z) \cdot \frac{1}{\lim_{z \rightarrow \zeta_j} \frac{Q(z) - Q(\zeta_j)}{z - \zeta_j}} = \frac{P(\zeta_j)}{Q'_j(\zeta_j)},$$

and the theorem is proved. \square

Example 4.2.1 We shall analyze two possible methods of decompositions of $\frac{1}{z^4 + 1}$. The denominator $Q(z) = z^4 + 1$ has its four simple roots given by the equation $z^4 = -1 = \exp(i\pi)$, hence

$$\zeta_1 = \exp\left(i \frac{\pi}{4}\right) = \frac{\sqrt{2}}{2} + i \frac{\sqrt{2}}{2}, \quad \zeta_2 = \exp\left(i \frac{3\pi}{4}\right) = -\frac{\sqrt{2}}{2} + i \frac{\sqrt{2}}{2},$$

$$\zeta_3 = \exp\left(i \frac{5\pi}{4}\right) = -\frac{\sqrt{2}}{2} - i \frac{\sqrt{2}}{2}, \quad \zeta_4 = \exp\left(i \frac{7\pi}{4}\right) = \frac{\sqrt{2}}{2} - i \frac{\sqrt{2}}{2},$$

cf. Theorem 1.3.2. We therefore have in principle

$$\frac{1}{z^4 + 1} = \frac{a_1}{z - \zeta_1} + \frac{a_2}{z - \zeta_2} + \frac{a_3}{z - \zeta_3} + \frac{a_4}{z - \zeta_4},$$

or, more explicitly,

$$\begin{aligned} & \frac{1}{\left(z - \frac{\sqrt{2}}{2} - i \frac{\sqrt{2}}{2}\right) \left(z + \frac{\sqrt{2}}{2} - i \frac{\sqrt{2}}{2}\right) \left(z + \frac{\sqrt{2}}{2} + i \frac{\sqrt{2}}{2}\right) \left(z - \frac{\sqrt{2}}{2} + i \frac{\sqrt{2}}{2}\right)} \\ &= \frac{a_1}{z - \frac{\sqrt{2}}{2} - i \frac{\sqrt{2}}{2}} + \frac{a_2}{z + \frac{\sqrt{2}}{2} - i \frac{\sqrt{2}}{2}} + \frac{a_3}{z + \frac{\sqrt{2}}{2} + i \frac{\sqrt{2}}{2}} + \frac{a_4}{z - \frac{\sqrt{2}}{2} + i \frac{\sqrt{2}}{2}}. \end{aligned}$$

We clearly run into a terrible mess of calculations if we just proceed according to the standard procedure. If we instead notice that $\zeta_j^4 = -1$ for $j = 1, \dots, 4$, then it follows from Theorem 4.2.1 that

$$a_j = \frac{P(\zeta_j)}{Q'(\zeta_j)} = \frac{1}{4\zeta_j^3} = \frac{1}{4} \cdot \frac{\zeta_j}{\zeta_j^4} = -\frac{1}{4} \zeta_j,$$

so

$$\frac{1}{z^4 + 1} = -\frac{1}{4} \frac{\zeta_1}{z - \zeta_1} - \frac{1}{4} \frac{\zeta_2}{z - \zeta_2} - \frac{1}{4} \frac{\zeta_3}{z - \zeta_3} - \frac{1}{4} \frac{\zeta_4}{z - \zeta_4}. \quad \diamond$$

Example 4.2.2 We shall in this example and later also in Example 4.2.3 and Example 4.2.4 decompose

$$\frac{8}{(z-1)(z^2+1)^2} = \frac{a_1}{z-1} + \frac{a_{21}}{z-i} + \frac{a_{31}}{z+i} + \frac{a_{22}}{(z-i)^2} + \frac{a_{32}}{(z+i)^2},$$

in three different ways. In all three cases a_1 , corresponding to the simple real root, is found by multiplying by $z-1$ and then taking the limit $z \rightarrow 1$, thus

$$a_1 = 2.$$

Furthermore, it follows by a complex conjugation that $a_{21} = \overline{a_{32}}$ and $a_{22} = \overline{a_{31}}$. It therefore suffices to find a_{21} and a_{22} .

If we multiply by $(z-i)^2$ and then let $z \rightarrow i$, we get

$$a_{22} = \frac{8}{(i-1)(i+i)^2} = \frac{8(-1-i)}{(2i)^2(i-1)(-i-1)} = \frac{8(-1-i)}{-4 \cdot 2} = 1+i,$$

so

$$a_{32} = \overline{a_{22}} = 1-i.$$

Now,

$$\frac{a_{22}}{(z-i)^2} + \frac{a_{32}}{(z+i)^2} = \frac{(1+i)(z+i)^2 + (1-i)(z-i)^2}{(z-i)^2(z+i)^2} = \dots = 2 \cdot \frac{z^2 - 2z - 1}{(z^2 + 1)^2},$$

hence we get for the remaining terms, which otherwise are “shadowed” by these higher order terms,

$$\begin{aligned} \frac{a_{21}}{z-i} + \frac{a_{31}}{z+i} &= \frac{8}{(z-1)(z^2+1)^2} - \frac{2}{z-1} - 2 \cdot \frac{z^2 - 2z - 1}{(z^2 + 1)^2} \\ &= 2 \cdot \frac{4 - (z^2 + 1)^2}{(z^2 + 1)^2(z-1)} - 2 \cdot \frac{z^2 - 2z - 1}{(z^2 + 1)^2} = 2 \cdot \frac{(2 + z^2 + 1)(2 - z^2 - 1)}{(z-1)(z^2 + 1)^2} - 2 \cdot \frac{z^2 - 2z - 1}{(z^2 + 1)^2} \\ &= -2 \frac{(z+1)(z^2+3)}{(z^2+1)^2} - 2 \frac{z^2 - 2z - 1}{(z^2 + 1)^2} = -2 \frac{z^3 + z^2 + 3z + z^2 - 2z - 1}{(z^2 + 1)^2} \\ &= -2 \frac{(z^3 + z) + (2z^2 + 2)}{(z^2 + 1)^2} = -2 \frac{z+2}{z^2 + 1}. \end{aligned}$$

Notice that we in this computation always collect terms that are more or less “like each other”, and then reduce partially. In particular, we start by getting rid of the factor $z - 1$ in the denominator by just pairing two terms without involving the remainder, and then reduce.

Finally, it follows from Theorem 4.2.1 that

$$a_{21} = -2 \cdot \frac{z+2}{2z} \Big|_{z=i} = -1 + 2i, \quad \text{so } a_{31} = \overline{a_{21}} = -1 - 2i,$$

and the complex decomposition becomes

$$\frac{8}{(z-1)(z^2+1)^2} = \frac{2}{z-1} - \frac{1-2i}{z-i} - \frac{1+2i}{z+i} + \frac{1+i}{(z-i)^2} + \frac{1-i}{(z+i)^2}. \quad \diamond$$

Decomposition formula for multiple roots in the denominator.

We saw in Example 4.2.2 that when the roots of the denominator are not all simple, then it could be fairly difficult to decompose the rational function. On the other hand, Theorem 4.2.1 showed that when all roots of the denominator indeed are simple, then (121) provides us with a simple formula for this decomposition. We shall in this subsection demonstrate that we have a similar, though of course also more complicated formula for the decomposition in case of multiple roots.

Theorem 4.2.2 *Assume that $P(z)$ and $Q(z)$ are polynomials, and that α is a root of $Q(z)$, i.e.*

$$(122) \quad Q(z) = (z - \alpha)^n Q_1(z), \quad \text{where } Q_1(\alpha) \neq 0 \text{ and } n \in \mathbb{N}.$$

Then in the decomposition of $f(z) = \frac{P(z)}{Q(z)}$ occurs in particular the “block”

$$(123) \quad \frac{a_1}{z - \alpha} + \frac{a_2}{(z - \alpha)^2} + \cdots + \frac{a_n}{(z - \alpha)^n}$$

corresponding to the root α of multiplicity n .

The coefficients a_1, \dots, a_n of (123) are given by

$$(124) \quad a_j = \frac{1}{(n-j)!} \lim_{z \rightarrow \alpha} \frac{d^{n-j}}{dz^{n-j}} \{(z - \alpha)^n f(z)\} = \frac{1}{(n-j)!} \lim_{z \rightarrow \alpha} \frac{d^{n-j}}{dz^{n-j}} \left\{ \frac{P(z)}{Q_1(z)} \right\},$$

where $Q_1(z)$ is defined by (122).

Remark 4.2.1 If $n = 1$, then α is a simple root, so we have already Theorem 4.2.1. We shall show that the two results are the same. Using (124) we get

$$a_1 = \frac{1}{(1-1)!} \lim_{z \rightarrow \alpha} \frac{d^0}{dz^0} \left\{ (z - \alpha) \cdot \frac{P(z)}{Q(z)} \right\} = \lim_{z \rightarrow \alpha} \frac{P(z)}{\frac{Q(z) - Q(\alpha)}{z - \alpha}} = \frac{P(\alpha)}{Q'(\alpha)} = \frac{P(\alpha)}{Q_1(\alpha)},$$

and we get the same result. \diamond

PROOF. We know that

$$f(z) = \frac{P(z)}{Q(z)} = \frac{1}{(z-\alpha)^n} \frac{P(z)}{Q_1(z)} = \frac{a_1}{z-\alpha} + \frac{a_2}{(z-\alpha)^2} + \cdots + \frac{a_n}{(z-\alpha)^n} + r(z),$$

where the remainder $r(z)$ is an analytic function in a neighbourhood of $z = \alpha$. Multiply by $(z - \alpha)^n$ to get

$$(125) \quad (z - \alpha)^n f(z) = \frac{P(z)}{Q_1(z)} = a_n + a_{n-1}(z - \alpha) + \cdots + a_1(z - \alpha)^{n-1} + (z - \alpha)^n r(z).$$

It follows immediately by letting $z \rightarrow \alpha$ in (125) that

$$a_n = \lim_{z \rightarrow \alpha} (z - \alpha)^n f(z) = \frac{P(\alpha)}{Q_1(\alpha)},$$

which clearly is (124) for $j = n$.



Empowering People. Improving Business.

BI Norwegian Business School is one of Europe's largest business schools welcoming more than 20,000 students. Our programmes provide a stimulating and multi-cultural learning environment with an international outlook ultimately providing students with professional skills to meet the increasing needs of businesses.

BI offers four different two-year, full-time Master of Science (MSc) programmes that are taught entirely in English and have been designed to provide professional skills to meet the increasing need of businesses. The MSc programmes provide a stimulating and multi-cultural learning environment to give you the best platform to launch into your career.

- MSc in Business
- MSc in Financial Economics
- MSc in Strategic Marketing Management
- MSc in Leadership and Organisational Psychology

www.bi.edu/master

BI NORWEGIAN BUSINESS SCHOOL

EFMD EQUIS ACCREDITED



Then differentiate (125) in total $n - j$ times,

$$(126) \quad \begin{aligned} \frac{d^{n-j}}{dz^{n-j}} \{(z - \alpha)^n f(z)\} &= \frac{d^{n-j}}{dz^{n-j}} \{a_n + a_{n-1}(z - \alpha) + \cdots + a_{j+1}(z - \alpha)^{n-j-1}\} \\ &+ \frac{d^{n-j}}{dz^{n-j}} \{a_j(z - \alpha)^{n-j}\} + \frac{d^{n-j}}{dz^{n-j}} \{(z - \alpha)^{n-j+1} q(z)\}, \end{aligned}$$

where

$$q(z) = a_{j-1} + a_{j-2}(z - \alpha) + \cdots + a_1(z - \alpha)^{j-2} + (z - \alpha)^{j-1} r(z).$$

The first term on the right hand side of (126) is clearly 0, because the polynomial between the brackets is of degree $< n - j$. The value of the second term is $(n - j)! a_j$, so it is a constant not depending on z , while the third term after the differentiations contains a factor $z - \alpha$, which tends towards 0 for $z \rightarrow \alpha$.

Hence

$$\frac{d^{n-j}}{dz^{n-j}} \{(z - \alpha)^n f(z)\} = \frac{d^{n-j}}{dz^{n-j}} \left\{ \frac{P(z)}{Q_1(z)} \right\} = (n - j)! a_j + (z - \alpha) q_1(z),$$

and (124) follows by a rearrangement and then letting $z \rightarrow \alpha$. \square

Example 4.2.3 We consider again

$$f(z) = \frac{8}{(z - 1)(z^2 + 1)^2} = \frac{a_1}{z - 1} + \frac{a_{21}}{z - i} + \frac{a_{22}}{(z - i)^2} + \frac{a_{31}}{z + i} + \frac{a_{32}}{(z + i)^2},$$

where we in Example 4.2.2 showed that $a_1 = 2$ and $a_{21} = \overline{a_{31}}$ and $a_{22} = \overline{a_{32}}$. For a_{22} we get by (124),

$$a_{22} = \frac{1}{(2 - 2)!} \lim_{z \rightarrow i} \frac{d^0}{dz^0} \left\{ \frac{8}{(z - 1)(z + i)^2} \right\} = \frac{8}{(i - 1)(i + 1)^2} = 1 + i,$$

so we get the same result as in Example 4.2.2.

Then we turn to a_{21} . We apply (124) with $n = 2$ and $j = 1$ and $\alpha = i$ to get

$$\begin{aligned} a_{21} &= \frac{1}{(2 - 1)!} \lim_{z \rightarrow i} \frac{d^{2-1}}{dz^{2-1}} \{(z - i)^2 f(z)\} = \lim_{z \rightarrow i} \frac{d}{dz} \left\{ \frac{8}{(z - 1)(z + i)^2} \right\} \\ &= \lim_{z \rightarrow i} \left\{ -\frac{8}{(z - 1)^2(z + i)^2} - \frac{2 \cdot 8}{(z - 1)(z + i)^3} \right\} = -\frac{8}{(i - 1)^2(i + i)^2} - \frac{16}{(i - 1)(i + i)^3} \\ &= \frac{8}{-2i(2i)^2} + \frac{16}{(1 - i)(2i)^3} = \frac{8 \cdot 4i}{(2i)^4} - \frac{16(1 - i)}{(2i)^4} = i - (1 - i) = -1 + 2i, \end{aligned}$$

which is in agreement with the result of Example 4.2.2. \diamond

Example 4.2.4 For comparison we also show what happens if we first perform a real decomposition, before we make the final complex decomposition. We consider the same rational function as in Example 4.2.2 and Example 4.2.3, but this time we start with the real decomposition

$$f(z) = \frac{8}{(z - 1)(z^2 + 1)^2} = \frac{a_1}{z - 1} + \frac{c_1 z + d_1}{z^2 + 1} + \frac{c_2 z + d_2}{(z^2 + 1)^2}.$$

The method of finding $a_1 = 2$ is the same as before, because the root $z = 1$ is simple and real.

Then proceed in the following way,

$$\begin{aligned}
 \frac{8}{(z-1)(z^2+1)^2} &= \frac{2}{z-1} + \left\{ \frac{8}{(z-1)(z^2+1)^2} - \frac{2}{z-1} \right\} = \frac{2}{z-1} - 2 \cdot \frac{(z^2+1)^2 - 4}{(z-1)(z^2+1)^2} \\
 &= \frac{2}{z-1} - 2 \cdot \frac{(z^2+1)^2 - 2^2}{(z-1)(z^2+1)^2} = \frac{2}{z-1} - 2 \cdot \frac{(z^2-1)(z^2+1+2)}{(z-1)(z^2+1)^2} \\
 (127) \quad &= \frac{2}{z-1} - 2 \cdot \frac{(z+1)\{(z^2+1)+2\}}{(z^2+1)^2} = \frac{2}{z-1} - 2 \frac{z+1}{z^2+1} - 4 \frac{z+1}{(z^2+1)^2}.
 \end{aligned}$$

Next, decompose $\frac{1}{z^2+1}$ in \mathbb{C} , i.e.

$$(128) \quad \frac{1}{z^2+1} = \frac{1}{(z-i)(z+i)} = \frac{1}{2i} \frac{1}{z-i} + \frac{1}{-2i} \frac{1}{z+i} = \frac{i}{2} \left\{ \frac{1}{z+i} - \frac{1}{z-i} \right\},$$

where we e.g. may apply Theorem 4.2.1, or alternatively just (124) for $n = 1$.

The *trick* here is to *square* (128),

$$\begin{aligned}
 \frac{1}{(z^2+1)^2} &= -\frac{1}{4} \left\{ \frac{1}{(z+i)^2} + \frac{1}{(z-i)^2} - \frac{2}{(z+i)(z-i)} \right\} \\
 &= -\frac{1}{4} \frac{1}{(z+i)^2} - \frac{1}{4} \frac{1}{(z-i)^2} + \frac{1}{2} \frac{1}{z^2+1},
 \end{aligned}$$

where we do not yet decompose the last term!

Then we continue the computation of (127) in the following way, where we first use (128) to eliminate the last term,

$$\begin{aligned}
 \frac{8}{(z-1)(z^2+1)^2} &= \frac{2}{z-1} - 2 \frac{z+1}{z^2+1} + 4 \frac{z+1}{(z^2+1)^2} \\
 &= \frac{2}{z-1} - 2 \frac{z+1}{z^2+1} + \frac{z+1}{(z+i)^2} + \frac{z+1}{(z-i)^2} - 2 \cdot \frac{z+1}{z^2+1} \\
 &= \frac{2}{z-1} - 4 \frac{z+1}{z^2+1} + \frac{(z+i)+(1-i)}{(z+i)^2} + \frac{(z-i)+(1+i)}{(z-i)^2} \\
 &= \frac{2}{z-1} - 2i \frac{z+1}{z+i} + 2i \frac{z+1}{z-i} + \frac{1}{z-i} + \frac{1-i}{(z+i)^2} + \frac{1}{z-i} + \frac{1+i}{(z-i)^2} \\
 &= \frac{2}{z-1} - 2i \frac{z+i+1-i}{z+i} + 2i \frac{z-i+1+i}{z-i} + \frac{1}{z+i} + \frac{1}{z-i} + \frac{1+i}{(z-i)^2} + \frac{1-i}{(z+i)^2} \\
 &= \frac{2}{z-1} - 2i + \frac{-2i-2+1}{z+i} + 2i + \frac{2i-2+1}{z-i} + \frac{1+i}{(z-i)^2} + \frac{1-i}{(z+i)^2} \\
 &= \frac{2}{z-1} - \frac{1-2i}{z-i} - \frac{1+2i}{z+i} + \frac{1+i}{(z-i)^2} + \frac{1-i}{(z+i)^2},
 \end{aligned}$$

so even if this (real) method is more difficult than the complex ones, we can succeed also with this procedure. \diamond

Remark 4.2.2 Some readers may wonder, why we have spent a whole section on decomposition, “instead of letting the computer do it!” The reason is that according to the author’s experience there are still problems with these decompositions programmes on the computer. Sometimes one may even get some very strange results. Therefore, this section has been included as an alternative, if anything else goes wrong. \diamond

4.3 The exponential

We have already introduced the *exponential* $\exp : \mathbb{C} \rightarrow \mathbb{C}$ in Definition 1.2.1 on page 13 by

$$(129) \quad \exp z = \exp(x + iy) := e^x \cos y + i e^x \sin y, \quad z \in \mathbb{C}.$$

We proved that it fulfils the functional equation (10), i.e.

$$(130) \quad \exp(z + w) = \exp z \cdot \exp w, \quad \text{for } z, w \in \mathbb{C}.$$

We shall for convenience usually use the slightly incorrect notation e^z instead of $\exp z$. That this is incorrect will first be explained in *Ventus: Complex Functions Theory a-3*, and for the time being there will be no risk of misunderstanding the symbol.

We proved in Theorem 3.1.4 that the exponential e^z is analytic in \mathbb{C} and that its derivative is given by

$$(131) \quad \frac{d}{dz} e^z = e^z.$$

Now, $e^x > 0$ for every $x \in \mathbb{R}$, and $|e^{iy}| = \sqrt{\cos^2 y + \sin^2 y} = 1$, so $|e^z| = |e^x e^{iy}| = e^x > 0$ for every $z = x + iy \in \mathbb{C}$, and we have proved that $0 \notin \exp \mathbb{C}$.

Conversely, we shall now prove that the range $\exp \mathbb{C} = \mathbb{C} \setminus \{0\}$, so 0 is the only point in \mathbb{C} which does not lie in the range of \exp .

Let us first check the special equation $e^z = 1$. Since $|e^z| = e^x = 1$, we get $x = 0$, thus $z = iy$, and it is well-known that

$$e^{iy} = \cos y + i \sin y = 1, \quad \text{if and only if } y = 2p\pi, \quad p \in \mathbb{Z}.$$

We conclude that the solution set of the equation $e^z = 1$ is $\{2ip\pi \mid p \in \mathbb{Z}\}$.

Then choose any $a = r e^{i\Theta} \in \mathbb{C} \setminus \{0\}$, given by its polar coordinates $r > 0$ and $\Theta \in \mathbb{R}$. We shall find the complete solution of the equation $e^z = a$. When this equation is divided by $r e^{i\Theta} = a \neq 0$, it follows that it has precisely the same set of solutions as the equation

$$\exp\{z - \ln r - i\Theta\} = 1,$$

which was solved above, hence

$$(132) \quad z - \ln r - i\Theta = 2ip\pi, \quad \text{or} \quad z = \ln r + i\{\Theta + 2p\pi\}, \quad p \in \mathbb{Z}.$$

This shows that $\mathbb{C} \setminus \{0\} \subseteq \exp \mathbb{C} \subseteq \mathbb{C} \setminus \{0\}$, i.e. $\exp \mathbb{C} = \mathbb{C} \setminus \{0\}$ as claimed above.

When $a = r e^{i\Theta} \neq 0$, it was proved in Section 1.2 and Example 3.2.1 that $\Theta \in \mathbb{R}$ above can be chosen uniquely as a *principal argument* in the interval $] - \pi, \pi]$, and for this $\Theta \in] - \pi, \pi]$ we have

$$\ln r + i\Theta = \operatorname{Log} a, \quad \text{for } a \in \mathbb{C} \setminus \{0\},$$

where the *principal logarithm* Log was introduced in Example 3.2.1. Then it follows from (132) that

Theorem 4.3.1 *If $a \in \mathbb{C} \setminus \{0\}$, then all solutions of the equation $e^z = a$ are given by*

$$(133) \quad z = \operatorname{Log} a + 2ip\pi, \quad p \in \mathbb{Z}.$$

Remark 4.3.1 the (principal) logarithm is not an elementary analytic function, so apart from Theorem 4.3.1 above we shall not go further into the properties of the logarithm. We postpone this discussion to *Ventus: Complex Functions Theory a-3*. \diamond

Need help with your dissertation?

Get in-depth feedback & advice from experts in your topic area. Find out what you can do to improve the quality of your dissertation!

Get Help Now



Go to www.helpmyassignment.co.uk for more info



4.4 The trigonometric and hyperbolic functions

In *Complex Functions Theory* the trigonometric and hyperbolic functions “are more or less the same”, in the sense that e.g.

$$\sin(iz) = i \sinh z \quad \text{and} \quad \cos(iz) = \cosh z,$$

so it would formally be sufficient just to stick to one set of functions, e.g. the trigonometric functions. It is, however, convenient to use all the usual notations from the real also in the complex, even if we have two different symbols describing the same.

First note that e^z for $z \in \mathbb{C}$ was *defined* in Definition 1.2.1 (and reviewed in Section 4.3) by means of the *real* exponential e^x and the *real* trigonometric functions $\cos y$ and $\sin y$.

We shall below *define* the *complex* trigonometric and hyperbolic functions by means of the *complex* exponential e^z . This means that we finally shall check if we have not made a notational mess, i.e. we shall show that for $z = x$ real the definitions give the same functions.

Definition of the complex trigonometric and hyperbolic functions.

We *define* for $z \in \mathbb{C}$ the *complex* trigonometric and hyperbolic functions by

$$(134) \quad \begin{cases} \sin z := \frac{e^{iz} - e^{-iz}}{2i}, & \cos z := \frac{e^{iz} + e^{-iz}}{2}, \\ \sinh z := \frac{e^z - e^{-z}}{2}, & \cosh z := \frac{e^z + e^{-z}}{2}. \end{cases}$$

It follows from e.g. Theorem 3.1.1 that they are all analytic in \mathbb{C} , and it follows immediately that

$$(135) \quad \begin{cases} \frac{d}{dz} \sin z = \cos z, & \frac{d}{dz} \cos z = -\sin z, \\ \frac{d}{dz} \sinh z = \cosh z, & \frac{d}{dz} \cosh z = \sinh z. \end{cases}$$

Clearly, the definitions of $\sinh x$ and $\cosh x$ are the same for the two definitions, when $z = x \in \mathbb{R}$ is real. Concerning the trigonometric functions we use that $e^{ix} = \cos x + i \sin x$ for $z = x \in \mathbb{R}$,

$$\text{“sin } z\text{”} = \frac{1}{2i} \left\{ e^{ix} - e^{i(-x)} \right\} = \frac{1}{2i} \left\{ (\cos x + i \sin x) - (\cos x - i \sin x) \right\} = \sin x,$$

and

$$\text{“cos } z\text{”} = \frac{1}{2} \left\{ e^{ix} + e^{i(-x)} \right\} = \frac{1}{2} \left\{ (\cos x + i \sin x) + (\cos x - i \sin x) \right\} = \cos x,$$

so the two “different” definitions agree for $z = x \in \mathbb{R}$.

Example 4.4.1 The following is only a small exercise in the definitions above in order to become accustomed to these new functions. We shall compute the complex value of $\cos(-i)$ and $\sin(1+i)$. Using (134) we get

$$\cos(-i) = \frac{1}{2} \left\{ e^{i(-i)} + e^{-i(-i)} \right\} = \frac{1}{2} \left\{ e^1 + e^{-1} \right\} = \cosh 1,$$

and

$$\begin{aligned}
 \sin(1+i) &= \frac{1}{2i} \{e^{i(1+i)} - e^{-i(1+i)}\} = \frac{1}{2i} \{e^{-1+i} - e^{1-i}\} \\
 &= \frac{1}{2i} \cdot \frac{1}{e} \{\cos 1 + i \sin 1\} - \frac{1}{2i} \cdot e \cdot \{\cos 1 - i \sin 1\} \\
 &= \frac{1}{2} \{e^{-1} + e\} \sin 1 + i \cdot \frac{1}{2} \{e - e^{-1}\} \cos 1 \\
 &= \sin 1 \cdot \cosh 1 + i \cos 1 \cdot \sinh 1.
 \end{aligned}$$

Warning. The real angle of the trigonometric functions is *always* measured in *radians* in *Complex Functions Theory*, so $1 \approx 57^\circ$, and $\cos 1$ and $\sin 1$ are not “nice numbers” like $\sin \frac{\pi}{2} = 1$, etc.. \diamond

It follows from (134) that

$$\begin{aligned}
 \sin(iz) &= \frac{e^{-z} - e^z}{2i} = i \cdot \frac{e^z - e^{-z}}{2} = i \sinh z, & \cos(iz) &= \frac{e^{-z} + e^z}{2} = \cosh z, \\
 \sinh(iz) &= \frac{e^{iz} - e^{-iz}}{2} = i \cdot \frac{e^{iz} - e^{-iz}}{2i} = i \sin z, & \cosh(iz) &= \frac{e^{iz} + e^{-iz}}{2} = \cos,
 \end{aligned}$$

so we have proved the *transition formulæ*

$$(136) \quad \begin{cases} \sinh(iz) = i \sin z, & \sin(iz) = i \sinh z, \\ \cosh(iz) = \cos z, & \cos(iz) = \cosh z. \end{cases}$$

It also follows from (134) that like in the real case,

$$(137) \quad e^{iz} = \cos z + i \sin z, \quad e^z = \cosh z + \sinh z.$$

In particular, $e^{iy} = \cos y + i \sin y$ is not just valid for $y \in \mathbb{R}$, but for all complex $y = z \in \mathbb{C}$.

Using the elementary analytic functions above we define the following “new” analytic functions, whenever the denominator is $\neq 0$,

$$(138) \quad \begin{cases} \tan z := \frac{\sin z}{\cos z}, & \cot z := \frac{\cos z}{\sin z}, \\ \tanh z := \frac{\sinh z}{\cosh z}, & \coth z := \frac{\cosh z}{\sinh z}. \end{cases}$$

Whenever z is real, these definitions agree with the usual ones. However, when $z \in \mathbb{C} \setminus \mathbb{R}$ we of course lose our usual geometric interpretation of the trigonometric functions. Instead we may consider these new eight analytic functions as natural (analytic) extensions of the well-known real functions, on which we in the future can use the properties of analytic functions.

From (136) we immediately get the following formulæ,

$$(139) \quad \begin{cases} \tan(iz) = i \tanh z, & \cot(iz) = -i \coth z, \\ \tanh(iz) = i \tan z, & \coth(iz) = -i \cot z. \end{cases}$$

Using (137) we get

$$\cosh^2 z - \sinh^2 z = (\cosh z + \sinh z)(\cosh z - \sinh z) = e^z \cdot e^{-z} = e^0 = 1,$$

and

$$\cos^2 z + \sin^2 z = (\cos z + i \sin z)(\cos z - i \sin z) = e^{iz} \cdot e^{-iz} = e^0 = 1,$$

hence, for all $z \in \mathbb{C}$,

$$(140) \quad \cos^2 z + \sin^2 z = 1 \quad \text{and} \quad \cosh^2 z - \sinh^2 z = 1.$$

Then we get as in the real analysis,

$$(141) \quad \begin{cases} 1 + \tan^2 z = \frac{1}{\cos^2 z}, & 1 - \tanh^2 z = \frac{1}{\cosh^2 z}, \\ 1 + \cot^2 z = \frac{1}{\sin^2 z}, & \coth^2 z - 1 = \frac{1}{\sinh^2 z}, \end{cases}$$

and we conclude that

$$(142) \quad \begin{cases} \frac{d}{dz} \tan z = \frac{1}{\cos^2 z}, & \frac{d}{dz} \cot z = -\frac{1}{\sin^2 z}, \\ \frac{d}{dz} \tanh z = \frac{1}{\cosh^2 z}, & \frac{d}{dz} \coth z = -\frac{1}{\sinh^2 z}. \end{cases}$$

Addition formulæ

We first note that if we replace z by $\frac{\pi}{2} - z$ in (134), then we get e.g.

$$\sin\left(\frac{\pi}{2} - z\right) = \frac{1}{2i} \{e^{i\frac{\pi}{2}-iz} - e^{-i\frac{\pi}{2}+iz}\} = \frac{1}{2i} \{i e^{-iz} - (-i)e^{iz}\} = \frac{1}{2} \{e^{iz} + e^{-iz}\} = \cos z,$$

so we have proved that in general,

$$(143) \quad \sin\left(\frac{\pi}{2} - z\right) = \cos z,$$

as in the real case. This is a special case of the *addition formulæ*, which are proved in the same way,

$$(144) \quad \begin{cases} \sin(z+w) = \sin z \cdot \cos w + \cos z \cdot \sin w, \\ \cos(z+w) = \cos z \cdot \cos w - \sin z \cdot \sin w, \\ \sinh(z+w) = \sinh z \cdot \cosh w + \cosh z \cdot \sinh w, \\ \cosh(z+w) = \cosh z \cdot \cosh w + \sinh z \cdot \sinh w, \end{cases}$$

for all z and $w \in \mathbb{C}$. If we in particular put $z = x \in \mathbb{R}$ and $w = iy$, $y \in \mathbb{R}$, into (144) and use (136), then we implicitly split into the real and imaginary parts,

$$(145) \quad \begin{cases} \sin z = \sin x \cdot \cosh y + i \cos x \cdot \sinh y, \\ \cos z = \cos x \cdot \cosh y - i \sin x \cdot \sinh y, \\ \sinh z = \sinh x \cdot \cos y + i \cosh x \cdot \sin y, \\ \cosh z = \cosh x \cdot \cos y + i \sinh x \cdot \sin y, \end{cases}$$

where as usual $z = i + iy$. These formulæ are used to prove the following theorem, which we shall need in the following books of *Ventus: Complex Functions Theory*.

Theorem 4.4.1 *Let $z = x + iy \in \mathbb{C}$. Then*

$$(146) \quad \left\{ \begin{array}{l} |\sin z|^2 = \sin^2 x + \sinh^2 y = \cosh^2 y - \cos^2 x, \\ |\cos z|^2 = \cos^2 x + \sinh^2 y = \cosh^2 y - \sin^2 x, \\ |\sinh z|^2 = \sinh^2 x + \sin^2 y = \cosh^2 x - \cos^2 y, \\ |\cosh z|^2 = \sinh^2 x + \cos^2 y = \cosh^2 x - \sin^2 y. \end{array} \right.$$

PROOF. The proofs of these formulæ all follow the same pattern, so we shall only prove the first one, leaving the other proofs to the reader. It follows from (145) that

$$\begin{aligned} |\sin z|^2 &= \sin^2 x \cdot \cosh^2 y + \cos^2 x \cdot \sinh^2 y = \sin^2 x \cdot (1 + \sinh^2 y) + \cos^2 x \cdot \sinh^2 y \\ &= \sin^2 x + \sinh^2 y = (1 - \cos^2 x) + (\cosh^2 y - 1) = \cosh^2 y - \cos^2 x, \end{aligned}$$

and the claim is proved. \square



Brain power

By 2020, wind could provide one-tenth of our planet's electricity needs. Already today, SKF's innovative know-how is crucial to running a large proportion of the world's wind turbines.

Up to 25 % of the generating costs relate to maintenance. These can be reduced dramatically thanks to our systems for on-line condition monitoring and automatic lubrication. We help make it more economical to create cleaner, cheaper energy out of thin air.

By sharing our experience, expertise, and creativity, industries can boost performance beyond expectations. Therefore we need the best employees who can meet this challenge!

The Power of Knowledge Engineering

Plug into The Power of Knowledge Engineering.
Visit us at www.skf.com/knowledge

SKF



It follows trivially from Theorem 4.4.1 that we have the following estimates on the unit disc.

Corollary 4.4.1 *If $|z| \leq 1$, then*

$$(147) \quad \begin{cases} |\sin z| \leq \cosh 1, & |\cos z| \leq \cosh 1, \\ |\sinh z| \leq \cosh 1, & |\cosh z| \leq \cosh 1. \end{cases}$$

Zeros of the trigonometric and hyperbolic functions.

It was proved in Section 4.3 that e^z did not have any zero. The complex trigonometric functions must of course have at least all their usual real zeros. We shall now prove that these are indeed all zeros in \mathbb{C} .

Theorem 4.4.2 *The zeros of the analytic functions $\sin z$, $\cos z$, $\sinh z$ and $\cosh z$ are given by*

$$\begin{aligned} \sin z = 0 & \quad \text{for } z = p\pi, & p \in \mathbb{Z}, \\ \cos z = 0 & \quad \text{for } z = \frac{\pi}{2} + p\pi, & p \in \mathbb{Z}, \\ \sinh z = 0 & \quad \text{for } z = ip\pi, & p \in \mathbb{Z}, \\ \cosh z = 0 & \quad \text{for } z = i \left\{ \frac{\pi}{2} + p\pi \right\}, & p \in \mathbb{Z}. \end{aligned}$$

PROOF. Assume that

$$\sin z = \frac{1}{2i} \{e^{iz} - e^{-iz}\} = \frac{e^{-iz}}{2i} \{e^{2iz} - 1\} = 0.$$

We have proved that $\frac{1}{2i} e^{-iz} \neq 0$ for all $z \in \mathbb{C}$, so this equation is fulfilled, if and only if $e^{2iz} = 1 = e^{2ip\pi}$, $p \in \mathbb{Z}$, hence if and only if $z = p\pi$, $p \in \mathbb{Z}$, and we have proved the first statement.

From $\cos z = \sin\left(\frac{\pi}{2} - z\right)$ and the proof above follow that $\cos z = 0$, if and only if $\frac{\pi}{2} - z = -p\pi$, $p \in \mathbb{Z}$, or by a rearrangement, for $z = \frac{\pi}{2} + p\pi$, $p \in \mathbb{Z}$.

From (136) follows that $\sinh z = -i \sin(iz) = 0$, if and only if $iz = -p\pi$, $p \in \mathbb{Z}$, i.e. for $z = ip\pi$, $p \in \mathbb{Z}$.

Finally, it follows from (136) that $\cosh z = \cos(iz) = 0$, if and only if $iz = -\frac{\pi}{2} - p\pi$, $p \in \mathbb{Z}$, i.e. for $z = i \left\{ \frac{\pi}{2} + p\pi \right\}$, $p \in \mathbb{Z}$. \square

Table of some elementary analytic functions and their real and imaginary parts.

	$f(z)$	$\Re f(z)$	$\Im f(z)$
1	$if(z)$	$-\Im f(z)$	$\Re f(z)$
2	z	x	y
3	z^2	$x^2 - y^2$	$2xy$
4	z^3	$x^3 - 3xy^2$	$3x^2y - y^3$
5	$\frac{1}{z}$	$\frac{x}{x^2 + y^2}$	$-\frac{y}{x^2 + y^2}$
6	e^z	$e^x \cos y$	$e^x \sin y$
7	$\sin z$	$\sin x \cdot \cosh y$	$\cos x \cdot \sinh y$
8	$\cos z$	$\cos x \cdot \cosh y$	$-\sin x \cdot \sinh y$
9	$\sinh z$	$\sinh x \cdot \cos y$	$\cosh x \cdot \sin y$
10	$\cosh z$	$\cosh x \cdot \cos y$	$\sinh x \cdot \sin y$
11	$\tan z$	$\frac{\sin 2x}{\cos 2x + \cosh 2y}$	$\frac{\sinh 2y}{\cos 2x + \cosh 2y}$

TURN TO THE EXPERTS FOR SUBSCRIPTION CONSULTANCY

Subscribe is one of the leading companies in Europe when it comes to innovation and business development within subscription businesses.

We innovate new subscription business models or improve existing ones. We do business reviews of existing subscription businesses and we develop acquisition and retention strategies.

Learn more at [linkedin.com/company/subscribe](https://www.linkedin.com/company/subscribe) or contact Managing Director Morten Suhr Hansen at mha@subscribe.dk

SUBSCRIBE - to the future



Index

- absolute value, 10, 13, 14
 accumulation point, 46
 addition formulæ, 139
 Aerodynamics, 7
 amplitude, 37
 analytic function, 84, 86
 analytic functions, 84
 angular speed, 37
 argument, 10, 14, 16
 Ars magna, 27
- biharmonic equation, 7
 binomial equation, 20, 22
 binomial formula, 19
 boundary, 51
 boundary point, 51
- capacitance, 39
 Cardano, 27
 Cardano's formula, 27
 cardioid, 68
 Cauchy Integral formula, 8
 Cauchy Integral Theorem, 8
 Cauchy sequence, 56, 57, 61
 Cauchy's inequalities, 119, 123
 Cauchy's integral formula, 109, 110
 Cauchy's integral theorem, 98
 Cauchy's integral theorem for multiply connected domains, 104
 Cauchy-Riemann equations, 8
 Cauchy-Riemann's equations, 83, 88
 Cauchy-Riemann's equations in polar coordinates, 94
 causality, 7
 chain rule, 87, 95
 Chevalier, 28
 Circuit Theory, 7, 38
 circulation, 79
 closed differential form, 83
 closed discs, 41
 closed domain, 51
 closed set, 42, 45
 closure, 51
 cluster point, 46
 compact set, 44
- compact sets, 44
 complex addition, 11
 complex conjugation, 10, 11
 complex curves, 74
 complex decomposition, 128
 complex differentiable functions, 84
 complex exponential, 16, 71, 90, 93
 complex function, 67
 complex infinity, 72
 complex limits, 69
 complex line integral, 74
 complex line integrals, 75
 complex line integrals, practical computation of, 77
 complex multiplication, 9
 complex plane, 10
 complex potential, 122
 complex sequence, 71
 complex square root, 26
 composition, 44
 composition of curves, 76
 conformal maps, 8
 connected component, 54
 connected set, 50
 continuity at a point, 40
 continuous function, 40, 43
 contraction, 56, 61
 convergence of sequence, 71
 Cramer's formula, 95
 Cybernetics, 7, 8
- decomposition, 126, 131
 degree of polynomial, 123
 direction, 72
 Dirichlet problem, 8
 divergence free field, 120
 domain, 51
- electric circuit, 37
 electric current, 14
 elementary admittances, 39
 elementary impedances, 39
 equation of fourth degree, 31
 equation of third degree, 28
 equipotential curve, 121
 exponential, 7, 16, 71, 135

- Ferrari, 27
 field of forces, 79
 finite open covering, 44
 fix point, 56
 Fix Point Theorem, 56
 fix point theorem, 56, 72
 flow, 79
 fluid, 119
 Fourier series, 37
 Fourier transform, 7
 Functional Analysis, 7
 functional matrix, 58
 Fundamental Theorem of Algebra, 32, 123, 124
 fundamental theorem of algebra, 21
- Galois, 27
 Gau 's theorem, 120
 general linear fractional transformations, 126
 Geometry, 8
 Group Theory, 28
- harmonic function, 7
 harmonic functions, 8
 holomorphic function, 86
 Hydrodynamics, 7, 119
 hyperbolic functions, 7, 137
- imaginary axis, 10
 imaginary part, 10
 implicit differentiation, 62
 improper integrals, 8
 indenite integral, 105
 inductance, 39
 innity, 72
 interior, 51
 inverse Laplace transform, 72
 inverse map, 43
 isolated point, 51, 52
 iteration method, 57
- Jacobian, 58, 62, 63, 91
- Laplace transform, 7, 8
 Laurent series, 7, 8
 limit of sequence, 71
 linearity, 76
 Liouville's Theorem, 123
- logarithm, 7
 low temperature Physics, 7
- main theorem for continuous functions, 51
 main theorem for continuous functions, 48, 55
 mean value theorem, 112
 Mellin transform, 8
 method of successive approximations, 57
 Möbius transformation, 126
 module, 10, 22
 Moivre's formula, 18, 20
 Morera's theorem, 115
 multi-valued function, 11
 multi-valued functions, 8
 multiplicity, 21
 multiply connected domain, 53
- n-connected set, 54
 natural logarithm, 97
 negative orientation, 80
 Nicolo Tartaglia, 27
 non-isolated point, 69
 non-oriented innity, 72
 norm, 56
- Ohm's law, 39
 open covering, 44
 open disc, 40
 open domain, 51
 open set, 42
 open sets, 42
 orientation, 72, 74
 oriented innity, 72
- periodic function, 93
 phase angle, 37
 phase function, 37
 plane electrostatic eld, 7
 pocket calculator, 19
 polar coordinates, 14, 68, 94
 polynomial, 7, 87, 123
 positive orientation, 79, 80
 potential flow, 121
 potential line, 122
 power function, 17
 power series, 7
 principal argument, 11, 16, 20, 22, 97, 136

- principal logarithm, 97, 109, 136
principal value, 11
- radian, 138
rational function, 87, 126
real axis, 10
real part, 10
real square root, 26
relative topology, 48
remainder, 127
residue calculus, 7, 8, 52
residue theorem, 7
resistance, 39
reversed orientation, 76
Riemann surfaces, 8
rotation free field, 121
sampling theorem, 7
Scipio del Ferro, 27
sense of direction, 74
Shannon's theorem, 7
simple closed curve, 80
simple curve, 74
simply connected set, 98
simply connected domain, 53, 83
sine shaped current, 38
sine shaped voltage, 37
single-valued function, 11
stability, 8
streamline, 122
successive approximations, 57
sum of sets, 15
symbolic current, 38
symbolic elementary relations, 39
symbolic voltage, 38
- table of elementary analytic functions and their
real and imaginary parts, 142
Tartaglia, Nicolo, 27
Taylor's formula, 60, 63
termwise differentiation of series, 118
theorem of implicit differentiation, 62
theorem of implicit given functions, 56, 59, 65
theorem of inverse map, 66
theorem of inverse mapping, 56
time, 79
time vector, 38
topology, 42
topology of open sets, 42
transfer function, 7
transition formulæ, 138
triangle inequality, 13, 55, 56
trigonometric addition formulæ, 15
trigonometric functions, 7, 137
trigonometric integrals, 8
two-dimensional elastic problems, 7
- uniform continuity, 55
uniform convergence, 116, 118
- vector field, 79
velocity field, 79, 119
velocity potential, 122
Viète, 30
- Weierstra , 116
- z-transform, 7, 8
zero polynomial, 123
zeros of trigonometric and hyperbolic functions, 141